



PIERBURG









PRODUCT CATALOG EMISSION CONTROL

TAKING RESPONSIBILITY IN A CHANGING WORLD



RHEINMETALL

	DE	EN	FR	ES	IT	RU	AR
	Schadstoff-reduzierung	Emission control	Réduction des émissions nocives	Reducción de contaminantes	Riduzione delle sostanze nocive	Уменьшение содержания вредных веществ	تقليل المواد الضارة
AT	Automatikgetriebe	Automatic transmission unit	Boîte de vitesses automatique	Transmisión automática	Cambio automatico	Автоматическая коробка передач	ناقل الحركة الأوتوماتيكي
EL	Elektrisch	Electric	Électrique	Eléctrico	Elettrico	Электрический	كهربائي
EP	Elektrisch-pneumatisch	Electric-pneumatic	Electropneumatique	Electroneumático	Elettropneumatico	Электропневматический	كهرونيوماتيكي
ET	Elektronisch	Electronic	Electronique	Electrónico	Elettronico	Электронный	إلكتروني
PN	Pneumatisch	Pneumatic	Pneumatique	Neumático	Pneumatico	Пневматический	نيوماتيكي
SPI	Zentraleinspritzung	Central injection	Injection centrale	Inyección centralizada	Iniezione centrale	Центральный впрыск	الحقن المركزي
	Mit Dichtung	With gasket	Avec joint	Con junta	Con guarnizione	С уплотнением	مع جوان
	Ohne Dichtung	Without gasket	Sans joint	Sin junta	Senza guarnizione	Без уплотнения	بدون جوان
	Ab / bis Motornummer	From / to engine number	A partir du / jusqu'au numéro de moteur	Desde / hasta número del motor	A partire dal / fino al numero del motore	Начиная с / до номера двигателя	بداية من/حتى رقم المحرك
	Ab / bis Fahrgestellnummer	From / to chassis number	A partir du / jusqu'au numéro de châssis	Desde / hasta número del chasis	A partire dal / fino al numero di telaio	Начиная с / до номера шасси	بداية من/حتى رقم الشاسيه
	Länderausführung	Country version	Version pays	Ejecución para diferentes países	Versione nazionale	Экспортное исполнение	تصميم لبلدان معينة
AGR	AGR-Ventil	EGR valve	Vanne EGR	Válvula EGR	Valvola EGR	Клапан системы EGR	صمام إعادة تدوير العادم (EGR)
AGR-K	AGR-Kühler	EGR cooler	Refroidisseur EGR	Radiador EGR	Radiatore EGR	Радиатор системы EGR	مبرد إعادة تدوير العادم (EGR)
AGR-M	AGR-Modul	EGR module	Module EGR	Módulo EGR	Modulo EGR	Модуль системы EGR	وحدة إعادة تدوير العادم (EGR)
AGR-TH	AGR-Thermostat	EGR thermostat	Thermostat EGR	Termostato EGR	Termostato EGR	Термостат системы EGR	ثرموستات إعادة تدوير العادم (EGR)
AK	Abgasklappe	Exhaust gas flap	Volet de gaz d'échappement	Mariposa del escape	Farfalla gas di scarico	заслонка в системе выпуска отработавших газов	صمام العادم
ARV	Abschaltbares Rückschlagventil	Cut-off secondary air valve	Clapet anti-retour de coupure d'air secondaire	Válvula de retención desconectable	Valvola di non ritorno disinseribile	Отключаемый обратный клапан	صمام أحادي الاتجاه قابل للإيقاف
SLP	Sekundärluftpumpe	Secondary air pump	Pompe à air secondaire	Bomba de aire secundario	Pompa aria secondaria	Насос вторичного воздуха	مضخة الهواء الثانوي
SLP-M	Sekundärluft-pumpenmodul	Secondary air pump module	Module de pompe à air secondaire	Módulo de bomba de aire secundario	Modulo pompa aria secondaria	Модуль насоса вторичного воздуха	وحدة مضخة الهواء الثانوي
SLV	Sekundärluftventil	Secondary air valve	Valve d'air secondaire	Válvula de aire secundario	Valvola aria secondaria	клапан вторичного воздуха	سوپاپ هوای ثانویه
SRM-AK	Steller Abgasklappe	Exhaust gas flap actuator	Régulateur Volet de gaz d'échappement	Regulador mariposa del escape	Attuatore farfalla gas di scarico	Исполнительный элемент для выпускной заслонки	عنصر ضبط صمام العادم



NO FAKES!

LABEL AND SECURITY SEAL

1
SECURITY SEAL

ORIGINAL CLOSURE



DAMAGED CLOSURE



⚠ ATTENTION
Label and Security Seal must always be undamaged.

2
SECURITY CODE



TESA® HOLOSPOT SECURITYCODE (FOUR-DIGIT) WITH 2D MATRIX CODE

On the label the logo and Security-Code shine in rainbow colours when under direct light. The four digits match the last four digits of the complete 2D matrix code.

3
ONLINE CHECK



(01)04052938000016(21)2VPF2P400440D



MOTORSERVICE APP
YOUR MOBILE FAKE CHECK

www.ms-motorservice.com/app



SCHADSTOFFREDUZIERUNG

EMISSION CONTROL

RÉDUCTION DES ÉMISSIONS NOCIVES

REDUCCIÓN DE CONTAMINANTES

RIDUZIONE DELLE SOSTANZE NOCIVE

УМЕНЬШЕНИЕ СОДЕРЖАНИЯ ВРЕДНЫХ ВЕЩЕСТВ

خفض الانبعاثات الضارة

INDEX

Page

DE	Grundlagen	2
	Hinweise zur Benutzung des Katalogs	10
EN	Basic information	14
	Instructions for using the catalogue	22
FR	Généralités	26
	Précisions sur l'utilisation du catalogue	34
ES	Fundamentos	38
	Indicaciones para la utilización del catálogo	46
IT	Nozioni basilari	50
	Avvertenze sull'utilizzo del catalogo	58
RU	Основы	62
	Примечания по пользованию каталогом	70
AR	نقاط أساسية	83
	إرشادات استخدام الكاتالوج	75

Disclaimer

Namen, Beschreibungen, Nummern von Motoren, Fahrzeugen, Produkten, Herstellern etc. sind nur zu Vergleichszwecken aufgeführt. Die im Katalog enthaltenen Teile sind Ersatzteile für die aufgeführten Applikationen.

Names, descriptions and numbers of engines, vehicles, products, manufacturers, etc. are mentioned solely for the purpose of comparison. The parts contained in the catalogue are spare parts for the applications listed.

Les noms, les descriptions, les numéros de moteurs, les véhicules, les produits, les constructeurs, etc., ne sont donnés qu'à des fins de comparaison. Les articles mentionnés dans le catalogue sont des pièces de rechange destinées aux applications stipulées.

Los nombres, las designaciones y los números de motores, vehículos, productos o de fabricantes, etc., se indican sólo a modo de comparación. Las piezas incluidas en el catálogo son repuestos para las aplicaciones indicadas.

Nomi, descrizioni, numeri di motori, veicoli, prodotti, produttori, eccetera sono riportati solo per poter fare confronti. I componenti contenuti nel catalogo sono ricambi per le applicazioni citate.

Названия, описания и номера двигателей, транспортных средств, продуктов, изготовителей и т. п. приводятся только для сравнения. Содержащиеся в каталоге части представляют собой запасные части для приведенных продуктов.

أسماء وشروح وأرقام المحركات والسيارات والمنتجات والشركات المنتجة وغيرها مذكورة فقط بهدف المقارنة. الأجزاء المذكورة في الكاتالوج عبارة عن قطع غير للتطبيقات المذكورة.

WICHTIGE HINWEISE

Alle Angaben in diesem Katalog sind unverbindlich. Für deren Richtigkeit und Vollständigkeit können wir keine Haftung übernehmen. Informationen über eventuelle Fehler im Katalog sind uns stets willkommen und werden in den zukünftigen Ausgaben korrigiert.

Namen, Beschreibungen und Nummernangaben von Fahrzeugen oder Herstellern u. ä. sind ebenso wie die Original-Teilnummern der Fahrzeug- und Motorenhersteller nur zu Vergleichszwecken aufgeführt. Entsprechende Angaben sind keine Herkunftsbezeichnungen und dürfen gegenüber Dritten nicht verwendet werden. Bitte beachten Sie zudem, dass Änderungen der Ausrüstung durch die Fahrzeug- oder Motorenhersteller bzw. Änderungen der Bezeichnungen nicht ausgeschlossen werden können. Für die Anwendung der Vergleichslisten können wir daher keine Haftung übernehmen.

Wir behalten uns ausdrücklich vor, die Produktspezifikationen, die Werkstoffe, das Aussehen und den Lieferumfang unserer Produkte jederzeit zu ändern. Die Abbildungen im Katalog sind daher unverbindlich.

Vor dem Einbau ist stets zu prüfen, ob das erworbene Produkt für den beabsichtigten Verwendungszweck geeignet ist. Eine Aussage über eine bestimmte Beschaffenheit oder eine Eignung für einen bestimmten Einsatzzweck kann aus unseren Angaben nicht abgeleitet werden. Insbesondere gilt es zu beachten, dass die im Katalog angebotenen Produkte nicht für den Einsatz in Luft- und Raumfahrzeugen bestimmt sind. Bei der Verwendung in Off-Highway Motoren (z. B. Marine-, Stationär- oder Bahn-Motoren) ist darauf zu achten, dass bei gleicher Motorbezeichnung unterschiedliche Motorenteile (z. B. Kolben) zum Einsatz kommen können. Ggf. ist vor dem Einbau der Produkte daher der fachkundige Rat des Herstellers oder dessen autorisierter Vertragswerkstatt einzuholen. Wir weisen zudem darauf hin, dass der Einbau stets durch unterwiesenes Fachpersonal zu erfolgen hat. Abbildungen, Schemazeichnungen und andere Angaben dienen der Erläuterung und Darstellung und können nicht als Grundlage für den Einbau verwendet werden.

Jegliche Vervielfältigung, Nachahmung, Verbreitung oder öffentliche Wiedergabe dieses Kataloges, auch auszugsweise, ist nur mit unserer vorherigen schriftlichen Zustimmung und einer entsprechenden Quellenangabe gestattet. Mit Erscheinen dieses Kataloges verlieren alle früheren Ausgaben ihre Gültigkeit.

ZERTIFIZIERUNGEN

MS Motorservice International GmbH verfügt über ein nach ISO 9001 zertifiziertes Qualitätsmanagementsystem und ein nach ISO 14001 zertifiziertes Umweltmanagementsystem.





DIE INHALTE DES KATALOGS SIND AUCH IN UNSEREM ONLINE KATALOG, IN UNSERER APP SOWIE AUF TECALLIANCE ENTHALTEN.

Weitere Informationen:
catalog.ms-motorservice.com
motorservice.app

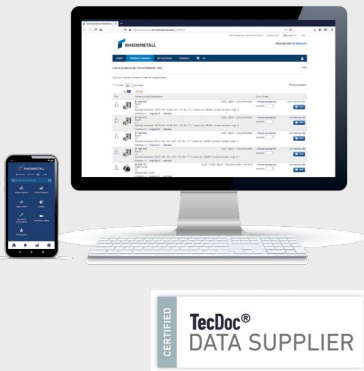

INHALT	SEITE
Wichtige Hinweise	2
Qualitätsmanagement	2
Know-how Transfer – Fachwissen vom Experten	4
1. Schadstoffreduzierung	7
2. HINWEISE ZUR BENUTZUNG DES KATALOGS	10
3. Hauptanwendungen / Produktabbildungen	85
4. Programmergänzung	231
5. Herstellerverzeichnis	249
6. PRODUKTPROGRAMM	253
7. Referenzliste	1933
8. Vorgehensweise bei Reklamation / Reklamationsformular	

MOTORSERVICE GRUPPE

QUALITÄT UND SERVICE AUS EINER HAND

Die Motorservice Gruppe ist die Vertriebsorganisation für die weltweiten Aftermarket-Aktivitäten von Rheinmetall. Sie ist ein führender Anbieter von Motorkomponenten für den freien Ersatzteilmarkt. Mit den Premiummarken Kolbenschmidt, Pierburg, TRW Engine Components sowie den Marken BF und turbo by Intec bietet Motorservice seinen Kunden aus Handel und Werkstatt ein breites und tiefes Sortiment in Spitzenqualität.

RHEINMETALL

TECHNOLOGIEN FÜR DIE MOBILITÄT DER ZUKUNFT

Als weltweiter Automobilzulieferer nimmt Rheinmetall mit seiner Kompetenz in den Bereichen Luftversorgung, Schadstoffreduzierung und Pumpen sowie bei der Entwicklung, Fertigung und Ersatzteillieferung von Kolben, Motorblöcken und Gleitlagern Spitzenpositionen auf den jeweiligen Märkten ein. Die Produktentwicklung erfolgt in enger Kooperation mit renommierten Automobilherstellern.

KNOW-HOW TRANSFER FACHWISSEN VOM EXPERTEN

WELTWEITE SCHULUNGEN

Direkt vom Hersteller

Jährlich profitieren rund 4.500 Mechaniker und Techniker von unseren Schulungen und Seminaren, die wir weltweit vor Ort oder auch in unseren Schulungszentren in Neuenstadt, Dormagen und Tamm (Deutschland) durchführen.

TECHNISCHE INFORMATIONEN

Aus der Praxis für die Praxis

Mit unseren Produkt Informationen, Service Informationen, technischen Broschüren und Postern sind Sie immer auf dem neuesten Stand der Technik.

TECHNISCHE VIDEOS

Wissensvermittlung per Video

In unseren Videos finden Sie praxisbezogene Einbauhinweise und Systemerklärungen rund um unsere Produkte.



PRODUKTE IM FOKUS ONLINE

Unsere Lösungen anschaulich erklärt

Erfahren Sie durch interaktive Elemente, Animationen und Videoclips Wissenswertes über unsere Produkte im und um den Motor.

ONLINESHOP

Ihr direkter Zugang zu unseren Produkten

Bestellen rund um die Uhr. Schnelles Prüfen der Verfügbarkeit. Umfangreiche Produktsuche über Motor, Fahrzeug, Abmessungen usw..

NEWS

Regelmäßige Informationen per E-Mail

Melden Sie sich jetzt online zu unserem kostenlosen Newsletter an und Sie erhalten regelmäßige Informationen über Produktneuaufnahmen, technische Publikationen und vieles mehr.

INDIVIDUELLE INFORMATIONEN

Speziell für unsere Kunden

Von uns erhalten Sie umfangreiche Informationen und Services zu unserem breiten Leistungsspektrum: wie z. B. personalisierte Verkaufsförderungsmaterialien, Verkaufunterstützungen, technischen Support und vieles mehr.



TECHNIPEDIA

Technische Informationen rund um den Motor

In unserer Technipedia teilen wir unser Know-how mit Ihnen. Hier finden Sie Fachwissen direkt vom Experten.

MOTORSERVICE APP

Mobiler Zugang zu technischem Know-how

Hier erhalten Sie schnell und einfach die aktuellsten Informationen und Services rund um unsere Produkte.

SOCIAL MEDIA

Immer aktuell



www.ms-motorservice.com





1. SCHADSTOFFREDUZIERUNG

50 % WENIGER SCHADSTOFFE VOR ERREICHEN DES KATALYSATORS

Nicht umsonst ist Pierburg mit AGR-Ventilen und AGR-Kühlern in zahlreichen modernen Fahrzeugen als Erstausrüster vertreten. Die korrosions- und temperaturbeständigen Werkstoffe der Pierburg Produkte garantieren eine lange Funktionsdauer unter schwierigsten Bedingungen – wie z. B. aggressivem Abgaskondensat, Temperaturen bis zu 700 °C und bis zu 3 bar Druck.

PRODUKTPROGRAMM

- 01 AGR-Kühlermodul
- 02 AGR-Ventil (elektrisch)
- 03 AGR-Ventil (pneumatisch)
- 04 Druckwandler zur Ansteuerung pneumatischer AGR-Ventile
- 05 Sekundärluftventil (pneumatisch)
- 06 Umschaltventil zur Ansteuerung pneumatischer Sekundärluftventile
- 07 Sekundärluftventil (elektrisch)
- 08 Umschaltventil zur Ansteuerung der Abgasklappe
- 09 Abgastempersensor
- 10 Abgasklappe
- 11 Lambdasonde
- 12 Sekundärluftpumpe

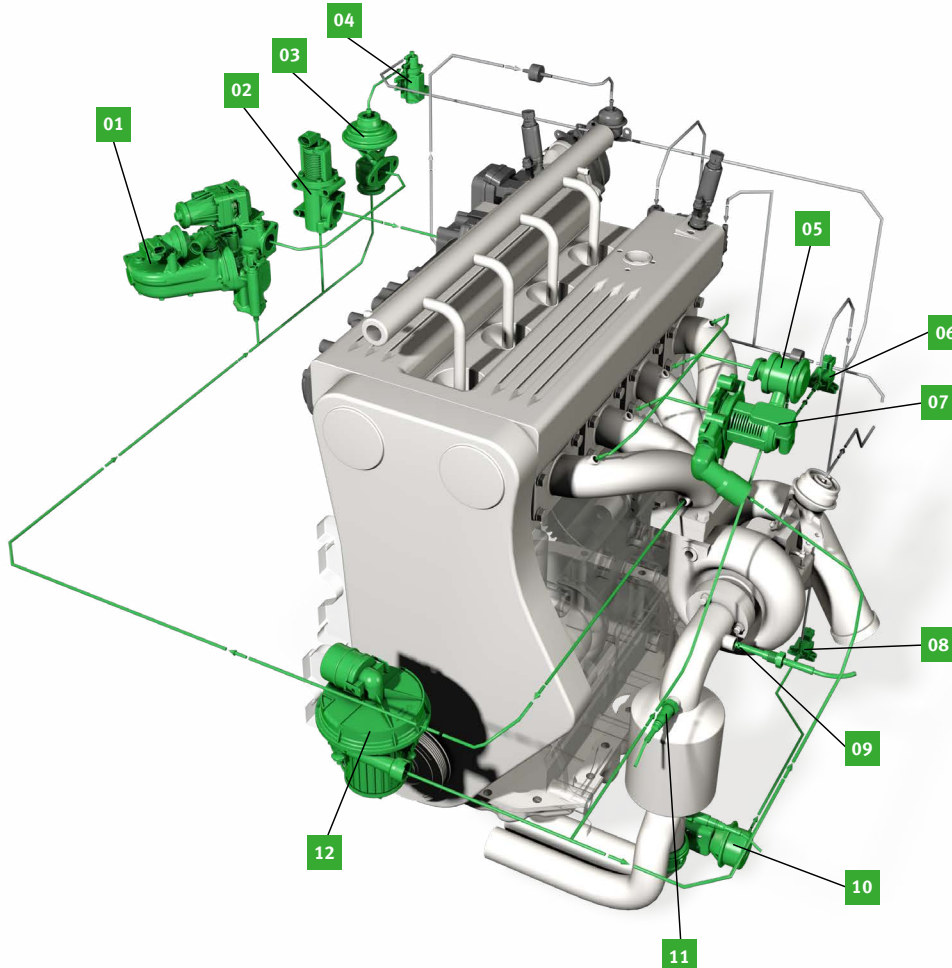

AGR-VENTILE

Alle modernen Dieselmotoren müssen heute mit AGR-Systemen ausgestattet sein, um die Abgasvorschriften einhalten zu können.

Unmittelbar hinter dem Zylinder wird Abgas entnommen und der Ansaugluft wieder zugemischt. Dadurch gelangt weniger Sauerstoff in den Zylinder. Dies verursacht eine geringere Verbrennungstemperatur. Dadurch kann die Menge an Stickoxiden im Abgas um bis zu 50% reduziert werden. Bei Benzinmotoren lassen sich dadurch außerdem der Kohlendioxidausstoß und der Verbrauch verringern.



↓
Pierburg hat diese Systeme seit den 70er Jahren bis heute mitentwickelt und somit maßgeblich zum heutigen Stand der Technik beigetragen.

AGR-KÜHLER

Um den immer strengeren Anforderungen der Abgasvorschriften gerecht zu werden, bedarf es gekühlter Abgasrückführungssysteme.

Gekühltes Abgas senkt die Verbrennungs-Spitzentemperatur. Dadurch entstehen deutlich weniger Stickoxide. Zudem sind gekühlte Gase dichter als wärmere. Dies bedeutet: Bei gleichem Ladedruck passt mehr Masse in eine Zylinderfüllung. Die dadurch ausgelöste „magere“ Verbrennung macht sich im Verbrauch und bei den Partikelemissionen positiv bemerkbar.



ABGASKLAPPEN

Für die Schadstoffreduzierung und die Komfortsteigerung sind Abgasklappen ein wichtiges Element moderner Motoren. Durch sie wird das Abgas je nach Betriebszustand in verschiedene Abgasstränge geleitet.

Einsatzbereiche in motornahen Bereichen:

- DeNO_x-Katalysatoren
- Niederdruck-Abgasrückführung
- HC-Absorber

Das Lieferprogramm von Motorservice umfasst pneumatische und elektrische Abgasklappen sowie Abgasklappen für Motorräder. Alle Klappen sind für extreme Gastemperaturen von -40°C bis +950°C sowie einer Dauerhaltbarkeit von über 1.000.000 Schaltspielen ausgelegt.



LAMBDASENDEN

Lambdasonden messen den Restsauerstoff im Abgas. Mit Hilfe des daraus berechneten Lambdawertes regelt das Motormanagement die Gemischzusammensetzung für eine möglichst optimale Verbrennung.

Lambdasonden sind die wichtigsten Elemente im Motormanagement, um einen perfekten Motorlauf bei geringen Emissionen zu gewährleisten.

Hohe Betriebstemperaturen und aggressives Abgas stellen hohe Anforderungen an Lambdasonden. Entscheiden Sie sich daher für die Produkte des Spezialisten für Schadstoffreduzierung.



ABGASTEMPERATURENSENOREN

Abgastemperatursensoren kontrollieren den heißen Abgasstrom und schützen Bauteile vor Überhitzung. Typische Anwendungen sind der Schutz von temperaturempfindlichen Komponenten wie z. B. Turbolader und alle Arten von Katalysatoren, die Überwachung des Freibrennvorgangs des Dieselpartikelfilters, die Kontrolle des optimalen Temperaturfensters von Katalysatoren und die Messung der AGR-Abgastemperatur im Rahmen der On-Board-Diagnose (OBD). Bei einer kritischen Überhitzung reagiert das Steuergerät mit entsprechenden Maßnahmen, um die Temperatur zu senken, z. B. durch reduzierte Leistung (Notlauf).

Motorservice deckt mit 30 Abgastemperatursensoren rund 1.400 Fahrzeugtypen ab.



SEKUNDÄRLUFTPUMPEN

Sekundärluftpumpen sind hocheffiziente, ein- oder zweistufige Gebläse. Diese saugen die Umgebungsluft an und blasen sie in den Abgaskrümmen hinter den Auslassventilen ein. Damit sorgen sie bei Ottomotoren dafür, dass die hohen Mengen an Kohlenmonoxid und unverbrannten Kohlenwasserstoffen während der Kaltstartphase – wenn der Katalysator noch nicht auf Arbeitstemperatur ist – deutlich reduziert werden.



SEKUNDÄRLUFTVENTILE

Die Sekundärluftventile befinden sich zwischen Sekundärluftpumpe und dem Abgaskrümmen. Das Sekundärluftventil hat mehrere Aufgaben zu erfüllen:

- Die Rückschlagfunktion verhindert, dass Abgas, Kondensat oder Druckspitzen im Abgasstrang Schäden an der Sekundärluftpumpe verursachen.
- Die Abschaltfunktion sorgt dafür, dass die Sekundärluft nur in der Kaltstartphase zum Abgaskrümmen gelangt.



IM UMFANGREICHEN PRODUKTPORTFOLIO VON MOTORSERVICE BEFINDEN SICH DREI VERSCHIEDENE ARTEN VON PIERBURG SEKUNDÄRLUFTVENTILEN:

↘

ELEKTRISCH

Elektrische Sekundärluftventile verfügen über kürzere Öffnungs- und Schließzeiten und sind resistenter gegen Verklebungen durch Ruß oder Schmutz.

↘

PNEUMATISCH

Pneumatische Sekundärluftventile haben sich seit Jahrzehnten bewährt. Sie benötigen ein Umschaltventil zum Ansteuern.

↘

DRUCKGESTEUERT

Diese Art von Sekundärluftventil öffnet durch den Druck der Sekundärluftpumpe.

2. HINWEISE ZUR BENUTZUNG DES KATALOGS

VOLKSWAGEN

POLO (9N_)							
1.9 TDI 74 kW (100 PS) AXR	10.2001→11.2009		7.24809.16.0	AGR	PN		ch. 9N-2-000 001→
1.9 TDI 74 kW (101 PS) BMT	10.2001→11.2009		7.00678.04.0*	AGR-M	EL	mit Rohrstützen with pipe socket ch. 9N-5-500 001→	
			↳ 7.00907.03.0	AGR	EL		
1.9 TDI 96 kW (130 PS) ASZ	11.2003→11.2009		7.24809.55.0	AGR	PN		
1.9 TDI 96 kW (130 PS) BLT	05.2004→11.2009		7.24809.16.0	AGR	PN		ch. 9N-2-000 001→

01 Fahrzeug / Motor

02 Baujahr von → bis

03 Produktgruppe

04 7.xxxxx.xx.x
↳ 4.xxxxx.xx.x
Reparaturatz
7.xxxxx.xx.x**

05 Artikel-Code*

06 Antriebsart / Ausführung

07 Info / Kriterien

08 Artikel-Kürzel*

09 Pierburg Nr.

* siehe Abkürzungsverzeichnis
** nicht mehr lieferbar

PIERBURG NR.

PIERBURG No. 123





01	7.00075.07.0	AGR	4	7.05574.03.0	SLV	32	7.22778.96.0	SLV	33
	7.00216.06.0	SLP	25	7.06712.23.0	ARV	20	7.22778.97.0	SLV	33
	7.00306.37.0	AGR	4	7.07696.00.0	SRM-AK	35	7.22778.98.0	SLV	33

01 Pierburg Nr.

02 Artikel-Code

03 Abbildung / Seite

HAUPTANWENDUNGEN

PIERBURG		PIERBURG		emission control 	
AGR-K	7.02156.34.0	AGR-K	7.02156.35.0	AGR-K	7.02756.07.0
					
<p>05 CITROEN</p> <p>BERLINGO (B9)</p> <p>BERLINGO Kasten (B9)</p> <p>C-ELYSEE</p> <p>C3 II (SC_)</p> <p>C3 Picasso</p> <p>C4 AIRCROSS</p> <p>C4 CACTUS</p>		<p>CITROEN</p> <p>BERLINGO (B9)</p> <p>BERLINGO Kasten (B9)</p> <p>C-ELYSEE</p> <p>C3 II (SC_)</p> <p>C3 Picasso</p> <p>C4 AIRCROSS</p> <p>C4 CACTUS</p>		<p>02</p> <p>→SI 0090</p> <p>→SI 0092</p> <p>→SI 0108</p> <p>→SI 1003</p> <p>04</p> <p>VOLKSWAGEN</p> <p>MULTIVAN V (7HM, 7HN, 7HF, 7EF, 7EM, 7EN)</p> <p>TRANSPORTER V Bus (7HB, 7HJ, 7EB, 7EJ, 7EF, 7EG, 7HF, 7EC)</p>	

01 Pierburg Nr.

02 Artikel-Code

03 Produktgruppe

04 Produkt- / Service Information

05 Fahrzeug

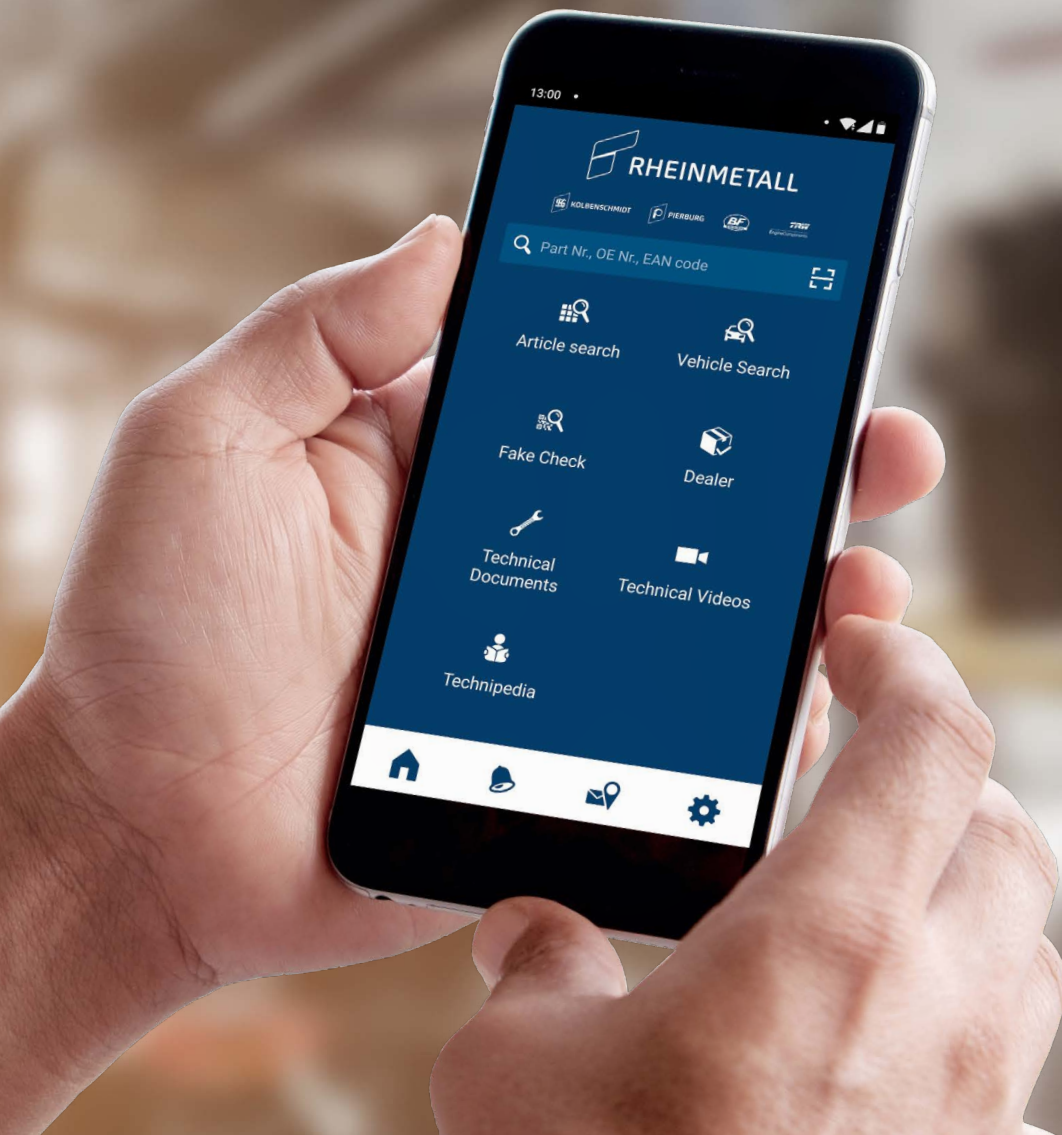

MOTORSERVICE APP

MOBILER ZUGANG ZU TECHNISCHEM KNOW-HOW



Mehr erfahren
www.ms-motorservice.com/app

EN

Basic information ►

IMPORTANT INFORMATION

All information in this catalogue is non-binding. We cannot accept any liability for correctness and completeness. We always welcome feedback about any errors in the catalogue and will correct them in future editions.

Names, descriptions and numbers of vehicles or manufacturers etc. are listed for comparison purposes only, as are the original part numbers of vehicle and engine manufacturers. These are not designations of origin and may not be used for third parties. Please also note that changes may be made to the equipment or to designations by the vehicle or engine manufacturers. We therefore cannot accept any liability for the use of the comparison lists.

We expressly reserve the right to change the product specifications, materials, appearance and scope of supply of our products at any time. The images in the catalogue are therefore non-binding.

Before installation, always check whether the product purchased is suitable for the intended use. Our information cannot be used to make a claim about a specific quality or suitability for a specific intended purpose. In particular, it should be noted that the products offered in the catalogue are not intended for use in aircraft and spacecraft. When used in off-highway engines (e.g. marine, stationary or train engines), please note that the same engine designation may be used for different engine parts (e.g. pistons). Therefore, before installing the products, it may be necessary to seek expert advice from the manufacturer or an authorised repair shop. We would also like to point out that the installation must always be carried out by trained, qualified personnel. Images, schematic diagrams and other information are for explanation and illustration purposes and must not be used as a basis for installation.

Any duplication, imitation, distribution or public reproduction of this catalogue, even in part, is permitted only with our prior written consent and a corresponding reference to the source. The publication of this catalogue renders all previous editions invalid.

CERTIFICATIONS

MS Motorservice International GmbH has an ISO 9001 certified quality management system and an ISO 14001 certified environmental management system.





THE CONTENTS OF THE CATALOGUE ARE ALSO AVAILABLE IN OUR ONLINE CATALOGUE, IN OUR APP AND ON TECALLIANCE.

Further information:
catalog.ms-motorservice.com
motorservice.app

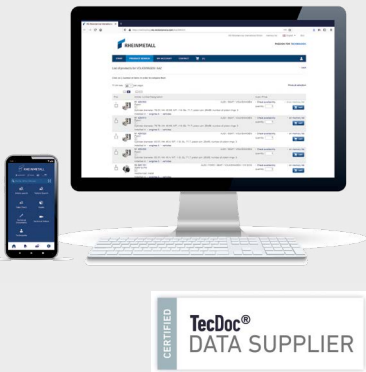

CONTENTS	PAGE
Important information	14
Quality management	14
Know-how transfer – professional knowledge from the expert	16
1. Emission control	19
2. INSTRUCTIONS FOR USING THE CATALOGUE	22
3. Main applications / product images	85
4. Addition to the range	231
5. Directory of manufacturers	249
6. PRODUCT RANGE	253
7. Reference list	1933
8. Procedure for claims / claims form	

MOTORSERVICE GROUP

QUALITY AND SERVICE FROM A SINGLE SOURCE

The Motorservice Group is the sales organisation for the global aftermarket activities of Rheinmetall. It is a leading supplier of engine components for the independent aftermarket. With the premium brands Kolbenschmidt, Pierburg, TRW Engine Components and the brands BF and turbo by Intec, Motorservice offers its trade and repair shop customers a wide and comprehensive range of top-quality products.

RHEINMETALL

TECHNOLOGY FOR FUTURE MOBILITY

As a global supplier to the automotive industry, Rheinmetall’s expertise in air supply systems, emission control and pumps and in the development, manufacture and spare parts supply of pistons, engine blocks and engine bearings puts it right at the top of the markets. Product development is carried out in close cooperation with well-known automotive manufacturers.

KNOW-HOW TRANSFER

PROFESSIONAL KNOWLEDGE FROM THE EXPERTS

WORLDWIDE TRAININGS

Direct from the manufacturer

Each year, around 4,500 mechanics and engineers benefit from our training courses and seminars, which we hold on-site in locations across the world or in our training centres in Neuenstadt, Dormagen and Tamm (Germany).

TECHNICAL INFORMATION

From practical experience for practical use

Our Product Information and Service Information publications, technical brochures and posters keep you at the forefront of the latest technological developments.

TECHNICAL VIDEOS

Knowledge transfer via video

Our videos provide you with useful information on our products, such as hands-on fitting instructions and system descriptions.



PRODUCTS IN FOCUS ONLINE

Our solutions explained clearly

Interactive elements, animations and video clips provide interesting information about our products in and around the engine.

ONLINESHOP

Your direct access to our products

Order at any time. Quick availability check. Extensive product search by engine, vehicle, dimensions etc.

NEWS

Regular information via e-mail

Subscribe online to our free newsletter now and receive regular information about additions to the product range, technical publications and much more.

INDIVIDUAL INFORMATION

Especially for our customers

We provide extensive information and services relating to our wide range of services: e.g. personalised sales-promoting materials, sales support, technical support and much more.



TECHNIPEDIA

Technical information on all aspects of the engine

We share our know-how with you in our Technipedia. You can get professional knowledge direct from experts here.

MOTORSERVICE APP

Access technical know-how on the move

Here, you will find the latest information and services relating to our products quickly and easily.

SOCIAL MEDIA

Always up to date



www.ms-motorservice.com





1. EMISSION CONTROL

50% FEWER POLLUTANTS BEFORE REACHING THE CATALYTIC CONVERTER

There's a reason why Pierburg is represented as the OEM in a large number of modern vehicles with EGR valves and EGR coolers. The corrosion and temperature-resistant materials used in the Pierburg products guarantee lasting function under the harshest conditions, e.g. aggressive exhaust gas condensate, temperatures up to 700°C and pressures up to 3 bar.

PRODUCT RANGE

- 01 EGR cooler module
- 02 EGR valve (electrical)
- 03 EGR valve (pneumatic)
- 04 Pressure transducer for controlling pneumatic EGR valves
- 05 Secondary air valve (pneumatic)
- 06 Switchover valve for controlling pneumatic secondary air valves
- 07 Secondary air valve (electrical)
- 08 Switchover valve for controlling the exhaust gas flap
- 09 Exhaust temperature sensor
- 10 Exhaust gas flap
- 11 Lambda sensor
- 12 Secondary air pump

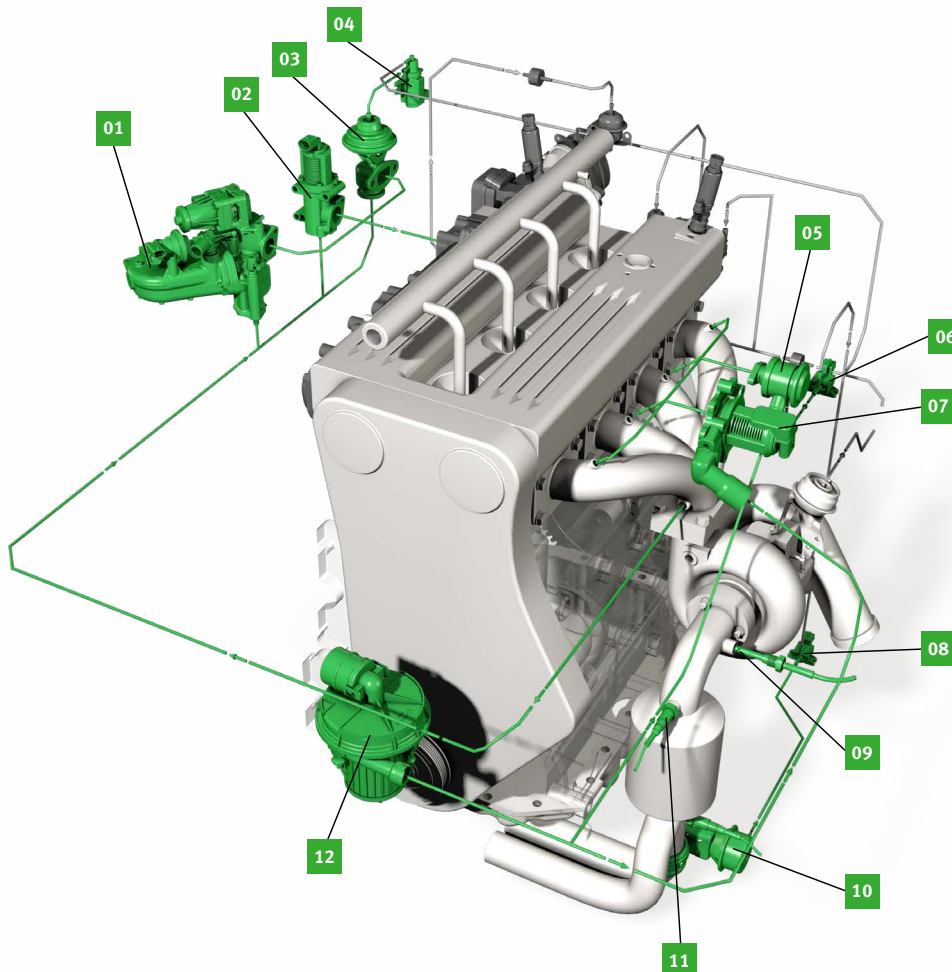

EGR VALVES

Nowadays all modern diesel engines must be fitted with EGR systems in order to comply with exhaust gas regulations.

Exhaust gas is removed immediately after the cylinder and mixed with the intake air. This means that less oxygen reaches the cylinder, which results in a lower combustion temperature. As a result, the amount of nitrogen oxides in the exhaust gas can be reduced by up to 50%. In petrol engines, this can also reduce carbon dioxide emissions and fuel consumption.



Pierburg has been developing these systems since the 70s up to present day, and have therefore made a significant contribution to the current state of the art.

EGR COOLERS

In order to keep up with the increasingly strict emissions regulations, exhaust gas recirculation systems are required.

Cooled exhaust gas reduces the peak combustion temperature. This significantly reduces the amount of nitrogen oxides. Additionally, cooled gases are denser than warmer ones. This means that: at the same boost pressure, a larger volume of gas fits into one cylinder filling. This produces a “leaner” combustion which also improves fuel consumption and particulate emissions.



EXHAUST GAS FLAPS

Exhaust gas flaps are an important element in modern engines for emission control and increased comfort. They direct the exhaust gas into different exhaust tracts depending on the operating state.

Fields of application for areas close to the engine:

- DeNO_x catalytic converters
- Low-pressure exhaust gas recirculation
- HC absorbers

Motorservice’s product range encompasses pneumatic and electrical exhaust gas flaps as well as exhaust gas flaps for motorcycles. All flaps are designed for extreme gas temperatures from -40°C to +950°C and a durability of over 1,000,000 switching cycles.



LAMBDA SENSORS

Lambda sensors measure the residual oxygen in the exhaust gas. This produces a lambda value, which the engine management system uses to regulate the mixture composition for the most optimal combustion possible.

Lambda sensors are the most important element in engine management systems in terms of ensuring perfect engine running with low emissions.

High operating temperatures and aggressive exhaust gas place high demands on lambda sensors. You should therefore choose specialist products for emission control.



EXHAUST GAS TEMPERATURE SENSORS

Exhaust gas temperature sensors monitor the hot exhaust gas flow and protect components from overheating. Typical applications include protecting components which are sensitive to temperature, such as turbochargers and all forms of catalytic converters, monitoring the free-burning process of the diesel particulate filter, controlling the optimal temperature range for catalytic converters and measuring the EGR exhaust gas temperature as part of on-board diagnostics (OBD). In the event of critical overheating, the control unit responds by taking appropriate action to reduce the temperature, e.g. through reduced performance (limp home function).

Motorservice covers around 1,400 vehicle types with 30 exhaust gas temperature sensors.



SECONDARY AIR PUMPS

Secondary air pumps are high-speed one or two-stage blowers. These draw in ambient air and inject them into the exhaust manifold downstream of the exhaust valves. In petrol engines this ensures a noticeable reduction of a large amount of carbon monoxide and unburnt hydrocarbons during the cold start phase – when the catalytic converter has not yet reached working temperature.



SECONDARY AIR VALVES

The secondary air valves are located between the secondary air pump and the exhaust manifold. The secondary air valve performs multiple tasks:

- The non-return function stops exhaust gas, condensate or pressure peaks in the exhaust tract from causing damage to the secondary air pump.
- The shut-off function ensures that secondary air is only routed to the exhaust manifold in the cold start phase.



IN MOTORSERVICE'S EXTENSIVE PRODUCT PORTFOLIO ARE THREE DIFFERENT TYPES OF PIERBURG SECONDARY AIR VALVES:

↘

ELECTRICAL
Electrical secondary air valves have shorter opening and closing times and are more resistant against sticking due to soot or dirt.

↘

PNEUMATIC
Pneumatic secondary air valves have proven their worth over decades. They need to be actuated by a switchover valve.

↘

PRESSURE-CONTROLLED
This type of secondary air valve opens due to pressure from the secondary air pump.

2. INSTRUCTIONS FOR USING THE CATALOGUE

ENGLISH

01

02

03

04

05

06

07

VOLKSWAGEN

56

POLO (9N_)						
1.9 TDI 74 kW (100 PS) AXR	10.2001→11.2009		7.24809.16.0	AGR	PN	ch. 9N-2-000 001→
1.9 TDI 74 kW (101 PS) BMT	10.2001→11.2009		7.00678.04.0*	AGR-M	EL	mit Rohrstützen with pipe socket ch. 9N-5-500 001→
			↳ 7.00907.03.0	AGR	EL	
1.9 TDI 96 kW (130 PS) ASZ	11.2003→11.2009		7.24809.55.0	AGR	PN	
1.9 TDI 96 kW (130 PS) BLT	05.2004→11.2009		7.24809.16.0	AGR	PN	ch. 9N-2-000 001→

09

08

01 Vehicle / engine

02 Model year from → to

03 Product group

04 7.xxxxx.xx.x
↳ 4.xxxxx.xx.x
Repair kit
7.xxxxx.xx.x**

05 Article code*

06 Type of drive / version

07 Info / criteria

08 Article abbreviation*

09 Pierburg no.

* see list of abbreviations
** no longer available

PIERBURG NO.

PIERBURG

02

PIERBURG No. 123





01	7.00075.07.0	AGR	4	7.05574.03.0	SLV	32	7.22778.96.0	SLV	33
	7.00216.06.0	SLP	25	7.06712.23.0	ARV	20	7.22778.97.0	SLV	33
	7.00306.37.0	AGR	4	7.07696.00.0	SRM-AK	35	7.22778.98.0	SLV	33

01 Pierburg no.

02 Article code

03 Figure / page

MAIN APPLICATIONS

			
01	03		
AGR-K	7.02156.34.0	AGR-K	7.02156.35.0
			
05		02	
CITROEN BERLINGO (B9) BERLINGO Kasten (B9) C-ELYSEE C3 II (SC_) C3 Picasso C4 AIRCROSS C4 CACTUS		CITROEN BERLINGO (B9) BERLINGO Kasten (B9) C-ELYSEE C3 II (SC_) C3 Picasso C4 AIRCROSS C4 CACTUS	
		→SI 0090 →SI 0092 →SI 0108 →SI 1003	
		04	
		VOLKSWAGEN MULTIVAN V (7HM, 7HN, 7HF, 7EF, 7EM, 7EN) TRANSPORTER V Bus (7HB, 7HJ, 7EB, 7EJ, 7EF, 7EG, 7HF, 7EC)	
01 Pierburg no. 02 Article code 03 Product group 04 Product / Service Information 05 Vehicle			

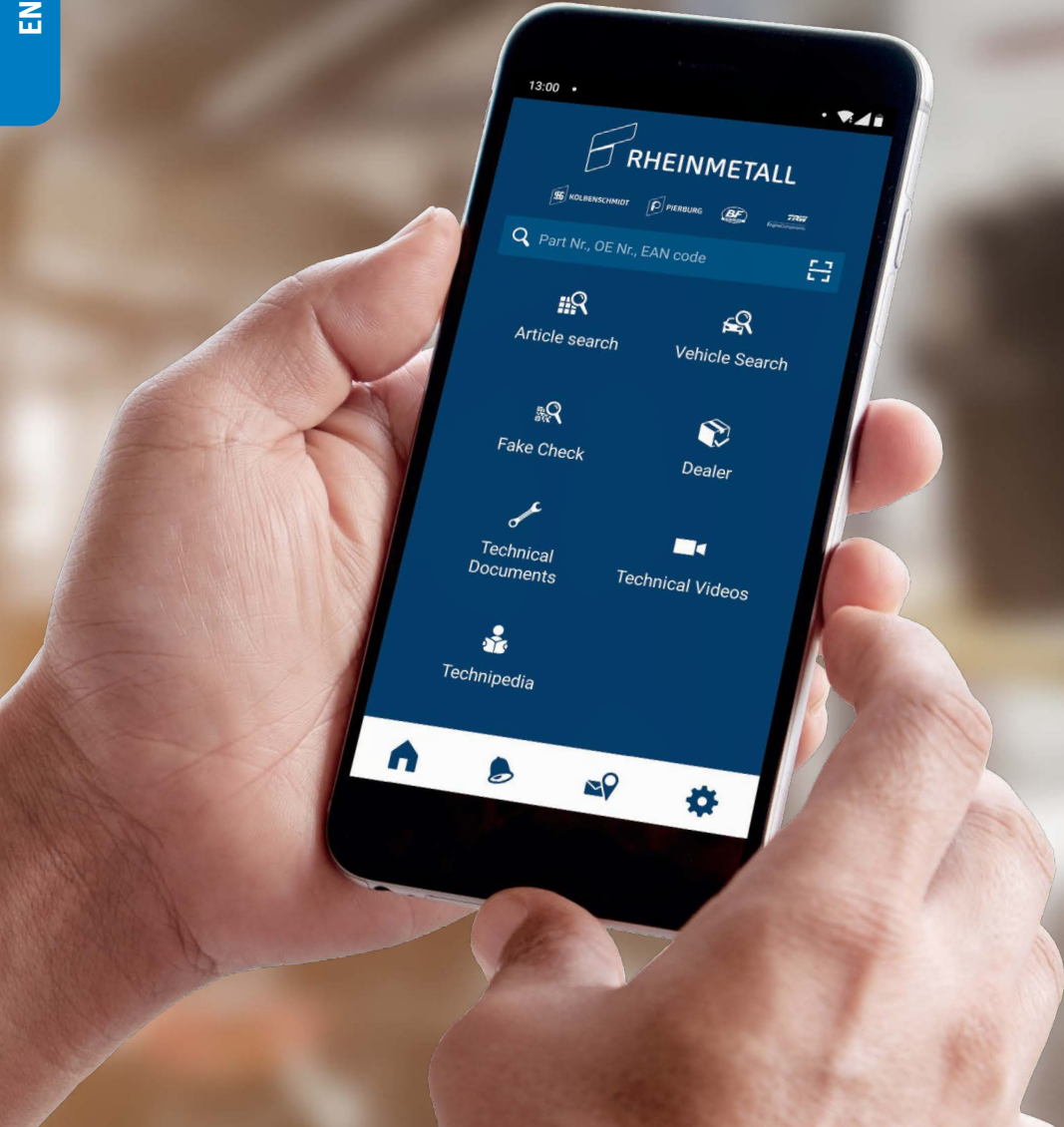

MOTORSERVICE APP

MOBILE ACCESS TO TECHNICAL KNOW-HOW



Find out more
www.ms-motorservice.com/app

REMARQUES IMPORTANTES

Toutes les informations figurant dans ce catalogue sont fournies sans engagement de notre part. Nous déclinons toute responsabilité quant à l'exactitude et l'exhaustivité des contenus. Si vous relevez des erreurs dans ce catalogue, n'hésitez pas à nous les communiquer : nous veillerons à les corriger dans les futures éditions.

Les noms, descriptions, numéros de véhicule ou de constructeur, etc. ne sont donnés qu'à titre de comparaison, tout comme les références des pièces d'origine des constructeurs automobiles ou de moteurs. Ces informations ne doivent pas être utilisées dans le cadre de communications externes car ce ne sont pas les désignations d'origine. Il est de plus impossible d'exclure que les constructeurs automobiles ou de moteurs n'apportent des modifications aux équipements et aux désignations. Nous déclinons donc toute responsabilité pour l'utilisation des listes de correspondances.

Nous nous réservons explicitement le droit d'apporter à tout moment des modifications aux spécifications de nos produits, aux matériaux utilisés, à leur aspect et à la composition des lots. Les illustrations du catalogue n'ont donc qu'une valeur indicative.

Avant le montage, vérifiez toujours que le produit acheté est adapté à l'usage prévu. Une quelconque qualité ou aptitude à un usage particulier ne peut être déduite de nos indications. Il convient notamment de noter que les produits proposés dans le catalogue ne sont pas destinés aux applications aérospatiales. Dans le cas de l'utilisation sur des moteurs off-highway (par ex. moteurs de marine, moteurs stationnaires ou moteurs de traction), tenir compte du fait que des pièces de moteur différentes (par ex. des pistons) peuvent être utilisées pour une même désignation du moteur. Le cas échéant, demandez conseil au constructeur ou à un concessionnaire agréé avant de monter les produits. Nous rappelons que le montage doit toujours être confié à des techniciens qualifiés et formés. Les illustrations, dessins schématisés et autres indications sont destinés à expliquer et à représenter nos produits ; ils ne peuvent en aucun cas servir de base au montage des pièces.

Toute duplication, imitation, diffusion ou reproduction, même partielle, du présent catalogue sans notre consentement écrit préalable et sans indication de la source est illicite. La présente édition remplace et annule toutes les éditions précédentes du catalogue.

CERTIFICATIONS

MS Motorservice International GmbH bénéficie d'un système de gestion de la qualité certifié conforme à ISO 9001 et d'un système de gestion de l'environnement certifié conforme à ISO 14001.





VOUS TROUVEREZ LES
INFORMATIONS DE CE
CATALOGUE DANS NOTRE
CATALOGUE EN LIGNE,
SUR NOTRE APPLICATION
ET SUR TECALLIANCE.

Plus d'informations :
catalog.ms-motorservice.com
motorservice.app

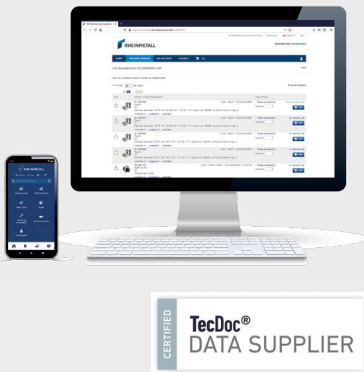

CONTENU	PAGE
Remarques importantes	26
Gestion de la qualité	26
Transfert de savoir-faire – Compétence des experts	28
1. Réduction des émissions nocives	31
2. PRÉCISIONS SUR L'UTILISATION DU CATALOGUE	34
3. Principales applications / Illustrations	85
4. Complément de gamme	231
5. Liste de constructeurs	249
6. GAMME DE PRODUITS	253
7. Liste de références	1933
8. Marche à suivre en cas de réclamation / Formulaire de réclamation	

GRUPE MOTORSERVICE

QUALITÉ ET SERVICE AUPRÈS D'UN UNIQUE FOURNISSEUR

Le groupe Motorservice est l'organisation commerciale en charge des activités internationales Aftermarket de Rheinmetall. C'est l'un des premiers fournisseurs de composants de moteurs pour le marché indépendant des pièces de rechange. Avec les marques haut de gamme Kolbenschmidt, Pierburg, TRW Engine Components ainsi que les marques BF et turbo by Intec, Motorservice propose à ses clients commerçants et garagistes une gamme étendue et variée de très grande qualité.

RHEINMETALL

DES TECHNOLOGIES AU SERVICE DE LA MOBILITÉ DE DEMAIN

Équipementier automobile présent dans le monde entier, Rheinmetall se place, grâce à son savoir-faire dans les domaines de l'alimentation en air, de la réduction des émissions nocives et des pompes ainsi que dans le développement, la fabrication et la fourniture de pistons, de blocs-moteurs et de coussinets, en tête de ces marchés respectifs. Le développement des produits se déroule en étroite coopération avec des constructeurs automobiles renommés.

TRANSFERT DE SAVOIR-FAIRE LA COMPÉTENCE D'UN EXPERT

FORMATIONS DANS LE MONDE ENTIER

En direct du fabricant

Tous les ans, environ 4 500 mécaniciens et techniciens profitent de nos formations et des séminaires que nous organisons sur place, dans le monde entier, ou dans nos centres de formation de Neuenstadt, Dormagen et Tamm (Allemagne).

INFORMATIONS TECHNIQUES

Des informations issues de la pratique pour la pratique

Avec nos Product Information, Service Information, brochures techniques et posters, vous êtes à chaque instant à la pointe de la technique.

VIDÉOS TECHNIQUES

Transmission des connaissances par vidéo

Dans nos vidéos, vous trouverez des instructions de montage pratiques et des explications système concernant nos produits.



PLEINS FEUX SUR LES PRODUITS EN LIGNE

Nos solutions clairement expliquées

Au travers d'éléments interactifs, d'animations et de clips vidéo, apprenez tout ce qu'il faut savoir sur nos produits pour le moteur.

BOUTIQUE EN LIGNE

Votre accès direct à nos produits

Commande 24 h sur 24. Contrôle rapide de la disponibilité. Recherche produits exhaustive par moteur, véhicule, dimensions, etc.

NEWS

Informations régulières par e-mail

Inscrivez-vous vite en ligne à notre newsletter gratuite pour recevoir régulièrement des informations sur les nouveaux produits, les publications techniques et de nombreux autres sujets.

INFORMATIONS PERSONNALISÉES

Spécialement pour nos clients

Par notre intermédiaire, vous profitez d'informations et de services complets sur notre large gamme de prestations tels que du matériel de promotion des ventes personnalisé, des aides à la vente, un support technique et bien d'autres choses encore.



TECHNIPEDIA

Informations techniques concernant le moteur

Avec Technipedia, nous vous offrons un accès à notre savoir-faire. Vous y trouverez les connaissances techniques de nos experts directement.

L'APPLI MOTORSERVICE

Un accès mobile à notre savoir-faire technique

Vous y trouverez rapidement et facilement les informations et les services les plus à jour relatifs à nos produits.

MÉDIAS SOCIAUX

Toujours à jour

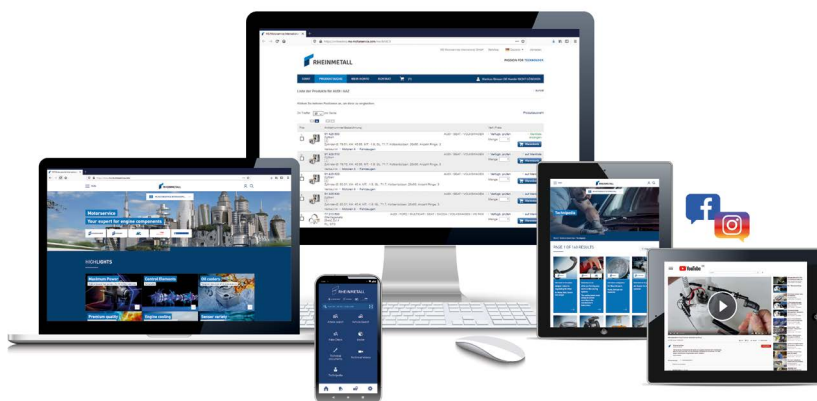

www.ms-motorservice.com





1. RÉDUCTION DES ÉMISSIONS NOCIVES

50 % DE POLLUANTS EN MOINS AVANT MÊME D'ARRIVER AU CATALYSEUR

Ce n'est pas un hasard si Pierburg est l'équipementier pour la première monte des vannes et refroidisseurs EGR de nombreux véhicules modernes. Résistants à la corrosion et à la chaleur, les matériaux des produits Pierburg garantissent une longue durée de fonctionnement dans les conditions d'utilisation les plus difficiles, notamment avec des condensats de gaz d'échappement agressifs, des températures jusqu'à 700 °C et jusqu'à 3 bars de pression.

GAMME DE PRODUITS

- 01 Module refroidisseur EGR
- 02 Vanne EGR (électrique)
- 03 Vanne EGR (pneumatique)
- 04 Convertisseur de pression pour la commande des vannes EGR pneumatiques
- 05 Valve d'air secondaire (pneumatique)
- 06 Vanne d'inversion pour la commande des valves d'air secondaire pneumatiques
- 07 Valve d'air secondaire (électrique)
- 08 Vanne d'inversion pour la commande du volet de gaz d'échappement
- 09 Capteur de température des gaz d'échappement
- 10 Volet de gaz d'échappement
- 11 Sonde lambda
- 12 Pompe d'air secondaire

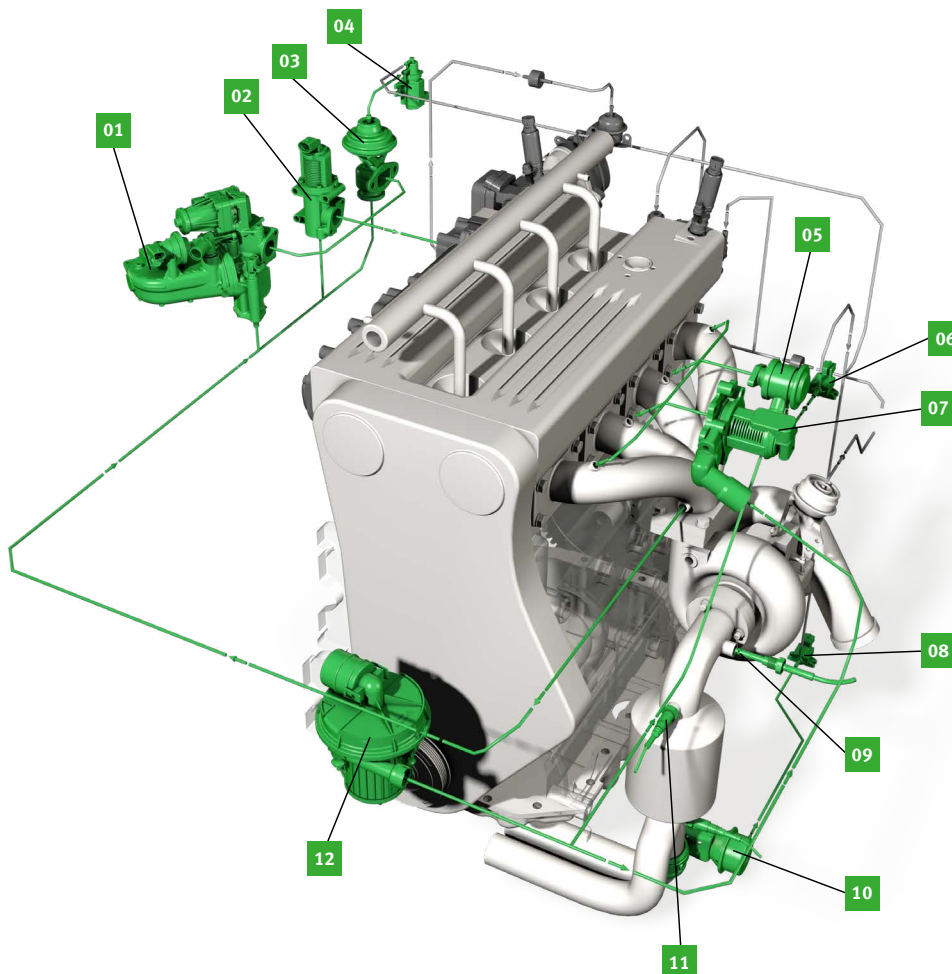

VANNES EGR

Pratiquement tous les moteurs diesel modernes sont aujourd'hui équipés de systèmes EGR pour pouvoir respecter les normes d'émission.

Les gaz d'échappement sont prélevés directement derrière le cylindre avant d'être rajoutés à l'air aspiré. Ainsi, moins d'oxygène entre dans le cylindre. Et moins d'oxygène, cela signifie une température de combustion plus basse, qui permet de réduire de 50 % la part des oxydes d'azote (NO_x) dans les gaz d'échappement. Sur les moteurs à essence, ce recyclage permet en outre de réduire les émissions de CO_2 et la consommation de carburant.



Dans la mesure où Pierburg a participé au développement de ces systèmes depuis les années 1970, l'état actuel de la technologie est en partie le résultat de son travail.

REFROIDISSEUR EGR

Afin de répondre aux exigences croissantes des normes d'émission, les systèmes de recyclage des gaz d'échappement doivent être refroidis.

Le refroidissement des gaz d'échappement permet d'abaisser la température de combustion maximale et, donc, de réduire significativement la quantité d'oxydes d'azote produite. De plus, les gaz refroidis prennent moins de place que les gaz chauds. Par conséquent, pour le même taux de compression, une masse plus importante est traitée en un remplissage de cylindre. La combustion appauvrie qui en résulte a un effet positif sur la consommation et les émissions de particules.



VOLETS DE GAZ D'ÉCHAPPEMENT

Les volets de gaz d'échappement sont un élément important des moteurs modernes pour la réduction des émissions nocives et l'amélioration du confort. Ils dirigent les gaz d'échappement dans différentes lignes d'échappement en fonction du régime de service.

Domaines d'utilisation à proximité du moteur :

- Catalyseurs DeNO_x
- Recyclage des gaz d'échappement à basse pression
- Absorbants d'hydrocarbures

La gamme de Motorservice comprend des volets de gaz d'échappement pneumatiques, électriques, mais aussi pour les motos.

Tous les volets sont conçus pour des températures extrêmes de -40°C à $+950^\circ\text{C}$, et pour une durée de service de plus de 1000 000 de cycles.



SONDES LAMBDA

Les sondes lambda mesurent la teneur en oxygène résiduelle des gaz d'échappement. Grâce à la valeur lambda qu'elles permettent d'obtenir, la gestion du moteur régule la composition du mélange pour une combustion optimisée.

Dans la gestion du moteur, les sondes lambda sont essentielles pour assurer un régime moteur parfait parallèlement à de faibles émissions.

Les températures de service élevées et les gaz d'échappement agressifs sont autant de défis pour les sondes lambda. N'hésitez donc pas à opter pour les produits du spécialiste de la réduction des émissions nocives.



CAPTEURS DE TEMPÉRATURE DES GAZ D'ÉCHAPPEMENT

Les capteurs de température des gaz d'échappement contrôlent le flux des gaz d'échappement chauds et protègent les composants de la surchauffe. Parmi leurs applications typiques, nous pourrions citer la protection des composants sensibles à la chaleur, notamment turbocompresseurs et tous les types de catalyseur, la surveillance du processus de combustion régénérative dans le filtre à particules diesel, le contrôle de la plage des températures optimales des catalyseurs et la mesure de la température des gaz d'échappement lors du recyclage des gaz d'échappement dans le cadre du diagnostic embarqué (OBD). En cas de surchauffe critique, l'appareil de commande réagit en prenant les mesures nécessaires pour abaisser la température, par ex. en diminuant la puissance (mode dégradé).

Avec une gamme de 30 capteurs de température des gaz d'échappement, Motorservice couvre près de 1 400 modèles de véhicule.



POMPES D'AIR SECONDAIRE

Les pompes d'air secondaire fonctionnent à haut régime avec des ventilateurs à un ou deux niveaux. Elles aspirent l'air environnant pour le souffler dans le collecteur de gaz d'échappement derrière les soupapes d'échappement. Sur les moteurs à essence, elles permettent ainsi de réduire nettement le monoxyde de carbone et les hydrocarbures imbrûlés produits au cours de la phase de démarrage à froid – lorsque le catalyseur n'est pas encore à la température de service.



VALVES D'AIR SECONDAIRE

Les valves d'air secondaire se situent entre la pompe d'air secondaire et le collecteur de gaz d'échappement. Une valve d'air secondaire a plusieurs fonctions :

- Sa fonction anti-retour permet de protéger la pompe d'air secondaire des détériorations causées par les gaz d'échappement, les condensats ou les pointes de pression dans la ligne d'échappement.
- Sa fonction de coupure permet d'acheminer l'air secondaire uniquement durant la phase de démarrage à froid vers le collecteur de gaz d'échappement.



DANS LA VASTE PALETTE DE PRODUITS MOTORSERVICE, VOUS TROUVerez TROIS TYPES DE VALVES D'AIR SECONDAIRE DE LA MARQUE PIERBURG :

↘

ÉLECTRIQUE

Les valves d'air secondaire électriques disposent de durées d'ouverture et de fermeture raccourcies, et elles présentent une meilleure résistance au calaminage causé par la suie et les salissures.

↘

PNEUMATIQUE

Utilisées depuis des décennies, les valves d'air secondaire pneumatiques ont apporté la preuve de leur efficacité. Leur commande nécessite une vanne d'inversion.

↘

COMMANDE PAR PRESSION

Ce type de valve d'air secondaire s'ouvre sous la pression produite par la pompe d'air secondaire.

2. PRÉCISIONS SUR L'UTILISATION DU CATALOGUE

FRANÇAIS

01		02		03		04		05		06		07	
PIERBURG												VOLKSWAGEN	
POLO (9N_)												56	
1.9 TDI 74 kW (100 PS) AXR		10.2001→11.2009				7.24809.16.0		AGR		PN		ch. 9N-2-000 001→	
1.9 TDI 74 kW (101 PS) BMT		10.2001→11.2009				7.00678.04.0*		AGR-M		EL		mit Rohrstutzen with pipe socket ch. 9N-5-500 001→	
						↳ 7.00907.03.0		AGR		EL			
1.9 TDI 96 kW (130 PS) ASZ		11.2003→11.2009				7.24809.55.0		AGR		PN			
1.9 TDI 96 kW (130 PS) BLT		05.2004→11.2009				7.24809.16.0		AGR		PN		ch. 9N-2-000 001→	
						09		08					

01 Véhicule / Moteur	05 Code d'article*
02 Année de construction de → à	06 Mode d'entraînement / Modèle
03 Groupe de produits	07 Infos / Critères
04 7.xxxxx.xx.x ↳ 4.xxxxx.xx.x Kit de réparation 7.xxxxx.xx.x**	08 Sigles des articles*
	09 N° Pierburg



* voir liste des abréviations
** plus disponible

N° PIERBURG

PIERBURG		02		PIERBURG No.		03	
						123	
01		7.00075.07.0		AGR		4	
		7.00216.06.0		SLP		25	
		7.00306.37.0		AGR		4	
		7.05574.03.0		SLV		32	
		7.06712.23.0		ARV		20	
		7.07696.00.0		SRM-AK		35	
		7.22778.96.0		SLV		33	
		7.22778.97.0		SLV		33	
		7.22778.98.0		SLV		33	

01 N° Pierburg
02 Code d'article
03 Illustration / Page

APPLICATIONS PRINCIPALES

PIERBURG		AGR-K 7.02156.34.0		AGR-K 7.02156.35.0		AGR-K 7.02756.07.0	
							
<p>01 N° Pierburg</p>		<p>02 Code d'article</p>		<p>03 Groupe de produits</p>		<p>04 Product / Service Information</p>	
<p>05 Véhicule</p>		<p>CITROEN BERLINGO (B9) BERLINGO Kasten (B9) C-ELYSEE C3 II (SC_) C3 Picasso C4 AIRCROSS C4 CACTUS</p>		<p>CITROEN BERLINGO (B9) BERLINGO Kasten (B9) C-ELYSEE C3 II (SC_) C3 Picasso C4 AIRCROSS C4 CACTUS</p>		<p>VOLKSWAGEN MULTIVAN V (7HM, 7HN, 7HF, 7EF, 7EM, 7EN) TRANSPORTER V Bus (7HB, 7HJ, 7EB, 7EJ, 7EF, 7EG, 7HF, 7EC)</p>	



APPLICATION MOTORSERVICE ACCÈS MOBILE AU SAVOIR-FAIRE TECHNIQUE



Pour plus d'informations
www.ms-motorservice.com/app

INDICACIONES IMPORTANTES

Todos los datos de este catálogo no son vinculantes. No podemos asumir ninguna responsabilidad por su exactitud e integridad. La información sobre posibles errores en el catálogo es siempre bienvenida y será corregida en futuras ediciones.

Los nombres, descripciones y números de vehículos o fabricantes, entre otros, así como los números de pieza originales de los fabricantes de vehículos y motores, solo se indican con fines comparativos. Las indicaciones correspondientes no son denominaciones de origen y no pueden utilizarse con terceros. Tenga también en cuenta que no se pueden descartar modificaciones en el equipamiento por parte de los fabricantes de vehículos o motores, ni cambios en las denominaciones. Por lo tanto, no podemos asumir ninguna responsabilidad por el uso de las listas comparativas.

Nos reservamos expresamente el derecho de modificar en cualquier momento las especificaciones del producto, los materiales, el aspecto y el volumen de suministro de nuestros productos. Por lo tanto, las ilustraciones del catálogo no son vinculantes.

Antes del montaje, se debe comprobar siempre si el producto adquirido es adecuado para el uso previsto. De nuestra información no se puede derivar una afirmación sobre una determinada naturaleza o idoneidad para un uso determinado. En particular, hay que tener en cuenta que los productos ofrecidos en el catálogo no están destinados a ser utilizados en aeronaves o naves espaciales. Cuando se utilizan en motores fuera de carretera (p. ej. motores marinos, estacionarios o subterráneos) se debe tener en cuenta que, con la misma denominación del motor, pueden utilizarse diferentes piezas del motor (p. ej. pistones). En caso necesario, se debe solicitar el asesoramiento del fabricante o del taller autorizado antes de instalar los productos. Además, le informamos de que el montaje debe ser realizado siempre por personal técnico con formación. Las ilustraciones, los esquemas y demás indicaciones se muestran con fines explicativos e ilustrativos y no pueden utilizarse como base para la instalación.

Cualquier duplicación, imitación, distribución o reproducción pública de este catálogo, incluso parcial, solo está permitida con nuestro consentimiento previo por escrito y la correspondiente referencia a la fuente. Con la publicación de este catálogo, todas las ediciones anteriores pierden su validez.

ESPAÑOL

CERTIFICACIONES

MS Motorservice International GmbH cuenta con un sistema de gestión de calidad certificado según ISO 9001 y un sistema de gestión medioambiental certificado según ISO 14001.





LOS CONTENIDOS DEL CATÁLOGO TAMBIÉN SE RECOGEN EN NUESTRO CATÁLOGO ONLINE, EN NUESTRA APLICACIÓN, ASÍ COMO EN TECALLIANCE.

Más información:
catalog.ms-motorservice.com
motorservice.app



CONTENIDO	PÁGINA
Indicaciones importantes	38
Gestión de calidad	38
Transferencia de conocimientos especiales: conocimientos técnicos del experto	40
1. Reducción de contaminantes	43
2. INDICACIONES PARA LA UTILIZACIÓN DEL CATÁLOGO	46
3. Aplicaciones principales / figuras de productos	85
4. Adición al programa	231
5. Índice de fabricantes	249
6. PROGRAMA DE PRODUCTOS	253
7. Lista de referencias	1933
8. Manera de proceder en caso de reclamación / formulario de reclamación	

GRUPO MOTORSERVICE

CALIDAD Y SERVICIO EN UN SOLO PROVEEDOR

El Grupo Motorservice es la organización de ventas y distribución para las actividades de servicio posventa de Rheinmetall en todo el mundo. Se trata de uno de los principales proveedores de componentes del motor en el mercado libre de piezas de repuesto. Gracias a las marcas de primera calidad Kolbenschmidt, Pierburg y TRW Engine Components, así como a las marcas BF y turbo by Intec, Motorservice ofrece a sus clientes comerciales y de talleres un amplio y completo surtido de máxima calidad.

RHEINMETALL

TECNOLOGÍAS PARA LA MOVILIDAD DEL FUTURO

Como proveedor automotriz internacional, Rheinmetall está a la cabeza en los mercados correspondientes gracias a su gran competencia en los sectores de alimentación de aire, reducción de contaminantes y bombas, así como en el desarrollo, producción y suministro de piezas de repuesto para pistones, bloques de motor y cojinetes de fricción. El desarrollo de productos se efectúa en estrecha colaboración con fabricantes de automóviles de renombre.

TRANSFERENCIA DE EXPERIENCIAS CONOCIMIENTOS TÉCNICOS DEL EXPERTO

CURSOS FORMATIVOS EN TODO EL MUNDO

Directamente del fabricante

Aualmente, alrededor de 4.500 mecánicos y técnicos se benefician de nuestros cursos formativos y seminarios, que realizamos a escala mundial in situ o también en nuestros centros de formación en Neuenstadt y Dormagen y Tamm (Alemania).

INFORMACIONES TÉCNICAS

De la práctica para la práctica

Con las Product Information, las Service Information, los folletos técnicos y los pósters, estará usted siempre a la vanguardia de la técnica.

VÍDEOS TÉCNICOS

Difusión de conocimientos por vídeo

En nuestros vídeos encontrará indicaciones prácticas para el montaje y aclaraciones sistemáticas sobre nuestros productos.



PRODUCTOS EN EL PUNTO DE MIRA ONLINE

Nuestras soluciones explicadas de forma gráfica

Conozca, gracias a los elementos interactivos, las animaciones y los clips de vídeo, aspectos curiosos de nuestros productos para y acerca del motor.

TIENDA ONLINE

Su acceso directo a nuestros productos

Realice pedidos las 24 horas. Rápida comprobación de la disponibilidad. Amplia búsqueda de productos del motor, el vehículo, las dimensiones, etc.

NOVEDADES

Informaciones regulares por e-mail

Suscríbase de forma online a nuestro Newsletter gratuito y recibirá periódicamente informaciones sobre productos recién incluidos, publicaciones técnicas y mucho más.

INFORMACIONES INDIVIDUALES

Especialmente para nuestros clientes

Le ofrecemos numerosas informaciones y servicios sobre nuestro amplio espectro de prestaciones: como por ejemplo, materiales de promoción de ventas personalizados, asistencias de ventas, soporte técnico y mucho más.



TECNIPEDIA

Informaciones técnicas en torno al motor

En nuestra Tecnipedia compartimos con usted nuestra experiencia. Aquí podrá encontrar conocimientos técnicos directamente del experto.

APLICACIÓN DE MOTORSERVICE

Acceso móvil a la experiencia técnica

Aquí podrá obtener de forma rápida y sencilla las informaciones y los servicios más actuales acerca de nuestros productos.

MEDIOS SOCIALES

Siempre actual



www.ms-motorservice.com





1. REDUCCIÓN DE CONTAMINANTES

50 % MENOS DE SUSTANCIAS CONTAMINANTES ANTES DE ALCANZARSE EL CATALIZADOR

No en vano, Pierburg está representada con las válvulas EGR y radiador EGR en numerosos vehículos modernos como fabricante de equipamiento original. Los materiales resistentes a la corrosión y a la temperatura de los productos Pierburg garantizan una larga durabilidad bajo las condiciones más adversas, como, por ejemplo, el condensado de gases de escape, una temperatura de hasta 700 °C y una presión de hasta 3 bares.

PROGRAMA DE PRODUCTOS

- 01 Módulo radiador EGR
- 02 Válvula EGR (eléctrica)
- 03 Válvula EGR (neumática)
- 04 Convertidor de presión para el control de las válvulas EGR neumáticas
- 05 Válvula de aire secundario (neumática)
- 06 Válvula de inversión para el control de las válvulas de aire secundario neumáticas
- 07 Válvula de aire secundario (eléctrica)
- 08 Válvula de inversión para el control de la mariposa del escape
- 09 Sensor de temperatura de los gases de escape
- 10 Mariposa del escape
- 11 Sonda Lambda
- 12 Bomba de aire secundario

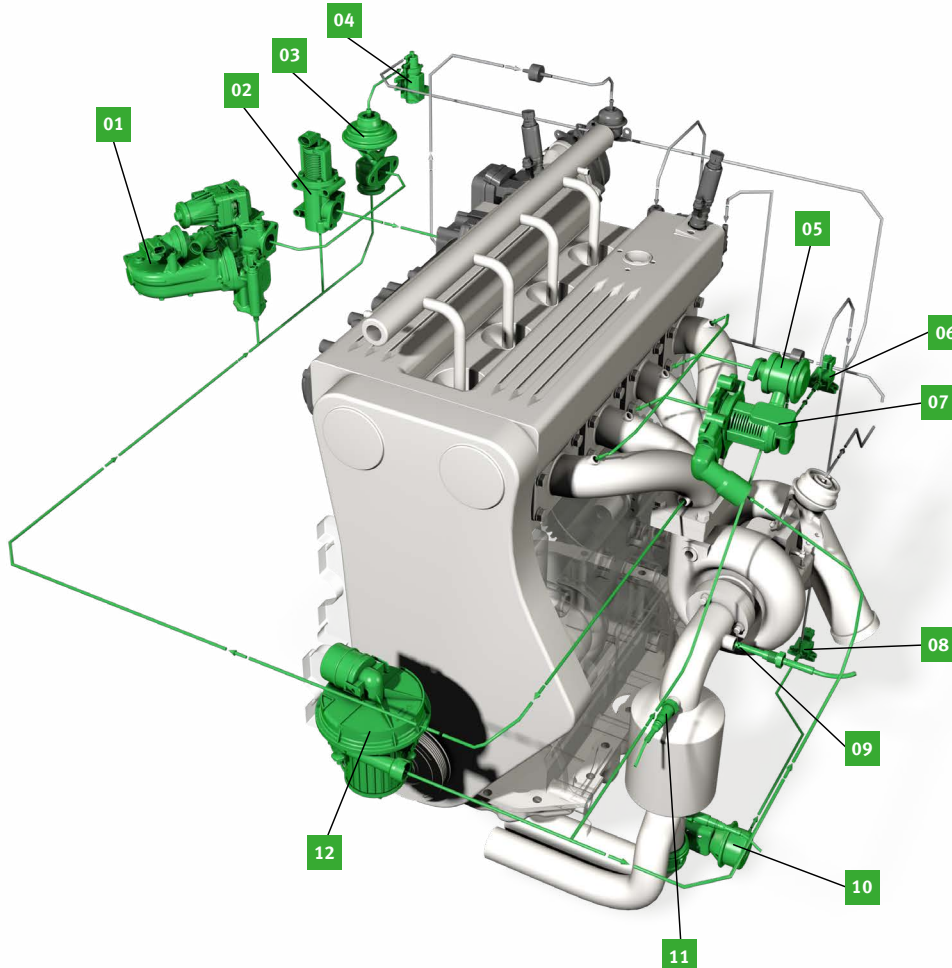

VÁLVULAS EGR

Todos los motores diésel modernos han de estar equipados actualmente con sistemas EGR para poder cumplir las normas sobre gases de escape.

Se extrae gas de escape inmediatamente detrás del cilindro y se vuelve a mezclar con el aire de aspiración. De esta forma entra menos oxígeno en el cilindro. Esto origina una menor temperatura de combustión. De este modo se puede reducir hasta en un 50 % la cantidad de óxidos de nitrógeno en el gas de escape. Además, en los motores de gasolina se puede reducir la emisión de dióxido de carbono, así como el consumo.



Pierburg ha participado en el desarrollo de estos sistemas desde los años 70 hasta la actualidad y, por lo tanto, ha contribuido notablemente al estado actual de la técnica.

RADIADOR EGR

Para afrontar las exigencias cada vez mayores de las normas sobre gases de escape se requieren sistemas de recirculación refrigerada de los gases de escape.

El gas de escape refrigerado hace disminuir la temperatura pico de combustión. De este modo se reduce notablemente la producción de óxidos de nitrógeno. Además, los gases refrigerados son más densos que los más calientes. Esto significa: con igual presión de carga se ajusta más masa en un llenado del cilindro. La combustión «más pobre» que esto ocasiona se nota positivamente en el consumo y en las emisiones de partículas.



MARIPOSAS DEL ESCAPE

Para la reducción de contaminantes y el aumento de la comodidad las mariposas del escape son un elemento importante de los motores modernos. Gracias a ellas, el gas de escape se conduce a través de diferentes sistemas de escape, en función del estado de funcionamiento.

Se emplean en zonas próximas al motor:

- catalizadores DeNO_x
- recirculación de los gases de escape de baja presión
- absorbedores HC

El programa de suministro de Motorservice abarca mariposas del escape neumáticas y eléctricas, así como mariposas del escape para motos. Todas las válvulas están diseñadas para temperaturas del gas extremas de -40°C a +950°C, así como para una vida útil de más de 1 000 000 de ciclos de conmutación.



SONDAS LAMBDA

Las sondas Lambda miden el resto de oxígeno en el gas de escape. Por medio del valor Lambda calculado de esta manera, la gestión del motor regula la composición de la mezcla para una combustión lo más óptima posible.

Las sondas Lambda son los elementos más importantes en la gestión del motor para garantizar una perfecta marcha del motor con bajas emisiones.

Las altas temperaturas de servicio y los agresivos gases de escape someten a las sondas Lambda a elevadas exigencias. Por lo tanto, decídase por los productos del especialista en la reducción de contaminantes.



SENSORES DE TEMPERATURA DE LOS GASES DE ESCAPE

Los sensores de temperatura de los gases de escape controlan el flujo caliente de gases de escape y protegen los componentes frente al sobrecalentamiento. Son aplicaciones típicas la protección de componentes sensibles a la temperatura como, p. ej., turbocargadores y todos los tipos de catalizadores, la supervisión del proceso de combustión libre del filtro de partículas diésel, el control de la ventana de temperatura óptima de catalizadores y la medición de la temperatura de gases de escape como parte integrante del diagnóstico de a bordo (OBD). En caso de un sobrecalentamiento crítico la unidad de control reacciona con las medidas correspondientes para bajar la temperatura, p. ej., reduciendo la potencia (modo de emergencia).

Con sus 30 sensores de temperatura de los gases de escape Motorservice abarca alrededor de 1400 tipos de vehículos.



BOMBAS DE AIRE SECUNDARIO

Las bombas de aire secundario son ventiladores altamente revolucionados de uno o dos escalones. Estas aspiran el aire ambiental y lo inyectan en el colector de gases de escape detrás de las válvulas de escape. De este modo, en los motores de gasolina se ocupan de que las cantidades elevadas de monóxido de carbono e hidrocarburos no quemados durante la fase de arranque en frío se reduzcan claramente si el catalizador todavía no está a la temperatura de trabajo.



VÁLVULAS DE AIRE SECUNDARIO

Las válvulas de aire secundario se encuentran entre la bomba de aire secundario y el colector de gases de escape. La válvula de aire secundario ha de cumplir varias funciones:

- La función de retención impide que el gas de escape, el condensado o los picos de presión en el sistema de escape ocasionen daños en la bomba de aire secundario.
- La función de desconexión se encarga de que el aire secundario solo llegue al colector de gases de escape en la fase de arranque en frío.



LA AMPLIA GAMA DE PRODUCTOS DE MOTORSERVICE INCLUYE TRES TIPOS DISTINTOS DE VÁLVULAS DE AIRE SECUNDARIO PIERBURG:

ELÉCTRICAS

Las válvulas de aire secundario eléctricas ofrecen tiempos de apertura y cierre relativamente cortos y son resistentes frente a las adhesiones de hollín o suciedad.

NEUMÁTICAS

Las válvulas de aire secundario neumáticas han sido probadas desde hace décadas. Para su control necesitan una válvula de inversión.

CONTROLADAS POR PRESIÓN

Este tipo de válvula de aire secundario se abre por la presión de la bomba de aire secundario.

ESPAÑOL

2. INDICACIONES PARA LA UTILIZACIÓN DEL CATÁLOGO

01

02

03

04

05

06

07

VOLKSWAGEN

POLO (9N_)						56
1.9 TDI 74 kW (100 PS) AXR	10.2001→11.2009		7.24809.16.0	AGR	PN	ch. 9N-2-000 001→
1.9 TDI 74 kW (101 PS) BMT	10.2001→11.2009		7.00678.04.0*	AGR-M	EL	mit Rohrstutzen with pipe socket ch. 9N-5-500 001→
			↳ 7.00907.03.0	AGR	EL	
1.9 TDI 96 kW (130 PS) ASZ	11.2003→11.2009		7.24809.55.0	AGR	PN	
1.9 TDI 96 kW (130 PS) BLT	05.2004→11.2009		7.24809.16.0	AGR	PN	ch. 9N-2-000 001→

09

08

01 Vehículo / motor

02 Año de construcción desde → hasta

03 Grupo de productos

04 7.xxxxx.xx.x
↳ 4.xxxxx.xx.x
Juego de reparaciones
7.xxxxx.xx.x**

05 Código de artículo*

06 Modo de accionamiento / versión

07 Inform. / criterios

08 Abreviatura de artículo*

09 N.º Pierburg

* Véase la lista de abreviaturas

** Ya no está disponible

ESPAÑOL

N.º PIERBURG

PIERBURG

02

PIERBURG No. 123





7.00075.07.0	AGR	4	7.05574.03.0	SLV	32	7.22778.96.0
7.00216.06.0	SLP	25	7.06712.23.0	ARV	20	7.22778.97.0
7.00306.37.0	AGR	4	7.07696.00.0	SRM-AK	35	7.22778.98.0
						33

01 N.º Pierburg

02 Código de artículo

03 Figura página

APLICACIONES PRINCIPALES

		emission control 	
01	03		
AGR-K 7.02156.34.0	AGR-K 7.02156.35.0	AGR-K 7.02756.07.0	
			
<p>05 CITROEN</p> <p>BERLINGO (B9) BERLINGO Kasten (B9) C-ELYSEE C3 II (SC_) C3 Picasso C4 AIRCROSS C4 CACTUS</p>	<p>CITROEN</p> <p>BERLINGO (B9) BERLINGO Kasten (B9) C-ELYSEE C3 II (SC_) C3 Picasso C4 AIRCROSS C4 CACTUS</p>	<p style="text-align: right;">→SI 0090 →SI 0092 →SI 0108 →SI 1003</p> <p>04 VOLKSWAGEN</p> <p>MULTIVAN V (7HM, 7HN, 7HF, 7EF, 7EM, 7EN) TRANSPORTER V Bus (7HB, 7HJ, 7EB, 7EJ, 7EF, 7EG, 7HF, 7EC)</p>	
<p>01 N.º Pierburg 02 Código de artículo 03 Grupo de productos 04 Product Information Service Information 05 Vehículo</p>			



APLICACIÓN MOTORSERVICE

ACCESO MÓVIL A LA EXPERIENCIA TÉCNICA



Saber más
www.ms-motorservice.com/app

INFORMAZIONI IMPORTANTI

Tutte le informazioni contenute in questo catalogo sono non vincolanti. Decliniamo ogni responsabilità quanto alla loro correttezza e completezza. Le segnalazioni di eventuali errori presenti nel catalogo sono sempre benvenute e verranno utilizzate a fini di rettifica delle edizioni future.

I nomi, le descrizioni e i numeri dei veicoli o dei costruttori ecc., nonché i numeri delle parti originali dei costruttori di veicoli e motori, sono indicati solo a scopo di confronto. Tali indicazioni non costituiscono denominazioni di origine e non possono essere utilizzate nei confronti di terzi. Si noti, inoltre, che non si possono escludere modifiche all'attrezzatura da parte dei costruttori di veicoli o motori né modifiche alle denominazioni. Pertanto, non ci assumiamo nessuna responsabilità riguardo all'uso delle liste di comparazione.

Ci riserviamo espressamente di modificare in qualsiasi momento le specifiche, i materiali, l'aspetto e l'ambito di consegna dei nostri prodotti. Le illustrazioni del catalogo non sono quindi vincolanti.

Prima dell'installazione, verificare sempre che il prodotto acquistato sia idoneo all'uso che se ne intende fare. Dalle nostre informazioni non è lecito desumere affermazioni su una particolare natura o sull'idoneità a uno scopo particolare. Si noti, in particolare, che i prodotti presentati nel catalogo non sono destinati all'uso in aeromobili e veicoli spaziali. In caso di utilizzo in motori Off-Highway (ad es. marini, stazionari o ferroviari), tenere presente che per la stessa denominazione di motore possono trovare impiego componenti del motore differenti (ad es. pistoni). Pertanto, prima dell'installazione dei prodotti potrebbe essere necessario il parere di un esperto del produttore o della sua officina autorizzata. Si ricorda, inoltre, che l'installazione deve sempre essere eseguita da personale specializzato e qualificato. Le illustrazioni, i disegni schematici e le altre informazioni hanno uno scopo illustrativo e esplicativo e non possono essere utilizzate come base per l'installazione.

Qualsiasi riproduzione, imitazione, distribuzione o comunicazione pubblica di questo catalogo, anche in estratti, è consentita solo con il nostro preventivo consenso scritto, e citando correttamente la fonte. Con la pubblicazione di questo catalogo tutte le precedenti edizioni perdono di validità.

CERTIFICAZIONI

MS Motorservice International GmbH dispone di un sistema di gestione della qualità certificato ISO 9001 e di un sistema di gestione ambientale certificato ISO 14001.





I CONTENUTI DEL CATALOGO SONO CONSULTABILI ANCHE NEL NOSTRO CATALOGO ONLINE, NELLA NOSTRA APP E IN TECALLIANCE.

Maggiori informazioni:
catalog.ms-motorservice.com
motorservice.app

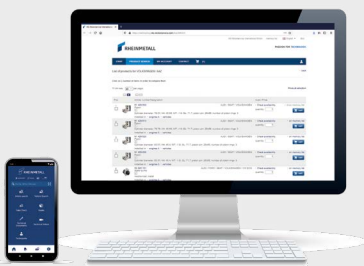

CONTENUTO	PAGINA
Avvertenze importanti	50
Gestione della qualità	50
Trasferimento di know-how – competenza tecnica di esperti	52
1. Riduzione delle sostanze nocive	55
2. AVVERTENZE SULL'UTILIZZO DEL CATALOGO	58
3. Applicazioni principali / illustrazioni prodotti	85
4. Integrazione programma	231
5. Elenco dei produttori	249
6. APPLICAZIONI PRODOTTI	253
7. Liste corrispondenze	1933
8. Modo di procedere in caso di reclamo / modulo reclami	

GRUPPO MOTORSERVICE

QUALITÀ E ASSISTENZA DA UN UNICO FORNITORE

Il gruppo Motorservice è l'organizzazione di distribuzione per le attività aftermarket di Rheinmetall a livello globale. L'azienda rappresenta uno dei fornitori leader per componenti del motore nel mercato libero dei ricambi. Con i marchi premium Kolbenschmidt, Pierburg, TRW Engine Components e i marchi BF e turbo by Intec, Motorservice offre ai suoi rivenditori e alle officine un ampio e vario assortimento di elevata qualità.

RHEINMETALL

TECNOLOGIE PER LA MOBILITÀ DEL FUTURO

In qualità di partner privilegiato dell'industria automobilistica, Rheinmetall è leader a livello mondiale nei settori dell'alimentazione dell'aria, della riduzione delle sostanze nocive e delle pompe nonché nello sviluppo, nella produzione e nella fornitura di ricambi di pistoni, blocchi motore e cuscinetti a strisciamento. Lo sviluppo dei prodotti avviene in stretta collaborazione con i principali costruttori automobilistici.



TRASFERIMENTO DI KNOW-HOW CONSULENZA DI ESPERTI

FORMAZIONE A LIVELLO GLOBALE

Ogni anno circa 4.500 meccanici e tecnici colgono l'opportunità e partecipano ai nostri corsi di formazione e seminari che organizziamo in loco in tutto il mondo o anche nei nostri centri di formazione a Dormagen e Tamm (Germania).

INFORMAZIONI TECNICHE

Con le Product Information, le Service Information, le brochure e i poster tecnici lo stato attuale della tecnica non è più un mistero.

VIDEO TECNICI

Nei nostri video tecnici potrete trovare avvertenze per il montaggio orientate alla pratica e spiegazioni sul sistema relative ai nostri prodotti.

 **YouTube**

PRODOTTI IN DETTAGLIO ONLINE

Tramite gli elementi interattivi, le animazioni e i videoclip imparerete tutto quello che è utile sapere sui prodotti e sul motore.

ONLINESHOP

Ordini 24 ore su 24. Verifica rapida della disponibilità. Ampia ricerca prodotti in base a motore, a veicolo, dimensioni, etc.

NOTIZIE

Iscrivetevi ora online alla nostra newsletter gratuita. Riceverete regolarmente informazioni sui nuovi prodotti, sulle pubblicazioni tecniche e tanto altro ancora.

INFORMAZIONI PERSONALIZZATE

Vi forniremo informazioni dettagliate e assistenza sul nostro ampio spettro di servizi: come ad es. materiale di promozione delle vendite, supporto alle vendite, assistenza tecnica e tanto altro ancora.



TECHNIPEDIA

Nella nostra Technipedia condividiamo con voi il nostro vasto know-how. Avrete accesso diretto alle conoscenze tecniche dei nostri esperti.

MOTORSERVICE APP

Qui troverete in modo semplice e rapido informazioni aggiornate e assistenza sui nostri prodotti.

SOCIAL MEDIA

Aggiornamento costante



www.ms-motorservice.com





1° RIDUZIONE DELLE SOSTANZE NOCIVE

50 % IN MENO DI SOSTANZE NOCIVE ANCORA PRIMA DI RAGGIUNGERE IL CATALIZZATORE

Non per nulla Pierburg è presente in numerosi veicoli moderni con le sue valvole EGR e i suoi radiatori EGR. I materiali resistenti alla corrosione e alle temperature dei prodotti Pierburg garantiscono una lunga durata di funzionamento in condizioni proibitive come ad es. condensa dei gas di scarico aggressiva, temperature fino a 700 °C e pressioni di ben 3 bar.

GAMMA DI PRODOTTI

- 01 Modulo radiatore EGR
- 02 Valvola EGR (elettrica)
- 03 Valvola EGR (pneumatica)
- 04 Convertitore di pressione per il comando di valvole EGR pneumatiche
- 05 Valvola aria secondaria (pneumatica)
- 06 Valvola di commutazione per l'attivazione delle valvole aria secondaria pneumatiche
- 07 Valvola aria secondaria (elettrica)
- 08 Valvola di commutazione per il comando della farfalla gas di scarico
- 09 Sensore della temperatura dei gas di scarico
- 10 Farfalla gas di scarico
- 11 Sonda lambda
- 12 Pompa aria secondaria

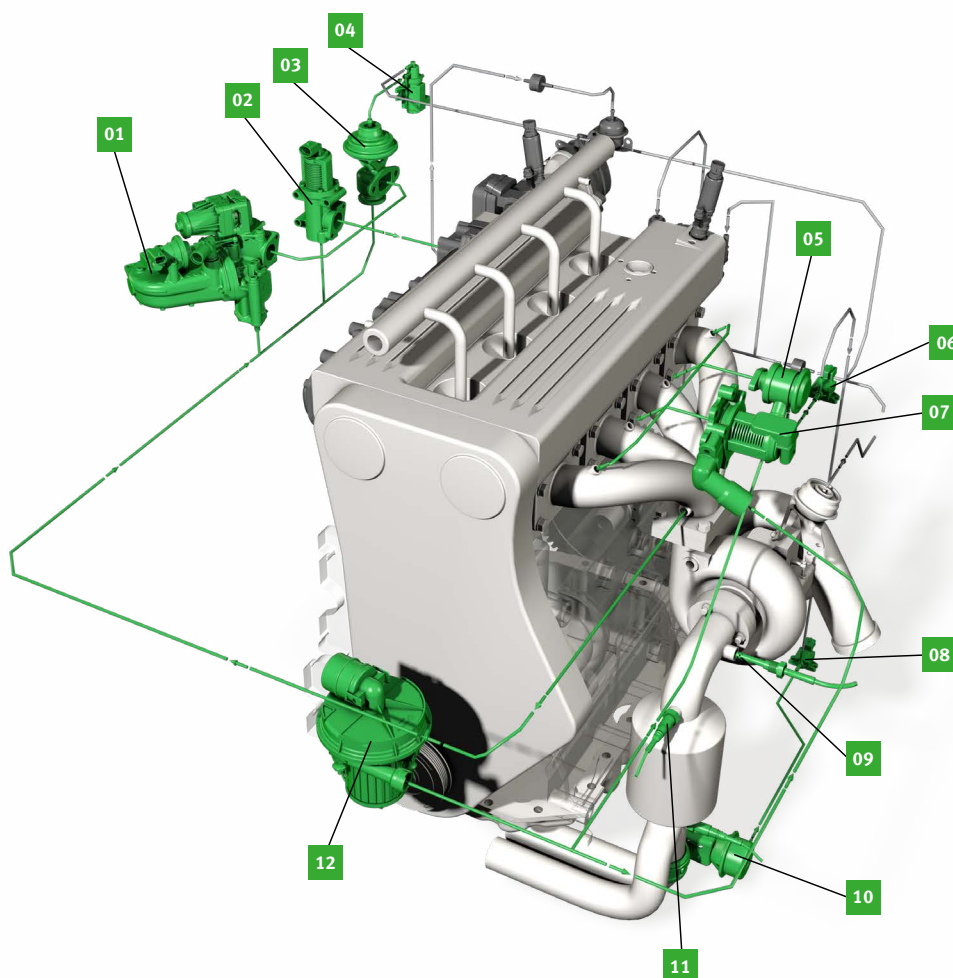

VALVOLE EGR

Tutti i moderni motori diesel devono oggi essere equipaggiati con sistemi EGR per poter rispettare le norme sui gas di scarico.

Il gas di scarico viene prelevato direttamente a valle dei cilindri e di nuovo immesso nel flusso dell'aria di aspirazione. Per questo giunge meno ossigeno nel cilindro. Ciò causa una temperatura di combustione inferiore. La quantità di ossido di azoto nel gas di scarico può quindi essere ridotta del 50%. Nei motori a benzina è inoltre possibile ridurre anche le emissioni di anidride carbonica e i consumi.



Pierburg sviluppa questi sistemi dagli anni Settanta e ha prestato dunque un importante contributo allo stato della tecnica attuale.

RADIATORI EGR

Per soddisfare i requisiti sempre più stringenti delle norme sui gas di scarico, i sistemi ricircolo gas di scarico sono oggi irrinunciabili.

Il gas di scarico raffreddato abbassa la temperatura di picco della combustione. Di conseguenza si formano meno ossidi d'azoto. Inoltre i gas più freddi hanno una maggiore densità rispetto a gas più caldi. Questo significa che: con una pressione di sovralimentazione invariata è possibile introdurre con una carica di cilindro una massa maggiore di gas. Il conseguente "impoverimento" della miscela ha un effetto positivo anche sui consumi e sulle emissioni di particolato.



FARFALLE GAS DI SCARICO

Le farfalle gas di scarico sono un componente importante dei motori moderni per la riduzione delle sostanze nocive e l'aumento del comfort. Esse si occupano dello scarico dei gas in base allo stato di funzionamento nei vari sistemi dei gas di scarico.

Ambiti di applicazione in prossimità del motore:

- Catalizzatori DeNO_x
- Ritorno dei gas di scarico a bassa pressione
- Assorbitori HC

Il programma di consegna di Motorservice comprende farfalle gas di scarico pneumatiche e elettriche nonché farfalle gas di scarico per motocicli. Tutte le valvole a farfalla sono concepite per resistere a temperature gas estreme da -40 °C a +950 °C nonché per una avere una durata di oltre 1.000.000 innesti.



SONDE LAMBDA

Le sonde lambda misurano l'ossigeno residuo contenuto nei gas di scarico. Con l'ausilio del valore lambda così calcolato, la gestione motore regola la composizione della miscela per una combustione il più possibile ottimale.

Le sonde lambda sono gli elementi più importanti nella gestione motore per garantire un perfetto funzionamento del motore con emissioni contenute.

Le elevate temperature di esercizio e gli aggressivi gas di scarico sollecitano notevolmente le sonde lambda. Andate sul sicuro e scegliete dunque i prodotti di un esperto nella riduzione delle sostanze nocive.



SENSORI DELLA TEMPERATURA DEI GAS DI SCARICO

I sensori della temperatura dei gas di scarico hanno il compito di controllare il flusso dei gas di scarico caldi e proteggono i componenti dal surriscaldamento. Applicazioni tipiche sono la protezione dei componenti sensibili alle temperature come ad es. i turbocompressori e tutti i tipi di catalizzatori, il monitoraggio della combustione libera del filtro antiparticolato diesel, il controllo della finestra di temperatura ottimale dei catalizzatori e la misurazione della temperatura dei gas di scarico EGR nell'ambito della diagnosi On Board (OBD). In caso di surriscaldamento critico la centralina di comando reagisce con interventi volti ad abbassare la temperatura, ad es. riduzione della potenza (funzionamento d'emergenza).

Con 30 sensori della temperatura dei gas di scarico Motorservice copre circa 1.400 tipi di veicoli.



POMPE ARIA SECONDARIA

Le pompe aria secondaria sono soffianti a uno o due stadi con un regime di funzionamento elevato. Queste aspirano l'aria ambiente e la soffiano nel collettore dei gas di scarico dietro le valvole di scarico. Nei motori a benzina fanno sì che le quantità elevate di monossido di carbonio e di idrocarburi non combusti della fase di avviamento a freddo, quando il catalizzatore non ha ancora raggiunto la sua temperatura di esercizio, si riducano notevolmente.



VALVOLE ARIA SECONDARIA

Le valvole aria secondaria si trovano tra la pompa aria secondaria e il collettore dei gas di scarico. La valvola aria secondaria svolge una serie di compiti:

- La funzione di non ritorno integrata impedisce che gas di scarico, condensa o picchi di pressione presenti nel sistema dei gas di scarico possano causare danni all'interno della pompa aria secondaria.
- La funzione di disinserimento fa sì che l'aria secondaria giunga nel collettore dei gas di scarico solo nella fase di avviamento a freddo.



IL VASTO PORTFOLIO DI PRODOTTI DI MOTORSERVICE COMPRENDE TRE DIVERSI TIPI DI VALVOLE ARIA SECONDARIA DI PIERBURG:



ELETRICA

Le valvole elettriche aria secondaria sono dotate di tempi di apertura e chiusura più brevi e sono più resistenti contro ostruzioni dovute a fuliggine o sporco.



PNEUMATICA

Le valvole pneumatiche aria secondaria hanno dato prova della propria validità nel corso di decenni. Esse necessitano di una valvola di commutazione per l'attivazione.



COMANDATA A PRESSIONE

Questo tipo di valvola aria secondaria si apre per effetto della pressione della pompa aria secondaria.



2° AVVERTENZE SULL'UTILIZZO DEL CATALOGO

01	02	03	04	05	06	07	
PIERBURG							VOLKSWAGEN
POLO (9N_)							56
1.9 TDI 74 kW (100 PS) AXR	10.2001→11.2009		7.24809.16.0	AGR	PN	ch. 9N-2-000 001→	
1.9 TDI 74 kW (101 PS) BMT	10.2001→11.2009		7.00678.04.0* ↳ 7.00907.03.0	AGR-M AGR	EL	mit Rohrstutzen with pipe socket ch. 9N-5-500 001→	
1.9 TDI 96 kW (130 PS) ASZ	11.2003→11.2009		7.24809.55.0	AGR	PN		
1.9 TDI 96 kW (130 PS) BLT	05.2004→11.2009		7.24809.16.0	AGR	PN	ch. 9N-2-000 001→	
			09	08			

01 Veicolo / motore
02 Anno di costruzione da → a
03 Gruppo prodotti
04 7.xxxxx.xx.x
↳ 4.xxxxx.xx.x
Set di riparazione
7.xxxxx.xx.x**

05 Codice articolo*
06 Tipo di azionamento / versione
07 Info / criteri
08 Abbreviazione articolo*
09 N. Pierburg

* vedere indice abbreviazioni
** non più disponibile





ITALIANO

N. PIERBURG

	02			03					
PIERBURG			PIERBURG No.	123					
01	7.00075.07.0	AGR	4	7.05574.03.0	SLV	32	7.22778.96.0	SLV	33
	7.00216.06.0	SLP	25	7.06712.23.0	ARV	20	7.22778.97.0	SLV	33
	7.00306.37.0	AGR	4	7.07696.00.0	SRM-AK	35	7.22778.98.0	SLV	33

01 N. Pierburg
02 Codice articolo
03 Figura / pagina

APPLICAZIONI PRINCIPALI

		emission control 	
01	03		
AGR-K 7.02156.34.0	AGR-K 7.02156.35.0	AGR-K 7.02756.07.0	
			
<p>05 CITROEN</p> <p>BERLINGO (B9)</p> <p>BERLINGO Kasten (B9)</p> <p>C-ELYSEE</p> <p>C3 II (SC_)</p> <p>C3 Picasso</p> <p>C4 AIRCROSS</p> <p>C4 CACTUS</p>	<p>CITROEN</p> <p>BERLINGO (B9)</p> <p>BERLINGO Kasten (B9)</p> <p>C-ELYSEE</p> <p>C3 II (SC_)</p> <p>C3 Picasso</p> <p>C4 AIRCROSS</p> <p>C4 CACTUS</p>	<p style="text-align: right;">02</p> <p style="text-align: right;">→SI 0090</p> <p style="text-align: right;">→SI 0092</p> <p style="text-align: right;">→SI 0108</p> <p style="text-align: right;">→SI 1003</p> <p>04 VOLKSWAGEN</p> <p>MULTIVAN V (7HM, 7HN, 7HF, 7EF, 7EM, 7EN)</p> <p>TRANSPORTER V Bus (7HB, 7HJ, 7EB, 7EJ, 7EF, 7EG, 7HF, 7EC)</p>	
<p>01 N. Pierburg</p> <p>02 Codice articolo</p> <p>03 Gruppo prodotti</p> <p>04 Product / Service Information</p> <p>05 Veicolo</p>			

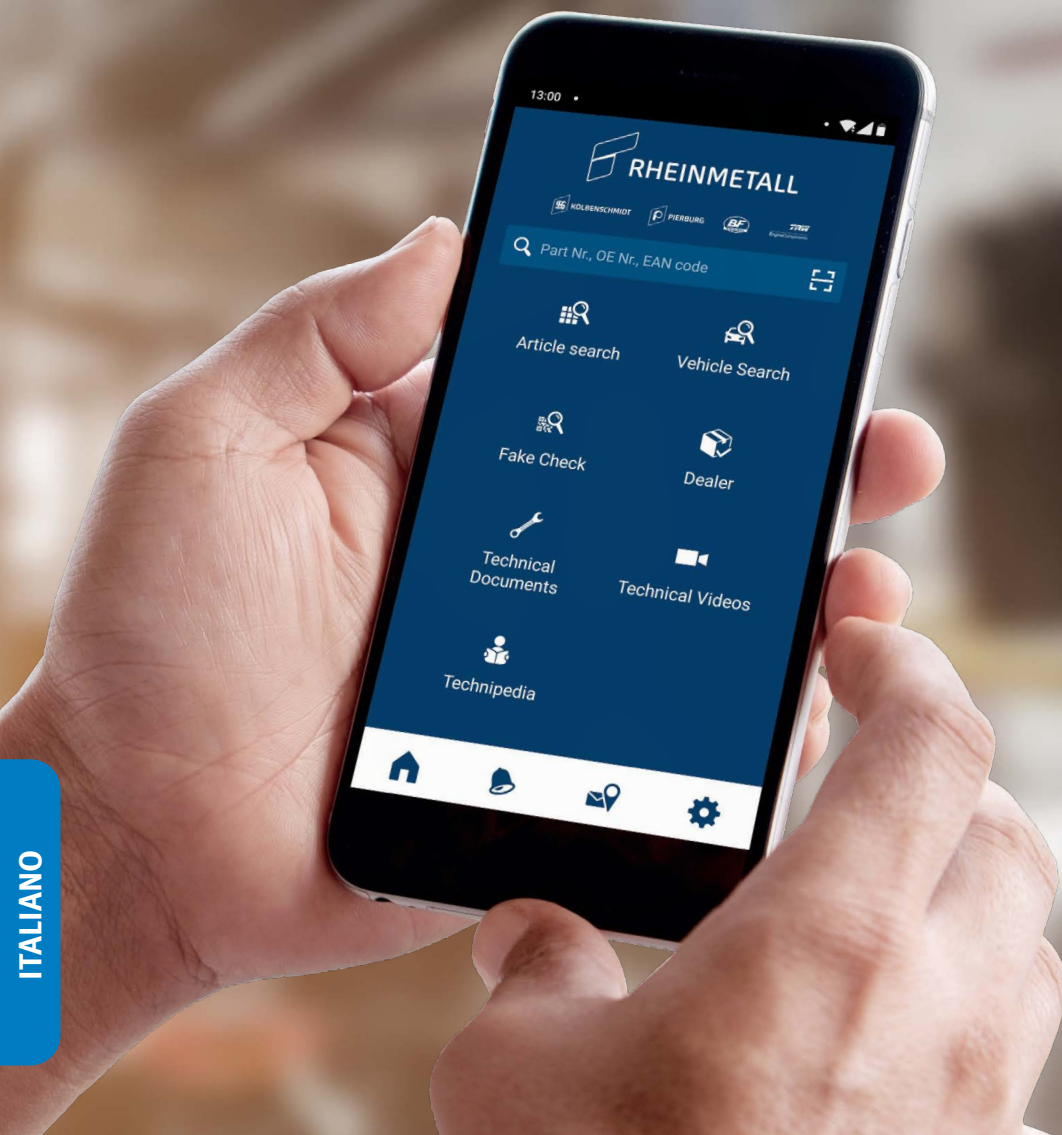

MOTORSERVICE APP

ACCESSO MOBILE AL NOSTRO KNOW-HOW TECNICO



Per maggiori informazioni
www.ms-motorservice.com/app

ВАЖНЫЕ УКАЗАНИЯ

Все приведенные в этом каталоге данные не являются обязательными. Мы не можем принять на себя ответственность за их правильность и полноту. Мы всегда рады получить информацию о возможных допущенных в каталоге ошибках, которые мы исправляем в следующих изданиях.

Названия, описания и номера автомобилей, производителей и т. п., а также оригинальные артикулы производителей автомобилей и двигателей приводятся только для сравнения. Соответствующие данные не являются данными о происхождении и не могут быть использованы против третьих лиц. Просим вас также учитывать, что не исключаются изменения в оснащении, внесенные производителями автомобилей или двигателей, а также изменения обозначений. По этой причине мы не можем принять на себя ответственность за использование списков сравнения.

Мы оставляем за собой право в любое время изменять спецификации, материалы, внешний вид и комплекты поставки наших компонентов. Поэтому приведенные в каталоге рисунки не являются обязательными.

Перед установкой всегда необходимо проверять пригодность приобретенного компонента к использованию в намеченных целях. На основании предоставленных нами данных нельзя делать заключения о наличии определенных характеристик или о пригодности к использованию в какой-либо области применения. В частности, следует учесть, что предлагаемые в каталоге компоненты не предназначены для использования в воздушных и космических транспортных средствах. В случае применения в двигателях, не предназначенных для дорожного транспорта (напр., судовых и стационарных двигателях, а также тяговых двигателях рельсового транспорта) необходимо учитывать, что при одном и том же обозначении двигателей в них могут использоваться разные компоненты (например, поршни). По этой причине перед установкой компонентов может потребоваться компетентная консультация производителя или авторизованной СТО. Мы также обращаем ваше внимание на то, что установку компонентов всегда должны выполнять квалифицированные специалисты. Рисунки, схематические чертежи и прочие данные используются для пояснения и иллюстрации; они не могут служить основой для установки.

Любое копирование, повторение, распространение или публичная демонстрация настоящего каталога или его частей возможны только с нашего предварительного письменного согласия с соответствующим указанием источника. С момента выпуска данного каталога все предыдущие издания теряют свою силу.

СЕРТИФИКАТЫ

Компания MS Motorservice International GmbH успешно прошла сертификацию системы менеджмента качества по ISO 9001 и системы экологического менеджмента по ISO 14001.





ИНФОРМАЦИЯ КАТАЛОГА СОДЕРЖИТСЯ ТАКЖЕ В НАШЕМ ОНЛАЙН-КАТАЛОГЕ, В НАШЕМ ПРИЛОЖЕНИИ И НА TECALLIANCE.

Дополнительная информация:
catalog.ms-motorservice.com
motorservice.app

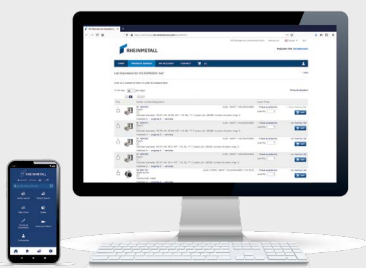

СОДЕРЖАНИЕ

СТР.

Важные указания	62
Менеджмент качества	62
Передача ноу-хау: специальные знания от эксперта	64
1. Уменьшение содержания вредных веществ	67
2. УКАЗАНИЯ ПО ПОЛЬЗОВАНИЮ КАТАЛОГОМ	70
3. Основные области применения / изображения компонентов	85
4. Дополнение к программе	231
5. Перечень производителей	249
6. ПРОИЗВОДСТВЕННЫЙ АССОРТИМЕНТ	253
7. Списки сравнения	1933
8. Процедура рассмотрения рекламаций / формуляр для рекламаций	

ГРУППА MOTORSERVICE

КАЧЕСТВО И СЕРВИС ИЗ ОДНИХ РУК

Группа Motorservice — это организация по сбыту продукции концерна Rheinmetall, активно действующая на мировом рынке послепродажного обслуживания автомобилей. Она является ведущей фирмой, предлагающей компоненты двигателей для свободного рынка запасных частей. Клиенты Motorservice получают из магазинов и СТО широкий и глубокий ассортимент продукции высочайшего качества, охватывающий премиум-марки Kolbenschmidt, Pierburg, TRW Engine Components, а также марки VF и turbo by Intec.

RHEINMETALL

ТЕХНОЛОГИИ В СФЕРЕ МОБИЛЬНОСТИ БУДУЩЕГО

В качестве поставщика автомобильной промышленности в мировом масштабе Rheinmetall, благодаря своему профессионализму, занимает на соответствующих рынках ведущие в мире позиции в таких областях, как снабжение воздухом, уменьшение содержания вредных веществ и насосы, а также по разработке и производству поршней, блоков цилиндров двигателей и подшипников скольжения, включая поставку запасных частей к ним. Разработка продуктов осуществляется в тесном сотрудничестве с известными компаниями-производителями транспортных средств.

ПЕРЕДАЧА НОУ-ХАУ СПЕЦИАЛЬНЫЕ ЗНАНИЯ ОТ ЭКСПЕРТА

КУРСЫ ОБУЧЕНИЯ ПО ВСЕМУ МИРУ

Напрямую от изготовителя

Ежегодно около 4 500 механиков и техников приобретают новые знания на наших курсах обучения и семинарах, которые мы проводим как на местах, в различных странах мира, так и в наших учебных центрах, расположенных в Нойенштадте, Дормагене и Тамме (Германия).

ТЕХНИЧЕСКАЯ ИНФОРМАЦИЯ

Практические навыки для практического применения

Благодаря нашим Product Information, Service Information, техническим брошюрам и плакатам Вы всегда будете идти в ногу со временем.

ТЕХНИЧЕСКИЕ ВИДЕОФИЛЬМЫ

Передача знаний по видео

Наши видеофильмы содержат проверенные на практике инструкции по монтажу и системные пояснения к нашим продуктам.



ПРОДУКТЫ В ФОКУСЕ ВНИМАНИЯ ОНЛАЙН

Наглядное описание наших решений

Вы узнаете много интересного о наших продуктах, установленных внутри двигателя и вокруг него, благодаря интерактивным элементам, анимации и видеороликам.

ВИРТУАЛЬНЫЙ МАГАЗИН

Ваш прямой доступ к нашим продуктам

Оформление заказов круглосуточно. Быстрый контроль наличия. Обширный поиск продуктов по двигателю, транспортному средству, размерам и т. д.

НОВОСТИ

Регулярно рассылаемая по e-mail информация

Подпишитесь онлайн на наш бюллетень, и Вы будете регулярно и бесплатно получать информацию о новых продуктах в программе, технические издания и многое другое.

ИНДИВИДУАЛЬНАЯ ИНФОРМАЦИЯ

Специально для наших заказчиков

Подробная информация и сервис из нашего обширного спектра услуг, например: индивидуализированные материалы для содействия сбыту, поддержка сбыта, техническая поддержка и многое другое.



ТЕХНИПЕДИЯ

Техническая информация, связанная с двигателями

В нашей технпедии мы поделимся с Вами своими ноу-хау. Здесь Вы найдете специальные знания напрямую от эксперта.

ПРИЛОЖЕНИЕ MOTORSERVICE

Мобильный доступ к техническому ноу-хау

Здесь Вы быстро и просто получите самую актуальную информацию и услуги по нашим продуктам.

СОЦИАЛЬНЫЕ СЕТИ

Всегда в курсе



www.ms-motorservice.com





1. УМЕНЬШЕНИЕ СОДЕРЖАНИЯ ВРЕДНЫХ ВЕЩЕСТВ

НА 50 % ЕЩЕ ДО ВХОДА В КАТАЛИЗАТОР

Именно поэтому многие современные автомобили оснащены клапанами EGR и охладителями системы EGR производства Pierburg. Термостойкие и антикоррозионные материалы, из которых изготовлены компоненты Pierburg, гарантируют их длительный срок службы в самых экстремальных условиях, например, при воздействии агрессивного конденсата отработанных газов, температуры до 700 °С и давления до 3 бар.

ПРОИЗВОДСТВЕННЫЙ АССОРТИМЕНТ

- 01 Модуль охладителя системы EGR
- 02 Клапан EGR (электрический)
- 03 Клапан EGR (пневматический)
- 04 Преобразователь давления для управления пневматическими клапанами EGR
- 05 Клапан вторичного воздуха (пневматический)
- 06 Переключающий клапан для управления пневматическими клапанами вторичного воздуха
- 07 Клапан вторичного воздуха (электрический)
- 08 Переключающий клапан для управления выпускной заслонкой
- 09 Датчик температуры ОГ
- 10 Выпускная заслонка
- 11 Лямбда-зонд
- 12 Насос вторичного воздуха

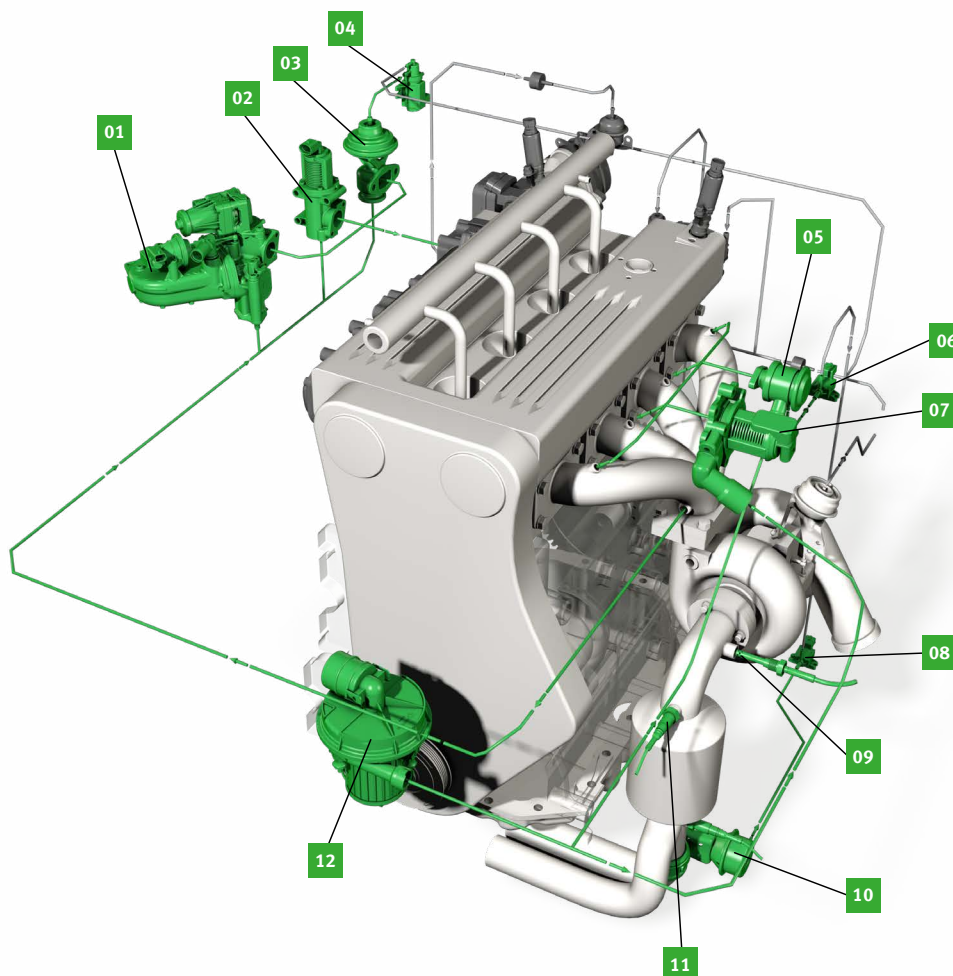

КЛАПАНЫ EGR

Для соблюдения актуальных норм токсичности отработанных газов все современные дизельные двигатели должны быть оснащены системами EGR.

Отработанные газы отбираются непосредственно на выходе из цилиндра и снова подмешиваются к впускному воздуху. Это означает, что в цилиндр попадает меньше кислорода, что в результате приводит к снижению температуры сгорания. Благодаря этому, содержание оксидов азота в отработанных газах можно уменьшить на 50%. У бензиновых двигателей также снижаются уровень содержания в выхлопе двуокси углерода и расход топлива.



Компания Pierburg разрабатывает эти системы с 970-х годов и по сей день, внося существенный вклад в развитие современной техники.

ОХЛАДИТЕЛИ СИСТЕМЫ EGR

Ужесточение требований норм токсичности отработанных газов вынуждает производителей использовать системы рециркуляции ОГ с охлаждением.

Охлажденные отработанные газы снижают максимальную температуру сгорания. Благодаря этому образуется намного меньше оксидов азота. Кроме того, плотность охлажденных газов выше, чем у более горячих газов. Это значит, что при одном и том же давлении наддува в цилиндр поступит большее количество воздуха. Смесь становится «беднее», и в результате её сгорания уменьшается расход топлива и уровень выбросов частиц сажи.



ВЫПУСКНЫЕ ЗАСЛОНКИ

Выпускные заслонки, используемые в современных двигателях, играют важную роль в уменьшении содержания вредных веществ и повышении комфорта. Они направляют отработанные газы в различные тракты системы выпуска ОГ, в зависимости от режима работы двигателя.

Области применения в системах, обслуживающих двигатель:

- катализаторы DeNO_x
- системы рециркуляции отработанных газов низкого давления
- накопительные нейтрализаторы углеводородов

В программу поставок компании Motorservice входят пневматические и электрические выпускные заслонки, а также выпускные заслонки для мотоциклов. Все виды заслонок рассчитаны на экстремальные температуры газа от -40°C до +950°C; их ресурс составляет более чем 1 000 000 циклов переключения.



ЛЯМБДА-ЗОНДЫ

Лямбда-зонды измеряют остаточное содержание кислорода в отработанных газах. На этой основе рассчитывается значение лямбда-фактора, которое система управления двигателем использует для поддержания заданного состава рабочей смеси и её оптимального сгорания.

Лямбда-зонды являются важнейшими элементами системы управления двигателем, обеспечивая его идеальную работу и низкий уровень вредных выбросов.

Высокая рабочая температура и агрессивные отработанные газы предъявляют к лямбда-зондам жёсткие требования. Поэтому сделайте свой выбор в пользу компонентов от производителя, специализирующегося на уменьшении содержания вредных веществ.



ДАТЧИКИ ТЕМПЕРАТУРЫ ОГ

Датчики температуры ОГ измеряют температуру потока отработанных газов и защищают компоненты от перегрева. Типичные случаи применения: защита чувствительных к температуре компонентов, например, турбокомпрессоров и всех типов катализаторов, контроль процесса регенерации дизельного сажевого фильтра, контроль за соблюдением оптимального температурного диапазона катализаторов и измерение температуры ОГ в системе EGR в рамках бортовой диагностики (OBD). В случае критического перегрева блок управления двигателем принимает соответствующие меры для снижения температуры, например, ограничивает мощность (аварийный режим).

В ассортимент Motorservice входят 30 видов датчиков температуры ОГ, предназначенных для применения на более чем 1 400 моделях автомобилей.



НАСОСЫ ВТОРИЧНОГО ВОЗДУХА

Насосы вторичного воздуха представляют собой высокооборотные, одно- или двухступенчатые вентиляторы. Они всасывают окружающий воздух и нагнетают его в выпускной коллектор за выпускными клапанами. Таким образом, в бензиновых двигателях они обеспечивают значительное снижение уровня выбросов окиси углерода и несгоревших углеводородов во время фазы холодного пуска, пока катализатор еще не достиг рабочей температуры.



КЛАПАНЫ ВТОРИЧНОГО ВОЗДУХА

Клапаны вторичного воздуха устанавливаются между насосом вторичного воздуха и выпускным коллектором. Клапан вторичного воздуха выполняет несколько функций:

- Функция отсечки предотвращает повреждение насоса вторичного воздуха под действием отработанных газов, конденсата или пиков давления в системе выпуска отработанных газов.
- Функция переключения обеспечивает подачу вторичного воздуха в выпускной коллектор только во время фазы холодного пуска.



В ШИРОКИЙ ПРОИЗВОДСТВЕННЫЙ АССОРТИМЕНТ КОМПАНИИ MOTORSERVICE ВХОДЯТ КЛАПАНЫ ВТОРИЧНОГО ВОЗДУХА PIERBURG ТРЕХ РАЗНЫХ ВИДОВ:

➤

ЭЛЕКТРИЧЕСКИЕ

Электрические клапаны вторичного воздуха отличаются малым временем открытия и закрытия и повышенной устойчивостью к заклиниванию из-за сажи или грязи.

➤

ПНЕВМАТИЧЕСКИЕ

Пневматические клапаны вторичного воздуха подтверждают свою надежность на протяжении десятилетий. Для их активации требуется переключающий клапан.

➤

КЛАПАНЫ, УПРАВЛЯЕМЫЕ ДАВЛЕНИЕМ

Клапаны вторичного воздуха этого типа открываются под действием давления насоса вторичного воздуха.

2. УКАЗАНИЯ ПО ПОЛЬЗОВАНИЮ КАТАЛОГОМ

01	02	03	04	05	06	07
PIERBURG						VOLKSWAGEN
POLO (9N_)						56
1.9 TDI 74 kW (100 PS) AXR	10.2001→11.2009		7.24809.16.0	AGR	PN	ch. 9N-2-000 001→
1.9 TDI 74 kW (101 PS) BMT	10.2001→11.2009		7.00678.04.0*	AGR-M	EL	mit Rohrstutzen with pipe socket ch. 9N-5-500 001→
			↳ 7.00907.03.0	AGR	EL	
1.9 TDI 96 kW (130 PS) ASZ	11.2003→11.2009		7.24809.55.0	AGR	PN	
1.9 TDI 96 kW (130 PS) BLT	05.2004→11.2009		7.24809.16.0	AGR	PN	ch. 9N-2-000 001→
			09	08		

01 Автомобиль / двигатель	05 Код изделия*
02 Год выпуска с → по	06 Вид привода / исполнение
03 Группа компонентов	07 Информация / критерии
04 7.xxxxx.xx.x ↳ 4.xxxxx.xx.x Ремонтный комплект 7.xxxxx.xx.x**	08 Сокращенное обозначение изделия*
	09 Pierburg №





* см. перечень сокращений
** больше не поставляется

PIERBURG №

	02	PIERBURG No.	03
		123	
01	7.00075.07.0	AGR	4
	7.00216.06.0	SLP	25
	7.00306.37.0	AGR	4
	7.05574.03.0	SLV	32
	7.06712.23.0	ARV	20
	7.07696.00.0	SRM-AK	35
	7.22778.96.0	SLV	33
	7.22778.97.0	SLV	33
	7.22778.98.0	SLV	33

01 Pierburg №
02 Код изделия
03 Рисунок / страница

ОСНОВНЫЕ ОБЛАСТИ ПРИМЕНЕНИЯ

			
<p>01</p>	<p>03</p>	<p>02</p>	<p>04</p>
<p>AGR-K 7.02156.34.0</p> 	<p>AGR-K 7.02156.35.0</p> 	<p>AGR-K 7.02756.07.0</p> 	
<p>05 CITROEN BERLINGO (B9) BERLINGO Kasten (B9) C-ELYSEE C3 II (SC_) C3 Picasso C4 AIRCROSS C4 CACTUS</p>	<p>CITROEN BERLINGO (B9) BERLINGO Kasten (B9) C-ELYSEE C3 II (SC_) C3 Picasso C4 AIRCROSS C4 CACTUS</p>	<p>→SI 0090 →SI 0092 →SI 0108 →SI 1003</p> <p>VOLKSWAGEN MULTIVAN V (7HM, 7HN, 7HF, 7EF, 7EM, 7EN) TRANSPORTER V Bus (7HB, 7HJ, 7EB, 7EJ, 7EF, 7EG, 7HF, 7EC)</p>	
<p>01 Pierburg № 02 Код изделия 03 Группа компонентов 04 Product / Service Information 05 Автомобиль</p>			

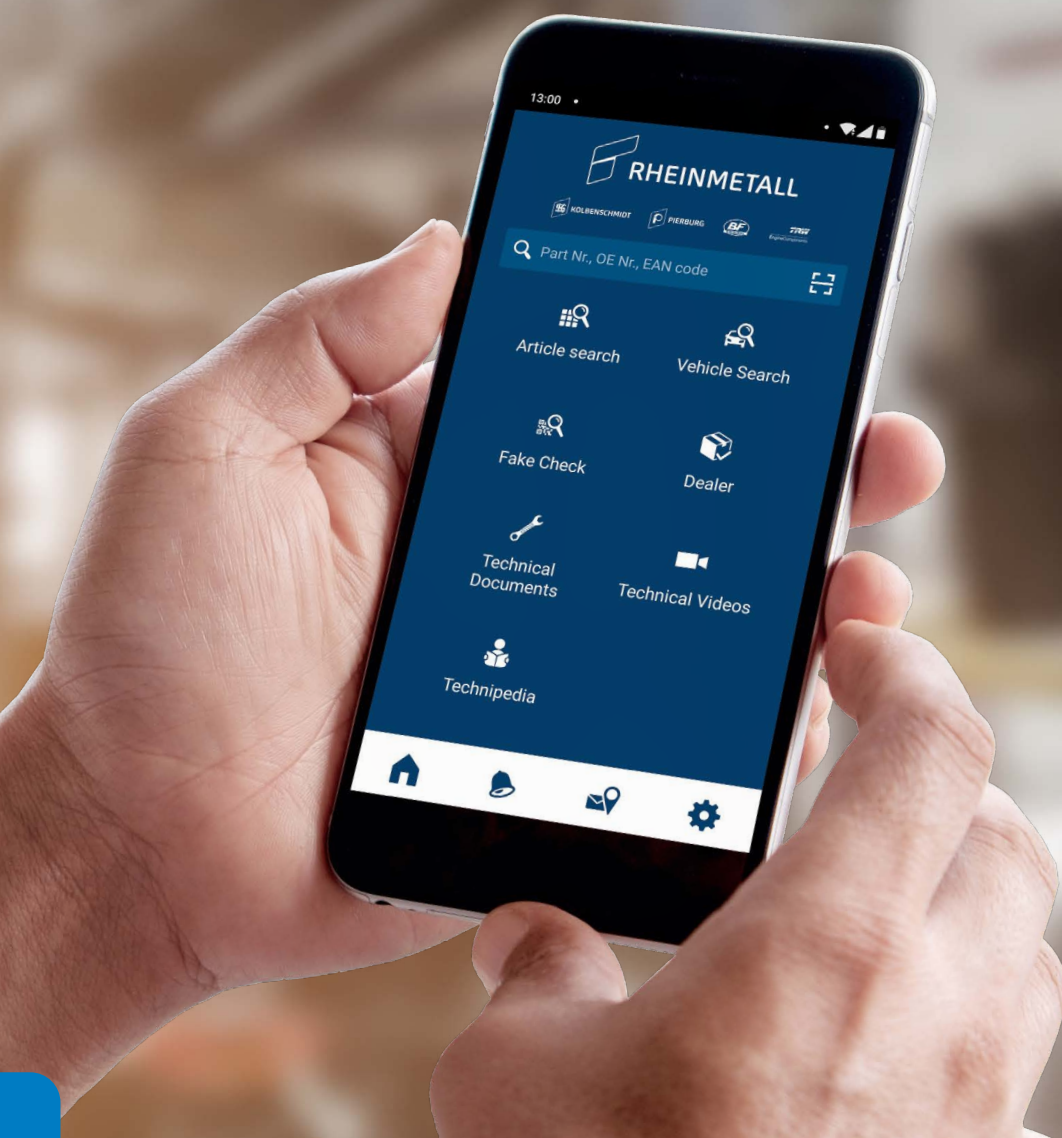

ПРИЛОЖЕНИЕ MOTORSERVICE МОБИЛЬНЫЙ ДОСТУП К ТЕХНИЧЕСКОМУ НОУ-ХАУ



Узнать больше
www.ms-motorservice.com/app

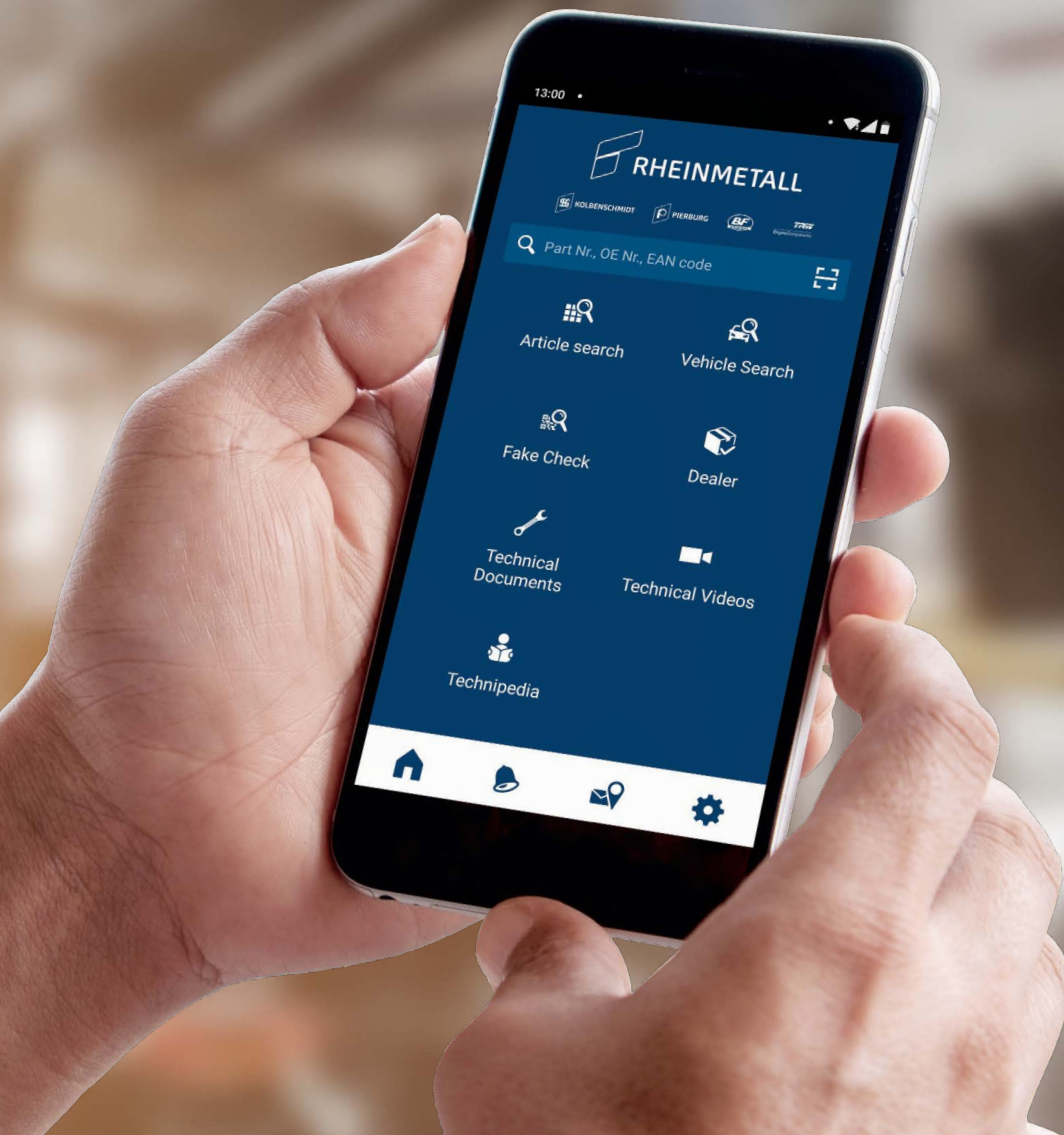

MOTORSERVICE تطبيق مدخل متحرك إلى المعارف الفنية

تعرف على المزيد

www.ms-motorservice.com/app
باللغة الإنجليزية







٠١



emission control

AGR-K	AGR-K	AGR-K
7.02156.34.0	7.02156.35.0	7.02756.07.0
		
<p>CITROEN</p> <p>٠٥ BERLINGO (B9)</p> <p>BERLINGO Kasten (B9)</p> <p>C-ELYSEE</p> <p>C3 II (SC_)</p> <p>C3 Picasso</p> <p>C4 AIRCROSS</p> <p>C4 CACTUS</p>	<p>CITROEN</p> <p>BERLINGO (B9)</p> <p>BERLINGO Kasten (B9)</p> <p>C-ELYSEE</p> <p>C3 II (SC_)</p> <p>C3 Picasso</p> <p>C4 AIRCROSS</p> <p>C4 CACTUS</p>	<p style="text-align: right;">→SI 0090</p> <p style="text-align: right;">→SI 0092</p> <p style="text-align: right;">→SI 0108</p> <p style="text-align: right;">→SI 1003</p> <p>VOLKSWAGEN</p> <p>MULTIVAN V (7HM, 7HN, 7HF, 7EF, 7EM, 7EN)</p> <p>TRANSPORTER V Bus (7HB, 7HJ, 7EB, 7EJ, 7EF, 7EG, 7HF, 7EC)</p>

٠١ رقم Pierburg

٠٢ كود المنتج

٠٣ مجموعة المنتجات

٠٤ معلومات عن المنتج / الخدمة

٠٥ سيارة

٢- إرشادات حول استخدام الكتالوج

PIERBURG		VOLKSWAGEN				
POLO (9N_)						56
1.9 TDI 74 kW (100 PS) AXR	10.2001→11.2009		7.24809.16.0	AGR	PN	ch. 9N-2-000 001→
1.9 TDI 74 kW (101 PS) BMT	10.2001→11.2009		7.00678.04.0*	AGR-M	EL	mit Rohrstutzen with pipe socket ch. 9N-5-500 001→
			↪ 7.00907.03.0	AGR	EL	
1.9 TDI 96 kW (130 PS) ASZ	11.2003→11.2009		7.24809.55.0	AGR	PN	
1.9 TDI 96 kW (130 PS) BLT	05.2004→11.2009		7.24809.16.0	AGR	PN	ch. 9N-2-000 001→

٠١ السيارة / المحرك

٠٢ سنة الصنع من ← حتى

٠٣ مجموعة المنتجات

٠٤ 7.xxxxx.xx.x

← xxxxx.xx.x.4

طقم إصلاح

**7.xxxxx.xx.x

٠٥ كود المنتج*

٠٦ طريقة الإدارة / التصميم

٠٧ معلومات / معايير

٠٨ مختصر المنتج*

٠٩ رقم Pierburg

* انظر فهرس الاختصارات
** لم يعد متوفرًا

رقم PIERBURG

PIERBURG		PIERBURG No. 123						
7.00075.07.0	AGR	4	7.05574.03.0	SLV	32	7.22778.96.0	SLV	33
7.00216.06.0	SLP	25	7.06712.23.0	ARV	20	7.22778.97.0	SLV	33
7.00306.37.0	AGR	4	7.07696.00.0	SRM-AK	35	7.22778.98.0	SLV	33

٠١ رقم Pierburg

٠٢ كود المنتج

٠٣ الصورة/ الصفحة

مستشعرات درجة حرارة العادم

تراقب مستشعرات درجة حرارة العادم تيار العادم الساخن وتحمي الأجزاء التركيبية من فرط السخونة. التطبيقات النمطية هي حماية المكونات الحساسة لدرجات الحرارة، مثل الشاحن التوربيني وكل أنواع أجهزة تنقية العادم ومراقبة عملية الاحتراق الحر لفلتر جزيئات الديزل ومراقبة عملية النقل الأمثل لدرجات الحرارة بأجهزة تنقية العادم وقياس درجة حرارة عادم EGR في إطار تشخيص أنبورد (OBD). في حالات فرط السخونة الحرج فإن وحدة التحكم تستجيب من خلال اتخاذ إجراءات مناسبة لتقليل درجة الحرارة، مثلًا من خلال انخفاض القدرة (التشغيل الاضطراري).

نظام خدمة المحرك تغطي حوالي ١٤٠٠ نوع مركبة من خلال عدد مستشعرات درجة حرارة العادم البالغ ٣٠.



مضخات الهواء الثانوي

مضخات الهواء الثانوي هي مراوح عالية الدوران بمرحلة واحدة أو اثنين. وهذه تعمل على شفط الهواء المحيط ونفخه إلى داخل مجمع العادم وراء صمامات الصرف. وبذلك فإنها تعمل مع محركات البنزين على تقليل الكميات العالية من أول أكسيد الكربون ومواد الهيدروكربونات أثناء مرحلة بدء الدوران على البارد - إذا لم يصل بعد جهاز تنقية العادم إلى درجة حرارة العمل.



صمامات الهواء الثانوي

توجد صمامات الهواء الثانوي بين مضخة الهواء الثانوي ومجمع العادم. صمام الهواء الثانوي لديه العديد من المهام لتنفيذها:

- تمنع وظيفة الارتداد من أن تتسبب غازات العادم أو الماء المتكثف أو قيم الضغط الفائقة في مجموعة العادم في إلحاق أضرار بمضخة الهواء الثانوي.
- تعنى وظيفة الإطفاء بالألا يصل الهواء الثانوي إلى مجمع العادم إلا في مرحلة البدء على البارد.



تتضمن باقة المنتجات الشاملة من خدمة المحركات ثلاثة أنواع مختلفة من صمامات الهواء الثانوي PIERBURG:

↙

محكوم الضغط

هذا النوع من صمامات الهواء الثانوي يفتح تحت تأثير ضغط مضخة الهواء الثانوي.



↙

بنيوماتيكي

صمامات الهواء الثانوي البنيوماتيكية لا تزال قائمة منذ عقود. أنت بحاجة إلى صمام تحويل للتحكم.



↙

كهربائي

صمامات الهواء الثانوي الكهربائي تتميز بأوقات فتح وغلق أقصر وهي أكثر مقاومة للاتصاقات الناتجة عن السخام أو الاتساخات.



صمامات إعادة تدوير العادم

كل محركات الديزل الحديثة يجب تجهيزها اليوم بنظم إعادة تدوير العادم حتى يمكن الالتزام بتعليمات انبعاثات العادم.

يتم وراء الأسطوانة مباشرة التخلص من غازات العادم ويتم مرة أخرى خلط هواء السحب. ومن خلال ذلك تصل كمية أقل من الأكسجين إلى داخل الأسطوانة، الأمر الذي يتسبب في تقليل درجة حرارة الاحتراق. ومن خلال ذلك يمكن تقليل كمية أكاسيد النيتروجين في غازات العادم بنسبة تصل إلى ٥٠٪. وبالإضافة إلى ذلك فيمكن من خلال ذلك مع محركات الديزل تقليل انبعاثات ثاني أكسيد الكربون ومعدل الاستهلاك.

مبرد نظام إعادة تدوير العادم

حتى يمكن الإبقاء بالمتطلبات الأكثر شدة التي تفرضها تعليمات انبعاثات العادم فإن الأمر يتطلب تبريد نظم إعادة تدوير غازات العادم.

العادم المبرد من شأنه أن يقلل درجة الحرارة القصوى للاحتراق. ومن خلال ذلك يقل معدل انبعاث أكاسيد النيتروجين بشكل واضح. وفي هذا الإطار تصبح الغازات المبردة أكثر كثافة من تلك الدافئة. وهذا يعني: مع ثبات ضغط الشحن تتواءم كمية أكبر مع ملء الأسطوانة. عملية الاحتراق التي تصبح "أقل تشبعًا" من خلال ذلك تصبح إيجابية بشكل ملحوظ أثناء الاستخدام ومع انبعاثات الجزيئات.



ومنذ السبعينات وحتى الآن وشركة Pierburg تشارك في تطوير هذه النظم، وبالتالي فإنها أسهمت في الوصول إلى المستوى التقني الحالي.

صمامات العادم

لغرض خفض الانبعاثات الضارة وزيادة مستوى الراحة فإن صمامات العادم تمثل عنصرًا هامًا للمحركات الحديثة. فمن خلالها يتم توجيه العادم، بحسب حالة التشغيل، إلى دموعات عادم مختلفة.

مجالات الاستخدام في النطاقات القريبة من المحرك:

- أجهزة تنقية العادم DeNO_x
- إعادة تدوير العادم بالضغط المنخفض
- ممتص الهيدروكربونات

برنامج التوريد من شركة Motorservice يشمل صمامات عادم بنيماتيكية وكهربائية وأيضًا صمامات عادم للدراجات النارية. كل الصمامات مصممة للعمل مع درجات حرارة فائقة للعادم تتراوح بين -٤٠°م و ٩٥٠+°م وقدرة استدامة تزيد عن ١,٠٠٠,٠٠٠ دورة تشغيل.

حساسات لامدا

حساسات لامدا تقيس الأكسجين المتبقي في غازات العادم. بالاستعانة بقيمة الأكسجين، التي يتم حسابها من خلال ذلك، فإن نظام إدارة المحرك يتحكم في نسبة الخليط لتحقيق قدرة احتراق مثالية بقدر الإمكان.

حساسات لامدا تمثل العناصر الأكثر أهمية في نظام إدارة المحرك ضمانًا لدوران المحرك بشكل مثالي مع معدلات الانبعاث المنخفضة.

درجات حرارة التشغيل العالية وغازات العادم الضارة تمثل متطلبات عالية لحساسات لامدا. ولذلك فأنت من تحدد اختيار منتجات القوائم الخاصة لخفض الانبعاثات الضارة.



١- خفض الانبعاثات الضارة

مواد ضارة أقل بنسبة ٥٠ ٪ قبل الوصول إلى جهاز تنقية العادم تُعتبر شركة Pierburg مع صمامات EGR ومبردات نظام إعادة تدوير العادم في العديد من السيارات الحديثة، شركة لصناعة المعدات الأصلية. تضمن المواد المصنوعة منها منتجات بيربورج المقاومة للصدأ ولدرجات الحرارة عمر تشغيلي طويل تحت أقصى الظروف، مثل: نواتج تكثف العوادم الضارة ودرجات الحرارة التي قد تصل إلى ٧٠٠ درجة وضغط يصل إلى ٣ بار.

مجموعة المنتجات

- ٠١ وحدة مبرد فلتر الفحم النشط
- ٠٢ صمام فلتر الفحم النشط (كهربائي)
- ٠٣ صمام فلتر الفحم النشط (بنيوماتيكي)
- ٠٤ محول الضغط للتحكم في صمامات فلتر الفحم النشط البنيوماتيكية
- ٠٥ صمام الهواء الثانوي (بنيوماتيكي)
- ٠٦ صمام التحويل للتحكم في صمامات الهواء الثانوي البنيوماتيكية
- ٠٧ صمام الهواء الثانوي (كهربائي)
- ٠٨ صمام التحويل للتحكم في صمام العادم
- ٠٩ مستشعر درجة حرارة العادم
- ١٠ صمام العادم
- ١١ حساس لامدا
- ١٢ مضخة الهواء الثانوي

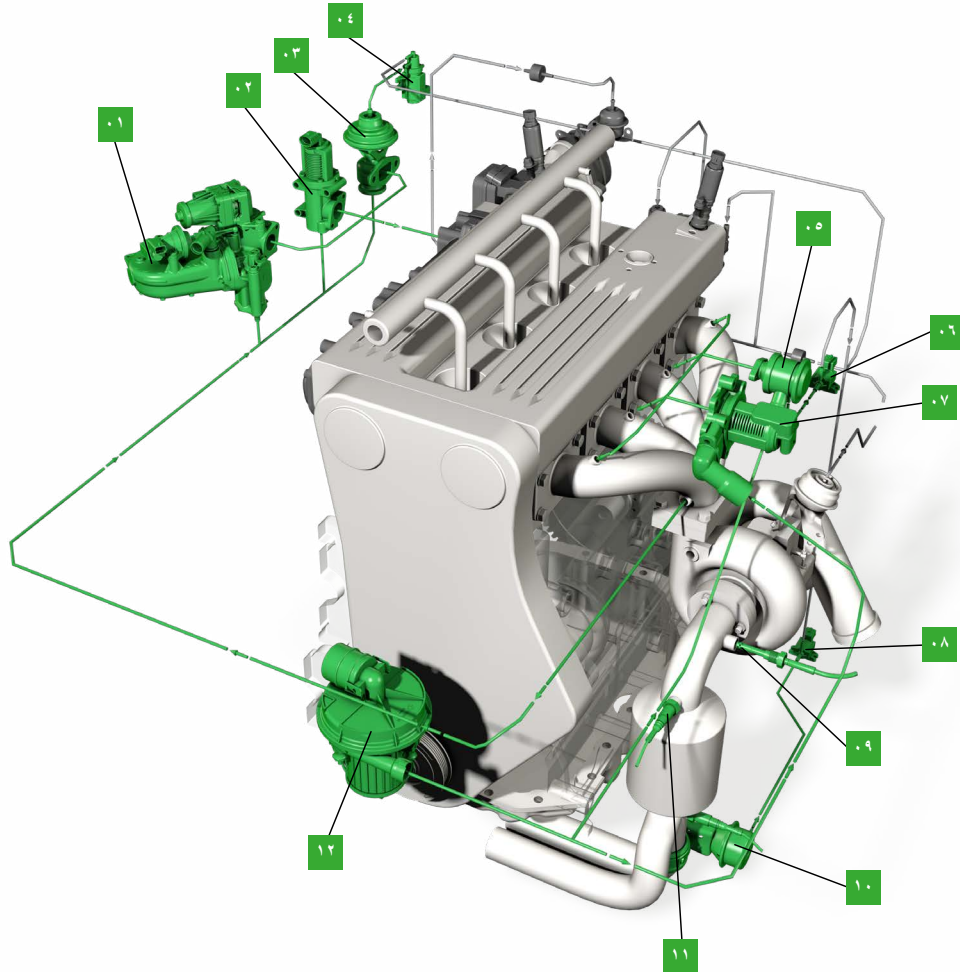





نقل المعرفة الفنية المتخصصة المعرفة الفنية المتخصصة للخبير

دورات تدريب في جميع أنحاء العالم من الجهة الصانعة مباشرة

يوجد حوالي ٤٥٠٠ ميكانيكي وفني يستفيدون سنويًا من الدورات التدريبية والسيمنارات التي نعددها في موقعك في جميع أنحاء العالم أو في مراكزنا التدريبية في نويشتاد ودورماجن وتام (ألمانيا).

معلومات فنية

من رحم التدريب العملي لواقع التدريب العملي

من خلال ما نوفره من معلومات للمنتج ومعلومات الخدمة والكتيبات والملصقات الفنية فسوف تكون دائمًا مواكبًا لأحدث مستوى معرفي في المجال التقني.

مقاطع فيديو فنية

نقل المعرفة عن طريق الفيديو

ستجد في مقاطع الفيديو التي نقدمها إرشادات تركيبية عملية وشروحات خاصة بنظم منتجاتنا.

YouTube

البؤرة مسلطة على المنتجات أونلاين

حلولنا موضحة بشكل مرئي

من خلال العناصر التفاعلية والصور المتحركة ومقاطع الفيديو يمكنك الاستعلام عن منتجاتنا سواء التي في المحرك أو في نطاقه.

متجر أونلاين

طريقك المباشر لمنتجاتنا

يمكنك الطلب على مدار الساعة. الفحص السريع للتوفرية. البحث الشامل عن المنتجات من خلال المحرك والمركبة والأبعاد وما إلى ذلك.

أخبار

معلومات دورية عن طريق البريد الإلكتروني

قم الآن بتسجيل اشتراكك أونلاين في صحيفتنا المجانية وستحصل على معلومات دورية خاصة بمستجدات المنتجات والمنشورات الفنية وغيرها الكثير.

معلومات فردية

مخصصة لعملائنا

سوف نقدم لك معلومات وخدمات شاملة متعلقة بنطاق معدلات أداتنا العريض: مثلاً خامات تعزيز البيع المتوائمة مع المتطلبات الشخصية ووسائل دعم البيع والدعم الفني وغيرها الكثير.



الموسوعة الفنية

معلومات فنية خاصة بالمحرك

في موسوعتنا الفنية سوف نتشارك معك معرفتنا الفنية المتخصصة. سوف تجد هنا المعرفة الفنية المتخصصة مباشرة من الخبراء.

تطبيق خدمة المحرك

إمكانية وصول جواله للمعرفة الفنية المتخصصة

سوف تحصل هنا بسرعة وسهولة على أحدث مستوى للمعلومات والخدمات بشأن منتجاتنا.

الوسائط الاجتماعية

دائمًا محدثة

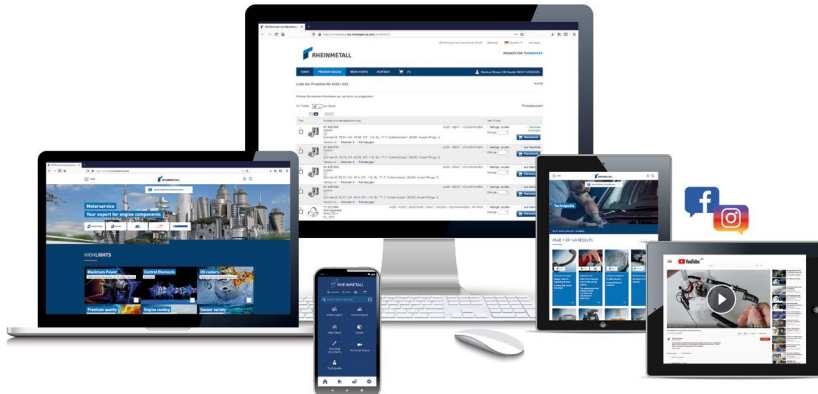

صفحة	المحتوى
٨٣	إرشادات مهمة
٨٣	إدارة الجودة
٨١	نقل الخبرة الفنية - الدراية الفنية للخبراء
٧٨	١- خفض الانبعاثات الضارة
٧٥	٢- إرشادات حول استخدام الكتالوج
٨٥	٣- التطبيقات الرئيسية / صور المنتجات
٢٣١	٤- استكمال البرنامج
٢٤٩	٥- فهرس الشركات الصانعة
٢٥٣	٦- تطبيقات المنتج
١٩٣٣	٧- قوائم المراجع
	٨- طريقة التصرف في حالة وجود شكوى / صيغة الشكوى

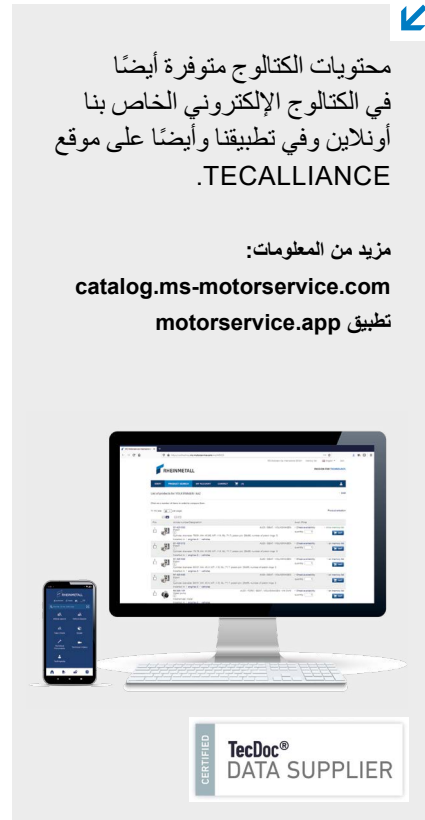

محتويات الكتالوج متوفرة أيضًا في الكتالوج الإلكتروني الخاص بنا أونلاين وفي تطبيقنا أيضًا على موقع .TECALLIANCE

مزيد من المعلومات:
catalog.ms-motorservice.com
 تطبيق motorservice.app

TecDoc®
 CERTIFIED DATA SUPPLIER

مجموعة MOTORSERVICE الجودة والخدمة من مصدر واحد

تعد مجموعة Motorservice شركة مبالاء وسويتلا نشطة ما بعدة بصتمخا معوزيتلا مؤسسة Rheinmetall. شركة مكدت. معساوولا يارغلا عطة قسو يمحركات فلأ وفير مكونات في فدنارلا شركاتلا إحدى ي هو Motorservice تميزتلا جاريتلا علماماتلا مع لفلوذ قجود يلعابة بليصوا قة كبيرلشكيت شورلاو تجارنتلا نها منعمل Kolbenschmidt و Pierburg و TRW Engine Components لاضجارية فتلا علماملا نBF و turbo by Intec.

RHEINMETALL تقنيات للتقل في المستقبل

بصفتها مورد سيارات على مستوى العالم، تتمتع شركة Rheinmetall بالكفاءة العليا في الأسواق المعنية في مجالات إمداد الهواء، وخفض الانبعاثات الضارة والمضخات وكذلك في تطوير وتصنيع وتوريد قطع غيار المكابيس وكتل المحركات والمحامل الانزلاقية. يتم تطوير المنتجات بالتعاون الوثيق مع مصنعي السيارات المعروفين.

إرشادات مهمة

يتعين دائماً قبل التركيب القيام بالفحص للتحقق مما إذا كان المنتج المعني مناسباً لغرض الاستخدام المقصود. لا يمكن الاطلاع على بياناتنا ومعرفة أي معلومات عن طبيعة معينة أو التحقق من ملاءمة لغرض معين. وبصفة خاصة يرجى مراعاة أن المنتجات المطروحة في الكتالوج ليست مناسبة للاستخدام في المركبات الهوائية أو الفضائية. عند الاستخدام في محركات الطرق الوعرة (مثل المحركات البحرية أو الثابتة أو محركات القطارات) يجب مراعاة أنه حتى في حالة تشابه مسمى المحرك فهناك أجزاء أخرى مختلفة من المحرك (المكابس مثلاً). ولذلك فقد يتعين أيضاً قبل تركيب المنتجات طلب المشورة الفنية المتخصصة من الجهة الصانعة أو الورشة الفنية المعتمدة. وفي هذا الصدد فإننا نشير إلى ضرورة إجراء أعمال التركيب دائماً على يد عمالة فنية متخصصة ومدربة. الصور والرسوم التوضيحية وغيرها من البيانات الأخرى تستخدم للشرح والإيضاح ولا يمكن استخدامها كأساس للتركيب.

لا يُسمح بأي نسخ أو محاكاة أو توزيع أو استنساخ عام لهذا الكتالوج، حتى ولو بشكل جزئي دون الحصول على تصريح كتابي مسبق وأن يكون هناك بيان مصدر يحمل هذا المضمون. إصدار هذا الكتالوج يُفقد الإصدارات السابقة صلاحيتها.

كل البيانات الواردة في هذا الكتالوج غير ملزمة. ولا يمكننا تحمل أية مسؤولية عن سلامتها واكتمالها. ويسعدنا دائماً تلقي إخطاراتكم بخصوص أية أخطاء قد ترد في الكتالوج على أن نصححها في الطبعة القادمة.

السماء والتوصيفات وبيانات الأرقام الخاصة بالمركبات أو الجهات المصنعة وما شابه واردة فقط لأغراض المقارنة، تماماً مثل أرقام القطع الأصلية للجهات المصنعة للمركبات والمحركات. مثل هذه البيانات ليست رسوماً أساسية ولا يجوز استخدامها ضد أطراف أخرى. يرجى في هذا الإطار مراعاة أنه يمكن إدخال تغييرات على التجهيزات من قبل الشركات الصانعة للسيارات والمحركات أو قد تطرأ تغييرات على التسميات. ولذلك فلا يمكننا تحمل أية مسؤولية عن استخدام قوائم المقارنة.

نحن نحفظ صراحة بحق إدخال تغييرات على مواصفات المنتجات والخامات والمظهر الخارجي ونطاق توريد منتجاتنا في أي وقت. ولذلك فإن الأشكال الواردة في الكتالوج ليست ملزمة.

شهادات الاعتماد











شركة MS Motorservice International GmbH مزودة بنظام لإدارة الجودة معتمد طبقاً للمواصفة ISO 9001 ونظام لإدارة البيئة معتمد وفقاً للمواصفة ISO 14001.









AR









← أساسيات









		Page
123	PIERBURG NO.	86
	EMISSION CONTROL	90



 PIERBURG			 PIERBURG			 PIERBURG		
7.00018.50.0	SLV	222	7.02014.07.0	AGR	96	7.03196.09.0	AGR	98
7.00018.51.0	SLV	223	7.02107.09.0	AGR-K	131	7.03295.03.0	AGR	98
7.00018.52.0	SLV	223	7.02132.07.0	AGR	97	7.03379.03.0	AGR	99
7.00018.55.0	SLV	223	7.02156.24.0	AGR-K	132	7.03390.09.0	AGR-M	142
7.00018.56.0	SLV	223	7.02156.33.0	AGR-K	132	7.03391.11.0	AGR-M	142
7.00020.24.0	AGR	90	7.02156.34.0	AGR-K	133	7.03435.05.0	AGR	99
7.00020.25.0	AGR	90	7.02156.35.0	AGR-K	133	7.03446.01.0	SLP	215
7.00020.39.0	AGR	90	7.02187.12.0	AGR	97	7.03527.12.0	AGR-M	142
7.00020.40.0	AGR	90	7.02209.11.0	AGR	97	7.03571.16.0	AK	144
7.00020.50.0	AGR	90	7.02209.20.0	AGR	98	7.03608.16.0	AK	144
7.00063.10.0	AGR	91	7.02321.17.0	AK	144	7.03622.06.0	AGR-K	134
7.00075.07.0	AGR	91	7.02604.01.0	LS	182	7.03622.09.0	AGR-K	134
7.00216.06.0	SLP	215	7.02604.03.0	LS	183	7.03622.10.0	AGR-K	135
7.00224.13.0	SLP	215	7.02604.04.0	LS	185	7.03622.11.0	AGR-K	135
7.00306.36.0	AGR	91	7.02604.05.0	LS	185	7.03635.12.0	SLP	215
7.00306.37.0	AGR	91	7.02604.07.0	LS	186	7.03635.37.0	SLP	216
7.00309.07.0	AGR	91	7.02604.08.0	LS	186	7.03635.38.0	SLP	216
7.00365.06.0	AGR	92	7.02604.10.0	LS	186	7.03635.39.0	SLP	216
7.00368.15.0	AGR	92	7.02604.11.0	LS	187	7.03635.40.0	SLP	216
7.00368.16.0	AGR	92	7.02604.12.0	LS	187	7.03635.41.0	SLP	216
7.00411.05.0	SLV	223	7.02604.13.0	LS	187	7.03635.46.0	SLP	216
7.00450.09.0	AGR	93	7.02604.15.0	LS	187	7.03647.10.0	AGR-K	135
7.00450.10.0	AGR	93	7.02604.21.0	LS	187	7.03692.11.0	AGR-K	135
7.00512.03.0	AGR	93	7.02604.25.0	LS	188	7.03693.12.0	AGR-M	142
7.00555.06.0	AGR	93	7.02604.26.0	LS	188	7.03761.09.0	AGR-M	142
7.00555.07.0	AGR	93	7.02604.27.0	LS	188	7.03762.10.0	AGR-M	142
7.00578.12.0	AGR	93	7.02604.28.0	LS	188	7.03784.34.0	AGR	99
7.00632.13.0	AGR	94	7.02604.30.0	LS	188	7.03803.03.0	AGR	99
7.00678.04.0*	AGR-M	141	7.02604.31.0	LS	189	7.03991.12.0	AGR-K	135
7.00678.06.0	AGR-M	141	7.02604.32.0	LS	189	7.04038.08.0	AGR-K	135
7.00684.14.0	AGR	94	7.02604.34.0	LS	189	7.04039.13.0	AGR-K	136
7.00748.06.0	SLV	223	7.02604.37.0	LS	189	7.04209.06.0	AK	145
7.00789.10.0	AGR	94	7.02604.38.0	LS	189	7.04210.06.0	AK	145
7.00823.06.0	AGR	94	7.02604.41.0	LS	189	7.04239.04.0	AK	145
7.00837.01.0	AGR-K	131	7.02604.42.0	LS	190	7.04256.35.0	AGR	99
7.00907.03.0	AGR	94	7.02604.43.0	LS	190	7.04256.36.0	AGR	99
7.00992.36.0	AGR	95	7.02604.44.0	LS	190	7.04257.19.0	AGR	99
7.00999.08.0	AGR	95	7.02604.47.0	LS	191	7.04257.20.0	AGR	100
7.01106.38.0	AGR-K	131	7.02604.49.0	LS	191	7.04275.09.0	AGR-M	143
7.01240.03.0	SLV	223	7.02604.51.0	LS	191	7.04371.07.0	AGR	100
7.01268.03.0	AGR	95	7.02604.53.0	LS	191	7.04382.09.0	AGR-M	143
7.01293.38.0	AGR	95	7.02604.54.0	LS	192	7.04389.00.0	SLP	216
7.01300.24.0	AK	144	7.02604.55.0	LS	192	7.04389.02.0	SLP	217
7.01317.10.0	AGR	95	7.02604.56.0	LS	192	7.04389.04.0	SLP	217
7.01318.20.0	SLV	223	7.02604.60.0	LS	192	7.04389.05.0	SLP	217
7.01318.24.0	SLV	224	7.02604.61.0	LS	192	7.04389.06.0	SLP	217
7.01486.08.0	SLP	215	7.02604.62.0	LS	193	7.04389.07.0	SLP	218
7.01486.10.0	SLP	215	7.02604.63.0	LS	193	7.04389.08.0	SLP	218
7.01493.07.0	AGR	96	7.02604.64.0	LS	193	7.04389.09.0	SLP	218
7.01510.31.0	SLV	224	7.02604.65.0	LS	193	7.04402.02.0	AGR-K	136
7.01510.57.0	SLV	224	7.02604.73.0	LS	193	7.04433.02.0	AGR-K	136
7.01510.85.0	SLV	224	7.02604.75.0	LS	194	7.04448.18.0	AGR-K	136
7.01510.86.0	SLV	224	7.02604.77.0	LS	194	7.04493.17.0	AGR	100
7.01510.87.0	SLV	224	7.02604.79.0	LS	194	7.04511.29.0	AGR-M	143
7.01510.91.0	SLV	224	7.02604.80.0	LS	194	7.04512.08.0	AGR-K	136
7.01510.94.0	SLV	225	7.02604.92.0	LS	194	7.04589.06.0	AGR	100
7.01599.10.0	AGR	96	7.02604.95.0	LS	194	7.04709.13.0	AK	145
7.01604.02.0	AGR	96	7.02604.96.0	LS	194	7.04723.10.0	AGR-K	136
7.01621.08.0	AGR	96	7.02604.99.0	LS	194	7.04739.09.0	AGR	100
7.01782.07.0	AGR	96	7.02738.13.0	AGR	98	7.04784.06.0	AGR-K	136
7.01859.03.0	SLV	225	7.02751.02.0	AGR-M	142	7.04787.12.0	AGR-K	136
7.01881.06.0	AGR-M	142	7.02756.07.0	AGR-K	134	7.04788.06.0	AGR-K	137
7.01881.07.0	AGR-M	142	7.02769.05.0	AGR	98	7.04799.08.0	AK	145
7.01881.08.0*	AGR-K	131	7.03051.04.0	AGR	98	7.04879.00.0	AGR-TH	143
7.01881.09.0*	AGR-K	131	7.03083.20.0	SRM-AK	228	7.04923.17.0	AGR	100

 PIERBURG			 PIERBURG			 PIERBURG		
7.04923.18.0	AGR	101	7.05271.00.0	LS	204	7.05448.07.0	AK	145
7.04924.14.0	AGR	101	7.05271.01.0	LS	205	7.05454.07.0	AGR	102
7.04924.15.0	AGR	101	7.05271.02.0	LS	205	7.05483.25.0	AGR-K	138
7.04930.06.0	AGR-K	137	7.05271.03.0	LS	205	7.05499.05.0	AK	145
7.04931.04.0	AGR-K	137	7.05271.04.0	LS	205	7.05500.02.0	AK	146
7.04999.34.0	AGR-M	143	7.05271.05.0	LS	205	7.05501.02.0	AK	146
7.04999.35.0*	AGR-K	137	7.05271.06.0	LS	206	7.05502.02.0	AK	146
7.05012.01.0	AGR	101	7.05271.07.0	LS	206	7.05506.14.0	AGR-M	143
7.05031.06.0	AGR-M	143	7.05271.11.0	LS	206	7.05574.00.0	SLV	225
7.05052.00.0	AGR-K	137	7.05271.12.0	LS	206	7.05574.01.0	SLV	225
7.05052.01.0	AGR-K	137	7.05271.13.0	LS	206	7.05574.02.0	SLV	225
7.05052.03.0	AGR-K	137	7.05271.14.0	LS	207	7.05574.03.0	SLV	225
7.05107.12.0	AGR-K	137	7.05271.15.0	LS	207	7.05578.15.0	AGR	102
7.05194.26.0	AGR-K	137	7.05271.16.0	LS	207	7.05590.03.0	AGR	102
7.05243.04.0	AGR-M	143	7.05271.18.0	LS	207	7.05590.04.0*	AGR-K	138
7.05264.03.0	AGR	101	7.05271.19.0	LS	208	7.05632.04.0	AGR	102
7.05264.04.0*	AGR-K	137	7.05271.20.0	LS	208	7.05662.07.0	AK	146
7.05270.00.0	LS	196	7.05271.21.0	LS	208	7.05742.11.0	AGR	102
7.05270.03.0	LS	196	7.05271.22.0	LS	208	7.05838.08.0	AGR	102
7.05270.11.0	LS	196	7.05271.23.0	LS	208	7.06036.14.0	AGR-K	138
7.05270.12.0	LS	196	7.05271.24.0	LS	209	7.06036.15.0	AGR	103
7.05270.15.0	LS	196	7.05271.27.0	LS	209	7.06712.23.0	ARV	147
7.05270.17.0	LS	196	7.05271.28.0	LS	209	7.06712.24.0	ARV	147
7.05270.18.0	LS	197	7.05271.29.0	LS	209	7.06713.09.0	ARV	147
7.05270.21.0	LS	197	7.05271.30.0	LS	210	7.06713.10.0	ARV	147
7.05270.22.0	LS	197	7.05271.32.0	LS	210	7.06714.21.0	ARV	147
7.05270.25.0	LS	198	7.05271.35.0	LS	210	7.06714.22.0	ARV	147
7.05270.26.0	LS	198	7.05271.36.0	LS	210	7.06714.23.0	ARV	147
7.05270.27.0	LS	198	7.05271.37.0	LS	210	7.06714.24.0	ARV	147
7.05270.29.0	LS	198	7.05271.38.0	LS	210	7.07044.12.0	AGR	103
7.05270.30.0	LS	198	7.05271.39.0	LS	211	7.07141.01.0	AK	146
7.05270.32.0	LS	199	7.05271.46.0	LS	211	7.07417.39.0	AGR	103
7.05270.33.0	LS	199	7.05271.48.0	LS	211	7.07419.06.0	AK	146
7.05270.34.0	LS	199	7.05271.51.0	LS	211	7.07420.09.0	AK	146
7.05270.36.0	LS	199	7.05271.52.0	LS	211	7.07549.09.0	AGR	103
7.05270.37.0	LS	199	7.05271.53.0	LS	211	7.07696.00.0	SRM-AK	228
7.05270.38.0	LS	200	7.05271.54.0	LS	211	7.07794.22.0	AGR	103
7.05270.39.0	LS	200	7.05271.55.0	LS	211	7.07794.23.0	AGR	103
7.05270.45.0	LS	200	7.05271.56.0	LS	212	7.07969.06.0	AGR-K	138
7.05270.47.0	LS	200	7.05271.58.0	LS	212	7.08369.00.0	ATS	154
7.05270.48.0	LS	200	7.05271.59.0	LS	212	7.08369.01.0	ATS	154
7.05270.49.0	LS	201	7.05271.61.0	LS	212	7.08369.02.0	ATS	154
7.05270.51.0	LS	201	7.05271.62.0	LS	212	7.08369.03.0	ATS	154
7.05270.54.0	LS	201	7.05271.63.0	LS	212	7.08369.04.0	ATS	155
7.05270.55.0	LS	201	7.05271.65.0	LS	212	7.08369.05.0	ATS	155
7.05270.56.0	LS	201	7.05271.66.0	LS	212	7.08369.06.0	ATS	155
7.05270.66.0	LS	201	7.05271.67.0	LS	213	7.08369.07.0	ATS	156
7.05270.67.0	LS	202	7.05271.68.0	LS	213	7.08369.08.0	ATS	156
7.05270.69.0	LS	202	7.05271.69.0	LS	213	7.08369.09.0	ATS	156
7.05270.70.0	LS	202	7.05271.70.0	LS	213	7.08369.11.0	ATS	156
7.05270.71.0	LS	202	7.05271.71.0	LS	213	7.08369.12.0	ATS	156
7.05270.72.0	LS	202	7.05271.72.0	LS	213	7.08369.13.0	ATS	156
7.05270.73.0	LS	202	7.05271.73.0	LS	213	7.08369.14.0	ATS	157
7.05270.79.0	LS	202	7.05271.74.0	LS	214	7.08369.15.0	ATS	157
7.05270.80.0	LS	202	7.05271.75.0	LS	214	7.08369.16.0	ATS	157
7.05270.81.0	LS	203	7.05271.76.0	LS	214	7.08369.17.0	ATS	157
7.05270.82.0	LS	203	7.05271.77.0	LS	214	7.08369.18.0	ATS	157
7.05270.83.0	LS	203	7.05271.81.0	LS	215	7.08369.19.0	ATS	157
7.05270.86.0	LS	203	7.05315.05.0	SLP	218	7.08369.20.0	ATS	158
7.05270.88.0	LS	203	7.05320.04.0	AGR	101	7.08369.21.0	ATS	158
7.05270.89.0	LS	203	7.05343.17.0	AGR	102	7.08369.22.0	ATS	158
7.05270.91.0	LS	204	7.05343.18.0*	AGR-K	138	7.08369.23.0	ATS	158
7.05270.96.0	LS	204	7.05363.00.0	AGR	102	7.08369.24.0	ATS	158
7.05270.98.0	LS	204	7.05446.07.0	AK	145	7.08369.25.0	ATS	158
7.05270.99.0	LS	204	7.05447.08.0	AK	145	7.08369.26.0	ATS	158

 PIERBURG			 PIERBURG			 PIERBURG		
7.08369.27.0	ATS	158	7.08369.95.0	ATS	167	7.11020.22.0	ATS	171
7.08369.30.0	ATS	159	7.08369.96.0	ATS	168	7.11020.23.0	ATS	172
7.08369.31.0	ATS	159	7.08369.97.0	ATS	168	7.11020.24.0	ATS	172
7.08369.32.0	ATS	159	7.08369.98.0	ATS	168	7.11020.25.0	ATS	172
7.08369.33.0	ATS	159	7.08369.99.0	ATS	168	7.11020.26.0	ATS	172
7.08369.34.0	ATS	159	7.08965.03.0	AK	146	7.11020.27.0	ATS	172
7.08369.35.0	ATS	159	7.09002.00.0	AGR	104	7.11020.28.0	ATS	173
7.08369.36.0	ATS	159	7.09002.01.0	AGR	104	7.11020.29.0	ATS	173
7.08369.37.0	ATS	160	7.09002.02.0	AGR	104	7.11020.30.0	ATS	173
7.08369.38.0	ATS	160	7.09002.03.0	AGR	104	7.11020.31.0	ATS	173
7.08369.39.0	ATS	160	7.09002.04.0	AGR	104	7.11020.32.0	ATS	173
7.08369.40.0	ATS	160	7.09002.05.0	AGR	104	7.11020.33.0	ATS	173
7.08369.41.0	ATS	160	7.09002.06.0	AGR	105	7.11020.35.0	ATS	173
7.08369.42.0	ATS	160	7.09002.07.0	AGR	105	7.11020.36.0	ATS	174
7.08369.43.0	ATS	160	7.09002.08.0	AGR	105	7.11020.37.0	ATS	174
7.08369.44.0	ATS	160	7.09002.09.0	AGR	105	7.11020.38.0	ATS	174
7.08369.45.0	ATS	161	7.09002.10.0	AGR	105	7.11020.40.0	ATS	174
7.08369.46.0	ATS	161	7.09002.11.0	AGR	105	7.11020.41.0	ATS	174
7.08369.47.0	ATS	161	7.09002.12.0	AGR	105	7.11020.42.0	ATS	174
7.08369.48.0	ATS	161	7.09002.13.0	AGR	106	7.11020.43.0	ATS	175
7.08369.49.0	ATS	161	7.09002.14.0	AGR	106	7.11020.44.0	ATS	175
7.08369.50.0	ATS	161	7.09720.00.0	AGR-K	138	7.11020.45.0	ATS	175
7.08369.51.0	ATS	161	7.09720.01.0	AGR-K	139	7.11020.48.0	ATS	175
7.08369.52.0	ATS	162	7.09720.02.0	AGR-K	139	7.11020.49.0	ATS	175
7.08369.53.0	ATS	162	7.09720.03.0	AGR-K	139	7.11190.00.0	DDS	175
7.08369.54.0	ATS	162	7.09720.04.0	AGR-K	139	7.11190.01.0	DDS	175
7.08369.55.0	ATS	162	7.09720.05.0	AGR-K	139	7.11190.02.0	DDS	176
7.08369.56.0	ATS	162	7.09730.00.0	AGR-K	139	7.11190.03.0	DDS	176
7.08369.57.0	ATS	162	7.09730.01.0	AGR-K	140	7.11190.04.0	DDS	177
7.08369.58.0	ATS	162	7.10197.01.0	AK	146	7.11190.08.0	DDS	177
7.08369.59.0	ATS	162	7.10334.00.0	AGR	106	7.11190.09.0	DDS	178
7.08369.60.0	ATS	162	7.10334.02.0	AGR	106	7.11190.10.0	DDS	178
7.08369.61.0	ATS	163	7.10334.03.0	AGR	107	7.11190.12.0	DDS	179
7.08369.62.0	ATS	163	7.10334.04.0	AGR	107	7.11237.00.0	AGR	108
7.08369.63.0	ATS	163	7.10334.05.0	AGR	107	7.11237.01.0	AGR	108
7.08369.64.0	ATS	163	7.10334.06.0	AGR	107	7.11237.02.0	AGR-K	140
7.08369.65.0	ATS	163	7.10334.07.0	AGR	107	7.11237.03.0	AGR	108
7.08369.66.0	ATS	163	7.10334.08.0	AGR	108	7.11237.04.0	AGR	109
7.08369.67.0	ATS	163	7.10334.09.0	AGR	108	7.11237.05.0	AGR-K	140
7.08369.68.0	ATS	163	7.10334.10.0	AGR	108	7.11237.06.0	AGR-K	141
7.08369.69.0	ATS	164	7.10992.00.0	AGR-K	140	7.11237.07.0	AGR	109
7.08369.70.0	ATS	164	7.10993.00.0	AGR-K	140	7.11237.08.0	AGR	109
7.08369.72.0	ATS	164	7.11010.00.0	AGR-K	140	7.11457.07.0*	DDS	179
7.08369.73.0	ATS	164	7.11020.00.0	ATS	168	7.11492.00.0	DDS	179
7.08369.74.0	ATS	164	7.11020.01.0	ATS	168	7.11492.01.0	DDS	180
7.08369.75.0	ATS	164	7.11020.02.0	ATS	169	7.11492.02.0	DDS	180
7.08369.76.0	ATS	164	7.11020.03.0	ATS	169	7.11492.03.0	DDS	181
7.08369.77.0	ATS	165	7.11020.04.0	ATS	169	7.11492.05.0	DDS	181
7.08369.78.0	ATS	165	7.11020.05.0	ATS	169	7.11492.07.0	DDS	182
7.08369.79.0	ATS	165	7.11020.06.0	ATS	169	7.21851.31.0	SLP	218
7.08369.80.0	ATS	165	7.11020.07.0	ATS	169	7.21851.32.0	SLP	218
7.08369.81.0	ATS	165	7.11020.08.0	ATS	169	7.21852.24.0	SLP	218
7.08369.82.0	ATS	165	7.11020.09.0	ATS	169	7.21852.78.0	SLP	219
7.08369.83.0	ATS	166	7.11020.10.0	ATS	170	7.21852.79.0	SLP	219
7.08369.84.0	ATS	166	7.11020.11.0	ATS	170	7.21852.82.0	SLP	219
7.08369.85.0	ATS	166	7.11020.12.0	ATS	170	7.21852.85.0	SLP	219
7.08369.86.0	ATS	166	7.11020.13.0	ATS	170	7.21857.01.0	SLP	219
7.08369.87.0	ATS	166	7.11020.14.0	ATS	170	7.21857.59.0	SLP	219
7.08369.88.0	ATS	166	7.11020.15.0	ATS	170	7.21920.62.0	AGR	109
7.08369.89.0	ATS	166	7.11020.16.0	ATS	170	7.21949.51.0	AGR	109
7.08369.90.0	ATS	167	7.11020.17.0	ATS	171	7.22090.11.0	ARV	148
7.08369.91.0	ATS	167	7.11020.18.0	ATS	171	7.22136.50.0	AGR	109
7.08369.92.0	ATS	167	7.11020.19.0	ATS	171	7.22166.00.0	SLP-M	222
7.08369.93.0	ATS	167	7.11020.20.0	ATS	171	7.22166.01.0*	SLP-M	222
7.08369.94.0	ATS	167	7.11020.21.0	ATS	171	7.22166.02.0	SLP-M	222

 PIERBURG			 PIERBURG			 PIERBURG		
7.22166.20.0*	SLP-M	222	7.22818.57.0	AGR	112	7.24809.69.0	AGR	125
7.22166.38.0	SLP-M	222	7.22818.58.0	AGR	112	7.24809.70.0	AGR	125
7.22166.39.0	SLP	219	7.22818.59.0	AGR	113	7.24809.71.0	AGR	125
7.22166.50.0*	SLP-M	222	7.22818.62.0	AGR	113	7.24809.72.0	AGR	125
7.22166.52.0*	SLP-M	222	7.22818.63.0	AGR	113	7.24809.73.0	AGR	125
7.22166.64.0*	SLP-M	222	7.22841.08.0	AGR	113	7.24809.74.0	AGR	126
7.22166.65.0*	SLP-M	222	7.22843.06.0	AGR	114	7.24809.75.0	AGR	126
7.22166.66.0	SLP-M	222	7.22843.07.0	AGR	114	7.24809.76.0	AGR	126
7.22286.26.0	ARV	148	7.22875.13.0	AGR	114	7.24809.77.0	AGR	126
7.22286.41.0	ARV	148	7.22875.16.0	AGR	114	7.24809.78.0	AGR	126
7.22286.51.0	ARV	148	7.22888.02.0	AGR	115	7.24809.79.0	AGR	127
7.22286.52.0	ARV	148	7.22934.57.0	SLP	220	7.24809.80.0	AGR	127
7.22286.53.0	ARV	149	7.22934.63.0	SLP	221	7.24809.81.0	AGR	127
7.22286.54.0	ARV	149	7.22936.08.0	SLV	227	7.24809.82.0	AGR	127
7.22286.55.0	ARV	149	7.22938.06.0	ARV	154	7.24809.83.0	AGR	127
7.22295.61.0	ARV	149	7.22939.03.0	AGR	115	7.24809.84.0	AGR	128
7.22295.62.0	ARV	149	7.22946.33.0	AGR	115	7.24809.85.0	AGR	128
7.22295.63.0	ARV	150	7.22946.34.0	AGR	115	7.24809.86.0	AGR	128
7.22295.65.0	ARV	150	7.22946.38.0	AGR	115	7.24809.87.0	AGR	128
7.22295.66.0	ARV	150	7.22996.11.0	AGR	116	7.24809.88.0	AGR-K	141
7.22295.67.0	ARV	150	7.22996.12.0	AGR	116	7.24809.89.0	AGR	128
7.22295.68.0	ARV	150	7.24809.06.0	AGR	116	7.24809.90.0	AGR	128
7.22295.69.0	ARV	150	7.24809.07.0	AGR	116	7.24809.91.0	AGR	129
7.22295.70.0	ARV	150	7.24809.10.0	AGR	116	7.24809.92.0	AGR	129
7.22295.71.0	ARV	151	7.24809.16.0	AGR	117	7.24809.93.0	AGR	129
7.22296.02.0	ARV	151	7.24809.17.0	AGR	117	7.24809.94.0	AGR-K	141
7.22299.03.0	ARV	151	7.24809.19.0	AGR	118	7.24809.95.0	AGR	129
7.22414.04.0	AGR	110	7.24809.20.0	AGR	118	7.24809.96.0	AGR	129
7.22414.07.0	AGR	110	7.24809.24.0*	AGR	118	7.24809.97.0	AGR	129
7.22414.08.0	AGR	110	7.24809.25.0*	AGR	118	7.24809.99.0	AGR-K	141
7.22427.03.0	ARV	151	7.24809.26.0	AGR	118	7.28069.03.0	AGR	129
7.22472.07.0	SLP	219	7.24809.27.0	AGR	118	7.28069.04.0	AGR	130
7.22477.10.0	AGR	110	7.24809.28.0	AGR	119	7.28070.03.0	AGR	130
7.22477.11.0	AGR	110	7.24809.29.0	AGR	119	7.28124.19.0	SLP	221
7.22560.40.0	ARV	151	7.24809.30.0	AGR	119	7.28124.20.0	SLP	221
7.22560.41.0	ARV	152	7.24809.31.0	AGR	119	7.28124.21.0	SLP	221
7.22560.42.0	ARV	152	7.24809.32.0	AGR	120	7.28124.30.0	SLP	221
7.22560.43.0	ARV	152	7.24809.33.0	AGR	120	7.28129.14.0*	SLP-M	222
7.22560.44.0	ARV	152	7.24809.34.0	AGR	120	7.28129.22.0*	SLP-M	222
7.22560.45.0	ARV	152	7.24809.35.0	AGR	120	7.28129.32.0*	SLP-M	222
7.22574.12.0	AGR	110	7.24809.36.0	AGR	120	7.28129.52.0*	SLP-M	222
7.22630.28.0	AGR	111	7.24809.37.0	AGR	120	7.28238.55.0	SLV	227
7.22738.08.0	SLP	220	7.24809.38.0	AGR	120	7.28238.56.0	SLV	227
7.22738.20.0	SLP	220	7.24809.39.0	AGR	121	7.28238.57.0	SLV	228
7.22748.18.0	SLV	225	7.24809.40.0	AGR	121	7.28238.58.0	SLV	228
7.22769.73.0	ARV	153	7.24809.46.0	AGR	121	7.28238.61.0	SLV	228
7.22769.76.0	ARV	153	7.24809.47.0	AGR	121	7.28238.62.0	SLV	228
7.22769.77.0	ARV	153	7.24809.48.0	AGR	122	7.28238.63.0	SLV	228
7.22769.78.0	ARV	153	7.24809.49.0	AGR	122	7.28247.13.0	SLP	221
7.22769.79.0	ARV	153	7.24809.50.0	AGR	122	7.28248.17.0	AGR	130
7.22769.80.0	ARV	153	7.24809.51.0	AGR	122	7.28264.06.0	AGR	130
7.22772.11.0	AGR	111	7.24809.52.0	AGR	122	7.28264.07.0	AGR	130
7.22772.12.0	AGR	111	7.24809.53.0	AGR	122	7.28270.14.0	AGR	130
7.22778.79.0	SLV	226	7.24809.54.0	AGR	122	7.28290.11.0	AGR	131
7.22778.80.0	SLV	226	7.24809.55.0	AGR	123	7.28384.13.0	AGR	131
7.22778.94.0	SLV	226	7.24809.56.0	AGR	123	7.28415.09.0	SLP	221
7.22778.95.0	SLV	226	7.24809.57.0	AGR	123			
7.22778.96.0	SLV	226	7.24809.59.0	AGR	123			
7.22778.97.0	SLV	227	7.24809.60.0	AGR	123			
7.22778.98.0	SLV	227	7.24809.61.0	AGR	123			
7.22778.99.0	SLV	227	7.24809.63.0	AGR	124			
7.22785.16.0	AGR	111	7.24809.64.0	AGR	124			
7.22785.17.0	AGR	111	7.24809.65.0	AGR	124			
7.22785.18.0	AGR	112	7.24809.66.0	AGR	124			
7.22785.20.0	AGR	112	7.24809.68.0	AGR	124			



AGR 7.00020.24.0	AGR 7.00020.25.0	AGR 7.00020.39.0
-------------------------	-------------------------	-------------------------



→SI 0092
→SI 0100

FIAT

- 500 (312_)
- 500 C (312_)
- DOBLO Box Body/MPV (223_)
- DOBLO MPV (119_, 223_)
- FIORINO Box Body/MPV (225_)
- GRANDE PUNTO (199_)
- GRANDE PUNTO Van (199_)
- IDEA (350_)
- PALIO (178_)
- PANDA (169_)
- PANDA Hatchback Van (169_)
- PUNTO (188_)
- PUNTO (199_)
- PUNTO EVO (199_)
- PUNTO EVO Hatchback Van (199_)
- PUNTO Hatchback Van (188_)
- PUNTO Hatchback Van (199_)
- QUBO (225_)
- SIENA (178_, 172_)

LANCIA

- MUSA (350_)
- YPSILON (843_)

OPEL

- AGILA (A) (H00)
- AGILA (B) (H08)
- COMBO Box Body/MPV
- COMBO Tour
- CORSA C (X01)
- CORSA C Hatchback Van (X01)
- CORSA D (S07)
- CORSA D Hatchback Van (S07)
- MERIVA A MPV (X03)
- TIGRA TwinTop (X04)

SUZUKI

- IGNIS II (MH)
- WAGON R+ Hatchback (MM)

VAUXHALL

- AGILA Mk II (B) (H08)
- COMBO Mk II (C) Box Body/MPV (F25)
- CORSA Mk II (C) (X01)
- CORSA Mk III (D) (S07)
- CORSAVAN Mk II (C) Hatchback Van (X01)
- CORSAVAN Mk III (D) Hatchback Van (S07)
- MERIVA A (X03)
- TIGRA TwinTop (X04)



→SI 0092
→SI 0100

ALFA ROMEO

- MITO (955_)
- FIAT**
- DOBLO Box Body/MPV (223_)
 - DOBLO Bus (263_)
 - DOBLO Cargo (263_)
 - DOBLO MPV (119_, 223_)
 - FIORINO Box Body/MPV (225_)
 - GRANDE PUNTO (199_)
 - IDEA (350_)
 - LINEA (323_, 110_)
 - PUNTO EVO (199_)
 - QUBO (225_)
 - STRADA Pickup (178_)

LANCIA

- MUSA (350_)
- YPSILON (843_)

OPEL

- ASTRA H (A04)
- ASTRA H CLASSIC Hatchback (A04)
- ASTRA H Estate (A04)
- ASTRA H Estate Van (L70)
- ASTRA H GTC (A04)
- ASTRA H Saloon (A04)
- CORSA D (S07)
- CORSA D Hatchback Van (S07)

VAUXHALL

- ASTRA Mk V (H) (A04)
- ASTRA Mk V (H) Estate (A04)
- ASTRA Mk V (H) Sport Hatch (A04)
- ASTRAVAN Mk V (H) Estate Van (A04)
- CORSA Mk III (D) (S07)



→SI 0092
→SI 0100

FIAT

- 500 (312_)
- 500 C (312_)
- IDEA (350_)
- PANDA (169_)
- PANDA Hatchback Van (169_)

FORD

- KA (RU8)

LANCIA

- MUSA (350_)

AGR 7.00020.40.0



→SI 0092
→SI 0100

FIAT

- IDEA (350_)

LANCIA

- MUSA (350_)

AGR 7.00020.50.0



→SI 0092
→SI 0100





AGR 7.00020.50.0	AGR 7.00063.10.0	AGR 7.00306.37.0
<p>OPEL AGILA (B) (H08) SUZUKI SPLASH (EX) SWIFT III (MZ, EZ) SWIFT IV (FZ, NZ) VAUXHALL AGILA Mk II (B) (H08)</p>	<p>ASTRA Mk V (H) TwinTop (A04) ASTRAVAN Mk V (H) Estate Van (A04) SIGNUM (Z03) VECTRA Mk II (C) (Z02) VECTRA Mk II (C) Estate (Z02) VECTRA Mk II (C) GTS (Z02) ZAFIRA Mk II (B) (A05)</p>	 <p>→SI 0096 →SI 0100</p>
<p>AGR 7.00063.10.0</p>	<p>AGR 7.00075.07.0</p>	
 <p>→SI 0092 →SI 0100</p>	 <p>→SI 0092 →SI 0100</p>	<p>MERCEDES-BENZ A-CLASS (W169) B-CLASS Sports Tourer (W245)</p>
<p>ALFA ROMEO 147 (937_) 156 (932_) 156 Sportwagon (932_) 159 (939_) 159 Sportwagon (939_) 166 (936_) BRERA (939_) GT (937_) SPIDER (939_) FIAT BRAVO II (198_) CROMA (194_) STILO (192_) STILO Multi Wagon (192_) LANCIA THESIS (841_) OPEL ASTRA H (A04) ASTRA H Estate (A04) ASTRA H Estate Van (L70) ASTRA H GTC (A04) ASTRA H TwinTop (A04) SIGNUM Hatchback (Z03) VECTRA C (Z02) VECTRA C Estate (Z02) VECTRA C GTS (Z02) ZAFIRA / ZAFIRA FAMILY B (A05) SAAB 9-3 (YS3F, E79, D79, D75) 9-3 Convertible (YS3F) 9-3 Estate (E50) 9-5 (YS3E) 9-5 Estate (YS3E) VAUXHALL ASTRA Mk V (H) (A04) ASTRA Mk V (H) Estate (A04) ASTRA Mk V (H) Sport Hatch (A04)</p>	<p>RENAULT GRAND SCÉNIC II (JM0/1_) LAGUNA II (BG0/1_) LAGUNA II Grandtour (KG0/1_) MEGANE II (BM0/1_, CM0/1_) MEGANE II Estate (KM0/1_) MEGANE II Saloon (LM0/1_) SCÉNIC II (JM0/1_)</p>	<p>AGR 7.00309.07.0</p>  <p>→SI 0096 →SI 0100</p>
<p>AGR 7.00306.36.0</p>	<p>AGR 7.00306.36.0</p>	
	 <p>→SI 0096 →SI 0100</p> <p>MITSUBISHI COLT VI (Z3_A, Z2_A) SMART FORFOUR (454) FORTWO Cabrio (451) FORTWO Coupe (451)</p>	<p>AUDI A4 B7 (8EC) A4 B7 Avant (8ED) A4 B7 Convertible (8HE) A6 Allroad C6 (4FH) A6 C6 (4F2) A6 C6 Avant (4F5) A8 D3 (4E2, 4E8) Q7 (4LB) VOLKSWAGEN PHAETON (3D1, 3D2, 3D3, 3D4, 3D6, 3D7, 3D8, 3D9) TOUAREG (7LA, 7L6, 7L7)</p>



AGR 7.00365.06.0 AGR 7.00368.15.0 AGR 7.00368.16.0



→SI 0092
→SI 0100

AUDI

- A4 B6 (8E2)
- A4 B6 Avant (8E5)
- A4 B7 (8EC)
- A4 B7 Avant (8ED)
- A4 B7 Convertible (8HE)

SKODA

- SUPERB I (3U4)

VOLKSWAGEN

- MULTIVAN V (7HM, 7HN, 7HF, 7EF, 7EM, 7EN)
- NEW BEETLE (9C1, 1C1)
- PASSAT B5.5 (3B3)
- PASSAT B5.5 Variant (3B6)
- TRANSPORTER V Bus (7HB, 7HJ, 7EB, 7EJ, 7EF, 7EG, 7HF, 7EC)
- TRANSPORTER V Platform/Chassis (7JD, 7JE, 7JL, 7JY, 7JZ, 7FD)
- TRANSPORTER V Van (7HA, 7HH, 7EA, 7EH)

- QASHQAI / QASHQAI +2 I (J10, NJ10, JJ10E)
- TIIDA Hatchback (C11)
- TIIDA Saloon (SC11)

RENAULT

- CLIO II (BB_, CB_)
- CLIO II Hatchback Van (SB0/1/2_)
- CLIO III (BR0/1, CR0/1)
- CLIO III Grandtour (KR0/1_)
- CLIO III Hatchback Van (SB_, SR_)
- DUSTER (HS_)
- FLUENCE (L3_)
- GRAND SCÉNIC II (JM0/1_)
- GRAND SCÉNIC III (JZ0/1_)
- KANGOO (KC0/1_)
- KANGOO / GRAND KANGOO (KW0/1_)
- KANGOO BE BOP (KW0/1_)
- KANGOO Express (FC0/1_)
- KANGOO Express (FW0/1_)
- LAGUNA III (BT0/1)
- LAGUNA III Grandtour (KT0/1)
- LOGGY (JS_)

- LOGAN EXPRESS (US_)

- LOGAN I (LS_)

- LOGAN I Estate (KS_)

- LOGAN II Estate (K8_)

- LOGAN/STEPWAY II (L8_)

- MEGANE II (BM0/1_, CM0/1_)

- MEGANE II Coupé-Cabriolet (EM0/1_)

- MEGANE II Estate (KM0/1_)

- MEGANE II Estate Van (KM_)

- MEGANE II Hatchback Van (KM0/2_)

- MEGANE II Saloon (LM0/1_)

- MEGANE III Coupe (DZ0/1_)

- MEGANE III Grandtour (KZ0/1)

- MEGANE III Hatchback (BZ0/1_, B3_)

- MODUS / GRAND MODUS (F/JP0_)

- SANDERO/STEPWAY I (BS_)

- SANDERO/STEPWAY II (B8_)

- SCALA (LJM_)

- SCÉNIC II (JM0/1_)

- SCÉNIC III (JZ0/1_)

- THALIA I (LB_)

- THALIA II (LU_)

- TWINGO II (CN0_)

SUZUKI

- JIMNY Closed Off-Road Vehicle (SN)

DACIA

- DOKKER Express Box Body/MPV
- DOKKER MPV (KE_)
- DUSTER (HS_)
- DUSTER SUV Van
- LOGGY (JS_)
- LOGAN (LS_)
- LOGAN EXPRESS (FS_)
- LOGAN II
- LOGAN MCV (KS_)
- LOGAN MCV II
- LOGAN Pickup (US_)
- SANDERO
- SANDERO II

NISSAN

- JUKE (F15)
- NOTE (E12)
- NV200 / EVALIA Bus
- NV200 Van
- QASHQAI / QASHQAI +2 I (J10, NJ10, JJ10E)

RENAULT

- CAPTUR I (J5_, H5_)
- CLIO III (BR0/1, CR0/1)
- CLIO III Grandtour (KR0/1_)
- CLIO III Hatchback Van (SB_, SR_)
- CLIO IV (BH_)
- CLIO IV Grandtour (KH_)
- CLIO IV Hatchback Van (BH_)
- DOKKER
- DUSTER (HS_)
- FLUENCE (L3_)
- GRAND SCÉNIC III (JZ0/1_)
- KANGOO / GRAND KANGOO (KW0/1_)
- KANGOO BE BOP (KW0/1_)
- KANGOO Express (FW0/1_)
- LAGUNA Coupe (DT0/1)
- LAGUNA III (BT0/1)
- LAGUNA III Grandtour (KT0/1)
- LATITUDE (L70_)
- LOGGY (JS_)
- MEGANE CC (EZ0/1_)
- MEGANE III Combi Van (KZ0/1)
- MEGANE III Coupe (DZ0/1_)
- MEGANE III Grandtour (KZ0/1)
- MEGANE III Hatchback (BZ0/1_, B3_)
- MEGANE III Hatchback Van (BZ_)
- MODUS / GRAND MODUS (F/JP0_)

- SCÉNIC III (JZ0/1_)

- SCÉNIC IV (J9_)

- THALIA II (LU_)

- THALIA III (L8_)

- TWINGO II (CN0_)

AGR 7.00368.15.0



→SI 0092
→SI 0100

DACIA

- DUSTER (HS_)
- LOGAN (LS_)
- LOGAN EXPRESS (FS_)
- LOGAN II
- LOGAN MCV (KS_)
- LOGAN MCV II
- LOGAN Pickup (US_)
- SANDERO
- SANDERO II

NISSAN

- KUBISTAR Van (X76)
- MICRA III (K12)
- NOTE (E11, NE11)

AGR 7.00368.16.0



→SI 0092
→SI 0100

EMISSION CONTROL



AGR	AGR	AGR
-----	-----	-----

7.00450.09.0

7.00512.03.0

7.00555.07.0



→SI 0096
→SI 0100

→SI 0096
→SI 0100

→PI 1172
→SI 0092
→SI 0100

BMW

- 1 (E87)
- 3 (E90)
- 3 Convertible (E93)
- 3 Coupe (E92)
- 3 Touring (E91)
- 5 (E60)
- 5 Touring (E61)
- 7 (E65, E66, E67)
- X3 (E83)
- X5 (E53)
- X5 (E70)
- X6 (E71, E72)

BMW

- 1 (E87)
- 3 (E90)
- 3 Convertible (E93)
- 3 Coupe (E92)
- 3 Touring (E91)
- 5 (E60)
- 5 Touring (E61)
- 7 (E65, E66, E67)
- X3 (E83)
- X5 (E70)
- X6 (E71, E72)

VOLVO

- C30 (533)
- C70 II Convertible (542)
- S40 II (544)
- S60 I (384)
- S80 II (124)
- V50 (545)
- V70 II (285)
- V70 III (135)
- XC60 I SUV (156)
- XC70 CROSS COUNTRY I (295)
- XC70 II (136)
- XC90 I (275)

AGR	AGR	AGR
-----	-----	-----

7.00450.10.0

7.00555.06.0

7.00578.12.0



→SI 0096
→SI 0100

→PI 1172
→SI 0092
→SI 0100

→SI 0092
→SI 0100

BMW

- 3 (E90)
- 3 Coupe (E92)
- 3 Touring (E91)
- 5 (E60)
- 5 Touring (E61)
- 6 (E63)
- 6 Convertible (E64)
- X3 (E83)
- X5 (E70)
- X6 (E71, E72)

VOLVO

- C30 (533)
- C70 II Convertible (542)
- S40 II (544)
- S60 I (384)
- S80 II (124)
- V50 (545)
- V70 II (285)
- V70 III (135)
- XC60 I SUV (156)
- XC70 CROSS COUNTRY I (295)
- XC70 II (136)
- XC90 I (275)

CITROEN

- C-CROSSER (VU_, VV_)
- C-CROSSER ENTERPRISE (VU_, VV_)
- C-CROSSER Van (VU_)
- C5 II (RC_)
- C5 II Break (RE_)
- C5 III (RD_)
- C5 III Break (RW_)
- C6 (TD_)
- C8 (EA_, EB_)

FIAT

- ULYSSE (179_)

FORD

- GALAXY II (WA6)
- MONDEO IV (BA7)
- MONDEO IV Saloon (BA7)
- MONDEO IV Turnier (BA7)





AGR	7.00578.12.0	AGR	7.00684.14.0	AGR	7.00907.03.0
S-MAX (WA6) JAGUAR XF I (X250) XF SPORTBRAKE (X250) LANCIA PHEDRA (179_) LAND ROVER DISCOVERY SPORT (L550) FREELANDER 2 (L359) FREELANDER 2 VAN (L359) RANGE ROVER EVOQUE (L538) RANGE ROVER EVOQUE VAN (L538) MITSUBISHI OUTLANDER II (CW_W) PEUGEOT 4007 (VU_, VV_) 4007 Van (VU_, VV_) 407 (6D_) 407 SW (6E_) 607 (9D, 9U) 807 (EB_)		3 (E90) 3 Convertible (E93) 3 Coupe (E92) 3 Touring (E91) 5 (E60) 5 Touring (E61) X3 (E83)			→SI 0092 →SI 0100
		AGR	7.00789.10.0		
				AUDI A3 (8P1) A3 Convertible (8P7) A3 Sportback (8PA) SEAT ALTEA (5P1) ALTEA XL (5P5, 5P8) CORDOBA (6L2) IBIZA III (6L1) IBIZA IV (6J5, 6P1) IBIZA IV SC (6J1, 6P5) LEON (1P1) TOLEDO III (5P2) SKODA FABIA II (542) FABIA II Combi (545) OCTAVIA II (1Z3) OCTAVIA II Combi (1Z5) ROOMSTER (5J7) ROOMSTER Praktik (5J) SUPERB II (3T4) SUPERB II Estate (3T5) VOLKSWAGEN CADDY III Box Body/MPV (2KA, 2KH, 2CA, 2CH) CADDY III MPV (2KB, 2KJ, 2CB, 2CJ) EOS (1F7, 1F8) GOLF PLUS V (5M1, 521) GOLF V (1K1) GOLF V Variant (1K5) JETTA III (1K2) PASSAT B6 (3C2) PASSAT B6 Variant (3C5) POLO (9N_) TOURAN (1T1, 1T2)	→SI 0092 →SI 0100
		AGR	7.00632.13.0		
				AUDI A8 D3 (4E2, 4E8) A8 D4 (4H2, 4H8, 4HC, 4HL) Q7 (4LB) PORSCHE CAYENNE (92A) VOLKSWAGEN TOUAREG (7P5, 7P6)	→SI 0092 →SI 0100
		AGR	7.00823.06.0		
				VOLKSWAGEN CRAFTER 30-35 Bus (2E_) CRAFTER 30-50 Platform/Chassis (2F_) CRAFTER 30-50 Van (2E_) MULTIVAN V (7HM, 7HN, 7HF, 7EF, 7EM, 7EN) TOUAREG (7LA, 7L6, 7L7) TRANSPORTER V Bus (7HB, 7HJ, 7EB, 7EJ, 7EF, 7EG, 7HF, 7EC) TRANSPORTER V Platform/Chassis (7JD, 7JE, 7JL, 7JY, 7JZ, 7FD) TRANSPORTER V Van (7HA, 7HH, 7EA, 7EH)	→SI 0092 →SI 0100
		AGR	7.00684.14.0		
				VOLKSWAGEN CRAFTER 30-35 Bus (2E_) CRAFTER 30-50 Platform/Chassis (2F_) CRAFTER 30-50 Van (2E_) MULTIVAN V (7HM, 7HN, 7HF, 7EF, 7EM, 7EN) TOUAREG (7LA, 7L6, 7L7) TRANSPORTER V Bus (7HB, 7HJ, 7EB, 7EJ, 7EF, 7EG, 7HF, 7EC) TRANSPORTER V Platform/Chassis (7JD, 7JE, 7JL, 7JY, 7JZ, 7FD) TRANSPORTER V Van (7HA, 7HH, 7EA, 7EH)	→SI 0096 →SI 0100
		JEEP CHEROKEE (KJ) JEEP LIBERTY			
		BMW 1 (E81) 1 (E87) 1 Convertible (E88) 1 Coupe (E82)			

EMISSION CONTROL





AGR 7.00992.36.0 New



© MS Motorservice International GmbH

→SI 1830

DODGE

- DAKOTA
- DAKOTA Crew Cab Pickup
- DAKOTA Extended Cab Pickup
- DURANGO (HB)
- NITRO
- RAM 1500 Crew Cab Pickup
- RAM 1500 Extended Cab Pickup
- RAM 1500 Extended Crew Cab Pickup
- RAM 1500 Standard Cab Pickup

JEEP

- CHEROKEE (KK)
- COMMANDER (XK, XH)
- GRAND CHEROKEE III (WH, WK)

RAM

- 1500 Crew Cab Pickup (DS)
- 1500 Extended Cab Pickup (DS)
- 1500 Standard Cab Pickup (DS)
- DAKOTA

AGR 7.01268.03.0



© MS Motorservice International GmbH

→SI 0100

MAN

- 18T-SERIES
- BUS
- CLA
- FOCL
- HOCL
- L2000
- LION'S CITY
- LION'S COACH
- LION'S REGIO
- M 2000 L
- M 2000 M
- NG
- NL
- NM
- NÜ
- SG
- SL II
- SÜ
- TGA
- TGL
- TGM
- TGS
- TGX
- ÜL

ENGINE

MERCEDES-BENZ

- ACTROS III
- ACTROS MP2 / MP3
- ACTROS MP4 / MP5
- ANTOS
- AROCS

NEOPLAN Bus GmbH

- Airliner
- Centroliner
- Cityliner
- Euroliner
- Tourliner
- Trendliner

AGR 7.00999.08.0



© MS Motorservice International GmbH

→SI 0092

→SI 0100

RENAULT

- LAGUNA Coupe (DT0/1)
- LAGUNA III (BT0/1)
- LAGUNA III Grandtour (KT0/1)
- LATITUDE (L70_)

AGR 7.01293.38.0



© MS Motorservice International GmbH

FORD USA

- F-250 SUPER DUTY Crew Cab Pickup
- F-250 SUPER DUTY Extended Cab Pickup
- F-250 SUPER DUTY Standard Cab Pickup
- F-350 SUPER DUTY Cab & Chassis
- F-350 SUPER DUTY Crew Cab Pickup
- F-350 SUPER DUTY Extended Cab Pickup
- F-350 SUPER DUTY Standard Cab Pickup
- F-450 SUPER DUTY Cab & Chassis
- F-450 SUPER DUTY Crew Cab Pickup
- F-550 SUPER DUTY Cab & Chassis

AGR 7.01317.10.0



© MS Motorservice International GmbH

→SI 0096

→SI 0100

CHEVROLET

- TRAILBLAZER (31UX)

CHRYSLER

- GRAND VOYAGER V (RT)

DODGE

- NITRO

JEEP

- CHEROKEE (KK)
- WRANGLER III (JK)

EMISSION CONTROL





AGR 7.01493.07.0



→SI 0092
→SI 0100

VOLKSWAGEN
 BEETLE (5C1, 5C2)
 BEETLE Convertible (5C7, 5C8)
 GOLF VI (5K1)
 GOLF VI Van (5K1_)
 GOLF VI Variant (AJ5)
 JETTA III (1K2)
 JETTA IV (162, 163, AV3, AV2)

AGR 7.01599.10.0

PANDA VAN (312_, 519_)
 PUNTO (199_)
 PUNTO EVO (199_)
 PUNTO EVO Hatchback Van (199_)
 PUNTO Hatchback Van (199_)
 QUBO (225_)
 STRADA Pickup (178_)
 TIPO Estate (356_)
 TIPO Hatchback (356_)
 TIPO Saloon (356_)
LANCIA
 MUSA (350_)
 YPSILON (312_)
 YPSILON (843_)
OPEL
 ASTRA J (P10)
 ASTRA J Saloon
 ASTRA J Sports Tourer (P10)
 CORSA D (S07)
 CORSA D Hatchback Van (S07)
 MERIVA B MPV (S10)
PEUGEOT
 BIPPER (AA_)
 BIPPER TEPEE
SUZUKI
 SWIFT IV (FZ, NZ)
VAUXHALL
 ASTRA Mk VI (J) (P10)
 ASTRA Mk VI (J) Estate (P10)
 ASTRA Mk VI (J) Saloon (P10)
 CORSA Mk III (D) (S07)
 CORSAVAN Mk III (D) Hatchback Van (S07)
 MERIVA Mk II (B) (S10)

AGR 7.01621.08.0



FORD
 TRANSIT Bus (FD_, FB_, FS_, FZ_, FC_)
 TRANSIT Platform/Chassis (FM_, FN_, FF_)
 TRANSIT TOURNEO Bus
 TRANSIT Van (FA_)

AGR 7.01599.10.0



→SI 0092
→SI 0100

ALFA ROMEO
 MITO (955_)
CHRYSLER
 YPSILON
CITROEN
 NEMO Box Body/MPV (AA_)
 NEMO MPV
FIAT
 500 (312_)
 500 C (312_)
 500L (351_, 352_)
 500X (334_)
 DOBLO Bus (263_)
 DOBLO Cargo (263_)
 DOBLO Platform/Chassis (263_)
 FIORINO Box Body/MPV (225_)
 GRANDE PUNTO (199_)
 GRANDE PUNTO Van (199_)
 IDEA (350_)
 LINEA (323_, 110_)
 PANDA (169_)
 PANDA (312_, 319_)
 PANDA Hatchback Van (169_)

AGR 7.01604.02.0



→PI 1172
→SI 0092
→SI 0100

VOLVO
 C30 (533)
 C70 II Convertible (542)
 S40 II (544)
 V50 (545)

AGR 7.01782.07.0



→SI 0092
→SI 0100

AUDI
 A4 B8 (8K2)
 A4 B8 Avant (8K5)
 A5 (8T3)
 A5 Sportback (8TA)
 Q7 (4LB)
PORSCHE
 CAYENNE (9PA)
VOLKSWAGEN
 PHAETON (3D1, 3D2, 3D3, 3D4, 3D6, 3D7, 3D8, 3D9)
 TOUAREG (7LA, 7L6, 7L7)

AGR 7.02014.07.0



→SI 0092
→SI 0100

EMISSION CONTROL



AGR 7.02209.20.0	AGR 7.02738.13.0	AGR 7.03196.09.0
 <p>FORD B-MAX (JK) B-MAX Van (JK) C-MAX II (DXA/CB7, DXA/CEU) C-MAX II Van ECOSPORT FIESTA Saloon FIESTA VI (CB1, CCN) FIESTA VI Van FIESTA VII (HJ, HF) FIESTA VII Van FOCUS III FOCUS III Estate Van FOCUS III Hatchback Van FOCUS III Saloon FOCUS III Turnier GRAND C-MAX (DXA/CB7, DXA/CEU) GRAND C-MAX Van KA+ III (UK, FK) KA+ III Saloon (TK, FK) KUGA II (DM2) KUGA II VAN MONDEO V Hatchback (CE) MONDEO V Saloon (CD) MONDEO V Turnier (CF) TOURNEO CONNECT / GRAND TOURNEO CONNECT V408 MPV TOURNEO COURIER B460 MPV TRANSIT CONNECT MPV TRANSIT CONNECT V408 Box Body/MPV TRANSIT COURIER B460 Box Body/MPV TRANSIT COURIER B460 MPV</p>	<p>F-250 SUPER DUTY Standard Cab Pickup (F2A, F2B) F-550 SUPER DUTY Cab & Chassis</p> <hr/> <p>AGR 7.02769.05.0</p>  <p>→SI 1830</p> <p>CHRYSLER ASPEN (HG)</p> <p>JEEP COMMANDER (XK, XH) GRAND CHEROKEE III (WH, WK)</p> <p>RAM 1500 Crew Cab Pickup (DS) 1500 Extended Cab Pickup (DS) 1500 Standard Cab Pickup (DS)</p>	 <p>→SI 0092 →SI 0100</p> <p>VOLKSWAGEN MULTIVAN V (7HM, 7HN, 7HF, 7EF, 7EM, 7EN) MULTIVAN VI (SGF, SGM, SGN, SHM, SHN) TRANSPORTER / CARAVELLE VI Bus (SGB, SGG, SGJ, SGC, SHB, SHJ) TRANSPORTER V Bus (7HB, 7HJ, 7EB, 7EJ, 7EF, 7EG, 7HF, 7EC) TRANSPORTER V Platform/Chassis (7JD, 7JE, 7JL, 7JY, 7JZ, 7FD) TRANSPORTER V Van (7HA, 7HH, 7EA, 7EH) TRANSPORTER VI Platform/Chassis (SFD, SFE, SFL, SFZ, SJD, SJ) TRANSPORTER VI Van (SGA, SGH, SHA, SHH)</p>
<p>AGR 7.02738.13.0</p>  <p>FORD USA F-250 SUPER DUTY Crew Cab Pickup (W2A, W2B) F-250 SUPER DUTY Extended Cab Pickup (X2A, X2B)</p>	<p>AGR 7.03051.04.0</p>  <p>→SI 0096 →SI 0100</p> <p>MINI (BMW) MINI (R56) MINI CLUBMAN (R55) MINI CLUBVAN (R55) MINI COUNTRYMAN (R60) MINI Convertible (R57) MINI Coupe (R58) MINI PACEMAN (R61) MINI Roadster (R59)</p> <p>TOYOTA VERSO (_R2_)</p>	<p>AGR 7.03295.03.0</p>  <p>→SI 0092 →SI 0100</p> <p>CHRYSLER GRAND VOYAGER V (RT)</p> <p>DODGE NITRO</p> <p>JEEP CHEROKEE (KK) WRANGLER III (JK)</p> <p>LANCIA VOYAGER MPV (404_)</p>

EMISSION CONTROL



AGR 7.03379.03.0



DEUTZ
ENGINE

AGR 7.03784.34.0



→PI 1728
→SI 0092
→SI 0100

AGR 7.04256.35.0



DEUTZ
ENGINE

→SI 0092
→SI 0100

AGR 7.03435.05.0



→SI 0092
→SI 0100

MERCEDES-BENZ

- A-CLASS (W176)
- B-CLASS Sports Tourer (W246, W242)
- CITAN Box Body/MPV (W415)
- CITAN MPV (415)
- CITAN Mixto (Double Cabin) (W415)
- CLA Coupe (C117)
- CLA Shooting Brake (X117)
- GLA-CLASS (X156)

NISSAN

- JUKE (F15)
- NOTE (E12)
- NV200 / EVALIA Bus
- NV200 Van
- QASHQAI II SUV (J11, J11_)

RENAULT

- CAPTUR I (J5_, H5_)
- CLIO IV (BH_)
- CLIO IV Grandtour (KH_)
- CLIO IV Hatchback Van (BH_)
- GRAND SCÉNIC III (JZ0/1_)
- KANGOO / GRAND KANGOO (KW0/1_)
- KANGOO Express (FW0/1_)
- MEGANE III Coupe (DZ0/1_)
- MEGANE III Grandtour (KZ0/1)
- MEGANE III Hatchback (BZ0/1_, B3_)
- SCÉNIC III (JZ0/1_)

CITROEN

- JUMPER Bus
- JUMPER Platform/Chassis
- JUMPER Van

FORD

- RANGER (TKE)
- TOURNEO CUSTOM V362 Bus (F3)
- TRANSIT Bus (FD_, FB_, FS_, FZ_, FC_)
- TRANSIT CUSTOM V362 Bus (F3)
- TRANSIT CUSTOM V362 Van (FY, FZ)
- TRANSIT Platform/Chassis (FM_, FN_, FF_)
- TRANSIT TOURNEO Bus
- TRANSIT V363 Bus (FAD, FBD)
- TRANSIT V363 Platform/Chassis (FED, FFD)
- TRANSIT V363 Van (FCD, FDD)
- TRANSIT Van (FA_)

LAND ROVER

- DEFENDER Cabrio (L316)
- DEFENDER II
- DEFENDER Pick Up (L316)
- DEFENDER Platform/Chassis (L316)
- DEFENDER Station Wagon (L316)

PEUGEOT

- BOXER Bus
- BOXER Platform/Chassis
- BOXER Van

AGR 7.03803.03.0 New



JOHN DEERE
ENGINE

AGR 7.04256.36.0



DEUTZ
ENGINE

→SI 0092
→SI 0100

AGR 7.04257.19.0











DEUTZ
ENGINE

→SI 0092
→SI 0100

EMISSION CONTROL











AGR	7.04257.20.0	AGR	7.04493.17.0	AGR	7.04589.06.0 New
 <p>→SI 0092 →SI 0100</p> <p>DEUTZ ENGINE</p>		4 Convertible (F33, F83) 4 Coupe (F32, F82) 4 Gran Coupe (F36) 5 (F10) 5 (G30, F90) 5 Touring (F11) 5 Touring (G31) 6 Gran Turismo (G32) 7 (G11, G12) 8 Convertible (G14, F91) 8 Coupe (G15, F92) X1 (F48) X2 (F39) X3 (F25) X4 (F26) X4 (G02, F98) X5 (F15, F85) X5 (G05, F95) X7 (G07)	 <p>→SI 1830</p> <p>RAM 2500 2500 Crew Cab Pickup (DJ) 2500 Extended Crew Cab Pickup (DJ) 2500 Standard Cab Pickup (DJ) 3500 Crew Cab Pickup (D2) 3500 Extended Crew Cab Pickup (D2) 3500 Platform/Chassis (D2) 3500 Standard Cab Pickup (D2) 4500 Platform/Chassis (DC) 5500 Cab & Chassis (DC)</p>		
		MINI (BMW) MINI (F55) MINI (F56) MINI CLUBMAN (F54) MINI COUNTRYMAN (F60) MINI COUNTRYMAN (R60) MINI Convertible (F57) MINI PACEMAN (R61)			
 <p>→SI 0100</p> <p>DEUTZ ENGINE</p>		TOYOTA AURIS (_E18_) AURIS Estate (_E18_) AVENSIS Estate (_T27_) AVENSIS Saloon (_T27_) RAV 4 IV (_A4_) VERSO (_R2_)			
		MINI (BMW) MINI (F55) MINI (F56) MINI CLUBMAN (F54) MINI COUNTRYMAN (F60) MINI COUNTRYMAN (R60) MINI Convertible (F57) MINI PACEMAN (R61)			
 <p>→SI 0092 →SI 0100 →SI 1597</p> <p>BMW 1 (F20) 1 (F21) 2 Active Tourer (F45) 2 Convertible (F23) 2 Coupe (F22, F87) 2 Gran Tourer (F46) 3 (F30, F80) 3 (G20, G80) 3 Gran Turismo (F34) 3 Touring (F31)</p>		ALFA ROMEO MITO (955_)			
		FIAT 500L (351_, 352_) 500X (334_) DOBLO Bus (263_) DOBLO Cargo (263_) DOBLO Platform/Chassis (263_) FIORINO Box Body/MPV (225_) PANDA (312_, 319_) PUNTO (199_) TIPO Hatchback (356_) TIPO Saloon (356_)			
 <p>→SI 0092 →SI 0100 →SI 1597</p> <p>BMW 1 (F20) 1 (F21) 2 Active Tourer (F45) 2 Convertible (F23) 2 Coupe (F22, F87) 2 Gran Tourer (F46) 3 (F30, F80) 3 (G20, G80) 3 Gran Turismo (F34) 3 Touring (F31)</p>		JAGUAR F-PACE (X761) XE (X760) XF II (X260) XF SPORTBRAKE (X260)			
		LAND ROVER DISCOVERY V (L462) RANGE ROVER SPORT II (L494) RANGE ROVER VELAR (L560)			

EMISSION CONTROL



<p>AGR 7.04923.18.0 New</p>  <p>JAGUAR E-PACE (X540)</p> <p>LAND ROVER DISCOVERY SPORT (L550) RANGE ROVER EVOQUE (L538) RANGE ROVER EVOQUE (L551) RANGE ROVER EVOQUE Convertible (L538)</p>	<p>AGR 7.04924.15.0 New</p> <p>DISCOVERY V (L462) RANGE ROVER SPORT II (L494) RANGE ROVER VELAR (L560)</p> <hr/> <p>AGR 7.05012.01.0</p>  <p>CHEVROLET COLORADO Crew Cab Pickup COLORADO Extended Cab Pickup COLORADO Standard Cab Pickup S10 Pickup S10 Platform/Chassis TRAILBLAZER (31UX)</p> <p>GM HOLDEN LTD COLORADO 7 (RG) COLORADO Pickup (RG) COLORADO Platform/Chassis (RG) TRAILBLAZER (RG)</p> <p>GMC CANYON Crew Cab Pickup CANYON Extended Cab Pickup</p>	<p>AGR 7.05320.04.0</p>  <p>DACIA DOKKER Express Box Body/MPV DOKKER MPV (KE_) DUSTER (HM_) DUSTER (HS_) DUSTER SUV Van LODGY (JS_) LOGAN II LOGAN MCV II SANDERO II</p> <p>INFINITI Q30</p> <p>MERCEDES-BENZ A-CLASS (W176) B-CLASS Sports Tourer (W246, W242) CITAN Box Body/MPV (W415) CITAN MPV (415) CITAN Mixto (Double Cabin) (W415) CLA Coupe (C117) CLA Shooting Brake (X117) GLA-CLASS (X156)</p>
<p>AGR 7.04924.14.0 New</p>  <p>JAGUAR E-PACE (X540)</p> <p>LAND ROVER DISCOVERY SPORT (L550) RANGE ROVER EVOQUE (L538) RANGE ROVER EVOQUE (L551) RANGE ROVER EVOQUE Convertible (L538)</p>	<p>AGR 7.05264.03.0 New</p>  <p>JAGUAR F-PACE (X761) XF II (X260) XF SPORTBRAKE (X260)</p> <p>LAND ROVER DISCOVERY V (L462) RANGE ROVER IV (L405) RANGE ROVER SPORT II (L494) RANGE ROVER VELAR (L560)</p>	<p>NISSAN JUKE (F15) MICRA V (K14) NV200 / EVALIA Bus NV200 Van QASHQAI II SUV (J11, J11_)</p> <p>RENAULT CAPTUR I (J5_, H5_) CLIO IV (BH_) CLIO IV Grandtour (KH_) DUSTER (HM_) FLUENCE (L3_) GRAND SCÉNIC IV (R9_) KADJAR (HA_, HL_) KANGOO / GRAND KANGOO (KW0/1_) KANGOO Express (FW0/1_) MEGANE IV GRAND COUPE MEGANE IV Grandtour (K9A/M/N_) MEGANE IV Hatchback (B9A/M/N_) SCÉNIC III (JZ0/1_) SCÉNIC IV (J9_) TALISMAN (LP_) TALISMAN Grandtour (KP_)</p>
<p>AGR 7.04924.15.0 New</p>  <p>JAGUAR F-PACE (X761) XE (X760) XF II (X260) XF SPORTBRAKE (X260)</p> <p>LAND ROVER DEFENDER Station Wagon (L663)</p>		





AGR 7.05343.17.0 New **AGR 7.05454.07.0 New** **AGR 7.05632.04.0 New**



- BMW**
 3 (G20, G80)
 3 Touring (G21, G81)
 5 (G30, F90)
 5 Touring (G31)
 6 Gran Turismo (G32)
 7 (G11, G12)
 8 Convertible (G14, F91)
 8 Coupe (G15, F92)
 8 Gran Coupe (G16, F93)
 X3 (G01, F97)
 X3 Van (G01)
 X4 (G02, F98)
 X5 (G05, F95)
 X6 (G06, F96)
 X7 (G07)



MAN
 ENGINE



- FUSO**
 CANTER
IVECO
 DAILY CITYS Bus
 DAILY LINE Bus
 DAILY TOURYS Bus
 DAILY VI Platform/Chassis
 DAILY VI Van

AGR 7.05363.00.0



→SI 0092
 →SI 0100

- VOLVO**
 C30 (533)
 C70 II Convertible (542)
 S40 II (544)
 S60 II (134)
 S80 II (124)
 V40 Hatchback (525, 526)
 V40 Hatchback Van (525, 526)
 V50 (545)
 V60 I (155, 157)
 V70 III (135)
 V70 III Estate Van (135)
 XC60 I SUV (156)
 XC70 II
 XC70 II (136)

AGR 7.05578.15.0



- FORD**
 FOCUS IV (HN)
 FOCUS IV Turnier (HP)
 GALAXY III (CK)
 GALAXY MK III VAN (CK)
 KUGA III (DFK)
 MONDEO V Hatchback (CE)
 MONDEO V Saloon (CD)
 MONDEO V Turnier (CF)
 S-MAX (CJ, WA6)
FORD USA
 EDGE

AGR 7.05742.11.0 New



FORD
 ECOSPORT

AGR 7.05838.08.0 New



- BMW**
 1 (F40)
 2 Active Tourer (F45)
 2 Gran Tourer (F46)
 5 (G30, F90)
 5 Touring (G31)
 7 (G11, G12)
 X1 (F48)
 X2 (F39)
 X3 (G01, F97)
 X4 (G02, F98)
 X5 (G05, F95)
 X6 (G06, F96)
 X7 (G07)

AGR 7.05590.03.0 New



- JAGUAR**
 F-PACE (X761)
 XF II (X260)
 XF SPORTBRAKE (X260)
LAND ROVER
 DISCOVERY V (L462)
 RANGE ROVER IV (L405)
 RANGE ROVER SPORT II (L494)
 RANGE ROVER VELAR (L560)

EMISSION CONTROL





AGR 7.06036.15.0 New



FORD

- GALAXY III (CK)
- RANGER (TKE)
- S-MAX (CJ, WA6)
- TOURNEO CUSTOM V362 Bus (F3)
- TRANSIT CUSTOM V362 Bus (F3)
- TRANSIT CUSTOM V362 Van (FY, FZ)
- TRANSIT V363 Bus (FAD, FBD)
- TRANSIT V363 Platform/Chassis (FED, FFD)
- TRANSIT V363 Van (FCD, FDD)

FORD USA

- EDGE

AGR 7.07044.12.0 New



JEEP

- CHEROKEE (KL)
- WRANGLER IV (JL)

AGR 7.07417.39.0 New



BMW

- 1 (F40)
- 2 Active Tourer (F45)
- 2 Gran Coupe (F44)
- 2 Gran Tourer (F46)
- X1 (F48)
- X2 (F39)

MINI (BMW)

- MINI (F55)
- MINI (F56)
- MINI CLUBMAN (F54)

AGR 7.07417.39.0 New

- MINI COUNTRYMAN (F60)
- MINI Convertible (F57)

AGR 7.07549.09.0 New



ALFA ROMEO

- GIULIETTA (940_)

FIAT

- 500X (334_)
- TIPO Estate (356_)
- TIPO Hatchback (356_)
- TIPO Saloon (356_)

AGR 7.07794.22.0 New



FORD

- ECOSPORT
- FOCUS IV (HN)
- FOCUS IV Saloon (HM)
- FOCUS IV Turnier (HP)
- KUGA III (DFK)
- PUMA
- TOURNEO CONNECT / GRAND TOURNEO
- CONNECT V408 MPV
- TRANSIT CONNECT MPV
- TRANSIT CONNECT V408 Box Body/MPV

AGR 7.07794.23.0 New



CITROEN

- BERLINGO (ER_, EC_)
- BERLINGO Box Body/MPV (K9)
- C-ELYSEE (DD_)
- C3 AIRCROSS II (2R_, 2C_)
- C3 AIRCROSS II Van (2C_, 2R_)
- C3 III (SX)
- C3 III Van (SX_, SY_)
- C4 CACTUS
- C4 CACTUS Van (0B_, 0P_)
- C5 AIRCROSS
- GRAND C4 SPACETOURER Van (3A_, 3E_)
- JUMPY Bus (V_)
- JUMPY Van (V_)

DS

- DS 3 CROSSBACK (UR_, UC_, UJ_)
- DS 7 Crossback (J_)

OPEL

- COMBO Box Body/MPV (X19)
- COMBO E Tour / Life (X19)
- CORSA F
- CROSSLAND X / CROSSLAND (P17, P2Q0)
- GRANDLAND X (A18)
- VIVARO C Bus (K0)
- VIVARO C Van (K0)
- ZAFIRA LIFE Bus (K0)

PEUGEOT

- 2008 I (CU_)
- 2008 II (UD_, US_, UY_, UK_)
- 208 Hatchback Van (CR_)
- 208 I (CA_, CC_)
- 208 II (UB_, UP_, UW_, UJ_)
- 3008 SUV (MC_, MR_, MJ_, M4_)
- 301
- 5008 II (MC_, MJ_, MR_, M4_)
- 508 II (FB_, FH_, F3_)
- 508 SW II (FC_, FJ_, F4_)
- PARTNER Box Body/MPV (K9)

RIFTER

VAUXHALL

- COMBO Mk IV (E) Box Body/MPV
- COMBO Mk IV (E) Life (X19)
- CROSSLAND X (P17)
- GRANDLAND X (A18)
- VIVARO C Van (K0)
- VIVARO LIFE Bus (K0)





AGR 7.09002.00.0



FIAT
 DUCATO Bus (250_)
 DUCATO Platform/Chassis (250_)
 DUCATO Van (250_)
IVECO
 DAILY IV Bus
 DAILY IV Platform/Chassis
 DAILY IV Van

AGR 7.09002.02.0



CHEVROLET
 LANOS Saloon
DAEWOO
 CIELO
 CIELO LOAD RUNNER
 LANOS (KLAT)
 LANOS Saloon (KLAT)
 NEXIA
 NEXIA Saloon

→SI 1830

AGR 7.09002.04.0



CHEVROLET
 AVEO / KALOS Hatchback (T250, T255)
 AVEO / KALOS Saloon (T200)
 AVEO / KALOS Saloon (T250, T255)
 CRUZE (J300)
 CRUZE Hatchback (J305)
 EPICA Saloon
 LACETTI (J200)
 LACETTI Estate (J200)
 LACETTI Saloon (J200)
 NUBIRA Estate
 NUBIRA Saloon
 OPTRA (1J_)
 OPTRA Estate
 OPTRA Hatchback
 REZZO MPV (U100)
 VIVANT

→SI 1830

AGR 7.09002.01.0



→SI 1830

CHEVROLET
 EPICA (KL1_)
 LACETTI (J200)
 LACETTI Estate (J200)
 LACETTI Saloon (J200)
 OPTRA (1J_)
 OPTRA Hatchback
 VIVANT
DAEWOO
 LACETTI Hatchback (KLAN)
 LACETTI Saloon (J200)
 LANOS (KLAT)
 LANOS Saloon (KLAT)
 LEGANZA (KLAV)
 NUBIRA (J100)
 NUBIRA (J150)
 NUBIRA Estate (J150)
 NUBIRA Saloon (J100)
 NUBIRA Saloon (J150)
 NUBIRA Wagon (J100)

AGR 7.09002.03.0



HYUNDAI
 GETZ (TB)
 TUCSON (JM)
KIA
 SPORTAGE II (JE_, KM)

AGR 7.09002.05.0



HYUNDAI
 GRANDEUR (TG)
 SANTA FÉ II (CM)
 SANTA FÉ II SUV Van (CM)
 SONATA V (NF)
 TUCSON (JM)
 TUCSON SUV Van (JM)
 i30 (FD)
 i30 Estate (FD)





AGR 7.09002.05.0

INOKOM
SANTA FE (CM)

KIA
CARENS II MPV (FJ)
CARENS III MPV (UN)
CEE'D Hatchback (ED)
CEE'D SW (ED)
MAGENTIS (MG)
PRO CEE'D (ED)
SPORTAGE II (JE, KM)
SPORTAGE II VAN (KM_)



HYUNDAI
SANTA FÉ I (SM)
TRAJET (FO)

KIA
CARENS II MPV (FJ)
CERATO I Hatchback (LD)
CERATO I Saloon (LD)



HYUNDAI
ACCENT III (MC)
ACCENT III Saloon (MC)
ELANTRA IV Saloon (HD)
GETZ (TB)
i10 I (PA)
i30 (FD)
i30 Estate (FD)

KIA
CEE'D Hatchback (ED)
CEE'D SW (ED)
CERATO I Hatchback (LD)
CERATO I Saloon (LD)
PICANTO (SA)
PRO CEE'D (ED)

AGR 7.09002.07.0

RIO II (JB)
RIO II Saloon (JB)



HYUNDAI
i20 I (PB, PBT)
i30 (FD)
i30 (GD)
i30 Coupe
i30 Estate (FD)
i30 Estate (GD)
ix20 (JC)

KIA
CEE'D (JD)
CEE'D Combi Van (JD)
CEE'D Hatchback (ED)
CEE'D SW (ED)
CEE'D Sportswagon (JD)
PRO CEE'D (ED)
PRO CEE'D (JD)
PRO CEE'D Hatchback Van (JD)

SOUL I (AM)
VENGA (YN)



HYUNDAI
MATRIX (FC)

KIA
CERATO I Hatchback (LD)
CERATO I Saloon (LD)



CHEVROLET
MATIZ (M200, M250)
SPARK
SPARK (M300)

DAEWOO
MATIZ (M100, M150)



HYUNDAI
H-1 / STAREX Bus (A1)
H-1 Platform/Chassis
H-1 Van (A1)

KIA
SORENTO I (JC)
SORENTO I VAN (JC)



HYUNDAI
GRAND SANTA FÉ
SANTA FÉ II (CM)
SANTA FÉ II SUV Van (CM)
SANTA FÉ III (DM, DMA)
ix35 (LM, EL, ELH)
ix35 Van







AGR 7.09002.12.0	AGR 7.10334.00.0	AGR 7.10334.02.0 New
<p>INOKOM SANTA FE (DM)</p> <p>KIA CARNIVAL / GRAND CARNIVAL III (VQ) SORENTO II (XM) SORENTO II SUV Van (XM) SPORTAGE III (SL)</p>		
<p>AGR 7.09002.13.0</p>  <p>→SI 1830</p> <p>CHEVROLET CAPTIVA (C100, C140) EPICA Saloon EVANDA</p> <p>DAEWOO LANOS Saloon (KLAT) LEGANZA (KLAV) NUBIRA Saloon (J100)</p> <p>OPEL ANTARA A (L07)</p> <p>VAUXHALL ANTARA A (L07)</p>	<p>AUDI A3 (8P1) A3 Convertible (8P7) A3 Sportback (8PA) A4 Allroad B8 (8KH) A4 B8 (8K2) A4 B8 Avant (8K5) A5 (8T3) A5 Convertible (8F7) A5 Sportback (8TA) A6 C6 (4F2) A6 C6 Avant (4F5) Q5 (8RB) TT (8J3) TT Roadster (8J9)</p> <p>SEAT ALTEA (5P1) ALTEA XL (5P5, 5P8) EXEO (3R2) EXEO ST (3R5) LEON (1P1) TOLEDO III (5P2)</p> <p>SKODA OCTAVIA II (1Z3) OCTAVIA II Combi (1Z5) SUPERB II (3T4) SUPERB II Estate (3T5) YETI (5L)</p> <p>VOLKSWAGEN BEETLE (5C1, 5C2) EOS (1F7, 1F8) GOLF PLUS V (5M1, 521) GOLF V (1K1) GOLF V Variant (1K5) GOLF VI (5K1) GOLF VI Variant (AJ5) JETTA III (1K2) JETTA IV (162, 163, AV3, AV2) PASSAT ALLTRACK B7 (365) PASSAT B6 (3C2) PASSAT B6 Variant (3C5) PASSAT B7 (362) PASSAT B7 (A32, A33) PASSAT B7 Estate Van (365) PASSAT B7 Variant (365) PASSAT CC B6 (357) SCIROCCO III (137, 138) TIGUAN (5N_) TOURAN (1T1, 1T2)</p>	<p>AUDI A3 (8V1, 8VK) A3 Convertible (8V7, 8VE) A3 Limousine (8VS, 8VM) A3 Sportback (8VA, 8VF) Q2 (GAB, GAG) Q3 (8UB, 8UG) TT (FV3, FVP)</p> <p>SEAT ALHAMBRA (710, 711) ATECA (KH7, KHP) LEON (5F1) LEON Hatchback Van (5F1) LEON SC (5F5) LEON ST (5F8) LEON ST Estate Van (5F8) TARRACO (KN2)</p> <p>SKODA KAMIQ (NW4) KAROQ (NU7) KODIAQ (NS7, NV7) OCTAVIA III (5E3, NL3, NR3) OCTAVIA III Combi (5E5, 5E6) SCALA (NW1) SUPERB III (3V3) SUPERB III Estate (3V5)</p> <p>VOLKSWAGEN ARTEON (3H7, 3H8) GOLF ALLTRACK VII Variant (BA5, BV5) GOLF SPORTSVAN VII (AM1, AN1) GOLF VAN VII Variant (BA5) GOLF VII (5G1, BQ1, BE1, BE2) GOLF VII Van (5G1) GOLF VII Variant (BA5, BV5) PASSAT ALLTRACK B8 Variant (3G5, CB5) PASSAT B8 (3G2, CB2) PASSAT B8 Variant (3G5, CB5) POLO VI (AW1, BZ1) SHARAN (7N1, 7N2) T-CROSS (C11) T-ROC (A11) TIGUAN (5N_) TIGUAN (AD1, AX1) TIGUAN ALLSPACE (BW2) TOURAN (5T1)</p>
<p>AGR 7.09002.14.0</p>  <p>→SI 1830</p> <p>HYUNDAI SANTA FÉ I (SM) SONATA IV (EF)</p> <p>KIA MAGENTIS (GD, MS)</p>		





AGR 7.10334.03.0	AGR 7.10334.04.0 New	AGR 7.10334.06.0
 <p>NISSAN NV400 Bus (X62, X62B) NV400 Platform/Chassis (X62, X62B) NV400 Van (X62, X62B) PRIMASTAR Bus (X83) PRIMASTAR Van (X83) QASHQAI / QASHQAI +2 I (J10, NJ10, JJ10E) X-TRAIL (T31) X-TRAIL (T32_)</p> <p>OPEL MOVANO B Bus (X62) MOVANO B Platform/Chassis (X62) MOVANO B Van (X62) VIVARO A Bus (X83) VIVARO A Platform/Chassis (X83) VIVARO A Van (X83)</p> <p>RENAULT ESPACE IV (JK0/1_) GRAND SCÉNIC III (JZ0/1_) KOLEOS I (HY_) KOLEOS II (HC_) LAGUNA Coupe (DT0/1) LAGUNA III (BT0/1) LAGUNA III Grandtour (KT0/1) LATITUDE (L70_) MASTER III Bus (JV) MASTER III Platform/Chassis (EV, HV, UV) MASTER III Van (FV) MEGANE CC (EZ0/1_) MEGANE III Coupe (DZ0/1_) MEGANE III Grandtour (KZ0/1) MEGANE III Hatchback (BZ0/1_, B3_) SCÉNIC III (JZ0/1_) TRAFIC II Bus (JL) TRAFIC II Platform/Chassis (EL) TRAFIC II Van (FL)</p> <p>VAUXHALL VIVARO A Bus (X83) VIVARO A Platform/Chassis (X83) VIVARO A Van (X83)</p>	<p>A3 Sportback (8PA) SKODA OCTAVIA II (1Z3) OCTAVIA II Combi (1Z5) VOLKSWAGEN EOS (1F7, 1F8) GOLF PLUS V (5M1, 521) GOLF V (1K1) JETTA III (1K2) PASSAT B6 (3C2) PASSAT B6 Variant (3C5) POLO (9N_) TOURAN (1T1, 1T2)</p> <hr/> <p>AGR 7.10334.05.0</p>  <p>NISSAN PRIMASTAR Bus (X83) PRIMASTAR Van (X83) QASHQAI / QASHQAI +2 I (J10, NJ10, JJ10E) X-TRAIL (T31)</p> <p>OPEL VIVARO A Bus (X83) VIVARO A Platform/Chassis (X83) VIVARO A Van (X83)</p> <p>RENAULT ESPACE IV (JK0/1_) GRAND SCÉNIC II (JM0/1_) KOLEOS I (HY_) LAGUNA Coupe (DT0/1) LAGUNA II (BG0/1_) LAGUNA II Grandtour (KG0/1_) LAGUNA III (BT0/1) LAGUNA III Grandtour (KT0/1) MEGANE II (BM0/1_, CM0/1_) MEGANE II Coupé-Cabriolet (EM0/1_) MEGANE II Estate (KM0/1_) MEGANE II Saloon (LM0/1_) SCÉNIC II (JM0/1_) TRAFIC II Bus (JL) TRAFIC II Platform/Chassis (EL) TRAFIC II Van (FL) VEL SATIS (BJ0_)</p> <p>VAUXHALL VIVARO A Bus (X83) VIVARO A Platform/Chassis (X83) VIVARO A Van (X83)</p>	 <p>RENAULT LAGUNA II (BG0/1_) LAGUNA II Grandtour (KG0/1_) MEGANE II Saloon (LM0/1_) SCÉNIC II (JM0/1_)</p> <hr/> <p>AGR 7.10334.07.0</p>  <p>→SI 0092</p> <p>BMW 1 (E81) 1 (E87) 1 (F20) 1 (F21) 1 Convertible (E88) 1 Coupe (E82) 2 Coupe (F22, F87) 3 (E90) 3 (F30, F80) 3 Convertible (E93) 3 Coupe (E92) 3 Gran Turismo (F34) 3 Touring (E91) 3 Touring (F31) 4 Convertible (F33, F83) 4 Coupe (F32, F82) 4 Gran Coupe (F36) 5 (E60) 5 (F10) 5 Gran Turismo (F07) 5 Touring (E61) 5 Touring (F11) 6 Convertible (F12) 6 Coupe (F13) 6 Gran Coupe (F06) 7 (F01, F02, F03, F04) X1 (E84) X3 (E83) X3 (F25)</p>
<p>AGR 7.10334.04.0 New</p>  <p>AUDI A3 (8P1)</p>		





AGR 7.10334.07.0

X4 (F26)
X5 (E70)
X5 (F15, F85)
X6 (E71, E72)
X6 (F16, F86)

AGR 7.10334.08.0 New



OPEL

- ASTRA H (A04)
- ASTRA H CLASSIC Estate (A04)
- ASTRA H CLASSIC Hatchback (A04)
- ASTRA H CLASSIC Saloon (A04)
- ASTRA H Estate (A04)
- ASTRA H GTC (A04)
- ASTRA H Saloon (A04)
- ASTRA J (P10)
- ASTRA J GTC
- ASTRA J Saloon
- ASTRA J Sports Tourer (P10)
- CORSA D (S07)
- MERIVA A MPV (X03)
- MERIVA B MPV (S10)
- ZAFIRA / ZAFIRA FAMILY B (A05)

VAUXHALL

- ASTRA Mk V (H) (A04)
- ASTRA Mk V (H) Estate (A04)
- ASTRA Mk V (H) Sport Hatch (A04)
- ASTRA Mk VI (J) (P10)
- ASTRA Mk VI (J) Estate (P10)
- ASTRA Mk VI (J) GTC (P10)
- ASTRA Mk VI (J) Saloon (P10)
- CORSA Mk III (D) (S07)
- MERIVA Mk II (B) (S10)
- ZAFIRA Mk II (B) (A05)

AGR 7.10334.09.0 New



AUDI
A3 (8P1)

AGR 7.10334.09.0 New

- A3 Sportback (8PA)
- SEAT**
ALTEA (5P1)
ALTEA XL (5P5, 5P8)
LEON (1P1)
TOLEDO III (5P2)
- SKODA**
OCTAVIA II (1Z3)
OCTAVIA II Combi (1Z5)
- VOLKSWAGEN**
EOS (1F7, 1F8)
GOLF PLUS V (5M1, 521)
GOLF V (1K1)
JETTA III (1K2)
PASSAT B6 (3C2)
PASSAT B6 Variant (3C5)
TOURAN (1T1, 1T2)

AGR 7.10334.10.0 New



- AUDI**
A4 B7 (8EC)
A4 B7 Avant (8ED)
A6 C6 (4F2)
A6 C6 Avant (4F5)

AGR 7.11237.00.0 New



- LAND ROVER**
RANGE ROVER III (L322)
RANGE ROVER SPORT I (L320)

AGR 7.11237.01.0 New



- CITROEN**
C5 III (RD_)
C5 III Break (RW_)
C6 (TD_)
- JAGUAR**
S-TYPE II (X200)
XF I (X250)
XJ (X350, X358)
- LAND ROVER**
DISCOVERY III (L319)
RANGE ROVER SPORT I (L320)
- PEUGEOT**
407 (6D_)
407 Coupe (6C_)
407 SW (6E_)
607 (9D, 9U)

AGR 7.11237.03.0 New



- LAND ROVER**
DISCOVERY III (L319)
DISCOVERY IV (L319)
RANGE ROVER SPORT I (L320)





AGR 7.11237.04.0 New



CITROEN

- JUMPER Bus (244, Z_)
- JUMPER Platform/Chassis (244)
- JUMPER Van (230L)
- JUMPER Van (244)

FIAT

- DUCATO Bus (230_)
- DUCATO Bus (244_)
- DUCATO Platform/Chassis (230_)
- DUCATO Platform/Chassis (244_)
- DUCATO Van (244_)

PEUGEOT

- BOXER Bus (244, Z_)
- BOXER Platform/Chassis (244)
- BOXER Van (244)

AGR 7.11237.07.0 New



HYUNDAI

- ACCENT IV (RB)
- ACCENT IV Saloon (RB)
- i20 I (PB, PBT)
- i30 (GD)
- i30 Coupe
- i30 Estate (GD)
- ix20 (JC)

KIA

- CEE'D (JD)
- CEE'D Hatchback (ED)
- CEE'D SW (ED)
- CEE'D Sportswagon (JD)
- PRO CEE'D (ED)
- PRO CEE'D (JD)
- SOUL I (AM)
- VENGA (YN)

AGR 7.11237.08.0 New



KIA

- SORENTO I (JC)

AGR 7.21920.62.0



- SI 0096
- SI 0100

BMW

- 3 (E36)
- 3 Compact (E36)
- 3 Touring (E36)
- 5 (E39)
- 5 Touring (E39)
- 7 (E38)

OPEL

- OMEGA B (V94)
- OMEGA B Estate (V94)

VAUXHALL

- OMEGA (B) Estate (V94)
- OMEGA (B) Saloon (V94)

AGR 7.21949.51.0



- SI 0096
- SI 0100

MERCEDES-BENZ

- 123 Coupe (C123)

AGR 7.21949.51.0

- 123 Saloon (W123)
- 123 T-Model (S123)
- 124 Saloon (W124)
- 124 T-Model (S124)
- 190 (W201)
- E-CLASS (W124)
- E-CLASS T-Model (S124)
- G-CLASS (W463)
- G-CLASS Cabrio (W463)
- S-CLASS (W126)
- S-CLASS (W140)

AGR 7.22136.50.0



- SI 0096
- SI 0100
- SI 1830

MERCEDES-BENZ

- C-CLASS (W202)
- C-CLASS (W203)
- C-CLASS Coupe (CL203)
- C-CLASS T-Model (S202)
- C-CLASS T-Model (S203)
- CLK (C208)
- CLK (C209)
- CLK Convertible (A208)
- CLK Convertible (A209)
- CLS (C219)
- E-CLASS (W210)
- E-CLASS (W211)
- E-CLASS T-Model (S210)
- E-CLASS T-Model (S211)
- G-CLASS (W463)
- G-CLASS Cabrio (W463)
- M-CLASS (W163)
- M-CLASS (W164)
- R-CLASS (W251, V251)
- S-CLASS (W220)
- S-CLASS Coupe (C215)
- SL (R129)
- SL (R230)
- SLK (R170)
- SLK (R171)
- VIANO (W639)
- VITO / MIXTO Van (W639)
- VITO Bus (W639)





AGR 7.22414.04.0	AGR 7.22414.08.0	AGR 7.22477.10.0
 <p>→SI 0082 →SI 0082-02 →SI 0092 →SI 0100 →SI 1830</p> <p>OPEL CORSA B (S93) VAUXHALL CORSA Mk I (B) (S93)</p>	 <p>→SI 0082 →SI 0082-02 →SI 0092 →SI 0100 →SI 1830</p> <p>OPEL CORSA B (S93) VAUXHALL CORSA Mk I (B) (S93)</p>	<p>LUPO I (6X1, 6E1) POLO (6N2) POLO (9N_) POLO III (6N1) POLO III CLASSIC (6V2) POLO IV Saloon (9A4, 9A2, 9N2, 9A6) POLO Van Estate Van (6V5) POLO Variant (6V5)</p>
		AGR 7.22477.11.0
		 <p>→SI 0096 →SI 0100</p> <p>VOLKSWAGEN CADDY III Box Body/MPV (2KA, 2KH, 2CA, 2CH) CADDY III MPV (2KB, 2KJ, 2CB, 2CJ) GOLF V (1K1)</p>
AGR 7.22414.07.0	AGR 7.22477.10.0	AGR 7.22574.12.0
 <p>→SI 0082 →SI 0082-02 →SI 0092 →SI 0100 →SI 1830</p> <p>OPEL ASTRA G Estate (T98) ASTRA G Estate Van (F70) ASTRA G Hatchback (T98) ASTRA G Saloon (T98)</p>	 <p>→SI 0096 →SI 0100</p> <p>SEAT AROSA (6H1) CORDOBA (6K1, 6K2) CORDOBA (6L2) CORDOBA Vario (6K5) IBIZA II (6K1) IBIZA III (6L1) INCA (6K9) LEON (1M1) SKODA FABIA I (6Y2) FABIA I Combi (6Y5) FABIA I Praktik (6Y5) FABIA I Saloon (6Y3) OCTAVIA I (1U2) OCTAVIA I Combi (1U5) VOLKSWAGEN BORA I (1J2) CADDY II Box Body/MPV (9K9A) CADDY II MPV (9K9B) CADDY III Box Body/MPV (2KA, 2KH, 2CA, 2CH) CADDY III MPV (2KB, 2KJ, 2CB, 2CJ) GOLF IV (1J1) GOLF IV Variant (1J5)</p>	 <p>→SI 0090 →SI 0092 →SI 0100 →SI 1830</p> <p>AUDI A3 (8L1) A3 (8P1) A3 Sportback (8PA) SEAT ALHAMBRA (7V8, 7V9) ALTEA (5P1) CORDOBA (6K1, 6K2) CORDOBA Vario (6K5) IBIZA II (6K1) LEON (1M1) TOLEDO III (5P2) SKODA OCTAVIA I (1U2) OCTAVIA I Combi (1U5)</p>





AGR	7.22574.12.0
OCTAVIA II (1Z3) OCTAVIA II Combi (1Z5) VOLKSWAGEN BORA I (1J2) BORA Variant (1J6) CADDY III Box Body/MPV (2KA, 2KH, 2CA, 2CH) CADDY III MPV (2KB, 2KJ, 2CB, 2CJ) GOLF IV (1J1) GOLF IV Variant (1J5) GOLF V (1K1) NEW BEETLE (9C1, 1C1) NEW BEETLE Convertible (1Y7) POLO III CLASSIC (6V2) POLO Variant (6V5) SHARAN (7M8, 7M9, 7M6) TOURAN (1T1, 1T2) VW FAW GOLF IV (1J1)	

AGR	7.22630.28.0
 <p>→SI 0092 →SI 0100 →SI 1830</p>	

OPEL	
ASTRA G Convertible (T98) ASTRA G Coupe (T98) ASTRA G Estate (T98) ASTRA G Hatchback (T98) ASTRA G Saloon (T98) VECTRA B (J96) VECTRA B Estate (J96) VECTRA B Hatchback (J96) VECTRA C (Z02) VECTRA C GTS (Z02) ZAFIRA A MPV (T98)	
VAUXHALL	
ASTRA Mk IV (G) Convertible (T98) ASTRA Mk IV (G) Coupe (T98) ASTRA Mk IV (G) Estate (T98) ASTRA Mk IV (G) Hatchback (T98) VECTRA (B) Estate (J96) VECTRA (B) Hatchback (J96) VECTRA (B) Saloon (J96) VECTRA Mk II (C) (Z02) VECTRA Mk II (C) GTS (Z02) ZAFIRA A (T98)	

AGR	7.22772.11.0
 <p>→SI 0096 →SI 0100</p>	
CHEVROLET	
COMBO	
OPEL	
COMBO Box Body/MPV COMBO Tour	
VAUXHALL	
COMBO Mk II (C) Box Body/MPV (F25) COMBO TOUR Mk II (C) (F25)	

AGR	7.22772.12.0
 <p>→SI 0096 →SI 0100</p>	
CHEVROLET	
ASTRA Hatchback COMBO CORSA Pickup	
HONDA	
CIVIC VII Hatchback (EU, EP, EV)	
OPEL	
ASTRA G Estate (T98) ASTRA G Estate Van (F70) ASTRA G Hatchback (T98) ASTRA G Saloon (T98) COMBO Box Body/MPV COMBO Tour CORSA C (X01) CORSA C Hatchback Van (X01) CORSA Utility Pickup	
VAUXHALL	
ASTRA Mk IV (G) Estate (T98) ASTRA Mk IV (G) Hatchback (T98) ASTRA Mk IV (G) Saloon (T98) ASTRAVAN Mk IV (G) Estate Van (T98) COMBO Mk II (C) Box Body/MPV (F25) COMBO TOUR Mk II (C) (F25)	

AUDI	
A2 (8Z0)	
SEAT	
AROSA (6H1) IBIZA III (6L1) INCA (6K9) LEON (1M1) TOLEDO II (1M2)	
SKODA	
FABIA I (6Y2) FABIA I Combi (6Y5) FABIA I Saloon (6Y3)	

AGR	7.22772.12.0
CORSA Mk II (C) (X01) CORSAVAN Mk II (C) Hatchback Van (X01)	

AGR	7.22785.16.0
 <p>→SI 0084 →SI 0090 →SI 0092 →SI 0100 →SI 1830</p>	
SEAT	
CORDOBA (6L2) IBIZA III (6L1)	
SKODA	
FABIA I (6Y2) FABIA I Combi (6Y5) FABIA I Praktik (6Y5) FABIA I Saloon (6Y3)	
VOLKSWAGEN	
POLO (9N_)	

SEAT	
CORDOBA (6L2) IBIZA III (6L1)	
SKODA	
FABIA I (6Y2) FABIA I Combi (6Y5) FABIA I Praktik (6Y5) FABIA I Saloon (6Y3)	
VOLKSWAGEN	
POLO (9N_)	

AGR	7.22785.17.0
 <p>→SI 0090 →SI 0092 →SI 0100 →SI 1830</p>	
AUDI	
A2 (8Z0)	
SEAT	
AROSA (6H1) IBIZA III (6L1) INCA (6K9) LEON (1M1) TOLEDO II (1M2)	
SKODA	
FABIA I (6Y2) FABIA I Combi (6Y5) FABIA I Saloon (6Y3)	

EMISSION CONTROL





AGR 7.22785.17.0	AGR 7.22785.20.0	AGR 7.22818.57.0
<p>OCTAVIA I (1U2) OCTAVIA I Combi (1U5) VOLKSWAGEN BORA I (1J2) BORA Variant (1J6) CADDY II Box Body/MPV (9K9A) CADDY II MPV (9K9B) GOLF IV (1J1) GOLF IV Variant (1J5) GOLF VAN IV Variant (1J5) LUPO I (6X1, 6E1) NEW BEETLE (9C1, 1C1) NEW BEETLE Convertible (1Y7) POLO (6N2) POLO III CLASSIC (6V2) POLO Van Estate Van (6V5) POLO Variant (6V5)</p>	 <p>→SI 0090 →SI 0092 →SI 0100 →SI 1830</p>	<p>VIVARO A Bus (X83) VIVARO A Platform/Chassis (X83) VIVARO A Van (X83) RENAULT CLIO I (B/C57_, 5/357_) CLIO II (BB_, CB_) CLIO II Hatchback Van (SB0/1/2_) ESPACE IV (JK0/1_) KANGOO (KC0/1_) KANGOO Express (FC0/1_) LAGUNA I (B56_, 556_) LAGUNA I Grandtour (K56_) LAGUNA II (BG0/1_) LAGUNA II Grandtour (KG0/1_) MASTER II Bus (JD) MASTER II Van (FD) MEGANE I (BA0/1_) MEGANE I Classic (LA0/1_) MEGANE I Coach (DA0/1_) MEGANE I Grandtour (KA0/1_) MEGANE I Hatchback Van (SA0/1_) SCÉNIC I MPV (JA0/1_, FA0_) TRAFIC II Bus (JL) TRAFIC II Platform/Chassis (EL) TRAFIC II Van (FL) VAUXHALL MOVANO Mk I (A) Combi (X70) MOVANO Mk I (A) Van (X70) VIVARO A Bus (X83) VIVARO A Van (X83) VOLVO S40 I (644) V40 Estate (645)</p>
<p>AGR 7.22785.18.0</p>  <p>→SI 0090 →SI 0092 →SI 0100 →SI 1830</p>	<p>AUDI A4 B5 (8D2) A4 B5 Avant (8D5) A4 B6 (8E2) A4 B6 Avant (8E5) A4 B7 (8EC) A4 B7 Avant (8ED) SEAT EXEO (3R2) EXEO ST (3R5) VOLKSWAGEN PASSAT B5.5 (3B3) PASSAT B5.5 Variant (3B6)</p>	<p>AGR 7.22818.57.0</p>  <p>→SI 0085 →SI 0092 →SI 0100</p>
<p>AUDI A3 (8L1) SEAT LEON (1M1) TOLEDO II (1M2) VOLKSWAGEN BORA I (1J2) VW FAW BORA (1J2, 9D2) BORA GP Saloon (9D2) BORA HS Hatchback (9D1) GOLF IV (1J1)</p>	<p>AGR 7.22818.57.0</p>  <p>→SI 0085 →SI 0092 →SI 0100</p> <p>DACIA SOLENZA (B41_) MITSUBISHI CARISMA (DA_) CARISMA Saloon (DA_) SPACE STAR MPV (DG_A) NISSAN INTERSTAR Bus (X70) INTERSTAR Van (X70) PRIMASTAR Bus (X83) PRIMASTAR Platform/Chassis (X83) PRIMASTAR Van (X83) OPEL MOVANO Bus (X70) MOVANO Van (X70)</p>	<p>AGR 7.22818.58.0</p>  <p>→SI 0085 →SI 0092 →SI 0100</p> <p>DACIA LOGAN (LS_) LOGAN Pickup (US_) SANDERO NISSAN KUBISTAR Van (X76) MICRA III (K12) RENAULT CLIO II (BB_, CB_) CLIO II Hatchback Van (SB0/1/2_) CLIO III (BR0/1, CR0/1) CLIO III Grandtour (KR0/1_)</p>

EMISSION CONTROL



AGR 7.22818.58.0	AGR 7.22818.59.0	AGR 7.22818.63.0
<p>GRAND SCÉNIC II (JM0/1_) KANGOO (KC0/1_) KANGOO Express (FC0/1_) KANGOO Express (FW0/1_) LOGAN I (LS_) MEGANE II (BM0/1_, CM0/1_) MEGANE II Estate (KM0/1_) MEGANE II Estate Van (KM_) MEGANE II Saloon (LM0/1_) MODUS / GRAND MODUS (F/JP0_) SANDERO/STEPWAY I (BS_) SCÉNIC II (JM0/1_) THALIA I (LB_) THALIA II (LU_) SUZUKI JIMNY Closed Off-Road Vehicle (SN)</p>	<p>MOVANO Mk I (A) Van (X70) VIVARO A Bus (X83) VIVARO A Platform/Chassis (X83) VIVARO A Van (X83)</p>	<p>MASTER II Platform/Chassis (ED/HD/UD) MASTER II Van (FD) VEL SATIS (BJ0_) VAUXHALL VIVARO A Bus (X83) VIVARO A Platform/Chassis (X83) VIVARO A Van (X83)</p>
	<p>AGR 7.22818.62.0</p>  <p>→SI 0085 →SI 0092 →SI 0100</p> <p>NISSAN PRIMERA (P12) PRIMERA Estate (WP12) PRIMERA Hatchback (P12) RENAULT MEGANE II (BM0/1_, CM0/1_) MEGANE II Coupé-Cabriolet (EM0/1_) MEGANE II Estate (KM0/1_) MEGANE II Saloon (LM0/1_)</p>	<p>AGR 7.22841.08.0</p>  <p>→PI 0041 →SI 0100</p> <p>MAN 18T-SERIES 23T-SERIES 24T-SERIES 26T-SERIES 27T-SERIES 28T-SERIES 29T-SERIES 30T-SERIES 32T-SERIES 33T-SERIES 35T-SERIES 40T-SERIES 41T-SERIES 42T-SERIES 50T-SERIES E2000 F2000 LION'S STAR SERIES FE SERIES RHC SERIES RHS SERIES TG TGA ENGINE</p>
<p>AGR 7.22818.59.0</p>  <p>→SI 0085 →SI 0092 →SI 0100</p> <p>NISSAN INTERSTAR Bus (X70) INTERSTAR Platform/Chassis INTERSTAR Van (X70) PRIMASTAR Bus (X83) PRIMASTAR Van (X83) OPEL MOVANO Bus (X70) MOVANO Platform/Chassis (X70) MOVANO Van (X70) VIVARO A Bus (X83) VIVARO A Platform/Chassis (X83) VIVARO A Van (X83) RENAULT AVANTIME (DE0_) ESPACE III (JE0_) ESPACE IV (JK0/1_) LAGUNA II (BG0/1_) LAGUNA II Grandtour (KG0/1_) MASTER II Bus (JD) MASTER II Platform/Chassis (ED/HD/UD) MASTER II Van (FD) TRAFIC II Bus (JL) TRAFIC II Platform/Chassis (EL) TRAFIC II Van (FL) VEL SATIS (BJ0_) VAUXHALL MOVANO Mk I (A) Chassis/Cab (X70) MOVANO Mk I (A) Combi (X70)</p>	<p>AGR 7.22818.63.0</p>  <p>→SI 0085 →SI 0092 →SI 0100</p> <p>NISSAN INTERSTAR Bus (X70) INTERSTAR Van (X70) OPEL VIVARO A Bus (X83) VIVARO A Platform/Chassis (X83) VIVARO A Van (X83) RENAULT AVANTIME (DE0_) ESPACE III (JE0_) ESPACE IV (JK0/1_) LAGUNA II (BG0/1_) LAGUNA II Grandtour (KG0/1_) MASTER II Bus (JD)</p>	





AGR 7.22843.06.0	AGR 7.22843.07.0	AGR 7.22875.13.0
 <p>→SI 0096 →SI 0100</p> <p>CITROEN BERLINGO / BERLINGO FIRST Box Body/MPV (M_) BERLINGO / BERLINGO FIRST MPV (MF_, GJK_, GFK_) C4 I (LC_) C4 I Saloon C5 I (DC_) C5 I Break (DE_) JUMPY (U6U_) JUMPY Platform/Chassis (BU_, BV_, BW_, BX_) JUMPY Van (BS_, BT_, BY_, BZ_) XSARA (N1) XSARA Break (N2) XSARA Coupe (N0) XSARA Estate Van XSARA Hatchback Van (N3_) XSARA PICASSO (N68)</p> <p>FIAT SCUDO Bus (220_) SCUDO Platform/Chassis (220_) SCUDO Van (220_) ULYSSE (220_)</p> <p>LANCIA ZETA (22_)</p> <p>PEUGEOT 206 Hatchback (2A/C) 206 SW (2E/K) 306 (7B, N3, N5) 306 Break (7E, N3, N5) 306 Estate Van (N_, 7_) 306 Hatchback (7A, 7C, N3, N5) 307 (3A/C) 307 Break (3E) 307 SW (3H) 307 Saloon 406 (8B) 406 Break (8E/F) 607 (9D, 9U) 806 (221) EXPERT (224_) EXPERT Platform/Chassis (223) EXPERT Van (222) PARTNER Box Body/MPV (5_, G_) PARTNER MPV (5_, G_)</p>	 <p>→SI 0096 →SI 0100</p> <p>CITROEN C5 I (DC_) C5 I Break (DE_)</p> <p>PEUGEOT 307 (3A/C) 307 Break (3E) 307 SW (3H) 307 Saloon 406 (8B) 406 Break (8E/F) 607 (9D, 9U)</p>	<p>ASTRA H GTC (A04) ASTRA H Saloon (A04) ASTRA H TwinTop (A04) COMBO Box Body/MPV COMBO Tour CORSA C (X01) CORSA C Hatchback Van (X01) CORSA CLASSIC Saloon MERIVA A MPV (X03) TIGRA TwinTop (X04)</p> <p>VAUXHALL AGILA Mk I (A) (H00) ASTRA MK V ASTRA Mk V (H) (A04) ASTRA Mk V (H) Estate (A04) ASTRA Mk V (H) Sport Hatch (A04) ASTRAVAN Mk V (H) Estate Van (A04) COMBO Mk II (C) Box Body/MPV (F25) COMBO TOUR Mk II (C) (F25) CORSA Mk II (C) (X01) CORSAVAN Mk II (C) Hatchback Van (X01) MERIVA A (X03) TIGRA TwinTop (X04)</p>
	<p>AGR 7.22875.13.0</p>  <p>→SI 0082 →SI 0082-02 →SI 0092 →SI 0100 →SI 1011 →SI 1011-02 →SI 1830</p> <p>CHEVROLET COMBO</p> <p>GM HOLDEN LTD BARINA Hatchback (XC) COMBO Van (XC)</p> <p>OPEL AGILA (A) (H00) ASTRA G Estate (T98) ASTRA G Hatchback (T98) ASTRA G Saloon (T98) ASTRA H (A04) ASTRA H CLASSIC Estate (A04) ASTRA H CLASSIC Hatchback (A04) ASTRA H Estate (A04) ASTRA H Estate Van (L70) ASTRA H GTC (A04) ASTRA H Saloon (A04) ASTRA H TwinTop (A04) COMBO Box Body/MPV</p>	<p>AGR 7.22875.16.0</p>  <p>→SI 0082 →SI 0082-02 →SI 0092 →SI 0100 →SI 1830</p> <p>CHEVROLET COMBO</p> <p>GM HOLDEN LTD BARINA Hatchback (XC) COMBO Van (XC)</p> <p>OPEL AGILA (A) (H00) AGILA A ASTRA G CLASSIC Caravan (F35) ASTRA G Hatchback (T98) ASTRA G Saloon (T98) ASTRA H (A04) ASTRA H CLASSIC Estate (A04) ASTRA H CLASSIC Hatchback (A04) ASTRA H Estate (A04) ASTRA H Estate Van (L70) ASTRA H GTC (A04) ASTRA H Saloon (A04) ASTRA H TwinTop (A04) COMBO Box Body/MPV</p>

EMISSION CONTROL



AGR	7.22875.16.0
COMBO Tour	
CORSA C (X01)	
CORSA C Hatchback Van (X01)	
CORSA CLASSIC Saloon	
CORSA D (S07)	
CORSA D Hatchback Van (S07)	
MERIVA A MPV (X03)	
TIGRA TwinTop (X04)	
VAUXHALL	
AGILA Mk I (A) (H00)	
ASTRA MK V	
ASTRA Mk V (H) (A04)	
ASTRA Mk V (H) Estate (A04)	
ASTRA Mk V (H) Sport Hatch (A04)	
ASTRAVAN Mk V (H) Estate Van (A04)	
COMBO Mk II (C) Box Body/MPV (F25)	
COMBO TOUR Mk II (C) (F25)	
CORSA Mk II (C) (X01)	
CORSA Mk III (D) (S07)	
CORSAVAN Mk II (C) Hatchback Van (X01)	
CORSAVAN Mk III (D) Hatchback Van (S07)	
MERIVA A (X03)	
TIGRA TwinTop (X04)	

AGR	7.22939.03.0
→SI 0096 →SI 0100	
VOLKSWAGEN	
TRANSPORTER IV Bus (70B, 70C, 7DB, 7DK, 70J, 70K, 7DC, 7DJ)	
TRANSPORTER IV Platform/Chassis (70E, 70L, 70M, 7DE, 7DL, 7D)	
TRANSPORTER IV Van (70A, 70H, 7DA, 7DH)	

AGR	7.22946.34.0
→SI 0092 →SI 0100	
ALFA ROMEO	
147 (937_)	
156 (932_)	
156 Sportwagon (932_)	
166 (936_)	

AGR	7.22888.02.0
→SI 0096 →SI 0100	
CITROEN	
C5 I (DC_)	
C5 I Break (DE_)	
C5 II (RC_)	
C5 II Break (RE_)	
PEUGEOT	
406 (8B)	
406 Break (8E/F)	
406 Coupe (8C)	
607 (9D, 9U)	

AGR	7.22946.33.0
→SI 0092 →SI 0100	
FIAT	
DOBLO Box Body/MPV (223_)	
DOBLO MPV (119_, 223_)	
IDEA (350_)	
PALIO (178_)	
PALIO Weekend (178_, 173_, 373_, 374_, 171_)	
PUNTO (188_)	
PUNTO Hatchback Van (188_)	
STRADA Pickup (178_)	
LANCIA	
MUSA (350_)	
ZETOR	
Proxima	

AGR	7.22946.33.0
BRAVA (182_)	
BRAVO I (182_)	
BRAVO II (198_)	
DOBLO Box Body/MPV (223_)	
DOBLO MPV (119_, 223_)	
IDEA (350_)	
MAREA (185_)	
MAREA Weekend (185_)	
MULTIPLA (186_)	
PALIO (178_)	
PALIO Weekend (178_, 173_, 373_, 374_, 171_)	
PUNTO (188_)	
PUNTO Hatchback Van (188_)	
STILO (192_)	
STILO Multi Wagon (192_)	
STRADA Pickup (178_)	
LANCIA	
LYBRA (839_)	
LYBRA SW (839_)	
MUSA (350_)	
THESIS (841_)	
ZETOR	
Proxima	

AGR	7.22946.38.0
→SI 0092 →SI 0100	
ALFA ROMEO	
159 (939_)	



AGR	7.22946.38.0
159 Sportwagon (939_)	
FIAT	
CROMA (194_)	
GRANDE PUNTO (199_)	
SEDICI (189_)	
OPEL	
ASTRA H (A04)	
ASTRA H Estate (A04)	
ASTRA H Estate Van (L70)	
ASTRA H GTC (A04)	
SIGNUM Hatchback (Z03)	
VECTRA C (Z02)	
VECTRA C Estate (Z02)	
VECTRA C GTS (Z02)	
ZAFIRA / ZAFIRA FAMILY B (A05)	
ZAFIRA B Box Body/MPV (A05)	
SAAB	
9-3 (YS3F, E79, D79, D75)	
9-3 Convertible (YS3F)	
9-3 Estate (E50)	
SUZUKI	
SX4 (EY, GY)	
VAUXHALL	
ASTRA Mk V (H) (A04)	
ASTRA Mk V (H) Estate (A04)	
ASTRA Mk V (H) Sport Hatch (A04)	
ASTRAVAN Mk V (H) Estate Van (A04)	
SIGNUM (Z03)	
VECTRA Mk II (C) (Z02)	
VECTRA Mk II (C) Estate (Z02)	
VECTRA Mk II (C) GTS (Z02)	
ZAFIRA Mk II (B) (A05)	

AGR	7.22996.12.0
	
VOLVO	
S60 I (384)	
S80 I (184)	
V70 II (285)	
XC70 CROSS COUNTRY I (295)	
XC90 I (275)	

AGR	7.24809.06.0
LIANA (ER, RH_)	
LIANA Hatchback	

AGR	7.24809.07.0
	
→SI 0096	
→SI 0100	

AGR	7.24809.06.0
	
→SI 0096	
→SI 0100	

FORD	
MONDEO III (B5Y)	
MONDEO III Saloon (B4Y)	
MONDEO III Turnier (BWY)	
TRANSIT Bus (FD_, FB_, FS_, FZ_, FC_)	
TRANSIT Platform/Chassis (FM_, FN_)	
TRANSIT Van (FA_)	
JAGUAR	
X-TYPE I (X400)	
X-TYPE I Estate (X400)	

AGR	7.22996.11.0
	
→SI 0092	
→SI 0100	
VOLVO	
S60 I (384)	
S80 I (184)	
V70 II (285)	
XC70 CROSS COUNTRY I (295)	
XC90 I (275)	

CITROEN	
C2 (JM_)	
C2 ENTERPRISE (JG_)	
C3 I (FC_, FN_)	
C3 Pluriel (HB_)	
XSARA (N1)	
XSARA Break (N2)	
XSARA Coupe (N0)	
FORD	
FIESTA Saloon	
FIESTA V (JH_, JD_)	
FIESTA V Van	
FUSION (JU_)	
FORD ASIA / OZEANIA	
FIESTA Saloon	
MAZDA	
2 (DY)	
PEUGEOT	
1007 (KM_)	
206 Hatchback (2A/C)	
206 SW (2E/K)	
206 Van	
307 (3A/C)	
307 Break (3E)	
307 SW Estate Van (3E_, 3H_)	
SUZUKI	

AGR	7.24809.10.0
	
→SI 0092	
→SI 0100	
→SI 1830	

CHEVROLET	
ASTRA Estate	
ASTRA Hatchback	
ASTRA Saloon	
CHEVY	
COMBO	
CORSA Pickup	
MERIVA	
VIVA	
ZAFIRA (F75)	
GM HOLDEN LTD	
ASTRA Hatchback (TS)	
ASTRA Saloon (TS)	
BARINA Hatchback (XC)	
TIGRA (XC)	

EMISSION CONTROL



AGR 7.24809.10.0	AGR 7.24809.16.0	AGR 7.24809.17.0
<p>OPEL</p> <p>ASTRA G CLASSIC (T98) ASTRA G CLASSIC Caravan (F35) ASTRA G CLASSIC Saloon (T98) ASTRA G Convertible (T98) ASTRA G Coupe (T98) ASTRA G Estate (T98) ASTRA G Estate Van (F70) ASTRA G Hatchback (T98) ASTRA G Saloon (T98) COMBO Box Body/MPV COMBO Tour CORSA C (X01) CORSA C Saloon (X01) CORSA CLASSIC Saloon CORSA Utility Pickup MERIVA A MPV (X03) TIGRA TwinTop (X04) VECTRA B (J96) VECTRA B Estate (J96) VECTRA B Hatchback (J96) VECTRA C (Z02) VECTRA C Estate (Z02) VECTRA C GTS (Z02) ZAFIRA A MPV (T98)</p> <p>VAUXHALL</p> <p>ASTRA Mk IV (G) Convertible (T98) ASTRA Mk IV (G) Coupe (T98) ASTRA Mk IV (G) Estate (T98) ASTRA Mk IV (G) Hatchback (T98) ASTRA Mk IV (G) Saloon (T98) ASTRAVAN Mk IV (G) Estate Van (T98) COMBO COMBO Mk II (C) Box Body/MPV (F25) COMBO TOUR Mk II (C) (F25) CORSA Mk II (C) (X01) MERIVA A (X03) TIGRA TwinTop (X04) VECTRA (B) Estate (J96) VECTRA (B) Hatchback (J96) VECTRA (B) Saloon (J96) VECTRA Mk II (C) (Z02) VECTRA Mk II (C) Estate (Z02) VECTRA Mk II (C) GTS (Z02) ZAFIRA A (T98)</p>	<p>AUDI</p> <p>A3 (8L1) A3 (8P1) A3 Sportback (8PA)</p> <p>CHRYSLER</p> <p>SEBRING (JS) SEBRING Convertible (JS)</p> <p>DODGE</p> <p>AVENGER CALIBER</p> <p>JEEP</p> <p>COMPASS (MK49) PATRIOT (MK74)</p> <p>MITSUBISHI</p> <p>GRANDIS (NA_W) LANCER VIII (CY_A, CZ_A) LANCER VIII Sportback (CX_A) OUTLANDER II (CW_W)</p> <p>SEAT</p> <p>ALTEA (5P1) ALTEA XL (5P5, 5P8) CORDOBA (6L2) IBIZA III (6L1) LEON (1M1) LEON (1P1) TOLEDO II (1M2) TOLEDO III (5P2)</p> <p>SKODA</p> <p>FABIA I (6Y2) FABIA I Combi (6Y5) FABIA I Praktik (6Y5) FABIA I Saloon (6Y3) FABIA II (542) FABIA II Combi (545) OCTAVIA I (1U2) OCTAVIA I Combi (1U5) OCTAVIA II (1Z3) OCTAVIA II Combi (1Z5) ROOMSTER (5J7) SUPERB II (3T4) SUPERB II Estate (3T5)</p> <p>VOLKSWAGEN</p> <p>BORA I (1J2) BORA Variant (1J6) GOLF IV (1J1) GOLF IV Variant (1J5) GOLF PLUS V (5M1, 521) GOLF V (1K1) GOLF V Variant (1K5) GOLF VAN IV Variant (1J5) JETTA III (1K2) LUPO I (6X1, 6E1) NEW BEETLE (9C1, 1C1) NEW BEETLE Convertible (1Y7) PASSAT B6 (3C2) PASSAT B6 Variant (3C5) POLO (9N_) TOURAN (1T1, 1T2)</p>	<div data-bbox="1082 250 1465 600" data-label="Image">  </div> <p data-bbox="1385 609 1484 636">→SI 0096</p> <p data-bbox="1385 645 1484 672">→SI 0100</p> <p>AUDI</p> <p>A2 (8Z0) A3 (8L1)</p> <p>SEAT</p> <p>AROSA (6H1) CORDOBA (6K1, 6K2) CORDOBA (6L2) CORDOBA Vario (6K5) IBIZA II (6K1) IBIZA III (6L1) LEON (1M1) TOLEDO II (1M2)</p> <p>SKODA</p> <p>FABIA I (6Y2) FABIA I Combi (6Y5) FABIA I Praktik (6Y5) FABIA I Saloon (6Y3) OCTAVIA I (1U2) OCTAVIA I Combi (1U5)</p> <p>VOLKSWAGEN</p> <p>BORA I (1J2) BORA Variant (1J6) CADDY II Box Body/MPV (9K9A) CADDY II MPV (9K9B) GOLF IV (1J1) GOLF IV Van (1J1) GOLF IV Variant (1J5) GOLF VAN IV Variant (1J5) LUPO I (6X1, 6E1) NEW BEETLE (9C1, 1C1) NEW BEETLE Convertible (1Y7) POLO (6N2) POLO (9N_) POLO III CLASSIC (6V2) POLO IV Saloon (9N4) POLO Variant (6V5) ENGINE</p>
<div data-bbox="178 1646 545 2011" data-label="Image">  </div> <p data-bbox="470 2020 569 2047">→SI 0096</p> <p data-bbox="470 2056 569 2083">→SI 0100</p>		



AGR 7.24809.19.0	AGR 7.24809.20.0	AGR 7.24809.26.0	
 <p style="text-align: right;">→SI 0096 →SI 0100</p> <p>AUDI A4 B5 (8D2) A4 B5 Avant (8D5) A4 B6 (8E2) A4 B6 Avant (8E5) A6 C5 (4B2) A6 C5 Avant (4B5)</p> <p>FORD GALAXY I (WGR)</p> <p>SEAT ALHAMBRA (7V8, 7V9)</p> <p>SKODA SUPERB I (3U4)</p> <p>VOLKSWAGEN PASSAT B5 (3B2) PASSAT B5 Variant (3B5) PASSAT B5.5 (3B3) PASSAT B5.5 Variant (3B6) SHARAN (7M8, 7M9, 7M6)</p>	<p>VOLKSWAGEN MULTIVAN V (7HM, 7HN, 7HF, 7EF, 7EM, 7EN) PASSAT B5.5 (3B3) PASSAT B5.5 Variant (3B6) SHARAN (7M8, 7M9, 7M6) TRANSPORTER V Bus (7HB, 7HJ, 7EB, 7EJ, 7EF, 7EG, 7HF, 7EC) TRANSPORTER V Platform/Chassis (7JD, 7JE, 7JL, 7JY, 7JZ, 7FD) TRANSPORTER V Van (7HA, 7HH, 7EA, 7EH)</p> <tr> <th data-bbox="550 548 1005 582">AGR 7.24809.24.0*</th> <td data-bbox="550 582 1005 1265"> <p style="text-align: right;">→SI 0096 →SI 0100</p> <p>OPEL ASTRA G Estate (T98) ASTRA G Estate Van (F70) ASTRA G Hatchback (T98) ASTRA G Saloon (T98) OMEGA B (V94) OMEGA B Estate (V94) VECTRA B (J96) VECTRA B Estate (J96) VECTRA B Hatchback (J96) ZAFIRA A MPV (T98)</p> <p>VAUXHALL ASTRA Mk IV (G) Estate (T98) ASTRA Mk IV (G) Hatchback (T98) ASTRA Mk IV (G) Saloon (T98) ASTRAVAN Mk IV (G) Estate Van (T98) OMEGA (B) Estate (V94) OMEGA (B) Saloon (V94) VECTRA (B) Estate (J96) VECTRA (B) Hatchback (J96) VECTRA (B) Saloon (J96) ZAFIRA A (T98)</p> </td> </tr>	AGR 7.24809.24.0*	<p style="text-align: right;">→SI 0096 →SI 0100</p> <p>OPEL ASTRA G Estate (T98) ASTRA G Estate Van (F70) ASTRA G Hatchback (T98) ASTRA G Saloon (T98) OMEGA B (V94) OMEGA B Estate (V94) VECTRA B (J96) VECTRA B Estate (J96) VECTRA B Hatchback (J96) ZAFIRA A MPV (T98)</p> <p>VAUXHALL ASTRA Mk IV (G) Estate (T98) ASTRA Mk IV (G) Hatchback (T98) ASTRA Mk IV (G) Saloon (T98) ASTRAVAN Mk IV (G) Estate Van (T98) OMEGA (B) Estate (V94) OMEGA (B) Saloon (V94) VECTRA (B) Estate (J96) VECTRA (B) Hatchback (J96) VECTRA (B) Saloon (J96) ZAFIRA A (T98)</p>
AGR 7.24809.24.0*	<p style="text-align: right;">→SI 0096 →SI 0100</p> <p>OPEL ASTRA G Estate (T98) ASTRA G Estate Van (F70) ASTRA G Hatchback (T98) ASTRA G Saloon (T98) OMEGA B (V94) OMEGA B Estate (V94) VECTRA B (J96) VECTRA B Estate (J96) VECTRA B Hatchback (J96) ZAFIRA A MPV (T98)</p> <p>VAUXHALL ASTRA Mk IV (G) Estate (T98) ASTRA Mk IV (G) Hatchback (T98) ASTRA Mk IV (G) Saloon (T98) ASTRAVAN Mk IV (G) Estate Van (T98) OMEGA (B) Estate (V94) OMEGA (B) Saloon (V94) VECTRA (B) Estate (J96) VECTRA (B) Hatchback (J96) VECTRA (B) Saloon (J96) ZAFIRA A (T98)</p>		

AGR 7.24809.20.0
 <p style="text-align: right;">→SI 0096 →SI 0100</p> <p>AUDI A4 B6 (8E2) A4 B6 Avant (8E5) A6 C5 (4B2) A6 C5 Avant (4B5)</p> <p>FORD GALAXY I (WGR)</p> <p>SEAT ALHAMBRA (7V8, 7V9)</p> <p>SKODA SUPERB I (3U4)</p>

AGR 7.24809.25.0*
<p style="text-align: right;">→SI 0096 →SI 0100</p> <p>OPEL ASTRA G Estate (T98) ASTRA G Estate Van (F70) ASTRA G Hatchback (T98) ASTRA G Saloon (T98) OMEGA B (V94) OMEGA B Estate (V94) VECTRA B (J96) VECTRA B Estate (J96) VECTRA B Hatchback (J96) ZAFIRA A MPV (T98)</p> <p>VAUXHALL ASTRA Mk IV (G) Estate (T98) ASTRA Mk IV (G) Hatchback (T98) ASTRA Mk IV (G) Saloon (T98) ASTRAVAN Mk IV (G) Estate Van (T98) OMEGA (B) Estate (V94) OMEGA (B) Saloon (V94) VECTRA (B) Estate (J96) VECTRA (B) Hatchback (J96) VECTRA (B) Saloon (J96) ZAFIRA A (T98)</p>

AGR 7.24809.27.0
 <p style="text-align: right;">→SI 0096 →SI 0100</p> <p>OPEL ASTRA G Estate (T98) ASTRA G Estate Van (F70) ASTRA G Hatchback (T98) ASTRA G Saloon (T98) FRONTERA B (U99) OMEGA B (V94) OMEGA B Estate (V94) SINTR A (APV) VECTRA B (J96) VECTRA B Estate (J96) VECTRA B Hatchback (J96) ZAFIRA A MPV (T98)</p> <p>VAUXHALL ASTRA Mk IV (G) Estate (T98) ASTRA Mk IV (G) Hatchback (T98)</p>

EMISSION CONTROL



AGR	7.24809.27.0
ASTRA Mk IV (G) Saloon (T98) ASTRAVAN Mk IV (G) Estate Van (T98) FRONTERA Mk II (B) (U99) OMEGA (B) Estate (V94) OMEGA (B) Saloon (V94) SINTRA (APV) VECTRA (B) Estate (J96) VECTRA (B) Hatchback (J96) VECTRA (B) Saloon (J96) ZAFIRA A (T98)	

AGR	7.24809.28.0
-----	--------------



→SI 0096
→SI 0100

OPEL

- ASTRA G Estate (T98)
- ASTRA G Estate Van (F70)
- ASTRA G Hatchback (T98)
- ASTRA G Saloon (T98)
- OMEGA B (V94)
- OMEGA B Estate (V94)
- VECTRA B (J96)
- VECTRA B Estate (J96)
- VECTRA B Hatchback (J96)
- ZAFIRA A MPV (T98)

VAUXHALL

- ASTRA Mk IV (G) Estate (T98)
- ASTRA Mk IV (G) Hatchback (T98)
- ASTRA Mk IV (G) Saloon (T98)
- ASTRAVAN Mk IV (G) Estate Van (T98)
- OMEGA (B) Estate (V94)
- OMEGA (B) Saloon (V94)
- VECTRA (B) Estate (J96)
- VECTRA (B) Hatchback (J96)
- VECTRA (B) Saloon (J96)
- ZAFIRA A (T98)

AGR	7.24809.29.0
-----	--------------



→SI 0092
→SI 0100

OPEL

- ASTRA G Convertible (T98)
- ASTRA G Coupe (T98)
- ASTRA G Estate (T98)
- ASTRA G Estate Van (F70)
- ASTRA G Hatchback (T98)
- ASTRA G Saloon (T98)
- FRONTERA B (U99)
- SIGNUM Hatchback (Z03)
- VECTRA C (Z02)
- VECTRA C Estate (Z02)
- VECTRA C GTS (Z02)
- ZAFIRA A MPV (T98)

SAAB

- 9-3 (YS3D)
- 9-3 (YS3F, E79, D79, D75)
- 9-5 (YS3E)
- 9-5 Estate (YS3E)

VAUXHALL

- ASTRA Mk IV (G) Estate (T98)
- ASTRA Mk IV (G) Hatchback (T98)
- ASTRA Mk IV (G) Saloon (T98)
- ASTRAVAN Mk IV (G) Estate Van (T98)
- FRONTERA Mk II (B) (U99)
- SIGNUM (Z03)
- VECTRA Mk II (C) (Z02)
- VECTRA Mk II (C) Estate (Z02)
- VECTRA Mk II (C) GTS (Z02)
- ZAFIRA A (T98)

AGR	7.24809.30.0
-----	--------------



→SI 0096
→SI 0100

SEAT

- CORDOBA (6L2)
- IBIZA III (6L1)

AGR	7.24809.30.0
SKODA FABIA I (6Y2) FABIA I Combi (6Y5) FABIA I Praktik (6Y5) FABIA I Saloon (6Y3) OCTAVIA I (1U2) OCTAVIA I Combi (1U5) OCTAVIA I Estate Van (1U5)	
VOLKSWAGEN POLO (9N_) POLO IV Saloon (9A4, 9A2, 9N2, 9A6) POLO IV Saloon (9N4)	

AGR	7.24809.31.0
-----	--------------



→SI 0096
→SI 0100

AUDI

- A2 (8Z0)

SEAT

- CORDOBA (6L2)
- IBIZA III (6L1)

SKODA

- FABIA I (6Y2)
- FABIA I Combi (6Y5)
- FABIA I Praktik (6Y5)
- FABIA I Saloon (6Y3)
- FABIA II (542)
- FABIA II Combi (545)
- ROOMSTER (5J7)
- ROOMSTER Praktik (5J)

VOLKSWAGEN

- FOX Hatchback (5Z1, 5Z3, 5Z4)
- POLO (9N_)
- POLO IV Saloon (9A4, 9A2, 9N2, 9A6)



AGR 7.24809.32.0



→SI 0096
→SI 0100

SEAT

ALTEA (5P1)
TOLEDO III (5P2)

SKODA

OCTAVIA II (1Z3)
OCTAVIA II Combi (1Z5)

VOLKSWAGEN

CADDY III Box Body/MPV (2KA, 2KH, 2CA, 2CH)
CADDY III MPV (2KB, 2KJ, 2CB, 2CJ)

AGR 7.24809.34.0

SPRINTER 2-t Van (B901, B902)
SPRINTER 3-t Bus (B903)
SPRINTER 3-t Platform/Chassis (B903)
SPRINTER 3-t Van (B903)
SPRINTER 4-t Bus (B904)
SPRINTER 4-t Platform/Chassis (B904)
SPRINTER 4-t Van (B904)
V-CLASS (638/2)
VITO Bus (W638)
VITO Van (W638)

AGR 7.24809.35.0



→SI 0096
→SI 0100

MERCEDES-BENZ

SPRINTER 2-t Bus (B901, B902)
SPRINTER 2-t Platform/Chassis (B901, B902)
SPRINTER 2-t Van (B901, B902)
SPRINTER 3-t Bus (B903)
SPRINTER 3-t Platform/Chassis (B903)
SPRINTER 3-t Van (B903)
SPRINTER 4-t Bus (B904)
SPRINTER 4-t Platform/Chassis (B904)
SPRINTER 4-t Van (B904)
V-CLASS (638/2)
VITO Bus (W638)
VITO Van (W638)

AGR 7.24809.36.0

E-CLASS (W211)
E-CLASS T-Model (S211)

AGR 7.24809.37.0



→SI 0092
→SI 0100

MERCEDES-BENZ

C-CLASS (W203)
C-CLASS Coupe (CL203)
C-CLASS T-Model (S203)
E-CLASS (W211)
E-CLASS Platform/Chassis (VF211)
E-CLASS T-Model (S211)
S-CLASS (W220)
VIANO (W639)
VITO / MIXTO Van (W639)
VITO Bus (W639)

MERCEDES-BENZ (FJDA)

VITO (V639)

AGR 7.24809.33.0



→SI 0092
→SI 0100

MERCEDES-BENZ

A-CLASS (W169)
B-CLASS Sports Tourer (W245)

AGR 7.24809.38.0



→SI 0096
→SI 0100

VOLKSWAGEN

MULTIVAN V (7HM, 7HN, 7HF, 7EF, 7EM, 7EN)
TRANSPORTER V Bus (7HB, 7HJ, 7EB, 7EJ, 7EF, 7EG, 7HF, 7EC)
TRANSPORTER V Platform/Chassis (7JD, 7JE, 7JL, 7JY, 7JZ, 7FD)
TRANSPORTER V Van (7HA, 7HH, 7EA, 7EH)

AGR 7.24809.34.0



→SI 0096
→SI 0100

MERCEDES-BENZ

SPRINTER 2-t Bus (B901, B902)
SPRINTER 2-t Platform/Chassis (B901, B902)

AGR 7.24809.36.0



→SI 0092
→SI 0100

MERCEDES-BENZ

C-CLASS (W203)
C-CLASS Coupe (CL203)
C-CLASS T-Model (S203)
CLC-CLASS (CL203)
CLK (C209)



AGR 7.24809.39.0	AGR 7.24809.39.0	AGR 7.24809.46.0
 <p style="text-align: right;">→SI 0092 →SI 0100</p> <p>CITROEN BERLINGO / BERLINGO FIRST Box Body/MPV (M_) BERLINGO / BERLINGO FIRST MPV (MF_, GJK_, GFK_) BERLINGO Box Body/MPV (B9) BERLINGO MULTISPACE (B9) BERLINGO Platform/Chassis (B9) C2 (JM_) C3 I (FC_, FN_) C3 II (SC_) C3 PICASSO (SH_) C4 Coupe (LA_) C4 GRAND PICASSO I (UA_) C4 I (LC_) C4 I Saloon C4 PICASSO I MPV (UD_) C5 II (RC_) C5 II Break (RE_) C5 III (RD_) C5 III Break (RW_) JUMPY (VF7) JUMPY Van XSARA PICASSO (N68)</p>	<p>PEUGEOT 1007 (KM_) 206 CC (2D) 206 Hatchback (2A/C) 206 SW (2E/K) 207 (WA_, WC_) 207 CC (WD_) 207 Hatchback Van (WA_, WC_) 207 SW (WK_) 3008 MPV (0U_) 307 (3A/C) 307 Break (3E) 307 SW (3H) 308 CC (4B_) 308 I (4A_, 4C_) 308 SW I (4E_, 4H_) 407 (6D_) 407 SW (6E_) 5008 (0U_, 0E_) EXPERT Platform/Chassis EXPERT TEPEE (VF3X_) EXPERT Van (VF3A_, VF3U_, VF3X_) PARTNER Box Body/MPV PARTNER Box Body/MPV (5_, G_) PARTNER MPV (5_, G_) PARTNER Platform/Chassis PARTNER TEPEE</p> <p>SUZUKI SX4 (EY, GY)</p> <p>VOLVO C30 (533) S40 II (544) S80 II (124) V50 (545) V70 III (135)</p>	 <p style="text-align: right;">→SI 0092 →SI 0100</p> <p>MERCEDES-BENZ A-CLASS (W169) B-CLASS Sports Tourer (W245)</p>
<p>FIAT SCUDO Bus (270_, 272_) SCUDO Platform/Chassis (270_, 272_) SCUDO Van (270_, 272_)</p> <p>FORD C-MAX (DM2) FIESTA V (JH_, JD_) FIESTA V Van FIESTA VI (CB1, CCN) FIESTA VI Van FOCUS C-MAX (DM2) FOCUS II (DA_, HCP, DP) FOCUS II Saloon (DB_, FCH, DH) FOCUS II Turnier (DA_, FFS, DS) FUSION (JU_)</p> <p>MAZDA 3 (BK) 3 (BL) 3 Saloon (BK) 3 Saloon (BL)</p> <p>MINI (BMW) MINI (R56) MINI CLUBMAN (R55)</p>	<p style="text-align: center;">AGR 7.24809.40.0</p>  <p style="text-align: right;">→PI 1728 →SI 0092 →SI 0100</p> <p>FORD TRANSIT Bus (FD_, FB_, FS_, FZ_, FC_) TRANSIT Platform/Chassis (FM_, FN_, FF_) TRANSIT TOURNEO Bus TRANSIT Van (FA_)</p>	<p style="text-align: center;">AGR 7.24809.47.0</p>  <p style="text-align: right;">→SI 0092 →SI 0100</p> <p>CHRYSLER 300C (LX, LE) 300C Touring (LX, LE)</p> <p>JEEP COMMANDER (XK, XH) GRAND CHEROKEE III (WH, WK)</p> <p>MERCEDES-BENZ C-CLASS (W203) C-CLASS (W204) C-CLASS T-Model (S203) C-CLASS T-Model (S204) CLK (C209) CLK Convertible (A209) CLS (C219) E-CLASS (W211) E-CLASS Platform/Chassis (VF211) E-CLASS T-Model (S211) GLK-CLASS (X164) GLK-CLASS (X204) M-CLASS (W164) R-CLASS (W251, V251) S-CLASS (W221)</p>



AGR 7.24809.48.0



→SI 0092
→SI 0100

MERCEDES-BENZ

- C-CLASS (W204)
- C-CLASS T-Model (S204)
- E-CLASS (W211)
- E-CLASS Platform/Chassis (VF211)
- E-CLASS T-Model (S211)

AGR 7.24809.50.0

- 3 (E90)
- 3 Convertible (E93)
- 3 Coupe (E92)
- 3 Touring (E91)
- 5 (E60)
- 5 Touring (E61)

AGR 7.24809.51.0



→SI 0096
→SI 0100

CITROEN

- JUMPER Bus
- JUMPER Platform/Chassis
- JUMPER Van

FIAT

- DUCATO Bus (250_)
- DUCATO Platform/Chassis (250_)
- DUCATO Van (250_)

IVECO

- DAILY IV Platform/Chassis
- DAILY IV Van

MASSIF

- MASSIF Pickup
- MASSIF Single Cab
- MASSIF Station Wagon

PEUGEOT

- BOXER Bus
- BOXER Platform/Chassis
- BOXER Van

AGR 7.24809.49.0



→SI 0096
→SI 0100

MERCEDES-BENZ

- A-CLASS (W168)
- VANEO (414)

AGR 7.24809.50.0



→SI 0092
→SI 0100
→SI 1830

BMW

- 1 (E81)
- 1 (E87)
- 1 Convertible (E88)
- 1 Coupe (E82)

AGR 7.24809.52.0



→SI 0096
→SI 0100

VOLKSWAGEN

- LT 28-35 II Bus (2DB, 2DE, 2DK)
- LT 28-46 II Platform/Chassis (2DC, 2DF, 2DG, 2DL, 2DM)
- LT 28-46 II Van (2DA, 2DD, 2DH)

AGR 7.24809.53.0



→SI 0096
→SI 0100

CITROEN

- JUMPER Bus (230P)
- JUMPER Platform/Chassis (230)
- JUMPER Van (230L)

FIAT

- DUCATO Bus (230_)
- DUCATO Platform/Chassis (230_)
- DUCATO Van (230_)

IVECO

- DAILY II Platform/Chassis
- DAILY II Van
- DAILY III Platform/Chassis
- DAILY III Van

PEUGEOT

- BOXER Bus (230P)
- BOXER Platform/Chassis (ZCT_)
- BOXER Van (230L)

AGR 7.24809.54.0



→SI 0092
→SI 0100

DODGE

- SPRINTER 2500 Cab & Chassis
- SPRINTER 2500 Standard Cargo Van (VA)
- SPRINTER 2500 Standard Passenger Van
- SPRINTER 3500 Cab & Chassis

FREIGHTLINER

- SPRINTER 2500 Cab & Chassis
- SPRINTER 3500 Cab & Chassis

MERCEDES-BENZ

- SPRINTER 2-t Bus (B901, B902)
- SPRINTER 2-t Platform/Chassis (B901, B902)
- SPRINTER 2-t Van (B901, B902)
- SPRINTER 3-t Bus (B903)
- SPRINTER 3-t Platform/Chassis (B903)

EMISSION CONTROL



AGR 7.24809.54.0

SPRINTER 3-t Van (B903)
 SPRINTER 4-t Bus (B904)
 SPRINTER 4-t Platform/Chassis (B904)
 SPRINTER 4-t Van (B904)
 SPRINTER 5-t Platform/Chassis (B905)
 SPRINTER Dump Truck (B905)

AGR 7.24809.55.0



→SI 0096
 →SI 0100

SEAT
 CORDOBA (6L2)
 IBIZA III (6L1)
SKODA
 FABIA I (6Y2)
VOLKSWAGEN
 POLO (9N_)

AGR 7.24809.56.0



→SI 0096
 →SI 0100

VOLKSWAGEN
 TOUAREG (7LA, 7L6, 7L7)

AGR 7.24809.57.0



→SI 0096
 →SI 0100

AUDI
 A2 (8Z0)
SEAT
 AROSA (6H1)
VOLKSWAGEN
 LUPO I (6X1, 6E1)
 POLO (6N2)
 POLO (9N_)

AGR 7.24809.59.0



→SI 0092
 →SI 0100

MERCEDES-BENZ
 E-CLASS (W211)
 E-CLASS T-Model (S211)
 VIANO (W639)
 VITO / MIXTO Van (W639)
 VITO Bus (W639)
 ENGINE
MERCEDES-BENZ (FJDA)
 VITO (V639)

AGR 7.24809.60.0



→SI 0092
 →SI 0100

DODGE
 SPRINTER 2500 Cab & Chassis
 SPRINTER 2500 Standard Cargo Van
 SPRINTER 2500 Standard Passenger Van
 SPRINTER 3500 Cab & Chassis
 SPRINTER 3500 Standard Cargo Van
 SPRINTER 3500 Standard Passenger Van
FREIGHTLINER
 SPRINTER 2500 Cab & Chassis
 SPRINTER 3500 Standard Passenger Van
MERCEDES-BENZ
 G-CLASS (W461)
 SPRINTER 3,5-t Bus (B906)
 SPRINTER 3,5-t Platform/Chassis (B906)
 SPRINTER 3,5-t Van (B906)
 SPRINTER 3-t Platform/Chassis (B906)
 SPRINTER 3-t Van (B906)
 SPRINTER 4,6-t Platform/Chassis (B906)
 SPRINTER 4,6-t Van (B906)
 SPRINTER 5-t Platform/Chassis (B906)
 SPRINTER 5-t Van (B906)
 VIANO (W639)
 VITO / MIXTO Van (W639)
 VITO Bus (W639)

AGR 7.24809.61.0







→SI 0096
 →SI 0100





VOLKSWAGEN
 TRANSPORTER IV Bus (70B, 70C, 7DB, 7DK, 70J, 70K, 7DC, 7DJ)
 TRANSPORTER IV Platform/Chassis (70E, 70L, 70M, 7DE, 7DL, 7D)
 TRANSPORTER IV Van (70A, 70H, 7DA, 7DH)





AGR	7.24809.63.0	AGR	7.24809.65.0	AGR	7.24809.68.0
 <p>→SI 0096 →SI 0100</p> <p>VOLKSWAGEN PHAETON (3D1, 3D2, 3D3, 3D4, 3D6, 3D7, 3D8, 3D9) TOUAREG (7LA, 7L6, 7L7)</p>		<p>MERCEDES-BENZ SPRINTER (901/902/903/904/905) SPRINTER 3,5-t Bus (B906) SPRINTER 3,5-t Platform/Chassis (B906) SPRINTER 3,5-t Van (B906) SPRINTER 3-t Bus (B906) SPRINTER 3-t Platform/Chassis (B906) SPRINTER 3-t Van (B906) SPRINTER 4,6-t Platform/Chassis (B906) SPRINTER 4,6-t Van (B906) SPRINTER 5-t Platform/Chassis (B906) SPRINTER 5-t Van (B906) SPRINTER CLASSIC 3,5-t Van (B909) SPRINTER CLASSIC 4,6-t Bus (B909)</p>		<p>C5 II Break (RE_) C5 III (RD_) C5 III Break (RW_) C8 (EA_, EB_) JUMPY (VF7) JUMPY Van FIAT SCUDO Bus (270_, 272_) SCUDO Platform/Chassis (270_, 272_) SCUDO Van (270_, 272_) ULYSSE (179_) FORD C-MAX (DM2) FOCUS C-MAX (DM2) FOCUS II (DA_, HCP, DP) FOCUS II Convertible FOCUS II Saloon (DB_, FCH, DH) FOCUS II Turnier (DA_, FFS, DS) GALAXY II (WA6) KUGA I MONDEO IV (BA7) MONDEO IV Saloon (BA7) MONDEO IV Turnier (BA7) S-MAX (WA6) LANCIA PHEDRA (179_) PEUGEOT 307 (3A/C) 307 Break (3E) 307 CC (3B) 307 SW (3H) 307 SW Estate Van (3E_, 3H_) 308 CC (4B_) 308 I (4A_, 4C_) 308 SW I (4E_, 4H_) 308 SW I Estate Van (4E_) 407 (6D_) 407 Coupe (6C_) 407 SW (6E_) 407 SW Estate Van (6E_) 508 I (8D_) 508 SW Estate Van (8E_) 508 SW I (8E_) 607 (9D, 9U) 807 (EB_) EXPERT Platform/Chassis EXPERT TEPEE (VF3X_) EXPERT Van (VF3A_, VF3U_, VF3X_) VOLVO C30 (533) C70 II Convertible (542) S40 I (644) S40 II (544) S80 II (124) V50 (545) V70 III (135)</p>	
 <p>→SI 0096 →SI 0100</p> <p>VOLKSWAGEN NEW BEETLE (9C1, 1C1)</p>		 <p>→SI 0092 →SI 0100</p> <p>MERCEDES-BENZ 11T-SERIES 13T-SERIES 14T-SERIES 15T-SERIES 16T-SERIES 17T-SERIES ENGINE</p>			
 <p>→SI 0092 →SI 0100</p> <p>DODGE SPRINTER 2500 Standard Passenger Van SPRINTER 3500 Standard Cargo Van FREIGHTLINER SPRINTER 2500 Standard Cargo Van SPRINTER 2500 Standard Passenger Van SPRINTER 3500 Standard Cargo Van SPRINTER 3500 Standard Passenger Van</p>		 <p>→SI 0092 →SI 0100</p> <p>CITROEN C4 Coupe (LA_) C4 GRAND PICASSO I (UA_) C4 I (LC_) C4 I Hatchback Van (LR_) C4 I Saloon C4 PICASSO I MPV (UD_) C5 II (RC_)</p>			



AGR 7.24809.69.0	AGR 7.24809.71.0	AGR 7.24809.73.0
 <p>→SI 0092 →SI 0100</p> <p>FORD TRANSIT Bus (FD_, FB_, FS_, FZ_, FC_) TRANSIT Platform/Chassis (FM_, FN_, FF_) TRANSIT TOURNEO Bus TRANSIT Van (FA_) FORD JMC TRANSIT Bus</p>	 <p>→SI 0092 →SI 0100</p> <p>FORD C-MAX (DM2) FOCUS C-MAX (DM2) FOCUS II (DA_, HCP, DP) FOCUS II Saloon (DB_, FCH, DH) FOCUS II Turnier (DA_, FFS, DS) GALAXY II (WA6) MONDEO IV (BA7) MONDEO IV Saloon (BA7) MONDEO IV Turnier (BA7) S-MAX (WA6) TOURNEO CONNECT TRANSIT CONNECT (P65_, P70_, P80_)</p>	 <p>→SI 0092 →SI 0100 →SI 1830</p> <p>FORD C-MAX (DM2) FIESTA V (JH_, JD_) FOCUS C-MAX (DM2) FOCUS II (DA_, HCP, DP) FOCUS II Convertible FOCUS II Saloon (DB_, FCH, DH) FOCUS II Turnier (DA_, FFS, DS) GALAXY II (WA6) KUGA II (DM2) MAVERICK MONDEO III (B5Y) MONDEO III Saloon (B4Y) MONDEO III Turnier (BWY) MONDEO IV (BA7) MONDEO IV Saloon (BA7) MONDEO IV Turnier (BA7) MONDEO V Saloon (CD) S-MAX (WA6) FORD (CHANGAN) FOCUS Hatchback FOCUS Hatchback (CD5) FOCUS Saloon FOCUS Saloon (CD4) MONDEO MONDEO / ZHISHENG MAZDA 3 (BK) 3 (BL) 3 Saloon (BK) 3 Saloon (BL) 5 (CR19) 5 (CW) 6 Estate (GH) 6 Hatchback (GG) 6 Hatchback (GH) 6 Saloon (GG) 6 Saloon (GH) 6 Station Wagon (GY) CX-7 (ER) MPV II (LW) MPV III (LY) TRIBUTE (EP) VOLVO C30 (533) S40 II (544) S80 II (124)</p>
 <p>→SI 0092 →SI 0100</p> <p>CITROEN JUMPER Bus JUMPER Platform/Chassis JUMPER Van FIAT DUCATO Bus (250_) DUCATO Platform/Chassis (250_) DUCATO Van (250_) FORD TRANSIT Bus (FD_, FB_, FS_, FZ_, FC_) TRANSIT Platform/Chassis (FM_, FN_, FF_) TRANSIT TOURNEO Bus TRANSIT Van (FA_) FORD AUSTRALIA TRANSIT Van (VM) LAND ROVER DEFENDER Cabrio (L316) DEFENDER Pick Up (L316) DEFENDER Platform/Chassis (L316) DEFENDER Station Wagon (L316) PEUGEOT BOXER Bus BOXER Platform/Chassis BOXER Van</p>	 <p>→SI 0092 →SI 0100</p> <p>FORD GALAXY II (WA6) S-MAX (WA6) TOURNEO CONNECT TRANSIT CONNECT (P65_, P70_, P80_)</p>	





AGR 7.24809.73.0	AGR 7.24809.76.0	AGR 7.24809.77.0
<p>V50 (545) V70 III (135)</p>		<p>GIULIETTA (940_) MITO (955_) SPIDER (939_) CHRYSLER DELTA FIAT 500L (351_, 352_) 500X (334_) BRAVO II (198_) DOBLO Bus (263_) DOBLO Cargo (263_) DOBLO Platform/Chassis (263_) DUCATO Bus (250_) DUCATO Platform/Chassis (250_) DUCATO Van (250_) FREEMONT (345_) GRANDE PUNTO (199_) IDEA (350_) LINEA (323_, 110_) PUNTO EVO (199_) SEDICI (189_) TIPO Estate (356_) TIPO Hatchback (356_) TIPO Saloon (356_) JEEP CHEROKEE (KL) RENEGADE SUV (BU, B1) LANCIA DELTA III (844_) MUSA (350_) OPEL COMBO Box Body/MPV (X12) COMBO Tour (X12) SAAB 9-3 (YS3F, E79, D79, D75) 9-3 Convertible (YS3F) 9-3 Estate (E50) 9-3X (YS3) SUZUKI SX4 (EY, GY) SX4 S-CROSS (JY) VITARA (LY) VAUXHALL COMBO Mk III (D) Box Body/MPV (X12)</p>
<p>AGR 7.24809.74.0</p>		
<p>FORD TRANSIT Bus (FD_, FB_, FS_, FZ_, FC_) TRANSIT Platform/Chassis (FM_, FN_) TRANSIT TOURNEO Bus (FC_) TRANSIT Van (FA_)</p>	<p>CITROEN C1 (PM_, PN_) C2 (JM_) C2 ENTERPRISE (JG_) C3 I (FC_, FN_) C3 II (SC_) C3 Pluriel (HB_) NEMO Box Body/MPV (AA_) NEMO MPV FORD FIESTA Saloon FIESTA V (JH_, JD_) FIESTA V Van FIESTA VI (CB1, CCN) FIESTA VI Van FUSION (JU_) MAZDA 2 (DY) PEUGEOT 1007 (KM_) 107 (PM_, PN_) 206 Hatchback (2A/C) 206 SW (2E/K) 206 Saloon 206 Van 206+ (2L_, 2M_) 207 (WA_, WC_) 207 Hatchback Van (WA_, WC_) BIPPER (AA_) BIPPER TEPEE TOYOTA AYGO (_B1_)</p>	
<p>AGR 7.24809.75.0</p>		
		
<p>FORD RANGER (ET) FORD ASIA / OZEANIA EVEREST (25N_) FORD AUSTRALIA RANGER Pickup (PJ) RANGER Pickup (PK) RANGER Platform/Chassis (PJ) RANGER Platform/Chassis (PK) MAZDA BT-50 Pickup (CD, UN) BT-50 Platform/Chassis (CD, UN)</p>		
<p>AGR 7.24809.77.0</p>	<p>AGR 7.24809.77.0</p>	<p>AGR 7.24809.78.0</p>
	<p>ALFA ROMEO 159 (939_) 159 Sportwagon (939_) BRERA (939_)</p>	 <p>CHEVROLET MALIBU (V300) OPEL ASTRA J (P10)</p>





AGR 7.24809.78.0	AGR 7.24809.80.0	AGR 7.24809.82.0 New
<p>ASTRA J Estate Van (P10) ASTRA J GTC ASTRA J Sports Tourer (P10) CASCADA (W13) INSIGNIA A (G09) INSIGNIA A Country Tourer (G09) INSIGNIA A Saloon (G09) INSIGNIA A Sports Tourer (G09) ZAFIRA TOURER C (P12) SAAB 9-5 (YS3G) VAUXHALL ASTRA Mk VI (J) (P10) ASTRA Mk VI (J) Estate (P10) ASTRA Mk VI (J) GTC (P10) CASCADA Convertible (W13) INSIGNIA Mk I (A) Country Tourer (G09) INSIGNIA Mk I (A) Hatchback (G09) INSIGNIA Mk I (A) Saloon (G09) INSIGNIA Mk I (A) Sports Tourer (G09) ZAFIRA Mk III (P12)</p>	<p>1500 Extended Cab Pickup (DS) 1500 Standard Cab Pickup (DS)</p>	<div data-bbox="1161 241 1374 607" data-label="Image"> </div> <p data-bbox="1086 405 1458 488">© MS Motorservice International GmbH</p> <p data-bbox="1048 611 1251 636">MERCEDES-BENZ</p> <p data-bbox="1048 645 1410 965"> A-CLASS (W176) B-CLASS Sports Tourer (W246, W242) C-CLASS (W205) C-CLASS Convertible (A205) C-CLASS Coupe (C205) C-CLASS T-Model (S205) CLA Coupe (C117) CLA Shooting Brake (X117) GLA-CLASS (X156) GLC (X253) GLC Coupe (C253) </p>
AGR 7.24809.79.0	AGR 7.24809.81.0	AGR 7.24809.83.0 New
<div data-bbox="225 936 475 1294" data-label="Image"> </div> <p data-bbox="177 1093 549 1176">© MS Motorservice International GmbH</p> <p data-bbox="135 1301 217 1326">IVECO</p> <p data-bbox="135 1335 384 1447"> DAILY V Platform/Chassis DAILY V Van DAILY VI Platform/Chassis DAILY VI Van </p>	<div data-bbox="667 360 954 719" data-label="Image"> </div> <p data-bbox="635 517 1007 600">© MS Motorservice International GmbH</p> <p data-bbox="592 728 735 752">CHEVROLET</p> <p data-bbox="592 761 839 873"> TRAX OPEL ASTRA J (P10) ASTRA J Estate Van (P10) ASTRA J GTC ASTRA J Hatchback Van (P10) ASTRA J Saloon ASTRA J Sports Tourer (P10) </p>	<div data-bbox="1114 1041 1449 1400" data-label="Image"> </div> <p data-bbox="1086 1205 1458 1288">© MS Motorservice International GmbH</p> <p data-bbox="1048 1406 1251 1431">MERCEDES-BENZ</p> <p data-bbox="1048 1440 1318 1821"> C-CLASS (W205) C-CLASS Convertible (A205) C-CLASS Coupe (C205) C-CLASS T-Model (S204) C-CLASS T-Model (S205) E-CLASS (W212) E-CLASS (W213) E-CLASS Convertible (A207) E-CLASS Convertible (A238) E-CLASS Coupe (C207) E-CLASS Coupe (C238) E-CLASS T-Model (S212) E-CLASS T-Model (S213) </p>
AGR 7.24809.80.0	<p data-bbox="592 728 735 752">CHEVROLET</p> <p data-bbox="592 761 839 873"> TRAX OPEL ASTRA J (P10) ASTRA J Estate Van (P10) ASTRA J GTC ASTRA J Hatchback Van (P10) ASTRA J Saloon ASTRA J Sports Tourer (P10) ASTRA K (B16) ASTRA K Hatchback Van ASTRA K Sports Tourer (B16) </p> <p data-bbox="592 882 999 1384"> INSIGNIA A (G09) INSIGNIA A Country Tourer (G09) INSIGNIA A Saloon (G09) INSIGNIA A Sports Tourer (G09) INSIGNIA B Grand Sport (Z18) INSIGNIA B Sports Tourer (Z18) INSIGNIA B Sports Tourer Combi Van (Z18) MERIVA B MPV (S10) MOKKA / MOKKA X (J13) ZAFIRA TOURER C (P12) </p> <p data-bbox="592 1393 724 1417">VAUXHALL</p> <p data-bbox="592 1426 967 1832"> ASTRA Mk VI (J) (P10) ASTRA Mk VI (J) Estate (P10) ASTRA Mk VI (J) GTC (P10) ASTRA Mk VII (K) (B16) ASTRA Mk VII (K) Estate (B16) INSIGNIA Mk I (A) Country Tourer (G09) INSIGNIA Mk I (A) Hatchback (G09) INSIGNIA Mk I (A) Saloon (G09) INSIGNIA Mk I (A) Sports Tourer (G09) INSIGNIA Mk II (B) Hatchback (Z18) INSIGNIA Mk II (B) Sports Tourer (Z18) MERIVA Mk II (B) (S10) MOKKA / MOKKA X (J13) ZAFIRA Mk III (P12) </p>	<p data-bbox="1048 1406 1251 1431">MERCEDES-BENZ</p> <p data-bbox="1048 1440 1318 1821"> C-CLASS (W205) C-CLASS Convertible (A205) C-CLASS Coupe (C205) C-CLASS T-Model (S204) C-CLASS T-Model (S205) E-CLASS (W212) E-CLASS (W213) E-CLASS Convertible (A207) E-CLASS Convertible (A238) E-CLASS Coupe (C207) E-CLASS Coupe (C238) E-CLASS T-Model (S212) E-CLASS T-Model (S213) </p>
<div data-bbox="252 1518 459 1877" data-label="Image"> </div> <p data-bbox="177 1675 549 1758">© MS Motorservice International GmbH</p> <p data-bbox="135 1886 264 1910">CHRYSLER</p> <p data-bbox="135 1919 193 1944">300C</p> <p data-bbox="135 1953 197 1977">JEEP</p> <p data-bbox="135 1986 456 2011">GRAND CHEROKEE IV (WK, WK2)</p> <p data-bbox="135 2020 229 2045">LANCIA</p> <p data-bbox="135 2054 264 2078">THEMA (LX_)</p> <p data-bbox="135 2087 197 2112">RAM</p> <p data-bbox="135 2121 395 2145">1500 Crew Cab Pickup (DS)</p>		





AGR 7.24809.84.0 New



MERCEDES-BENZ

- A-CLASS (W176)
- B-CLASS Sports Tourer (W246, W242)
- CLA Coupe (C117)
- CLA Shooting Brake (X117)
- GLA-CLASS (X156)

AGR 7.24809.86.0 New



FIAT

- DUCATO Bus (250_)
- DUCATO Platform/Chassis (250_)
- DUCATO Van (250_)

AGR 7.24809.89.0 New



FORD

- C-MAX (DM2)
- FOCUS C-MAX (DM2)
- FOCUS II (DA_, HCP, DP)
- FOCUS II Saloon (DB_, FCH, DH)
- FOCUS II Turnier (DA_, FFS, DS)
- GALAXY II (WA6)
- MONDEO IV (BA7)
- MONDEO IV Saloon (BA7)
- MONDEO IV Turnier (BA7)
- S-MAX (WA6)
- TOURNEO CONNECT
- TRANSIT CONNECT (P65_, P70_, P80_)

AGR 7.24809.85.0 New



MERCEDES-BENZ

- C-CLASS (W205)
- C-CLASS Convertible (A205)
- C-CLASS Coupe (C205)
- C-CLASS T-Model (S204)
- C-CLASS T-Model (S205)
- CLS (C218)
- E-CLASS (W212)
- E-CLASS (W213)
- E-CLASS Convertible (A207)
- E-CLASS Convertible (A238)
- E-CLASS Coupe (C207)
- E-CLASS Coupe (C238)
- E-CLASS T-Model (S212)
- E-CLASS T-Model (S213)
- GLC (X253)
- GLC Coupe (C253)
- GLK-CLASS (X204)
- SLC (R172)
- SLK (R172)
- V-CLASS (W447)
- VITO Tourer (W447)

AGR 7.24809.87.0 New



OPEL

- ANTARA A (L07)
- CASCADA (W13)
- INSIGNIA A (G09)
- INSIGNIA A Country Tourer (G09)
- INSIGNIA A Saloon (G09)
- INSIGNIA A Sports Tourer (G09)
- INSIGNIA B Country Tourer (Z18)
- INSIGNIA B Grand Sport (Z18)
- INSIGNIA B Sports Tourer (Z18)
- ZAFIRA TOURER C (P12)

VAUXHALL

- CASCADA Convertible (W13)
- INSIGNIA Mk I (A) Country Tourer (G09)
- INSIGNIA Mk I (A) Hatchback (G09)
- INSIGNIA Mk I (A) Saloon (G09)
- INSIGNIA Mk I (A) Sports Tourer (G09)
- INSIGNIA Mk II (B) Country Tourer (Z18)
- INSIGNIA Mk II (B) Hatchback (Z18)
- INSIGNIA Mk II (B) Sports Tourer (Z18)
- ZAFIRA Mk III (P12)

AGR 7.24809.90.0 New



MERCEDES-BENZ

- C-CLASS (W205)
- C-CLASS T-Model (S205)
- VITO Mixto (Double Cabin) (W447)
- VITO Tourer (W447)
- VITO Van (W447)
- NISSAN**
- NV300 Kombi (X82)
- NV300 Van (X82)
- QASHQAI / QASHQAI + 2 I (J10, NJ10, JJ10E)
- QASHQAI II SUV (J11, J11_)
- X-TRAIL (T32_)
- OPEL**
- VIVARO B Bus (X82)
- VIVARO B Van (X82)
- RENAULT**
- ESPACE V (JR_)
- GRAND SCÉNIC III (JZ0/1_)
- KADJAR (HA_, HL_)
- KOLEOS II (HC_)
- MEGANE CC (EZ0/1_)
- MEGANE III Coupe (DZ0/1_)
- MEGANE III Grandtour (KZ0/1)





AGR 7.24809.90.0 New

MEGANE III Hatchback (BZ0/1_, B3_)
 MEGANE IV Grandtour (K9A/M/N_)
 MEGANE IV Hatchback (B9A/M/N_)
 SCÉNIC III (JZ0/1_)
 TALISMAN (LP_)
 TALISMAN Grandtour (KP_)
 TRAFIC III Bus (JG_)
 TRAFIC III Platform/Chassis (EG_)
 TRAFIC III Van (FG_)
VAUXHALL
 VIVARO B Bus (X82)
 VIVARO B Platform/Chassis (X82)
 VIVARO B Van (X82)

AGR 7.24809.93.0

without Picture

VOLKSWAGEN
 AMAROK (2HA, 2HB, S1B, S6B, S7A, S7B)
 AMAROK Platform/Chassis (S1B, S6B, S7B)
 CRAFTER 30-35 Bus (2E_)
 CRAFTER 30-50 Platform/Chassis (2F_)
 CRAFTER 30-50 Van (2E_)

AGR 7.24809.97.0 New



LAND ROVER
 RANGE ROVER III (L322)
 RANGE ROVER SPORT I (L320)

AGR 7.24809.91.0 New



FORD
 FOCUS C-MAX (DM2)
 FOCUS II (DA_, HCP, DP)
 FOCUS II Saloon (DB_, FCH, DH)
 FOCUS II Turnier (DA_, FFS, DS)

AGR 7.24809.95.0 New



LAND ROVER
 DISCOVERY III (L319)
 DISCOVERY IV (L319)
 RANGE ROVER SPORT I (L320)

AGR 7.28069.03.0



→SI 0096
 →SI 0100

VOLVO
 C30 (533)
 S40 II (544)
 S80 II (124)
 V50 (545)
 V70 III (135)

AGR 7.24809.96.0 New



JAGUAR
 S-TYPE II (X200)
 XF I (X250)
 XJ (X350, X358)

LAND ROVER
 DISCOVERY III (L319)
 RANGE ROVER SPORT I (L320)

PEUGEOT
 407 (6D_)
 407 Coupe (6C_)
 407 SW (6E_)
 607 (9D, 9U)

CITROEN
 C8 (EA_, EB_)
 EVASION MPV (22, U6)
 JUMPY (U6U_)
 JUMPY Platform/Chassis (BU_, BV_, BW_, BX_)
 JUMPY Van (BS_, BT_, BY_, BZ_)

FIAT
 SCUDO Bus (220_)
 SCUDO Platform/Chassis (220_)
 SCUDO Van (220_)
 ULYSSE (179_)
 ULYSSE (220_)

LANCIA
 PHEDRA (179_)
 ZETA (22_)

PEUGEOT
 806 (221)
 807 (EB_)
 EXPERT Platform/Chassis (223)
 EXPERT Van (222)

AGR 7.24809.92.0 New



FORD
 FOCUS C-MAX (DM2)

EMISSION CONTROL



AGR 7.28069.04.0



© MS Motorservice International GmbH

→SI 0096
→SI 0100

CITROEN
C8 (EA_, EB_)
PEUGEOT
807 (EB_)

AGR 7.28070.03.0



© MS Motorservice International GmbH

→SI 0090
→SI 0092
→SI 0100
→SI 1830

SEAT
ALHAMBRA (7V8, 7V9)
VOLKSWAGEN
SHARAN (7M8, 7M9, 7M6)

AGR 7.28248.17.0



© MS Motorservice International GmbH

→SI 0090
→SI 0092
→SI 0100
→SI 1830

AUDI
A2 (8Z0)

AGR 7.28248.17.0

SEAT
AROSA (6H1)
CORDOBA (6K1, 6K2)
CORDOBA (6L2)
CORDOBA Vario (6K5)
IBIZA II (6K1)
IBIZA III (6L1)
INCA (6K9)
LEON (1M1)
TOLEDO II (1M2)
SKODA
FABIA I (6Y2)
FABIA I Combi (6Y5)
FABIA I Saloon (6Y3)
OCTAVIA I (1U2)
OCTAVIA I Combi (1U5)
OCTAVIA II (1Z3)
VOLKSWAGEN

BORA I (1J2)
BORA Variant (1J6)
CADDY II Box Body/MPV (9K9A)
CADDY II MPV (9K9B)
CADDY III Box Body/MPV (2KA, 2KH, 2CA, 2CH)
CADDY III MPV (2KB, 2KJ, 2CB, 2CJ)
GOLF IV (1J1)
GOLF IV Variant (1J5)
GOLF PLUS V (5M1, 521)
GOLF V (1K1)
LUPU I (6X1, 6E1)
POLO (6N2)
POLO (9N_)
POLO III CLASSIC (6V2)
POLO IV Saloon (9A4, 9A2, 9N2, 9A6)
POLO Variant (6V5)

AGR 7.28264.06.0



© MS Motorservice International GmbH

→SI 0096
→SI 0100

BMW
3 (E46)
3 Compact (E46)
3 Convertible (E46)
3 Coupe (E46)
3 Touring (E46)
5 (E39)
5 Touring (E39)
7 (E38)
7 (E65, E66, E67)
X5 (E53)

AGR 7.28264.06.0

LAND ROVER
FREELANDER I (L314)
FREELANDER I Soft Top (L314)
RANGE ROVER III (L322)

AGR 7.28264.07.0



© MS Motorservice International GmbH

→SI 0096
→SI 0100

BMW
3 (E46)
3 Convertible (E46)
3 Coupe (E46)
3 Touring (E46)
5 (E60)
5 Touring (E61)
7 (E65, E66, E67)
X5 (E53)

AGR 7.28270.14.0



© MS Motorservice International GmbH





→SI 0096
→SI 0100

CHRYSLER
VOYAGER IV (RG, RS)
JEEP
CHEROKEE (KJ)
JEEP LIBERTY

EMISSION CONTROL











AGR 7.28290.11.0	AGR 7.28384.13.0	AGR-K 7.01106.38.0
 <p>→SI 0096 →SI 0100</p> <p>CHRYSLER VOYAGER IV (RG, RS)</p>	<p>MERIVA A (X03) ZAFIRA Mk II (B) (A05)</p>	<p>AUDI FAW A6L C6 (4Z8) PORSCHE CAYENNE (92A) VOLKSWAGEN TOUAREG (7P5, 7P6)</p>
	<p>AGR-K 7.00837.01.0</p>  <p>→SI 0100 →SI 0108 →SI 0108-01 →SI 1003 →SI 1003-02</p>	<p>AGR-K 7.01881.08.0*</p> <p>→7.01881.06.0 AGR-M</p> <p>JAGUAR XF I (X250) XF SPORTBRAKE (X250) XJ (X351) LAND ROVER DISCOVERY IV (L319) DISCOVERY IV VAN (L319) DISCOVERY V (L462) RANGE ROVER IV (L405) RANGE ROVER SPORT I (L320) RANGE ROVER SPORT II (L494)</p>
<p>AGR 7.28384.13.0</p>  <p>→SI 0092 →SI 0100 →SI 1830</p> <p>OPEL ASTRA G CLASSIC Caravan (F35) ASTRA G Convertible (T98) ASTRA G Coupe (T98) ASTRA G Estate (T98) ASTRA G Estate Van (F70) ASTRA G Hatchback (T98) ASTRA G Saloon (T98) ASTRA H (A04) ASTRA H Estate (A04) ASTRA H Estate Van (L70) ASTRA H GTC (A04) ASTRA H TwinTop (A04) MERIVA A MPV (X03) VECTRA C (Z02) VECTRA C Estate (Z02) VECTRA C GTS (Z02) ZAFIRA / ZAFIRA FAMILY B (A05)</p>	<p>RENAULT GRAND SCÉNIC II (JM0/1_) LAGUNA II (BG0/1_) LAGUNA II Grandtour (KG0/1_) MEGANE II (BM0/1_, CM0/1_) MEGANE II Estate (KM0/1_) MEGANE II Saloon (LM0/1_) SCÉNIC II (JM0/1_)</p>	<p>AGR-K 7.01881.09.0*</p> <p>→7.01881.07.0 AGR-M</p> <p>JAGUAR XF I (X250) XF SPORTBRAKE (X250) XJ (X351) LAND ROVER DISCOVERY IV (L319) DISCOVERY IV VAN (L319) DISCOVERY V (L462) RANGE ROVER IV (L405) RANGE ROVER SPORT I (L320) RANGE ROVER SPORT II (L494)</p>
<p>AUDI A4 Allroad B8 (8KH) A4 B8 (8K2) A4 B8 Avant (8K5) A5 (8T3) A5 Convertible (8F7) A5 Sportback (8TA) A6 Allroad C6 (4FH) A6 C6 (4F2) A6 C6 Avant (4F5) Q5 (8RB)</p>	<p>AGR-K 7.02107.09.0</p>  <p>→SI 0092 →SI 0100 →SI 0108 →SI 0108-01 →SI 1003 →SI 1003-02</p>	<p>→SI 0100 →SI 0108 →SI 0108-01 →SI 1003 →SI 1003-02</p> <p>VOLVO C30 (533) C70 II Convertible (542) S40 II (544) S60 II (134) S80 II (124) V40 Hatchback (525, 526) V40 Hatchback Van (525, 526) V50 (545)</p>





AGR-K 7.02156.34.0	AGR-K 7.02156.34.0	AGR-K 7.02156.35.0
		
<p>CITROEN BERLINGO Box Body/MPV (B9) BERLINGO MULTISPACE (B9) BERLINGO Platform/Chassis (B9) C-ELYSEE (DD_) C3 AIRCROSS II (2R_, 2C_) C3 II (SC_) C3 II Hatchback Van (SC_) C3 III (SX) C3 PICASSO (SH_) C4 AIRCROSS C4 CACTUS C4 GRAND PICASSO I (UA_) C4 GRAND PICASSO II (DA_, DE_) C4 II (B7) C4 II Hatchback Van (NC_) C4 II Saloon (NC_) C4 PICASSO I MPV (UD_) C4 PICASSO II C4 SPACETOURER (3D_) C5 III (RD_) C5 III Break (RW_) DS3 DS3 Convertible DS4 (NX_) DS5 GRAND C4 SPACETOURER (3A_, 3E_) JUMPY (VF7) JUMPY Platform/Chassis JUMPY Van JUMPY Van (V_) SPACETOURER Bus (V_)</p> <p>DS DS 3 (SA_) DS 4 / DS 4 CROSSBACK (NX_) DS 5 (KF_)</p> <p>FIAT SCUDO Bus (270_, 272_) SCUDO Van (270_, 272_)</p> <p>FORD B-MAX (JK) B-MAX Van (JK) C-MAX II (DXA/CB7, DXA/CEU) C-MAX II Van ECOSPORT FIESTA Saloon FIESTA VI (CB1, CCN) FIESTA VI Van FIESTA VII (HJ, HF) FIESTA VII Van</p>	<p>FOCUS III FOCUS III Hatchback Van FOCUS III Saloon FOCUS III Turnier GALAXY II (WA6) GRAND C-MAX (DXA/CB7, DXA/CEU) GRAND C-MAX Van KA+ III (UK, FK) KA+ III Saloon (TK, FK) MONDEO IV (BA7) MONDEO IV Saloon (BA7) MONDEO IV Turnier (BA7) S-MAX (WA6) TOURNEO CONNECT / GRAND TOURNEO CONNECT V408 MPV TOURNEO COURIER B460 MPV TRANSIT CONNECT MPV TRANSIT CONNECT V408 Box Body/MPV TRANSIT COURIER B460 Box Body/MPV TRANSIT COURIER B460 MPV</p> <p>MITSUBISHI ASX (GA_W_)</p> <p>PEUGEOT 2008 I (CU_) 206+ (2L_, 2M_) 207 (WA_, WC_) 207 CC (WD_) 207 Hatchback Van (WA_, WC_) 207 SW (WK_) 208 Hatchback Van (CR_) 208 I (CA_, CC_) 3008 MPV (0U_) 301 308 CC (4B_) 308 Hatchback Van (LB_) 308 I (4A_, 4C_) 308 II (LB_, LP_, LW_, LH_, L3_) 308 SW I (4E_, 4H_) 308 SW II (LC_, LJ_, LR_, LX_, L4_) 4008 5008 (0U_, 0E_) 508 I (8D_) 508 SW Estate Van (8E_) 508 SW I (8E_) EXPERT Platform/Chassis EXPERT TEPEE (VF3X_) EXPERT Van (VF3A_, VF3U_, VF3X_) PARTNER Box Body/MPV PARTNER Box Body/MPV (K9) PARTNER Platform/Chassis PARTNER TEPEE RIFTER</p> <p>VOLVO S60 II (134) S80 II (124) V40 Hatchback (525, 526) V40 Hatchback Van (525, 526) V60 I (155, 157) V60 I Estate Van (155) V70 III (135)</p>	<p>CITROEN BERLINGO Box Body/MPV (B9) BERLINGO MULTISPACE (B9) BERLINGO Platform/Chassis (B9) C-ELYSEE (DD_) C3 AIRCROSS II (2R_, 2C_) C3 II (SC_) C3 II Hatchback Van (SC_) C3 III (SX) C3 PICASSO (SH_) C4 AIRCROSS C4 CACTUS C4 GRAND PICASSO I (UA_) C4 GRAND PICASSO II (DA_, DE_) C4 II (B7) C4 II Hatchback Van (NC_) C4 II Saloon (NC_) C4 PICASSO I MPV (UD_) C4 PICASSO II C4 SPACETOURER (3D_) C5 III (RD_) C5 III Break (RW_) DS3 DS3 Convertible DS4 (NX_) DS5 GRAND C4 SPACETOURER (3A_, 3E_) JUMPY (VF7) JUMPY Platform/Chassis JUMPY Van JUMPY Van (V_) SPACETOURER Bus (V_)</p> <p>DS DS 3 (SA_) DS 4 / DS 4 CROSSBACK (NX_) DS 5 (KF_)</p> <p>FIAT SCUDO Bus (270_, 272_) SCUDO Van (270_, 272_)</p> <p>FORD B-MAX (JK) B-MAX Van (JK) C-MAX II (DXA/CB7, DXA/CEU) C-MAX II Van ECOSPORT FIESTA Saloon FIESTA VI (CB1, CCN) FIESTA VI Van FIESTA VII (HJ, HF) FIESTA VII Van</p>



AGR-K 7.02156.35.0	AGR-K 7.02756.07.0	AGR-K 7.03622.06.0
<p>FOCUS III FOCUS III Hatchback Van FOCUS III Saloon FOCUS III Turnier GALAXY II (WA6) GRAND C-MAX (DXA/CB7, DXA/CEU) GRAND C-MAX Van KA+ III (UK, FK) KA+ III Saloon (TK, FK) MONDEO IV (BA7) MONDEO IV Saloon (BA7) MONDEO IV Turnier (BA7) S-MAX (WA6) TOURNEO CONNECT / GRAND TOURNEO CONNECT V408 MPV TOURNEO COURIER B460 MPV TRANSIT CONNECT MPV TRANSIT CONNECT V408 Box Body/MPV TRANSIT COURIER B460 Box Body/MPV TRANSIT COURIER B460 MPV</p> <p>MITSUBISHI ASX (GA_W_)</p> <p>PEUGEOT 2008 I (CU_) 206+ (2L_, 2M_) 207 (WA_, WC_) 207 CC (WD_) 207 Hatchback Van (WA_, WC_) 207 SW (WK_) 208 Hatchback Van (CR_) 208 I (CA_, CC_) 3008 MPV (0U_) 301 308 CC (4B_) 308 Hatchback Van (LB_) 308 I (4A_, 4C_) 308 II (LB_, LP_, LW_, LH_, L3_) 308 SW I (4E_, 4H_) 308 SW II (LC_, LJ_, LR_, LX_, L4_) 4008 5008 (0U_, 0E_) 508 I (8D_) 508 SW Estate Van (8E_) 508 SW I (8E_)</p> <p>EXPERT Platform/Chassis EXPERT TEPEE (VF3X_) EXPERT Van (VF3A_, VF3U_, VF3X_) PARTNER Box Body/MPV PARTNER Box Body/MPV (K9) PARTNER Platform/Chassis PARTNER TEPEE RIFTER</p> <p>VOLVO S60 II (134) S80 II (124) V40 Hatchback (525, 526) V40 Hatchback Van (525, 526) V60 I (155, 157) V60 I Estate Van (155) V70 III (135)</p>	 <p>→SI 0092 →SI 0100 →SI 0108 →SI 0108-01 →SI 1003 →SI 1003-02</p> <p>VOLKSWAGEN MULTIVAN V (7HM, 7HN, 7HF, 7EF, 7EM, 7EN) MULTIVAN VI (SGF, SGM, SGN, SHM, SHN) TRANSPORTER / CARAVELLE VI Bus (SGB, SGG, SGJ, SGC, SHB, SHJ) TRANSPORTER V Bus (7HB, 7HJ, 7EB, 7EJ, 7EF, 7EG, 7HF, 7EC) TRANSPORTER V Platform/Chassis (7JD, 7JE, 7JL, 7JY, 7JZ, 7FD) TRANSPORTER V Van (7HA, 7HH, 7EA, 7EH) TRANSPORTER VI Platform/Chassis (SFD, SFE, SFL, SFZ, SJD, SJ) TRANSPORTER VI Van (SGA, SGH, SHA, SHH)</p>	<p>DOBLO Bus (263_) DOBLO Cargo (263_) DOBLO Platform/Chassis (263_) FIORINO Box Body/MPV (225_) GRANDE PUNTO (199_) GRANDE PUNTO Van (199_) IDEA (350_) LINEA (323_, 110_) PANDA (169_) PANDA (312_, 319_) PANDA Hatchback Van (169_) PANDA VAN (312_, 519_) PUNTO (199_) PUNTO EVO (199_) PUNTO EVO Hatchback Van (199_) PUNTO Hatchback Van (199_) QUBO (225_)</p> <p>FORD KA (RU8)</p> <p>LANCIA MUSA (350_)</p> <p>OPEL ASTRA J (P10) ASTRA J Estate Van (P10) ASTRA J Hatchback Van (P10) ASTRA J Saloon ASTRA J Sports Tourer (P10) CORSA D (S07) CORSA D Hatchback Van (S07) MERIVA B MPV (S10)</p> <p>PEUGEOT BIPPER (AA_) BIPPER TEPEE</p> <p>VAUXHALL ASTRA Mk VI (J) (P10) ASTRA Mk VI (J) Estate (P10) ASTRA Mk VI (J) Saloon (P10) CORSA Mk III (D) (S07) CORSAVAN Mk III (D) Hatchback Van (S07) MERIVA Mk II (B) (S10)</p>
	<p>AGR-K 7.03622.06.0</p>  <p>→SI 0100 →SI 0108 →SI 0108-01 →SI 1003 →SI 1003-02</p> <p>ALFA ROMEO MITO (955_)</p> <p>CHEVROLET AVEO Hatchback (T300) AVEO Saloon (T300)</p> <p>CITROEN NEMO Box Body/MPV (AA_) NEMO MPV</p> <p>FIAT 500 (312_) 500 C (312_)</p>	<p>AGR-K 7.03622.09.0</p>  <p>OPEL ASTRA J (P10) ASTRA J Estate Van (P10) ASTRA J Hatchback Van (P10) ASTRA J Saloon ASTRA J Sports Tourer (P10) CORSA D (S07) CORSA D Hatchback Van (S07)</p>

EMISSION CONTROL





AGR-K 7.03622.09.0
 MERIVA B MPV (S10)
VAUXHALL
 ASTRA Mk VI (J) (P10)
 ASTRA Mk VI (J) Estate (P10)
 ASTRA Mk VI (J) Saloon (P10)
 CORSA Mk III (D) (S07)
 CORSAVAN Mk III (D) Hatchback Van (S07)
 MERIVA Mk II (B) (S10)

AGR-K 7.03622.10.0



CHEVROLET

AVEO Hatchback (T300)
 AVEO Saloon (T300)

CHRYSLER

YPSILON

FIAT

500 (312_)
 500L (351_, 352_)
 FIORINO Box Body/MPV (225_)
 PANDA (312_, 319_)
 PANDA VAN (312_, 519_)
 QUBO (225_)
 TIPO Estate (356_)
 TIPO Hatchback (356_)
 TIPO Saloon (356_)

LANCIA

YPSILON (312_)

OPEL

ASTRA J (P10)
 ASTRA J Estate Van (P10)
 ASTRA J Hatchback Van (P10)
 ASTRA J Saloon
 ASTRA J Sports Tourer (P10)
 COMBO Box Body/MPV (X12)
 COMBO Tour (X12)
 CORSA D (S07)
 CORSA D Hatchback Van (S07)
 MERIVA B MPV (S10)
VAUXHALL
 ASTRA Mk VI (J) (P10)
 ASTRA Mk VI (J) Estate (P10)
 ASTRA Mk VI (J) Saloon (P10)
 COMBO Mk III (D) Box Body/MPV (X12)
 CORSA Mk III (D) (S07)
 CORSAVAN Mk III (D) Hatchback Van (S07)
 MERIVA Mk II (B) (S10)



OPEL

ASTRA J (P10)
 ASTRA J Estate Van (P10)
 ASTRA J Hatchback Van (P10)
 ASTRA J Saloon
 ASTRA J Sports Tourer (P10)
 MERIVA B MPV (S10)

VAUXHALL

ASTRA Mk VI (J) (P10)
 ASTRA Mk VI (J) Estate (P10)
 ASTRA Mk VI (J) Saloon (P10)
 MERIVA Mk II (B) (S10)

AGR-K 7.03647.10.0



CITROEN

BERLINGO / BERLINGO FIRST Box Body/MPV (M_)
 BERLINGO / BERLINGO FIRST MPV (MF_, GJK_, GFK_)
 BERLINGO Box Body/MPV (B9)
 BERLINGO MULTISPACE (B9)
 BERLINGO Platform/Chassis (B9)
 C-ELYSEE (DD_)
 C3 II (SC_)
 C3 III (SX)
 C4 CACTUS
 C4 II (B7)
 JUMPY (VF7)
 JUMPY Platform/Chassis
 JUMPY Van
PEUGEOT
 208 I (CA_, CC_)
 301
 308 I (4A_, 4C_)
 EXPERT Platform/Chassis
 EXPERT TEPEE (VF3X_)
 EXPERT Van (VF3A_, VF3U_, VF3X_)
 PARTNER Box Body/MPV

AGR-K 7.03647.10.0
 PARTNER Box Body/MPV (5_, G_)
 PARTNER MPV (5_, G_)
 PARTNER TEPEE

AGR-K 7.03692.11.0 New



FUSO

CANTER

AGR-K 7.03991.12.0 New



FORD

FOCUS III
 FOCUS III Saloon
 FOCUS III Turnier
 MONDEO V Hatchback (CE)
 MONDEO V Turnier (CF)

AGR-K 7.04038.08.0











DEUTZ
 ENGINE

→SI 0092
 →SI 0100
 →SI 0108
 →SI 0108-01
 →SI 1003
 →SI 1003-02

EMISSION CONTROL





AGR-K 7.04039.13.0	AGR-K 7.04448.18.0 New	AGR-K 7.04723.10.0
 <p>DEUTZ ENGINE</p>	 <p>DEUTZ ENGINE</p>	 <p>DEUTZ ENGINE</p>
AGR-K 7.04402.02.0	AGR-K 7.04512.08.0	AGR-K 7.04784.06.0
 <p>→SI 0092 →SI 0100 →SI 0108 →SI 0108-01 →SI 1003 →SI 1003-02</p> <p>DEUTZ ENGINE</p>	 <p>FORD B-MAX (JK) B-MAX Van (JK) C-MAX II (DXA/CB7, DXA/CEU) C-MAX II Van ECOSPORT FIESTA Saloon FIESTA VI (CB1, CCN) FIESTA VI Van FIESTA VII (HJ, HF) FIESTA VII Van FOCUS III FOCUS III Estate Van FOCUS III Hatchback Van FOCUS III Saloon FOCUS III Turnier GRAND C-MAX (DXA/CB7, DXA/CEU) GRAND C-MAX Van KA+ III (UK, FK) KA+ III Saloon (TK, FK) KUGA II (DM2) KUGA II VAN MONDEO V Hatchback (CE) MONDEO V Saloon (CD) MONDEO V Turnier (CF) TOURNEO CONNECT / GRAND TOURNEO CONNECT V408 MPV TOURNEO COURIER B460 MPV TRANSIT CONNECT MPV TRANSIT CONNECT V408 Box Body/MPV TRANSIT COURIER B460 Box Body/MPV TRANSIT COURIER B460 MPV</p>	 <p>DEUTZ ENGINE</p>
AGR-K 7.04433.02.0	AGR-K 7.04787.12.0 New	
 <p>DEUTZ ENGINE</p>	 <p>DEUTZ ENGINE</p>	

EMISSION CONTROL









<p>AGR-K 7.04788.06.0</p>  <p>DEUTZ ENGINE</p>	<p>AGR-K 7.04999.35.0*</p> <p>MULTIVAN VI (SGF, SGM, SGN, SHM, SHN) TRANSPORTER / CARAVELLE VI Bus (SGB, SGG, SGJ, SGC, SHB, SHJ) TRANSPORTER VI Platform/Chassis (SFD, SFE, SFL, SFZ, SJD, SJ) TRANSPORTER VI Van (SGA, SGH, SHA, SHH)</p> <p>AGR-K 7.05052.00.0</p>  <p>HYUNDAI ACCENT IV (RB) ACCENT IV Saloon (RB) i20 I (PB, PBT) i30 (FD) i30 (GD) i30 Estate (FD) ix20 (JC)</p> <p>KIA CEE'D Hatchback (ED) CEE'D SW (ED) PRO CEE'D (ED) RIO III (UB) SOUL I (AM) VENGA (YN) VENGA Hatchback Van (YN)</p>	<p>AGR-K 7.05052.03.0 New</p>  <p>FIAT DUCATO Bus (250_) DUCATO Platform/Chassis (250_) DUCATO Van (250_)</p>
<p>AGR-K 7.04930.06.0 New</p>  <p>FUSO ENGINE</p>	<p>AGR-K 7.05107.12.0 New</p>  <p>DEUTZ ENGINE</p>	<p>AGR-K 7.05194.26.0 New</p>  <p>ALFA ROMEO GIULIA (952_)</p>
<p>AGR-K 7.04931.04.0 New</p>  <p>IVECO DAILY CITYS Bus DAILY LINE Bus DAILY TOURYS Bus DAILY VI Platform/Chassis DAILY VI Van</p>	<p>AGR-K 7.05052.01.0 New</p>  <p>IVECO DAILY V Platform/Chassis DAILY V Van DAILY VI Platform/Chassis DAILY VI Van</p>	<p>AGR-K 7.05264.04.0*</p> <p>JAGUAR F-PACE (X761) XF II (X260) XF SPORTBRAKE (X260)</p> <p>LAND ROVER DISCOVERY V (L462) RANGE ROVER IV (L405) RANGE ROVER SPORT II (L494) RANGE ROVER VELAR (L560)</p>
<p>AGR-K 7.04999.35.0* → 7.04999.34.0 AGR-M</p> <p>MAN TGE Bus TGE Platform/Chassis (UZ_) TGE Van</p> <p>VOLKSWAGEN CRAFTER Bus (SYI, SYJ) CRAFTER Platform/Chassis (SZ_) CRAFTER Van (SY_, SX_)</p>		

EMISSION CONTROL





AGR-K 7.05343.18.0*	AGR-K 7.06036.14.0 New	AGR-K 7.09720.00.0
<p>BMW</p> <ul style="list-style-type: none"> 3 (G20, G80) 3 Touring (G21, G81) 5 (G30, F90) 5 Touring (G31) 6 Gran Turismo (G32) 7 (G11, G12) 8 Convertible (G14, F91) 8 Coupe (G15, F92) 8 Gran Coupe (G16, F93) X3 (G01, F97) X3 Van (G01) X4 (G02, F98) X5 (G05, F95) X6 (G06, F96) X7 (G07) 	 <p>FORD</p> <ul style="list-style-type: none"> GALAXY III (CK) S-MAX (CJ, WA6) <p>FORD USA</p> <ul style="list-style-type: none"> EDGE 	<p>TT Roadster (8J9)</p> <p>SEAT</p> <ul style="list-style-type: none"> ALHAMBRA (710, 711) ALTEA (5P1) ALTEA XL (5P5, 5P8) IBIZA IV (6J5, 6P1) LEON (1P1) <p>SKODA</p> <ul style="list-style-type: none"> OCTAVIA II (1Z3) OCTAVIA II Combi (1Z5) RAPID (NA2) RAPID (NH3) RAPID Spaceback (NH1) SUPERB II (3T4) SUPERB II Estate (3T5) YETI (5L) <p>VOLKSWAGEN</p> <ul style="list-style-type: none"> AMEO (631) BEETLE (5C1, 5C2) BEETLE Convertible (5C7, 5C8) CADDY III Box Body/MPV (2KA, 2KH, 2CA, 2CH) CADDY III MPV (2KB, 2KJ, 2CB, 2CJ) CADDY IV Box Body/MPV (SAA, SAH) CADDY IV MPV (SAB, SAJ) CC B7 (358) EOS (1F7, 1F8) GOLF PLUS V (5M1, 521) GOLF PLUS Van (521) GOLF VAN VI Variant (AJ5) GOLF VI (5K1) GOLF VI Convertible (517) GOLF VI Van (5K1_) GOLF VI Variant (AJ5) JETTA III (1K2) JETTA IV (162, 163, AV3, AV2) PASSAT ALLTRACK B7 (365) PASSAT B6 (3C2) PASSAT B6 Variant (3C5) PASSAT B7 (362) PASSAT B7 (A32, A33) PASSAT B7 Estate Van (365) PASSAT B7 Variant (365) PASSAT CC B6 (357) POLO V (6R1, 6C1) POLO V Saloon (602, 604, 612, 614) POLO Van (6R) SCIROCCO III (137, 138) SCIROCCO Van (137) SHARAN (7N1, 7N2) TIGUAN (5N_) TOURAN (1T3)
<p>AGR-K 7.05483.25.0 New</p>  <p>FORD</p> <ul style="list-style-type: none"> RANGER (TKE) TOURNEO CUSTOM V362 Bus (F3) TRANSIT CUSTOM V362 Bus (F3) TRANSIT CUSTOM V362 Van (FY, FZ) TRANSIT V363 Bus (FAD, FBD) TRANSIT V363 Platform/Chassis (FED, FFD) TRANSIT V363 Van (FCD, FDD) 	<p>AGR-K 7.07969.06.0 New</p>  <p>FIAT</p> <ul style="list-style-type: none"> 500L (351_, 352_) 500X (334_) DOBLO Bus (263_) DOBLO Cargo (263_) DOBLO Platform/Chassis (263_) FIORINO Box Body/MPV (225_) TIPO Hatchback (356_) TIPO Saloon (356_) 	<p>AGR-K 7.09720.00.0</p>  <p>AUDI</p> <ul style="list-style-type: none"> A3 (8P1) A3 Convertible (8P7) A3 Sportback (8PA) Q3 (8UB, 8UG) TT (8J3) <p>→PI 1855</p>
<p>AGR-K 7.05590.04.0*</p> <p>JAGUAR</p> <ul style="list-style-type: none"> F-PACE (X761) XF II (X260) XF SPORTBRAKE (X260) <p>LAND ROVER</p> <ul style="list-style-type: none"> DISCOVERY V (L462) RANGE ROVER IV (L405) RANGE ROVER SPORT II (L494) RANGE ROVER VELAR (L560) 		





AGR-K 7.09720.01.0	AGR-K 7.09720.03.0 New	AGR-K 7.09720.05.0 New
 <p style="text-align: right;">→PI 1855</p> <p>AUDI A1 (8X1, 8XK) A1 Sportback (8XA, 8XF)</p> <p>SEAT IBIZA IV (6J5, 6P1) IBIZA IV Hatchback Van (6J1) IBIZA IV SC (6J1, 6P5) IBIZA IV ST (6J8, 6P8) TOLEDO IV (KG3)</p> <p>SKODA FABIA II (542) FABIA II Combi (545) RAPID (NA2) RAPID (NH3) RAPID Spaceback (NH1) ROOMSTER (5J7) ROOMSTER Praktik (5J)</p> <p>VOLKSWAGEN POLO V (6R1, 6C1) POLO V Saloon (602, 604, 612, 614) POLO Van (6R)</p>	 <p>AUDI A4 Allroad B8 (8KH) A4 B8 (8K2) A4 B8 Avant (8K5) A5 (8T3) A5 Convertible (8F7) A5 Sportback (8TA) A6 C7 (4G2, 4GC) A6 C7 Avant (4G5, 4GD) Q5 (8RB)</p> <p>SEAT EXEO (3R2) EXEO ST (3R5)</p>	 <p>FIAT DUCATO Bus (250_) DUCATO Plattform/Chassis (250_) DUCATO Van (250_)</p>
<p style="text-align: center;">AGR-K 7.09720.02.0</p>  <p style="text-align: right;">→PI 1855</p> <p>SEAT IBIZA IV (6J5, 6P1) IBIZA IV SC (6J1, 6P5) IBIZA IV ST (6J8, 6P8)</p> <p>SKODA FABIA II (542) FABIA II Combi (545) ROOMSTER (5J7) ROOMSTER Praktik (5J)</p> <p>VOLKSWAGEN POLO V (6R1, 6C1) POLO Van (6R)</p>	<p style="text-align: center;">AGR-K 7.09720.04.0 New</p>  <p>VOLKSWAGEN MULTIVAN V (7HM, 7HN, 7HF, 7EF, 7EM, 7EN) MULTIVAN VI (SGF, SGM, SGN, SHM, SHN) TRANSPORTER / CARAVELLE VI Bus (SGB, SGG, SGJ, SGC, SHB, SHJ) TRANSPORTER V Bus (7HB, 7HJ, 7EB, 7EJ, 7EF, 7EG, 7HF, 7EC) TRANSPORTER V Plattform/Chassis (7JD, 7JE, 7JL, 7JY, 7JZ, 7FD) TRANSPORTER V Van (7HA, 7HH, 7EA, 7EH) TRANSPORTER VI Plattform/Chassis (SFD, SFE, SFL, SFZ, SJD, SJ) TRANSPORTER VI Van (SGA, SGH, SHA, SHH)</p>	<p style="text-align: center;">AGR-K 7.09730.00.0</p>  <p>CITROEN C4 Coupe (LA_) C4 GRAND PICASSO I (UA_) C4 I (LC_) C4 I Saloon C4 PICASSO I MPV (UD_) C5 II (RC_) C5 II Break (RE_) C5 III (RD_) C5 III Break (RW_) C8 (EA_, EB_) JUMPY (VF7) JUMPY Van</p> <p>FORD C-MAX (DM2) FOCUS C-MAX (DM2) FOCUS II (DA_, HCP, DP) FOCUS II Convertible FOCUS II Saloon (DB_, FCH, DH) FOCUS II Turnier (DA_, FFS, DS) GALAXY II (WA6) KUGA I MONDEO IV (BA7) MONDEO IV Saloon (BA7) MONDEO IV Turnier (BA7) S-MAX (WA6)</p> <p>PEUGEOT 307 (3A/C) 307 Break (3E) 307 CC (3B) 307 SW (3H) 308 CC (4B_)</p>



AGR-K	7.09730.00.0
308 I (4A_, 4C_) 308 SW I (4E_, 4H_) 407 (6D_) 407 Coupe (6C_) 407 SW (6E_) 607 (9D, 9U) 807 (EB_) EXPERT Platform/Chassis EXPERT TEPEE (VF3X_) EXPERT Van (VF3A_, VF3U_, VF3X_) VOLVO C30 (533) C70 II Convertible (542) S40 II (544) S80 II (124) V50 (545) V70 III (135)	

AGR-K	7.10992.00.0 New
 BMW 1 (F20) 1 (F21) 2 Coupe (F22, F87) 3 (F30, F80) 3 Gran Turismo (F34) 3 Touring (F31) 4 Convertible (F33, F83) 4 Coupe (F32, F82) 4 Gran Coupe (F36) 5 (F10) 5 Gran Turismo (F07) 5 Touring (F11) 6 Convertible (F12) 6 Coupe (F13) 6 Gran Coupe (F06) 7 (F01, F02, F03, F04) X1 (E84) X3 (F25) X4 (F26) X5 (E70) X5 (F15, F85) X6 (F16, F86)	

AGR-K	7.11010.00.0 New
 BMW 1 (F20) 1 (F21) 2 Convertible (F23) 2 Coupe (F22, F87) 3 (F30, F80) 3 Gran Turismo (F34) 3 Touring (F31) 4 Convertible (F33, F83) 4 Coupe (F32, F82) 4 Gran Coupe (F36) 5 (F10) 5 (G30, F90) 5 Touring (F11) 5 Touring (G31) X3 (G01, F97) X4 (G02, F98)	

AGR-K	7.09730.01.0
	

AGR-K	7.10993.00.0 New
	

AGR-K	7.11237.02.0 New
 SUZUKI GRAND VITARA II (JT, TE, TD)	



CITROEN BERLINGO / BERLINGO FIRST Box Body/MPV (M_) BERLINGO / BERLINGO FIRST MPV (MF_, GJK_, GFK_) C5 I (DC_) C5 I Break (DE_) JUMPY (U6U_) JUMPY Platform/Chassis (BU_, BV_, BW_, BX_) JUMPY Van (BS_, BT_, BY_, BZ_) XSARA (N1) XSARA Break (N2) XSARA Coupe (N0) XSARA Estate Van XSARA Hatchback Van (N3_) XSARA PICASSO (N68)	
PEUGEOT 406 (8B) 406 Break (8E/F) 607 (9D, 9U) EXPERT (224_) EXPERT Platform/Chassis (223) EXPERT Van (222) PARTNER Box Body/MPV (5_, G_) PARTNER MPV (5_, G_)	

AGR-K	7.11237.05.0 New
 RENAULT GRAND SCÉNIC III (JZ0/1_)	

EMISSION CONTROL





AGR-K 7.11237.05.0 New	AGR-K 7.24809.94.0 New	AGR-M 7.00678.04.0*
<p>MEGANE CC (EZ0/1_) MEGANE III Coupe (DZ0/1_) MEGANE III Grandtour (KZ0/1) MEGANE III Hatchback (BZ0/1_, B3_) SCÉNIC III (JZ0/1_)</p>	<p>JUMPY (VF7) JUMPY Platform/Chassis JUMPY Van FIAT SCUDO Bus (270_, 272_) SCUDO Platform/Chassis (270_, 272_) SCUDO Van (270_, 272_)</p>	<p>IBIZA IV (6J5, 6P1) IBIZA IV SC (6J1, 6P5) LEON (1P1) TOLEDO III (5P2) SKODA OCTAVIA II (1Z3) OCTAVIA II Combi (1Z5) ROOMSTER (5J7) ROOMSTER Praktik (5J) SUPERB II (3T4) SUPERB II Estate (3T5)</p>
<p>AGR-K 7.11237.06.0 New</p>  <p>VOLKSWAGEN AMAROK (2HA, 2HB, S1B, S6B, S7A, S7B) AMAROK Platform/Chassis (S1B, S6B, S7B)</p>	<p>FORD C-MAX II (DXA/CB7, DXA/CEU) FOCUS III FOCUS III Saloon FOCUS III Turnier GALAXY II (WA6) GRAND C-MAX (DXA/CB7, DXA/CEU) KUGA I KUGA II (DM2) MONDEO IV (BA7) MONDEO IV Saloon (BA7) MONDEO IV Turnier (BA7) S-MAX (WA6) PEUGEOT 3008 MPV (0U_) 308 CC (4B_) 308 I (4A_, 4C_) 308 SW I (4E_, 4H_) 407 (6D_) 407 Coupe (6C_) 407 SW (6E_) 5008 (0U_, 0E_) 508 I (8D_) 508 SW I (8E_) 807 (EB_) EXPERT TEPEE (VF3X_) RCZ</p>	<p>VOLKSWAGEN CADDY III Box Body/MPV (2KA, 2KH, 2CA, 2CH) CADDY III MPV (2KB, 2KJ, 2CB, 2CJ) EOS (1F7, 1F8) GOLF PLUS V (5M1, 521) GOLF V (1K1) GOLF V Variant (1K5) JETTA III (1K2) PASSAT B6 (3C2) PASSAT B6 Variant (3C5) POLO (9N_) TOURAN (1T1, 1T2)</p>
<p>AGR-K 7.24809.88.0 New</p>  <p>IVECO DAILY IV Bus DAILY IV Platform/Chassis DAILY IV Van</p>	<p>AGR-K 7.24809.99.0 New</p>  <p>VOLKSWAGEN AMAROK (2HA, 2HB, S1B, S6B, S7A, S7B) AMAROK Platform/Chassis (S1B, S6B, S7B)</p>	<p>AGR-M 7.00678.06.0</p>  <p>AUDI A3 (8P1) A3 Convertible (8P7) A3 Sportback (8PA) SEAT ALTEA (5P1) ALTEA XL (5P5, 5P8) CORDOBA (6L2) IBIZA III (6L1) IBIZA IV (6J5, 6P1) IBIZA IV SC (6J1, 6P5) LEON (1P1) TOLEDO III (5P2)</p>
<p>AGR-K 7.24809.94.0 New</p>  <p>CITROEN C4 II (B7) C4 PICASSO I MPV (UD_) C5 III (RD_) C5 III Break (RW_) C8 (EA_, EB_) DS4 (NX_) DS5</p>	<p>AGR-M 7.00678.04.0*</p> <p>AUDI A3 (8P1) A3 Convertible (8P7) A3 Sportback (8PA) SEAT ALTEA (5P1) ALTEA XL (5P5, 5P8) CORDOBA (6L2) IBIZA III (6L1)</p>	<p>SKODA FABIA II (542) FABIA II Combi (545) OCTAVIA II (1Z3) OCTAVIA II Combi (1Z5) ROOMSTER (5J7) ROOMSTER Praktik (5J) SUPERB II (3T4) VOLKSWAGEN CADDY III Box Body/MPV (2KA, 2KH, 2CA, 2CH) CADDY III MPV (2KB, 2KJ, 2CB, 2CJ) EOS (1F7, 1F8)</p>



AGR-M 7.00678.06.0
 GOLF PLUS V (5M1, 521)
 GOLF V (1K1)
 GOLF V Variant (1K5)
 JETTA III (1K2)
 PASSAT B6 (3C2)
 PASSAT B6 Variant (3C5)
 POLO (9N_)
 TOURAN (1T1, 1T2)

AGR-M 7.01881.06.0



JAGUAR

XF I (X250)
 XF SPORTBRAKE (X250)
 XJ (X351)

LAND ROVER

DISCOVERY IV (L319)
 DISCOVERY IV VAN (L319)
 DISCOVERY V (L462)
 RANGE ROVER IV (L405)
 RANGE ROVER SPORT I (L320)
 RANGE ROVER SPORT II (L494)

AGR-M 7.01881.07.0



JAGUAR

XF I (X250)
 XF SPORTBRAKE (X250)
 XJ (X351)

LAND ROVER

DISCOVERY IV (L319)
 DISCOVERY IV VAN (L319)
 DISCOVERY V (L462)
 RANGE ROVER IV (L405)
 RANGE ROVER SPORT I (L320)
 RANGE ROVER SPORT II (L494)

AGR-M 7.02751.02.0



LAND ROVER

RANGE ROVER III (L322)
 RANGE ROVER IV (L405)
 RANGE ROVER SPORT II (L494)

AGR-M 7.03390.09.0



CATERPILLAR
 ENGINE

AGR-M 7.03391.11.0 New



CATERPILLAR

BACKHOE LOADER
 PAVING COMPACTOR
 TELEHANDLADER
 TRACK-TYPE TRACTOR

AGR-M 7.03527.12.0



→SI 0092
 →SI 0100

AGR-M 7.03527.12.0
DEUTZ
 ENGINE

AGR-M 7.03693.12.0 New



IVECO

ENGINE
NEW HOLLAND
 ENGINE

AGR-M 7.03761.09.0



CATERPILLAR

ASPHALT PAVERS
 EXCAVATOR
 FOREST MACHINES
 MOTOR GRADER
 WHEEL-TYPE-LOADER

AGR-M 7.03762.10.0 New



CATERPILLAR

BACKHOE LOADER
 PAVING COMPACTOR
 TELEHANDLADER
 TRACK-TYPE TRACTOR

EMISSION CONTROL



AGR-M 7.04275.09.0 New



IVECO
ENGINE

AGR-M 7.04382.09.0



DEUTZ
ENGINE

AGR-M 7.04511.29.0



FORD
FOCUS IV (HN)
FOCUS IV Turnier (HP)
GALAXY III (CK)
GALAXY MK III VAN (CK)
KUGA III (DFK)
MONDEO V Hatchback (CE)
MONDEO V Saloon (CD)
MONDEO V Turnier (CF)
S-MAX (CJ, WA6)
FORD AUSTRALIA
ENDURA (CA)
FOCUS Estate (SA)
FORD USA
EDGE

AGR-M 7.04999.34.0 New



MAN
TGE Bus
TGE Platform/Chassis (UZ_)
TGE Van

VOLKSWAGEN
CRAFTER Bus (SYI, SYJ)
CRAFTER Platform/Chassis (SZ_)
CRAFTER Van (SY_, SX_)
MULTIVAN VI (SGF, SGM, SGN, SHM, SHN)
TRANSPORTER / CARAVELLE VI Bus (SGB, SGG, SGJ, SGC, SHB, SHJ)
TRANSPORTER VI Platform/Chassis (SFD, SFE, SFL, SFZ, SJD, SJ)
TRANSPORTER VI Van (SGA, SGH, SHA, SHH)

AGR-M 7.05031.06.0



OPEL
CORSA E (X15)
CORSA E Hatchback Van (X15)
VAUXHALL
CORSA Mk IV (E) (X15)
CORSAVAN Mk IV (E) Hatchback Van (X15)

AGR-M 7.05243.04.0 New



IVECO
ENGINE

AGR-M 7.05243.04.0 New

NEW HOLLAND
ENGINE

AGR-M 7.05506.14.0 New



DEUTZ
ENGINE

AGR-TH 7.04879.00.0



→SI 0100
→SI 1830

ALFA ROMEO
159 (939_)
159 Sportwagon (939_)

CHEVROLET
ASTRA Hatchback
ASTRA Saloon
AVEO / KALOS Hatchback (T250, T255)
AVEO / KALOS Saloon (T250, T255)
AVEO Hatchback (T300)
AVEO Saloon (T300)
CRUZE (J300)
CRUZE Hatchback (J305)
CRUZE Station Wagon (J308)
ORLANDO (J309)

TRAX
FIAT
CROMA (194_)

OPEL
ASTRA G CLASSIC Caravan (F35)
ASTRA G Convertible (T98)
ASTRA G Coupe (T98)
ASTRA G Estate (T98)
ASTRA G Estate Van (F70)
ASTRA G Hatchback (T98)
ASTRA H (A04)
ASTRA H Estate (A04)
ASTRA H Estate Van (L70)
ASTRA H GTC (A04)





AGR-TH 7.04879.00.0

ASTRA H Saloon (A04)
 ASTRA H TwinTop (A04)
 INSIGNIA A (G09)
 INSIGNIA A Saloon (G09)
 INSIGNIA A Sports Tourer (G09)
 MERIVA A MPV (X03)
 SIGNUM Hatchback (Z03)
 VECTRA C (Z02)
 VECTRA C Estate (Z02)
 VECTRA C GTS (Z02)
 ZAFIRA / ZAFIRA FAMILY B (A05)
 ZAFIRA A MPV (T98)
 ZAFIRA B Box Body/MPV (A05)

VAUXHALL

ASTRA Mk V (H) (A04)
 ASTRA Mk V (H) Estate (A04)
 ASTRA Mk V (H) Sport Hatch (A04)
 ASTRA Mk V (H) TwinTop (A04)
 ASTRAVAN Mk V (H) Estate Van (A04)
 INSIGNIA Mk I (A) Hatchback (G09)
 INSIGNIA Mk I (A) Saloon (G09)
 INSIGNIA Mk I (A) Sports Tourer (G09)
 MERIVA A (X03)
 SIGNUM (Z03)
 VECTRA Mk II (C) (Z02)
 VECTRA Mk II (C) Estate (Z02)
 VECTRA Mk II (C) GTS (Z02)
 ZAFIRA Mk II (B) (A05)

AK 7.02321.17.0



→PI 1649

FUSO

CANTER

IVECO

DAILY CITYS Bus
 DAILY IV Van
 DAILY LINE Bus
 DAILY TOURYS Bus
 DAILY V Kasten
 DAILY V Platform/Chassis
 DAILY V Van
 DAILY VI Platform/Chassis
 DAILY VI Van
 ENGINE

MITSUBISHI

Canter (FB7, FB8, FE7, FE8) VII
 Canter (FE5, FE6) VI
 FUSO CANTER

AK 7.03571.16.0

ESPACE V (JR_)
 FLUENCE (L3_)
 GRAND SCÉNIC III (JZ0/1_)
 GRAND SCÉNIC IV (R9_)
 KADJAR (HA_, HL_)
 KANGOO / GRAND KANGOO (KW0/1_)
 KANGOO Express (FW0/1_)
 MEGANE CC (EZ0/1_)
 MEGANE III Coupe (DZ0/1_)
 MEGANE III Grandtour (KZ0/1_)
 MEGANE III Hatchback (BZ0/1_, B3_)
 MEGANE IV GRAND COUPE
 MEGANE IV Grandtour (K9A/M/N_)
 MEGANE IV Hatchback (B9A/M/N_)
 SCÉNIC III (JZ0/1_)
 SCÉNIC IV (J9_)
 TALISMAN (LP_)
 TALISMAN Grandtour (KP_)

SAMSUNG

QM3

AK 7.03608.16.0



→PI 1649

AUDI

A3 (8V1, 8VK)
 A3 Convertible (8V7, 8VE)
 A3 Limousine (8VS, 8VM)
 A3 Sportback (8VA, 8VF)
 Q2 (GAB, GAG)

SEAT

ATECA (KH7, KHP)
 LEON (5F1)
 LEON Hatchback Van (5F1)
 LEON SC (5F5)
 LEON ST (5F8)
 LEON ST Estate Van (5F8)

SKODA

KAROQ (NU7)
 OCTAVIA III (5E3, NL3, NR3)
 OCTAVIA III Combi (5E5, 5E6)
 SUPERB III (3V3)
 SUPERB III Estate (3V5)

VOLKSWAGEN

ARTEON (3H7, 3H8)
 GOLF SPORTSVAN VII (AM1, AN1)
 GOLF VAN VII Variant (BA5)
 GOLF VII (5G1, BQ1, BE1, BE2)
 GOLF VII Van (5G1)
 GOLF VII Variant (BA5, BV5)

AK 7.01300.24.0



→PI 1649

VOLKSWAGEN

BEETLE (5C1, 5C2)
 BEETLE Convertible (5C7, 5C8)
 GOLF VI (5K1)
 GOLF VI Variant (AJ5)
 JETTA III (1K2)
 JETTA IV (162, 163, AV3, AV2)

AK 7.03571.16.0



→PI 1649

MERCEDES-BENZ

A-CLASS (W176)
 B-CLASS Sports Tourer (W246, W242)
 CITAN Box Body/MPV (W415)
 CITAN MPV (415)
 CITAN Mixto (Double Cabin) (W415)
 CLA Coupe (C117)
 CLA Shooting Brake (X117)
 GLA-CLASS (X156)

NISSAN

QASHQAI / QASHQAI +2 I (J10, NJ10, JJ10E)
 QASHQAI II SUV (J11, J11_)

RENAULT

CAPTUR I (J5_, H5_)
 CLIO IV (BH_)
 CLIO IV Grandtour (KH_)
 CLIO IV Hatchback Van (BH_)





AK 7.03608.16.0
 PASSAT B8 (3G2, CB2)
 PASSAT B8 Variant (3G5, CB5)

AK 7.04209.06.0



→PI 1649

PERKINS
 ENGINE

AK 7.04210.06.0



→PI 1649

PERKINS
 ENGINE

AK 7.04239.04.0



IVECO
 DAILY CITYS Bus
 DAILY LINE Bus
 DAILY VI Platform/Chassis
 DAILY VI Van

AK 7.04709.13.0



→PI 1649

VOLKSWAGEN
 PASSAT B8 (3G2, CB2)
 PASSAT B8 Variant (3G5, CB5)

AK 7.04799.08.0



IVECO
 ENGINE

AK 7.05446.07.0



JOHN DEERE
 ENGINE

AK 7.05447.08.0



JOHN DEERE
 ENGINE

AK 7.05448.07.0



JOHN DEERE
 ENGINE

AK 7.05499.05.0



IVECO
 ENGINE

EMISSION CONTROL





AK 7.05500.02.0



CLAAS
NECTIS
NEXOS
IVECO
ENGINE

AK 7.05662.07.0



MAZDA
3 (BM, BN)

→PI 1649

AK 7.07420.09.0



JOHN DEERE
ENGINE

AK 7.05501.02.0



CLAAS
NECTIS
NEXOS
IVECO
ENGINE

AK 7.07141.01.0



AUDI
A5 (F53, F5P)
A5 Convertible (F57, F5E)
A5 Sportback (F5A, F5F)
Q5 (FYB, FYG)

AK 7.08965.03.0



JOHN DEERE
ENGINE

AK 7.05502.02.0



CLAAS
NECTIS
NEXOS
IVECO
ENGINE

AK 7.07419.06.0



JOHN DEERE
ENGINE

AK 7.10197.01.0



JOHN DEERE
ENGINE

EMISSION CONTROL





ARV 7.06712.23.0



AUDI
R8 (422, 423)
R8 Spyder (427, 429)

BENTLEY
BENTAYGA (4V1)
CONTINENTAL Convertible (3S_)
CONTINENTAL Coupe (3S3)
FLYING SPUR (ZG2_)

ARV 7.06712.24.0



AUDI
A8 D4 (4H2, 4H8, 4HC, 4HL)
Q7 (4LB)

VOLKSWAGEN
TOUAREG (7LA, 7L6, 7L7)
TOUAREG (7P5, 7P6)

ARV 7.06713.09.0



AUDI
A6 C7 (4G2, 4GC)
A6 C7 Avant (4G5, 4GD)
A7 Sportback (4GA, 4GF)
A8 D4 (4H2, 4H8, 4HC, 4HL)

BENTLEY
CONTINENTAL Convertible (3W_, 394)

ARV 7.06713.09.0

CONTINENTAL Coupe (3W_, 393)
FLYING SPUR (4W_)

ARV 7.06713.10.0



AUDI
A8 D4 (4H2, 4H8, 4HC, 4HL)

BENTLEY
CONTINENTAL Convertible (3W_, 394)
CONTINENTAL Coupe (3W_, 393)
FLYING SPUR (4W_)

ARV 7.06714.21.0



AUDI
A4 B8 (8K2)
A4 B8 Avant (8K5)
A5 (8T3)

A5 Convertible (8F7)
A5 Sportback (8TA)
A6 Allroad C7 (4GH, 4GJ)
A6 C7 (4G2, 4GC)
A6 C7 Avant (4G5, 4GD)
A7 Sportback (4GA, 4GF)
A8 D4 (4H2, 4H8, 4HC, 4HL)

AUDI FAW
A6L C7 (4X8, 4XL)

VW SVW
PHIDEON (3E9)

ARV 7.06714.22.0



AUDI
Q7 (4MB, 4MG)

ARV 7.06714.23.0



AUDI
Q7 (4MB, 4MG)

ARV 7.06714.24.0



AUDI
A4 B8 Avant (8K5)
A5 (8T3)
A5 Convertible (8F7)
R8 (422, 423)
R8 (4S3, 4SP)
R8 Spyder (427, 429)
R8 Spyder (4S9, 4SR)

LAMBORGHINI
AVENTADOR Coupe
AVENTADOR Targa
GALLARDO
GALLARDO SPYDER
HURACÁN

EMISSION CONTROL





ARV 7.22090.11.0



→SI 0083
→SI 0096
→SI 0106

FORD

GALAXY I (WGR)
GALAXY MK I VAN (WGR)

MERCEDES-BENZ

V-CLASS (638/2)

VOLKSWAGEN

GOLF III (1H1)
PASSAT B3/B4 (3A2, 351)
PASSAT B3/B4 Variant (3A5, 351)
SHARAN (7M8, 7M9, 7M6)
SHARAN VAN (7M_)
TRANSPORTER IV Bus (70B, 70C, 7DB, 7DK, 70J, 70K, 7DC, 7DJ)
TRANSPORTER IV Platform/Chassis (70E, 70L, 70M, 7DE, 7DL, 7D)
TRANSPORTER IV Van (70A, 70H, 7DA, 7DH)

ARV 7.22286.26.0



→SI 0083
→SI 0096
→SI 0106

AUDI

A3 (8L1)
A8 D3 (4E2, 4E8)

SEAT

LEON (1M1)
TOLEDO II (1M2)

SKODA

OCTAVIA I (1U2)
OCTAVIA I Combi (1U5)

VOLKSWAGEN

BORA I (1J2)
BORA Variant (1J6)
GOLF IV (1J1)

ARV 7.22286.26.0

GOLF IV Cabriolet (1E7)
GOLF IV Variant (1J5)
NEW BEETLE (9C1, 1C1)
PASSAT B3/B4 (315, 3A5)
PASSAT B3/B4 (3A2, 351)
PASSAT B3/B4 Variant (3A5, 351)
PASSAT B5 (3B2)
PASSAT B5 Variant (3B5)
PASSAT B5.5 (3B3)
PASSAT B5.5 Variant (3B6)
VW FAW
BORA GP Saloon (9D2)
BORA HS Hatchback (9D1)

ARV 7.22286.41.0



→SI 0083
→SI 0096
→SI 0106

AUDI

A3 (8L1)

SEAT

ALHAMBRA (7V8, 7V9)
CORDOBA (6K1, 6K2)
CORDOBA Vario (6K5)
IBIZA II (6K1)

VOLKSWAGEN

BORA I (1J2)
BORA Variant (1J6)
GOLF IV (1J1)
GOLF IV Variant (1J5)
MULTIVAN V (7HM, 7HN, 7HF, 7EF, 7EM, 7EN)
NEW BEETLE (9C1, 1C1)
NEW BEETLE Convertible (1Y7)
POLO III CLASSIC (6V2)
POLO Variant (6V5)
SHARAN (7M8, 7M9, 7M6)
TRANSPORTER IV Bus (70B, 70C, 7DB, 7DK, 70J, 70K, 7DC, 7DJ)
TRANSPORTER IV Platform/Chassis (70E, 70L, 70M, 7DE, 7DL, 7D)
TRANSPORTER IV Van (70A, 70H, 7DA, 7DH)
TRANSPORTER V Bus (7HB, 7HJ, 7EB, 7EJ, 7EF, 7EG, 7HF, 7EC)
TRANSPORTER V Platform/Chassis (7JD, 7JE, 7JL, 7JY, 7JZ, 7FD)
TRANSPORTER V Van (7HA, 7HH, 7EA, 7EH)

ARV 7.22286.51.0



→SI 0083
→SI 0096
→SI 0106

AUDI

TT (8J3)
TT Roadster (8J9)

VOLKSWAGEN

PASSAT B5.5 (3B3)
PASSAT B5.5 Variant (3B6)
TOUAREG (7LA, 7L6, 7L7)

ARV 7.22286.52.0



→SI 0083
→SI 0096
→SI 0106

AUDI

A4 B8 (8K2)
A4 B8 Avant (8K5)
A5 (8T3)
A5 Convertible (8F7)
A5 Sportback (8TA)
A6 Allroad C6 (4FH)
A6 Allroad C7 (4GH, 4GJ)
A6 C6 (4F2)
A6 C6 Avant (4F5)
A6 C7 (4G2, 4GC)
A6 C7 Avant (4G5, 4GD)
A7 Sportback (4GA, 4GF)
A8 D4 (4H2, 4H8, 4HC, 4HL)
Q5 (8RB)
Q5 Van (8RB)
Q7 (4LB)
Q7 Van (4LB)

AUDI FAW

A6L C7 (4X8, 4XL)

PORSCHE

CAYENNE (92A)





ARV 7.22286.52.0	ARV 7.22286.54.0	ARV 7.22286.55.0
<p>PANAMERA (970) VOLKSWAGEN TOUAREG (7P5, 7P6)</p>	 <p>→SI 0083 →SI 0096 →SI 0106</p> <p>AUDI A6 C6 (4F2) A6 C6 Avant (4F5) SEAT IBIZA III (6L1) VOLKSWAGEN POLO (9N_) VW SVW TOURAN (9R1, 9R3)</p>	<p>PHAETON (3D1, 3D2, 3D3, 3D4, 3D6, 3D7, 3D8, 3D9) SHARAN (7M8, 7M9, 7M6) SHARAN VAN (7M_)</p>
 <p>→SI 0083 →SI 0096 →SI 0106</p> <p>AUDI A4 B8 (8K2) A4 B8 Avant (8K5) A5 (8T3) A5 Convertible (8F7) A5 Sportback (8TA) A6 Allroad C6 (4FH) A6 Allroad C7 (4GH, 4GJ) A6 C6 (4F2) A6 C6 Avant (4F5) A6 C7 (4G2, 4GC) A6 C7 Avant (4G5, 4GD) A7 Sportback (4GA, 4GF) A8 D4 (4H2, 4H8, 4HC, 4HL) Q5 (8RB) Q5 Van (8RB) Q7 (4LB) Q7 Van (4LB)</p> <p>AUDI FAW A6L C6 (4Z8) A6L C7 (4X8, 4XL)</p> <p>PORSCHE CAYENNE (92A) PANAMERA (970)</p> <p>VOLKSWAGEN TOUAREG (7P5, 7P6)</p>	 <p>→SI 0083 →SI 0096 →SI 0106</p> <p>BMW 5 (E39) 5 Touring (E39) 7 (E38)</p>	
	 <p>→SI 0083 →SI 0096 →SI 0106</p> <p>AUDI A3 (8P1) A3 Sportback (8PA) TT (8N3) TT Roadster (8N9)</p> <p>FORD GALAXY I (WGR) GALAXY MK I VAN (WGR)</p> <p>SEAT ALHAMBRA (7V8, 7V9) LEON (1M1) TOLEDO II (1M2)</p> <p>VOLKSWAGEN BORA I (1J2) BORA Variant (1J6) GOLF IV (1J1) GOLF IV Variant (1J5) NEW BEETLE (9C1, 1C1) PASSAT B5 (3B2) PASSAT B5 Variant (3B5)</p>	 <p>→SI 0083 →SI 0096 →SI 0106</p> <p>BMW 3 (E46) 3 Compact (E46) 3 Convertible (E46) 3 Coupe (E46) 3 Touring (E46)</p>





<p>ARV 7.22295.63.0</p>  <p>© MS Motorservice International GmbH</p> <p>→SI 0083 →SI 0096 →SI 0106</p> <p>BMW X5 (E53)</p>	<p>ARV 7.22295.66.0</p> <p>5 (E39) Z3 Roadster (E36) Z8 Roadster (E52)</p>	<p>ARV 7.22295.69.0</p>  <p>© MS Motorservice International GmbH</p> <p>→SI 0083 →SI 0096 →SI 0106</p> <p>BMW 3 (E46) 3 Compact (E36) 3 Coupe (E46) 3 Touring (E46) Z3 Roadster (E36)</p>
<p>ARV 7.22295.65.0</p>  <p>© MS Motorservice International GmbH</p> <p>→SI 0083 →SI 0096 →SI 0106</p> <p>BMW 3 (E46) 3 Coupe (E46) 3 Touring (E46)</p>	<p>ARV 7.22295.67.0</p>  <p>© MS Motorservice International GmbH</p> <p>→SI 0083 →SI 0096 →SI 0106</p> <p>BMW Z3 (E36) Z3 Coupe (E36) Z3 Roadster (E36)</p>	<p>ARV 7.22295.70.0</p>  <p>© MS Motorservice International GmbH</p> <p>→SI 0083 →SI 0096 →SI 0106</p> <p>BMW 3 (E36) 3 Compact (E36) 3 Convertible (E36) 3 Coupe (E36) Z3 Coupe (E36) Z3 Roadster (E36)</p>
<p>ARV 7.22295.66.0</p>  <p>© MS Motorservice International GmbH</p> <p>→SI 0083 →SI 0106</p> <p>ALPINA ROADSTER V8 (E52)</p> <p>BMW 3 (E36) 3 Compact (E36) 3 Convertible (E36) 3 Coupe (E36)</p>	<p>ARV 7.22295.68.0</p>  <p>© MS Motorservice International GmbH</p> <p>→SI 0083 →SI 0096 →SI 0106</p> <p>BMW 5 (E39) 5 Touring (E39) 7 (E38) X5 (E53)</p>	

EMISSION CONTROL





ARV	7.22295.71.0	ARV	7.22296.02.0	ARV	7.22299.03.0	
 <p>© MS Motorservice International GmbH</p> <p>→SI 0083 →SI 0096 →SI 0106</p> <p>BMW 5 (E39)</p>		<p>GRANCABRIO GRANSPORT Convertible GRANSPORT Coupe QUATTROPORTE V OPEL ASTRA F (T92) ASTRA F CLASSIC Estate (T92) ASTRA F CLASSIC Hatchback (T92) ASTRA F CLASSIC Saloon (T92) ASTRA F Convertible (T92) ASTRA F Estate (T92) ASTRA F Estate Van (T92) ASTRA F Hatchback (T92) CALIBRA A (C89) COMBO Box Body/MPV (71_) CORSA B (S93) CORSA B Estate (S93) SINTRA (APV) TIGRA (S93) VECTRA B (J96) VECTRA B Estate (J96) VECTRA B Hatchback (J96) VAUXHALL ASTRA Mk III (F) Convertible (T92) ASTRA Mk III (F) Estate (T92) ASTRA Mk III (F) Hatchback (T92) ASTRA Mk III (F) Saloon (T92) CALIBRA (C89) COMBO Mk I (B) (S93) CORSA Mk I (B) (S93) SINTRA (APV) TIGRA Mk I (S93) VECTRA (B) Estate (J96) VECTRA (B) Hatchback (J96) VECTRA (B) Saloon (J96)</p>	<p>V90 I Estate (965) XC70 CROSS COUNTRY I (295)</p>			
		<p>© MS Motorservice International GmbH</p> <p>→SI 0083 →SI 0106</p> <p>LAND ROVER DISCOVERY II (L318) RANGE ROVER II (P38A)</p>				
	<p>ARV</p> <p>7.22296.02.0</p>	 <p>© MS Motorservice International GmbH</p> <p>→SI 0083 →SI 0096 →SI 0106</p> <p>FERRARI 360 (F131) 360 Spider (F131) 458 458 Spider 599 GTB/GTO 599 SA 5_ MARANELLO 612 SCAGLIETTI CALIFORNIA F430 F430 Spider FF SUPERAMERICA GM HOLDEN LTD ASTRA Hatchback (TR) BARINA Hatchback (SB) BARINA Hatchback (XC) CALIBRA (YE) VECTRA Hatchback (JR) VECTRA Hatchback (JS) VECTRA Saloon (JR) MASERATI 3200 GT Coupe 4200 GT / COUPE Coupe 4200 GT SPYDER Convertible GRAN TURISMO</p>	<p>ARV</p> <p>7.22299.03.0</p>	 <p>© MS Motorservice International GmbH</p> <p>→SI 0083 →SI 0096 →SI 0106</p> <p>VOLVO 850 (854) C70 I Convertible (873) C70 I Coupe (872) S70 (874) S90 I (964) V70 V70 I (875, 876) V70 II (285)</p>	<p>ARV</p> <p>7.22560.40.0</p>	 <p>© MS Motorservice International GmbH</p> <p>→SI 0083 →SI 0096 →SI 0106</p> <p>AUDI A4 B5 (8D2) A4 B5 Avant (8D5) A4 B6 (8E2) A4 B6 Avant (8E5) A4 B6 Convertible (8H7) A6 C5 (4B2) A6 C5 Avant (4B5) A8 D2 (4D2, 4D8) A8 D3 (4E2, 4E8) AUDI FAW A4 B6 (8E2) A6 C5 (4Y8) SKODA SUPERB I (3U4) VOLKSWAGEN PASSAT B5 (3B2) PASSAT B5 Variant (3B5) PASSAT B5.5 (3B3) PASSAT B5.5 Variant (3B6) PHAETON (3D1, 3D2, 3D3, 3D4, 3D6, 3D7, 3D8, 3D9) TOUAREG (7LA, 7L6, 7L7)</p>





ARV 7.22560.40.0

VW SVW
PASSAT B5 (9F8)
PASSAT LINGYU (B5, 9F0, 9F9)

ARV 7.22560.41.0



→SI 0083
→SI 0096
→SI 0106

AUDI

- A4 B5 (8D2)
- A4 B5 Avant (8D5)
- A4 B6 (8E2)
- A4 B6 Avant (8E5)
- A4 B6 Convertible (8H7)
- A4 B7 (8EC)
- A4 B7 Avant (8ED)
- A4 B7 Convertible (8HE)
- A6 C5 (4B2)
- A6 C5 Avant (4B5)
- A6 C6 (4F2)
- A6 C6 Avant (4F5)
- A8 D2 (4D2, 4D8)
- A8 D3 (4E2, 4E8)
- ALLROAD C5 (4BH)

AUDI FAW

- A4 B6 (8E2)
- A6 C5 (4Y8)
- A6L C6 (4Z8)

SKODA

SUPERB I (3U4)

VOLKSWAGEN

- PASSAT B5 (3B2)
- PASSAT B5 Variant (3B5)
- PASSAT B5.5 (3B3)
- PASSAT B5.5 Variant (3B6)
- PHAETON (3D1, 3D2, 3D3, 3D4, 3D6, 3D7, 3D8, 3D9)
- TOUAREG (7LA, 7L6, 7L7)

VW SVW

- PASSAT B5 (9F8)
- PASSAT LINGYU (B5, 9F0, 9F9)

ARV 7.22560.42.0



→SI 0083
→SI 0096
→SI 0106

AUDI

- A4 B5 (8D2)
- A4 B5 Avant (8D5)
- A6 C5 (4B2)
- A6 C5 Avant (4B5)

VOLKSWAGEN

- PASSAT B5 (3B2)
- PASSAT B5 Variant (3B5)

ARV 7.22560.43.0



→SI 0083
→SI 0096
→SI 0106

AUDI

- A4 B5 (8D2)
- A4 B5 Avant (8D5)
- A4 B6 (8E2)
- A4 B6 Avant (8E5)
- A4 B6 Convertible (8H7)
- A4 B7 (8EC)
- A4 B7 Avant (8ED)
- A6 C5 (4B2)
- A6 C5 Avant (4B5)
- A6 C7 (4G2, 4GC)
- A6 C7 Avant (4G5, 4GD)
- A7 Sportback (4GA, 4GF)
- A8 D3 (4E2, 4E8)

AUDI FAW

- A4 B6 (8E2)
- A4 B7 (8YC)

SEAT

- EXEO (3R2)
- EXEO ST (3R5)

ARV 7.22560.43.0

SKODA
SUPERB I (3U4)
VOLKSWAGEN
PASSAT B5.5 (3B3)
PASSAT B5.5 Variant (3B6)
VW SVW
PASSAT LINGYU (B5, 9F0, 9F9)

ARV 7.22560.44.0



→SI 0083
→SI 0096
→SI 0106

AUDI

- A4 B6 (8E2)
- A4 B6 Avant (8E5)
- A4 B6 Convertible (8H7)
- A4 B7 (8EC)
- A4 B7 Avant (8ED)
- A6 C5 (4B2)
- A6 C5 Avant (4B5)
- A6 C6 (4F2)
- A6 C6 Avant (4F5)
- A8 D3 (4E2, 4E8)

AUDI FAW

- A4 B6 (8E2)
- A4 B7 (8YC)
- A6L C6 (4Z8)

ARV 7.22560.45.0



→SI 0083
→SI 0096
→SI 0106

AUDI

- A4 B6 (8E2)
- A4 B6 Avant (8E5)
- A4 B6 Convertible (8H7)
- A4 B7 (8EC)





ARV 7.22560.45.0
 A4 B7 Avant (8ED)
 A6 C5 (4B2)
 A6 C5 Avant (4B5)
 A6 C6 (4F2)
 A6 C6 Avant (4F5)
 A8 D3 (4E2, 4E8)
AUDI FAW
 A4 B6 (8E2)
 A4 B7 (8YC)
 A6L C6 (4Z8)



AUDI
 A3 (8L1)
 TT (8N3)
 TT Roadster (8N9)
SEAT
 CORDOBA (6K1, 6K2)
 IBIZA II (6K1)
 LEON (1M1)
 TOLEDO II (1M2)
SKODA
 OCTAVIA I (1U2)
 OCTAVIA I Combi (1U5)
VOLKSWAGEN
 BORA
 BORA I (1J2)
 BORA Variant (1J6)
 GOLF IV (1J1)
 GOLF IV (9B3)
 GOLF IV Variant (1J5)
VW FAW
 BORA (1J2, 9D2)

ARV 7.22769.76.0

→SI 0083
 →SI 0096
 →SI 0106

AUDI
 A4 B5 (8D2)
 A4 B5 Avant (8D5)
 A4 B6 Avant (8E5)
 A6 C5 (4B2)

ARV 7.22769.77.0

→SI 0083
 →SI 0096
 →SI 0106

AUDI
 A4 B5 Avant (8D5)
 A6 C5 (4B2)
 A6 C5 Avant (4B5)
 ALLROAD C5 (4BH)

ARV 7.22769.78.0

→SI 0083
 →SI 0096
 →SI 0106

AUDI
 A4 B5 Avant (8D5)

ARV 7.22769.78.0
 A6 C5 (4B2)
 A6 C5 Avant (4B5)
 ALLROAD C5 (4BH)

ARV 7.22769.79.0

→SI 0083
 →SI 0096
 →SI 0106

AUDI
 Q7 (4LB)
 Q7 Van (4LB)
VOLKSWAGEN
 TOUAREG (7LA, 7L6, 7L7)

ARV 7.22769.80.0

→SI 0083
 →SI 0096
 →SI 0106

AUDI
 A4 B7 (8EC)
 A4 B7 Avant (8ED)
 A4 B7 Convertible (8HE)
 R8 (422, 423)
 R8 Spyder (427, 429)
LAMBORGHINI
 GALLARDO
 GALLARDO SPYDER



ARV	7.22938.06.0	ATS	7.08369.00.0	ATS	7.08369.01.0
<p>→SI 0083 →SI 0106</p>		<p>CADDY III MPV (2KB, 2KJ, 2CB, 2CJ) CADDY LIFE (2K) CADDY MAXI (2K) EOS (1F7, 1F8) GOLF PLUS V (5M1, 521) GOLF V (1K1) GOLF V Variant (1K5) GOLF VI (5K1) JETTA III (1K2) PASSAT B6 (3C2) PASSAT B6 Variant (3C5) PASSAT CC B6 (357) SCIROCCO III (137, 138) SCIROCCO Van (137) TIGUAN (5N_) TOURAN (1T1, 1T2) TOURAN VAN (1T1, 1T2) ENGINE</p>		<p>PASSAT B6 Variant (3C5) PASSAT B7 (362) PASSAT B7 Estate Van (365) PASSAT B7 Variant (365) PASSAT CC B6 (357) SCIROCCO III (137, 138) SCIROCCO Van (137) ENGINE</p>	
<p>PORSCHE 911 (991) 911 (996) 911 (997) 911 Convertible (996) 911 Targa (996) BOXSTER (986) CARRERA GT (980)</p>		<p>ATS 7.08369.01.0</p>		<p>ATS 7.08369.02.0</p>	
<p>ATS 7.08369.00.0</p>		<p>ATS 7.08369.01.0</p>		<p>AUDI A3 (8P1) A3 Convertible (8P7) A3 Sportback (8PA) SEAT ALTEA (5P1) ALTEA XL (5P5, 5P8) LEON (1P1) TOLEDO III (5P2) SKODA OCTAVIA II (1Z3) OCTAVIA II Combi (1Z5) SUPERB II (3T4) SUPERB II Estate (3T5) VOLKSWAGEN EOS (1F7, 1F8) GOLF PLUS V (5M1, 521) GOLF V (1K1) GOLF V Variant (1K5) JETTA III (1K2)</p>	
<p>AUDI A3 (8P1) A3 Convertible (8P7) A3 Sportback (8PA) A4 B7 (8EC) A4 B7 Avant (8ED) TT (8J3) TT Roadster (8J9) SEAT ALTEA (5P1) ALTEA XL (5P5, 5P8) IBIZA IV (6J5, 6P1) IBIZA IV SC (6J1, 6P5) LEON (1P1) TOLEDO III (5P2) SKODA FABIA II (542) FABIA II Combi (545) OCTAVIA II (1Z3) OCTAVIA II Combi (1Z5) ROOMSTER (5J7) SUPERB II (3T4) SUPERB II Estate (3T5) YETI (5L) VOLKSWAGEN CADDY III Box Body/MPV (2KA, 2KH, 2CA, 2CH)</p>		<p>AUDI A3 (8P1) A3 Convertible (8P7) A3 Sportback (8PA) TT (8J3) TT Roadster (8J9) SEAT ALTEA (5P1) ALTEA XL (5P5, 5P8) LEON (1P1) SKODA OCTAVIA II (1Z3) OCTAVIA II Combi (1Z5) SUPERB II (3T4) SUPERB II Estate (3T5) YETI (5L) VOLKSWAGEN BEETLE (5C1, 5C2) BEETLE Convertible (5C7, 5C8) EOS (1F7, 1F8) GOLF PLUS V (5M1, 521) GOLF PLUS Van (521) GOLF V Variant (1K5) GOLF VAN VI Variant (AJ5) GOLF VI (5K1) GOLF VI Convertible (517) GOLF VI Van (5K1_) GOLF VI Variant (AJ5) JETTA III (1K2) JETTA IV (162, 163, AV3, AV2) PASSAT B6 (3C2)</p>		<p>ATS 7.08369.03.0</p> <p>AUDI A3 (8P1) A3 Convertible (8P7) A3 Sportback (8PA) TT (8J3) TT Roadster (8J9)</p>	





ATS 7.08369.03.0	ATS 7.08369.04.0	ATS 7.08369.06.0
<p>SEAT ALTEA (5P1) ALTEA XL (5P5, 5P8) LEON (1P1) TOLEDO III (5P2)</p> <p>SKODA OCTAVIA II (1Z3) OCTAVIA II Combi (1Z5) SUPERB II (3T4) SUPERB II Estate (3T5)</p> <p>VOLKSWAGEN EOS (1F7, 1F8) GOLF PLUS V (5M1, 521) GOLF V (1K1) GOLF V Variant (1K5) JETTA III (1K2) TIGUAN (5N_) TIGUAN VAN (5N_)</p>	<p>TIGUAN (5N_) TIGUAN VAN (5N_)</p>	 <p>© MS Motorservice International GmbH</p>
	<p>ATS 7.08369.05.0</p>	<p>MERCEDES-BENZ C-CLASS (W204) C-CLASS Coupe (C204) C-CLASS T-Model (S204) C-CLASS T-Model (S205) CLS (C218) CLS Shooting Brake (X218) E-CLASS (W212) E-CLASS Convertible (A207) E-CLASS Coupe (C207) E-CLASS T-Model (S212) GLE (W166) GLK-CLASS (X204) M-CLASS (W166) MARCO POLO Camper (W447) S-CLASS (W221) S-CLASS (W222, V222, X222) SLC (R172) SLK (R172) SPRINTER 3,5-t Bus (B906) SPRINTER 3,5-t Platform/Chassis (B906) SPRINTER 3,5-t Van (B906) SPRINTER 3-t Bus (B906) SPRINTER 3-t Platform/Chassis (B906) SPRINTER 3-t Van (B906) SPRINTER 4,6-t Bus (B906) SPRINTER 4,6-t Platform/Chassis (B906) SPRINTER 4,6-t Van (B906) SPRINTER 5-t Bus (B906) SPRINTER 5-t Platform/Chassis (B906) SPRINTER 5-t Van (B906) V-CLASS (W447) VIANO (W639) VITO / MIXTO Van (W639) VITO Bus (W639) VITO Mixto (Double Cabin) (W447) VITO Tourer (W447) VITO Van (W447)</p> <p>MERCEDES-BENZ (FJDA) SPRINTER (B906) VITO (V639)</p>
<p>ATS 7.08369.04.0</p>	 <p>© MS Motorservice International GmbH</p>	
 <p>© MS Motorservice International GmbH</p>	<p>CADILLAC BLS BLS Wagon</p> <p>OPEL ASTRA H (A04) ASTRA H Estate (A04) ASTRA H Estate Van (L70) ASTRA H GTC (A04) ASTRA H TwinTop (A04) SIGNUM Hatchback (Z03) VECTRA C (Z02) VECTRA C Estate (Z02) VECTRA C GTS (Z02) ZAFIRA / ZAFIRA FAMILY B (A05) ZAFIRA B Box Body/MPV (A05)</p> <p>SAAB 9-3 (YS3F, E79, D79, D75) 9-3 Convertible (YS3F) 9-3 Estate (E50) 9-3X (YS3)</p> <p>VAUXHALL ASTRA Mk V (H) (A04) ASTRA Mk V (H) Estate (A04) ASTRA Mk V (H) Sport Hatch (A04) ASTRA Mk V (H) TwinTop (A04) ASTRAVAN Mk V (H) Estate Van (A04) SIGNUM (Z03) VECTRA Mk II (C) (Z02) VECTRA Mk II (C) Estate (Z02) VECTRA Mk II (C) GTS (Z02) ZAFIRA Mk II (B) (A05)</p>	
<p>AUDI A3 (8P1) A3 Convertible (8P7) A3 Sportback (8PA)</p> <p>SEAT ALTEA (5P1) ALTEA XL (5P5, 5P8) LEON (1P1)</p> <p>SKODA OCTAVIA II (1Z3) OCTAVIA II Combi (1Z5) SUPERB II (3T4) SUPERB II Estate (3T5) YETI (5L)</p> <p>VOLKSWAGEN BEETLE (5C1, 5C2) BEETLE Convertible (5C7, 5C8) EOS (1F7, 1F8) GOLF PLUS V (5M1, 521) GOLF PLUS Van (521) GOLF V Variant (1K5) GOLF VAN VI Variant (AJ5) GOLF VI (5K1) GOLF VI Convertible (517) GOLF VI Van (5K1_) GOLF VI Variant (AJ5) JETTA III (1K2) JETTA IV (162, 163, AV3, AV2) SCIROCCO III (137, 138) SCIROCCO Van (137)</p>		





ATS 7.08369.07.0	ATS 7.08369.09.0	ATS 7.08369.12.0
 <p>VOLKSWAGEN PASSAT B6 (3C2) PASSAT B6 Variant (3C5) PASSAT B7 (362) PASSAT B7 Estate Van (365) PASSAT B7 Variant (365) PASSAT CC B6 (357)</p>	<p>SEAT IBIZA IV (6J5, 6P1) IBIZA IV Hatchback Van (6J1) IBIZA IV SC (6J1, 6P5) IBIZA IV ST (6J8, 6P8) TOLEDO IV (KG3)</p> <p>SKODA FABIA II (542) FABIA II Combi (545) RAPID (NH3) RAPID Spaceback (NH1) ROOMSTER (5J7) ROOMSTER Praktik (5J)</p> <p>VOLKSWAGEN POLO V (6R1, 6C1) POLO Van (6R)</p>	 <p>MERCEDES-BENZ C-CLASS (W204) C-CLASS (W205) C-CLASS Convertible (A205) C-CLASS Coupe (C204) C-CLASS Coupe (C205) C-CLASS T-Model (S204) C-CLASS T-Model (S205) CLS (C218) CLS (C219) CLS Shooting Brake (X218) E-CLASS (W211) E-CLASS (W212) E-CLASS Convertible (A207) E-CLASS Coupe (C207) E-CLASS T-Model (S211) E-CLASS T-Model (S212) G-CLASS (W461) G-CLASS (W463) G-CLASS Cabrio (W463) GL-CLASS (X164) GLK-CLASS (X204) M-CLASS (W164) R-CLASS (W251, V251)</p>
<p>ATS 7.08369.08.0</p>  <p>SEAT EXEO (3R2) EXEO ST (3R5)</p> <p>VOLKSWAGEN CADDY III Box Body/MPV (2KA, 2KH, 2CA, 2CH) CADDY III MPV (2KB, 2KJ, 2CB, 2CJ) CADDY LIFE (2K) CADDY MAXI (2K) TOURAN (1T1, 1T2) TOURAN VAN (1T1, 1T2)</p>	<p>ATS 7.08369.11.0</p>  <p>AUDI A1 (8X1, 8XK) A1 Sportback (8XA, 8XF)</p> <p>SEAT IBIZA IV (6J5, 6P1) IBIZA IV Hatchback Van (6J1) IBIZA IV SC (6J1, 6P5) IBIZA IV ST (6J8, 6P8) TOLEDO IV (KG3)</p> <p>SKODA FABIA II (542) FABIA II Combi (545) RAPID (NH3) RAPID Spaceback (NH1) ROOMSTER (5J7) ROOMSTER Praktik (5J)</p> <p>VOLKSWAGEN POLO V (6R1, 6C1) POLO Van (6R)</p>	<p>ATS 7.08369.13.0</p>  <p>AUDI A4 Allroad B8 (8KH) A4 B7 (8EC) A4 B7 Avant (8ED) A4 B7 Convertible (8HE) A4 B8 (8K2) A4 B8 Avant (8K5) A5 (8T3) A5 Convertible (8F7) A5 Sportback (8TA) A6 Allroad C6 (4FH) A6 C6 (4F2)</p>
<p>ATS 7.08369.09.0</p>  <p>AUDI A1 (8X1, 8XK) A1 Sportback (8XA, 8XF)</p>	<p>ATS 7.08369.09.0</p> <p>VOLKSWAGEN POLO V (6R1, 6C1) POLO Van (6R)</p>	

EMISSION CONTROL



ATS	7.08369.13.0	ATS	7.08369.15.0	ATS	7.08369.17.0
<p>A6 C6 Avant (4F5) A8 D3 (4E2, 4E8) Q5 (8RB) Q5 Van (8RB) Q7 (4LB) Q7 Van (4LB)</p> <p>VOLKSWAGEN PHAETON (3D1, 3D2, 3D3, 3D4, 3D6, 3D7, 3D8, 3D9) TOUAREG (7LA, 7L6, 7L7) TOUAREG (7P5, 7P6) ENGINE</p>		<p>COMBO Tour MERIVA A MPV (X03)</p> <p>VAUXHALL ASTRA Mk V (H) (A04) ASTRA Mk V (H) Estate (A04) ASTRA Mk V (H) Sport Hatch (A04) ASTRAVAN Mk V (H) Estate Van (A04) COMBO Mk II (C) Box Body/MPV (F25) COMBO TOUR Mk II (C) (F25) MERIVA A (X03)</p>		<p>ASTRA Mk VI (J) GTC (P10) CASCADA Convertible (W13) INSIGNIA Mk I (A) Country Tourer (G09) INSIGNIA Mk I (A) Hatchback (G09) INSIGNIA Mk I (A) Saloon (G09) INSIGNIA Mk I (A) Sports Tourer (G09) ZAFIRA Mk III (P12)</p>	
ATS	7.08369.14.0	ATS	7.08369.16.0	ATS	7.08369.18.0
 <p>AUDI A4 Allroad B8 (8KH) A4 B8 (8K2) A4 B8 Avant (8K5) A5 (8T3) A5 Convertible (8F7) A5 Sportback (8TA) Q5 (8RB) Q5 Van (8RB)</p> <p>SEAT EXEO (3R2) EXEO ST (3R5)</p> <p>VOLKSWAGEN ENGINE</p>		 <p>AUDI A4 Allroad B8 (8KH) A4 B8 (8K2) A4 B8 Avant (8K5) A5 (8T3) A5 Convertible (8F7) A5 Sportback (8TA) Q5 (8RB) Q5 Van (8RB)</p>		 <p>VOLKSWAGEN MULTIVAN V (7HM, 7HN, 7HF, 7EF, 7EM, 7EN) TOUAREG (7LA, 7L6, 7L7) TRANSPORTER V Bus (7HB, 7HJ, 7EB, 7EJ, 7EF, 7EG, 7HF, 7EC) TRANSPORTER V Platform/Chassis (7JD, 7JE, 7JL, 7JY, 7JZ, 7FD) TRANSPORTER V Van (7HA, 7HH, 7EA, 7EH)</p>	
ATS	7.08369.15.0	ATS	7.08369.17.0	ATS	7.08369.19.0
 <p>OPEL ASTRA H (A04) ASTRA H CLASSIC Hatchback (A04) ASTRA H Estate (A04) ASTRA H Estate Van (L70) ASTRA H GTC (A04) ASTRA H Saloon (A04) COMBO Box Body/MPV</p>		 <p>OPEL ASTRA J (P10) ASTRA J Estate Van (P10) ASTRA J GTC ASTRA J Sports Tourer (P10) CASCADA (W13) INSIGNIA A (G09) INSIGNIA A Country Tourer (G09) INSIGNIA A Saloon (G09) INSIGNIA A Sports Tourer (G09) ZAFIRA TOURER C (P12) ZAFIRA TOURER C VAN (P12)</p> <p>VAUXHALL ASTRA Mk VI (J) (P10) ASTRA Mk VI (J) Estate (P10)</p>		 <p>VOLKSWAGEN CADDY ALLTRACK Box Body/MPV (SAA) CADDY ALLTRACK MPV (SAB) CADDY III Box Body/MPV (2KA, 2KH, 2CA, 2CH) CADDY III MPV (2KB, 2KJ, 2CB, 2CJ) CADDY IV Box Body/MPV (SAA, SAH) CADDY IV MPV (SAB, SAJ) TOURAN (1T3) TOURAN VAN (1T3)</p>	

EMISSION CONTROL



ATS 7.08369.20.0



VOLKSWAGEN

MULTIVAN V (7HM, 7HN, 7HF, 7EF, 7EM, 7EN)
 MULTIVAN VI (SGF, SGM, SGN, SHM, SHN)
 TRANSPORTER / CARAVELLE VI Bus (SGB, SGG, SGJ, SGC, SHB, SHJ)
 TRANSPORTER V Bus (7HB, 7HJ, 7EB, 7EJ, 7EF, 7EG, 7HF, 7EC)
 TRANSPORTER V Platform/Chassis (7JD, 7JE, 7JL, 7JY, 7JZ, 7FD)
 TRANSPORTER V Van (7HA, 7HH, 7EA, 7EH)
 TRANSPORTER VI Platform/Chassis (SFD, SFE, SFL, SFZ, SJD, SJ)
 TRANSPORTER VI Van (SGA, SGH, SHA, SHH)

ATS 7.08369.21.0



VOLKSWAGEN

MULTIVAN V (7HM, 7HN, 7HF, 7EF, 7EM, 7EN)
 MULTIVAN VI (SGF, SGM, SGN, SHM, SHN)
 TRANSPORTER / CARAVELLE VI Bus (SGB, SGG, SGJ, SGC, SHB, SHJ)
 TRANSPORTER V Bus (7HB, 7HJ, 7EB, 7EJ, 7EF, 7EG, 7HF, 7EC)
 TRANSPORTER V Platform/Chassis (7JD, 7JE, 7JL, 7JY, 7JZ, 7FD)
 TRANSPORTER V Van (7HA, 7HH, 7EA, 7EH)
 TRANSPORTER VI Platform/Chassis (SFD, SFE, SFL, SFZ, SJD, SJ)
 TRANSPORTER VI Van (SGA, SGH, SHA, SHH)

ATS 7.08369.22.0

AUDI

A4 B7 (8EC)
 A4 B7 Avant (8ED)
 A4 B7 Convertible (8HE)
 A6 C6 (4F2)
 A6 C6 Avant (4F5)

ATS 7.08369.23.0



AUDI

A4 B7 (8EC)
 A4 B7 Avant (8ED)
 A4 B7 Convertible (8HE)

ATS 7.08369.24.0



VOLKSWAGEN

MULTIVAN V (7HM, 7HN, 7HF, 7EF, 7EM, 7EN)
 MULTIVAN VI (SGF, SGM, SGN, SHM, SHN)
 TRANSPORTER / CARAVELLE VI Bus (SGB, SGG, SGJ, SGC, SHB, SHJ)
 TRANSPORTER V Bus (7HB, 7HJ, 7EB, 7EJ, 7EF, 7EG, 7HF, 7EC)
 TRANSPORTER V Platform/Chassis (7JD, 7JE, 7JL, 7JY, 7JZ, 7FD)
 TRANSPORTER V Van (7HA, 7HH, 7EA, 7EH)
 TRANSPORTER VI Platform/Chassis (SFD, SFE, SFL, SFZ, SJD, SJ)
 TRANSPORTER VI Van (SGA, SGH, SHA, SHH)

ATS 7.08369.25.0



VOLKSWAGEN

MULTIVAN V (7HM, 7HN, 7HF, 7EF, 7EM, 7EN)
 MULTIVAN VI (SGF, SGM, SGN, SHM, SHN)
 TRANSPORTER / CARAVELLE VI Bus (SGB, SGG, SGJ, SGC, SHB, SHJ)

ATS 7.08369.25.0

TRANSPORTER V Bus (7HB, 7HJ, 7EB, 7EJ, 7EF, 7EG, 7HF, 7EC)
 TRANSPORTER V Platform/Chassis (7JD, 7JE, 7JL, 7JY, 7JZ, 7FD)
 TRANSPORTER V Van (7HA, 7HH, 7EA, 7EH)
 TRANSPORTER VI Platform/Chassis (SFD, SFE, SFL, SFZ, SJD, SJ)
 TRANSPORTER VI Van (SGA, SGH, SHA, SHH)

ATS 7.08369.26.0



AUDI

A1 (8X1, 8XK)
 A1 Sportback (8XA, 8XF)

SEAT

IBIZA IV (6J5, 6P1)
 IBIZA IV Hatchback Van (6J1)
 IBIZA IV SC (6J1, 6P5)
 IBIZA IV ST (6J8, 6P8)
 TOLEDO IV (KG3)

SKODA

FABIA II (542)
 FABIA II Combi (545)
 RAPID (NH3)
 RAPID Spaceback (NH1)
 ROOMSTER (5J7)
 ROOMSTER Praktik (5J)

VOLKSWAGEN

POLO V (6R1, 6C1)
 POLO Van (6R)

ATS 7.08369.27.0



VOLVO

C30 (533)
 C70 II Convertible (542)
 S40 II (544)
 S80 II (124)
 V50 (545)
 V70 III (135)

EMISSION CONTROL



ATS 7.08369.27.0

XC60 I SUV (156)
XC70 CROSS COUNTRY I (295)
XC70 II (136)
XC70 II VAN (136)

ATS 7.08369.30.0



MERCEDES-BENZ

C-CLASS (W203)
C-CLASS Coupe (CL203)
C-CLASS T-Model (S203)
CLC-CLASS (CL203)
E-CLASS (W211)
E-CLASS T-Model (S211)
S-CLASS (W221)
SPRINTER 3,5-t Bus (B906)
SPRINTER 3,5-t Platform/Chassis (B906)
SPRINTER 3,5-t Van (B906)
SPRINTER 3-t Bus (B906)
SPRINTER 3-t Platform/Chassis (B906)
SPRINTER 3-t Van (B906)
SPRINTER 4,6-t Platform/Chassis (B906)
SPRINTER 5-t Platform/Chassis (B906)
SPRINTER 5-t Van (B906)

ATS 7.08369.31.0



VOLKSWAGEN

MULTIVAN V (7HM, 7HN, 7HF, 7EF, 7EM, 7EN)
TRANSPORTER V Bus (7HB, 7HJ, 7EB, 7EJ, 7EF, 7EG, 7HF, 7EC)
TRANSPORTER V Platform/Chassis (7JD, 7JE, 7JL, 7JY, 7JZ, 7FD)
TRANSPORTER V Van (7HA, 7HH, 7EA, 7EH)

ATS 7.08369.32.0



OPEL

ASTRA H (A04)
ASTRA H Estate (A04)
ASTRA H Estate Van (L70)
ASTRA H GTC (A04)
ASTRA H TwinTop (A04)
ZAFIRA / ZAFIRA FAMILY B (A05)
ZAFIRA B Box Body/MPV (A05)

VAUXHALL

ASTRA Mk V (H) (A04)
ASTRA Mk V (H) Estate (A04)
ASTRA Mk V (H) Sport Hatch (A04)
ASTRA Mk V (H) TwinTop (A04)
ASTRAVAN Mk V (H) Estate Van (A04)
ZAFIRA Mk II (B) (A05)

ATS 7.08369.33.0



VOLKSWAGEN

MULTIVAN V (7HM, 7HN, 7HF, 7EF, 7EM, 7EN)
TRANSPORTER V Bus (7HB, 7HJ, 7EB, 7EJ, 7EF, 7EG, 7HF, 7EC)
TRANSPORTER V Platform/Chassis (7JD, 7JE, 7JL, 7JY, 7JZ, 7FD)
TRANSPORTER V Van (7HA, 7HH, 7EA, 7EH)

ATS 7.08369.34.0



AUDI

A2 (8Z0)
A3 (8P1)

VOLKSWAGEN

BORA I (1J2)
BORA Variant (1J6)
GOLF IV (1J1)
GOLF IV Variant (1J5)
GOLF V (1K1)
LUPO I (6X1, 6E1)
POLO (9N_)

ATS 7.08369.35.0



→PI 1978

FIAT

500 (312_)
500 C (312_)
PANDA (169_)
PANDA Hatchback Van (169_)

ATS 7.08369.36.0



VOLKSWAGEN

MULTIVAN V (7HM, 7HN, 7HF, 7EF, 7EM, 7EN)
TRANSPORTER V Bus (7HB, 7HJ, 7EB, 7EJ, 7EF, 7EG, 7HF, 7EC)

EMISSION CONTROL





ATS 7.08369.36.0
 TRANSPORTER V Platform/Chassis (7JD, 7JE, 7JL, 7JY, 7JZ, 7FD)
 TRANSPORTER V Van (7HA, 7HH, 7EA, 7EH)

ATS 7.08369.37.0



SEAT
 IBIZA IV (6J5, 6P1)
 IBIZA IV Hatchback Van (6J1)
 IBIZA IV SC (6J1, 6P5)
 IBIZA IV ST (6J8, 6P8)

SKODA
 FABIA II (542)
 FABIA II Combi (545)
 ROOMSTER (5J7)
 ROOMSTER Praktik (5J)

VOLKSWAGEN
 POLO V (6R1, 6C1)
 POLO Van (6R)

ATS 7.08369.38.0



OPEL
 SIGNUM Hatchback (Z03)
 VECTRA C (Z02)
 VECTRA C Estate (Z02)
 VECTRA C GTS (Z02)

VAUXHALL
 SIGNUM (Z03)
 VECTRA Mk II (C) (Z02)
 VECTRA Mk II (C) Estate (Z02)
 VECTRA Mk II (C) GTS (Z02)

ATS 7.08369.39.0



VOLKSWAGEN
 CRAFTER 30-35 Bus (2E_)
 CRAFTER 30-50 Platform/Chassis (2F_)
 CRAFTER 30-50 Van (2E_)

ATS 7.08369.40.0



AUDI
 A4 B7 (8EC)
 A4 B7 Avant (8ED)
 A4 B7 Convertible (8HE)

SKODA
 SUPERB I (3U4)

VOLKSWAGEN
 PASSAT B5.5 (3B3)
 PASSAT B5.5 Variant (3B6)

ATS 7.08369.41.0



AUDI
 A3 (8P1)
 A3 Sportback (8PA)

VOLKSWAGEN
 GOLF PLUS V (5M1, 521)
 GOLF V (1K1)
 TOURAN (1T1, 1T2)
 TOURAN VAN (1T1, 1T2)

ATS 7.08369.42.0



AUDI
 A6 Allroad C6 (4FH)
 A6 C6 (4F2)
 A6 C6 Avant (4F5)
 A8 D3 (4E2, 4E8)
 Q7 (4LB)
 Q7 Van (4LB)

ATS 7.08369.43.0



SEAT
 ALHAMBRA (7V8, 7V9)

VOLKSWAGEN
 SHARAN (7M8, 7M9, 7M6)

ATS 7.08369.44.0



VOLKSWAGEN
 CRAFTER 30-35 Bus (2E_)
 CRAFTER 30-50 Platform/Chassis (2F_)
 CRAFTER 30-50 Van (2E_)





ATS 7.08369.45.0	ATS 7.08369.47.0	ATS 7.08369.49.0
 <p>AUDI A4 Allroad B8 (8KH) A4 B8 (8K2) A4 B8 Avant (8K5) A5 (8T3) A5 Convertible (8F7) A5 Sportback (8TA) A6 Allroad C6 (4FH) A6 C6 (4F2) A6 C6 Avant (4F5) Q5 (8RB) Q5 Van (8RB) Q7 (4LB) Q7 Van (4LB) PORSCHE CAYENNE (92A) VOLKSWAGEN TOUAREG (7LA, 7L6, 7L7) TOUAREG (7P5, 7P6)</p>	 <p>VOLKSWAGEN BEETLE (5C1, 5C2) BEETLE Convertible (5C7, 5C8) GOLF VI Variant (AJ5) JETTA III (1K2) JETTA IV (162, 163, AV3, AV2)</p>	<p>VAUXHALL ASTRA Mk V (H) (A04) ASTRA Mk V (H) Estate (A04) ASTRA Mk V (H) Sport Hatch (A04) CORSA Mk III (D) (S07) ZAFIRA Mk II (B) (A05)</p>
 <p>CHEVROLET AVEO Hatchback (T300) AVEO Saloon (T300) OPEL ASTRA J (P10) ASTRA J Saloon CORSA D (S07) CORSA D Hatchback Van (S07) MERIVA B MPV (S10) VAUXHALL ASTRA Mk VI (J) (P10) ASTRA Mk VI (J) Saloon (P10) CORSA Mk III (D) (S07) CORSAVAN Mk III (D) Hatchback Van (S07) MERIVA Mk II (B) (S10)</p>	 <p>VOLKSWAGEN CADDY III Box Body/MPV (2KA, 2KH, 2CA, 2CH) CADDY III MPV (2KB, 2KJ, 2CB, 2CJ) CADDY IV Box Body/MPV (SAA, SAH) CADDY IV MPV (SAB, SAJ) TOURAN (1T3)</p>	 <p>SEAT IBIZA IV (6J5, 6P1) IBIZA IV SC (6J1, 6P5) IBIZA IV ST (6J8, 6P8) SKODA FABIA II (542) FABIA II Combi (545) ROOMSTER (5J7) ROOMSTER Praktik (5J) VOLKSWAGEN POLO V (6R1, 6C1)</p>
 <p>OPEL ASTRA H (A04) ASTRA H Estate (A04) ASTRA H Estate Van (L70) ASTRA H GTC (A04) ASTRA H Saloon (A04) CORSA D (S07) MERIVA A MPV (X03) ZAFIRA / ZAFIRA FAMILY B (A05)</p>	 <p>MERCEDES-BENZ C-CLASS (W204) C-CLASS T-Model (S204) E-CLASS (W212) E-CLASS Convertible (A207) E-CLASS Coupe (C207) E-CLASS T-Model (S212) G-CLASS (W463) G-CLASS Cabrio (W463) GLK-CLASS (X204)</p>	



ATS 7.08369.52.0



AUDI
 A4 Allroad B8 (8KH)
 A4 B8 (8K2)
 A4 B8 Avant (8K5)
 A5 Sportback (8TA)
 Q5 (8RB)

ATS 7.08369.53.0



SEAT
 CORDOBA (6L2)
 IBIZA III (6L1)
 IBIZA IV (6J5, 6P1)
 IBIZA IV SC (6J1, 6P5)

SKODA
 FABIA II (542)
 FABIA II Combi (545)
 ROOMSTER (5J7)
 ROOMSTER Praktik (5J)

VOLKSWAGEN
 POLO (9N_)

ATS 7.08369.54.0



CHEVROLET
 CAPTIVA (C100, C140)

ATS 7.08369.54.0

OPEL
 ANTARA A (L07)

ATS 7.08369.55.0



VOLVO
 S60 I (384)
 V70 II (285)
 V70 III (135)
 XC70 CROSS COUNTRY I (295)
 XC70 II (136)
 XC90 I (275)

ATS 7.08369.56.0



VOLKSWAGEN
 TIGUAN (5N_)

ATS 7.08369.57.0



ALFA ROMEO
 159 (939_)
 159 Sportwagon (939_)
 BRERA (939_)
 SPIDER (939_)

ATS 7.08369.58.0



VOLKSWAGEN
 CRAFTER 30-35 Bus (2E_)
 CRAFTER 30-50 Platform/Chassis (2F_)
 CRAFTER 30-50 Van (2E_)

ATS 7.08369.59.0



VOLKSWAGEN
 AMAROK (2HA, 2HB, S1B, S6B, S7A, S7B)
 CRAFTER 30-35 Bus (2E_)
 CRAFTER 30-50 Van (2E_)

ATS 7.08369.60.0



MERCEDES-BENZ
 A-CLASS (W169)
 B-CLASS Sports Tourer (W245)



ATS 7.08369.61.0	ATS 7.08369.63.0	ATS 7.08369.66.0
 <p>MERCEDES-BENZ C-CLASS (W204) C-CLASS T-Model (S204) CLS (C218) CLS Shooting Brake (X218) E-CLASS (W212) E-CLASS Convertible (A207) E-CLASS Coupe (C207) E-CLASS T-Model (S212) GL-CLASS (X164) GLK-CLASS (X204) M-CLASS (W164) S-CLASS (W221) S-CLASS (W222, V222, X222) SPRINTER 3,5-t Bus (B906) SPRINTER 3,5-t Platform/Chassis (B906) SPRINTER 3,5-t Van (B906) SPRINTER 3-t Bus (B906) SPRINTER 3-t Platform/Chassis (B906) SPRINTER 3-t Van (B906) SPRINTER 5-t Platform/Chassis (B906) SPRINTER 5-t Van (B906) VITO Mixto (Double Cabin) (W447) VITO Tourer (W447) VITO Van (W447)</p>	 <p>VOLKSWAGEN MULTIVAN V (7HM, 7HN, 7HF, 7EF, 7EM, 7EN) TRANSPORTER V Bus (7HB, 7HJ, 7EB, 7EJ, 7EF, 7EG, 7HF, 7EC) TRANSPORTER V Platform/Chassis (7JD, 7JE, 7JL, 7JY, 7JZ, 7FD) TRANSPORTER V Van (7HA, 7HH, 7EA, 7EH)</p>	 <p>AUDI A6 Allroad C6 (4FH) A6 C6 (4F2) A6 C6 Avant (4F5) A8 D3 (4E2, 4E8)</p>
<p>ATS 7.08369.62.0</p>  <p>AUDI Q7 (4LB) VOLKSWAGEN TOUAREG (7LA, 7L6, 7L7)</p>	<p>ATS 7.08369.65.0</p>  <p>AUDI A4 B7 (8EC) A4 B7 Avant (8ED)</p>	<p>ATS 7.08369.68.0</p>  <p>AUDI Q7 (4LB) VOLKSWAGEN TOUAREG (7LA, 7L6, 7L7) TOUAREG (7P5, 7P6)</p>
<p>ATS 7.08369.64.0</p>  <p>VOLKSWAGEN CRAFTER 30-35 Bus (2E_) CRAFTER 30-50 Platform/Chassis (2F_) CRAFTER 30-50 Van (2E_)</p>	<p>ATS 7.08369.67.0</p>  <p>OPEL CORSA D (S07) CORSA D Hatchback Van (S07) VAUXHALL CORSA Mk III (D) (S07) CORSAVAN Mk III (D) Hatchback Van (S07)</p>	



ATS 7.08369.69.0 **ATS 7.08369.73.0** **ATS 7.08369.75.0** **New**



VOLVO
S60 I (384)
V70 II (285)
XC70 CROSS COUNTRY I (295)
XC90 I (275)



AUDI
A4 Allroad B8 (8KH)
A4 B8 (8K2)
A4 B8 Avant (8K5)
A5 (8T3)
A5 Convertible (8F7)
A5 Sportback (8TA)
A6 Allroad C7 (4GH, 4GJ)
A6 C7 (4G2, 4GC)
A6 C7 Avant (4G5, 4GD)
A7 Sportback (4GA, 4GF)
A8 D4 (4H2, 4H8, 4HC, 4HL)
Q5 (8RB)
Q7 (4LB)
PORSCHE
CAYENNE (92A)
MACAN (95B)
PANAMERA (970)
VOLKSWAGEN
TOUAREG (7P5, 7P6)



OPEL
ASTRA H (A04)
ASTRA H Estate Van (L70)
ASTRA H GTC (A04)
ZAFIRA / ZAFIRA FAMILY B (A05)
ZAFIRA B Box Body/MPV (A05)
VAUXHALL
ASTRA Mk V (H) (A04)
ASTRA Mk V (H) Estate (A04)
ASTRA Mk V (H) Sport Hatch (A04)
ASTRAVAN Mk V (H) Estate Van (A04)
ZAFIRA Mk II (B) (A05)

ATS 7.08369.70.0



CHEVROLET
CAPTIVA (C100, C140)

OPEL
ANTARA A (L07)
VAUXHALL
ANTARA A (L07)

ATS 7.08369.74.0 **New**



OPEL
ASTRA H (A04)
ASTRA H Estate (A04)
ASTRA H Estate Van (L70)
ASTRA H Saloon (A04)
ZAFIRA / ZAFIRA FAMILY B (A05)
ZAFIRA B Box Body/MPV (A05)
VAUXHALL
ASTRA Mk V (H) (A04)
ASTRA Mk V (H) Estate (A04)
ASTRAVAN Mk V (H) Estate Van (A04)
ZAFIRA Mk II (B) (A05)

ATS 7.08369.76.0 **New**



MERCEDES-BENZ
C-CLASS (W205)
C-CLASS Convertible (A205)
C-CLASS Coupe (C205)
C-CLASS T-Model (S205)
CLS (C218)
CLS Shooting Brake (X218)
E-CLASS (W212)
E-CLASS Convertible (A207)
E-CLASS Coupe (C207)
E-CLASS T-Model (S212)
GLC (X253)
GLC Coupe (C253)
SLK (R172)

ATS 7.08369.72.0



SKODA
SUPERB I (3U4)
VOLKSWAGEN
PASSAT B5.5 (3B3)
PASSAT B5.5 Variant (3B6)





ATS 7.08369.77.0 New	ATS 7.08369.79.0 New	ATS 7.08369.81.0 New
 <p>MERCEDES-BENZ G-CLASS (W463) G-CLASS Cabrio (W463) GL-CLASS (X164) GL-CLASS (X166) GLE (W166) GLE Coupe (C292) M-CLASS (W164) M-CLASS (W166)</p>	<p>LEON SC (5F5) LEON ST (5F8) LEON ST Estate Van (5F8) SKODA KAROQ (NU7) OCTAVIA III (5E3, NL3, NR3) OCTAVIA III Combi (5E5, 5E6) VOLKSWAGEN GOLF ALLTRACK VII Variant (BA5, BV5) GOLF SPORTSVAN VII (AM1, AN1) GOLF VAN VII Variant (BA5) GOLF VII (5G1, BQ1, BE1, BE2) GOLF VII Van (5G1) GOLF VII Variant (BA5, BV5)</p>	<p>TT (FV3, FVP) TT Roadster (FV9, FVR) SEAT ALHAMBRA (710, 711) ATECA (KH7, KHP) LEON (5F1) LEON Hatchback Van (5F1) LEON SC (5F5) LEON ST (5F8) LEON ST Estate Van (5F8) TARRACO (KN2) SKODA KAROQ (NU7) KODIAQ (NS7, NV7) OCTAVIA III (5E3, NL3, NR3) OCTAVIA III Combi (5E5, 5E6) SUPERB III (3V3) SUPERB III Estate (3V5) VOLKSWAGEN ARTEON (3H7, 3H8) BEETLE (5C1, 5C2) GOLF ALLTRACK VII Variant (BA5, BV5) GOLF SPORTSVAN VII (AM1, AN1) GOLF VAN VII Variant (BA5) GOLF VII (5G1, BQ1, BE1, BE2) GOLF VII Variant (BA5, BV5) JETTA IV (162, 163, AV3, AV2) PASSAT ALLTRACK B8 Variant (3G5, CB5) PASSAT B7 (A32, A33) PASSAT B8 (3G2, CB2) PASSAT B8 Variant (3G5, CB5) SHARAN (7N1, 7N2) T-ROC (A11) TIGUAN (AD1, AX1) TIGUAN ALLSPACE (BW2) TOURAN (5T1)</p>
 <p>VOLKSWAGEN CRAFTER 30-35 Bus (2E_) CRAFTER 30-50 Platform/Chassis (2F_) CRAFTER 30-50 Van (2E_)</p>	 <p>MERCEDES-BENZ C-CLASS (W203) C-CLASS Coupe (CL203) C-CLASS T-Model (S203) CLC-CLASS (CL203) CLK (C209) E-CLASS (W211) E-CLASS Platform/Chassis (VF211) E-CLASS T-Model (S211) VIANO (W639) VITO / MIXTO Van (W639) VITO Bus (W639)</p>	<p>ATS 7.08369.80.0 New</p>
 <p>AUDI A3 (8V1, 8VK) A3 Convertible (8V7, 8VE) A3 Limousine (8VS, 8VM) A3 Sportback (8VA, 8VF) SEAT LEON (5F1) LEON Hatchback Van (5F1)</p>	 <p>AUDI A3 (8V1, 8VK) A3 Convertible (8V7, 8VE) A3 Limousine (8VS, 8VM) A3 Sportback (8VA, 8VF) Q2 (GAB, GAG) Q3 (F3B) Q3 Sportback (F3N)</p>	 <p>AUDI A3 (8V1, 8VK) A3 Convertible (8V7, 8VE) A3 Limousine (8VS, 8VM) A3 Sportback (8VA, 8VF) SEAT LEON (5F1) LEON Hatchback Van (5F1) LEON SC (5F5) LEON ST (5F8) LEON ST Estate Van (5F8)</p>

EMISSION CONTROL





ATS 7.08369.82.0 New

SKODA
 KAROQ (NU7)
 OCTAVIA III (5E3, NL3, NR3)
 OCTAVIA III Combi (5E5, 5E6)

VOLKSWAGEN
 GOLF ALLTRACK VII Variant (BA5, BV5)
 GOLF SPORTSVAN VII (AM1, AN1)
 GOLF VAN VII Variant (BA5)
 GOLF VII (5G1, BQ1, BE1, BE2)
 GOLF VII Van (5G1)
 GOLF VII Variant (BA5, BV5)

ATS 7.08369.85.0 New

SMART
 FORFOUR (454)



ATS 7.08369.87.0 New

VIANO (W639)
 VITO / MIXTO Van (W639)
 VITO Bus (W639)
 VITO Mixto (Double Cabin) (W447)
 VITO Tourer (W447)
 VITO Van (W447)



SEAT
 IBIZA IV (6J5, 6P1)
 IBIZA IV SC (6J1, 6P5)
 IBIZA IV ST (6J8, 6P8)

SKODA
 FABIA II (542)
 FABIA II Combi (545)
 ROOMSTER (5J7)
 ROOMSTER Praktik (5J)

VOLKSWAGEN
 POLO V (6R1, 6C1)
 POLO Van (6R)

SEAT
 CORDOBA (6L2)
 EXEO (3R2)
 EXEO ST (3R5)
 IBIZA III (6L1)
 IBIZA IV (6J5, 6P1)
 IBIZA IV SC (6J1, 6P5)

SKODA
 FABIA II (542)
 FABIA II Combi (545)
 ROOMSTER (5J7)
 ROOMSTER Praktik (5J)

VOLKSWAGEN
 POLO (9N_)

MERCEDES-BENZ
 C-CLASS (W205)
 C-CLASS Convertible (A205)
 C-CLASS Coupe (C205)
 C-CLASS T-Model (S205)
 S-CLASS (W221)



VOLKSWAGEN
 CADDY III Box Body/MPV (2KA, 2KH, 2CA, 2CH)
 CADDY III MPV (2KB, 2KJ, 2CB, 2CJ)
 PASSAT B6 (3C2)
 PASSAT B6 Variant (3C5)
 TOURAN (1T1, 1T2)
 ENGINE

MERCEDES-BENZ
 E-CLASS (W211)
 E-CLASS T-Model (S211)
 G-CLASS (W461)
 G-CLASS (W463)
 G-CLASS Cabrio (W463)
 GL-CLASS (X164)
 M-CLASS (W164)
 MARCO POLO Camper (W447)
 R-CLASS (W251, V251)
 V-CLASS (W447)

MERCEDES-BENZ
 A-CLASS (W176)
 B-CLASS Sports Tourer (W246, W242)
 CLA Coupe (C117)
 CLA Shooting Brake (X117)
 CLS (C218)
 CLS Shooting Brake (X218)
 E-CLASS (W212)
 E-CLASS Convertible (A207)
 E-CLASS Coupe (C207)
 E-CLASS T-Model (S212)
 GLA-CLASS (X156)

EMISSION CONTROL



ATS 7.08369.90.0 New



MERCEDES-BENZ

- C-CLASS (W204)
- C-CLASS Coupe (C204)
- C-CLASS T-Model (S204)
- CLS (C218)
- CLS Shooting Brake (X218)
- E-CLASS (W212)
- E-CLASS Convertible (A207)
- E-CLASS Coupe (C207)
- E-CLASS T-Model (S212)
- GLE (W166)
- M-CLASS (W166)
- SLC (R172)
- SLK (R172)
- SPRINTER CLASSIC 3,5-t Van (B909)
- SPRINTER CLASSIC 4,6-t Bus (B909)

ATS 7.08369.91.0 New



MERCEDES-BENZ

- E-CLASS (W211)
- E-CLASS T-Model (S211)
- M-CLASS (W164)
- R-CLASS (W251, V251)
- S-CLASS (W220)
- SPRINTER 3,5-t Bus (B906)
- SPRINTER 3,5-t Platform/Chassis (B906)
- SPRINTER 3,5-t Van (B906)
- SPRINTER 3-t Bus (B906)
- SPRINTER 3-t Platform/Chassis (B906)
- SPRINTER 3-t Van (B906)
- SPRINTER 4,6-t Platform/Chassis (B906)
- SPRINTER 5-t Platform/Chassis (B906)
- SPRINTER 5-t Van (B906)
- SPRINTER CLASSIC 3,5-t Van (B909)
- SPRINTER CLASSIC 4,6-t Bus (B909)
- VIANO (W639)
- VITO / MIXTO Van (W639)
- VITO Bus (W639)

ATS 7.08369.92.0 New



VOLKSWAGEN

- MULTIVAN V (7HM, 7HN, 7HF, 7EF, 7EM, 7EN)
- TRANSPORTER V Bus (7HB, 7HJ, 7EB, 7EJ, 7EF, 7EG, 7HF, 7EC)
- TRANSPORTER V Platform/Chassis (7JD, 7JE, 7JL, 7JY, 7JZ, 7FD)
- TRANSPORTER V Van (7HA, 7HH, 7EA, 7EH)

ATS 7.08369.93.0 New



VOLKSWAGEN

- CRAFTER 30-35 Bus (2E_)
- CRAFTER 30-50 Platform/Chassis (2F_)
- CRAFTER 30-50 Van (2E_)
- MULTIVAN V (7HM, 7HN, 7HF, 7EF, 7EM, 7EN)
- TRANSPORTER V Bus (7HB, 7HJ, 7EB, 7EJ, 7EF, 7EG, 7HF, 7EC)
- TRANSPORTER V Platform/Chassis (7JD, 7JE, 7JL, 7JY, 7JZ, 7FD)
- TRANSPORTER V Van (7HA, 7HH, 7EA, 7EH)

ATS 7.08369.94.0 New



MERCEDES-BENZ

- C-CLASS (W203)
- C-CLASS Coupe (CL203)
- C-CLASS T-Model (S203)
- CLC-CLASS (CL203)

ATS 7.08369.94.0 New

- CLK (C209)
- E-CLASS (W211)
- E-CLASS T-Model (S211)
- G-CLASS (W461)
- GL-CLASS (X164)
- M-CLASS (W164)
- R-CLASS (W251, V251)
- S-CLASS (W221)
- VIANO (W639)
- VITO / MIXTO Van (W639)
- VITO Bus (W639)

ATS 7.08369.95.0 New



AUDI

- A3 (8V1, 8VK)
- A3 Convertible (8V7, 8VE)
- A3 Limousine (8VS, 8VM)
- A3 Sportback (8VA, 8VF)
- Q2 (GAB, GAG)

SEAT

- ATECA (KH7, KHP)
- LEON (5F1)
- LEON Hatchback Van (5F1)
- LEON SC (5F5)
- LEON ST (5F8)
- LEON ST Estate Van (5F8)

SKODA

- KAROQ (NU7)
- OCTAVIA III (5E3, NL3, NR3)
- OCTAVIA III Combi (5E5, 5E6)
- SUPERB III (3V3)
- SUPERB III Estate (3V5)

VOLKSWAGEN

- GOLF ALLTRACK VII Variant (BA5, BV5)
- GOLF SPORTSVAN VII (AM1, AN1)
- GOLF VAN VII Variant (BA5)
- GOLF VII (5G1, BQ1, BE1, BE2)
- GOLF VII Van (5G1)
- GOLF VII Variant (BA5, BV5)
- PASSAT B8 (3G2, CB2)
- PASSAT B8 Variant (3G5, CB5)

EMISSION CONTROL





ATS 7.08369.96.0 New



VOLKSWAGEN
 MULTIVAN V (7HM, 7HN, 7HF, 7EF, 7EM, 7EN)
 TRANSPORTER V Bus (7HB, 7HJ, 7EB, 7EJ, 7EF, 7EG, 7HF, 7EC)
 TRANSPORTER V Platform/Chassis (7JD, 7JE, 7JL, 7JY, 7JZ, 7FD)
 TRANSPORTER V Van (7HA, 7HH, 7EA, 7EH)

ATS 7.08369.98.0 New



CITROEN
 JUMPER Bus
 JUMPER Platform/Chassis
 JUMPER Van
FIAT
 DUCATO Bus (250_)
 DUCATO Platform/Chassis (250_)
 DUCATO Van (250_)

ATS 7.11020.00.0 New



MERCEDES-BENZ
 C-CLASS (W204)
 C-CLASS Coupe (C204)
 C-CLASS T-Model (S204)
 CLS (C218)
 E-CLASS (W212)
 E-CLASS T-Model (S212)

ATS 7.08369.97.0 New



MERCEDES-BENZ
 B-CLASS Sports Tourer (W246, W242)
 C-CLASS (W203)
 C-CLASS Coupe (CL203)
 C-CLASS T-Model (S203)
 CLC-CLASS (CL203)
 CLS (C218)
 CLS Shooting Brake (X218)
 E-CLASS (W212)
 E-CLASS Convertible (A207)
 E-CLASS Coupe (C207)
 E-CLASS T-Model (S212)
 MARCO POLO Camper (W447)
 V-CLASS (W447)
 VITO Mixto (Double Cabin) (W447)
 VITO Tourer (W447)
 VITO Van (W447)

ATS 7.08369.99.0 New



CITROEN
 JUMPER Bus
 JUMPER Platform/Chassis
 JUMPER Van
FIAT
 DUCATO Bus (250_)
 DUCATO Platform/Chassis (250_)
 DUCATO Van (250_)

ATS 7.11020.01.0 New



MERCEDES-BENZ
 A-CLASS (W176)
 B-CLASS Sports Tourer (W246, W242)
 C-CLASS (W204)
 C-CLASS T-Model (S204)
 CLA Coupe (C117)
 CLA Shooting Brake (X117)
 CLS (C218)
 CLS Shooting Brake (X218)
 E-CLASS (W212)
 E-CLASS (W213)
 E-CLASS All-Terrain (S213)
 E-CLASS Convertible (A207)
 E-CLASS Convertible (A238)
 E-CLASS Coupe (C207)
 E-CLASS Coupe (C238)
 E-CLASS T-Model (S212)
 E-CLASS T-Model (S213)
 GL-CLASS (X166)
 GLA-CLASS (X156)
 GLC (X253)
 GLC Coupe (C253)
 GLE (W166)
 GLE Coupe (C292)
 GLK-CLASS (X204)
 GLS (X166)
 M-CLASS (W166)
 R-CLASS (W251, V251)
 S-CLASS (W221)





ATS 7.11020.01.0 New
 S-CLASS (W222, V222, X222)
 SPRINTER CLASSIC 3,5-t Van (B909)
 SPRINTER CLASSIC 4,6-t Bus (B909)

ATS 7.11020.02.0 New



SEAT
 CORDOBA (6L2)
 IBIZA III (6L1)
 IBIZA IV (6J5, 6P1)
 IBIZA IV SC (6J1, 6P5)
SKODA
 FABIA II (542)
 FABIA II Combi (545)
 ROOMSTER (5J7)
 ROOMSTER Praktik (5J)
VOLKSWAGEN
 POLO (9N_)

ATS 7.11020.03.0 New



SEAT
 CORDOBA (6L2)
 IBIZA III (6L1)
 IBIZA IV (6J5, 6P1)
 IBIZA IV SC (6J1, 6P5)
SKODA
 FABIA II (542)
 FABIA II Combi (545)
 ROOMSTER (5J7)
 ROOMSTER Praktik (5J)
VOLKSWAGEN
 POLO (9N_)
 ENGINE

ATS 7.11020.04.0 New



ALFA ROMEO
 MITO (955_)
FIAT
 GRANDE PUNTO (199_)
 GRANDE PUNTO Van (199_)
 PUNTO (199_)
 PUNTO EVO (199_)
 PUNTO EVO Hatchback Van (199_)
 PUNTO Hatchback Van (199_)

ATS 7.11020.05.0 New



MERCEDES-BENZ
 A-CLASS (W169)
 B-CLASS Sports Tourer (W245)

ATS 7.11020.06.0 New



VOLKSWAGEN
 MULTIVAN V (7HM, 7HN, 7HF, 7EF, 7EM, 7EN)
 TRANSPORTER V Bus (7HB, 7HJ, 7EB, 7EJ, 7EF, 7EG, 7HF, 7EC)
 TRANSPORTER V Platform/Chassis (7JD, 7JE, 7JL, 7JY, 7JZ, 7FD)
 TRANSPORTER V Van (7HA, 7HH, 7EA, 7EH)

ATS 7.11020.07.0 New



SEAT
 CORDOBA (6L2)
 IBIZA III (6L1)
 IBIZA IV (6J5, 6P1)
 IBIZA IV SC (6J1, 6P5)
SKODA
 FABIA II (542)
 FABIA II Combi (545)
 ROOMSTER (5J7)
 ROOMSTER Praktik (5J)
VOLKSWAGEN
 POLO (9N_)

ATS 7.11020.08.0 New



ALFA ROMEO
 MITO (955_)
FIAT
 GRANDE PUNTO (199_)
 GRANDE PUNTO Van (199_)

ATS 7.11020.09.0 New



ALFA ROMEO
 159 (939_)
 159 Sportwagon (939_)
 BRERA (939_)

EMISSION CONTROL





ATS 7.11020.09.0 New
 SPIDER (939_)
FIAT
 DOBLO Box Body/MPV (223_)
 DOBLO MPV (119_, 223_)
 FREEMONT (345_)
JEEP
 CHEROKEE (KL)



MERCEDES-BENZ
 A-CLASS (W169)
 B-CLASS Sports Tourer (W245)



FIAT
 DUCATO Bus (250_)
 DUCATO Platform/Chassis (250_)
 DUCATO Van (250_)



ALFA ROMEO
 GIULIETTA (940_)
FIAT
 BRAVO II (198_)
LANCIA
 DELTA III (844_)



VOLVO
 S80 II (124)
 V70 III (135)
 XC60 I SUV (156)
 XC70 II (136)



MERCEDES-BENZ
 C-CLASS (W204)
 C-CLASS T-Model (S204)
 GLK-CLASS (X204)
 SPRINTER 3,5-t Bus (B906)
 SPRINTER 3,5-t Platform/Chassis (B906)
 SPRINTER 3,5-t Platform/Chassis (B907, B910)
 SPRINTER 3,5-t Tourer Bus (B907)
 SPRINTER 3,5-t Van (B906)
 SPRINTER 3,5-t Van (B907, B910)
 SPRINTER 3-t Bus (B906)
 SPRINTER 3-t Platform/Chassis (B906)
 SPRINTER 3-t Platform/Chassis (B910, B907)
 SPRINTER 3-t Tourer Bus (B907)
 SPRINTER 3-t Van (B906)
 SPRINTER 4,6-t Platform/Chassis (B906)
 SPRINTER 4,6-t Van (B906)
 SPRINTER 4-t Platform/Chassis (B907, B910)
 SPRINTER 4-t Van (B907, B910)
 SPRINTER 5-t Platform/Chassis (B906)
 SPRINTER 5-t Platform/Chassis (B907)
 SPRINTER 5-t Tourer Bus (B907)
 SPRINTER 5-t Van (B906)
 SPRINTER 5-t Van (B907)



MERCEDES-BENZ
 C-CLASS (W204)
 C-CLASS T-Model (S204)
 GL-CLASS (X164)
 M-CLASS (W164)
 R-CLASS (W251, V251)
 S-CLASS (W221)
SMART
 FORTWO Cabrio (451)
 FORTWO Coupe (451)



VOLVO
 C30 (533)
 C70 II Convertible (542)
 S40 II (544)
 S60 II (134)
 S80 II (124)
 V50 (545)
 V60 I (155, 157)
 V70 III (135)
 XC60 I SUV (156)
 XC70 II (136)

EMISSION CONTROL



ATS 7.11020.17.0 New



AUDI

- A3 (8V1, 8VK)
- A3 Convertible (8V7, 8VE)
- A3 Limousine (8VS, 8VM)
- A3 Sportback (8VA, 8VF)
- Q2 (GAB, GAG)

SEAT

- ARONA (KJ7)
- ATECA (KH7, KHP)
- IBIZA V (KJ1)
- LEON (5F1)
- LEON SC (5F5)
- LEON ST (5F8)
- LEON ST Estate Van (5F8)

SKODA

- KAMIQ (NW4)
- KAROQ (NU7)
- OCTAVIA III (5E3, NL3, NR3)
- OCTAVIA III Combi (5E5, 5E6)
- SCALA (NW1)
- SUPERB III (3V3)
- SUPERB III Estate (3V5)

VOLKSWAGEN

- GOLF ALLTRACK VII Variant (BA5, BV5)
- GOLF SPORTSVAN VII (AM1, AN1)
- GOLF VAN VII Variant (BA5)
- GOLF VII (5G1, BQ1, BE1, BE2)
- GOLF VII Variant (BA5, BV5)
- PASSAT B8 (3G2, CB2)
- PASSAT B8 Variant (3G5, CB5)
- POLO VI (AW1, BZ1)
- T-CROSS (C11)
- T-ROC (A11)

ATS 7.11020.18.0 New

- A3 Limousine (8VS, 8VM)
 - A3 Sportback (8VA, 8VF)
- SEAT**
- LEON (5F1)
 - LEON Hatchback Van (5F1)
 - LEON SC (5F5)
 - LEON ST (5F8)
 - LEON ST Estate Van (5F8)

SKODA

- KAROQ (NU7)
- OCTAVIA III (5E3, NL3, NR3)
- OCTAVIA III Combi (5E5, 5E6)

VOLKSWAGEN

- GOLF VAN VII Variant (BA5)
- GOLF VII (5G1, BQ1, BE1, BE2)
- GOLF VII Variant (BA5, BV5)

ATS 7.11020.21.0 New



AUDI

- A4 Allroad B8 (8KH)
- A4 B8 (8K2)
- A4 B8 Avant (8K5)
- A5 (8T3)
- A5 Convertible (8F7)
- A5 Sportback (8TA)
- A6 C7 (4G2, 4GC)
- A6 C7 Avant (4G5, 4GD)
- Q5 (8RB)

ATS 7.11020.19.0 New



VOLKSWAGEN

- AMAROK (2HA, 2HB, S1B, S6B, S7A, S7B)
- AMAROK Platform/Chassis (S1B, S6B, S7B)

ATS 7.11020.22.0 New



AUDI

- A3 Limousine (8VS, 8VM)
- A3 Sportback (8VA, 8VF)
- Q2 (GAB, GAG)

SEAT

- ARONA (KJ7)
- ATECA (KH7, KHP)
- IBIZA V (KJ1)
- LEON (5F1)
- LEON Hatchback Van (5F1)
- LEON SC (5F5)
- LEON ST (5F8)
- LEON ST Estate Van (5F8)

SKODA

- KAROQ (NU7)
- OCTAVIA III (5E3, NL3, NR3)
- OCTAVIA III Combi (5E5, 5E6)
- SUPERB III (3V3)
- SUPERB III Estate (3V5)

VOLKSWAGEN

- CRAFTER Bus (SY1, SYJ)
- CRAFTER Platform/Chassis (SZ_)
- CRAFTER Van (SY_, SX_)
- GOLF SPORTSVAN VII (AM1, AN1)
- GOLF VII (5G1, BQ1, BE1, BE2)
- GOLF VII Variant (BA5, BV5)

ATS 7.11020.18.0 New



AUDI

- A3 (8V1, 8VK)
- A3 Convertible (8V7, 8VE)

VOLKSWAGEN

- AMAROK (2HA, 2HB, S1B, S6B, S7A, S7B)
- AMAROK Platform/Chassis (S1B, S6B, S7B)





ATS 7.11020.22.0 New	ATS 7.11020.24.0 New	ATS 7.11020.26.0 New
<p>PASSAT B8 (3G2, CB2) PASSAT B8 Variant (3G5, CB5) POLO VI (AW1, BZ1) T-CROSS (C11) T-ROC (A11)</p>		
<p>ATS 7.11020.23.0 New</p>  <p>AUDI A3 Limousine (8VS, 8VM) A3 Sportback (8VA, 8VF) Q2 (GAB, GAG)</p> <p>SEAT ARONA (KJ7) ATECA (KH7, KHP) IBIZA V (KJ1) LEON (5F1) LEON Hatchback Van (5F1) LEON SC (5F5) LEON ST (5F8) LEON ST Estate Van (5F8)</p> <p>SKODA KAMIQ (NW4) KAROQ (NU7) OCTAVIA III (5E3, NL3, NR3) OCTAVIA III Combi (5E5, 5E6) SCALA (NW1) SUPERB III (3V3) SUPERB III Estate (3V5)</p> <p>VOLKSWAGEN GOLF SPORTSVAN VII (AM1, AN1) GOLF VII (5G1, BQ1, BE1, BE2) GOLF VII Variant (BA5, BV5) PASSAT B8 (3G2, CB2) PASSAT B8 Variant (3G5, CB5) POLO VI (AW1, BZ1) T-CROSS (C11) T-ROC (A11)</p>	<p>AUDI A4 Allroad B9 (8WH, 8WJ) A4 B9 (8W2, 8WC) A4 B9 Avant (8W5, 8WD) A5 (F53, F5P) A5 Convertible (F57, F5E) A5 Sportback (F5A, F5F) A6 Allroad C7 (4GH, 4GJ) A6 C7 (4G2, 4GC) A6 C7 Avant (4G5, 4GD) A7 Sportback (4GA, 4GF) A7 Sportback (4KA) A8 D5 (4N2, 4N8) Q5 (FYB, FYG) Q7 (4MB, 4MG) Q8 (4MN)</p> <p>VOLKSWAGEN TOUAREG (CR7)</p>	<p>AUDI Q2 (GAB, GAG) Q3 (F3B) Q3 Sportback (F3N)</p> <p>SEAT ATECA (KH7, KHP) TARRACO (KN2)</p> <p>SKODA KODIAQ (NS7, NV7) SUPERB III (3V3) SUPERB III Estate (3V5)</p> <p>VOLKSWAGEN ARTEON (3H7, 3H8) PASSAT ALLTRACK B8 Variant (3G5, CB5) PASSAT B8 (3G2, CB2) PASSAT B8 Variant (3G5, CB5) T-ROC (A11) TIGUAN (AD1, AX1) TIGUAN ALLSPACE (BW2) TOURAN (5T1)</p>
	<p>ATS 7.11020.25.0 New</p> 	<p>ATS 7.11020.27.0 New</p> 
	<p>AUDI A4 Allroad B8 (8KH) A4 B8 (8K2) A4 B8 Avant (8K5) A5 (8T3) A5 Convertible (8F7) A5 Sportback (8TA) A6 Allroad C7 (4GH, 4GJ) A6 C7 (4G2, 4GC) A6 C7 Avant (4G5, 4GD) A7 Sportback (4GA, 4GF) A8 D4 (4H2, 4H8, 4HC, 4HL) Q5 (8RB) Q7 (4LB)</p> <p>PORSCHE MACAN (95B)</p>	<p>CHEVROLET TRAX</p> <p>OPEL ASTRA J (P10) ASTRA J Estate Van (P10) ASTRA J Hatchback Van (P10) ASTRA J Sports Tourer (P10) ASTRA K (B16) ASTRA K Sports Tourer (B16) INSIGNIA A (G09) INSIGNIA A Country Tourer (G09) INSIGNIA A Saloon (G09) INSIGNIA A Sports Tourer (G09) MERIVA B MPV (S10) MOKKA / MOKKA X (J13) ZAFIRA TOURER C (P12)</p>





ATS	7.11020.27.0	New
VAUXHALL		
ASTRA Mk VI (J) (P10)		
ASTRA Mk VI (J) Estate (P10)		
ASTRA Mk VI (J) GTC (P10)		
ASTRA Mk VII (K) (B16)		
ASTRA Mk VII (K) Estate (B16)		
INSIGNIA Mk I (A) Country Tourer (G09)		
INSIGNIA Mk I (A) Hatchback (G09)		
INSIGNIA Mk I (A) Saloon (G09)		
INSIGNIA Mk I (A) Sports Tourer (G09)		
MERIVA Mk II (B) (S10)		
MOKKA / MOKKA X (J13)		
ZAFIRA Mk III (P12)		

ATS	7.11020.29.0	New
		
MERCEDES-BENZ		
GL-CLASS (X166)		
GLE (W166)		
GLE Coupe (C292)		
GLS (X166)		
M-CLASS (W166)		

ATS	7.11020.31.0	New
A6 C8 Avant (4A5)		
Q5 (FYB, FYG)		

ATS	7.11020.32.0	New
		
MERCEDES-BENZ		
A-CLASS (W176)		
B-CLASS Sports Tourer (W246, W242)		
CLA Coupe (C117)		
CLA Shooting Brake (X117)		
GLA-CLASS (X156)		

ATS	7.11020.28.0	New
		
MERCEDES-BENZ		
G-CLASS (W463)		
G-CLASS Cabrio (W463)		
GL-CLASS (X164)		
M-CLASS (W164)		
SPRINTER 3,5-t Bus (B906)		
SPRINTER 3,5-t Platform/Chassis (B906)		
SPRINTER 3,5-t Platform/Chassis (B907, B910)		
SPRINTER 3,5-t Tourer Bus (B907)		
SPRINTER 3,5-t Van (B906)		
SPRINTER 3,5-t Van (B907, B910)		
SPRINTER 3-t Platform/Chassis (B906)		
SPRINTER 3-t Van (B906)		
SPRINTER 4,6-t Platform/Chassis (B906)		
SPRINTER 4,6-t Van (B906)		
SPRINTER 4-t Platform/Chassis (B907, B910)		
SPRINTER 4-t Van (B907, B910)		
SPRINTER 5-t Platform/Chassis (B906)		
SPRINTER 5-t Platform/Chassis (B907)		
SPRINTER 5-t Van (B906)		
SPRINTER 5-t Van (B907)		

ATS	7.11020.30.0	New
		
MERCEDES-BENZ		
GL-CLASS (X164)		
GL-CLASS (X166)		
GLE (W166)		
GLE Coupe (C292)		
GLS (X166)		
M-CLASS (W166)		

ATS	7.11020.33.0	New
		
MERCEDES-BENZ		
C-CLASS (W205)		
C-CLASS Coupe (C205)		
C-CLASS T-Model (S205)		
GLC (X253)		
GLC Coupe (C253)		

MERCEDES-BENZ		
G-CLASS (W463)		
G-CLASS Cabrio (W463)		
GL-CLASS (X164)		
M-CLASS (W164)		
SPRINTER 3,5-t Bus (B906)		
SPRINTER 3,5-t Platform/Chassis (B906)		
SPRINTER 3,5-t Platform/Chassis (B907, B910)		
SPRINTER 3,5-t Tourer Bus (B907)		
SPRINTER 3,5-t Van (B906)		
SPRINTER 3,5-t Van (B907, B910)		
SPRINTER 3-t Platform/Chassis (B906)		
SPRINTER 3-t Van (B906)		
SPRINTER 4,6-t Platform/Chassis (B906)		
SPRINTER 4,6-t Van (B906)		
SPRINTER 4-t Platform/Chassis (B907, B910)		
SPRINTER 4-t Van (B907, B910)		
SPRINTER 5-t Platform/Chassis (B906)		
SPRINTER 5-t Platform/Chassis (B907)		
SPRINTER 5-t Van (B906)		
SPRINTER 5-t Van (B907)		

ATS	7.11020.31.0	New
		
AUDI		
A4 B9 (8W2, 8WC)		
A4 B9 Avant (8W5, 8WD)		
A5 (F53, F5P)		
A5 Convertible (F57, F5E)		
A5 Sportback (F5A, F5F)		
A6 C8 (4A2)		

ATS	7.11020.31.0	New
A6 C8 Avant (4A5)		
Q5 (FYB, FYG)		

ATS	7.11020.35.0	New
		
MERCEDES-BENZ		
E-CLASS (W211)		
E-CLASS Platform/Chassis (VF211)		
E-CLASS T-Model (S211)		
SPRINTER 3,5-t Platform/Chassis (B906)		
SPRINTER 3,5-t Platform/Chassis (B907, B910)		





ATS	7.11020.35.0	New
SPRINTER 3,5-t Tourer Bus (B907)		
SPRINTER 3,5-t Van (B906)		
SPRINTER 3,5-t Van (B907, B910)		
SPRINTER 3-t Bus (B906)		
SPRINTER 3-t Platform/Chassis (B906)		
SPRINTER 3-t Platform/Chassis (B910, B907)		
SPRINTER 3-t Tourer Bus (B907)		
SPRINTER 3-t Van (B906)		
SPRINTER 4,6-t Platform/Chassis (B906)		
SPRINTER 4-t Platform/Chassis (B907, B910)		
SPRINTER 4-t Tourer Bus (B907)		
SPRINTER 4-t Van (B907, B910)		
SPRINTER 5-t Platform/Chassis (B906)		
SPRINTER 5-t Platform/Chassis (B907)		
SPRINTER 5-t Tourer Bus (B907)		
SPRINTER 5-t Van (B907)		
VITO Tourer (W447)		

ATS	7.11020.38.0	New
		
CHEVROLET		
CRUZE (J300)		
CRUZE Hatchback (J305)		
CRUZE Station Wagon (J308)		
TRAX		

ATS	7.11020.40.0	New
VITO / MIXTO Van (W639)		
VITO Bus (W639)		

ATS	7.11020.41.0	New
		
FIAT		
DOBLO Bus (263_)		
DOBLO Cargo (263_)		
DOBLO Platform/Chassis (263_)		
OPEL		
COMBO Box Body/MPV (X12)		
COMBO Tour (X12)		
VAUXHALL		
COMBO Mk III (D) Box Body/MPV (X12)		

ATS	7.11020.36.0	New
		
FIAT		
FIORINO Box Body/MPV (225_)		
QUBO (225_)		

ATS	7.11020.36.0	New
OPEL		
ASTRA J (P10)		
ASTRA J Estate Van (P10)		
ASTRA J Hatchback Van (P10)		
ASTRA J Sports Tourer (P10)		
MOKKA / MOKKA X (J13)		
VAUXHALL		
ASTRA Mk VI (J) (P10)		
ASTRA Mk VI (J) Estate (P10)		
ASTRA Mk VI (J) GTC (P10)		
ASTRA Mk VI (J) Saloon (P10)		
MOKKA / MOKKA X (J13)		

ATS	7.11020.42.0	New
		
CHEVROLET		
TRAX		
OPEL		
ASTRA J (P10)		
ASTRA J Estate Van (P10)		
ASTRA J Hatchback Van (P10)		
ASTRA J Sports Tourer (P10)		
ASTRA K (B16)		
ASTRA K Sports Tourer (B16)		
INSIGNIA B Sports Tourer Combi Van (Z18)		
MERIVA B MPV (S10)		
MOKKA / MOKKA X (J13)		
ZAFIRA TOURER C (P12)		
VAUXHALL		
ASTRA Mk VI (J) (P10)		
ASTRA Mk VI (J) Estate (P10)		
ASTRA Mk VI (J) GTC (P10)		
ASTRA Mk VII (K) (B16)		
ASTRA Mk VII (K) Estate (B16)		
INSIGNIA Mk II (B) Hatchback (Z18)		
INSIGNIA Mk II (B) Sports Tourer (Z18)		
MERIVA Mk II (B) (S10)		

ATS	7.11020.40.0	New
		
MERCEDES-BENZ		
G-CLASS (W461)		
SPRINTER 3,5-t Bus (B906)		
SPRINTER 3,5-t Platform/Chassis (B906)		
SPRINTER 3,5-t Platform/Chassis (B907, B910)		
SPRINTER 3,5-t Tourer Bus (B907)		
SPRINTER 3,5-t Van (B906)		
SPRINTER 3,5-t Van (B907, B910)		
SPRINTER 3-t Platform/Chassis (B906)		
SPRINTER 3-t Van (B906)		
SPRINTER 4,6-t Platform/Chassis (B906)		
SPRINTER 4,6-t Van (B906)		
SPRINTER 4-t Platform/Chassis (B907, B910)		
SPRINTER 4-t Van (B907, B910)		
SPRINTER 5-t Platform/Chassis (B906)		
SPRINTER 5-t Platform/Chassis (B907)		
SPRINTER 5-t Van (B906)		
SPRINTER 5-t Van (B907)		
VIANO (W639)		

ATS	7.11020.37.0	New
		
FIAT		
500 (312_)		
500 C (312_)		
500L (351_, 352_)		
PANDA (169_)		
PANDA (312_, 319_)		
PANDA Hatchback Van (169_)		
PANDA VAN (312_, 519_)		
LANCIA		
YPSILON (312_)		

ATS	7.11020.40.0	New
		
MERCEDES-BENZ		
G-CLASS (W461)		
SPRINTER 3,5-t Bus (B906)		
SPRINTER 3,5-t Platform/Chassis (B906)		
SPRINTER 3,5-t Platform/Chassis (B907, B910)		
SPRINTER 3,5-t Tourer Bus (B907)		
SPRINTER 3,5-t Van (B906)		
SPRINTER 3,5-t Van (B907, B910)		
SPRINTER 3-t Platform/Chassis (B906)		
SPRINTER 3-t Van (B906)		
SPRINTER 4,6-t Platform/Chassis (B906)		
SPRINTER 4,6-t Van (B906)		
SPRINTER 4-t Platform/Chassis (B907, B910)		
SPRINTER 4-t Van (B907, B910)		
SPRINTER 5-t Platform/Chassis (B906)		
SPRINTER 5-t Platform/Chassis (B907)		
SPRINTER 5-t Van (B906)		
SPRINTER 5-t Van (B907)		
VIANO (W639)		

ATS	7.11020.42.0	New
		
CHEVROLET		
TRAX		
OPEL		
ASTRA J (P10)		
ASTRA J Estate Van (P10)		
ASTRA J Hatchback Van (P10)		
ASTRA J Sports Tourer (P10)		
ASTRA K (B16)		
ASTRA K Sports Tourer (B16)		
INSIGNIA B Sports Tourer Combi Van (Z18)		
MERIVA B MPV (S10)		
MOKKA / MOKKA X (J13)		
ZAFIRA TOURER C (P12)		
VAUXHALL		
ASTRA Mk VI (J) (P10)		
ASTRA Mk VI (J) Estate (P10)		
ASTRA Mk VI (J) GTC (P10)		
ASTRA Mk VII (K) (B16)		
ASTRA Mk VII (K) Estate (B16)		
INSIGNIA Mk II (B) Hatchback (Z18)		
INSIGNIA Mk II (B) Sports Tourer (Z18)		
MERIVA Mk II (B) (S10)		

EMISSION CONTROL



ATS 7.11020.42.0 New
 MOKKA / MOKKA X (J13)
 ZAFIRA Mk III (P12)

ATS 7.11020.43.0 New



VOLVO

- S60 II (134)
- S80 II (124)
- S90 II (234)
- V40 Hatchback (525, 526)
- V60 I (155, 157)
- V60 II (225, 227)
- V70 III (135)
- V90 II Estate (235, 236)
- XC40 (536)
- XC60 I SUV (156)
- XC60 II (246)
- XC70 II (136)
- XC90 II (256)

ATS 7.11020.44.0 New

VOLVO

- S60 II (134)
- S80 II (124)
- V60 I (155, 157)
- V70 III (135)
- XC60 I SUV (156)
- XC70 II (136)

ATS 7.11020.45.0 New

VOLVO

- C30 (533)
- C70 II Convertible (542)
- S40 II (544)
- S60 II (134)
- S80 II (124)
- V40 Hatchback (525, 526)
- V50 (545)
- V60 I (155, 157)
- V70 III (135)
- XC60 I SUV (156)
- XC70 II (136)

ATS 7.11020.48.0 New



ALFA ROMEO

- GIULIETTA (940_)
- JEEP**
 RENEGADE SUV (BU, B1)

ATS 7.11020.49.0 New



CHEVROLET

- CAPTIVA (C100, C140)
- CRUZE (J300)
- CRUZE Hatchback (J305)
- CRUZE Station Wagon (J308)
- ORLANDO (J309)

OPEL

- ANTARA A (L07)

VAUXHALL

- ANTARA A (L07)

DDS 7.11190.00.0 New



AUDI

- A4 B7 (8EC)
- A4 B7 Avant (8ED)
- A4 B7 Convertible (8HE)
- A6 Allroad C6 (4FH)
- A6 C6 (4F2)
- A6 C6 Avant (4F5)

DDS 7.11190.00.0 New

A8 D3 (4E2, 4E8)

Q7 (4LB)

SKODA

SUPERB I (3U4)

VOLKSWAGEN

PASSAT B5.5 (3B3)

PASSAT B5.5 Variant (3B6)

PHAETON (3D1, 3D2, 3D3, 3D4, 3D6, 3D7, 3D8, 3D9)

TOUAREG (7LA, 7L6, 7L7)

DDS 7.11190.01.0 New



CHRYSLER

300C (LX, LE)

300C Touring (LX, LE)

GRAND VOYAGER V (RT)

DODGE

CALIBER

NITRO

JEEP

CHEROKEE (KK)

COMMANDER (XK, XH)

COMPASS (MK49)

GRAND CHEROKEE III (WH, WK)

GRAND CHEROKEE IV (WK, WK2)

PATRIOT (MK74)

WRANGLER III (JK)

WRANGLER IV (JL)

MERCEDES-BENZ

A-CLASS (W169)

C-CLASS (W203)

C-CLASS (W204)

C-CLASS Coupe (CL203)

C-CLASS T-Model (S203)

C-CLASS T-Model (S204)

CLC-CLASS (CL203)

CLK (C209)

CLK Convertible (A209)

CLS (C219)

E-CLASS (W211)

E-CLASS Convertible (A207)

E-CLASS Platform/Chassis (VF211)

E-CLASS T-Model (S211)

G-CLASS (W461)

G-CLASS (W463)

G-CLASS Cabrio (W463)

GL-CLASS (X164)

M-CLASS (W164)

R-CLASS (W251, V251)

S-CLASS (W221)





DDS 7.11190.01.0 New	DDS 7.11190.02.0 New	DDS 7.11190.03.0 New
SPRINTER 3,5-t Bus (B906) SPRINTER 3,5-t Platform/Chassis (B906) SPRINTER 3,5-t Van (B906) SPRINTER 3-t Platform/Chassis (B906) SPRINTER 3-t Van (B906) SPRINTER 4,6-t Platform/Chassis (B906) SPRINTER 4,6-t Van (B906) SPRINTER 5-t Platform/Chassis (B906) SPRINTER 5-t Van (B906) VIANO (W639) VITO / MIXTO Van (W639) VITO Bus (W639)	GOLF PLUS V (5M1, 521) GOLF V (1K1) GOLF V Variant (1K5) JETTA III (1K2) PHAETON (3D1, 3D2, 3D3, 3D4, 3D6, 3D7, 3D8, 3D9) SHARAN (7M8, 7M9, 7M6) TOUAREG (7LA, 7L6, 7L7) TOUAREG (7P5, 7P6) TRANSPORTER V Bus (7HB, 7HJ, 7EB, 7EJ, 7EF, 7EG, 7HF, 7EC) TRANSPORTER V Platform/Chassis (7JD, 7JE, 7JL, 7JY, 7JZ, 7FD) TRANSPORTER V Van (7HA, 7HH, 7EA, 7EH)	IDEA (350_) LINEA (323_, 110_) PANDA (312_, 319_) PUNTO (199_) PUNTO EVO (199_) PUNTO Hatchback Van (199_) STRADA Pickup (178_) TIPO Estate (356_) TIPO Hatchback (356_) TIPO Saloon (356_) FORD KA (RU8) IVECO DAILY CITYS Bus DAILY IV Dump Truck DAILY IV Platform/Chassis DAILY IV Van DAILY LINE Bus DAILY TOURYS Bus DAILY V Platform/Chassis DAILY V Van DAILY VI Platform/Chassis DAILY VI Van JEEP CHEROKEE (KL) COMPASS (MP, M6) RENEGADE SUV (BU, B1) LANCIA DELTA III (844_) MUSA (350_) YPSILON (312_) YPSILON (843_) MASERATI GHIBLI III (M157) LEVANTE SUV (M161) QUATTROPORTE VI OPEL ASTRA H (A04) ASTRA H Estate (A04) ASTRA H Estate Van (L70) ASTRA H GTC (A04) COMBO Box Body/MPV (X12) COMBO Tour (X12) SIGNUM Hatchback (Z03) VECTRA C (Z02) VECTRA C Estate (Z02) VECTRA C GTS (Z02) ZAFIRA / ZAFIRA FAMILY B (A05) ZAFIRA B Box Body/MPV (A05) PEUGEOT BIPPER (AA_) BIPPER TEPEE BOXER Bus BOXER Platform/Chassis BOXER Van RAM PROMASTER 1500 Van (VF1) PROMASTER 2500 Cab & Chassis PROMASTER 2500 Standard Cargo Van (VF2) PROMASTER 3500 Cab & Chassis (VF3) PROMASTER 3500 Cutaway Van (VF3) PROMASTER 3500 Extended Cargo Van



AUDI

- A4 Allroad B8 (8KH)
- A4 B8 (8K2)
- A4 B8 Avant (8K5)
- A5 (8T3)
- A5 Convertible (8F7)
- A5 Sportback (8TA)
- A6 Allroad C6 (4FH)
- A6 Allroad C7 (4GH, 4GJ)
- A6 C6 (4F2)
- A6 C6 Avant (4F5)
- A6 C7 (4G2, 4GC)
- A6 C7 Avant (4G5, 4GD)
- A7 Sportback (4GA, 4GF)
- A8 D4 (4H2, 4H8, 4HC, 4HL)
- Q5 (8RB)
- Q7 (4LB)

PORSCHE

- CAYENNE (92A)
- MACAN (95B)
- PANAMERA (970)

SEAT

- ALHAMBRA (7V8, 7V9)
- ALTEA (5P1)
- ALTEA XL (5P5, 5P8)
- EXEO (3R2)
- EXEO ST (3R5)
- LEON (1P1)
- TOLEDO III (5P2)

SKODA

- FABIA II (542)
- FABIA II Combi (545)
- OCTAVIA II (1Z3)
- OCTAVIA II Combi (1Z5)

VOLKSWAGEN

- EOS (1F7, 1F8)

ALFA ROMEO

- 159 (939_)
- 159 Sportwagon (939_)
- BRERA (939_)
- GIULIA (952_)
- GIULIETTA (940_)
- MITO (955_)
- SPIDER (939_)

CADILLAC

- BLS
 - BLS Wagon
- CITROEN**
- JUMPER Bus
 - JUMPER Platform/Chassis
 - JUMPER Van
 - NEMO Box Body/MPV (AA_)
 - NEMO MPV

FIAT

- 500 (312_)
- 500 C (312_)
- 500L (351_, 352_)
- 500X (334_)
- BRAVO II (198_)
- BRAVO Van (198_)
- CROMA (194_)
- CROMA Estate Van (194_)
- DOBLO Bus (263_)
- DOBLO Cargo (263_)
- DOBLO Platform/Chassis (263_)
- DUCATO Bus (250_)
- DUCATO Platform/Chassis (250_)
- DUCATO Van (250_)
- FIORINO Box Body/MPV (225_)
- GRANDE PUNTO (199_)
- GRANDE PUNTO Van (199_)

EMISSION CONTROL





DDS 7.11190.03.0 New	DDS 7.11190.04.0 New	DDS 7.11190.04.0 New
<p>SAAB 9-3 (YS3F, E79, D79, D75) 9-3 Convertible (YS3F) 9-3 Estate (E50)</p> <p>SUZUKI SWIFT IV (FZ, NZ) SX4 (EY, GY) SX4 S-CROSS (JY) VITARA (LY)</p> <p>VAUXHALL ASTRA Mk V (H) (A04) ASTRA Mk V (H) Estate (A04) ASTRA Mk V (H) Sport Hatch (A04) ASTRA Mk V (H) TwinTop (A04) ASTRAVAN Mk V (H) Estate Van (A04) COMBO Mk III (D) Box Body/MPV (X12) SIGNUM (Z03) VECTRA Mk II (C) (Z02) VECTRA Mk II (C) Estate (Z02) VECTRA Mk II (C) GTS (Z02) ZAFIRA Mk II (B) (A05)</p>	<p>CROMA Estate Van (194_) DOBLO Box Body/MPV (223_) DOBLO MPV (119_, 223_) FIORINO Box Body/MPV (225_) GRANDE PUNTO (199_) GRANDE PUNTO Van (199_) IDEA (350_) MULTIPLA (186_) PANDA (169_) PANDA Hatchback Van (169_) QUBO (225_) SEDICI (189_) STILO (192_) STILO VAN (192_)</p> <p>FORD KA (RU8)</p> <p>JEEP GRAND CHEROKEE IV (WK, WK2)</p> <p>LANCIA MUSA (350_) THESIS (841_) YPSILON (843_)</p> <p>OPEL AGILA (B) (H08) ASTRA H (A04) ASTRA H CLASSIC Estate (A04) ASTRA H CLASSIC Hatchback (A04) ASTRA H CLASSIC Saloon (A04) ASTRA H Estate (A04) ASTRA H Estate Van (L70) ASTRA H GTC (A04) ASTRA H Saloon (A04) ASTRA H TwinTop (A04) ASTRA J (P10) ASTRA J Estate Van (P10) ASTRA J GTC ASTRA J Hatchback Van (P10) ASTRA J Saloon ASTRA J Sports Tourer (P10) CASCADA (W13) CORSA D (S07) CORSA D Hatchback Van (S07) MERIVA A MPV (X03) MERIVA B MPV (S10) MOKKA / MOKKA X (J13) SIGNUM Hatchback (Z03) VECTRA C (Z02) VECTRA C Estate (Z02) VECTRA C GTS (Z02) ZAFIRA / ZAFIRA FAMILY B (A05) ZAFIRA B Box Body/MPV (A05) ZAFIRA TOURER C (P12)</p> <p>SUZUKI SPLASH (EX) SWIFT III (MZ, EZ) SX4 (EY, GY)</p> <p>VAUXHALL AGILA Mk II (B) (H08) ASTRA Mk V (H) (A04) ASTRA Mk V (H) Estate (A04) ASTRA Mk V (H) Sport Hatch (A04) ASTRA Mk VI (J) (P10) ASTRA Mk VI (J) Estate (P10)</p>	<p>ASTRA Mk VI (J) GTC (P10) ASTRA Mk VI (J) Saloon (P10) CASCADA Convertible (W13) CORSA Mk III (D) (S07) INSIGNIA Mk I (A) Country Tourer (G09) INSIGNIA Mk I (A) Hatchback (G09) INSIGNIA Mk I (A) Saloon (G09) INSIGNIA Mk I (A) Sports Tourer (G09) MERIVA A (X03) MERIVA Mk II (B) (S10) MOKKA / MOKKA X (J13) SIGNUM (Z03) VECTRA Mk II (C) (Z02) VECTRA Mk II (C) Estate (Z02) VECTRA Mk II (C) GTS (Z02) ZAFIRA Mk II (B) (A05) ZAFIRA Mk III (P12)</p>
<p>DDS 7.11190.04.0 New</p> 	<p>DDS 7.11190.08.0 New</p> 	<p>FORD TOURNEO CONNECT / GRAND TOURNEO CONNECT V408 MPV TRANSIT CONNECT MPV</p> <p>MERCEDES-BENZ A-CLASS (W176) B-CLASS Sports Tourer (W246, W242) CITAN Box Body/MPV (W415) CITAN MPV (415) CITAN Mixto (Double Cabin) (W415) CLA Coupe (C117) CLA Shooting Brake (X117) GLA-CLASS (X156)</p> <p>NISSAN INTERSTAR Bus (X70) INTERSTAR Platform/Chassis INTERSTAR Van (X70) JUKE (F15) NP300 NAVARA Pickup (D23) NV200 / EVALIA Bus NV200 Van NV400 Bus (X62, X62B) NV400 Platform/Chassis (X62, X62B) NV400 Van (X62, X62B) PULSAR Hatchback (C13) QASHQAI / QASHQAI +2 I (J10, NJ10, JJ10E) X-TRAIL (T31) X-TRAIL (T32_)</p> <p>OPEL ADAM (M13) ASTRA K (B16) ASTRA K Sports Tourer (B16)</p>
<p>ALFA ROMEO 147 (937_) 159 (939_) 159 Sportwagon (939_) BRERA (939_) GT (937_) MITO (955_) SPIDER (939_)</p> <p>CADILLAC BLS BLS Wagon</p> <p>CHEVROLET AVEO Hatchback (T300) AVEO Saloon (T300) CRUZE Hatchback (J305) CRUZE Station Wagon (J308) MALIBU (V300) TRAX</p> <p>CHRYSLER 300C</p> <p>DODGE CHARGER</p> <p>FIAT 500 (312_) 500 C (312_) BRAVO II (198_) CROMA (194_)</p>		



DDS 7.11190.08.0 New	DDS 7.11190.09.0 New	DDS 7.11190.09.0 New
<p>CORSA E (X15) MOVANO B Bus (X62) MOVANO B Platform/Chassis (X62) MOVANO B Van (X62) VIVARO B Bus (X82) VIVARO B Platform/Chassis (X82) VIVARO B Van (X82)</p> <p>RENAULT CAPTUR I (J5_, H5_) CLIO IV (BH_) CLIO IV Grandtour (KH_) FLUENCE (L3_) GRAND SCÉNIC III (JZ0/1_) KADJAR (HA_, HL_) KOLEOS I (HY_) MEGANE III Coupe (DZ0/1_) MEGANE III Grandtour (KZ0/1) MEGANE III Hatchback (BZ0/1_, B3_) SCÉNIC III (JZ0/1_) TRAFIC III Bus (JG_) TRAFIC III Van (FG_)</p> <p>SUZUKI GRAND VITARA II (JT, TE, TD) SWIFT V (AZ) SX4 S-CROSS (JY) VITARA (LY)</p> <p>VAUXHALL ADAM (M13) ASTRA Mk VII (K) (B16) ASTRA Mk VII (K) Estate (B16) CORSA Mk IV (E) (X15) MOVANO Mk II (B) Chassis/Cab (X62) MOVANO Mk II (B) Combi (X62) MOVANO Mk II (B) VAN (X62) VIVARO B Bus (X82) VIVARO B Platform/Chassis (X82) VIVARO B Van (X82)</p> <p>VOLVO C30 (533) C70 II Convertible (542) S40 II (544) S60 II (134) S80 II (124) S90 II (234) V40 Hatchback (525, 526) V50 (545) V60 I (155, 157) V60 II (225, 227) V70 III (135) V90 II Estate (235, 236) XC40 (536) XC60 I SUV (156) XC60 II (246) XC70 II (136) XC90 II (256)</p>	 <p>AUDI A1 (8X1, 8XK) A1 Sportback (8XA, 8XF) A3 (8P1) A3 Convertible (8P7) A3 Sportback (8PA) A4 Allroad B8 (8KH) A4 B8 (8K2) A4 B8 Avant (8K5) A5 (8T3) A5 Convertible (8F7) A5 Sportback (8TA) A6 C7 (4G2, 4GC) A6 C7 Avant (4G5, 4GD) Q5 (8RB) TT (8J3) TT Roadster (8J9)</p> <p>SEAT ALTEA (5P1) ALTEA XL (5P5, 5P8) EXEO (3R2) EXEO ST (3R5) IBIZA IV (6J5, 6P1) IBIZA IV Hatchback Van (6J1) IBIZA IV SC (6J1, 6P5) IBIZA IV ST (6J8, 6P8) LEON (1P1) TOLEDO IV (KG3)</p> <p>SKODA FABIA II (542) FABIA II Combi (545) OCTAVIA II (1Z3) OCTAVIA II Combi (1Z5) RAPID (NH3) RAPID Spaceback (NH1) ROOMSTER (5J7) ROOMSTER Praktik (5J) SUPERB II (3T4) SUPERB II Estate (3T5)</p> <p>VOLKSWAGEN BEETLE (5C1, 5C2) BEETLE Convertible (5C7, 5C8) CADDY III Box Body/MPV (2KA, 2KH, 2CA, 2CH) CADDY III MPV (2KB, 2KJ, 2CB, 2CJ) EOS (1F7, 1F8) GOLF PLUS V (5M1, 521) GOLF PLUS Van (521) GOLF VAN VI Variant (AJ5) GOLF VI (5K1) GOLF VI Convertible (517)</p>	<p>GOLF VI Van (5K1_) GOLF VI Variant (AJ5) POLO V (6R1, 6C1) POLO V Saloon (602, 604, 612, 614) POLO Van (6R) SCIROCCO III (137, 138) TOURAN (1T1, 1T2) TOURAN (1T3)</p>
		<p>DDS 7.11190.10.0 New</p>  <p>FORD C-MAX (DM2) FOCUS C-MAX (DM2) FOCUS II (DA_, HCP, DP) FOCUS II Convertible FOCUS II Estate Van FOCUS II Saloon (DB_, FCH, DH) FOCUS II Turnier (DA_, FFS, DS) GALAXY II (WA6) KUGA I MONDEO III (B5Y) MONDEO III Saloon (B4Y) MONDEO III Turnier (BWY) MONDEO IV (BA7) MONDEO IV Saloon (BA7) MONDEO IV Turnier (BA7) S-MAX (WA6)</p> <p>FORD AUSTRALIA MONDEO Hatchback (MA, MB, MC)</p> <p>JAGUAR S-TYPE II (X200) XJ (X350, X358)</p> <p>LAND ROVER FREELANDER 2 (L359)</p> <p>MAZDA 3 (BL) 3 Saloon (BL) 5 (CW)</p> <p>VOLVO C30 (533) C70 II Convertible (542) S40 I (644) S40 II (544) S60 I (384) S80 II (124) V50 (545) V70 II (285) V70 III (135) XC90 I (275)</p>

EMISSION CONTROL





DDS 7.11190.12.0 New	DDS 7.11457.07.0*	DDS 7.11492.00.0 New
BMW 1 (F20) 2 Coupe (F22, F87) 3 (E90) 3 (F30, F80) 3 Gran Turismo (F34) 3 Touring (E91) 3 Touring (F31) 4 Convertible (F33, F83) 4 Coupe (F32, F82) 4 Gran Coupe (F36) 5 (F10) 5 Gran Turismo (F07) 5 Touring (F11) 6 Convertible (F12) 6 Coupe (F13) 6 Gran Coupe (F06) 7 (F01, F02, F03, F04) X3 (F25) X4 (F26) X5 (E70) X5 (F15, F85) X6 (E71, E72) X6 (F16, F86) MINI (BMW) MINI COUNTRYMAN (R60) MINI PACEMAN (R61) TOYOTA AURIS (_E18_) AURIS Estate (_E18_) AVENSIS Estate (_T27_) AVENSIS Saloon (_T27_) RAV 4 IV (_A4_) VERSO (_R2_)	MARCO POLO Camper (W447) VITO Mixto (Double Cabin) (W447) VITO Tourer (W447) VITO Van (W447) X-CLASS (470) X-CLASS Platform/Chassis (470) NISSAN JUKE (F15) MICRA V (K14) NAVARA Platform/Chassis (D23) NOTE (E12) NP300 NAVARA Pickup (D23) NV200 / EVALIA Bus NV200 Van NV250 Bus (X61) NV250 Van (X61) NV300 Kombi (X82) NV300 Platform/Chassis (X82) NV300 Van (X82) PULSAR Hatchback (C13) QASHQAI II SUV (J11, J11_) QASHQAI II VAN (J11_) TERRA (JD23TT, JD23F) X-TRAIL (T32_) X-TRAIL VAN (T32) OPEL VIVARO B Bus (X82) VIVARO B Platform/Chassis (X82) VIVARO B Van (X82) RENAULT ALASKAN CAPTUR I (J5_, H5_) CAPTUR II CLIO IV (BH_) CLIO IV Grandtour (KH_) CLIO IV Hatchback Van (BH_) CLIO V (B7_) DUSTER (HM_) ESPACE V (JR_) FLUENCE (L3_) GRAND SCÉNIC III (JZ0/1_) GRAND SCÉNIC IV (R9_) KADJAR (HA_, HL_) KANGOO / GRAND KANGOO (KW0/1_) KANGOO Express (FW0/1_) KOLEOS II (HC_) MEGANE III Grandtour (KZ0/1) MEGANE IV GRAND COUPE MEGANE IV Grandtour (K9A/M/N_) MEGANE IV Hatchback (B9A/M/N_) SCÉNIC III (JZ0/1_) SCÉNIC IV (J9_) TALISMAN (LP_) TALISMAN Grandtour (KP_) TRAFIC III Bus (JG_) TRAFIC III Platform/Chassis (EG_) TRAFIC III Van (FG_) SAMSUNG QM6 VAUXHALL VIVARO B Bus (X82) VIVARO B Van (X82)	 AUDI A3 (8P1) A3 Convertible (8P7) A3 Sportback (8PA) Q3 (8UB, 8UG) SEAT ALHAMBRA (710, 711) ALTEA (5P1) ALTEA XL (5P5, 5P8) LEON (1P1) SKODA FABIA II (542) FABIA II Combi (545) OCTAVIA II (1Z3) OCTAVIA II Combi (1Z5) ROOMSTER (5J7) ROOMSTER Praktik (5J) SUPERB II (3T4) SUPERB II Estate (3T5) YETI (5L) VOLKSWAGEN AMAROK (2HA, 2HB, S1B, S6B, S7A, S7B) AMAROK Platform/Chassis (S1B, S6B, S7B) BEETLE (5C1, 5C2) BEETLE Convertible (5C7, 5C8) CADDY ALLTRACK Box Body/MPV (SAA) CADDY ALLTRACK MPV (SAB) CADDY III Box Body/MPV (2KA, 2KH, 2CA, 2CH) CADDY III MPV (2KB, 2KJ, 2CB, 2CJ) CADDY IV Box Body/MPV (SAA, SAH) CADDY IV MPV (SAB, SAJ) CC B7 (358) CRAFTER 30-35 Bus (2E_) CRAFTER 30-50 Platform/Chassis (2F_) CRAFTER 30-50 Van (2E_) GOLF PLUS V (5M1, 521) GOLF PLUS Van (521) GOLF VAN VI Variant (AJ5) GOLF VI (5K1) GOLF VI Convertible (517) GOLF VI Van (5K1_) GOLF VI Variant (AJ5) JETTA III (1K2) JETTA IV (162, 163, AV3, AV2) MULTIVAN V (7HM, 7HN, 7HF, 7EF, 7EM, 7EN) MULTIVAN VI (SGF, SGM, SGN, SHM, SHN) PASSAT ALLTRACK B7 (365) PASSAT B6 (3C2) PASSAT B6 Variant (3C5) PASSAT B7 (362)
DACIA DOKKER Express Box Body/MPV DOKKER MPV (KE_) DUSTER (HM_) DUSTER (HS_) DUSTER SUV Van LODGY (JS_) LOGAN II LOGAN MCV II SANDERO II FIAT TALENTO Bus (296_) TALENTO Platform/Chassis (296_) TALENTO Van (296_) INFINITI Q30 MERCEDES-BENZ A-CLASS (W177) A-CLASS Saloon (V177) B-CLASS Sports Tourer (W247) C-CLASS (W205) C-CLASS T-Model (S205) CITAN Box Body/MPV (W415) CITAN MPV (415) CITAN Mixto (Double Cabin) (W415) CLA (C118) CLA Shooting Brake (X118)	DDS 7.11457.07.0*	





DDS 7.11492.00.0 New	DDS 7.11492.01.0 New	DDS 7.11492.01.0 New
<p>PASSAT B7 (A32, A33) PASSAT B7 Estate Van (365) PASSAT B7 Variant (365) PASSAT CC B6 (357) SCIROCCO III (137, 138) SCIROCCO Van (137) SHARAN (7N1, 7N2) TIGUAN (5N_) TOURAN (1T3) TRANSPORTER / CARAVELLE VI Bus (SGB, SGG, SGJ, SGC, SHB, SHJ) TRANSPORTER V Bus (7HB, 7HJ, 7EB, 7EJ, 7EF, 7EG, 7HF, 7EC) TRANSPORTER V Platform/Chassis (7JD, 7JE, 7JL, 7JY, 7JZ, 7FD) TRANSPORTER V Van (7HA, 7HH, 7EA, 7EH) TRANSPORTER VI Platform/Chassis (SFD, SFE, SFL, SFZ, SJD, SJ) TRANSPORTER VI Van (SGA, SGH, SHA, SHH) ENGINE</p>	<p>C8 (EA_, EB_) DS3 DS3 Convertible DS4 (NX_) DS5 JUMPER Bus JUMPER Platform/Chassis JUMPER Van JUMPY (VF7) JUMPY Bus (V_) JUMPY Platform/Chassis JUMPY Platform/Chassis (V_) JUMPY Van JUMPY Van (V_) SPACETOURER Bus (V_) XSARA PICASSO (N68) DS DS 3 (SA_) DS 4 / DS 4 CROSSBACK (NX_) DS 5 (KF_) FIAT SCUDO Bus (270_, 272_) ULYSSE (179_) LANCIA PHEDRA (179_) MINI (BMW) MINI (R56) MINI CLUBMAN (R55) OPEL COMBO E Tour / Life (X19) CROSSLAND X / CROSSLAND (P17, P2QO) VIVARO C Bus (K0) VIVARO C Platform Cabin (K0) VIVARO C Van (K0) PEUGEOT 1007 (KM_) 2008 I (CU_) 206 CC (2D) 206 Hatchback (2A/C) 206 SW (2E/K) 206+ (2L_, 2M_) 207 (WA_, WC_) 207 CC (WD_) 207 Hatchback Van (WA_, WC_) 207 SW (WK_) 207 SW Estate Van (WK_) 208 Hatchback Van (CR_) 208 I (CA_, CC_) 3008 MPV (0U_) 3008 SUV (MC_, MR_, MJ_, M4_) 301 307 (3A/C) 307 Break (3E) 307 CC (3B) 307 SW (3H) 307 SW Estate Van (3E_, 3H_) 308 CC (4B_) 308 Hatchback Van (LB_) 308 I (4A_, 4C_) 308 II (LB_, LP_, LW_, LH_, L3_) 308 SW I (4E_, 4H_) 308 SW I Estate Van (4E_) 308 SW II (LC_, LJ_, LR_, LX_, L4_)</p>	<p>4007 (VU_, VV_) 4008 407 (6D_) 407 Coupe (6C_) 407 SW (6E_) 407 SW Estate Van (6E_) 5008 (0U_, 0E_) 5008 II (MC_, MJ_, MR_, M4_) 508 I (8D_) 508 SW I (8E_) 607 (9D, 9U) 807 (EB_) BOXER Bus BOXER Platform/Chassis BOXER Van EXPERT Bus (V_) EXPERT Platform/Chassis EXPERT Platform/Chassis (V_) EXPERT TEPEE (VF3X_) EXPERT Van (VF3A_, VF3U_, VF3X_) EXPERT Van (V_) PARTNER Box Body/MPV PARTNER Box Body/MPV (5_, G_) PARTNER Platform/Chassis PARTNER TEPEE RCZ RIFTER TRAVELLER Bus (V_) VAUXHALL CROSSLAND X (P17)</p>
<p>DDS 7.11492.01.0 New</p>	<p>FIAT SCUDO Bus (270_, 272_) ULYSSE (179_) LANCIA PHEDRA (179_) MINI (BMW) MINI (R56) MINI CLUBMAN (R55) OPEL COMBO E Tour / Life (X19) CROSSLAND X / CROSSLAND (P17, P2QO) VIVARO C Bus (K0) VIVARO C Platform Cabin (K0) VIVARO C Van (K0) PEUGEOT 1007 (KM_) 2008 I (CU_) 206 CC (2D) 206 Hatchback (2A/C) 206 SW (2E/K) 206+ (2L_, 2M_) 207 (WA_, WC_) 207 CC (WD_) 207 Hatchback Van (WA_, WC_) 207 SW (WK_) 207 SW Estate Van (WK_) 208 Hatchback Van (CR_) 208 I (CA_, CC_) 3008 MPV (0U_) 3008 SUV (MC_, MR_, MJ_, M4_) 301 307 (3A/C) 307 Break (3E) 307 CC (3B) 307 SW (3H) 307 SW Estate Van (3E_, 3H_) 308 CC (4B_) 308 Hatchback Van (LB_) 308 I (4A_, 4C_) 308 II (LB_, LP_, LW_, LH_, L3_) 308 SW I (4E_, 4H_) 308 SW I Estate Van (4E_) 308 SW II (LC_, LJ_, LR_, LX_, L4_)</p>	<p>DDS 7.11492.02.0 New</p>
<p>CITROEN BERLINGO / BERLINGO FIRST Box Body/MPV (M_) BERLINGO / BERLINGO FIRST MPV (MF_, GJK_, GFK_) BERLINGO Box Body/MPV (B9) BERLINGO MULTISPACE (B9) BERLINGO Platform/Chassis (B9) C-CROSSER (VU_, VV_) C-ELYSEE (DD_) C2 (JM_) C3 AIRCROSS II (2R_, 2C_) C3 II (SC_) C3 II Hatchback Van (SC_) C3 PICASSO (SH_) C4 AIRCROSS C4 CACTUS C4 Coupe (LA_) C4 I (LC_) C4 I Hatchback Van (LR_) C4 I Saloon C4 II (B7) C4 PICASSO I MPV (UD_) C4 PICASSO II C4 SPACETOURER (3D_) C5 II (RC_) C5 II Break (RE_) C5 III (RD_) C5 III Break (RW_) C6 (TD_)</p>	<p></p>	<p></p>
<p>AUDI A3 (8P1) A3 Convertible (8P7) A3 Sportback (8PA) A4 B7 (8EC) A4 B7 Avant (8ED) A4 B7 Convertible (8HE) A6 C6 (4F2) A6 C6 Avant (4F5) TT (8J3) TT Roadster (8J9)</p>	<p>SEAT ALHAMBRA (7V8, 7V9) ALTEA (5P1) ALTEA XL (5P5, 5P8) CORDOBA (6L2) IBIZA III (6L1) IBIZA IV (6J5, 6P1) IBIZA IV SC (6J1, 6P5)</p>	





DDS 7.11492.02.0 New	DDS 7.11492.03.0 New	DDS 7.11492.03.0 New
<p>LEON (1P1) TOLEDO III (5P2) SKODA FABIA II (542) FABIA II Combi (545) OCTAVIA II (1Z3) OCTAVIA II Combi (1Z5) ROOMSTER (5J7) ROOMSTER Praktik (5J) SUPERB II (3T4) SUPERB II Estate (3T5) YETI (5L) VOLKSWAGEN CADDY III Box Body/MPV (2KA, 2KH, 2CA, 2CH) CADDY III MPV (2KB, 2KJ, 2CB, 2CJ) CRAFTER 30-35 Bus (2E_) CRAFTER 30-50 Platform/Chassis (2F_) CRAFTER 30-50 Van (2E_) EOS (1F7, 1F8) GOLF PLUS V (5M1, 521) GOLF V (1K1) GOLF V Variant (1K5) GOLF VAN VI Variant (AJ5) GOLF VI (5K1) GOLF VI Variant (AJ5) JETTA III (1K2) MULTIVAN V (7HM, 7HN, 7HF, 7EF, 7EM, 7EN) PASSAT B6 (3C2) PASSAT B6 Variant (3C5) PASSAT CC B6 (357) PHAETON (3D1, 3D2, 3D3, 3D4, 3D6, 3D7, 3D8, 3D9) POLO (9N_) SCIROCCO III (137, 138) SCIROCCO Van (137) SHARAN (7M8, 7M9, 7M6) TIGUAN (5N_) TOUAREG (7LA, 7L6, 7L7) TOURAN (1T1, 1T2) TRANSPORTER V Bus (7HB, 7HJ, 7EB, 7EJ, 7EF, 7EG, 7HF, 7EC) TRANSPORTER V Platform/Chassis (7JD, 7JE, 7JL, 7JY, 7JZ, 7FD) TRANSPORTER V Van (7HA, 7HH, 7EA, 7EH) ENGINE</p>	<p>A3 Sportback (8VA, 8VF) A4 Allroad B8 (8KH) A4 Allroad B9 (8WH, 8WJ) A4 B8 (8K2) A4 B8 Avant (8K5) A4 B9 (8W2, 8WC) A4 B9 Avant (8W5, 8WD) A5 (8T3) A5 (F53, F5P) A5 Convertible (8F7) A5 Convertible (F57, F5E) A5 Sportback (8TA) A5 Sportback (F5A, F5F) A6 C7 (4G2, 4GC) A6 C7 Avant (4G5, 4GD) A6 C8 (4A2) A6 C8 Avant (4A5) Q3 (8UB, 8UG) Q3 (F3B) Q3 Sportback (F3N) Q5 (8RB) Q5 (FYB, FYG) TT (FV3, FVP) TT Roadster (FV9, FVR) PORSCHE CAYENNE (92A) SEAT ALHAMBRA (710, 711) LEON (5F1) LEON Hatchback Van (5F1) LEON SC (5F5) LEON ST (5F8) LEON ST Estate Van (5F8) SKODA KODIAQ (NS7, NV7) OCTAVIA III (5E3, NL3, NR3) OCTAVIA III Combi (5E5, 5E6) SUPERB III (3V3) SUPERB III Estate (3V5) YETI (5L) VOLKSWAGEN ARTEON (3H7, 3H8) BEETLE (5C1, 5C2) BEETLE Convertible (5C7, 5C8) CADDY ALLTRACK Box Body/MPV (SAA) CADDY ALLTRACK MPV (SAB) CADDY IV Box Body/MPV (SAA, SAH) CADDY IV MPV (SAB, SAJ) CC B7 (358) CRAFTER 30-35 Bus (2E_) CRAFTER 30-50 Platform/Chassis (2F_) CRAFTER 30-50 Van (2E_) GOLF ALLTRACK VII Variant (BA5, BV5) GOLF SPORTSVAN VII (AM1, AN1) GOLF VAN VII Variant (BA5) GOLF VI Convertible (517) GOLF VII (5G1, BQ1, BE1, BE2) GOLF VII Van (5G1) GOLF VII Variant (BA5, BV5) JETTA IV (162, 163, AV3, AV2) PASSAT B7 (A32, A33) PASSAT B8 (3G2, CB2) PASSAT B8 Variant (3G5, CB5)</p>	<p>SCIROCCO III (137, 138) SHARAN (7N1, 7N2) TIGUAN (5N_) TIGUAN (AD1, AX1) TIGUAN ALLSPACE (BW2) TOUAREG (7P5, 7P6) TOURAN (5T1) XL1 (6Z1) ENGINE</p>
		<p>DDS 7.11492.05.0 New</p> <div style="text-align: center;"> </div> <p>AUDI A3 (8V1, 8VK) A3 Convertible (8V7, 8VE) A3 Limousine (8VS, 8VM) A3 Limousine (8YS) A3 Sportback (8VA, 8VF) A3 Sportback (8YA) A4 B9 (8W2, 8WC) A4 B9 Avant (8W5, 8WD) A5 (F53, F5P) A5 Convertible (F57, F5E) A5 Sportback (F5A, F5F) A6 C8 (4A2) A6 C8 Avant (4A5) A7 Sportback (4KA) Q2 (GAB, GAG) MAN TGE Bus TGE Platform/Chassis (UZ_) TGE Van SEAT ARONA (KJ7) ATECA (KH7, KHP) IBIZA V (KJ1) LEON (5F1) LEON (KL1) LEON Hatchback Van (5F1) LEON SC (5F5) LEON ST (5F8) LEON ST Estate Van (5F8) SKODA KAMIQ (NW4) KAROQ (NU7) KODIAQ (NS7, NV7) OCTAVIA III (5E3, NL3, NR3) OCTAVIA III Combi (5E5, 5E6) OCTAVIA IV (NX3) OCTAVIA IV Combi (NX5) SCALA (NW1) SUPERB III (3V3)</p>
<p>DDS 7.11492.03.0 New</p> <div style="text-align: center;"> </div> <p>AUDI A3 (8V1, 8VK) A3 Convertible (8V7, 8VE) A3 Limousine (8VS, 8VM)</p>		



DDS 7.11492.05.0 New	DDS 7.11492.07.0 New	DDS 7.11492.07.0 New
<p>SUPERB III Estate (3V5)</p> <p>VOLKSWAGEN</p> <p>ARTEON (3H7, 3H8)</p> <p>CRAFTER Bus (SYI, SYJ)</p> <p>CRAFTER Platform/Chassis (SZ_)</p> <p>CRAFTER Van (SY_, SX_)</p> <p>GOLF ALLTRACK VII Variant (BA5, BV5)</p> <p>GOLF SPORTSVAN VII (AM1, AN1)</p> <p>GOLF VII (5G1, BQ1, BE1, BE2)</p> <p>GOLF VII Variant (BA5, BV5)</p> <p>GOLF VIII (CD1)</p> <p>MULTIVAN VI (SGF, SGM, SGN, SHM, SHN)</p> <p>PASSAT ALLTRACK B8 Variant (3G5, CB5)</p> <p>PASSAT B8 (3G2, CB2)</p> <p>PASSAT B8 Variant (3G5, CB5)</p> <p>POLO VI (AW1, BZ1)</p> <p>T-CROSS (C11)</p> <p>T-ROC (A11)</p> <p>TIGUAN (AD1, AX1)</p> <p>TRANSPORTER / CARAVELLE VI Bus (SGB, SGG, SGJ, SGC, SHB, SHJ)</p> <p>TRANSPORTER VI Platform/Chassis (SFD, SFE, SFL, SFZ, SJD, SJ)</p> <p>TRANSPORTER VI Van (SGA, SGH, SHA, SHH)</p>	<p>X-CLASS (470)</p> <p>X-CLASS Platform/Chassis (470)</p> <p>NISSAN</p> <p>JUKE (F15)</p> <p>MICRA V (K14)</p> <p>NAVARA Platform/Chassis (D23)</p> <p>NOTE (E12)</p> <p>NP300 NAVARA Pickup (D23)</p> <p>NV200 / EVALIA Bus</p> <p>NV200 Van</p> <p>NV250 Bus (X61)</p> <p>NV250 Van (X61)</p> <p>NV300 Kombi (X82)</p> <p>NV300 Platform/Chassis (X82)</p> <p>NV300 Van (X82)</p> <p>NV400 Bus (X62, X62B)</p> <p>NV400 Platform/Chassis (X62, X62B)</p> <p>NV400 Van (X62, X62B)</p> <p>PULSAR Hatchback (C13)</p> <p>QASHQAI II SUV (J11, J11_)</p> <p>QASHQAI II VAN (J11_)</p> <p>TERRA (JD23TT, JD23F)</p> <p>X-TRAIL (T32_)</p> <p>X-TRAIL VAN (T32)</p> <p>OPEL</p> <p>MOVANO B Bus (X62)</p> <p>MOVANO B Platform/Chassis (X62)</p> <p>MOVANO B Van (X62)</p> <p>VIVARO B Bus (X82)</p> <p>VIVARO B Platform/Chassis (X82)</p> <p>VIVARO B Van (X82)</p> <p>RENAULT</p> <p>ALASKAN</p> <p>CAPTUR I (J5_, H5_)</p> <p>CAPTUR II</p> <p>CLIO IV (BH_)</p> <p>CLIO IV Grandtour (KH_)</p> <p>CLIO IV Hatchback Van (BH_)</p> <p>CLIO V (B7_)</p> <p>DUSTER (HM_)</p> <p>ESPACE V (JR_)</p> <p>FLUENCE (L3_)</p> <p>GRAND SCÉNIC III (JZ0/1_)</p> <p>GRAND SCÉNIC IV (R9_)</p> <p>KADJAR (HA_, HL_)</p> <p>KANGOO / GRAND KANGOO (KW0/1_)</p> <p>KANGOO Express (FW0/1_)</p> <p>KOLEOS II (HC_)</p> <p>MASTER III Bus (JV)</p> <p>MASTER III Platform/Chassis (EV, HV, UV)</p> <p>MASTER III Van (FV)</p> <p>MEGANE III Grandtour (KZ0/1)</p> <p>MEGANE IV GRAND COUPE</p> <p>MEGANE IV Grandtour (K9A/M/N_)</p> <p>MEGANE IV Hatchback (B9A/M/N_)</p> <p>SCÉNIC III (JZ0/1_)</p> <p>SCÉNIC IV (J9_)</p> <p>TALISMAN (LP_)</p> <p>TALISMAN Grandtour (KP_)</p> <p>TRAFIC III Bus (JG_)</p> <p>TRAFIC III Platform/Chassis (EG_)</p> <p>TRAFIC III Van (FG_)</p>	<p>SAMSUNG</p> <p>QM6</p> <p>VAUXHALL</p> <p>MOVANO Mk II (B) Chassis/Cab (X62)</p> <p>MOVANO Mk II (B) Combi (X62)</p> <p>MOVANO Mk II (B) VAN (X62)</p> <p>VIVARO B Bus (X82)</p> <p>VIVARO B Van (X82)</p>
		<p>LS 7.02604.01.0</p> <div style="text-align: center;"> </div> <p>AUDI</p> <p>100 C2 Avant (435, 436)</p> <p>100 C2 Saloon (431, 433, 434)</p> <p>100 C3 Avant (445, 446)</p> <p>100 C3 Saloon (443, 444)</p> <p>80 B2 Saloon (811, 813, 814, 819, 853)</p> <p>80 B3 Saloon (893, 894, 8A2)</p> <p>80 B4 Saloon (8C2)</p> <p>90 B2 (813, 814, 853)</p> <p>90 B3 (893, 894, 8A2)</p> <p>COUPE B2 (81, 855, 856)</p> <p>COUPE B3 (89, 8B3)</p> <p>BMW</p> <p>3 (E21)</p> <p>5 (E28)</p> <p>DAEWOO</p> <p>ESPERO (KLEJ)</p> <p>NEXIA</p> <p>NEXIA Saloon</p> <p>NUBIRA (J100)</p> <p>NUBIRA Saloon (J100)</p> <p>NUBIRA Wagon (J100)</p> <p>DAIHATSU</p> <p>APPLAUSE</p> <p>APPLAUSE I Hatchback (A101, A111)</p> <p>CHARADE</p> <p>CHARADE III (G100, G101, G102)</p> <p>CUORE II (L80, L81)</p> <p>CUORE III (L201)</p> <p>CUORE IV (L501)</p> <p>FIAT</p> <p>PANDA (141_)</p> <p>RITMO (138_)</p> <p>RITMO Convertible (138_)</p> <p>HONDA</p> <p>CIVIC II Shuttle (EE)</p> <p>CIVIC IV Hatchback (EC, ED, EE)</p> <p>CIVIC IV Saloon (ED)</p> <p>CIVIC V Coupe (EJ)</p> <p>CIVIC V Hatchback (EG)</p>
<p>DDS 7.11492.07.0 New</p> <div style="text-align: center;"> </div> <p>DACIA</p> <p>DOKKER Express Box Body/MPV</p> <p>DOKKER MPV (KE_)</p> <p>DUSTER (HM_)</p> <p>DUSTER (HS_)</p> <p>DUSTER SUV Van</p> <p>LODGY (JS_)</p> <p>LOGAN II</p> <p>LOGAN MCV II</p> <p>SANDERO II</p> <p>FIAT</p> <p>TALENTO Bus (296_)</p> <p>TALENTO Platform/Chassis (296_)</p> <p>TALENTO Van (296_)</p> <p>INFINITI</p> <p>Q30</p> <p>MERCEDES-BENZ</p> <p>A-CLASS (W177)</p> <p>A-CLASS Saloon (V177)</p> <p>B-CLASS Sports Tourer (W247)</p> <p>C-CLASS (W205)</p> <p>C-CLASS T-Model (S205)</p> <p>CITAN Box Body/MPV (W415)</p> <p>CITAN MPV (415)</p> <p>CITAN Mixto (Double Cabin) (W415)</p> <p>CLA (C118)</p> <p>CLA Shooting Brake (X118)</p> <p>MARCO POLO Camper (W447)</p> <p>VITO Mixto (Double Cabin) (W447)</p> <p>VITO Tourer (W447)</p> <p>VITO Van (W447)</p>		



LS	7.02604.01.0	LS	7.02604.01.0	LS	7.02604.01.0
CIVIC V Saloon (EG, EH) CIVIC VI Aerodeck (MB, MC) CIVIC VI Coupe (EJ, EM1) CIVIC VI Fastback (MA, MB) CIVIC VI Hatchback (EJ, EK) CIVIC VI Saloon (EJ, EK) CIVIC VII Coupe (EM2) CIVIC VII Hatchback (EU, EP, EV) CIVIC VII Saloon (ES, ET) CONCERTO (HW, MA) CONCERTO Saloon (HWW) LEGEND I (HS, KA) LEGEND I Coupe (KA_) PRELUDE III (BA) HYUNDAI H-1 Van (A1) H100 Bus (P) H100 Platform/Chassis H100 Van PONY (X-1) PONY (X-2) PONY / EXCEL Saloon (X-2) PONY Saloon (X-1) SONATA II (Y-2) SONATA III (Y-3) KIA SEPHIA (FA) SEPHIA Saloon (FA) LANCIA PRISMA (831_) MAZDA 323 C IV (BG) 323 C V (BA) 323 F IV (BG) 323 F VI (BJ) 323 III (BF) 323 III Hatchback (BF) 323 III Station Wagon (BW) 323 S IV (BG) 323 S VI (BJ) 626 II (GC) 626 II Coupe (GC) 626 II Hatchback (GC) 626 III (GD) 626 III Coupe (GD) MX-3 (EC) MX-5 I (NA) MX-5 II (NB) RX-7 I (SA) RX-7 II (FC) MERCEDES-BENZ 123 Coupe (C123) 123 Saloon (W123) 123 T-Model (S123) MG MIDGET MITSUBISHI COLT II (C1_A) COLT III (C5_A) COLT IV (CA_A) COLT V (CJ_, CP_) GALANT GALANT VI (E3_A)	GALANT VI Saloon (E3_A) GALANT VII (E5_A, E7_A, E8_A) GALANT VII Saloon (E5_A, E7_A, E8_A) L 300 / DELICA II Bus (LO3_P/G, LO_2P) L 300 III Bus (P0_W, P1_W, P2_W, P3_W) L 300 III Van (P0_V, P1_V, P_2V) L200 (K3_T, K2_T, K1_T, K0_T) LANCER III (C1_A, C6_A) LANCER III Station Wagon (C1_V, C3_V) SAPPORO III (E16A) NISSAN 100NX (B13) BLUEBIRD (T72, T12, U12) BLUEBIRD Hatchback (T72, T12) MICRA I (K10) PRIMERA (P10) PRIMERA (P11) PRIMERA (P12) PRIMERA Hatchback (P10) PRIMERA Hatchback (P11) PRIMERA Hatchback (P12) PRIMERA Traveller (W10) PRIMERA Traveller (WP11) SERENA (C23) SUNNY II (N13, B12) SUNNY II Hatchback (N13) SUNNY III (N14) SUNNY III Estate Van (Y10) SUNNY III Hatchback (N14) SUNNY III Liftback (N14) SUNNY III Traveller (Y10) TERRANO I (WD21) TERRANO II (R20) VANETTE Bus (C22) OPEL ASTRA F (T92) COMBO Box Body/MPV (71_) CORSA A Hatchback (S83) CORSA A Hatchback Van (S83) CORSA A TR (S83) CORSA B (S93) CORSA B Estate (S93) TIGRA (S93) VECTRA A (J89) VECTRA A Hatchback (J89) RENAULT 18 (134_) 18 Estate Van 18 Variable (135_) 19 I Cabriolet (D53_) 19 I Chamade (L53_) 19 II Chamade (L53_) 25 (B29_) ESPACE I (J11_) MASTER I Bus (T_) MASTER I Platform/Chassis (P_) MASTER I Van (T_) RAPID Box Body/MPV (F40_, G40_) SUPER 5 (B/C40_) ROVER 800 (XS) SEAT TOLEDO III (5P2)	SUZUKI BALENO (EG) BALENO Estate (EG) BALENO Hatchback (EG) SAMURAI Closed Off-Road Vehicle (SJ_) SWIFT II Hatchback (EA, MA) TOYOTA CAMRY (_V1_) CAMRY (_V2_) CAMRY Estate (_V1_) CAMRY Estate (_V2_) COROLLA (_E7_) COROLLA Compact (_E9_) COROLLA Estate (_E7_) COROLLA FX Compact (E8B) COROLLA Hatchback (_E7_) COROLLA Station Wagon (_E9_) TERCEL (AL2_) TERCEL (_L1_, _L2_) VAUXHALL ASTRA Mk III (F) Estate (T92) COMBO Mk I (B) (S93) VOLKSWAGEN CORRADO (53I) GOLF III (1H1) GOLF III Cabriolet (1E7) GOLF III Variant (1H5) JETTA I (16) JETTA II (19E, 1G2, 165) PASSAT B1 (32) PASSAT B1 Variant (33) PASSAT B2 (32B) PASSAT B2 Saloon (32B) PASSAT B2 Variant (33B) PASSAT B3/B4 (3A2, 35I) PASSAT B3/B4 Variant (3A5, 35I) PASSAT B5 (3B2) PASSAT B5 Variant (3B5) PASSAT B5.5 (3B3) PASSAT B5.5 Variant (3B6) PASSAT B6 (3C2) PASSAT B6 Variant (3C5) SCIROCCO (53B)			
				LS	7.02604.03.0
					
				ALFA ROMEO	155 (167_) 164 (164_) 33 (907_) 33 Sportwagon (905_)





LS	7.02604.03.0	LS	7.02604.03.0	LS	7.02604.03.0
33 Sportwagon (907_)		PRISMA (831_)		PORSCHE	
6 (119_)		THEMA (834_)		911	
75 (162_)		THEMA SW (834_)		911 (964)	
90 (162_)		Y10 (156_)		911 Convertible	
ALFA 33		MAZDA		911 Convertible (964)	
AUDI		121 I (DA)		924	
100 C3 Avant (445, 446)		121 II (DB)		928	
100 C3 Saloon (443, 444)		MERCEDES-BENZ		944	
100 C4 Avant (4A5)		124 Convertible (A124)		944 Convertible	
100 C4 Saloon (4A2)		124 Coupe (C124)		968	
200 C3 Avant (447, 448)		124 Saloon (W124)		968 Convertible	
200 C3 Saloon (447, 448)		124 T-Model (S124)		RENAULT	
80 B2 Saloon (811, 813, 814, 819, 853)		190 (W201)		19 I (B/C53_)	
80 B3 Saloon (893, 894, 8A2)		300		19 I Cabriolet (D53_)	
80 B4 Avant (8C5)		E-CLASS (W124)		19 I Chamade (L53_)	
80 B4 Saloon (8C2)		E-CLASS T-Model (S124)		19 II (B/C53_)	
90 B3 (893, 894, 8A2)		G-CLASS (W460)		19 II Cabriolet (D53_, 853_)	
A4 B5 (8D2)		S-CLASS (W126)		19 II Chamade (L53_)	
A4 B5 Avant (8D5)		S-CLASS Coupe (C126)		21 (B48_)	
A6 C4 (4A2)		SL (R107)		21 Estate (K48_)	
A6 C4 Avant (4A5)		SL (R129)		21 Saloon (L48_)	
A8 D2 (4D2, 4D8)		NISSAN		CLIO I (B/C57_, 5/357_)	
CABRIOLET B3 (8G7)		ALMERA I (N15)		CLIO I Hatchback Van (S57_)	
COUPE B2 (81, 855, 856)		ALMERA I Hatchback (N15)		KANGOO (KC0/1_)	
COUPE B3 (89, 8B3)		ALMERA II (N16)		KANGOO Express (FC0/1_)	
AUTOBIANCHI		MICRA II (K11)		LAGUNA I (B56_, 556_)	
Y10		MICRA III (K12)		MEGANE I (BA0/1_)	
BMW		PRIMERA (P10)		MEGANE I Cabriolet (EA0/1_)	
3 (E30)		PRIMERA (P11)		MEGANE I Classic (LA0/1_)	
6 (E24)		PRIMERA (P12)		MEGANE I Coach (DA0/1_)	
CITROEN		PRIMERA Estate (WP12)		SAFRANE I (B54_)	
VISA		PRIMERA Hatchback (P10)		SAFRANE II (B54_)	
FIAT		PRIMERA Hatchback (P11)		TWINGO I (C06_)	
COUPE (175_)		PRIMERA Hatchback (P12)		TWINGO I Hatchback Van (S06_)	
TEMPRA (159_)		PRIMERA Traveller (W10)		SAAB	
TEMPRA S.W. (159_)		PRIMERA Traveller (WP11)		900 I (AC4, AM4)	
TIPO (160_)		SERENA (C23)		900 I Combi Coupe	
UNO (146_)		SERENA (C24)		900 I Convertible	
FORD		SERENA (C25)		900 II	
SCORPIO I (GAE, GGE)		OPEL		900 II Convertible	
SCORPIO I Saloon (GGE)		ASCONA C (J82)		900 II Coupe	
SCORPIO I Turnier (GGE)		ASCONA C Hatchback (J82)		9000	
SCORPIO II (GFR, GGR)		ASTRA F (T92)		9000 Hatchback	
SCORPIO II Turnier (GMR, GGR)		ASTRA F Convertible (T92)		SEAT	
SIERRA II (GBG, GB4)		ASTRA F Estate (T92)		TOLEDO I (1L2)	
SIERRA II Hatchback (GBC, GBG)		ASTRA F Hatchback (T92)		SUBARU	
SIERRA II Turnier (BNG)		CALIBRA A (C89)		IMPREZA Coupe (GFC)	
HYUNDAI		FRONTERA A Sport (U92)		IMPREZA Estate (GF)	
S COUPE (SLC)		KADETT E (T85)		IMPREZA Estate (GG)	
JAGUAR		KADETT E Convertible (T85)		IMPREZA Saloon (GC)	
XJ (XJ40, XJ81)		KADETT E Estate (T85)		IMPREZA Saloon (GD)	
XJ Coupe		KADETT E Hatchback (T85)		SVX (CX)	
XJSC Convertible (X27)		OMEGA A (V87)		TOYOTA	
KIA		OMEGA A Estate (V87)		LAND CRUISER 80 (_J8_)	
CLARUS (K9A)		OMEGA B (V94)		VAUXHALL	
CLARUS Estate (GC)		OMEGA B Estate (V94)		ASTRA Mk II Convertible (T85)	
SPORTAGE SUV (K00)		SENATOR B (V88)		ASTRA Mk II Hatchback (T85)	
LANCIA		SINTR A (APV)		ASTRA Mk III (F) Convertible (T92)	
DEDRA (835_)		VECTRA A (J89)		ASTRA Mk III (F) Estate (T92)	
DEDRA SW (835_)		VECTRA A Hatchback (J89)		ASTRA Mk III (F) Hatchback (T92)	
DELTA I (831_)		PEUGEOT		ASTRA Mk III (F) Saloon (T92)	
DELTA II (836_)		505 (551A)		CARLTON Mk III Estate (V87)	
		505 Break (551D)		CARLTON Mk III Saloon (V87)	





LS	7.02604.03.0	LS	7.02604.04.0	LS	7.02604.04.0
CAVALIER Mk II Hatchback (J82) CAVALIER Mk II Saloon (J82) NOVA Hatchback (S83) VOLKSWAGEN CORRADO (53I) GOLF II (19E, 1G1) JETTA I (16) JETTA II (19E, 1G2, 165) JETTA III (1H5) POLO Coupe (86C, 80) VENTO (1H2) VOLVO 440 (445) 460 (464) 480 (482)		FERRARI 512 TR FIAT BRAVA (182_) BRAVO I (182_) CINQUECENTO (170_) CROMA (154_) MAREA (185_) MAREA Weekend (185_) PANDA (141_) PANDA Hatchback Van (141_) PUNTO (176_) PUNTO (188_) TEMPRA (159_) TEMPRA S.W. (159_) TIPO (160_) ULYSSE (220_) FORD FIESTA III (GFJ) SIERRA I Hatchback (GBC) SIERRA II (GBG, GB4) SIERRA II Hatchback (GBC, GBG) SIERRA II Turnier (BNG) SIERRA Turnier (BNC) LANCIA DEDRA (835_) DEDRA SW (835_) DELTA I (831_) DELTA II (836_) KAPPA (838_) KAPPA Coupe (838_) KAPPA SW (838_) THEMA (834_) THEMA SW (834_) Y (840_) MERCEDES-BENZ 124 Saloon (W124) 124 T-Model (S124) E-CLASS (W210) E-CLASS T-Model (S210) VITO Bus (W638) VITO Van (W638) PEUGEOT 106 I (1A, 1C) 106 II (1A_, 1C_) 205 I (741A/C) 205 I Convertible (741B, 20D) 205 II (20A/C) 306 (7B, N3, N5) 306 Break (7E, N3, N5) 306 Convertible (7D, N3, N5) 306 Hatchback (7A, 7C, N3, N5) 405 II (4B) 405 II Break (4E) 406 (8B) 406 Break (8E/F) 406 Coupe (8C) 605 (6B) 806 (221) BOXER Bus (230P) BOXER Platform/Chassis (ZCT_) BOXER Van (230L) EXPERT (224_)	EXPERT Platform/Chassis (223) EXPERT Van (222) ROVER 200 Coupe (XW) 200 II Convertible (XW) 200 II Hatchback (RF) 200 II Hatchback (XW) 400 II (XW) SEAT CORDOBA (6K1, 6K2) CORDOBA Vario (6K5) TOLEDO I (1L2) VOLKSWAGEN GOLF III (1H1) PASSAT B3/B4 (3A2, 35I) PASSAT B3/B4 Variant (3A5, 35I) VOLVO 850 (854) 850 Estate (855)		
LS	7.02604.04.0			LS	7.02604.05.0
					
ALFA ROMEO 145 (930_) 146 (930_) 155 (167_) AUDI CABRIOLET B3 (8G7) BMW 6 (E24) 7 (E32) CITROEN BERLINGO / BERLINGO FIRST Box Body/MPV (M_) BERLINGO / BERLINGO FIRST MPV (MF_, GJK_, GFK_) BX (XB_) C15 Box Body/MPV (VD_) C25 Bus (280_, 290_) C25 Platform/Chassis (280_, 290_) C25 Van (280_, 290_) EVASION MPV (22, U6) JUMPER Bus (230P) JUMPER Platform/Chassis (230) JUMPER Van (230L) JUMPY (U6U_) JUMPY Van (BS_, BT_, BY_, BZ_) SAXO (S0, S1) XANTIA (X1_, X2_) XANTIA Break (X1_, X2_) XM (Y3) XM (Y4) XM Break (Y3) XM Break (Y4) ZX (N2) ZX Break (N2)			OPEL ASTRA G CLASSIC Caravan (F35) ASTRA G Convertible (T98) ASTRA G Coupe (T98) ASTRA G Estate (T98) ASTRA G Estate Van (F70) ASTRA G Hatchback (T98) ASTRA G Saloon (T98) ASTRA H (A04) ASTRA H Estate (A04) ASTRA H Estate Van (L70) ASTRA H GTC (A04) ASTRA H Saloon (A04) ASTRA H TwinTop (A04) MERIVA A MPV (X03) VECTRA C (Z02) VECTRA C Estate (Z02) VECTRA C GTS (Z02) ZAFIRA / ZAFIRA FAMILY B (A05) ZAFIRA A MPV (T98) VAUXHALL ASTRA Mk IV (G) Convertible (T98) ASTRA Mk IV (G) Coupe (T98) ASTRA Mk IV (G) Estate (T98) ASTRA Mk IV (G) Hatchback (T98) ASTRA Mk V (H) (A04) ASTRA Mk V (H) Estate (A04) ASTRA Mk V (H) Sport Hatch (A04) ASTRA Mk V (H) TwinTop (A04)		





LS 7.02604.05.0	LS 7.02604.07.0	LS 7.02604.08.0
<p>ASTRAVAN Mk V (H) Estate Van (A04) MERIVA A (X03) ZAFIRA Mk II (B) (A05)</p>	<p>ASTRA Mk IV (G) Hatchback (T98) ASTRA Mk V (H) (A04) ASTRA Mk V (H) Estate (A04) ASTRA Mk V (H) Sport Hatch (A04) ASTRA Mk V (H) TwinTop (A04) ASTRA Mk VI (J) (P10) ASTRA Mk VI (J) Estate (P10) ASTRA Mk VI (J) Saloon (P10) ASTRAVAN Mk V (H) Estate Van (A04) CORSA Mk II (C) (X01) CORSAVAN Mk II (C) Hatchback Van (X01) INSIGNIA Mk I (A) Hatchback (G09) INSIGNIA Mk I (A) Saloon (G09) INSIGNIA Mk I (A) Sports Tourer (G09) MERIVA A (X03) MOKKA / MOKKA X (J13) OMEGA (B) Estate (V94) OMEGA (B) Saloon (V94) TIGRA TwinTop (X04) VX220 Convertible (E01) ZAFIRA A (T98) ZAFIRA Mk II (B) (A05) ZAFIRA Mk III (P12)</p>	<p>9-3 Estate (E50) VAUXHALL AGILA Mk I (A) (H00) ASTRA Mk V (H) (A04) ASTRA Mk V (H) Estate (A04) ASTRA Mk V (H) Sport Hatch (A04) ASTRAVAN Mk V (H) Estate Van (A04) CORSA Mk II (C) (X01) CORSA Mk III (D) (S07) CORSAVAN Mk II (C) Hatchback Van (X01) MERIVA A (X03) OMEGA (B) Estate (V94) OMEGA (B) Saloon (V94) SIGNUM (Z03) TIGRA TwinTop (X04) VECTRA Mk II (C) (Z02) VECTRA Mk II (C) Estate (Z02) VECTRA Mk II (C) GTS (Z02) ZAFIRA Mk II (B) (A05)</p>
<p>LS 7.02604.07.0</p>  <p>CHEVROLET AVEO Hatchback (T300) AVEO Saloon (T300) CRUZE (J300) CRUZE Hatchback (J305) CRUZE Station Wagon (J308) TRAX OPEL AGILA (A) (H00) ASTRA G CLASSIC Caravan (F35) ASTRA G Convertible (T98) ASTRA G Coupe (T98) ASTRA G Estate (T98) ASTRA G Hatchback (T98) ASTRA G Saloon (T98) ASTRA H (A04) ASTRA H Estate (A04) ASTRA H Estate Van (L70) ASTRA H GTC (A04) ASTRA H TwinTop (A04) ASTRA J (P10) ASTRA J GTC ASTRA J Saloon ASTRA J Sports Tourer (P10) CORSA C (X01) CORSA C Hatchback Van (X01) INSIGNIA A (G09) INSIGNIA A Saloon (G09) INSIGNIA A Sports Tourer (G09) MERIVA A MPV (X03) MOKKA / MOKKA X (J13) OMEGA B (V94) OMEGA B Estate (V94) SPEEDSTER (E01) TIGRA TwinTop (X04) ZAFIRA / ZAFIRA FAMILY B (A05) ZAFIRA B Box Body/MPV (A05) ZAFIRA TOURER C (P12) PORSCHE 911 (997) 911 Convertible (997) 911 Targa (997) VAUXHALL AGILA Mk I (A) (H00) ASTRA Mk IV (G) Convertible (T98) ASTRA Mk IV (G) Coupe (T98)</p>	<p>LS 7.02604.08.0</p>  <p>OPEL AGILA (A) (H00) AGILA A ASTRA G Estate (T98) ASTRA G Hatchback (T98) ASTRA G Saloon (T98) ASTRA H (A04) ASTRA H Estate (A04) ASTRA H GTC (A04) ASTRA H TwinTop (A04) CORSA C (X01) CORSA C Hatchback Van (X01) CORSA D (S07) CORSA D Hatchback Van (S07) MERIVA A MPV (X03) OMEGA B (V94) OMEGA B Estate (V94) SIGNUM Hatchback (Z03) TIGRA TwinTop (X04) VECTRA C (Z02) VECTRA C Estate (Z02) VECTRA C GTS (Z02) ZAFIRA / ZAFIRA FAMILY B (A05) SAAB 9-3 (YS3F, E79, D79, D75) 9-3 Convertible (YS3F)</p>	<p>LS 7.02604.10.0</p>  <p>OPEL VIVARO A Bus (X83) VIVARO A Platform/Chassis (X83) VIVARO A Van (X83) RENAULT CLIO II (BB_, CB_) CLIO II Hatchback Van (SB0/1/2_) CLIO III (BR0/1, CR0/1) CLIO III Grandtour (KR0/1_) ESPACE III (JE0_) ESPACE IV (JK0/1_) GRAND SCÉNIC II (JM0/1_) KANGOO (KC0/1_) KANGOO Express (FC0/1_) LAGUNA I (B56_, 556_) LAGUNA I Grandtour (K56_) LAGUNA II (BG0/1_) LAGUNA II Grandtour (KG0/1_) LAGUNA III (BT0/1) LAGUNA III Grandtour (KT0/1) MEGANE I (BA0/1_) MEGANE I Cabriolet (EA0/1_) MEGANE I Classic (LA0/1_) MEGANE I Coach (DA0/1_) MEGANE I Grandtour (KA0/1_) MEGANE II (BM0/1_, CM0/1_) MEGANE II Coupé-Cabriolet (EM0/1_) MEGANE II Estate (KM0/1_) MEGANE II Saloon (LM0/1_) MEGANE Scenic (JA0/1_)</p>











LS 7.02604.10.0	LS 7.02604.13.0	LS 7.02604.15.0
<p>MODUS / GRAND MODUS (F/JP0_) Megane I Kombi van (KA_) SCÉNIC I MPV (JA0/1_, FA0_) SCÉNIC II (JM0/1_) THALIA I (LB_) THALIA II (LU_) TRAFIC II Bus (JL) TRAFIC II Platform/Chassis (EL) TRAFIC II Van (FL) TWINGO I (C06_) TWINGO I Hatchback Van (S06_)</p> <p>VAUXHALL VIVARO A Bus (X83) VIVARO A Van (X83)</p>	 <p>CITROEN C3 I (FC_, FN_)</p> <p>PEUGEOT 307 CC (3B)</p>	<p>TIGRA (S93) VECTRA A (J89) VECTRA A Hatchback (J89) VECTRA B (J96) VECTRA B Estate (J96) VECTRA B Hatchback (J96)</p> <p>SUBARU JUSTY II (JMA, MS)</p> <p>SUZUKI SWIFT Convertible (SF413) SWIFT I (AA) SWIFT II Hatchback (EA, MA) SWIFT II Saloon (AH, AJ)</p> <p>VAUXHALL ASTRA Mk II Belmont (T85) ASTRA Mk II Hatchback (T85) ASTRA Mk III (F) Convertible (T92) ASTRA Mk III (F) Estate (T92) ASTRA Mk III (F) Hatchback (T92) ASTRA Mk III (F) Saloon (T92) ASTRA Mk IV (G) Estate (T98) ASTRA Mk IV (G) Hatchback (T98) ASTRA Mk IV (G) Saloon (T98) ASTRAVAN Mk III (F) Estate Van (T92) ASTRAVAN Mk IV (G) Estate Van (T98) BRAVA Pickup (TF0, TF1) CAVALIER Mk II Saloon (J82) CAVALIER Mk III Hatchback (J89) CAVALIER Mk III Saloon (J89) CORSA Mk I (B) (S93) CORSAVAN Mk I (B) Hatchback Van (S93) NOVA Hatchback (S83) NOVA Saloon (S83) TIGRA Mk I (S93) VECTRA (B) Hatchback (J96) VECTRA (B) Saloon (J96)</p>
<p>LS 7.02604.11.0</p> <p>CADILLAC BLS BLS Wagon</p> <p>CITROEN C2 (JM_) C3 I (FC_, FN_) C4 Coupe (LA_) C4 I (LC_)</p> <p>FIAT ULYSSE (179_)</p> <p>PEUGEOT 1007 (KM_) 206 Hatchback (2A/C) 206 SW (2E/K) 207 (WA_, WC_) 207 SW (WK_) 307 (3A/C) 307 Break (3E) 307 SW (3H)</p> <p>SAAB 9-3 (YS3F, E79, D79, D75)</p>	<p>LS 7.02604.15.0</p>  <p>DAEWOO LANOS Saloon (KLAT) LEGANZA (KLAV) NUBIRA (J100) NUBIRA (J150) NUBIRA Estate (J150) NUBIRA Saloon (J100) NUBIRA Saloon (J150) NUBIRA Wagon (J100)</p> <p>OPEL ASCONA C (J82) ASTRA F (T92) ASTRA F CLASSIC Estate (T92) ASTRA F CLASSIC Hatchback (T92) ASTRA F CLASSIC Saloon (T92) ASTRA F Convertible (T92) ASTRA F Estate (T92) ASTRA F Estate Van (T92) ASTRA F Hatchback (T92) ASTRA G Estate (T98) ASTRA G Estate Van (F70) ASTRA G Hatchback (T98) CORSA A Hatchback (S83) CORSA A Hatchback Van (S83) CORSA B (S93) CORSA B Hatchback Van (S93) KADETT E (T85) KADETT E Combo (T85) KADETT E Convertible (T85) KADETT E Estate (T85) KADETT E Estate Van (T85) KADETT E Hatchback (T85)</p>	<p>LS 7.02604.21.0</p>  <p>BMW 3 (E46) 3 Compact (E46) 3 Convertible (E46) 3 Coupe (E46) 3 Touring (E46) 5 (E39) 5 (E60) 5 Touring (E39) 5 Touring (E61) 7 (E38) 7 (E65, E66, E67) X3 (E83)</p>
<p>LS 7.02604.12.0</p>  <p>CITROEN C3 I (FC_, FN_) C4 Coupe (LA_) C4 I (LC_)</p> <p>PEUGEOT 206 Hatchback (2A/C) 206 SW (2E/K) 307 (3A/C) 307 Break (3E) 307 SW (3H)</p>		

EMISSION CONTROL







LS	7.02604.21.0	LS	7.02604.26.0	LS	7.02604.28.0	
<p>X5 (E53) Z3 (E36) Z3 Coupe (E36) Z3 Roadster (E36) Z4 Roadster (E85)</p>		<p>3 Touring (E91) 5 (E60) 5 Touring (E61) 6 Convertible (E64) X1 (E84) X3 (E83) X5 (E70) Z4 Coupe (E86) Z4 Roadster (E85) Z4 Roadster (E89)</p> <p>MERCEDES-BENZ C-CLASS (W203) C-CLASS Coupe (CL203) C-CLASS T-Model (S203) CLK (C209) CLK Convertible (A209) CLS (C219) E-CLASS (W211) E-CLASS T-Model (S211) M-CLASS (W164) R-CLASS (W251, V251) SL (R230) SLR (R199) SLR Roadster (R199)</p>			<p>BMW 3 (E90) 3 (E92) 3 Convertible (E93) 5 (E60) 5 Touring (E61) 6 (E63) 6 (E64) 6 Convertible (E64) 7 (E65, E66, E67) X5 (E70) X6 (E71, E72)</p> <p>MERCEDES-BENZ C-CLASS (W202) C-CLASS T-Model (S202) CLK (C208) CLK Convertible (A208)</p>	<p>BMW 3 (E36) 3 Convertible (E36) 3 Convertible (E46) 3 Coupe (E36) 3 Coupe (E46) Z3 Coupe (E36) Z3 Roadster (E36) Z4 Coupe (E86) Z4 Roadster (E85)</p>
<p>LS</p> <p>7.02604.25.0</p>		<p>LS</p> <p>7.02604.27.0</p>		<p>LS</p> <p>7.02604.30.0</p>		
<p>LS</p> <p>7.02604.26.0</p>		<p>LS</p> <p>7.02604.26.0</p>	<p>LS</p> <p>7.02604.26.0</p>	<p>LS</p> <p>7.02604.26.0</p>	<p>LS</p> <p>7.02604.26.0</p>	
<p>BMW 1 (E81) 1 (E82) 1 (E87) 1 (E88) 1 Convertible (E88) 1 Coupe (E82) 3 (E90) 3 (E91) 3 (E93) 3 Convertible (E93) 3 Coupe (E92)</p>	<p>BMW 5 (E60) 5 (F10) 5 Touring (E61) 6 (E63) 6 Convertible (E64) 7 (F01, F02, F03, F04)</p> <p>MERCEDES-BENZ C-CLASS (W202) C-CLASS (W203) C-CLASS Coupe (CL203) C-CLASS T-Model (S202) C-CLASS T-Model (S203) CLK (C208) CLK Convertible (A208) SL (R230) SLK (R171)</p>	<p>BMW 3 (E36) 3 (E46) 3 Compact (E46) 3 Convertible (E36) 3 Convertible (E46) 3 Coupe (E36) 3 Coupe (E46) 3 Touring (E46) 5 (E39) 5 Touring (E39) 7 (E38) Z3 Coupe (E36) Z3 Roadster (E36) Z4 Roadster (E85)</p>				

EMISSION CONTROL



LS	7.02604.31.0	LS	7.02604.32.0	LS	7.02604.37.0
		<p>7 (E65, E66, E67) X5 (E53)</p>		<p>3 Coupe (E36) 3 Touring (E36) 5 (E39) 5 Touring (E39)</p>	
<p>BMW 3 (E36) 3 (E46) 3 Compact (E36) 3 Compact (E46) 3 Convertible (E46) 3 Coupe (E36) 3 Coupe (E46) 3 Touring (E46) 5 (E39) 5 (E60) 5 Touring (E39) 5 Touring (E61) 7 (E38) 7 (E65, E66, E67) 8 (E31) X3 (E83) X5 (E53) Z3 (E36) Z3 Coupe (E36) Z3 Roadster (E36) Z4 Roadster (E85) Z8 Roadster (E52)</p> <p>LAND ROVER RANGE ROVER III (L322)</p>		<p>LS</p> <p>7.02604.34.0</p> <p>BMW 1 (E81) 1 (E82) 1 (E87) 1 (E88) 1 Convertible (E88) 1 Coupe (E82) 3 (E90) 3 (E91) 3 (E93) 3 Convertible (E93) 3 Coupe (E92) 3 Touring (E91) 5 (E60) 5 (F10) 5 Gran Turismo (F07) 5 Touring (E61) 6 (E63) 6 (E64) 7 (E65, E66, E67) 7 (F01, F02, F03, F04) X1 (E84) X3 (E83) X5 (E70) X6 (E71, E72) Z4 Coupe (E86) Z4 Roadster (E85) Z4 Roadster (E89)</p>		<p>LS</p> <p>7.02604.38.0</p> <p>BMW 3 (E36) 3 Convertible (E36) 3 Coupe (E36) 3 Touring (E36)</p>	
<p>LS</p> <p>7.02604.32.0</p> <p>BMW 3 (E46) 3 Compact (E46) 3 Convertible (E46) 3 Coupe (E46) 3 Touring (E46) 5 (E60) 5 Touring (E61) 6 (E63) 6 Convertible (E64)</p>		<p>LS</p> <p>7.02604.37.0</p> <p>BMW 3 (E36) 3 Compact (E36) 3 Convertible (E36)</p>		<p>LS</p> <p>7.02604.41.0</p> <p>BMW 1 (E81) 1 (E87) 1 Convertible (E88) 1 Coupe (E82) 3 (E90) 3 Convertible (E93) 3 Coupe (E92) 3 Touring (E91) 5 (E60) 5 (F10) 5 Gran Turismo (F07) 5 Touring (E61) 5 Touring (F11) 6 (E63) 6 Convertible (E64) 7 (E65, E66, E67) 7 (F01, F02, F03, F04) X5 (E70) X5 (F15, F85) X6 (E71, E72)</p> <p>CITROEN C4 Coupe (LA_) C4 GRAND PICASSO I (UA_) C4 I (LC_)</p>	







LS	7.02604.41.0	LS	7.02604.42.0	LS	7.02604.44.0
C4 PICASSO I MPV (UD_) DS3 DS3 Convertible MINI (BMW) MINI (R56) MINI CLUBMAN (R55) MINI Convertible (R57) MINI Coupe (R58) MINI Roadster (R59) PEUGEOT 207 (WA_, WC_) 207 CC (WD_) 207 SW (WK_) 308 CC (4B_) 308 I (4A_, 4C_) 308 SW I (4E_, 4H_) RENAULT ESPACE IV (JK0/1_) KOLEOS I (HY_) LAGUNA Coupe (DT0/1) LAGUNA III (BT0/1) LAGUNA III Grandtour (KT0/1) LATITUDE (L70_) ROLLS-ROYCE PHANTOM VII (RR1) PHANTOM VII Coupe (RR3) PHANTOM VII Drophead Coupe (RR2) SKODA SUPERB II (3T4) SUPERB II Estate (3T5) VOLKSWAGEN CC B7 (358) PASSAT B6 (3C2) PASSAT B6 Variant (3C5) PASSAT B7 (362) PASSAT B7 Estate Van (365) PASSAT B7 Variant (365) PASSAT CC B6 (357)	3 Convertible (E93) 3 Coupe (E92) 3 Touring (E91) 5 (E60) 5 (F10) 5 Touring (E61) 6 (E63) 6 (E64) 7 (F01, F02, F03, F04) X1 (E84) X3 (E83) X5 (E70) Z4 Coupe (E86) Z4 Roadster (E85) Z4 Roadster (E89)		LS 7.02604.43.0	BMW 1 (F20) 1 (F21) 2 Coupe (F22, F87) 3 (E46) 3 (E90) 3 (F30, F80) 3 Compact (E46) 3 Convertible (E46) 3 Coupe (E46) 3 Gran Turismo (F34) 3 Touring (E46) 3 Touring (F31) 4 Convertible (F33, F83) 4 Coupe (F32, F82) 4 Gran Coupe (F36) 5 (E60) 5 (F10) 5 Gran Turismo (F07) 5 Touring (F11) 6 Convertible (F12) 6 Coupe (F13) 6 Gran Coupe (F06) 7 (E65, E66, E67) 7 (F01, F02, F03, F04) X3 (E83) X3 (F25) X4 (F26) X5 (E70) X5 (F15, F85) X6 (F16, F86) CHEVROLET MALIBU (V300) FIAT BRAVO II (198_) DOBLO Bus (263_) DOBLO Cargo (263_) GRANDE PUNTO (199_) IDEA (350_) LINEA (323_, 110_) PUNTO EVO (199_) LANCIA DELTA III (844_) MUSA (350_) MERCEDES-BENZ C-CLASS (W204) C-CLASS (W205) C-CLASS Convertible (A205) C-CLASS Coupe (C204) C-CLASS Coupe (C205) C-CLASS T-Model (S204) C-CLASS T-Model (S205) CLS (C218) CLS Shooting Brake (X218) E-CLASS (W212) E-CLASS (W213) E-CLASS Convertible (A207) E-CLASS Coupe (C207) E-CLASS T-Model (S212) E-CLASS T-Model (S213) G-CLASS (W463) GLC (X253) GLC Coupe (C253)	
LS 7.02604.42.0		LS 7.02604.44.0		BMW 1 (E81) 1 (E82) 1 (E87) 1 (E88) 1 Convertible (E88) 1 Coupe (E82) 3 (E90) 3 (E91) 3 (E93)	ALFA ROMEO 159 (939_) 159 Sportwagon (939_) 166 (936_) BRERA (939_) GIULIETTA (940_) MITO (955_) SPIDER (939_)

EMISSION CONTROL





LS	7.02604.44.0	LS	7.02604.44.0	LS	7.02604.49.0
GLE (W166) GLK-CLASS (X204) S-CLASS (W221) S-CLASS (W222, V222, X222) S-CLASS Convertible (A217) S-CLASS Coupe (C216) S-CLASS Coupe (C217) SL (R231) MERCEDES-BENZ (BBDC) E-CLASS (W212) E-CLASS (W213) NISSAN QASHQAI / QASHQAI +2 I (J10, NJ10, JJ10E) X-TRAIL (T31) OPEL ASTRA J (P10) ASTRA J Estate Van (P10) ASTRA J GTC ASTRA J Hatchback Van (P10) ASTRA J Saloon ASTRA J Sports Tourer (P10) CASCADA (W13) CORSA D (S07) CORSA D Hatchback Van (S07) INSIGNIA A (G09) INSIGNIA A Country Tourer (G09) INSIGNIA A Saloon (G09) INSIGNIA A Sports Tourer (G09) MERIVA B MPV (S10) MOVANO Bus (X70) MOVANO Platform/Chassis (X70) MOVANO Van (X70) VIVARO A Bus (X83) VIVARO A Platform/Chassis (X83) VIVARO A Van (X83) ZAFIRA TOURER C (P12)	VIVARO A Platform/Chassis (X83) VIVARO A Van (X83) ZAFIRA Mk III (P12)		FIAT BRAVA (182_) BRAVO I (182_) MAREA (185_) MAREA Weekend (185_) MULTIPLA (186_) PUNTO (176_) PUNTO Convertible (176_) PUNTO Hatchback Van (188_)	FIAT BRAVA (182_) BRAVO I (182_) MAREA (185_) MAREA Weekend (185_) MULTIPLA (186_) PUNTO (176_) PUNTO Convertible (176_) PUNTO Hatchback Van (188_)	
RENAULT ESPACE IV (JK0/1_) KOLEOS I (HY_) LAGUNA Coupe (DT0/1) LAGUNA III (BT0/1) LAGUNA III Grandtour (KT0/1) MASTER II Bus (JD) MASTER II Platform/Chassis (ED/HD/UD) MASTER II Van (FD) TRAFIC II Bus (JL) TRAFIC II Platform/Chassis (EL) TRAFIC II Van (FL) VAUXHALL ASTRA Mk VI (J) (P10) ASTRA Mk VI (J) Estate (P10) ASTRA Mk VI (J) GTC (P10) CASCADA Convertible (W13) CORSA Mk III (D) (S07) INSIGNIA Mk I (A) Country Tourer (G09) INSIGNIA Mk I (A) Hatchback (G09) INSIGNIA Mk I (A) Saloon (G09) INSIGNIA Mk I (A) Sports Tourer (G09) MERIVA Mk II (B) (S10) MOVANO Mk I (A) Chassis/Cab (X70) MOVANO Mk I (A) Combi (X70) MOVANO Mk I (A) Van (X70) VIVARO A Bus (X83)	FIAT BARCETTA (183_) BRAVA (182_) BRAVO I (182_) CINQUECENTO (170_) DOBLO Box Body/MPV (223_) DOBLO MPV (119_, 223_) MAREA (185_) MAREA Weekend (185_) PALIO (178 BX7DX) PALIO (178_) PALIO Weekend (178_, 173_, 373_, 374_, 171_) PANDA (141_) PANDA (169_) PANDA Hatchback Van (141_) PANDA Hatchback Van (169_) PUNTO (176_) PUNTO (188_) PUNTO Convertible (176_) SEICENTO / 600 (187_) SEICENTO / 600 Hatchback Van (287_) SIENA (178_, 172_) STILO (192_) STILO Multi Wagon (192_) LANCIA LYBRA (839_) LYBRA SW (839_) Y (840_)		LANCIA DEDRA (835_) DEDRA SW (835_) DELTA II (836_) LYBRA (839_) LYBRA SW (839_)	LANCIA DEDRA (835_) DEDRA SW (835_) DELTA II (836_) LYBRA (839_) LYBRA SW (839_)	
				LS	7.02604.51.0
					ABARTH 500 / 595 / 695 GRANDE PUNTO ALFA ROMEO 147 (937_) 156 (932_) 156 Sportwagon (932_)
				LS	7.02604.49.0
					





LS 7.02604.53.0	LS 7.02604.54.0	LS 7.02604.56.0
<p>166 (936_) GIULIETTA (940_) GT (937_) GTV (916_) MITO (955_) SPIDER (916_)</p> <p>FIAT 500 (312_) ALBEA BRAVA (182_) BRAVO I (182_) BRAVO II (198_) DOBLO Box Body/MPV (223_) DOBLO MPV (119_, 223_) DUCATO Bus (250_) DUCATO Platform/Chassis (250_) GRANDE PUNTO (199_) IDEA (350_) LINEA (323_, 110_) MAREA (185_) MAREA Weekend (185_) PALIO (178_) PALIO Weekend (178_, 173_, 373_, 374_, 171_) PANDA (169_) PANDA Hatchback Van (169_) PETRA PUNTO (188_) PUNTO (199_) PUNTO EVO (199_) QUBO (225_) SIENA (178_, 172_) STILO (192_) STILO Multi Wagon (192_) STRADA Pickup (178_)</p> <p>LANCIA DELTA III (844_) LYBRA (839_) LYBRA SW (839_) MUSA (350_) THESIS (841_) Y (840_) YPSILON (843_)</p>	<p>TIPO (160_)</p> <p>LANCIA KAPPA (838_) KAPPA Coupe (838_) KAPPA SW (838_)</p> <hr/> <p>LS 7.02604.55.0</p> <p>ABARTH 500 / 595 / 695 GRANDE PUNTO</p> <p>ALFA ROMEO 147 (937_) 156 (932_) 156 Sportwagon (932_) 166 (936_) GT (937_) GTV (916_) MITO (955_) SPIDER (916_)</p> <p>FIAT BRAVA (182_) BRAVO I (182_) BRAVO II (198_) COUPE (175_) LINEA (323_, 110_) MAREA (185_) MAREA Weekend (185_) SIENA (178_, 172_) STILO (192_) STILO Multi Wagon (192_)</p> <p>LANCIA DELTA III (844_) KAPPA (838_) KAPPA SW (838_) LYBRA (839_) LYBRA SW (839_)</p>	<p>FIAT DOBLO Box Body/MPV (223_) DOBLO MPV (119_, 223_)</p> <p>LANCIA KAPPA (838_) KAPPA Coupe (838_) KAPPA SW (838_)</p> <hr/> <p>LS 7.02604.60.0</p> <div data-bbox="1037 537 1420 828" data-label="Image"> </div> <p>FORD COUGAR (EC_) FIESTA Box Body/MPV (J5_, J3_) FIESTA IV (JA_, JB_) FOCUS I (DAW, DBW) FOCUS I Saloon (DFW) FOCUS I Turnier (DNW) FUSION (JU_) KA (RB_) KA Van (RB) MAVERICK MONDEO I (GBP) MONDEO I Saloon (GBP) MONDEO I Turnier (BNP) MONDEO III (B5Y) MONDEO III Saloon (B4Y) MONDEO III Turnier (BWY) STREET KA (RL2) TRANSIT CONNECT (P65_, P70_, P80_)</p>
<p>LS 7.02604.54.0</p> <div data-bbox="127 1590 510 1881" data-label="Image"> </div> <p>ALFA ROMEO 155 (167_) 164 (164_) GTV (916_) SPIDER (916_)</p> <p>FIAT CROMA (154_)</p>	<p>LS 7.02604.56.0</p> <div data-bbox="590 1411 957 1724" data-label="Image"> </div> <p>ALFA ROMEO 145 (930_) 146 (930_) 156 (932_) 156 Sportwagon (932_) 159 (939_) 159 Sportwagon (939_) 166 (936_) BRERA (939_) GTV (916_) SPIDER (916_) SPIDER (939_)</p>	<p>LS 7.02604.61.0</p> <div data-bbox="1037 1523 1420 1836" data-label="Image"> </div> <p>FORD COUGAR (EC_) ESCORT IV (GAF, AWF, ABFT) ESCORT IV Convertible (ALF) ESCORT IV Turnier (AWF, AVF) ESCORT V (AAL, ABL) ESCORT V Convertible (ALL) ESCORT V Express (AVF)</p>

EMISSION CONTROL



LS 7.02604.61.0	LS 7.02604.63.0	LS 7.02604.64.0
<p>ESCORT V Saloon (AFL) ESCORT V Turnier (ANL) ESCORT VI (GAL, AAL, ABL) ESCORT VI Convertible (ALL) ESCORT VI Saloon (GAL, AFL) ESCORT VI Turnier (GAL, ANL) FIESTA Box Body/MPV (J5_, J3_) FIESTA I (GFBT) FIESTA III (GFJ) FIESTA IV (JA_, JB_) FIESTA V (JH_, JD_) MONDEO I (GBP) MONDEO I Saloon (GBP) MONDEO I Turnier (BNP) MONDEO II (BAP) MONDEO II Saloon (BFP) MONDEO II Turnier (BNP) ORION III (GAL) SCORPIO II (GFR, GGR) SCORPIO II Turnier (GNR, GGR)</p>	 <p>FORD FIESTA IV (JA_, JB_) FIESTA VI (CB1, CCN) GALAXY I (WGR) PUMA (EC_) SCORPIO II (GFR, GGR) SCORPIO II Turnier (GNR, GGR) TRANSIT Bus (E_) TRANSIT TOURNEO Bus TRANSIT Van (E_) FORD AUSTRALIA TRANSIT Platform/Chassis (VF, VG)</p>	<p>VOLVO C30 (533) S40 II (544) V50 (545)</p>
LS 7.02604.62.0	LS 7.02604.64.0	LS 7.02604.65.0
 <p>FORD ESCORT V (AAL, ABL) ESCORT V Convertible (ALL) ESCORT V Express (AVF) ESCORT V Saloon (AFL) ESCORT V Turnier (ANL) ESCORT VI (GAL, AAL, ABL) ESCORT VI Convertible (ALL) ESCORT VI Saloon (GAL, AFL) ESCORT VI Turnier (GAL, ANL) FIESTA II (FBD) FIESTA III (GFJ) FIESTA V (JH_, JD_) FIESTA VI (CB1, CCN) GRANADA KA (RB_) ORION III (GAL) SCORPIO I (GAE, GGE) SCORPIO I Saloon (GGE) SCORPIO I Turnier (GGE) SCORPIO II (GFR, GGR) SCORPIO II Turnier (GNR, GGR) SIERRA I Hatchback (GBC) SIERRA II (GBG, GB4) SIERRA II Hatchback (GBC, GBG) SIERRA II Turnier (BNG) SIERRA Turnier (BNC)</p>	 <p>FORD COUGAR (EC_) FIESTA IV (JA_, JB_) FIESTA V (JH_, JD_) FOCUS C-MAX (DM2) FOCUS I (DAW, DBW) FOCUS I Saloon (DFW) FOCUS I Turnier (DNW) FOCUS II (DA_, HCP, DP) FOCUS II Saloon (DB_, FCH, DH) FOCUS II Turnier (DA_, FFS, DS) GALAXY I (WGR) KA (RB_) KA Van (RB) MONDEO I (GBP) MONDEO I Saloon (GBP) MONDEO I Turnier (BNP) TRANSIT Bus (FD_, FB_, FS_, FZ_, FC_) TRANSIT CONNECT (P65_, P70_, P80_) TRANSIT Platform/Chassis (FM_, FN_) TRANSIT Van (FA_) FORD USA EXPLORER (U2, U_)</p>	 <p>FORD FOCUS C-MAX (DM2) FOCUS I (DAW, DBW) FOCUS I Saloon (DFW) FOCUS I Turnier (DNW) VOLVO C30 (533)</p>
LS 7.02604.73.0		
 <p>HYUNDAI ACCENT II (LC) ACCENT II Saloon (LC) ACCENT III (MC) ACCENT III Saloon (MC) ACCENT IV (RB) COUPE (RD) ELANTRA III (XD) ELANTRA III Saloon (XD) GETZ (TB) LANTRA II (J-2) LANTRA II Estate (J-2) MATRIX (FC) TRAJET (FO) TUCSON (JM) i30 (FD) i30 Estate (FD) KIA CARENS II MPV (FJ) CERATO I Hatchback (LD) CERATO I Saloon (LD) RIO II (JB) RIO II Saloon (JB)</p>		





<p>LS 7.02604.75.0</p>  <p>HYUNDAI SANTA FÉ I (SM) SANTAMO SONATA II (Y-2) SONATA III SONATA III (Y-3) SONATA IV SONATA IV (EF) TRAJET (FO)</p> <p>KIA JOICE (MTE1P) MAGENTIS (GD, MS)</p>	<p>LS 7.02604.79.0</p> <p>XG (XG) KIA MAGENTIS (GD, MS) OPIRUS (GH)</p>	<p>LS 7.02604.95.0</p>  <p>HYUNDAI ATOS (MX) SANTRO I i10 I (PA)</p> <p>KIA PICANTO (SA)</p>
<p>LS 7.02604.77.0</p>  <p>KIA RIO Hatchback (DC) RIO Saloon (DC_)</p>	<p>LS 7.02604.80.0</p>  <p>HYUNDAI COUPE (GK) COUPE (RD) ELANTRA III (XD) ELANTRA III Saloon (XD) LANTRA II (J-2) LANTRA II Estate (J-2) MATRIX (FC) TRAJET (FO) TUCSON (JM) i30 (FD) i30 Estate (FD)</p> <p>KIA CEE'D Hatchback (ED) CEE'D SW (ED) CERATO I Hatchback (LD) CERATO I Saloon (LD)</p>	<p>LS 7.02604.96.0</p>  <p>HYUNDAI ATOS (MX) SANTRO I i10 I (PA)</p> <p>KIA PICANTO (SA)</p>
<p>LS 7.02604.79.0</p>  <p>HYUNDAI SANTA FÉ I (SM) SONATA II (Y-2) SONATA IV SONATA IV (EF) TRAJET (FO)</p>	<p>LS 7.02604.92.0</p>  <p>HYUNDAI EQUUS / CENTENNIAL GENESIS (BH) GENESIS Coupe GRANDEUR (TG) SONATA V (NF)</p> <p>KIA SORENTO I (JC)</p>	<p>LS 7.02604.99.0</p>  <p>ALPINA C2 (E30)</p> <p>BMW 1 (E87) 3 (E90) 3 Convertible (E93) 3 Coupe (E92) 3 Touring (E91) 5 (E60)</p>

EMISSION CONTROL









LS	7.02604.99.0	LS	7.02604.99.0	LS	7.02604.99.0
5 Touring (E61)		i30 Coupe		VITO Bus (W639)	
6 (E63)		i30 Estate (FD)		MITSUBISHI	
6 Convertible (E64)		i30 Estate (GD)		COLT VI (Z3_A, Z2_A)	
7 (E65, E66, E67)		i40 I (VF)		NISSAN	
CITROEN		i40 I CW (VF)		QASHQAI / QASHQAI +2 I (J10, NJ10, JJ10E)	
BERLINGO Box Body/MPV (B9)		ix20 (JC)		OPEL	
BERLINGO MULTISPACE (B9)		ix35 (LM, EL, ELH)		ASTRA H (A04)	
C-ELYSEE (DD_)		IVECO		ASTRA H Estate (A04)	
C3 II (SC_)		DAILY IV Dump Truck		ASTRA H Estate Van (L70)	
C3 PICASSO (SH_)		DAILY IV Platform/Chassis		ASTRA H GTC (A04)	
C4 CACTUS		DAILY IV Van		ASTRA H TwinTop (A04)	
C4 GRAND PICASSO I (UA_)		DAILY V Van		INSIGNIA A (G09)	
C4 GRAND PICASSO II (DA_, DE_)		DAILY VI Platform/Chassis		INSIGNIA A Saloon (G09)	
C4 II (B7)		DAILY VI Van		INSIGNIA A Sports Tourer (G09)	
C4 PICASSO I MPV (UD_)		MASSIF Pickup		SIGNUM Hatchback (Z03)	
C4 PICASSO II		MASSIF Single Cab		VECTRA C (Z02)	
C5 III (RD_)		MASSIF Station Wagon		VECTRA C Estate (Z02)	
C5 III Break (RW_)		JEEP		VECTRA C GTS (Z02)	
DS3		COMMANDER (XK, XH)		ZAFIRA / ZAFIRA FAMILY B (A05)	
DS3 Convertible		GRAND CHEROKEE III (WH, WK)		PEUGEOT	
DS4 (NX_)		KIA		2008 I (CU_)	
DS5		CARENS III MPV (UN)		207 (WA_, WC_)	
JUMPER Bus		CARENS IV		207 SW (WK_)	
JUMPER Platform/Chassis		CEE'D (JD)		208 I (CA_, CC_)	
JUMPER Van		CEE'D Hatchback (ED)		3008 MPV (OU_)	
DODGE		CEE'D SW (ED)		301	
NITRO		CEE'D Sportswagon (JD)		308 CC (4B_)	
DS		CERATO I Hatchback (LD)		308 I (4A_, 4C_)	
DS 5 (KF_)		CERATO I Saloon (LD)		308 II (LB_, LP_, LW_, LH_, L3_)	
FIAT		OPTIMA (FSGDS6B)		308 SW I (4E_, 4H_)	
BRAVO II (198_)		PICANTO (SA)		308 SW II (LC_, LJ_, LR_, LX_, L4_)	
CROMA (194_)		PRO CEE'D (ED)		407 (6D_)	
DUCATO Bus (250_)		PRO CEE'D (JD)		407 Coupe (6C_)	
DUCATO Platform/Chassis (250_)		RIO II (JB)		407 SW (6E_)	
DUCATO Van (250_)		RIO II Saloon (JB)		5008 (0U_, 0E_)	
GRANDE PUNTO (199_)		SORENTO I (JC)		508 I (8D_)	
IDEA (350_)		SOUL I (AM)		508 SW I (8E_)	
STILO (192_)		SOUL II (PS)		BOXER Bus	
STILO Multi Wagon (192_)		SPORTAGE III (SL)		BOXER Platform/Chassis	
FORD		VENGA (YN)		BOXER Van	
GALAXY II (WA6)		LANCIA		PARTNER Box Body/MPV	
MONDEO IV (BA7)		DELTA III (844_)		PARTNER TEPEE	
MONDEO IV Turnier (BA7)		MUSA (350_)		RCZ	
S-MAX (WA6)		MERCEDES-BENZ		RENAULT	
HYUNDAI		A-CLASS (W169)		FLUENCE (L3_)	
ACCENT III (MC)		B-CLASS Sports Tourer (W245)		GRAND SCÉNIC III (JZ0/1_)	
ACCENT III Saloon (MC)		C-CLASS (W204)		MASTER III Bus (JV)	
ACCENT IV Saloon (RB)		C-CLASS Coupe (C204)		MASTER III Platform/Chassis (EV, HV, UV)	
ELANTRA IV Saloon (HD)		C-CLASS T-Model (S204)		MASTER III Van (FV)	
ELANTRA V Saloon (MD, UD)		CLK (C209)		MEGANE CC (EZ0/1_)	
GETZ (TB)		E-CLASS (W212)		MEGANE III Coupe (DZ0/1_)	
H-1 / STAREX Bus (A1)		E-CLASS Convertible (A207)		MEGANE III Grandtour (KZ0/1)	
H-1 Cargo (TQ)		E-CLASS Coupe (C207)		MEGANE III Hatchback (BZ0/1_, B3_)	
H-1 Travel (TQ)		E-CLASS T-Model (S212)		SCÉNIC III (JZ0/1_)	
H-1 Van (A1)		G-CLASS (W463)		TRAFIC III Bus (JG_)	
TUCSON (TL, TLE)		GL-CLASS (X166)		TRAFIC III Van (FG_)	
i10 I (PA)		GLK-CLASS (X204)		SAAB	
i20 ACTIVE (IB, GB)		M-CLASS (W166)		9-3 (YS3F, E79, D79, D75)	
i20 I (PB, PBT)		R-CLASS (W251, V251)		9-3 Convertible (YS3F)	
i20 II (GB, IB)		S-CLASS (W221)		9-3 Estate (E50)	
i20 II Coupe (GB)		S-CLASS Coupe (C216)		9-3X (YS3)	
i30 (FD)		VIANO (W639)		9-5 (YS3G)	
i30 (GD)		VITO / MIXTO Van (W639)			





LS 7.02604.99.0	LS 7.05270.03.0	LS 7.05270.12.0
<p>SMART</p> <p>FORTWO Cabrio (451) FORTWO Coupe (451)</p>	<p>SPRINTER 3-t Van (B903) SPRINTER 4-t Platform/Chassis (B904)</p>	<p>C-CLASS T-Model (S202) C-CLASS T-Model (S203) CLK (C208) CLK (C209) CLK Convertible (A208) CLK Convertible (A209) E-CLASS (W210) E-CLASS (W211) E-CLASS Platform/Chassis (VF210) E-CLASS T-Model (S210) E-CLASS T-Model (S211) S-CLASS (W220) S-CLASS Coupe (C215) SL (R230) SLK (R170) VIANO (W639) VITO / MIXTO Van (W639) VITO Bus (W639)</p>
<p>LS 7.05270.00.0</p> 	<p>LS 7.05270.11.0</p> 	
<p>MERCEDES-BENZ</p> <p>124 Saloon (W124) 300 500 C-CLASS (W202) E-CLASS (W124) S-CLASS (W140) S-CLASS Coupe (C140) SL (R129)</p>	<p>MERCEDES-BENZ</p> <p>C-CLASS (W203) C-CLASS (W204) C-CLASS Coupe (CL203) C-CLASS T-Model (S202) C-CLASS T-Model (S203) C-CLASS T-Model (S204) CLC-CLASS (CL203) CLK (C208) CLK (C209) CLK Convertible (A208) CLK Convertible (A209) E-CLASS (W211) E-CLASS (W212) E-CLASS T-Model (S211) G-CLASS (W463) M-CLASS (W164) R-CLASS (W251, V251) SLK (R171) SPRINTER 3,5-t Bus (B906) SPRINTER 3,5-t Platform/Chassis (B906) SPRINTER 3-t Platform/Chassis (B906) SPRINTER 3-t Van (B906) SPRINTER 5-t Platform/Chassis (B906)</p>	
<p>LS 7.05270.03.0</p> 	<p>MERCEDES-BENZ (BBDC)</p> <p>C-CLASS (W204)</p>	<p>LS 7.05270.15.0</p> 
<p>BMW</p> <p>3 (E36) 3 Convertible (E36) 3 Convertible (E46) 3 Coupe (E36) 3 Coupe (E46) Z3 Coupe (E36) Z3 Roadster (E36)</p>	<p>LS 7.05270.12.0</p> 	<p>MERCEDES-BENZ</p> <p>500 C-CLASS (W202) C-CLASS T-Model (S202) CLK (C208) CLK Convertible (A208) E-CLASS (W210) E-CLASS T-Model (S210) M-CLASS (W163) SL (R129) SLK (R170) SPRINTER 2-t Van (B901, B902) SPRINTER 3-t Bus (B903) SPRINTER 3-t Platform/Chassis (B903)</p>
<p>MERCEDES-BENZ</p> <p>500 C-CLASS (W202) C-CLASS T-Model (S202) CLK (C208) CLK Convertible (A208) E-CLASS (W210) E-CLASS T-Model (S210) M-CLASS (W163) SL (R129) SLK (R170) SPRINTER 2-t Van (B901, B902) SPRINTER 3-t Bus (B903) SPRINTER 3-t Platform/Chassis (B903)</p>	<p>MAYBACH</p> <p>57 (W240) 62 (V240)</p> <p>MERCEDES-BENZ</p> <p>C-CLASS (W203) C-CLASS Coupe (CL203)</p>	<p>LS 7.05270.17.0</p> <p>MERCEDES-BENZ</p> <p>A-CLASS (W169) B-CLASS Sports Tourer (W245) C-CLASS (W203) C-CLASS (W204) C-CLASS Coupe (C204) C-CLASS Coupe (CL203) C-CLASS T-Model (S203) C-CLASS T-Model (S204) CLC-CLASS (CL203) CLK (C209) CLK Convertible (A209) CLS (C219) E-CLASS (W211) E-CLASS (W212) E-CLASS Convertible (A207) E-CLASS Coupe (C207)</p>

EMISSION CONTROL





LS	7.05270.17.0	LS	7.05270.21.0	LS	7.05270.21.0
<p>E-CLASS T-Model (S211) E-CLASS T-Model (S212) GL-CLASS (X164) GLK-CLASS (X204) M-CLASS (W164) R-CLASS (W251, V251) SL (R230) SLK (R171)</p>		<p>BMW 1 (E81) 1 (E87) 1 Convertible (E88) 1 Coupe (E82) 3 (E90) 3 Convertible (E93) 3 Coupe (E92) 3 Touring (E91) 5 (E60) 5 Touring (E61) 6 Convertible (E64) 7 (E65, E66, E67) CHRYSLER PT CRUISER (PT_) CITROEN C8 (EA_, EB_) JUMPY (VF7) JUMPY Platform/Chassis JUMPY Van DODGE CALIBER JOURNEY FIAT SCUDO Bus (270_, 272_) SCUDO Platform/Chassis (270_, 272_) SCUDO Van (270_, 272_) IVECO DAILY CITYS Bus DAILY LINE Bus DAILY TOURYS Bus DAILY V Platform/Chassis DAILY V Van DAILY VI Platform/Chassis DAILY VI Van JEEP COMPASS (MK49) PATRIOT (MK74) MERCEDES-BENZ A-CLASS (W169) A-CLASS (W176) B-CLASS Sports Tourer (W245) B-CLASS Sports Tourer (W246, W242) C-CLASS (W203) C-CLASS (W204) C-CLASS Coupe (C204) C-CLASS T-Model (S203) C-CLASS T-Model (S204) CLA Coupe (C117) CLA Shooting Brake (X117) CLK (C209) CLK Convertible (A209) CLS (C218) CLS (C219) CLS Shooting Brake (X218) E-CLASS (W211) E-CLASS (W212) E-CLASS Convertible (A207) E-CLASS Coupe (C207) E-CLASS Platform/Chassis (VF211) E-CLASS T-Model (S211) E-CLASS T-Model (S212) G-CLASS (W463)</p>		<p>G-CLASS Cabrio (W463) GL-CLASS (X164) GLA-CLASS (X156) GLK-CLASS (X204) M-CLASS (W164) R-CLASS (W251, V251) S-CLASS (W221) S-CLASS Coupe (C216) SL (R230) SL (R231) SLK (R171) SLK (R172) SPRINTER 3,5-t Bus (B906) SPRINTER 3,5-t Platform/Chassis (B906) SPRINTER 3,5-t Van (B906) SPRINTER 3-t Bus (B906) SPRINTER 3-t Platform/Chassis (B906) SPRINTER 3-t Van (B906) SPRINTER 5-t Platform/Chassis (B906) SPRINTER 5-t Van (B906) VIANO (W639) VITO / MIXTO Van (W639) VITO Bus (W639) MERCEDES-BENZ (BBDC) GLK-CLASS (X204) PEUGEOT EXPERT Platform/Chassis EXPERT TEPEE (VF3X_) EXPERT Van (VF3A_, VF3U_, VF3X_) PARTNER Box Body/MPV PARTNER TEPEE SUZUKI SX4 (EY, GY)</p>	
<p>LS 7.05270.18.0</p>  <p>MERCEDES-BENZ C-CLASS (W204) C-CLASS T-Model (S204) CLS (C219) E-CLASS (W211) E-CLASS (W212) E-CLASS T-Model (S211) E-CLASS T-Model (S212) GL-CLASS (X164) GLK-CLASS (X204) M-CLASS (W164) R-CLASS (W251, V251) S-CLASS (W221) S-CLASS Coupe (C216) VIANO (W639) MERCEDES-BENZ (BBDC) GLK-CLASS (X204)</p>		<p>LS 7.05270.22.0</p>  <p>MERCEDES-BENZ C-CLASS (W203) C-CLASS (W204) C-CLASS Coupe (C204) C-CLASS Coupe (CL203) C-CLASS T-Model (S203) C-CLASS T-Model (S204) CLC-CLASS (CL203) CLK (C209) CLK Convertible (A209) CLS (C219) E-CLASS (W211) E-CLASS (W212) E-CLASS T-Model (S211) E-CLASS T-Model (S212) GL-CLASS (X164)</p>			
<p>LS 7.05270.21.0</p>  <p>ALFA ROMEO 147 (937_) 156 (932_) 156 Sportwagon (932_) 159 (939_) BRERA (939_) GT (937_) SPIDER (939_)</p>		<p>EMISION CONTROL</p> 			



LS	7.05270.22.0
M-CLASS (W164)	
S-CLASS (W221)	
S-CLASS Coupe (C216)	
SL (R230)	
SLK (R171)	
SLS AMG (C197)	
SLS AMG Roadster (R197)	
SPRINTER 3,5-t Bus (B906)	
SPRINTER 3,5-t Platform/Chassis (B906)	
SPRINTER 3,5-t Van (B906)	
SPRINTER 3-t Bus (B906)	
SPRINTER 3-t Platform/Chassis (B906)	
SPRINTER 3-t Van (B906)	
SPRINTER 5-t Platform/Chassis (B906)	
SPRINTER 5-t Van (B906)	



LS	7.05270.25.0

OPEL

ASTRA G Convertible (T98)
 ASTRA G Coupe (T98)
 ASTRA G Estate (T98)
 ASTRA G Estate Van (F70)
 ASTRA G Hatchback (T98)
 ASTRA G Saloon (T98)
 CORSA C (X01)
 MERIVA A MPV (X03)
 VECTRA C (Z02)
 VECTRA C Estate (Z02)
 VECTRA C GTS (Z02)
 ZAFIRA A MPV (T98)

VAUXHALL

ASTRA MK IV
 ASTRA Mk III (F) Estate (T92)
 ASTRA Mk III (F) Hatchback (T92)
 ASTRA Mk III (F) Saloon (T92)
 ASTRA Mk IV (G) Estate (T98)
 ASTRA Mk IV (G) Hatchback (T98)
 ASTRA Mk IV (G) Saloon (T98)
 ASTRAVAN Mk IV (G) Estate Van (T98)
 CORSA Mk II (C) (X01)
 MERIVA A (X03)
 ZAFIRA A (T98)

OPEL

ASTRA G Convertible (T98)
 ASTRA G Coupe (T98)
 ASTRA G Estate (T98)
 ASTRA G Hatchback (T98)
 ASTRA G Saloon (T98)
 SPEEDSTER (E01)
 VECTRA B (J96)
 VECTRA B Estate (J96)
 VECTRA B Hatchback (J96)
 ZAFIRA A MPV (T98)

VAUXHALL

ASTRA Mk IV (G) Convertible (T98)
 ASTRA Mk IV (G) Coupe (T98)
 ASTRA Mk IV (G) Estate (T98)
 ASTRA Mk IV (G) Hatchback (T98)
 VECTRA (B) Estate (J96)
 VECTRA (B) Hatchback (J96)
 VECTRA (B) Saloon (J96)
 VX220 Convertible (E01)
 ZAFIRA A (T98)

OPEL

ASTRA G Convertible (T98)
 ASTRA G Coupe (T98)
 ASTRA G Estate (T98)
 ASTRA G Hatchback (T98)
 ASTRA G Saloon (T98)
 CORSA C (X01)
 VECTRA B (J96)
 VECTRA B Estate (J96)
 VECTRA B Hatchback (J96)
 ZAFIRA A MPV (T98)

VAUXHALL

ASTRA MK IV
 ASTRA Mk IV (G) Convertible (T98)
 ASTRA Mk IV (G) Estate (T98)
 ASTRA Mk IV (G) Hatchback (T98)
 ASTRA Mk IV (G) Saloon (T98)
 CORSA Mk II (C) (X01)
 VECTRA (B) Hatchback (J96)
 VECTRA (B) Saloon (J96)
 ZAFIRA A (T98)



OPEL

SIGNUM Hatchback (Z03)
 VECTRA C (Z02)
 VECTRA C Estate (Z02)
 VECTRA C GTS (Z02)

VAUXHALL

SIGNUM (Z03)
 VECTRA Mk II (C) (Z02)
 VECTRA Mk II (C) Estate (Z02)
 VECTRA Mk II (C) GTS (Z02)

OPEL

ASTRA G Convertible (T98)
 ASTRA G Coupe (T98)
 ASTRA G Estate (T98)
 ASTRA G Hatchback (T98)
 ASTRA G Saloon (T98)
 SPEEDSTER (E01)
 VECTRA B (J96)
 VECTRA B Estate (J96)
 VECTRA B Hatchback (J96)
 ZAFIRA A MPV (T98)

VAUXHALL

ASTRA Mk IV (G) Convertible (T98)
 ASTRA Mk IV (G) Coupe (T98)
 ASTRA Mk IV (G) Estate (T98)

EMISSION CONTROL



LS 7.05270.30.0

ASTRA Mk IV (G) Hatchback (T98)
 VECTRA (B) Estate (J96)
 VECTRA (B) Hatchback (J96)
 VECTRA (B) Saloon (J96)
 VX220 Convertible (E01)
 ZAFIRA A (T98)

LS 7.05270.32.0



OPEL

ASTRA F (T92)
 ASTRA F Convertible (T92)
 ASTRA F Estate (T92)
 ASTRA F Hatchback (T92)
 ASTRA G Coupe (T98)
 ASTRA G Estate (T98)
 ASTRA G Hatchback (T98)
 ASTRA G Saloon (T98)
 CALIBRA A (C89)
 VECTRA A (J89)
 VECTRA A Hatchback (J89)
 VECTRA B (J96)
 VECTRA B Estate (J96)
 VECTRA B Hatchback (J96)
 ZAFIRA A MPV (T98)

VAUXHALL

ASTRA Mk III (F) Convertible (T92)
 ASTRA Mk III (F) Estate (T92)
 ASTRA Mk III (F) Hatchback (T92)
 ASTRA Mk III (F) Saloon (T92)
 ASTRA Mk IV (G) Coupe (T98)
 ASTRA Mk IV (G) Estate (T98)
 ASTRA Mk IV (G) Hatchback (T98)
 ASTRA Mk IV (G) Saloon (T98)
 CALIBRA (C89)
 CAVALIER Mk III Hatchback (J89)
 CAVALIER Mk III Saloon (J89)
 VECTRA (B) Estate (J96)
 VECTRA (B) Hatchback (J96)
 ZAFIRA A (T98)

LS 7.05270.33.0



OPEL

ASTRA F (T92)
 ASTRA F Convertible (T92)
 ASTRA F Estate (T92)
 ASTRA F Hatchback (T92)
 ASTRA G Estate (T98)
 ASTRA G Hatchback (T98)
 ASTRA G Saloon (T98)
 CALIBRA A (C89)
 VECTRA B (J96)
 VECTRA B Estate (J96)
 VECTRA B Hatchback (J96)

VAUXHALL

ASTRA Mk III (F) Convertible (T92)
 ASTRA Mk III (F) Estate (T92)
 ASTRA Mk III (F) Hatchback (T92)
 ASTRA Mk III (F) Saloon (T92)
 ASTRA Mk IV (G) Hatchback (T98)
 ASTRA Mk IV (G) Saloon (T98)
 CALIBRA (C89)
 VECTRA (B) Estate (J96)
 VECTRA (B) Hatchback (J96)
 VECTRA (B) Saloon (J96)

LS 7.05270.34.0



OPEL

OMEGA B (V94)
 OMEGA B Estate (V94)

VAUXHALL

OMEGA (B) Estate (V94)
 OMEGA (B) Saloon (V94)

LS 7.05270.36.0



CITROEN

BERLINGO / BERLINGO FIRST Box Body/MPV (M_)
 BERLINGO / BERLINGO FIRST MPV (MF_, GJK_, GFK_)
 SAXO (S0, S1)
 XSARA (N1)
 XSARA Break (N2)
 XSARA Coupe (N0)
 XSARA Estate Van
 XSARA Hatchback Van (N3_)

PEUGEOT

106 II (1A_, 1C_)
 206 Hatchback (2A/C)
 206 SW (2E/K)
 206 Saloon
 206 Van
 306 (7B, N3, N5)
 306 Break (7E, N3, N5)
 306 Convertible (7D, N3, N5)
 306 Estate Van (N_, 7_)
 306 Hatchback (7A, 7C, N3, N5)
 307 (3A/C)
 307 Break (3E)
 307 SW (3H)
 406 (8B)
 406 Break (8E/F)
 406 Coupe (8C)
 605 (6B)
 PARTNER Box Body/MPV (5_, G_)
 PARTNER MPV (5_, G_)
 PARTNER ORIGIN Box Body/MPV (G_)
 PARTNER ORIGIN MPV (G_)

LS 7.05270.37.0



CITROEN

C4 Coupe (LA_)
 C4 I (LC_)





LS	7.05270.37.0	LS	7.05270.38.0	LS	7.05270.45.0
C5 I (DC_) C5 I Break (DE_) C5 II (RC_) C5 II Break (RE_) C5 III (RD_) C5 III Break (RW_) ELYSEE EVASION MPV (22, U6) JUMPER Bus (244, Z_) JUMPER Van (244) XANTIA (X1_, X2_) XANTIA Break (X1_, X2_) XSARA (N1) XSARA Break (N2) XSARA Coupe (N0) XSARA PICASSO (N68) FIAT ULYSSE (220_) LANCIA ZETA (22_) OPEL SIGNUM Hatchback (Z03) VECTRA C (Z02) VECTRA C Estate (Z02) VECTRA C GTS (Z02) PEUGEOT 206 Hatchback (2A/C) 206 SW (2E/K) 206 Saloon 306 (7B, N3, N5) 306 Break (7E, N3, N5) 306 Convertible (7D, N3, N5) 306 Hatchback (7A, 7C, N3, N5) 307 (3A/C) 307 Break (3E) 307 SW (3H) 406 (8B) 406 Break (8E/F) 406 Coupe (8C) 607 (9D, 9U) 806 (221) SAAB 9-5 (YS3E) 9-5 Estate (YS3E) VOLVO S80 I (184)	C5 I (DC_) C5 I Break (DE_) C5 II (RC_) C5 II Break (RE_) C5 III (RD_) C5 III Break (RW_) XSARA (N1) XSARA Break (N2) XSARA Coupe (N0) ZX (N2) ZX Break (N2) PEUGEOT 406 (8B) 406 Break (8E/F) 406 Coupe (8C) 407 (6D_) 407 SW (6E_) LS 7.05270.39.0  CITROEN BERLINGO / BERLINGO FIRST Box Body/MPV (M_) BERLINGO / BERLINGO FIRST MPV (MF_, GJK_, GFK_) C15 Box Body/MPV (VD_) SAXO (S0, S1) XSARA (N1) XSARA Break (N2) XSARA Coupe (N0) ZX (N2) ZX Break (N2) PEUGEOT 106 I (1A, 1C) 106 II (1A_, 1C_) 206 Hatchback (2A/C) 206 SW (2E/K) 206 Saloon 306 (7B, N3, N5) 306 Break (7E, N3, N5) 306 Convertible (7D, N3, N5) 306 Hatchback (7A, 7C, N3, N5) 406 (8B) 406 Break (8E/F) PARTNER Box Body/MPV (5_, G_) PARTNER MPV (5_, G_) LS 7.05270.38.0  CITROEN AX (ZA-_)	 RENAULT CLIO I (B/C57_, 5/357_) CLIO I Hatchback Van (S57_) RAPID Box Body/MPV (F40_, G40_) TWINGO I (C06_) TWINGO I Hatchback Van (S06_) LS 7.05270.47.0  RENAULT LAGUNA I (B56_, 556_) LAGUNA I Grandtour (K56_) SAFRANE I (B54_) TRAFIC Bus (TXW) TRAFIC Platform/Chassis (PXX) TRAFIC Van (TXX) TWINGO I (C06_) TWINGO I Hatchback Van (S06_) LS 7.05270.48.0  RENAULT CLIO II (BB_, CB_) CLIO II Hatchback Van (SB0/1/2_) KANGOO (KC0/1_) KANGOO Express (FC0/1_)			

EMISSION CONTROL



LS 7.05270.48.0
 TWINGO I (C06_)
 TWINGO I Hatchback Van (S06_)

LS 7.05270.49.0



RENAULT

CLIO II (BB_, CB_)
 KANGOO (KC0/1_)
 KANGOO Express (FC0/1_)

LS 7.05270.51.0



RENAULT

11 (B/C37_)
 19 I (B/C53_)
 19 I Cabriolet (D53_)
 19 I Chamade (L53_)
 19 II (B/C53_)
 19 II Cabriolet (D53_, 853_)
 19 II Chamade (L53_)
 21 (B48_)
 21 Estate (K48_)
 21 Estate Van (S48_)
 21 Saloon (L48_)
 25 (B29_)
 CLIO I (B/C57_, 5/357_)
 CLIO I Hatchback Van (S57_)
 ESPACE II (J/S63_)
 LAGUNA I (B56_, 556_)
 LAGUNA I Grandtour (K56_)
 MEGANE I (BA0/1_)
 MEGANE I Cabriolet (EA0/1_)
 MEGANE I Classic (LA0/1_)
 MEGANE I Coach (DA0/1_)
 MEGANE I Grandtour (KA0/1_)
 RAPID Box Body/MPV (F40_, G40_)

LS 7.05270.54.0



DACIA

DUSTER (HS_)
 LOGAN (LS_)
 LOGAN MCV (KS_)
 LOGAN Pickup (US_)

NISSAN

KUBISTAR Van (X76)

PEUGEOT

206 Hatchback (2A/C)

RENAULT

CLIO II (BB_, CB_)
 CLIO III (BR0/1, CR0/1)
 CLIO III Grandtour (KR0/1_)
 CLIO III Hatchback Van (SB_, SR_)
 CLIO IV (BH_)
 CLIO IV Grandtour (KH_)
 DUSTER (HS_)
 KANGOO (KC0/1_)
 KANGOO Express (FC0/1_)
 LOGAN EXPRESS (US_)
 LOGAN I (LS_)
 LOGAN I Estate (KS_)
 MODUS / GRAND MODUS (F/JP0_)
 THALIA I (LB_)
 THALIA II (LU_)
 TWINGO I (C06_)
 TWINGO I Hatchback Van (S06_)

LS 7.05270.55.0



NISSAN

MICRA C+C III (K12)
 MICRA III (K12)
 PRIMERA (P12)
 PRIMERA Estate (WP12)
 PRIMERA Hatchback (P12)
 X-TRAIL (T30)

RENAULT

LS 7.05270.55.0

ESPACE IV (JK0/1_)
 VEL SATIS (BJ0_)

LS 7.05270.56.0



DACIA

LOGAN (LS_)
 LOGAN EXPRESS (FS_)
 LOGAN MCV (KS_)
 LOGAN Pickup (US_)

RENAULT

CLIO II (BB_, CB_)
 KANGOO (KC0/1_)
 KANGOO Express (FC0/1_)
 MEGANE I (BA0/1_)
 MEGANE I Classic (LA0/1_)
 MEGANE I Grandtour (KA0/1_)
 THALIA I (LB_)

LS 7.05270.66.0









VOLVO

C70 I Convertible (873)
 C70 I Coupe (872)
 S60 I (384)
 S70 (874)
 S80 I (184)
 V70 I (875, 876)
 V70 II (285)





LS	7.05270.67.0	LS	7.05270.69.0	LS	7.05270.73.0
 <p>FORD FOCUS II (DA_, HCP, DP) MONDEO IV (BA7) MONDEO IV Saloon (BA7) MONDEO IV Turnier (BA7) S-MAX (WA6)</p> <p>SAAB 9-3 (YS3D) 9-3 Cabriolet (YS3D) 9-5 (YS3E) 9-5 Estate (YS3E)</p> <p>VOLVO C30 (533) C70 I Convertible (873) C70 I Coupe (872) C70 II Convertible (542) S40 II (544) S60 I (384) S70 (874) S80 I (184) V50 (545) V70 I (875, 876) V70 II (285) XC70 XC70 CROSS COUNTRY I (295) XC90 I (275)</p>		<p>XC60 I SUV (156) XC70 II (136)</p>		 <p>VOLVO S40 I (644)</p>	
		LS	7.05270.70.0		
		 <p>VOLVO S60 I (384) S80 I (184) S80 II (124) V70 II (285)</p>			
		LS	7.05270.71.0		
		 <p>VOLVO S70 (874) V70 I (875, 876)</p>			
		LS	7.05270.72.0	LS	7.05270.79.0
 <p>VOLVO C30 (533) C70 II Convertible (542) S40 II (544) S60 I (384) S80 I (184) S80 II (124) V50 (545) V70 II V70 II (285)</p>		 <p>VOLVO S40 I (644)</p>		 <p>VOLVO S70 (874) V70 I (875, 876)</p>	
		LS	7.05270.80.0		
		 <p>ALFA ROMEO 156 (932_) 156 Sportwagon (932_) 166 (936_) GT (937_) GTV (916_) SPIDER (916_)</p> <p>FORD MONDEO IV (BA7) MONDEO IV Saloon (BA7) MONDEO IV Turnier (BA7) S-MAX (WA6)</p> <p>NISSAN 350 Z Coupe (Z33) 350Z Roadster (Z33) MURANO I (Z50)</p>			

EMISSION CONTROL





LS 7.05270.80.0
 MURANO II (Z51)
 PATHFINDER III (R51)
VOLVO
 C70 I Convertible (873)
 C70 I Coupe (872)
 S70 (874)
 V70 I (875, 876)



VOLVO
 S80 I (184)
 V70 II (285)

AUDI
 A8 D2 (4D2, 4D8)
FORD
 GALAXY I (WGR)

VOLVO
 C70 I Convertible (873)
 C70 I Coupe (872)
 S60 I (384)
 S70 (874)
 S80 I (184)
 V70 I (875, 876)
 V70 II (285)
 XC70
 XC70 CROSS COUNTRY I (295)
 XC90 I (275)



SEAT
 CORDOBA (6K1, 6K2)
 CORDOBA Vario (6K5)
 IBIZA II (6K1)
 INCA (6K9)
VOLKSWAGEN
 CADDY II Box Body/MPV (9K9A)
 CADDY II MPV (9K9B)
 GOLF III (1H1)
 GOLF III Variant (1H5)
 PASSAT B3/B4 (3A2, 35I)
 PASSAT B3/B4 Variant (3A5, 35I)
 POLO (6N2)
 POLO III (6N1)
 POLO Variant (6V5)
 SHARAN (7M8, 7M9, 7M6)
 TRANSPORTER IV Bus (70B, 70C, 7DB, 7DK, 70J, 70K, 7DC, 7DJ)
 TRANSPORTER IV Platform/Chassis (70E, 70L, 70M, 7DE, 7DL, 7D)
 TRANSPORTER IV Van (70A, 70H, 7DA, 7DH)
 VENTO (1H2)



SEAT
 CORDOBA (6K1, 6K2)
 IBIZA II (6K1)
 TOLEDO I (1L2)
SKODA
 FAVORIT (781)
 FELICIA I (6U1)
 FELICIA I Estate (6U5)
 FELICIA I Pickup (6UF, 6U7)
 FELICIA II (6U1)
 FELICIA II Estate (6U5)
VOLKSWAGEN
 CORRADO (53I)
 GOLF III (1H1)
 GOLF III Cabriolet (1E7)
 GOLF III Variant (1H5)
 PASSAT B3/B4 (3A2, 35I)
 PASSAT B3/B4 Variant (3A5, 35I)
 POLO III (6N_/6KV_)
 VENTO (1H2)

VOLVO
 C30 (533)
 C70 II Convertible (542)
 S40 II (544)
 S60 I (384)
 S80 II (124)
 V50 (545)
 V70 II (285)



AUDI
 A3 (8L1)
 TT (8N3)
 TT Roadster (8N9)
SEAT
 ALHAMBRA (7V8, 7V9)
 LEON (1M1)
 TOLEDO II (1M2)
VOLKSWAGEN
 BORA I (1J2)

EMISSION CONTROL



LS	7.05270.89.0
BORA Variant (1J6) GOLF IV (1J1) GOLF IV Variant (1J5) SHARAN (7M8, 7M9, 7M6)	



SEAT

- CORDOBA (6L2)
- IBIZA III (6L1)
- LEON (1M1)
- VOLKSWAGEN**
- BORA I (1J2)
- BORA Variant (1J6)
- GOLF IV (1J1)
- GOLF IV Variant (1J5)
- NEW BEETLE (9C1, 1C1)
- POLO (9N_)

LS	7.05270.96.0
TRANSPORTER IV Van (70A, 70H, 7DA, 7DH) VENTO (1H2)	



AUDI

- A4 B6 Convertible (8H7)
- TT (8N3)
- TT Roadster (8N9)

SEAT

- IBIZA IV (6J5, 6P1)
- IBIZA IV SC (6J1, 6P5)
- LEON (1M1)
- TOLEDO II (1M2)

SKODA

- OCTAVIA I (1U2)
- OCTAVIA I Combi (1U5)

VOLKSWAGEN

- BORA I (1J2)
- BORA Variant (1J6)
- GOLF IV (1J1)
- GOLF IV Variant (1J5)
- GOLF V (1K1)
- JETTA III (1K2)
- NEW BEETLE (9C1, 1C1)
- NEW BEETLE Convertible (1Y7)
- TOUAREG (7LA, 7L6, 7L7)

LS	7.05270.99.0
ALLROAD C5 (4BH) TT (8N3) TT Roadster (8N9)	

- SEAT**
- AROSA (6H1)
 - LEON (1M1)
- SKODA**
- OCTAVIA I (1U2)
 - OCTAVIA I Combi (1U5)
- VOLKSWAGEN**
- BORA I (1J2)
 - BORA Variant (1J6)
 - GOLF IV (1J1)
 - GOLF IV Variant (1J5)
 - LUPO I (6X1, 6E1)
 - NEW BEETLE (9C1, 1C1)
 - NEW BEETLE Convertible (1Y7)
 - PASSAT B5 (3B2)
 - PASSAT B5 Variant (3B5)
 - PASSAT B5.5 (3B3)
 - PASSAT B5.5 Variant (3B6)
 - PHAETON (3D1, 3D2, 3D3, 3D4, 3D6, 3D7, 3D8, 3D9)
 - POLO (6N2)
 - POLO SEDAN (9A4)
 - POLO Variant (6V5)
 - TOUAREG (7LA, 7L6, 7L7)

LS	7.05270.96.0
----	--------------



AUDI

- A4 B5 (8D2)
- A4 B5 Avant (8D5)
- A6 C4 (4A2)
- A6 C4 Avant (4A5)
- A6 C5 (4B2)
- A6 C5 Avant (4B5)

FORD

- GALAXY I (WGR)

VOLKSWAGEN

- GOLF III (1H1)
- GOLF III Variant (1H5)
- PASSAT B3/B4 Variant (3A5, 35I)
- POLO III (6N1)
- SHARAN (7M8, 7M9, 7M6)
- TRANSPORTER IV Bus (70B, 70C, 7DB, 7DK, 70J, 70K, 7DC, 7DJ)
- TRANSPORTER IV Platform/Chassis (70E, 70L, 70M, 7DE, 7DL, 7D)

LS	7.05270.99.0
----	--------------



AUDI

- A3 (8L1)
- A4 B5 (8D2)
- A4 B5 Avant (8D5)
- A4 B6 (8E2)
- A4 B6 Avant (8E5)
- A4 B6 Convertible (8H7)
- A6 C5 (4B2)
- A6 C5 Avant (4B5)
- A8 D3 (4E2, 4E8)

LS	7.05271.00.0
----	--------------



AUDI

- A4 B6 (8E2)
- A4 B6 Avant (8E5)
- A4 B6 Convertible (8H7)
- A4 B7 (8EC)
- A4 B7 Avant (8ED)
- A6 C5 (4B2)
- A6 C5 Avant (4B5)
- A8 D3 (4E2, 4E8)
- ALLROAD C5 (4BH)

SEAT

- INCA (6K9)
- LEON (1M1)

VOLKSWAGEN

- BORA I (1J2)
- BORA Variant (1J6)
- CADDY II Box Body/MPV (9K9A)
- CADDY II MPV (9K9B)
- GOLF IV (1J1)
- GOLF IV Variant (1J5)
- NEW BEETLE (9C1, 1C1)





EMISSION CONTROL



LS 7.05271.00.0	LS 7.05271.02.0	LS 7.05271.04.0
<p>POLO Variant (6V5) TOUAREG (7LA, 7L6, 7L7)</p>	<p>TT Roadster (8N9) SEAT INCA (6K9) SKODA FABIA I (6Y2) FABIA I Combi (6Y5) FABIA I Praktik (6Y5) FABIA I Saloon (6Y3) OCTAVIA I (1U2) OCTAVIA I Combi (1U5) VOLKSWAGEN BORA I (1J2) BORA Variant (1J6) CADDY II Box Body/MPV (9K9A) CADDY II MPV (9K9B) GOLF IV (1J1) GOLF IV Variant (1J5) LUPO I (6X1, 6E1) NEW BEETLE (9C1, 1C1) NEW BEETLE Convertible (1Y7)</p>	 <p>AUDI A3 (8L1) SEAT AROSA (6H1) SKODA OCTAVIA I (1U2) OCTAVIA I Combi (1U5) VOLKSWAGEN BORA I (1J2) BORA Variant (1J6) GOLF IV (1J1) GOLF IV Variant (1J5) LUPO I (6X1, 6E1) POLO III (6N1)</p>
<p>LS 7.05271.01.0</p>  <p>AUDI A3 (8L1) A4 B5 (8D2) A4 B5 Avant (8D5) A4 B6 (8E2) A4 B6 Avant (8E5) A4 B7 (8EC) A4 B7 Avant (8ED) A8 D3 (4E2, 4E8) TT (8N3) TT Roadster (8N9) SEAT EXEO (3R2) EXEO ST (3R5) INCA (6K9) VOLKSWAGEN BORA I (1J2) BORA Variant (1J6) CADDY II Box Body/MPV (9K9A) CADDY II MPV (9K9B) GOLF IV (1J1) GOLF IV Variant (1J5) NEW BEETLE (9C1, 1C1) NEW BEETLE Convertible (1Y7) PASSAT B5.5 (3B3) PASSAT B5.5 Variant (3B6) PHAETON (3D1, 3D2, 3D3, 3D4, 3D6, 3D7, 3D8, 3D9) POLO Variant (6V5)</p>	<p>LS 7.05271.03.0</p>  <p>AUDI A3 (8L1) SEAT ALHAMBRA (7V8, 7V9) AROSA (6H1) CORDOBA (6K1, 6K2) CORDOBA Vario (6K5) IBIZA II (6K1) INCA (6K9) LEON (1M1) TOLEDO II (1M2) SKODA OCTAVIA I (1U2) OCTAVIA I Combi (1U5) VOLKSWAGEN BORA I (1J2) BORA Variant (1J6) CADDY II Box Body/MPV (9K9A) CADDY II MPV (9K9B) GOLF IV (1J1) GOLF IV Variant (1J5) LUPO I (6X1, 6E1) POLO (6N2) POLO III (6N1) POLO Variant (6V5) SHARAN (7M8, 7M9, 7M6)</p>	<p>LS 7.05271.05.0</p>  <p>AUDI A2 (8Z0) A3 (8L1) A4 B5 (8D2) A4 B5 Avant (8D5) A4 B6 (8E2) A4 B6 Avant (8E5) SEAT CORDOBA (6L2) IBIZA III (6L1) IBIZA IV (6J5, 6P1) IBIZA IV SC (6J1, 6P5) IBIZA IV ST (6J8, 6P8) SKODA FABIA I (6Y2) FABIA I Combi (6Y5) FABIA I Praktik (6Y5) FABIA I Saloon (6Y3) FABIA II (542) FABIA II Combi (545) ROOMSTER (5J7) ROOMSTER Praktik (5J)</p>
<p>LS 7.05271.02.0</p>  <p>AUDI A3 (8L1) TT (8N3)</p>		





LS 7.05271.05.0	LS 7.05271.07.0	LS 7.05271.12.0
<p>VOLKSWAGEN FOX Hatchback (5Z1, 5Z3, 5Z4) FOX Van (5Z1) PASSAT B5 (3B2) PASSAT B5 Variant (3B5) PASSAT B5.5 (3B3) PASSAT B5.5 Variant (3B6) POLO (9N_) POLO IV Saloon (9A4, 9A2, 9N2, 9A6) POLO V (6R1, 6C1) POLO Van (6R) ENGINE VW FAW BORA (1J2, 9D2) GOLF IV (1J1) VW SVW POLO Hatchback (9J1) POLO Saloon (9J2)</p>	<p>VOLKSWAGEN PASSAT B5 (3B2) PASSAT B5 Variant (3B5) PASSAT B5.5 (3B3) PASSAT B5.5 Variant (3B6)</p> <hr/> <p>LS 7.05271.11.0</p> 	
<p>LS 7.05271.06.0</p> 	<p>AUDI A3 (8P1) A3 Convertible (8P7) A3 Sportback (8PA) A4 B7 (8EC) A4 B7 Avant (8ED) A4 B7 Convertible (8HE) A6 C5 (4B2) A6 C5 Avant (4B5) A6 C6 (4F2) A6 C6 Avant (4F5) A8 D3 (4E2, 4E8) Q7 (4LB) R8 (422, 423) R8 Spyder (427, 429) SEAT ALTEA (5P1) ALTEA XL (5P5, 5P8) EXEO (3R2) EXEO ST (3R5) LEON (1P1) TOLEDO III (5P2) SKODA OCTAVIA II (1Z3) OCTAVIA II Combi (1Z5) SUPERB II (3T4) VOLKSWAGEN EOS (1F7, 1F8) GOLF V (1K1) GOLF V Variant (1K5) SCIROCCO III (137, 138) TOUAREG (7LA, 7L6, 7L7)</p>	<p>AUDI A6 C5 (4B2) A6 C5 Avant (4B5) SKODA SUPERB II (3T4) SUPERB II Estate (3T5) VOLKSWAGEN PASSAT B6 (3C2) PASSAT B6 Variant (3C5) PASSAT B7 (362) PASSAT B7 Variant (365)</p>
<p>LS 7.05271.07.0</p> 	<p>AUDI A4 B5 (8D2) A4 B5 Avant (8D5) A4 B6 (8E2) A4 B6 Avant (8E5) A4 B7 (8EC) A4 B7 Avant (8ED) SKODA SUPERB I (3U4)</p>	<p>LS 7.05271.13.0</p> 
<p>SEAT AROSA (6H1) VOLKSWAGEN LUPO I (6X1, 6E1) POLO (6N2) POLO (9N_) POLO Variant (6V5)</p>	<p>AUDI A5 (8T3) A5 Convertible (8F7) A6 C6 (4F2) A6 C6 Avant (4F5) A8 D3 (4E2, 4E8) VOLKSWAGEN GOLF V (1K1) JETTA III (1K2) JETTA IV (162, 163, AV3, AV2)</p>	

EMISSION CONTROL



LS 7.05271.14.0	LS 7.05271.15.0	LS 7.05271.18.0
 <p>AUDI A8 D3 (4E2, 4E8)</p> <p>SEAT AROSA (6H1)</p> <p>SKODA OCTAVIA I (1U2) OCTAVIA I Combi (1U5)</p> <p>VOLKSWAGEN LUPO I (6X1, 6E1) PASSAT B5.5 (3B3) PASSAT B5.5 Variant (3B6) PHAETON (3D1, 3D2, 3D3, 3D4, 3D6, 3D7, 3D8, 3D9) POLO (6N2) POLO Variant (6V5)</p>	<p>TT Roadster (8J9)</p> <p>SEAT ALTEA (5P1) ALTEA XL (5P5, 5P8) LEON (1P1) TOLEDO III (5P2)</p> <p>SKODA RAPID (NH3) RAPID Spaceback (NH1)</p> <p>VOLKSWAGEN CADDY III Box Body/MPV (2KA, 2KH, 2CA, 2CH) CADDY III MPV (2KB, 2KJ, 2CB, 2CJ) EOS (1F7, 1F8) GOLF PLUS V (5M1, 521) GOLF V (1K1) GOLF V Variant (1K5) GOLF VI (5K1) JETTA III (1K2) TOUAREG (7LA, 7L6, 7L7) TOURAN (1T1, 1T2)</p>	 <p>AUDI A3 (8P1) A3 Convertible (8P7) A3 Sportback (8PA) A4 B8 (8K2) A4 B8 Avant (8K5) A5 (8T3) A5 Convertible (8F7) A5 Sportback (8TA) Q5 (8RB)</p>
<p>LS 7.05271.15.0</p>  <p>AUDI A1 (8X1, 8XK) A1 Sportback (8XA, 8XF) A3 (8P1) A3 Convertible (8P7) A3 Sportback (8PA) A4 B7 (8EC) A4 B7 Avant (8ED) A4 B7 Convertible (8HE) A5 (8T3) A5 Convertible (8F7) A5 Sportback (8TA) A6 C6 (4F2) A6 C6 Avant (4F5) A6 C7 (4G2, 4GC) A6 C7 Avant (4G5, 4GD) A8 D3 (4E2, 4E8) A8 D4 (4H2, 4H8, 4HC, 4HL) Q5 (8RB) Q7 (4LB) TT (8J3)</p>	<p>LS 7.05271.16.0</p>  <p>AUDI A3 (8P1) A3 Sportback (8PA) A6 C6 (4F2) A6 C6 Avant (4F5) Q7 (4LB)</p> <p>SEAT ALTEA (5P1) ALTEA XL (5P5, 5P8) LEON (1P1) TOLEDO III (5P2)</p> <p>SKODA OCTAVIA II (1Z3) OCTAVIA II Combi (1Z5)</p> <p>VOLKSWAGEN EOS (1F7, 1F8) GOLF V (1K1) JETTA III (1K2) TOUAREG (7LA, 7L6, 7L7) TOURAN (1T1, 1T2)</p>	<p>SEAT ALTEA (5P1) ALTEA XL (5P5, 5P8) CORDOBA (6L2) IBIZA III (6L1) LEON (1P1) TOLEDO III (5P2)</p> <p>SKODA FABIA II (542) FABIA II Combi (545) FABIA SCOUT OCTAVIA II (1Z3) OCTAVIA II Combi (1Z5) ROOMSTER (5J7)</p> <p>VOLKSWAGEN CADDY III Box Body/MPV (2KA, 2KH, 2CA, 2CH) CADDY III MPV (2KB, 2KJ, 2CB, 2CJ) EOS (1F7, 1F8) GOLF PLUS V (5M1, 521) GOLF PLUS Van (521) GOLF V (1K1) GOLF V Variant (1K5) GOLF VAN VI Variant (AJ5) GOLF VI (5K1) GOLF VI Variant (AJ5) JETTA III (1K2) PASSAT B6 (3C2) PASSAT B6 Variant (3C5) POLO (9N_) POLO V (6R1, 6C1) TOURAN (1T1, 1T2)</p>





LS 7.05271.19.0



AUDI

- A3 (8P1)
- A3 Sportback (8PA)
- TT (8J3)
- TT Roadster (8J9)

SEAT

- ALTEA (5P1)
- ALTEA XL (5P5, 5P8)
- LEON (1P1)
- TOLEDO III (5P2)

SKODA

- OCTAVIA II (1Z3)
- OCTAVIA II Combi (1Z5)
- SUPERB II (3T4)

LS 7.05271.21.0



AUDI

- A3 (8L1)
- A4 B5 (8D2)
- A4 B5 Avant (8D5)
- A4 B6 (8E2)
- A4 B6 Avant (8E5)
- A4 B6 Convertible (8H7)
- A4 B7 (8EC)
- A4 B7 Avant (8ED)
- A6 C5 (4B2)
- A6 C5 Avant (4B5)

SEAT

- LEON (1M1)
- TOLEDO II (1M2)

SKODA

- OCTAVIA I (1U2)
- OCTAVIA I Combi (1U5)

VOLKSWAGEN

- BORA I (1J2)
- BORA Variant (1J6)
- GOLF IV (1J1)
- GOLF IV Cabriolet (1E7)
- GOLF IV Variant (1J5)
- NEW BEETLE (9C1, 1C1)
- PASSAT B5 (3B2)
- PASSAT B5 Variant (3B5)
- PASSAT B5.5 (3B3)
- PASSAT B5.5 Variant (3B6)
- POLO (6N2)
- POLO Variant (6V5)
- TOUAREG (7LA, 7L6, 7L7)
- TRANSPORTER IV Bus (70B, 70C, 7DB, 7DK, 70J, 70K, 7DC, 7DJ)
- TRANSPORTER IV Platform/Chassis (70E, 70L, 70M, 7DE, 7DL, 7D)
- TRANSPORTER IV Van (70A, 70H, 7DA, 7DH)

LS 7.05271.22.0



BMW

- 1 (E87)
- 3 (E90)
- 3 Touring (E91)
- 5 (E60)
- 5 Touring (E61)
- 6 (E63)
- 6 Convertible (E64)
- 7 (E65, E66, E67)

LS 7.05271.20.0



SEAT

- CORDOBA (6L2)
- IBIZA III (6L1)
- IBIZA V (6J_)

SKODA

- FABIA I (6Y2)
- FABIA I Combi (6Y5)
- FABIA I Praktik (6Y5)
- FABIA I Saloon (6Y3)
- ROOMSTER (5J7)
- ROOMSTER Praktik (5J)

VOLKSWAGEN

- POLO (9N_)

LS 7.05271.23.0



AUDI

- A3 (8L1)
- A4 B6 (8E2)
- A4 B6 Avant (8E5)
- A4 B6 Convertible (8H7)
- A6 C5 (4B2)
- A6 C5 Avant (4B5)
- Q7 (4LB)
- TT (8N3)
- TT Roadster (8N9)

BMW

- 1 (E87)
- 3 (E90)
- 3 Touring (E91)
- 5 (E60)
- 5 Touring (E61)
- 6 (E63)
- 6 Convertible (E64)
- 7 (E65, E66, E67)
- X5 (E53)

MERCEDES-BENZ

- C-CLASS (W203)
- C-CLASS Coupe (CL203)
- C-CLASS T-Model (S203)
- CLC-CLASS (CL203)
- CLK (C209)
- CLK Convertible (A209)





LS	7.05271.23.0	LS	7.05271.24.0	LS	7.05271.27.0
<p>E-CLASS (W211) E-CLASS T-Model (S211) SLK (R171) SPRINTER 3,5-t Bus (B906) SPRINTER 3,5-t Platform/Chassis (B906) SPRINTER 3,5-t Van (B906) SPRINTER 3-t Bus (B906) SPRINTER 3-t Platform/Chassis (B906) SPRINTER 3-t Van (B906) SPRINTER 5-t Platform/Chassis (B906)</p> <p>SEAT ALHAMBRA (7V8, 7V9) CORDOBA (6L2) IBIZA III (6L1) LEON (1M1) TOLEDO II (1M2)</p> <p>VOLKSWAGEN BORA I (1J2) BORA Variant (1J6) GOLF IV (1J1) GOLF IV Variant (1J5) NEW BEETLE (9C1, 1C1) NEW BEETLE Convertible (1Y7) PASSAT B5.5 (3B3) PASSAT B5.5 Variant (3B6) PHAETON (3D1, 3D2, 3D3, 3D4, 3D6, 3D7, 3D8, 3D9) POLO (9N_) SHARAN (7M8, 7M9, 7M6) TOUAREG (7LA, 7L6, 7L7) TRANSPORTER IV Bus (70B, 70C, 7DB, 7DK, 70J, 70K, 7DC, 7DJ) TRANSPORTER IV Platform/Chassis (70E, 70L, 70M, 7DE, 7DL, 7D) TRANSPORTER IV Van (70A, 70H, 7DA, 7DH)</p>		<p>BENTLEY CONTINENTAL Coupe (3W_, 393) CONTINENTAL FLYING SPUR (3W_)</p> <p>SEAT EXEO (3R2) EXEO ST (3R5) IBIZA III (6L1) LEON (1M1) TOLEDO II (1M2)</p> <p>SKODA OCTAVIA I (1U2) OCTAVIA I Combi (1U5) OCTAVIA II (1Z3) OCTAVIA II Combi (1Z5)</p> <p>VOLKSWAGEN BORA I (1J2) BORA Variant (1J6) GOLF IV (1J1) GOLF IV (9B3) GOLF IV Variant (1J5) GOLF V (1K1) GOLF VAN IV Variant (1J5) NEW BEETLE (9C1, 1C1) NEW BEETLE Convertible (1Y7) PASSAT B5.5 (3B3) PASSAT B5.5 Variant (3B6) PHAETON (3D1, 3D2, 3D3, 3D4, 3D6, 3D7, 3D8, 3D9) POLO (9N_) TOUAREG (7LA, 7L6, 7L7) TRANSPORTER IV Bus (70B, 70C, 7DB, 7DK, 70J, 70K, 7DC, 7DJ) TRANSPORTER IV Platform/Chassis (70E, 70L, 70M, 7DE, 7DL, 7D) TRANSPORTER IV Van (70A, 70H, 7DA, 7DH)</p>		<p>VOLKSWAGEN TOUAREG (7LA, 7L6, 7L7)</p> <p>LS 7.05271.28.0</p>  <p>AUDI A3 (8P1) A3 Sportback (8PA) TT (8J3) TT Roadster (8J9)</p> <p>VOLKSWAGEN EOS (1F7, 1F8) GOLF V (1K1) PHAETON (3D1, 3D2, 3D3, 3D4, 3D6, 3D7, 3D8, 3D9)</p>	
<p>LS 7.05271.24.0</p>  <p>AUDI A3 (8L1) A4 B5 (8D2) A4 B5 Avant (8D5) A4 B6 (8E2) A4 B6 Avant (8E5) A4 B6 Convertible (8H7) A4 B7 (8EC) A4 B7 Avant (8ED) A6 C5 (4B2) A6 C5 Avant (4B5) A8 D3 (4E2, 4E8) TT (8N3) TT Roadster (8N9)</p>		<p>LS 7.05271.27.0</p>  <p>AUDI A4 B8 (8K2) A4 B8 Avant (8K5) A5 (8T3) A5 Convertible (8F7) A5 Sportback (8TA) A6 C6 (4F2) A6 C6 Avant (4F5) A6 C7 (4G2, 4GC) A6 C7 Avant (4G5, 4GD) A8 D3 (4E2, 4E8) Q5 (8RB) Q7 (4LB)</p>		<p>LS 7.05271.29.0</p>  <p>AUDI Q3 (8UB, 8UG)</p> <p>SEAT ALTEA (5P1) ALTEA XL (5P5, 5P8) LEON (1P1) TOLEDO III (5P2)</p> <p>SKODA OCTAVIA II (1Z3) OCTAVIA II Combi (1Z5) SUPERB II (3T4) SUPERB II Estate (3T5)</p> <p>VOLKSWAGEN EOS (1F7, 1F8) GOLF PLUS V (5M1, 521) GOLF V (1K1) NEW BEETLE (9C1, 1C1) NEW BEETLE Convertible (1Y7) PASSAT B6 (3C2) PASSAT B6 Variant (3C5) PASSAT B7 (362) PASSAT B7 Variant (365)</p>	





LS 7.05271.29.0
 PHAETON (3D1, 3D2, 3D3, 3D4, 3D6, 3D7, 3D8, 3D9)
 TOURAN (1T1, 1T2)

LS 7.05271.30.0



AUDI

A3 (8P1)
 A3 Sportback (8PA)
 Q7 (4LB)

SKODA

OCTAVIA II (1Z3)
 OCTAVIA II Combi (1Z5)

TOYOTA

YARIS (_P1_)
 YARIS (_P9_)
 YARIS VERSO (_P2_)

VOLKSWAGEN

EOS (1F7, 1F8)
 GOLF PLUS V (5M1, 521)
 GOLF V (1K1)
 JETTA III (1K2)
 PASSAT B6 (3C2)
 PASSAT B6 Variant (3C5)
 TOURAREG (7LA, 7L6, 7L7)
 TOURAN (1T1, 1T2)

LS 7.05271.32.0



DAIHATSU

COPEN (L880_, L881_)
 CUORE VI (L251, L250_, L260_)
 MOVE (L9_)
 SIRION (M1)
 TREVIS
 YRV (M2)

LS 7.05271.35.0



SUBARU

JUSTY II (JMA, MS)

SUZUKI

CARRY Platform/Chassis (FD, DA5_T, DA6_T)
 CARRY Van (FD)
 GRAND VITARA I (FT, HT)
 JIMNY Closed Off-Road Vehicle (SN)
 SAMURAI Closed Off-Road Vehicle (SJ_)
 SWIFT II Hatchback (EA, MA)
 SWIFT II Saloon (AH, AJ)
 WAGON R Hatchback
 WAGON R+ Hatchback (MM)

LS 7.05271.37.0



NISSAN

ALMERA II (N16)
 ALMERA II Hatchback (N16)
 ALMERA TINO (V10)
 MICRA C+C III (K12)
 MICRA II (K11)
 MICRA III (K12)
 NOTE (E11, NE11)
 PRIMERA (P12)
 PRIMERA Estate (WP12)
 PRIMERA Hatchback (P11)
 PRIMERA Hatchback (P12)

LS 7.05271.36.0



LEXUS

RX (_L1_)
 RX (_U3_)

TOYOTA

AURIS (_E15_)
 AURIS (_E18_)
 AURIS Estate (_E18_)
 AVENSIS (_T22_)
 AVENSIS Estate (_T22_)
 AVENSIS Estate (_T27_)
 AVENSIS Liftback (_T22_)
 AVENSIS Saloon (_T27_)
 CAMRY Saloon (_V3_)
 IQ (_J1_)
 SOLARA Coupe (_V3_)

LS 7.05271.38.0



LEXUS

GS (_S16_)
 GS (_S19_)
 LS (_F4_)

TOYOTA

CELICA Coupe (_T23_)
 PREVIA II (_R3_)
 PRIUS Liftback (_W2_)
 PRIUS Saloon (_W1_)





LS 7.05271.39.0



TOYOTA

- AYGO (_B1_)
- AYGO (_B4_)
- COROLLA (_E11_)
- COROLLA (_E12_)
- COROLLA Compact (_E11_)
- COROLLA Estate (_E11_)
- COROLLA Estate (_E12_)
- COROLLA Liftback (_E11_)
- COROLLA Saloon (_E12_)
- YARIS (_P13_)
- YARIS (_P9_)

LS 7.05271.51.0



CITROEN

- C1 (PM_, PN_)
- PEUGEOT**
- 107 (PM_, PN_)
- TOYOTA**
- AYGO (_B1_)
 - YARIS (_P1_)

LS 7.05271.54.0



FIAT

- SEDICI (189_)
- SUBARU**
- JUSTY III (G3X)
- SUZUKI**
- IGNIS I (FH)
 - IGNIS II (MH)
 - LIANA (ER, RH_)
 - SWIFT III (MZ, EZ)
 - WAGON R+ Hatchback (MM)

LS 7.05271.46.0



HONDA

- CIVIC VIII Hatchback (FN, FK)
- FR-V (BE)

LS 7.05271.52.0



DAEWOO

- LEGANZA (KLAV)
 - MATIZ (M100, M150)
- OPEL**
- FRONTERA B (U99)
 - MONTEREY B (M98)

LS 7.05271.55.0



OPEL

- ASTRA G Convertible (T98)
 - ASTRA G Coupe (T98)
 - ASTRA G Estate (T98)
 - ASTRA G Hatchback (T98)
 - ASTRA G Saloon (T98)
 - ASTRA H (A04)
 - ASTRA H Estate (A04)
 - ASTRA H GTC (A04)
 - ASTRA H TwinTop (A04)
 - CORSA C (X01)
 - MERIVA A MPV (X03)
 - OMEGA B Estate (V94)
 - SIGNUM Hatchback (Z03)
 - TIGRA TwinTop (X04)
 - VECTRA B (J96)
 - VECTRA B Estate (J96)
 - VECTRA B Hatchback (J96)
 - VECTRA C (Z02)
 - VECTRA C Estate (Z02)
 - VECTRA C GTS (Z02)
 - ZAFIRA A MPV (T98)
- SAAB**
- 9-3 (YS3F, E79, D79, D75)
 - 9-3 Estate (E50)

LS 7.05271.48.0



TOYOTA

- PRIUS (_W3_)

LS 7.05271.53.0



TOYOTA

- CAMRY (_V2_)
- RAV 4 II (_A2_)
- YARIS (_P1_)

EMISSION CONTROL





LS	7.05271.55.0
VAUXHALL	
ASTRA Mk IV (G) Convertible (T98)	
ASTRA Mk IV (G) Coupe (T98)	
ASTRA Mk IV (G) Estate (T98)	
ASTRA Mk IV (G) Hatchback (T98)	
ASTRA Mk IV (G) Saloon (T98)	
CORSA Mk II (C) (X01)	
OMEGA (B) Estate (V94)	
OMEGA (B) Saloon (V94)	
VECTRA (B) Estate (J96)	
VECTRA (B) Hatchback (J96)	
VECTRA (B) Saloon (J96)	
ZAFIRA A (T98)	

LS	7.05271.59.0
SUZUKI	
BALENO (EG)	
BALENO Estate (EG)	
BALENO Hatchback (EG)	
JIMNY Closed Off-Road Vehicle (SN)	
VITARA (ET, TA, TD)	
VITARA Cabrio (ET, TA)	

LS	7.05271.63.0
FIAT	
SEDICI (189_)	
MITSUBISHI	
CARISMA (DA_)	
COLT V (CJ_, CP_)	
GALANT VIII (EA_)	
GALANT VIII Estate (EA_)	
L200 (K7_T, K6_T)	
LANCER VI (CJ_, CP_)	
OUTLANDER I (CU_W)	
PAJERO PININ I (H6_W, H7_W)	

LS	7.05271.56.0
LEXUS	
IS I (_E1_)	
IS SportCross (_E1_)	
TOYOTA	
CAMRY (_V2_)	
LAND CRUISER PRADO (_J12_)	
MR2 II (SW2_)	
MR2 III (ZZW3_)	
PRIUS Saloon (_W1_)	
YARIS (_P1_)	
YARIS VERSO (_P2_)	

LS	7.05271.61.0
HONDA	
CIVIC VII Coupe (EM2)	
CIVIC VII Hatchback (EU, EP, EV)	
CIVIC VII Saloon (ES, ET)	
PRELUDE V (BB_)	
STREAM (RN)	

LS	7.05271.65.0
TOYOTA	
AVENSIS (_T22_)	
AVENSIS Estate (_T22_)	
AVENSIS Estate (_T25_)	
AVENSIS Liftback (_T22_)	

LS	7.05271.58.0
HONDA	
CIVIC VI Aerodeck (MB, MC)	
CIVIC VI Fastback (MA, MB)	
CIVIC VI Hatchback (EJ, EK)	
CIVIC VI Saloon (EJ, EK)	

LS	7.05271.62.0
ALFA ROMEO	
159 (939_)	
159 Sportwagon (939_)	
FIAT	
CROMA (194_)	
OPEL	
ASTRA H (A04)	
ASTRA H Estate (A04)	
ASTRA H GTC (A04)	
ASTRA H TwinTop (A04)	
OMEGA B (V94)	
OMEGA B Estate (V94)	
SIGNUM Hatchback (Z03)	
VECTRA C (Z02)	
VECTRA C Estate (Z02)	
VECTRA C GTS (Z02)	
ZAFIRA / ZAFIRA FAMILY B (A05)	

LS	7.05271.66.0
SUZUKI	
SWIFT III (MZ, EZ)	
SX4 (EY, GY)	
SX4 Saloon (GY, RW)	

EMISSION CONTROL



LS	7.05271.58.0
HONDA	
CIVIC VI Aerodeck (MB, MC)	
CIVIC VI Fastback (MA, MB)	
CIVIC VI Hatchback (EJ, EK)	
CIVIC VI Saloon (EJ, EK)	

LS	7.05271.62.0
ALFA ROMEO	
159 (939_)	
159 Sportwagon (939_)	
FIAT	
CROMA (194_)	
OPEL	
ASTRA H (A04)	
ASTRA H Estate (A04)	
ASTRA H GTC (A04)	
ASTRA H TwinTop (A04)	
OMEGA B (V94)	
OMEGA B Estate (V94)	
SIGNUM Hatchback (Z03)	
VECTRA C (Z02)	
VECTRA C Estate (Z02)	
VECTRA C GTS (Z02)	
ZAFIRA / ZAFIRA FAMILY B (A05)	

LS	7.05271.66.0
SUZUKI	
SWIFT III (MZ, EZ)	
SX4 (EY, GY)	
SX4 Saloon (GY, RW)	



LS 7.05271.67.0



NISSAN

- MICRA C+C III (K12)
- MICRA III (K12)
- NOTE (E11, NE11)
- NV200 / EVALIA Bus
- NV200 Van
- QASHQAI / QASHQAI +2 I (J10, NJ10, JJ10E)
- TIIDA Hatchback (C11)
- TIIDA Saloon (SC11)

LS 7.05271.68.0



OPEL

- AGILA (A) (H00)
- OMEGA B (V94)
- OMEGA B Estate (V94)
- VECTRA B (J96)
- VECTRA B Estate (J96)
- VECTRA B Hatchback (J96)

PORSCHE

- 911 (997)
- BOXSTER (987)
- CAYMAN (987)

VAUXHALL

- AGILA Mk I (A) (H00)
- OMEGA (B) Estate (V94)
- OMEGA (B) Saloon (V94)
- VECTRA (B) Estate (J96)
- VECTRA (B) Hatchback (J96)
- VECTRA (B) Saloon (J96)

LS 7.05271.69.0



NISSAN

- ALMERA II (N16)
- ALMERA II Hatchback (N16)
- ALMERA TINO (V10)
- MICRA II (K11)
- MURANO I (Z50)
- PRIMERA (P12)
- PRIMERA Estate (WP12)
- PRIMERA Hatchback (P12)
- X-TRAIL (T30)
- X-TRAIL (T31)

LS 7.05271.70.0



BMW

- 5 (E34)
- 5 Touring (E34)

LS 7.05271.71.0



HONDA

- ACCORD IV (CB)
- ACCORD IV Aerodeck (CB)
- ACCORD IV Coupe (CB, CC)
- CIVIC V Coupe (EJ)
- CIVIC VI Aerodeck (MB, MC)
- CIVIC VI Fastback (MA, MB)

LS 7.05271.71.0

- CIVIC VI Hatchback (EJ, EK)
- CRX III (EH, EG)

LS 7.05271.72.0



MG

- MG ZS
- MG ZS Hatchback
- MG ZT
- MG ZT- T

MINI (BMW)

- MINI (R50, R53)
- MINI (R56)
- MINI Convertible (R52)

ROVER

- 45 I Hatchback (RT)
- 45 I Saloon (RT)
- 75 (RJ)
- 75 I Tourer (RJ)

LS 7.05271.73.0



CHEVROLET

- AVEO / KALOS Hatchback (T250, T255)
- AVEO / KALOS Saloon (T250, T255)
- LACETTI (J200)
- MATIZ (M200, M250)
- NUBIRA Estate
- NUBIRA Saloon
- SPARK

DAEWOO

- KALOS (KLAS)
- LACETTI Hatchback (KLAN)
- MATIZ (M100, M150)
- NUBIRA Saloon (J200)
- NUBIRA Wagon (J200)

FORD USA

- PROBE II (ECP)

MAZDA

- 626 IV Hatchback (GE)

EMISSION CONTROL





LS 7.05271.73.0

MX-6 (GE)
XEDOS 6 (CA)

LS 7.05271.74.0



CITROEN

- BERLINGO Box Body/MPV (B9)
- BERLINGO MULTISPACE (B9)
- C3 II (SC_)
- C3 PICASSO (SH_)
- C4 Coupe (LA_)
- C4 GRAND PICASSO I (UA_)
- C4 I (LC_)
- C4 II (B7)
- C4 PICASSO I MPV (UD_)
- C4 PICASSO II
- C5 III (RD_)
- C5 III Break (RW_)
- DS3
- DS3 Convertible
- DS4 (NX_)
- DS5
- MINI (BMW)**
- MINI (R50, R53)
- MINI (R56)
- MINI CLUBMAN (R55)
- MINI COUNTRYMAN (R60)
- MINI Convertible (R57)
- MINI Coupe (R58)
- MINI PACEMAN (R61)
- MINI Roadster (R59)

PEUGEOT

- 2008 I (CU_)
- 207 (WA_, WC_)
- 207 CC (WD_)
- 207 SW (WK_)
- 208 I (CA_, CC_)
- 3008 MPV (OU_)
- 308 CC (4B_)
- 308 I (4A_, 4C_)
- 308 SW I (4E_, 4H_)
- 5008 (OU_, OE_)
- 508 I (8D_)
- 508 SW I (8E_)
- PARTNER Box Body/MPV
- PARTNER TEPEE
- RCZ

LS 7.05271.75.0



LAND ROVER

- FREELANDER I (L314)
- FREELANDER I Soft Top (L314)

MG

- MG TF
- MG ZR
- MG ZS
- MG ZS Hatchback
- MGF (RD)

ROVER

- 200 II Hatchback (RF)
- 25 I Hatchback (RF)
- 400 II (RT)
- 400 II Hatchback (RT)
- 45 I Hatchback (RT)
- 45 I Saloon (RT)

LS 7.05271.76.0 New



OPEL

- ASTRA G CLASSIC Caravan (F35)
- ASTRA G CLASSIC Saloon (T98)
- ASTRA G Coupe (T98)
- ASTRA G Estate (T98)
- ASTRA G Estate Van (F70)
- ASTRA G Hatchback (T98)
- ASTRA G Saloon (T98)
- CORSA B (S93)
- CORSA B Estate (S93)
- CORSA C (X01)
- MERIVA A MPV (X03)
- VECTRA C (Z02)
- VECTRA C Estate (Z02)
- VECTRA C GTS (Z02)
- ZAFIRA A MPV (T98)

VAUXHALL

- ASTRA Mk IV (G) Convertible (T98)
- ASTRA Mk IV (G) Estate (T98)
- ASTRA Mk IV (G) Hatchback (T98)

LS 7.05271.76.0 New

- ASTRA Mk IV (G) Saloon (T98)
- ASTRAVAN Mk IV (G) Estate Van (T98)
- CORSA Mk I (B) (S93)
- CORSA Mk II (C) (X01)
- MERIVA A (X03)
- ZAFIRA A (T98)

LS 7.05271.77.0 New



AUDI

- A3 (8L1)
- A4 B6 (8E2)
- A4 B6 Avant (8E5)
- A4 B6 Convertible (8H7)
- A4 B7 (8EC)
- A4 B7 Avant (8ED)
- A6 C5 (4B2)
- A6 C5 Avant (4B5)
- A6 C6 (4F2)
- A6 C6 Avant (4F5)
- A8 D2 (4D2, 4D8)
- ALLROAD C5 (4BH)
- TT (8N3)
- TT Roadster (8N9)

AUDI FAW

- A4 B7 (8YC)

BENTLEY

- CONTINENTAL Coupe (3W_, 393)

PORSCHE

- CAYENNE (9PA)

SEAT

- ALHAMBRA (7V8, 7V9)
- AROSA (6H1)
- CORDOBA (6K1, 6K2)
- CORDOBA (6L2)
- CORDOBA Vario (6K5)
- IBIZA II (6K1)
- IBIZA III (6L1)
- INCA (6K9)
- LEON (1M1)

SKODA

- FABIA I (6Y2)
- FABIA I Combi (6Y5)
- FABIA I Saloon (6Y3)

VOLKSWAGEN

- CADDY II Box Body/MPV (9K9A)
- CADDY II MPV (9K9B)
- LUPO I (6X1, 6E1)
- NEW BEETLE (9C1, 1C1)
- NEW BEETLE Convertible (1Y7)

EMISSION CONTROL





LS 7.05271.77.0 New	SLP 7.00216.06.0	SLP 7.01486.10.0
PHAETON (3D1, 3D2, 3D3, 3D4, 3D6, 3D7, 3D8, 3D9) POLO (6N2) POLO III CLASSIC (6V2) SHARAN (7M8, 7M9, 7M6)		
LS 7.05271.81.0 BUICK RENDEZVOUZ CHEVROLET CAPTIVA (C100, C140) OPEL AGILA (A) (H00) ANTARA A (L07) ASTRA G CLASSIC Caravan (F35) ASTRA G Hatchback (T98) ASTRA G Saloon (T98) ASTRA H (A04) ASTRA H CLASSIC Estate (A04) ASTRA H CLASSIC Hatchback (A04) ASTRA H Estate (A04) ASTRA H GTC (A04) ASTRA H Saloon (A04) ASTRA H TwinTop (A04) ASTRA J (P10) ASTRA J Sports Tourer (P10) CORSA C (X01) CORSA D (S07) CORSA E (X15) INSIGNIA A (G09) INSIGNIA A Saloon (G09) INSIGNIA A Sports Tourer (G09) MERIVA A MPV (X03) OMEGA B (V94) OMEGA B Estate (V94) SIGNUM Hatchback (Z03) TIGRA TwinTop (X04) VECTRA C (Z02) VECTRA C Estate (Z02) VECTRA C GTS (Z02)	AUDI A4 B6 (8E2) A4 B6 Avant (8E5) A4 B6 Convertible (8H7) A4 B7 (8EC) A4 B7 Avant (8ED) A4 B7 Convertible (8HE)	AUDI A6 Allroad C6 (4FH) A6 C6 (4F2) A6 C6 Avant (4F5) A8 D3 (4E2, 4E8) A8 D4 (4H2, 4H8, 4HC, 4HL) AUDI FAW A6L C6 (4Z8)
SAAB 9-5 (YS3G) VAUXHALL AGILA Mk I (A) (H00) ASTRA Mk V (H) (A04) ASTRA Mk V (H) Estate (A04) ASTRA Mk V (H) Sport Hatch (A04) ASTRAVAN Mk V (H) Estate Van (A04) CORSA Mk II (C) (X01) CORSA Mk III (D) (S07) CORSA Mk IV (E) (X15) MERIVA A (X03) OMEGA (B) Estate (V94) OMEGA (B) Saloon (V94) SIGNUM (Z03) TIGRA TwinTop (X04) VECTRA Mk II (C) (Z02) VECTRA Mk II (C) Estate (Z02) VECTRA Mk II (C) GTS (Z02)	SLP 7.00224.13.0  JAGUAR S-TYPE II (X200) XF I (X250) XJ (X350, X358) XJ (X351)	SLP 7.03446.01.0  AUDI A8 D4 (4H2, 4H8, 4HC, 4HL) →SI 0083 →SI 0106 →SI 1150
AGILA Mk I (A) (H00) ASTRA Mk V (H) (A04) ASTRA Mk V (H) Estate (A04) ASTRA Mk V (H) Sport Hatch (A04) ASTRAVAN Mk V (H) Estate Van (A04) CORSA Mk II (C) (X01) CORSA Mk III (D) (S07) CORSA Mk IV (E) (X15) MERIVA A (X03) OMEGA (B) Estate (V94) OMEGA (B) Saloon (V94) SIGNUM (Z03) TIGRA TwinTop (X04) VECTRA Mk II (C) (Z02) VECTRA Mk II (C) Estate (Z02) VECTRA Mk II (C) GTS (Z02)	SLP 7.01486.08.0  AUDI A8 D3 (4E2, 4E8) →SI 0083 →SI 0106 →SI 1150	SLP 7.03635.12.0  AUDI A4 B8 (8K2) A4 B8 Avant (8K5) A5 (8T3) A5 Convertible (8F7) →SI 0083 →SI 0106 →SI 1150





SLP 7.03635.12.0
 A5 Sportback (8TA)
 A6 C7 (4G2, 4GC)
 A6 C7 Avant (4G5, 4GD)
 A7 Sportback (4GA, 4GF)
 A8 D4 (4H2, 4H8, 4HC, 4HL)
BENTLEY
 BENTAYGA (4V1)
 CONTINENTAL Convertible (3W_, 394)
 CONTINENTAL Coupe (3W_, 393)
 FLYING SPUR (4W_)

SLP 7.03635.37.0



AUDI
 A3 Sportback (8VA, 8VF)
SEAT
 ALHAMBRA (710, 711)
 LEON (5F1)
VOLKSWAGEN
 BEETLE (5C1, 5C2)
 BEETLE Convertible (5C7, 5C8)
 JETTA IV (162, 163, AV3, AV2)
 PASSAT B7 (A32, A33)
 SHARAN (7N1, 7N2)

SLP 7.03635.38.0



AUDI
 A3 (8V1, 8VK)
 A3 Limousine (8VS, 8VM)
 A3 Sportback (8VA, 8VF)
VOLKSWAGEN
 JETTA VII Saloon (BU3)

SLP 7.03635.39.0



AUDI
 A3 Convertible (8V7, 8VE)
 A3 Limousine (8VS, 8VM)
 Q3 (F3B)
 Q3 Sportback (F3N)
 TT (FV3, FVP)
 TT Roadster (FV9, FVR)
VOLKSWAGEN
 BEETLE (5C1, 5C2)
 BEETLE Convertible (5C7, 5C8)
 GOLF VII (5G1, BQ1, BE1, BE2)
 GOLF VII Variant (BA5, BV5)
 PASSAT B7 (A32, A33)
 TIGUAN ALLSPACE (BW2)

SLP 7.03635.40.0



AUDI
 Q7 (4LB)
 Q7 Van (4LB)

SLP 7.03635.41.0



AUDI
 A6 C7 (4G2, 4GC)
 A6 C7 Avant (4G5, 4GD)
 A7 Sportback (4GA, 4GF)

SLP 7.03635.46.0



AUDI
 A6 C8 (4A2)
 A6 C8 Avant (4A5)
 A7 Sportback (4KA)
 Q5 (FYB, FYG)
 Q7 (4MB, 4MG)
VOLKSWAGEN
 TOUAREG (CR7)

SLP 7.04389.00.0



→SI 0083
 →SI 0106
 →SI 1150

CHRYSLER
 CROSSFIRE
 CROSSFIRE Roadster
MERCEDES-BENZ
 C-CLASS (W202)
 C-CLASS (W203)
 C-CLASS Coupe (CL203)
 C-CLASS T-Model (S202)
 C-CLASS T-Model (S203)
 CLK (C208)
 CLK (C209)
 CLK Convertible (A208)
 CLK Convertible (A209)
 CLS (C219)
 E-CLASS (W210)
 E-CLASS (W211)
 E-CLASS Platform/Chassis (VF210)
 E-CLASS T-Model (S210)
 E-CLASS T-Model (S211)
 G-CLASS (W463)
 G-CLASS Cabrio (W463)
 M-CLASS (W163)
 M-CLASS (W164)
 R-CLASS (W251, V251)
 S-CLASS (W220)

EMISSION CONTROL



SLP	7.04389.00.0	SLP	7.04389.02.0	SLP	7.04389.05.0
<p>S-CLASS Coupe (C215) SL (R129) SL (R230) SLK (R170) V-CLASS (638/2) VIANO (W639) VITO / MIXTO Van (W639) VITO Bus (W639)</p>		<p>S-CLASS Coupe (C216) SL (R230) SLK (R171) SPRINTER 3,5-t Bus (B906) SPRINTER 3,5-t Platform/Chassis (B906) SPRINTER 3,5-t Van (B906) SPRINTER 3-t Bus (B906) SPRINTER 3-t Platform/Chassis (B906) SPRINTER 3-t Van (B906) SPRINTER 4,6-t Platform/Chassis (B906) SPRINTER 4,6-t Van (B906) SPRINTER 5-t Platform/Chassis (B906) SPRINTER 5-t Van (B906) VIANO (W639) VITO / MIXTO Van (W639) VITO Bus (W639) MERCEDES-BENZ (BBDC) C-CLASS (W204) E-CLASS (W211) E-CLASS (W212) GLK-CLASS (X204) MERCEDES-BENZ (FJDA) VIANO VITO (V639)</p>		 <p>MERCEDES-BENZ M-CLASS (W164) S-CLASS (W221) S-CLASS Coupe (C216) SL (R230) SLK (R170) SLR (R199) SLR Roadster (R199) SPRINTER 2-t Van (B901, B902) SPRINTER 3-t Bus (B903) SPRINTER 3-t Platform/Chassis (B903) SPRINTER 3-t Van (B903) SPRINTER 4-t Platform/Chassis (B904) V-CLASS (638/2) VITO Bus (W638) VITO Van (W638)</p>	
<p>SLP 7.04389.02.0</p>  <p>→SI 0083 →SI 0106 →SI 1150</p> <p>DODGE SPRINTER 2500 Cab & Chassis SPRINTER 2500 Standard Cargo Van SPRINTER 2500 Standard Passenger Van SPRINTER 3500 Cab & Chassis SPRINTER 3500 Standard Cargo Van SPRINTER 3500 Standard Passenger Van FREIGHTLINER SPRINTER 2500 Cab & Chassis SPRINTER 2500 Standard Cargo Van SPRINTER 2500 Standard Passenger Van SPRINTER 3500 Cab & Chassis SPRINTER 3500 Standard Cargo Van SPRINTER 3500 Standard Passenger Van MERCEDES-BENZ C-CLASS (W203) C-CLASS (W204) C-CLASS Coupe (CL203) C-CLASS T-Model (S203) C-CLASS T-Model (S204) CLC-CLASS (CL203) CLK (C209) CLK Convertible (A209) CLS (C219) E-CLASS (W211) E-CLASS (W212) E-CLASS Convertible (A207) E-CLASS Coupe (C207) E-CLASS T-Model (S211) E-CLASS T-Model (S212) G-CLASS (W463) G-CLASS Cabrio (W463) GL-CLASS (X164) GLK-CLASS (X204) M-CLASS (W164) R-CLASS (W251, V251) S-CLASS (W221)</p>		<p>SLP 7.04389.04.0</p>  <p>→SI 0106 →SI 1150</p> <p>MERCEDES-BENZ C-CLASS (W203) C-CLASS Coupe (CL203) C-CLASS T-Model (S202) C-CLASS T-Model (S203) CLK (C209) CLK Convertible (A209) E-CLASS (W211) E-CLASS T-Model (S211) R-CLASS (W251, V251) S-CLASS (W220) S-CLASS Coupe (C215) S-CLASS Coupe (C216) SL (R230) SLK (R171) SLS AMG (C197) SLS AMG Roadster (R197)</p>		<p>SLP 7.04389.06.0</p>  <p>MERCEDES-BENZ C-CLASS (W203) C-CLASS T-Model (S203) CLK (C209) CLK Convertible (A209) CLS (C219) E-CLASS (W211) E-CLASS T-Model (S211) G-CLASS (W463) R-CLASS (W251, V251) S-CLASS (W220) S-CLASS (W221) S-CLASS Coupe (C215) S-CLASS Coupe (C216) SL (R230) SLK (R171)</p>	





SLP	7.04389.07.0	SLP	7.04389.09.0	SLP	7.21851.31.0
<p>MERCEDES-BENZ C-CLASS (W204) C-CLASS Coupe (C204) C-CLASS T-Model (S204) E-CLASS (W212) E-CLASS Convertible (A207) E-CLASS Coupe (C207) E-CLASS T-Model (S212) SLK (R172) MERCEDES-BENZ (BBDC) C-CLASS (W204)</p>		<p>E-CLASS (W212) E-CLASS T-Model (S212)</p>	<p>AUDI R8 (4S3, 4SP) R8 Spyder (4S9, 4SR) LAMBORGHINI HURACÁN</p>	<p>BORA Variant (1J6) GOLF IV (1J1) GOLF IV Cabriolet (1E7) GOLF IV Variant (1J5) NEW BEETLE (9C1, 1C1) NEW BEETLE Convertible (1Y7) PASSAT B5 (3B2) PASSAT B5 Variant (3B5)</p>	
		SLP			
<p>MERCEDES-BENZ G-CLASS (W463) S-CLASS (W222, V222, X222) S-CLASS Convertible (A217) S-CLASS Coupe (C217) SL (R231)</p>	<p>→SI 0083 →SI 0106 →SI 1150</p> <p>AUDI A6 C5 (4B2) A6 C5 Avant (4B5) A8 D2 (4D2, 4D8) A8 D3 (4E2, 4E8)</p>	<p>MERCEDES-BENZ C-CLASS (W204) C-CLASS Coupe (C204) C-CLASS T-Model (S204)</p>	<p>→SI 0083 →SI 0106 →SI 1150</p> <p>AUDI A3 (8L1) A4 B5 (8D2) A4 B5 Avant (8D5) A4 B6 (8E2) A4 B6 Avant (8E5) A4 B6 Convertible (8H7) A4 B7 (8EC) A4 B7 Avant (8ED) A6 C5 (4B2) A6 C5 Avant (4B5) TT (8N3) TT Roadster (8N9) SEAT CORDOBA (6K1, 6K2) IBIZA II (6K1) LEON (1M1) TOLEDO II (1M2) SKODA OCTAVIA I (1U2) OCTAVIA I Combi (1U5) VOLKSWAGEN BORA I (1J2)</p>	<p>→SI 0083 →SI 0106 →SI 1150</p> <p>BMW 3 (E46) 3 Compact (E46) 3 Convertible (E46) 3 Coupe (E46) 3 Touring (E46)</p>	
<p>MERCEDES-BENZ C-CLASS (W204) C-CLASS Coupe (C204) C-CLASS T-Model (S204)</p>	<p>MERCEDES-BENZ C-CLASS (W204) C-CLASS Coupe (C204) C-CLASS T-Model (S204)</p>	<p>MERCEDES-BENZ C-CLASS (W204) C-CLASS Coupe (C204) C-CLASS T-Model (S204)</p>	<p>MERCEDES-BENZ C-CLASS (W204) C-CLASS Coupe (C204) C-CLASS T-Model (S204)</p>	<p>MERCEDES-BENZ C-CLASS (W204) C-CLASS Coupe (C204) C-CLASS T-Model (S204)</p>	

EMISSION CONTROL





SLP 7.21852.78.0



→SI 0083
→SI 0106
→SI 1150

BMW
7 (E38)
X5 (E53)

SLP 7.21852.79.0



→SI 0083
→SI 0106
→SI 1150

BMW
3 Convertible (E46)
3 Coupe (E46)

SLP 7.21852.82.0



BMW
Z8 Roadster (E52)

SLP 7.21852.85.0



→SI 0083
→SI 0106
→SI 1150

BMW
3 (E36)
3 Compact (E36)
3 Convertible (E36)
3 Coupe (E36)

SLP 7.21857.01.0



→SI 0083
→SI 0106
→SI 1150

VOLVO
C70 I Convertible (873)
C70 I Coupe (872)
S70 (874)
V70 I (875, 876)
XC70 CROSS COUNTRY I (295)

SLP 7.21857.59.0



→SI 0083
→SI 0106
→SI 1150

SLP 7.21857.59.0

VOLVO
850 (854)
850 Estate (855)

SLP 7.22166.39.0



→SI 0083
→SI 0106
→SI 1150

BMW
X5 (E53)

SLP 7.22472.07.0



FERRARI
360 (F131)
360 Spider (F131)
599 GTB/GTO
5__ MARANELLO
612 SCAGLIETTI
CALIFORNIA
F430

F430 Spider
SUPERAMERICA

MASERATI
3200 GT Coupe
4200 GT / COUPE Coupe
4200 GT SPYDER Convertible
GRAN TURISMO
GRANCABRIO
GRANSPORT Convertible
GRANSPORT Coupe
QUATTROPORTE V





SLP	7.22738.08.0	SLP	7.22738.08.0	SLP	7.22738.20.0
	<p>→SI 0083 →SI 0106 →SI 1150</p>		<p>OCTAVIA I Combi (1U5) OCTAVIA II (1Z3) OCTAVIA II Combi (1Z5) SUPERB I (3U4) VOLKSWAGEN BORA I (1J2) BORA Variant (1J6) CADDY III Box Body/MPV (2KA, 2KH, 2CA, 2CH) CADDY III MPV (2KB, 2KJ, 2CB, 2CJ) GOLF IV (1J1) GOLF IV Cabriolet (1E7) GOLF IV Variant (1J5) GOLF PLUS V (5M1, 521) GOLF V (1K1) GOLF V Variant (1K5) GOLF VI (5K1) GOLF VI Variant (AJ5) JETTA III (1K2) NEW BEETLE (9C1, 1C1) NEW BEETLE Convertible (1Y7) PASSAT B5 (3B2) PASSAT B5 Variant (3B5) PASSAT B5.5 (3B3) PASSAT B5.5 Variant (3B6) PASSAT B6 (3C2) PASSAT B6 Variant (3C5) POLO III CLASSIC (6V2) POLO Variant (6V5) SHARAN (7M8, 7M9, 7M6) TOUAREG (7LA, 7L6, 7L7) TOUAREG (7P5, 7P6) TOURAN (1T1, 1T2) TRANSPORTER IV Bus (70B, 70C, 7DB, 7DK, 70J, 70K, 7DC, 7DJ) TRANSPORTER IV Platform/Chassis (70E, 70L, 70M, 7DE, 7DL, 7D) TRANSPORTER IV Van (70A, 70H, 7DA, 7DH) VW FAW BORA (1J2, 9D2) BORA GP Saloon (9D2) BORA HS Hatchback (9D1) VW SVW PASSAT B5 (9F8) PASSAT LINGYU (B5, 9F0, 9F9) SANTANA 3000 (345) SANTANA VISTA (345) TOURAN (9R1, 9R3)</p>		<p>→SI 0083 →SI 0106 →SI 1150</p>
	<p>AUDI A3 (8L1) A3 (8P1) A3 Convertible (8P7) A3 Sportback (8PA) A4 B5 (8D2) A4 B5 Avant (8D5) A4 B6 (8E2) A4 B6 Avant (8E5) A4 B6 Convertible (8H7) A4 B7 (8EC) A4 B7 Avant (8ED) A6 Allroad C6 (4FH) A6 C5 (4B2) A6 C5 Avant (4B5) A6 C6 (4F2) A6 C6 Avant (4F5) A8 D3 (4E2, 4E8) Q7 (4LB) TT (8N3) TT Roadster (8N9)</p> <p>AUDI FAW A6L C6 (4Z8)</p> <p>FORD GALAXY I (WGR)</p> <p>PORSCHE CAYENNE (9PA)</p> <p>SEAT ALHAMBRA (7V8, 7V9) ALTEA (5P1) ALTEA XL (5P5, 5P8) CORDOBA (6K1, 6K2) CORDOBA (6L2) CORDOBA Vario (6K5) EXEO (3R2) EXEO ST (3R5) IBIZA II (6K1) IBIZA III (6L1) LEON (1M1) LEON (1P1) TOLEDO II (1M2) TOLEDO III (5P2)</p> <p>SKODA FABIA I (6Y2) FABIA I Combi (6Y5) FABIA I Saloon (6Y3) OCTAVIA I (1U2)</p>		<p>AUDI A3 (8P1) A3 Sportback (8PA) TT (8J3) TT Roadster (8J9)</p> <p>SEAT IBIZA III (6L1)</p> <p>VOLKSWAGEN EOS (1F7, 1F8) GOLF V (1K1) POLO (9N_)</p>		
					<p>→SI 0083 →SI 0106 →SI 1150</p>
					<p>AUDI A4 B8 (8K2) A4 B8 Avant (8K5) A5 (8T3) A5 Convertible (8F7) A5 Sportback (8TA) A6 Allroad C7 (4GH, 4GJ) A6 C7 (4G2, 4GC) A6 C7 Avant (4G5, 4GD) A7 Sportback (4GA, 4GF) Q5 (8RB) Q7 (4MB, 4MG)</p> <p>AUDI FAW A6L C7 (4X8, 4XL)</p>



SLP 7.22934.63.0



AUDI

- A6 C7 (4G2, 4GC)
- A6 C7 Avant (4G5, 4GD)
- A7 Sportback (4GA, 4GF)
- A8 D3 (4E2, 4E8)

VOLKSWAGEN

- MULTIVAN V (7HM, 7HN, 7HF, 7EF, 7EM, 7EN)
- TRANSPORTER V Bus (7HB, 7HJ, 7EB, 7EJ, 7EF, 7EG, 7HF, 7EC)
- TRANSPORTER V Platform/Chassis (7JD, 7JE, 7JL, 7JY, 7JZ, 7FD)
- TRANSPORTER V Van (7HA, 7HH, 7EA, 7EH)

SLP 7.28124.19.0



- SI 0083
- SI 0106
- SI 1150

BMW

- 3 (E46)
- 3 (E90)
- 3 Compact (E46)
- 3 Convertible (E46)
- 3 Coupe (E46)
- 3 Touring (E46)
- 5 (E60)
- 5 Touring (E61)
- 6 (E63)
- 6 Convertible (E64)
- X1 (E84)
- X3 (E83)
- X5 (E53)

SLP 7.28124.20.0



- SI 0083
- SI 0106
- SI 1150

BMW

- 3 (E46)
- 3 Compact (E46)
- 3 Convertible (E46)
- 3 Coupe (E46)
- 3 Touring (E46)
- 5 (E60)
- 5 Touring (E61)
- X3 (E83)
- Z4 Roadster (E85)

SLP 7.28124.21.0



- SI 0083
- SI 0106
- SI 1150

BMW

- 3 (E46)
- 3 Compact (E46)
- 3 Convertible (E46)
- 3 Coupe (E46)
- 3 Touring (E46)

SLP 7.28124.30.0



- SI 0083
- SI 0106
- SI 1150

BMW

- 3 (E90)
- 3 Convertible (E93)
- 3 Coupe (E92)

SLP 7.28247.13.0



CHRYSLER

- 200 Convertible
- 200 Saloon
- SEBRING (JS)
- SEBRING Convertible (JS)

DODGE

- AVENGER
- JOURNEY

LANCIA

- FLAVIA Convertible (JS_)

SLP 7.28415.09.0



- SI 0083
- SI 0106
- SI 1150

EMISSION CONTROL





SLV 7.00018.50.0

PORSCHE
 911 (997)
 911 Convertible (997)
 911 Targa (997)
 BOXSTER (987)
 BOXSTER Spyder (987)
 CAYENNE (92A)
 CAYENNE (9PA)
 CAYMAN (987)
 PANAMERA (970)



SLV 7.00018.51.0

→SI 0083
 →SI 0106

PORSCHE
 911 (997)
 CAYENNE (9PA)

PORSCHE
 CAYENNE (92A)
 PANAMERA (970)

→PI 1609

BMW MOTORCYCLES
 HP
 M
 S



SLV 7.00018.52.0

→SI 0083
 →SI 0106

PORSCHE
 911 (991)
 911 (997)
 911 Convertible (991)
 911 Convertible (997)
 MACAN (95B)

PORSCHE
 CAYENNE (92A)
 PANAMERA (970)

BMW MOTORCYCLES
 F



BMW MOTORCYCLES
 K

BMW
 1 (E82)
 1 (E88)
 1 Convertible (E88)
 1 Coupe (E82)
 3 (E90)
 3 (E93)
 3 Convertible (E93)
 3 Coupe (E92)
 5 Touring (F11)

EMISSION CONTROL



SLV 7.01318.20.0

BMW (BRILLIANCE)
3 SERIES (E90)
5 SERIES (F10, F18)

SLV 7.01318.24.0



BMW
3 (E90)
5 (E60)
X1 (E84)
BMW (BRILLIANCE)
3 SERIES (E90)
X1 (E84)

SLV 7.01510.57.0



AUDI
A6 C7 (4G2, 4GC)
A8 D4 (4H2, 4H8, 4HC, 4HL)
Q5 (8RB)

→SI 0083
→SI 0106

SLV 7.01510.86.0



AUDI
A3 Convertible (8V7, 8VE)
A3 Limousine (8VS, 8VM)
TT (FV3, FVP)
TT Roadster (FV9, FVR)

VOLKSWAGEN
BEETLE (5C1, 5C2)
BEETLE Convertible (5C7, 5C8)
GOLF VII (5G1, BQ1, BE1, BE2)
GOLF VII Van (5G1)
GOLF VII Variant (BA5, BV5)
JETTA IV (162, 163, AV3, AV2)
PASSAT B7 (A32, A33)

SLV 7.01510.85.0



AUDI
A3 Convertible (8V7, 8VE)
A3 Limousine (8VS, 8VM)
Q3 (F3B)
Q3 Sportback (F3N)
TT (FV3, FVP)
TT Roadster (FV9, FVR)

VOLKSWAGEN
BEETLE (5C1, 5C2)
BEETLE Convertible (5C7, 5C8)
GOLF ALLTRACK VII Variant (BA5, BV5)
GOLF VII (5G1, BQ1, BE1, BE2)
GOLF VII Van (5G1)
GOLF VII Variant (BA5, BV5)
JETTA IV (162, 163, AV3, AV2)
PASSAT B7 (A32, A33)
TIGUAN ALLSPACE (BW2)

SLV 7.01510.87.0



VOLKSWAGEN
BEETLE (5C1, 5C2)
BEETLE Convertible (5C7, 5C8)
PASSAT B7 (A32, A33)

SLV 7.01510.91.0



AUDI
A3 Sportback (8VA, 8VF)
VOLKSWAGEN
GOLF VII (5G1, BQ1, BE1, BE2)

EMISSION CONTROL



SLV 7.01510.31.0



→SI 0083
→SI 0106

AUDI
A3 (8P1)
A3 Sportback (8PA)
VOLKSWAGEN
BEETLE (5C1, 5C2)
BEETLE Convertible (5C7, 5C8)
CC B7 (358)
EOS (1F7, 1F8)
GOLF V (1K1)
GOLF VI (5K1)
JETTA III (1K2)
JETTA IV (162, 163, AV3, AV2)
PASSAT B6 (3C2)
PASSAT B6 Variant (3C5)
PASSAT CC B6 (357)



SLV 7.01510.91.0
 GOLF VII Variant (BA5, BV5)
 JETTA VII Saloon (BU3)

SLV 7.01510.94.0



AUDI
 A6 C8 (4A2)
 A6 C8 Avant (4A5)
 A7 Sportback (4KA)
 Q5 (FYB, FYG)
 Q7 (4MB, 4MG)
VOLKSWAGEN
 TOUAREG (CR7)

SLV 7.01859.03.0



BMW MOTORCYCLES
 F
 K

→PI 1609

SLV 7.05574.00.0



AUDI
 A4 B8 (8K2)
 A4 B8 Avant (8K5)

→SI 0083
 →SI 0106

SLV 7.05574.00.0
 A5 (8T3)
 A5 Convertible (8F7)
 A5 Sportback (8TA)
 A6 C6 (4F2)
 A6 C6 Avant (4F5)
 A6 C7 (4G2, 4GC)
 A6 C7 Avant (4G5, 4GD)
 A7 Sportback (4GA, 4GF)
 A8 D4 (4H2, 4H8, 4HC, 4HL)
 Q5 (8RB)

AUDI FAW
 A4L B8 (828)
 A6L C6 (4Z8)
 A6L C7 (4X8, 4XL)

SLV 7.05574.01.0



→SI 0083
 →SI 0106

AUDI
 A4 B8 (8K2)
 A4 B8 Avant (8K5)
 A5 (8T3)
 A5 Convertible (8F7)
 A5 Sportback (8TA)
 A6 C6 (4F2)
 A6 C6 Avant (4F5)
 A6 C7 (4G2, 4GC)
 A6 C7 Avant (4G5, 4GD)
 A7 Sportback (4GA, 4GF)
 A8 D4 (4H2, 4H8, 4HC, 4HL)
 Q5 (8RB)

AUDI FAW
 A4L B8 (828)
 A6L C6 (4Z8)
 A6L C7 (4X8, 4XL)

SLV 7.05574.02.0



→SI 0083
 →SI 0106

AUDI
 A5 (8T3)

SLV 7.05574.03.0



→SI 0083
 →SI 0106

AUDI
 A5 (8T3)

SLV 7.22748.18.0



→SI 0083
 →SI 0106

BMW
 3 Convertible (E46)
 3 Coupe (E46)
 Z3 Coupe (E36)
 Z3 Roadster (E36)
 Z4 Coupe (E86)
 Z4 Roadster (E85)
WIESMANN
 MF3 Roadster

EMISSION CONTROL





SLV 7.22778.79.0	SLV 7.22778.80.0	SLV 7.22778.96.0
 <p>→SI 0083 →SI 0106</p> <p>AUDI A8 D3 (4E2, 4E8)</p> <p>SEAT ALHAMBRA (7V8, 7V9)</p> <p>VOLKSWAGEN SHARAN (7M8, 7M9, 7M6)</p>	<p>TRANSPORTER V Van (7HA, 7HH, 7EA, 7EH)</p> <p>VW FAW MAGOTAN (B6, 9X2) SAGITAR (9L2)</p> <p>VW SVW TOURAN (9R1, 9R3)</p> <hr/> <p>SLV 7.22778.94.0</p>  <p>→SI 0083 →SI 0106</p> <p>AUDI A3 (8L1) A3 (8P1) A3 Convertible (8P7) A3 Sportback (8PA)</p> <p>SEAT ALTEA (5P1) ALTEA XL (5P5, 5P8) LEON (1M1) LEON (1P1) TOLEDO III (5P2)</p> <p>SKODA OCTAVIA I (1U2) OCTAVIA I Combi (1U5) OCTAVIA II (1Z3) OCTAVIA II Combi (1Z5)</p> <p>VOLKSWAGEN BORA I (1J2) BORA Variant (1J6) CADDY III Box Body/MPV (2KA, 2KH, 2CA, 2CH) CADDY III MPV (2KB, 2KJ, 2CB, 2CJ) GOLF IV (1J1) GOLF IV Variant (1J5) GOLF PLUS V (5M1, 521) GOLF V (1K1) GOLF V Variant (1K5) GOLF VI (5K1) GOLF VI Variant (AJ5) JETTA III (1K2) NEW BEETLE (9C1, 1C1) NEW BEETLE Convertible (1Y7) PASSAT B6 (3C2) PASSAT B6 Variant (3C5) POLO IV Saloon (9N4) TOURAN (1T1, 1T2)</p> <p>VW FAW BORA GP Saloon (9D2) BORA HS Hatchback (9D1) CADDY (9HB) GOLF IV (1J1) SAGITAR (9L2)</p> <p>VW SVW POLO Hatchback (9J1) POLO Saloon (9J2)</p>	 <p>→SI 0083 →SI 0106</p>
<p>SLV 7.22778.80.0</p>  <p>→SI 0083 →SI 0106</p> <p>SEAT ALHAMBRA (7V8, 7V9) ALHAMBRA VAN (7V8, 7V9) CORDOBA (6L2) IBIZA III (6L1)</p> <p>SKODA FABIA I (6Y2) FABIA I Combi (6Y5) FABIA I Saloon (6Y3) OCTAVIA I (1U2) OCTAVIA I Combi (1U5)</p> <p>VOLKSWAGEN BORA I (1J2) BORA Variant (1J6) GOLF IV (1J1) GOLF IV Cabriolet (1E7) GOLF IV Variant (1J5) MULTIVAN V (7HM, 7HN, 7HF, 7EF, 7EM, 7EN) NEW BEETLE (9C1, 1C1) NEW BEETLE Convertible (1Y7) SHARAN (7M8, 7M9, 7M6) SHARAN VAN (7M_) TRANSPORTER V Bus (7HB, 7HJ, 7EB, 7EJ, 7EF, 7EG, 7HF, 7EC) TRANSPORTER V Platform/Chassis (7JD, 7JE, 7JL, 7JY, 7JZ, 7FD)</p>	<p>SLV 7.22778.95.0</p>  <p>→SI 0083 →SI 0106</p> <p>SKODA SUPERB I (3U4)</p> <p>VOLKSWAGEN PASSAT B5.5 (3B3) PASSAT B5.5 Variant (3B6)</p> <p>VW SVW PASSAT B5 (9F8) PASSAT LINGYU (B5, 9F0, 9F9) SANTANA 3000 (345) SANTANA VISTA (345)</p>	

EMISSION CONTROL



SLV 7.22778.97.0



→SI 0083
→SI 0106

AUDI

- A6 Allroad C6 (4FH)
- A6 C6 (4F2)
- A6 C6 Avant (4F5)
- A8 D3 (4E2, 4E8)
- Q7 (4LB)
- Q7 Van (4LB)

VOLKSWAGEN

- TOUAREG (7LA, 7L6, 7L7)

SLV 7.22778.99.0



→SI 0083
→SI 0106

AUDI

- A4 B5 (8D2)
- A4 B5 Avant (8D5)
- A4 B6 (8E2)
- A4 B6 Avant (8E5)
- A4 B7 (8EC)
- A4 B7 Avant (8ED)

SEAT

- EXEO (3R2)
- EXEO ST (3R5)

VOLKSWAGEN

- PASSAT B5.5 (3B3)
- PASSAT B5.5 Variant (3B6)

SLV 7.28238.55.0



→SI 0083
→SI 0106

BMW

- 3 (E46)
- 3 (E90)
- 3 Compact (E46)
- 3 Convertible (E46)
- 3 Coupe (E46)
- 3 Touring (E46)
- Z4 Roadster (E85)

BMW (BRILLIANCE)

- 3 SERIES (E46)

SLV 7.22778.98.0



→SI 0083
→SI 0106

AUDI

- A3 (8P1)
- A3 Sportback (8PA)
- TT (8J3)
- TT Roadster (8J9)

VOLKSWAGEN

- EOS (1F7, 1F8)
- GOLF V (1K1)

SLV 7.22936.08.0



→SI 0083
→SI 0106

SAAB

- 9-3 (YS3F, E79, D79, D75)
- 9-3 Convertible (YS3F)
- 9-3 Estate (E50)
- 9-3X (YS3)
- 9-5 (YS3E)
- 9-5 Estate (YS3E)

SLV 7.28238.56.0



→SI 0083
→SI 0106





BMW

- 5 (E60)
- 5 Touring (E61)
- 6 (E63)
- 6 Convertible (E64)
- 7 (E65, E66, E67)

EMISSION CONTROL





SLV 7.28238.57.0	SLV 7.28238.61.0	SRM-AK 7.03083.20.0			
 <p>→SI 0083 →SI 0106</p> <p>BMW 7 (E65, E66, E67)</p> <p>ROLLS-ROYCE PHANTOM VII (RR1) PHANTOM VII Coupe (RR3) PHANTOM VII Drophead Coupe (RR2)</p>	<p>3 Convertible (E46) 3 Coupe (E46) 3 Touring (E46) X3 (E83)</p> <hr/> <th>SLV 7.28238.62.0</th> <td> <p>MERCEDES-BENZ A-CLASS (W176) B-CLASS Sports Tourer (W246, W242) CITAN Box Body/MPV (W415) CITAN MPV (415) CITAN Mixto (Double Cabin) (W415) CLA Coupe (C117) CLA Shooting Brake (X117) GLA-CLASS (X156)</p> <p>NISSAN QASHQAI / QASHQAI + 2 I (J10, NJ10, JJ10E) QASHQAI II SUV (J11, J11_)</p> <p>RENAULT CAPTUR I (J5_, H5_) CLIO IV (BH_) CLIO IV Grandtour (KH_) CLIO IV Hatchback Van (BH_) ESPACE V (JR_) FLUENCE (L3_) GRAND SCÉNIC III (JZ0/1_) GRAND SCÉNIC IV (R9_) KADJAR (HA_, HL_) KANGOO / GRAND KANGOO (KW0/1_) KANGOO Express (FW0/1_) MEGANE CC (EZ0/1_) MEGANE III Coupe (DZ0/1_) MEGANE III Grandtour (KZ0/1) MEGANE III Hatchback (BZ0/1_, B3_) MEGANE IV GRAND COUPE MEGANE IV Grandtour (K9A/M/N_) MEGANE IV Hatchback (B9A/M/N_) SCÉNIC III (JZ0/1_) SCÉNIC IV (J9_) TALISMAN (LP_) TALISMAN Grandtour (KP_)</p> <p>SAMSUNG QM3</p> </td>	SLV 7.28238.62.0	<p>MERCEDES-BENZ A-CLASS (W176) B-CLASS Sports Tourer (W246, W242) CITAN Box Body/MPV (W415) CITAN MPV (415) CITAN Mixto (Double Cabin) (W415) CLA Coupe (C117) CLA Shooting Brake (X117) GLA-CLASS (X156)</p> <p>NISSAN QASHQAI / QASHQAI + 2 I (J10, NJ10, JJ10E) QASHQAI II SUV (J11, J11_)</p> <p>RENAULT CAPTUR I (J5_, H5_) CLIO IV (BH_) CLIO IV Grandtour (KH_) CLIO IV Hatchback Van (BH_) ESPACE V (JR_) FLUENCE (L3_) GRAND SCÉNIC III (JZ0/1_) GRAND SCÉNIC IV (R9_) KADJAR (HA_, HL_) KANGOO / GRAND KANGOO (KW0/1_) KANGOO Express (FW0/1_) MEGANE CC (EZ0/1_) MEGANE III Coupe (DZ0/1_) MEGANE III Grandtour (KZ0/1) MEGANE III Hatchback (BZ0/1_, B3_) MEGANE IV GRAND COUPE MEGANE IV Grandtour (K9A/M/N_) MEGANE IV Hatchback (B9A/M/N_) SCÉNIC III (JZ0/1_) SCÉNIC IV (J9_) TALISMAN (LP_) TALISMAN Grandtour (KP_)</p> <p>SAMSUNG QM3</p>		
<th>SLV 7.28238.58.0</th> <td>  <p>→SI 0083 →SI 0106</p> <p>BMW 5 (E60) 5 Touring (E61) 7 (E65, E66, E67) X5 (E53) Z4 Roadster (E85)</p> </td> <td> <p>3 (E90) 3 (E92) 3 Convertible (E93) 3 Coupe (E92)</p> <hr/> <th>SLV 7.28238.63.0</th> <td>  <p>→SI 0083 →SI 0106</p> <p>BMW 3 (E90) 3 (E92) 3 Convertible (E93) 3 Coupe (E92)</p> </td> </td>	SLV 7.28238.58.0	 <p>→SI 0083 →SI 0106</p> <p>BMW 5 (E60) 5 Touring (E61) 7 (E65, E66, E67) X5 (E53) Z4 Roadster (E85)</p>	<p>3 (E90) 3 (E92) 3 Convertible (E93) 3 Coupe (E92)</p> <hr/> <th>SLV 7.28238.63.0</th> <td>  <p>→SI 0083 →SI 0106</p> <p>BMW 3 (E90) 3 (E92) 3 Convertible (E93) 3 Coupe (E92)</p> </td>	SLV 7.28238.63.0	 <p>→SI 0083 →SI 0106</p> <p>BMW 3 (E90) 3 (E92) 3 Convertible (E93) 3 Coupe (E92)</p>
<th>SLV 7.28238.61.0</th> <td>  <p>→SI 0083 →SI 0106</p> <p>BMW 3 (E46) 3 Compact (E46)</p> </td> <td> <th>SRM-AK 7.03083.20.0</th> <td>  <p>→PI 1649</p> <p>AUDI A3 (8V1, 8VK) A3 Convertible (8V7, 8VE) A3 Limousine (8VS, 8VM) A3 Sportback (8VA, 8VF) A4 Allroad B9 (8WH, 8WJ) A4 B9 (8W2, 8WC) A4 B9 Avant (8W5, 8WD) A5 (F53, F5P) A5 Sportback (F5A, F5F)</p> </td> </td>	SLV 7.28238.61.0	 <p>→SI 0083 →SI 0106</p> <p>BMW 3 (E46) 3 Compact (E46)</p>	<th>SRM-AK 7.03083.20.0</th> <td>  <p>→PI 1649</p> <p>AUDI A3 (8V1, 8VK) A3 Convertible (8V7, 8VE) A3 Limousine (8VS, 8VM) A3 Sportback (8VA, 8VF) A4 Allroad B9 (8WH, 8WJ) A4 B9 (8W2, 8WC) A4 B9 Avant (8W5, 8WD) A5 (F53, F5P) A5 Sportback (F5A, F5F)</p> </td>	SRM-AK 7.03083.20.0	 <p>→PI 1649</p> <p>AUDI A3 (8V1, 8VK) A3 Convertible (8V7, 8VE) A3 Limousine (8VS, 8VM) A3 Sportback (8VA, 8VF) A4 Allroad B9 (8WH, 8WJ) A4 B9 (8W2, 8WC) A4 B9 Avant (8W5, 8WD) A5 (F53, F5P) A5 Sportback (F5A, F5F)</p>



SRM-AK	7.07696.00.0	
A6 C8 (4A2)		
A6 C8 Avant (4A5)		
A7 Sportback (4KA)		
Q2 (GAB, GAG)		
Q3 (F3B)		
Q3 Sportback (F3N)		
Q5 (FYB, FYG)		
Q7 (4MB, 4MG)		
Q8 (4MN)		
SEAT		
ALHAMBRA (710, 711)		
ARONA (KJ7)		
ATECA (KH7, KHP)		
IBIZA IV (6J5, 6P1)		
IBIZA IV SC (6J1, 6P5)		
IBIZA IV ST (6J8, 6P8)		
IBIZA V (KJ1)		
LEON (5F1)		
LEON ST (5F8)		
TARRACO (KN2)		
SKODA		
KAMIQ (NW4)		
KAROQ (NU7)		
KODIAQ (NS7, NV7)		
OCTAVIA III (5E3, NL3, NR3)		
OCTAVIA III Combi (5E5, 5E6)		
SCALA (NW1)		
SUPERB III (3V3)		
SUPERB III Estate (3V5)		
YETI (5L)		
VOLKSWAGEN		
ARTEON (3H7, 3H8)		
BEETLE (5C1, 5C2)		
BEETLE Convertible (5C7, 5C8)		
CADDY ALLTRACK Box Body/MPV (SAA)		
CADDY ALLTRACK MPV (SAB)		
CADDY IV Box Body/MPV (SAA, SAH)		
CADDY IV MPV (SAB, SAJ)		
CC B7 (358)		
GOLF SPORTSVAN VII (AM1, AN1)		
GOLF VI Convertible (517)		
GOLF VII (5G1, BQ1, BE1, BE2)		
GOLF VII Variant (BA5, BV5)		
GOLF VIII (CD1)		
JETTA IV (162, 163, AV3, AV2)		
PASSAT ALLTRACK B8 Variant (3G5, CB5)		
PASSAT B7 (A32, A33)		
PASSAT B8 (3G2, CB2)		
PASSAT B8 Variant (3G5, CB5)		
POLO V (6R1, 6C1)		
POLO VI (AW1, BZ1)		
POLO Van (6R)		
SHARAN (7N1, 7N2)		
T-ROC (A11)		
TIGUAN (5N_)		
TIGUAN (AD1, AX1)		
TIGUAN ALLSPACE (BW2)		
TOUAREG (CR7)		
TOURAN (5T1)		



D

PROGRAMMERGÄNZUNGEN

E

ADDITIONS TO THE RANGE

ADDITIONS TO THE RANGE

ADDITIONS TO THE RANGE

AGR 7.00992.36.0 New	AGR 7.04589.06.0 New	AGR 7.04924.15.0 New
DODGE DAKOTA DAKOTA Crew Cab Pickup DAKOTA Extended Cab Pickup DURANGO (HB) NITRO RAM 1500 Crew Cab Pickup RAM 1500 Extended Cab Pickup RAM 1500 Extended Crew Cab Pickup RAM 1500 Standard Cab Pickup JEEP CHEROKEE (KK) COMMANDER (XK, XH) GRAND CHEROKEE III (WH, WK) RAM 1500 Crew Cab Pickup (DS) 1500 Extended Cab Pickup (DS) 1500 Standard Cab Pickup (DS) DAKOTA	ALFA ROMEO MITO (955_) FIAT 500L (351_, 352_) 500X (334_) DOBLO Bus (263_) DOBLO Cargo (263_) DOBLO Platform/Chassis (263_) FIORINO Box Body/MPV (225_) PANDA (312_, 319_) PUNTO (199_) TIPO Hatchback (356_) TIPO Saloon (356_) OPEL COMBO Box Body/MPV (X12) COMBO Tour (X12) VAUXHALL COMBO Mk III (D) Box Body/MPV (X12)	RANGE ROVER SPORT II (L494) RANGE ROVER VELAR (L560)
AGR-M 7.03391.11.0 New	AGR-K 7.04787.12.0 New	AGR-K 7.04930.06.0 New
CATERPILLAR BACKHOE LOADER PAVING COMPACTOR TELEHANDLADER TRACK-TYPE TRACTOR	DEUTZ ENGINE	FUSO ENGINE
AGR-K 7.03692.11.0 New	AGR 7.04923.17.0 New	AGR-K 7.04931.04.0 New
FUSO CANTER	JAGUAR F-PACE (X761) XE (X760) XF II (X260) XF SPORTBRAKE (X260)	IVECO DAILY CITYS Bus DAILY LINE Bus DAILY TOURYS Bus DAILY VI Platform/Chassis DAILY VI Van
AGR-M 7.03693.12.0 New	AGR-K 7.04787.12.0 New	AGR-M 7.04999.34.0 New
IVECO ENGINE NEW HOLLAND ENGINE	LAND ROVER DISCOVERY V (L462) RANGE ROVER SPORT II (L494) RANGE ROVER VELAR (L560)	MAN TGE Bus TGE Platform/Chassis (UZ_) TGE Van
AGR-M 7.03762.10.0 New	AGR 7.04923.18.0 New	AGR-K 7.04999.34.0 New
CATERPILLAR BACKHOE LOADER PAVING COMPACTOR TELEHANDLADER TRACK-TYPE TRACTOR	JAGUAR E-PACE (X540)	VOLKSWAGEN CRAFTER Bus (SYI, SYJ) CRAFTER Platform/Chassis (SZ_) CRAFTER Van (SY_, SX_) MULTIVAN VI (SGF, SGM, SGN, SHM, SHN) TRANSPORTER / CARAVELLE VI Bus (SGB, SGG, SGJ, SGC, SHB, SHJ) TRANSPORTER VI Platform/Chassis (SFD, SFE, SFL, SFZ, SJD, SJ) TRANSPORTER VI Van (SGA, SGH, SHA, SHH)
AGR 7.03803.03.0 New	AGR 7.04924.14.0 New	AGR-K 7.05052.01.0 New
JOHN DEERE ENGINE	LAND ROVER DISCOVERY SPORT (L550) RANGE ROVER EVOQUE (L538) RANGE ROVER EVOQUE (L551) RANGE ROVER EVOQUE Convertible (L538)	IVECO DAILY V Platform/Chassis DAILY V Van DAILY VI Platform/Chassis DAILY VI Van
AGR-K 7.03991.12.0 New	AGR 7.04924.15.0 New	AGR-K 7.05052.03.0 New
FORD FOCUS III FOCUS III Saloon FOCUS III Turnier MONDEO V Hatchback (CE) MONDEO V Turnier (CF)	JAGUAR E-PACE (X540)	FIAT DUCATO Bus (250_) DUCATO Platform/Chassis (250_) DUCATO Van (250_)
AGR-M 7.04275.09.0 New	AGR-K 7.05107.12.0 New	AGR-K 7.05194.26.0 New
IVECO ENGINE	LAND ROVER DISCOVERY SPORT (L550) RANGE ROVER EVOQUE (L538) RANGE ROVER EVOQUE (L551) RANGE ROVER EVOQUE Convertible (L538)	ALFA ROMEO GIULIA (952_)
AGR-K 7.04448.18.0 New	AGR 7.05243.04.0 New	AGR-M 7.05243.04.0 New
DEUTZ ENGINE	JAGUAR F-PACE (X761) XE (X760) XF II (X260) XF SPORTBRAKE (X260)	IVECO ENGINE NEW HOLLAND ENGINE
AGR-K 7.04448.18.0 New	AGR 7.05264.03.0 New	AGR 7.05264.03.0 New
DEUTZ ENGINE	LAND ROVER DEFENDER Station Wagon (L663) DISCOVERY V (L462)	JAGUAR F-PACE (X761) XF II (X260) XF SPORTBRAKE (X260)

ADDITIONS TO THE RANGE

AGR 7.05264.03.0 New	LS 7.05271.77.0 New	AGR 7.05590.03.0 New
LAND ROVER DISCOVERY V (L462) RANGE ROVER IV (L405) RANGE ROVER SPORT II (L494) RANGE ROVER VELAR (L560)	IBIZA III (6L1) INCA (6K9) LEON (1M1) SKODA FABIA I (6Y2) FABIA I Combi (6Y5) FABIA I Saloon (6Y3) VOLKSWAGEN CADDY II Box Body/MPV (9K9A) CADDY II MPV (9K9B) LUPO I (6X1, 6E1) NEW BEETLE (9C1, 1C1) NEW BEETLE Convertible (1Y7) PHAETON (3D1, 3D2, 3D3, 3D4, 3D6, 3D7, 3D8, 3D9) POLO (6N2) POLO III CLASSIC (6V2) SHARAN (7M8, 7M9, 7M6)	RANGE ROVER SPORT II (L494) RANGE ROVER VELAR (L560)
LS 7.05271.76.0 New	AGR 7.05343.17.0 New	AGR 7.05632.04.0 New
OPEL ASTRA G CLASSIC Caravan (F35) ASTRA G CLASSIC Saloon (T98) ASTRA G Coupe (T98) ASTRA G Estate (T98) ASTRA G Estate Van (F70) ASTRA G Hatchback (T98) ASTRA G Saloon (T98) CORSA B (S93) CORSA B Estate (S93) CORSA C (X01) MERIVA A MPV (X03) VECTRA C (Z02) VECTRA C Estate (Z02) VECTRA C GTS (Z02) ZAFIRA A MPV (T98)	BMW 3 (G20, G80) 3 Touring (G21, G81) 5 (G30, F90) 5 Touring (G31) 6 Gran Turismo (G32) 7 (G11, G12) 8 Convertible (G14, F91) 8 Coupe (G15, F92) 8 Gran Coupe (G16, F93) X3 (G01, F97) X3 Van (G01) X4 (G02, F98) X5 (G05, F95) X6 (G06, F96) X7 (G07)	FUSO CANTER IVECO DAILY CITYS Bus DAILY LINE Bus DAILY TOURYS Bus DAILY VI Platform/Chassis DAILY VI Van
LS 7.05271.77.0 New	AGR 7.05454.07.0 New	AGR 7.05742.11.0 New
AUDI A3 (8L1) A4 B6 (8E2) A4 B6 Avant (8E5) A4 B6 Convertible (8H7) A4 B7 (8EC) A4 B7 Avant (8ED) A6 C5 (4B2) A6 C5 Avant (4B5) A6 C6 (4F2) A6 C6 Avant (4F5) A8 D2 (4D2, 4D8) ALLROAD C5 (4BH) TT (8N3) TT Roadster (8N9)	MAN ENGINE	FORD ECOSPORT
LS 7.05271.77.0 New	AGR-K 7.05483.25.0 New	AGR 7.05838.08.0 New
AUDI FAW A4 B7 (8YC)	FORD RANGER (TKE) TOURNEO CUSTOM V362 Bus (F3) TRANSIT CUSTOM V362 Bus (F3) TRANSIT CUSTOM V362 Van (FY, FZ) TRANSIT V363 Bus (FAD, FBD) TRANSIT V363 Platform/Chassis (FED, FFD) TRANSIT V363 Van (FCD, FDD)	BMW 1 (F40) 2 Active Tourer (F45) 2 Gran Tourer (F46) 5 (G30, F90) 5 Touring (G31) 7 (G11, G12) X1 (F48) X2 (F39) X3 (G01, F97) X4 (G02, F98) X5 (G05, F95) X6 (G06, F96) X7 (G07)
LS 7.05271.77.0 New	AGR-M 7.05506.14.0 New	AGR-K 7.06036.14.0 New
BENTLEY CONTINENTAL Coupe (3W_, 393)	DEUTZ ENGINE	FORD GALAXY III (CK) S-MAX (CJ, WA6)
LS 7.05271.77.0 New	AGR 7.05590.03.0 New	AGR 7.06036.15.0 New
PORSCHE CAYENNE (9PA)	JAGUAR F-PACE (X761) XF II (X260) XF SPORTBRAKE (X260)	FORD USA EDGE
LS 7.05271.77.0 New	AGR 7.05590.03.0 New	AGR 7.06036.15.0 New
SEAT ALHAMBRA (7V8, 7V9) AROSA (6H1) CORDOBA (6K1, 6K2) CORDOBA (6L2) CORDOBA Vario (6K5) IBIZA II (6K1)	LAND ROVER DISCOVERY V (L462) RANGE ROVER IV (L405)	FORD GALAXY III (CK) RANGER (TKE) S-MAX (CJ, WA6) TOURNEO CUSTOM V362 Bus (F3) TRANSIT CUSTOM V362 Bus (F3) TRANSIT CUSTOM V362 Van (FY, FZ) TRANSIT V363 Bus (FAD, FBD) TRANSIT V363 Platform/Chassis (FED, FFD) TRANSIT V363 Van (FCD, FDD)
LS 7.05271.77.0 New	AGR 7.05590.03.0 New	AGR 7.07044.12.0 New
AUDI A3 (8L1) A4 B6 (8E2) A4 B6 Avant (8E5) A4 B6 Convertible (8H7) A4 B7 (8EC) A4 B7 Avant (8ED) A6 C5 (4B2) A6 C5 Avant (4B5) A6 C6 (4F2) A6 C6 Avant (4F5) A8 D2 (4D2, 4D8) ALLROAD C5 (4BH) TT (8N3) TT Roadster (8N9)	JAGUAR F-PACE (X761) XF II (X260) XF SPORTBRAKE (X260)	FORD USA EDGE
LS 7.05271.77.0 New	AGR 7.05590.03.0 New	AGR 7.07417.39.0 New
AUDI A3 (8L1) A4 B6 (8E2) A4 B6 Avant (8E5) A4 B6 Convertible (8H7) A4 B7 (8EC) A4 B7 Avant (8ED) A6 C5 (4B2) A6 C5 Avant (4B5) A6 C6 (4F2) A6 C6 Avant (4F5) A8 D2 (4D2, 4D8) ALLROAD C5 (4BH) TT (8N3) TT Roadster (8N9)	LAND ROVER DISCOVERY V (L462) RANGE ROVER IV (L405)	BMW 1 (F40) 2 Active Tourer (F45)

ADDITIONS TO THE RANGE

ADDITIONS TO THE RANGE

AGR 7.07417.39.0 New	AGR 7.07794.23.0 New	ATS 7.08369.76.0 New
2 Gran Coupe (F44) 2 Gran Tourer (F46) X1 (F48) X2 (F39) MINI (BMW) MINI (F55) MINI (F56) MINI CLUBMAN (F54) MINI COUNTRYMAN (F60) MINI Convertible (F57)	208 Hatchback Van (CR_) 208 I (CA_, CC_) 208 II (UB_, UP_, UW_, UJ_) 3008 SUV (MC_, MR_, MJ_, M4_) 301 5008 II (MC_, MJ_, MR_, M4_) 508 II (FB_, FH_, F3_) 508 SW II (FC_, FJ_, F4_) PARTNER Box Body/MPV (K9) RIFTER VAUXHALL COMBO Mk IV (E) Box Body/MPV COMBO Mk IV (E) Life (X19) CROSSLAND X (P17) GRANDLAND X (A18) VIVARO C Van (K0) VIVARO LIFE Bus (K0)	CLS (C218) CLS Shooting Brake (X218) E-CLASS (W212) E-CLASS Convertible (A207) E-CLASS Coupe (C207) E-CLASS T-Model (S212) GLC (X253) GLC Coupe (C253) SLK (R172)
AGR 7.07549.09.0 New	AGR-K 7.07969.06.0 New	ATS 7.08369.77.0 New
ALFA ROMEO GIULIETTA (940_) FIAT 500X (334_) TIPO Estate (356_) TIPO Hatchback (356_) TIPO Saloon (356_)	FIAT 500L (351_, 352_) 500X (334_) DOBLO Bus (263_) DOBLO Cargo (263_) DOBLO Platform/Chassis (263_) FIORINO Box Body/MPV (225_) TIPO Hatchback (356_) TIPO Saloon (356_)	MERCEDES-BENZ G-CLASS (W463) G-CLASS Cabrio (W463) GL-CLASS (X164) GL-CLASS (X166) GLE (W166) GLE Coupe (C292) M-CLASS (W164) M-CLASS (W166)
AGR 7.07794.22.0 New	ATS 7.08369.74.0 New	ATS 7.08369.78.0 New
FORD ECOSPORT FOCUS IV (HN) FOCUS IV Saloon (HM) FOCUS IV Turnier (HP) KUGA III (DFK) PUMA TOURNEO CONNECT / GRAND TOURNEO CONNECT V408 MPV TRANSIT CONNECT MPV TRANSIT CONNECT V408 Box Body/MPV	OPEL ASTRA H (A04) ASTRA H Estate (A04) ASTRA H Estate Van (L70) ASTRA H Saloon (A04) ZAFIRA / ZAFIRA FAMILY B (A05) ZAFIRA B Box Body/MPV (A05) VAUXHALL ASTRA Mk V (H) (A04) ASTRA Mk V (H) Estate (A04) ASTRAVAN Mk V (H) Estate Van (A04) ZAFIRA Mk II (B) (A05)	VOLKSWAGEN CRAFTER 30-35 Bus (2E_) CRAFTER 30-50 Platform/Chassis (2F_) CRAFTER 30-50 Van (2E_)
AGR 7.07794.23.0 New	ATS 7.08369.75.0 New	ATS 7.08369.79.0 New
CITROEN BERLINGO (ER_, EC_) BERLINGO Box Body/MPV (K9) C-ELYSEE (DD_) C3 AIRCROSS II (2R_, 2C_) C3 AIRCROSS II Van (2C_, 2R_) C3 III (SX) C3 III Van (SX_, SY_) C4 CACTUS C4 CACTUS Van (0B_, 0P_) C5 AIRCROSS GRAND C4 SPACETOURER Van (3A_, 3E_) JUMPY Bus (V_) JUMPY Van (V_) DS DS 3 CROSSBACK (UR_, UC_, UJ_) DS 7 Crossback (J_) OPEL COMBO Box Body/MPV (X19) COMBO E Tour / Life (X19) CORSA F CROSSLAND X / CROSSLAND (P17, P200) GRANDLAND X (A18) VIVARO C Bus (K0) VIVARO C Van (K0) ZAFIRA LIFE Bus (K0) PEUGEOT 2008 I (CU_) 2008 II (UD_, US_, UY_, UK_)	OPEL ASTRA H (A04) ASTRA H Estate Van (L70) ASTRA H GTC (A04) ZAFIRA / ZAFIRA FAMILY B (A05) ZAFIRA B Box Body/MPV (A05) VAUXHALL ASTRA Mk V (H) (A04) ASTRA Mk V (H) Estate (A04) ASTRA Mk V (H) Sport Hatch (A04) ASTRAVAN Mk V (H) Estate Van (A04) ZAFIRA Mk II (B) (A05)	AUDI A3 (8V1, 8VK) A3 Convertible (8V7, 8VE) A3 Limousine (8VS, 8VM) A3 Sportback (8VA, 8VF) SEAT LEON (5F1) LEON Hatchback Van (5F1) LEON SC (5F5) LEON ST (5F8) LEON ST Estate Van (5F8) SKODA KAROQ (NU7) OCTAVIA III (5E3, NL3, NR3) OCTAVIA III Combi (5E5, 5E6) VOLKSWAGEN GOLF ALLTRACK VII Variant (BA5, BV5) GOLF SPORTSVAN VII (AM1, AN1) GOLF VAN VII Variant (BA5) GOLF VII (5G1, BQ1, BE1, BE2) GOLF VII Van (5G1) GOLF VII Variant (BA5, BV5)
ATS 7.08369.80.0 New	ATS 7.08369.76.0 New	ATS 7.08369.80.0 New
	MERCEDES-BENZ C-CLASS (W205) C-CLASS Coupe (CL203) C-CLASS T-Model (S203) CLC-CLASS (CL203) CLK (C209) E-CLASS (W211) E-CLASS Platform/Chassis (VF211) E-CLASS T-Model (S211) VIANO (W639)	

ATS 7.08369.80.0 New	ATS 7.08369.82.0 New	ATS 7.08369.87.0 New
VITO / MIXTO Van (W639) VITO Bus (W639)	OCTAVIA III (5E3, NL3, NR3) OCTAVIA III Combi (5E5, 5E6) VOLKSWAGEN GOLF ALLTRACK VII Variant (BA5, BV5) GOLF SPORTSVAN VII (AM1, AN1) GOLF VAN VII Variant (BA5) GOLF VII (5G1, BQ1, BE1, BE2) GOLF VII Van (5G1) GOLF VII Variant (BA5, BV5)	R-CLASS (W251, V251) V-CLASS (W447) VIANO (W639) VITO / MIXTO Van (W639) VITO Bus (W639) VITO Mixto (Double Cabin) (W447) VITO Tourer (W447) VITO Van (W447)
ATS 7.08369.81.0 New	ATS 7.08369.83.0 New	ATS 7.08369.88.0 New
AUDI A3 (8V1, 8VK) A3 Convertible (8V7, 8VE) A3 Limousine (8VS, 8VM) A3 Sportback (8VA, 8VF) Q2 (GAB, GAG) Q3 (F3B) Q3 Sportback (F3N) TT (FV3, FVP) TT Roadster (FV9, FVR)	SEAT IBIZA IV (6J5, 6P1) IBIZA IV SC (6J1, 6P5) IBIZA IV ST (6J8, 6P8)	MERCEDES-BENZ C-CLASS (W205) C-CLASS Convertible (A205) C-CLASS Coupe (C205) C-CLASS T-Model (S205) S-CLASS (W221)
SEAT ALHAMBRA (710, 711) ATECA (KH7, KHP) LEON (5F1) LEON Hatchback Van (5F1) LEON SC (5F5) LEON ST (5F8) LEON ST Estate Van (5F8) TARRACO (KN2)	SKODA FABIA II (542) FABIA II Combi (545) ROOMSTER (5J7) ROOMSTER Praktik (5J)	ATS 7.08369.89.0 New
SKODA KAROQ (NU7) KODIAQ (NS7, NV7) OCTAVIA III (5E3, NL3, NR3) OCTAVIA III Combi (5E5, 5E6) SUPERB III (3V3) SUPERB III Estate (3V5)	VOLKSWAGEN POLO V (6R1, 6C1) POLO Van (6R)	MERCEDES-BENZ A-CLASS (W176) B-CLASS Sports Tourer (W246, W242) CLA Coupe (C117) CLA Shooting Brake (X117) CLS (C218) CLS Shooting Brake (X218) E-CLASS (W212) E-CLASS Convertible (A207) E-CLASS Coupe (C207) E-CLASS T-Model (S212) GLA-CLASS (X156)
VOLKSWAGEN ARTEON (3H7, 3H8) BEETLE (5C1, 5C2) GOLF ALLTRACK VII Variant (BA5, BV5) GOLF SPORTSVAN VII (AM1, AN1) GOLF VAN VII Variant (BA5) GOLF VII (5G1, BQ1, BE1, BE2) GOLF VII Variant (BA5, BV5) JETTA IV (162, 163, AV3, AV2) PASSAT ALLTRACK B8 Variant (3G5, CB5) PASSAT B7 (A32, A33) PASSAT B8 (3G2, CB2) PASSAT B8 Variant (3G5, CB5) SHARAN (7N1, 7N2) T-ROC (A11) TIGUAN (AD1, AX1) TIGUAN ALLSPACE (BW2) TOURAN (5T1)	ATS 7.08369.84.0 New	ATS 7.08369.90.0 New
	VOLKSWAGEN CADDY III Box Body/MPV (2KA, 2KH, 2CA, 2CH) CADDY III MPV (2KB, 2KJ, 2CB, 2CJ) PASSAT B6 (3C2) PASSAT B6 Variant (3C5) TOURAN (1T1, 1T2) ENGINE	MERCEDES-BENZ C-CLASS (W204) C-CLASS Coupe (C204) C-CLASS T-Model (S204) CLS (C218) CLS Shooting Brake (X218) E-CLASS (W212) E-CLASS Convertible (A207) E-CLASS Coupe (C207) E-CLASS T-Model (S212) GLE (W166) M-CLASS (W166) SLC (R172) SLK (R172) SPRINTER CLASSIC 3,5-t Van (B909) SPRINTER CLASSIC 4,6-t Bus (B909)
ATS 7.08369.82.0 New	ATS 7.08369.85.0 New	ATS 7.08369.91.0 New
AUDI A3 (8V1, 8VK) A3 Convertible (8V7, 8VE) A3 Limousine (8VS, 8VM) A3 Sportback (8VA, 8VF)	SMART FORFOUR (454)	MERCEDES-BENZ E-CLASS (W211) E-CLASS T-Model (S211) M-CLASS (W164) R-CLASS (W251, V251) S-CLASS (W220) SPRINTER 3,5-t Bus (B906) SPRINTER 3,5-t Platform/Chassis (B906) SPRINTER 3,5-t Van (B906) SPRINTER 3-t Bus (B906) SPRINTER 3-t Platform/Chassis (B906) SPRINTER 3-t Van (B906) SPRINTER 4,6-t Platform/Chassis (B906)
SEAT LEON (5F1) LEON Hatchback Van (5F1) LEON SC (5F5) LEON ST (5F8) LEON ST Estate Van (5F8)	ATS 7.08369.86.0 New	
SKODA KAROQ (NU7)	SEAT CORDOBA (6L2) EXEO (3R2) EXEO ST (3R5) IBIZA III (6L1) IBIZA IV (6J5, 6P1) IBIZA IV SC (6J1, 6P5)	
	SKODA FABIA II (542) FABIA II Combi (545) ROOMSTER (5J7) ROOMSTER Praktik (5J)	
	VOLKSWAGEN POLO (9N_)	
	ATS 7.08369.87.0 New	
	MERCEDES-BENZ E-CLASS (W211) E-CLASS T-Model (S211) G-CLASS (W461) G-CLASS (W463) G-CLASS Cabrio (W463) GL-CLASS (X164) M-CLASS (W164) MARCO POLO Camper (W447)	

ATS 7.08369.91.0 New	ATS 7.08369.95.0 New	ATS 7.08369.99.0 New
SPRINTER 5-t Platform/Chassis (B906) SPRINTER 5-t Van (B906) SPRINTER CLASSIC 3,5-t Van (B909) SPRINTER CLASSIC 4,6-t Bus (B909) VIANO (W639) VITO / MIXTO Van (W639) VITO Bus (W639)	OCTAVIA III Combi (5E5, 5E6) SUPERB III (3V3) SUPERB III Estate (3V5) VOLKSWAGEN GOLF ALLTRACK VII Variant (BA5, BV5) GOLF SPORTSVAN VII (AM1, AN1) GOLF VAN VII Variant (BA5) GOLF VII (5G1, BQ1, BE1, BE2) GOLF VII Van (5G1) GOLF VII Variant (BA5, BV5) PASSAT B8 (3G2, CB2) PASSAT B8 Variant (3G5, CB5)	DUCATO Van (250_) PEUGEOT BOXER Bus BOXER Platform/Chassis BOXER Van
ATS 7.08369.92.0 New	ATS 7.08369.96.0 New	AGR-K 7.09720.03.0 New
VOLKSWAGEN MULTIVAN V (7HM, 7HN, 7HF, 7EF, 7EM, 7EN) TRANSPORTER V Bus (7HB, 7HJ, 7EB, 7EJ, 7EF, 7EG, 7HF, 7EC) TRANSPORTER V Platform/Chassis (7JD, 7JE, 7JL, 7JY, 7JZ, 7FD) TRANSPORTER V Van (7HA, 7HH, 7EA, 7EH)	VOLKSWAGEN MULTIVAN V (7HM, 7HN, 7HF, 7EF, 7EM, 7EN) TRANSPORTER V Bus (7HB, 7HJ, 7EB, 7EJ, 7EF, 7EG, 7HF, 7EC) TRANSPORTER V Platform/Chassis (7JD, 7JE, 7JL, 7JY, 7JZ, 7FD) TRANSPORTER V Van (7HA, 7HH, 7EA, 7EH)	AUDI A4 Allroad B8 (8KH) A4 B8 (8K2) A4 B8 Avant (8K5) A5 (8T3) A5 Convertible (8F7) A5 Sportback (8TA) A6 C7 (4G2, 4GC) A6 C7 Avant (4G5, 4GD) Q5 (8RB)
ATS 7.08369.93.0 New	ATS 7.08369.97.0 New	AGR-K 7.09720.04.0 New
VOLKSWAGEN CRAFTER 30-35 Bus (2E_) CRAFTER 30-50 Platform/Chassis (2F_) CRAFTER 30-50 Van (2E_) MULTIVAN V (7HM, 7HN, 7HF, 7EF, 7EM, 7EN) TRANSPORTER V Bus (7HB, 7HJ, 7EB, 7EJ, 7EF, 7EG, 7HF, 7EC) TRANSPORTER V Platform/Chassis (7JD, 7JE, 7JL, 7JY, 7JZ, 7FD) TRANSPORTER V Van (7HA, 7HH, 7EA, 7EH)	MERCEDES-BENZ B-CLASS Sports Tourer (W246, W242) C-CLASS (W203) C-CLASS Coupe (CL203) C-CLASS T-Model (S203) CLC-CLASS (CL203) CLS (C218) CLS Shooting Brake (X218) E-CLASS (W212) E-CLASS Convertible (A207) E-CLASS Coupe (C207) E-CLASS T-Model (S212) MARCO POLO Camper (W447) V-CLASS (W447) VITO Mixto (Double Cabin) (W447) VITO Tourer (W447) VITO Van (W447)	SEAT EXEO (3R2) EXEO ST (3R5)
ATS 7.08369.94.0 New	ATS 7.08369.98.0 New	AGR-K 7.09720.05.0 New
MERCEDES-BENZ C-CLASS (W203) C-CLASS Coupe (CL203) C-CLASS T-Model (S203) CLC-CLASS (CL203) CLK (C209) E-CLASS (W211) E-CLASS T-Model (S211) G-CLASS (W461) GL-CLASS (X164) M-CLASS (W164) R-CLASS (W251, V251) S-CLASS (W221) VIANO (W639) VITO / MIXTO Van (W639) VITO Bus (W639)	CITROEN JUMPER Bus JUMPER Platform/Chassis JUMPER Van FIAT DUCATO Bus (250_) DUCATO Platform/Chassis (250_) DUCATO Van (250_) PEUGEOT BOXER Bus BOXER Platform/Chassis BOXER Van	VOLKSWAGEN MULTIVAN V (7HM, 7HN, 7HF, 7EF, 7EM, 7EN) MULTIVAN VI (SGF, SGM, SGN, SHM, SHN) TRANSPORTER / CARAVELLE VI Bus (SGB, SGG, SGJ, SGC, SHB, SHJ) TRANSPORTER V Bus (7HB, 7HJ, 7EB, 7EJ, 7EF, 7EG, 7HF, 7EC) TRANSPORTER V Platform/Chassis (7JD, 7JE, 7JL, 7JY, 7JZ, 7FD) TRANSPORTER V Van (7HA, 7HH, 7EA, 7EH) TRANSPORTER VI Platform/Chassis (SFD, SFE, SFL, SFZ, SJD, SJ) TRANSPORTER VI Van (SGA, SGH, SHA, SHH)
ATS 7.08369.95.0 New	ATS 7.08369.99.0 New	AGR 7.10334.02.0 New
AUDI A3 (8V1, 8VK) A3 Convertible (8V7, 8VE) A3 Limousine (8VS, 8VM) A3 Sportback (8VA, 8VF) Q2 (GAB, GAG) SEAT ATECA (KH7, KHP) LEON (5F1) LEON Hatchback Van (5F1) LEON SC (5F5) LEON ST (5F8) LEON ST Estate Van (5F8) SKODA KAROQ (NU7) OCTAVIA III (5E3, NL3, NR3)	CITROEN JUMPER Bus JUMPER Platform/Chassis JUMPER Van FIAT DUCATO Bus (250_) DUCATO Platform/Chassis (250_) SKODA KAMIQ (NW4) KAROQ (NU7)	FIAT DUCATO Bus (250_) DUCATO Platform/Chassis (250_) DUCATO Van (250_) AUDI A3 (8V1, 8VK) A3 Convertible (8V7, 8VE) A3 Limousine (8VS, 8VM) A3 Sportback (8VA, 8VF) Q2 (GAB, GAG) Q3 (8UB, 8UG) TT (FV3, FVP) SEAT ALHAMBRA (710, 711) ATECA (KH7, KHP) LEON (5F1) LEON Hatchback Van (5F1) LEON SC (5F5) LEON ST (5F8) LEON ST Estate Van (5F8) TARRACO (KN2)

AGR 7.10334.02.0 New	AGR 7.10334.08.0 New	AGR-K 7.10993.00.0 New
KODIAQ (NS7, NV7) OCTAVIA III (5E3, NL3, NR3) OCTAVIA III Combi (5E5, 5E6) SCALA (NW1) SUPERB III (3V3) SUPERB III Estate (3V5) VOLKSWAGEN ARTEON (3H7, 3H8) GOLF ALLTRACK VII Variant (BA5, BV5) GOLF SPORTSVAN VII (AM1, AN1) GOLF VAN VII Variant (BA5) GOLF VII (5G1, BQ1, BE1, BE2) GOLF VII Van (5G1) GOLF VII Variant (BA5, BV5) PASSAT ALLTRACK B8 Variant (3G5, CB5) PASSAT B8 (3G2, CB2) PASSAT B8 Variant (3G5, CB5) POLO VI (AW1, BZ1) SHARAN (7N1, 7N2) T-CROSS (C11) T-ROC (A11) TIGUAN (5N_) TIGUAN (AD1, AX1) TIGUAN ALLSPACE (BW2) TOURAN (5T1)	ASTRA Mk V (H) Sport Hatch (A04) ASTRA Mk VI (J) (P10) ASTRA Mk VI (J) Estate (P10) ASTRA Mk VI (J) GTC (P10) ASTRA Mk VI (J) Saloon (P10) CORSA Mk III (D) (S07) MERIVA Mk II (B) (S10) ZAFIRA Mk II (B) (A05)	BMW 5 (F10) 5 Gran Turismo (F07) 5 Touring (F11) 7 (F01, F02, F03, F04) X3 (F25) X4 (F26) X5 (F15, F85) X6 (F16, F86)
	AGR 7.10334.09.0 New	AGR-K 7.11010.00.0 New
	AUDI A3 (8P1) A3 Sportback (8PA) SEAT ALTEA (5P1) ALTEA XL (5P5, 5P8) LEON (1P1) TOLEDO III (5P2) SKODA OCTAVIA II (1Z3) OCTAVIA II Combi (1Z5) VOLKSWAGEN EOS (1F7, 1F8) GOLF PLUS V (5M1, 521) GOLF V (1K1) JETTA III (1K2) PASSAT B6 (3C2) PASSAT B6 Variant (3C5) TOURAN (1T1, 1T2)	BMW 1 (F20) 1 (F21) 2 Convertible (F23) 2 Coupe (F22, F87) 3 (F30, F80) 3 Gran Turismo (F34) 3 Touring (F31) 4 Convertible (F33, F83) 4 Coupe (F32, F82) 4 Gran Coupe (F36) 5 (F10) 5 (G30, F90) 5 Touring (F11) 5 Touring (G31) X3 (G01, F97) X4 (G02, F98)
	AGR 7.10334.04.0 New	ATS 7.11020.00.0 New
AUDI A3 (8P1) A3 Sportback (8PA) SKODA OCTAVIA II (1Z3) OCTAVIA II Combi (1Z5) VOLKSWAGEN EOS (1F7, 1F8) GOLF PLUS V (5M1, 521) GOLF V (1K1) JETTA III (1K2) PASSAT B6 (3C2) PASSAT B6 Variant (3C5) POLO (9N_) TOURAN (1T1, 1T2)		MERCEDES-BENZ C-CLASS (W204) C-CLASS Coupe (C204) C-CLASS T-Model (S204) CLS (C218) E-CLASS (W212) E-CLASS T-Model (S212)
	AGR 7.10334.10.0 New	ATS 7.11020.01.0 New
	AUDI A4 B7 (8EC) A4 B7 Avant (8ED) A6 C6 (4F2) A6 C6 Avant (4F5)	MERCEDES-BENZ A-CLASS (W176) B-CLASS Sports Tourer (W246, W242) C-CLASS (W204) C-CLASS T-Model (S204) CLA Coupe (C117) CLA Shooting Brake (X117) CLS (C218) CLS Shooting Brake (X218) E-CLASS (W212) E-CLASS (W213) E-CLASS All-Terrain (S213) E-CLASS Convertible (A207) E-CLASS Convertible (A238) E-CLASS Coupe (C207) E-CLASS Coupe (C238) E-CLASS T-Model (S212) E-CLASS T-Model (S213) GL-CLASS (X166) GLA-CLASS (X156) GLC (X253) GLC Coupe (C253) GLE (W166) GLE Coupe (C292)
	AGR-K 7.10992.00.0 New	
	BMW 1 (F20) 1 (F21) 2 Coupe (F22, F87) 3 (F30, F80) 3 Gran Turismo (F34) 3 Touring (F31) 4 Convertible (F33, F83) 4 Coupe (F32, F82) 4 Gran Coupe (F36) 5 (F10) 5 Gran Turismo (F07) 5 Touring (F11) 6 Convertible (F12) 6 Coupe (F13) 6 Gran Coupe (F06) 7 (F01, F02, F03, F04) X1 (E84) X3 (F25) X4 (F26) X5 (E70) X5 (F15, F85) X6 (F16, F86)	
	AGR 7.10334.08.0 New	
OPEL ASTRA H (A04) ASTRA H CLASSIC Estate (A04) ASTRA H CLASSIC Hatchback (A04) ASTRA H CLASSIC Saloon (A04) ASTRA H Estate (A04) ASTRA H GTC (A04) ASTRA H Saloon (A04) ASTRA J (P10) ASTRA J GTC ASTRA J Saloon ASTRA J Sports Tourer (P10) CORSA D (S07) MERIVA A MPV (X03) MERIVA B MPV (S10) ZAFIRA / ZAFIRA FAMILY B (A05) VAUXHALL ASTRA Mk V (H) (A04) ASTRA Mk V (H) Estate (A04)		

ADDITIONS TO THE RANGE

ADDITIONS TO THE RANGE

ATS 7.11020.01.0 New	ATS 7.11020.07.0 New	ATS 7.11020.13.0 New
GLK-CLASS (X204) GLS (X166) M-CLASS (W166) R-CLASS (W251, V251) S-CLASS (W221) S-CLASS (W222, V222, X222) SPRINTER CLASSIC 3,5-t Van (B909) SPRINTER CLASSIC 4,6-t Bus (B909)	SEAT CORDOBA (6L2) IBIZA III (6L1) IBIZA IV (6J5, 6P1) IBIZA IV SC (6J1, 6P5) SKODA FABIA II (542) FABIA II Combi (545) ROOMSTER (5J7) ROOMSTER Praktik (5J) VOLKSWAGEN POLO (9N_)	XC60 I SUV (156) XC70 II (136)
ATS 7.11020.02.0 New	ATS 7.11020.08.0 New	ATS 7.11020.14.0 New
SEAT CORDOBA (6L2) IBIZA III (6L1) IBIZA IV (6J5, 6P1) IBIZA IV SC (6J1, 6P5) SKODA FABIA II (542) FABIA II Combi (545) ROOMSTER (5J7) ROOMSTER Praktik (5J) VOLKSWAGEN POLO (9N_)	ALFA ROMEO MITO (955_) FIAT GRANDE PUNTO (199_) GRANDE PUNTO Van (199_)	VOLVO C30 (533) C70 II Convertible (542) S40 II (544) S60 II (134) S80 II (124) V50 (545) V60 I (155, 157) V70 III (135) XC60 I SUV (156) XC70 II (136)
ATS 7.11020.03.0 New	ATS 7.11020.09.0 New	ATS 7.11020.15.0 New
SEAT CORDOBA (6L2) IBIZA III (6L1) IBIZA IV (6J5, 6P1) IBIZA IV SC (6J1, 6P5) SKODA FABIA II (542) FABIA II Combi (545) ROOMSTER (5J7) ROOMSTER Praktik (5J) VOLKSWAGEN POLO (9N_) ENGINE	ALFA ROMEO 159 (939_) 159 Sportwagon (939_) BRERA (939_) SPIDER (939_) FIAT DOBLO Box Body/MPV (223_) DOBLO MPV (119_, 223_) FREEMONT (345_) JEEP CHEROKEE (KL)	FIAT DUCATO Bus (250_) DUCATO Platform/Chassis (250_) DUCATO Van (250_)
ATS 7.11020.04.0 New	ATS 7.11020.10.0 New	ATS 7.11020.16.0 New
ALFA ROMEO MITO (955_) FIAT GRANDE PUNTO (199_) GRANDE PUNTO Van (199_) PUNTO (199_) PUNTO EVO (199_) PUNTO EVO Hatchback Van (199_) PUNTO Hatchback Van (199_)	ALFA ROMEO GIULIETTA (940_) FIAT BRAVO II (198_) LANCIA DELTA III (844_)	MERCEDES-BENZ C-CLASS (W204) C-CLASS T-Model (S204) GLK-CLASS (X204) SPRINTER 3,5-t Bus (B906) SPRINTER 3,5-t Platform/Chassis (B906) SPRINTER 3,5-t Platform/Chassis (B907, B910) SPRINTER 3,5-t Tourer Bus (B907) SPRINTER 3,5-t Van (B906) SPRINTER 3,5-t Van (B907, B910) SPRINTER 3-t Bus (B906) SPRINTER 3-t Platform/Chassis (B906) SPRINTER 3-t Platform/Chassis (B910, B907) SPRINTER 3-t Tourer Bus (B907) SPRINTER 3-t Van (B906) SPRINTER 4,6-t Platform/Chassis (B906) SPRINTER 4,6-t Van (B906) SPRINTER 4-t Platform/Chassis (B907, B910) SPRINTER 4-t Van (B907, B910) SPRINTER 5-t Platform/Chassis (B906) SPRINTER 5-t Platform/Chassis (B907) SPRINTER 5-t Tourer Bus (B907) SPRINTER 5-t Van (B906) SPRINTER 5-t Van (B907)
ATS 7.11020.05.0 New	ATS 7.11020.11.0 New	ATS 7.11020.17.0 New
MERCEDES-BENZ A-CLASS (W169) B-CLASS Sports Tourer (W245)	MERCEDES-BENZ C-CLASS (W204) C-CLASS T-Model (S204) GL-CLASS (X164) M-CLASS (W164) R-CLASS (W251, V251) S-CLASS (W221) SMART FORTWO Cabrio (451) FORTWO Coupe (451)	AUDI A3 (8V1, 8VK) A3 Convertible (8V7, 8VE) A3 Limousine (8VS, 8VM) A3 Sportback (8VA, 8VF) Q2 (GAB, GAG)
ATS 7.11020.06.0 New	ATS 7.11020.12.0 New	ATS 7.11020.13.0 New
VOLKSWAGEN MULTIVAN V (7HM, 7HN, 7HF, 7EF, 7EM, 7EN) TRANSPORTER V Bus (7HB, 7HJ, 7EB, 7EJ, 7EF, 7EG, 7HF, 7EC) TRANSPORTER V Platform/Chassis (7JD, 7JE, 7JL, 7JY, 7JZ, 7FD) TRANSPORTER V Van (7HA, 7HH, 7EA, 7EH)	MERCEDES-BENZ A-CLASS (W169) B-CLASS Sports Tourer (W245)	SEAT ARONA (KJ7) ATECA (KH7, KHP) IBIZA V (KJ1) LEON (5F1) LEON SC (5F5) LEON ST (5F8) LEON ST Estate Van (5F8)
	ATS 7.11020.13.0 New	
	VOLVO S80 II (124) V70 III (135)	

ATS 7.11020.17.0 New	ATS 7.11020.22.0 New	ATS 7.11020.24.0 New
SKODA KAMIQ (NW4) KAROQ (NU7) OCTAVIA III (5E3, NL3, NR3) OCTAVIA III Combi (5E5, 5E6) SCALA (NW1) SUPERB III (3V3) SUPERB III Estate (3V5) VOLKSWAGEN GOLF ALLTRACK VII Variant (BA5, BV5) GOLF SPORTSVAN VII (AM1, AN1) GOLF VAN VII Variant (BA5) GOLF VII (5G1, BQ1, BE1, BE2) GOLF VII Variant (BA5, BV5) PASSAT B8 (3G2, CB2) PASSAT B8 Variant (3G5, CB5) POLO VI (AW1, BZ1) T-CROSS (C11) T-ROC (A11)	AUDI A3 Limousine (8VS, 8VM) A3 Sportback (8VA, 8VF) Q2 (GAB, GAG) SEAT ARONA (KJ7) ATECA (KH7, KHP) IBIZA V (KJ1) LEON (5F1) LEON Hatchback Van (5F1) LEON SC (5F5) LEON ST (5F8) LEON ST Estate Van (5F8) SKODA KAROQ (NU7) OCTAVIA III (5E3, NL3, NR3) OCTAVIA III Combi (5E5, 5E6) SUPERB III (3V3) SUPERB III Estate (3V5) VOLKSWAGEN CRAFTER Bus (SYI, SYJ) CRAFTER Platform/Chassis (SZ_) CRAFTER Van (SY_, SX_) GOLF SPORTSVAN VII (AM1, AN1) GOLF VII (5G1, BQ1, BE1, BE2) GOLF VII Variant (BA5, BV5) PASSAT B8 (3G2, CB2) PASSAT B8 Variant (3G5, CB5) POLO VI (AW1, BZ1) T-CROSS (C11) T-ROC (A11)	AUDI A4 Allroad B9 (8WH, 8WJ) A4 B9 (8W2, 8WC) A4 B9 Avant (8W5, 8WD) A5 (F53, F5P) A5 Convertible (F57, F5E) A5 Sportback (F5A, F5F) A6 Allroad C7 (4GH, 4GJ) A6 C7 (4G2, 4GC) A6 C7 Avant (4G5, 4GD) A7 Sportback (4GA, 4GF) A7 Sportback (4KA) A8 D5 (4N2, 4N8) Q5 (FYB, FYG) Q7 (4MB, 4MG) Q8 (4MN) VOLKSWAGEN TOUAREG (CR7)
ATS 7.11020.18.0 New	ATS 7.11020.23.0 New	ATS 7.11020.25.0 New
AUDI A3 (8V1, 8VK) A3 Convertible (8V7, 8VE) A3 Limousine (8VS, 8VM) A3 Sportback (8VA, 8VF) SEAT LEON (5F1) LEON Hatchback Van (5F1) LEON SC (5F5) LEON ST (5F8) LEON ST Estate Van (5F8) SKODA KAROQ (NU7) OCTAVIA III (5E3, NL3, NR3) OCTAVIA III Combi (5E5, 5E6) VOLKSWAGEN GOLF VAN VII Variant (BA5) GOLF VII (5G1, BQ1, BE1, BE2) GOLF VII Variant (BA5, BV5)	AUDI A3 Limousine (8VS, 8VM) A3 Sportback (8VA, 8VF) Q2 (GAB, GAG) SEAT ARONA (KJ7) ATECA (KH7, KHP) IBIZA V (KJ1) LEON (5F1) LEON Hatchback Van (5F1) LEON SC (5F5) LEON ST (5F8) LEON ST Estate Van (5F8) SKODA KAMIQ (NW4) KAROQ (NU7) OCTAVIA III (5E3, NL3, NR3) OCTAVIA III Combi (5E5, 5E6) SCALA (NW1) SUPERB III (3V3) SUPERB III Estate (3V5) VOLKSWAGEN GOLF SPORTSVAN VII (AM1, AN1) GOLF VII (5G1, BQ1, BE1, BE2) GOLF VII Variant (BA5, BV5) PASSAT B8 (3G2, CB2) PASSAT B8 Variant (3G5, CB5) POLO VI (AW1, BZ1) T-CROSS (C11) T-ROC (A11)	AUDI A4 Allroad B8 (8KH) A4 B8 (8K2) A4 B8 Avant (8K5) A5 (8T3) A5 Convertible (8F7) A5 Sportback (8TA) A6 C7 (4G2, 4GC) A6 C7 Avant (4G5, 4GD) A8 D4 (4H2, 4H8, 4HC, 4HL) Q5 (8RB) Q7 (4LB) PORSCHE MACAN (95B)
ATS 7.11020.19.0 New	ATS 7.11020.20.0 New	ATS 7.11020.26.0 New
VOLKSWAGEN AMAROK (2HA, 2HB, S1B, S6B, S7A, S7B) AMAROK Platform/Chassis (S1B, S6B, S7B)	VOLKSWAGEN AMAROK (2HA, 2HB, S1B, S6B, S7A, S7B) AMAROK Platform/Chassis (S1B, S6B, S7B)	AUDI Q2 (GAB, GAG) Q3 (F3B) Q3 Sportback (F3N) SEAT ATECA (KH7, KHP) TARRACO (KN2) SKODA KODIAQ (NS7, NV7) SUPERB III (3V3) SUPERB III Estate (3V5) VOLKSWAGEN ARTEON (3H7, 3H8) PASSAT ALLTRACK B8 Variant (3G5, CB5) PASSAT B8 (3G2, CB2) PASSAT B8 Variant (3G5, CB5) T-ROC (A11) TIGUAN (AD1, AX1) TIGUAN ALLSPACE (BW2) TOURAN (5T1)
ATS 7.11020.21.0 New	ATS 7.11020.27.0 New	
AUDI A4 Allroad B8 (8KH) A4 B8 (8K2) A4 B8 Avant (8K5) A5 (8T3) A5 Convertible (8F7) A5 Sportback (8TA) A6 C7 (4G2, 4GC) A6 C7 Avant (4G5, 4GD) Q5 (8RB)	CHEVROLET TRAX	

ATS 7.11020.27.0 New	ATS 7.11020.30.0 New	ATS 7.11020.37.0 New
OPEL ASTRA J (P10) ASTRA J Estate Van (P10) ASTRA J Hatchback Van (P10) ASTRA J Sports Tourer (P10) ASTRA K (B16) ASTRA K Sports Tourer (B16) INSIGNIA A (G09) INSIGNIA A Country Tourer (G09) INSIGNIA A Saloon (G09) INSIGNIA A Sports Tourer (G09) MERIVA B MPV (S10) MOKKA / MOKKA X (J13) ZAFIRA TOURER C (P12) VAUXHALL ASTRA Mk VI (J) (P10) ASTRA Mk VI (J) Estate (P10) ASTRA Mk VI (J) GTC (P10) ASTRA Mk VII (K) (B16) ASTRA Mk VII (K) Estate (B16) INSIGNIA Mk I (A) Country Tourer (G09) INSIGNIA Mk I (A) Hatchback (G09) INSIGNIA Mk I (A) Saloon (G09) INSIGNIA Mk I (A) Sports Tourer (G09) MERIVA Mk II (B) (S10) MOKKA / MOKKA X (J13) ZAFIRA Mk III (P12)	GLE (W166) GLE Coupe (C292) GLS (X166) M-CLASS (W166) ATS 7.11020.31.0 New AUDI A4 B9 (8W2, 8WC) A4 B9 Avant (8W5, 8WD) A5 (F53, F5P) A5 Convertible (F57, F5E) A5 Sportback (F5A, F5F) A6 C8 (4A2) A6 C8 Avant (4A5) Q5 (FYB, FYG) ATS 7.11020.32.0 New MERCEDES-BENZ A-CLASS (W176) B-CLASS Sports Tourer (W246, W242) CLA Coupe (C117) CLA Shooting Brake (X117) GLA-CLASS (X156) ATS 7.11020.33.0 New MERCEDES-BENZ C-CLASS (W205) C-CLASS Coupe (C205) C-CLASS T-Model (S205) GLC (X253) GLC Coupe (C253) ATS 7.11020.35.0 New MERCEDES-BENZ E-CLASS (W211) E-CLASS Platform/Chassis (VF211) E-CLASS T-Model (S211) SPRINTER 3,5-t Platform/Chassis (B906) SPRINTER 3,5-t Platform/Chassis (B907, B910) SPRINTER 3,5-t Tourer Bus (B907) SPRINTER 3,5-t Van (B906) SPRINTER 3,5-t Van (B907, B910) SPRINTER 3-t Platform/Chassis (B906) SPRINTER 3-t Van (B906) SPRINTER 4,6-t Platform/Chassis (B906) SPRINTER 4,6-t Van (B906) SPRINTER 4-t Platform/Chassis (B907, B910) SPRINTER 4-t Van (B907, B910) SPRINTER 5-t Platform/Chassis (B906) SPRINTER 5-t Platform/Chassis (B907) SPRINTER 5-t Van (B906) SPRINTER 5-t Van (B907)	FIAT 500 (312_) 500 C (312_) 500L (351_, 352_) PANDA (169_) PANDA (312_, 319_) PANDA Hatchback Van (169_) PANDA VAN (312_, 519_) LANCIA YPSILON (312_) ATS 7.11020.38.0 New CHEVROLET CRUZE (J300) CRUZE Hatchback (J305) CRUZE Station Wagon (J308) TRAX OPEL ASTRA J (P10) ASTRA J Estate Van (P10) ASTRA J Hatchback Van (P10) ASTRA J Sports Tourer (P10) MOKKA / MOKKA X (J13) VAUXHALL ASTRA Mk VI (J) (P10) ASTRA Mk VI (J) Estate (P10) ASTRA Mk VI (J) GTC (P10) ASTRA Mk VI (J) Saloon (P10) MOKKA / MOKKA X (J13) ATS 7.11020.40.0 New MERCEDES-BENZ G-CLASS (W461) SPRINTER 3,5-t Bus (B906) SPRINTER 3,5-t Platform/Chassis (B906) SPRINTER 3,5-t Platform/Chassis (B907, B910) SPRINTER 3,5-t Tourer Bus (B907) SPRINTER 3,5-t Van (B906) SPRINTER 3,5-t Van (B907, B910) SPRINTER 3-t Platform/Chassis (B906) SPRINTER 3-t Van (B906) SPRINTER 4,6-t Platform/Chassis (B906) SPRINTER 4,6-t Van (B906) SPRINTER 4-t Platform/Chassis (B907, B910) SPRINTER 4-t Van (B907, B910) SPRINTER 5-t Platform/Chassis (B906) SPRINTER 5-t Platform/Chassis (B907) SPRINTER 5-t Van (B906) SPRINTER 5-t Van (B907) VIANO (W639) VITO / MIXTO Van (W639) VITO Bus (W639)
ATS 7.11020.28.0 New MERCEDES-BENZ G-CLASS (W463) G-CLASS Cabrio (W463) GL-CLASS (X164) M-CLASS (W164) SPRINTER 3,5-t Bus (B906) SPRINTER 3,5-t Platform/Chassis (B906) SPRINTER 3,5-t Platform/Chassis (B907, B910) SPRINTER 3,5-t Tourer Bus (B907) SPRINTER 3,5-t Van (B906) SPRINTER 3,5-t Van (B907, B910) SPRINTER 3-t Platform/Chassis (B906) SPRINTER 3-t Van (B906) SPRINTER 4,6-t Platform/Chassis (B906) SPRINTER 4,6-t Van (B906) SPRINTER 4-t Platform/Chassis (B907, B910) SPRINTER 4-t Van (B907, B910) SPRINTER 5-t Platform/Chassis (B906) SPRINTER 5-t Platform/Chassis (B907) SPRINTER 5-t Van (B906) SPRINTER 5-t Van (B907)	ATS 7.11020.29.0 New MERCEDES-BENZ GL-CLASS (X166) GLE (W166) GLE Coupe (C292) GLS (X166) M-CLASS (W166) ATS 7.11020.30.0 New MERCEDES-BENZ GL-CLASS (X164) GL-CLASS (X166)	ATS 7.11020.41.0 New FIAT DOBLO Bus (263_) DOBLO Cargo (263_) DOBLO Platform/Chassis (263_) OPEL COMBO Box Body/MPV (X12) COMBO Tour (X12) VAUXHALL COMBO Mk III (D) Box Body/MPV (X12)
ATS 7.11020.29.0 New MERCEDES-BENZ GL-CLASS (X166) GLE (W166) GLE Coupe (C292) GLS (X166) M-CLASS (W166)	ATS 7.11020.36.0 New FIAT FIORINO Box Body/MPV (225_) QUBO (225_)	

ATS 7.11020.42.0 New	ATS 7.11020.48.0 New	DDS 7.11190.01.0 New
CHEVROLET TRAX OPEL ASTRA J (P10) ASTRA J Estate Van (P10) ASTRA J Hatchback Van (P10) ASTRA J Sports Tourer (P10) ASTRA K (B16) ASTRA K Sports Tourer (B16) INSIGNIA B Sports Tourer Combi Van (Z18) MERIVA B MPV (S10) MOKKA / MOKKA X (J13) ZAFIRA TOURER C (P12) VAUXHALL ASTRA Mk VI (J) (P10) ASTRA Mk VI (J) Estate (P10) ASTRA Mk VI (J) GTC (P10) ASTRA Mk VII (K) (B16) ASTRA Mk VII (K) Estate (B16) INSIGNIA Mk II (B) Hatchback (Z18) INSIGNIA Mk II (B) Sports Tourer (Z18) MERIVA Mk II (B) (S10) MOKKA / MOKKA X (J13) ZAFIRA Mk III (P12)	ALFA ROMEO GIULIETTA (940_) JEEP RENEGADE SUV (BU, B1) <hr/> ATS 7.11020.49.0 New CHEVROLET CAPTIVA (C100, C140) CRUZE (J300) CRUZE Hatchback (J305) CRUZE Station Wagon (J308) ORLANDO (J309) OPEL ANTARA A (L07) VAUXHALL ANTARA A (L07) <hr/> DDS 7.11190.00.0 New AUDI A4 B7 (8EC) A4 B7 Avant (8ED) A4 B7 Convertible (8HE) A6 Allroad C6 (4FH) A6 C6 (4F2) A6 C6 Avant (4F5) A8 D3 (4E2, 4E8) Q7 (4LB) SKODA SUPERB I (3U4) VOLKSWAGEN PASSAT B5.5 (3B3) PASSAT B5.5 Variant (3B6) PHAETON (3D1, 3D2, 3D3, 3D4, 3D6, 3D7, 3D8, 3D9) TOUAREG (7LA, 7L6, 7L7) <hr/> DDS 7.11190.01.0 New CHRYSLER 300C (LX, LE) 300C Touring (LX, LE) GRAND VOYAGER V (RT) DODGE CALIBER NITRO JEEP CHEROKEE (KK) COMMANDER (XK, XH) COMPASS (MK49) GRAND CHEROKEE III (WH, WK) GRAND CHEROKEE IV (WK, WK2) PATRIOT (MK74) WRANGLER III (JK) WRANGLER IV (JL) MERCEDES-BENZ A-CLASS (W169) C-CLASS (W203) C-CLASS (W204) C-CLASS Coupe (CL203) C-CLASS T-Model (S203) C-CLASS T-Model (S204) CLC-CLASS (CL203) CLK (C209) CLK Convertible (A209)	CLS (C219) E-CLASS (W211) E-CLASS Convertible (A207) E-CLASS Platform/Chassis (VF211) E-CLASS T-Model (S211) G-CLASS (W461) G-CLASS (W463) G-CLASS Cabrio (W463) GL-CLASS (X164) M-CLASS (W164) R-CLASS (W251, V251) S-CLASS (W221) SPRINTER 3,5-t Bus (B906) SPRINTER 3,5-t Platform/Chassis (B906) SPRINTER 3,5-t Van (B906) SPRINTER 3-t Platform/Chassis (B906) SPRINTER 3-t Van (B906) SPRINTER 4,6-t Platform/Chassis (B906) SPRINTER 4,6-t Van (B906) SPRINTER 5-t Platform/Chassis (B906) SPRINTER 5-t Van (B906) VIANO (W639) VITO / MIXTO Van (W639) VITO Bus (W639) <hr/> DDS 7.11190.02.0 New AUDI A4 Allroad B8 (8KH) A4 B8 (8K2) A4 B8 Avant (8K5) A5 (8T3) A5 Convertible (8F7) A5 Sportback (8TA) A6 Allroad C6 (4FH) A6 Allroad C7 (4GH, 4GJ) A6 C6 (4F2) A6 C6 Avant (4F5) A6 C7 (4G2, 4GC) A6 C7 Avant (4G5, 4GD) A7 Sportback (4GA, 4GF) A8 D4 (4H2, 4H8, 4HC, 4HL) Q5 (8RB) Q7 (4LB) PORSCHE CAYENNE (92A) MACAN (95B) PANAMERA (970) SEAT ALHAMBRA (7V8, 7V9) ALTEA (5P1) ALTEA XL (5P5, 5P8) EXEO (3R2) EXEO ST (3R5) LEON (1P1) TOLEDO III (5P2) SKODA FABIA II (542) FABIA II Combi (545) OCTAVIA II (1Z3) OCTAVIA II Combi (1Z5) VOLKSWAGEN EOS (1F7, 1F8) GOLF PLUS V (5M1, 521)
ATS 7.11020.43.0 New VOLVO S60 II (134) S80 II (124) S90 II (234) V40 Hatchback (525, 526) V60 I (155, 157) V60 II (225, 227) V70 III (135) V90 II Estate (235, 236) XC40 (536) XC60 I SUV (156) XC60 II (246) XC70 II (136) XC90 II (256)	<hr/> DDS 7.11190.01.0 New CHRYSLER 300C (LX, LE) 300C Touring (LX, LE) GRAND VOYAGER V (RT) DODGE CALIBER NITRO JEEP CHEROKEE (KK) COMMANDER (XK, XH) COMPASS (MK49) GRAND CHEROKEE III (WH, WK) GRAND CHEROKEE IV (WK, WK2) PATRIOT (MK74) WRANGLER III (JK) WRANGLER IV (JL) MERCEDES-BENZ A-CLASS (W169) C-CLASS (W203) C-CLASS (W204) C-CLASS Coupe (CL203) C-CLASS T-Model (S203) C-CLASS T-Model (S204) CLC-CLASS (CL203) CLK (C209) CLK Convertible (A209)	<hr/> DDS 7.11190.01.0 New CHRYSLER 300C (LX, LE) 300C Touring (LX, LE) GRAND VOYAGER V (RT) DODGE CALIBER NITRO JEEP CHEROKEE (KK) COMMANDER (XK, XH) COMPASS (MK49) GRAND CHEROKEE III (WH, WK) GRAND CHEROKEE IV (WK, WK2) PATRIOT (MK74) WRANGLER III (JK) WRANGLER IV (JL) MERCEDES-BENZ A-CLASS (W169) C-CLASS (W203) C-CLASS (W204) C-CLASS Coupe (CL203) C-CLASS T-Model (S203) C-CLASS T-Model (S204) CLC-CLASS (CL203) CLK (C209) CLK Convertible (A209)
ATS 7.11020.44.0 New VOLVO S60 II (134) S80 II (124) V60 I (155, 157) V70 III (135) XC60 I SUV (156) XC70 II (136)	<hr/> DDS 7.11190.01.0 New CHRYSLER 300C (LX, LE) 300C Touring (LX, LE) GRAND VOYAGER V (RT) DODGE CALIBER NITRO JEEP CHEROKEE (KK) COMMANDER (XK, XH) COMPASS (MK49) GRAND CHEROKEE III (WH, WK) GRAND CHEROKEE IV (WK, WK2) PATRIOT (MK74) WRANGLER III (JK) WRANGLER IV (JL) MERCEDES-BENZ A-CLASS (W169) C-CLASS (W203) C-CLASS (W204) C-CLASS Coupe (CL203) C-CLASS T-Model (S203) C-CLASS T-Model (S204) CLC-CLASS (CL203) CLK (C209) CLK Convertible (A209)	<hr/> DDS 7.11190.01.0 New CHRYSLER 300C (LX, LE) 300C Touring (LX, LE) GRAND VOYAGER V (RT) DODGE CALIBER NITRO JEEP CHEROKEE (KK) COMMANDER (XK, XH) COMPASS (MK49) GRAND CHEROKEE III (WH, WK) GRAND CHEROKEE IV (WK, WK2) PATRIOT (MK74) WRANGLER III (JK) WRANGLER IV (JL) MERCEDES-BENZ A-CLASS (W169) C-CLASS (W203) C-CLASS (W204) C-CLASS Coupe (CL203) C-CLASS T-Model (S203) C-CLASS T-Model (S204) CLC-CLASS (CL203) CLK (C209) CLK Convertible (A209)
ATS 7.11020.45.0 New VOLVO C30 (533) C70 II Convertible (542) S40 II (544) S60 II (134) S80 II (124) V40 Hatchback (525, 526) V50 (545) V60 I (155, 157) V70 III (135) XC60 I SUV (156) XC70 II (136)	<hr/> DDS 7.11190.01.0 New CHRYSLER 300C (LX, LE) 300C Touring (LX, LE) GRAND VOYAGER V (RT) DODGE CALIBER NITRO JEEP CHEROKEE (KK) COMMANDER (XK, XH) COMPASS (MK49) GRAND CHEROKEE III (WH, WK) GRAND CHEROKEE IV (WK, WK2) PATRIOT (MK74) WRANGLER III (JK) WRANGLER IV (JL) MERCEDES-BENZ A-CLASS (W169) C-CLASS (W203) C-CLASS (W204) C-CLASS Coupe (CL203) C-CLASS T-Model (S203) C-CLASS T-Model (S204) CLC-CLASS (CL203) CLK (C209) CLK Convertible (A209)	<hr/> DDS 7.11190.01.0 New CHRYSLER 300C (LX, LE) 300C Touring (LX, LE) GRAND VOYAGER V (RT) DODGE CALIBER NITRO JEEP CHEROKEE (KK) COMMANDER (XK, XH) COMPASS (MK49) GRAND CHEROKEE III (WH, WK) GRAND CHEROKEE IV (WK, WK2) PATRIOT (MK74) WRANGLER III (JK) WRANGLER IV (JL) MERCEDES-BENZ A-CLASS (W169) C-CLASS (W203) C-CLASS (W204) C-CLASS Coupe (CL203) C-CLASS T-Model (S203) C-CLASS T-Model (S204) CLC-CLASS (CL203) CLK (C209) CLK Convertible (A209)

ADDITIONS TO THE RANGE

ADDITIONS TO THE RANGE

DDS	7.11190.02.0 New	DDS	7.11190.03.0 New	DDS	7.11190.03.0 New	
GOLF V (1K1) GOLF V Variant (1K5) JETTA III (1K2) PHAETON (3D1, 3D2, 3D3, 3D4, 3D6, 3D7, 3D8, 3D9) SHARAN (7M8, 7M9, 7M6) TOUAREG (7LA, 7L6, 7L7) TOUAREG (7P5, 7P6) TRANSPORTER V Bus (7HB, 7HJ, 7EB, 7EJ, 7EF, 7EG, 7HF, 7EC) TRANSPORTER V Platform/Chassis (7JD, 7JE, 7JL, 7JY, 7JZ, 7FD) TRANSPORTER V Van (7HA, 7HH, 7EA, 7EH)		IVECO DAILY CITYS Bus DAILY IV Dump Truck DAILY IV Platform/Chassis DAILY IV Van DAILY LINE Bus DAILY TOURYS Bus DAILY V Platform/Chassis DAILY V Van DAILY VI Platform/Chassis DAILY VI Van		ASTRA Mk V (H) Sport Hatch (A04) ASTRA Mk V (H) TwinTop (A04) ASTRAVAN Mk V (H) Estate Van (A04) COMBO Mk III (D) Box Body/MPV (X12) SIGNUM (Z03) VECTRA Mk II (C) (Z02) VECTRA Mk II (C) Estate (Z02) VECTRA Mk II (C) GTS (Z02) ZAFIRA Mk II (B) (A05)		
	DDS	7.11190.03.0 New		DDS	7.11190.04.0 New	
ALFA ROMEO 147 (937_) 159 Sportwagon (939_) BRERA (939_) GIULIA (952_) GIULIETTA (940_) MITO (955_) SPIDER (939_)		JEEP CHEROKEE (KL) COMPASS (MP, M6) RENEGADE SUV (BU, B1)	LANCIA DELTA III (844_) MUSA (350_) YPSILON (312_) YPSILON (843_)	ALFA ROMEO 147 (937_) 159 (939_) 159 Sportwagon (939_) BRERA (939_) GT (937_) MITO (955_) SPIDER (939_)		
CADILLAC BLS BLS Wagon		MASERATI GHIBLI III (M157) LEVANTE SUV (M161) QUATTROPORTE VI	OPEL ASTRA H (A04) ASTRA H Estate (A04) ASTRA H Estate Van (L70) ASTRA H GTC (A04) COMBO Box Body/MPV (X12) COMBO Tour (X12) SIGNUM Hatchback (Z03) VECTRA C (Z02) VECTRA C Estate (Z02) VECTRA C GTS (Z02) ZAFIRA / ZAFIRA FAMILY B (A05) ZAFIRA B Box Body/MPV (A05)	CADILLAC BLS BLS Wagon	CHEVROLET AVEO Hatchback (T300) AVEO Saloon (T300) CRUZE Hatchback (J305) CRUZE Station Wagon (J308) MALIBU (V300) TRAX	
CITROEN JUMPER Bus JUMPER Platform/Chassis JUMPER Van NEMO Box Body/MPV (AA_) NEMO MPV		RAM PROMASTER 1500 Van (VF1) PROMASTER 2500 Cab & Chassis PROMASTER 2500 Standard Cargo Van (VF2) PROMASTER 3500 Cab & Chassis (VF3) PROMASTER 3500 Cutaway Van (VF3) PROMASTER 3500 Extended Cargo Van		CHRYSLER 300C	DODGE CHARGER	
FIAT 500 (312_) 500 C (312_) 500L (351_, 352_) 500X (334_) BRAVO II (198_) BRAVO Van (198_) CROMA (194_) CROMA Estate Van (194_) DOBLO Bus (263_) DOBLO Cargo (263_) DOBLO Platform/Chassis (263_) DUCATO Bus (250_) DUCATO Platform/Chassis (250_) DUCATO Van (250_) FIORINO Box Body/MPV (225_) GRANDE PUNTO (199_) GRANDE PUNTO Van (199_) IDEA (350_) LINEA (323_, 110_) PANDA (312_, 319_) PUNTO (199_) PUNTO EVO (199_) PUNTO Hatchback Van (199_) STRADA Pickup (178_) TIPO Estate (356_) TIPO Hatchback (356_) TIPO Saloon (356_)		SAAB 9-3 (YS3F, E79, D79, D75) 9-3 Convertible (YS3F) 9-3 Estate (E50)		FIAT 500 (312_) 500 C (312_) BRAVO II (198_) CROMA (194_) CROMA Estate Van (194_) DOBLO Box Body/MPV (223_) DOBLO MPV (119_, 223_) FIORINO Box Body/MPV (225_) GRANDE PUNTO (199_) GRANDE PUNTO Van (199_) IDEA (350_) MULTIPLA (186_) PANDA (169_) PANDA Hatchback Van (169_) QUBO (225_) SEDICI (189_) STILO (192_) STILO VAN (192_)	FORD KA (RU8)	JEEP GRAND CHEROKEE IV (WK, WK2)
FORD KA (RU8)		SUZUKI SWIFT IV (FZ, NZ) SX4 (EY, GY) SX4 S-CROSS (JY) VITARA (LY)	VAUXHALL ASTRA Mk V (H) (A04) ASTRA Mk V (H) Estate (A04)		LANCIA MUSA (350_) THESIS (841_) YPSILON (843_)	
				OPEL AGILA (B) (H08) ASTRA H (A04)		

DDS 7.11190.04.0 New	DDS 7.11190.08.0 New	DDS 7.11190.08.0 New
<p>ASTRA H CLASSIC Estate (A04) ASTRA H CLASSIC Hatchback (A04) ASTRA H CLASSIC Saloon (A04) ASTRA H Estate (A04) ASTRA H Estate Van (L70) ASTRA H GTC (A04) ASTRA H Saloon (A04) ASTRA H TwinTop (A04) ASTRA J (P10) ASTRA J Estate Van (P10) ASTRA J GTC ASTRA J Hatchback Van (P10) ASTRA J Saloon ASTRA J Sports Tourer (P10) CASCADA (W13) CORSA D (S07) CORSA D Hatchback Van (S07) MERIVA A MPV (X03) MERIVA B MPV (S10) MOKKA / MOKKA X (J13) SIGNUM Hatchback (Z03) VECTRA C (Z02) VECTRA C Estate (Z02) VECTRA C GTS (Z02) ZAFIRA / ZAFIRA FAMILY B (A05) ZAFIRA B Box Body/MPV (A05) ZAFIRA TOURER C (P12)</p> <p>SUZUKI SPLASH (EX) SWIFT III (MZ, EZ) SX4 (EY, GY)</p> <p>VAUXHALL AGILA Mk II (B) (H08) ASTRA Mk V (H) (A04) ASTRA Mk V (H) Estate (A04) ASTRA Mk V (H) Sport Hatch (A04) ASTRA Mk VI (J) (P10) ASTRA Mk VI (J) Estate (P10) ASTRA Mk VI (J) GTC (P10) ASTRA Mk VI (J) Saloon (P10) CASCADA Convertible (W13) CORSA Mk III (D) (S07) INSIGNIA Mk I (A) Country Tourer (G09) INSIGNIA Mk I (A) Hatchback (G09) INSIGNIA Mk I (A) Saloon (G09) INSIGNIA Mk I (A) Sports Tourer (G09) MERIVA A (X03) MERIVA Mk II (B) (S10) MOKKA / MOKKA X (J13) SIGNUM (Z03) VECTRA Mk II (C) (Z02) VECTRA Mk II (C) Estate (Z02) VECTRA Mk II (C) GTS (Z02) ZAFIRA Mk II (B) (A05) ZAFIRA Mk III (P12)</p>	<p>B-CLASS Sports Tourer (W246, W242) CITAN Box Body/MPV (W415) CITAN MPV (415) CITAN Mixto (Double Cabin) (W415) CLA Coupe (C117) CLA Shooting Brake (X117) GLA-CLASS (X156)</p> <p>NISSAN INTERSTAR Bus (X70) INTERSTAR Platform/Chassis INTERSTAR Van (X70) JUKE (F15) NP300 NAVARA Pickup (D23) NV200 / EVALIA Bus NV200 Van NV400 Bus (X62, X62B) NV400 Platform/Chassis (X62, X62B) NV400 Van (X62, X62B) PULSAR Hatchback (C13) QASHQAI / QASHQAI +2 I (J10, NJ10, JJ10E) X-TRAIL (T31) X-TRAIL (T32_)</p> <p>OPEL ADAM (M13) ASTRA K (B16) ASTRA K Sports Tourer (B16) CORSA E (X15) MOVANO B Bus (X62) MOVANO B Platform/Chassis (X62) MOVANO B Van (X62) VIVARO B Bus (X82) VIVARO B Platform/Chassis (X82) VIVARO B Van (X82)</p> <p>RENAULT CAPTUR I (J5_, H5_) CLIO IV (BH_) CLIO IV Grandtour (KH_) FLUENCE (L3_) GRAND SCÉNIC III (JZ0/1_) KADJAR (HA_, HL_) KOLEOS I (HY_) MEGANE III Coupe (DZ0/1_) MEGANE III Grandtour (KZ0/1) MEGANE III Hatchback (BZ0/1_, B3_) SCÉNIC III (JZ0/1_) TRAFIC III Bus (JG_) TRAFIC III Van (FG_)</p> <p>SUZUKI GRAND VITARA II (JT, TE, TD) SWIFT V (AZ) SX4 S-CROSS (JY) VITARA (LY)</p> <p>VAUXHALL ADAM (M13) ASTRA Mk VII (K) (B16) ASTRA Mk VII (K) Estate (B16) CORSA Mk IV (E) (X15) MOVANO Mk II (B) Chassis/Cab (X62) MOVANO Mk II (B) Combi (X62) MOVANO Mk II (B) VAN (X62) VIVARO B Bus (X82) VIVARO B Platform/Chassis (X82) VIVARO B Van (X82)</p>	<p>VOLVO C30 (533) C70 II Convertible (542) S40 II (544) S60 II (134) S80 II (124) S90 II (234) V40 Hatchback (525, 526) V50 (545) V60 I (155, 157) V60 II (225, 227) V70 III (135) V90 II Estate (235, 236) XC40 (536) XC60 I SUV (156) XC60 II (246) XC70 II (136) XC90 II (256)</p>
		<p>DDS 7.11190.09.0 New</p> <p>AUDI A1 (8X1, 8XK) A1 Sportback (8XA, 8XF) A3 (8P1) A3 Convertible (8P7) A3 Sportback (8PA) A4 Allroad B8 (8KH) A4 B8 (8K2) A4 B8 Avant (8K5) A5 (8T3) A5 Convertible (8F7) A5 Sportback (8TA) A6 C7 (4G2, 4GC) A6 C7 Avant (4G5, 4GD) Q5 (8RB) TT (8J3) TT Roadster (8J9)</p> <p>SEAT ALTEA (5P1) ALTEA XL (5P5, 5P8) EXEO (3R2) EXEO ST (3R5) IBIZA IV (6J5, 6P1) IBIZA IV Hatchback Van (6J1) IBIZA IV SC (6J1, 6P5) IBIZA IV ST (6J8, 6P8) LEON (1P1) TOLEDO IV (KG3)</p> <p>SKODA FABIA II (542) FABIA II Combi (545) OCTAVIA II (1Z3) OCTAVIA II Combi (1Z5) RAPID (NH3) RAPID Spaceback (NH1) ROOMSTER (5J7) ROOMSTER Praktik (5J) SUPERB II (3T4) SUPERB II Estate (3T5)</p> <p>VOLKSWAGEN BEETLE (5C1, 5C2) BEETLE Convertible (5C7, 5C8) CADDY III Box Body/MPV (2KA, 2KH, 2CA, 2CH)</p>
<p>DDS 7.11190.08.0 New</p> <p>FORD TOURNEO CONNECT / GRAND TOURNEO CONNECT V408 MPV TRANSIT CONNECT MPV</p> <p>MERCEDES-BENZ A-CLASS (W176)</p>		

ADDITIONS TO THE RANGE

ADDITIONS TO THE RANGE

DDS 7.11190.09.0 New	DDS 7.11190.12.0 New	AGR 7.11237.04.0 New
CADDY III MPV (2KB, 2KJ, 2CB, 2CJ) EOS (1F7, 1F8) GOLF PLUS V (5M1, 521) GOLF PLUS Van (521) GOLF VAN VI Variant (AJ5) GOLF VI (5K1) GOLF VI Convertible (517) GOLF VI Van (5K1_) GOLF VI Variant (AJ5) POLO V (6R1, 6C1) POLO V Saloon (602, 604, 612, 614) POLO Van (6R) SCIROCCO III (137, 138) TOURAN (1T1, 1T2) TOURAN (1T3)	3 Gran Turismo (F34) 3 Touring (E91) 3 Touring (F31) 4 Convertible (F33, F83) 4 Coupe (F32, F82) 4 Gran Coupe (F36) 5 (F10) 5 Gran Turismo (F07) 5 Touring (F11) 6 Convertible (F12) 6 Coupe (F13) 6 Gran Coupe (F06) 7 (F01, F02, F03, F04) X3 (F25) X4 (F26) X5 (E70) X5 (F15, F85) X6 (E71, E72) X6 (F16, F86)	CITROEN JUMPER Bus (244, Z_) JUMPER Platform/Chassis (244) JUMPER Van (230L) JUMPER Van (244) FIAT DUCATO Bus (230_) DUCATO Bus (244_) DUCATO Platform/Chassis (230_) DUCATO Platform/Chassis (244_) DUCATO Van (244_) PEUGEOT BOXER Bus (244, Z_) BOXER Platform/Chassis (244) BOXER Van (244)
DDS 7.11190.10.0 New		AGR-K 7.11237.05.0 New
FORD C-MAX (DM2) FOCUS C-MAX (DM2) FOCUS II (DA_, HCP, DP) FOCUS II Convertible FOCUS II Estate Van FOCUS II Saloon (DB_, FCH, DH) FOCUS II Turnier (DA_, FFS, DS) GALAXY II (WA6) KUGA I MONDEO III (B5Y) MONDEO III Saloon (B4Y) MONDEO III Turnier (BWY) MONDEO IV (BA7) MONDEO IV Saloon (BA7) MONDEO IV Turnier (BA7) S-MAX (WA6) FORD AUSTRALIA MONDEO Hatchback (MA, MB, MC) JAGUAR S-TYPE II (X200) XJ (X350, X358) LAND ROVER FREELANDER 2 (L359) MAZDA 3 (BL) 3 Saloon (BL) 5 (CW) VOLVO C30 (533) C70 II Convertible (542) S40 I (644) S40 II (544) S60 I (384) S80 II (124) V50 (545) V70 II (285) V70 III (135) XC90 I (275)	MINI (BMW) MINI COUNTRYMAN (R60) MINI PACEMAN (R61) TOYOTA AURIS (_E18_) AURIS Estate (_E18_) AVENSIS Estate (_T27_) AVENSIS Saloon (_T27_) RAV 4 IV (_A4_) VERSO (_R2_)	RENAULT GRAND SCÉNIC III (JZ0/1_) MEGANE CC (EZ0/1_) MEGANE III Coupe (DZ0/1_) MEGANE III Grandtour (KZ0/1) MEGANE III Hatchback (BZ0/1_, B3_) SCÉNIC III (JZ0/1_)
	AGR 7.11237.00.0 New	AGR-K 7.11237.06.0 New
	LAND ROVER RANGE ROVER III (L322) RANGE ROVER SPORT I (L320)	VOLKSWAGEN AMAROK (2HA, 2HB, S1B, S6B, S7A, S7B) AMAROK Platform/Chassis (S1B, S6B, S7B)
	AGR 7.11237.01.0 New	AGR 7.11237.07.0 New
	CITROEN C5 III (RD_) C5 III Break (RW_) C6 (TD_) JAGUAR S-TYPE II (X200) XF I (X250) XJ (X350, X358) LAND ROVER DISCOVERY III (L319) RANGE ROVER SPORT I (L320) PEUGEOT 407 (6D_) 407 Coupe (6C_) 407 SW (6E_) 607 (9D, 9U)	HYUNDAI ACCENT IV (RB) ACCENT IV Saloon (RB) i20 I (PB, PBT) i30 (GD) i30 Coupe i30 Estate (GD) ix20 (JC) KIA CEE'D (JD) CEE'D Hatchback (ED) CEE'D SW (ED) CEE'D Sportswagon (JD) PRO CEE'D (ED) PRO CEE'D (JD) SOUL I (AM) VENGA (YN)
	AGR-K 7.11237.02.0 New	AGR 7.11237.08.0 New
	SUZUKI GRAND VITARA II (JT, TE, TD)	KIA SORENTO I (JC)
DDS 7.11190.12.0 New	AGR 7.11237.03.0 New	DDS 7.11492.00.0 New
BMW 1 (F20) 2 Coupe (F22, F87) 3 (E90) 3 (F30, F80)	LAND ROVER DISCOVERY III (L319) DISCOVERY IV (L319) RANGE ROVER SPORT I (L320)	AUDI A3 (8P1) A3 Convertible (8P7) A3 Sportback (8PA) Q3 (8UB, 8UG) SEAT ALHAMBRA (710, 711) ALTEA (5P1) ALTEA XL (5P5, 5P8)

DDS	7.11492.00.0 New	DDS	7.11492.01.0 New	DDS	7.11492.01.0 New
LEON (1P1)		CITROEN		VIVARO C Van (K0)	
SKODA		BERLINGO / BERLINGO FIRST Box Body/MPV (M_)		PEUGEOT	
FABIA II (542)		BERLINGO / BERLINGO FIRST MPV (MF_, GJK_, GFK_)		1007 (KM_)	
FABIA II Combi (545)		BERLINGO Box Body/MPV (B9)		2008 I (CU_)	
OCTAVIA II (1Z3)		BERLINGO MULTISPACE (B9)		206 CC (2D)	
OCTAVIA II Combi (1Z5)		BERLINGO Platform/Chassis (B9)		206 Hatchback (2A/C)	
ROOMSTER (5J7)		C-CROSSER (VU_, VV_)		206 SW (2E/K)	
ROOMSTER Praktik (5J)		C-ELYSEE (DD_)		206+ (2L_, 2M_)	
SUPERB II (3T4)		C2 (JM_)		207 (WA_, WC_)	
SUPERB II Estate (3T5)		C3 AIRCROSS II (2R_, 2C_)		207 CC (WD_)	
YETI (5L)		C3 II (SC_)		207 Hatchback Van (WA_, WC_)	
VOLKSWAGEN		C3 II Hatchback Van (SC_)		207 SW (WK_)	
AMAROK (2HA, 2HB, S1B, S6B, S7A, S7B)		C3 PICASSO (SH_)		207 SW Estate Van (WK_)	
AMAROK Platform/Chassis (S1B, S6B, S7B)		C4 AIRCROSS		208 Hatchback Van (CR_)	
BEETLE (5C1, 5C2)		C4 CACTUS		208 I (CA_, CC_)	
BEETLE Convertible (5C7, 5C8)		C4 Coupe (LA_)		3008 MPV (0U_)	
CADDY ALLTRACK Box Body/MPV (SAA)		C4 I (LC_)		3008 SUV (MC_, MR_, MJ_, M4_)	
CADDY ALLTRACK MPV (SAB)		C4 I Hatchback Van (LR_)		301	
CADDY III Box Body/MPV (2KA, 2KH, 2CA, 2CH)		C4 I Saloon		307 (3A/C)	
CADDY III MPV (2KB, 2KJ, 2CB, 2CJ)		C4 II (B7)		307 Break (3E)	
CADDY IV Box Body/MPV (SAA, SAH)		C4 PICASSO I MPV (UD_)		307 CC (3B)	
CADDY IV MPV (SAB, SAJ)		C4 PICASSO II		307 SW (3H)	
CC B7 (358)		C4 SPACETOURER (3D_)		307 SW Estate Van (3E_, 3H_)	
CRAFTER 30-35 Bus (2E_)		C5 II (RC_)		308 CC (4B_)	
CRAFTER 30-50 Platform/Chassis (2F_)		C5 II Break (RE_)		308 Hatchback Van (LB_)	
CRAFTER 30-50 Van (2E_)		C5 III (RD_)		308 I (4A_, 4C_)	
GOLF PLUS V (5M1, 521)		C5 III Break (RW_)		308 II (LB_, LP_, LW_, LH_, L3_)	
GOLF PLUS Van (521)		C6 (TD_)		308 SW I (4E_, 4H_)	
GOLF VAN VI Variant (AJ5)		C8 (EA_, EB_)		308 SW I Estate Van (4E_)	
GOLF VI (5K1)		DS3		308 SW II (LC_, LJ_, LR_, LX_, L4_)	
GOLF VI Convertible (517)		DS3 Convertible		4007 (VU_, VV_)	
GOLF VI Van (5K1_)		DS4 (NX_)		4008	
GOLF VI Variant (AJ5)		DS5		407 (6D_)	
JETTA III (1K2)		JUMPER Bus		407 Coupe (6C_)	
JETTA IV (162, 163, AV3, AV2)		JUMPER Platform/Chassis		407 SW (6E_)	
MULTIVAN V (7HM, 7HN, 7HF, 7EF, 7EM, 7EN)		JUMPER Van		407 SW Estate Van (6E_)	
MULTIVAN VI (SGF, SGM, SGN, SHM, SHN)		JUMPY (VF7)		5008 (0U_, 0E_)	
PASSAT ALLTRACK B7 (365)		JUMPY Bus (V_)		5008 II (MC_, MJ_, MR_, M4_)	
PASSAT B6 (3C2)		JUMPY Platform/Chassis		508 I (8D_)	
PASSAT B6 Variant (3C5)		JUMPY Platform/Chassis (V_)		508 SW I (8E_)	
PASSAT B7 (362)		JUMPY Van		607 (9D, 9U)	
PASSAT B7 (A32, A33)		JUMPY Van (V_)		807 (EB_)	
PASSAT B7 Estate Van (365)		SPACETOURER Bus (V_)		BOXER Bus	
PASSAT B7 Variant (365)		XSARA PICASSO (N68)		BOXER Platform/Chassis	
PASSAT CC B6 (357)		DS		BOXER Van	
SCIROCCO III (137, 138)		DS 3 (SA_)		EXPERT Bus (V_)	
SCIROCCO Van (137)		DS 4 / DS 4 CROSSBACK (NX_)		EXPERT Platform/Chassis	
SHARAN (7N1, 7N2)		DS 5 (KF_)		EXPERT Platform/Chassis (V_)	
TIGUAN (5N_)		FIAT		EXPERT TEPEE (VF3X_)	
TOURAN (1T3)		SCUDO Bus (270_, 272_)		EXPERT Van (VF3A_, VF3U_, VF3X_)	
TRANSPORTER / CARAVELLE VI Bus (SGB, SGG, SGJ, SGC, SHB, SHJ)		ULYSSE (179_)		EXPERT Van (V_)	
TRANSPORTER V Bus (7HB, 7HJ, 7EB, 7EJ, 7EF, 7EG, 7HF, 7EC)		LANCIA		PARTNER Box Body/MPV	
TRANSPORTER V Platform/Chassis (7JD, 7JE, 7JL, 7JY, 7JZ, 7FD)		PHEdra (179_)		PARTNER Box Body/MPV (5_, G_)	
TRANSPORTER V Van (7HA, 7HH, 7EA, 7EH)		MINI (BMW)		PARTNER Platform/Chassis	
TRANSPORTER VI Platform/Chassis (SFD, SFE, SFL, SFZ, SJD, SJ)		MINI (R56)		PARTNER TEPEE	
TRANSPORTER VI Van (SGA, SGH, SHA, SHH)		MINI CLUBMAN (R55)		RCZ	
ENGINE		OPEL		RIFTER	
		COMBO E Tour / Life (X19)		TRAVELLER Bus (V_)	
		CROSSLAND X / CROSSLAND (P17, P2QO)		VAUXHALL	
		VIVARO C Bus (K0)		CROSSLAND X (P17)	
		VIVARO C Platform Cabin (K0)			

DDS 7.11492.02.0 New	DDS 7.11492.03.0 New	DDS 7.11492.03.0 New
<p>AUDI A3 (8P1) A3 Convertible (8P7) A3 Sportback (8PA) A4 B7 (8EC) A4 B7 Avant (8ED) A4 B7 Convertible (8HE) A6 C6 (4F2) A6 C6 Avant (4F5) TT (8J3) TT Roadster (8J9)</p> <p>SEAT ALHAMBRA (7V8, 7V9) ALTEA (5P1) ALTEA XL (5P5, 5P8) CORDOBA (6L2) IBIZA III (6L1) IBIZA IV (6J5, 6P1) IBIZA IV SC (6J1, 6P5) LEON (1P1) TOLEDO III (5P2)</p> <p>SKODA FABIA II (542) FABIA II Combi (545) OCTAVIA II (1Z3) OCTAVIA II Combi (1Z5) ROOMSTER (5J7) ROOMSTER Praktik (5J) SUPERB II (3T4) SUPERB II Estate (3T5) YETI (5L)</p> <p>VOLKSWAGEN CADDY III Box Body/MPV (2KA, 2KH, 2CA, 2CH) CADDY III MPV (2KB, 2KJ, 2CB, 2CJ) CRAFTER 30-35 Bus (2E_) CRAFTER 30-50 Platform/Chassis (2F_) CRAFTER 30-50 Van (2E_) EOS (1F7, 1F8) GOLF PLUS V (5M1, 521) GOLF V (1K1) GOLF V Variant (1K5) GOLF VAN VI Variant (AJ5) GOLF VI (5K1) GOLF VI Variant (AJ5) JETTA III (1K2) MULTIVAN V (7HM, 7HN, 7HF, 7EF, 7EM, 7EN) PASSAT B6 (3C2) PASSAT B6 Variant (3C5) PASSAT CC B6 (357) PHAETON (3D1, 3D2, 3D3, 3D4, 3D6, 3D7, 3D8, 3D9) POLO (9N_) SCIROCCO III (137, 138) SCIROCCO Van (137) SHARAN (7M8, 7M9, 7M6) TIGUAN (5N_) TOUAREG (7LA, 7L6, 7L7) TOURAN (1T1, 1T2) TRANSPORTER V Bus (7HB, 7HJ, 7EB, 7EJ, 7EF, 7EG, 7HF, 7EC) TRANSPORTER V Platform/Chassis (7JD, 7JE, 7JL, 7JY, 7JZ, 7FD) TRANSPORTER V Van (7HA, 7HH, 7EA, 7EH) ENGINE</p>	<p>AUDI A3 (8V1, 8VK) A3 Convertible (8V7, 8VE) A3 Limousine (8VS, 8VM) A3 Sportback (8VA, 8VF) A4 Allroad B8 (8KH) A4 Allroad B9 (8WH, 8WJ) A4 B8 (8K2) A4 B8 Avant (8K5) A4 B9 (8W2, 8WC) A4 B9 Avant (8W5, 8WD) A5 (8T3) A5 (F53, F5P) A5 Convertible (8F7) A5 Convertible (F57, F5E) A5 Sportback (8TA) A5 Sportback (F5A, F5F) A6 C7 (4G2, 4GC) A6 C7 Avant (4G5, 4GD) A6 C8 (4A2) A6 C8 Avant (4A5) Q3 (8UB, 8UG) Q3 (F3B) Q3 Sportback (F3N) Q5 (8RB) Q5 (FYB, FYG) TT (FV3, FVP) TT Roadster (FV9, FVR)</p> <p>PORSCHE CAYENNE (92A)</p> <p>SEAT ALHAMBRA (710, 711) LEON (5F1) LEON Hatchback Van (5F1) LEON SC (5F5) LEON ST (5F8) LEON ST Estate Van (5F8)</p> <p>SKODA KODIAQ (NS7, NV7) OCTAVIA III (5E3, NL3, NR3) OCTAVIA III Combi (5E5, 5E6) SUPERB III (3V3) SUPERB III Estate (3V5) YETI (5L)</p> <p>VOLKSWAGEN ARTEON (3H7, 3H8) BEETLE (5C1, 5C2) BEETLE Convertible (5C7, 5C8) CADDY ALLTRACK Box Body/MPV (SAA) CADDY ALLTRACK MPV (SAB) CADDY IV Box Body/MPV (SAA, SAH) CADDY IV MPV (SAB, SAJ) CC B7 (358) CRAFTER 30-35 Bus (2E_) CRAFTER 30-50 Platform/Chassis (2F_) CRAFTER 30-50 Van (2E_) GOLF ALLTRACK VII Variant (BA5, BV5) GOLF SPORTSVAN VII (AM1, AN1) GOLF VAN VII Variant (BA5) GOLF VI Convertible (517) GOLF VII (5G1, BQ1, BE1, BE2) GOLF VII Van (5G1) GOLF VII Variant (BA5, BV5)</p>	<p>JETTA IV (162, 163, AV3, AV2) PASSAT B7 (A32, A33) PASSAT B8 (3G2, CB2) PASSAT B8 Variant (3G5, CB5) SCIROCCO III (137, 138) SHARAN (7N1, 7N2) TIGUAN (5N_) TIGUAN (AD1, AX1) TIGUAN ALLSPACE (BW2) TOUAREG (7P5, 7P6) TOURAN (5T1) XL1 (6Z!) ENGINE</p>
		<p>DDS 7.11492.05.0 New</p> <p>AUDI A3 (8V1, 8VK) A3 Convertible (8V7, 8VE) A3 Limousine (8VS, 8VM) A3 Limousine (8YS) A3 Sportback (8VA, 8VF) A3 Sportback (8YA) A4 B9 (8W2, 8WC) A4 B9 Avant (8W5, 8WD) A5 (F53, F5P) A5 Convertible (F57, F5E) A5 Sportback (F5A, F5F) A6 C8 (4A2) A6 C8 Avant (4A5) A7 Sportback (4KA) Q2 (GAB, GAG)</p> <p>MAN TGE Bus TGE Platform/Chassis (UZ_) TGE Van</p> <p>SEAT ARONA (KJ7) ATECA (KH7, KHP) IBIZA V (KJ1) LEON (5F1) LEON (KL1) LEON Hatchback Van (5F1) LEON SC (5F5) LEON ST (5F8) LEON ST Estate Van (5F8)</p> <p>SKODA KAMIQ (NW4) KAROQ (NU7) KODIAQ (NS7, NV7) OCTAVIA III (5E3, NL3, NR3) OCTAVIA III Combi (5E5, 5E6) OCTAVIA IV (NX3) OCTAVIA IV Combi (NX5) SCALA (NW1) SUPERB III (3V3) SUPERB III Estate (3V5)</p> <p>VOLKSWAGEN ARTEON (3H7, 3H8) CRAFTER Bus (SY1, SYJ) CRAFTER Platform/Chassis (SZ_) CRAFTER Van (SY_, SX_) GOLF ALLTRACK VII Variant (BA5, BV5) GOLF SPORTSVAN VII (AM1, AN1)</p>

DDS 7.11492.05.0 New	DDS 7.11492.07.0 New	AGR 7.24809.82.0 New
<p>GOLF VII (5G1, BQ1, BE1, BE2) GOLF VII Variant (BA5, BV5) GOLF VIII (CD1) MULTIVAN VI (SGF, SGM, SGN, SHM, SHN) PASSAT ALLTRACK B8 Variant (3G5, CB5) PASSAT B8 (3G2, CB2) PASSAT B8 Variant (3G5, CB5) POLO VI (AW1, BZ1) T-CROSS (C11) T-ROC (A11) TIGUAN (AD1, AX1) TRANSPORTER / CARAVELLE VI Bus (SGB, SGG, SGJ, SGC, SHB, SHJ) TRANSPORTER VI Platform/Chassis (SFD, SFE, SFL, SFZ, SJD, SJ) TRANSPORTER VI Van (SGA, SGH, SHA, SHH)</p>	<p>NV300 Van (X82) NV400 Bus (X62, X62B) NV400 Platform/Chassis (X62, X62B) NV400 Van (X62, X62B) PULSAR Hatchback (C13) QASHQAI II SUV (J11, J11_) QASHQAI II VAN (J11_) TERRA (JD23TT, JD23F) X-TRAIL (T32_) X-TRAIL VAN (T32) OPEL MOVANO B Bus (X62) MOVANO B Platform/Chassis (X62) MOVANO B Van (X62) VIVARO B Bus (X82) VIVARO B Platform/Chassis (X82) VIVARO B Van (X82) RENAULT ALASKAN CAPTUR I (J5_, H5_) CAPTUR II CLIO IV (BH_) CLIO IV Grandtour (KH_) CLIO IV Hatchback Van (BH_) CLIO V (B7_) DUSTER (HM_) ESPACE V (JR_) FLUENCE (L3_) GRAND SCÉNIC III (JZ0/1_) GRAND SCÉNIC IV (R9_) KADJAR (HA_, HL_) KANGOO / GRAND KANGOO (KW0/1_) KANGOO Express (FW0/1_) KOLEOS II (HC_) MASTER III Bus (JV) MASTER III Platform/Chassis (EV, HV, UV) MASTER III Van (FV) MEGANE III Grandtour (KZ0/1) MEGANE IV GRAND COUPE MEGANE IV Grandtour (K9A/M/N_) MEGANE IV Hatchback (B9A/M/N_) SCÉNIC III (JZ0/1_) SCÉNIC IV (J9_) TALISMAN (LP_) TALISMAN Grandtour (KP_) TRAFIC III Bus (JG_) TRAFIC III Platform/Chassis (EG_) TRAFIC III Van (FG_) SAMSUNG QM6 VAUXHALL MOVANO Mk II (B) Chassis/Cab (X62) MOVANO Mk II (B) Combi (X62) MOVANO Mk II (B) VAN (X62) VIVARO B Bus (X82) VIVARO B Van (X82)</p>	<p>C-CLASS Coupe (C205) C-CLASS T-Model (S205) CLA Coupe (C117) CLA Shooting Brake (X117) GLA-CLASS (X156) GLC (X253) GLC Coupe (C253)</p>
<p>DDS 7.11492.07.0 New</p> <p>DACIA DOKKER Express Box Body/MPV DOKKER MPV (KE_) DUSTER (HM_) DUSTER (HS_) DUSTER SUV Van LODGY (JS_) LOGAN II LOGAN MCV II SANDERO II FIAT TALENTO Bus (296_) TALENTO Platform/Chassis (296_) TALENTO Van (296_) INFINITI Q30 MERCEDES-BENZ A-CLASS (W177) A-CLASS Saloon (V177) B-CLASS Sports Tourer (W247) C-CLASS (W205) C-CLASS T-Model (S205) CITAN Box Body/MPV (W415) CITAN MPV (415) CITAN Mixto (Double Cabin) (W415) CLA (C118) CLA Shooting Brake (X118) MARCO POLO Camper (W447) VITO Mixto (Double Cabin) (W447) VITO Tourer (W447) VITO Van (W447) X-CLASS (470) X-CLASS Platform/Chassis (470) NISSAN JUKE (F15) MICRA V (K14) NAVARA Platform/Chassis (D23) NOTE (E12) NP300 NAVARA Pickup (D23) NV200 / EVALIA Bus NV200 Van NV250 Bus (X61) NV250 Van (X61) NV300 Kombi (X82) NV300 Platform/Chassis (X82)</p>	<p>AGR 7.24809.82.0 New</p> <p>MERCEDES-BENZ C-CLASS (W205) C-CLASS Convertible (A205) C-CLASS Coupe (C205) C-CLASS T-Model (S204) C-CLASS T-Model (S205) E-CLASS (W212) E-CLASS (W213) E-CLASS Convertible (A207) E-CLASS Convertible (A238) E-CLASS Coupe (C207) E-CLASS Coupe (C238) E-CLASS T-Model (S212) E-CLASS T-Model (S213)</p>	<p>AGR 7.24809.83.0 New</p> <p>MERCEDES-BENZ C-CLASS (W205) C-CLASS Convertible (A205) C-CLASS Coupe (C205) C-CLASS T-Model (S204) C-CLASS T-Model (S205) E-CLASS (W212) E-CLASS (W213) E-CLASS Convertible (A207) E-CLASS Convertible (A238) E-CLASS Coupe (C207) E-CLASS Coupe (C238) E-CLASS T-Model (S212) E-CLASS T-Model (S213)</p>
		<p>AGR 7.24809.84.0 New</p> <p>MERCEDES-BENZ A-CLASS (W176) B-CLASS Sports Tourer (W246, W242) CLA Coupe (C117) CLA Shooting Brake (X117) GLA-CLASS (X156)</p>
		<p>AGR 7.24809.85.0 New</p> <p>MERCEDES-BENZ C-CLASS (W205) C-CLASS Convertible (A205) C-CLASS Coupe (C205) C-CLASS T-Model (S204) C-CLASS T-Model (S205) CLS (C218) E-CLASS (W212) E-CLASS (W213) E-CLASS Convertible (A207) E-CLASS Convertible (A238) E-CLASS Coupe (C207) E-CLASS Coupe (C238) E-CLASS T-Model (S212) E-CLASS T-Model (S213) GLC (X253) GLC Coupe (C253) GLK-CLASS (X204) SLC (R172) SLK (R172) V-CLASS (W447) VITO Tourer (W447)</p>
	<p>AGR 7.24809.82.0 New</p> <p>MERCEDES-BENZ A-CLASS (W176) B-CLASS Sports Tourer (W246, W242) C-CLASS (W205) C-CLASS Convertible (A205)</p>	<p>AGR 7.24809.86.0 New</p> <p>FIAT DUCATO Bus (250_) DUCATO Platform/Chassis (250_) DUCATO Van (250_)</p>

ADDITIONS TO THE RANGE

ADDITIONS TO THE RANGE

<p style="text-align: center;">AGR 7.24809.87.0 New</p>	<p style="text-align: center;">AGR 7.24809.90.0 New</p>	<p style="text-align: center;">AGR-K 7.24809.94.0 New</p>
<p>OPEL ANTARA A (L07) CASCADA (W13) INSIGNIA A (G09) INSIGNIA A Country Tourer (G09) INSIGNIA A Saloon (G09) INSIGNIA A Sports Tourer (G09) INSIGNIA B Country Tourer (Z18) INSIGNIA B Grand Sport (Z18) INSIGNIA B Sports Tourer (Z18) ZAFIRA TOURER C (P12) VAUXHALL CASCADA Convertible (W13) INSIGNIA Mk I (A) Country Tourer (G09) INSIGNIA Mk I (A) Hatchback (G09) INSIGNIA Mk I (A) Saloon (G09) INSIGNIA Mk I (A) Sports Tourer (G09) INSIGNIA Mk II (B) Country Tourer (Z18) INSIGNIA Mk II (B) Hatchback (Z18) INSIGNIA Mk II (B) Sports Tourer (Z18) ZAFIRA Mk III (P12)</p>	<p>KOLEOS II (HC_) MEGANE CC (EZ0/1_) MEGANE III Coupe (DZ0/1_) MEGANE III Grandtour (KZ0/1) MEGANE III Hatchback (BZ0/1_, B3_) MEGANE IV Grandtour (K9A/M/N_) MEGANE IV Hatchback (B9A/M/N_) SCÉNIC III (JZ0/1_) TALISMAN (LP_) TALISMAN Grandtour (KP_) TRAFIC III Bus (JG_) TRAFIC III Platform/Chassis (EG_) TRAFIC III Van (FG_) VAUXHALL VIVARO B Bus (X82) VIVARO B Platform/Chassis (X82) VIVARO B Van (X82)</p>	<p>S-MAX (WA6) PEUGEOT 3008 MPV (0U_) 308 CC (4B_) 308 I (4A_, 4C_) 308 SW I (4E_, 4H_) 407 (6D_) 407 Coupe (6C_) 407 SW (6E_) 5008 (0U_, 0E_) 508 I (8D_) 508 SW I (8E_) 807 (EB_) EXPERT TEPEE (VF3X_) RCZ</p>
<p style="text-align: center;">AGR-K 7.24809.88.0 New</p>	<p style="text-align: center;">AGR 7.24809.91.0 New</p>	<p style="text-align: center;">AGR 7.24809.95.0 New</p>
<p>IVECO DAILY IV Bus DAILY IV Platform/Chassis DAILY IV Van</p>	<p>FORD FOCUS C-MAX (DM2) FOCUS II (DA_, HCP, DP) FOCUS II Saloon (DB_, FCH, DH) FOCUS II Turnier (DA_, FFS, DS)</p>	<p>LAND ROVER DISCOVERY III (L319) DISCOVERY IV (L319) RANGE ROVER SPORT I (L320)</p>
<p style="text-align: center;">AGR 7.24809.89.0 New</p>	<p style="text-align: center;">VOLVO</p>	<p style="text-align: center;">AGR 7.24809.96.0 New</p>
<p>FORD C-MAX (DM2) FOCUS C-MAX (DM2) FOCUS II (DA_, HCP, DP) FOCUS II Saloon (DB_, FCH, DH) FOCUS II Turnier (DA_, FFS, DS) GALAXY II (WA6) MONDEO IV (BA7) MONDEO IV Saloon (BA7) MONDEO IV Turnier (BA7) S-MAX (WA6) TOURNEO CONNECT TRANSIT CONNECT (P65_, P70_, P80_)</p>	<p>C30 (533) S40 II (544) S80 II (124) V50 (545) V70 III (135)</p>	<p>JAGUAR S-TYPE II (X200) XF I (X250) XJ (X350, X358) LAND ROVER DISCOVERY III (L319) RANGE ROVER SPORT I (L320) PEUGEOT 407 (6D_) 407 Coupe (6C_) 407 SW (6E_) 607 (9D, 9U)</p>
<p style="text-align: center;">AGR 7.24809.90.0 New</p>	<p style="text-align: center;">AGR 7.24809.92.0 New</p>	<p style="text-align: center;">AGR 7.24809.97.0 New</p>
<p>MERCEDES-BENZ C-CLASS (W205) C-CLASS T-Model (S205) VITO Mixto (Double Cabin) (W447) VITO Tourer (W447) VITO Van (W447) NISSAN NV300 Kombi (X82) NV300 Van (X82) QASHQAI / QASHQAI +2 I (J10, NJ10, JJ10E) QASHQAI II SUV (J11, J11_) X-TRAIL (T32_) OPEL VIVARO B Bus (X82) VIVARO B Van (X82) RENAULT ESPACE V (JR_) GRAND SCÉNIC III (JZ0/1_) KADJAR (HA_, HL_)</p>	<p>FORD FOCUS C-MAX (DM2)</p>	<p>LAND ROVER RANGE ROVER III (L322) RANGE ROVER SPORT I (L320)</p>
<p style="text-align: center;">AGR 7.24809.90.0 New</p>	<p style="text-align: center;">AGR-K 7.24809.94.0 New</p>	<p style="text-align: center;">AGR-K 7.24809.99.0 New</p>
<p>AGAR C4 II (B7) C4 PICASSO I MPV (UD_) C5 III (RD_) C5 III Break (RW_) C8 (EA_, EB_) DS4 (NX_) DS5 JUMPY (VF7) JUMPY Platform/Chassis JUMPY Van FIAT SCUDO Bus (270_, 272_) SCUDO Platform/Chassis (270_, 272_) SCUDO Van (270_, 272_) FORD C-MAX II (DXA/CB7, DXA/CEU) FOCUS III FOCUS III Saloon FOCUS III Turnier GALAXY II (WA6) GRAND C-MAX (DXA/CB7, DXA/CEU) KUGA I KUGA II (DM2) MONDEO IV (BA7) MONDEO IV Saloon (BA7) MONDEO IV Turnier (BA7)</p>	<p>CITROEN C4 II (B7) C4 PICASSO I MPV (UD_) C5 III (RD_) C5 III Break (RW_) C8 (EA_, EB_) DS4 (NX_) DS5 JUMPY (VF7) JUMPY Platform/Chassis JUMPY Van FIAT SCUDO Bus (270_, 272_) SCUDO Platform/Chassis (270_, 272_) SCUDO Van (270_, 272_) FORD C-MAX II (DXA/CB7, DXA/CEU) FOCUS III FOCUS III Saloon FOCUS III Turnier GALAXY II (WA6) GRAND C-MAX (DXA/CB7, DXA/CEU) KUGA I KUGA II (DM2) MONDEO IV (BA7) MONDEO IV Saloon (BA7) MONDEO IV Turnier (BA7)</p>	<p>LAND ROVER RANGE ROVER III (L322) RANGE ROVER SPORT I (L320) AGAR-K AMAROK (2HA, 2HB, S1B, S6B, S7A, S7B) AMAROK Platform/Chassis (S1B, S6B, S7B)</p>

D

HERSTELLERVERZEICHNIS

E

LIST OF MANUFACTURERS

	Page		Page
A		F	
ABARTH	254	FAHR	660
AGRIA	1436 → DEUTZ	660
ALFA ROMEO	255 → FORD	722
ALPINA	277 → MERCEDES-BENZ	979
..... → BMW	442 → VOLKSWAGEN	1688
ATLAS	1365	FAUN	660
ATLAS COPCO	1365 → DEUTZ	660
AUDI	278 → FORD	722
AUDI FAW	432	FENDT	660
AUSTIN (BLMC)	1506 → DEUTZ	660
AUTOBIANCHI	436 → MAN	894
..... → LANCIA	868	FERRARI	666
B		FIAT	668
BENTLEY	437	FIATALLIS	979
BMW	442	FORD	722
BMW (BRILLIANCE)	568	FORD (CHANGAN)	788
BMW MOTORCYCLES	569	FORD ASIA / OZEANIA	786
BOBCAT	1365	FORD AUSTRALIA	787
..... → PERKINS	1365	FORD JMC	789
BOMAG	660	FORD USA	790
..... → DEUTZ	660	FORDSON	722
..... → PERKINS	1365 → FORD	722
BUICK	572 → PERKINS	1365
C		FREIGHTLINER	794
CADILLAC	573	FSO	795
CASE	979	FUSO	796
..... → MERCEDES-BENZ	979	G	
CATERPILLAR	574	GM HOLDEN LTD	798
CHEVROLET	578	GMC	797
CHEVROLET (SGM)	588	H	
CHRYSLER	589	HONDA	800
..... → JEEP	846	HYUNDAI	805
CITROEN	592	I	
CLAAS	645	IHC-CASE (CNH)	979
..... → DEUTZ	660 → MERCEDES-BENZ	979
..... → FORD	722 → PERKINS	1365
..... → MERCEDES-BENZ	979	INFINITI	821
..... → VOLKSWAGEN	1688 → NISSAN	1255
COMPAIR	1365	INGERSOLL-RAND	1365
..... → PERKINS	1365	INOKOM	822
CONTINENTAL	1254	IVECO	823
..... → NEW HOLLAND	1254 → FIAT	668
D		J	
DACIA	646	JAGUAR	841
..... → RENAULT	1436	JCB	1365
DAEWOO	653 → PERKINS	1365
DAIHATSU	658	JEEP	846
DETROIT DIESEL	979	JOHN DEERE	854
..... → MERCEDES-BENZ	979	K	
DEUTZ	660	KIA	856
DODGE	661	KOMATSU	979
DS	664 → MERCEDES-BENZ	979
		KÄSSBOHRER	894
	 → MAN	894
	 → MERCEDES-BENZ	979

D

PRODUKTPROGRAMM

E





PRODUCT RANGE

A



500 / 595 / 695

1

1.4 (312.AXD1A) 99-140 kW (135-190 PS) 312 A1.000	08.2008→		7.02604.55.0 LS 650 mm
			7.02604.53.0 LS 400 mm
1.4 (312.AXF11, 312.AXF1A) 103-132 kW (140-180 PS) 312 A3.000	08.2008→		7.02604.55.0 LS 650 mm
			7.02604.53.0 LS 400 mm
1.4 (312.AXF11, 312.AXF1A, 312.AXD1A) 99-140 kW (135-190 PS) 312 A1.000, 312 A3.000	08.2008→		7.02604.55.0 LS 650 mm
			7.02604.53.0 LS 400 mm
1.4 (312.AXT1A) 99-140 kW (135-190 PS) 312 A1.000, 312 A9.000	08.2008→		7.02604.55.0 LS 650 mm
			7.02604.53.0 LS 400 mm









GRANDE PUNTO

2



1.4 (199.AXN1B) 114-132 kW (155-180 PS) 199 A8.000	07.2007→06.2010		7.02604.55.0 LS 650 mm
			7.02604.53.0 LS 400 mm



145 (930_) 1

1.4 i.e. 16V T.S. (930.A3A) 76 kW (103 PS) AR 33503, AR 38501	12.1996→01.2001		7.02604.49.0	LS	985 mm
			7.02604.56.0	LS	1190 mm
1.6 16V T.S. (930.A2C) 82-88 kW (112-120 PS) AR 32102	09.1997→12.2000		7.02604.49.0	LS	985 mm
			7.02604.56.0	LS	1190 mm
1.6 i.e. (930.A2) 76 kW (103 PS) AR 33201	10.1994→12.1996		7.02604.04.0	LS	200 mm
1.6 i.e. 16V T.S. (930.A2) 88 kW (120 PS) AR 38201, AR 67601	12.1996→01.2001		7.02604.49.0	LS	985 mm
			7.02604.56.0	LS	1190 mm
1.8 i.e. 16V (930.A1A) 106 kW (144 PS) AR 32201	03.1998→01.2001		7.02604.56.0	LS	1190 mm
1.8 i.e. 16V T.S. (930.A1A) 103 kW (140 PS) AR 38401, AR 67106, AR 67199	12.1996→12.1998		7.02604.56.0	LS	1190 mm
2.0 16V (930.A5) 114 kW (155 PS) AR 32301	03.1998→01.2001		7.02604.04.0	LS	200 mm
			7.02604.56.0	LS	1190 mm
2.0 16V T.S. (930.A5) 110 kW (150 PS) AR 67204	10.1995→01.2001		7.02604.04.0	LS	200 mm
			7.02604.56.0	LS	1190 mm

146 (930_) 2

1.4 i.e. 16V T.S. (930.B3A) 76 kW (103 PS) AR 33503, AR 38501	11.1996→01.2001		7.02604.49.0	LS	985 mm
			7.02604.56.0	LS	1190 mm
1.6 16V T.S. (930.B2C) 82-88 kW (112-120 PS) AR 32102	09.1997→12.2000		7.02604.49.0	LS	985 mm
			7.02604.56.0	LS	1190 mm
1.6 i.e. 16V T.S. (930.B2B, 930.B2C) 88 kW (120 PS) AR 38201, AR 67601	11.1996→10.2001		7.02604.49.0	LS	985 mm
			7.02604.56.0	LS	1190 mm
1.8 i.e. 16V T.S. (930.B1A) 103 kW (140 PS) AR 38401, AR 67106	11.1996→01.2001		7.02604.56.0	LS	1190 mm
1.8 i.e. 16V T.S. (930.B1A) 106 kW (144 PS) AR 32201	03.1998→01.2001		7.02604.56.0	LS	1190 mm
2.0 16V (930.B5) 114 kW (155 PS) AR 32301	03.1998→10.2001		7.02604.04.0	LS	200 mm
			7.02604.56.0	LS	1190 mm

A



146 (930_)

2







2.0 16V T.S. (930.B5) 110 kW (150 PS) AR 67204	10.1995→01.2001		7.02604.04.0	LS	200 mm	
			7.02604.56.0	LS	1190 mm	

147 (937_)









3

1.6 16V T.SPARK (937.AXA1A, 937.AXB1A, 937.BXB1A) 88 kW (120 PS) AR 32104	01.2001→03.2010		7.02604.53.0	LS	400 mm	
1.6 16V T.SPARK ECO (937.AXA1A, 937.BXA1A) 77 kW (105 PS) AR 37203	01.2001→03.2010		7.02604.55.0	LS	650 mm	Diagnosesonde Diagnostic Probe
			7.02604.53.0	LS	400 mm	
1.9 JTD (937.AXD1A, 937.BXD1A) 81-88 kW (110-120 PS) 937 A2.000	04.2001→03.2010		7.22946.34.0	AGR	EL	
			7.11190.04.0	DDS		Euro 4 Euro 4
			7.05270.21.0	LS	600 mm	Motorcode: CF4 Engine Code: CF4 vor Katalysator in front of the catalyst
1.9 JTD (937.AXF1A, 937.BXF1A) 74-77 kW (101-105 PS) 182 B9.000	06.2003→03.2010		7.22946.34.0	AGR	EL	
			7.11190.04.0	DDS		Euro 4 Euro 4
1.9 JTD 16V (937.AXG1B, 937.BXG1B) 103 kW (140 PS) 192 A5.000	11.2002→03.2010		7.00063.10.0	AGR	EL	
			7.11190.04.0	DDS		Euro 4 Euro 4
1.9 JTD 16V (937.AXG1B, 937.BXG1B) 93-103 kW (126-140 PS) 937 A4.000	09.2003→09.2004		7.00063.10.0	AGR	EL	
1.9 JTD 16V (937.AXM1B, 937.AXS1B) 100 kW (136 PS) 192 B1.000	10.2004→03.2010		7.00063.10.0	AGR	EL	
			7.11190.04.0	DDS		Euro 4 Euro 4
			7.05270.21.0	LS	600 mm	vor Katalysator in front of the catalyst Euro 4 Euro 4
1.9 JTDM (937.AXD1A, 937.AXV1A, 937.BXB1A) 85 kW (115 PS) 939 A7.000	10.2004→03.2010		7.22946.34.0	AGR	EL	
			7.11190.04.0	DDS		Euro 4 Euro 4
			7.05270.21.0	LS	600 mm	Motorcode: CF4 Engine Code: CF4 vor Katalysator in front of the catalyst
1.9 JTDM 16V (937.AXN1B, 937.AXZ1B) 125 kW (170 PS) 937 A6.000	06.2008→03.2010		7.11190.04.0	DDS		Euro 4 Euro 4

147 (937_)
3

			7.05270.21.0	LS	600 mm	vor Katalysator in front of the catalyst Euro 4 Euro 4
1.9 JTDM 16V (937.AXN1B, 937.BXN1B) 110 kW (150 PS) 937 A5.000	09.2004→03.2010		7.00063.10.0	AGR	EL	
			7.11190.04.0	DDS		Euro 4 Euro 4
1.9 JTDM 8V (937.AXD1A, 937.AXU1A, 937.BXU1A) 88 kW (120 PS) 937 A3.000	07.2005→03.2010		7.22946.34.0	AGR	EL	
			7.11190.04.0	DDS		Euro 4 Euro 4
			7.05270.21.0	LS	600 mm	vor Katalysator in front of the catalyst Euro 4 Euro 4
2.0 (937.AXC, 937.BXC) 119-122 kW (162-166 PS) 937 A1.000	07.2002→05.2005		7.02604.53.0	LS	400 mm	
3.2 GTA (937.AXL1) 184 kW (250 PS) 932 A.000	02.2003→03.2010		7.02604.53.0	LS	400 mm	

155 (167_)
4

1.6 16V T.S. (167.A6A) 88 kW (120 PS) AR 67601	05.1996→12.1997		7.02604.54.0	LS	980 mm	
1.7 T.S. (167.A4D, 167.A4H) 83-85 kW (113-115 PS) AR 67105	04.1993→04.1996		7.02604.04.0	LS	200 mm	
1.7 T.S. (167.A4G) 83 kW (113 PS) AR 67103	04.1993→04.1996		7.02604.04.0	LS	200 mm	
1.7 T.S. 16V (167.A4N) 103 kW (140 PS) AR 67106	05.1996→12.1997		7.02604.54.0	LS	980 mm	
1.8 T.S. (167.A4A, 167.A4C, 167.A4E) 93-95 kW (126-129 PS) AR 67101	02.1992→05.1994		7.02604.04.0	LS	200 mm	
1.8 T.S. (167.A4C, 167.A) 77 kW (105 PS) AR 67402	02.1992→12.1997		7.02604.04.0	LS	200 mm	
1.8 T.S. Sport (167.A4A, 167.A4C, 167.A4E) 93-95 kW (126-129 PS) AR 67101, AR 67102	03.1992→12.1996		7.02604.04.0	LS	200 mm	
2.0 16V Turbo Q4 (167.A2B, 167.A2C, 167.A2E) 137-140 kW (186-190 PS) AR 67203	01.1992→12.1997		7.02604.03.0	LS	200 mm	
2.0 16V Turbo Q4 (167.A2B, 167.A2C, 167.A2E) 137-140 kW (186-190 PS) AR 67203	03.1992→12.1997		7.02604.03.0	LS	200 mm	
2.0 T.S. (167.A2A, 167.A2D) 104-106 kW (141-144 PS) AR 67201, AR 67202	02.1992→05.1995		7.02604.04.0	LS	200 mm	
2.0 T.S. (167.A2D) 104-106 kW (141-144 PS) AR 67201, AR 67202	02.1992→01.1995		7.02604.04.0	LS	200 mm	

A





















155 (167_)

4

2.0 T.S. 16V (167.A2G) 110-114 kW (150-155 PS) AR 67204, AR 67299	03.1995→12.1997		7.02604.54.0	LS	980 mm	
2.5 V6 (167.A1C, 167.A1) 121 kW (165 PS) AR 67301	03.1992→05.1995		7.02604.04.0	LS	200 mm	
2.5 V6 (167.A1C, 167.A1E) 120 kW (163 PS) AR 67302, AR 67303	10.1992→12.1997		7.02604.04.0	LS	200 mm	

156 (932_)





5

1.6 16V T.SPARK (932.A4, 932.A4100) 81-88 kW (110-120 PS) AR 32103, AR 32104	09.2000→09.2005		7.02604.53.0	LS	400 mm	 AR 32103, AR 32104: links, rechts Left, Right Regelsonde Regulating Probe
1.8 16V T.SPARK (932.A3) 106 kW (144 PS) AR 32201	09.1997→10.2000		7.02604.56.0	LS	1190 mm	
1.8 16V T.SPARK (932.A3100) 103 kW (140 PS) AR 32205	09.1997→09.2005		7.02604.53.0	LS	400 mm	
			7.02604.56.0	LS	1190 mm	
1.9 JTD (932.A2B00) 81 kW (110 PS) AR 37101	01.2001→05.2001		7.22946.34.0	AGR	EL	
1.9 JTD (932.A2B00, 932.A2C00) 81-88 kW (110-120 PS) 937 A2.000	05.2001→09.2005		7.22946.34.0	AGR	EL	
1.9 JTD (932.AXN00, 932.BXE00) 110 kW (150 PS) 937 A5.000	07.2004→09.2005		7.00063.10.0	AGR	EL	
			7.05270.21.0	LS	600 mm	vor Katalysator in front of the catalyst
1.9 JTD (932.AXE00) 100 kW (136 PS) 192 B1.000	11.2002→11.2004		7.00063.10.0	AGR	EL	
1.9 JTD (932.AXE00) 93-103 kW (126-140 PS) 937 A4.000	11.2003→09.2005		7.00063.10.0	AGR	EL	
			7.05270.21.0	LS	600 mm	vor Katalysator in front of the catalyst ** Frankreich ** France
1.9 JTD 16V (932.AXE00) 103 kW (140 PS) 192 A5.000	11.2002→09.2005		7.00063.10.0	AGR	EL	
2.0 16V T.SPARK (932A2) 110-114 kW (150-155 PS) AR 32301, AR 32310	09.1997→06.2002		7.02604.55.0	LS	650 mm	
			7.02604.53.0	LS	400 mm	
			7.02604.56.0	LS	1190 mm	
2.0 16V T.SPARK (932A21_) 110-114 kW (150-155 PS) AR 32310	10.2000→03.2002		7.02604.55.0	LS	650 mm	
			7.02604.53.0	LS	400 mm	
			7.02604.56.0	LS	1190 mm	

156 (932_)
5

2.0 JTS (932AXA) 119-122 kW (162-166 PS) 937 A1.000	03.2002→09.2005		7.02604.55.0	LS	650 mm	
			7.05270.80.0	LS	650 mm	
2.0 JTS (932AXD00, 932AXD01) 110-121 kW (150-165 PS) 932 A2.000	03.2001→09.2005		7.05270.80.0	LS	650 mm	
			7.02604.55.0	LS	650 mm	
			7.02604.53.0	LS	400 mm	
			7.02604.56.0	LS	1190 mm	
2.4 JTD (932AXC) 110 kW (150 PS) 841 C000	03.2002→09.2005		7.22946.34.0	AGR	EL	⊙
2.4 JTD (932AXF00) 120-147 kW (163-200 PS) 841 M.000, 841 N.000	06.2003→09.2005		7.00063.10.0	AGR	EL	⊙
2.4 JTD (932AXF00) 129 kW (175 PS) 841 G.000	10.2003→09.2005		7.00063.10.0	AGR	EL	⊙
2.4 JTD (932B1) 99-100 kW (135-136 PS) AR 32501	09.1997→09.2003		7.22946.34.0	AGR	EL	⊙
2.5 V6 24V (932A1) 140-141 kW (190-192 PS) AR 32401, AR 32402	09.1997→09.2002		7.02604.55.0	LS	650 mm	
			7.02604.53.0	LS	400 mm	
			7.02604.56.0	LS	1190 mm	
2.5 V6 24V (932A11_) 141 kW (192 PS) AR 32405	10.2000→09.2005		7.02604.55.0	LS	650 mm	
			7.02604.53.0	LS	400 mm	
			7.02604.56.0	LS	1190 mm	
3.2 GTA (932AXB) 184 kW (250 PS) 932 A.000	03.2002→09.2005		7.02604.53.0	LS	400 mm	

156 Sportwagon (932_)
6

























1.6 16V T.SPARK. (932B4100) 81-88 kW (110-120 PS) AR 32103, AR 32104	09.2000→05.2006		7.02604.53.0	LS	400 mm	⊙ AR 32103, AR 32104: links, rechts Left, Right Regelsonde Regulating Probe
1.8 16V T.SPARK (932A3) 106 kW (144 PS) AR 32201	05.2000→10.2000		7.02604.56.0	LS	1190 mm	
1.8 16V T.SPARK (932B31_) 103 kW (140 PS) AR 32205	02.1997→05.2006		7.02604.53.0	LS	400 mm	
			7.02604.56.0	LS	1190 mm	
1.9 JTD (932.B2B00) 81 kW (110 PS) AR 37101	01.2001→05.2001		7.22946.34.0	AGR	EL	⊙

A





156 Sportwagon (932_)











6

1.9 JTD (932B2B, 932B2C) 81-88 kW (110-120 PS) 937 A2.000	05.2001→05.2006		7.22946.34.0	AGR	EL	
1.9 JTD (932BXE00) 100 kW (136 PS) 192 B1.000	11.2002→11.2004		7.00063.10.0	AGR	EL	
1.9 JTD (932BXE00) 93-103 kW (126-140 PS) 937 A4.000	11.2003→05.2006		7.00063.10.0 7.05270.21.0	AGR LS	EL 600 mm	 vor Katalysator in front of the catalyst ** Frankreich ** France
1.9 JTD (932BXE00, 932BXN00) 110 kW (150 PS) 937 A5.000	03.2005→05.2006		7.00063.10.0 7.05270.21.0	AGR LS	EL 600 mm	 vor Katalysator in front of the catalyst
1.9 JTD 16V (932BXE00) 103 kW (140 PS) 192 A5.000	11.2002→05.2006		7.00063.10.0	AGR	EL	
1.9 JTD 16V Q4 (932BXN20) 110 kW (150 PS) 937 A5.000	07.2004→05.2006		7.00063.10.0 7.05270.21.0	AGR LS	EL 600 mm	 vor Katalysator in front of the catalyst
2.0 16V T.SPARK (932A2) 110-114 kW (150-155 PS) AR 32301, AR 32310	05.2000→06.2002		7.02604.55.0 7.02604.53.0 7.02604.56.0	LS LS LS	650 mm 400 mm 1190 mm	
2.0 16V T.SPARK (932B21_) 110-114 kW (150-155 PS) AR 32310	10.2000→03.2002		7.02604.55.0 7.02604.53.0 7.02604.56.0	LS LS LS	650 mm 400 mm 1190 mm	
2.0 JTS (932BXA) 119-122 kW (162-166 PS) 937 A1.000	03.2002→05.2006		7.02604.55.0 7.05270.80.0	LS LS	650 mm 650 mm	
2.4 JTD (932.B1B00) 103 kW (140 PS) 839 A6.000	10.2000→05.2006		7.22946.34.0	AGR	EL	
2.4 JTD (932.BXC00) 110 kW (150 PS) 841 C000	03.2002→05.2006		7.22946.34.0	AGR	EL	
2.4 JTD (932B1) 99-100 kW (135-136 PS) AR 32501	05.2000→09.2003		7.22946.34.0	AGR	EL	
2.4 JTD (932BXF00) 120-147 kW (163-200 PS) 841 M.000, 841 N.000	06.2003→05.2006		7.00063.10.0	AGR	EL	
2.4 JTD (932BXF00) 129 kW (175 PS) 841 G.000	10.2003→05.2006		7.00063.10.0	AGR	EL	

156 Sportwagon (932_)
6

2.5 V6 24V (932A1) 140 kW (190 PS) AR 32401	05.2000→08.2003		7.02604.55.0 LS 650 mm
			7.02604.53.0 LS 400 mm
			7.02604.56.0 LS 1190 mm
2.5 V6 24V (932B1100) 141 kW (192 PS) AR 32405	02.1997→05.2006		7.02604.55.0 LS 650 mm
			7.02604.53.0 LS 400 mm
			7.02604.56.0 LS 1190 mm
3.2 GTA (932.BXB00) 184 kW (250 PS) 932 A.000	03.2002→05.2006		7.02604.53.0 LS 400 mm

159 (939_)
7













1.8 MPI (939AXL1A) 96-103 kW (131-140 PS) 939 A4.000	06.2005→11.2011		7.04879.00.0 AGR-TH 
			7.05271.62.0 LS 500 mm Diagnosesonde Diagnostic Probe nach Katalysator Post-catalyst
			7.02604.56.0 LS 1190 mm
1.8 Tbi (939.AXN1B) 147 kW (200 PS) 939 B1.000	05.2009→12.2012		7.05270.21.0 LS 600 mm vor Katalysator in front of the catalyst
			7.02604.56.0 LS 1190 mm
1.9 JTDM 16V (939AXC1B, 939AXC12) 110 kW (150 PS) 939 A2.000	09.2005→11.2011		7.00063.10.0 AGR EL 
			7.08369.57.0 ATS EL 7.11190.03.0 DDS ohne Zubehör without accessories für OE-Nummer: 55200301 for OE number: 55200301
			7.11190.04.0 DDS für OE-Nummer: 51792301 for OE number: 51792301
1.9 JTDM 16V (939AXF1B, 939AXC1B) 100 kW (136 PS) 937 A8.000, 939 A8.000	09.2005→11.2011		7.00063.10.0 AGR EL 
			7.08369.57.0 ATS EL 7.11190.03.0 DDS ohne Zubehör without accessories  937 A8.000, 939 A8.000: für OE-Nummer: 55200301 for OE number: 55200301
			7.11190.04.0 DDS  937 A8.000, 939 A8.000: für OE-Nummer: 51792301 for OE number: 51792301
1.9 JTDM 8V (939AXE1B) 88 kW (120 PS) 939 A1.000	09.2005→11.2011		7.22946.38.0 AGR EL 
			7.08369.57.0 ATS EL 7.11190.03.0 DDS ohne Zubehör without accessories für OE-Nummer: 55200301 for OE number: 55200301

A





159 (939_)





7

		7.11190.04.0	DDS		für OE-Nummer: 51792301 for OE number: 51792301
1.9 JTDM 8V (939AXE1B, 939BXE1B, 939BXH1B) 85 kW (115 PS) 937 A7.000, 939 A7.000	09.2005→11.2011	 7.22946.38.0	AGR	EL	 ohne Zubehör without accessories  937 A7.000, 939 A7.000: für OE-Nummer: 55200301 for OE number: 55200301  937 A7.000, 939 A7.000: für OE-Nummer: 51792301 for OE number: 51792301
		7.08369.57.0	ATS	EL	
		7.11190.03.0	DDS		
		7.11190.04.0	DDS		
1.9 JTS (939AXA1B) 118 kW (160 PS) 939 A6.000	09.2005→11.2011	 7.08369.57.0	ATS	EL	ohne Zubehör without accessories für OE-Nummer: 55200301 for OE number: 55200301 für OE-Nummer: 51792301 for OE number: 51792301 vor Katalysator in front of the catalyst
		7.11190.03.0	DDS		
		7.11190.04.0	DDS		
		7.05270.21.0	LS	600 mm	
2.0 JTDM (939AXP1B) 125 kW (170 PS) 939 B3.000	05.2009→11.2011	 7.24809.77.0	AGR	ET	<input checked="" type="checkbox"/>
		7.11020.09.0	ATS	EL	ohne Zubehör without accessories Euro 5 Euro 5 vor Katalysator in front of the catalyst
		7.11190.03.0	DDS		
		7.02604.44.0	LS	500 mm	
2.0 JTDM (939AXQ1B) 120 kW (163 PS) 844 A2.000	05.2009→11.2011	 7.24809.77.0	AGR	ET	<input checked="" type="checkbox"/>
		7.11020.09.0	ATS	EL	ohne Zubehör without accessories Euro 5 Euro 5
		7.11190.03.0	DDS		
2.0 JTDM (939AXR1B) 100 kW (136 PS) 939 B4.000	06.2010→11.2011	 7.24809.77.0	AGR	ET	<input checked="" type="checkbox"/>
		7.11020.09.0	ATS	EL	ohne Zubehör without accessories Euro 5 Euro 5 vor Katalysator in front of the catalyst
		7.11190.03.0	DDS		
		7.02604.44.0	LS	500 mm	
2.2 JTS (939AXB1B, 939AXB11) 136 kW (185 PS) 939 A5.000	09.2005→11.2011	 7.05270.21.0	LS	600 mm	vor Katalysator in front of the catalyst
2.2 Q4 (939AXB1B, 939BXB1B) 136 kW (185 PS) 939 A5.000	09.2006→12.2007	 7.05270.21.0	LS	600 mm	vor Katalysator in front of the catalyst
2.4 JTDM (939AXD) 154 kW (210 PS) 939 A9.000	07.2007→11.2011	 7.00063.10.0	AGR	EL	

159 (939_)
7

			7.08369.57.0	ATS	EL	ohne Zubehör without accessories für OE-Nummer: 55200301 for OE number: 55200301 für OE-Nummer: 51792301 for OE number: 51792301
			7.11190.03.0	DDS		
			7.11190.04.0	DDS		
2.4 JTDM (939AXD12, 939AXD1B) 147-154 kW (200-209 PS) 939 A3.000	09.2005→11.2011		7.00063.10.0	AGR	EL	⊗ ohne Zubehör without accessories für OE-Nummer: 55200301 for OE number: 55200301 für OE-Nummer: 51792301 for OE number: 51792301
			7.08369.57.0	ATS	EL	
			7.11190.03.0	DDS		
			7.11190.04.0	DDS		
2.4 JTDM Q4 (939AXMB2) 154 kW (210 PS) 939 A9.000	05.2007→11.2011		7.00063.10.0	AGR	EL	⊗ ohne Zubehör without accessories für OE-Nummer: 55200301 for OE number: 55200301 für OE-Nummer: 51792301 for OE number: 51792301
			7.08369.57.0	ATS	EL	
			7.11190.03.0	DDS		
			7.11190.04.0	DDS		

159 Sportwagon (939_)
8

1.8 MPI (939BXL1A) 96-103 kW (131-140 PS) 939 A4.000	06.2005→11.2011		7.04879.00.0	AGR-TH		⊗ Öffnungstemperatur/opening temperature 105C ⊗ 939 A4.000: Regelsonde Regulating Probe vor Katalysator in front of the catalyst ⊗ 939 A4.000: Diagnosesonde Diagnostic Probe nach Katalysator Post-catalyst
			7.05271.62.0	LS	500 mm	
			7.02604.56.0	LS	1190 mm	
1.8 Tbi (939BXN1B) 147 kW (200 PS) 939 B1.000	07.2009→11.2011		7.02604.56.0	LS	1190 mm	
1.9 JTDM 16V (939BXC1B) 100 kW (136 PS) 937 A8.000	03.2006→11.2011		7.00063.10.0	AGR	EL	⊗ ohne Zubehör without accessories für OE-Nummer: 55200301 for OE number: 55200301 für OE-Nummer: 51792301 for OE number: 51792301
			7.08369.57.0	ATS	EL	
			7.11190.03.0	DDS		
			7.11190.04.0	DDS		
1.9 JTDM 16V (939BXC1B, 939BXC12) 110 kW (150 PS) 939 A2.000	03.2006→11.2011		7.00063.10.0	AGR	EL	⊗ ohne Zubehör without accessories für OE-Nummer: 55200301 for OE number: 55200301
			7.08369.57.0	ATS	EL	
			7.11190.03.0	DDS		

A







159 Sportwagon (939_)



8

			7.11190.04.0	DDS		für OE-Nummer: 51792301 for OE number: 51792301
1.9 JTDM 8V (939AXH1B, 939BXH1B) 85 kW (115 PS) 937 A7.000	03.2006→11.2011		7.22946.38.0	AGR	EL	<input type="checkbox"/> ohne Zubehör without accessories für OE-Nummer: 55200301 for OE number: 55200301 für OE-Nummer: 51792301 for OE number: 51792301
			7.08369.57.0	ATS	EL	
			7.11190.03.0	DDS		
1.9 JTDM 8V (939BXE1B) 88 kW (120 PS) 939 A1.000	03.2006→11.2011		7.22946.38.0	AGR	EL	<input type="checkbox"/> ohne Zubehör without accessories für OE-Nummer: 55200301 for OE number: 55200301 für OE-Nummer: 51792301 for OE number: 51792301
			7.08369.57.0	ATS	EL	
			7.11190.03.0	DDS		
1.9 JTS (939BXA1B) 118 kW (160 PS) 939 A6.000	03.2006→11.2011		7.08369.57.0	ATS	EL	ohne Zubehör without accessories für OE-Nummer: 55200301 for OE number: 55200301 für OE-Nummer: 51792301 for OE number: 51792301
			7.11190.03.0	DDS		
			7.11190.04.0	DDS		
2.0 JTDM (939BXP1B) 125 kW (170 PS) 939 B3.000	07.2009→11.2011		7.24809.77.0	AGR	ET	<input checked="" type="checkbox"/> ohne Zubehör without accessories Euro 5 Euro 5 vor Katalysator in front of the catalyst
			7.11020.09.0	ATS	EL	
			7.11190.03.0	DDS		
2.0 JTDM (939BXQ1B) 120 kW (163 PS) 844 A2.000	05.2009→11.2011		7.24809.77.0	AGR	ET	<input checked="" type="checkbox"/> ohne Zubehör without accessories Euro 5 Euro 5
			7.11020.09.0	ATS	EL	
			7.11190.03.0	DDS		
2.0 JTDM (939BXR1B) 100 kW (136 PS) 939 B4.000	06.2010→11.2011		7.24809.77.0	AGR	ET	<input checked="" type="checkbox"/> ohne Zubehör without accessories Euro 5 Euro 5 vor Katalysator in front of the catalyst
			7.11020.09.0	ATS	EL	
			7.11190.03.0	DDS		
2.4 JTDM (939.BXM1B) 154 kW (210 PS) 939 A9.000	05.2007→12.2012		7.00063.10.0	AGR	EL	<input type="checkbox"/>
			7.08369.57.0	ATS	EL	

159 Sportwagon (939_)
8

			7.11190.03.0	DDS		ohne Zubehör without accessories für OE-Nummer: 55200301 for OE number: 55200301
			7.11190.04.0	DDS		für OE-Nummer: 51792301 for OE number: 51792301
2.4 JTDM (939BXD1B, 939BXD12) 147-154 kW (200-209 PS) 939 A3.000	03.2006→11.2011		7.00063.10.0	AGR	EL	
			7.08369.57.0	ATS	EL	
			7.11190.03.0	DDS		ohne Zubehör without accessories für OE-Nummer: 55200301 for OE number: 55200301
			7.11190.04.0	DDS		für OE-Nummer: 51792301 for OE number: 51792301
2.4 JTDM Q4 (939BXM2B) 154 kW (210 PS) 939 A9.000	05.2007→11.2011		7.00063.10.0	AGR	EL	
			7.08369.57.0	ATS	EL	
			7.11190.03.0	DDS		ohne Zubehör without accessories für OE-Nummer: 55200301 for OE number: 55200301
			7.11190.04.0	DDS		für OE-Nummer: 51792301 for OE number: 51792301

164 (164_)
9

2.0 (164A2C) 102-106 kW (138-144 PS) AR 06416	06.1987→09.1998		7.02604.03.0	LS	200 mm	
2.0 (164A2C, 164A2L, 164A2H) 105-109 kW (143-148 PS) AR 06420	11.1987→10.1992		7.02604.03.0	LS	200 mm	
2.0 T.S. (164.A2C, 164.A2L) 105-109 kW (143-148 PS) AR 06420	06.1987→09.1992		7.02604.03.0	LS	200 mm	
2.0 T.S. (164.A2H) 105-109 kW (143-148 PS) AR 06420	06.1987→09.1992		7.02604.03.0	LS	200 mm	
2.0 T.S. (164.H3) 106 kW (144 PS) AR 64103	09.1992→09.1998		7.02604.03.0	LS	200 mm	
2.0 Turbo (164A2B) 128-129 kW (174-175 PS) AR 06476	10.1987→09.1998		7.02604.03.0	LS	200 mm	
2.0 Turbo (164A2B) 128-129 kW (174-175 PS) AR 06476	02.1988→10.1992		7.02604.03.0	LS	200 mm	
2.0 Twin Spark (164A2) 105-109 kW (143-148 PS) AR 06420	06.1987→09.1992		7.02604.03.0	LS	200 mm	
2.0 Twin Spark (164A2C, 164A2L, 164A2H) 105-109 kW (143-148 PS) AR 06420	07.1990→10.1992		7.02604.03.0	LS	200 mm	
2.0 V6 Turbo (164.A2G, 164.A2F) 150 kW (204 PS) AR 64101	03.1991→09.1992		7.02604.03.0	LS	200 mm	
2.0 V6 Turbo (164.K3) 148-150 kW (201-204 PS) AR 64102	09.1992→09.1998		7.02604.03.0	LS	200 mm	

A





164 (164_)



























9

3.0 (164A) 136-141 kW (184-192 PS) AR 06410	11.1987→09.1991		7.02604.03.0	LS	200 mm
3.0 (164AG, 164H1) 156-171 kW (212-233 PS) AR 64304	09.1993→12.1995		7.02604.54.0	LS	980 mm
3.0 (164H1) 156-171 kW (212-233 PS) AR 64304	04.1993→02.1995		7.02604.54.0	LS	980 mm
3.0 (164H1) 156-171 kW (212-233 PS) AR 64304	03.1995→08.1997		7.02604.54.0	LS	980 mm
3.0 24V (164.K1) 132-170 kW (180-231 PS) AR 64306, AR 66301, AR 66302	09.1992→09.1998		7.02604.54.0	LS	980 mm
3.0 24V (164K1G, 164K1F) 151-155 kW (205-211 PS) AR 66302	03.1995→10.1997		7.02604.54.0	LS	980 mm
3.0 24V (164K1M) 150-170 kW (204-231 PS) AR 64308	11.1992→10.1997		7.02604.54.0	LS	980 mm
3.0 24V Q4 (164.K1M, 164.K1C) 150-170 kW (204-231 PS) AR 64307, AR 64308	02.1994→09.1998		7.02604.54.0	LS	980 mm
3.0 24V QV (164.H1) 156-171 kW (212-233 PS) AR 64304	09.1992→09.1998		7.02604.54.0	LS	980 mm
3.0 24V QV All-wheel Drive (164K1H) 156-171 kW (212-233 PS) AR 64304, AR 64307	11.1992→10.1997		7.02604.54.0	LS	980 mm
3.0 V6 (164.A) 136-141 kW (184-192 PS) AR 06410	06.1987→09.1992		7.02604.03.0	LS	200 mm
3.0 V6 (164.AD, 164.AH, 164.AB) 135 kW (184 PS) AR 06412	06.1987→09.1992		7.02604.03.0	LS	200 mm
3.0 V6 (164.H1A, 164.H1B, 164.K1P) 132-145 kW (180-197 PS) AR 64303, AR 64305, AR 64399, AR 66303	09.1992→09.1998		7.02604.03.0	LS	200 mm
3.0 i.e. QV (164.AG) 147 kW (200 PS) AR 06430, AR 64301	09.1990→09.1992		7.02604.03.0	LS	200 mm

166 (936_)

10

2.0 T.Spark (936A3A_) 114 kW (155 PS) AR 34103	09.1998→10.2000		7.02604.55.0	LS	650 mm
			7.02604.53.0	LS	400 mm
2.0 T.Spark (936A3B00) 110 kW (150 PS) AR 36301	10.2000→06.2007		7.05270.80.0	LS	650 mm
			7.02604.55.0	LS	650 mm
			7.02604.53.0	LS	400 mm







						
166 (936_)						10
2.0 V6 (936A3_) 151 kW (205 PS) AR 34102	09.1998→10.2000		7.02604.56.0	LS	1190 mm	
2.4 JTD (936A2B_) 103 kW (140 PS) 839 A6.000	10.2000→06.2007		7.22946.34.0	AGR	EL	
2.4 JTD (936AXA00, 936A3B00) 110 kW (150 PS) 841 C000	04.2002→06.2007		7.22946.34.0	AGR	EL	
2.4 JTD (936AXC00) 120-147 kW (163-200 PS) 841 M.000	07.2006→06.2007		7.00063.10.0	AGR	EL	
			7.02604.44.0	LS	500 mm	vor Katalysator in front of the catalyst
2.4 JTD (936AXC00, 936AXD01) 129 kW (175 PS) 841 G.000, 841 H.000	10.2003→06.2007		7.00063.10.0	AGR	EL	
2.4 JTD (936AXD01, 936AXC00) 120-147 kW (163-200 PS) 841 M.000, 841 N.000	10.2003→06.2007		7.00063.10.0	AGR	EL	
2.5 V6 24V (936A21_) 138 kW (188 PS) AR 36201	10.2000→06.2007		7.02604.53.0	LS	400 mm	
			7.02604.56.0	LS	1190 mm	
2.5 V6 24V (936A2_) 140 kW (190 PS) AR 34201	09.1998→12.2006		7.02604.53.0	LS	400 mm	
			7.02604.56.0	LS	1190 mm	
3.0 V6 24V (936A1000, 936A1001) 166 kW (226 PS) AR 34301, AR 34302	09.1998→06.2007		7.02604.53.0	LS	400 mm	
			7.02604.56.0	LS	1190 mm	
3.0 V6 24V (936A11_) 162 kW (220 PS) AR 36101	10.2000→06.2007		7.02604.53.0	LS	400 mm	
			7.02604.56.0	LS	1190 mm	
3.2 V6 24V (936AXB00, 936AXA00) 176-184 kW (240-250 PS) 936 A.000	10.2003→06.2007		7.02604.53.0	LS	400 mm	
33 (907_)						11
1.4 i.e. (907.A3A, 907.A3B) 65-66 kW (88-90 PS) AR 30753, AR 30755	06.1991→09.1994		7.02604.03.0	LS	200 mm	
1.4 i.e. (907.A3A, 907.A3B) 65-66 kW (88-90 PS) AR 30753, AR 30755	06.1991→09.1994		7.02604.03.0	LS	200 mm	
1.7 16V (907.A1B) 101 kW (137 PS) AR 30746	01.1990→03.1992		7.02604.03.0	LS	200 mm	
1.7 16V (907.A1C) 95-97 kW (129-132 PS) AR 30747	01.1990→09.1994		7.02604.03.0	LS	200 mm	
1.7 16V (907.A1C) 95-97 kW (129-132 PS) AR 30747	01.1990→03.1992		7.02604.03.0	LS	200 mm	

A







33 (907_)							11
1.7 16V 4x4 (907.A1G) 95-97 kW (129-132 PS) AR 30747	01.1990→09.1994		7.02604.03.0	LS	200 mm		
1.7 16V 4x4 (907.A1G) 95-97 kW (129-132 PS) AR 30747	01.1990→09.1994		7.02604.03.0	LS	200 mm		
1.7 16V 4x4 (907A1F) 101 kW (137 PS) AR 30746	01.1990→09.1994		7.02604.03.0	LS	200 mm		
33 Sportwagon (905_)							12
1.4 (905A1H) 63-66 kW (86-90 PS) AR 30587	01.1984→12.1988		7.02604.03.0	LS	200 mm		
33 Sportwagon (907_)							13
1.4 i.e. (907B3B) 65-66 kW (88-90 PS) AR 30753, AR 30755	06.1991→09.1994		7.02604.03.0	LS	200 mm		
1.4 i.e. (907B3B) 65-66 kW (88-90 PS) AR 30755	06.1991→09.1994		7.02604.03.0	LS	200 mm		
1.4 i.e. 4x4 (907B3) 65-66 kW (88-90 PS) AR 30755	07.1990→09.1994		7.02604.03.0	LS	200 mm		
1.7 16V (907.B1G) 95-97 kW (129-132 PS) AR 30747	01.1990→09.1994		7.02604.03.0	LS	200 mm		
1.7 16V (907.B1G) 95-97 kW (129-132 PS) AR 30747	01.1990→09.1994		7.02604.03.0	LS	200 mm		
1.7 16V (907B1B) 101 kW (137 PS) AR 30746	07.1990→09.1994		7.02604.03.0	LS	200 mm		
1.7 16V 4x4 (907.B1H) 95-97 kW (129-132 PS) AR 30747	01.1990→03.1992		7.02604.03.0	LS	200 mm		
1.7 16V 4x4 (907.B1H) 95-97 kW (129-132 PS) AR 30747	01.1990→09.1994		7.02604.03.0	LS	200 mm		
6 (119_)							14
2.5 i.e. (119.AA, 119.AB) 110-118 kW (150-160 PS) AR 01928	10.1983→12.1986		7.02604.03.0	LS	200 mm		
2.5 i.e. (119AA, 119AB) 110-118 kW (150-160 PS) AR 01928	08.1979→06.1984		7.02604.03.0	LS	200 mm		
75 (162_)							15
2.5 V6 (162.B3) 110-116 kW (150-158 PS) AR 01646, AR 01648, AR 01911	05.1985→08.1986		7.02604.03.0	LS	200 mm		
90 (162_)							16
2.5 i.e. V6 (162.A, 162.AA) 110-116 kW (150-158 PS) AR 01646, AR 01911	10.1984→07.1987		7.02604.03.0	LS	200 mm		
ALFA 33							17
1.4 63-65 kW (86-88 PS) AR 30506	03.1988→03.1994		7.02604.03.0	LS	200 mm		

BRERA (939_)
18

1.8 TBi (939DXN1B) 147 kW (200 PS) 939 B1.000	05.2009→06.2010		7.05270.21.0 LS 600 mm für OE-Nummer: 55204005 for OE number: 55204005
			7.02604.56.0 LS 1190 mm
2.0 JTDM (939DXP1B) 125 kW (170 PS) 939 B3.000	05.2009→06.2010		7.24809.77.0 AGR ET ☒
			7.11190.03.0 DDS ohne Zubehör without accessories für OE-Nummer: 51908411 for OE number: 51908411
			7.02604.44.0 LS 500 mm vor Katalysator in front of the catalyst
2.0 JTDM (939DXQ1B) 120 kW (163 PS) 844 A2.000	03.2008→06.2010		7.24809.77.0 AGR ET ☒
			7.11020.09.0 ATS EL
			7.11190.03.0 DDS ohne Zubehör without accessories für OE-Nummer: 51908411 for OE number: 51908411
			7.02604.44.0 LS 500 mm vor Katalysator in front of the catalyst
2.2 JTS (939.DXB11) 136 kW (185 PS) 939 A5.000	01.2006→05.2011		7.05270.21.0 LS 600 mm für OE-Nummer: 55204005 for OE number: 55204005
2.4 JTDM 20V (939DXD1B, 939DXD12) 147-154 kW (200-209 PS) 939 A3.000	01.2006→03.2011		7.00063.10.0 AGR EL ○
			7.08369.57.0 ATS EL
			7.11190.03.0 DDS ohne Zubehör without accessories für OE-Nummer: 55200301 for OE number: 55200301
			7.11190.04.0 DDS für OE-Nummer: 51792301 for OE number: 51792301
2.4 JTDM 20V (939DXD1B, 939DXM1B) 154 kW (210 PS) 939 A9.000	05.2007→03.2011		7.00063.10.0 AGR EL ○
			7.08369.57.0 ATS EL
			7.11190.03.0 DDS ohne Zubehör without accessories für OE-Nummer: 55200301 for OE number: 55200301
			7.11190.04.0 DDS für OE-Nummer: 51792301 for OE number: 51792301

GIULIA (952_)
19





2.2 D (952AEM250, 952AEA250) 100-132 kW (136-180 PS) 552 66 388, 552 68 532	10.2015→		7.11190.03.0 DDS ohne Zubehör without accessories  552 66 388, 552 68 532: Euro 6 Euro 6
2.2 D (952AEM250, 952AEA250) 100-140 kW (136-190 PS) 463 35 975	08.2018→		7.05194.26.0 AGR-K EL ○
2.2 D (952AFA25, 952AFM25, 952ALA25) 100-132 kW (136-180 PS) 552 66 388, 552 68 532, 552 71 040	10.2015→		7.11190.03.0 DDS ohne Zubehör without accessories  552 66 388, 552 68 532, 552 71 040: Euro 6 Euro 6

A

















GIULIA (952_)

19

2.2 D (952AGA250, 952AGM250, 952ASM2, 952ASA2) 100-140 kW (136-190 PS) 463 35 975, 552 66 388, 552 68 532, 552 84 636	10.2015→		7.11190.03.0	DDS		ohne Zubehör without accessories 463 35 975, 552 66 388, 552 68 532, 552 84 636: Euro 6 Euro 6
2.2 D (952ALA25, 952AFM25, 952APA2) 100-140 kW (136-190 PS) 552 84 636	08.2018→		7.05194.26.0	AGR-K	EL	
2.2 D Q4 (952AFA45M) 132-154 kW (180-209 PS) 552 68 818	04.2017→		7.11190.03.0	DDS		ohne Zubehör without accessories Euro 6 Euro 6
2.2 D Q4 (952AHA45, 952AMA4) 132-154 kW (180-209 PS) 552 68 818	11.2016→		7.11190.03.0	DDS		ohne Zubehör without accessories Euro 6 Euro 6
2.2 D Q4 (952AHA45, 952AMA4) 140-154 kW (190-209 PS) 552 84 529	11.2016→		7.05194.26.0 7.11190.03.0	AGR-K DDS	EL	 ohne Zubehör without accessories Euro 6 Euro 6

GIULIETTA (940_)

20

1.4 BiFuel (940FXA1A, 940FXT1A) 88 kW (120 PS) 198 A4.000	12.2011→02.2017		7.02604.53.0	LS	400 mm	
1.4 TB (940FXA1A) 88 kW (120 PS) 198 A4.000, 940 B7.000	04.2010→		7.02604.53.0	LS	400 mm	
1.4 TB (940FXB1A) 110-125 kW (150-170 PS) 940 A2.000	04.2010→		7.02604.53.0	LS	400 mm	
1.4 TB (940FXF1A) 85 kW (116 PS) 940 A6.000	04.2010→02.2016		7.02604.53.0	LS	400 mm	
1.4 TB (940FXG1A) 120 kW (163 PS) 955 A8.000	04.2010→		7.02604.53.0	LS	400 mm	
1.4 TB (940FXN1A, 940FXU1A) 77 kW (105 PS) 940 B1.000, 940 B8.000	04.2011→		7.02604.53.0	LS	400 mm	
1.6 JTDM (940.FYB1_) 85-88 kW (116-120 PS) 940 C1.000, 940 C5.000	02.2015→		7.24809.77.0	AGR	ET	
1.6 JTDM (940.FYE1_) 85-88 kW (116-120 PS) 940 C5.000	09.2015→		7.24809.77.0 7.02604.44.0	AGR LS	ET 500 mm	 Vett No. →7295956 vor Katalysator in front of the catalyst
1.6 JTDM (940FXD1A) 77 kW (105 PS) 940 A3.000	04.2010→		7.24809.77.0 7.11020.10.0 7.11190.03.0 7.02604.44.0	AGR ATS DDS LS	ET EL 500 mm	 ohne Zubehör without accessories Vett No. →7295956 vor Katalysator in front of the catalyst
2.0 JTDM (940.FXL1A) 103 kW (140 PS) 940 A5.000	04.2010→		7.24809.77.0	AGR	ET	

GIULIETTA (940_)
20

			7.11020.10.0 ATS 7.11190.03.0 DDS 7.02604.44.0 LS	EL 500 mm	ohne Zubehör without accessories vor Katalysator in front of the catalyst
2.0 JTDM (940.FXQ1A) 103-150 kW (140-204 PS) 940 B5.000	08.2013→		7.24809.77.0 AGR 7.11020.10.0 ATS 7.11020.48.0 ATS 7.11190.03.0 DDS 7.02604.44.0 LS	ET EL EL 500 mm	<input checked="" type="checkbox"/> Euro 5 Euro 5 Euro 6 Euro 6 ohne Zubehör without accessories
2.0 JTDM (940.FXQ1A) 103-110 kW (140-150 PS) 940 C3.000	08.2013→		7.24809.77.0 AGR 7.07549.09.0 AGR 7.11020.48.0 ATS 7.11190.03.0 DDS 7.02604.44.0 LS	ET EL EL 500 mm	<input checked="" type="checkbox"/> mit Dichtring with O-ring 01.2015→ Euro 6 Euro 6 ohne Zubehör without accessories
2.0 JTDM (940.FXV11) 125-129 kW (170-175 PS) 940 B4.000	11.2013→		7.24809.77.0 AGR 7.11020.48.0 ATS 7.11190.03.0 DDS	ET EL 500 mm	<input checked="" type="checkbox"/> Euro 6 Euro 6 ohne Zubehör without accessories
2.0 JTDM (940FXE1A) 125 kW (170 PS) 940 A4.000	04.2010→		7.24809.77.0 AGR 7.11020.10.0 ATS 7.11190.03.0 DDS 7.02604.44.0 LS	ET EL 500 mm	<input checked="" type="checkbox"/> ohne Zubehör without accessories →12.2013 vor Katalysator in front of the catalyst
2.0 JTDM (940FXH1A, 940FXH11, 940.FXZ11, 940.FXZ1A) 120 kW (163 PS) 940 A7.000, 940 B9.000	04.2010→		7.24809.77.0 AGR 7.11020.48.0 ATS 7.11190.03.0 DDS	ET EL	<input checked="" type="checkbox"/> ohne Zubehör without accessories
2.0 JTDM (940FXM1A, 940FXS1A, 940FYD1A) 100 kW (136 PS) 940 A8.000, 940 B6.000	04.2010→02.2016		7.24809.77.0 AGR 7.11020.48.0 ATS 7.11190.03.0 DDS	ET EL	<input checked="" type="checkbox"/> ohne Zubehör without accessories
2.0 JTDM (940FXM1A, 940FXS1A, 940FYD1A) 100 kW (136 PS) 940 C4.000	04.2010→02.2016		7.24809.77.0 AGR 7.07549.09.0 AGR	ET EL	<input checked="" type="checkbox"/> mit Dichtring with O-ring 01.2015→

A











GIULIETTA (940_)

20

		7.11020.48.0	ATS	EL	ohne Zubehör without accessories
		7.11190.03.0	DDS		



GT (937_)



















21

1.8 TS (937CXR1A) 103 kW (140 PS) AR 32205	11.2003→09.2010	 7.02604.53.0	LS	400 mm	
1.9 JTD (937CXN1B) 110 kW (150 PS) 937 A5.000	11.2003→09.2010	 7.00063.10.0	AGR	EL	
		7.11190.04.0	DDS		Euro 4
		7.05270.21.0	LS	600 mm	für OE-Nummer: 55204005 for OE number: 55204005
1.9 JTD (937CXN1B, 937CXZ1B) 125 kW (170 PS) 937 A6.000	05.2008→09.2010	 7.00063.10.0	AGR	EL	
		7.05270.21.0	LS	600 mm	für OE-Nummer: 55204005 for OE number: 55204005
2.0 JTS (937CXH11, 937CXH1A, 937CXT1A) 110-121 kW (150-165 PS) 932 A2.000	12.2006→09.2010	 7.02604.55.0	LS	650 mm	
2.0 JTS (937CXH1A, 937CXH11) 110-122 kW (150-166 PS) 932 A2.000, 937 A1.000	11.2003→09.2010	 7.05270.80.0	LS	650 mm	
		7.02604.55.0	LS	650 mm	
3.2 GTA (937CXP1B) 176-184 kW (240-250 PS) 936 A.000	11.2003→09.2010	 7.02604.53.0	LS	400 mm	

GTV (916_)

22

1.8 16V (916C3) 106 kW (144 PS) AR 32201	05.1998→10.2005	 7.02604.56.0	LS	1190 mm	
2.0 JTS (916CXA00) 119-122 kW (162-166 PS) 937 A1.000	04.2003→10.2005	 7.02604.55.0	LS	650 mm	
		7.05270.80.0	LS	650 mm	
2.0 T.SPARK 16V (916.C2__, 916C2C00) 110 kW (150 PS) AR 16201	06.1995→10.2005	 7.02604.54.0	LS	980 mm	
		7.02604.53.0	LS	400 mm	
		7.02604.56.0	LS	1190 mm	
2.0 T.SPARK 16V (916.C2__, 916C2C00) 110-114 kW (150-155 PS) AR 32310	10.2000→10.2005	 7.02604.53.0	LS	400 mm	
		7.02604.56.0	LS	1190 mm	
3.0 V6 24V (916.C1) 162 kW (220 PS) AR 16102	10.1996→10.2000	 7.02604.55.0	LS	650 mm	
		7.02604.53.0	LS	400 mm	
		7.02604.56.0	LS	1190 mm	

						A
GTV (916_)						22
3.0 V6 24V (916.C1B_) 160 kW (218 PS) AR 16105	10.2000→10.2005		7.02604.55.0	LS	650 mm	
			7.02604.53.0	LS	400 mm	
			7.02604.56.0	LS	1190 mm	
3.2 V6 24V (916CXB00) 176 kW (240 PS) 936 A6.000	04.2003→10.2005		7.02604.53.0	LS	400 mm	
MITO (955_)						23
1.3 MultiJet (955AXH1B, 955AXT1A) 66 kW (90 PS) 199 A3.000	08.2008→08.2010		7.00020.25.0	AGR	EL 	
			7.01599.10.0	AGR	EL 	
			7.11020.08.0	ATS	EL	vor Katalysator, vor Rußpartikelfilter in front of the catalyst, before soot particulate filter Euro 4 Euro 4
			7.11190.03.0	DDS		ohne Zubehör without accessories für OE-Nummer: 51908411 for OE number: 51908411
1.3 MultiJet (955AXH1B, 955AXT1A) 66 kW (90 PS) 955 B2.000	08.2008→08.2010		7.11020.08.0	ATS	EL	vor Katalysator, vor Rußpartikelfilter in front of the catalyst, before soot particulate filter Euro 4 Euro 4
			7.11190.03.0	DDS		ohne Zubehör without accessories für OE-Nummer: 51908411 for OE number: 51908411
			7.11190.04.0	DDS		Euro 4 Euro 4
1.3 MultiJet (955AXP1A, 955AYC1A) 70 kW (95 PS) 199 B1.000	09.2009→12.2018		7.01599.10.0	AGR	EL 	Euro 5 Euro 5
			7.03622.06.0	AGR-K		
			7.11020.04.0	ATS	EL	ab Euro 5 From Euro 5
			7.11020.08.0	ATS	EL	vor Katalysator, vor Rußpartikelfilter in front of the catalyst, before soot particulate filter Euro 4 Euro 4 2011 2011
1.3 MultiJet (955AXP1A, 955AYC1A) 70 kW (95 PS) 330 A1.000	09.2009→12.2018		7.04589.06.0	AGR	EL 	12.2017→
			7.01599.10.0	AGR	EL 	Euro 5 Euro 5
			7.03622.06.0	AGR-K		
			7.11020.04.0	ATS	EL	ab Euro 5 From Euro 5

A



MITO (955_)

23

			7.11020.08.0	ATS	EL	vor Katalysator, vor Rußpartikelfilter in front of the catalyst, before soot particulate filter Euro 4 Euro 4 2011 2011
			7.11190.03.0	DDS		ohne Zubehör without accessories Euro 5 Euro 5
1.3 MultiJet (955AXT1A) 62 kW (84 PS) 199 B4.000	01.2011→		7.01599.10.0	AGR	EL	
			7.03622.06.0	AGR-K		
			7.11020.04.0	ATS	EL	2013 2013
			7.11190.03.0	DDS		ohne Zubehör without accessories
1.3 MultiJet (955AXT1A, 955AYA1A) 59 kW (80 PS) 199 B8.000	12.2013→		7.04589.06.0	AGR	EL	 12.2017→
			7.01599.10.0	AGR	EL	
			7.11020.04.0	ATS	EL	
1.4 (955.AXB1B, 955.AXU1A) 57 kW (78 PS) 350 A1.000	03.2011→		7.02604.53.0	LS	400 mm	
1.4 (955AXB1B) 57-58 kW (78-79 PS) 955 A1.000	08.2008→08.2013		7.02604.53.0	LS	400 mm	
1.4 (955AXB1B, 955.AXF1B) 70 kW (95 PS) 199 A6.000	09.2008→08.2013		7.02604.53.0	LS	400 mm	
1.4 Bifuel (955AXG1A) 88 kW (120 PS) 198 A4.000	01.2009→		7.02604.55.0	LS	650 mm	
			7.02604.53.0	LS	400 mm	
1.4 TJet (955AXA1B) 114 kW (155 PS) 199 A8.000	08.2008→06.2011		7.02604.55.0	LS	650 mm	
			7.02604.53.0	LS	400 mm	
1.4 TJet (955AXD1B) 110 kW (150 PS) 198 A1.000	09.2008→06.2011		7.02604.55.0	LS	650 mm	
			7.02604.53.0	LS	400 mm	
1.4 TJet (955AXG1A) 88 kW (120 PS) 198 A4.000	08.2008→		7.02604.55.0	LS	650 mm	
			7.02604.53.0	LS	400 mm	
1.6 JTDM (955AXC1B) 88 kW (120 PS) 198 A2.000, 955 A3.000	08.2008→		7.24809.77.0	AGR	ET	
			7.11190.03.0	DDS		ohne Zubehör without accessories
			7.02604.44.0	LS	500 mm	 198 A2.000, 955 A3.000: vor Katalysator in front of the catalyst





						
MITO (955_)						23
1.6 JTDM (955AXE1B) 85 kW (115 PS) 955 A4.000	08.2008→		7.24809.77.0	AGR	ET	<input checked="" type="checkbox"/>
			7.11190.03.0	DDS		ohne Zubehör without accessories
			7.02604.44.0	LS	500 mm	vor Katalysator in front of the catalyst
SPIDER (916_)						24
1.8 16V (916S3) 106 kW (144 PS) AR 32201	05.1998→04.2005		7.02604.56.0	LS	1190 mm	
2.0 JTS (916SXA00) 119-122 kW (162-166 PS) 937 A1.000	04.2003→04.2005		7.02604.55.0	LS	650 mm	
			7.05270.80.0	LS	650 mm	
2.0 T.SPARK 16V (916S2B) 114 kW (155 PS) AR 32301	05.1998→08.2000		7.02604.54.0	LS	980 mm	
			7.02604.53.0	LS	400 mm	
			7.02604.56.0	LS	1190 mm	
2.0 T.SPARK 16V (916S2C00) 110-114 kW (150-155 PS) AR 16201, AR 32310	06.1995→04.2005		7.02604.54.0	LS	980 mm	
			7.02604.53.0	LS	400 mm	
			7.02604.56.0	LS	1190 mm	
3.0 V6 (916S1) 141 kW (192 PS) AR 16199	04.1995→04.1998		7.02604.53.0	LS	400 mm	
3.0 V6 (916S1) 141 kW (192 PS) AR 16101	06.1995→04.2005		7.02604.53.0	LS	400 mm	
3.0 V6 (916S1B00) 160 kW (218 PS) AR 16105	09.1994→04.2005		7.02604.53.0	LS	400 mm	
3.0 V6 24V (916S1) 162 kW (220 PS) AR 16102	01.1999→10.2003		7.02604.53.0	LS	400 mm	
3.2 V6 24V (916SXB00) 176 kW (240 PS) 936 A6.000	04.2003→04.2005		7.02604.53.0	LS	400 mm	
SPIDER (939_)						25
1.8 TBi (939DXN1B) 147 kW (200 PS) 939 B1.000	05.2009→03.2011		7.05270.21.0	LS	600 mm	für OE-Nummer: 55204005 for OE number: 55204005
			7.02604.56.0	LS	1190 mm	
2.0 JTDM (939DXP1B, 939EXP1B) 125 kW (170 PS) 939 B3.000	05.2009→06.2010		7.24809.77.0	AGR	ET	<input checked="" type="checkbox"/>
			7.02604.44.0	LS	500 mm	vor Katalysator in front of the catalyst
2.0 JTDM (939DXQ1B) 120 kW (163 PS) 844 A2.000	04.2009→03.2011		7.24809.77.0	AGR	ET	<input checked="" type="checkbox"/>
			7.11020.09.0	ATS	EL	
			7.11190.03.0	DDS		ohne Zubehör without accessories Euro 5 Euro 5







A



SPIDER (939_)

25

<p>2.2 JTS (939EXB1B, 939EXB11) 136 kW (185 PS) 939 A5.000</p>	<p>03.2006→03.2011</p>	<p> 7.05270.21.0</p>	<p>LS</p>	<p>600 mm</p>	<p>für OE-Nummer: 55204005 for OE number: 55204005</p>
<p>2.4 JTDM (939DXM1B, 939EXM1B) 147-154 kW (200-209 PS) 939 A3.000</p>	<p>03.2008→03.2011</p>	<p> 7.00063.10.0</p>	<p>AGR</p>	<p>EL</p>	<p></p>
<p>2.4 JTDM (939EXD1B, 939EXD12) 147-154 kW (200-209 PS) 939 A3.000</p>	<p>03.2006→03.2011</p>	<p> 7.00063.10.0 7.08369.57.0 7.11190.04.0</p>	<p>ATS AGR ATS DDS</p>	<p>EL EL EL</p>	<p> Euro 4 Euro 4</p>















						A
C2 (E30)						1
2.5 136-140 kW (185-190 PS) M20 B25 (256KE1)	07.1985→03.1988		7.02604.99.0	LS	400 mm	Produktionsdatum ab: 07.1985 Production date from: 07.1985 Produktionsdatum bis: 03.1988 Production date to: 03.1988
ROADSTER V8 (E52)						2
4.8 V8 280 kW (381 PS) M62 B48 (488S2)	06.2002→10.2003		7.22295.66.0	ARV	PN  USA  USA	

A









100 C2 Avant (435, 436)						1
2.1 100 kW (136 PS) WC, WG	07.1977→07.1983		7.02604.01.0	LS	200 mm	
100 C2 Saloon (431, 433, 434)						2
2.1 96-100 kW (130-136 PS) WC, WG, WK	03.1977→07.1982		7.02604.01.0	LS	200 mm	
100 C3 Avant (445, 446)						3
2.1 100 kW (136 PS) WC	08.1982→07.1984		7.02604.01.0	LS	200 mm	
2.1 96 kW (130 PS) KF	08.1982→07.1984		7.02604.01.0	LS	200 mm	
2.2 101-103 kW (137-140 PS) KU	08.1984→12.1988		7.02604.01.0	LS	200 mm	
2.2 82-85 kW (112-116 PS) KZ	10.1984→09.1986		7.02604.01.0	LS	200 mm	
2.2 Cat 101-103 kW (137-140 PS) HX, KU	06.1989→11.1990		7.02604.01.0	LS	200 mm	
2.2 Cat quattro 101-103 kW (137-140 PS) HX, KU	06.1989→11.1990		7.02604.01.0	LS	200 mm	
2.2 E quattro 88 kW (120 PS) PX	08.1985→07.1986		7.02604.01.0	LS	200 mm	
2.2 Turbo 97-121 kW (132-165 PS) MC	08.1986→11.1990		7.02604.03.0	LS	200 mm	
2.2 Turbo quattro 97-121 kW (132-165 PS) MC	08.1986→11.1990		7.02604.03.0	LS	200 mm	
2.2 quattro 101-103 kW (137-140 PS) KU	08.1984→12.1988		7.02604.01.0	LS	200 mm	
2.3 97-100 kW (132-136 PS) NF	11.1986→11.1990		7.02604.03.0	LS	200 mm	
2.3 97-100 kW (132-136 PS) NF	03.1990→11.1990		7.02604.03.0	LS	200 mm	
2.3 E quattro 97-100 kW (132-136 PS) NF	11.1986→11.1990		7.02604.03.0	LS	200 mm	
2.3 quattro 97-100 kW (132-136 PS) NF	01.1990→11.1990		7.02604.03.0	LS	200 mm	
100 C3 Saloon (443, 444)						4
2.1 100 kW (136 PS) WC	08.1982→07.1984		7.02604.01.0	LS	200 mm	
2.2 101-103 kW (137-140 PS) KU	08.1984→12.1988		7.02604.01.0	LS	200 mm	
2.2 82-85 kW (112-116 PS) KZ	10.1984→09.1986		7.02604.01.0	LS	200 mm	
2.2 Cat 101-103 kW (137-140 PS) HX, KU	06.1989→11.1990		7.02604.01.0	LS	200 mm	
2.2 Cat quattro 101-103 kW (137-140 PS) HX, KU	06.1989→11.1990		7.02604.01.0	LS	200 mm	
2.2 E Turbo quattro 97-121 kW (132-165 PS) MC	08.1986→11.1990		7.02604.03.0	LS	200 mm	
2.2 E quattro 88 kW (120 PS) PX	08.1985→07.1986		7.02604.01.0	LS	200 mm	
2.2 Turbo 97-121 kW (132-165 PS) MC	08.1986→11.1990		7.02604.03.0	LS	200 mm	























100 C3 Saloon (443, 444)						4
2.2 quattro 101-103 kW (137-140 PS) KU	08.1984→12.1988		7.02604.01.0	LS	200 mm	
2.3 E 97-100 kW (132-136 PS) NF	11.1986→11.1990		7.02604.03.0	LS	200 mm	
2.3 E 97-100 kW (132-136 PS) NF	01.1990→11.1990		7.02604.03.0	LS	200 mm	
2.3 E quattro 97-100 kW (132-136 PS) NF	11.1986→11.1990		7.02604.03.0	LS	200 mm	
2.3 quattro 97-100 kW (132-136 PS) NF	01.1990→11.1990		7.02604.03.0	LS	200 mm	
100 C4 Avant (4A5)						5
2.3 E 98 kW (133 PS) AAR	09.1991→07.1994		7.02604.03.0	LS	200 mm	
2.3 E quattro 98 kW (133 PS) AAR	09.1991→07.1994		7.02604.03.0	LS	200 mm	
100 C4 Saloon (4A2)						6
2.3 E 98 kW (133 PS) AAR	12.1990→07.1994		7.02604.03.0	LS	200 mm	
2.3 E quattro 98 kW (133 PS) AAR	12.1990→07.1994		7.02604.03.0	LS	200 mm	
200 C3 Avant (447, 448)						7
2.2 20V Turbo quattro 162 kW (220 PS) 3B	07.1989→12.1990		7.02604.03.0	LS	200 mm	
200 C3 Saloon (447, 448)						8
2.2 20V Turbo quattro 162 kW (220 PS) 3B	03.1989→12.1990		7.02604.03.0	LS	200 mm	
80 B2 Saloon (811, 813, 814, 819, 853)						9
1.6 55 kW (75 PS) DT, JU	08.1978→03.1987		7.02604.01.0	LS	200 mm	
1.6 63 kW (85 PS) YP	08.1978→02.1983		7.02604.01.0	LS	200 mm	
1.6 51 kW (70 PS) YT, YY	08.1978→07.1981		7.02604.01.0	LS	200 mm	
1.6 55 kW (75 PS) WV, WY, YN	08.1978→07.1986		7.02604.01.0	LS	200 mm	
1.6 54 kW (73 PS) SA	02.1986→07.1986		7.02604.01.0	LS	200 mm	
1.8 66 kW (90 PS) DS, JV	01.1983→08.1986		7.02604.01.0	LS	200 mm	
1.8 66-68 kW (90-93 PS) JN	08.1983→08.1986		7.02604.01.0	LS	200 mm	
1.8 65 kW (88 PS) SF	02.1986→07.1986		7.02604.01.0	LS	200 mm	
1.8 CC quattro (85Q) 66 kW (90 PS) JV, NE	08.1984→08.1986		7.02604.03.0	LS	200 mm	
1.8 CC quattro (85Q) 66-68 kW (90-93 PS) JN	08.1985→08.1986		7.02604.01.0	LS	200 mm	
1.8 GTE 82 kW (112 PS) DZ, MU	10.1984→08.1986		7.02604.03.0	LS	200 mm	

























A

80 B2 Saloon (811, 813, 814, 819, 853)
9

1.8 GTE 79-81 kW (107-110 PS) PV	08.1985→07.1986		7.02604.03.0	LS	200 mm
1.8 GTE quattro (85Q) 82 kW (112 PS) DZ	08.1984→08.1986		7.02604.03.0	LS	200 mm
1.8 GTE quattro (85Q) 79-81 kW (107-110 PS) PV	03.1985→08.1986		7.02604.03.0	LS	200 mm
1.9 CD-5S 85 kW (115 PS) WN	09.1981→07.1983		7.02604.03.0	LS	200 mm
2.0 85 kW (115 PS) HP, JS	10.1983→09.1984		7.02604.03.0	LS	200 mm
2.0 quattro (85Q) 85 kW (115 PS) JS	10.1983→09.1984		7.02604.03.0	LS	200 mm

80 B3 Saloon (893, 894, 8A2)
10

1.6 55 kW (75 PS) RN	09.1986→08.1991		7.02604.01.0	LS	200 mm
1.6 51 kW (70 PS) PP	08.1987→09.1991		7.02604.01.0	LS	200 mm
1.6 73-75 kW (99-102 PS) ABB	08.1990→10.1991		7.02604.01.0	LS	200 mm
1.8 83 kW (113 PS) SD	09.1986→07.1988		7.02604.03.0	LS	200 mm
1.8 55 kW (75 PS) RU	10.1986→01.1990		7.02604.01.0	LS	200 mm
1.8 E 82 kW (112 PS) DZ	09.1986→08.1991		7.02604.03.0	LS	200 mm
1.8 E quattro 82 kW (112 PS) DZ	09.1986→08.1991		7.02604.03.0	LS	200 mm
1.8 S 65 kW (88 PS) SF	08.1986→01.1990		7.02604.01.0	LS	200 mm
1.8 S 66-68 kW (90-93 PS) JN, JV, NE, PM	09.1986→10.1991		7.02604.01.0	LS	200 mm
1.8 S quattro 65 kW (88 PS) SF	09.1986→07.1990		7.02604.01.0	LS	200 mm
1.8 S quattro 66-68 kW (90-93 PS) JN, NE, PM	09.1986→09.1991		7.02604.03.0	LS	200 mm
1.8 quattro 83 kW (113 PS) SD	09.1986→08.1990		7.02604.03.0	LS	200 mm
1.9 D 50 kW (68 PS) 1Y	08.1989→08.1991		7.02604.01.0	LS	200 mm
2.0 82-85 kW (112-115 PS) AAD	12.1990→08.1991		7.02604.03.0	LS	200 mm
2.0 E 80-83 kW (109-113 PS) 3A	08.1988→10.1990		7.02604.03.0	LS	200 mm
2.0 E 16V 101 kW (137 PS) 6A	03.1990→08.1991		7.02604.03.0	LS	200 mm
2.0 E 16V quattro 101 kW (137 PS) 6A	03.1990→08.1991		7.02604.03.0	LS	200 mm
2.0 E quattro 80-83 kW (109-113 PS) 3A	08.1988→09.1990		7.02604.03.0	LS	200 mm
2.0 quattro 80-83 kW (109-113 PS) 3A	08.1988→07.1990		7.02604.03.0	LS	200 mm
2.0 quattro 82-85 kW (112-115 PS) AAD	12.1990→08.1991		7.02604.03.0	LS	200 mm





						
80 B4 Avant (8C5)						11
2.0 66 kW (90 PS) ABT	07.1992→12.1994		7.02604.03.0	LS	200 mm	
2.0 E 85 kW (115 PS) ABK	07.1992→01.1996		7.02604.03.0	LS	200 mm	
2.0 E 16V 101-103 kW (137-140 PS) ACE	02.1993→01.1996		7.02604.03.0	LS	200 mm	
2.0 E 16V quattro 101-103 kW (137-140 PS) ACE	12.1992→07.1995		7.02604.03.0	LS	200 mm	
2.0 quattro 79 kW (107 PS) ADW	11.1993→01.1996		7.02604.03.0	LS	200 mm	
2.3 E 97-100 kW (132-136 PS) NG	07.1992→01.1996		7.02604.03.0	LS	200 mm	
2.3 E quattro 97-100 kW (132-136 PS) NG	09.1991→11.1994		7.02604.03.0	LS	200 mm	
80 B4 Saloon (8C2)						12
1.6 52 kW (71 PS) ABM	09.1991→12.1994		7.02604.01.0	LS	200 mm	
2.0 66 kW (90 PS) ABT	09.1991→12.1994		7.02604.03.0	LS	200 mm	
2.0 E 85 kW (115 PS) ABK	09.1991→12.1994		7.02604.03.0	LS	200 mm	
2.0 E 16V 101 kW (137 PS) 6A	09.1991→07.1992		7.02604.03.0	LS	200 mm	
2.0 E 16V 101-103 kW (137-140 PS) ACE	08.1992→12.1994		7.02604.03.0	LS	200 mm	
2.0 E 16V quattro 101-103 kW (137-140 PS) ACE	04.1992→12.1994		7.02604.03.0	LS	200 mm	
2.0 E quattro 85 kW (115 PS) ABK	09.1991→12.1994		7.02604.03.0	LS	200 mm	
2.0 quattro 79 kW (107 PS) ADW	11.1993→07.1994		7.02604.03.0	LS	200 mm	
2.3 E 97-100 kW (132-136 PS) NG	09.1991→12.1994		7.02604.03.0	LS	200 mm	
2.3 E quattro 97-100 kW (132-136 PS) NG	09.1991→12.1994		7.02604.03.0	LS	200 mm	
90 B2 (813, 814, 853)						13
2.0 85 kW (115 PS) HP, JS	10.1984→03.1987		7.02604.01.0	LS	200 mm	
2.0 83 kW (113 PS) SK	03.1987→03.1987		7.02604.01.0	LS	200 mm	
2.0 quattro 85 kW (115 PS) JS	08.1984→08.1986		7.02604.01.0	LS	200 mm	
90 B3 (893, 894, 8A2)						14
2.0 85 kW (115 PS) PS	07.1988→09.1991		7.02604.01.0	LS	200 mm	
2.3 E 97-100 kW (132-136 PS) NG	04.1987→07.1991		7.02604.03.0	LS	200 mm	
2.3 E 97-100 kW (132-136 PS) NG	03.1990→09.1991		7.02604.03.0	LS	200 mm	
2.3 E 20V 122-125 kW (166-170 PS) 7A	08.1988→07.1991		7.02604.03.0	LS	200 mm	

A











90 B3 (893, 894, 8A2)

14

2.3 E 20V 122-125 kW (166-170 PS) 7A	04.1990→07.1991		7.02604.03.0	LS	200 mm	
2.3 E 20V quattro 122-125 kW (166-170 PS) 7A	06.1988→09.1991		7.02604.03.0	LS	200 mm	
2.3 E 20V quattro 122-125 kW (166-170 PS) 7A	04.1990→09.1991		7.02604.03.0	LS	200 mm	
2.3 E quattro 97-100 kW (132-136 PS) NG	08.1989→07.1991		7.02604.03.0	LS	200 mm	
2.3 E quattro 97-100 kW (132-136 PS) NG	04.1990→09.1991		7.02604.03.0	LS	200 mm	





A1 (8X1, 8XK)

15

1.4 TFSI 90 kW (122 PS) CAXA	05.2010→04.2015		7.05271.15.0	LS	525 mm	
1.6 TDI 77 kW (105 PS) CAYC	05.2010→04.2015		7.09720.01.0	AGR-K	EL	 für Linkslenker for left-hand drive vehicles für Rechtslenker for right-hand drive vehicles
			7.08369.09.0	ATS	EL	
			7.08369.11.0	ATS	EL	
			7.08369.26.0	ATS	EL	
1.6 TDI 66 kW (90 PS) CAYB	03.2011→04.2015		7.11190.09.0	DDS	EL	
			7.09720.01.0	AGR-K	EL	 für Linkslenker for left-hand drive vehicles für Rechtslenker for right-hand drive vehicles
			7.08369.09.0	ATS	EL	
			7.08369.11.0	ATS	EL	
7.08369.26.0	ATS	EL				
2.0 TDI 105 kW (143 PS) CFHD	09.2011→04.2015		7.11190.09.0	DDS	EL	
			7.09720.01.0	AGR-K	EL	
2.0 TDI 100 kW (136 PS) CFHB	05.2012→04.2015		7.09720.01.0	AGR-K	EL	
			7.11190.09.0	DDS		

A1 Sportback (8XA, 8XF)

16

1.4 TFSI 90 kW (122 PS) CAXA	11.2011→04.2015		7.05271.15.0	LS	525 mm	
1.6 TDI 66 kW (90 PS) CAYB	11.2011→04.2015		7.09720.01.0	AGR-K	EL	 für Rechtslenker for right-hand drive vehicles
			7.08369.09.0	ATS	EL	
			7.08369.11.0	ATS	EL	
			7.08369.26.0	ATS	EL	
1.6 TDI 77 kW (105 PS) CAYC	11.2011→04.2015		7.11190.09.0	DDS	EL	 für Linkslenker for left-hand drive vehicles für Rechtslenker for right-hand drive vehicles
			7.09720.01.0	AGR-K	EL	
			7.08369.09.0	ATS	EL	
			7.08369.11.0	ATS	EL	
			7.08369.26.0	ATS	EL	
			7.11190.09.0	DDS		

A1 Sportback (8XA, 8XF)						16
2.0 TDI 105 kW (143 PS) CFHD	09.2011→04.2015		7.09720.01.0	AGR-K	EL	
			7.11190.09.0	DDS		
2.0 TDI 100 kW (136 PS) CFHB	05.2012→04.2015		7.09720.01.0	AGR-K	EL	
			7.11190.09.0	DDS		
A2 (8Z0)						17
1.2 TDI 45 kW (61 PS) ANY	03.2001→08.2005		7.24809.17.0	AGR	PN	
1.4 55 kW (75 PS) AUA, BBY	02.2000→08.2005		7.28248.17.0	AGR	EL	
			7.22785.17.0	AGR	EL	AUA, BBY: ch. 8Z-2-000 001→
			7.05271.05.0	LS	700 mm	AUA, BBY: →ch. 8Z-1-070 000 AUA, BBY: nach Katalysator Post-catalyst
1.4 TDI 55 kW (75 PS) AMF	02.2000→08.2005		7.24809.57.0	AGR	PN	
1.4 TDI 55 kW (75 PS) BHC	02.2000→08.2005		7.24809.31.0	AGR	PN	
1.4 TDI 66 kW (90 PS) ATL	11.2003→08.2005		7.24809.31.0	AGR	PN	
1.6 FSI 81 kW (110 PS) BAD	05.2002→08.2005		7.08369.34.0	ATS	EL	
A3 (8L1)						18
1.6 74 kW (101 PS) AEH	09.1996→05.2003		7.05271.03.0	LS	730 mm	→ch. 8L-V-095 000 Regelsonde Regulating Probe
			7.05271.04.0	LS	505 mm	ch. 8L-V-095 001→ch. 8L-W-150 000
			7.05271.21.0	LS	1250 mm	ch. 8L-X-000 001→ Regelsonde Regulating Probe
1.6 74 kW (101 PS) AKL	08.1997→05.2003		7.05271.04.0	LS	505 mm	ch. 8L-V-095 001→ch. 8L-W-150 000
			7.05271.21.0	LS	1250 mm	ch. 8L-X-000 001→ Regelsonde Regulating Probe
1.6 74 kW (101 PS) APF	08.1998→05.2003		7.22574.12.0	AGR	EL	
			7.22286.41.0	ARV	PN	
			7.05271.24.0	LS	1500 mm	vor Katalysator in front of the catalyst
			7.22738.08.0	SLP	EL	
1.6 75 kW (102 PS) AVU, BFQ	08.2000→05.2003		7.22574.12.0	AGR	EL	
			7.05271.24.0	LS	1500 mm	AVU, BFQ: vor Katalysator in front of the catalyst
			7.22738.08.0	SLP	EL	
			7.22778.96.0	SLV	PN	
1.8 92 kW (125 PS) AGN	09.1996→05.2003		7.05271.03.0	LS	730 mm	
			7.05271.05.0	LS	700 mm	ch. 8L-V-106 586→
1.8 92 kW (125 PS) APG	08.1998→05.2003		7.22785.18.0	AGR	EL	
			7.22286.26.0	ARV	PN	
			7.22769.73.0	ARV	PN	
			7.05271.23.0	LS	900 mm	

A



A3 (8L1)

18

			7.22738.08.0	SLP	EL	
1.8 T 110 kW (150 PS) AGU	12.1996→05.2003		7.22769.73.0	ARV	PN	
			7.05271.03.0	LS	730 mm	ch. 8L-W-000 001→ Regelsonde Regulating Probe
			7.21851.31.0	SLP	EL	
1.8 T 110 kW (150 PS) AUM	12.1996→05.2003		7.22769.73.0	ARV	PN	
			7.05271.01.0	LS	950 mm	Diagnosesonde Diagnostic Probe
			7.05271.23.0	LS	900 mm	
			7.05271.24.0	LS	1500 mm	vor Katalysator in front of the catalyst
7.21851.31.0	SLP	EL				
1.8 T 110 kW (150 PS) AQA	08.1998→05.2003		7.05270.89.0	LS	925 mm	Allrad All-wheel Drive Regelsonde Regulating Probe
1.8 T 110 kW (150 PS) ARZ	08.1998→05.2003		7.22769.73.0	ARV	PN	
			7.21851.31.0	SLP	EL	
1.8 T 132 kW (180 PS) AJQ	12.1998→05.2003		7.05270.89.0	LS	925 mm	Allrad All-wheel Drive Regelsonde Regulating Probe
1.8 T 132 kW (180 PS) APP	12.1998→05.2003		7.22769.73.0	ARV	PN	
			7.21851.31.0	SLP	EL	
1.8 T 132 kW (180 PS) ARY, AUQ	12.1998→05.2003		7.22769.73.0	ARV	PN	
			7.05271.01.0	LS	950 mm	ARY, AUQ: Diagnosesonde Diagnostic Probe
			7.05271.23.0	LS	900 mm	
			7.05271.24.0	LS	1500 mm	ARY, AUQ: vor Katalysator in front of the catalyst
7.21851.31.0	SLP	EL				
1.8 T quattro 110 kW (150 PS) AGU	12.1996→05.2003		7.22769.73.0	ARV	PN	
			7.05271.03.0	LS	730 mm	ch. 8L-W-000 001→ Regelsonde Regulating Probe
			7.21851.31.0	SLP	EL	
1.8 T quattro 110 kW (150 PS) ARX	12.1996→05.2003		7.22769.73.0	ARV	PN	
			7.05271.01.0	LS	950 mm	Diagnosesonde Diagnostic Probe
			7.05271.23.0	LS	900 mm	
			7.05271.24.0	LS	1500 mm	vor Katalysator in front of the catalyst
7.21851.31.0	SLP	EL				
1.8 T quattro 110 kW (150 PS) AQA	08.1998→05.2003		7.05270.89.0	LS	925 mm	Allrad All-wheel Drive Regelsonde Regulating Probe
1.8 T quattro 132 kW (180 PS) AJQ	10.1998→05.2003		7.05270.89.0	LS	925 mm	Allrad All-wheel Drive Regelsonde Regulating Probe















A3 (8L1)						18
1.8 T quattro 132 kW (180 PS) ARY	10.1998→05.2003		7.22769.73.0	ARV	PN	
			7.05271.01.0	LS	950 mm	Diagnosesonde Diagnostic Probe
			7.05271.23.0	LS	900 mm	
			7.05271.24.0	LS	1500 mm	vor Katalysator in front of the catalyst
			7.21851.31.0	SLP	EL	
1.9 TDI 66 kW (90 PS) AGR, ALH	09.1996→07.2001		7.24809.17.0	AGR	PN	ch. 8L-V-110 000→
1.9 TDI 81 kW (110 PS) AHF, ASV	08.1997→07.2001		7.24809.17.0	AGR	PN	
1.9 TDI 96 kW (130 PS) ASZ	08.2000→05.2003		7.24809.26.0	AGR	PN	
1.9 TDI 74 kW (101 PS) ATD	10.2000→05.2003		7.24809.17.0	AGR	PN	
1.9 TDI 74 kW (100 PS) AXR	11.2001→05.2003		7.24809.16.0	AGR	PN	
1.9 TDI quattro 96 kW (130 PS) ASZ	08.2000→05.2003		7.24809.26.0	AGR	PN	
S3 quattro 154 kW (209 PS) AMK	03.1999→04.2002		7.05270.99.0	LS	940 mm	ch. 8L-1A060 001→ Diagnosesonde Diagnostic Probe
			7.05270.89.0	LS	925 mm	→ch. 8L-1-060 000 Diagnosesonde Diagnostic Probe
			7.05271.77.0	LS	800 mm	vor Katalysator in front of the catalyst
S3 quattro 154 kW (209 PS) APY	03.1999→04.2002		7.22769.73.0	ARV	PN	
			7.05271.02.0	LS	500 mm	Regelsonde Regulating Probe
			7.21851.31.0	SLP	EL	
S3 quattro 154 kW (209 PS) AUL	03.1999→04.2002		7.22769.73.0	ARV	PN	
			7.05270.99.0	LS	940 mm	ch. 8L-1A060 001→ Diagnosesonde Diagnostic Probe
			7.05270.89.0	LS	925 mm	→ch. 8L-1-060 000 Diagnosesonde Diagnostic Probe
			7.05271.77.0	LS	800 mm	vor Katalysator in front of the catalyst
S3 quattro 165 kW (224 PS) BAM	10.2001→05.2003		7.05270.99.0	LS	940 mm	ch. 8L-1A060 001→ Diagnosesonde Diagnostic Probe
			7.05271.77.0	LS	800 mm	vor Katalysator in front of the catalyst
A3 (8P1)						19
1.4 TFSI 92 kW (125 PS) CAXC	09.2007→08.2012		7.05271.18.0	LS	525 mm	für Schaltgetriebe for manual transmission Euro 4
1.6 75 kW (102 PS) BGU	05.2003→08.2012		7.22574.12.0	AGR	EL	01.2004→12.2005
			7.05271.18.0	LS	525 mm	
			7.22738.08.0	SLP	EL	
			7.22778.96.0	SLV	PN	

A



A3 (8P1)

19

1.6 75 kW (102 PS) BSE, BSF	05.2003→08.2012	 7.05271.18.0	LS	525 mm	
		7.22738.08.0	SLP	EL	
		7.22778.96.0	SLV	PN	⊗
1.6 E-Power 75 kW (102 PS) CCSA, CMXA	01.2011→08.2012	 7.22738.08.0	SLP	EL	
		7.22778.96.0	SLV	PN	⊗
1.6 FSI 85 kW (115 PS) BAG	08.2003→09.2007	 7.10334.04.0	AGR	EL	⊗
		7.08369.34.0	ATS	EL	
1.6 FSI 85 kW (115 PS) BLF	08.2003→09.2007	 7.10334.04.0	AGR	EL	⊗
		7.05271.15.0	LS	525 mm	
		7.05271.30.0	LS	400 mm	
1.6 FSI 85 kW (115 PS) BLP	06.2004→09.2007	 7.10334.04.0	AGR	EL	⊗
		7.08369.41.0	ATS	EL	
		7.05271.30.0	LS	400 mm	
1.6 TDI 66 kW (90 PS) CAYB	05.2009→08.2012	 7.08369.01.0	ATS	EL	
		7.08369.04.0	ATS	EL	
		7.11492.00.0	DDS		ohne Zubehör without accessories
1.6 TDI 77 kW (105 PS) CAYC	05.2009→08.2012	 7.09720.00.0	AGR-K	EL	⊗
		7.08369.01.0	ATS	EL	
		7.08369.04.0	ATS	EL	
		7.11492.00.0	DDS		ohne Zubehör without accessories
1.8 TFSI 118 kW (160 PS) BYT	11.2006→08.2012	 7.05271.19.0	LS	975 mm	Regelsonde Regulating Probe
1.8 TFSI 118 kW (160 PS) BZB	11.2006→08.2012	 7.05271.11.0	LS	800 mm	Regelsonde Regulating Probe
1.8 TFSI 118 kW (160 PS) CDAA	11.2006→08.2012	 7.05271.15.0	LS	525 mm	
1.8 TFSI quattro 118 kW (160 PS) CDAA	07.2008→08.2012	 7.05271.15.0	LS	525 mm	
1.9 TDI 77 kW (105 PS) BKC, BXE	05.2003→05.2010	 7.24809.16.0	AGR	PN	⊗
1.9 TDI 77 kW (105 PS) BLS	05.2003→05.2010	 7.00678.04.0*	AGR-M	EL	mit Rohrstutzen with pipe socket
		↳ 7.00907.03.0	AGR	EL	
		7.00678.06.0	AGR-M	EL	
		7.08369.00.0	ATS	EL	
		7.08369.02.0	ATS	EL	
		7.08369.03.0	ATS	EL	
7.11492.02.0	DDS		ohne Zubehör without accessories		
2.0 FSI 110 kW (150 PS) AXW, BLX	05.2003→06.2008	 7.10334.09.0	AGR	EL	⊗ AXW, BLX: →11.2006
		7.08369.41.0	ATS	EL	
		7.05271.16.0	LS	1300 mm	⊗ AXW, BLX: links, rechts Left, Right Diagnosesonde Diagnostic Probe











A3 (8P1)						19
2.0 FSI 110 kW (150 PS) BLR, BVY, BVZ	05.2003→06.2008		7.10334.09.0	AGR	EL	BLR, BVY: →11.2006
			7.05271.16.0	LS	1300 mm	BLR, BVY, BVZ: Diagnosesonde Diagnostic Probe
2.0 FSI 110 kW (150 PS) BLY, BMB	01.2004→06.2008		7.05271.16.0	LS	1300 mm	BLY: Diagnosesonde Diagnostic Probe BMB: links, rechts Left, Right Diagnosesonde Diagnostic Probe
2.0 TDI 100 kW (136 PS) AZV	05.2003→08.2012		7.24809.16.0	AGR	PN	
2.0 TDI 100 kW (136 PS) CBAA	05.2003→08.2012		7.10334.00.0	AGR	EL	 ohne Zubehör without accessories Euro 5, Euro 4 Euro 5, Euro 4
			7.08369.01.0	ATS	EL	
			7.08369.04.0	ATS	EL	
			7.11492.02.0	DDS		
2.0 TDI 100 kW (136 PS) CFFA	05.2003→08.2012		7.09720.00.0	AGR-K	EL	
			7.11190.09.0	DDS		Euro 5 Euro 5
2.0 TDI 103 kW (140 PS) BMM	06.2005→06.2008		7.00678.04.0*	AGR-M	EL	mit Rohrstützen with pipe socket ohne Zubehör without accessories
			↳ 7.00907.03.0	AGR	EL	
			7.00678.06.0	AGR-M	EL	
			7.08369.00.0	ATS	EL	
			7.08369.02.0	ATS	EL	
			7.08369.03.0	ATS	EL	
			7.11492.02.0	DDS		
2.0 TDI 125 kW (170 PS) BMN	03.2006→08.2012		7.08369.00.0	ATS	EL	ohne Zubehör without accessories
			7.08369.02.0	ATS	EL	
			7.08369.03.0	ATS	EL	
			7.11492.02.0	DDS		
2.0 TDI 125 kW (170 PS) CBBB	03.2006→08.2012		7.10334.00.0	AGR	EL	 ohne Zubehör without accessories Euro 5, Euro 4 Euro 5, Euro 4
			7.08369.00.0	ATS	EL	
			7.08369.01.0	ATS	EL	
			7.08369.04.0	ATS	EL	
7.11492.02.0	DDS					
2.0 TDI 125 kW (170 PS) CFGB	03.2006→08.2012		7.09720.00.0	AGR-K	EL	
			7.11190.09.0	DDS		Euro 5 Euro 5
2.0 TDI 120 kW (163 PS) BUY	06.2006→06.2008		7.08369.00.0	ATS	EL	ohne Zubehör without accessories
			7.08369.02.0	ATS	EL	
			7.08369.03.0	ATS	EL	
			7.11492.02.0	DDS		
2.0 TDI 16V 103 kW (140 PS) BKD	05.2003→08.2012		7.24809.16.0	AGR	PN	

A



A3 (8P1)

19

2.0 TDI 16V 103 kW (140 PS) CBAB	05.2003→08.2012		7.10334.00.0	AGR	EL	<input type="checkbox"/> ohne Zubehör without accessories Euro 5, Euro 4 Euro 5, Euro 4
			7.08369.01.0	ATS	EL	
			7.08369.04.0	ATS	EL	
			7.11492.02.0	DDS		
2.0 TDI 16V 103-104 kW (140-141 PS) CBEA	05.2003→08.2012		7.08369.01.0	ATS	EL	Baujahr ab: 01.2009 Construction year from: 01.2009 USA USA
2.0 TDI 16V 103 kW (140 PS) CFFB	05.2003→08.2012		7.09720.00.0	AGR-K	EL	<input type="checkbox"/> Euro 5 Euro 5
			7.11190.09.0	DDS		
2.0 TDI 16V 103 kW (140 PS) CLJA	05.2003→08.2012		7.09720.00.0	AGR-K	EL	<input type="checkbox"/>
2.0 TDI 16V quattro 103 kW (140 PS) BKD	08.2004→08.2012		7.24809.16.0	AGR	PN	<input type="checkbox"/>
2.0 TDI 16V quattro 103 kW (140 PS) CBAB	08.2004→08.2012		7.08369.01.0	ATS	EL	ohne Zubehör without accessories Euro 5, Euro 4 Euro 5, Euro 4
			7.08369.04.0	ATS	EL	
			7.11492.02.0	DDS		
2.0 TDI 16V quattro 103 kW (140 PS) CFFB	08.2004→08.2012		7.09720.00.0	AGR-K	EL	<input type="checkbox"/> Euro 5 Euro 5
			7.11190.09.0	DDS		
2.0 TDI quattro 100 kW (136 PS) AZV	05.2003→06.2008		7.24809.16.0	AGR	PN	<input type="checkbox"/>
2.0 TDI quattro 103 kW (140 PS) BMM	01.2006→06.2008		7.00678.04.0*	AGR-M	EL	mit Rohrstutzen with pipe socket ohne Zubehör without accessories
			↳ 7.00907.03.0	AGR	EL	
			7.00678.06.0	AGR-M	EL	
			7.08369.00.0	ATS	EL	
			7.08369.02.0	ATS	EL	
			7.08369.03.0	ATS	EL	
			7.11492.02.0	DDS		
2.0 TDI quattro 125 kW (170 PS) BMN	03.2006→08.2012		7.10334.00.0	AGR	EL	<input type="checkbox"/> ohne Zubehör without accessories
			7.08369.00.0	ATS	EL	
			7.08369.02.0	ATS	EL	
			7.08369.03.0	ATS	EL	
			7.11492.02.0	DDS		
2.0 TDI quattro 125 kW (170 PS) CBBB	03.2006→08.2012		7.10334.00.0	AGR	EL	<input type="checkbox"/> ohne Zubehör without accessories Euro 5, Euro 4 Euro 5, Euro 4
			7.08369.00.0	ATS	EL	
			7.08369.01.0	ATS	EL	
			7.08369.04.0	ATS	EL	
			7.11492.02.0	DDS		









































A3 (8P1)						19
2.0 TDI quattro 125 kW (170 PS) CFGB	03.2006→08.2012		7.09720.00.0	AGR-K	EL	
			7.11190.09.0	DDS		Euro 5 Euro 5
2.0 TFSI 147 kW (200 PS) BWA, CCZA	09.2004→08.2012		7.05271.15.0	LS	525 mm	
2.0 TFSI 147 kW (200 PS) CAWB	09.2004→08.2012		7.05271.11.0	LS	800 mm	Regelsonde Regulating Probe
2.0 TFSI quattro 147 kW (200 PS) BWA, CCZA	09.2004→08.2012		7.05271.15.0	LS	525 mm	
2.0 TFSI quattro 147 kW (200 PS) CBFA	09.2004→08.2012		7.01510.31.0	SLV	EL	 CBFA: USA USA 2008 2008 2008 2008 CBFA: 2009 2009
3.2 V6 quattro 184 kW (250 PS) BDB, BMJ	07.2003→05.2009		7.22286.55.0	ARV	PN	 BDB, BMJ: →ch. 8P-7A034 719
			7.05271.15.0	LS	525 mm	BDB, BMJ: →ch. 8P-7-250 000 für Zylinder: 1-3 for cylinder: 1-3
			7.22738.20.0	SLP	EL	
			7.22778.98.0	SLV	PN	 BDB, BMJ: ch. 8P-7A034 720→
3.2 V6 quattro 184-186 kW (250-253 PS) BUB	07.2003→05.2009		7.22286.55.0	ARV	PN	 →ch. 8P-7A034 719
			7.05271.28.0	LS	800 mm	ch. 8P-6A093 287→ch. 8P-7A250 000 für Zylinder: 4-6 for cylinder: 4-6
			7.05271.15.0	LS	525 mm	für Zylinder: 1-3 for cylinder: 1-3
			7.22738.20.0	SLP	EL	
			7.22778.98.0	SLV	PN	 ch. 8P-7A034 720→
S3 quattro 195 kW (265 PS) BHZ	11.2006→08.2012		7.05271.15.0	LS	525 mm	
A3 (8V1, 8VK)						20
1.4 TSI 110 kW (150 PS) CZEA	05.2014→12.2017		7.03635.38.0	SLP	EL	Fahrgestellnummer ab: 8V-L-000 001 Vehicle Identification Number from: 8V-L-000 001
1.6 TDI 77 kW (105 PS) CLHA	10.2012→05.2015		7.10334.02.0	AGR	EL	 ch. 8V-D-000 001→
			7.03608.16.0	AK	EL	ch. 8V-D-000 001→
			7.08369.82.0	ATS	EL	ch. 8V-D-000 001→
			7.08369.79.0	ATS	EL	ch. 8V-D-000 001 →
			7.11492.03.0	DDS		ohne Zubehör without accessories ch. 8V-D-000 001→
1.6 TDI 81 kW (110 PS) CRKB	09.2013→12.2017		7.03608.16.0	AK	EL	→05.2016, ch. 8V-D-000 001→
			7.08369.79.0	ATS	EL	ch. 8V-D-000 001→
			7.08369.82.0	ATS	EL	ch. 8V-D-000 001→
			7.11020.18.0	ATS	EL	ch. 8V-D-000 001→ vor Katalysator in front of the catalyst

A



A3 (8V1, 8VK)

20

			7.11492.03.0	DDS		ohne Zubehör without accessories  ch. 8V-D-000 001→ für Hersteller-Abgasnorm: Euro 6 plus for manufacturer exhaust norm: Euro 6 plus
1.6 TDI 81 kW (110 PS) CXXB, DBKA	09.2013→12.2017		7.10334.02.0	AGR	EL	 CXXB, DBKA:  ch. 8V-D-000 001→
			7.03608.16.0	AK	EL	 CXXB, DBKA: →05.2016,  ch. 8V-D-000 001→
			7.08369.95.0	ATS	EL	 CXXB, DBKA:  ch. 8V-D-000 001→
			7.11020.17.0	ATS	EL	 CXXB, DBKA:  ch. 8V-D-000 001→ vor Katalysator in front of the catalyst
			7.11492.03.0	DDS		ohne Zubehör without accessories  CXXB, DBKA:  ch. 8V-D-000 001→
1.6 TDI 85 kW (115 PS) DDYA	02.2017→10.2020		7.10334.02.0	AGR	EL	
			7.08369.95.0	ATS	EL	
			7.11492.05.0	DDS		ohne Zubehör without accessories  ch. 8V-L-000001→
2.0 TDI 110 kW (150 PS) CRBC, CRLB	04.2012→12.2017		7.10334.02.0	AGR	EL	 CRBC, CRLB:  ch. 8V-D-000 001→
			7.03608.16.0	AK	EL	 CRBC, CRLB:  ch. 8V-D-000 001→
			7.07696.00.0	SRM-AK	EL	
			7.08369.81.0	ATS	EL	 CRBC, CRLB:  ch. 8V-D-000 001→
			7.11492.03.0	DDS		ohne Zubehör without accessories  CRBC:  ch. 8V-D-000 001→  CRLB:  ch. 8V-D-000 001→ Produktionsdatum bis: 01.05.2017 Production date to: 01.05.2017
2.0 TDI 110 kW (150 PS) CRUA	04.2012→12.2017		7.10334.02.0	AGR	EL	  ch. 8V-D-000 001→
			7.08369.81.0	ATS	EL	 ch. 8V-D-000 001→
			7.11492.03.0	DDS		ohne Zubehör without accessories  ch. 8V-D-000 001→
			7.07696.00.0	SRM-AK	EL	 ch. 8V-D-000 001→
2.0 TDI 110 kW (150 PS) DBGA	04.2012→12.2017		7.10334.02.0	AGR	EL	  ch. 8V-D-000 001→
			7.03608.16.0	AK	EL	 ch. 8V-D-000 001→
			7.08369.81.0	ATS	EL	 ch. 8V-D-000 001→
			7.11492.03.0	DDS		ohne Zubehör without accessories  ch. 8V-D-000 001→
2.0 TDI 110 kW (150 PS) DCYA	04.2012→12.2017		7.08369.81.0	ATS	EL	 ch. 8V-D-000 001→
			7.11492.05.0	DDS		ohne Zubehör without accessories  ch. 8V-L-000001→ für PR-Nummer: 7MM, 7MW for PR number: 7MM, 7MW Produktionsdatum ab: 01.05.2017 Production date from: 01.05.2017

						A
A3 (8V1, 8VK)						20
2.0 TDI 110 kW (150 PS) DEJA	04.2012→12.2017	7.10334.02.0 7.11492.03.0	AGR DDS	EL	ch. 8V-D-000 001→ ohne Zubehör without accessories ch. 8V-D-000 001→	
2.0 TDI 81 kW (110 PS) CRFA	01.2013→08.2016	7.11492.05.0 7.11492.03.0	DDS DDS		ohne Zubehör without accessories ch. 8V-L-000001→ für PR-Nummer: 7MM, 7MW for PR number: 7MM, 7MW Produktionsdatum ab: 01.05.2017 Production date from: 01.05.2017 ohne Zubehör without accessories für PR-Nummer: 7MM, 7MW for PR number: 7MM, 7MW Produktionsdatum bis: 01.05.2017 Production date to: 01.05.2017	
2.0 TDI 135 kW (184 PS) CUNA	05.2013→08.2016	7.10334.02.0 7.03608.16.0 ↳ 7.07696.00.0 7.08369.81.0 7.11492.03.0	AGR AK SRM-AK ATS DDS	EL EL EL EL	ch. 8V-D-000 001→ ch. 8V-D-000 001→ ch. 8V-D-000 001→ ohne Zubehör without accessories ch. 8V-D-000 001→	
2.0 TDI 100 kW (136 PS) CRBD, CRLC	05.2013→08.2016	7.10334.02.0 7.03608.16.0 ↳ 7.07696.00.0 7.08369.81.0 7.11492.03.0	AGR AK SRM-AK ATS DDS	EL EL EL EL	CRBD, CRLC: ch. 8V-D-000 001→ CRBD, CRLC: ch. 8V-D-000 001→ CRBD, CRLC: ch. 8V-D-000 001→ ohne Zubehör without accessories CRBD, CRLC: ch. 8V-D-000 001→	
2.0 TDI quattro 110 kW (150 PS) CRBC	10.2012→12.2017	7.03608.16.0 ↳ 7.07696.00.0 7.08369.81.0 7.11492.03.0	AK SRM-AK ATS DDS	EL EL EL	ch. 8V-D-000 001→ ch. 8V-D-000 001→ ohne Zubehör without accessories ch. 8V-D-000 001→	
2.0 TDI quattro 110 kW (150 PS) CRLB	10.2012→12.2017	7.03608.16.0 7.08369.81.0 7.11492.03.0	AK ATS DDS	EL EL	ch. 8V-D-000 001→ ch. 8V-D-000 001→ ohne Zubehör without accessories ch. 8V-D-000 001→ Produktionsdatum bis: 01.05.2017 Production date to: 01.05.2017	
2.0 TDI quattro 110 kW (150 PS) DCYA	10.2012→12.2017	7.08369.81.0 7.11492.05.0	ATS DDS	EL	ohne Zubehör without accessories ch. 8V-L-000001→ für PR-Nummer: 7MM, 7MW for PR number: 7MM, 7MW Produktionsdatum ab: 01.05.2017 Production date from: 01.05.2017	
2.0 TDI quattro 135 kW (184 PS) CUNA	12.2012→12.2017	7.03608.16.0	AK	EL	ch. 8V-D-000 001→	

A



A3 (8V1, 8VK)

20

			↳ 7.07696.00.0 7.08369.81.0 7.11492.03.0	SRM-AK ATS DDS	EL EL	ch. 8V-D-000 001→ ohne Zubehör without accessories ch. 8V-D-000 001→
2.0 TDI quattro 135 kW (184 PS) DGCA	12.2012→12.2017		7.08369.81.0	ATS	EL	

A3 Convertible (8P7)

21

1.6 75 kW (102 PS) BSE	09.2008→05.2010		7.05271.18.0 7.22738.08.0 7.22778.96.0	LS SLP SLV	525 mm EL PN	
1.6 TDI 77 kW (105 PS) CAYC	05.2009→05.2013		7.09720.00.0 7.08369.01.0 7.08369.04.0 7.11492.00.0	AGR-K ATS ATS DDS	EL EL EL	 ohne Zubehör without accessories
1.8 TFSI 118 kW (160 PS) BZB	04.2008→05.2013		7.05271.11.0	LS	800 mm	Regelsonde Regulating Probe
1.8 TFSI 118 kW (160 PS) CDA A	04.2008→05.2013		7.05271.15.0	LS	525 mm	
1.9 TDI 77 kW (105 PS) BLS	04.2008→10.2009		7.00678.04.0* ↳ 7.00907.03.0 7.00678.06.0 7.08369.00.0 7.08369.02.0 7.08369.03.0 7.11492.02.0	AGR-M AGR AGR-M ATS ATS ATS DDS	EL EL EL EL EL	mit Rohrstützen with pipe socket ohne Zubehör without accessories
2.0 TDI 103 kW (140 PS) CBAB	04.2008→05.2013		7.10334.00.0 7.08369.01.0 7.08369.04.0 7.11492.02.0	AGR ATS ATS DDS	EL EL EL	 ohne Zubehör without accessories
2.0 TDI 103 kW (140 PS) CFFB	04.2008→05.2013		7.09720.00.0 7.11190.09.0	AGR-K DDS	EL	
2.0 TDI 100 kW (136 PS) CBAA	04.2008→05.2013		7.10334.00.0 7.08369.01.0 7.08369.04.0 7.11492.02.0	AGR ATS ATS DDS	EL EL EL	 ohne Zubehör without accessories
2.0 TDI 100 kW (136 PS) CFFA	04.2008→05.2013		7.09720.00.0 7.11190.09.0	AGR-K DDS	EL	
2.0 TFSI 147 kW (200 PS) CAWB	04.2008→05.2013		7.05271.11.0	LS	800 mm	Regelsonde Regulating Probe
2.0 TFSI 147 kW (200 PS) CCZA	04.2008→05.2013		7.05271.15.0	LS	525 mm	

A3 Convertible (8V7, 8VE)

22

1.6 TDI 81 kW (110 PS) CRKB	02.2014→10.2020		7.10334.02.0 7.03608.16.0	AGR AK	EL EL	 ch. 8V-D-000 001→
--------------------------------	-----------------	--	------------------------------	-----------	----------	-----------------------

A3 Convertible (8V7, 8VE)						22
			7.08369.79.0 ATS EL 7.08369.82.0 ATS EL 7.11020.18.0 ATS EL 7.11492.03.0 DDS			vor Katalysator in front of the catalyst ohne Zubehör without accessories für OE-Nummer: 03L 906 051 B, 03L 906 051 D, 03N 906 051 B for OE number: 03L 906 051 B, 03L 906 051 D, 03N 906 051 B
1.6 TDI 81 kW (110 PS) CXXB	02.2014→10.2020		7.10334.02.0 AGR EL 7.03608.16.0 AK EL 7.08369.79.0 ATS EL 7.08369.95.0 ATS EL 7.11020.17.0 ATS EL 7.11492.03.0 DDS			ch. 8V-D-000 001→ →05.2016 vor Katalysator in front of the catalyst ohne Zubehör without accessories
1.6 TDI 85 kW (115 PS) DDYA	04.2017→10.2020		7.08369.95.0 ATS EL 7.11492.05.0 DDS			ohne Zubehör without accessories
1.8 TFSI 125 kW (170 PS) CNSB	05.2014→10.2020		7.03635.39.0 SLP EL 7.01510.85.0 SLV EL 7.01510.86.0 SLV EL			Produktionsdatum ab: 02.11.2015 Production date from: 02.11.2015 Produktionsdatum bis: 02.11.2015 Production date to: 02.11.2015
2.0 TDI 110 kW (150 PS) CRLB	10.2013→10.2020		7.03608.16.0 AK EL ↳ 7.07696.00.0 SRM-AK EL 7.08369.81.0 ATS EL 7.11492.03.0 DDS			ohne Zubehör without accessories
2.0 TDI 110 kW (150 PS) DCYA	10.2013→10.2020		7.08369.81.0 ATS EL 7.11492.03.0 DDS			ohne Zubehör without accessories
2.0 TDI 100 kW (136 PS) CRLC	10.2013→		7.03608.16.0 AK EL ↳ 7.07696.00.0 SRM-AK EL 7.08369.81.0 ATS EL 7.11492.03.0 DDS			ohne Zubehör without accessories
2.0 TDI 135 kW (184 PS) CUNA	05.2014→		7.10334.02.0 AGR EL 7.03608.16.0 AK EL ↳ 7.07696.00.0 SRM-AK EL 7.08369.81.0 ATS EL 7.11492.03.0 DDS			ch. 8V-D-000 001→ ohne Zubehör without accessories
2.0 TDI quattro 110 kW (150 PS) CRLB	03.2014→10.2020		7.03608.16.0 AK EL ↳ 7.07696.00.0 SRM-AK EL 7.08369.81.0 ATS EL 7.11492.03.0 DDS			ohne Zubehör without accessories
2.0 TDI quattro 110 kW (150 PS) DCYA	03.2014→10.2020		7.08369.81.0 ATS EL			

A



A3 Convertible (8V7, 8VE)

22

			7.11492.03.0	DDS		ohne Zubehör without accessories
2.0 TDI quattro 135 kW (184 PS) CUNA	05.2014→10.2020		7.03608.16.0	AK	EL	ohne Zubehör without accessories
			↳ 7.07696.00.0	SRM-AK	EL	
			7.08369.81.0	ATS	EL	
			7.11492.03.0	DDS		
2.0 TDI quattro 135 kW (184 PS) DGCA	05.2014→10.2020		7.08369.81.0	ATS	EL	ohne Zubehör without accessories
			7.11492.03.0	DDS		
2.0 TFSI 137 kW (186 PS) CZRA	09.2016→10.2020		7.03635.39.0	SLP	EL	
			7.01510.85.0	SLV	EL	
2.0 TFSI quattro 162 kW (220 PS) CNTC	05.2014→10.2020		7.03635.39.0	SLP	EL	Produktionsdatum ab: 02.11.2015 Production date from: 02.11.2015 Produktionsdatum bis: 02.11.2015 Production date to: 02.11.2015
			7.01510.85.0	SLV	EL	
			7.01510.86.0	SLV	EL	

A3 Limousine (8VS, 8VM)

23

1.4 TFSI 103 kW (140 PS) CPTA	05.2013→		7.03635.38.0	SLP	EL	Fahrgestellnummer ab: 8V-L-000 001 Vehicle Identification Number from: 8V-L-000 001
1.4 TFSI 90 kW (122 PS) CXSA	09.2013→10.2020		7.03635.38.0	SLP	EL	Fahrgestellnummer ab: 8V-L-000 001 Vehicle Identification Number from: 8V-L-000 001
1.4 TSI 110 kW (150 PS) CZEA	05.2014→10.2020		7.03635.38.0	SLP	EL	Fahrgestellnummer ab: 8V-L-000 001 Vehicle Identification Number from: 8V-L-000 001
1.6 TDI 77 kW (105 PS) CLHA	09.2013→		7.10334.02.0	AGR	EL	ch. 8V-D-000 001→
			7.03608.16.0	AK	EL	ch. 8V-D-000 001→
			7.08369.79.0	ATS	EL	ch. 8V-D-000 001→
			7.08369.82.0	ATS	EL	ch. 8V-D-000 001→
			7.11492.03.0	DDS		ohne Zubehör without accessories ch. 8V-D-000 001→
1.6 TDI 81 kW (110 PS) CRKB	05.2014→10.2020		7.10334.02.0	AGR	EL	ch. 8V-D-000 001→
			7.03608.16.0	AK	EL	→05.2016
			7.08369.79.0	ATS	EL	ch. 8V-D-000 001→
			7.08369.82.0	ATS	EL	ch. 8V-D-000 001→
			7.11020.18.0	ATS	EL	ch. 8V-D-000 001→ vor Katalysator in front of the catalyst
1.6 TDI 81 kW (110 PS) CXXB	05.2014→10.2020		7.10334.02.0	AGR	EL	ch. 8V-D-000 001→
			7.03608.16.0	AK	EL	→05.2016
			7.08369.95.0	ATS	EL	ch. 8V-D-000 001→
			7.11020.17.0	ATS	EL	CXXB: ch. 8V-D-000 001→ vor Katalysator in front of the catalyst
			7.11492.03.0	DDS		CXXB: ch. 8V-D-000 001→ vor Katalysator in front of the catalyst ohne Zubehör without accessories ch. 8V-D-000 001→



A3 Limousine (8VS, 8VM)						23
1.6 TDI 81 kW (110 PS) DBKA	05.2014→10.2020		7.10334.02.0	AGR	EL	ch. 8V-D-000 001→
			7.03608.16.0	AK	EL	→05.2016
			7.08369.95.0	ATS	EL	ch. 8V-D-000 001→
			7.11492.03.0	DDS		ohne Zubehör without accessories ch. 8V-D-000 001→
1.6 TDI 85 kW (115 PS) DDYA	03.2017→10.2020		7.08369.95.0	ATS	EL	
			7.11492.05.0	DDS		ohne Zubehör without accessories ch. 8V-L-000001→
1.6 TDI quattro 81 kW (110 PS) CXXB	05.2015→		7.03608.16.0	AK	EL	→05.2016
			7.08369.95.0	ATS	EL	ch. 8V-D-000 001→
			7.11020.17.0	ATS	EL	ch. 8V-D-000 001→ vor Katalysator in front of the catalyst
			7.11492.03.0	DDS		ohne Zubehör without accessories ch. 8V-D-000 001→
1.8 TFSI 125 kW (170 PS) CNSB	11.2013→10.2020		7.03635.39.0	SLP	EL	ch. 8V-D-000 001→
			7.01510.85.0	SLV	EL	ch. 8V-D-000 001→ Produktionsdatum ab: 02.11.2015 Production date from: 02.11.2015
			7.01510.86.0	SLV	EL	ch. 8V-D-000 001→ Produktionsdatum bis: 02.11.2015 Production date to: 02.11.2015
2.0 TDI 81 kW (110 PS) CRFA	05.2013→10.2020		7.11492.05.0	DDS		ohne Zubehör without accessories ch. 8V-L-000001→ für PR-Nummer: 7MM, 7MW for PR number: 7MM, 7MW Produktionsdatum ab: 01.05.2017 Production date from: 01.05.2017
			7.11492.03.0	DDS		ohne Zubehör without accessories für PR-Nummer: 7MM, 7MW for PR number: 7MM, 7MW Produktionsdatum bis: 01.05.2017 Production date to: 01.05.2017
2.0 TDI 81 kW (110 PS) DEJB	05.2013→10.2020		7.10334.02.0	AGR	EL	ch. 8V-D-000 001→
2.0 TDI 110 kW (150 PS) CRBC, CRLB	05.2013→10.2020		7.08369.81.0	ATS	EL	
			7.10334.02.0	AGR	EL	CRBC, CRLB: ch. 8V-D-000 001→
			7.03608.16.0	AK	EL	CRBC, CRLB: ch. 8V-D-000 001→
			↳7.07696.00.0	SRM-AK	EL	
			7.08369.81.0	ATS	EL	CRBC, CRLB: ch. 8V-D-000 001→
7.11492.03.0	DDS		ohne Zubehör without accessories CRBC, CRLB: ch. 8V-D-000 001→			
2.0 TDI 110 kW (150 PS) CRUA	05.2013→10.2020		7.10334.02.0	AGR	EL	ch. 8V-D-000 001→
			7.08369.81.0	ATS	EL	ch. 8V-D-000 001→
			7.11492.03.0	DDS		ohne Zubehör without accessories ch. 8V-D-000 001→
			7.07696.00.0	SRM-AK	EL	ch. 8V-D-000 001→































A



A3 Limousine (8VS, 8VM)

23

<p>2.0 TDI 110 kW (150 PS) DBGA</p>	<p>05.2013→10.2020</p>	 <p>7.10334.02.0 7.03608.16.0 7.08369.81.0 7.11492.03.0</p>	<p>AGR AK ATS DDS</p>	<p>EL  ch. 8V-D-000 001→ EL  ch. 8V-D-000 001→ EL  ch. 8V-D-000 001→ ohne Zubehör without accessories  ch. 8V-D-000 001→</p>
<p>2.0 TDI 110 kW (150 PS) DCYA</p>	<p>05.2013→10.2020</p>	 <p>7.08369.81.0 7.11492.05.0</p>	<p>ATS DDS</p>	<p>EL ohne Zubehör without accessories für PR-Nummer: 7MM, 7MW for PR number: 7MM, 7MW Produktionsdatum ab: 01.05.2017 Production date from: 01.05.2017</p>
<p>2.0 TDI 110 kW (150 PS) DEJA</p>	<p>05.2013→10.2020</p>	 <p>7.10334.02.0 7.08369.81.0 7.11492.03.0</p>	<p>AGR ATS DDS</p>	<p>EL  ch. 8V-D-000 001→ EL  ch. 8V-D-000 001→ ohne Zubehör without accessories  ch. 8V-D-000 001→</p>
<p>2.0 TDI 100 kW (136 PS) CRBD, CRLC</p>	<p>09.2013→</p>	 <p>7.10334.02.0 7.03608.16.0 ↳ 7.07696.00.0 7.08369.81.0 7.11492.03.0</p>	<p>AGR AK SRM-AK ATS DDS</p>	<p>EL  CRBD, CRLC:  ch. 8V-D-000 001→ EL  CRBD, CRLC:  ch. 8V-D-000 001→ EL  CRBD, CRLC:  ch. 8V-D-000 001→ ohne Zubehör without accessories  CRBD, CRLC:  ch. 8V-D-000 001→</p>
<p>2.0 TDI 135 kW (184 PS) CUNA</p>	<p>05.2014→10.2020</p>	 <p>7.03608.16.0 ↳ 7.07696.00.0 7.08369.81.0 7.11492.03.0</p>	<p>AK SRM-AK ATS DDS</p>	<p>EL  ch. 8V-D-000 001→ EL EL  ch. 8V-D-000 001→ ohne Zubehör without accessories  ch. 8V-D-000 001→</p>
<p>2.0 TDI 110 kW (150 PS) DFGA</p>	<p>07.2018→10.2020</p>	 <p>7.10334.02.0 7.08369.81.0 7.11492.05.0</p>	<p>AGR ATS DDS</p>	<p>EL  EL ohne Zubehör without accessories  ch. 8V-L-000001→ für PR-Nummer: 7MM, 7MW for PR number: 7MM, 7MW Produktionsdatum ab: 01.05.2017 Production date from: 01.05.2017</p>
<p>2.0 TDI quattro 110 kW (150 PS) CRBC, CRLB</p>	<p>10.2013→10.2020</p>	 <p>7.03608.16.0 ↳ 7.07696.00.0 7.08369.81.0 7.11492.03.0</p>	<p>AK SRM-AK ATS DDS</p>	<p>EL  CRBC, CRLB:  ch. 8V-D-000 001→ EL EL ohne Zubehör without accessories  CRBC:  ch. 8V-D-000 001→  CRLB:  ch. 8V-D-000 001→ Produktionsdatum bis: 01.05.2017 Production date to: 01.05.2017</p>
<p>2.0 TDI quattro 110 kW (150 PS) DCYA</p>	<p>10.2013→10.2020</p>	 <p>7.08369.81.0</p>	<p>ATS</p>	<p>EL</p>















						A
A3 Limousine (8VS, 8VM)						23
			7.11492.05.0	DDS	ohne Zubehör without accessories  ch. 8V-L-000001→ für PR-Nummer: 7MM, 7MW for PR number: 7MM, 7MW Produktionsdatum ab: 01.05.2017 Production date from: 01.05.2017	
2.0 TDI quattro 135 kW (184 PS) CUNA	05.2014→07.2018		7.03608.16.0	AK	EL  ch. 8V-D-000 001→	
			7.07696.00.0	SRM-AK	EL	
			7.08369.81.0	ATS	EL  ch. 8V-D-000 001→	
			7.11492.03.0	DDS	ohne Zubehör without accessories  ch. 105628→	
2.0 TDI quattro 135 kW (184 PS) DGCA	05.2014→07.2018		7.08369.81.0	ATS	EL	
2.0 TFSI 137 kW (186 PS) CZRA	09.2016→10.2020		7.03635.39.0	SLP	EL	
			7.01510.85.0	SLV	EL  ch. 8V-L-000 001→	
2.0 TFSI quattro 162 kW (220 PS) CNTC	11.2013→10.2020		7.03635.39.0	SLP	EL  ch. 8V-D-000 001→	
			7.01510.85.0	SLV	EL  ch. 8V-D-000 001→ Produktionsdatum ab: 02.11.2015 Production date from: 02.11.2015	
			7.01510.86.0	SLV	EL  ch. 8V-D-000 001→ Produktionsdatum bis: 02.11.2015 Production date to: 02.11.2015	
30 TDI 85 kW (115 PS) DGTE	07.2018→10.2020		7.11020.17.0	ATS	EL  ch. 8V-L-000001→ vor Katalysator in front of the catalyst	
			7.11020.22.0	ATS	EL  ch. 8V-L-000001→	
			7.11020.23.0	ATS	EL  ch. 8V-L-000001→	
			7.11492.05.0	DDS	ohne Zubehör without accessories  ch. 8V-L-000001→	
35 TDI 110 kW (150 PS) DFGA	07.2018→10.2020		7.03608.16.0	AK	EL  ch. 8V-L-000 001→	
			7.11492.05.0	DDS	ohne Zubehör without accessories  ch. 8V-L-000001→ für PR-Nummer: 7MM / 7MW for PR number: 7MM / 7MW Produktionsdatum ab: 01.05.2017 Production date from: 01.05.2017	
40 TDI quattro 135 kW (184 PS) DJGA	07.2018→07.2019		7.10334.02.0	AGR	EL 	
			7.03608.16.0	AK	EL  ch. 8V-L-000 001→	
			7.08369.81.0	ATS	EL	
A3 Limousine (8YS)						24
30 TDI 85 kW (115 PS) DSUD	06.2020→		7.11492.05.0	DDS	ohne Zubehör without accessories für OE-Nummer: 04L 906 051 AB, 04L 906 051 F, 04L 906 051 L for OE number: 04L 906 051 AB, 04L 906 051 F, 04L 906 051 L	
35 TDI 110 kW (150 PS) DSRB	04.2020→		7.11492.05.0	DDS	ohne Zubehör without accessories für OE-Nummer: 04L 906 051 AB, 04L 906 051 F, 04L 906 051 L for OE number: 04L 906 051 AB, 04L 906 051 F, 04L 906 051 L	





























A



A3 Sportback (8PA)

25

1.4 TFSI 92 kW (125 PS) CAXC	09.2007→03.2013		7.05271.18.0	LS	525 mm	für Schaltgetriebe for manual transmission Euro 4 Euro 4
1.6 75 kW (102 PS) BGU	09.2004→03.2013		7.22574.12.0	AGR	EL	○ →12.2005
			7.05271.18.0	LS	525 mm	
			7.22738.08.0	SLP	EL	
			7.22778.96.0	SLV	PN	
1.6 75 kW (102 PS) BSE, BSF	09.2004→03.2013		7.05271.18.0	LS	525 mm	○
			7.22738.08.0	SLP	EL	
			7.22778.96.0	SLV	PN	
1.6 E-Power 75 kW (102 PS) CCSA, CMXA	01.2011→03.2013		7.22738.08.0	SLP	EL	○
			7.22778.96.0	SLV	PN	
1.6 FSI 85 kW (115 PS) BLF	09.2004→09.2007		7.10334.04.0	AGR	EL	○
			7.05271.15.0	LS	525 mm	
			7.05271.30.0	LS	400 mm	
1.6 FSI 85 kW (115 PS) BLP	09.2004→09.2007		7.10334.04.0	AGR	EL	○
			7.08369.41.0	ATS	EL	
			7.05271.30.0	LS	400 mm	
1.6 TDI 66 kW (90 PS) CAYB	05.2009→03.2013		7.08369.01.0	ATS	EL	ohne Zubehör without accessories
			7.08369.04.0	ATS	EL	
			7.11492.00.0	DDS		
1.6 TDI 77 kW (105 PS) CAYC	05.2009→03.2013		7.09720.00.0	AGR-K	EL	○
			7.08369.01.0	ATS	EL	
			7.08369.04.0	ATS	EL	
			7.11492.00.0	DDS		
1.8 TFSI 118 kW (160 PS) BYT	11.2006→03.2013		7.05271.19.0	LS	975 mm	Regelsonde Regulating Probe
1.8 TFSI 118 kW (160 PS) BZB	11.2006→03.2013		7.05271.11.0	LS	800 mm	Regelsonde Regulating Probe
1.8 TFSI 118 kW (160 PS) CDAA	11.2006→03.2013		7.05271.15.0	LS	525 mm	
1.8 TFSI quattro 118 kW (160 PS) CDAA	07.2008→03.2013		7.05271.15.0	LS	525 mm	
1.9 TDI 77 kW (105 PS) BKC, BXE	09.2004→05.2010		7.24809.16.0	AGR	PN	○
1.9 TDI 77 kW (105 PS) BLS	09.2004→05.2010		7.00678.04.0*	AGR-M	EL	mit Rohrstützen with pipe socket
			↳ 7.00907.03.0	AGR	EL	
			7.00678.06.0	AGR-M	EL	
			7.08369.00.0	ATS	EL	
			7.08369.02.0	ATS	EL	
			7.08369.03.0	ATS	EL	
			7.11492.02.0	DDS		
						ohne Zubehör without accessories

						A
A3 Sportback (8PA)						
2.0 FSI 110 kW (150 PS) AXW, BLX	09.2004→06.2008		7.10334.09.0 7.08369.41.0 7.05271.16.0	AGR ATS LS	EL EL 1300 mm	 AXW, BLX: →11.2006  AXW, BLX: links, rechts Left, Right Diagnosesonde Diagnostic Probe
2.0 FSI 110 kW (150 PS) BLR, BVY, BVZ	09.2004→06.2008		7.10334.09.0 7.05271.16.0	AGR LS	EL 1300 mm	 BLR, BVY: →11.2006  BLR, BVY, BVZ: Diagnosesonde Diagnostic Probe
2.0 FSI 110 kW (150 PS) BLY, BMB	09.2004→06.2008		7.05271.16.0	LS	1300 mm	 BLY: Diagnosesonde Diagnostic Probe  BMB: links, rechts Left, Right Diagnosesonde Diagnostic Probe
2.0 TDI 100 kW (136 PS) AZV	09.2004→03.2013		7.24809.16.0	AGR	PN	
2.0 TDI 100 kW (136 PS) CBAA	09.2004→03.2013		7.10334.00.0 7.08369.01.0 7.08369.04.0 7.11492.02.0	AGR ATS ATS DDS	EL EL EL	 ohne Zubehör without accessories Euro 5, Euro 4 Euro 5, Euro 4
2.0 TDI 100 kW (136 PS) CFFA	09.2004→03.2013		7.09720.00.0 7.11190.09.0	AGR-K DDS	EL	 Euro 5 Euro 5
2.0 TDI 103 kW (140 PS) BMM	06.2005→06.2008		7.00678.04.0* ↳ 7.00907.03.0 7.00678.06.0 7.08369.00.0 7.08369.02.0 7.08369.03.0 7.11492.02.0	AGR-M AGR AGR-M ATS ATS ATS DDS	EL EL EL EL EL EL	mit Rohrstützen with pipe socket ohne Zubehör without accessories
2.0 TDI 125 kW (170 PS) BMN	03.2006→03.2013		7.08369.00.0 7.08369.02.0 7.08369.03.0 7.11492.02.0	ATS ATS ATS DDS	EL EL EL	ohne Zubehör without accessories
2.0 TDI 125 kW (170 PS) CBBB	03.2006→03.2013		7.10334.00.0 7.08369.00.0 7.08369.01.0 7.08369.04.0 7.11492.02.0	AGR ATS ATS ATS DDS	EL EL EL EL	 ohne Zubehör without accessories Euro 5, Euro 4 Euro 5, Euro 4
2.0 TDI 125 kW (170 PS) CFGB	03.2006→03.2013		7.09720.00.0 7.11190.09.0	AGR-K DDS	EL	 Euro 5 Euro 5
2.0 TDI 120 kW (163 PS) BUY	06.2006→06.2008		7.08369.00.0	ATS	EL	



















25

A



A3 Sportback (8PA)

25

			7.08369.02.0	ATS	EL	
			7.08369.03.0	ATS	EL	
			7.11492.02.0	DDS		ohne Zubehör without accessories
2.0 TDI 103-104 kW (140-141 PS) CBEA	01.2010→03.2013		7.08369.01.0	ATS	EL	USA USA
2.0 TDI 16V 103 kW (140 PS) BKD	09.2004→03.2013		7.24809.16.0	AGR	PN	
2.0 TDI 16V 103 kW (140 PS) CBAB	09.2004→03.2013		7.10334.00.0	AGR	EL	
			7.08369.01.0	ATS	EL	
			7.08369.04.0	ATS	EL	
			7.11492.02.0	DDS		ohne Zubehör without accessories Euro 5, Euro 4 Euro 5, Euro 4
2.0 TDI 16V 103-104 kW (140-141 PS) CBEA	09.2004→03.2013		7.08369.01.0	ATS	EL	Baujahr ab: 01.2009 Construction year from: 01.2009 USA USA
2.0 TDI 16V 103 kW (140 PS) CFFB	09.2004→03.2013		7.09720.00.0	AGR-K	EL	
			7.11190.09.0	DDS		Euro 5 Euro 5
2.0 TDI 16V 103 kW (140 PS) CLJA	09.2004→03.2013		7.09720.00.0	AGR-K	EL	
2.0 TDI 16V quattro 103 kW (140 PS) BKD	11.2005→03.2013		7.24809.16.0	AGR	PN	
2.0 TDI 16V quattro 103 kW (140 PS) CBAB	11.2005→03.2013		7.10334.00.0	AGR	EL	
			7.08369.01.0	ATS	EL	
			7.08369.04.0	ATS	EL	
			7.11492.02.0	DDS		ohne Zubehör without accessories Euro 5, Euro 4 Euro 5, Euro 4
2.0 TDI 16V quattro 103 kW (140 PS) CFFB	11.2005→03.2013		7.09720.00.0	AGR-K	EL	
			7.11190.09.0	DDS		Euro 5 Euro 5
2.0 TDI quattro 103 kW (140 PS) BMM	01.2006→06.2008		7.00678.04.0*	AGR-M	EL	mit Rohrstutzen with pipe socket
			↳ 7.00907.03.0	AGR	EL	
			7.00678.06.0	AGR-M	EL	
			7.08369.00.0	ATS	EL	
			7.08369.02.0	ATS	EL	
			7.08369.03.0	ATS	EL	
			7.11492.02.0	DDS		ohne Zubehör without accessories
2.0 TDI quattro 125 kW (170 PS) BMN	03.2006→03.2013		7.10334.00.0	AGR	EL	
			7.08369.00.0	ATS	EL	
			7.08369.02.0	ATS	EL	
			7.08369.03.0	ATS	EL	
			7.11492.02.0	DDS		ohne Zubehör without accessories



						A
A3 Sportback (8PA)						25
2.0 TDI quattro 125 kW (170 PS) CBBB	03.2006→03.2013		7.10334.00.0	AGR	EL	
			7.08369.00.0	ATS	EL	
			7.08369.01.0	ATS	EL	
			7.08369.04.0	ATS	EL	
			7.11492.02.0	DDS		ohne Zubehör without accessories Euro 5, Euro 4 Euro 5, Euro 4
2.0 TDI quattro 125 kW (170 PS) CFGB	03.2006→03.2013		7.09720.00.0	AGR-K	EL	
			7.11190.09.0	DDS		Euro 5 Euro 5
2.0 TFSI 147 kW (200 PS) BPY, BWA, CCZA	09.2004→03.2013		7.05271.15.0	LS	525 mm	
2.0 TFSI 147 kW (200 PS) CAWB	09.2004→03.2013		7.05271.11.0	LS	800 mm	Regelsonde Regulating Probe
2.0 TFSI 147 kW (200 PS) CBFA	09.2004→03.2013		7.05271.11.0	LS	800 mm	Regelsonde Regulating Probe
			7.05271.15.0	LS	525 mm	
			7.01510.31.0	SLV	EL	 CBFA: USA USA 2008 2008 2008 CBFA: 2009 2009
2.0 TFSI quattro 147 kW (200 PS) BPY, BWA, CCZA	09.2004→03.2013		7.05271.15.0	LS	525 mm	
2.0 TFSI quattro 147 kW (200 PS) CBFA	09.2004→03.2013		7.01510.31.0	SLV	EL	 CBFA: USA USA 2008 2008 2008 CBFA: 2009 2009
3.2 V6 quattro 184 kW (250 PS) BDB	09.2004→05.2009		7.22286.55.0	ARV	PN	 →ch. 8P-7A034 719
			7.22738.20.0	SLP	EL	
			7.22778.98.0	SLV	PN	 ch. 8P-7A034 720→
3.2 V6 quattro 184 kW (250 PS) BMJ	09.2004→05.2009		7.22286.55.0	ARV	PN	 →ch. 8P-7A034 719
			7.05271.15.0	LS	525 mm	→ch. 8P-7-250 000 für Zylinder: 1-3 for cylinder: 1-3
			7.22738.20.0	SLP	EL	
			7.22778.98.0	SLV	PN	 ch. 8P-7A034 720→
3.2 V6 quattro 184-186 kW (250-253 PS) BUB	09.2004→05.2009		7.22286.55.0	ARV	PN	 →ch. 8P-7A034 719
			7.05271.28.0	LS	800 mm	ch. 8P-6A093 287→ch. 8P-7A250 000 für Zylinder: 4-6 for cylinder: 4-6
			7.05271.15.0	LS	525 mm	für Zylinder: 1-3 for cylinder: 1-3

A





















A3 Sportback (8PA)

25

			7.22738.20.0	SLP	EL	
			7.22778.98.0	SLV	PN	 ch. 8P-7A034 720→
S3 quattro 195 kW (265 PS) BHZ	06.2008→03.2013		7.05271.15.0	LS	525 mm	

A3 Sportback (8VA, 8VF)

26

1.4 TFSI 90 kW (122 PS) CXSA	09.2012→10.2020		7.03635.38.0	SLP	EL	Fahrgestellnummer ab: 8V-L-000 001 Vehicle Identification Number from: 8V-L-000 001
1.4 TFSI 103 kW (140 PS) CPTA	03.2013→		7.03635.38.0	SLP	EL	Fahrgestellnummer ab: 8V-L-000 001 Vehicle Identification Number from: 8V-L-000 001
1.4 TFSI e-tron 110 kW (150 PS) CUKB	05.2014→10.2020		7.03635.38.0	SLP	EL	Fahrgestellnummer ab: 8V-L-000 001 Vehicle Identification Number from: 8V-L-000 001
1.4 TFSI e-tron 110 kW (150 PS) CXUA	05.2014→10.2020		7.03635.37.0	SLP	EL	Fahrgestellnummer ab: 8V-D-000 001 Vehicle Identification Number from: 8V-D-000 001 Produktionsdatum bis: 03.11.2014 Production date to: 03.11.2014
			7.03635.38.0	SLP	EL	Fahrgestellnummer ab: 8V-D-000 001 Vehicle Identification Number from: 8V-D-000 001
			7.01510.91.0	SLV	EL	mit Dichtring with O-ring Produktionsdatum ab: 19.06.2017 Production date from: 19.06.2017
1.4 TFSI e-tron 110 kW (150 PS) CXUA	05.2014→10.2020		7.03635.37.0	SLP	EL	Fahrgestellnummer ab: 8V-D-000 001 Vehicle Identification Number from: 8V-D-000 001 Produktionsdatum bis: 03.11.2014 Production date to: 03.11.2014
			7.03635.38.0	SLP	EL	Fahrgestellnummer ab: 8V-D-000 001 Vehicle Identification Number from: 8V-D-000 001
1.4 TFSI g-tron 81 kW (110 PS) CPWA	11.2013→10.2020		7.03635.38.0	SLP	EL	Fahrgestellnummer ab: 8V-L-000 001 Vehicle Identification Number from: 8V-L-000 001
1.4 TSI 110 kW (150 PS) CZEA	05.2014→10.2020		7.03635.38.0	SLP	EL	Fahrgestellnummer ab: 8V-L-000 001 Vehicle Identification Number from: 8V-L-000 001
1.6 TDI 77 kW (105 PS) CLHA	10.2012→		7.10334.02.0	AGR	EL	 ch. 8V-D-000 001→
			7.03608.16.0	AK	EL	 ch. 8V-D-000 001→
			7.08369.82.0	ATS	EL	 ch. 8V-D-000 001→
			7.08369.79.0	ATS	EL	 ch. 8V-D-000 001→
			7.11492.03.0	DDS		ohne Zubehör without accessories  ch. 8V-D-000 001→
1.6 TDI 81 kW (110 PS) CRKB	09.2013→10.2020		7.03608.16.0	AK	EL	→05.2016,  ch. 8V-D-000 001→
			7.08369.79.0	ATS	EL	 ch. 8V-D-000 001→
			7.08369.82.0	ATS	EL	
			7.11020.18.0	ATS	EL	 ch. 8V-D-000 001→ vor Katalysator in front of the catalyst
1.6 TDI 81 kW (110 PS) CXXB	09.2013→10.2020		7.11492.03.0	DDS		ohne Zubehör without accessories  ch. 8V-D-000 001→ für Hersteller-Abgasnorm: Euro 6 plus for manufacturer exhaust norm: Euro 6 plus
			7.08369.82.0	ATS	EL	



























A3 Sportback (8VA, 8VF)					26
			7.08369.95.0 ATS 7.11020.17.0 ATS	EL	ch. 8V-D-000 001→ ch. 8V-D-000 001→ vor Katalysator in front of the catalyst
1.6 TDI 81 kW (110 PS) DBKA	09.2013→10.2020		7.10334.02.0 AGR 7.08369.82.0 ATS 7.08369.95.0 ATS 7.11020.17.0 ATS 7.11492.03.0 DDS	EL	ch. 8V-D-000 001→ ch. 8V-D-000 001→ vor Katalysator in front of the catalyst ohne Zubehör without accessories DBKA: ch. 8V-D-000 001→ DBKA: ch. 8V-D-000 001→
1.6 TDI 85 kW (115 PS) DDYA	02.2017→10.2020		7.10334.02.0 AGR 7.08369.95.0 ATS 7.11492.05.0 DDS	EL	ch. 8V-L-000001→ ohne Zubehör without accessories ch. 8V-L-000001→
1.6 TDI quattro 81 kW (110 PS) CXXB	05.2015→08.2016		7.03608.16.0 AK 7.08369.95.0 ATS 7.11020.17.0 ATS 7.11492.03.0 DDS	EL	→05.2016 ch. 8V-D-000 001→ ch. 8V-D-000 001→ vor Katalysator in front of the catalyst ohne Zubehör without accessories ch. 8V-D-000 001→
2.0 TDI 110 kW (150 PS) CRBC, CRLB	09.2012→10.2020		7.10334.02.0 AGR 7.03608.16.0 AK 7.07696.00.0 SRM-AK 7.08369.81.0 ATS 7.11492.03.0 DDS	EL	CRBC, CRLB: ch. 8V-D-000 001→ CRBC, CRLB: ch. 8V-D-000 001→ CRBC, CRLB: ch. 8V-D-000 001→ ohne Zubehör without accessories CRBC: ch. 8V-D-000 001→ CRLB: ch. 8V-D-000 001→ Produktionsdatum bis: 01.05.2017 Production date to: 01.05.2017
2.0 TDI 110 kW (150 PS) CRUA	09.2012→10.2020		7.10334.02.0 AGR 7.08369.81.0 ATS 7.11492.03.0 DDS 7.07696.00.0 SRM-AK	EL	ch. 8V-D-000 001→ ch. 8V-D-000 001→ ohne Zubehör without accessories ch. 8V-D-000 001→ ch. 8V-D-000 001→
2.0 TDI 110 kW (150 PS) DBGA	09.2012→10.2020		7.10334.02.0 AGR 7.03608.16.0 AK 7.08369.81.0 ATS 7.11492.03.0 DDS	EL	ch. 8V-D-000 001→ ch. 8V-D-000 001→ ohne Zubehör without accessories ch. 8V-D-000 001→
2.0 TDI 110 kW (150 PS) DCYA	09.2012→10.2020		7.08369.81.0 ATS	EL	





























A



A3 Sportback (8VA, 8VF)

26

			7.11492.05.0	DDS		ohne Zubehör without accessories  ch. 8V-L-000001→ für PR-Nummer: 7MM, 7MW for PR number: 7MM, 7MW Produktionsdatum ab: 01.05.2017 Production date from: 01.05.2017
2.0 TDI 110 kW (150 PS) DEJA	09.2012→10.2020		7.10334.02.0 7.08369.81.0 7.11492.03.0	AGR ATS DDS	EL EL	  ch. 8V-D-000 001→  ch. 8V-D-000 001→ ohne Zubehör without accessories  ch. 8V-D-000 001→
2.0 TDI 81 kW (110 PS) CRFA	05.2013→10.2020		7.11492.05.0 7.11492.03.0	DDS DDS		ohne Zubehör without accessories  ch. 8V-L-000001→ für PR-Nummer: 7MM, 7MW for PR number: 7MM, 7MW Produktionsdatum ab: 01.05.2017 Production date from: 01.05.2017 ohne Zubehör without accessories für PR-Nummer: 7MM, 7MW for PR number: 7MM, 7MW Produktionsdatum bis: 01.05.2017 Production date to: 01.05.2017
2.0 TDI 135 kW (184 PS) CUNA	05.2013→08.2016		7.10334.02.0 7.03608.16.0 ↳ 7.07696.00.0 7.08369.81.0 7.11492.03.0	AGR AK SRM-AK ATS DDS	EL EL EL	  ch. 8V-D-000 001→  ch. 8V-D-000 001→  ch. 8V-D-000 001→ ohne Zubehör without accessories  ch. 8V-D-000 001→
2.0 TDI 100 kW (136 PS) CRBD, CRLC	05.2013→08.2016		7.10334.02.0 7.03608.16.0 ↳ 7.07696.00.0 7.08369.81.0 7.11492.03.0	AGR AK SRM-AK ATS DDS	EL EL EL	 CRBD, CRLC:  ch. 8V-D-000 001→ CRBD, CRLC:  ch. 8V-D-000 001→ CRBD, CRLC:  ch. 8V-D-000 001→ ohne Zubehör without accessories CRBD, CRLC:  ch. 8V-D-000 001→
2.0 TDI 110 kW (150 PS) DFGA	07.2018→10.2020		7.10334.02.0 7.08369.81.0 7.11492.05.0	AGR ATS DDS	EL EL	 ohne Zubehör without accessories für PR-Nummer: 7MM , 7MW for PR number: 7MM , 7MW Produktionsdatum ab: 01.05.2017 Production date from: 01.05.2017
2.0 TDI quattro 110 kW (150 PS) CRBC, CRLB	02.2013→10.2020		7.03608.16.0 ↳ 7.07696.00.0 7.08369.81.0 7.11492.03.0	AK SRM-AK ATS DDS	EL EL EL	 CRBC, CRLB:  ch. 8V-D-000 001→ CRBC, CRLB:  ch. 8V-D-000 001→ ohne Zubehör without accessories  ch. 8V-D-000 001→ Produktionsdatum bis: 01.05.2017 Production date to: 01.05.2017













						A
A3 Sportback (8VA, 8VF)						26
2.0 TDI quattro 110 kW (150 PS) DCYA	02.2013→10.2020		7.08369.81.0	ATS	EL	ohne Zubehör without accessories  ch. 8V-L-000001→ für PR-Nummer: 7MM, 7MW for PR number: 7MM, 7MW Produktionsdatum ab: 01.05.2017 Production date from: 01.05.2017
			7.11492.05.0	DDS		
2.0 TDI quattro 135 kW (184 PS) CUNA	05.2013→07.2018		7.03608.16.0	AK	EL	 ch. 8V-D-000 001→
			↳7.07696.00.0	SRM-AK	EL	
			7.08369.81.0	ATS	EL	 ch. 8V-D-000 001→
			7.11492.03.0	DDS		ohne Zubehör without accessories
2.0 TDI quattro 135 kW (184 PS) DGCA	05.2013→07.2018		7.10334.02.0	AGR	EL	
			7.08369.81.0	ATS	EL	
			7.11492.03.0	DDS		ohne Zubehör without accessories
30 TDI 85 kW (115 PS) DGTE	07.2018→10.2020		7.03608.16.0	AK	EL	 ch. 8V-L-000 001→
			7.11020.17.0	ATS	EL	 ch. 8V-L-000001→ vor Katalysator in front of the catalyst
			7.11020.22.0	ATS	EL	 ch. 8V-L-000001→
			7.11020.23.0	ATS	EL	 ch. 8V-L-000001→
			7.11492.05.0	DDS		ohne Zubehör without accessories  ch. 8V-L-000001→
35 TDI 110 kW (150 PS) DFGA	07.2018→10.2020		7.03608.16.0	AK	EL	 ch. 8V-L-000 001→
			7.11492.05.0	DDS		ohne Zubehör without accessories  ch. 8V-L-000001→ für PR-Nummer: 7MM , 7MW for PR number: 7MM , 7MW Produktionsdatum ab: 01.05.2017 Production date from: 01.05.2017
40 TDI quattro 135 kW (184 PS) DJGA	07.2018→10.2020		7.10334.02.0	AGR	EL	
			7.03608.16.0	AK	EL	 ch. 8V-L-000 001→
			7.08369.81.0	ATS	EL	
A3 Sportback (8YA)						27
30 TDI 85 kW (115 PS) DSUD	11.2019→		7.11492.05.0	DDS		ohne Zubehör without accessories für OE-Nummer: 04L 906 051 AB, 04L 906 051 F, 04L 906 051 L for OE number: 04L 906 051 AB, 04L 906 051 F, 04L 906 051 L
35 TDI 110 kW (150 PS) DSRB	11.2019→		7.11492.05.0	DDS		ohne Zubehör without accessories für OE-Nummer: 04L 906 051 AB, 04L 906 051 F, 04L 906 051 L for OE number: 04L 906 051 AB, 04L 906 051 F, 04L 906 051 L
A4 Allroad B8 (8KH)						28
2.0 TDI quattro 125 kW (170 PS) CAHA	04.2009→05.2016		7.10334.00.0	AGR	EL	
			7.08369.14.0	ATS	EL	Euro 5
			7.08369.16.0	ATS	EL	Euro 5























A



A4 Allroad B8 (8KH)

28

2.0 TDI quattro 120 kW (163 PS) CAHB	04.2009→05.2016		7.11190.02.0	DDS		
			7.10334.00.0	AGR	EL	
			7.08369.14.0	ATS	EL	Euro 5 Euro 5
			7.08369.16.0	ATS	EL	
2.0 TDI quattro 120 kW (163 PS) CGLD	04.2009→05.2016		7.11190.02.0	DDS		
			7.09720.03.0	AGR-K	EL	
			7.11190.09.0	DDS		Euro 5 Euro 5 ohne Zubehör without accessories für Hersteller-Abgasnorm: Euro 6 plus for manufacturer exhaust norm: Euro 6 plus
2.0 TDI quattro 120 kW (163 PS) CNHC	04.2009→05.2016		7.11020.21.0	ATS	EL	für PR-Nummer: 7MM for PR number: 7MM
			7.11190.09.0	DDS		Euro 5 Euro 5
			7.11492.03.0	DDS		ohne Zubehör without accessories für Hersteller-Abgasnorm: Euro 6 plus for manufacturer exhaust norm: Euro 6 plus
2.0 TDI quattro 105 kW (143 PS) CAGA	09.2009→05.2016		7.10334.00.0	AGR	EL	
			7.08369.14.0	ATS	EL	Euro 5 Euro 5
			7.08369.16.0	ATS	EL	
			7.08369.52.0	ATS	EL	Euro4/Euro5 Euro4/Euro5 für Fahrzeuge mit Automatikgetriebe for vehicles with automatic transmission
			7.11190.02.0	DDS		
2.0 TDI quattro 105 kW (143 PS) CJCA	09.2009→05.2016		7.09720.03.0	AGR-K	EL	
			7.11190.09.0	DDS		Euro 5 Euro 5
			7.11492.03.0	DDS		ohne Zubehör without accessories für Hersteller-Abgasnorm: Euro 6 plus for manufacturer exhaust norm: Euro 6 plus
2.0 TDI quattro 100 kW (136 PS) CAGB	09.2009→05.2016		7.10334.00.0	AGR	EL	
			7.08369.14.0	ATS	EL	Euro 5 Euro 5
			7.08369.16.0	ATS	EL	
			7.08369.52.0	ATS	EL	Euro4/Euro5 Euro4/Euro5 für Fahrzeuge mit Automatikgetriebe for vehicles with automatic transmission
2.0 TDI quattro 100 kW (136 PS) CJCB	09.2009→05.2016		7.09720.03.0	AGR-K	EL	 ch. 8K-8-000 001→
			7.11190.09.0	DDS		Euro 5 Euro 5
			7.11492.03.0	DDS		ohne Zubehör without accessories für Hersteller-Abgasnorm: Euro 6 plus for manufacturer exhaust norm: Euro 6 plus



						A
A4 Allroad B8 (8KH)						28
2.0 TDI quattro 100 kW (136 PS) CSUB	09.2009→05.2016		7.11190.09.0	DDS	Euro 5 Euro 5 ohne Zubehör without accessories für Hersteller-Abgasnorm: Euro 6 plus for manufacturer exhaust norm: Euro 6 plus	
			7.11492.03.0	DDS		
2.0 TDI quattro 130 kW (177 PS) CGLC	11.2011→05.2016		7.09720.03.0	AGR-K	EL 	ohne Zubehör without accessories für Hersteller-Abgasnorm: Euro 6 plus for manufacturer exhaust norm: Euro 6 plus
			7.11492.03.0	DDS		
2.0 TDI quattro 110 kW (150 PS) CJCD	05.2013→05.2016		7.09720.03.0	AGR-K	EL 	Euro 5 Euro 5 ohne Zubehör without accessories für Hersteller-Abgasnorm: Euro 6 plus for manufacturer exhaust norm: Euro 6 plus
			7.11190.09.0	DDS		
			7.11492.03.0	DDS		
2.0 TDI quattro 110 kW (150 PS) CSUA	05.2013→05.2016		7.11190.09.0	DDS	Euro 5 Euro 5 ohne Zubehör without accessories für Hersteller-Abgasnorm: Euro 6 plus for manufacturer exhaust norm: Euro 6 plus	
			7.11492.03.0	DDS		
2.0 TDI quattro 140 kW (190 PS) CNHA	09.2013→05.2016		7.11020.21.0	ATS	EL für PR-Nummer: 7MM for PR number: 7MM	Euro 5 Euro 5 ohne Zubehör without accessories für Hersteller-Abgasnorm: Euro 6 plus for manufacturer exhaust norm: Euro 6 plus
			7.11190.09.0	DDS		
			7.11492.03.0	DDS		
3.0 TDI quattro 176 kW (240 PS) CCWA	04.2009→01.2012		7.02132.07.0	AGR	EL 	mit AGR-Ventil with EGR valve
			7.01106.38.0	AGR-K	EL	
			7.08369.13.0	ATS	EL	
			7.08369.45.0	ATS	EL	
			7.11190.02.0	DDS	 ch. 8K-8-000 001→	
3.0 TDI quattro 180 kW (245 PS) CDUC, CKVB, CKVC	01.2012→05.2016		7.08369.73.0	ATS	EL	 CDUC, CKVC: vor Rußpartikelfilter before soot particulate filter  CKVB: Euro 5 Euro 5
			7.11020.25.0	ATS	EL	
			7.11190.02.0	DDS		
A4 Allroad B9 (8WH, 8WJ)						29
2.0 TDI quattro 140 kW (190 PS) DESA, DETA, DFVA	01.2016→		7.11492.03.0	DDS	ohne Zubehör without accessories	
2.0 TDI quattro 120 kW (163 PS) DETB	05.2016→10.2019		7.11492.03.0	DDS	ohne Zubehör without accessories	
			7.07696.00.0	SRM-AK	EL	
2.0 TDI quattro 100 kW (136 PS) DEUB	11.2016→07.2018		7.07696.00.0	SRM-AK	EL	

A

































A4 Allroad B9 (8WH, 8WJ)

29

3.0 TDI quattro 160 kW (218 PS) CSWB	01.2016→08.2018		7.11020.24.0	ATS	EL	Produktionsdatum bis: 06.08.2018 Production date to: 06.08.2018
3.0 TDI quattro 200 kW (272 PS) CRTC	01.2016→08.2018		7.11020.24.0	ATS	EL	Produktionsdatum bis: 06.08.2018 Production date to: 06.08.2018

A4 B5 (8D2)

30

1.6 74 kW (100 PS) ANA	08.1998→10.2000		7.05271.05.0	LS	700 mm	 ch. 8D-X-200 001→ nach Katalysator Post-catalyst
			7.05271.07.0	LS	1100 mm	
			7.21851.31.0	SLP	EL	 ch. 8D-X-200 001→ch. 8D-Y-100 000
			7.22738.08.0	SLP	EL	 ch. 8D-Y-100 001→
1.6 75 kW (102 PS) ALZ	07.2000→11.2000		7.22785.20.0	AGR	EL	 ch. 8D-X-200 001→
			7.05271.01.0	LS	950 mm	Diagnosesonde Diagnostic Probe
			7.05271.05.0	LS	700 mm	 ch. 8D-X-200 001→ nach Katalysator Post-catalyst
			7.05271.07.0	LS	1100 mm	
			7.21851.31.0	SLP	EL	 ch. 8D-X-200 001→ch. 8D-Y-100 000
			7.22738.08.0 7.22778.99.0	SLP SLV	EL PN	 ch. 8D-Y-100 001→  ch. 8E-1-200 001→
1.8 92-95 kW (125-129 PS) ADR, APT	11.1994→11.2000		7.05271.21.0	LS	1250 mm	 ADR, APT: Regelsonde Regulating Probe
1.8 92 kW (125 PS) ARG	11.1994→11.2000		7.05271.21.0	LS	1250 mm	Regelsonde Regulating Probe
			7.21851.31.0	SLP	EL	 ch. 8D-X-200 001→ch. 8D-Y-100 000 Automatikgetriebe Automatic Transmission
			7.22738.08.0	SLP	EL	 ch. 8D-Y-100 001→ Automatikgetriebe Automatic Transmission
1.8 92 kW (125 PS) AVV	11.1994→11.2000		7.05271.24.0	LS	1500 mm	 ch. 8D-X-200 001→ vor Katalysator in front of the catalyst
			7.21851.31.0	SLP	EL	 ch. 8D-X-200 001→ch. 8D-Y-100 000
			7.22738.08.0	SLP	EL	 ch. 8D-Y-100 001→
1.8 85 kW (115 PS) AFY	04.1995→11.2000		7.05271.21.0	LS	1250 mm	
1.8 T 110-112 kW (150-152 PS) AEB	01.1995→12.1998		7.05270.96.0	LS	1440 mm	08.1997→ Regelsonde Regulating Probe
1.8 T 110 kW (150 PS) AWT	01.1995→11.2000		7.22560.43.0	ARV	PN	 ch. 8D-X-200 001→
			7.05270.99.0	LS	940 mm	Diagnosesonde Diagnostic Probe
			7.21851.31.0	SLP	EL	 ch. 8D-X-200 001→ch. 8D-Y-100 000
			7.22738.08.0	SLP	EL	 ch. 8D-Y-100 001→
1.8 T 132 kW (180 PS) AJL	12.1997→11.2000		7.05270.96.0	LS	1440 mm	Regelsonde Regulating Probe
1.8 T 110 kW (150 PS) APU, ARK	07.1998→11.2000		7.05271.21.0	LS	1250 mm	 APU, ARK: Regelsonde Regulating Probe
1.8 T 110 kW (150 PS) ANB	07.1999→11.2000		7.22560.42.0	ARV	PN	 ch. 8D-X-200 001→





























A4 B5 (8D2)					30
			7.05270.99.0	LS	940 mm Diagnosesonde Diagnostic Probe
			7.05271.21.0	LS	1250 mm Regelsonde Regulating Probe
			7.21851.31.0	SLP	EL ch. 8D-X-200 001→ch. 8D-Y-100 000
			7.22738.08.0	SLP	EL ch. 8D-Y-100 001→
1.8 T 125-127 kW (170-173 PS) AMB	05.2000→09.2000		7.22560.43.0	ARV	PN
			7.05271.24.0	LS	1500 mm ch. 8E-1-000 001→ch. 8E-5-400 000 vor Katalysator in front of the catalyst
			7.22738.08.0	SLP	EL
1.8 T quattro 110 kW (150 PS) AWT	01.1995→11.2000		7.22560.43.0	ARV	PN ch. 8D-X-200 001→
			7.05270.99.0	LS	940 mm Diagnosesonde Diagnostic Probe
			7.21851.31.0	SLP	EL ch. 8D-X-200 001→ch. 8D-Y-100 000
			7.22738.08.0	SLP	EL ch. 8D-Y-100 001→
1.8 T quattro 110-112 kW (150-152 PS) AEB	12.1995→12.1998		7.05270.96.0	LS	1440 mm 08.1997→ Regelsonde Regulating Probe
1.8 T quattro 132 kW (180 PS) AJL	12.1997→11.2000		7.05270.96.0	LS	1440 mm Regelsonde Regulating Probe
1.8 T quattro 110 kW (150 PS) APU, ARK	07.1998→11.2000		7.05271.21.0	LS	1250 mm APU, ARK: Regelsonde Regulating Probe
1.8 T quattro 110 kW (150 PS) ANB	07.1999→11.2000		7.22560.42.0	ARV	PN ch. 8D-X-200 001→
			7.05270.99.0	LS	940 mm Diagnosesonde Diagnostic Probe
			7.05271.21.0	LS	1250 mm Regelsonde Regulating Probe
			7.21851.31.0	SLP	EL ch. 8D-X-200 001→ch. 8D-Y-100 000
			7.22738.08.0	SLP	EL ch. 8D-Y-100 001→
1.8 quattro 85 kW (115 PS) AFY	07.1995→11.2000		7.05271.21.0	LS	1250 mm
1.8 quattro 92-95 kW (125-129 PS) ADR, APT	12.1995→11.2000		7.05271.21.0	LS	1250 mm ADR, APT: Regelsonde Regulating Probe
1.8 quattro 92 kW (125 PS) ARG	07.1998→11.2000		7.05271.21.0	LS	1250 mm Regelsonde Regulating Probe
			7.21851.31.0	SLP	EL ch. 8D-X-200 001→ch. 8D-Y-100 000 Automatikgetriebe Automatic Transmission
			7.22738.08.0	SLP	EL ch. 8D-Y-100 001→ Automatikgetriebe Automatic Transmission
1.9 TDI 85 kW (115 PS) AJM	03.2000→11.2000		7.24809.19.0	AGR	PN
1.9 TDI quattro 85 kW (115 PS) AJM, ATJ	03.2000→11.2000		7.24809.19.0	AGR	PN
2.4 121 kW (165 PS) ALF	08.1997→07.1998		7.22560.40.0	ARV	PN links Left
			7.22560.41.0	ARV	PN rechts Right
			7.21851.31.0	SLP	EL

A



A4 B5 (8D2)

30

2.4 120 kW (163 PS) AMM	08.1997→11.2000	 7.22560.41.0	ARV	PN  ch. 8D-X-200 001→ch. 8E-5-400 000 rechts Right
		7.22560.40.0	ARV	PN  Fahrgestellnummer ab: 8E-1-000 001 Vehicle Identification Number from: 8E-1-000 001 Fahrgestellnummer bis: 8E-5-400 000 Vehicle Identification Number to: 8E-5-400 000 links Left
		7.21851.31.0	SLP	EL  ch. 8D-X-200 001→ch. 8D-Y-100 000
		7.22738.08.0	SLP	EL  ch. 8D-Y-100 001→ch. 8E-5-400 000
2.4 121 kW (165 PS) AML, ARJ	08.1998→11.2000	 7.22560.41.0	ARV	PN  AML, ARJ:  ch. 8D-X-200 001→ rechts Right
		7.22560.40.0	ARV	PN  AML, ARJ: Fahrgestellnummer ab: 8D-X-200 001 Vehicle Identification Number from: 8D-X-200 001 links Left
		7.21851.31.0	SLP	EL  AML, ARJ:  ch. 8D-X-200 001→ch. 8D-Y-100 000
		7.22738.08.0	SLP	EL  AML, ARJ:  ch. 8D-Y-100 001→
2.4 quattro 121 kW (165 PS) ALF	08.1997→07.1998	 7.22560.40.0	ARV	PN  links Left
		7.22560.41.0	ARV	PN  rechts Right
		7.21851.31.0	SLP	EL
2.4 quattro 121 kW (165 PS) AML, ARJ	08.1998→11.2000	 7.22560.41.0	ARV	PN  AML, ARJ:  ch. 8D-X-200 001→ rechts Right
		7.22560.40.0	ARV	PN  AML, ARJ: Fahrgestellnummer ab: 8D-X-200 001 Vehicle Identification Number from: 8D-X-200 001 links Left
		7.21851.31.0	SLP	EL  AML, ARJ:  ch. 8D-X-200 001→ch. 8D-Y-100 000
		7.22738.08.0	SLP	EL  AML, ARJ:  ch. 8D-Y-100 001→
2.6 110 kW (150 PS) ABC	01.1995→11.2000	 7.02604.03.0	LS	200 mm
2.6 quattro 110 kW (150 PS) ABC	01.1995→11.2000	 7.02604.03.0	LS	200 mm
2.8 120-128 kW (163-174 PS) AAH, AFC	09.1995→07.1997	 7.02604.03.0	LS	200 mm
2.8 142 kW (193 PS) ALG	08.1997→11.2000	 7.22560.40.0	ARV	PN  links Left

						A
A4 B5 (8D2)						30
			7.22560.41.0	ARV	PN	rechts Right
			7.21851.31.0	SLP	EL	
2.8 142 kW (193 PS) AMX	08.1998→11.2000		7.21851.31.0	SLP	EL	ch. 8D-X-200 001→ch. 8D-Y-100 000
			7.22738.08.0	SLP	EL	ch. 8D-Y-100 001→
2.8 142 kW (193 PS) AQD	08.1998→11.2000		7.22560.41.0	ARV	PN	ch. 8D-X-200 001→ rechts Right
			7.22560.40.0	ARV	PN	Fahrgestellnummer ab: 8D-X-200 001 Vehicle Identification Number from: 8D-X-200 001
			7.21851.31.0	SLP	EL	ch. 8D-X-200 001→ch. 8D-Y-100 000
			7.22738.08.0	SLP	EL	ch. 8D-Y-100 001→
2.8 quattro 120-128 kW (163-174 PS) AAH, AFC	01.1995→07.1997		7.02604.03.0	LS	200 mm	
2.8 quattro 142 kW (193 PS) ALG	08.1997→08.2001		7.22560.40.0	ARV	PN	links Left
			7.22560.41.0	ARV	PN	rechts Right
			7.21851.31.0	SLP	EL	
2.8 quattro 142 kW (193 PS) AMX	08.1998→08.2001		7.21851.31.0	SLP	EL	ch. 8D-X-200 001→ch. 8D-Y-100 000
			7.22738.08.0	SLP	EL	ch. 8D-Y-100 001→
2.8 quattro 142 kW (193 PS) AQD	08.1998→08.2001		7.22560.41.0	ARV	PN	ch. 8D-X-200 001→ rechts Right
			7.22560.40.0	ARV	PN	Fahrgestellnummer ab: 8D-X-200 001 Vehicle Identification Number from: 8D-X-200 001
			7.21851.31.0	SLP	EL	ch. 8D-X-200 001→ch. 8D-Y-100 000
			7.22738.08.0	SLP	EL	ch. 8D-Y-100 001→
S4 quattro 185-187 kW (252-254 PS) APB	10.1997→12.1998		7.22769.76.0	ARV	PN	ch. 8D-X-200 001→ links Left
A4 B5 Avant (8D5)						31
1.6 74 kW (100 PS) ANA	11.1994→09.2001		7.05271.05.0	LS	700 mm	ch. 8D-X-200 001→ nach Katalysator Post-catalyst
			7.05271.07.0	LS	1100 mm	
			7.21851.31.0	SLP	EL	ch. 8D-X-200 001→ch. 8D-Y-100 000
			7.22738.08.0	SLP	EL	ch. 8D-Y-100 001→
1.6 75 kW (102 PS) ALZ	07.2000→09.2001		7.22785.20.0	AGR	EL	ch. 8D-X-200 001→
			7.05271.01.0	LS	950 mm	Diagnosesonde Diagnostic Probe

A



A4 B5 Avant (8D5)

31

			7.05271.05.0	LS	700 mm	ch. 8D-X-200 001→ nach Katalysator Post-catalyst
			7.05271.07.0	LS	1100 mm	
			7.21851.31.0	SLP	EL	ch. 8D-X-200 001→ch. 8D-Y-100 000
			7.22738.08.0	SLP	EL	ch. 8D-Y-100 001→
			7.22778.99.0	SLV	PN	ch. 8E-1-200 001→
1.8 85 kW (115 PS) AFY	07.1995→09.2001		7.05271.21.0	LS	1250 mm	
1.8 92-95 kW (125-129 PS) ADR, APT	02.1996→09.2001		7.05271.21.0	LS	1250 mm	ADR, APT: Regelsonde Regulating Probe
1.8 92 kW (125 PS) AVV	02.1996→09.2001		7.05271.24.0	LS	1500 mm	ch. 8D-X-200 001→ vor Katalysator in front of the catalyst
			7.21851.31.0	SLP	EL	ch. 8D-X-200 001→ch. 8D-Y-100 000
			7.22738.08.0	SLP	EL	ch. 8D-Y-100 001→
1.8 92 kW (125 PS) ARG	07.1998→09.2001		7.05271.21.0	LS	1250 mm	Regelsonde Regulating Probe
			7.21851.31.0	SLP	EL	ch. 8D-X-200 001→ch. 8D-Y-100 000 Automatikgetriebe Automatic Transmission
			7.22738.08.0	SLP	EL	ch. 8D-Y-100 001→ Automatikgetriebe Automatic Transmission
1.8 T 110-112 kW (150-152 PS) AEB	03.1996→12.1998		7.05270.96.0	LS	1440 mm	08.1997→ Regelsonde Regulating Probe
1.8 T 110 kW (150 PS) AWT	03.1996→09.2001		7.22560.43.0	ARV	PN	ch. 8D-X-200 001→
			7.05270.99.0	LS	940 mm	Diagnosesonde Diagnostic Probe
			7.21851.31.0	SLP	EL	ch. 8D-X-200 001→ch. 8D-Y-100 000
			7.22738.08.0	SLP	EL	ch. 8D-Y-100 001→
1.8 T 132 kW (180 PS) AJL	12.1997→09.2001		7.05270.96.0	LS	1440 mm	Regelsonde Regulating Probe
1.8 T 110 kW (150 PS) APU, ARK	07.1998→09.2001		7.05271.21.0	LS	1250 mm	APU, ARK: Regelsonde Regulating Probe
1.8 T 110 kW (150 PS) ANB	07.1999→09.2001		7.22560.42.0	ARV	PN	ch. 8D-X-200 001→
			7.05270.99.0	LS	940 mm	Diagnosesonde Diagnostic Probe
			7.05271.21.0	LS	1250 mm	Regelsonde Regulating Probe
			7.21851.31.0	SLP	EL	ch. 8D-X-200 001→ch. 8D-Y-100 000
			7.22738.08.0	SLP	EL	ch. 8D-Y-100 001→
1.8 T quattro 110-112 kW (150-152 PS) AEB	01.1996→12.1998		7.05270.96.0	LS	1440 mm	08.1997→ Regelsonde Regulating Probe
1.8 T quattro 110 kW (150 PS) AWT	01.1996→09.2001		7.22560.43.0	ARV	PN	ch. 8D-X-200 001→
			7.05270.99.0	LS	940 mm	Diagnosesonde Diagnostic Probe
			7.21851.31.0	SLP	EL	ch. 8D-X-200 001→ch. 8D-Y-100 000
			7.22738.08.0	SLP	EL	ch. 8D-Y-100 001→

A4 B5 Avant (8D5)						31
1.8 T quattro 132 kW (180 PS) AJL	12.1997→09.2001		7.05270.96.0	LS	1440 mm	Regelsonde Regulating Probe
1.8 T quattro 110 kW (150 PS) APU, ARK	07.1998→09.2001		7.05271.21.0	LS	1250 mm	APU, ARK: Regelsonde Regulating Probe
1.8 T quattro 110 kW (150 PS) ANB	07.1999→09.2001		7.22560.42.0	ARV	PN	ch. 8D-X-200 001→
			7.05270.99.0	LS	940 mm	Diagnosesonde Diagnostic Probe
			7.05271.21.0	LS	1250 mm	Regelsonde Regulating Probe
			7.21851.31.0	SLP	EL	ch. 8D-X-200 001→ch. 8D-Y-100 000
			7.22738.08.0	SLP	EL	ch. 8D-Y-100 001→
1.8 quattro 85 kW (115 PS) AFY	07.1995→09.2001		7.05271.21.0	LS	1250 mm	
1.8 quattro 92-95 kW (125-129 PS) ADR, APT	01.1996→09.2001		7.05271.21.0	LS	1250 mm	ADR, APT: Regelsonde Regulating Probe
1.8 quattro 92 kW (125 PS) ARG	07.1998→09.2001		7.05271.21.0	LS	1250 mm	Regelsonde Regulating Probe
			7.21851.31.0	SLP	EL	ch. 8D-X-200 001→ch. 8D-Y-100 000 Automatikgetriebe Automatic Transmission
			7.22738.08.0	SLP	EL	ch. 8D-Y-100 001→ Automatikgetriebe Automatic Transmission
1.9 TDI 85 kW (115 PS) AJM	03.2000→09.2001		7.24809.19.0	AGR	PN	
1.9 TDI quattro 85 kW (115 PS) ATJ	03.2000→09.2001		7.24809.19.0	AGR	PN	
2.4 121 kW (165 PS) ALF	08.1997→07.1998		7.22560.40.0	ARV	PN	links Left
			7.22560.41.0	ARV	PN	rechts Right
			7.21851.31.0	SLP	EL	
2.4 120 kW (163 PS) AMM	08.1997→09.2001		7.22560.41.0	ARV	PN	ch. 8D-X-200 001→ch. 8E-5-400 000 rechts Right
			7.22560.40.0	ARV	PN	Fahrgestellnummer ab: 8E-1-000 001 Vehicle Identification Number from: 8E-1-000 001 Fahrgestellnummer bis: 8E-5-400 000 Vehicle Identification Number to: 8E-5-400 000 links Left
			7.21851.31.0	SLP	EL	ch. 8D-X-200 001→ch. 8D-Y-100 000
			7.22738.08.0	SLP	EL	ch. 8D-Y-100 001→ch. 8E-5-400 000
2.4 121 kW (165 PS) AML, ARJ	08.1998→09.2001		7.22560.41.0	ARV	PN	AML, ARJ: ch. 8D-X-200 001→ rechts Right

A



A4 B5 Avant (8D5)

31

			7.22560.40.0	ARV	PN	 AML, ARJ: Fahrgestellnummer ab: 8D-X-200 001 Vehicle Identification Number from: 8D-X-200 001 links Left
			7.21851.31.0	SLP	EL	AML, ARJ: ch. 8D-X-200 001→ch. 8D-Y-100 000
			7.22738.08.0	SLP	EL	AML, ARJ: ch. 8D-Y-100 001→
2.4 quattro 121 kW (165 PS) ALF	08.1997→07.1998		7.22560.40.0	ARV	PN	 links Left
			7.22560.41.0	ARV	PN	 rechts Right
			7.21851.31.0	SLP	EL	
2.4 quattro 121 kW (165 PS) AML, ARJ	08.1998→09.2001		7.22560.41.0	ARV	PN	AML, ARJ: ch. 8D-X-200 001→ rechts Right
			7.22560.40.0	ARV	PN	AML, ARJ: Fahrgestellnummer ab: 8D-X-200 001 Vehicle Identification Number from: 8D-X-200 001 links Left
			7.21851.31.0	SLP	EL	AML, ARJ: ch. 8D-X-200 001→ch. 8D-Y-100 000
			7.22738.08.0	SLP	EL	AML, ARJ: ch. 8D-Y-100 001→
2.6 110 kW (150 PS) ABC	02.1996→09.2001		7.02604.03.0	LS	200 mm	
2.6 quattro 110 kW (150 PS) ABC	01.1996→09.2001		7.02604.03.0	LS	200 mm	
2.8 128 kW (174 PS) AAH	03.1996→09.1996		7.02604.03.0	LS	200 mm	
2.8 142-149 kW (193-203 PS) ACK, AHA, APR	10.1996→09.2001		7.22738.08.0	SLP	EL	
2.8 142 kW (193 PS) ALG, AQD	08.1997→09.2001		7.22560.41.0	ARV	PN	ALG: rechts Right AQD: ch. 8D-X-200 001→ rechts Right
			7.22560.40.0	ARV	PN	ALG: links Left AQD: Fahrgestellnummer ab: 8D-X-200 001 Vehicle Identification Number from: 8D-X-200 001 links Left
			7.21851.31.0	SLP	EL	ch. 8D-X-200 001→ch. 8D-Y-100 000
			7.22738.08.0	SLP	EL	ch. 8D-Y-100 001→
2.8 quattro 128 kW (174 PS) AAH	01.1996→09.1996		7.02604.03.0	LS	200 mm	
2.8 quattro 142 kW (193 PS) ALG	08.1997→09.2001		7.22560.40.0	ARV	PN	 links Left



A4 B5 Avant (8D5)						31
			7.22560.41.0	ARV	PN	rechts Right
			7.21851.31.0	SLP	EL	
2.8 quattro 142 kW (193 PS) AMX	08.1998→09.2001		7.22560.41.0	ARV	PN	ch. 8D-X-200 001→ rechts Right
			7.21851.31.0	SLP	EL	ch. 8D-X-200 001→ch. 8D-Y-100 000
			7.22738.08.0	SLP	EL	ch. 8D-Y-100 001→
2.8 quattro 142 kW (193 PS) AQD	08.1998→09.2001		7.22560.41.0	ARV	PN	ch. 8D-X-200 001→ rechts Right
			7.22560.40.0	ARV	PN	Fahrgestellnummer ab: 8D-X-200 001 Vehicle Identification Number from: 8D-X-200 001 links Left
			7.21851.31.0	SLP	EL	ch. 8D-X-200 001→ch. 8D-Y-100 000
			7.22738.08.0	SLP	EL	ch. 8D-Y-100 001→
RS4 quattro 280 kW (380 PS) ASJ, AZR	05.2000→09.2001		7.22769.77.0	ARV	PN	
			7.22769.78.0	ARV	PN	
S4 quattro 185-187 kW (252-254 PS) APB	01.2001→12.2002		7.22769.76.0	ARV	PN	ch. 8D-X-200 001→ links Left
A4 B6 (8E2)						32
1.6 75 kW (102 PS) ALZ	11.2000→12.2004		7.22785.20.0	AGR	EL	ch. 8E-1-000 001→ch. 8E-5-400 000
			7.05271.01.0	LS	950 mm	
			7.05271.05.0	LS	700 mm	ch. 8E-1-000 001→ch. 8E-5-400 000 nach Katalysator Post-catalyst
			7.05271.07.0	LS	1100 mm	
			7.21851.31.0	SLP	EL	ch. 8D-X-200 001→ch. 8D-Y-100 000
			7.22738.08.0	SLP	EL	ch. 8D-Y-100 001→
			7.22778.99.0	SLV	PN	ch. 8E-1-200 001→
1.8 T 110 kW (150 PS) AVJ	11.2000→07.2002		7.22560.43.0	ARV	PN	ch. 8E-1-000 001→ch. 8E-5-400 000
			7.05270.99.0	LS	940 mm	
			7.05271.24.0	LS	1500 mm	ch. 8E-1-000 001→ch. 8E-5-400 000 vor Katalysator in front of the catalyst
			7.22738.08.0	SLP	EL	ch. 8E-1-000 001→ch. 8E-5-400 000
1.8 T 125-127 kW (170-173 PS) AMB	07.2001→12.2004		7.22560.43.0	ARV	PN	
			7.05270.99.0	LS	940 mm	





























A



A4 B6 (8E2)

32

			7.05271.24.0	LS	1500 mm	 ch. 8E-1-000 001→ch. 8E-5-400 000 vor Katalysator in front of the catalyst
			7.22738.08.0	SLP	EL	
1.8 T 120 kW (163 PS) BFB	07.2002→12.2004		7.22560.43.0	ARV	PN	 ch. 8E-1-000 001→
			7.05270.99.0	LS	940 mm	
			7.05271.24.0	LS	1500 mm	 ch. 8E-1-000 001→ch. 8E-5-400 000 vor Katalysator in front of the catalyst
			7.22738.08.0	SLP	EL	 ch. 8E-1-000 001→
1.8 T 140 kW (190 PS) BEX	11.2002→12.2004		7.22560.43.0	ARV	PN	 ch. 8E-1-000 001→ch. 8E-5-400 000
			7.05270.99.0	LS	940 mm	
			7.05271.24.0	LS	1500 mm	 ch. 8E-1-000 001→ch. 8E-5-400 000 vor Katalysator in front of the catalyst
			7.22738.08.0	SLP	EL	 ch. 8E-1-000 001→ch. 8E-5-400 000
1.8 T quattro 110 kW (150 PS) AVJ	11.2000→07.2002		7.22560.43.0	ARV	PN	 ch. 8E-1-000 001→ch. 8E-5-400 000
			7.05270.99.0	LS	940 mm	
			7.05271.24.0	LS	1500 mm	 ch. 8E-1-000 001→ch. 8E-5-400 000 vor Katalysator in front of the catalyst
			7.22738.08.0	SLP	EL	 ch. 8E-1-000 001→ch. 8E-5-400 000
1.8 T quattro 125-127 kW (170-173 PS) AMB	07.2001→12.2004		7.22560.43.0	ARV	PN	
			7.05270.99.0	LS	940 mm	
			7.05271.24.0	LS	1500 mm	 ch. 8E-1-000 001→ch. 8E-5-400 000 vor Katalysator in front of the catalyst
			7.22738.08.0	SLP	EL	
1.8 T quattro 125-127 kW (170-173 PS) AWM	07.2001→12.2004		7.22560.43.0	ARV	PN	
			7.05270.99.0	LS	940 mm	
1.8 T quattro 120 kW (163 PS) BFB	07.2002→12.2004		7.22560.43.0	ARV	PN	 ch. 8E-1-000 001→
			7.05270.99.0	LS	940 mm	
			7.05271.24.0	LS	1500 mm	 ch. 8E-1-000 001→ch. 8E-5-400 000 vor Katalysator in front of the catalyst
			7.22738.08.0	SLP	EL	 ch. 8E-1-000 001→
1.8 T quattro 140 kW (190 PS) BEX	11.2002→12.2004		7.22560.43.0	ARV	PN	 ch. 8E-1-000 001→ch. 8E-5-400 000

















						A
A4 B6 (8E2)						32
			7.05270.99.0	LS	940 mm	
			7.05271.24.0	LS	1500 mm	 ch. 8E-1-000 001→ch. 8E-5-400 000 vor Katalysator in front of the catalyst
			7.22738.08.0	SLP	EL	 ch. 8E-1-000 001→ch. 8E-5-400 000
1.9 TDI 96 kW (130 PS) AVF, AWX	11.2000→12.2004		7.24809.20.0	AGR	PN	
1.9 TDI 74 kW (101 PS) AVB	05.2001→12.2004		7.24809.19.0	AGR	PN	
1.9 TDI 85 kW (116 PS) BKE	06.2004→12.2004		7.00365.06.0	AGR	EL	
1.9 TDI quattro 96 kW (130 PS) AVF	11.2001→12.2004		7.24809.20.0	AGR	PN	
2.0 96 kW (130 PS) ALT	11.2000→12.2004		7.05270.99.0	LS	940 mm	
			7.05271.24.0	LS	1500 mm	 ch. 8E-1-000 001→ch. 8E-5-400 000 vor Katalysator in front of the catalyst
			7.22738.08.0	SLP	EL	 ch. 8E-1-000 001→ch. 8E-5-400 000 Automatikgetriebe Automatic Transmission
2.0 FSI 110 kW (150 PS) AWA	07.2002→12.2004		7.05271.24.0	LS	1500 mm	 ch. 8E-1-000 001→ch. 8E-5-400 000 vor Katalysator in front of the catalyst
2.4 125 kW (170 PS) BDV	09.2001→12.2004		7.22560.41.0	ARV	PN	 ch. 8E-1-000 001→ch. 8E-5-400 000 rechts Right
			7.22560.40.0	ARV	PN	 Fahrgestellnummer ab: 8E-1-000 001 Vehicle Identification Number from: 8E-1-000 001 Fahrgestellnummer bis: 8E-5-400 000 Vehicle Identification Number to: 8E-5-400 000 links Left
			7.05270.99.0	LS	940 mm	
			7.22738.08.0	SLP	EL	 ch. 8E-1-000 001→ch. 8E-5-400 000
2.4 120 kW (163 PS) AMM	09.2001→12.2004		7.22560.41.0	ARV	PN	 ch. 8D-X-200 001→ch. 8E-5-400 000 rechts Right
			7.22560.40.0	ARV	PN	 Fahrgestellnummer ab: 8E-1-000 001 Vehicle Identification Number from: 8E-1-000 001 Fahrgestellnummer bis: 8E-5-400 000 Vehicle Identification Number to: 8E-5-400 000 links Left
			7.05270.99.0	LS	940 mm	
			7.21851.31.0	SLP	EL	 ch. 8D-X-200 001→ch. 8D-Y-100 000

A

















A4 B6 (8E2)

32

		7.22738.08.0	SLP	EL	 ch. 8D-Y-100 001→ch. 8E-5-400 000	
3.0 162 kW (220 PS) ASN	11.2000→12.2004		7.22560.44.0	ARV	PN  ch. 8E-1-000 001→ch. 8E-5-400 000 links Left	
			7.22560.45.0	ARV	PN  ch. 8E-1-000 001→ch. 8E-5-400 000 rechts Right	
			7.05271.23.0	LS	900 mm	
			7.05271.77.0	LS	800 mm	 ch. 8E-1-000 001→ch. 8E-5-400 000 vor Katalysator in front of the catalyst
			7.05271.00.0	LS	1525 mm	rechts Right
			7.05271.21.0	LS	1250 mm	
			7.22738.08.0	SLP	EL	 ch. 8E-1-000 001→ch. 8E-5-400 000
3.0 162-164 kW (220-223 PS) AVK	11.2000→12.2004		7.22560.44.0	ARV	PN  ch. 8E-1-000 001→ch. 8E-5-400 000 links Left	
			7.22560.45.0	ARV	PN  ch. 8E-1-000 001→ch. 8E-5-400 000 rechts Right	
			7.05271.23.0	LS	900 mm	
			7.05271.77.0	LS	800 mm	 ch. 8E-1-000 001→ch. 8E-5-400 000 vor Katalysator in front of the catalyst
			7.05271.21.0	LS	1250 mm	
			7.22738.08.0	SLP	EL	 ch. 8E-1-000 001→ch. 8E-5-400 000
			3.0 160-162 kW (218-220 PS) BBJ	04.2001→12.2004		7.22560.44.0
7.22560.45.0	ARV	PN  ch. 8E-1-000 001→ rechts Right				
7.05271.23.0	LS	900 mm				
7.05271.77.0	LS	800 mm				 ch. 8E-1-000 001→ vor Katalysator in front of the catalyst
7.05271.00.0	LS	1525 mm				rechts Right
7.05271.21.0	LS	1250 mm				
7.22738.08.0	SLP	EL				 ch. 8E-1-000 001→
3.0 quattro 162 kW (220 PS) ASN	11.2000→12.2004		7.22560.44.0	ARV	PN  ch. 8E-1-000 001→ch. 8E-5-400 000 links Left	

A4 B6 (8E2) **32**

			7.22560.45.0	ARV	PN	 ch. 8E-1-000 001→ch. 8E-5-400 000 rechts Right
			7.05271.23.0	LS	900 mm	
			7.05271.77.0	LS	800 mm	 ch. 8E-1-000 001→ch. _8E-5-400 000 vor Katalysator in front of the catalyst
			7.05271.00.0	LS	1525 mm	rechts Right
			7.05271.21.0	LS	1250 mm	
			7.22738.08.0	SLP	EL	 ch. 8E-1-000 001→ch. 8E-5-400 000
3.0 quattro 162-164 kW (220-223 PS) AVK	11.2000→12.2004		7.22560.44.0	ARV	PN	 ch. 8E-1-000 001→ch. 8E-5-400 000 links Left
			7.22560.45.0	ARV	PN	 ch. 8E-1-000 001→ch. 8E-5-400 000 rechts Right
			7.05271.23.0	LS	900 mm	
			7.05271.77.0	LS	800 mm	 ch. 8E-1-000 001→ch. _8E-5-400 000 vor Katalysator in front of the catalyst
			7.05271.21.0	LS	1250 mm	
			7.22738.08.0	SLP	EL	 ch. 8E-1-000 001→ch. 8E-5-400 000
			3.0 quattro 160-162 kW (218-220 PS) BBJ	04.2001→12.2004		7.22560.44.0
7.22560.45.0	ARV	PN				 ch. 8E-1-000 001→ rechts Right
7.05271.23.0	LS	900 mm				
7.05271.77.0	LS	800 mm				 ch. 8E-1-000 001→ vor Katalysator in front of the catalyst
7.05271.00.0	LS	1525 mm				rechts Right
7.05271.21.0	LS	1250 mm				
7.22738.08.0	SLP	EL				 ch. 8E-1-000 001→
S4 quattro 253 kW (344 PS) BBK	03.2003→12.2004		7.22560.41.0	ARV	PN	 ch. 8E-1-000 001→
			7.05271.00.0	LS	1525 mm	
			7.00216.06.0	SLP	EL	Fahrgestellnummer ab: 8E-1-000 001 Vehicle Identification Number from: 8E-1-000 001 Fahrgestellnummer bis: 8E-5-400 000 Vehicle Identification Number to: 8E-5-400 000

A



A4 B6 (8E2)

32

S4 quattro 253 kW (344 PS) BHF	03.2003→12.2004		7.22560.41.0	ARV	PN	ch. 8E-5-400 001→
			7.05271.00.0	LS	1525 mm	

A4 B6 Avant (8E5)

33

1.6 75 kW (102 PS) ALZ	09.2001→12.2004		7.22785.20.0	AGR	EL	ch. 8E-1-000 001→ch. 8E-5-400 000
			7.05271.01.0	LS	950 mm	
			7.05271.05.0	LS	700 mm	ch. 8E-1-000 001→ch. 8E-5-400 000 nach Katalysator Post-catalyst
			7.05271.07.0	LS	1100 mm	
			7.21851.31.0	SLP	EL	ch. 8D-X-200 001→ch. 8D-Y-100 000
			7.22738.08.0	SLP	EL	ch. 8D-Y-100 001→
1.8 T 110 kW (150 PS) AVJ	09.2001→07.2002		7.22560.43.0	ARV	PN	ch. 8E-1-000 001→ch. 8E-5-400 000
			7.05270.99.0	LS	940 mm	
			7.05271.24.0	LS	1500 mm	vor Katalysator in front of the catalyst
			7.22738.08.0	SLP	EL	ch. 8E-1-000 001→ch. 8E-5-400 000
1.8 T 120 kW (163 PS) BFB	07.2002→12.2004		7.22560.43.0	ARV	PN	ch. 8E-1-000 001→
			7.05270.99.0	LS	940 mm	
			7.05271.24.0	LS	1500 mm	ch. 8E-1-000 001→ch. 8E-5-400 000 vor Katalysator in front of the catalyst
			7.22738.08.0	SLP	EL	ch. 8E-1-000 001→
1.8 T 140 kW (190 PS) BEX	11.2002→12.2004		7.22560.43.0	ARV	PN	ch. 8E-1-000 001→ch. 8E-5-400 000
			7.05270.99.0	LS	940 mm	
			7.05271.24.0	LS	1500 mm	ch. 8E-1-000 001→ch. 8E-5-400 000 vor Katalysator in front of the catalyst
			7.22738.08.0	SLP	EL	ch. 8E-1-000 001→ch. 8E-5-400 000
1.8 T quattro 110 kW (150 PS) AVJ	09.2001→07.2002		7.22560.43.0	ARV	PN	ch. 8E-1-000 001→ch. 8E-5-400 000
			7.05270.99.0	LS	940 mm	
			7.05271.24.0	LS	1500 mm	ch. 8E-1-000 001→ch. 8E-5-400 000 vor Katalysator in front of the catalyst
			7.22738.08.0	SLP	EL	ch. 8E-1-000 001→ch. 8E-5-400 000
1.8 T quattro 125-127 kW (170-173 PS) AMB	09.2001→12.2004		7.22560.43.0	ARV	PN	
			7.05270.99.0	LS	940 mm	

A4 B6 Avant (8E5)
33

















		7.05271.24.0	LS	1500 mm	ch. 8E-1-000 001→ch. 8E-5-400 000 vor Katalysator in front of the catalyst
1.8 T quattro 120 kW (163 PS) BFB	07.2002→12.2004	7.22738.08.0	SLP	EL	
		7.22560.43.0	ARV	PN	ch. 8E-1-000 001→
		7.05270.99.0	LS	940 mm	
		7.05271.24.0	LS	1500 mm	ch. 8E-1-000 001→ch. 8E-5-400 000 vor Katalysator in front of the catalyst
		7.22738.08.0	SLP	EL	ch. 8E-1-000 001→
1.8 T quattro 140 kW (190 PS) BEX	11.2002→12.2004	7.22560.43.0	ARV	PN	ch. 8E-1-000 001→ch. 8E-5-400 000
		7.05270.99.0	LS	940 mm	
		7.05271.24.0	LS	1500 mm	ch. 8E-1-000 001→ch. 8E-5-400 000 vor Katalysator in front of the catalyst
		7.22738.08.0	SLP	EL	ch. 8E-1-000 001→ch. 8E-5-400 000
		7.24809.20.0	AGR	PN	
1.9 TDI 96 kW (130 PS) AVF, AWX	09.2001→12.2004	7.24809.19.0	AGR	PN	
1.9 TDI 74 kW (101 PS) AVB	11.2001→12.2004	7.00365.06.0	AGR	EL	
1.9 TDI 85 kW (116 PS) BKE	06.2004→12.2004	7.24809.20.0	AGR	PN	
1.9 TDI quattro 96 kW (130 PS) AVF	11.2001→12.2004	7.05270.99.0	LS	940 mm	
2.0 96 kW (130 PS) ALT	09.2001→12.2004	7.05271.24.0	LS	1500 mm	ch. 8E-1-000 001→ch. 8E-5-400 000 vor Katalysator in front of the catalyst
		7.22738.08.0	SLP	EL	ch. 8E-1-000 001→ch. 8E-5-400 000 Automatikgetriebe Automatic Transmission
		7.05271.24.0	LS	1500 mm	ch. 8E-1-000 001→ch. 8E-5-400 000 vor Katalysator in front of the catalyst
2.0 FSI 110 kW (150 PS) AWA	06.2003→12.2004	7.22560.41.0	ARV	PN	ch. 8E-1-000 001→ch. 8E-5-400 000 rechts Right
2.4 125 kW (170 PS) BDV	09.2001→12.2004	7.22560.40.0	ARV	PN	Fahrgestellnummer ab: 8E-1-000 001 Vehicle Identification Number from: 8E-1-000 001 Fahrgestellnummer bis: 8E-5-400 000 Vehicle Identification Number to: 8E-5-400 000 links Left
		7.05270.99.0	LS	940 mm	
		7.22738.08.0	SLP	EL	ch. 8E-1-000 001→ch. 8E-5-400 000

A



A4 B6 Avant (8E5)

33

2.4 120 kW (163 PS) AMM	09.2001→12.2004	7.22560.41.0 	ARV	PN	 ch. 8D-X-200 001→ch. 8E-5-400 000 rechts Right
		7.22560.40.0	ARV	PN	 Fahrgestellnummer ab: 8E-1-000 001 Vehicle Identification Number from: 8E-1-000 001 Fahrgestellnummer bis: 8E-5-400 000 Vehicle Identification Number to: 8E-5-400 000 links Left
		7.05270.99.0	LS	940 mm	
		7.21851.31.0	SLP	EL	 ch. 8D-X-200 001→ch. 8D-Y-100 000
		7.22738.08.0	SLP	EL	 ch. 8D-Y-100 001→ch. 8E-5-400 000
2.7 S4 quattro 185-187 kW (252-254 PS) APB	04.2001→12.2002		ARV	PN	 ch. 8D-X-200 001→ links Left
3.0 160-162 kW (218-220 PS) BBJ	04.2001→12.2004		ARV	PN	 ch. 8E-1-000 001→ links Left
		7.22560.45.0	ARV	PN	 ch. 8E-1-000 001→ rechts Right
		7.05271.23.0	LS	900 mm	
		7.05271.77.0	LS	800 mm	 ch. 8E-1-000 001→ vor Katalysator in front of the catalyst
		7.05271.00.0	LS	1525 mm	rechts Right
		7.05271.21.0	LS	1250 mm	
		7.22738.08.0	SLP	EL	 ch. 8E-1-000 001→
3.0 162 kW (220 PS) ASN	09.2001→12.2004		ARV	PN	 ch. 8E-1-000 001→ch. 8E-5-400 000 links Left
		7.22560.45.0	ARV	PN	 ch. 8E-1-000 001→ch. 8E-5-400 000 rechts Right
		7.05271.23.0	LS	900 mm	
		7.05271.77.0	LS	800 mm	 ch. 8E-1-000 001→ch. 8E-5-400 000 vor Katalysator in front of the catalyst
		7.05271.00.0	LS	1525 mm	rechts Right
		7.05271.21.0	LS	1250 mm	
		7.22738.08.0	SLP	EL	 ch. 8E-1-000 001→ch. 8E-5-400 000

A4 B6 Avant (8E5)
33







3.0 quattro 160-162 kW (218-220 PS) BBJ	04.2001→12.2004		7.22560.44.0 ARV PN ch. 8E-1-000 001→ links Left
			7.22560.45.0 ARV PN ch. 8E-1-000 001→ rechts Right
			7.05271.23.0 LS 900 mm
			7.05271.77.0 LS 800 mm ch. 8E-1-000 001→ vor Katalysator in front of the catalyst
			7.05271.00.0 LS 1525 mm rechts Right
			7.05271.21.0 LS 1250 mm
			7.22738.08.0 SLP EL ch. 8E-1-000 001→
3.0 quattro 162 kW (220 PS) ASN	09.2001→12.2004		7.22560.44.0 ARV PN ch. 8E-1-000 001→ch. 8E-5-400 000 links Left
			7.22560.45.0 ARV PN ch. 8E-1-000 001→ch. 8E-5-400 000 rechts Right
			7.05271.23.0 LS 900 mm
			7.05271.77.0 LS 800 mm ch. 8E-1-000 001→ch. _8E-5-400 000 vor Katalysator in front of the catalyst
			7.05271.00.0 LS 1525 mm rechts Right
			7.05271.21.0 LS 1250 mm
			7.22738.08.0 SLP EL ch. 8E-1-000 001→ch. 8E-5-400 000
3.0 quattro 162-164 kW (220-223 PS) AVK	09.2001→12.2004		7.22560.44.0 ARV PN ch. 8E-1-000 001→ch. 8E-5-400 000 links Left
			7.22560.45.0 ARV PN ch. 8E-1-000 001→ch. 8E-5-400 000 rechts Right
			7.05271.23.0 LS 900 mm
			7.05271.77.0 LS 800 mm ch. 8E-1-000 001→ch. _8E-5-400 000 vor Katalysator in front of the catalyst
			7.05271.21.0 LS 1250 mm
			7.22738.08.0 SLP EL ch. 8E-1-000 001→ch. 8E-5-400 000
			7.22560.44.0 ARV PN ch. 8E-1-000 001→

A





















A4 B6 Avant (8E5)

33

			7.22560.45.0	ARV	PN	 ch. 8E-1-000 001→ch. 8E-5-400 000 rechts Right
S4 quattro 253 kW (344 PS) BBK	03.2003→12.2004		7.22560.41.0	ARV	PN	
			7.05271.00.0	LS	1525 mm	
			7.00216.06.0	SLP	EL	Fahrgestellnummer ab: 8E-1-000 001 Vehicle Identification Number from: 8E-1-000 001 Fahrgestellnummer bis: 8E-5-400 000 Vehicle Identification Number to: 8E-5-400 000
S4 quattro 253 kW (344 PS) BHF	03.2003→12.2004		7.22560.41.0	ARV	PN	
			7.05271.00.0	LS	1525 mm	

A4 B6 Convertible (8H7)

34

1.8 T 120 kW (163 PS) BFB	07.2002→12.2005		7.22560.43.0	ARV	PN	 ch. 8E-1-000 001→
			7.05271.24.0	LS	1500 mm	vor Katalysator in front of the catalyst
			7.22738.08.0	SLP	EL	 ch. 8E-1-000 001→
1.8 T 125-127 kW (170-173 PS) AMB	10.2002→10.2005		7.22560.43.0	ARV	PN	
			7.22738.08.0	SLP	EL	
1.8 T quattro 120 kW (163 PS) BFB	05.2003→12.2005		7.22560.43.0	ARV	PN	 ch. 8E-1-000 001→
			7.05271.24.0	LS	1500 mm	vor Katalysator in front of the catalyst
			7.22738.08.0	SLP	EL	 ch. 8E-1-000 001→
1.8 T quattro 125-127 kW (170-173 PS) AMB	09.2003→12.2004		7.22560.43.0	ARV	PN	
			7.22738.08.0	SLP	EL	
2.0 96 kW (130 PS) ALT	09.2004→12.2005		7.05270.99.0	LS	940 mm	
			7.05271.24.0	LS	1500 mm	vor Katalysator in front of the catalyst
			7.22738.08.0	SLP	EL	 ch. 8E-1-000 001→ch. 8E-5-400 000 Automatikgetriebe Automatic Transmission
2.4 125 kW (170 PS) BDV	04.2002→12.2005		7.22560.40.0	ARV	PN	 links Left
			7.22560.41.0	ARV	PN	 rechts Right
			7.05270.99.0	LS	940 mm	
			7.22738.08.0	SLP	EL	 ch. 8E-1-000 001→ch. 8E-5-400 000
2.4 120 kW (163 PS) AMM	04.2002→12.2005		7.22560.40.0	ARV	PN	 links Left
			7.22560.41.0	ARV	PN	 rechts Right
			7.05270.99.0	LS	940 mm	

A4 B6 Convertible (8H7) **34**

			7.21851.31.0	SLP	EL	ch. 8D-X-200 001→ch. 8D-Y-100 000
			7.22738.08.0	SLP	EL	ch. 8D-Y-100 001→ch. 8E-5-400 000
3.0 162 kW (220 PS) ASN	04.2002→12.2005		7.22560.44.0	ARV	PN	links Left
			7.22560.45.0	ARV	PN	rechts Right
			7.05271.23.0	LS	900 mm	
			7.05271.77.0	LS	800 mm	vor Katalysator in front of the catalyst
			7.05271.00.0	LS	1525 mm	rechts Right
			7.05271.21.0	LS	1250 mm	
			7.22738.08.0	SLP	EL	ch. 8E-1-000 001→ch. 8E-5-400 000
3.0 162-164 kW (220-223 PS) AVK	04.2002→12.2005		7.05271.23.0	LS	900 mm	
			7.05271.21.0	LS	1250 mm	
3.0 162-164 kW (220-223 PS) BGN	04.2002→12.2005		7.05271.23.0	LS	900 mm	
			7.05270.98.0	LS	700 mm	nach Katalysator Post-catalyst Mexico Mexico
			7.05271.21.0	LS	1250 mm	
3.0 160-162 kW (218-220 PS) BBJ	04.2002→12.2005		7.22560.44.0	ARV	PN	links Left
			7.22560.45.0	ARV	PN	rechts Right
			7.05271.77.0	LS	800 mm	vor Katalysator in front of the catalyst
			7.05271.21.0	LS	1250 mm	
			7.22738.08.0	SLP	EL	ch. 8E-1-000 001→
3.0 quattro 162 kW (220 PS) ASN	05.2003→12.2005		7.22560.44.0	ARV	PN	links Left
			7.22560.45.0	ARV	PN	rechts Right
			7.05271.23.0	LS	900 mm	
			7.05271.77.0	LS	800 mm	für OE-Nummer: 1k0 998 262 F for OE number: 1k0 998 262 F
			7.05271.00.0	LS	1525 mm	rechts Right
			7.05271.21.0	LS	1250 mm	
			7.22738.08.0	SLP	EL	ch. 8E-1-000 001→ch. 8E-5-400 000
3.0 quattro 162-164 kW (220-223 PS) AVK	05.2003→12.2005		7.05271.23.0	LS	900 mm	
			7.05271.21.0	LS	1250 mm	

A



A4 B6 Convertible (8H7)























34

3.0 quattro 162-164 kW (220-223 PS) BGN	05.2003→12.2005		7.05271.23.0 LS 900 mm	ch. 8E-1-000 001→ch. 8E-5-400 000 nach Katalysator Post-catalyst ■ Mexico ■ Mexico
			7.05270.98.0 LS 700 mm	
			7.05271.21.0 LS 1250 mm	
S4 quattro 253 kW (344 PS) BBK	03.2004→12.2005		7.22560.41.0 ARV PN	vor Katalysator in front of the catalyst
			7.05271.77.0 LS 800 mm	
			7.05271.00.0 LS 1525 mm	
			7.00216.06.0 SLP EL	
S4 quattro 253 kW (344 PS) BHF	03.2004→12.2005		7.22560.41.0 ARV PN	
			7.05271.00.0 LS 1525 mm	

A4 B7 (8EC)

35

1.6 75 kW (102 PS) ALZ	11.2004→06.2008		7.22785.20.0 AGR EL	ch. 8E-5-400 001→	
			7.05271.01.0 LS 950 mm		
			7.05271.07.0 LS 1100 mm		
			7.21851.31.0 SLP EL		ch. 8D-X-200 001→ch. 8D-Y-100 000
			7.22738.08.0 SLP EL		ch. 8D-Y-100 001→
			7.22778.99.0 SLV PN		ch. 8E-1-200 001→
1.8 T 120 kW (163 PS) BFB	11.2004→06.2008		7.22560.43.0 ARV PN	ch. 8E-1-000 001→	
			7.05271.24.0 LS 1500 mm		ch. 8E-1-000 001→ch. 8E-5-400 000 vor Katalysator in front of the catalyst
			7.22738.08.0 SLP EL		ch. 8E-1-000 001→
1.8 T 125-127 kW (170-173 PS) AMB	01.2005→12.2005		7.22560.43.0 ARV PN		
1.8 T quattro 120 kW (163 PS) BFB	11.2004→06.2008		7.22560.43.0 ARV PN	ch. 8E-1-000 001→	
			7.05271.24.0 LS 1500 mm		ch. 8E-1-000 001→ch. 8E-5-400 000 vor Katalysator in front of the catalyst
			7.22738.08.0 SLP EL		ch. 8E-1-000 001→
1.9 TDI 85 kW (116 PS) BKE	11.2004→06.2008		7.00365.06.0 AGR EL		
1.9 TDI 85 kW (116 PS) BRB	11.2004→06.2008		7.00365.06.0 AGR EL	Fahrgestellnummer ab: 8E-6-159 001 Vehicle Identification Number from: 8E-6-159 001	
			7.08369.22.0 ATS EL		
			7.08369.23.0 ATS EL		Fahrgestellnummer ab: 8E-5-400 001 Vehicle Identification Number from: 8E-5-400 001

						A
A4 B7 (8EC)						35
			7.08369.40.0	ATS	EL	Fahrgestellnummer ab: 8E-5-400 001 Vehicle Identification Number from: 8E-5-400 001 Euro 4 Euro 4
			7.11190.00.0	DDS	 ch. 8E-5-400 001→ch. 8E-7-248 161 Euro 4 Euro 4	
			7.11492.02.0	DDS	ohne Zubehör without accessories  ch. 8E-7-248 162→ Euro 4 Euro 4	
2.0 96 kW (130 PS) ALT	11.2004→06.2008		7.05271.24.0	LS	1500 mm  ch. 8E-1-000 001→ch. 8E-5-400 000 vor Katalysator in front of the catalyst	
			7.22738.08.0	SLP	EL  ch. 8E-1-000 001→ch. 8E-5-400 000 Automatikgetriebe Automatic Transmission	
2.0 FSI 110 kW (150 PS) AWA	01.2005→07.2005		7.05271.24.0	LS	1500 mm  ch. 8E-1-000 001→ch. 8E-5-400 000 vor Katalysator in front of the catalyst	
2.0 TDI 100 kW (136 PS) BNA	11.2004→06.2008		7.10334.10.0	AGR	EL  ch. 8E-5-400 001→	
			7.08369.22.0	ATS	EL Fahrgestellnummer ab: 4F-7-000 001 Vehicle Identification Number from: 4F-7-000 001	
2.0 TDI 100 kW (136 PS) BRF	11.2004→06.2008		7.10334.10.0	AGR	EL  ch. 8E-5-400 001→	
			7.08369.00.0	ATS	EL Fahrgestellnummer ab: 8E-5-400 001 Vehicle Identification Number from: 8E-5-400 001	
			7.08369.22.0	ATS	EL Fahrgestellnummer ab: 4F-7-000 001 Vehicle Identification Number from: 4F-7-000 001	
2.0 TDI 103 kW (140 PS) BPW	11.2004→06.2008		7.00365.06.0	AGR	EL 	
			7.08369.22.0	ATS	EL Fahrgestellnummer ab: 8E-6-159 001 Vehicle Identification Number from: 8E-6-159 001	
			7.08369.23.0	ATS	EL Fahrgestellnummer ab: 8E-5-400 001 Vehicle Identification Number from: 8E-5-400 001	
			7.08369.40.0	ATS	EL Fahrgestellnummer ab: 8E-5-400 001 Vehicle Identification Number from: 8E-5-400 001 Euro 4 Euro 4	
			7.11190.00.0	DDS	 ch. 8E-5-400 001→ch. 8E-7-248 161 Euro 4 Euro 4	
			7.11492.02.0	DDS	ohne Zubehör without accessories  ch. 8E-7-248 162→ Euro 4 Euro 4	
2.0 TDI 89 kW (121 PS) BVG	09.2005→09.2006		7.10334.10.0	AGR	EL  ch. 8E-5-400 001→	
			7.08369.00.0	ATS	EL Fahrgestellnummer ab: 8E-5-400 001 Vehicle Identification Number from: 8E-5-400 001	

A



A4 B7 (8EC)

35

			7.08369.22.0	ATS	EL	Fahrgestellnummer ab: 4F-7-000 001 Vehicle Identification Number from: 4F-7-000 001
2.0 TDI 93 kW (126 PS) BVF	11.2005→11.2006		7.08369.00.0	ATS	EL	Fahrgestellnummer ab: 8E-5-400 001 Vehicle Identification Number from: 8E-5-400 001
2.0 TDI 125 kW (170 PS) BRD	06.2006→06.2008		7.10334.10.0	AGR	EL	ch. 8E-5-400 001→
			7.08369.22.0	ATS	EL	Fahrgestellnummer ab: 8E-6-159 001 Vehicle Identification Number from: 8E-6-159 001
			7.08369.23.0	ATS	EL	Fahrgestellnummer ab: 8E-5-400 001 Vehicle Identification Number from: 8E-5-400 001
			7.08369.65.0 7.11190.00.0	ATS DDS	EL	ch. 8E-5-400 001→ch. 8E-7-248 1 61 Euro 4 Euro 4
			7.11492.02.0	DDS		ohne Zubehör without accessories ch. 8E-7-248 162→ Euro 4 Euro 4
2.0 TDI 120 kW (163 PS) BVA	06.2006→06.2008		7.10334.10.0	AGR	EL	ch. 8E-5-400 001→
			7.08369.22.0	ATS	EL	Fahrgestellnummer ab: 8E-6-159 001 Vehicle Identification Number from: 8E-6-159 001
			7.08369.23.0	ATS	EL	Fahrgestellnummer ab: 8E-5-400 001 Vehicle Identification Number from: 8E-5-400 001
			7.08369.65.0 7.11190.00.0	ATS DDS	EL	ch. 8E-5-400 001→ch. 8E-7-248 1 61 Euro 4 Euro 4
7.11492.02.0	DDS		ohne Zubehör without accessories ch. 8E-7-248 162→ Euro 4 Euro 4			
2.0 TDI 16V 103 kW (140 PS) BLB	11.2004→06.2008		7.10334.10.0	AGR	EL	ch. 8E-5-400 001→
			7.08369.22.0	ATS	EL	Fahrgestellnummer ab: 8E-6-159 001 Vehicle Identification Number from: 8E-6-159 001
2.0 TDI 16V 103 kW (140 PS) BRE	11.2004→06.2008		7.10334.10.0	AGR	EL	ch. 8E-5-400 001→
			7.08369.00.0	ATS	EL	Fahrgestellnummer ab: 8E-5-400 001 Vehicle Identification Number from: 8E-5-400 001
			7.08369.22.0	ATS	EL	Fahrgestellnummer ab: 8E-6-159 001 Vehicle Identification Number from: 8E-6-159 001
			7.08369.23.0	ATS	EL	Fahrgestellnummer ab: 8E-5-400 001 Vehicle Identification Number from: 8E-5-400 001
7.11492.02.0	DDS		ohne Zubehör without accessories ch. 8E-7-248 162→ Euro 4 Euro 4			
2.0 TDI quattro 103 kW (140 PS) BPW	01.2006→06.2008		7.00365.06.0	AGR	EL	

A4 B7 (8EC)
35































			7.08369.22.0	ATS	EL	Fahrgestellnummer ab: 8E-6-159 001 Vehicle Identification Number from: 8E-6-159 001
			7.08369.23.0	ATS	EL	Fahrgestellnummer ab: 8E-5-400 001 Vehicle Identification Number from: 8E-5-400 001
			7.08369.40.0	ATS	EL	Fahrgestellnummer ab: 8E-5-400 001 Vehicle Identification Number from: 8E-5-400 001 Euro 4 Euro 4
			7.11190.00.0	DDS	ch. 8E-5-400 001→ch. 8E-7-248 1 61 Euro 4 Euro 4	
			7.11492.02.0	DDS		ohne Zubehör without accessories ch. 8E-7-248 162→ Euro 4 Euro 4
2.0 TDI quattro 125 kW (170 PS) BRD	06.2006→06.2008		7.10334.10.0	AGR	EL	 ch. 8E-5-400 001→
			7.08369.22.0	ATS	EL	Fahrgestellnummer ab: 8E-6-159 001 Vehicle Identification Number from: 8E-6-159 001
			7.08369.23.0	ATS	EL	Fahrgestellnummer ab: 8E-5-400 001 Vehicle Identification Number from: 8E-5-400 001
			7.08369.65.0	ATS	EL	
			7.11190.00.0	DDS		ch. 8E-5-400 001→ch. 8E-7-248 1 61 Euro 4 Euro 4
			7.11492.02.0	DDS		ohne Zubehör without accessories ch. 8E-7-248 162→ Euro 4 Euro 4
2.0 TDI quattro 120 kW (163 PS) BVA	06.2006→06.2008		7.10334.10.0	AGR	EL	 ch. 8E-5-400 001→
			7.08369.22.0	ATS	EL	Fahrgestellnummer ab: 8E-6-159 001 Vehicle Identification Number from: 8E-6-159 001
			7.08369.23.0	ATS	EL	Fahrgestellnummer ab: 8E-5-400 001 Vehicle Identification Number from: 8E-5-400 001
			7.08369.65.0	ATS	EL	
			7.11190.00.0	DDS		ch. 8E-5-400 001→ch. 8E-7-248 1 61 Euro 4 Euro 4
			7.11492.02.0	DDS		ohne Zubehör without accessories ch. 8E-7-248 162→ Euro 4 Euro 4
2.0 TFSI 147-149 kW (200-203 PS) BGB, BPG, BWE, BWT	11.2004→06.2008		7.05271.11.0	LS	800 mm	
2.0 TFSI 162 kW (220 PS) BUL	06.2005→06.2008		7.05271.11.0	LS	800 mm	
2.0 TFSI 125 kW (170 PS) BPJ, BYK	10.2006→06.2008		7.05271.11.0	LS	800 mm	
2.0 TFSI quattro 147-149 kW (200-203 PS) BGB, BPG, BWE, BWT	11.2004→06.2008		7.05271.11.0	LS	800 mm	

A



A4 B7 (8EC)

35

2.0 TFSI quattro 162 kW (220 PS) BUL	06.2005→06.2008	 7.05271.11.0	LS	800 mm	
2.7 TDI 120 kW (163 PS) BSG	11.2005→06.2008	 7.00309.07.0 7.08369.13.0	AGR ATS	PN EL	 Fahrgestellnummer ab: 8E-5-400 001 Vehicle Identification Number from: 8E-5-400 001
2.7 TDI 132 kW (180 PS) BPP	01.2006→06.2008	 7.00309.07.0 7.08369.13.0	AGR ATS	PN EL	 Fahrgestellnummer ab: 8E-5-400 001 Vehicle Identification Number from: 8E-5-400 001
3.0 160-162 kW (218-220 PS) BBJ	11.2004→05.2006	 7.22560.44.0 7.22560.45.0 7.05271.21.0 7.22738.08.0	ARV ARV LS SLP	PN PN 1250 mm EL	  ch. 8E-1-000 001→ links Left   ch. 8E-1-000 001→ rechts Right  ch. 8E-1-000 001→
3.0 TDI quattro 150 kW (204 PS) BKN	11.2004→06.2008	 7.00309.07.0 7.08369.13.0	AGR ATS	PN EL	 Fahrgestellnummer ab: 8E-5-400 001 Vehicle Identification Number from: 8E-5-400 001
3.0 TDI quattro 171 kW (233 PS) ASB	01.2006→06.2008	 7.00309.07.0 7.08369.13.0	AGR ATS	PN EL	 Fahrgestellnummer ab: 8E-5-400 001 Vehicle Identification Number from: 8E-5-400 001
3.0 quattro 160-162 kW (218-220 PS) BBJ	11.2004→07.2006	 7.22560.44.0 7.22560.45.0 7.05271.77.0 7.05271.21.0 7.22738.08.0	ARV ARV LS LS SLP	PN PN 800 mm 1250 mm EL	  ch. 8E-1-000 001→ links Left   ch. 8E-1-000 001→ rechts Right  ch. 8E-1-000 001→ vor Katalysator in front of the catalyst
RS4 quattro 309 kW (420 PS) BNS	09.2005→06.2008	 7.22769.80.0 7.05271.15.0 7.00216.06.0	ARV LS SLP	PN 525 mm EL	 beidseitig Left and right
S4 quattro 253 kW (344 PS) BBK, BHF	11.2004→06.2008	 7.22560.41.0 7.05271.77.0 7.05271.00.0 7.00216.06.0	ARV LS LS SLP	PN 800 mm 1525 mm EL	 BBK:  ch. 8E-1-000 001→ BHF:  ch. 8E-5-400 001→  BBK, BHF:  ch. 8E-5-400 001→ vor Katalysator in front of the catalyst
					 BBK, BHF: Fahrgestellnummer ab: 8E-5-400 001 Vehicle Identification Number from: 8E-5-400 001

















						A
A4 B7 Avant (8ED)						36
1.6 75 kW (102 PS) ALZ	11.2004→06.2008		7.22785.20.0	AGR	EL	ch. 8E-5-400 001→
			7.05271.01.0	LS	950 mm	
			7.05271.07.0	LS	1100 mm	
			7.21851.31.0	SLP	EL	ch. 8D-X-200 001→ch. 8D-Y-100 000
			7.22738.08.0 7.22778.99.0	SLP SLV	EL PN	ch. 8D-Y-100 001→ ch. 8E-1-200 001→
1.8 T 120 kW (163 PS) BFB	11.2004→06.2008		7.22560.43.0	ARV	PN	ch. 8E-1-000 001→
			7.05271.24.0	LS	1500 mm	vor Katalysator in front of the catalyst
			7.22738.08.0	SLP	EL	ch. 8E-1-000 001→
1.8 T quattro 120 kW (163 PS) BFB	11.2004→06.2008		7.22560.43.0	ARV	PN	ch. 8E-1-000 001→
			7.05271.24.0	LS	1500 mm	ch. 8E-1-000 001→ch. 8E-5-400 000 vor Katalysator in front of the catalyst
			7.22738.08.0	SLP	EL	ch. 8E-1-000 001→
1.9 TDI 85 kW (116 PS) BKE	11.2004→06.2008		7.00365.06.0	AGR	EL	
1.9 TDI 85 kW (116 PS) BRB	11.2004→06.2008		7.00365.06.0	AGR	EL	
			7.08369.22.0	ATS	EL	Fahrgestellnummer ab: 8E-6-159 001 Vehicle Identification Number from: 8E-6-159 001
			7.08369.23.0	ATS	EL	Fahrgestellnummer ab: 8E-5-400 001 Vehicle Identification Number from: 8E-5-400 001
			7.08369.40.0	ATS	EL	Fahrgestellnummer ab: 8E-5-400 001 Vehicle Identification Number from: 8E-5-400 001 Euro 4 Euro 4
			7.11190.00.0	DDS		ch. 8E-5-400 001→ch. 8E-7-248 161 Euro 4 Euro 4
			7.11492.02.0	DDS		ohne Zubehör without accessories ch. 8E-7-248 162→ Euro 4 Euro 4
2.0 96 kW (130 PS) ALT	11.2004→06.2008		7.05271.24.0	LS	1500 mm	ch. 8E-1-000 001→ch. 8E-5-400 000 vor Katalysator in front of the catalyst
			7.22738.08.0	SLP	EL	ch. 8E-1-000 001→ch. 8E-5-400 000 Automatikgetriebe Automatic Transmission
2.0 TDI 100 kW (136 PS) BNA	11.2004→06.2008		7.10334.10.0	AGR	EL	ch. 8E-5-400 001→
			7.08369.22.0	ATS	EL	Fahrgestellnummer ab: 4F-7-000 001 Vehicle Identification Number from: 4F-7-000 001
2.0 TDI 100 kW (136 PS) BRF	11.2004→06.2008		7.10334.10.0	AGR	EL	ch. 8E-5-400 001→

A



A4 B7 Avant (8ED)

36

			7.08369.00.0	ATS	EL	Fahrgestellnummer ab: 8E-5-400 001 Vehicle Identification Number from: 8E-5-400 001
			7.08369.22.0	ATS	EL	Fahrgestellnummer ab: 4F-7-000 001 Vehicle Identification Number from: 4F-7-000 001
2.0 TDI 103 kW (140 PS) BPW	11.2004→06.2008		7.00365.06.0	AGR	EL	
			7.08369.22.0	ATS	EL	 ch. 8E-6-159 001→ nach Rußpartikelfilter after soot particulate filter
			7.08369.23.0	ATS	EL	Fahrgestellnummer ab: 8E-5-400 001 Vehicle Identification Number from: 8E-5-400 001
			7.08369.40.0	ATS	EL	Fahrgestellnummer ab: 8E-5-400 001 Vehicle Identification Number from: 8E-5-400 001 Euro 4 Euro 4
			7.11190.00.0	DDS		 ch. 8E-5-400 001→ch. 8E-7-248 1 61 Euro 4 Euro 4
			7.11492.02.0	DDS		ohne Zubehör without accessories  ch. 8E-7-248 162→ Euro 4 Euro 4
2.0 TDI 89 kW (121 PS) BVG	09.2005→09.2006		7.10334.10.0	AGR	EL	  ch. 8E-5-400 001→
			7.08369.00.0	ATS	EL	Fahrgestellnummer ab: 8E-5-400 001 Vehicle Identification Number from: 8E-5-400 001
			7.08369.22.0	ATS	EL	Fahrgestellnummer ab: 4F-7-000 001 Vehicle Identification Number from: 4F-7-000 001
2.0 TDI 93 kW (126 PS) BVF	11.2005→11.2006		7.08369.00.0	ATS	EL	Fahrgestellnummer ab: 8E-5-400 001 Vehicle Identification Number from: 8E-5-400 001
2.0 TDI 125 kW (170 PS) BRD	06.2006→06.2008		7.10334.10.0	AGR	EL	  ch. 8E-5-400 001→
			7.08369.22.0	ATS	EL	Fahrgestellnummer ab: 8E-6-159 001 Vehicle Identification Number from: 8E-6-159 001
			7.08369.23.0	ATS	EL	Fahrgestellnummer ab: 8E-5-400 001 Vehicle Identification Number from: 8E-5-400 001
			7.08369.65.0	ATS	EL	
			7.11190.00.0	DDS		 ch. 8E-5-400 001→ch. 8E-7-248 1 61 Euro 4 Euro 4
			7.11492.02.0	DDS		ohne Zubehör without accessories  ch. 8E-7-248 162→ Euro 4 Euro 4
2.0 TDI 120 kW (163 PS) BVA	06.2006→06.2008		7.10334.10.0	AGR	EL	  ch. 8E-5-400 001→
			7.08369.22.0	ATS	EL	Fahrgestellnummer ab: 8E-6-159 001 Vehicle Identification Number from: 8E-6-159 001
			7.08369.23.0	ATS	EL	Fahrgestellnummer ab: 8E-5-400 001 Vehicle Identification Number from: 8E-5-400 001
			7.08369.65.0	ATS	EL	

A4 B7 Avant (8ED)
36





















			7.11190.00.0	DDS		ch. 8E-5-400 001→ch. 8E-7-248 161 Euro 4 Euro 4
			7.11492.02.0	DDS		ohne Zubehör without accessories ch. 8E-7-248 162→ Euro 4 Euro 4
2.0 TDI 16V 103 kW (140 PS) BLB	11.2004→06.2008		7.10334.10.0	AGR	EL	ch. 8E-5-400 001→
			7.08369.22.0	ATS	EL	Fahrgestellnummer ab: 8E-6-159 001 Vehicle Identification Number from: 8E-6-159 001
2.0 TDI 16V 103 kW (140 PS) BRE	11.2004→06.2008		7.10334.10.0	AGR	EL	ch. 8E-5-400 001→
			7.08369.00.0	ATS	EL	Fahrgestellnummer ab: 8E-5-400 001 Vehicle Identification Number from: 8E-5-400 001
			7.08369.22.0	ATS	EL	Fahrgestellnummer ab: 8E-6-159 001 Vehicle Identification Number from: 8E-6-159 001
			7.08369.23.0	ATS	EL	Fahrgestellnummer ab: 8E-5-400 001 Vehicle Identification Number from: 8E-5-400 001
			7.11492.02.0	DDS		ohne Zubehör without accessories ch. 8E-7-248 162→ Euro 4 Euro 4
2.0 TDI quattro 103 kW (140 PS) BPW	01.2006→06.2008		7.00365.06.0	AGR	EL	
			7.08369.22.0	ATS	EL	Fahrgestellnummer ab: 8E-6-159 001 Vehicle Identification Number from: 8E-6-159 001
			7.08369.23.0	ATS	EL	Fahrgestellnummer ab: 8E-5-400 001 Vehicle Identification Number from: 8E-5-400 001
			7.08369.40.0	ATS	EL	Fahrgestellnummer ab: 8E-5-400 001 Vehicle Identification Number from: 8E-5-400 001 Euro 4 Euro 4
			7.11190.00.0	DDS		ch. 8E-5-400 001→ch. 8E-7-248 161 Euro 4 Euro 4
			7.11492.02.0	DDS		ohne Zubehör without accessories ch. 8E-7-248 162→ Euro 4 Euro 4
2.0 TDI quattro 125 kW (170 PS) BRD	06.2006→06.2008		7.10334.10.0	AGR	EL	ch. 8E-5-400 001→
			7.08369.22.0	ATS	EL	Fahrgestellnummer ab: 8E-6-159 001 Vehicle Identification Number from: 8E-6-159 001
			7.08369.23.0	ATS	EL	Fahrgestellnummer ab: 8E-5-400 001 Vehicle Identification Number from: 8E-5-400 001
			7.08369.65.0	ATS	EL	
			7.11190.00.0	DDS		ch. 8E-5-400 001→ch. 8E-7-248 161 Euro 4 Euro 4

A



A4 B7 Avant (8ED)

36

			7.11492.02.0	DDS		ohne Zubehör without accessories  ch. 8E-7-248 162→ Euro 4 Euro 4
2.0 TDI quattro 120 kW (163 PS) BVA	06.2006→06.2008		7.10334.10.0	AGR	EL	 ch. 8E-5-400 001→
			7.08369.22.0	ATS	EL	Fahrgestellnummer ab: 8E-6-159 001 Vehicle Identification Number from: 8E-6-159 001
			7.08369.23.0	ATS	EL	Fahrgestellnummer ab: 8E-5-400 001 Vehicle Identification Number from: 8E-5-400 001
			7.08369.65.0	ATS	EL	
			7.11190.00.0	DDS		 ch. 8E-5-400 001→ch. 8E-7-248 1 61 Euro 4 Euro 4
			7.11492.02.0	DDS		ohne Zubehör without accessories  ch. 8E-7-248 162→ Euro 4 Euro 4
2.0 TFSI 147 kW (200 PS) BGB, BPG, BWE	11.2004→06.2008		7.05271.11.0	LS	800 mm	
2.0 TFSI 162 kW (220 PS) BUL	06.2005→06.2008		7.05271.11.0	LS	800 mm	
2.0 TFSI 125 kW (170 PS) BPJ, BYK	10.2006→06.2008		7.05271.11.0	LS	800 mm	
2.0 TFSI quattro 147-149 kW (200-203 PS) BGB, BPG, BWE, BWT	11.2004→06.2008		7.05271.11.0	LS	800 mm	
2.0 TFSI quattro 162 kW (220 PS) BUL	06.2005→06.2008		7.05271.11.0	LS	800 mm	
2.7 TDI 132 kW (180 PS) BPP	01.2006→06.2008		7.00309.07.0	AGR	PN	
			7.08369.13.0	ATS	EL	Fahrgestellnummer ab: 8E-5-400 001 Vehicle Identification Number from: 8E-5-400 001
2.7 TDi 120 kW (163 PS) BSG	11.2005→03.2008		7.00309.07.0	AGR	PN	
			7.08369.13.0	ATS	EL	Fahrgestellnummer ab: 8E-5-400 001 Vehicle Identification Number from: 8E-5-400 001
3.0 160-162 kW (218-220 PS) BBJ	11.2004→05.2006		7.22560.44.0	ARV	PN	 ch. 8E-1-000 001→ links Left
			7.22560.45.0	ARV	PN	 ch. 8E-1-000 001→ rechts Right
			7.05271.77.0	LS	800 mm	 ch. 8E-5-400 001→ vor Katalysator in front of the catalyst
			7.05271.21.0	LS	1250 mm	
3.0 TDI quattro 150 kW (204 PS) BKN	11.2004→06.2008		7.00309.07.0	AGR	PN	
			7.08369.13.0	ATS	EL	Fahrgestellnummer ab: 8E-5-400 001 Vehicle Identification Number from: 8E-5-400 001













A4 B7 Avant (8ED)						36
3.0 TDI quattro 171 kW (233 PS) ASB	01.2006→06.2008		7.00309.07.0	AGR	PN	
			7.08369.13.0	ATS	EL	Fahrgestellnummer ab: 8E-5-400 001 Vehicle Identification Number from: 8E-5-400 001
3.0 quattro 160-162 kW (218-220 PS) BBJ	11.2004→07.2006		7.22560.44.0	ARV	PN	 ch. 8E-1-000 001→ links Left
			7.22560.45.0	ARV	PN	 ch. 8E-1-000 001→ rechts Right
			7.05271.77.0	LS	800 mm	ch. 8E-1-000 001→ vor Katalysator in front of the catalyst
			7.05271.21.0	LS	1250 mm	
RS4 quattro 309 kW (420 PS) BNS	09.2005→06.2008		7.22769.80.0	ARV	PN	 beidseitig Left and right
			7.05271.15.0	LS	525 mm	
S4 quattro 253 kW (344 PS) BBK	11.2004→06.2008		7.00216.06.0	SLP	EL	
			7.22560.41.0	ARV	PN	 ch. 8E-1-000 001→
			7.05271.77.0	LS	800 mm	ch. 8E-5-400 001→ vor Katalysator in front of the catalyst
S4 quattro 253 kW (344 PS) BHF	11.2004→06.2008		7.05271.00.0	LS	1525 mm	
			7.00216.06.0	SLP	EL	Fahrgestellnummer ab: 8E-5-400 001 Vehicle Identification Number from: 8E-5-400 001
S4 quattro 253 kW (344 PS) BHF	11.2004→06.2008		7.22560.41.0	ARV	PN	 ch. 8E-5-400 001→
			7.05271.00.0	LS	1525 mm	
A4 B7 Convertible (8HE)						37
2.0 TDI 103 kW (140 PS) BPW	01.2006→03.2009		7.00365.06.0	AGR	EL	
			7.08369.22.0	ATS	EL	
			7.08369.23.0	ATS	EL	
			7.08369.40.0	ATS	EL	Euro 4 Euro 4
			7.11492.02.0	DDS		ohne Zubehör without accessories ch. 8H-7-034 937→ →ch. 8H-7-034 936
2.0 TDI 100 kW (136 PS) BRC	01.2006→03.2009		7.11190.00.0	DDS		
			7.00365.06.0	AGR	EL	
			7.08369.22.0	ATS	EL	
			7.08369.23.0	ATS	EL	
			7.08369.40.0	ATS	EL	Euro 4 Euro 4
2.0 TDI 100 kW (136 PS) BRC	01.2006→03.2009		7.11492.02.0	DDS		ohne Zubehör without accessories ch. 8H-7-034 937→ →ch. 8H-7-034 936
			7.11190.00.0	DDS		

A













A4 B7 Convertible (8HE)































37

2.0 TFSI 16V 147-149 kW (200-203 PS) BWE, BWT	01.2006→03.2009		7.05271.11.0	LS	800 mm	
2.0 TFSI quattro 147-149 kW (200-203 PS) BWT	11.2005→03.2009		7.05271.11.0	LS	800 mm	
2.7 TDI 132 kW (180 PS) BPP	06.2006→03.2009		7.00309.07.0	AGR	PN	
			7.08369.13.0	ATS	EL	Fahrgestellnummer ab: 8E-5-400 001 Vehicle Identification Number from: 8E-5-400 001
			7.11190.00.0	DDS		
3.0 TDI quattro 171 kW (233 PS) ASB	01.2006→03.2009		7.00309.07.0	AGR	PN	
			7.08369.13.0	ATS	EL	Fahrgestellnummer ab: 8E-5-400 001 Vehicle Identification Number from: 8E-5-400 001
			7.11190.00.0	DDS		
3.0 TDI quattro 150 kW (204 PS) BKN	01.2006→03.2009		7.00309.07.0	AGR	PN	
			7.08369.13.0	ATS	EL	Fahrgestellnummer ab: 8E-5-400 001 Vehicle Identification Number from: 8E-5-400 001
			7.11190.00.0	DDS		
RS4 quattro 309 kW (420 PS) BNS	02.2006→12.2008		7.22769.80.0	ARV	PN	 beidseitig Left and right
			7.05271.15.0	LS	525 mm	
			7.00216.06.0	SLP	EL	
S4 quattro 253 kW (344 PS) BBK	11.2005→03.2009		7.22560.41.0	ARV	PN	
			7.00216.06.0	SLP	EL	
S4 quattro 253 kW (344 PS) BHF	11.2005→03.2009		7.00216.06.0	SLP	EL	

A4 B8 (8K2)

38

1.8 TFSI 118 kW (160 PS) CDHB	11.2007→03.2012		7.05271.27.0	LS	475 mm	
1.8 TFSI 88 kW (120 PS) CDHA	01.2008→12.2015		7.05271.27.0	LS	475 mm	
1.8 TFSI quattro 118 kW (160 PS) CDHB	09.2008→03.2012		7.05271.27.0	LS	475 mm	
2.0 TDI 105 kW (143 PS) CAGA	11.2007→12.2015		7.10334.00.0	AGR	EL	
			7.08369.16.0	ATS	EL	 ch. 8K-8-000 001→  ch. 8K-8-000 001→ für Fahrzeuge mit Schaltgetriebe for vehicles with manual transmission
			7.08369.14.0	ATS	EL	Fahrgestellnummer ab: 8K-8-000 001 Vehicle Identification Number from: 8K-8-000 001 Euro4/Euro5
			7.08369.52.0	ATS	EL	Euro4/Euro5 Euro4/Euro5 für Fahrzeuge mit Automatikgetriebe for vehicles with automatic transmission
2.0 TDI 105 kW (143 PS) CJCA, CMFA	11.2007→12.2015		7.09720.03.0	AGR-K	EL	
			7.11190.09.0	DDS		 CJCA, CMFA: Euro 5 Euro 5

						A
A4 B8 (8K2)						38
			7.11492.03.0	DDS		ohne Zubehör without accessories  CJCA, CMFA: für Hersteller-Abgasnorm: Euro 6 plus for manufacturer exhaust norm: Euro 6 plus
2.0 TDI 105 kW (143 PS) CMEA	11.2007→12.2015		7.10334.00.0	AGR	EL 	 ch. 8K-8-000 001→
			7.11492.03.0	DDS		ohne Zubehör without accessories für Hersteller-Abgasnorm: Euro 6 plus for manufacturer exhaust norm: Euro 6 plus
2.0 TDI 100 kW (136 PS) CAGB	11.2007→12.2015		7.10334.00.0	AGR	EL 	 ch. 8K-8-000 001→
			7.08369.16.0	ATS	EL 	 ch. 8K-8-000 001→ für Fahrzeuge mit Schaltgetriebe for vehicles with manual transmission
			7.08369.14.0	ATS	EL	Fahrgestellnummer ab: 8K-8-000 001 Vehicle Identification Number from: 8K-8-000 001 Euro4/Euro5 Euro4/Euro5
			7.08369.52.0	ATS	EL	Euro4/Euro5 Euro4/Euro5 für Fahrzeuge mit Automatikgetriebe for vehicles with automatic transmission
2.0 TDI 100 kW (136 PS) CJCB	11.2007→12.2015		7.09720.03.0	AGR-K	EL 	 ch. 8K-8-000 001→
			7.11190.09.0	DDS		 ch. 8K-8-000 001→ Euro 5 Euro 5
			7.11492.03.0	DDS		ohne Zubehör without accessories für Hersteller-Abgasnorm: Euro 6 plus for manufacturer exhaust norm: Euro 6 plus
2.0 TDI 100 kW (136 PS) CSUB	11.2007→12.2015		7.11492.03.0	DDS		ohne Zubehör without accessories für Hersteller-Abgasnorm: Euro 6 plus for manufacturer exhaust norm: Euro 6 plus
2.0 TDI 125 kW (170 PS) CAHA	01.2008→03.2012		7.10334.00.0	AGR	EL 	 ch. 8K-8-000 001→
			7.08369.16.0	ATS	EL 	 ch. 8K-8-000 001→ für Fahrzeuge mit Schaltgetriebe for vehicles with manual transmission
			7.08369.14.0	ATS	EL	Fahrgestellnummer ab: 8K-8-000 001 Vehicle Identification Number from: 8K-8-000 001 Euro4/Euro5 Euro4/Euro5
2.0 TDI 88 kW (120 PS) CAGC	06.2008→12.2015		7.10334.00.0	AGR	EL 	 ch. 8K-8-000 001→
			7.08369.16.0	ATS	EL 	 ch. 8K-8-000 001→ für Fahrzeuge mit Schaltgetriebe for vehicles with manual transmission
			7.08369.14.0	ATS	EL	Fahrgestellnummer ab: 8K-8-000 001 Vehicle Identification Number from: 8K-8-000 001 Euro4/Euro5 Euro4/Euro5
2.0 TDI 88 kW (120 PS) CJCC	06.2008→12.2015		7.09720.03.0	AGR-K	EL 	
			7.11190.09.0	DDS		Euro 5 Euro 5

A



















A4 B8 (8K2)

38

			7.11492.03.0	DDS		ohne Zubehör without accessories für Hersteller-Abgasnorm: Euro 6 plus for manufacturer exhaust norm: Euro 6 plus
2.0 TDI 120 kW (163 PS) CAHB	08.2008→12.2015		7.10334.00.0	AGR	EL	ch. 8K-8-000 001→
			7.08369.16.0	ATS	EL	ch. 8K-8-000 001→ für Fahrzeuge mit Schaltgetriebe for vehicles with manual transmission
			7.08369.14.0	ATS	EL	Fahrgestellnummer ab: 8K-8-000 001 Vehicle Identification Number from: 8K-8-000 001 Euro4/Euro5 Euro4/Euro5
2.0 TDI 120 kW (163 PS) CGLD	08.2008→12.2015		7.09720.03.0	AGR-K	EL	
			7.11492.03.0	DDS		ohne Zubehör without accessories für Hersteller-Abgasnorm: Euro 6 plus for manufacturer exhaust norm: Euro 6 plus
2.0 TDI 120 kW (163 PS) CNHC	08.2008→12.2015		7.11020.21.0	ATS	EL	für PR-Nummer: 7MM for PR number: 7MM
			7.11492.03.0	DDS		ohne Zubehör without accessories für Hersteller-Abgasnorm: Euro 6 plus for manufacturer exhaust norm: Euro 6 plus
2.0 TDI 130 kW (177 PS) CGLC	11.2011→12.2015		7.09720.03.0	AGR-K	EL	
			7.11492.03.0	DDS		ohne Zubehör without accessories für Hersteller-Abgasnorm: Euro 6 plus for manufacturer exhaust norm: Euro 6 plus
2.0 TDI 130 kW (177 PS) CMGB	11.2011→12.2015		7.09720.03.0	AGR-K	EL	
			7.11190.09.0	DDS		Euro 5 Euro 5
			7.11492.03.0	DDS		ohne Zubehör without accessories für Hersteller-Abgasnorm: Euro 6 plus for manufacturer exhaust norm: Euro 6 plus
2.0 TDI 110 kW (150 PS) CJCD, CMFB	05.2013→12.2015		7.09720.03.0	AGR-K	EL	
			7.11190.09.0	DDS		CJCD, CMFB: Euro 5 Euro 5
			7.11492.03.0	DDS		ohne Zubehör without accessories CJCD, CMFB: für Hersteller-Abgasnorm: Euro 6 plus for manufacturer exhaust norm: Euro 6 plus
2.0 TDI 110 kW (150 PS) CSUA	05.2013→12.2015		7.11492.03.0	DDS		ohne Zubehör without accessories für Hersteller-Abgasnorm: Euro 6 plus for manufacturer exhaust norm: Euro 6 plus
2.0 TDI 140 kW (190 PS) CNHA	09.2013→12.2015		7.11020.21.0	ATS	EL	für PR-Nummer: 7MM for PR number: 7MM

A4 B8 (8K2)
38

















			7.11492.03.0	DDS		ohne Zubehör without accessories für Hersteller-Abgasnorm: Euro 6 plus for manufacturer exhaust norm: Euro 6 plus
2.0 TDI quattro 125 kW (170 PS) CAHA	01.2008→03.2012		7.10334.00.0	AGR	EL 	 ch. 8K-8-000 001→
			7.08369.16.0	ATS	EL 	ch. 8K-8-000 001→ für Fahrzeuge mit Schaltgetriebe for vehicles with manual transmission
			7.08369.14.0	ATS	EL	Fahrgestellnummer ab: 8K-8-000 001 Vehicle Identification Number from: 8K-8-000 001 Euro4/Euro5 Euro4/Euro5
2.0 TDI quattro 105 kW (143 PS) CAGA	11.2008→12.2015		7.10334.00.0	AGR	EL 	 ch. 8K-8-000 001→
			7.08369.16.0	ATS	EL 	ch. 8K-8-000 001→ für Fahrzeuge mit Schaltgetriebe for vehicles with manual transmission
			7.08369.14.0	ATS	EL	Fahrgestellnummer ab: 8K-8-000 001 Vehicle Identification Number from: 8K-8-000 001 Euro4/Euro5 Euro4/Euro5
			7.08369.52.0	ATS	EL	Euro4/Euro5 Euro4/Euro5 für Fahrzeuge mit Automatikgetriebe for vehicles with automatic transmission
2.0 TDI quattro 105 kW (143 PS) CJCA	11.2008→12.2015		7.09720.03.0	AGR-K	EL 	
			7.11190.09.0	DDS		Euro 5 Euro 5
			7.11492.03.0	DDS		ohne Zubehör without accessories für Hersteller-Abgasnorm: Euro 6 plus for manufacturer exhaust norm: Euro 6 plus
2.0 TDI quattro 130 kW (177 PS) CGLC	11.2011→12.2015		7.09720.03.0	AGR-K	EL 	
			7.11492.03.0	DDS		ohne Zubehör without accessories für Hersteller-Abgasnorm: Euro 6 plus for manufacturer exhaust norm: Euro 6 plus
2.0 TDI quattro 110 kW (150 PS) CJCD	05.2013→12.2015		7.09720.03.0	AGR-K	EL 	
			7.11190.09.0	DDS		Euro 5 Euro 5
			7.11492.03.0	DDS		ohne Zubehör without accessories für Hersteller-Abgasnorm: Euro 6 plus for manufacturer exhaust norm: Euro 6 plus
2.0 TDI quattro 110 kW (150 PS) CSUA	05.2013→12.2015		7.11492.03.0	DDS		ohne Zubehör without accessories für Hersteller-Abgasnorm: Euro 6 plus for manufacturer exhaust norm: Euro 6 plus
2.0 TDI quattro 140 kW (190 PS) CNHA	09.2013→12.2015		7.11020.21.0	ATS	EL	für PR-Nummer: 7MM for PR number: 7MM
			7.11492.03.0	DDS		ohne Zubehör without accessories für Hersteller-Abgasnorm: Euro 6 plus for manufacturer exhaust norm: Euro 6 plus

























A



A4 B8 (8K2)

38

2.0 TFSI 132 kW (180 PS) CAEA, CDNB	06.2008→12.2015		7.05271.27.0	LS	475 mm	
2.0 TFSI 155-164 kW (211-223 PS) CAEB, CDNC	06.2008→05.2013		7.05271.27.0	LS	475 mm	
2.0 TFSI flexible fuel 132 kW (180 PS) CFKA	11.2009→12.2015		7.05271.27.0	LS	475 mm	
2.0 TFSI flexible fuel quattro 132 kW (180 PS) CFKA	11.2009→12.2015		7.05271.27.0	LS	475 mm	
2.0 TFSI quattro 155-164 kW (211-223 PS) CAEB, CDNC	06.2008→12.2015		7.05271.27.0	LS	475 mm	
2.7 TDI 140 kW (190 PS) CAMA	11.2007→03.2012		7.01782.07.0	AGR	EL	 ch. 8K-8-000 001→
			7.08369.13.0	ATS	EL	Fahrgestellnummer ab: 8K-8-000 001 Vehicle Identification Number from: 8K-8-000 001
			7.08369.45.0	ATS	EL	Fahrgestellnummer ab: 8K-8-000 001 Vehicle Identification Number from: 8K-8-000 001 Euro 5, Euro 6
			7.11190.02.0	DDS		 ch. 8K-8-000 001→
2.7 TDI 140 kW (190 PS) CGKA	11.2007→03.2012		7.02132.07.0	AGR	EL	 ch. 8K-8-000 001→
			7.01106.38.0	AGR-K	EL	mit AGR-Ventil with EGR valve
			7.08369.13.0	ATS	EL	Fahrgestellnummer ab: 8K-8-000 001 Vehicle Identification Number from: 8K-8-000 001
			7.08369.45.0	ATS	EL	Fahrgestellnummer ab: 8K-8-000 001 Vehicle Identification Number from: 8K-8-000 001 Euro 5, Euro 6
			7.11190.02.0	DDS		 ch. 8K-8-000 001→
2.7 TDI 120 kW (163 PS) CAMB	11.2007→03.2012		7.01782.07.0	AGR	EL	 ch. 8K-8-000 001→
			7.08369.13.0	ATS	EL	Fahrgestellnummer ab: 8K-8-000 001 Vehicle Identification Number from: 8K-8-000 001
			7.08369.45.0	ATS	EL	Fahrgestellnummer ab: 8K-8-000 001 Vehicle Identification Number from: 8K-8-000 001 Euro 5, Euro 6
			7.11190.02.0	DDS		 ch. 8K-8-000 001→
2.7 TDI 120 kW (163 PS) CGKB	11.2007→03.2012		7.02132.07.0	AGR	EL	 ch. 8K-8-000 001→
			7.01106.38.0	AGR-K	EL	mit AGR-Ventil with EGR valve
			7.08369.13.0	ATS	EL	Fahrgestellnummer ab: 8K-8-000 001 Vehicle Identification Number from: 8K-8-000 001
			7.08369.45.0	ATS	EL	Fahrgestellnummer ab: 8K-8-000 001 Vehicle Identification Number from: 8K-8-000 001 Euro 5, Euro 6
			7.11190.02.0	DDS		 ch. 8K-8-000 001→

























						A
A4 B8 (8K2)						38
3.0 TDI 150 kW (204 PS) CLAB	11.2011→12.2015		7.11020.25.0	ATS	EL	vor Rußpartikelfilter before soot particulate filter Euro 5 Euro 5 für Hersteller-Abgasnorm: Euro 5 Plus, Euro 6 Plus for manufacturer exhaust norm: Euro 5 Plus, Euro 6 Plus
3.0 TDI quattro 176 kW (240 PS) CAPA	11.2007→03.2012		7.01782.07.0	AGR	EL	 ch. 8K-8-000 001→
			7.08369.13.0	ATS	EL	Fahrgestellnummer ab: 8K-8-000 001 Vehicle Identification Number from: 8K-8-000 001
			7.08369.45.0	ATS	EL	Fahrgestellnummer ab: 8K-8-000 001 Vehicle Identification Number from: 8K-8-000 001 Euro 5, Euro 6 Euro 5, Euro 6
			7.11190.02.0	DDS		 ch. 8K-8-000 001→
3.0 TDI quattro 176 kW (240 PS) CCLA, CCWA	11.2007→03.2012		7.02132.07.0	AGR	EL	 CCLA, CCWA:  ch. 8K-8-000 001→
			7.01106.38.0	AGR-K	EL	 CCLA, CCWA: mit AGR-Ventil with EGR valve
			7.08369.13.0	ATS	EL	 CCLA, CCWA: Fahrgestellnummer ab: 8K-8-000 001 Vehicle Identification Number from: 8K-8-000 001
			7.08369.45.0	ATS	EL	 CCLA, CCWA: Fahrgestellnummer ab: 8K-8-000 001 Vehicle Identification Number from: 8K-8-000 001 Euro 5, Euro 6 Euro 5, Euro 6
			7.11190.02.0	DDS		 CCLA, CCWA:  ch. 8K-8-000 001→
3.0 TDI quattro 155 kW (211 PS) CCWB	06.2008→05.2010		7.02132.07.0	AGR	EL	 ch. 8K-8-000 001→
			7.01106.38.0	AGR-K	EL	mit AGR-Ventil with EGR valve
			7.08369.13.0	ATS	EL	Fahrgestellnummer ab: 8K-8-000 001 Vehicle Identification Number from: 8K-8-000 001
			7.08369.45.0	ATS	EL	Fahrgestellnummer ab: 8K-8-000 001 Vehicle Identification Number from: 8K-8-000 001 Euro 5, Euro 6 Euro 5, Euro 6
			7.11190.02.0	DDS		Euro 5, Euro 6 Euro 5, Euro 6
3.0 TDI quattro 171 kW (233 PS) ASB	04.2009→12.2015		7.08369.13.0	ATS	EL	Fahrgestellnummer ab: 8E-5-400 001 Vehicle Identification Number from: 8E-5-400 001
3.0 TDI quattro 180 kW (245 PS) CDUC, CKVB, CKVC	11.2011→12.2015		7.08369.73.0	ATS	EL	
			7.11020.25.0	ATS	EL	 CDUC, CKVB, CKVC: vor Rußpartikelfilter before soot particulate filter Euro 5 Euro 5 für Hersteller-Abgasnorm: Euro 5 Plus, Euro 6 Plus for manufacturer exhaust norm: Euro 5 Plus, Euro 6 Plus
			7.11190.02.0	DDS		 CDUC, CKVB, CKVC: Euro 5, Euro 6 Euro 5, Euro 6

A



A4 B8 (8K2)

38

3.0 TFSI quattro 200 kW (272 PS) CMUA	02.2012→12.2015		7.22286.52.0	ARV	PN	 rechts Right
			7.22286.53.0	ARV	PN	 links Left
			7.05271.18.0	LS	525 mm	
			7.03635.12.0	SLP	EL	
3.0 TFSI quattro 200 kW (272 PS) CRED	02.2012→12.2015		7.06714.21.0	ARV	PN	 rechts Right
			7.22286.53.0	ARV	PN	 links Left
			7.05271.18.0	LS	525 mm	
			7.03635.12.0	SLP	EL	
3.2 FSI 190-195 kW (258-265 PS) CALA	09.2008→03.2012		7.05271.18.0	LS	525 mm	
			7.22934.57.0	SLP	EL	 ch. 8K-8-000 001→
			7.05574.00.0	SLV	PN	 rechts Right
			7.05574.01.0	SLV	PN	 links Left
3.2 FSI quattro 190-195 kW (258-265 PS) CALA	11.2007→03.2012		7.05271.18.0	LS	525 mm	
			7.22934.57.0	SLP	EL	 ch. 8K-8-000 001→
			7.05574.00.0	SLV	PN	 rechts Right
			7.05574.01.0	SLV	PN	 links Left
S4 quattro 245 kW (333 PS) CAKA	11.2008→12.2015		7.22286.52.0	ARV	PN	 rechts Right
			7.22286.53.0	ARV	PN	 links Left
			7.05271.18.0	LS	525 mm	
			7.22934.57.0	SLP	EL	 ch. 8K-8-000 001→
S4 quattro 245 kW (333 PS) CCBA	11.2008→12.2015		7.05271.18.0	LS	525 mm	
S4 quattro 245-249 kW (333-339 PS) CGWC, CGXC, CTUB	11.2008→12.2015		7.22286.53.0	ARV	PN	 CGWC, CGXC: links Left
			7.22286.52.0	ARV	PN	 CTUB:  ch. 8K-8-000 001→ links Left
			7.05271.18.0	LS	525 mm	 CGWC, CGXC, CTUB: rechts Right















A4 B8 (8K2)					38	
S4 quattro 245 kW (333 PS) CREC	11.2008→12.2015		7.03635.12.0 SLP EL		ch. 8K-8-000 001→ links Left	
			7.22286.53.0 ARV PN			
			7.06714.21.0 ARV PN			rechts Right
			7.05271.18.0 LS 525 mm			
			7.03635.12.0 SLP EL			
A4 B8 Avant (8K5)					39	
1.8 TFSI 118 kW (160 PS) CDHB	11.2007→03.2012		7.05271.27.0 LS 475 mm			
1.8 TFSI 88 kW (120 PS) CDHA	04.2008→12.2015		7.05271.27.0 LS 475 mm			
1.8 TFSI quattro 118 kW (160 PS) CDHB	09.2008→03.2012		7.05271.27.0 LS 475 mm			
2.0 TDI 105 kW (143 PS) CAGA	04.2008→12.2015		7.10334.00.0 AGR EL		ch. 8K-8-000 001→	
			7.08369.16.0 ATS EL			ch. 8K-8-000 001→ für Fahrzeuge mit Schaltgetriebe for vehicles with manual transmission
			7.08369.14.0 ATS EL			Fahrgestellnummer ab: 8K-8-000 001 Vehicle Identification Number from: 8K-8-000 001 Euro4/Euro5 Euro4/Euro5
			7.08369.52.0 ATS EL			Euro4/Euro5 Euro4/Euro5 für Fahrzeuge mit Automatikgetriebe for vehicles with automatic transmission
2.0 TDI 105 kW (143 PS) CJCA, CMFA	04.2008→12.2015		7.09720.03.0 AGR-K EL		CJCA, CMFA: Euro 5 Euro 5 ohne Zubehör without accessories CJCA, CMFA: für Hersteller-Abgasnorm: Euro 6 plus for manufacturer exhaust norm: Euro 6 plus	
			7.11190.09.0 DDS			
			7.11492.03.0 DDS			
2.0 TDI 105 kW (143 PS) CMEA	04.2008→12.2015		7.10334.00.0 AGR EL		ch. 8K-8-000 001→	
			7.11492.03.0 DDS			ohne Zubehör without accessories für Hersteller-Abgasnorm: Euro 6 plus for manufacturer exhaust norm: Euro 6 plus
2.0 TDI 125 kW (170 PS) CAHA	04.2008→03.2012		7.10334.00.0 AGR EL		ch. 8K-8-000 001→	
			7.08369.16.0 ATS EL			ch. 8K-8-000 001→ für Fahrzeuge mit Schaltgetriebe for vehicles with manual transmission
			7.08369.14.0 ATS EL			Fahrgestellnummer ab: 8K-8-000 001 Vehicle Identification Number from: 8K-8-000 001 Euro4/Euro5 Euro4/Euro5
2.0 TDI 100 kW (136 PS) CAGB	04.2008→12.2015		7.10334.00.0 AGR EL		ch. 8K-8-000 001→	
			7.08369.16.0 ATS EL			ch. 8K-8-000 001→ für Fahrzeuge mit Schaltgetriebe for vehicles with manual transmission

A



A4 B8 Avant (8K5)

39

			7.08369.14.0	ATS	EL	Fahrgestellnummer ab: 8K-8-000 001 Vehicle Identification Number from: 8K-8-000 001 Euro4/Euro5 Euro4/Euro5
			7.08369.52.0	ATS	EL	Euro4/Euro5 Euro4/Euro5 für Fahrzeuge mit Automatikgetriebe for vehicles with automatic transmission
2.0 TDI 100 kW (136 PS) CJCB	04.2008→12.2015		7.09720.03.0	AGR-K	EL	 ch. 8K-8-000 001→
			7.11190.09.0	DDS		 ch. 8K-8-000 001→ Euro 5 Euro 5
			7.11492.03.0	DDS		ohne Zubehör without accessories für Hersteller-Abgasnorm: Euro 6 plus for manufacturer exhaust norm: Euro 6 plus
2.0 TDI 100 kW (136 PS) CSUB	04.2008→12.2015		7.11492.03.0	DDS		ohne Zubehör without accessories für Hersteller-Abgasnorm: Euro 6 plus for manufacturer exhaust norm: Euro 6 plus
2.0 TDI 88 kW (120 PS) CAGC	06.2008→12.2015		7.10334.00.0	AGR	EL	 ch. 8K-8-000 001→
			7.08369.16.0	ATS	EL	 ch. 8K-8-000 001→ für Fahrzeuge mit Schaltgetriebe for vehicles with manual transmission
			7.08369.14.0	ATS	EL	Fahrgestellnummer ab: 8K-8-000 001 Vehicle Identification Number from: 8K-8-000 001 Euro4/Euro5 Euro4/Euro5
2.0 TDI 88 kW (120 PS) CJCC	06.2008→12.2015		7.09720.03.0	AGR-K	EL	
			7.11190.09.0	DDS		Euro 5 Euro 5
			7.11492.03.0	DDS		ohne Zubehör without accessories für Hersteller-Abgasnorm: Euro 6 plus for manufacturer exhaust norm: Euro 6 plus
2.0 TDI 120 kW (163 PS) CAHB	08.2008→12.2015		7.10334.00.0	AGR	EL	 ch. 8K-8-000 001→
			7.08369.16.0	ATS	EL	 ch. 8K-8-000 001→ für Fahrzeuge mit Schaltgetriebe for vehicles with manual transmission
			7.08369.14.0	ATS	EL	Fahrgestellnummer ab: 8K-8-000 001 Vehicle Identification Number from: 8K-8-000 001 Euro4/Euro5 Euro4/Euro5
2.0 TDI 120 kW (163 PS) CGLD	08.2008→12.2015		7.09720.03.0	AGR-K	EL	
			7.11492.03.0	DDS		ohne Zubehör without accessories für Hersteller-Abgasnorm: Euro 6 plus for manufacturer exhaust norm: Euro 6 plus
2.0 TDI 120 kW (163 PS) CNHC	08.2008→12.2015		7.11020.21.0	ATS	EL	für PR-Nummer: 7MM for PR number: 7MM



















						A
A4 B8 Avant (8K5)						39
			7.11492.03.0	DDS		ohne Zubehör without accessories für Hersteller-Abgasnorm: Euro 6 plus for manufacturer exhaust norm: Euro 6 plus
2.0 TDI 130 kW (177 PS) CGLC	11.2011→12.2015		7.09720.03.0	AGR-K	EL	
			7.11492.03.0	DDS		ohne Zubehör without accessories für Hersteller-Abgasnorm: Euro 6 plus for manufacturer exhaust norm: Euro 6 plus
2.0 TDI 110 kW (150 PS) CJCD, CMFB	05.2013→12.2015		7.09720.03.0	AGR-K	EL	
			7.11190.09.0	DDS		CJCD, CMFB: Euro 5 Euro 5
			7.11492.03.0	DDS		ohne Zubehör without accessories CJCD, CMFB: für Hersteller-Abgasnorm: Euro 6 plus for manufacturer exhaust norm: Euro 6 plus
2.0 TDI 110 kW (150 PS) CSUA	05.2013→12.2015		7.11492.03.0	DDS		ohne Zubehör without accessories für Hersteller-Abgasnorm: Euro 6 plus for manufacturer exhaust norm: Euro 6 plus
2.0 TDI 140 kW (190 PS) CNHA	09.2013→12.2015		7.11020.21.0	ATS	EL	für PR-Nummer: 7MM for PR number: 7MM
			7.11492.03.0	DDS		ohne Zubehör without accessories für Hersteller-Abgasnorm: Euro 6 plus for manufacturer exhaust norm: Euro 6 plus
2.0 TDI quattro 105 kW (143 PS) CAGA	04.2008→12.2015		7.10334.00.0	AGR	EL	
			7.08369.16.0	ATS	EL	ch. 8K-8-000 001→ für Fahrzeuge mit Schaltgetriebe for vehicles with manual transmission
			7.08369.14.0	ATS	EL	Fahrgestellnummer ab: 8K-8-000 001 Vehicle Identification Number from: 8K-8-000 001 Euro4/Euro5 Euro4/Euro5
			7.08369.52.0	ATS	EL	Euro4/Euro5 Euro4/Euro5 für Fahrzeuge mit Automatikgetriebe for vehicles with automatic transmission
2.0 TDI quattro 105 kW (143 PS) CJCA	04.2008→12.2015		7.09720.03.0	AGR-K	EL	
			7.11190.09.0	DDS		Euro 5 Euro 5
			7.11492.03.0	DDS		ohne Zubehör without accessories für Hersteller-Abgasnorm: Euro 6 plus for manufacturer exhaust norm: Euro 6 plus
2.0 TDI quattro 125 kW (170 PS) CAHA	08.2008→03.2012		7.10334.00.0	AGR	EL	
			7.08369.16.0	ATS	EL	ch. 8K-8-000 001→ für Fahrzeuge mit Schaltgetriebe for vehicles with manual transmission

A



















A4 B8 Avant (8K5)

39

			7.08369.14.0	ATS	EL	Fahrgestellnummer ab: 8K-8-000 001 Vehicle Identification Number from: 8K-8-000 001 Euro4/Euro5 Euro4/Euro5
2.0 TDI quattro 130 kW (177 PS) CGLC	11.2011→12.2015		7.09720.03.0 7.11492.03.0	AGR-K DDS	EL	 ohne Zubehör without accessories für Hersteller-Abgasnorm: Euro 6 plus for manufacturer exhaust norm: Euro 6 plus
2.0 TDI quattro 110 kW (150 PS) CJCD	05.2013→12.2015		7.09720.03.0 7.11190.09.0 7.11492.03.0	AGR-K DDS DDS	EL	 Euro 5 Euro 5 ohne Zubehör without accessories für Hersteller-Abgasnorm: Euro 6 plus for manufacturer exhaust norm: Euro 6 plus
2.0 TDI quattro 110 kW (150 PS) CSUA	05.2013→12.2015		7.11492.03.0	DDS		ohne Zubehör without accessories für Hersteller-Abgasnorm: Euro 6 plus for manufacturer exhaust norm: Euro 6 plus
2.0 TDI quattro 140 kW (190 PS) CNHA	09.2013→12.2015		7.11020.21.0 7.11492.03.0	ATS DDS	EL	für PR-Nummer: 7MM for PR number: 7MM ohne Zubehör without accessories für Hersteller-Abgasnorm: Euro 6 plus for manufacturer exhaust norm: Euro 6 plus
2.0 TFSI 155-164 kW (211-223 PS) CAEB, CDNC	06.2008→05.2013		7.05271.27.0	LS	475 mm	
2.0 TFSI 132 kW (180 PS) CDNB	06.2008→12.2015		7.05271.27.0	LS	475 mm	
2.0 TFSI flexible fuel 132 kW (180 PS) CFKA	11.2009→12.2015		7.05271.27.0	LS	475 mm	
2.0 TFSI flexible fuel quattro 132 kW (180 PS) CFKA	11.2009→12.2015		7.05271.27.0	LS	475 mm	
2.0 TFSI quattro 155-164 kW (211-223 PS) CAEB, CDNC	06.2008→12.2015		7.05271.27.0	LS	475 mm	
2.7 TDI 140 kW (190 PS) CAMA	04.2008→03.2012		7.01782.07.0 7.08369.13.0 7.08369.45.0 7.11190.02.0	AGR ATS ATS DDS	EL	  ch. 8K-8-000 001→ Fahrgestellnummer ab: 8K-8-000 001 Vehicle Identification Number from: 8K-8-000 001 Fahrgestellnummer ab: 8K-8-000 001 Vehicle Identification Number from: 8K-8-000 001 Euro 5, Euro 6 Euro 5, Euro 6  ch. 8K-8-000 001→
2.7 TDI 140 kW (190 PS) CGKA	04.2008→03.2012		7.02132.07.0 7.01106.38.0 7.08369.13.0	AGR AGR-K ATS	EL	  ch. 8K-8-000 001→ mit AGR-Ventil with EGR valve Fahrgestellnummer ab: 8K-8-000 001 Vehicle Identification Number from: 8K-8-000 001

A4 B8 Avant (8K5)
39

			7.08369.45.0	ATS	EL	Fahrgestellnummer ab: 8K-8-000 001 Vehicle Identification Number from: 8K-8-000 001 Euro 5, Euro 6 Euro 5, Euro 6
			7.11190.02.0	DDS		 ch. 8K-8-000 001→
2.7 TDI 120 kW (163 PS) CAMB	06.2008→03.2012		7.01782.07.0	AGR	EL	 ch. 8K-8-000 001→
			7.08369.13.0	ATS	EL	Fahrgestellnummer ab: 8K-8-000 001 Vehicle Identification Number from: 8K-8-000 001
			7.08369.45.0	ATS	EL	Fahrgestellnummer ab: 8K-8-000 001 Vehicle Identification Number from: 8K-8-000 001 Euro 5, Euro 6 Euro 5, Euro 6
			7.11190.02.0	DDS		 ch. 8K-8-000 001→
2.7 TDI 120 kW (163 PS) CGKB	06.2008→03.2012		7.02132.07.0	AGR	EL	 ch. 8K-8-000 001→
			7.01106.38.0	AGR-K	EL	mit AGR-Ventil with EGR valve
			7.08369.13.0	ATS	EL	Fahrgestellnummer ab: 8K-8-000 001 Vehicle Identification Number from: 8K-8-000 001
			7.08369.45.0	ATS	EL	Fahrgestellnummer ab: 8K-8-000 001 Vehicle Identification Number from: 8K-8-000 001 Euro 5, Euro 6 Euro 5, Euro 6
			7.11190.02.0	DDS		 ch. 8K-8-000 001→
3.0 TDI 150 kW (204 PS) CLAB	11.2011→12.2015		7.08369.73.0	ATS	EL	
			7.11020.25.0	ATS	EL	vor Rußpartikelfilter before soot particulate filter Euro 5 Euro 5 für Hersteller-Abgasnorm: Euro 5 Plus, Euro 6 Plus for manufacturer exhaust norm: Euro 5 Plus, Euro 6 Plus
			7.11190.02.0	DDS		Euro 5, Euro 6 Euro 5, Euro 6
3.0 TDI quattro 176 kW (240 PS) CAPA	04.2008→03.2012		7.01782.07.0	AGR	EL	 ch. 8K-8-000 001→
			7.08369.13.0	ATS	EL	Fahrgestellnummer ab: 8K-8-000 001 Vehicle Identification Number from: 8K-8-000 001
			7.08369.45.0	ATS	EL	Fahrgestellnummer ab: 8K-8-000 001 Vehicle Identification Number from: 8K-8-000 001 Euro 5, Euro 6 Euro 5, Euro 6
			7.11190.02.0	DDS		 ch. 8K-8-000 001→
3.0 TDI quattro 176 kW (240 PS) CCLA, CCWA	04.2008→03.2012		7.02132.07.0	AGR	EL	 CCLA, CCWA:  ch. 8K-8-000 001→
			7.01106.38.0	AGR-K	EL	 CCLA, CCWA: mit AGR-Ventil with EGR valve
			7.08369.13.0	ATS	EL	 CCLA, CCWA: Fahrgestellnummer ab: 8K-8-000 001 Vehicle Identification Number from: 8K-8-000 001

A



A4 B8 Avant (8K5)

39

			7.08369.45.0	ATS	EL	CCLA, CCWA: Fahrgestellnummer ab: 8K-8-000 001 Vehicle Identification Number from: 8K-8-000 001 Euro 5, Euro 6 Euro 5, Euro 6 CCLA, CCWA: ch. 8K-8-000 001→
			7.11190.02.0	DDS		
3.0 TDI quattro 155 kW (211 PS) CCWB	06.2008→05.2010		7.02132.07.0	AGR	EL	ch. 8K-8-000 001→
			7.01106.38.0	AGR-K	EL	mit AGR-Ventil with EGR valve
			7.08369.13.0	ATS	EL	Fahrgestellnummer ab: 8K-8-000 001 Vehicle Identification Number from: 8K-8-000 001
			7.08369.45.0	ATS	EL	Fahrgestellnummer ab: 8K-8-000 001 Vehicle Identification Number from: 8K-8-000 001 Euro 5, Euro 6 Euro 5, Euro 6
			7.11190.02.0	DDS		ch. 8K-8-000 001→
3.0 TDI quattro 180 kW (245 PS) CDUC, CKVB, CKVC	11.2011→12.2015		7.08369.73.0	ATS	EL	
			7.11020.25.0	ATS	EL	CDUC, CKVB, CKVC: vor Rußpartikelfilter before soot particulate filter Euro 5 Euro 5 für Hersteller-Abgasnorm: Euro 5 Plus, Euro 6 Plus for manufacturer exhaust norm: Euro 5 Plus, Euro 6 Plus CDUC, CKVB, CKVC: Euro 5, Euro 6 Euro 5, Euro 6
			7.11190.02.0	DDS		
3.0 TFSI quattro 200 kW (272 PS) CMUA	02.2012→12.2015		7.22286.52.0	ARV	PN	rechts Right
			7.22286.53.0	ARV	PN	links Left
			7.05271.18.0	LS		525 mm
			7.03635.12.0	SLP		EL
3.0 TFSI quattro 200 kW (272 PS) CRED	02.2012→12.2015		7.06714.21.0	ARV	PN	rechts Right
			7.22286.53.0	ARV	PN	links Left
			7.05271.18.0	LS		525 mm
			7.03635.12.0	SLP		EL
3.2 FSI 190-195 kW (258-265 PS) CALA	09.2008→03.2012		7.05271.18.0	LS		525 mm
			7.22934.57.0	SLP	EL	ch. 8K-8-000 001→
			7.05574.00.0	SLV	PN	ch. 8K-8-000 001→ rechts Right
			7.05574.01.0	SLV	PN	ch. 8K-8-000 001→ links Left











A4 B8 Avant (8K5)						39
3.2 FSI quattro 190-195 kW (258-265 PS) CALA	04.2008→03.2012		7.05271.18.0	LS	525 mm	
			7.22934.57.0	SLP	EL	ch. 8K-8-000 001→
			7.05574.00.0	SLV	PN	ch. 8K-8-000 001→ rechts Right
			7.05574.01.0	SLV	PN	ch. 8K-8-000 001→ links Left
RS4 quattro 331 kW (450 PS) CFSA	05.2012→08.2015		7.06714.24.0	ARV	PN	
S4 quattro 245 kW (333 PS) CAKA	11.2008→12.2015		7.22286.52.0	ARV	PN	ch. 8K-8-000 001→ rechts Right
			7.22286.53.0	ARV	PN	ch. 8K-8-000 001→ links Left
			7.05271.18.0	LS	525 mm	
			7.22934.57.0	SLP	EL	ch. 8K-8-000 001→
S4 quattro 245 kW (333 PS) CCBA	11.2008→12.2015		7.05271.18.0	LS	525 mm	
S4 quattro 245-249 kW (333-339 PS) CGWC, CGXC, CTUB	11.2008→12.2015		7.22286.52.0	ARV	PN	CGWC, CGXC, CTUB: rechts Right
			7.22286.53.0	ARV	PN	CGWC, CGXC, CTUB: links Left
			7.05271.18.0	LS	525 mm	
			7.03635.12.0	SLP	EL	
S4 quattro 245 kW (333 PS) CREC	11.2008→12.2015		7.22286.53.0	ARV	PN	ch. 8K-8-000 001→ links Left
			7.06714.21.0	ARV	PN	rechts Right
			7.05271.18.0	LS	525 mm	
			7.03635.12.0	SLP	EL	
A4 B9 (8W2, 8WC)						40
2.0 TDI 100 kW (136 PS) DEUB	05.2015→11.2019		7.07696.00.0	SRM-AK	EL	
2.0 TDI 110 kW (150 PS) CZHA	05.2015→11.2019		7.11492.03.0	DDS		ohne Zubehör without accessories
2.0 TDI 140 kW (190 PS) DESA, DETA	05.2015→		7.11020.31.0	ATS	EL	DESA, DETA: für OE-Nummer: 04L 919 529 E for OE number: 04L 919 529 E
			7.11492.03.0	DDS		ohne Zubehör without accessories
2.0 TDI 140 kW (190 PS) DFVA	05.2015→		7.11492.03.0	DDS		ohne Zubehör without accessories
2.0 TDI quattro 140 kW (190 PS) DESA, DETA	09.2015→11.2019		7.11020.31.0	ATS	EL	DESA, DETA: für OE-Nummer: 04L 919 529 E for OE number: 04L 919 529 E
			7.11492.03.0	DDS		ohne Zubehör without accessories

A











A4 B9 (8W2, 8WC)























40

2.0 TDI quattro 140 kW (190 PS) DFVA	09.2015→11.2019		7.11492.03.0	DDS		ohne Zubehör without accessories
2.0 TDI quattro 120 kW (163 PS) DETB	09.2016→11.2019		7.11020.31.0	ATS	EL	ohne Zubehör without accessories
			7.11492.03.0	DDS		
			7.07696.00.0	SRM-AK	EL	
3.0 TDI 160 kW (218 PS) CSWB	09.2015→08.2018		7.11020.24.0	ATS	EL	Produktionsdatum bis: 06.08.2018 Production date to: 06.08.2018
3.0 TDI quattro 200 kW (272 PS) CRTC	05.2015→08.2018		7.11020.24.0	ATS	EL	Produktionsdatum bis: 06.08.2018 Production date to: 06.08.2018
3.0 TDI quattro 160 kW (218 PS) CSWB	09.2015→08.2018		7.11020.24.0	ATS	EL	Produktionsdatum bis: 06.08.2018 Production date to: 06.08.2018
30 TDI Mild Hybrid 100 kW (136 PS) DEZB	07.2019→		7.11492.05.0	DDS		ohne Zubehör without accessories
			7.07696.00.0	SRM-AK	EL	
35 TDI Mild Hybrid 120 kW (163 PS) DEZE	03.2019→		7.11492.05.0	DDS		ohne Zubehör without accessories
			7.07696.00.0	SRM-AK	EL	
40 TDI 140 kW (190 PS) DESA, DETA	05.2015→11.2019		7.11020.31.0	ATS	EL	DES, DETA: für OE-Nummer: 04L 919 529 E for OE number: 04L 919 529 E ohne Zubehör without accessories
			7.11492.03.0	DDS		
40 TDI Mild Hybrid quattro 150 kW (204 PS) DTPA	05.2020→		7.11492.05.0	DDS		ohne Zubehör without accessories
40 TDI quattro 140 kW (190 PS) DETA	09.2015→11.2019		7.11020.31.0	ATS	EL	für OE-Nummer: 04L 919 529 E for OE number: 04L 919 529 E ohne Zubehör without accessories
			7.11492.03.0	DDS		

A4 B9 Avant (8W5, 8WD)

41

2.0 TDI 100 kW (136 PS) DEUB	08.2015→10.2019		7.07696.00.0	SRM-AK	EL	
2.0 TDI 110 kW (150 PS) CZHA	08.2015→09.2018		7.11492.03.0	DDS		ohne Zubehör without accessories
			7.11020.31.0	ATS	EL	DES, DETA: für OE-Nummer: 04L 919 529 E for OE number: 04L 919 529 E ohne Zubehör without accessories
2.0 TDI 140 kW (190 PS) DESA, DETA	08.2015→09.2018		7.11492.03.0	DDS		
			7.11020.31.0	ATS	EL	
2.0 TDI 140 kW (190 PS) DFVA	08.2015→09.2018		7.11492.03.0	DDS		ohne Zubehör without accessories
2.0 TDI quattro 140 kW (190 PS) DESA, DETA	10.2015→09.2018		7.11020.31.0	ATS	EL	DES, DETA: für OE-Nummer: 04L 919 529 E for OE number: 04L 919 529 E ohne Zubehör without accessories
			7.11492.03.0	DDS		
2.0 TDI quattro 140 kW (190 PS) DFVA	10.2015→09.2018		7.11492.03.0	DDS		ohne Zubehör without accessories
2.0 TDI quattro 120 kW (163 PS) DETB	09.2016→09.2018		7.11020.31.0	ATS	EL	ohne Zubehör without accessories
			7.11492.03.0	DDS		
			7.07696.00.0	SRM-AK	EL	
3.0 TDI 160 kW (218 PS) CSWB	10.2015→08.2018		7.11020.24.0	ATS	EL	Produktionsdatum bis: 06.08.2018 Production date to: 06.08.2018

						
A4 B9 Avant (8W5, 8WD)						41
3.0 TDI quattro 200 kW (272 PS) CRTC	08.2015→08.2018		7.11020.24.0	ATS	EL	Produktionsdatum bis: 06.08.2018 Production date to: 06.08.2018
3.0 TDI quattro 160 kW (218 PS) CSWB	11.2015→08.2018		7.11020.24.0	ATS	EL	Produktionsdatum bis: 06.08.2018 Production date to: 06.08.2018
30 TDI Mild Hybrid 100 kW (136 PS) DEZB	07.2019→		7.11492.05.0	DDS		ohne Zubehör without accessories
			7.07696.00.0	SRM-AK	EL	
35 TDI Mild Hybrid 120 kW (163 PS) DEZE	07.2019→		7.11492.05.0	DDS		ohne Zubehör without accessories
			7.07696.00.0	SRM-AK	EL	
40 TDI 140 kW (190 PS) DESA, DETA	10.2018→05.2019		7.11020.31.0	ATS	EL	 DESA, DETA: für OE-Nummer: 04L 919 529 E for OE number: 04L 919 529 E
			7.11492.03.0	DDS		ohne Zubehör without accessories
40 TDI Mild Hybrid quattro 150 kW (204 PS) DTPA	05.2020→		7.11492.05.0	DDS		ohne Zubehör without accessories
40 TDI quattro 140 kW (190 PS) DETA	10.2018→09.2020		7.11020.31.0	ATS	EL	für OE-Nummer: 04L 919 529 E for OE number: 04L 919 529 E
			7.11492.03.0	DDS		ohne Zubehör without accessories
A5 (8T3)						42
1.8 TFSI 118 kW (160 PS) CDHB	05.2009→09.2011		7.05271.27.0	LS	475 mm	
2.0 TDI 125 kW (170 PS) CAHA	08.2008→03.2012		7.08369.14.0	ATS	EL	Euro4/Euro5
			7.08369.16.0	ATS	EL	für Fahrzeuge mit Schaltgetriebe for vehicles with manual transmission
			7.11190.02.0	DDS		
2.0 TDI 120 kW (163 PS) CAHB	08.2008→01.2017		7.10334.00.0	AGR	EL	
			7.08369.14.0	ATS	EL	Euro4/Euro5
			7.08369.16.0	ATS	EL	für Fahrzeuge mit Schaltgetriebe for vehicles with manual transmission
			7.11190.02.0	DDS		
2.0 TDI 120 kW (163 PS) CGLD	08.2008→01.2017		7.09720.03.0	AGR-K	EL	
			7.11492.03.0	DDS		ohne Zubehör without accessories für Hersteller-Abgasnorm: Euro 6 plus for manufacturer exhaust norm: Euro 6 plus
2.0 TDI 120 kW (163 PS) CNHC	08.2008→01.2017		7.11020.21.0	ATS	EL	für PR-Nummer: 7MM for PR number: 7MM
			7.11190.09.0	DDS		Euro 5
			7.11492.03.0	DDS		ohne Zubehör without accessories für Hersteller-Abgasnorm: Euro 6 plus for manufacturer exhaust norm: Euro 6 plus
2.0 TDI 130 kW (177 PS) CGLC	10.2011→01.2017		7.09720.03.0	AGR-K	EL	
			7.11492.03.0	DDS		ohne Zubehör without accessories für Hersteller-Abgasnorm: Euro 6 plus for manufacturer exhaust norm: Euro 6 plus



















A



A5 (8T3)

42

2.0 TDI 140 kW (190 PS) CNHA	09.2013→01.2017		7.11020.21.0	ATS	EL	für PR-Nummer: 7MM for PR number: 7MM Euro 5 Euro 5 ohne Zubehör without accessories für Hersteller-Abgasnorm: Euro 6 plus for manufacturer exhaust norm: Euro 6 plus
			7.11190.09.0	DDS		
			7.11492.03.0	DDS		
2.0 TDI quattro 125 kW (170 PS) CAHA	08.2008→03.2012		7.10334.00.0	AGR	EL	
			7.08369.14.0	ATS	EL	Euro4/Euro5 Euro4/Euro5
			7.08369.16.0	ATS	EL	für Fahrzeuge mit Schaltgetriebe for vehicles with manual transmission
			7.11190.02.0	DDS		
2.0 TDI quattro 130 kW (177 PS) CGLC	12.2011→01.2017		7.09720.03.0	AGR-K	EL	
			7.11492.03.0	DDS		ohne Zubehör without accessories für Hersteller-Abgasnorm: Euro 6 plus for manufacturer exhaust norm: Euro 6 plus
2.0 TDI quattro 140 kW (190 PS) CNHA	09.2013→01.2017		7.11020.21.0	ATS	EL	für PR-Nummer: 7MM for PR number: 7MM
			7.11190.09.0	DDS		Euro 5 Euro 5
			7.11492.03.0	DDS		ohne Zubehör without accessories für Hersteller-Abgasnorm: Euro 6 plus for manufacturer exhaust norm: Euro 6 plus
2.0 TFSI 155 kW (211 PS) CDNC	06.2008→11.2013		7.05271.15.0	LS	525 mm	
			7.05271.27.0	LS	475 mm	
2.0 TFSI 132 kW (180 PS) CDNB	11.2008→03.2012		7.05271.27.0	LS	475 mm	
2.0 TFSI quattro 155-164 kW (211-223 PS) CAEB	06.2008→01.2017		7.05271.27.0	LS	475 mm	
2.0 TFSI quattro 155 kW (211 PS) CDNC	06.2008→01.2017		7.05271.15.0	LS	525 mm	
			7.05271.27.0	LS	475 mm	
2.7 TDI 140 kW (190 PS) CAMA	06.2007→03.2012		7.01782.07.0	AGR	EL	
			7.08369.13.0	ATS	EL	
			7.11190.02.0	DDS		
2.7 TDI 140 kW (190 PS) CGKA	06.2007→03.2012		7.02132.07.0	AGR	EL	
			7.01106.38.0	AGR-K	EL	mit AGR-Ventil with EGR valve
			7.08369.13.0	ATS	EL	
			7.08369.45.0	ATS	EL	Euro 5 Euro 5
			7.11190.02.0	DDS		
2.7 TDI 120 kW (163 PS) CAMB	09.2007→03.2012		7.01782.07.0	AGR	EL	
			7.08369.13.0	ATS	EL	
			7.11190.02.0	DDS		







					
A5 (8T3)					
2.7 TDI 120 kW (163 PS) CGKB	09.2007→03.2012		7.02132.07.0 AGR EL 		
			7.01106.38.0 AGR-K EL mit AGR-Ventil with EGR valve		
			7.08369.13.0 ATS EL		
			7.08369.45.0 ATS EL Euro 5 Euro 5		
3.0 TDI 150 kW (204 PS) CLAB	10.2011→01.2017		7.08369.73.0 ATS EL		
			7.11020.25.0 ATS EL vor Rußpartikelfilter before soot particulate filter Euro 5 Euro 5 für Hersteller-Abgasnorm: Euro 5 Plus, Euro 6 Plus for manufacturer exhaust norm: Euro 5 Plus, Euro 6 Plus		
			7.11190.02.0 DDS Euro 5, Euro 6 Euro 5, Euro 6		
3.0 TDI quattro 176 kW (240 PS) CAPA	06.2007→03.2012		7.01782.07.0 AGR EL 		
			7.08369.13.0 ATS EL		
			7.11190.02.0 DDS		
3.0 TDI quattro 176 kW (240 PS) CCWA	06.2007→03.2012		7.02132.07.0 AGR EL 		
			7.01106.38.0 AGR-K EL mit AGR-Ventil with EGR valve		
			7.08369.13.0 ATS EL		
			7.08369.45.0 ATS EL Euro 5 Euro 5		
			7.11190.02.0 DDS		
3.0 TDI quattro 155 kW (211 PS) CCWB	03.2008→05.2010		7.02132.07.0 AGR EL 		
			7.01106.38.0 AGR-K EL mit AGR-Ventil with EGR valve		
			7.08369.13.0 ATS EL		
			7.08369.45.0 ATS EL Euro 5 Euro 5		
			7.11190.02.0 DDS		
3.0 TDI quattro 180 kW (245 PS) CDUC, CKVB, CKVC	10.2011→01.2017		7.08369.73.0 ATS EL		
			7.11020.25.0 ATS EL  CDUC, CKVB, CKVC: vor Rußpartikelfilter before soot particulate filter Euro 5 Euro 5 für Hersteller-Abgasnorm: Euro 5 Plus, Euro 6 Plus for manufacturer exhaust norm: Euro 5 Plus, Euro 6 Plus  CDUC, CKVB, CKVC: Euro 5, Euro 6 Euro 5, Euro 6		
			7.11190.02.0 DDS		
3.0 TDI quattro 160 kW (218 PS) CKVD	05.2015→01.2017		7.11020.25.0 ATS EL vor Rußpartikelfilter before soot particulate filter Euro 5 Euro 5 für Hersteller-Abgasnorm: Euro 5 Plus, Euro 6 Plus for manufacturer exhaust norm: Euro 5 Plus, Euro 6 Plus		
			7.11190.02.0 DDS Euro 5, Euro 6 Euro 5, Euro 6		

A



A5 (8T3)

42

3.0 TFSI quattro 200 kW (272 PS) CHMB, CMUA	12.2011→01.2017	 7.22286.52.0	ARV	PN	<input type="checkbox"/> CHMB, CMUA: rechts Right
		7.22286.53.0	ARV	PN	<input type="checkbox"/>
		7.05271.18.0	LS	525 mm	
3.0 TFSI quattro 200 kW (272 PS) CRED	12.2011→01.2017	 7.03635.12.0	SLP	EL	
		 7.06714.21.0	ARV	PN	<input type="checkbox"/> rechts Right
		7.22286.53.0	ARV	PN	<input type="checkbox"/>
3.0 TFSI quattro 200 kW (272 PS) CRED	12.2011→01.2017	7.05271.18.0	LS	525 mm	
		7.03635.12.0	SLP	EL	
		7.06714.21.0	ARV	PN	<input type="checkbox"/>
3.2 FSI 190-195 kW (258-265 PS) CALA	06.2007→03.2012	 7.22286.52.0	ARV	PN	<input type="checkbox"/> rechts Right USA USA
		7.22286.53.0	ARV	PN	<input type="checkbox"/> links Left USA USA
		7.05271.18.0	LS	525 mm	
		7.22934.57.0	SLP	EL	
		7.05574.00.0	SLV	PN	<input type="checkbox"/> rechts Right
		7.05574.01.0	SLV	PN	<input type="checkbox"/> links Left
3.2 FSI quattro 190-195 kW (258-265 PS) CALA	06.2007→03.2012	 7.22286.52.0	ARV	PN	<input type="checkbox"/> rechts Right USA USA
		7.22286.53.0	ARV	PN	<input type="checkbox"/> links Left USA USA
		7.05271.18.0	LS	525 mm	
		7.22934.57.0	SLP	EL	
		7.05574.00.0	SLV	PN	<input type="checkbox"/> rechts Right
3.2 FSI quattro 190-195 kW (258-265 PS) CALA	06.2007→03.2012	7.05574.01.0	SLV	PN	<input type="checkbox"/> links Left
RS5 quattro 331 kW (450 PS) CFSA	03.2010→01.2017	 7.06714.24.0	ARV	PN	<input type="checkbox"/>
		7.05271.13.0	LS	470 mm	
S5 quattro 253-260 kW (344-354 PS) CAUA	06.2007→12.2012	 7.22934.57.0	SLP	EL	Produktionsdatum bis: 31.05.2010 Production date to: 31.05.2010
		7.05574.02.0	SLV	PN	<input type="checkbox"/> →08.2010, PKW, Coupe/ Passenger car, coupé links Left

A



A5 (F53, F5P)

43

3.0 TDI 160 kW (218 PS) CSWB	11.2016→08.2018		7.11020.24.0	ATS	EL	Produktionsdatum bis: 09.04.2018 Production date to: 09.04.2018
3.0 TDI quattro 160 kW (218 PS) CSWB	07.2016→08.2018		7.11020.24.0	ATS	EL	Produktionsdatum bis: 09.04.2018 Production date to: 09.04.2018
3.0 TDI quattro 210 kW (286 PS) DCPC	01.2017→02.2020		7.07141.01.0	AK	EL	
			7.11020.24.0	ATS	EL	für PR-Nummer: T7V, TS8 for PR number: T7V, TS8 Produktionsdatum bis: 09.04.2018 Production date to: 09.04.2018
3.0 TDI quattro 200 kW (272 PS) CRTC	02.2017→12.2017		7.11020.24.0	ATS	EL	
30 TDI Mild Hybrid 100 kW (136 PS) DEZB	10.2019→		7.07696.00.0	SRM-AK	EL	
35 TDI 110 kW (150 PS) CZHA, DEUA	05.2017→02.2020		7.11492.03.0	DDS		ohne Zubehör without accessories
35 TDI Mild Hybrid 120 kW (163 PS) DEZE	10.2019→		7.11020.31.0	ATS	EL	
			7.11492.05.0	DDS		ohne Zubehör without accessories
40 TDI 140 kW (190 PS) DESA, DETA	06.2016→02.2020		7.11492.03.0	DDS		ohne Zubehör without accessories
40 TDI quattro 140 kW (190 PS) DETA	10.2016→02.2020		7.11492.03.0	DDS		ohne Zubehör without accessories
50 TDI quattro 210 kW (286 PS) DCPC	01.2017→02.2020		7.11020.24.0	ATS	EL	für PR-Nummer: T7V , TS8 for PR number: T7V , TS8 Produktionsdatum bis: 09.04.2018 Production date to: 09.04.2018

A5 Convertible (8F7)

44

1.8 TFSI 118 kW (160 PS) CDHB	09.2009→03.2012		7.05271.27.0	LS	475 mm	
2.0 TDI 125 kW (170 PS) CAHA	05.2009→03.2012		7.10334.00.0	AGR	EL	
			7.08369.14.0	ATS	EL	
			7.08369.16.0	ATS	EL	
			7.11190.02.0	DDS		
2.0 TDI 120 kW (163 PS) CAHB	05.2009→06.2014		7.10334.00.0	AGR	EL	
			7.08369.14.0	ATS	EL	
			7.08369.16.0	ATS	EL	für Fahrzeuge mit Schaltgetriebe for vehicles with manual transmission
			7.11190.02.0	DDS		
2.0 TDI 120 kW (163 PS) CGLD	05.2009→06.2014		7.09720.03.0	AGR-K	EL	
			7.11492.03.0	DDS		ohne Zubehör without accessories für Hersteller-Abgasnorm: Euro 6 plus for manufacturer exhaust norm: Euro 6 plus
2.0 TDI 130 kW (177 PS) CGLC	10.2011→01.2017		7.09720.03.0	AGR-K	EL	
			7.11492.03.0	DDS		ohne Zubehör without accessories für Hersteller-Abgasnorm: Euro 6 plus for manufacturer exhaust norm: Euro 6 plus
2.0 TDI 105 kW (143 PS) CJCA	10.2011→05.2015		7.09720.03.0	AGR-K	EL	

						A
A5 Convertible (8F7)						44
			7.11492.03.0	DDS		ohne Zubehör without accessories für Hersteller-Abgasnorm: Euro 6 plus for manufacturer exhaust norm: Euro 6 plus
2.0 TDI 110 kW (150 PS) CJCD	05.2013→01.2017		7.09720.03.0	AGR-K	EL	
			7.11492.03.0	DDS		ohne Zubehör without accessories für Hersteller-Abgasnorm: Euro 6 plus for manufacturer exhaust norm: Euro 6 plus
2.0 TDI 110 kW (150 PS) CSUA	05.2013→01.2017		7.11190.09.0	DDS		Euro 5 Euro 5
			7.11492.03.0	DDS		ohne Zubehör without accessories für Hersteller-Abgasnorm: Euro 6 plus for manufacturer exhaust norm: Euro 6 plus
2.0 TDI 140 kW (190 PS) CNHA	09.2013→01.2017		7.11020.21.0	ATS	EL	für PR-Nummer: 7MM for PR number: 7MM
			7.11190.09.0	DDS		Euro 5 Euro 5
			7.11492.03.0	DDS		ohne Zubehör without accessories für Hersteller-Abgasnorm: Euro 6 plus for manufacturer exhaust norm: Euro 6 plus
2.0 TDI quattro 130 kW (177 PS) CGLC	01.2012→05.2015		7.09720.03.0	AGR-K	EL	
			7.11492.03.0	DDS		ohne Zubehör without accessories für Hersteller-Abgasnorm: Euro 6 plus for manufacturer exhaust norm: Euro 6 plus
2.0 TDI quattro 140 kW (190 PS) CNHA	09.2013→01.2017		7.11020.21.0	ATS	EL	für PR-Nummer: 7MM for PR number: 7MM
			7.11190.09.0	DDS		Euro 5 Euro 5
			7.11492.03.0	DDS		ohne Zubehör without accessories für Hersteller-Abgasnorm: Euro 6 plus for manufacturer exhaust norm: Euro 6 plus
2.0 TFSI 132 kW (180 PS) CDNB	03.2009→03.2012		7.05271.27.0	LS	475 mm	
2.0 TFSI 155-164 kW (211-223 PS) CAEB	03.2009→06.2014		7.05271.27.0	LS	475 mm	
2.0 TFSI 155 kW (211 PS) CDNC	03.2009→06.2014		7.05271.15.0	LS	525 mm	
			7.05271.27.0	LS	475 mm	
2.0 TFSI quattro 155-164 kW (211-223 PS) CAEB	03.2009→01.2017		7.05271.27.0	LS	475 mm	
2.0 TFSI quattro 155 kW (211 PS) CDNC	03.2009→01.2017		7.05271.15.0	LS	525 mm	
			7.05271.27.0	LS	475 mm	
2.7 TDI 140 kW (190 PS) CGKA	03.2009→03.2012		7.02132.07.0	AGR	EL	
			7.01106.38.0	AGR-K	EL	mit AGR-Ventil with EGR valve
			7.08369.13.0	ATS	EL	

A



A5 Convertible (8F7)

44

			7.08369.45.0	ATS	EL	Euro 5 Euro 5
			7.11190.02.0	DDS		
2.7 TDI 120 kW (163 PS) CGKB	05.2009→03.2012		7.02132.07.0	AGR	EL	
			7.01106.38.0	AGR-K	EL	mit AGR-Ventil with EGR valve
			7.08369.13.0	ATS	EL	
			7.08369.45.0	ATS	EL	Euro 5 Euro 5
			7.11190.02.0	DDS		
3.0 TDI 150 kW (204 PS) CLAB	10.2011→01.2017		7.08369.73.0	ATS	EL	
			7.11020.25.0	ATS	EL	vor Rußpartikelfilter before soot particulate filter Euro 5 Euro 5 für Hersteller-Abgasnorm: Euro 5 Plus, Euro 6 Plus for manufacturer exhaust norm: Euro 5 Plus, Euro 6 Plus Euro 5, Euro 6 Euro 5, Euro 6
			7.11190.02.0	DDS		
3.0 TDI quattro 176 kW (240 PS) CCWA	03.2009→03.2012		7.02132.07.0	AGR	EL	
			7.01106.38.0	AGR-K	EL	mit AGR-Ventil with EGR valve
			7.08369.13.0	ATS	EL	
			7.08369.45.0	ATS	EL	
3.0 TDI quattro 180 kW (245 PS) CDUC, CKVC	10.2011→01.2017		7.08369.73.0	ATS	EL	
			7.11020.25.0	ATS	EL	CDUC: vor Rußpartikelfilter before soot particulate filter Euro 5 Euro 5 für Hersteller-Abgasnorm: Euro 5 Plus, Euro 6 Plus for manufacturer exhaust norm: Euro 5 Plus, Euro 6 Plus CKVC: vor Rußpartikelfilter before soot particulate filter Euro 5 Euro 5 für Hersteller-Abgasnorm: Euro 6 Plus, Euro 5 Plus for manufacturer exhaust norm: Euro 6 Plus, Euro 5 Plus CDUC, CKVC: Euro 5, Euro 6 Euro 5, Euro 6
			7.11190.02.0	DDS		
3.0 TDI quattro 160 kW (218 PS) CKVD	05.2015→01.2017		7.11020.25.0	ATS	EL	vor Rußpartikelfilter before soot particulate filter Euro 5 Euro 5 für Hersteller-Abgasnorm: Euro 5 Plus, Euro 6 Plus for manufacturer exhaust norm: Euro 5 Plus, Euro 6 Plus Euro 5, Euro 6 Euro 5, Euro 6
			7.11190.02.0	DDS		
3.0 TFSI quattro 200 kW (272 PS) CMUA	11.2011→01.2017		7.22286.52.0	ARV	PN	rechts Right
			7.22286.53.0	ARV	PN	

						A
A5 Convertible (8F7)						44
			7.05271.18.0 LS 525 mm 7.03635.12.0 SLP EL 7.22934.57.0 SLP EL			für OE-Nummer: 079 959 231 G for OE number: 079 959 231 G nicht für PR-Nummer: GP2 not for PR number: GP2 Produktionsdatum ab: 27.07.2016 Production date from: 27.07.2016
3.0 TFSI quattro 200 kW (272 PS) CRED	11.2011→01.2017		7.06714.21.0 ARV PN 7.22286.53.0 ARV PN 7.05271.18.0 LS 525 mm 7.03635.12.0 SLP EL			rechts Right
3.2 FSI 190-195 kW (258-265 PS) CALA	03.2009→03.2012		7.22286.52.0 ARV PN 7.22286.53.0 ARV PN 7.05271.18.0 LS 525 mm 7.22934.57.0 SLP EL 7.05574.00.0 SLV PN 7.05574.01.0 SLV PN			rechts Right USA USA links Left USA USA rechts Right für PR-Nummer: A8S for PR number: A8S links Left
3.2 FSI quattro 190-195 kW (258-265 PS) CALA	03.2009→03.2012		7.22286.52.0 ARV PN 7.22286.53.0 ARV PN 7.05271.18.0 LS 525 mm 7.22934.57.0 SLP EL 7.05574.00.0 SLV PN 7.05574.01.0 SLV PN			rechts Right USA USA links Left USA USA rechts Right für PR-Nummer: A8S for PR number: A8S links Left
RS5 quattro 331 kW (450 PS) CFSA	11.2012→08.2015		7.06714.24.0 ARV PN 7.05271.13.0 LS 470 mm			
S5 quattro 245 kW (333 PS) CAKA, CCBA	06.2009→01.2017		7.22286.52.0 ARV PN			CAKA, CCBA: rechts Right USA USA

A



A5 Convertible (8F7)

44

			7.22286.53.0	ARV	PN	CAKA, CCBA: links Left USA USA
			7.05271.18.0	LS	525 mm	
			7.22934.57.0	SLP	EL	CAKA: nicht für PR-Nummer: GP2 not for PR number: GP2 Produktionsdatum ab: 27.07.2016 Production date from: 27.07.2016 CCBA: PKW, Cabriolet/ Passenger car, cabriolet
			7.05574.00.0	SLV	PN	CAKA, CCBA: rechts Right für PR-Nummer: A8S for PR number: A8S
			7.05574.01.0	SLV	PN	CAKA, CCBA: links Left
S5 quattro 245-249 kW (333-339 PS) CGWC, CGXC	06.2009→01.2017		7.22286.52.0	ARV	PN	CGWC, CGXC: rechts Right
			7.22286.53.0	ARV	PN	CGWC, CGXC: links Left
			7.05271.18.0	LS	525 mm	
			7.03635.12.0	SLP	EL	CGWC, CGXC: für OE-Nummer: 079 959 231 G for OE number: 079 959 231 G
			7.22934.57.0	SLP	EL	CGWC: nicht für PR-Nummer: GP2 not for PR number: GP2 Produktionsdatum ab: 27.06.2016 Production date from: 27.06.2016 CGXC: nicht für PR-Nummer: GP2 not for PR number: GP2 Produktionsdatum ab: 27.07.2016 Production date from: 27.07.2016
S5 quattro 245 kW (333 PS) CREC	06.2009→01.2017		7.06714.21.0	ARV	PN	rechts Right
			7.05271.18.0	LS	525 mm	
			7.03635.12.0	SLP	EL	
S5 quattro 245 kW (333 PS) CTDA	06.2009→01.2017		7.06714.21.0	ARV	PN	rechts Right
			7.22286.53.0	ARV	PN	links Left
			7.05271.18.0	LS	525 mm	
			7.03635.12.0	SLP	EL	
S5 quattro 245 kW (333 PS) CTUB	06.2009→01.2017		7.22286.53.0	ARV	PN	links Left
			7.05271.18.0	LS	525 mm	
			7.03635.12.0	SLP	EL	für OE-Nummer: 079 959 231 G for OE number: 079 959 231 G
			7.22934.57.0	SLP	EL	Produktionsdatum ab: 27.07.2016 Production date from: 27.07.2016















A5 Convertible (F57, F5E)						45
2.0 TDI 140 kW (190 PS) DETA	11.2016→12.2019		7.11020.31.0	ATS	EL	ch. F5-H-000 001→
			7.11492.03.0	DDS		ohne Zubehör without accessories ch. F5-H-000 001→
2.0 TDI 110 kW (150 PS) DEUA	08.2017→12.2019		7.11492.03.0	DDS		ohne Zubehör without accessories ch. F5-H-000 001→
2.0 TDI quattro 140 kW (190 PS) DETA	03.2017→		7.11020.31.0	ATS	EL	ch. F5-H-000 001→
			7.11492.03.0	DDS		ohne Zubehör without accessories ch. F5-H-000 001→
3.0 TDI 160 kW (218 PS) CSWB	03.2017→08.2018		7.11020.24.0	ATS	EL	ch. F5-H-000 001→ Produktionsdatum bis: 26.03.2018 Production date to: 26.03.2018
3.0 TDI quattro 210 kW (286 PS) DCPC	11.2016→12.2019		7.07141.01.0	AK	EL	
			7.11020.24.0	ATS	EL	ch. F5-H-000 001→ Produktionsdatum bis: 26.03.2018 Production date to: 26.03.2018
3.0 TDI quattro 160 kW (218 PS) CSWB	12.2016→08.2018		7.11020.24.0	ATS	EL	ch. F5-H-000 001→ Produktionsdatum bis: 26.03.2018 Production date to: 26.03.2018
35 TDI Mild Hybrid 120 kW (163 PS) DEZE	10.2019→		7.11492.05.0	DDS		ohne Zubehör without accessories ch. F5-H-000 001→
40 TDI 140 kW (190 PS) DETA	11.2016→12.2019		7.11020.31.0	ATS	EL	ch. F5-H-000 001→
			7.11492.03.0	DDS		ohne Zubehör without accessories ch. F5-H-000 001→
40 TDI quattro 140 kW (190 PS) DETA	03.2017→12.2019		7.11020.31.0	ATS	EL	ch. F5-H-000 001→
			7.11492.03.0	DDS		ohne Zubehör without accessories ch. F5-H-000 001→
A5 Sportback (8TA)						46
1.8 TFSI 118 kW (160 PS) CDHB	11.2009→09.2011		7.05271.27.0	LS	475 mm	
2.0 TDI 125 kW (170 PS) CAHA	09.2009→03.2012		7.10334.00.0	AGR	EL	
			7.08369.14.0	ATS	EL	Euro4/Euro5 Euro4/Euro5
			7.08369.16.0	ATS	EL	für Fahrzeuge mit Schaltgetriebe for vehicles with manual transmission
			7.11190.02.0	DDS		
2.0 TDI 120 kW (163 PS) CAHB	09.2009→01.2017		7.10334.00.0	AGR	EL	
			7.08369.14.0	ATS	EL	Euro4/Euro5 Euro4/Euro5
			7.08369.16.0	ATS	EL	für Fahrzeuge mit Schaltgetriebe for vehicles with manual transmission
			7.11190.02.0	DDS		
2.0 TDI 120 kW (163 PS) CGLD	09.2009→01.2017		7.09720.03.0	AGR-K	EL	
			7.11492.03.0	DDS		ohne Zubehör without accessories für Hersteller-Abgasnorm: Euro 6 plus for manufacturer exhaust norm: Euro 6 plus





















A



A5 Sportback (8TA)

46

2.0 TDI 120 kW (163 PS) CNHC	09.2009→01.2017		7.11020.21.0	ATS	EL	für PR-Nummer: 7MM for PR number: 7MM
			7.11190.09.0	DDS		Euro 5
			7.11492.03.0	DDS		ohne Zubehör without accessories für Hersteller-Abgasnorm: Euro 6 plus for manufacturer exhaust norm: Euro 6 plus
2.0 TDI 100 kW (136 PS) CAGB	09.2009→01.2017		7.10334.00.0	AGR	EL	
			7.08369.14.0	ATS	EL	Euro4/Euro5
			7.08369.16.0	ATS	EL	für Fahrzeuge mit Schaltgetriebe for vehicles with manual transmission
			7.08369.52.0	ATS	EL	Euro4/Euro5
			7.11190.02.0	DDS		für Fahrzeuge mit Automatikgetriebe for vehicles with automatic transmission
2.0 TDI 100 kW (136 PS) CJCB	09.2009→01.2017		7.11492.03.0	DDS		ohne Zubehör without accessories für Hersteller-Abgasnorm: Euro 6 plus for manufacturer exhaust norm: Euro 6 plus
2.0 TDI 100 kW (136 PS) CSUB	09.2009→01.2017		7.11190.09.0	DDS		Euro 5
			7.11492.03.0	DDS		ohne Zubehör without accessories für Hersteller-Abgasnorm: Euro 6 plus for manufacturer exhaust norm: Euro 6 plus
2.0 TDI 105 kW (143 PS) CAGA	09.2009→01.2017		7.10334.00.0	AGR	EL	
			7.08369.14.0	ATS	EL	Euro4/Euro5
			7.08369.16.0	ATS	EL	für Fahrzeuge mit Schaltgetriebe for vehicles with manual transmission
			7.08369.52.0	ATS	EL	Euro4/Euro5
			7.11190.02.0	DDS		für Fahrzeuge mit Automatikgetriebe for vehicles with automatic transmission
2.0 TDI 105 kW (143 PS) CJCA	09.2009→01.2017		7.09720.03.0	AGR-K	EL	
			7.11492.03.0	DDS		ohne Zubehör without accessories für Hersteller-Abgasnorm: Euro 6 plus for manufacturer exhaust norm: Euro 6 plus
2.0 TDI 105 kW (143 PS) CMEA	09.2009→01.2017		7.10334.00.0	AGR	EL	
			7.11492.03.0	DDS		ohne Zubehör without accessories für Hersteller-Abgasnorm: Euro 6 plus for manufacturer exhaust norm: Euro 6 plus
2.0 TDI 105 kW (143 PS) CMFA	09.2009→01.2017		7.09720.03.0	AGR-K	EL	
2.0 TDI 130 kW (177 PS) CGLC	10.2011→01.2017		7.09720.03.0	AGR-K	EL	











						A
A5 Sportback (8TA)						46
			7.11492.03.0	DDS		ohne Zubehör without accessories für Hersteller-Abgasnorm: Euro 6 plus for manufacturer exhaust norm: Euro 6 plus
2.0 TDI 110 kW (150 PS) CJCD, CMFB	05.2013→01.2017		7.09720.03.0	AGR-K	EL	
			7.11492.03.0	DDS		ohne Zubehör without accessories  CJCD, CMFB: für Hersteller-Abgasnorm: Euro 6 plus for manufacturer exhaust norm: Euro 6 plus
2.0 TDI 110 kW (150 PS) CSUA	05.2013→01.2017		7.11190.09.0	DDS		Euro 5 Euro 5
			7.11492.03.0	DDS		ohne Zubehör without accessories für Hersteller-Abgasnorm: Euro 6 plus for manufacturer exhaust norm: Euro 6 plus
2.0 TDI 140 kW (190 PS) CNHA	09.2013→01.2017		7.11020.21.0	ATS	EL	für PR-Nummer: 7MM for PR number: 7MM
			7.11190.09.0	DDS		Euro 5 Euro 5
			7.11492.03.0	DDS		ohne Zubehör without accessories für Hersteller-Abgasnorm: Euro 6 plus for manufacturer exhaust norm: Euro 6 plus
2.0 TDI quattro 125 kW (170 PS) CAHA	09.2009→03.2012		7.10334.00.0	AGR	EL	
			7.08369.14.0	ATS	EL	Euro4/Euro5 Euro4/Euro5
			7.08369.16.0	ATS	EL	für Fahrzeuge mit Schaltgetriebe for vehicles with manual transmission
			7.11190.02.0	DDS		
2.0 TDI quattro 130 kW (177 PS) CGLC	12.2011→01.2017		7.09720.03.0	AGR-K	EL	
			7.11492.03.0	DDS		ohne Zubehör without accessories für Hersteller-Abgasnorm: Euro 6 plus for manufacturer exhaust norm: Euro 6 plus
2.0 TDI quattro 140 kW (190 PS) CNHA	09.2013→01.2017		7.11020.21.0	ATS	EL	für PR-Nummer: 7MM for PR number: 7MM
			7.11190.09.0	DDS		Euro 5 Euro 5
			7.11492.03.0	DDS		ohne Zubehör without accessories für Hersteller-Abgasnorm: Euro 6 plus for manufacturer exhaust norm: Euro 6 plus
2.0 TFSI 132 kW (180 PS) CDNB	09.2009→06.2014		7.05271.27.0	LS	475 mm	
2.0 TFSI 155 kW (211 PS) CDNC	09.2009→11.2013		7.05271.15.0	LS	525 mm	
			7.05271.27.0	LS	475 mm	
2.0 TFSI quattro 155 kW (211 PS) CDNC	09.2009→01.2017		7.05271.15.0	LS	525 mm	
			7.05271.27.0	LS	475 mm	
2.7 TDI 140 kW (190 PS) CAMA	09.2009→03.2012		7.01782.07.0	AGR	EL	













A



A5 Sportback (8TA)

46

			7.08369.13.0	ATS	EL	
			7.11190.02.0	DDS		
2.7 TDI 140 kW (190 PS) CGKA	09.2009→03.2012		7.02132.07.0	AGR	EL	
			7.01106.38.0	AGR-K	EL	mit AGR-Ventil with EGR valve
			7.08369.13.0	ATS	EL	
			7.08369.45.0	ATS	EL	Euro 5 Euro 5
			7.11190.02.0	DDS		
2.7 TDI 120 kW (163 PS) CGKB	09.2009→03.2012		7.02132.07.0	AGR	EL	
			7.01106.38.0	AGR-K	EL	mit AGR-Ventil with EGR valve
			7.08369.13.0	ATS	EL	
			7.08369.45.0	ATS	EL	Euro 5 Euro 5
			7.11190.02.0	DDS		
3.0 TDI 150 kW (204 PS) CLAB	10.2011→01.2017		7.08369.73.0	ATS	EL	
			7.11020.25.0	ATS	EL	vor Rußpartikelfilter before soot particulate filter Euro 5 Euro 5 für Hersteller-Abgasnorm: Euro 5 Plus, Euro 6 Plus for manufacturer exhaust norm: Euro 5 Plus, Euro 6 Plus
			7.11190.02.0	DDS		Euro 5, Euro 6 Euro 5, Euro 6
3.0 TDI quattro 176 kW (240 PS) CCWA	09.2009→03.2012		7.02132.07.0	AGR	EL	
			7.01106.38.0	AGR-K	EL	mit AGR-Ventil with EGR valve
			7.08369.13.0	ATS	EL	
			7.08369.45.0	ATS	EL	Euro 5 Euro 5
			7.11190.02.0	DDS		
3.0 TDI quattro 180 kW (245 PS) CDUC, CKVB, CKVC	10.2011→01.2017		7.08369.73.0	ATS	EL	
			7.11020.25.0	ATS	EL	 CDUC: vor Rußpartikelfilter before soot particulate filter Euro 5 Euro 5 für Hersteller-Abgasnorm: Euro 5 Plus, Euro 6 Plus for manufacturer exhaust norm: Euro 5 Plus, Euro 6 Plus  CKVB, CKVC: vor Rußpartikelfilter before soot particulate filter Euro 5 Euro 5 für Hersteller-Abgasnorm: Euro 5 Plus, Euro 6 Plus for manufacturer exhaust norm: Euro 5 Plus, Euro 6 Plus
			7.11190.02.0	DDS		 CDUC, CKVB, CKVC: Euro 5, Euro 6 Euro 5, Euro 6

						A			
A5 Sportback (8TA)						46			
3.0 TDI quattro 160 kW (218 PS) CKVD	05.2015→01.2017		7.11020.25.0	ATS	EL	vor Rußpartikelfilter before soot particulate filter Euro 5 Euro 5 für Hersteller-Abgasnorm: Euro 5 Plus, Euro 6 Plus for manufacturer exhaust norm: Euro 5 Plus, Euro 6 Plus			
			7.11190.02.0	DDS		Euro 5, Euro 6 Euro 5, Euro 6			
3.0 TFSI quattro 200 kW (272 PS) CHMB, CMUA	12.2011→01.2017		7.22286.52.0	ARV	PN	<input type="radio"/> CHMB, CMUA: rechts Right			
			7.22286.53.0	ARV	PN	<input type="radio"/>			
			7.05271.18.0	LS	525 mm	<input type="radio"/>			
			7.03635.12.0	SLP	EL	<input type="radio"/>			
3.0 TFSI quattro 200 kW (272 PS) CRED	12.2011→01.2017		7.06714.21.0	ARV	PN	<input type="radio"/> rechts Right			
			7.22286.53.0	ARV	PN	<input type="radio"/>			
			7.05271.18.0	LS	525 mm	<input type="radio"/>			
			7.03635.12.0	SLP	EL	<input type="radio"/>			
3.2 FSI quattro 190-195 kW (258-265 PS) CALA	09.2009→03.2012		7.22286.52.0	ARV	PN	<input type="radio"/> rechts Right USA USA			
			7.22286.53.0	ARV	PN	<input type="radio"/> links Left USA USA			
			7.05271.18.0	LS	525 mm	<input type="radio"/>			
			7.22934.57.0	SLP	EL	<input type="radio"/>			
			7.05574.00.0	SLV	PN	<input type="radio"/> rechts Right			
			7.05574.01.0	SLV	PN	<input type="radio"/> links Left			
			S5 quattro 245 kW (333 PS) CAKA	01.2010→01.2017		7.22286.52.0	ARV	PN	<input type="radio"/> rechts Right USA USA
						7.22286.53.0	ARV	PN	<input type="radio"/>
7.05271.18.0	LS	525 mm				<input type="radio"/>			
7.22934.57.0	SLP	EL				<input type="radio"/>			
7.05574.00.0	SLV	PN				<input type="radio"/>			
S5 quattro 245 kW (333 PS) CGWC	01.2010→01.2017		7.22286.52.0	ARV	PN	<input type="radio"/> rechts Right			
			7.22286.53.0	ARV	PN	<input type="radio"/>			
S5 quattro 245 kW (333 PS) CAKA	01.2010→01.2017		7.22286.52.0	ARV	PN	<input type="radio"/> rechts Right PKW, Cabriolet/ Passenger car, cabriolet			
			7.05574.01.0	SLV	PN	<input type="radio"/> links Left PKW, Cabriolet/ Passenger car, cabriolet			

A



A5 Sportback (8TA)

46

			7.05271.18.0	LS	525 mm	
			7.03635.12.0	SLP	EL	
S5 quattro 245 kW (333 PS) CREC, CTDA	01.2010→01.2017		7.06714.21.0	ARV	PN	
			7.22286.53.0	ARV	PN	
			7.05271.18.0	LS	525 mm	
			7.03635.12.0	SLP	EL	

A5 Sportback (F5A, F5F)

















47

2.0 TDI 140 kW (190 PS) DESA, DETA	09.2016→		7.11492.03.0	DDS		ohne Zubehör without accessories
2.0 TDI 110 kW (150 PS) CZHA, DEUA	01.2017→02.2020		7.11492.03.0	DDS		ohne Zubehör without accessories
2.0 TDI 100 kW (136 PS) DEUB	05.2017→08.2018		7.11492.03.0	DDS		ohne Zubehör without accessories
			7.07696.00.0	SRM-AK	EL	
2.0 TDI quattro 140 kW (190 PS) DESA, DETA	10.2016→		7.11492.03.0	DDS		ohne Zubehör without accessories
2.0 TDI quattro 110 kW (150 PS) CZHA, DEUA	05.2017→02.2020		7.11492.03.0	DDS		ohne Zubehör without accessories
3.0 TDI 160 kW (218 PS) CSWB	03.2017→08.2018		7.11020.24.0	ATS	EL	Produktionsdatum bis: 09.04.2018 Production date to: 09.04.2018
3.0 TDI quattro 160 kW (218 PS) CSWB	09.2016→		7.11020.24.0	ATS	EL	Produktionsdatum bis: 09.04.2018 Production date to: 09.04.2018
			7.07141.01.0	AK	EL	
3.0 TDI quattro 210 kW (286 PS) DCPC	01.2017→02.2020		7.11020.24.0	ATS	EL	für PR-Nummer: T7V, TS8 for PR number: T7V, TS8 Produktionsdatum bis: 09.04.2018 Production date to: 09.04.2018
			7.11020.24.0	ATS	EL	
3.0 TDI quattro 200 kW (272 PS) CRTC	02.2017→12.2017		7.11020.24.0	ATS	EL	Produktionsdatum bis: 09.04.2018 Production date to: 09.04.2018
30 TDI Mild Hybrid 100 kW (136 PS) DEZB	10.2019→		7.07696.00.0	SRM-AK	EL	
35 TDI 110 kW (150 PS) DEUA	01.2017→02.2020		7.11492.03.0	DDS		ohne Zubehör without accessories
35 TDI Mild Hybrid 120 kW (163 PS) DEZE	10.2019→		7.11020.31.0	ATS	EL	
			7.11492.05.0	DDS		ohne Zubehör without accessories
40 TDI 140 kW (190 PS) DESA, DETA	09.2016→02.2020		7.11492.03.0	DDS		ohne Zubehör without accessories
40 TDI quattro 140 kW (190 PS) DETA	08.2016→02.2020		7.11492.03.0	DDS		ohne Zubehör without accessories
50 TDI quattro 210 kW (286 PS) DCPC	01.2017→02.2020		7.11020.24.0	ATS	EL	für PR-Nummer: T7V, TS8 for PR number: T7V, TS8 Produktionsdatum bis: 09.04.2018 Production date to: 09.04.2018

A6 Allroad C6 (4FH)

48

2.7 TDI quattro 132 kW (180 PS) BPP	03.2006→10.2008		7.00309.07.0	AGR	PN	
			7.08369.42.0	ATS	EL	nach Katalysator Post-catalyst Euro4/Euro5 Euro4/Euro5













						
A6 Allroad C6 (4FH)						48
			7.11190.02.0	DDS		Euro 5, Euro 4 Euro 5, Euro 4
2.7 TDI quattro 120 kW (163 PS) BSG	05.2006→08.2011		7.00309.07.0	AGR	PN	
			7.08369.42.0	ATS	EL	nach Katalysator Post-catalyst Euro4/Euro5 Euro4/Euro5
			7.11190.02.0	DDS		Euro 5, Euro 4 Euro 5, Euro 4
2.7 TDI quattro 120 kW (163 PS) CAND	05.2006→08.2011		7.02132.07.0	AGR	EL	
			7.01106.38.0	AGR-K	EL	
			7.08369.42.0	ATS	EL	nach Katalysator Post-catalyst Euro4/Euro5 Euro4/Euro5
			7.08369.45.0	ATS	EL	Euro 5 Euro 5
			7.11190.00.0	DDS		für OE-Nummer: 07Z 906 051, 07Z 906 051 A, 4F0 131 552 AK for OE number: 07Z 906 051, 07Z 906 051 A, 4F0 131 552 AK
			7.11190.02.0	DDS		für OE-Nummer: 059 906 051 A, 07Z 906 051 B for OE number: 059 906 051 A, 07Z 906 051 B
2.7 TDI quattro 140 kW (190 PS) CANC	10.2008→08.2011		7.02132.07.0	AGR	EL	
			7.01106.38.0	AGR-K	EL	mit AGR-Ventil with EGR valve
			7.08369.42.0	ATS	EL	nach Katalysator Post-catalyst Euro4/Euro5 Euro4/Euro5
			7.08369.45.0	ATS	EL	Euro 5 Euro 5
			7.11190.00.0	DDS		für OE-Nummer: 07Z 906 051, 07Z 906 051 A, 4F0 131 552 AK for OE number: 07Z 906 051, 07Z 906 051 A, 4F0 131 552 AK
			7.11190.02.0	DDS		für OE-Nummer: 059 906 051 A, 07Z 906 051 B for OE number: 059 906 051 A, 07Z 906 051 B
3.0 TDI quattro 171 kW (233 PS) ASB	05.2006→10.2008		7.00309.07.0	AGR	PN	
			7.08369.13.0	ATS	EL	
			7.08369.42.0	ATS	EL	vor Rußpartikelfilter before soot particulate filter Euro4/Euro5 Euro4/Euro5
			7.08369.66.0	ATS	EL	Baujahr bis: 04.2008 Construction year to: 04.2008 Schaltgetriebe Manual Transmission Euro 4 Euro 4 vor Rußpartikelfilter before soot particulate filter
			7.11190.02.0	DDS		Euro 5, Euro 4 Euro 5, Euro 4
3.0 TDI quattro 155 kW (211 PS) BNG	05.2006→08.2011		7.00309.07.0	AGR	PN	
			7.08369.13.0	ATS	EL	

A



































A6 Allroad C6 (4FH)

48

			7.08369.42.0	ATS	EL	nach Katalysator Post-catalyst Euro4/Euro5 Euro4/Euro5
			7.08369.66.0	ATS	EL	Baujahr bis: 04.2008 Construction year to: 04.2008 Schaltgetriebe Manual Transmission Euro 4 Euro 4 vor Rußpartikelfilter before soot particulate filter
			7.11190.02.0	DDS		Euro 5, Euro 4 Euro 5, Euro 4
3.0 TDI quattro 155 kW (211 PS) CDYB	05.2006→08.2011		7.02132.07.0	AGR	EL	
			7.01106.38.0	AGR-K	EL	
			7.08369.13.0	ATS	EL	
			7.08369.42.0	ATS	EL	nach Katalysator Post-catalyst Euro4/Euro5 Euro4/Euro5
			7.08369.45.0	ATS	EL	Euro 5 Euro 5
			7.11190.00.0	DDS		für OE-Nummer: 07Z 906 051, 07Z 906 051 A, 4F0 131 552 AK for OE number: 07Z 906 051, 07Z 906 051 A, 4F0 131 552 AK
3.0 TDI quattro 176 kW (240 PS) CDYA, CDYC	10.2008→08.2011		7.02132.07.0	AGR	EL	
			7.01106.38.0	AGR-K	EL	 CDYA, CDYC: mit AGR-Ventil with EGR valve
			7.08369.13.0	ATS	EL	
			7.08369.42.0	ATS	EL	 CDYA, CDYC: nach Katalysator Post-catalyst Euro4/Euro5 Euro4/Euro5
			7.08369.45.0	ATS	EL	 CDYA, CDYC: Euro 5 Euro 5
			7.11190.00.0	DDS		 CDYA, CDYC: für OE-Nummer: 07Z 906 051, 07Z 906 051 A, 4F0 131 552 AK for OE number: 07Z 906 051, 07Z 906 051 A, 4F0 131 552 AK
3.0 TFSI quattro 213 kW (290 PS) CAJA	10.2008→08.2011		7.22286.52.0	ARV	PN	 rechts Right
			7.22286.53.0	ARV	PN	 links Left
			7.22738.08.0	SLP	EL	
4.2 FSI quattro 250-257 kW (340-350 PS) BVJ	05.2006→12.2010		7.01486.10.0	SLP	EL	
			7.22778.97.0	SLV	PN	

A6 Allroad C7 (4GH, 4GJ)
49

3.0 TDI quattro 150 kW (204 PS) CLAA	01.2012→12.2014	 7.08369.73.0	ATS	EL	vor Rußpartikelfilter before soot particulate filter Euro 5 Euro 5 für Hersteller-Abgasnorm: Euro 5 Plus for manufacturer exhaust norm: Euro 5 Plus Produktionsdatum ab: 08.07.2013 Production date from: 08.07.2013 Euro 5 Euro 5
		 7.11020.25.0	ATS	EL	
		 7.11190.02.0	DDS		
3.0 TDI quattro 180 kW (245 PS) CDUD	01.2012→06.2016	 7.08369.73.0	ATS	EL	vor Rußpartikelfilter before soot particulate filter Euro 5 Euro 5 für Hersteller-Abgasnorm: Euro 5 Plus for manufacturer exhaust norm: Euro 5 Plus Produktionsdatum ab: 08.07.2013 Production date from: 08.07.2013 Euro 5 Euro 5
		 7.11020.25.0	ATS	EL	
		 7.11190.02.0	DDS		
3.0 TDI quattro 180 kW (245 PS) CKVC	01.2012→06.2016	 7.08369.73.0	ATS	EL	vor Rußpartikelfilter before soot particulate filter Produktionsdatum ab: 08.07.2013 Production date from: 08.07.2013
		 7.11020.25.0	ATS	EL	
		 7.11190.02.0	DDS		
3.0 TDI quattro 230 kW (313 PS) CGQB	01.2012→12.2014	 7.11190.02.0	DDS		Euro 5 Euro 5
		 7.11020.24.0	ATS	EL	 CRTF, CZVC: Produktionsdatum bis: 26.03.2018 Production date to: 26.03.2018
		 7.11020.24.0	ATS	EL	 CRTE, CZVA: Produktionsdatum bis: 26.03.2018 Production date to: 26.03.2018
3.0 TDI quattro 160 kW (218 PS) CRTE, CZVA	09.2014→09.2018	 7.11020.24.0	ATS	EL	 CRTE, CZVA: Produktionsdatum bis: 26.03.2018 Production date to: 26.03.2018
		 7.11020.24.0	ATS	EL	Produktionsdatum bis: 26.03.2018 Production date to: 26.03.2018
		 7.11020.24.0	ATS	EL	Produktionsdatum bis: 26.03.2018 Production date to: 26.03.2018
3.0 TDI quattro 140 kW (190 PS) CZVF	11.2015→09.2018	 7.11020.24.0	ATS	EL	Produktionsdatum bis: 26.03.2018 Production date to: 26.03.2018
		 7.22286.52.0	ARV	PN	 rechts Right
		 7.22286.53.0	ARV	PN	 links Left
3.0 TFSI quattro 228 kW (310 PS) CGWD	01.2012→12.2014	 7.22286.52.0	ARV	PN	 rechts Right
		 7.22286.53.0	ARV	PN	 links Left
		 7.22934.57.0	SLP	EL	
3.0 TFSI quattro 245 kW (333 PS) CREC	09.2014→09.2018	 7.06714.21.0	ARV	PN	 rechts Right
		 7.22286.53.0	ARV	PN	 links Left
		 7.22934.57.0	SLP	EL	

A6 C4 (4A2)
50











2.0 74 kW (100 PS) AAE	06.1994→10.1997	 7.02604.03.0	LS	200 mm	
2.0 85 kW (115 PS) ABK	06.1994→10.1997	 7.02604.03.0	LS	200 mm	

A



A6 C4 (4A2)

50

2.0 79 kW (107 PS) ADW	06.1994→07.1995		7.02604.03.0	LS	200 mm
2.0 16V 101-103 kW (137-140 PS) ACE	06.1994→10.1997		7.02604.03.0	LS	200 mm
2.0 16V quattro 101-103 kW (137-140 PS) ACE	06.1994→10.1997		7.02604.03.0	LS	200 mm
2.3 98 kW (133 PS) AAR	06.1994→12.1995		7.02604.03.0	LS	200 mm
2.3 quattro 98 kW (133 PS) AAR	06.1994→12.1995		7.02604.03.0	LS	200 mm
2.6 110 kW (150 PS) ABC	06.1994→10.1997		7.02604.03.0	LS	200 mm
2.6 102 kW (139 PS) ACZ	06.1994→10.1997		7.02604.03.0	LS	200 mm
2.6 quattro 110 kW (150 PS) ABC	06.1994→10.1997		7.02604.03.0	LS	200 mm
2.8 quattro 120-128 kW (163-174 PS) AAH, AFC	06.1994→10.1997		7.02604.03.0	LS	200 mm
S6 4.2 quattro 213 kW (290 PS) AEC	06.1994→10.1997		7.05270.96.0	LS	1440 mm
S6 Plus quattro 240 kW (326 PS) AHK	04.1996→10.1997		7.05270.96.0	LS	1440 mm



A6 C4 Avant (4A5)









































51

2.0 74 kW (100 PS) AAE	06.1994→12.1997		7.02604.03.0	LS	200 mm
2.0 85 kW (115 PS) ABK	06.1994→12.1997		7.02604.03.0	LS	200 mm
2.0 16V 101-103 kW (137-140 PS) ACE	06.1994→12.1997		7.02604.03.0	LS	200 mm
2.0 16V quattro 101-103 kW (137-140 PS) ACE	06.1994→12.1997		7.02604.03.0	LS	200 mm
2.3 98 kW (133 PS) AAR	06.1994→12.1995		7.02604.03.0	LS	200 mm
2.3 quattro 98 kW (133 PS) AAR	06.1994→12.1995		7.02604.03.0	LS	200 mm
2.6 110 kW (150 PS) ABC	06.1994→12.1997		7.02604.03.0	LS	200 mm
2.6 102 kW (139 PS) ACZ	06.1994→02.1997		7.02604.03.0	LS	200 mm
2.6 quattro 110 kW (150 PS) ABC	06.1994→12.1997		7.02604.03.0	LS	200 mm
2.8 quattro 120-128 kW (163-174 PS) AAH, AFC	06.1994→12.1997		7.02604.03.0	LS	200 mm
S6 4.2 quattro 213 kW (290 PS) AEC	06.1994→12.1997		7.05270.96.0	LS	1440 mm
S6 Plus quattro 240 kW (326 PS) AHK	04.1996→12.1997		7.05270.96.0	LS	1440 mm

A6 C5 (4B2)

52

1.8 85 kW (115 PS) AFY	05.1997→01.2005		7.05271.21.0	LS	1250 mm
1.8 92 kW (125 PS) AJP, AQE	07.1997→01.2005		7.05271.21.0	LS	1250 mm
1.8 92 kW (125 PS) ARH	07.1997→01.2005		7.05271.21.0	LS	1250 mm

					
A6 C5 (4B2)					52
			7.22738.08.0	SLP	EL  ch. 4B-1-120 001→ Automatikgetriebe Automatic Transmission
			7.21851.31.0	SLP	EL  →ch. 4B-1-120 000 Automatikgetriebe Automatic Transmission
1.8 T 110-112 kW (150-152 PS) AEB	01.1997→01.1999		7.05270.96.0	LS	1440 mm Regelsonde Regulating Probe
1.8 T 110 kW (150 PS) AWT	01.1997→01.2005		7.22560.43.0	ARV	PN 
			7.05270.99.0	LS	940 mm Diagnosesonde Diagnostic Probe
			7.05271.24.0	LS	1500 mm vor Katalysator in front of the catalyst
			7.22738.08.0	SLP	EL  ch. 4B-Y-120 001→
			7.21851.31.0	SLP	EL  →ch. 4B-Y-120 000
1.8 T 132 kW (180 PS) AJL	12.1997→01.2005		7.05270.96.0	LS	1440 mm Regelsonde Regulating Probe
1.8 T 110 kW (150 PS) APU, ARK	11.1998→01.2005		7.05271.21.0	LS	 APU, ARK: Regelsonde Regulating Probe
1.8 T 110 kW (150 PS) ANB	01.1999→01.2005		7.22560.42.0	ARV	PN 
			7.22560.43.0	ARV	PN 
			7.05270.99.0	LS	940 mm Diagnosesonde Diagnostic Probe
			7.05271.21.0	LS	1250 mm Regelsonde Regulating Probe
			7.22738.08.0	SLP	EL  ch. 4B-Y-120 001→
			7.21851.31.0	SLP	EL  →ch. 4B-Y-120 000
1.8 T quattro 110-112 kW (150-152 PS) AEB	02.1997→01.1999		7.05270.96.0	LS	1440 mm Regelsonde Regulating Probe
1.8 T quattro 110 kW (150 PS) AWT	02.1997→01.2005		7.22560.43.0	ARV	PN 
			7.05270.99.0	LS	940 mm Diagnosesonde Diagnostic Probe
			7.05271.24.0	LS	1500 mm vor Katalysator in front of the catalyst
			7.22738.08.0	SLP	EL  ch. 4B-Y-120 001→
			7.21851.31.0	SLP	EL  →ch. 4B-Y-120 000
1.8 T quattro 132 kW (180 PS) AJL	12.1997→01.2005		7.05270.96.0	LS	1440 mm Regelsonde Regulating Probe
1.8 T quattro 110 kW (150 PS) APU, ARK	11.1998→01.2005		7.05271.21.0	LS	 APU, ARK: Regelsonde Regulating Probe
1.8 T quattro 110 kW (150 PS) ANB	01.1999→01.2005		7.22560.42.0	ARV	PN 
			7.22560.43.0	ARV	PN 
			7.05270.99.0	LS	940 mm Diagnosesonde Diagnostic Probe
			7.05271.21.0	LS	1250 mm Regelsonde Regulating Probe
			7.22738.08.0	SLP	EL  ch. 4B-Y-120 001→
7.21851.31.0	SLP	EL  →ch. 4B-Y-120 000			
1.9 TDI 85 kW (115 PS) AJM	07.2000→01.2005		7.24809.19.0	AGR	PN 
1.9 TDI 96 kW (130 PS) AVF, AWX	08.2001→01.2005		7.24809.20.0	AGR	PN 
2.4 121 kW (165 PS) ALF, AML, ARJ	02.1997→01.2005		7.22560.40.0	ARV	PN   ALF, AML, ARJ: links Left

A



A6 C5 (4B2)

52

			7.22560.41.0	ARV	PN	
			7.22738.08.0	SLP	EL	
			7.21851.31.0	SLP	EL	
2.4 120 kW (163 PS) AMM	02.1997→01.2005		7.22560.40.0	ARV	PN	
			7.22560.41.0	ARV	PN	
			7.05270.99.0	LS	940 mm	
			7.05271.00.0	LS	1525 mm	
			7.22738.08.0	SLP	EL	
			7.21851.31.0	SLP	EL	
2.4 100 kW (136 PS) ALW	07.1998→01.1999		7.22560.40.0	ARV	PN	
			7.22560.41.0	ARV	PN	
			7.22738.08.0	SLP	EL	
			7.21851.31.0	SLP	EL	
2.4 100 kW (136 PS) ASM	07.1998→01.2005		7.22560.40.0	ARV	PN	
			7.22560.41.0	ARV	PN	
			7.05270.99.0	LS	940 mm	
			7.05271.00.0	LS	1525 mm	
			7.22738.08.0	SLP	EL	
			7.21851.31.0	SLP	EL	
2.4 100 kW (136 PS) ARN	01.1999→01.2005		7.22560.40.0	ARV	PN	
			7.22560.41.0	ARV	PN	
			7.21851.31.0	SLP	EL	
2.4 125 kW (170 PS) BDV	08.2001→01.2005		7.22560.40.0	ARV	PN	
			7.22560.41.0	ARV	PN	
			7.05270.99.0	LS	940 mm	
			7.22738.08.0	SLP	EL	
2.4 quattro 121 kW (165 PS) ALF, AML, ARJ	02.1997→01.2005		7.22560.40.0	ARV	PN	
			7.22560.41.0	ARV	PN	
			7.22738.08.0	SLP	EL	
			7.21851.31.0	SLP	EL	

A6 C5 (4B2) **52**

2.4 quattro 125 kW (170 PS) BDV	08.2001→01.2005	7.22560.40.0	ARV	PN	links Left
		7.22560.41.0	ARV	PN	rechts Right
		7.05270.99.0	LS	940 mm	links, rechts Left, Right Regelsonde Regulating Probe
		7.22738.08.0	SLP	EL	
2.7 185-195 kW (252-265 PS) APB, BEL	05.2001→07.2004	7.05271.00.0	LS	1525 mm	
2.7 T 169 kW (230 PS) AJK	02.1999→01.2005	7.05271.00.0	LS	1525 mm	
2.7 T quattro 169 kW (230 PS) AZA	12.1997→01.2005	7.22769.77.0	ARV	PN	rechts Right
		7.22769.78.0	ARV	PN	links Left
		7.05271.00.0	LS	1525 mm	
2.7 T quattro 169 kW (230 PS) AJK	02.1999→01.2005	7.05271.00.0	LS	1525 mm	
2.7 T quattro 184 kW (250 PS) ARE, BES	08.2001→01.2005	7.22769.77.0	ARV	PN	ARE, BES: rechts Right
		7.22769.78.0	ARV	PN	ARE, BES: links Left
		7.05270.99.0	LS	940 mm	ARE, BES: links, rechts Left, Right Regelsonde Regulating Probe
		7.05271.00.0	LS	1525 mm	
2.7 quattro 185-187 kW (252-254 PS) APB	05.2001→07.2004	7.22769.76.0	ARV	PN	ch. 4B-W-000 001→ch. 4B-Y-200 000 links Left
		7.05271.00.0	LS	1525 mm	
2.7 quattro 187-195 kW (254-265 PS) BEL	05.2001→07.2004	7.05271.00.0	LS	1525 mm	
2.7 quattro 187-195 kW (254-265 PS) BEL	11.2003→07.2004	7.05271.00.0	LS	1525 mm	
2.8 142 kW (193 PS) ALG, AMX, AQD	02.1997→01.2005	7.22560.40.0	ARV	PN	ALG, AMX, AQD: links Left
		7.22560.41.0	ARV	PN	ALG, AMX, AQD: rechts Right
		7.22738.08.0	SLP	EL	ALG, AMX, AQD: ch. 4B-Y-120 001→
		7.21851.31.0	SLP	EL	ALG, AMX, AQD: →ch. 4B-Y-120 000
2.8 quattro 142 kW (193 PS) ALG, AMX, AQD	02.1997→01.2005	7.22560.40.0	ARV	PN	ALG, AMX, AQD: links Left

A



A6 C5 (4B2)

52

			7.22560.41.0	ARV	PN	ALG, AMX, AQD: rechts Right
			7.22738.08.0	SLP	EL	ALG, AMX, AQD: ch. 4B-Y-120 001→
			7.21851.31.0	SLP	EL	ALG, AMX, AQD: →ch. 4B-Y-120 000
3.0 160-162 kW (218-220 PS) BBJ	06.2001→01.2005		7.22560.44.0	ARV	PN	links Left
			7.22560.45.0	ARV	PN	rechts Right
			7.05271.23.0	LS	900 mm	
			7.05271.11.0	LS	800 mm	Diagnosesonde Diagnostic Probe für Zylinder: 4-6 for cylinder: 4-6
			7.05271.12.0	LS	800 mm	für Zylinder: 1-3 for cylinder: 1-3
			7.22738.08.0	SLP	EL	
3.0 162 kW (220 PS) ASN	08.2001→01.2005		7.22560.44.0	ARV	PN	links Left
			7.22560.45.0	ARV	PN	rechts Right
			7.05271.23.0	LS	900 mm	
			7.05271.77.0	LS	800 mm	vor Katalysator in front of the catalyst
			7.05271.00.0	LS	1525 mm	links, rechts Left, Right
			7.22738.08.0	SLP	EL	
3.0 quattro 160-162 kW (218-220 PS) BBJ	06.2001→07.2004		7.22560.44.0	ARV	PN	links Left
			7.22560.45.0	ARV	PN	rechts Right
			7.05271.23.0	LS	900 mm	
			7.05271.11.0	LS	800 mm	Diagnosesonde Diagnostic Probe für Zylinder: 4-6 for cylinder: 4-6
			7.05271.12.0	LS	800 mm	für Zylinder: 1-3 for cylinder: 1-3
			7.22738.08.0	SLP	EL	
3.0 quattro 162 kW (220 PS) ASN	08.2001→01.2005		7.22560.44.0	ARV	PN	links Left
			7.22560.45.0	ARV	PN	rechts Right
			7.05271.23.0	LS	900 mm	
			7.05271.77.0	LS	800 mm	vor Katalysator in front of the catalyst
			7.05271.00.0	LS	1525 mm	links, rechts Left, Right
			7.22738.08.0	SLP	EL	

A6 C5 (4B2)						52
4.2 quattro 220 kW (299 PS) ASG	11.1998→01.2005		7.22560.40.0	ARV	PN	○ links Left
			7.22560.41.0	ARV	PN	○ rechts Right
			7.21851.31.0	SLP	EL	
4.2 quattro 220 kW (299 PS) ARS	04.1999→01.2005		7.21851.31.0	SLP	EL	
RS6 quattro 331 kW (450 PS) BCY	07.2002→01.2005		7.21851.32.0	SLP	EL	
S6 quattro 250 kW (340 PS) ANK	09.1999→01.2005		7.22560.40.0	ARV	PN	○ links Left
			7.22560.41.0	ARV	PN	○ rechts Right
			7.21851.31.0	SLP	EL	
S6 quattro 250 kW (340 PS) AQJ	09.1999→01.2005		7.21851.31.0	SLP	EL	
A6 C5 Avant (4B5)						53
1.8 92 kW (125 PS) AJP, AQE	12.1997→01.2005		7.05271.21.0	LS	1250 mm	
			7.05271.21.0	LS	1250 mm	
			7.22738.08.0	SLP	EL	ch. 4B-1-120 001→ Automatikgetriebe Automatic Transmission
1.8 92 kW (125 PS) ARH	12.1997→01.2005		7.21851.31.0	SLP	EL	→ch. 4B-1-120 000 Automatikgetriebe Automatic Transmission
			7.05271.21.0	LS	1250 mm	
			7.05270.96.0	LS	1440 mm	Regelsonde Regulating Probe
1.8 T 110 kW (150 PS) AWT	12.1997→01.2005		7.22560.43.0	ARV	PN	○
			7.05270.99.0	LS	940 mm	Diagnosesonde Diagnostic Probe
			7.05271.24.0	LS	1500 mm	vor Katalysator in front of the catalyst
			7.22738.08.0	SLP	EL	ch. 4B-Y-120 001→
			7.21851.31.0	SLP	EL	→ch. 4B-Y-120 000
1.8 T 110 kW (150 PS) APU, ARK	11.1998→01.2005		7.05271.21.0	LS	1250 mm	APU, ARK: Regelsonde Regulating Probe
			7.22560.42.0	ARV	PN	○
1.8 T 110 kW (150 PS) ANB	01.1999→01.2005		7.22560.43.0	ARV	PN	○
			7.05270.99.0	LS	940 mm	Diagnosesonde Diagnostic Probe
			7.05271.21.0	LS	1250 mm	Regelsonde Regulating Probe
			7.22738.08.0	SLP	EL	ch. 4B-Y-120 001→
			7.21851.31.0	SLP	EL	→ch. 4B-Y-120 000
			7.05270.96.0	LS	1440 mm	Regelsonde Regulating Probe
1.8 T 132 kW (180 PS) AJL	04.1999→01.2005		7.05270.96.0	LS	1440 mm	Regelsonde Regulating Probe
			7.22560.43.0	ARV	PN	○
1.8 T quattro 110 kW (150 PS) AWT	12.1997→01.2005		7.05270.99.0	LS	940 mm	Diagnosesonde Diagnostic Probe

A



A6 C5 Avant (4B5)

53

			7.05271.24.0	LS	1500 mm	
			7.22738.08.0	SLP	EL	ch. 4B-Y-120 001→
			7.21851.31.0	SLP	EL	→ch. 4B-Y-120 000
1.8 T quattro 110-112 kW (150-152 PS) AEB	02.1998→01.1999		7.05270.96.0	LS	1440 mm	Regelsonde Regulating Probe
1.8 T quattro 132 kW (180 PS) AJL	02.1998→01.2005		7.05270.96.0	LS	1440 mm	Regelsonde Regulating Probe
1.8 T quattro 110 kW (150 PS) APU, ARK	11.1998→01.2005		7.05271.21.0	LS	1250 mm	APU, ARK: Regelsonde Regulating Probe
1.8 T quattro 110 kW (150 PS) ANB	01.1999→01.2005		7.22560.42.0	ARV	PN	
			7.22560.43.0	ARV	PN	
			7.05270.99.0	LS	940 mm	Diagnosesonde Diagnostic Probe
			7.05271.21.0	LS	1250 mm	Regelsonde Regulating Probe
			7.22738.08.0	SLP	EL	ch. 4B-Y-120 001→
			7.21851.31.0	SLP	EL	→ch. 4B-Y-120 000
1.9 TDI 85 kW (115 PS) AJM	07.2000→01.2005		7.24809.19.0	AGR	PN	
1.9 TDI 96 kW (130 PS) AVF, AWX	08.2001→01.2005		7.24809.20.0	AGR	PN	
2.4 121 kW (165 PS) ALF, AML, ARJ	12.1997→01.2005		7.22560.40.0	ARV	PN	 ALF, AML, ARJ: links Left
			7.22560.41.0	ARV	PN	 ALF, AML, ARJ: rechts Right
			7.22738.08.0	SLP	EL	ALF, AML, ARJ: ch. 4B-Y-120 001→
			7.21851.31.0	SLP	EL	ALF, AML, ARJ: →ch. 4B-Y-120 000
2.4 120 kW (163 PS) AMM	12.1997→01.2005		7.22560.40.0	ARV	PN	 links Left
			7.22560.41.0	ARV	PN	 rechts Right
			7.05270.99.0	LS	940 mm	links, rechts Left, Right Regelsonde Regulating Probe
			7.05271.00.0	LS	1525 mm	06.2001→
			7.22738.08.0	SLP	EL	ch. 4B-Y-120 001→
			7.21851.31.0	SLP	EL	→ch. 4B-Y-120 000
2.4 100 kW (136 PS) ALW	07.1998→01.1999		7.22560.40.0	ARV	PN	
			7.22560.41.0	ARV	PN	
			7.22738.08.0	SLP	EL	ch. 4B-Y-120 001→
			7.21851.31.0	SLP	EL	→ch. 4B-Y-120 000
2.4 100 kW (136 PS) ASM	07.1998→01.2005		7.22560.40.0	ARV	PN	
			7.22560.41.0	ARV	PN	
			7.05270.99.0	LS	940 mm	links, rechts Left, Right Regelsonde Regulating Probe
			7.05271.00.0	LS	1525 mm	06.2001→

A6 C5 Avant (4B5) **53**























			7.22738.08.0	SLP	EL	ch. 4B-Y-120 001→
			7.21851.31.0	SLP	EL	→ch. 4B-Y-120 000
2.4 100 kW (136 PS) ARN	01.1999→01.2005		7.22560.40.0	ARV	PN	
			7.22560.41.0	ARV	PN	
			7.21851.31.0	SLP	EL	→ch. 4B-Y-120 000
2.4 125 kW (170 PS) BDV	08.2001→01.2005		7.22560.40.0	ARV	PN	 links Left
			7.22560.41.0	ARV	PN	 rechts Right
			7.05270.99.0	LS	940 mm	links, rechts Left, Right Regelsonde Regulating Probe
			7.22738.08.0	SLP	EL	
2.4 quattro 121 kW (165 PS) ALF, AML, ARJ	12.1997→01.2005		7.22560.40.0	ARV	PN	 ALF, AML, ARJ: links Left
			7.22560.41.0	ARV	PN	 ALF, AML, ARJ: rechts Right
			7.22738.08.0	SLP	EL	ALF, AML, ARJ: ch. 4B-Y-120 001→
			7.21851.31.0	SLP	EL	ALF, AML, ARJ: →ch. 4B-Y-120 000
2.4 quattro 125 kW (170 PS) BDV	08.2001→01.2005		7.22560.40.0	ARV	PN	 links Left
			7.22560.41.0	ARV	PN	 rechts Right
			7.05270.99.0	LS	940 mm	links, rechts Left, Right Regelsonde Regulating Probe
			7.22738.08.0	SLP	EL	
2.7 T 169 kW (230 PS) AJK	02.1999→01.2005		7.05271.00.0	LS	1525 mm	
2.7 T quattro 169 kW (230 PS) AZA	12.1997→01.2005		7.22769.77.0	ARV	PN	 rechts Right
			7.22769.78.0	ARV	PN	 links Left
			7.05271.00.0	LS	1525 mm	
2.7 T quattro 169 kW (230 PS) AJK	02.1999→01.2005		7.05271.00.0	LS	1525 mm	
2.7 T quattro 184 kW (250 PS) ARE, BES	08.2001→01.2005		7.22769.77.0	ARV	PN	 ARE, BES: rechts Right
			7.22769.78.0	ARV	PN	 ARE, BES: links Left
			7.05270.99.0	LS	940 mm	ARE, BES: links, rechts Left, Right Regelsonde Regulating Probe
			7.05271.00.0	LS	1525 mm	

A



A6 C5 Avant (4B5)

53

2.8 142 kW (193 PS) ALG, AMX, AQD	12.1997→01.2005		7.22560.40.0 ARV PN 	ALG, AMX, AQD: links Left ALG, AMX, AQD: rechts Right ALG, AMX, AQD:  ch. 4B-Y-120 001→ ALG, AMX, AQD:  →ch. 4B-Y-120 000
			7.22560.41.0 ARV PN 	
			7.22738.08.0 SLP EL 	
			7.21851.31.0 SLP EL 	
2.8 quattro 142 kW (193 PS) ALG, AMX, AQD	12.1997→01.2005		7.22560.40.0 ARV PN 	ALG, AMX, AQD: links Left ALG, AMX, AQD: rechts Right ALG, AMX, AQD:  ch. 4B-Y-120 001→ ALG, AMX, AQD:  →ch. 4B-Y-120 000
			7.22560.41.0 ARV PN 	
			7.22738.08.0 SLP EL 	
			7.21851.31.0 SLP EL 	
3.0 160-162 kW (218-220 PS) BBJ	06.2001→01.2005		7.22560.44.0 ARV PN 	links Left rechts Right 900 mm 800 mm Diagnosesonde Diagnostic Probe für Zylinder: 4-6 for cylinder: 4-6 für Zylinder: 1-3 for cylinder: 1-3
			7.22560.45.0 ARV PN 	
			7.05271.23.0 LS 900 mm	
			7.05271.11.0 LS 800 mm	
			7.05271.12.0 LS 800 mm	
3.0 162 kW (220 PS) ASN	08.2001→01.2005		7.22560.44.0 ARV PN 	links Left rechts Right 900 mm 800 mm vor Katalysator in front of the catalyst 1525 mm links, rechts Left, Right
			7.22560.45.0 ARV PN 	
			7.05271.23.0 LS 900 mm	
			7.05271.77.0 LS 800 mm	
			7.05271.00.0 LS 1525 mm	
			7.22738.08.0 SLP EL	
3.0 quattro 160-162 kW (218-220 PS) BBJ	06.2001→01.2005		7.22560.44.0 ARV PN 	links Left rechts Right 900 mm 800 mm Diagnosesonde Diagnostic Probe für Zylinder: 4-6 for cylinder: 4-6 für Zylinder: 1-3 for cylinder: 1-3
			7.22560.45.0 ARV PN 	
			7.05271.23.0 LS 900 mm	
			7.05271.11.0 LS 800 mm	
			7.05271.12.0 LS 800 mm	
7.22738.08.0 SLP EL				



















A6 C5 Avant (4B5)						53
3.0 quattro 162 kW (220 PS) ASN	08.2001→01.2005		7.22560.44.0	ARV	PN	links Left
			7.22560.45.0	ARV	PN	rechts Right
			7.05271.23.0	LS	900 mm	
			7.05271.77.0	LS	800 mm	ch. 8E-1-000 001→ch. _8E-5-400 000 vor Katalysator in front of the catalyst
			7.05271.00.0	LS	1525 mm	links, rechts Left, Right
			7.22738.08.0	SLP	EL	
4.2 quattro 220 kW (299 PS) ASG	11.1998→01.2005		7.22560.40.0	ARV	PN	links Left
			7.22560.41.0	ARV	PN	rechts Right
			7.21851.31.0	SLP	EL	
4.2 quattro 220 kW (299 PS) ARS	04.1999→01.2005		7.21851.31.0	SLP	EL	
RS6 plus quattro 353 kW (480 PS) BRV	04.2004→01.2005		7.21851.32.0	SLP	EL	
RS6 quattro 331 kW (450 PS) BCY	07.2002→01.2005		7.21851.32.0	SLP	EL	
S6 quattro 250 kW (340 PS) ANK	09.1999→01.2005		7.22560.40.0	ARV	PN	links Left
			7.22560.41.0	ARV	PN	rechts Right
			7.21851.31.0	SLP	EL	
S6 quattro 250-268 kW (340-364 PS) AQJ, BBD	09.1999→01.2005		7.21851.31.0	SLP	EL	
A6 C6 (4F2)						54
2.0 TDI 103 kW (140 PS) BLB	07.2004→10.2008		7.10334.10.0	AGR	EL	01.2005→, ch. 4F-5-000 001→
			7.08369.22.0	ATS	EL	Fahrgestellnummer ab: 4F-7-000 001 Vehicle Identification Number from: 4F-7-000 001
2.0 TDI 103 kW (140 PS) BRE	07.2004→10.2008		7.10334.10.0	AGR	EL	01.2005→, ch. 4F-5-000 001→
			7.08369.22.0	ATS	EL	Fahrgestellnummer ab: 4F-7-000 001 Vehicle Identification Number from: 4F-7-000 001
			7.11190.00.0	DDS		ch. 4F-5-000 001→ch. 4F-7-159 515 Euro 4 Euro 4
			7.11492.02.0	DDS		ohne Zubehör without accessories ch. 4F-7-159 516→ Euro 4 Euro 4
2.0 TDI 100 kW (136 PS) BNA, BRF	07.2004→03.2011		7.10334.10.0	AGR	EL	BNA, BRF: →08.2008, ch. 4F-5-000 001→





















A



A6 C6 (4F2)

54

			7.08369.22.0	ATS	EL	 BNA, BRF: Fahrgestellnummer ab: 4F-7-000 001 Vehicle Identification Number from: 4F-7-000 001
2.0 TDI 100 kW (136 PS) CAGB	07.2004→03.2011		7.10334.00.0	AGR	EL	
			7.08369.22.0	ATS	EL	Fahrgestellnummer ab: 4F-7-000 001 Vehicle Identification Number from: 4F-7-000 001
			7.11190.02.0	DDS		Euro 5 Euro 5
2.0 TDI 89 kW (121 PS) BVG	09.2005→06.2006		7.08369.22.0	ATS	EL	Fahrgestellnummer ab: 4F-7-000 001 Vehicle Identification Number from: 4F-7-000 001
2.0 TDI 125 kW (170 PS) CAHA	11.2008→03.2011		7.10334.00.0	AGR	EL	
			7.08369.22.0	ATS	EL	
			7.11190.02.0	DDS		Euro 5 Euro 5
2.0 TDI 120 kW (163 PS) CAHB	04.2009→03.2011		7.10334.00.0	AGR	EL	
			7.08369.22.0	ATS	EL	
			7.11190.02.0	DDS		Euro 5 Euro 5
2.0 TFSI 125 kW (170 PS) BPJ, BYK	06.2005→03.2011		7.05271.11.0	LS	800 mm	
2.4 130 kW (177 PS) BDW	05.2004→10.2008		7.22738.08.0	SLP	EL	 ch. 4F-5-000 001→
			7.22778.94.0	SLV	PN	 ch. 4F-5-000 001→
2.4 quattro 130 kW (177 PS) BDW	01.2005→10.2008		7.22738.08.0	SLP	EL	 ch. 4F-5-000 001→
			7.22778.94.0	SLV	PN	 ch. 4F-5-000 001→
2.7 TDI 132 kW (180 PS) BPP	11.2004→10.2008		7.00309.07.0	AGR	PN	 ch. 4F-5-000 001→
			7.08369.42.0	ATS	EL	Fahrgestellnummer ab: 4F-8-140 061 Vehicle Identification Number from: 4F-8-140 061 nach Katalysator Post-catalyst Euro4/Euro5 Euro4/Euro5
			7.08369.66.0	ATS	EL	Fahrgestellnummer bis: 4F-8-140 061 Vehicle Identification Number to: 4F-8-140 061 Schaltgetriebe Manual Transmission Euro 4 Euro 4 vor Rußpartikelfilter before soot particulate filter
2.7 TDI 120 kW (163 PS) BSG	11.2004→03.2011		7.00309.07.0	AGR	PN	 ch. 4F-5-000 001→
			7.08369.42.0	ATS	EL	nach Katalysator Post-catalyst Euro4/Euro5 Euro4/Euro5

						A
A6 C6 (4F2)						54
			7.08369.66.0	ATS	EL	Fahrgestellnummer bis: 4F-8-140 061 Vehicle Identification Number to: 4F-8-140 061 Schaltgetriebe Manual Transmission Euro 4 Euro 4 vor Rußpartikelfilter before soot particulate filter
			7.11190.02.0	DDS		Euro 4 Euro 4
2.7 TDI 120 kW (163 PS) CANB	11.2004→03.2011		7.02132.07.0	AGR	EL	
			7.01106.38.0	AGR-K	EL	mit AGR-Ventil with EGR valve
			7.08369.42.0	ATS	EL	Euro4/Euro5 Euro4/Euro5 nach Katalysator Post-catalyst
			7.08369.45.0	ATS	EL	Euro 5 Euro 5
2.7 TDI 140 kW (190 PS) CANA	10.2008→03.2011		7.02132.07.0	AGR	EL	
			7.01106.38.0	AGR-K	EL	mit AGR-Ventil with EGR valve
			7.08369.42.0	ATS	EL	nach Katalysator Post-catalyst Euro 5 Euro 5
			7.08369.45.0	ATS	EL	Euro 5 Euro 5
2.7 TDI quattro 132 kW (180 PS) BPP	11.2004→10.2008		7.00309.07.0	AGR	PN	  ch. 4F-5-000 001→
			7.08369.42.0	ATS	EL	nach Katalysator Post-catalyst Euro4/Euro5 Euro4/Euro5
			7.11190.02.0	DDS		ab Euro 4 From Euro 4
2.7 TDI quattro 120 kW (163 PS) BSG	06.2005→03.2011		7.00309.07.0	AGR	PN	  ch. 4F-5-000 001→
			7.08369.42.0	ATS	EL	nach Katalysator Post-catalyst Euro4/Euro5 Euro4/Euro5
			7.11190.02.0	DDS		ab Euro 4 From Euro 4
2.7 TDI quattro 120 kW (163 PS) CAND	06.2005→03.2011		7.02132.07.0	AGR	EL	
			7.01106.38.0	AGR-K	EL	mit AGR-Ventil with EGR valve
			7.08369.42.0	ATS	EL	nach Katalysator Post-catalyst Euro4/Euro5 Euro4/Euro5
			7.08369.45.0	ATS	EL	Euro 5 Euro 5
2.7 TDI quattro 140 kW (190 PS) CANC	10.2008→03.2011		7.02132.07.0	AGR	EL	
			7.01106.38.0	AGR-K	EL	mit AGR-Ventil with EGR valve
			7.08369.42.0	ATS	EL	nach Katalysator Post-catalyst Euro4/Euro5 Euro4/Euro5















A



A6 C6 (4F2)

54

			7.08369.45.0	ATS	EL	Euro 5 Euro 5
2.8 FSI 140 kW (190 PS) CCDA	10.2008→03.2011		7.22738.08.0	SLP	EL	
			7.05574.00.0	SLV	PN	rechts Right
			7.05574.01.0	SLV	PN	links Left
2.8 FSI 162 kW (220 PS) CCEA	10.2008→03.2011		7.22738.08.0	SLP	EL	
			7.05574.00.0	SLV	PN	rechts Right
			7.05574.01.0	SLV	PN	links Left
2.8 FSI quattro 140 kW (190 PS) CCDA	10.2008→03.2011		7.22738.08.0	SLP	EL	
			7.05574.00.0	SLV	PN	rechts Right
			7.05574.01.0	SLV	PN	links Left
2.8 FSI quattro 162 kW (220 PS) CCEA	10.2008→03.2011		7.22738.08.0	SLP	EL	
			7.05574.00.0	SLV	PN	rechts Right
			7.05574.01.0	SLV	PN	links Left
3.0 160-162 kW (218-220 PS) BBJ	08.2004→05.2006		7.22560.44.0	ARV	PN	links Left
			7.22560.45.0	ARV	PN	rechts Right
			7.05271.77.0	LS	800 mm	vor Katalysator in front of the catalyst
			7.22738.08.0	SLP	EL	
3.0 TDI quattro 165 kW (225 PS) BMK	05.2004→05.2006		7.00309.07.0	AGR	PN	ch. 4F-5-000 001→
			7.08369.13.0	ATS	EL	Fahrgestellnummer ab: 4F-5-000 001 Vehicle Identification Number from: 4F-5-000 001
			7.08369.42.0	ATS	EL	nach Katalysator Post-catalyst Euro4/Euro5 Euro4/Euro5
			7.08369.66.0	ATS	EL	Fahrgestellnummer bis: 4F-8-140 061 Vehicle Identification Number to: 4F-8-140 061 Schaltgetriebe Manual Transmission Euro 4 Euro 4 vor Rußpartikelfilter before soot particulate filter
			7.11190.02.0	DDS	Euro 4 Euro 4	
3.0 TDI quattro 155 kW (211 PS) BNG	05.2004→03.2011		7.00309.07.0	AGR	PN	ch. 4F-5-000 001→

						A
A6 C6 (4F2)						54
			7.08369.13.0 ATS 7.08369.42.0 ATS 7.08369.66.0 ATS	EL EL EL	Fahrgestellnummer ab: 4F-5-000 001 Vehicle Identification Number from: 4F-5-000 001 nach Katalysator Post-catalyst Euro4/Euro5 Euro4/Euro5 Fahrgestellnummer bis: 4F-8-140 061 Vehicle Identification Number to: 4F-8-140 061 Schaltgetriebe Manual Transmission Euro 4 Euro 4 vor Rußpartikelfilter before soot particulate filter	
3.0 TDI quattro 155 kW (211 PS) CDYB	05.2004→03.2011		7.02132.07.0 AGR 7.01106.38.0 AGR-K 7.08369.13.0 ATS 7.08369.42.0 ATS 7.08369.45.0 ATS 7.11190.02.0 DDS	EL EL EL EL EL EL	 mit AGR-Ventil with EGR valve nach Katalysator Post-catalyst Euro4/Euro5 Euro4/Euro5 Euro 5 Euro 5 Euro 5 Euro 5	
3.0 TDI quattro 171 kW (233 PS) ASB	06.2006→10.2008		7.00309.07.0 AGR 7.08369.13.0 ATS 7.08369.42.0 ATS 7.08369.66.0 ATS	PN EL EL EL	 ch. 4F-5-000 001→ Fahrgestellnummer ab: 4F-5-000 001 Vehicle Identification Number from: 4F-5-000 001 vor Rußpartikelfilter before soot particulate filter Euro4/Euro5 Euro4/Euro5 Fahrgestellnummer bis: 4F-8-140 061 Vehicle Identification Number to: 4F-8-140 061 Schaltgetriebe Manual Transmission Euro 4 Euro 4 vor Rußpartikelfilter before soot particulate filter	
3.0 TDI quattro 176 kW (240 PS) CDYA, CDYC	10.2008→03.2011		7.02132.07.0 AGR 7.01106.38.0 AGR-K 7.08369.13.0 ATS 7.08369.42.0 ATS 7.08369.45.0 ATS 7.11190.02.0 DDS	EL EL EL EL EL EL	 CDYA, CDYC: mit AGR-Ventil with EGR valve CDYA, CDYC: nach Katalysator Post-catalyst Euro4/Euro5 Euro4/Euro5 CDYA, CDYC: Euro 5 Euro 5 CDYA, CDYC: Euro 5 Euro 5	
3.0 TFSI quattro 220 kW (299 PS) CCAA	10.2008→03.2011		7.22286.52.0 ARV 7.22286.53.0 ARV	PN PN	 rechts Right  links Left	

A



A6 C6 (4F2)

54

			7.22738.08.0	SLP	EL	
3.0 TFSI quattro 213 kW (290 PS) CAJA	10.2008→03.2011		7.22286.52.0	ARV	PN	rechts Right
			7.22286.53.0	ARV	PN	links Left
3.0 quattro 160-162 kW (218-220 PS) BBJ	05.2004→05.2006		7.22738.08.0	SLP	EL	
			7.22560.44.0	ARV	PN	links Left
			7.22560.45.0	ARV	PN	rechts Right
4.2 FSI quattro 250-257 kW (340-350 PS) BVJ	06.2006→03.2011		7.05271.77.0	LS	800 mm	vor Katalysator in front of the catalyst
			7.22738.08.0	SLP	EL	
4.2 quattro 246 kW (335 PS) BAT	05.2004→05.2006		7.01486.10.0	SLP	EL	Fahrgestellnummer ab: 4F-5-000 001 Vehicle Identification Number from: 4F-5-000 001
			7.22778.97.0	SLV	PN	Fahrgestellnummer ab: 4F-5-000 001 Vehicle Identification Number from: 4F-5-000 001
4.2 quattro 246 kW (335 PS) BNK	05.2004→05.2006		7.22560.41.0	ARV	PN	ch. 4F-5-000 001→ rechts Right
			7.05271.11.0	LS	800 mm	
			7.22738.08.0	SLP	EL	ch. 4F-5-000 001→
4.2 quattro 246 kW (335 PS) BUH	09.2008→08.2010		7.05271.11.0	LS	800 mm	
S6 quattro 320 kW (435 PS) BXA	03.2006→03.2011		7.05271.16.0	LS	1300 mm	
			7.22286.54.0	ARV	PN	ch. 4F-5-000 001→
			7.05271.15.0	LS	525 mm	
			7.05271.27.0	LS	475 mm	
			7.05271.13.0	LS	470 mm	

A6 C6 Avant (4F5)

55

2.0 TDI 103 kW (140 PS) BLB	06.2005→10.2008		7.10334.10.0	AGR	EL	ch. 4F-5-000 001→
			7.08369.22.0	ATS	EL	Fahrgestellnummer ab: 4F-7-000 001 Vehicle Identification Number from: 4F-7-000 001
2.0 TDI 103 kW (140 PS) BRE	06.2005→10.2008		7.10334.10.0	AGR	EL	ch. 4F-5-000 001→
			7.08369.22.0	ATS	EL	Fahrgestellnummer ab: 4F-7-000 001 Vehicle Identification Number from: 4F-7-000 001
			7.11190.00.0	DDS		ch. 4F-5-000 001→ch. 4F-7-159 515 Euro 4 Euro 4
			7.11492.02.0	DDS		ohne Zubehör without accessories ch. 4F-7-159 516→ Euro 4 Euro 4













A6 C6 Avant (4F5)						55
2.0 TDI 100 kW (136 PS) BNA, BRF	06.2005→08.2011		7.10334.10.0	AGR	EL	BNA, BRF: ch. 4F-5-000 001→ BNA, BRF: Fahrgestellnummer ab: 4F-7-000 001 Vehicle Identification Number from: 4F-7-000 001
			7.08369.22.0	ATS	EL	
2.0 TDI 100 kW (136 PS) CAGB	06.2005→08.2011		7.10334.00.0	AGR	EL	 Fahrgestellnummer ab: 4F-7-000 001 Vehicle Identification Number from: 4F-7-000 001 Euro 5 Euro 5
			7.08369.22.0	ATS	EL	
			7.11190.02.0	DDS	EL	
2.0 TDI 89 kW (121 PS) BVG	09.2005→06.2006		7.08369.22.0	ATS	EL	Fahrgestellnummer ab: 4F-7-000 001 Vehicle Identification Number from: 4F-7-000 001
2.0 TDI 125 kW (170 PS) CAHA	10.2008→08.2011		7.10334.00.0	AGR	EL	 Euro 5 Euro 5
			7.08369.22.0	ATS	EL	
			7.11190.02.0	DDS	EL	
2.0 TDI 120 kW (163 PS) CAHB	04.2009→08.2011		7.10334.00.0	AGR	EL	 Euro 5 Euro 5
			7.08369.22.0	ATS	EL	
			7.11190.02.0	DDS	EL	
2.0 TFSI 125 kW (170 PS) BPJ	06.2005→08.2011		7.05271.11.0	LS	800 mm	
2.4 130 kW (177 PS) BDW	03.2005→10.2008		7.22738.08.0	SLP	EL	ch. 4F-5-000 001→
			7.22778.94.0	SLV	PN	 ch. 4F-5-000 001→
2.4 quattro 130 kW (177 PS) BDW	03.2005→10.2008		7.22738.08.0	SLP	EL	ch. 4F-5-000 001→
			7.22778.94.0	SLV	PN	 ch. 4F-5-000 001→
2.7 TDI 120 kW (163 PS) BSG	03.2005→08.2011		7.00309.07.0	AGR	PN	 ch. 4F-5-000 001→
			7.08369.42.0	ATS	EL	nach Katalysator Post-catalyst Euro4/Euro5 Euro4/Euro5
			7.08369.66.0	ATS	EL	Fahrgestellnummer bis: 4F-8-140 061 Vehicle Identification Number to: 4F-8-140 061 Schaltgetriebe Manual Transmission Euro 4 Euro 4 vor Rußpartikelfilter before soot particulate filter
			7.11190.02.0	DDS	EL	Euro 4 Euro 4
2.7 TDI 120 kW (163 PS) CANB	03.2005→08.2011		7.02132.07.0	AGR	EL	
			7.01106.38.0	AGR-K	EL	mit AGR-Ventil with EGR valve
			7.08369.42.0	ATS	EL	nach Katalysator Post-catalyst Euro4/Euro5 Euro4/Euro5
			7.08369.45.0	ATS	EL	Euro 5 Euro 5

A























A6 C6 Avant (4F5)

55

2.7 TDI 132 kW (180 PS) BPP	03.2005→10.2008		7.00309.07.0	AGR	PN  ch. 4F-5-000 001→
			7.08369.42.0	ATS	EL Euro4/Euro5 Euro4/Euro5 nach Katalysator Post-catalyst
			7.08369.66.0	ATS	EL Fahrgestellnummer bis: 4F-8-140 061 Vehicle Identification Number to: 4F-8-140 061 Schaltgetriebe Manual Transmission Euro 4 Euro 4 vor Rußpartikelfilter before soot particulate filter
			7.11190.02.0	DDS	EL Euro 4 Euro 4
2.7 TDI 140 kW (190 PS) CANA	10.2008→08.2011		7.02132.07.0	AGR	EL 
			7.01106.38.0	AGR-K	EL mit AGR-Ventil with EGR valve
			7.08369.42.0	ATS	EL nach Katalysator Post-catalyst Euro 5 Euro 5
			7.08369.45.0	ATS	EL Euro 5 Euro 5
2.7 TDI quattro 132 kW (180 PS) BPP	11.2004→10.2008		7.00309.07.0	AGR	PN  ch. 4F-5-000 001→
			7.08369.42.0	ATS	EL nach Katalysator Post-catalyst Euro4/Euro5 Euro4/Euro5
			7.11190.02.0	DDS	EL Euro 4 Euro 4
2.7 TDI quattro 120 kW (163 PS) BSG	06.2005→08.2011		7.00309.07.0	AGR	PN  ch. 4F-5-000 001→
			7.08369.42.0	ATS	EL nach Katalysator Post-catalyst Euro4/Euro5 Euro4/Euro5
			7.11190.02.0	DDS	EL Euro 4 Euro 4
2.7 TDI quattro 120 kW (163 PS) CAND	06.2005→08.2011		7.02132.07.0	AGR	EL 
			7.01106.38.0	AGR-K	EL mit AGR-Ventil with EGR valve
			7.08369.42.0	ATS	EL nach Katalysator Post-catalyst Euro4/Euro5 Euro4/Euro5
			7.08369.45.0	ATS	EL Euro 5 Euro 5
2.7 TDI quattro 140 kW (190 PS) CANC	10.2008→08.2011		7.02132.07.0	AGR	EL 
			7.01106.38.0	AGR-K	EL mit AGR-Ventil with EGR valve
			7.08369.42.0	ATS	EL nach Katalysator Post-catalyst Euro4/Euro5 Euro4/Euro5
			7.08369.45.0	ATS	EL Euro 5 Euro 5
2.8 FSI 140 kW (190 PS) CCDA	10.2008→08.2011		7.22738.08.0	SLP	EL

A6 C6 Avant (4F5) **55**















			7.05574.00.0	SLV	PN	 rechts Right
			7.05574.01.0	SLV	PN	 links Left
2.8 FSI 162 kW (220 PS) CCEA	10.2008→08.2011		7.22738.08.0	SLP	EL	
			7.05574.00.0	SLV	PN	 rechts Right
			7.05574.01.0	SLV	PN	 links Left
2.8 FSI quattro 140 kW (190 PS) CCDA	10.2008→08.2011		7.22738.08.0	SLP	EL	
			7.05574.00.0	SLV	PN	 rechts Right
			7.05574.01.0	SLV	PN	 links Left
2.8 FSI quattro 162 kW (220 PS) CCEA	10.2008→08.2011		7.22738.08.0	SLP	EL	
			7.05574.00.0	SLV	PN	 rechts Right
			7.05574.01.0	SLV	PN	 links Left
3.0 160-162 kW (218-220 PS) BBJ	03.2005→05.2006		7.22560.44.0	ARV	PN	 links Left
			7.22560.45.0	ARV	PN	 rechts Right
			7.05271.77.0	LS	800 mm	vor Katalysator in front of the catalyst
			7.22738.08.0	SLP	EL	
3.0 TDI quattro 165 kW (225 PS) BMK	03.2005→05.2006		7.00309.07.0	AGR	PN	  ch. 4F-5-000 001→
			7.08369.13.0	ATS	EL	Fahrgestellnummer ab: 4F-5-000 001 Vehicle Identification Number from: 4F-5-000 001
			7.08369.42.0	ATS	EL	Euro4/Euro5 Euro4/Euro5 nach Katalysator Post-catalyst
			7.08369.66.0	ATS	EL	Fahrgestellnummer bis: 4F-8-140 061 Vehicle Identification Number to: 4F-8-140 061 Schaltgetriebe Manual Transmission Euro 4 Euro 4 vor Rußpartikelfilter before soot particulate filter
			7.11190.02.0	DDS		Euro 4 Euro 4
3.0 TDI quattro 155 kW (211 PS) BNG	03.2005→08.2011		7.00309.07.0	AGR	PN	  ch. 4F-5-000 001→
			7.08369.13.0	ATS	EL	Fahrgestellnummer ab: 4F-5-000 001 Vehicle Identification Number from: 4F-5-000 001

A



A6 C6 Avant (4F5)

55

			7.08369.42.0	ATS	EL	nach Katalysator Post-catalyst Euro4/Euro5 Euro4/Euro5
			7.08369.66.0	ATS	EL	Fahrgestellnummer bis: 4F-8-140 061 Vehicle Identification Number to: 4F-8-140 061 Schaltgetriebe Manual Transmission Euro 4 Euro 4 vor Rußpartikelfilter before soot particulate filter
3.0 TDI quattro 155 kW (211 PS) CDYB	03.2005→08.2011		7.02132.07.0	AGR	EL	
			7.01106.38.0	AGR-K	EL	mit AGR-Ventil with EGR valve
			7.08369.13.0	ATS	EL	
			7.08369.42.0	ATS	EL	nach Katalysator Post-catalyst Euro4/Euro5 Euro4/Euro5
			7.08369.45.0	ATS	EL	Euro 5 Euro 5
			7.11190.02.0	DDS	EL	Euro 5 Euro 5
3.0 TDI quattro 171 kW (233 PS) ASB	06.2006→10.2008		7.00309.07.0	AGR	PN	  ch. 4F-5-000 001→
			7.08369.13.0	ATS	EL	Fahrgestellnummer ab: 4F-5-000 001 Vehicle Identification Number from: 4F-5-000 001
			7.08369.42.0	ATS	EL	vor Rußpartikelfilter before soot particulate filter Euro4/Euro5 Euro4/Euro5
			7.08369.66.0	ATS	EL	Fahrgestellnummer bis: 4F-8-140 061 Vehicle Identification Number to: 4F-8-140 061 Schaltgetriebe Manual Transmission Euro 4 Euro 4 vor Rußpartikelfilter before soot particulate filter
3.0 TDI quattro 176 kW (240 PS) CDYA, CDYC	10.2008→08.2011		7.02132.07.0	AGR	EL	
			7.01106.38.0	AGR-K	EL	 CDYA, CDYC: mit AGR-Ventil with EGR valve
			7.08369.13.0	ATS	EL	
			7.08369.42.0	ATS	EL	 CDYA, CDYC: nach Katalysator Post-catalyst Euro4/Euro5 Euro4/Euro5
			7.08369.45.0	ATS	EL	 CDYA, CDYC: Euro 5 Euro 5
			7.11190.02.0	DDS	EL	 CDYA, CDYC: Euro 5 Euro 5
3.0 TFSI quattro 220 kW (299 PS) CCAA	10.2008→08.2011		7.22286.52.0	ARV	PN	 rechts Right
			7.22286.53.0	ARV	PN	 links Left
			7.22738.08.0	SLP	EL	

A6 C6 Avant (4F5) 55

3.0 TFSI quattro 213 kW (290 PS) CAJA	10.2008→08.2011		7.22286.52.0 ARV PN rechts Right
			7.22286.53.0 ARV PN links Left
			7.22738.08.0 SLP EL
3.0 quattro 160-162 kW (218-220 PS) BBJ	03.2005→05.2006		7.22560.44.0 ARV PN links Left
			7.22560.45.0 ARV PN rechts Right
			7.05271.77.0 LS 800 mm vor Katalysator in front of the catalyst
			7.22738.08.0 SLP EL
4.2 FSI quattro 250-257 kW (340-350 PS) BVJ	06.2006→08.2011		7.01486.10.0 SLP EL Fahrgestellnummer ab: 4F-5-000 001 Vehicle Identification Number from: 4F-5-000 001
			7.22778.97.0 SLV PN Fahrgestellnummer ab: 4F-5-000 001 Vehicle Identification Number from: 4F-5-000 001
4.2 quattro 246 kW (335 PS) BAT	03.2005→05.2006		7.22560.41.0 ARV PN ch. 4F-5-000 001→ rechts Right
			7.05271.11.0 LS 800 mm
			7.22738.08.0 SLP EL ch. 4F-5-000 001→
RS6 quattro 426 kW (580 PS) BUH	04.2008→08.2010		7.05271.16.0 LS 1300 mm
S6 quattro 320 kW (435 PS) BXA	03.2006→08.2011		7.22286.54.0 ARV PN ch. 4F-5-000 001→
			7.05271.15.0 LS 525 mm
			7.05271.27.0 LS 475 mm
			7.05271.13.0 LS 470 mm

A6 C7 (4G2, 4GC) 56





















2.0 TDI 130 kW (177 PS) CGLC	03.2011→09.2018		7.09720.03.0 AGR-K EL
			7.11190.09.0 DDS ch. 4G-B-000 001→
2.0 TDI 130 kW (177 PS) CMGB	03.2011→09.2018		7.09720.03.0 AGR-K EL
2.0 TDI 120 kW (163 PS) CGLD	03.2011→09.2018		7.09720.03.0 AGR-K EL
			7.11190.09.0 DDS ch. 4G-B-000 001→ Euro 5 Euro 5
2.0 TDI 100 kW (136 PS) CGLE	01.2012→09.2018		7.09720.03.0 AGR-K EL ch. 4G-B-000 001→
			7.11190.09.0 DDS ch. 4G-B-000 001→ Euro 5 Euro 5
2.0 TDI 100 kW (136 PS) CSUE	01.2012→09.2018		7.11492.03.0 DDS ohne Zubehör without accessories
2.0 TDI 140 kW (190 PS) CNHA, CZJA, DDDA	11.2013→09.2018		7.11020.21.0 ATS EL

A























A6 C7 (4G2, 4GC)

56

			7.11492.03.0	DDS		ohne Zubehör without accessories  ch. 4G-B-000 001→
2.0 TDI 110 kW (150 PS) CSUD, DDCB	09.2014→09.2018		7.11492.03.0	DDS		ohne Zubehör without accessories
2.0 TDI quattro 140 kW (190 PS) CNHA, DDDA	04.2015→09.2018		7.11020.21.0	ATS	EL	
			7.11492.03.0	DDS		ohne Zubehör without accessories  ch. 4G-B-000 001→
2.0 TFSI 155-164 kW (211-223 PS) CAEB	03.2011→05.2013		7.05271.15.0	LS	525 mm	
			7.05271.27.0	LS	475 mm	
2.0 TFSI 132 kW (180 PS) CDNB	05.2011→09.2018		7.05271.15.0	LS	525 mm	
			7.05271.27.0	LS	475 mm	
2.0 TFSI 162 kW (220 PS) CAED	05.2013→09.2018		7.05271.15.0	LS	525 mm	
			7.05271.27.0	LS	475 mm	
2.0 TFSI 185 kW (252 PS) CYNB, CYPA	09.2014→09.2018		7.05271.15.0	LS	525 mm	
			7.05271.27.0	LS	475 mm	
2.0 TFSI hybrid 155 kW (211 PS) CHJA	11.2011→09.2018		7.01510.57.0	SLV	EL	 ch. 4G-B-000 001→
2.0 TFSI quattro 155-164 kW (211-223 PS) CAEB	05.2012→05.2013		7.05271.15.0	LS	525 mm	
			7.05271.27.0	LS	475 mm	
2.0 TFSI quattro 162 kW (220 PS) CAED	05.2013→09.2018		7.05271.15.0	LS	525 mm	
			7.05271.27.0	LS	475 mm	
2.0 TFSI quattro 185 kW (252 PS) CYNB, CYPA	05.2014→09.2018		7.05271.15.0	LS	525 mm	
			7.05271.27.0	LS	475 mm	
2.8 FSI 150 kW (204 PS) CHVA	11.2010→04.2015		7.22286.52.0	ARV	PN	 ch. 4G-B-000 001→ rechts Right Produktionsdatum ab: 27.05.2013 Production date from: 27.05.2013
			7.22286.53.0	ARV	PN	 ch. 4G-B-000 001→ links Left Produktionsdatum ab: 27.05.2013 Production date from: 27.05.2013
			7.22934.57.0	SLP	EL	11.2011→,  ch. 4G-B-000 001→ Produktionsdatum ab: 07.11.2011 Production date from: 07.11.2011
			7.22934.63.0	SLP	EL	Fahrgestellnummer ab: 4G-B-000 001 Vehicle Identification Number from: 4G-B-000 001
			7.05574.00.0	SLV	PN	 →05.2013,  ch. 4G-B-000 001→ rechts Right

A6 C7 (4G2, 4GC)
56

		7.05574.01.0	SLV	PN	 →05.2013,  ch. 4G-B-000 001→ links Left
2.8 FSI quattro 150 kW (204 PS) CHVA	11.2010→04.2015	 7.22286.52.0	ARV	PN	 ch. 4G-B-000 001→ rechts Right Produktionsdatum ab: 27.05.2013 Production date from: 27.05.2013
		7.22286.53.0	ARV	PN	 ch. 4G-B-000 001→ links Left Produktionsdatum ab: 27.05.2013 Production date from: 27.05.2013
		7.22934.57.0	SLP	EL	11.2011→,  ch. 4G-B-000 001→ Produktionsdatum ab: 07.11.2011 Production date from: 07.11.2011
		7.22934.63.0	SLP	EL	Fahrgestellnummer ab: 4G-B-000 001 Vehicle Identification Number from: 4G-B-000 001
		7.05574.00.0	SLV	PN	 →05.2013,  ch. 4G-B-000 001→ rechts Right
		7.05574.01.0	SLV	PN	 →05.2013,  ch. 4G-B-000 001→ links Left
2.8 FSI quattro 162 kW (220 PS) CVPA	09.2014→09.2018	 7.22286.52.0	ARV	PN	 ch. 4G-B-000 001→ rechts Right
		7.22286.53.0	ARV	PN	 links Left
		7.22934.57.0	SLP	EL	
3.0 TDI 150 kW (204 PS) CLAB	11.2010→09.2018	 7.08369.73.0	ATS	EL	
		7.11020.25.0	ATS	EL	 ch. 4G-B-000 001→ vor Rußpartikelfilter before soot particulate filter Euro 5 Euro 5 für Hersteller-Abgasnorm: Euro 5 Plus for manufacturer exhaust norm: Euro 5 Plus Produktionsdatum ab: 08.07.2013 Production date from: 08.07.2013
		7.11190.02.0	DDS		 ch. 4G-B-000 001→ Euro 5 Euro 5
3.0 TDI 155 kW (211 PS) CZVD	09.2014→09.2018	 7.11020.24.0	ATS	EL	Produktionsdatum bis: 26.03.2018 Production date to: 26.03.2018
		7.11190.02.0	DDS		Euro 5, ULEV2 Euro 5, ULEV2
3.0 TDI 160 kW (218 PS) CTCC	09.2014→09.2018	 7.11190.02.0	DDS		Euro 5, ULEV2 Euro 5, ULEV2
3.0 TDI 160 kW (218 PS) CZVB	09.2014→09.2018	 7.11020.24.0	ATS	EL	Produktionsdatum bis: 26.03.2018 Production date to: 26.03.2018
		7.11190.02.0	DDS		Euro 5, ULEV2 Euro 5, ULEV2
3.0 TDI quattro 150 kW (204 PS) CLAA	03.2011→09.2018	 7.08369.73.0	ATS	EL	

A



A6 C7 (4G2, 4GC)

56

			7.11020.25.0	ATS	EL	 ch. 4G-B-000 001→ vor Rußpartikelfilter before soot particulate filter Euro 5 Euro 5 für Hersteller-Abgasnorm: Euro 5 Plus for manufacturer exhaust norm: Euro 5 Plus Produktionsdatum ab: 08.07.2013 Production date from: 08.07.2013
			7.11190.02.0	DDS		 ch. 4G-B-000 001→ Euro 6a Euro 6a
3.0 TDI quattro 180 kW (245 PS) CDUC, CKVB	03.2011→09.2018		7.11190.02.0	DDS		 CDUC:  ch. 4G-B-000 001→ Euro 5 Euro 5  CKVB:  ch. 4G-B-000 001→
3.0 TDI quattro 180 kW (245 PS) CDUD, CKVC	03.2011→09.2018		7.08369.73.0	ATS	EL	 CDUD, CKVC: 05.2013→
			7.11020.25.0	ATS	EL	 CDUD:  ch. 4G-B-000 001→ vor Rußpartikelfilter before soot particulate filter Euro 5 Euro 5 für Hersteller-Abgasnorm: Euro 5 Plus for manufacturer exhaust norm: Euro 5 Plus 2014 2014 Produktionsdatum ab: 08.07.2013 Production date from: 08.07.2013  CKVC:  ch. 4G-B-000 001→ vor Rußpartikelfilter before soot particulate filter Produktionsdatum ab: 08.07.2013 Production date from: 08.07.2013
			7.11190.02.0	DDS		 CDUD:  ch. 4G-B-000 001→ Euro 5 Euro 5  CKVC:  ch. 4G-B-000 001→
3.0 TDI quattro 230 kW (313 PS) CGQB	11.2011→09.2018		7.11190.02.0	DDS		 ch. 4G-B-000 001→ Euro 5 Euro 5
3.0 TDI quattro 176 kW (239 PS) CPNB	05.2013→09.2018		7.11020.25.0	ATS	EL	 ch. 4G-B-000 001→ vor Rußpartikelfilter before soot particulate filter
			7.11190.02.0	DDS		 ch. 4G-B-000 001→
3.0 TDI quattro 155 kW (211 PS) CRTF, CZVC	09.2014→09.2018		7.11020.24.0	ATS	EL	 CRTF, CZVC: Produktionsdatum bis: 26.03.2018 Production date to: 26.03.2018
			7.11190.02.0	DDS		 CRTF, CZVC: Euro 5, ULEV2 Euro 5, ULEV2
3.0 TDI quattro 160 kW (218 PS) CRTE, CZVA	09.2014→09.2018		7.11020.24.0	ATS	EL	 CRTE, CZVA: Produktionsdatum bis: 26.03.2018 Production date to: 26.03.2018
			7.11190.02.0	DDS		 CRTE, CZVA: Euro 5, ULEV2 Euro 5, ULEV2
3.0 TDI quattro 200 kW (272 PS) CRTD	09.2014→09.2018		7.11020.24.0	ATS	EL	Produktionsdatum bis: 26.03.2018 Production date to: 26.03.2018
			7.11190.02.0	DDS		Euro 5, ULEV2 Euro 5, ULEV2
3.0 TDI quattro 240 kW (326 PS) CVUB	09.2014→09.2018		7.11190.02.0	DDS		Euro 5, ULEV2 Euro 5, ULEV2
3.0 TFSI quattro 220 kW (299 PS) CCAA	11.2010→05.2012		7.22286.53.0	ARV	PN	  ch. 4G-B-000 001→ links Left

A6 C7 (4G2, 4GC)					56
			7.22286.52.0	ARV	PN rechts Right
3.0 TFSI quattro 220 kW (300 PS) CGWB	11.2010→05.2012		7.22286.52.0	ARV	PN ch. 4G-B-000 001→ rechts Right
			7.22286.53.0	ARV	PN ch. 4G-B-000 001→ links Left
			7.22934.57.0	SLP	EL ch. 4G-B-000 001→
3.0 TFSI quattro 228-231 kW (310-314 PS) CGWD, CTUA	03.2011→09.2018		7.22286.53.0	ARV	PN
			7.22934.57.0	SLP	EL CGWD, CTUA: ch. 4G-B-000 001→
3.0 TFSI quattro 228 kW (310 PS) CGXB	03.2011→09.2018		7.22286.52.0	ARV	PN ch. 4G-B-000 001→ rechts Right
			7.22286.53.0	ARV	PN
			7.22934.57.0	SLP	EL ch. 4G-B-000 001→
3.0 TFSI quattro 228-231 kW (310-314 PS) CTUA	01.2013→09.2018		7.22286.52.0	ARV	PN ch. 4G-B-000 001→ rechts Right
			7.22286.53.0	ARV	PN ch. 4G-B-000 001→
3.0 TFSI quattro 245 kW (333 PS) CREC	09.2014→09.2018		7.22286.53.0	ARV	PN ch. 4G-B-000 001→ links Left
			7.06714.21.0	ARV	PN rechts Right
			7.22934.57.0	SLP	EL
S6 quattro 309 kW (420 PS) CEUC	02.2012→09.2018		7.06713.09.0	ARV	PN ch. 4G-B-000 001→ rechts Right
			7.22560.43.0	ARV	PN ch. 4G-B-000 001→ links Left
			7.03635.12.0	SLP	EL Fahrgestellnummer ab: 4G-B-000 001 Vehicle Identification Number from: 4G-B-000 001
S6 quattro 331 kW (450 PS) CTGE	10.2014→09.2018		7.22560.43.0	ARV	PN links Left
			7.03635.41.0	SLP	EL
A6 C7 Avant (4G5, 4GD)					57
2.0 TDI 130 kW (177 PS) CGLC	05.2011→09.2018		7.09720.03.0	AGR-K	EL
			7.11190.09.0	DDS	ch. 4G-B-000 001→ Euro 5 Euro 5
2.0 TDI 130 kW (177 PS) CMGB	05.2011→09.2018		7.09720.03.0	AGR-K	EL
2.0 TDI 120 kW (163 PS) CGLD	05.2011→09.2018		7.09720.03.0	AGR-K	EL























A



A6 C7 Avant (4G5, 4GD)

57

			7.11190.09.0	DDS		ch. 4G-B-000 001→ Euro 5 Euro 5
2.0 TDI 100 kW (136 PS) CGLE	01.2012→09.2018		7.09720.03.0	AGR-K	EL	ch. 4G-B-000 001→
			7.11190.09.0	DDS		ch. 4G-B-000 001→ Euro 5 Euro 5
2.0 TDI 100 kW (136 PS) CSUE, DDCA	01.2012→09.2018		7.11492.03.0	DDS		ohne Zubehör without accessories
2.0 TDI 140 kW (190 PS) CNHA, CZJA, DDDA	11.2013→09.2018		7.11020.21.0	ATS	EL	
			7.11492.03.0	DDS		ohne Zubehör without accessories ch. 4G-B-000 001→
2.0 TDI 110 kW (150 PS) CSUD, DDCB	09.2014→09.2018		7.11492.03.0	DDS		ohne Zubehör without accessories
2.0 TDI quattro 140 kW (190 PS) CNHA, DDDA	04.2015→09.2018		7.11020.21.0	ATS	EL	
			7.11492.03.0	DDS		ohne Zubehör without accessories ch. 4G-B-000 001→
2.0 TFSI 132 kW (180 PS) CDNB	06.2011→09.2018		7.05271.15.0	LS	525 mm	
			7.05271.27.0	LS	475 mm	
2.0 TFSI 185 kW (252 PS) CYNB, CYPA	09.2014→09.2018		7.05271.15.0	LS	525 mm	
			7.05271.27.0	LS	475 mm	
2.0 TFSI quattro 185 kW (252 PS) CYPA	05.2015→09.2018		7.05271.15.0	LS	525 mm	
			7.05271.27.0	LS	475 mm	
2.8 FSI 150 kW (204 PS) CHVA	05.2011→04.2015		7.22286.52.0	ARV	PN	ch. 4G-B-000 001→ rechts Right Produktionsdatum ab: 27.05.2013 Production date from: 27.05.2013
			7.22286.53.0	ARV	PN	ch. 4G-B-000 001→ links Left Produktionsdatum ab: 27.05.2013 Production date from: 27.05.2013
			7.22934.57.0	SLP	EL	ch. 4G-B-000 001→ Produktionsdatum ab: 07.11.2011 Production date from: 07.11.2011
			7.22934.63.0	SLP	EL	Fahrgestellnummer ab: 4G-B-000 001 Vehicle Identification Number from: 4G-B-000 001
			7.05574.00.0	SLV	PN	→05.2013, ch. 4G-B-000 001→ rechts Right
			7.05574.01.0	SLV	PN	→05.2013, ch. 4G-B-000 001→ links Left

























 					A
A6 C7 Avant (4G5, 4GD)					
2.8 FSI quattro 150 kW (204 PS) CHVA	05.2011→04.2015		7.22286.52.0	ARV	PN  ch. 4G-B-000 001→ rechts Right Produktionsdatum ab: 27.05.2013 Production date from: 27.05.2013
			7.22286.53.0	ARV	PN  ch. 4G-B-000 001→ links Left Produktionsdatum ab: 27.05.2013 Production date from: 27.05.2013
			7.22934.57.0	SLP	EL  ch. 4G-B-000 001→ Produktionsdatum ab: 07.11.2011 Production date from: 07.11.2011
			7.22934.63.0	SLP	EL Fahrgestellnummer ab: 4G-B-000 001 Vehicle Identification Number from: 4G-B-000 001
			7.05574.00.0	SLV	PN  →05.2013,  ch. 4G-B-000 001→ rechts Right
			7.05574.01.0	SLV	PN  →05.2013,  ch. 4G-B-000 001→ links Left
2.8 FSI quattro 162 kW (220 PS) CVPA	09.2014→09.2018		7.22286.52.0	ARV	PN  rechts Right
			7.22286.53.0	ARV	PN  links Left
			7.22934.57.0	SLP	EL
3.0 TDI 150 kW (204 PS) CLAB	05.2011→09.2018		7.08369.73.0	ATS	EL
			7.11020.25.0	ATS	EL  ch. 4G-B-000 001→ vor Rußpartikelfilter before soot particulate filter Euro 5 Euro 5 für Hersteller-Abgasnorm: Euro 5 Plus for manufacturer exhaust norm: Euro 5 Plus Produktionsdatum ab: 08.07.2013 Production date from: 08.07.2013
			7.11190.02.0	DDS	 ch. 4G-B-000 001→ Euro 5 Euro 5
3.0 TDI 155 kW (211 PS) CZVD	09.2014→09.2018		7.11020.24.0	ATS	EL Produktionsdatum bis: 108585 Production date to: 108585
			7.11190.02.0	DDS	Euro 5, ULEV2 Euro 5, ULEV2
3.0 TDI 160 kW (218 PS) CTCC	09.2014→09.2018		7.11190.02.0	DDS	Euro 5, ULEV2 Euro 5, ULEV2
3.0 TDI 160 kW (218 PS) CZVB	09.2014→09.2018		7.11020.24.0	ATS	EL Produktionsdatum bis: 26.03.2018 Production date to: 26.03.2018
			7.11190.02.0	DDS	Euro 5, ULEV2 Euro 5, ULEV2

A



A6 C7 Avant (4G5, 4GD)

57

3.0 TDI quattro 150 kW (204 PS) CLAA	05.2011→09.2018		7.11020.25.0	ATS	EL	 ch. 4G-B-000 001→ vor Rußpartikelfilter before soot particulate filter Euro 5 Euro 5 für Hersteller-Abgasnorm: Euro 5 Plus for manufacturer exhaust norm: Euro 5 Plus Produktionsdatum ab: 08.07.2013 Production date from: 08.07.2013
			7.11190.02.0	DDS		 ch. 4G-B-000 001→ Euro 5 Euro 5
3.0 TDI quattro 180 kW (245 PS) CDUC, CKVB	05.2011→09.2018		7.11190.02.0	DDS		 CDUC:  ch. 4G-B-000 001→ Euro 5 Euro 5  CKVB:  ch. 4G-B-000 001→
3.0 TDI quattro 180 kW (245 PS) CDUD, CKVC	05.2011→09.2018		7.08369.73.0	ATS	EL	05.2013→
			7.11020.25.0	ATS	EL	 CDUD:  ch. 4G-B-000 001→ vor Rußpartikelfilter before soot particulate filter Euro 5 Euro 5 für Hersteller-Abgasnorm: Euro 5 Plus for manufacturer exhaust norm: Euro 5 Plus 2014 2014 Produktionsdatum ab: 08.07.2013 Production date from: 08.07.2013
			7.11190.02.0	DDS		 CKVC:  ch. 4G-B-000 001→ vor Rußpartikelfilter before soot particulate filter Produktionsdatum ab: 08.07.2013 Production date from: 08.07.2013  CDUD:  ch. 4G-B-000 001→ Euro 5 Euro 5  CKVC:  ch. 4G-B-000 001→
3.0 TDI quattro 230 kW (313 PS) CGQB	11.2011→09.2018		7.11190.02.0	DDS		Euro 5 Euro 5
3.0 TDI quattro 155 kW (211 PS) CRTF, CZVC	09.2014→09.2018		7.11020.24.0	ATS	EL	 CRTF, CZVC: Produktionsdatum bis: 26.03.2018 Production date to: 26.03.2018
			7.11190.02.0	DDS		 CRTF, CZVC: Euro 5, ULEV2 Euro 5, ULEV2
3.0 TDI quattro 160 kW (218 PS) CRTE, CZVA	09.2014→09.2018		7.11020.24.0	ATS	EL	 CRTE, CZVA: Produktionsdatum bis: 26.03.2018 Production date to: 26.03.2018
			7.11190.02.0	DDS		 CRTE, CZVA: Euro 5, ULEV2 Euro 5, ULEV2
3.0 TDI quattro 200 kW (272 PS) CRTD	09.2014→09.2018		7.11020.24.0	ATS	EL	Produktionsdatum bis: 26.03.2018 Production date to: 26.03.2018
			7.11190.02.0	DDS		Euro 5, ULEV2 Euro 5, ULEV2
3.0 TDI quattro 240 kW (326 PS) CVUB	09.2014→09.2018		7.11190.02.0	DDS		Euro 5, ULEV2 Euro 5, ULEV2
3.0 TFSI quattro 220 kW (300 PS) CGWB	05.2011→05.2012		7.22286.52.0	ARV	PN	 ch. 4G-B-000 001→ rechts Right
			7.22286.53.0	ARV	PN	 ch. 4G-B-000 001→ links Left
			7.22934.57.0	SLP	EL	 ch. 4G-B-000 001→

A6 C7 Avant (4G5, 4GD) 57

3.0 TFSI quattro 228 kW (310 PS) CGWD	11.2011→09.2018	7.22286.52.0	ARV	PN ch. 4G-B-000 001→ rechts Right
		7.22286.53.0	ARV	PN ch. 4G-B-000 001→ links Left
		7.22934.57.0	SLP	EL ch. 4G-B-000 001→
3.0 TFSI quattro 245 kW (333 PS) CREC	09.2014→09.2018	7.06714.21.0	ARV	PN rechts Right
		7.22286.53.0	ARV	PN links Left
		7.22934.57.0	SLP	EL
RS6 performance quattro 445 kW (605 PS) CWUC	11.2015→09.2018	7.06713.09.0	ARV	PN rechts Right
		7.22560.43.0	ARV	PN links Left
		7.03635.41.0	SLP	EL
RS6 quattro 412 kW (560 PS) CRDB	01.2013→09.2018	7.06713.09.0	ARV	PN rechts Right
		7.22560.43.0	ARV	PN links Left
		7.03635.12.0	SLP	EL
RS6 quattro 412 kW (560 PS) CWUB	01.2013→09.2018	7.06713.09.0	ARV	PN rechts Right
		7.22560.43.0	ARV	PN links Left
		7.03635.41.0	SLP	EL
S6 quattro 309 kW (420 PS) CEUC	02.2012→09.2018	7.06713.09.0	ARV	PN ch. 4G-B-000 001→ rechts Right
		7.22560.43.0	ARV	PN ch. 4G-B-000 001→ links Left
		7.03635.12.0	SLP	EL Fahrgestellnummer ab: 4G-B-000 001 Vehicle Identification Number from: 4G-B-000 001
S6 quattro 331 kW (450 PS) CTGE	10.2014→09.2018	7.22560.43.0	ARV	PN links Left
		7.03635.41.0	SLP	EL

A6 C8 (4A2) 58

35 TDI Mild Hybrid 120 kW (163 PS) DEZD	03.2019→	7.11020.31.0	ATS	EL
		7.11492.03.0	DDS	ohne Zubehör without accessories
		7.11492.05.0	DDS	ohne Zubehör without accessories für OE-Nummer: 04L 906 051 AB, 04L 906 051 F, 04L 906 051 L for OE number: 04L 906 051 AB, 04L 906 051 F, 04L 906 051 L

A



A6 C8 (4A2)

58

40 TDI Mild Hybrid 150 kW (204 PS) DFBA	02.2018→		7.11020.31.0	ATS	EL	ohne Zubehör without accessories für OE-Nummer: 03L 906 051 D for OE number: 03L 906 051 D ohne Zubehör without accessories für OE-Nummer: 04L 906 051 AB, 04L 906 051 F, 04L 906 051 L for OE number: 04L 906 051 AB, 04L 906 051 F, 04L 906 051 L
			7.11492.03.0	DDS		
			7.11492.05.0	DDS		
			7.07696.00.0	SRM-AK	EL	
40 TDI Mild Hybrid quattro 150 kW (204 PS) DFBA	07.2018→		7.11020.31.0	ATS	EL	ohne Zubehör without accessories ohne Zubehör without accessories für OE-Nummer: 04L 906 051 AB, 04L 906 051 F, 04L 906 051 L for OE number: 04L 906 051 AB, 04L 906 051 F, 04L 906 051 L
			7.11492.03.0	DDS		
			7.11492.05.0	DDS		
			7.07696.00.0	SRM-AK	EL	
45 TFSI Mild Hybrid 180 kW (245 PS) DKNA, DLHA	08.2018→		7.03635.46.0	SLP	EL	DKNA, DLHA: für PR-Nummer: T5R for PR number: T5R
			7.01510.94.0	SLV	EL	DKNA, DLHA: für PR-Nummer: T5R for PR number: T5R
45 TFSI Mild Hybrid quattro 180 kW (245 PS) DKNA, DLHA	08.2018→		7.03635.46.0	SLP	EL	DKNA, DLHA: für PR-Nummer: T5R for PR number: T5R
			7.01510.94.0	SLV	EL	DKNA, DLHA: für PR-Nummer: T5R for PR number: T5R

A6 C8 Avant (4A5)

59

35 TDI Mild Hybrid 120 kW (163 PS) DEZD	03.2019→		7.11020.31.0	ATS	EL	ohne Zubehör without accessories ohne Zubehör without accessories für OE-Nummer: 04L 906 051 AB, 04L 906 051 F, 04L 906 051 L for OE number: 04L 906 051 AB, 04L 906 051 F, 04L 906 051 L
			7.11492.03.0	DDS		
			7.11492.05.0	DDS		
40 TDI Mild Hybrid 150 kW (204 PS) DFBA	05.2018→		7.11020.31.0	ATS	EL	ohne Zubehör without accessories für OE-Nummer: 03L 906 051 D for OE number: 03L 906 051 D ohne Zubehör without accessories für OE-Nummer: 04L 906 051 AB, 04L 906 051 F, 04L 906 051 L for OE number: 04L 906 051 AB, 04L 906 051 F, 04L 906 051 L
			7.11492.03.0	DDS		
			7.11492.05.0	DDS		
			7.07696.00.0	SRM-AK	EL	















						A
A6 C8 Avant (4A5)						59
40 TDI Mild Hybrid quattro 150 kW (204 PS) DFBA	07.2018->		7.11020.31.0	ATS	EL	
			7.11492.03.0	DDS		ohne Zubehör without accessories für OE-Nummer: 03L 906 051 D for OE number: 03L 906 051 D
			7.11492.05.0	DDS		ohne Zubehör without accessories für OE-Nummer: 04L 906 051 AB, 04L 906 051 F, 04L 906 051 L for OE number: 04L 906 051 AB, 04L 906 051 F, 04L 906 051 L
			7.07696.00.0	SRM-AK	EL	
45 TFSI Mild Hybrid 180 kW (245 PS) DKNA, DLHA	08.2018->		7.03635.46.0	SLP	EL	DKNA, DLHA: für PR-Nummer: T5R for PR number: T5R
			7.01510.94.0	SLV	EL	DKNA, DLHA: für PR-Nummer: T5R for PR number: T5R
45 TFSI Mild Hybrid quattro 180 kW (245 PS) DKNA, DLHA	08.2018->		7.03635.46.0	SLP	EL	DKNA, DLHA: für PR-Nummer: T5R for PR number: T5R
			7.01510.94.0	SLV	EL	DKNA, DLHA: für PR-Nummer: T5R for PR number: T5R
A7 Sportback (4GA, 4GF)						60
2.5 FSI 150 kW (204 PS) CLXB	09.2012->03.2015		7.22934.57.0	SLP	EL	
			7.05574.00.0	SLV	PN	rechts Right
2.8 FSI 150 kW (204 PS) CHVA	02.2011->03.2015		7.22286.53.0	ARV	PN	links Left Produktionsdatum ab: 27.05.2013 Production date from: 27.05.2013
			7.22934.57.0	SLP	EL	Produktionsdatum ab: 07.11.2011 Production date from: 07.11.2011
			7.22934.63.0	SLP	EL	Produktionsdatum bis: 07.11.2011 Production date to: 07.11.2011
			7.05574.01.0	SLV	PN	→05.2013 links Left
			7.05574.00.0	SLV	PN	rechts Right
2.8 FSI quattro 150 kW (204 PS) CHVA, CNYA	10.2010->03.2015		7.22286.53.0	ARV	PN	CHVA, CNYA: links Left Produktionsdatum ab: 27.05.2013 Production date from: 27.05.2013
			7.22934.57.0	SLP	EL	CHVA, CNYA: Produktionsdatum ab: 07.11.2011 Production date from: 07.11.2011
			7.22934.63.0	SLP	EL	CHVA, CNYA: Produktionsdatum bis: 07.11.2011 Production date to: 07.11.2011
			7.05574.01.0	SLV	PN	CHVA, CNYA: →05.2013 links Left

A

































A7 Sportback (4GA, 4GF)

60

			7.05574.00.0	SLV	PN	 CHVA, CNYA: rechts Right
2.8 FSI quattro 162 kW (220 PS) CVPA	09.2014→05.2018		7.22286.52.0	ARV	PN	 rechts Right
			7.22286.53.0	ARV	PN	 links Left
			7.22934.57.0	SLP	EL	Produktionsdatum bis: 26.03.2018 Production date to: 26.03.2018
3.0 TDI 150 kW (204 PS) CLAB	11.2010→03.2015		7.08369.73.0	ATS	EL	
			7.11020.25.0	ATS	EL	vor Rußpartikelfilter before soot particulate filter Euro 5 Euro 5 für Hersteller-Abgasnorm: Euro 5 Plus for manufacturer exhaust norm: Euro 5 Plus Produktionsdatum ab: 08.07.2013 Production date from: 08.07.2013
			7.11190.02.0	DDS		Euro 5, Euro 6, ULEV2 Euro 5, Euro 6, ULEV2
3.0 TDI 160 kW (218 PS) CTCC	07.2014→05.2018		7.11190.02.0	DDS		Euro 5, ULEV2 Euro 5, ULEV2
3.0 TDI 160 kW (218 PS) CZVB	07.2014→05.2018		7.11020.24.0	ATS	EL	Produktionsdatum bis: 26.03.2018 Production date to: 26.03.2018
3.0 TDI 140 kW (190 PS) CZVE	11.2015→05.2018		7.11020.24.0	ATS	EL	Produktionsdatum bis: 26.03.2018 Production date to: 26.03.2018
3.0 TDI 155 kW (211 PS) CZVD	11.2015→05.2018		7.11020.24.0	ATS	EL	Produktionsdatum bis: 26.03.2018 Production date to: 26.03.2018
3.0 TDI quattro 180 kW (245 PS) CDUC	10.2010→06.2016		7.11190.02.0	DDS		Euro 5, Euro 6, ULEV2 Euro 5, Euro 6, ULEV2
			7.08369.73.0	ATS	EL	05.2013→
3.0 TDI quattro 180 kW (245 PS) CDUD	10.2010→06.2016		7.11020.25.0	ATS	EL	 CDUD: vor Rußpartikelfilter before soot particulate filter Euro 5 Euro 5 Produktionsdatum ab: 08.07.2013 Production date from: 08.07.2013
			7.11190.02.0	DDS		 CDUD: vor Rußpartikelfilter before soot particulate filter für Hersteller-Abgasnorm: Euro 5 Plus for manufacturer exhaust norm: Euro 5 Plus 2014 2014 Euro 5, ULEV2 Euro 5, ULEV2
			7.08369.73.0	ATS	EL	05.2013→
3.0 TDI quattro 180 kW (245 PS) CKVC	10.2010→06.2016		7.08369.73.0	ATS	EL	05.2013→
			7.11020.25.0	ATS	EL	vor Rußpartikelfilter before soot particulate filter Produktionsdatum ab: 08.07.2013 Production date from: 08.07.2013
3.0 TDI quattro 150 kW (204 PS) CLAA	12.2010→03.2015		7.08369.73.0	ATS	EL	

A7 Sportback (4GA, 4GF)
60

			7.11020.25.0	ATS	EL	vor Rußpartikelfilter before soot particulate filter Euro 5 Euro 5 für Hersteller-Abgasnorm: Euro 5 Plus for manufacturer exhaust norm: Euro 5 Plus Produktionsdatum ab: 08.07.2013 Production date from: 08.07.2013
			7.11190.02.0	DDS		Euro 5, Euro 6, ULEV2 Euro 5, Euro 6, ULEV2
3.0 TDI quattro 230 kW (313 PS) CGQB	11.2011→03.2015		7.11190.02.0	DDS		Euro 5, Euro 6, ULEV2 Euro 5, Euro 6, ULEV2
3.0 TDI quattro 176 kW (239 PS) CPNB	05.2013→06.2017		7.11190.02.0	DDS		Euro 5, ULEV2 Euro 5, ULEV2
3.0 TDI quattro 200 kW (272 PS) CRTD	05.2014→05.2018		7.11020.24.0	ATS	EL	Produktionsdatum bis: 26.03.2018 Production date to: 26.03.2018
3.0 TDI quattro 235 kW (320 PS) CVUA	05.2014→05.2018		7.11190.02.0	DDS		Euro 5, ULEV2 Euro 5, ULEV2
3.0 TDI quattro 160 kW (218 PS) CRTE, CZVA	07.2014→05.2018		7.11020.24.0	ATS	EL	 CRTE, CZVA: Produktionsdatum bis: 26.03.2018 Production date to: 26.03.2018
3.0 TDI quattro 155 kW (211 PS) CRTF, CZVC	07.2014→05.2018		7.11020.24.0	ATS	EL	 CRTF, CZVC: Produktionsdatum bis: 26.03.2018 Production date to: 26.03.2018
3.0 TDI quattro 155 kW (211 PS) CTCB	07.2014→05.2018		7.11190.02.0	DDS		Euro 5, ULEV2 Euro 5, ULEV2
3.0 TDI quattro 240 kW (326 PS) CVUB	09.2014→05.2018		7.11190.02.0	DDS		Euro 5, ULEV2 Euro 5, ULEV2
3.0 TDI quattro 140 kW (190 PS) CZVF	11.2015→05.2018		7.11020.24.0	ATS	EL	Produktionsdatum bis: 26.03.2018 Production date to: 26.03.2018
3.0 TFSI quattro 220 kW (300 PS) CGWB, CHMA			7.22286.52.0	ARV	PN	  CGWB, CHMA: rechts Right
			7.22286.53.0	ARV	PN	  CGWB, CHMA: links Left
			7.22934.57.0	SLP	EL	
3.0 TFSI quattro 228-231 kW (310-314 PS) CGWD, CGXB, CTTA, CTUA	01.2011→03.2015		7.22286.52.0	ARV	PN	  CGWD, CGXB, CTTA, CTUA: rechts Right
			7.22286.53.0	ARV	PN	  CGWD, CGXB, CTTA, CTUA: links Left
			7.22934.57.0	SLP	EL	
3.0 TFSI quattro 245 kW (333 PS) CREC	05.2014→05.2018		7.06714.21.0	ARV	PN	 rechts Right
			7.22286.53.0	ARV	PN	 links Left
			7.22934.57.0	SLP	EL	Produktionsdatum bis: 26.03.2018 Production date to: 26.03.2018
RS7 performance quattro 445 kW (605 PS) CWUC	11.2015→04.2018		7.03635.12.0	SLP	EL	Produktionsdatum bis: 21.07.2014 Production date to: 21.07.2014
			7.03635.41.0	SLP	EL	Produktionsdatum ab: 21.07.2014 Production date from: 21.07.2014
RS7 quattro 412 kW (560 PS) CRDB, CWUB	10.2013→04.2018		7.06713.09.0	ARV	PN	  CRDB, CWUB: rechts Right
			7.22560.43.0	ARV	PN	  CRDB, CWUB: links Left

A



A7 Sportback (4GA, 4GF)

60

			7.03635.12.0	SLP	EL	CRDB, CWUB: Produktionsdatum bis: 21.07.2014 Production date to: 21.07.2014
			7.03635.41.0	SLP	EL	CRDB, CWUB: Produktionsdatum ab: 21.07.2014 Production date from: 21.07.2014
S7 quattro 309 kW (420 PS) CEUC	02.2012→03.2015		7.06713.09.0	ARV	PN	rechts Right
			7.22560.43.0	ARV	PN	links Left
			7.03635.12.0	SLP	EL	
S7 quattro 331 kW (450 PS) CTGE	07.2014→05.2018		7.06713.09.0	ARV	PN	rechts Right
			7.22560.43.0	ARV	PN	links Left
			7.03635.41.0	SLP	EL	

A7 Sportback (4KA)

61































40 TDI Mild Hybrid 150 kW (204 PS) DFBA	09.2018→		7.11492.05.0	DDS		ohne Zubehör without accessories
			7.07696.00.0	SRM-AK	EL	
40 TDI Mild Hybrid quattro 150 kW (204 PS) DFBA	09.2018→		7.07696.00.0	SRM-AK	EL	
45 TFSI Mild Hybrid 180 kW (245 PS) DKNA, DLHA	07.2018→		7.03635.46.0	SLP	EL	DKNA, DLHA: für PR-Nummer: T5R for PR number: T5R
			7.01510.94.0	SLV	EL	DKNA, DLHA: für PR-Nummer: T5R for PR number: T5R
45 TFSI Mild hybrid quattro 180 kW (245 PS) DKNA, DLHA	07.2018→		7.03635.46.0	SLP	EL	DKNA, DLHA: für PR-Nummer: T5R for PR number: T5R
			7.01510.94.0	SLV	EL	DKNA, DLHA: für PR-Nummer: T5R for PR number: T5R
50 TDI Mild Hybrid quattro 210 kW (286 PS) DDVB	10.2017→		7.11020.24.0	ATS	EL	Produktionsdatum bis: 26.03.2018 Production date to: 26.03.2018

A8 D2 (4D2, 4D8)

62

2.8 128 kW (174 PS) AAH	03.1994→03.1996		7.02604.03.0	LS	200 mm	
2.8 120-128 kW (163-174 PS) AEJ	07.1995→03.1996		7.02604.03.0	LS	200 mm	
2.8 142 kW (193 PS) ALG, AMX, AQD	04.1996→09.2002		7.22560.41.0	ARV	PN	ALG: rechts Right AMX, AQD: ch. 4D-X-005 001→ rechts Right

A8 D2 (4D2, 4D8)
62

























			7.22560.40.0	ARV	PN	  ALG: links Left  AMX, AQD: Fahrgestellnummer ab: 4D-X-005 001 Vehicle Identification Number from: 4D-X-005 001 links Left
			7.21851.32.0	SLP	EL	 AMX, AQD: Fahrgestellnummer ab: 4D-X-005 001 Vehicle Identification Number from: 4D-X-005 001
2.8 quattro 128 kW (174 PS) AAH	03.1994→03.1996		7.02604.03.0	LS	200 mm	
2.8 quattro 120-128 kW (163-174 PS) AEJ	07.1995→03.1996		7.02604.03.0	LS	200 mm	
2.8 quattro 142 kW (193 PS) ALG	04.1996→09.2002		7.22560.41.0	ARV	PN	 rechts Right
			7.21851.32.0	SLP	EL	
2.8 quattro 142 kW (193 PS) AMX, AQD	04.1996→09.2002		7.22560.41.0	ARV	PN	  AMX, AQD:  ch. 4D-X-005 001→ rechts Right
			7.22560.40.0	ARV	PN	  AMX, AQD: Fahrgestellnummer ab: 4D-X-005 001 Vehicle Identification Number from: 4D-X-005 001 links Left
			7.21851.32.0	SLP	EL	 AMX, AQD: Fahrgestellnummer ab: 4D-X-005 001 Vehicle Identification Number from: 4D-X-005 001
3.7 169 kW (230 PS) AEW	07.1995→12.1998		7.05270.88.0	LS	740 mm	
3.7 191 kW (260 PS) AKC, AQG	11.1998→09.2002		7.22560.41.0	ARV	PN	  AKC, AQG:  ch. 4D-X-005 001→ rechts Right
			7.22560.40.0	ARV	PN	
			7.21851.32.0	SLP	EL	 AKC, AQG: Fahrgestellnummer ab: 4D-X-005 001 Vehicle Identification Number from: 4D-X-005 001
3.7 quattro 169 kW (230 PS) AEW, AKJ	07.1995→11.1998		7.05270.88.0	LS	740 mm	
3.7 quattro 191 kW (260 PS) AKC, AQG	11.1998→09.2002		7.22560.41.0	ARV	PN	  AKC, AQG:  ch. 4D-X-005 001→ rechts Right
			7.22560.40.0	ARV	PN	
			7.21851.32.0	SLP	EL	 AKC, AQG: Fahrgestellnummer ab: 4D-X-005 001 Vehicle Identification Number from: 4D-X-005 001
4.2 quattro 220-224 kW (299-305 PS) ABZ, AKG	03.1994→11.1998		7.05270.88.0	LS	740 mm	

A









A8 D2 (4D2, 4D8)

62

4.2 quattro 180 kW (245 PS) AEM	03.1994→07.1996		7.05270.88.0	LS	740 mm	
4.2 quattro 210 kW (285 PS) AGH	07.1995→09.1998		7.05270.88.0	LS	740 mm	
4.2 quattro 228 kW (310 PS) AQF, AUW	11.1998→09.2002		7.22560.40.0	ARV	PN	 AQF, AUW:  ch. 4D-X-005 001→ links Left
			7.22560.41.0	ARV	PN	 AQF, AUW:  ch. 4D-X-005 001→ rechts Right
			7.21851.32.0	SLP	EL	 AQF, AUW: Fahrgestellnummer ab: 4D-X-005 001 Vehicle Identification Number from: 4D-X-005 001
4.2 quattro 175 kW (238 PS) ARU	02.1999→04.2000		7.22560.40.0	ARV	PN	  ch. 4D-X-005 001→ links Left
			7.22560.41.0	ARV	PN	  ch. 4D-X-005 001→ rechts Right
			7.21851.32.0	SLP	EL	Fahrgestellnummer ab: 4D-X-005 001 Vehicle Identification Number from: 4D-X-005 001
6.0 W12 quattro 309 kW (420 PS) AZC	01.2001→09.2002		7.05271.77.0	LS	800 mm	  ch. 4D-X-005 001→ vor Katalysator in front of the catalyst
S8 quattro 250 kW (340 PS) AHC, AKH	07.1996→06.1999		7.05270.88.0	LS	740 mm	
S8 quattro 265 kW (360 PS) AQH, AVP	06.1999→09.2002		7.22560.40.0	ARV	PN	 AQH, AVP:  ch. 4D-X-005 001→ links Left
			7.21851.32.0	SLP	EL	 AQH, AVP: Fahrgestellnummer ab: 4D-X-005 001 Vehicle Identification Number from: 4D-X-005 001
S8 quattro 265-268 kW (360-364 PS) AYS	06.1999→09.2002		7.22560.41.0	ARV	PN	  ch. 4D-X-005 001→ rechts Right
			7.21851.32.0	SLP	EL	Fahrgestellnummer ab: 4D-X-005 001 Vehicle Identification Number from: 4D-X-005 001
S8 quattro 265 kW (360 PS) BCS	06.1999→09.2002		7.21851.32.0	SLP	EL	Fahrgestellnummer ab: 4D-X-005 001 Vehicle Identification Number from: 4D-X-005 001

A8 D3 (4E2, 4E8)

63

3.0 160-162 kW (218-220 PS) BBJ	07.2003→05.2006		7.22560.44.0	ARV	PN	  ch. 4E-3-000 001→ links Left	
			7.22560.45.0	ARV	PN	  ch. 4E-3-000 001→ rechts Right	
			7.05270.99.0	LS		940 mm	
			7.05271.24.0	LS		1500 mm	  ch. 4E-3-000 001→ vor Katalysator in front of the catalyst























						A
A8 D3 (4E2, 4E8)						63
3.0 162 kW (220 PS) ASN	08.2003→05.2005		7.22738.08.0	SLP	EL	
			7.22560.44.0	ARV	PN	ch. 4E-3-000 001→ links Left
			7.22560.45.0	ARV	PN	ch. 4E-3-000 001→ rechts Right
			7.05270.99.0	LS	940 mm	
			7.05271.24.0	LS	1500 mm	ch. 4E-3-000 001→ vor Katalysator in front of the catalystr
3.0 TDI quattro 171 kW (233 PS) ASB	08.2003→07.2010		7.22738.08.0	SLP	EL	
			7.00309.07.0	AGR	PN	
			7.08369.13.0	ATS	EL	Fahrgestellnummer ab: 4E-3-000 001 Vehicle Identification Number from: 4E-3-000 001
			7.08369.42.0	ATS	EL	vor Rußpartikelfilter before soot particulate filter Euro 4
			7.08369.66.0	ATS	EL	Euro 4 Euro 4 vor Rußpartikelfilter before soot particulate filter
	7.11190.00.0	DDS	Euro 4 Euro 4			
3.0 TDI quattro 155 kW (211 PS) BNG	11.2003→07.2010		7.00309.07.0	AGR	PN	
			7.08369.13.0	ATS	EL	Fahrgestellnummer ab: 4E-3-000 001 Vehicle Identification Number from: 4E-3-000 001
			7.08369.42.0	ATS	EL	vor Rußpartikelfilter before soot particulate filter Euro 4
			7.11190.00.0	DDS	Euro 4 Euro 4	ch. 4E-3-000 001→ Euro 4 Euro 4
3.0 quattro 162 kW (220 PS) ASN	07.2003→05.2005		7.22560.44.0	ARV	PN	ch. 4E-3-000 001→ links Left
			7.22560.45.0	ARV	PN	ch. 4E-3-000 001→ rechts Right
3.0 quattro 160-162 kW (218-220 PS) BBJ	11.2003→05.2004		7.22560.44.0	ARV	PN	ch. 4E-3-000 001→ links Left
			7.22560.45.0	ARV	PN	ch. 4E-3-000 001→ rechts Right
			7.05270.99.0	LS	940 mm	
			7.05271.24.0	LS	1500 mm	vor Katalysator in front of the catalystr
			7.22738.08.0	SLP	EL	

A



A8 D3 (4E2, 4E8)

63

3.7 quattro 206 kW (280 PS) BFL	10.2002→05.2006	 7.22560.40.0	ARV	PN 	 ch. 4E-3-000 001→ links Left
		7.22560.41.0	ARV	PN 	 ch. 4E-3-000 001→ rechts Right
		7.05271.01.0	LS	950 mm	
		7.05271.24.0	LS	1500 mm	 ch. 4E-3-000 001→ vor Katalysator in front of the catalyst
		7.22738.08.0	SLP	EL	
4.0 TDI quattro 202 kW (275 PS) ASE	05.2003→07.2005	 7.11190.00.0	DDS		Euro 4 Euro 4
4.2 FSI quattro 250-257 kW (340-350 PS) BVJ	06.2006→07.2010	 7.22286.26.0	ARV	PN 	links Left
		7.05271.11.0	LS	800 mm	
		7.01486.10.0	SLP	EL	Fahrgestellnummer ab: 4E-3-000 001 Vehicle Identification Number from: 4E-3-000 001
		7.22778.97.0	SLV	PN 	Fahrgestellnummer ab: 4E-3-000 001 Vehicle Identification Number from: 4E-3-000 001
4.2 TDI quattro 235 kW (320 PS) BMC	01.2005→06.2005	 7.00789.10.0	AGR	EL 	
		7.08369.66.0	ATS	EL	vor Rußpartikelfilter before soot particulate filter
		7.11190.00.0	DDS		 ch. 4E-3-000 001→ Euro 4 Euro 4
4.2 TDI quattro 240 kW (326 PS) BVN	07.2005→07.2010	 7.00789.10.0	AGR	EL 	
		7.08369.66.0	ATS	EL	vor Rußpartikelfilter before soot particulate filter
		7.11190.00.0	DDS		 ch. 4E-3-000 001→ Euro 4 Euro 4
4.2 quattro 246 kW (335 PS) BFM	10.2002→07.2010	 7.22560.41.0	ARV	PN 	 ch. 4E-3-000 001→ rechts Right
		7.22560.40.0	ARV	PN 	Fahrgestellnummer ab: 4E-3-000 001 Vehicle Identification Number from: 4E-3-000 001 links Left
		7.05271.01.0	LS	950 mm	
		7.05271.24.0	LS	1500 mm	 ch. 4E-3-000 001→ vor Katalysator in front of the catalyst
		7.22738.08.0	SLP	EL	
4.2 quattro 246 kW (335 PS) BGK	10.2002→07.2010	 7.05271.01.0	LS	950 mm	
6.0 W12 quattro 331-335 kW (450-456 PS) BHT, BSB, BTE	12.2003→07.2010	 7.05271.14.0	LS	1700 mm	
		7.05271.00.0	LS	1525 mm	

--	--	--	--	--	--

A8 D3 (4E2, 4E8) 63

			7.22738.08.0	SLP	EL	
			7.22934.63.0	SLP	EL	BHT, BSB, BTE: links Left
			7.22778.79.0	SLV	PN	BHT, BSB, BTE: links Left
S 8 quattro 265-268 kW (360-364 PS) AYS	09.2003→12.2004		7.22560.41.0	ARV	PN	ch. 4D-X-005 001→ rechts Right
			7.21851.32.0	SLP	EL	Fahrgestellnummer ab: 4D-X-005 001 Vehicle Identification Number from: 4D-X-005 001
S8 quattro 324-331 kW (441-450 PS) BSM	06.2006→07.2010		7.22560.43.0	ARV	PN	
			7.05271.15.0	LS	525 mm	
			7.05271.27.0	LS	475 mm	
			7.05271.13.0	LS	470 mm	
			7.01486.08.0	SLP	EL	
S8 quattro 324-331 kW (441-450 PS) BSM	09.2006→07.2010		7.22560.43.0	ARV	PN	
			7.01486.08.0	SLP	EL	

A8 D4 (4H2, 4H8, 4HC, 4HL) 64





















2.0 TFSI hybrid 155 kW (211 PS) CHJA	02.2012→11.2015		7.01510.57.0	SLV	EL	
2.5 TFSI 150 kW (204 PS) CPAA	07.2012→06.2016		7.03446.01.0	SLP	EL	Fahrgestellnummer ab: 4H-A-000 001 Vehicle Identification Number from: 4H-A-000 001
			7.05574.00.0	SLV	PN	 →05.2013, ch. 4H-A-000 001→ch. 4H-A-010 000 rechts Right
			7.05574.01.0	SLV	PN	 →05.2013, ch. 4H-A-000 001→ch. 4H-A-010 000 links Left
2.5 TFSI 150 kW (204 PS) CVBA	07.2012→06.2016		7.22286.52.0	ARV	PN	 rechts Right
			7.22286.53.0	ARV	PN	 links Left
3.0 TDI 150 kW (204 PS) CLAB	09.2011→09.2013		7.03446.01.0	SLP	EL	
			7.08369.73.0	ATS	EL	
			7.11020.25.0	ATS	EL	ch. 4H-A-000 001→ch. 4H-A-010 000 vor Rußpartikelfilter before soot particulate filter Euro 5 Euro 5 für Hersteller-Abgasnorm: Euro 5 Plus for manufacturer exhaust norm: Euro 5 Plus Produktionsdatum ab: 05.03.2012 Production date from: 05.03.2012

























A



A8 D4 (4H2, 4H8, 4HC, 4HL)

64

			7.11190.02.0	DDS		 ch. 4H-A-000 001→ch. 4H-A-010 000 Euro 5 Euro 5
3.0 TDI quattro 184 kW (250 PS) CDTA, CMHA	07.2010→01.2018		7.08369.73.0	ATS	EL	
			7.11020.25.0	ATS	EL	 CDTA:  ch. 4H-A-000 001→ch. 4H-A-010 000 vor Rußpartikelfilter before soot particulate filter Euro 5 Euro 5 für Hersteller-Abgasnorm: Euro 5 Plus for manufacturer exhaust norm: Euro 5 Plus Produktionsdatum ab: 05.03.2012 Production date from: 05.03.2012
			7.11190.02.0	DDS		 CMHA:  ch. 4H-A-000 001→ch. 4H-A-010 000 vor Rußpartikelfilter before soot particulate filter  CDTA:  ch. 4H-A-000 001→ch. 4H-A-010 000 Euro 5 Euro 5  CMHA:  ch. 4H-A-000 001→ch. 4H-A-010 000
3.0 TDI quattro 184 kW (250 PS) CDTC	07.2010→01.2018		7.08369.73.0	ATS	EL	
3.0 TDI quattro 155 kW (211 PS) CDTB	08.2010→11.2015		7.08369.73.0	ATS	EL	05.2013→
			7.11020.25.0	ATS	EL	 ch. 4H-A-000 001→ch. 4H-A-010 000 vor Rußpartikelfilter before soot particulate filter Euro 5 Euro 5 für Hersteller-Abgasnorm: Euro 5 Plus for manufacturer exhaust norm: Euro 5 Plus Produktionsdatum ab: 05.03.2012 Production date from: 05.03.2012
			7.11190.02.0	DDS		Euro 5 Euro 5
3.0 TDI quattro 176 kW (239 PS) CPNA	11.2012→06.2016		7.11020.25.0	ATS	EL	 ch. 4H-A-000 001→ch. 4H-A-010 000 vor Rußpartikelfilter before soot particulate filter
			7.11190.02.0	DDS		 ch. 4H-A-000 001→ch. 4H-A-010 000
3.0 TFSI quattro 245-249 kW (333-339 PS) CGXC, CMDA, CTUB	06.2010→01.2018		7.22286.52.0	ARV	PN	 CGXC, CMDA, CTUB:  ch. 4H-A-000 001→ch. 4H-A-010 000 rechts Right
			7.22286.53.0	ARV	PN	 CGXC, CMDA, CTUB:  ch. 4H-A-000 001→ch. 4H-A-010 000 links Left





















						A
A8 D4 (4H2, 4H8, 4HC, 4HL)						64
			7.03446.01.0	SLP	EL	 CGXC, CMDA, CTUB: Fahrgestellnummer ab: 4H-A-000 001 Vehicle Identification Number from: 4H-A-000 001
3.0 TFSI quattro 213 kW (290 PS) CGWA	07.2010→04.2014		7.22286.52.0	ARV	PN	 ch. 4H-A-000 001→ch. 4H-A-010 000 rechts Right
			7.22286.53.0	ARV	PN	 ch. 4H-A-000 001→ch. 4H-A-010 000 links Left
			7.03446.01.0	SLP	EL	Fahrgestellnummer ab: 4H-A-000 001 Vehicle Identification Number from: 4H-A-000 001
3.0 TFSI quattro 213 kW (290 PS) CREG	07.2010→04.2014		7.06714.21.0	ARV	PN	 rechts Right
			7.22286.53.0	ARV	PN	 links Left
			7.03446.01.0	SLP	EL	
3.0 TFSI quattro 228 kW (310 PS) CGWD	11.2011→01.2018		7.22286.52.0	ARV	PN	 ch. 4H-A-000 001→ch. 4H-A-010 000 rechts Right
			7.22286.53.0	ARV	PN	 ch. 4H-A-000 001→ch. 4H-A-010 000 links Left
			7.03446.01.0	SLP	EL	Fahrgestellnummer ab: 4H-A-000 001 Vehicle Identification Number from: 4H-A-000 001
3.0 TFSI quattro 228 kW (310 PS) CREA	11.2011→01.2018		7.06714.21.0	ARV	PN	 rechts Right
			7.22286.53.0	ARV	PN	 links Left
			7.03446.01.0	SLP	EL	
4.0 TFSI quattro 309 kW (420 PS) CEUA	03.2012→12.2014		7.06713.09.0	ARV	PN	 ch. 4H-A-000 001→ch. 4H-A-010 000 rechts Right
			7.06713.10.0	ARV	PN	 ch. 4H-A-000 001→ch. 4H-A-010 000 links Left
			7.03635.12.0	SLP	EL	Fahrgestellnummer ab: 4H-A-000 001 Vehicle Identification Number from: 4H-A-000 001 Fahrgestellnummer bis: 4H-A-010 000 Vehicle Identification Number to: 4H-A-010 000
4.0 TFSI quattro 320 kW (435 PS) CTGA	10.2013→12.2015		7.06713.09.0	ARV	PN	 rechts Right
			7.06713.10.0	ARV	PN	 links Left
			7.03635.12.0	SLP	EL	

A





A8 D4 (4H2, 4H8, 4HC, 4HL)

64

4.0 TFSI quattro 331 kW (450 PS) CTGF	07.2015→01.2018	 7.06713.09.0 7.06713.10.0 7.03635.12.0	ARV ARV SLP	PN PN EL	 rechts Right 
4.2 FSI quattro 273 kW (371 PS) CDRA	11.2009→12.2012	 7.06712.24.0 7.05271.15.0 7.01486.10.0	ARV LS SLP	PN 525 mm EL	 ch. 4H-A-000 001→ch. 4H-A-010 000
4.2 TDI quattro 258 kW (351 PS) CDSB	11.2009→04.2014	 7.00789.10.0 7.11190.02.0	AGR DDS	EL	  ch. 4H-A-000 001→ch. 4H-A-010 000 Euro 5 Euro 5
4.2 TDI quattro 283 kW (385 PS) CTEC	10.2013→01.2018	 7.00789.10.0	AGR	EL	
S8 plus quattro 445 kW (605 PS) DDTA	11.2015→01.2018	 7.06713.09.0 7.06713.10.0 7.03635.12.0	ARV ARV SLP	PN PN EL	 rechts Right  links Left
S8 quattro 382-388 kW (520-528 PS) CGTA, CTFA	04.2012→01.2018	 7.06713.09.0 7.06713.10.0 7.03635.12.0	ARV ARV SLP	PN PN EL	 CGTA:  ch. 4H-A-000 001→ch. 4H-A-010 000 rechts Right  CTFA: rechts Right  CGTA:  ch. 4H-A-000 001→ch. 4H-A-010 000 links Left  CTFA: links Left Fahrgestellnummer ab: 4H-A-000 001 Vehicle Identification Number from: 4H-A-000 001 Fahrgestellnummer bis: 4H-A-010 000 Vehicle Identification Number to: 4H-A-010 000



A8 D5 (4N2, 4N8)

































65

45 TDI quattro (4N2, 4N8) 183 kW (249 PS) CVMD	01.2019→	 7.11020.24.0	ATS	EL	für PR-Nummer: T7V for PR number: T7V Produktionsdatum bis: 26.03.2018 Production date to: 26.03.2018
50 TDI Mild Hybrid quattro 210 kW (286 PS) DDVC	06.2017→	 7.11020.24.0	ATS	EL	für PR-Nummer: T7V for PR number: T7V Produktionsdatum bis: 26.03.2018 Production date to: 26.03.2018

ALLROAD C5 (4BH)

66

2.7 T quattro 184 kW (250 PS) ARE, BES	05.2000→08.2005	 7.22769.77.0 7.22769.78.0	ARV ARV	PN PN	 ARE, BES: rechts Right  ARE, BES: links Left
--	-----------------	---	------------	----------	--









						
ALLROAD C5 (4BH)						66
			7.05270.99.0	LS	940 mm	 ARE, BES:  ch. 4B-2-000 001→ links, rechts Left, Right Regelsonde Regulating Probe
			7.05271.00.0	LS	1525 mm	 ARE, BES:  ch. 4B-2-000 001→ links, rechts Left, Right
4.2 V8 quattro 220-224 kW (299-305 PS) BAS	07.2002→08.2005		7.22560.41.0	ARV	PN	 rechts Right
			7.05271.77.0	LS	800 mm	vor Katalysator in front of the catalyst
			7.05271.00.0	LS	1525 mm	
CABRIOLET B3 (8G7)						67
1.8 92-95 kW (125-129 PS) ADR	01.1997→08.2000		7.02604.04.0	LS	200 mm	
2.0 16V 101-103 kW (137-140 PS) ACE	06.1995→07.1996		7.02604.03.0	LS	200 mm	
2.0 E 85 kW (115 PS) ABK	01.1993→07.1998		7.02604.03.0	LS	200 mm	
2.3 E 97-100 kW (132-136 PS) NG	05.1991→07.1994		7.02604.03.0	LS	200 mm	
2.8 120-128 kW (163-174 PS) AAH, AFC	11.1992→08.2000		7.02604.03.0	LS	200 mm	
COUPE B2 (81, 855, 856)						68
1.8 55 kW (75 PS) DD	08.1981→07.1983		7.02604.01.0	LS	200 mm	
2.0 85 kW (115 PS) HP, JS	09.1983→07.1986		7.02604.03.0	LS	200 mm	
2.0 83 kW (113 PS) SK	03.1986→04.1988		7.02604.03.0	LS	200 mm	
2.2 quattro 82-89 kW (112-121 PS) JT	08.1985→03.1987		7.02604.03.0	LS	200 mm	
2.3 97-100 kW (132-136 PS) NG	08.1986→07.1987		7.02604.03.0	LS	200 mm	
2.3 quattro 97-100 kW (132-136 PS) NG	01.1987→12.1987		7.02604.03.0	LS	200 mm	
COUPE B3 (89, 8B3)						69
1.8 82 kW (112 PS) DZ	08.1989→07.1991		7.02604.01.0	LS	200 mm	
2.0 80-83 kW (109-113 PS) 3A	05.1989→03.1990		7.02604.03.0	LS	200 mm	
2.0 80-83 kW (109-113 PS) 3A	03.1990→07.1990		7.02604.03.0	LS	200 mm	
2.0 82-85 kW (112-115 PS) AAD, ABK	10.1990→12.1996		7.02604.03.0	LS	200 mm	
2.0 16 V 101 kW (137 PS) 6A	01.1992→07.1992		7.02604.03.0	LS	200 mm	
2.3 97-100 kW (132-136 PS) NG	10.1988→07.1994		7.02604.03.0	LS	200 mm	
2.3 97-100 kW (132-136 PS) NG	03.1990→12.1996		7.02604.03.0	LS	200 mm	
2.3 20V 122-125 kW (166-170 PS) 7A	08.1989→07.1991		7.02604.03.0	LS	200 mm	
2.3 20V 122-125 kW (166-170 PS) 7A	08.1990→07.1991		7.02604.03.0	LS	200 mm	

A











COUPE B3 (89, 8B3)

69











2.3 20V quattro 122-125 kW (166-170 PS) 7A	11.1988→07.1991		7.02604.03.0	LS	200 mm	
2.3 20V quattro 122-125 kW (166-170 PS) 7A	05.1990→09.1991		7.02604.03.0	LS	200 mm	
2.3 quattro 97-100 kW (132-136 PS) NG	08.1989→12.1992		7.02604.03.0	LS	200 mm	
2.3 quattro 97-100 kW (132-136 PS) NG	05.1990→12.1996		7.02604.03.0	LS	200 mm	
2.6 110 kW (150 PS) ABC	08.1992→12.1996		7.02604.03.0	LS	200 mm	
2.6 quattro 110 kW (150 PS) ABC	08.1992→12.1996		7.02604.03.0	LS	200 mm	
2.8 128 kW (174 PS) AAH	09.1991→12.1996		7.02604.03.0	LS	200 mm	
2.8 quattro 128 kW (174 PS) AAH	09.1991→12.1996		7.02604.03.0	LS	200 mm	
S2 quattro 169 kW (230 PS) ABY	12.1992→12.1996		7.02604.03.0	LS	200 mm	

Q2 (GAB, GAG)

70

1.6 TDI 85 kW (115 PS) DDYA	06.2016→10.2018		7.10334.02.0	AGR	EL	 ohne Zubehör without accessories
			7.08369.95.0	ATS	EL	
			7.11492.05.0	DDS		
			7.07696.00.0	SRM-AK	EL	
2.0 TDI 110 kW (150 PS) DFGA	09.2016→		7.08369.81.0	ATS	EL	
			7.07696.00.0	SRM-AK	EL	
2.0 TDI 105 kW (143 PS) CRFC	11.2016→		7.03608.16.0	AK	EL	
2.0 TDI quattro 140 kW (190 PS) DFHA	07.2016→		7.03608.16.0	AK	EL	
			↳ 7.07696.00.0	SRM-AK	EL	
			7.11020.26.0	ATS	EL	
2.0 TDI quattro 110 kW (150 PS) DFGA	09.2016→		7.08369.81.0	ATS	EL	
			7.07696.00.0	SRM-AK	EL	
30 TDI 85 kW (115 PS) DGTE	07.2018→		7.11020.17.0	ATS	EL	vor Katalysator in front of the catalyst ohne Zubehör without accessories
			7.11020.22.0	ATS	EL	
			7.11020.23.0	ATS	EL	
			7.11492.05.0	DDS		
			7.07696.00.0	SRM-AK	EL	
35 TDI 110 kW (150 PS) DFGA	09.2016→		7.03608.16.0	AK	EL	
			↳ 7.07696.00.0	SRM-AK	EL	
			7.08369.81.0	ATS	EL	
35 TDI quattro 110 kW (150 PS) DFGA	09.2018→		7.03608.16.0	AK	EL	
			↳ 7.07696.00.0	SRM-AK	EL	
			7.08369.81.0	ATS	EL	

Q3 (8UB, 8UG)
71



2.0 TDI 130 kW (177 PS) CFGC	06.2011→04.2015		7.09720.00.0	AGR-K	EL	○
			7.11492.00.0	DDS		ohne Zubehör without accessories Euro 5 Euro 5
2.0 TDI 103 kW (140 PS) CFFB, CLJA	09.2011→10.2018		7.09720.00.0	AGR-K	EL	○
			7.11492.00.0	DDS		ohne Zubehör without accessories CFFB, CLJA: Euro 5 Euro 5
2.0 TDI 100 kW (136 PS) CFFA	09.2011→10.2018		7.09720.00.0	AGR-K	EL	○
			7.11492.00.0	DDS		ohne Zubehör without accessories Euro 5 Euro 5
2.0 TDI 100 kW (136 PS) CUVB	09.2011→10.2018		7.10334.02.0	AGR	EL	○
			7.11492.03.0	DDS		ohne Zubehör without accessories
2.0 TDI 100 kW (136 PS) DFTB	09.2011→10.2018		7.11492.03.0	DDS		ohne Zubehör without accessories
2.0 TDI 110 kW (150 PS) CUVC, DBBA	11.2014→10.2018		7.10334.02.0	AGR	EL	○
			7.11492.03.0	DDS		ohne Zubehör without accessories
2.0 TDI 110 kW (150 PS) DFTA	11.2014→10.2018		7.11492.03.0	DDS		ohne Zubehör without accessories
2.0 TDI 88 kW (120 PS) CUVD, DFTC	03.2015→10.2018		7.10334.02.0	AGR	EL	○
			7.11492.03.0	DDS		ohne Zubehör without accessories
2.0 TDI 135 kW (184 PS) CUWA, DFUA	05.2015→10.2018		7.10334.02.0	AGR	EL	○
			7.11492.03.0	DDS		ohne Zubehör without accessories
2.0 TDI quattro 130 kW (177 PS) CFGC, CLLB	06.2011→10.2018		7.09720.00.0	AGR-K	EL	○
			7.11492.00.0	DDS		ohne Zubehör without accessories CFGC, CLLB: Euro 5 Euro 5
2.0 TDI quattro 120 kW (163 PS) CFGD	06.2011→04.2015		7.09720.00.0	AGR-K	EL	○
			7.11492.00.0	DDS		ohne Zubehör without accessories Euro 5 Euro 5
2.0 TDI quattro 103 kW (140 PS) CFFB	01.2012→10.2018		7.09720.00.0	AGR-K	EL	○
			7.11492.00.0	DDS		ohne Zubehör without accessories Euro 5 Euro 5
2.0 TDI quattro 110 kW (150 PS) CUVC	11.2014→10.2018		7.10334.02.0	AGR	EL	○
			7.11492.03.0	DDS		ohne Zubehör without accessories
2.0 TDI quattro 110 kW (150 PS) DFTA	11.2014→10.2018		7.11492.03.0	DDS		ohne Zubehör without accessories

A







Q3 (8UB, 8UG)

71

2.0 TDI quattro 135 kW (184 PS) CUWA	11.2014→10.2018		7.11492.03.0	DDS		ohne Zubehör without accessories
2.0 TDI quattro 135 kW (184 PS) CYLA, DFUA	11.2014→10.2018		7.10334.02.0	AGR	EL	ohne Zubehör without accessories
			7.11492.03.0	DDS		
2.0 TFSI quattro 155 kW (211 PS) CPSA	06.2011→04.2015		7.05271.29.0	LS	900 mm	





Q3 (F3B)

72

35 TDI 110 kW (150 PS) DFGA	09.2018→		7.08369.81.0	ATS	EL	ohne Zubehör without accessories
			7.11492.03.0	DDS		
			7.07696.00.0	SRM-AK	EL	
35 TDI quattro 110 kW (150 PS) DFGA	09.2018→		7.08369.81.0	ATS	EL	ohne Zubehör without accessories
			7.11492.03.0	DDS		
			7.07696.00.0	SRM-AK	EL	
40 TDI quattro 140 kW (190 PS) DFHA	10.2018→		7.11020.26.0	ATS	EL	ohne Zubehör without accessories
			7.11492.03.0	DDS		
			7.07696.00.0	SRM-AK	EL	
40 TFSI quattro 140 kW (190 PS) DKTC	07.2018→		7.03635.39.0	SLP	EL	für OE-Nummer: 04E 959 231 C for OE number: 04E 959 231 C
			7.01510.85.0	SLV	EL	für PR-Nummer: TD7, TN9 for PR number: TD7, TN9
45 TFSI quattro 169 kW (230 PS) DKTA	07.2018→		7.03635.39.0	SLP	EL	für OE-Nummer: 04E 959 231 C for OE number: 04E 959 231 C
			7.01510.85.0	SLV	EL	für PR-Nummer: TD6, TN9 for PR number: TD6, TN9

Q3 Sportback (F3N)

73

35 TDI 110 kW (150 PS) DFGA	07.2019→		7.08369.81.0	ATS	EL	ohne Zubehör without accessories
			7.11492.03.0	DDS		
			7.07696.00.0	SRM-AK	EL	
35 TDI quattro 110 kW (150 PS) DFGA	09.2019→		7.08369.81.0	ATS	EL	ohne Zubehör without accessories
			7.11492.03.0	DDS		
			7.07696.00.0	SRM-AK	EL	
40 TDI quattro 140 kW (190 PS) DFHA	07.2019→		7.11020.26.0	ATS	EL	ohne Zubehör without accessories
			7.11492.03.0	DDS		
			7.07696.00.0	SRM-AK	EL	
40 TFSI quattro 140 kW (190 PS) DKTC	11.2019→		7.03635.39.0	SLP	EL	für OE-Nummer: 04E 959 231 C for OE number: 04E 959 231 C
			7.01510.85.0	SLV	EL	für PR-Nummer: TD6, TN9 for PR number: TD6, TN9
45 TFSI quattro 169 kW (230 PS) DKTA	06.2019→		7.03635.39.0	SLP	EL	für OE-Nummer: 04E 959 231 C for OE number: 04E 959 231 C
			7.01510.85.0	SLV	EL	für PR-Nummer: TD6, TN9 for PR number: TD6, TN9

















						A
Q5 (8RB)						74
2.0 Hybrid quattro 155 kW (211 PS) CHJA	09.2012→05.2016		7.01510.57.0	SLV	EL	○
2.0 TDI 100 kW (136 PS) CJCB	11.2010→05.2017		7.09720.03.0	AGR-K	EL	○
			7.11190.09.0	DDS		Euro 5, Euro 6 Euro 5, Euro 6
			7.11492.03.0	DDS		ohne Zubehör without accessories für Hersteller-Abgasnorm: Euro 6 plus for manufacturer exhaust norm: Euro 6 plus
2.0 TDI 100 kW (136 PS) CSUB	11.2010→05.2017		7.11190.09.0	DDS		Euro 5, Euro 6 Euro 5, Euro 6
			7.11492.03.0	DDS		ohne Zubehör without accessories für Hersteller-Abgasnorm: Euro 6 plus for manufacturer exhaust norm: Euro 6 plus
2.0 TDI 105 kW (143 PS) CJCA	11.2010→05.2013		7.09720.03.0	AGR-K	EL	○
			7.11190.09.0	DDS		Euro 5, Euro 6 Euro 5, Euro 6
			7.11492.03.0	DDS		ohne Zubehör without accessories für Hersteller-Abgasnorm: Euro 6 plus for manufacturer exhaust norm: Euro 6 plus
2.0 TDI 110 kW (150 PS) CJCD	05.2013→05.2017		7.09720.03.0	AGR-K	EL	○
			7.11190.09.0	DDS		Euro 5, Euro 6 Euro 5, Euro 6
			7.11492.03.0	DDS		ohne Zubehör without accessories für Hersteller-Abgasnorm: Euro 6 Plus for manufacturer exhaust norm: Euro 6 Plus
2.0 TDI 110 kW (150 PS) CSUA	05.2013→05.2017		7.11190.09.0	DDS		Euro 5, Euro 6 Euro 5, Euro 6
			7.11492.03.0	DDS		ohne Zubehör without accessories für Hersteller-Abgasnorm: Euro 6 Plus for manufacturer exhaust norm: Euro 6 Plus
2.0 TDI 140 kW (190 PS) CNHA	09.2015→05.2017		7.11020.21.0	ATS	EL	für PR-Nummer: 7MM for PR number: 7MM
			7.11190.09.0	DDS		Euro 5, Euro 6 Euro 5, Euro 6
			7.11492.03.0	DDS		ohne Zubehör without accessories für Hersteller-Abgasnorm: Euro 6 plus for manufacturer exhaust norm: Euro 6 plus
2.0 TDI quattro 125 kW (170 PS) CAHA	11.2008→09.2012		7.10334.00.0	AGR	EL	○
			7.08369.14.0	ATS	EL	für Fahrzeuge mit Schaltgetriebe for vehicles with manual transmission
			7.08369.16.0	ATS	EL	
			7.08369.52.0	ATS	EL	
			7.11190.02.0	DDS		Euro 5, Euro 4 Euro 5, Euro 4
2.0 TDI quattro 125 kW (170 PS) CGLB	11.2008→09.2012		7.09720.03.0	AGR-K	EL	○

A

















Q5 (8RB)

74

			7.11190.09.0	DDS		
2.0 TDI quattro 125 kW (170 PS) CMGA	11.2008→09.2012		7.09720.03.0	AGR-K	EL	
2.0 TDI quattro 120 kW (163 PS) CAHB	11.2008→05.2017		7.10334.00.0	AGR	EL	
			7.08369.14.0	ATS	EL	für Fahrzeuge mit Schaltgetriebe for vehicles with manual transmission für Fahrzeuge mit Automatikgetriebe for vehicles with automatic transmission Euro 5, Euro 4 Euro 5, Euro 4
			7.08369.16.0	ATS	EL	
			7.08369.52.0	ATS	EL	
			7.11190.02.0	DDS	EL	
2.0 TDI quattro 120 kW (163 PS) CGLA	11.2008→05.2017		7.09720.03.0	AGR-K	EL	
			7.11190.09.0	DDS		
2.0 TDI quattro 120 kW (163 PS) CGLD	11.2008→05.2017		7.09720.03.0	AGR-K	EL	
			7.11190.09.0	DDS		Euro 5, Euro 6 Euro 5, Euro 6 ohne Zubehör without accessories für Hersteller-Abgasnorm: Euro 6 plus for manufacturer exhaust norm: Euro 6 plus
			7.11492.03.0	DDS		
2.0 TDI quattro 120 kW (163 PS) CNHC	11.2008→05.2017		7.11020.21.0	ATS	EL	für PR-Nummer: 7MM for PR number: 7MM
			7.11190.09.0	DDS		Euro 5, Euro 6 Euro 5, Euro 6 ohne Zubehör without accessories für Hersteller-Abgasnorm: Euro 6 plus for manufacturer exhaust norm: Euro 6 plus
			7.11492.03.0	DDS		
2.0 TDI quattro 105 kW (143 PS) CAGA	08.2009→05.2013		7.10334.00.0	AGR	EL	
			7.08369.14.0	ATS	EL	für Fahrzeuge mit Schaltgetriebe for vehicles with manual transmission Euro 5, Euro 4 Euro 5, Euro 4
			7.08369.16.0	ATS	EL	
			7.11190.02.0	DDS	EL	
2.0 TDI quattro 105 kW (143 PS) CJCA	08.2009→05.2013		7.09720.03.0	AGR-K	EL	
			7.11190.09.0	DDS		Euro 5, Euro 6 Euro 5, Euro 6 ohne Zubehör without accessories für Hersteller-Abgasnorm: Euro 6 plus for manufacturer exhaust norm: Euro 6 plus
			7.11492.03.0	DDS		
2.0 TDI quattro 100 kW (136 PS) CAGB	08.2009→05.2017		7.10334.00.0	AGR	EL	
			7.08369.14.0	ATS	EL	für Fahrzeuge mit Schaltgetriebe for vehicles with manual transmission Euro 5, Euro 4 Euro 5, Euro 4
			7.08369.16.0	ATS	EL	
			7.11190.02.0	DDS	EL	
2.0 TDI quattro 100 kW (136 PS) CJCB	08.2009→05.2017		7.09720.03.0	AGR-K	EL	
			7.11190.09.0	DDS		Euro 5, Euro 6 Euro 5, Euro 6

Q5 (8RB)
74











			7.11492.03.0	DDS		ohne Zubehör without accessories für Hersteller-Abgasnorm: Euro 6 plus for manufacturer exhaust norm: Euro 6 plus
2.0 TDI quattro 100 kW (136 PS) CSUB	08.2009→05.2017		7.11190.09.0	DDS		Euro 5, Euro 6 Euro 5, Euro 6
			7.11492.03.0	DDS		ohne Zubehör without accessories für Hersteller-Abgasnorm: Euro 6 plus for manufacturer exhaust norm: Euro 6 plus
2.0 TDI quattro 130 kW (177 PS) CGLC	06.2012→05.2017		7.09720.03.0	AGR-K	EL	
			7.11492.03.0	DDS		ohne Zubehör without accessories für Hersteller-Abgasnorm: Euro 6 Plus for manufacturer exhaust norm: Euro 6 Plus
2.0 TDI quattro 130 kW (177 PS) CMGB	06.2012→05.2017		7.09720.03.0	AGR-K	EL	
			7.11190.09.0	DDS		Euro 5, Euro 6 Euro 5, Euro 6
			7.11492.03.0	DDS		ohne Zubehör without accessories für Hersteller-Abgasnorm: Euro 6 plus for manufacturer exhaust norm: Euro 6 plus
2.0 TDI quattro 110 kW (150 PS) CJCD	05.2013→05.2017		7.09720.03.0	AGR-K	EL	
			7.11190.09.0	DDS		Euro 5, Euro 6 Euro 5, Euro 6
			7.11492.03.0	DDS		ohne Zubehör without accessories für Hersteller-Abgasnorm: Euro 6 plus for manufacturer exhaust norm: Euro 6 plus
2.0 TDI quattro 110 kW (150 PS) CSUA	05.2013→05.2017		7.11190.09.0	DDS		Euro 5, Euro 6 Euro 5, Euro 6
			7.11492.03.0	DDS		ohne Zubehör without accessories für Hersteller-Abgasnorm: Euro 6 plus for manufacturer exhaust norm: Euro 6 plus
2.0 TDI quattro 140 kW (190 PS) CNHA	11.2013→05.2017		7.11020.21.0	ATS	EL	für PR-Nummer: 7MM for PR number: 7MM
			7.11190.09.0	DDS		Euro 5, Euro 6 Euro 5, Euro 6
			7.11492.03.0	DDS		ohne Zubehör without accessories für Hersteller-Abgasnorm: Euro 6 plus for manufacturer exhaust norm: Euro 6 plus
2.0 TFSI Hybrid quattro 155 kW (211 PS) CHJA	06.2011→06.2016		7.05271.15.0	LS	525 mm	
			7.01510.57.0	SLV	EL	
2.0 TFSI quattro 155 kW (211 PS) CDNC	11.2008→09.2012		7.05271.27.0	LS	475 mm	
2.0 TFSI quattro 132 kW (180 PS) CDNB	08.2009→10.2012		7.05271.27.0	LS	475 mm	
3.0 TDI quattro 176 kW (240 PS) CCWA	11.2008→05.2017		7.02132.07.0	AGR	EL	









































A



Q5 (8RB)

74

			7.01106.38.0	AGR-K	EL	mit AGR-Ventil with EGR valve
			7.08369.13.0	ATS	EL	
			7.08369.45.0	ATS	EL	Euro 5 Euro 5
			7.11190.02.0	DDS		Euro 5, Euro 4 Euro 5, Euro 4
3.0 TDI quattro 176 kW (239 PS) CPNB	11.2008→05.2017		7.08369.73.0	ATS	EL	05.2013→
			7.11020.25.0	ATS	EL	vor Rußpartikelfilter before soot particulate filter Euro 5, ULEV2 Euro 5, ULEV2 für Hersteller-Abgasnorm: Euro 5 Plus for manufacturer exhaust norm: Euro 5 Plus
			7.11190.09.0	DDS		Euro 5, Euro 6 Euro 5, Euro 6
3.0 TDI quattro 155 kW (211 PS) CCWB	11.2008→09.2012		7.02132.07.0	AGR	EL	
			7.01106.38.0	AGR-K	EL	mit AGR-Ventil with EGR valve
			7.08369.13.0	ATS	EL	
			7.08369.45.0	ATS	EL	Euro 5 Euro 5
			7.11190.02.0	DDS		Euro 5, Euro 4 Euro 5, Euro 4
3.0 TDI quattro 180 kW (245 PS) CDUD	06.2012→05.2017		7.08369.73.0	ATS	EL	
			7.11020.25.0	ATS	EL	vor Rußpartikelfilter before soot particulate filter Euro 5, ULEV2 Euro 5, ULEV2 für Hersteller-Abgasnorm: Euro 5 Plus for manufacturer exhaust norm: Euro 5 Plus
3.0 TFSI quattro 200 kW (272 PS) CTUC, CTVA	06.2012→05.2017		7.22286.52.0	ARV	PN	 CTUC, CTVA: rechts Right
			7.22286.53.0	ARV	PN	 CTUC, CTVA: links Left
			7.05271.18.0	LS	525 mm	
			7.22934.57.0	SLP	EL	
3.2 FSI quattro 199 kW (270 PS) CALB	11.2008→12.2012		7.22286.52.0	ARV	PN	 rechts Right USA USA
			7.22286.53.0	ARV	PN	 links Left USA USA
			7.05271.18.0	LS	525 mm	
			7.22934.57.0	SLP	EL	
			7.05574.00.0	SLV	PN	 rechts Right für PR-Nummer: A8S for PR number: A8S







						
Q5 (8RB)						74
			7.05574.01.0	SLV	PN 	links Left
SQ5 TFSI quattro 260 kW (354 PS) CTUD, CTXA	05.2013→05.2017		7.22286.52.0	ARV	PN 	 CTUD, CTXA: rechts Right
			7.22286.53.0	ARV	PN 	 CTUD, CTXA: links Left
			7.22934.57.0	SLP	EL	
Q5 (FYB, FYG)						75
2.0 TDI 110 kW (150 PS) DEUA	01.2017→11.2020		7.11492.03.0	DDS		ohne Zubehör without accessories  ch. FY-H-000 001→
2.0 TDI 100 kW (136 PS) DEUB	01.2017→11.2020		7.11492.03.0	DDS		ohne Zubehör without accessories  ch. FY-H-000 001→
2.0 TDI quattro 120 kW (163 PS) DETB	06.2016→08.2018		7.11020.31.0	ATS	EL 	ch. FY-H-000 001→ Getriebeautomatik 7 Gang 7-Speed Automatic Transmission
			7.11492.03.0	DDS		ohne Zubehör without accessories  ch. FY-H-000 001→
2.0 TDI quattro 140 kW (190 PS) DESA, DETA	06.2016→08.2018		7.11020.31.0	ATS	EL 	DESA, DETA:  ch. FY-H-000 001→ für Getriebeautomatik 7 Gang for 7-speed automatic transmission
			7.11492.03.0	DDS		ohne Zubehör without accessories  DESA, DETA:  ch. FY-H-000 001→
2.0 TFSI quattro 185 kW (252 PS) DAXB, DAYB	06.2016→		7.03635.46.0	SLP	EL 	DAXB, DAYB:  ch. FY-H-000 001→ für PR-Nummer: T5R for PR number: T5R
			7.01510.94.0	SLV	EL 	DAXB, DAYB:  ch. FY-H-000 001→ für PR-Nummer: T5R for PR number: T5R
2.0 TFSI quattro 183 kW (249 PS) DAXC	01.2017→11.2020		7.03635.46.0	SLP	EL 	ch. FY-H-000 001→ für PR-Nummer: T5R for PR number: T5R
			7.01510.94.0	SLV	EL 	ch. FY-H-000 001→ für PR-Nummer: T5R for PR number: T5R
3.0 TDI quattro 210 kW (286 PS) DCPC	07.2017→11.2020		7.07141.01.0	AK	EL	
			7.11020.24.0	ATS	EL	Produktionsdatum bis: 07.05.2018 Production date to: 07.05.2018
35 TDI quattro 120 kW (163 PS) DETB	08.2018→11.2020		7.11020.31.0	ATS	EL 	ch. FY-H-000 001→ für Getriebeautomatik 7 Gang for 7-speed automatic transmission
			7.11492.03.0	DDS		ohne Zubehör without accessories  ch. FY-H-000 001→
40 TDI Mild Hybrid quattro 150 kW (204 PS) DFBA	11.2019→11.2020		7.07696.00.0	SRM-AK	EL	
40 TDI quattro 140 kW (190 PS) DESA, DETA	10.2018→		7.11020.31.0	ATS	EL 	DESA, DETA:  ch. FY-H-000 001→ für Getriebeautomatik 7 Gang for 7-speed automatic transmission

A





















Q5 (FYB, FYG)

75

			7.11492.03.0	DDS		ohne Zubehör without accessories  DESA, DETA:  ch. FY-H-000 001→
45 TFSI Mild Hybrid quattro 180 kW (245 PS) DNNTA	12.2018→		7.03635.46.0	SLP	EL	 ch. FY-H-000 001→ für PR-Nummer: T5R for PR number: T5R
			7.01510.94.0	SLV	EL	  ch. FY-H-000 001→ für PR-Nummer: T5R for PR number: T5R
50 TDI quattro 210 kW (286 PS) DCPC	03.2019→11.2020		7.11020.24.0	ATS	EL	Produktionsdatum bis: 07.05.2018 Production date to: 07.05.2018

Q7 (4LB)

76

3.0 TDI quattro 171 kW (233 PS) BUG	03.2006→05.2008		7.00309.07.0	AGR	PN	
			7.08369.13.0	ATS	EL	
			7.08369.62.0	ATS	EL	
			7.11190.02.0	DDS		 ch. 4L-7-053 501→
			7.11190.00.0	DDS		 →ch. 4L-7-053 500
3.0 TDI quattro 155 kW (211 PS) BUN	03.2006→05.2010		7.00309.07.0	AGR	PN	
			7.08369.13.0	ATS	EL	
			7.08369.62.0	ATS	EL	
			7.11190.02.0	DDS		 ch. 4L-7-053 501→
			7.11190.00.0	DDS		 →ch. 4L-7-053 500
3.0 TDI quattro 155 kW (211 PS) CASB	03.2006→05.2010		7.01782.07.0	AGR	EL	
			7.08369.13.0	ATS	EL	
			7.08369.45.0	ATS	EL	ab Euro 5 From Euro 5
			7.08369.62.0	ATS	EL	
			7.08369.68.0	ATS	EL	nach Rußpartikelfilter after soot particulate filter
			7.11190.02.0	DDS		 ch. 4L-7-053 501→
3.0 TDI quattro 176 kW (240 PS) CASA	11.2007→08.2015		7.01782.07.0	AGR	EL	
			7.08369.13.0	ATS	EL	
			7.08369.45.0	ATS	EL	ab Euro 5 From Euro 5
			7.08369.62.0	ATS	EL	
			7.08369.68.0	ATS	EL	
			7.11190.02.0	DDS		 ch. 4L-7-053 501→
			7.02132.07.0	AGR	EL	
3.0 TDI quattro 176 kW (240 PS) CCMA	11.2007→08.2015		7.08369.13.0	ATS	EL	
			7.08369.45.0	ATS	EL	Euro 5, Euro 6 Euro 5, Euro 6
			7.08369.62.0	ATS	EL	Euro 4 Euro 4 für PR-Nummer: 7GG for PR number: 7GG
			7.08369.68.0	ATS	EL	
			7.11190.02.0	DDS		
			7.08369.45.0	ATS	EL	 CJGA: ab Euro 5 From Euro 5  CNRB: Euro 6 Euro 6
3.0 TDI quattro 176 kW (240 PS) CJGA, CNRB	11.2007→08.2015		7.08369.68.0	ATS	EL	
			7.11190.02.0	DDS		

























Q7 (4LB)						76
3.0 TDI quattro 165 kW (224 PS) CATA	06.2009→05.2012		7.02132.07.0	AGR	EL	 ab Euro 5 From Euro 5 vor Rußpartikelfilter before soot particulate filter
			7.08369.13.0	ATS	EL	
			7.08369.45.0	ATS	EL	
			7.08369.68.0	ATS	EL	
			7.11020.25.0	ATS	EL	
3.0 TDI quattro 150 kW (204 PS) CJGC, CJMA	05.2010→08.2015		7.08369.45.0	ATS	EL	CJGC, CJMA: Euro 6 Euro 6
			7.08369.68.0	ATS	EL	
			7.08369.73.0	ATS	EL	
			7.11190.02.0	DDS		
3.0 TDI quattro 180 kW (245 PS) CJGD	05.2011→08.2015		7.08369.45.0	ATS	EL	Euro 6 Euro 6
3.0 TDI quattro 180 kW (245 PS) CLZB, CRCA	05.2011→08.2015		7.08369.45.0	ATS	EL	CLZB, CRCA: Euro 6 Euro 6
			7.08369.68.0	ATS	EL	CLZB, CRCA: nach Rußpartikelfilter after soot particulate filter
			7.11190.02.0	DDS		
3.0 TFSI quattro 200 kW (272 PS) CJTC, CJWC	05.2010→08.2015		7.22286.52.0	ARV	PN	CJTC, CJWC: rechts Right
			7.22286.53.0	ARV	PN	CJTC, CJWC: links Left
			7.03635.40.0	SLP	EL	CJTC: Produktionsdatum ab: 17.11.2014 Production date from: 17.11.2014 CJWC: USA, Kanada USA, Kanada Produktionsdatum ab: 17.11.2014 Production date from: 17.11.2014 CJWC: USA, Kanada USA, Kanada zusätzlich benötigter Artikel (Artikel-Nummer): 7L0 131 625 F, 7L0 131 625 G, 7L0 906 287 B Additionally required articles (article numbers): 7L0 131 625 F, 7L0 131 625 G, 7L0 906 287 B Produktionsdatum bis: 17.11.2014 Production date to: 17.11.2014
3.0 TFSI quattro 245 kW (333 PS) CJTB, CJWB, CNA, CTWA	05.2010→08.2015		7.22286.52.0	ARV	PN	CJTB, CJWB, CNA, CTWA: rechts Right
			7.22286.53.0	ARV	PN	CJTB, CJWB, CNA, CTWA: links Left
			7.03635.40.0	SLP	EL	CJTB, CJWB, CNA, CTWA: Produktionsdatum ab: 17.11.2014 Production date from: 17.11.2014
3.0 TFSI quattro 206 kW (280 PS) CJWE, CTWB	05.2011→08.2015		7.22286.52.0	ARV	PN	CJWE, CTWB: rechts Right
			7.22286.53.0	ARV	PN	CJWE, CTWB: links Left



























A



Q7 (4LB)

76

			7.03635.40.0	SLP	EL	 CJWE, CTWB:  USA, Kanada  USA, Kanada Produktionsdatum ab: 17.11.2014 Production date from: 17.11.2014  CJWE, CTWB:  USA, Kanada  USA, Kanada zusätzlich benötigter Artikel (Artikel-Nummer): 7L0 131 625 F, 7L0 131 625 G, 7L0 906 287 B Additionally required articles (article numbers): 7L0 131 625 F, 7L0 131 625 G, 7L0 906 287 B Produktionsdatum bis: 17.11.2014 Production date to: 17.11.2014
3.6 FSI quattro 206 kW (280 PS) BHK	08.2006→05.2010		7.05271.11.0	LS	800 mm	
			7.05271.15.0	LS	525 mm	
			7.05271.27.0	LS	475 mm	
			7.05271.30.0	LS	400 mm	
4.2 FSI quattro 231-257 kW (314-350 PS) BAR	03.2006→05.2010		7.22769.79.0	ARV	PN	 ch. 4L-8-000 001→ch. 4L-8-095 000  USA  USA
			7.06712.24.0	ARV	PN	 für PR-Nummer: A8U for PR number: A8U
			7.05271.23.0	LS	900 mm	
			7.05271.16.0	LS	1300 mm	
			7.22738.08.0	SLP	EL	
			7.22778.97.0	SLV	PN	 Fahrgestellnummer bis: 4L-9-015 000 Vehicle Identification Number to: 4L-9-015 000
4.2 TDI quattro 240 kW (326 PS) BTR	03.2007→06.2009		7.00789.10.0	AGR	EL	
			7.08369.42.0	ATS	EL	Fahrgestellnummer ab: 4L-7-098 419 Vehicle Identification Number from: 4L-7-098 419 vor Rußpartikelfilter before soot particulate filter Euro 4 Euro 4 Euro 4 Euro 4
			7.11190.02.0	DDS		
4.2 TDI quattro 250 kW (340 PS) CCFA	05.2009→08.2015		7.00789.10.0	AGR	EL	
			7.11190.02.0	DDS		
4.2 TDI quattro 250 kW (340 PS) CCFC	05.2009→08.2015		7.00789.10.0	AGR	EL	
4.2 quattro 231-257 kW (314-350 PS) BAR	03.2006→12.2010		7.22769.79.0	ARV	PN	 ch. 4L-8-000 001→ch. 4L-8-095 000  USA  USA
			7.22738.08.0	SLP	EL	für PR-Nummer: A8S, A8U for PR number: A8S, A8U
			7.22778.97.0	SLV	PN	 Fahrgestellnummer bis: 4L-9-015 000 Vehicle Identification Number to: 4L-9-015 000



							
Q7 (4LB)						76	
6.0 TDI quattro 368 kW (500 PS) CCGA	09.2008→05.2014		7.02132.07.0	AGR	EL 	→09.2009	
			7.11190.00.0	DDS			
Q7 (4MB, 4MG)						77	
2.0 TFSI e-tron quattro 185 kW (252 PS) CVJA	02.2016→12.2019		7.03635.46.0	SLP	EL  CVJA: China 6b China 6b für PR-Nummer: T2G for PR number: T2G		
			7.01510.94.0	SLV	EL  CVJA: für PR-Nummer: 7MU for PR number: 7MU		
2.0 TFSI quattro 185 kW (252 PS) CYMC, CYRB	08.2015→		7.03635.46.0	SLP	EL  CYMC, CYRB: für PR-Nummer: 7MU for PR number: 7MU		
			7.01510.94.0	SLV	EL  CVJA: China 6b China 6b für PR-Nummer: T2G for PR number: T2G		
3.0 TDI e-tron quattro 190 kW (258 PS) CVZA	08.2015→12.2019		7.11020.24.0	ATS	EL	Produktionsdatum bis: 02.04.2018 Production date to: 02.04.2018	
3.0 TDI quattro 200 kW (272 PS) CRTC	01.2015→12.2019		7.11020.24.0	ATS	EL	Produktionsdatum bis: 02.04.2018 Production date to: 02.04.2018	
			7.07696.00.0	SRM-AK	EL		
3.0 TDI quattro 160 kW (218 PS) CRTE, CZZA	05.2015→12.2019		7.11020.24.0	ATS	EL  CRTE, CZZA: Produktionsdatum bis: 02.04.2018	Production date to: 02.04.2018	
			7.07696.00.0	SRM-AK	EL		
3.0 TDI quattro 183 kW (249 PS) CVMD	06.2015→12.2019		7.11020.24.0	ATS	EL	Produktionsdatum bis: 02.04.2018 Production date to: 02.04.2018	
			7.07696.00.0	SRM-AK	EL		
3.0 TDI quattro 190 kW (258 PS) CUEA	08.2015→12.2019		7.11020.24.0	ATS	EL	Produktionsdatum bis: 02.04.2018 Production date to: 02.04.2018	
			7.07696.00.0	SRM-AK	EL		
3.0 TDI quattro 155 kW (211 PS) CZZB	08.2015→12.2019		7.11020.24.0	ATS	EL	Produktionsdatum bis: 02.04.2018 Production date to: 02.04.2018	
			7.07696.00.0	SRM-AK	EL		
3.0 TFSI quattro 245 kW (333 PS) CREC	01.2015→12.2019		7.06714.22.0	ARV	PN 	rechts Right	
			7.06714.23.0	ARV	PN 		links Left
			7.22934.57.0	SLP	EL		
45 TDI Mild Hybrid quattro 170 kW (231 PS) DHXC	07.2018→12.2019		7.11020.24.0	ATS	EL	Produktionsdatum bis: 02.04.2018 Production date to: 02.04.2018	
50 TDI Mild Hybrid quattro 210 kW (286 PS) DHXA	07.2018→12.2019		7.11020.24.0	ATS	EL	Produktionsdatum bis: 02.04.2018 Production date to: 02.04.2018	

A









Q8 (4MN)

78

45 TDI Mild Hybrid quattro 170 kW (231 PS) DHXC	07.2018→		7.11020.24.0	ATS	EL	Produktionsdatum bis: 02.04.2018 Production date to: 02.04.2018
45 TDI quattro 183 kW (249 PS) CVMD	02.2018→		7.11020.24.0	ATS	EL	Produktionsdatum bis: 02.04.2018 Production date to: 02.04.2018
			7.07696.00.0	SRM-AK	EL	
50 TDI Mild Hybrid quattro 210 kW (286 PS) DHXA	07.2018→		7.11020.24.0	ATS	EL	Produktionsdatum bis: 02.04.2018 Production date to: 02.04.2018





R8 (422, 423)

79

4.2 FSI quattro 309 kW (420 PS) BYH	04.2007→09.2010		7.22769.80.0	ARV	PN	○ beidseitig Left and right
			7.05271.11.0	LS	800 mm	
4.2 FSI quattro 316 kW (430 PS) CNDA	07.2010→07.2015		7.06712.23.0	ARV	PN	rechts Right
			7.22769.80.0	ARV	PN	○ links Left
			7.05271.11.0	LS	800 mm	
5.2 FSI quattro 386 kW (525 PS) BUJ	04.2009→07.2015		7.06714.24.0	ARV	PN	○
			7.05271.11.0	LS	800 mm	Diagnosesonde Diagnostic Probe für Zylinder: 6-10 for cylinder: 6-10
5.2 FSI quattro 386 kW (525 PS) CTYA	04.2009→07.2015		7.06714.24.0	ARV	PN	○
5.2 FSI quattro 412 kW (560 PS) CMPA	11.2010→07.2015		7.06714.24.0	ARV	PN	○
			7.05271.11.0	LS	800 mm	
5.2 FSI quattro 404 kW (549 PS) CTPA	05.2012→07.2015		7.06714.24.0	ARV	PN	○

R8 (4S3, 4SP)



































80

5.2 FSI RWS 397 kW (540 PS) DKAB	09.2017→		7.06714.24.0	ARV	PN	○
			7.05315.05.0	SLP	EL	
5.2 FSI quattro 449 kW (610 PS) CSPA, DKAA	07.2015→		7.06714.24.0	ARV	PN	○
			7.05315.05.0	SLP	EL	
5.2 FSI quattro 397 kW (540 PS) CSPB	07.2015→		7.06714.24.0	ARV	PN	○
			7.05315.05.0	SLP	EL	
5.2 FSI quattro 456 kW (620 PS) DMWA	09.2018→		7.06714.24.0	ARV	PN	○
			7.05315.05.0	SLP	EL	
5.2 FSI quattro 419 kW (570 PS) DKAC	09.2018→		7.06714.24.0	ARV	PN	○
			7.05315.05.0	SLP	EL	

R8 Spyder (427, 429)

81

4.2 FSI quattro 316 kW (430 PS) CNDA	09.2010→07.2015		7.06712.23.0	ARV	PN	rechts Right
			7.22769.80.0	ARV	PN	○ links Left



















						
R8 Spyder (427, 429)						81
			7.05271.11.0	LS	800 mm	
5.2 FSI quattro 386 kW (525 PS) BUJ	02.2010→07.2015		7.06714.24.0	ARV	PN	
			7.05271.11.0	LS	800 mm	Diagnosesonde Diagnostic Probe für Zylinder: 6-10 for cylinder: 6-10
5.2 FSI quattro 386 kW (525 PS) CTYA	02.2010→07.2015		7.06714.24.0	ARV	PN	
5.2 FSI quattro 412 kW (560 PS) CMPA	11.2011→07.2015		7.06714.24.0	ARV	PN	
R8 Spyder (4S9, 4SR)						82
5.2 FSI RWS 397 kW (540 PS) DKAB	09.2017→		7.06714.24.0	ARV	PN	
			7.05315.05.0	SLP	EL	
5.2 FSI quattro 397 kW (540 PS) CSPB	05.2016→		7.06714.24.0	ARV	PN	
			7.05315.05.0	SLP	EL	
5.2 FSI quattro 449 kW (610 PS) CSPA	05.2017→		7.06714.24.0	ARV	PN	
5.2 FSI quattro 449 kW (610 PS) DKAA	05.2017→		7.06714.24.0	ARV	PN	
			7.05315.05.0	SLP	EL	
5.2 FSI quattro 456 kW (620 PS) DMWA	09.2018→		7.06714.24.0	ARV	PN	
			7.05315.05.0	SLP	EL	
5.2 FSI quattro 419 kW (570 PS) DKAC	09.2018→		7.06714.24.0	ARV	PN	
			7.05315.05.0	SLP	EL	
TT (8J3)						83
2.0 TDI quattro 125 kW (170 PS) CBBB	06.2008→06.2014		7.10334.00.0	AGR	EL	
			7.08369.00.0	ATS	EL	
			7.08369.01.0	ATS	EL	
			7.08369.03.0	ATS	EL	
			7.11492.02.0	DDS		ohne Zubehör without accessories
2.0 TDI quattro 125 kW (170 PS) CFGB	06.2008→06.2014		7.09720.00.0	AGR-K	EL	
			7.11190.09.0	DDS		
2.5 RS quattro 250 kW (340 PS) CEPA	07.2009→06.2014		7.05271.15.0	LS	525 mm	
2.5 RS quattro 265 kW (360 PS) CEPB	05.2011→06.2014		7.05271.15.0	LS	525 mm	
3.2 V6 quattro 184-186 kW (250-253 PS) BUB	08.2006→06.2010		7.05271.19.0	LS	975 mm	Diagnosesonde Diagnostic Probe für Zylinder: 4-6 for cylinder: 4-6
			7.05271.28.0	LS	800 mm	
			7.22738.20.0	SLP	EL	
			7.22778.98.0	SLV	PN	
3.2 V6 quattro 184 kW (250 PS) CBRA	08.2006→06.2010		7.22286.51.0	ARV	PN	 Fahrgestellnummer ab: 8J-8-000 001 Vehicle Identification Number from: 8J-8-000 001























A



TT (8N3)

84

1.8 T 132 kW (180 PS) AJQ	10.1998→06.2006		7.05270.89.0	LS	925 mm	Allrad All-wheel Drive Regelsonde Regulating Probe
1.8 T 132 kW (180 PS) APP	10.1998→06.2006		7.22769.73.0 7.21851.31.0	ARV SLP	PN EL	
1.8 T 132 kW (180 PS) AUQ	10.1998→06.2006		7.22769.73.0 7.05271.23.0 7.05271.24.0 7.21851.31.0	ARV LS LS SLP	PN 900 mm 1500 mm EL	 vor Katalysator in front of the catalyst
1.8 T 110 kW (150 PS) AUM	09.2002→06.2006		7.22769.73.0 7.05271.23.0 7.05271.24.0 7.21851.31.0	ARV LS LS SLP	PN 900 mm 1500 mm EL	 vor Katalysator in front of the catalyst
1.8 T 120 kW (163 PS) BVP	09.2005→06.2006		7.22769.73.0 7.05271.23.0 7.05271.24.0 7.21851.31.0	ARV LS LS SLP	PN 900 mm 1500 mm EL	 vor Katalysator in front of the catalyst
1.8 T 140 kW (190 PS) BVR	09.2005→06.2006		7.22769.73.0 7.05270.99.0 7.05271.24.0 7.21851.31.0	ARV LS LS SLP	PN 940 mm 1500 mm EL	 Allrad All-wheel Drive Diagnosesonde Diagnostic Probe vor Katalysator in front of the catalyst
1.8 T quattro 132 kW (180 PS) AJQ	10.1998→06.2006		7.05270.89.0	LS	925 mm	Allrad All-wheel Drive Regelsonde Regulating Probe
1.8 T quattro 132 kW (180 PS) ARY	10.1998→06.2006		7.22769.73.0 7.05270.99.0 7.05271.23.0 7.05271.24.0 7.21851.31.0	ARV LS LS LS SLP	PN 940 mm 900 mm 1500 mm EL	 Diagnosesonde Diagnostic Probe vor Katalysator in front of the catalyst
1.8 T quattro 132 kW (180 PS) AUQ	10.1998→06.2006		7.22769.73.0 7.05271.23.0 7.05271.24.0 7.21851.31.0	ARV LS LS SLP	PN 900 mm 1500 mm EL	 vor Katalysator in front of the catalyst
1.8 T quattro 165 kW (224 PS) APX	10.1998→06.2006		7.22769.73.0 7.05271.02.0 7.21851.31.0	ARV LS SLP	PN 500 mm EL	 Regelsonde Regulating Probe

						A
TT (8N3)						84
1.8 T quattro 165 kW (224 PS) BAM	10.1998→06.2006		7.05270.99.0	LS	940 mm  ch. 8N-1-010 101→ Diagnosesonde Diagnostic Probe	
			7.05270.89.0	LS	925 mm  →ch. 8N-1-010 100 Diagnosesonde Diagnostic Probe	
			7.05271.77.0	LS	800 mm vor Katalysator in front of the catalyst	
1.8 T quattro 180 kW (245 PS) BFV	03.2005→06.2006		7.05270.99.0	LS	940 mm Diagnosesonde Diagnostic Probe	
			7.05271.77.0	LS	800 mm vor Katalysator in front of the catalyst	
1.8 T quattro 140 kW (190 PS) BVR	09.2005→06.2006		7.22769.73.0	ARV	PN 	
			7.05270.99.0	LS	940 mm Allrad All-wheel Drive Diagnosesonde Diagnostic Probe	
			7.05271.24.0	LS	1500 mm vor Katalysator in front of the catalyst	
			7.21851.31.0	SLP	EL	
3.2 VR6 quattro 184 kW (250 PS) BHE, BPF	07.2003→06.2006		7.22286.55.0	ARV	PN 	
			7.05271.01.0	LS	950 mm	
			7.05270.98.0	LS	700 mm  BHE, BPF: nach Katalysator Post-catalyst für Zylinder: 4 - 6 for cylinder: 4 - 6	
			7.22738.08.0	SLP	EL	
TT (FV3, FVP)						85
2.0 TDI 135 kW (184 PS) CUNA	07.2014→		7.10334.02.0	AGR	EL 	
			7.08369.81.0	ATS	EL	
			7.11492.03.0	DDS	ohne Zubehör without accessories	
2.0 TDI quattro 135 kW (184 PS) CUNA	01.2017→		7.08369.81.0	ATS	EL	
			7.11492.03.0	DDS	ohne Zubehör without accessories	
2.0 TFSI 169 kW (230 PS) CHHC	07.2014→		7.03635.39.0	SLP	EL	
			7.01510.85.0	SLV	EL Produktionsdatum ab: 03.11.2015 Production date from: 03.11.2015	
			7.01510.86.0	SLV	EL Produktionsdatum bis: 02.11.2015 Production date to: 02.11.2015	
2.0 TFSI quattro 169 kW (230 PS) CHHC	07.2014→		7.03635.39.0	SLP	EL	
			7.01510.85.0	SLV	EL Produktionsdatum ab: 03.11.2015 Production date from: 03.11.2015	
			7.01510.86.0	SLV	EL Produktionsdatum bis: 02.11.2015 Production date to: 02.11.2015	
2.0 TFSI quattro 162 kW (220 PS) CNTC	04.2015→		7.03635.39.0	SLP	EL	
			7.01510.85.0	SLV	EL Produktionsdatum ab: 03.11.2015 Production date from: 03.11.2015	
			7.01510.86.0	SLV	EL Produktionsdatum bis: 02.11.2015 Production date to: 02.11.2015	
2.0 TTS quattro 228 kW (310 PS) CJXG	11.2014→		7.01510.85.0	SLV	EL Produktionsdatum ab: 03.11.2015 Production date from: 03.11.2015	
			7.01510.86.0	SLV	EL Produktionsdatum bis: 02.11.2015 Production date to: 02.11.2015	

A



TT (FV3, FVP)

85

2.0 TTS quattro 210 kW (286 PS) CJXF	02.2015→		7.01510.85.0	SLV	EL	Produktionsdatum ab: 03.11.2015 Production date from: 03.11.2015
			7.01510.86.0	SLV	EL	
2.0 TTS quattro 215 kW (292 PS) CYFB	07.2015→		7.01510.85.0	SLV	EL	Produktionsdatum ab: 03.11.2015 Production date from: 03.11.2015
			7.01510.86.0	SLV	EL	
40 TFSI 145 kW (197 PS) DKZB	07.2018→		7.01510.85.0	SLV	EL	
45 TFSI 180 kW (245 PS) DKTB	07.2018→		7.01510.85.0	SLV	EL	
45 TFSI quattro 180 kW (245 PS) DKTB	07.2018→		7.01510.85.0	SLV	EL	

TT Roadster (8J9)

86

2.0 TDI quattro 125 kW (170 PS) CBBB	06.2008→06.2014		7.10334.00.0	AGR	EL	ohne Zubehör without accessories
			7.08369.00.0	ATS	EL	
			7.08369.01.0	ATS	EL	
			7.08369.03.0	ATS	EL	
			7.11492.02.0	DDS		
2.0 TDI quattro 125 kW (170 PS) CFGB	06.2008→06.2014		7.09720.00.0	AGR-K	EL	
			7.11190.09.0	DDS		
2.5 RS quattro 250 kW (340 PS) CEPA	07.2009→06.2014		7.05271.15.0	LS	525 mm	
2.5 RS quattro 265 kW (360 PS) CEPB	03.2012→06.2014		7.05271.15.0	LS	525 mm	
3.2 V6 quattro 184-186 kW (250-253 PS) BUB	03.2007→06.2010		7.05271.19.0	LS	975 mm	Diagnosesonde Diagnostic Probe für Zylinder: 4-6 for cylinder: 4-6
			7.05271.28.0	LS	800 mm	
			7.22738.20.0	SLP	EL	
3.2 V6 quattro 184 kW (250 PS) CBRA	03.2007→06.2010		7.22778.98.0	SLV	PN	Fahrgestellnummer ab: 8J-8-000 001 Vehicle Identification Number from: 8J-8-000 001
			7.22286.51.0	ARV	PN	

TT Roadster (8N9)

87

1.8 T 132 kW (180 PS) AJQ	10.1999→06.2006		7.05270.89.0	LS	925 mm	Allrad All-wheel Drive Regelsonde Regulating Probe
1.8 T 132 kW (180 PS) APP	10.1999→06.2006		7.22769.73.0	ARV	PN	
			7.21851.31.0	SLP	EL	
1.8 T 132 kW (180 PS) AUQ	10.1999→06.2006		7.22769.73.0	ARV	PN	vor Katalysator in front of the catalyst
			7.05271.23.0	LS	900 mm	
			7.05271.24.0	LS	1500 mm	
			7.21851.31.0	SLP	EL	
1.8 T 110 kW (150 PS) AUM	01.2001→06.2006		7.22769.73.0	ARV	PN	
			7.05271.23.0	LS	900 mm	

TT Roadster (8N9)
87

			7.05271.24.0	LS	1500 mm	vor Katalysator in front of the catalyst
			7.21851.31.0	SLP	EL	
1.8 T 140 kW (190 PS) BVR	09.2005→06.2006		7.22769.73.0	ARV	PN	
			7.05270.99.0	LS	940 mm	Allrad All-wheel Drive Diagnosesonde Diagnostic Probe
			7.05271.24.0	LS	1500 mm	vor Katalysator in front of the catalyst
			7.21851.31.0	SLP	EL	
1.8 T 120 kW (163 PS) BVP	09.2005→06.2006		7.22769.73.0	ARV	PN	
			7.05271.23.0	LS	900 mm	
			7.05271.24.0	LS	1500 mm	vor Katalysator in front of the catalyst
			7.21851.31.0	SLP	EL	
1.8 T quattro 165 kW (224 PS) APX	10.1999→06.2006		7.22769.73.0	ARV	PN	
			7.05271.02.0	LS	500 mm	Regelsonde Regulating Probe
			7.21851.31.0	SLP	EL	
1.8 T quattro 165 kW (224 PS) BAM	10.1999→06.2006		7.05270.99.0	LS	940 mm	ch. 8N-1-010 101→ Diagnosesonde Diagnostic Probe
			7.05270.89.0	LS	925 mm	→ch. 8N-1-010 100 Diagnosesonde Diagnostic Probe
			7.05271.77.0	LS	800 mm	vor Katalysator in front of the catalyst
1.8 T quattro 132 kW (180 PS) AJQ	02.2000→06.2006		7.05270.89.0	LS	925 mm	Allrad All-wheel Drive Regelsonde Regulating Probe
1.8 T quattro 132 kW (180 PS) ARY	02.2000→06.2006		7.22769.73.0	ARV	PN	
			7.05270.99.0	LS	940 mm	Diagnosesonde Diagnostic Probe
			7.05271.23.0	LS	900 mm	
			7.05271.24.0	LS	1500 mm	→12.2002 vor Katalysator in front of the catalyst
			7.21851.31.0	SLP	EL	
1.8 T quattro 132 kW (180 PS) AUQ	02.2000→06.2006		7.22769.73.0	ARV	PN	
			7.05271.23.0	LS	900 mm	
			7.21851.31.0	SLP	EL	
1.8 T quattro 140 kW (190 PS) BVR	09.2005→06.2006		7.22769.73.0	ARV	PN	
			7.05270.99.0	LS	940 mm	Allrad All-wheel Drive Diagnosesonde Diagnostic Probe
			7.05271.24.0	LS	1500 mm	vor Katalysator in front of the catalyst
			7.21851.31.0	SLP	EL	
3.2 VR6 quattro 184 kW (250 PS) BHE, BPF	07.2003→06.2006		7.22286.55.0	ARV	PN	

A













TT Roadster (8N9)

87

			7.05271.01.0	LS	950 mm	 BHE, BPF: nach Katalysator Post-catalyst für Zylinder: 4 - 6 for cylinder: 4 - 6
			7.05270.98.0	LS	700 mm	
			7.22738.08.0	SLP	EL	



TT Roadster (FV9, FVR)

88

2.0 TDI 135 kW (184 PS) CUNA	11.2014→		7.08369.81.0	ATS	EL	ohne Zubehör without accessories
			7.11492.03.0	DDS		
2.0 TDI quattro 135 kW (184 PS) CUNA	01.2017→		7.08369.81.0	ATS	EL	ohne Zubehör without accessories
			7.11492.03.0	DDS		
2.0 TFSI 169 kW (230 PS) CHHC	11.2014→		7.03635.39.0	SLP	EL	Produktionsdatum ab: 03.11.2015 Production date from: 03.11.2015 Produktionsdatum bis: 02.11.2015 Production date to: 02.11.2015
			7.01510.85.0	SLV	EL	
			7.01510.86.0	SLV	EL	
2.0 TFSI quattro 169 kW (230 PS) CHHC	11.2014→		7.03635.39.0	SLP	EL	Produktionsdatum ab: 03.11.2015 Production date from: 03.11.2015 Produktionsdatum bis: 02.11.2015 Production date to: 02.11.2015
			7.01510.85.0	SLV	EL	
			7.01510.86.0	SLV	EL	
2.0 TFSI quattro 162 kW (220 PS) CNTC	04.2015→		7.03635.39.0	SLP	EL	Produktionsdatum ab: 03.11.2015 Production date from: 03.11.2015 Produktionsdatum bis: 02.11.2015 Production date to: 02.11.2015
			7.01510.85.0	SLV	EL	
			7.01510.86.0	SLV	EL	
2.0 TTS quattro 228 kW (310 PS) CJXG	11.2014→		7.01510.85.0	SLV	EL	Produktionsdatum ab: 03.11.2015 Production date from: 03.11.2015 Produktionsdatum bis: 02.11.2015 Production date to: 02.11.2015
			7.01510.86.0	SLV	EL	
2.0 TTS quattro 210 kW (286 PS) CJXF	02.2015→		7.01510.85.0	SLV	EL	Produktionsdatum ab: 03.11.2015 Production date from: 03.11.2015 Produktionsdatum bis: 02.11.2015 Production date to: 02.11.2015
			7.01510.86.0	SLV	EL	
40 TFSI 145 kW (197 PS) DKZB	07.2018→		7.01510.85.0	SLV	EL	
45 TFSI 180 kW (245 PS) DKTB	07.2018→		7.01510.85.0	SLV	EL	
45 TFSI quattro 180 kW (245 PS) DKTB	07.2018→		7.01510.85.0	SLV	EL	

Q5 Van (8RB)

89

2.0 TDI quattro 125 kW (170 PS) CAHA	11.2008→09.2012		7.08369.14.0	ATS	EL	für Fahrzeuge mit Schaltgetriebe for vehicles with manual transmission
			7.08369.16.0	ATS	EL	
3.0 TDI quattro 176 kW (240 PS) CCWA	11.2008→04.2013		7.08369.13.0	ATS	EL	Euro 5 Euro 5
			7.08369.45.0	ATS	EL	









Q5 Van (8RB)						89
3.2 FSI quattro 199 kW (270 PS) CALB	11.2008→09.2012		7.22286.52.0	ARV	PN	○ rechts Right USA USA
			7.22286.53.0	ARV	PN	○ links Left
Q7 Van (4LB)						90
3.0 TDI quattro 155 kW (211 PS) BUN	03.2006→05.2010		7.08369.13.0	ATS	EL	
3.0 TDI quattro 155 kW (211 PS) CASB	03.2006→05.2010		7.08369.13.0	ATS	EL	
			7.08369.45.0	ATS	EL	ab Euro 5 From Euro 5
3.0 TDI quattro 171 kW (233 PS) BUG	03.2006→05.2008		7.08369.13.0	ATS	EL	
3.0 TDI quattro 176 kW (240 PS) CASA, CCMA	11.2007→05.2012		7.08369.13.0	ATS	EL	
			7.08369.45.0	ATS	EL	CASA, CASA, CCMA: Euro 5, Euro 6 Euro 5, Euro 6
3.0 TDI quattro 176 kW (240 PS) CJGA	11.2007→05.2012		7.08369.45.0	ATS	EL	Euro 5, Euro 6 Euro 5, Euro 6
3.0 TDI quattro 150 kW (204 PS) CJMA	11.2010→08.2015		7.08369.45.0	ATS	EL	Euro 6 Euro 6
3.0 TDI quattro 180 kW (245 PS) CLZB, CRCA	05.2011→08.2015		7.08369.45.0	ATS	EL	CLZB, CRCA: Euro 6 Euro 6
3.0 TFSI quattro 245 kW (333 PS) CJTB	05.2010→08.2015		7.22286.52.0	ARV	PN	○ rechts Right
			7.22286.53.0	ARV	PN	○ links Left
			7.03635.40.0	SLP	EL	Produktionsdatum ab: 17.11.2014 Production date from: 17.11.2014
4.2 FSI quattro 231-257 kW (314-350 PS) BAR	08.2006→05.2010		7.22769.79.0	ARV	PN	○ ch. 4L-8-000 001→ch. 4L-8-095 000 USA USA
			7.22778.97.0	SLV	PN	○ Fahrgestellnummer bis: 4L-9-015 000 Vehicle Identification Number to: 4L-9-015 000
4.2 TDI quattro 240 kW (326 PS) BTR	03.2007→06.2009		7.08369.42.0	ATS	EL	Fahrgestellnummer ab: 4L-7-098 419 Vehicle Identification Number from: 4L-7-098 419 vor Rußpartikelfilter before soot particulate filter Euro 4 Euro 4

A











A4 B6 (8E2)

1

1.8 T 120 kW (163 PS) BFB, BKB	02.2003→07.2005		7.22560.43.0	ARV	PN	
2.4 125 kW (170 PS) BDV	01.2004→07.2005		7.22560.40.0	ARV	PN	 Fahrgestellnummer bis: 8E-5-400 000 Vehicle Identification Number to: 8E-5-400 000 links Left
			7.22560.41.0	ARV	PN	 rechts Right
3.0 quattro 160 kW (218 PS) BBJ	02.2003→07.2005		7.22560.44.0	ARV	PN	  →ch. 8E-5-400 000 links Left
			7.22560.45.0	ARV	PN	 rechts Right





A4 B7 (8YC)

2

1.8 T 120 kW (163 PS) BKB	04.2003→09.2008		7.22560.43.0	ARV	PN	
2.0 T 147 kW (200 PS) BGB	07.2005→09.2008		7.22560.43.0	ARV	PN	
3.0 quattro 160 kW (218 PS) BBJ	07.2005→09.2008		7.22560.44.0	ARV	PN	  ch. 8E-5-400 001→ links Left
			7.22560.45.0	ARV	PN	 rechts Right
			7.05271.77.0	LS	800 mm	 ch. 8E-5-400 001→ vor Katalysator in front of the catalyst



A4L B8 (828)

3

3.2 quattro 195 kW (265 PS) CALA	01.2009→12.2011		7.05574.00.0	SLV	PN	  ch. 8K-8-000 001→ rechts Right
			7.05574.01.0	SLV	PN	  ch. 8K-8-000 001→ links Left

A6 C5 (4Y8)

4

2.4 125 kW (170 PS) BDV	06.2002→12.2005		7.22560.40.0	ARV	PN	 Fahrgestellnummer bis: 4B-5-017 720 Vehicle Identification Number to: 4B-5-017 720 links Left
			7.22560.41.0	ARV	PN	 Fahrgestellnummer bis: 4B-5-017 750 Vehicle Identification Number to: 4B-5-017 750 rechts Right

A6 C5 (4Y8)						4
2.8 140 kW (190 PS) BBG	09.2000→07.2005		7.22560.40.0	ARV	PN	Fahrgestellnummer bis: 4B-5-017 720 Vehicle Identification Number to: 4B-5-017 720 links Left
			7.22560.41.0	ARV	PN	
A6L C6 (4Z8)						5
2.4 130 kW (177 PS) BDW	03.2005→12.2012		7.22738.08.0	SLP	EL	ch. 4F-5-000 001→
			7.22778.94.0	SLV	PN	ch. 4F-5-000 001→
2.7 TDI 140 kW (190 PS) CANA	08.2009→12.2012		7.01106.38.0	AGR-K	EL	
2.8 154-162 kW (209-220 PS) BDX	11.2007→12.2008		7.22738.08.0	SLP	EL	ch. 4F-5-000 001→
2.8 162 kW (220 PS) CCE	01.2008→12.2012		7.22738.08.0	SLP	EL	ch. 4F-5-000 001→
			7.05574.00.0	SLV	PN	ch. 4F-5-000 001→ rechts Right
			7.05574.01.0	SLV	PN	
2.8 quattro 162 kW (220 PS) CCEA	09.2008→12.2012		7.05574.00.0	SLV	PN	rechts Right
			7.05574.01.0	SLV	PN	links Left
3.0 160 kW (218 PS) BBJ	03.2005→12.2006		7.22560.44.0	ARV	PN	ch. 4F-5-000 001→ links Left
			7.22560.45.0	ARV	PN	
			7.22738.08.0	SLP	EL	ch. 4F-5-000 001→
3.0 TFSI quattro 213 kW (290 PS) CAJA	09.2008→12.2012		7.22286.53.0	ARV	PN	links Left
3.0 quattro 160 kW (218 PS) BBJ	03.2005→12.2006		7.22560.44.0	ARV	PN	ch. 4F-5-000 001→ links Left
			7.22560.45.0	ARV	PN	
			7.22738.08.0	SLP	EL	ch. 4F-5-000 001→
4.2 quattro 246 kW (335 PS) BAT	09.2005→12.2006		7.22560.41.0	ARV	PN	ch. 4F-5-000 001→ rechts Right

A



A6L C6 (4Z8)

5

		7.22738.08.0	SLP	EL	ch. 4F-5-000 001→
4.2 quattro 257 kW (349 PS) BVJ	11.2006→10.2008	7.01486.10.0	SLP	EL	Fahrgestellnummer ab: 4F-5-000 001 Vehicle Identification Number from: 4F-5-000 001



















A6L C7 (4X8, 4XL)

6

30 FSI 140 kW (190 PS) CLXA	01.2012→12.2016	7.22286.53.0	ARV	PN	ch. 4G-C-000 001→ links Left Produktionsdatum ab: 29.07.2013 Production date from: 29.07.2013
		7.22286.52.0	ARV	PN	rechts Right Produktionsdatum ab: 29.07.2013 Production date from: 29.07.2013
		7.22934.57.0	SLP	EL	ch. 4G-C-000 001→
		7.05574.00.0	SLV	PN	ch. 4G-C-000 001→ rechts Right Produktionsdatum bis: 29.07.2013 Production date to: 29.07.2013
		7.05574.01.0	SLV	PN	ch. 4G-C-000 001→ links Left Produktionsdatum bis: 29.07.2013 Production date to: 29.07.2013
30 FSI 150 kW (204 PS) CLXB	01.2016→12.2018	7.22286.52.0	ARV	PN	rechts Right
		7.22286.53.0	ARV	PN	links Left
		7.22934.57.0	SLP	EL	
35 FSI 162 kW (220 PS) CNYB	01.2012→12.2015	7.22286.52.0	ARV	PN	ch. 4G-C-000 001→ rechts Right Produktionsdatum ab: 29.07.2013 Production date from: 29.07.2013
		7.22286.53.0	ARV	PN	ch. 4G-C-000 001→ links Left Produktionsdatum ab: 29.07.2013 Production date from: 29.07.2013
		7.22934.57.0	SLP	EL	ch. 4G-C-000 001→
		7.05574.00.0	SLV	PN	ch. 4G-C-000 001→ rechts Right Produktionsdatum bis: 29.07.2013 Production date to: 29.07.2013
		7.05574.01.0	SLV	PN	ch. 4G-C-000 001→ links Left Produktionsdatum bis: 29.07.2013 Production date to: 29.07.2013
35 FSI quattro 162 kW (220 PS) CNYB	01.2012→12.2016	7.22286.52.0	ARV	PN	ch. 4G-C-000 001→ rechts Right Produktionsdatum ab: 29.07.2013 Production date from: 29.07.2013



A6L C7 (4X8, 4XL) **6**



























			7.22286.53.0	ARV	PN	 ch. 4G-C-000 001→ links Left Produktionsdatum ab: 29.07.2013 Production date from: 29.07.2013
			7.22934.57.0	SLP	EL	 ch. 4G-C-000 001→
			7.05574.00.0	SLV	PN	 ch. 4G-C-000 001→ rechts Right Produktionsdatum bis: 29.07.2013 Production date to: 29.07.2013
			7.05574.01.0	SLV	PN	 ch. 4G-C-000 001→ links Left Produktionsdatum bis: 29.07.2013 Production date to: 29.07.2013
45 TFSI quattro 200 kW (272 PS) CTDB	01.2016→12.2018		7.06714.21.0	ARV	PN	 rechts Right
			7.22286.53.0	ARV	PN	 links Left
			7.22934.57.0	SLP	EL	
50 TFSI quattro 200-228 kW (272-310 PS) CHMA	01.2012→01.2014		7.22286.52.0	ARV	PN	 ch. 4G-C-000 001→ rechts Right
			7.22286.53.0	ARV	PN	 ch. 4G-C-000 001→ links Left
			7.22934.57.0	SLP	EL	 ch. 4G-C-000 001→
50 TFSI quattro 228 kW (310 PS) CTTA	01.2014→12.2016		7.22286.52.0	ARV	PN	 ch. 4G-C-000 001→ rechts Right
			7.22286.53.0	ARV	PN	 ch. 4G-C-000 001→ links Left
			7.22934.57.0	SLP	EL	 ch. 4G-C-000 001→
50 TFSI quattro 245 kW (333 PS) CREC	01.2016→12.2018		7.06714.21.0	ARV	PN	 rechts Right
			7.22286.53.0	ARV	PN	 links Left
			7.22934.57.0	SLP	EL	

A



Y10 **1**

1.0 33 kW (45 PS) 156 A2.000	03.1985→10.1995		7.02604.03.0	LS	200 mm
1.0 38-41 kW (52-56 PS) 156A.000	03.1985→10.1995		7.02604.03.0	LS	200 mm
1.3 i.e. GT 57 kW (78 PS) 156B.000	06.1989→10.1995		7.02604.03.0	LS	200 mm
1.3 i.e. GT 54 kW (73 PS) 146A5.046	06.1989→10.1995		7.02604.03.0	LS	200 mm

							
BENTAYGA (4V1)						1	B
6.0 447-467 kW (608-635 PS) DDBB	10.2015→		7.06712.23.0	ARV	PN		
			7.03635.12.0	SLP	EL		
6.0 467 kW (635 PS) DDBD	03.2019→		7.06712.23.0	ARV	PN		
			7.03635.12.0	SLP	EL		
CONTINENTAL Convertible (3S_)						2	
6.0 AWD 467 kW (635 PS) DDBD	12.2018→		7.06712.23.0	ARV	PN		
CONTINENTAL Convertible (3W_, 394)						3	
4.0 AWD 388-389 kW (528-529 PS) CMMD, CYCA	09.2014→		7.06713.09.0	ARV	PN	 CMMD: für Zylinder: 1-4 for cylinder: 1-4 2014 2014  CYCA: für Zylinder: 1-4 for cylinder: 1-4 2015 2015	
			7.06713.10.0	ARV	PN	 CMMD: für Zylinder: 5-8 for cylinder: 5-8 2014 2014  CYCA: für Zylinder: 5-8 for cylinder: 5-8 2015 2015	
			7.03635.12.0	SLP	EL	 CMMD: 2014 2014  CYCA: 2015 2015	
4.0 FLEX AWD 373 kW (507 PS) CMMC, CYCB	04.2012→		7.06713.09.0	ARV	PN	 CMMC: für Zylinder: 1-4 for cylinder: 1-4 2014 2014  CYCB: für Zylinder: 1-4 for cylinder: 1-4 2015 2015	
			7.06713.10.0	ARV	PN	 CMMC: für Zylinder: 5-8 for cylinder: 5-8 2014 2014  CYCB: für Zylinder: 5-8 for cylinder: 5-8 2015 2015	
			7.03635.12.0	SLP	EL	 CMMC: 2014 2014  CYCB: 2015 2015	
4.0 FLEX AWD 388-389 kW (528-529 PS) CMMD, CYCA	12.2013→		7.06713.09.0	ARV	PN	 CMMD: für Zylinder: 1-4 for cylinder: 1-4 2014 2014  CYCA: für Zylinder: 1-4 for cylinder: 1-4 2015 2015	



B

CONTINENTAL Convertible (3W_, 394)

3

			7.06713.10.0	ARV	PN	CMMD: für Zylinder: 5-8 for cylinder: 5-8 2014 2014 CYCA: für Zylinder: 5-8 for cylinder: 5-8 2015 2015
			7.03635.12.0	SLP	EL	CMMD: 2014 2014 CYCA: 2015 2015
6.0 AWD 423 kW (575 PS) CVAB	11.2011→		7.03635.12.0	SLP	EL	2015 2015
6.0 AWD 434 kW (590 PS) DBDA	11.2017→07.2018		7.03635.12.0	SLP	EL	
6.0 AWD 472 kW (642 PS) DBDD	11.2017→07.2018		7.03635.12.0	SLP	EL	
6.0 CS ISR 467-472 kW (635-642 PS) CVAC	03.2011→		7.03635.12.0	SLP	EL	2015 2015
6.0 FLEX AWD 467-472 kW (635-642 PS) CVAC	05.2014→		7.03635.12.0	SLP	EL	
6.0 FLEX AWD 434 kW (590 PS) DBDA	05.2015→		7.03635.12.0	SLP	EL	
6.0 FLEX AWD 472 kW (642 PS) DBDD	01.2016→		7.03635.12.0	SLP	EL	
6.0 GTC Speed AWD 467-472 kW (635-642 PS) CVAC, DBDE	05.2014→05.2016		7.03635.12.0	SLP	EL	

CONTINENTAL Coupe (3S3)

4





















6.0 W12 AWD 467 kW (635 PS) DDBD	09.2017→		7.06712.23.0	ARV	PN	
--	----------	--	---------------------	-----	----	--

CONTINENTAL Coupe (3W_, 393)

5

4.0 373 kW (507 PS) CMMC	09.2011→		7.06713.09.0	ARV	PN	für Zylinder: 1-4 for cylinder: 1-4 2014 2014
			7.06713.10.0	ARV	PN	für Zylinder: 5-8 for cylinder: 5-8 2014 2014
			7.03635.12.0	SLP	EL	2014 2014
4.0 373 kW (507 PS) CYCB	09.2011→		7.06713.09.0	ARV	PN	für Zylinder: 1-4 for cylinder: 1-4 2015 2015
			7.03635.12.0	SLP	EL	2015 2015
4.0 388-389 kW (528-529 PS) CMMD, CYCA	01.2014→		7.06713.09.0	ARV	PN	CMMD, CYCA: für Zylinder: 1-4 for cylinder: 1-4 2014 2014

CONTINENTAL Coupe (3W_, 393)
5
B

			7.06713.10.0	ARV	PN	 CMMD: für Zylinder: 5-8 for cylinder: 5-8 2014 2014  CYCA: für Zylinder: 5-8 for cylinder: 5-8 2015 2015
			7.03635.12.0	SLP	EL	 CMMD: 2014 2014  CYCA: 2015 2015
4.0 FLEX 373 kW (507 PS) CMMC	09.2011→		7.06713.09.0	ARV	PN	 für Zylinder: 1-4 for cylinder: 1-4 2014 2014
			7.06713.10.0	ARV	PN	 für Zylinder: 5-8 for cylinder: 5-8 2014 2014
			7.03635.12.0	SLP	EL	2014 2014
4.0 FLEX 388-389 kW (528-529 PS) CMMC, CYCA	12.2013→		7.06713.09.0	ARV	PN	 CMMD: für Zylinder: 1-4 for cylinder: 1-4 2014 2014  CYCA: für Zylinder: 1-4 for cylinder: 1-4 2015 2015
			7.06713.10.0	ARV	PN	 CMMD: für Zylinder: 5-8 for cylinder: 5-8 2014 2014  CYCA: für Zylinder: 5-8 for cylinder: 5-8 2015 2015
			7.03635.12.0	SLP	EL	 CMMD: 2014 2014  CYCA: 2015 2015
4.0 FLEX 426 kW (579 PS) DCCA	10.2014→		7.03635.12.0	SLP	EL	
4.0 GT 373 kW (507 PS) CMMC	04.2012→		7.06713.09.0	ARV	PN	 für Zylinder: 1 - 4 for cylinder: 1 - 4 2014 2014
			7.06713.10.0	ARV	PN	 für Zylinder: 5-8 for cylinder: 5-8 2014 2014
			7.03635.12.0	SLP	EL	2014 2014
4.0 GT 373 kW (507 PS) CYCB	04.2012→		7.06713.09.0	ARV	PN	 für Zylinder: 1-4 for cylinder: 1-4 2015 2015
			7.03635.12.0	SLP	EL	2015 2015



B

CONTINENTAL Coupe (3W_, 393)

5

6.0 423 kW (575 PS) CVAB	09.2012→05.2015		7.03635.12.0	SLP	EL	2015 2015
6.0 AWD 434 kW (590 PS) DBDA	08.2015→		7.03635.12.0	SLP	EL	
6.0 FLEX 467-472 kW (635-642 PS) CVAC	05.2014→		7.03635.12.0	SLP	EL	
6.0 FLEX 434 kW (590 PS) DBDA	05.2015→		7.03635.12.0	SLP	EL	
6.0 FLEX 472 kW (642 PS) DBDD	09.2016→		7.03635.12.0	SLP	EL	
6.0 GT 412 kW (560 PS) BEB, BWR	06.2003→12.2011		7.05271.77.0	LS	800 mm	
			7.05271.24.0	LS	1500 mm	
6.0 GT Speed 467-472 kW (635-642 PS) CVAC, DBDE	05.2014→05.2016		7.03635.12.0	SLP	EL	
6.0 GT Speed 472 kW (642 PS) DBDD	05.2016→		7.03635.12.0	SLP	EL	

















CONTINENTAL FLYING SPUR (3W_)

6

6.0 412 kW (560 PS) BEB, BWR	03.2005→12.2010		7.05271.24.0	LS	1500 mm	
--	-----------------	--	---------------------	----	------------	--

FLYING SPUR (4W_)

7







4.0 388-389 kW (528-529 PS) CYCA	09.2014→		7.06713.09.0	ARV	PN	 für Zylinder: 1-4 for cylinder: 1-4
			7.03635.12.0	SLP	EL	
4.0 FLEX 373 kW (507 PS) CMMC	03.2013→		7.06713.09.0	ARV	PN	 für Zylinder: 1-4 for cylinder: 1-4
			7.06713.10.0	ARV	PN	 für Zylinder: 5-8 for cylinder: 5-8
			7.03635.12.0	SLP	EL	
4.0 FLEX 373 kW (507 PS) CYCB	03.2013→		7.03635.12.0	SLP	EL	
4.0 FLEX 388-389 kW (528-529 PS) CYCA	06.2016→		7.06713.09.0	ARV	PN	 für Zylinder: 1-4 for cylinder: 1-4
			7.06713.10.0	ARV	PN	 für Zylinder: 5-8 for cylinder: 5-8
			7.03635.12.0	SLP	EL	
4.0 V8 373 kW (507 PS) CMMC	03.2013→10.2020		7.06713.09.0	ARV	PN	 für Zylinder: 1-4 for cylinder: 1-4
			7.03635.12.0	SLP	EL	
4.0 V8 373 kW (507 PS) CYCB	03.2013→10.2020		7.06713.09.0	ARV	PN	 für Zylinder: 1-4 for cylinder: 1-4
			7.06713.10.0	ARV	PN	 für Zylinder: 5-8 for cylinder: 5-8
			7.03635.12.0	SLP	EL	
6.0 453-460 kW (616-626 PS) CVAA	03.2014→		7.03635.12.0	SLP	EL	
6.0 FLEX 453-460 kW (616-626 PS) CVAA	03.2013→		7.03635.12.0	SLP	EL	für PR-Nummer: T46 for PR number: T46
6.0 FLEX 453-460 kW (616-626 PS) CVAA	01.2014→		7.03635.12.0	SLP	EL	für PR-Nummer: T46 for PR number: T46



FLYING SPUR (4W_)

7

B

6.0 W12 453-460 kW (616-626 PS) CVAA, DBDB	03.2013→10.2020	 7.03635.12.0	SLP	EL	 CVAA, DBDB: für PR-Nummer: T46 für PR number: T46
V8 S 4.0 388-389 kW (528-529 PS) CYCA	05.2016→	 7.06713.09.0	ARV	PN	 für Zylinder: 1-4 for cylinder: 1-4
		7.06713.10.0	ARV	PN	 für Zylinder: 5-8 for cylinder: 5-8
		7.03635.12.0	SLP	EL	
W12 S 6.0 467 kW (635 PS) DBDE	11.2016→	 7.03635.12.0	SLP	EL	für PR-Nummer: T46 für PR number: T46

FLYING SPUR (ZG2_)

8



































6.0 W12 TSI 4WD (ZG21BB) 467 kW (635 PS) DDBD	04.2019→	 7.06712.23.0	ARV	PN	
--	----------	---	-----	----	--



























B

1 (E81)

1

116 d 66-150 kW (90-204 PS) N47 D20 A, N47 D20 C	11.2008→12.2011		7.00684.14.0	AGR	PN	mit Potentiometer with potentiometer
			7.10334.07.0	AGR	EL	 
116 d 66-150 kW (90-204 PS) N47 D20 A, N47 D20 C	01.2011→12.2011		7.00684.14.0	AGR	PN	mit Potentiometer with potentiometer
						 
116 i 89-90 kW (121-122 PS) N43 B16 AA	03.2007→12.2011		7.24809.50.0	AGR	ET	
			7.02604.41.0	LS	700 mm	
			7.02604.34.0	LS	600 mm	
116 i 85 kW (115 PS) N45 B16 A	09.2007→12.2011		7.02604.41.0	LS	700 mm	vor Katalysator in front of the catalyst
			7.02604.34.0	LS	600 mm	
116 i 90-125 kW (122-170 PS) N43 B20 A	11.2008→12.2011		7.24809.50.0	AGR	ET	
			7.02604.41.0	LS	700 mm	
118 d 66-150 kW (90-204 PS) N47 D20 A, N47 D20 C	09.2006→12.2011		7.00684.14.0	AGR	PN	mit Potentiometer with potentiometer
			7.10334.07.0	AGR	EL	 
118 d 66-150 kW (90-204 PS) N47 D20 A, N47 D20 C	09.2006→12.2011		7.00684.14.0	AGR	PN	mit Potentiometer with potentiometer
			7.10334.07.0	AGR	EL	 
118 i 90-125 kW (122-170 PS) N43 B20 A	09.2006→12.2011		7.24809.50.0	AGR	ET	
			7.02604.41.0	LS	700 mm	
			7.02604.34.0	LS	600 mm	
118 i 95-125 kW (129-170 PS) N46 B20 B	09.2006→12.2011		7.02604.34.0	LS	600 mm	
118 i 95-125 kW (129-170 PS) N46 B20 B	09.2006→02.2008		7.02604.41.0	LS	700 mm	vor Katalysator in front of the catalyst
120 d 66-145 kW (90-197 PS) N47 D20 A	03.2007→08.2008		7.00684.14.0	AGR	PN	mit Potentiometer with potentiometer
						
120 d 66-150 kW (90-204 PS) N47 D20 A, N47 D20 C	03.2007→12.2011		7.00684.14.0	AGR	PN	mit Potentiometer with potentiometer
			7.10334.07.0	AGR	EL	 
120 d 66-150 kW (90-204 PS) N47 D20 A, N47 D20 C	03.2007→12.2011		7.00684.14.0	AGR	PN	mit Potentiometer with potentiometer
						
120 d 66-150 kW (90-204 PS) N47 D20 C	09.2008→12.2011		7.00684.14.0	AGR	PN	mit Potentiometer with potentiometer
			7.10334.07.0	AGR	EL	 
						
120 i 90-125 kW (122-170 PS) N43 B20 A	03.2007→09.2012		7.24809.50.0	AGR	ET	
			7.02604.41.0	LS	700 mm	vor Katalysator in front of the catalyst für Zylinder: 2+3 for cylinder: 2+3
			7.02604.34.0	LS	600 mm	

						
1 (E81)					1	B
			7.05270.21.0	LS	600 mm	vor Katalysator in front of the catalyst für Zylinder: 1 + 4 for cylinder: 1 + 4
120 i 95-125 kW (129-170 PS) N46 B20 B, N46 B20 C	03.2007→12.2011		7.02604.34.0	LS	600 mm	
120 i 90-125 kW (122-170 PS) N43 B20 A	03.2007→12.2011		7.24809.50.0	AGR	ET	
			7.02604.34.0	LS	600 mm	
123 d 150-160 kW (204-218 PS) N47 D20 B, N47 D20 D	03.2007→12.2011		7.10334.07.0	AGR	EL	
130 i 155-200 kW (211-272 PS) N52 B30 A, N52 B30 B, N52 B30 BF	09.2006→12.2011		7.02604.34.0	LS	600 mm	
			7.02604.26.0	LS	500 mm	
			7.02604.42.0	LS	1050 mm	
130 i 155-200 kW (211-272 PS) N52 B30 A, N52 B30 B, N52 B30 BF	09.2006→12.2011		7.02604.34.0	LS	600 mm	
			7.02604.26.0	LS	500 mm	
			7.02604.42.0	LS	1050 mm	
1 (E82)					2	
128i 3.0 24V 190-195 kW (258-265 PS) N51 B30	09.2007→		7.02604.34.0	LS	600 mm	
			7.02604.26.0	LS	500 mm	
			7.02604.42.0	LS	1050 mm	
			7.01318.20.0	SLV	PN	 USA USA
128i 3.0 24V (USA) 155-200 kW (211-272 PS) N52 B30 A	09.2007→		7.02604.34.0	LS	600 mm	
			7.02604.26.0	LS	500 mm	
			7.02604.42.0	LS	1050 mm	
1 (E87)					3	
116 d 66-150 kW (90-204 PS) N47 D20 A, N47 D20 C	03.2009→06.2011		7.00684.14.0	AGR	PN	mit Potentiometer with potentiometer
			7.10334.07.0	AGR	EL	
116 d 66-150 kW (90-204 PS) N47 D20 C	01.2011→12.2011		7.10334.07.0	AGR	EL	
116 i 85 kW (115 PS) N45 B16 A	06.2004→06.2011		7.02604.41.0	LS	700 mm	03.2007→ vor Katalysator in front of the catalyst
116 i 89-90 kW (121-122 PS) N43 B16 AA	09.2007→06.2011		7.24809.50.0	AGR	ET	
			7.02604.41.0	LS	700 mm	vor Katalysator in front of the catalyst
			7.02604.34.0	LS	600 mm	
116 i 90-125 kW (122-170 PS) N43 B20 A	01.2009→06.2011		7.24809.50.0	AGR	ET	



B

1 (E87)

3











































			7.02604.41.0	LS	700 mm	
118 d 85-120 kW (116-163 PS) M47 D20 (204D4)	06.2004→02.2007		7.00450.09.0	AGR	PN	für Fahrzeuge mit Diesel-Partikel-Filter (DPF) for vehicles with diesel soot filter
			7.00512.03.0	AGR	PN	für Fahrzeuge ohne Diesel-Partikel-Filter (DPF) for vehicles without diesel soot filter
118 d 66-150 kW (90-204 PS) N47 D20 A, N47 D20 C	03.2007→06.2011		7.00684.14.0	AGR	PN	mit Potentiometer with potentiometer
			7.10334.07.0	AGR	EL	
118 d 66-150 kW (90-204 PS) N47 D20 A, N47 D20 C	03.2007→06.2011		7.00684.14.0	AGR	PN	mit Potentiometer with potentiometer
			7.10334.07.0	AGR	EL	
118 i 90-125 kW (122-170 PS) N43 B20 A	09.2006→06.2011		7.24809.50.0	AGR	ET	
			7.05271.23.0	LS	900 mm	
			7.02604.41.0	LS	700 mm	
			7.02604.34.0	LS	600 mm	
118 i 90-125 kW (122-170 PS) N43 B20 A	03.2007→12.2007		7.24809.50.0	AGR	ET	
			7.05271.23.0	LS	900 mm	
			7.02604.34.0	LS	600 mm	
120 d 85-120 kW (116-163 PS) M47 D20 (204D4)	06.2004→02.2007		7.00450.09.0	AGR	PN	→01.2007 für Fahrzeuge mit Diesel-Partikel-Filter (DPF) for vehicles with diesel soot filter
			7.00512.03.0	AGR	PN	für Fahrzeuge ohne Diesel-Partikel-Filter (DPF) for vehicles without diesel soot filter
120 d 85-120 kW (116-163 PS) M47 D20 (204D4)	06.2004→02.2007		7.00450.09.0	AGR	PN	für Fahrzeuge mit Diesel-Partikel-Filter (DPF) for vehicles with diesel soot filter
			7.00512.03.0	AGR	PN	für Fahrzeuge ohne Diesel-Partikel-Filter (DPF) for vehicles without diesel soot filter
120 d 85-120 kW (116-163 PS) M47 D20 (204D4)	05.2006→02.2007		7.00512.03.0	AGR	PN	für Fahrzeuge ohne Diesel-Partikel-Filter (DPF) for vehicles without diesel soot filter
120 d 66-145 kW (90-197 PS) N47 D20 A	03.2007→06.2011		7.10334.07.0	AGR	EL	
120 d 66-145 kW (90-197 PS) N47 D20 A	03.2007→06.2011		7.00684.14.0	AGR	PN	mit Potentiometer with potentiometer
			7.10334.07.0	AGR	EL	
120 d 66-150 kW (90-204 PS) N47 D20 C	03.2007→06.2011		7.10334.07.0	AGR	EL	
120 i 95-125 kW (129-170 PS) N46 B20 B, N46 B20 BD, N46 B20 C	06.2004→02.2007		7.05271.22.0	LS	600 mm	N46 B20 B, N46 B20 BD, N46 B20 C: vor Katalysator in front of the catalyst für Zylinder: 1 + 4 for cylinder: 1 + 4
			7.24809.50.0	AGR	ET	
120 i 90-125 kW (122-170 PS) N43 B20 A	03.2007→06.2011		7.24809.50.0	AGR	ET	

1 (E87)					3	B
			7.02604.41.0	LS	700 mm	für Zylinder: 2+3 for cylinder: 2+3
			7.02604.34.0	LS	600 mm	
120 i 90-125 kW (122-170 PS) N43 B20 A	03.2007→06.2011		7.24809.50.0	AGR	ET	
			7.02604.41.0	LS	700 mm	für Zylinder: 2+3 for cylinder: 2+3
			7.02604.34.0	LS	600 mm	
			7.05270.21.0	LS	600 mm	vor Katalysator in front of the catalyst für Zylinder: 1 + 4 for cylinder: 1 + 4
123 d 150-160 kW (204-218 PS) N47 D20 D	03.2009→06.2011		7.10334.07.0	AGR	EL	
130 i 155-200 kW (211-272 PS) N52 B30 A, N52 B30 AF, N52 B30 BF	09.2005→02.2007		7.02604.34.0	LS	600 mm	
			7.02604.26.0	LS	500 mm	
			7.02604.99.0	LS	400 mm	
			7.02604.42.0	LS	1050 mm	11.2005→
130 i 155-200 kW (211-272 PS) N52 B30 A, N52 B30 AF, N52 B30 B, N52 B30 BF	03.2007→06.2011		7.02604.34.0	LS	600 mm	
			7.02604.26.0	LS	500 mm	
			7.02604.99.0	LS	400 mm	
			7.02604.42.0	LS	1050 mm	
118d 2.0 16V 90 kW (122 PS) M47 D20 TU2 UL	09.2004→03.2007		7.00450.09.0	AGR	PN	für Fahrzeuge mit Diesel-Partikel-Filter (DPF) for vehicles with diesel soot filter
1 (E88)					4	
128i 3.0 24V 190-195 kW (258-265 PS) N51 B30	12.2007→		7.02604.34.0	LS	600 mm	
			7.02604.26.0	LS	500 mm	
			7.02604.42.0	LS	1050 mm	
			7.01318.20.0	SLV	PN	USA USA
1 (F20)					5	
114 d 70-85 kW (95-116 PS) N47 D16 A	11.2012→06.2015		7.10992.00.0	AGR-K	EL	Europa Europe
			↳ 7.10334.07.0	AGR	EL	
114 d 70-85 kW (95-116 PS) B37 D15 A	07.2015→06.2019		7.04493.17.0	AGR	EL	
			7.10334.07.0	AGR	EL	
116 d 66-150 kW (90-204 PS) N47 D20 C	07.2011→02.2015		7.10334.07.0	AGR	EL	
116 d 70-85 kW (95-116 PS) N47 D16 A	03.2012→02.2015		7.10992.00.0	AGR-K	EL	Europa Europe
			↳ 7.10334.07.0	AGR	EL	



B

1 (F20) 5

116 d 70-85 kW (95-116 PS) B37 D15 A	03.2015→06.2019		7.04493.17.0	AGR	EL	
			7.10334.07.0	AGR	EL	
118 d 66-150 kW (90-204 PS) N47 D20 C	07.2011→02.2015		7.10334.07.0	AGR	EL	
			7.10334.07.0	AGR	EL	
118 d 66-150 kW (90-204 PS) N47 D20 C	07.2011→02.2015		7.10334.07.0	AGR	EL	
			7.10334.07.0	AGR	EL	
118 d 85-155 kW (116-211 PS) B47 D20 A	03.2015→06.2019		7.11010.00.0	AGR-K	EL	  Europa, Indien  Europe, India
			↳ 7.04493.17.0	AGR	EL	
118 d 85-155 kW (116-211 PS) B47 D20 A	03.2015→06.2019		7.10334.07.0	AGR	EL	
			7.11010.00.0	AGR-K	EL	 01.2015→  Europa, Indien  Europe, India
118 d xDrive 66-150 kW (90-204 PS) N47 D20 C	07.2013→02.2015		7.10334.07.0	AGR	EL	
			7.10334.07.0	AGR	EL	
118 d xDrive 85-155 kW (116-211 PS) B47 D20 A	03.2015→06.2019		7.11010.00.0	AGR-K	EL	  Europa  Europe
			↳ 7.04493.17.0	AGR	EL	
120 d 66-150 kW (90-204 PS) N47 D20 C	07.2011→06.2019		7.10992.00.0	AGR-K	EL	 →01.2015  Europa  Europe
			↳ 7.10334.07.0	AGR	EL	
			7.11190.12.0	DDS	EL	ohne Zubehör without accessories Ausstattungsvariante: Blue Performance Equipment Variant: Blue Performance
			7.02604.44.0	LS	500 mm	Ausstattungsvariante: Blue Performance Equipment Variant: Blue Performance nach Rußpartikelfilter after soot particulate filter
120 d 85-155 kW (116-211 PS) B47 D20 A	07.2011→06.2019		7.10334.07.0	AGR	EL	
			7.11010.00.0	AGR-K	EL	 01.2015→  Europa  Europe
120 d 66-150 kW (90-204 PS) N47 D20 C	07.2011→02.2015		7.10992.00.0	AGR-K	EL	  Europa  Europe
			↳ 7.10334.07.0	AGR	EL	
			7.11190.12.0	DDS	EL	ohne Zubehör without accessories Ausstattungsvariante: Blue Performance Equipment Variant: Blue Performance
			7.02604.44.0	LS	500 mm	Ausstattungsvariante: Blue Performance Equipment Variant: Blue Performance nach Rußpartikelfilter after soot particulate filter
120 d 66-150 kW (90-204 PS) N47 D20 C	07.2011→02.2015		7.10992.00.0	AGR-K	EL	  Europa  Europe
			↳ 7.10334.07.0	AGR	EL	
			7.11190.12.0	DDS	EL	ohne Zubehör without accessories Ausstattungsvariante: Blue Performance Equipment Variant: Blue Performance



























1 (F20)					5	B
			7.02604.44.0	LS	500 mm	Ausstattungsvariante: Blue Performance Equipment Variant: Blue Performance nach Rußpartikelfilter after soot particulate filter
120 d 85-155 kW (116-211 PS) B47 D20 A	03.2015→06.2019		7.11010.00.0	AGR-K	EL	 Europa Europe
			↳ 7.04493.17.0	AGR	EL	
120 d xDrive 66-150 kW (90-204 PS) N47 D20 C	11.2012→02.2015		7.10334.07.0	AGR	EL	
			7.02604.44.0	LS	500 mm	Ausstattungsvariante: Blue Performance Equipment Variant: Blue Performance nach Rußpartikelfilter after soot particulate filter
120 d xDrive 66-150 kW (90-204 PS) N47 D20 C	11.2012→02.2015		7.10334.07.0	AGR	EL	
			7.11190.12.0	DDS		ohne Zubehör without accessories Ausstattungsvariante: Blue Performance Equipment Variant: Blue Performance
			7.02604.44.0	LS	500 mm	Ausstattungsvariante: Blue Performance Equipment Variant: Blue Performance nach Rußpartikelfilter after soot particulate filter
120 d xDrive 85-155 kW (116-211 PS) B47 D20 A	03.2015→06.2019		7.11010.00.0	AGR-K	EL	 Europa Europe
			↳ 7.04493.17.0	AGR	EL	
125 d 85-170 kW (116-231 PS) B47 D20 B	03.2012→06.2019		7.10334.07.0	AGR	EL	
125 d 150-160 kW (204-218 PS) N47 D20 D	03.2012→06.2019		7.10992.00.0	AGR-K	EL	 →02.2015 Europa Europe
			↳ 7.10334.07.0	AGR	EL	
125 d 150-160 kW (204-218 PS) N47 D20 D	03.2012→02.2015		7.10992.00.0	AGR-K	EL	 Europa Europe
			↳ 7.10334.07.0	AGR	EL	
125 d 85-170 kW (116-231 PS) B47 D20 B	03.2015→06.2019		7.04493.17.0	AGR	EL	
1 (F21)					6	
114 d 70-85 kW (95-116 PS) N47 D16 A	07.2012→		7.10992.00.0	AGR-K	EL	 Europa Europe
			↳ 7.10334.07.0	AGR	EL	
114 d 70-85 kW (95-116 PS) B37 D15 A	06.2015→		7.04493.17.0	AGR	EL	
			7.10334.07.0	AGR	EL	
116 d 70-85 kW (95-116 PS) N47 D16 A	12.2011→		7.10992.00.0	AGR-K	EL	 →02.2015 Europa Europe
			↳ 7.10334.07.0	AGR	EL	
116 d 66-150 kW (90-204 PS) N47 D20 C	01.2012→		7.10334.07.0	AGR	EL	
116 d 70-85 kW (95-116 PS) B37 D15 A	03.2015→		7.04493.17.0	AGR	EL	
			7.10334.07.0	AGR	EL	







































B

1 (F21)

6

118 d 66-150 kW (90-204 PS) N47 D20 C	12.2011→02.2015	 7.10334.07.0	AGR	EL	
118 d 66-150 kW (90-204 PS) N47 D20 C	12.2011→	 7.10334.07.0	AGR	EL	
118 d 85-155 kW (116-211 PS) B47 D20 A	03.2015→	 7.11010.00.0	AGR-K	EL	 →06.2019 ■ Europa ■ Europe
		↳ 7.04493.17.0	AGR	EL	
118 d xDrive 66-150 kW (90-204 PS) N47 D20 C	05.2013→	 7.10334.07.0	AGR	EL	
118 d xDrive 85-155 kW (116-211 PS) B47 D20 A	03.2015→	 7.11010.00.0	AGR-K	EL	 →06.2019 ■ Europa ■ Europe
		↳ 7.04493.17.0	AGR	EL	
120 d 66-150 kW (90-204 PS) N47 D20 C	01.2012→02.2015	 7.10992.00.0	AGR-K	EL	 ■ Europa ■ Europe
		↳ 7.10334.07.0	AGR	EL	
		7.02604.44.0	LS	500 mm	Ausstattungsvariante: Blue Performance Equipment Variant: Blue Performance nach Rußpartikelfilter after soot particulate filter
120 d 66-150 kW (90-204 PS) N47 D20 C	07.2012→	 7.10992.00.0	AGR-K	EL	 →02.2015 ■ Europa ■ Europe
		↳ 7.10334.07.0	AGR	EL	
		7.02604.44.0	LS	500 mm	Ausstattungsvariante: Blue Performance Equipment Variant: Blue Performance nach Rußpartikelfilter after soot particulate filter
120 d 66-150 kW (90-204 PS) N47 D20 C	07.2012→	 7.10992.00.0	AGR-K	EL	 →02.2015 ■ Europa ■ Europe
		↳ 7.10334.07.0	AGR	EL	
		7.02604.44.0	LS	500 mm	Ausstattungsvariante: Blue Performance Equipment Variant: Blue Performance nach Rußpartikelfilter after soot particulate filter
120 d 85-155 kW (116-211 PS) B47 D20 A	03.2015→	 7.11010.00.0	AGR-K	EL	 ■ Europa ■ Europe
		↳ 7.04493.17.0	AGR	EL	
120 d xDrive 66-150 kW (90-204 PS) N47 D20 C	01.2012→	 7.10334.07.0	AGR	EL	
120 d xDrive 66-150 kW (90-204 PS) N47 D20 C	02.2012→02.2015	 7.10334.07.0	AGR	EL	
120 d xDrive 85-155 kW (116-211 PS) B47 D20 A	03.2015→	 7.11010.00.0	AGR-K	EL	 →06.2019 ■ Europa ■ Europe
		↳ 7.04493.17.0	AGR	EL	
125 d 150-160 kW (204-218 PS) N47 D20 D	12.2011→02.2015	 7.10992.00.0	AGR-K	EL	 ■ Europa ■ Europe
		↳ 7.10334.07.0	AGR	EL	







							
1 (F21)						6	B
125 d 150-160 kW (204-218 PS) N47 D20 D	12.2011→		7.10992.00.0	AGR-K	EL		→02.2015 " Europa " Europe
			↳ 7.10334.07.0	AGR	EL		
125 d 85-170 kW (116-231 PS) B47 D20 B	03.2015→		7.04493.17.0	AGR	EL		
1 (F40)						7	
116 d 70-85 kW (95-116 PS) B37 C15 A	07.2019→		7.05838.08.0	AGR	EL		
			7.07417.39.0	AGR	EL		
1 Convertible (E88)						8	
118 d 66-150 kW (90-204 PS) N47 D20 A, N47 D20 C	09.2008→12.2013		7.00684.14.0	AGR	PN		mit Potentiometer with potentiometer
			7.10334.07.0	AGR	EL		
118 d 66-150 kW (90-204 PS) N47 D20 A, N47 D20 C	09.2008→12.2013		7.00684.14.0	AGR	PN		mit Potentiometer with potentiometer
			7.10334.07.0	AGR	EL		
118 i 90-125 kW (122-170 PS) N43 B20 A	03.2008→12.2013		7.24809.50.0	AGR	ET		
			7.02604.41.0	LS	700 mm		
			7.02604.34.0	LS	600 mm		
118 i 95-125 kW (129-170 PS) N46 B20 B	09.2008→12.2013		7.02604.41.0	LS	700 mm		für OE-Nummer: 11 78 7 561 410, 7 561 410 for OE number: 11 78 7 561 410, 7 561 410
			7.02604.34.0	LS	600 mm		
120 d 66-150 kW (90-204 PS) N47 D20 A, N47 D20 C	03.2008→12.2013		7.00684.14.0	AGR	PN		mit Potentiometer with potentiometer
			7.10334.07.0	AGR	EL		
120 d 66-150 kW (90-204 PS) N47 D20 A, N47 D20 C	03.2008→12.2013		7.00684.14.0	AGR	PN		mit Potentiometer with potentiometer
			7.10334.07.0	AGR	EL		
120 d 66-150 kW (90-204 PS) N47 D20 C	03.2008→12.2013		7.00684.14.0	AGR	PN		mit Potentiometer with potentiometer
			7.10334.07.0	AGR	EL		
120 i 90-125 kW (122-170 PS) N43 B20 A	12.2007→10.2013		7.24809.50.0	AGR	ET		
			7.02604.41.0	LS	700 mm		für Zylinder: 2+3 for cylinder: 2+3
			7.02604.34.0	LS	600 mm		
			7.05270.21.0	LS	600 mm		vor Katalysator in front of the catalyst für Zylinder: 1 + 4 for cylinder: 1 + 4
120 i 90-125 kW (122-170 PS) N43 B20 A	03.2008→12.2013		7.24809.50.0	AGR	ET		
			7.02604.41.0	LS	700 mm		
			7.02604.34.0	LS	600 mm		
120 i 95-125 kW (129-170 PS) N46 B20 B, N46 B20 C, N46 B20 E	03.2008→12.2013		7.02604.34.0	LS	600 mm		



B





















1 Convertible (E88)

8

123 d 150-160 kW (204-218 PS) N47 D20 B, N47 D20 D	09.2008→12.2013		7.10334.07.0	AGR	EL	
125 i 155-200 kW (211-272 PS) N52 B30 A, N52 B30 B, N52 B30 BF	12.2007→10.2013		7.02604.34.0	LS	600 mm	
			7.02604.26.0	LS	500 mm	
			7.02604.42.0	LS	1050 mm	
128 i 160-172 kW (218-234 PS) N51 B30 A	12.2007→10.2013		7.01318.20.0	SLV	PN	 USA USA
135 i 200-272 kW (272-370 PS) N54 B30 A, N55 B30 A	03.2008→10.2013		7.02604.34.0	LS	600 mm	
			7.02604.26.0	LS	500 mm	
			7.02604.43.0	LS	1200 mm	
135 i 200-272 kW (272-370 PS) N55 B30 A	03.2008→12.2013		7.02604.34.0	LS	600 mm	
			7.02604.26.0	LS	500 mm	
			7.02604.43.0	LS	1200 mm	

1 Coupe (E82)

9

118 d 66-150 kW (90-204 PS) N47 D20 C	09.2009→10.2013		7.10334.07.0	AGR	EL	
118 d 66-150 kW (90-204 PS) N47 D20 C	09.2009→10.2013		7.10334.07.0	AGR	EL	
120 d 66-150 kW (90-204 PS) N47 D20 A, N47 D20 C	09.2007→10.2013		7.00684.14.0	AGR	PN	mit Potentiometer with potentiometer  
			7.10334.07.0	AGR	EL	
120 d 66-150 kW (90-204 PS) N47 D20 A, N47 D20 C	09.2007→10.2013		7.00684.14.0	AGR	PN	mit Potentiometer with potentiometer  
			7.10334.07.0	AGR	EL	
120 d 66-150 kW (90-204 PS) N47 D20 A, N47 D20 C	09.2007→10.2013		7.00684.14.0	AGR	PN	mit Potentiometer with potentiometer  
			7.10334.07.0	AGR	EL	
120 i 90-125 kW (122-170 PS) N43 B20 A	10.2007→10.2013		7.24809.50.0	AGR	ET	
			7.02604.41.0	LS	700 mm	für Zylinder: 2+3 for cylinder: 2+3
			7.02604.34.0	LS	600 mm	
			7.05270.21.0	LS	600 mm	vor Katalysator in front of the catalyst für Zylinder: 1 + 4 for cylinder: 1 + 4
123 d 150-160 kW (204-218 PS) N47 D20 B, N47 D20 D	10.2007→10.2013		7.10334.07.0	AGR	EL	
125 i 155-200 kW (211-272 PS) N52 B30 A, N52 B30 B, N52 B30 BF	03.2008→10.2013		7.02604.34.0	LS	600 mm	
			7.02604.26.0	LS	500 mm	
			7.02604.42.0	LS	1050 mm	

1 Coupe (E82) **9** **B**

128 i 160-172 kW (218-234 PS) N51 B30 A	10.2007→10.2013		7.01318.20.0	SLV	PN	USA USA
135 i 200-272 kW (272-370 PS) N54 B30 A, N55 B30 A	10.2007→10.2013		7.02604.34.0	LS	600 mm	
			7.02604.26.0	LS	500 mm	
			7.02604.43.0	LS	1200 mm	

2 Active Tourer (F45) **10**

214 d 70-85 kW (95-116 PS) B37 C15 A	07.2014→02.2018		7.04493.17.0	AGR	EL	
			7.05838.08.0	AGR	EL	
216 d 70-85 kW (95-116 PS) B37 C15 A	03.2014→		7.04493.17.0	AGR	EL	
			7.07417.39.0	AGR	EL	 Produktionsdatum ab: 01.03.2019 Production date from: 01.03.2019
218 d 100-140 kW (136-190 PS) B47 C20 A	11.2013→		7.04493.17.0	AGR	EL	
218 d 100-170 kW (136-231 PS) B47 C20 A, B47 C20 B	11.2013→		7.04493.17.0	AGR	EL	
218 d xDrive 100-170 kW (136-231 PS) B47 C20 A, B47 C20 B	12.2014→		7.04493.17.0	AGR	EL	
218 d xDrive 100-170 kW (136-231 PS) B47 C20 A, B47 C20 B	12.2014→		7.04493.17.0	AGR	EL	
220 d 100-170 kW (136-231 PS) B47 C20 A, B47 C20 B	03.2014→		7.04493.17.0	AGR	EL	
220 d 100-170 kW (136-231 PS) B47 C20 A, B47 C20 B	03.2014→		7.04493.17.0	AGR	EL	
220 d xDrive 100-170 kW (136-231 PS) B47 C20 A, B47 C20 B	03.2014→		7.04493.17.0	AGR	EL	
220 d xDrive 100-170 kW (136-231 PS) B47 C20 A, B47 C20 B	03.2014→		7.04493.17.0	AGR	EL	

2 Convertible (F23) **11**

















218 d 85-155 kW (116-211 PS) B47 D20 A	07.2015→		7.11010.00.0	AGR-K	EL	 Europa Europe
			↳ 7.04493.17.0	AGR	EL	
218 d 85-155 kW (116-211 PS) B47 D20 A	07.2015→		7.11010.00.0	AGR-K	EL	 Europa Europe
			↳ 7.04493.17.0	AGR	EL	
220 d 85-155 kW (116-211 PS) B47 D20 A	03.2014→		7.11010.00.0	AGR-K	EL	 Europa Europe
			↳ 7.04493.17.0	AGR	EL	
220 d 85-155 kW (116-211 PS) B47 D20 A	03.2014→		7.11010.00.0	AGR-K	EL	 Europa Europe
			↳ 7.04493.17.0	AGR	EL	
225 d 85-170 kW (116-231 PS) B47 D20 B	07.2015→		7.04493.17.0	AGR	EL	



B

2 Coupe (F22, F87)

12

218 d 66-150 kW (90-204 PS) N47 D20 C	03.2014→06.2015		7.10992.00.0 AGR-K EL 	ohne Zubehör without accessories Euro 5 Euro 5 nach Rußpartikelfilter after soot particulate filter Euro 5, Euro 3 Euro 5, Euro 3
			↳ 7.10334.07.0 AGR EL	
			7.11190.12.0 DDS EL	
218 d 66-150 kW (90-204 PS) N47 D20 C	03.2014→06.2015		7.10992.00.0 AGR-K EL 	für OE-Nummer: 11 71 7 823 210 for OE number: 11 71 7 823 210 Euro 5 Euro 5 ohne Zubehör without accessories Euro 5 Euro 5 nicht für Facelift: LCI not for facelift: LCI
			↳ 7.10334.07.0 AGR EL	
			7.11190.12.0 DDS EL	
218 d 85-155 kW (116-211 PS) B47 D20 A	07.2015→		7.11010.00.0 AGR-K EL 	→06.2019 Euro 6 Euro 6
			↳ 7.04493.17.0 AGR EL	
218 d 85-155 kW (116-211 PS) B47 D20 A	07.2015→06.2015		7.11010.00.0 AGR-K EL 	→06.2019 Euro 6 Euro 6
			↳ 7.04493.17.0 AGR EL	
220 d 66-150 kW (90-204 PS) N47 D20 C	10.2012→11.2014		7.10992.00.0 AGR-K EL 	ohne Zubehör without accessories Euro 5 Euro 5 nach Rußpartikelfilter after soot particulate filter Euro 5, Euro 3 Euro 5, Euro 3
			↳ 7.10334.07.0 AGR EL	
			7.11190.12.0 DDS EL	
220 d 66-150 kW (90-204 PS) N47 D20 C	10.2012→11.2014		7.10992.00.0 AGR-K EL 	ohne Zubehör without accessories Euro 5 Euro 5 nach Rußpartikelfilter after soot particulate filter Euro 5, Euro 3 Euro 5, Euro 3
			↳ 7.10334.07.0 AGR EL	
			7.11190.12.0 DDS EL	
220 d 85-155 kW (116-211 PS) B47 D20 A	03.2014→		7.11010.00.0 AGR-K EL 	11.2014→ Euro 6 Euro 6
			↳ 7.04493.17.0 AGR EL	
220 d 66-150 kW (90-204 PS) N47 D20 C	11.2014→		7.10992.00.0 AGR-K EL 	→06.2017 Euro 6 Euro 6

2 Coupe (F22, F87) **12** **B**





























			7.11190.12.0	DDS		ohne Zubehör without accessories Euro 5 Euro 5 nicht für Facelift: LCI not for facelift: LCI
			7.02604.44.0	LS	500 mm	nach Rußpartikelfilter after soot particulate filter Euro 5, Euro 3 Euro 5, Euro 3
220 d 85-155 kW (116-211 PS) B47 D20 A	11.2014→		7.11010.00.0	AGR-K	EL	 " Europa " Europe
			↳ 7.04493.17.0	AGR	EL	
220 d xDrive 85-155 kW (116-211 PS) B47 D20 A	06.2014→		7.11010.00.0	AGR-K	EL	 11.2014→ " Europa " Europe
			↳ 7.04493.17.0	AGR	EL	
220 d xDrive 85-155 kW (116-211 PS) B47 D20 A	03.2015→		7.11010.00.0	AGR-K	EL	 " Europa " Europe
			↳ 7.04493.17.0	AGR	EL	
225 d 150-160 kW (204-218 PS) N47 D20 D	01.2014→		7.10992.00.0	AGR-K	EL	 →06.2017 " Europa " Europe
			↳ 7.10334.07.0	AGR	EL	
			7.11190.12.0	DDS		ohne Zubehör without accessories Euro 5 Euro 5 nicht für Facelift: LCI not for facelift: LCI
			7.02604.44.0	LS	500 mm	nach Rußpartikelfilter after soot particulate filter Euro 5 Euro 5
225 d 85-170 kW (116-231 PS) B47 D20 B	07.2015→		7.04493.17.0	AGR	EL	

2 Gran Coupe (F44) **13**

216 d 70-85 kW (95-116 PS) B37 C15 A	03.2020→		7.07417.39.0	AGR	EL	
--	----------	--	---------------------	-----	----	--

2 Gran Tourer (F46) **14**

214 d 70-85 kW (95-116 PS) B37 C15 A	07.2015→02.2018		7.04493.17.0	AGR	EL	
216 d 70-85 kW (95-116 PS) B37 C15 A	08.2014→		7.04493.17.0	AGR	EL	
			7.05838.08.0	AGR	EL	
			7.07417.39.0	AGR	EL	 Produktionsdatum ab: 01.03.2019 Production date from: 01.03.2019
218 d 100-170 kW (136-231 PS) B47 C20 A, B47 C20 B	07.2014→		7.04493.17.0	AGR	EL	
218 d 100-170 kW (136-231 PS) B47 C20 A, B47 C20 B	07.2014→		7.04493.17.0	AGR	EL	
218 d xDrive 100-170 kW (136-231 PS) B47 C20 A, B47 C20 B	03.2015→		7.04493.17.0	AGR	EL	
218 d xDrive 100-170 kW (136-231 PS) B47 C20 A, B47 C20 B	03.2015→		7.04493.17.0	AGR	EL	

			 PIERBURG		
B					
2 Gran Tourer (F46)					14
220 d 100-170 kW (136-231 PS) B47 C20 A, B47 C20 B	09.2014→		7.04493.17.0	AGR	EL 
220 d 100-170 kW (136-231 PS) B47 C20 A, B47 C20 B	09.2014→		7.04493.17.0	AGR	EL 
220 d xDrive 100-170 kW (136-231 PS) B47 C20 A, B47 C20 B	03.2015→02.2018		7.04493.17.0	AGR	EL 
220 d xDrive 100-170 kW (136-231 PS) B47 C20 A, B47 C20 B	03.2015→02.2018		7.04493.17.0	AGR	EL 
3 (E21)					15
318 i 66-77 kW (90-105 PS) M10 B18 (184VA)	11.1979→08.1982		7.02604.01.0	LS	200 mm
3 (E30)					16
325 e 2.7 90-95 kW (122-129 PS) M20 B27 (276KB)	01.1985→08.1987		7.02604.03.0	LS	200 mm
3 (E36)					17
318 is 103 kW (140 PS) M44 B19 (194S1)	01.1996→05.1998		7.22295.66.0	ARV	PN  USA USA
			7.02604.31.0	LS	350 mm
			7.22166.38.0	SLP-M	EL
318 tds 66 kW (90 PS) M41 D17 (174T1)	01.1995→02.1998		7.21920.62.0	AGR	PN mit Rohrstützen with pipe socket 
320 i 100-110 kW (136-150 PS) M52 B20 (206S3)	01.1991→02.1998		7.02604.37.0	LS	990 mm 09.1995→ hinten, vorne Rear, Front
			7.02604.38.0	LS	975 mm →09.1995 hinten, vorne Rear, Front
323 i 120-141 kW (163-192 PS) M52 B25 (256S3)	05.1995→11.1998		7.02604.37.0	LS	990 mm
			7.02604.38.0	LS	975 mm
325 td 85-105 kW (115-143 PS) M51 D25 (256T1)	09.1991→02.1998		7.21920.62.0	AGR	PN mit Rohrstützen with pipe socket 
325 tds 85-105 kW (115-143 PS) M51 D25 (256T1)	05.1993→02.1998		7.21920.62.0	AGR	PN mit Rohrstützen with pipe socket 
328 i 141-143 kW (192-194 PS) M52 B28 (286S1)	01.1995→04.1998		7.22295.70.0	ARV	PN  USA USA
			7.02604.37.0	LS	990 mm
			7.02604.38.0	LS	975 mm
			7.21852.85.0	SLP	EL
M3 3.2 236 kW (321 PS) S50 B32 (326S1)	10.1995→01.1998		7.02604.37.0	LS	990 mm
			7.02604.30.0	LS	980 mm
			7.05270.03.0	LS	820 mm
			7.02604.28.0	LS	1120 mm

3 (E36)						17
M3 3.2 176-179 kW (239-243 PS) S52 B32 (326S2)	09.1996→05.1998		7.22295.70.0	ARV	PN	USA USA
			7.21852.85.0	SLP	EL	
3 (E46)						18
316 i 77-87 kW (105-118 PS) M43 B19 (194E1)	12.1998→02.2002		7.22295.69.0	ARV	PN	
			7.02604.31.0	LS	350 mm	
			7.22166.00.0	SLP-M	EL	
316 i 77 kW (105 PS) M43 B16 (164E3)	04.2000→02.2005		7.22295.69.0	ARV	PN	
			7.02604.32.0	LS	450 mm	
			7.22166.00.0	SLP-M	EL	
316 i 85 kW (115 PS) N42 B18 A	02.2002→02.2005		7.02604.32.0	LS	450 mm	
			7.28124.20.0	SLP	EL	
			7.28238.55.0	SLV	PN	
316 i 85 kW (115 PS) N46 B18 A	02.2002→02.2005		7.02604.32.0	LS	450 mm	
			7.28129.22.0*	SLP-M	EL	
			↳ 7.28124.20.0	SLP	EL	
316 i 77-85 kW (105-115 PS) N40 B16 A, N45 B16 A	06.2002→02.2005		7.28238.55.0	SLV	PN	
			7.28124.20.0	SLP	EL	
			7.28238.55.0	SLV	PN	
318 d 85-100 kW (116-136 PS) M47 D20 (204D1)	09.2001→03.2003		7.28264.06.0	AGR	PN	
			7.28264.06.0	AGR	PN	
318 d 85-120 kW (116-163 PS) M47 D20 (204D4)	03.2003→02.2005		7.28264.06.0	AGR	PN	M47 D20 (204D4): vor Katalysator in front of the catalyst Euro 5 Euro 5 für Rechtslenker for right-hand drive vehicles Produktionsdatum ab: 01.01.2004 Production date from: 01.01.2004 M47 D20 (204D4): vor Katalysator in front of the catalyst Euro 5 Euro 5 für Linkslenker for left-hand drive vehicles Produktionsdatum ab: 01.03.2004 Production date from: 01.03.2004
			7.02604.44.0	LS	500 mm	
318 i 77-87 kW (105-118 PS) M43 B19 (194E1)	12.1997→09.2001		7.22295.69.0	ARV	PN	
			7.02604.31.0	LS	350 mm	
			7.22166.00.0	SLP-M	EL	
318 i 95-125 kW (129-170 PS) N42 B20 A, N46 B20 A, N46 B20 C	09.2001→02.2005		7.02604.32.0	LS	450 mm	
			7.28129.22.0*	SLP-M	EL	
			↳ 7.28124.20.0	SLP	EL	
318 i 100-110 kW (136-150 PS) N42 B20 A	09.2001→02.2005		7.28238.55.0	SLV	PN	
			7.28124.20.0	SLP	EL	



B

3 (E46)

18

			7.28238.55.0	SLV	PN	
320 d 85-100 kW (116-136 PS) M47 D20 (204D1)	02.1998→08.2001		7.28264.06.0	AGR	PN	
320 d 85-100 kW (116-136 PS) M47 D20 (204D1)	04.1998→09.2001		7.28264.06.0	AGR	PN	
320 d 85-120 kW (116-163 PS) M47 D20 (204D4)	09.2001→05.2005		7.28264.06.0	AGR	PN	
			7.02604.44.0	LS	500 mm	M47 D20 (204D4): vor Katalysator in front of the catalyst Euro 4 Euro 4 für Rechtslenker for right-hand drive vehicles Produktionsdatum ab: 01.01.2004 Production date from: 01.01.2004 M47 D20 (204D4): vor Katalysator in front of the catalyst Euro 4 Euro 4 für Linkslenker for left-hand drive vehicles Produktionsdatum ab: 01.03.2004 Production date from: 01.03.2004
320 i 100-110 kW (136-150 PS) M52 B20 (206S4)	03.1998→09.2000		7.22295.62.0	ARV	PN	
			7.02604.21.0	LS	990 mm	
			7.02604.30.0	LS	980 mm	
			7.02604.31.0	LS	350 mm	
			7.22166.50.0*	SLP-M	EL	
			↳ 7.21852.24.0	SLP	EL	
320 i 120-125 kW (163-170 PS) M54 B22 (226S1)	09.2000→02.2005		7.22295.62.0	ARV	PN	
			7.02604.21.0	LS	990 mm	
			7.02604.30.0	LS	980 mm	
			7.02604.31.0	LS	350 mm	
			7.22166.50.0*	SLP-M	EL	
			↳ 7.21852.24.0	SLP	EL	
320 i 120-125 kW (163-170 PS) M54 B22 (226S1)	09.2000→02.2005		7.21852.24.0	SLP	EL	
323 i 120-141 kW (163-192 PS) M52 B25 (256S4)	03.1998→09.2000		7.22295.62.0	ARV	PN	
			7.02604.21.0	LS	990 mm	
			7.02604.30.0	LS	980 mm	
			7.02604.31.0	LS	350 mm	
			7.22166.50.0*	SLP-M	EL	
			↳ 7.21852.24.0	SLP	EL	
323 i 120-141 kW (163-192 PS) M52 B25 (256S4)	03.1998→09.2000		7.22295.62.0	ARV	PN	
			7.21852.24.0	SLP	EL	
325 i 137-141 kW (186-192 PS) M54 B25 (256S5)	09.2000→04.2005		7.22295.62.0	ARV	PN	 →03.2003 USA USA
			7.21852.24.0	SLP	EL	

3 (E46) **18** **B**









			7.28238.61.0	SLV	PN	 03.2003→ USA USA
325 i 137 kW (186 PS) M56 B25 (256S6)	09.2000→04.2005		7.28124.21.0	SLP	EL	
325 i 137-141 kW (186-192 PS) M54 B25 (256S5)	09.2000→02.2005		7.22295.62.0	ARV	PN	
			7.02604.21.0	LS	990 mm	
			7.02604.30.0	LS	980 mm	
			7.02604.31.0	LS	350 mm	
			7.28124.19.0	SLP	EL	03.2003→ USA USA
			7.28124.21.0	SLP	EL	
			7.22166.50.0*	SLP-M	EL	
			↳ 7.21852.24.0	SLP	EL	
			7.28238.61.0	SLV	PN	
325 i 132 kW (179 PS) M56 B25 (256S6)	09.2002→01.2005		7.22295.65.0	ARV	PN	
			7.28124.21.0	SLP	EL	
325 xi 137-141 kW (186-192 PS) M54 B25 (256S5)	09.2000→04.2005		7.22295.62.0	ARV	PN	 →03.2003 USA USA
			7.21852.24.0	SLP	EL	
			7.28238.61.0	SLV	PN	 03.2003→ USA USA
325 xi 137-141 kW (186-192 PS) M54 B25 (256S5)	09.2000→02.2005		7.22295.62.0	ARV	PN	
			7.02604.21.0	LS	990 mm	
			7.02604.30.0	LS	980 mm	
			7.02604.31.0	LS	350 mm	
			7.28124.19.0	SLP	EL	03.2003→ USA USA
			7.28124.21.0	SLP	EL	
			7.22166.50.0*	SLP-M	EL	
			↳ 7.21852.24.0	SLP	EL	
			7.28238.61.0	SLV	PN	
328 i 141-144 kW (192-196 PS) M52 B28 (286S2)	02.1998→06.2000		7.22295.62.0	ARV	PN	
			7.02604.21.0	LS	990 mm	
			7.02604.30.0	LS	980 mm	
			7.02604.31.0	LS	350 mm	
			7.22166.50.0*	SLP-M	EL	
			↳ 7.21852.24.0	SLP	EL	
328 i 141-144 kW (192-196 PS) M52 B28 (286S2)	09.1998→12.2000		7.22295.62.0	ARV	PN	
			7.21852.24.0	SLP	EL	



B

3 (E46)































18

330 d 135-142 kW (184-193 PS) M57 D30 (306D1)	10.1999→02.2005		7.28264.06.0	AGR	PN	
330 d 150-160 kW (204-218 PS) M57 D30 (306D2)	03.2003→02.2005		7.28264.07.0 7.02604.44.0	AGR LS	PN 500 mm	vor Katalysator in front of the catalyst Euro 4 Euro 4
330 i 163-170 kW (222-231 PS) M54 B30 (306S3)	06.2000→02.2005		7.22295.62.0 7.02604.21.0 7.02604.30.0 7.02604.31.0 7.28124.19.0 7.22166.50.0* ↳ 7.21852.24.0 7.28238.61.0	ARV LS LS LS SLP SLP-M SLP SLV	PN 990 mm 980 mm 350 mm EL EL EL PN	03.2003→ ** USA ** USA
330 i 163-170 kW (222-231 PS) M54 B30 (306S3)	01.2001→04.2005		7.22295.62.0 7.21852.24.0 7.28238.61.0	ARV SLP SLV	PN EL PN	
330 xd 135-142 kW (184-193 PS) M57 D30 (306D1)	01.2000→02.2003		7.28264.06.0	AGR	PN	
330 xd 150-160 kW (204-218 PS) M57 D30 (306D2)	09.2002→12.2004		7.28264.07.0	AGR	PN	
330 xi 163-170 kW (222-231 PS) M54 B30 (306S3)	06.2000→02.2005		7.22295.62.0 7.02604.21.0 7.02604.30.0 7.02604.31.0 7.28124.19.0 7.22166.50.0* ↳ 7.21852.24.0 7.28238.61.0	ARV LS LS LS SLP SLP-M SLP SLV	PN 990 mm 980 mm 350 mm EL EL EL PN	03.2003→ ** USA ** USA →03.2003 Euro 4 (D4) Euro 4 (D4) ** USA ** USA
330 xi 163-170 kW (222-231 PS) M54 B30 (306S3)	09.2004→04.2005		7.22295.62.0 7.21852.24.0	ARV SLP	PN EL	

3 (E90)

19

316 d 66-150 kW (90-204 PS) N47 D20 C	07.2009→12.2011		7.10334.07.0	AGR	EL	
316 i 85 kW (115 PS) N45 B16 A	09.2005→10.2011		7.02604.41.0 7.28238.55.0	LS SLV	700 mm PN	vor Katalysator in front of the catalyst
316 i 85 kW (115 PS) N45 B16 AC	09.2005→10.2011		7.28238.55.0	SLV	PN	
316 i 85-90 kW (115-122 PS) N43 B16 A	09.2007→10.2011		7.02604.34.0	LS	600 mm	

















							
3 (E90)						19	B
316 i 89-90 kW (121-122 PS) N43 B16 AA	09.2007→10.2011		7.24809.50.0	AGR	ET		
			7.02604.41.0	LS	700 mm		
			7.02604.34.0	LS	600 mm		
318 d 85-120 kW (116-163 PS) M47 D20 (204D4)	03.2005→08.2007		7.00450.09.0	AGR	PN	für Fahrzeuge mit Diesel-Partikel-Filter (DPF) for vehicles with diesel soot filter	
			7.00512.03.0	AGR	PN	für Fahrzeuge ohne Diesel-Partikel-Filter (DPF) for vehicles without diesel soot filter	
318 d 66-145 kW (90-197 PS) N47 D20 A	02.2007→10.2011		7.00684.14.0	AGR	PN	mit Potentiometer with potentiometer  Automatikgetriebe Automatic Transmission Euro 3 (D3) Euro 3 (D3)	
			7.10334.07.0	AGR	EL		
318 d 66-150 kW (90-204 PS) N47 D20 C	02.2007→10.2011		7.10334.07.0	AGR	EL		
318 d 66-145 kW (90-197 PS) N47 D20 A	09.2007→08.2008		7.00684.14.0	AGR	PN	mit Potentiometer with potentiometer  Euro 3 (D3) Euro 3 (D3)	
			7.10334.07.0	AGR	EL		
318 d 66-150 kW (90-204 PS) N47 D20 C	09.2008→10.2011		7.10334.07.0	AGR	EL		
318 i 95-125 kW (129-170 PS) N46 B20 B	09.2005→08.2007		7.05271.23.0	LS	900 mm		
			7.02604.34.0	LS	600 mm		
			7.28124.19.0	SLP	EL	 Republik Korea (Südkorea) Republic of Korea (South Korea)	
			7.01318.24.0	SLV	PN	 China, Korea (Republik) China, Korea (Republic)	
318 i 90-125 kW (122-170 PS) N43 B20 A	09.2007→10.2011		7.24809.50.0	AGR	ET		
			7.02604.41.0	LS	700 mm		
			7.02604.34.0	LS	600 mm		
318 i 95-125 kW (129-170 PS) N46 B20 B	09.2007→10.2011		7.05271.23.0	LS	900 mm		
			7.02604.34.0	LS	600 mm		
			7.28124.19.0	SLP	EL	 Republik Korea (Südkorea) Republic of Korea (South Korea)	
318 i 95-125 kW (129-170 PS) N46 B20 C	09.2007→10.2011		7.02604.34.0	LS	600 mm		
			7.01318.24.0	SLV	PN	 Korea (Republik) Korea (Republic)	
318 i 95-125 kW (129-170 PS) N46 B20 CC, N46 B20 CD	09.2007→10.2011		7.02604.34.0	LS	600 mm		
318 i 95-125 kW (129-170 PS) N46 B20 E	09.2007→10.2011		7.02604.34.0	LS	600 mm		
			7.28124.19.0	SLP	EL	 China China	

























B

3 (E90)

19

			7.01318.24.0	SLV	PN	 ■■ China ■■ China
320 d 85-120 kW (116-163 PS) M47 D20 (204D4)	12.2004→08.2007		7.00450.09.0	AGR	PN	→08.2008 für Fahrzeuge mit Diesel-Partikel-Filter (DPF) for vehicles with diesel soot filter
			7.00512.03.0	AGR	PN	für Fahrzeuge ohne Diesel-Partikel-Filter (DPF) for vehicles without diesel soot filter
320 d 85-120 kW (116-163 PS) M47 D20 (204D4)	12.2004→09.2007		7.00450.09.0	AGR	PN	für Fahrzeuge mit Diesel-Partikel-Filter (DPF) for vehicles with diesel soot filter
			7.00512.03.0	AGR	PN	für Fahrzeuge ohne Diesel-Partikel-Filter (DPF) for vehicles without diesel soot filter
320 d 85-120 kW (116-163 PS) M47 D20 (204D4)	12.2004→09.2007		7.00450.09.0	AGR	PN	für Fahrzeuge mit Diesel-Partikel-Filter (DPF) for vehicles with diesel soot filter
320 d 66-150 kW (90-204 PS) N47 D20 C	01.2007→12.2009		7.02604.41.0	LS	700 mm	 N47 D20 C: Ausstattungsvariante: Blue Performance Equipment Variant: Blue Performance nach Katalysator Post-catalyst ■■ Indien, Malaysia, Thailand ■■ India, Malaysia, Thailand  N47 D20 C: für OE-Nummer: 13 62 7 794 634, 7 794 634 for OE number: 13 62 7 794 634, 7 794 634 ■■ Europa ■■ Europe
320 d 66-145 kW (90-197 PS) N47 D20 A	09.2007→02.2010		7.00684.14.0	AGR	PN	mit Potentiometer with potentiometer  Euro 3 (D3) Euro 3 (D3)
			7.10334.07.0	AGR	EL	
320 d 66-150 kW (90-204 PS) N47 D20 C	09.2007→02.2010		7.10334.07.0	AGR	EL	
			7.11190.12.0	DDS		ohne Zubehör without accessories Ausstattungsvariante: Blue Performance Equipment Variant: Blue Performance für Facelift: LCI for facelift: LCI
			7.02604.41.0	LS	700 mm	 N47 D20 C: für OE-Nummer: 13 62 7 794 634, 7 794 634 for OE number: 13 62 7 794 634, 7 794 634 ■■ Europa ■■ Europe  N47 D20 C: Ausstattungsvariante: Blue Performance Equipment Variant: Blue Performance nach Katalysator Post-catalyst ■■ Indien, Malaysia, Thailand ■■ India, Malaysia, Thailand
320 d 66-150 kW (90-204 PS) N47 D20 C	09.2008→10.2011		7.10334.07.0	AGR	EL	
			7.11190.12.0	DDS		ohne Zubehör without accessories Ausstattungsvariante: Blue Performance Equipment Variant: Blue Performance für Facelift: LCI for facelift: LCI

































						
3 (E90)					19	B
			7.02604.41.0	LS	700 mm	 N47 D20 C: Ausstattungsvariante: Blue Performance Equipment Variant: Blue Performance nach Katalysator Post-catalyst 🇮🇳 Indien, Malaysia, Thailand 🇮🇳 India, Malaysia, Thailand  N47 D20 C: für OE-Nummer: 13 62 7 794 634, 7 794 634 for OE number: 13 62 7 794 634, 7 794 634 🇪🇺 Europa 🇪🇺 Europe
320 d 66-150 kW (90-204 PS) N47 D20 C	03.2010→10.2011		7.00684.14.0	AGR	PN	mit Potentiometer with potentiometer
			7.10334.07.0	AGR	EL	 Euro 3 (D3) Euro 3 (D3)
			7.11190.12.0	DDS		ohne Zubehör without accessories
			7.02604.41.0	LS	700 mm	 N47 D20 C: für OE-Nummer: 13 62 7 794 634, 7 794 634 for OE number: 13 62 7 794 634, 7 794 634 🇪🇺 Europa 🇪🇺 Europe  N47 D20 C: Ausstattungsvariante: Blue Performance Equipment Variant: Blue Performance nach Katalysator Post-catalyst 🇮🇳 Indien, Malaysia, Thailand 🇮🇳 India, Malaysia, Thailand
320 d xDrive 66-150 kW (90-204 PS) N47 D20 C	09.2008→10.2011		7.10334.07.0	AGR	EL	
320 d xDrive 66-150 kW (90-204 PS) N47 D20 A, N47 D20 C	09.2008→02.2010		7.10334.07.0	AGR	EL	
320 d xDrive 66-150 kW (90-204 PS) N47 D20 C	03.2010→10.2011		7.10334.07.0	AGR	EL	
320 i 95-125 kW (129-170 PS) N46 B20 B, N46 B20 C	12.2004→08.2007		7.02604.34.0	LS	600 mm	
			7.05271.22.0	LS	600 mm	 N46 B20 B, N46 B20 C: vor Katalysator in front of the catalyst für Zylinder: 1 + 4 for cylinder: 1 + 4
			7.28124.19.0	SLP	EL	 N46 B20 B: für Linkslenker for left-hand drive vehicles 🇰🇷 Republik Korea (Südkorea) 🇰🇷 Republic of Korea (South Korea)  N46 B20 C: für Linkslenker for left-hand drive vehicles 🇨🇳 China, Republik Korea (Südkorea) 🇨🇳 China, Republic of Korea (South Korea)





















B

3 (E90)

19

			7.01318.24.0	SLV	PN	 N46 B20 B: für Linkslenker for left-hand drive vehicles  China, Korea (Republik)  China, Korea (Republik)  N46 B20 C: für Linkslenker for left-hand drive vehicles  Korea (Republik)  Korea (Republik)	
320 i 95-125 kW (129-170 PS) N46 B20 BD, N46 B20 CB	12.2004→08.2007		7.02604.34.0	LS	600 mm	 N46 B20 BD, N46 B20 CB: vor Katalysator in front of the catalyst für Zylinder: 1 + 4 for cylinder: 1 + 4	
			7.05271.22.0	LS	600 mm		
320 i 95-125 kW (129-170 PS) N46 B20 B, N46 B20 C, N46 B20 E	02.2007→12.2011		7.02604.34.0	LS	600 mm	 N46 B20 B: für Linkslenker for left-hand drive vehicles  Republik Korea (Südkorea)  Republic of Korea (South Korea)  N46 B20 C: für Linkslenker for left-hand drive vehicles  China, Republik Korea (Südkorea)  China, Republik of Korea (South Korea)  N46 B20 E: für Linkslenker for left-hand drive vehicles  China  China	
			7.28124.19.0	SLP	EL		
320 i 95-125 kW (129-170 PS) N46 B20 CC, N46 B20 CD	02.2007→12.2011		7.02604.34.0	LS	600 mm	 N46 B20 CC, N46 B20 CD: für Linkslenker for left-hand drive vehicles  China  China  N46 B20 CC: für Linkslenker for left-hand drive vehicles  China  China  N46 B20 CD: für Linkslenker for left-hand drive vehicles  China, Korea (Republik)  China, Korea (Republik)	
			7.28124.19.0	SLP	EL		
			7.01318.24.0	SLV	PN		
320 i 90-125 kW (122-170 PS) N43 B20 A	03.2007→12.2011		7.24809.50.0	AGR	ET		
			7.02604.41.0	LS	700 mm		
320 i 90-125 kW (122-170 PS) N43 B20 A	09.2007→10.2011		7.24809.50.0	AGR	ET		
			7.02604.41.0	LS	700 mm		für Zylinder: 2+3 for cylinder: 2+3
			7.02604.34.0	LS	600 mm		vor Katalysator in front of the catalyst für Zylinder: 1 + 4 for cylinder: 1 + 4
			7.05270.21.0	LS	600 mm		
320 si 127 kW (173 PS) N45 B20 A	09.2005→08.2006		7.05271.22.0	LS	600 mm	vor Katalysator in front of the catalyst für Zylinder: 1 + 4 for cylinder: 1 + 4	





















							
3 (E90)						19	B
323 i 130-160 kW (177-218 PS) N52 B25 A, N52 B25 B, N52 B25 BE, N52 B25 BF	09.2005→02.2007		7.02604.34.0	LS	600 mm		
			7.02604.26.0	LS	500 mm		
			7.02604.42.0	LS	1050 mm		
323 i 130-160 kW (177-218 PS) N52 B25 A, N52 B25 BF	03.2007→12.2011		7.02604.34.0	LS	600 mm		
			7.02604.26.0	LS	500 mm		
			7.02604.42.0	LS	1050 mm		
325 d 135-173 kW (184-235 PS) M57 D30 (306D3)	09.2006→02.2010		7.00450.09.0	AGR	PN	Euro 4 (D4) Euro 4 (D4)	
325 d 150-210 kW (204-286 PS) N57 D30 A	03.2010→10.2011		7.10334.07.0	AGR	EL		
325 i 130-160 kW (177-218 PS) N52 B25 A, N52 B25 B, N52 B25 BF	12.2004→12.2011		7.02604.34.0	LS	600 mm		
			7.02604.26.0	LS	500 mm		
			7.02604.99.0	LS	400 mm		
			7.02604.42.0	LS	1050 mm		
325 i 130-160 kW (177-218 PS) N52 B25 A	01.2006→12.2011		7.02604.34.0	LS	600 mm		
			7.02604.26.0	LS	500 mm		
			7.02604.42.0	LS	1050 mm		
325 i 150-200 kW (204-272 PS) N53 B30 A	03.2007→12.2011		7.02604.34.0	LS	600 mm		
			7.02604.26.0	LS	500 mm		
			7.02604.42.0	LS	1050 mm		
325 i 130-163 kW (177-222 PS) N52 B25	09.2008→12.2009		7.02604.34.0	LS	600 mm		
			7.02604.26.0	LS	500 mm		
			7.02604.42.0	LS	1050 mm		
325 i xDrive 150-200 kW (204-272 PS) N53 B30 A	09.2008→10.2011		7.02604.34.0	LS	600 mm		
			7.02604.26.0	LS	500 mm		
			7.02604.42.0	LS	1050 mm		
325 xi 130-160 kW (177-218 PS) N52 B25 A	09.2005→08.2008		7.02604.34.0	LS	600 mm		
			7.02604.26.0	LS	500 mm		
			7.02604.99.0	LS	400 mm		
			7.02604.42.0	LS	1050 mm		
325 xi 150-200 kW (204-272 PS) N53 B30 A	09.2007→08.2008		7.02604.34.0	LS	600 mm		













B

3 (E90)

19

			7.02604.26.0	LS	500 mm	
			7.02604.42.0	LS	1050 mm	
328 i 160-172 kW (218-234 PS) N51 B30 A	09.2006→12.2011		7.01318.20.0	SLV	PN	 USA, Korea (Republik)  USA, Korea (Republik)
328 i xDrive 155-200 kW (211-272 PS) N52 B30 A	09.2008→12.2010		7.02604.34.0	LS	600 mm	
			7.02604.26.0	LS	500 mm	
			7.02604.42.0	LS	1050 mm	
328 i xDrive 160-172 kW (218-234 PS) N51 B30 A	09.2008→12.2010		7.02604.34.0	LS	600 mm	
			7.02604.26.0	LS	500 mm	
			7.02604.42.0	LS	1050 mm	
			7.01318.20.0	SLV	PN	 USA, Korea (Republik)  USA, Korea (Republik)
328 xi 160-172 kW (218-234 PS) N51 B30 A	09.2006→12.2008		7.01318.20.0	SLV	PN	 USA  USA
330 d 135-173 kW (184-235 PS) M57 D30 (306D3)	09.2005→09.2008		7.00450.09.0	AGR	PN	Euro 4 (D4) Euro 4 (D4)
			7.00512.03.0	AGR	PN	Euro 3 (D3) Euro 3 (D3)
330 d 135-173 kW (184-235 PS) M57 D30 (306D3)	09.2005→12.2011		7.00450.09.0	AGR	PN	→08.2008 Euro 4 (D4) Euro 4 (D4)
			7.00512.03.0	AGR	PN	→08.2008 Euro 3 (D3) Euro 3 (D3)
330 d 150-210 kW (204-286 PS) N57 D30 A	09.2005→12.2011		7.10334.07.0	AGR	EL	
330 d 150-210 kW (204-286 PS) N57 D30 A	09.2008→10.2011		7.10334.07.0	AGR	EL	
			7.02604.44.0	LS	500 mm	Ausstattungsvariante: Blue Performance Equipment Variant: Blue Performance nach Katalysator Post-catalyst für Linkslenker for left-hand drive vehicles
330 d xDrive 150-210 kW (204-286 PS) N57 D30 A	09.2008→10.2011		7.10334.07.0	AGR	EL	
330 i 155-200 kW (211-272 PS) N52 B30 A, N52 B30 BF	12.2004→10.2011		7.02604.34.0	LS	600 mm	
			7.02604.26.0	LS	500 mm	
			7.02604.99.0	LS	400 mm	
			7.02604.42.0	LS	1050 mm	
330 i 155-200 kW (211-272 PS) N52 B30 A, N52 B30 BF	03.2007→12.2011		7.02604.34.0	LS	600 mm	
			7.02604.26.0	LS	500 mm	
			7.02604.99.0	LS	400 mm	

3 (E90) **19** **B**

			7.02604.42.0	LS	1050 mm	
330 i 150-200 kW (204-272 PS) N53 B30 A	09.2007→10.2011		7.02604.34.0	LS	600 mm	
			7.02604.26.0	LS	500 mm	
			7.02604.99.0	LS	400 mm	
			7.02604.42.0	LS	1050 mm	
330 i xDrive 150-200 kW (204-272 PS) N53 B30 A	09.2008→10.2011		7.02604.34.0	LS	600 mm	
			7.02604.26.0	LS	500 mm	
			7.02604.42.0	LS	1050 mm	
330 xd 135-173 kW (184-235 PS) M57 D30 (306D3)	09.2005→08.2008		7.00450.09.0	AGR	PN	Euro 4 (D4) Euro 4 (D4)
			7.00512.03.0	AGR	PN	Euro 3 (D3) Euro 3 (D3)
330 xi 150-200 kW (204-272 PS) N53 B30 A	09.2007→08.2008		7.02604.26.0	LS	500 mm	
			7.02604.42.0	LS	1050 mm	
335 d 198-221 kW (269-301 PS) M57 D30 (306D5)	09.2006→12.2011		7.00450.10.0	AGR	PN	
			7.11190.12.0	DDS		ohne Zubehör without accessories für Facelift: LCI for facelift: LCI
335 i 200-264 kW (272-359 PS) N54 B30 A	03.2006→12.2011		7.02604.34.0	LS	600 mm	
			7.02604.26.0	LS	500 mm	
			7.02604.43.0	LS	1200 mm	hinten Rear
335 i 200-264 kW (272-359 PS) N54 B30 A	03.2006→12.2011		7.02604.34.0	LS	600 mm	
			7.02604.26.0	LS	500 mm	
			7.02604.43.0	LS	1200 mm	hinten Rear
335 i 200-272 kW (272-370 PS) N55 B30 A	03.2006→12.2011		7.02604.34.0	LS	600 mm	
			7.02604.26.0	LS	500 mm	
335 i 200-264 kW (272-359 PS) N54 B30 A	09.2006→02.2010		7.02604.34.0	LS	600 mm	
			7.02604.26.0	LS	500 mm	
			7.02604.43.0	LS	1200 mm	hinten Rear
335 i 200-272 kW (272-370 PS) N55 B30 A	03.2010→12.2011		7.02604.34.0	LS	600 mm	
			7.02604.26.0	LS	500 mm	
335 i xDrive 200-264 kW (272-359 PS) N54 B30 A	09.2008→02.2010		7.02604.34.0	LS	600 mm	
			7.02604.26.0	LS	500 mm	



B

3 (E90)

19

			7.02604.43.0	LS	1200 mm	hinten Rear
335 i xDrive 200-272 kW (272-370 PS) N55 B30 A	03.2010→10.2011		7.02604.34.0	LS	600 mm	
			7.02604.26.0	LS	500 mm	
335 xi 200-264 kW (272-359 PS) N54 B30 A	03.2007→08.2008		7.02604.34.0	LS	600 mm	
			7.02604.26.0	LS	500 mm	
			7.02604.43.0	LS	1200 mm	
M3 309 kW (420 PS) S65 B40 A	12.2007→10.2011		7.02604.99.0	LS	400 mm	
			7.28124.30.0	SLP	EL	
			7.28238.62.0	SLV	PN	rechts Right
			7.28238.63.0	SLV	PN	links Left
M3 4.0i 32V 309 kW (420 PS) S65 B40	03.2008→12.2011		7.02604.25.0	LS	425 mm	
			7.28238.62.0	SLV	PN	rechts Right
			7.28238.63.0	SLV	PN	links Left

3 (E91)

20

328i 3.0 24V (USA) 155-200 kW (211-272 PS) N52 B30 A	09.2008→		7.02604.34.0	LS	600 mm	
			7.02604.26.0	LS	500 mm	
			7.02604.42.0	LS	1050 mm	

3 (E92)

21

M3 4.0i 32V 309 kW (420 PS) S65 B40	09.2007→12.2013		7.02604.25.0	LS	425 mm	
			7.28238.62.0	SLV	PN	
			7.28238.63.0	SLV	PN	

3 (E93)

22

323i 2.5 24V 130-160 kW (177-218 PS) N52 B25 A	03.2007→12.2013		7.02604.34.0	LS	600 mm	
			7.02604.26.0	LS	500 mm	
			7.02604.42.0	LS	1050 mm	
328i 3.0 24V 155-200 kW (211-272 PS) N52 B30 A	09.2007→12.2013		7.02604.34.0	LS	600 mm	
			7.02604.26.0	LS	500 mm	
			7.02604.42.0	LS	1050 mm	
328i 3.0 24V 190-195 kW (258-265 PS) N51 B30	09.2007→12.2013		7.02604.34.0	LS	600 mm	

3 (E93)					22	B
			7.02604.26.0	LS	500 mm	
			7.02604.42.0	LS	1050 mm	
			7.01318.20.0	SLV	PN	USA USA
3 (F30, F80)					23	
316 d 66-150 kW (90-204 PS) N47 D20 C	03.2012→10.2018		7.10334.07.0	AGR	EL	
			7.11190.12.0	DDS		ohne Zubehör without accessories Ausstattungsvariante: Blue Performance Equipment Variant: Blue Performance nicht für Facelift: LCI not for facelift: LCI
			7.02604.44.0	LS	500 mm	Ausstattungsvariante: Blue Performance Equipment Variant: Blue Performance nach Katalysator Post-catalyst
316 d 85-155 kW (116-211 PS) B47 D20 A	03.2012→10.2018		7.11010.00.0	AGR-K	EL	 Europa Europe
			↳ 7.04493.17.0	AGR	EL	
318 d 66-150 kW (90-204 PS) N47 D20 C	03.2012→06.2015		7.10992.00.0	AGR-K	EL	 Europa Europe
			↳ 7.10334.07.0	AGR	EL	
			7.11190.12.0	DDS		ohne Zubehör without accessories für OE-Nummer: 13 62 7 805 758 for OE number: 13 62 7 805 758
318 d 66-150 kW (90-204 PS) N47 D20 C	03.2012→10.2018		7.10992.00.0	AGR-K	EL	 →05.2015 Europa Europe
			↳ 7.10334.07.0	AGR	EL	
			7.11190.12.0	DDS		ohne Zubehör without accessories für OE-Nummer: 13 62 7 805 758 for OE number: 13 62 7 805 758
			7.02604.44.0	LS	500 mm	Ausstattungsvariante: Blue Performance Equipment Variant: Blue Performance für OE-Nummer: 13 62 7 793 825, 7 793 825 for OE number: 13 62 7 793 825, 7 793 825 nach Katalysator Post-catalyst
318 d 85-155 kW (116-211 PS) B47 D20 A	03.2012→10.2018		7.11010.00.0	AGR-K	EL	 05.2015→ Europa Europe
			↳ 7.04493.17.0	AGR	EL	
318 d 85-155 kW (116-211 PS) B47 D20 A	07.2015→10.2018		7.11010.00.0	AGR-K	EL	 Europa Europe
			↳ 7.04493.17.0	AGR	EL	
318 d xDrive 66-150 kW (90-204 PS) N47 D20 C	07.2013→06.2015		7.10334.07.0	AGR	EL	
318 d xDrive 85-155 kW (116-211 PS) B47 D20 A	07.2015→02.2018		7.11010.00.0	AGR-K	EL	 Europa Europe



B

3 (F30, F80)

23

			↳ 7.04493.17.0	AGR	EL	
320 d 66-150 kW (90-204 PS) N47 D20 C	11.2011→03.2016		7.10992.00.0	AGR-K	EL	
			↳ 7.10334.07.0 7.11190.12.0	AGR DDS	EL	ohne Zubehör without accessories Ausstattungsvariante: Blue Performance Equipment Variant: Blue Performance
			7.02604.44.0	LS	500 mm	Ausstattungsvariante: Blue Performance Equipment Variant: Blue Performance nach Katalysator Post-catalyst
320 d 66-150 kW (90-204 PS) N47 D20 C	11.2011→10.2018		7.10992.00.0	AGR-K	EL	 N47 D20 C: →05.2015 N47 D20 C: Europa Europe
			↳ 7.10334.07.0 7.11190.12.0	AGR DDS	EL	ohne Zubehör without accessories Ausstattungsvariante: Blue Performance Equipment Variant: Blue Performance
			7.02604.44.0	LS	500 mm	Ausstattungsvariante: Blue Performance Equipment Variant: Blue Performance nach Katalysator Post-catalyst
320 d 85-155 kW (116-211 PS) B47 D20 A	11.2011→10.2018		7.11010.00.0	AGR-K	EL	 07.2015→ Europa Europe
			↳ 7.04493.17.0	AGR	EL	
320 d 66-150 kW (90-204 PS) N47 D20 C	11.2011→03.2016		7.10992.00.0	AGR-K	EL	
			↳ 7.10334.07.0 7.11190.12.0	AGR DDS	EL	ohne Zubehör without accessories Ausstattungsvariante: Performance Equipment Variant: Performance
320 d 85-155 kW (116-211 PS) B47 D20 A	07.2015→10.2018		7.11010.00.0	AGR-K	EL	
			↳ 7.04493.17.0	AGR	EL	
320 d xDrive 66-150 kW (90-204 PS) N47 D20 C	08.2012→10.2018		7.10334.07.0	AGR	EL	
320 d xDrive 85-155 kW (116-211 PS) B47 D20 A	08.2012→10.2018		7.11010.00.0	AGR-K	EL	 07.2015→ Russland, Europa Russia, Europe
			↳ 7.04493.17.0	AGR	EL	
320 d xDrive 66-150 kW (90-204 PS) N47 D20 C	08.2012→06.2015		7.10334.07.0	AGR	EL	
			7.02604.44.0	LS	500 mm	Ausstattungsvariante: Blue Performance Equipment Variant: Blue Performance nach Katalysator Post-catalyst USA USA
320 d xDrive 66-150 kW (90-204 PS) N47 D20 C	08.2012→06.2015		7.10334.07.0	AGR	EL	
320 d xDrive 85-155 kW (116-211 PS) B47 D20 A	07.2015→10.2018		7.11010.00.0	AGR-K	EL	 Russland, Europa Russia, Europe

3 (F30, F80)					23	B
325 d 150-160 kW (204-218 PS) N47 D20 D	03.2013→02.2016		↳ 7.04493.17.0 AGR EL			
			7.10992.00.0 AGR-K EL			
			↳ 7.10334.07.0 AGR EL			
			7.02604.44.0 LS 500 mm	Ausstattungsvariante: Blue Performance Equipment Variant: Blue Performance nach Katalysator Post-catalyst		
325 d 150-160 kW (204-218 PS) N47 D20 D	03.2013→02.2016		7.10992.00.0 AGR-K EL			
			↳ 7.10334.07.0 AGR EL			
325 d 85-170 kW (116-231 PS) B47 D20 B	03.2016→02.2018		7.04493.17.0 AGR EL			
330 d 150-210 kW (204-286 PS) N57 D30 A	07.2012→10.2018		7.10992.00.0 AGR-K EL		Europa Europe	
			↳ 7.10334.07.0 AGR EL			
330 d 150-210 kW (204-286 PS) N57 D30 A	07.2012→10.2018		7.10992.00.0 AGR-K EL		Europa Europe	
			↳ 7.10334.07.0 AGR EL			
			7.11190.12.0 DDS		ohne Zubehör without accessories N57 D30 A: Ausstattungsvariante: Blue Performance Equipment Variant: Blue Performance nicht für Facelift: LCI not for facelift: LCI N57 D30 A: Euro 5 Euro 5 für Facelift: LCI for facelift: LCI	
			7.02604.44.0 LS 500 mm	N57 D30 A: vor Rußpartikelfilter before soot particulate filter N57 D30 A: nach Rußpartikelfilter after soot particulate filter Euro 6 Euro 6		
330 d xDrive 150-210 kW (204-286 PS) N57 D30 A	03.2013→10.2018		7.10992.00.0 AGR-K EL		Europa Europe	
			↳ 7.10334.07.0 AGR EL			
330 d xDrive 150-210 kW (204-286 PS) N57 D30 A	03.2013→10.2018		7.10992.00.0 AGR-K EL		Europa Europe	
			↳ 7.10334.07.0 AGR EL			
			7.11190.12.0 DDS		ohne Zubehör without accessories N57 D30 A: Ausstattungsvariante: Blue Performance Equipment Variant: Blue Performance nicht für Facelift: LCI not for facelift: LCI N57 D30 A: Euro 5 Euro 5 nicht für Facelift: LCI not for facelift: LCI	
			7.02604.44.0 LS 500 mm	für OE-Nummer: 13 62 7 793 825, 7 793 825 for OE number: 13 62 7 793 825, 7 793 825		
335 d xDrive 220-230 kW (299-313 PS) N57 D30 B	07.2013→10.2018		7.10992.00.0 AGR-K EL		Europa Europe	



B

3 (F30, F80)

23

			↳ 7.10334.07.0	AGR	EL	ohne Zubehör without accessories Ausstattungsvariante: Blue Performance Equipment Variant: Blue Performance für OE-Nummer: 13 62 7 793 825 for OE number: 13 62 7 793 825
			7.11190.12.0	DDS		
			7.02604.44.0	LS	500 mm	

3 (G20, G80)

24

318 d 85-170 kW (116-231 PS) B47 D20 B	03.2019→03.2020		7.04493.17.0	AGR	EL	
320 d 85-170 kW (116-231 PS) B47 D20 B	11.2018→02.2020		7.04493.17.0	AGR	EL	
320 d 85-170 kW (116-231 PS) B47 D20 B	11.2018→02.2020		7.04493.17.0	AGR	EL	
320 d xDrive 85-170 kW (116-231 PS) B47 D20 B	11.2018→02.2020		7.04493.17.0	AGR	EL	
320 d xDrive 85-170 kW (116-231 PS) B47 D20 B	11.2018→02.2020		7.04493.17.0	AGR	EL	
330 d 155-235 kW (211-320 PS) B57 D30 A	03.2019→		7.05343.18.0*	AGR-K	EL	
			↳ 7.05343.17.0	AGR	EL	
330 d xDrive 155-235 kW (211-320 PS) B57 D30 A	07.2019→		7.05343.18.0*	AGR-K	EL	
			↳ 7.05343.17.0	AGR	EL	

3 Compact (E36)

25

316 i 77-87 kW (105-118 PS) M43 B19 (194E1)	01.1999→08.2000		7.22295.69.0	ARV	PN	
			7.02604.31.0	LS	350 mm	
318 tds 66 kW (90 PS) M41 D17 (174T1)	06.1995→08.2000		7.21920.62.0	AGR	PN	mit Rohrstutzen with pipe socket
318 ti 103 kW (140 PS) M44 B19 (194S1)	01.1996→08.1999		7.22295.66.0	ARV	PN	 USA USA
			7.02604.31.0	LS	350 mm	
			7.22166.38.0	SLP-M	EL	
323 ti 120-141 kW (163-192 PS) M52 B25 (256S3)	09.1997→08.2000		7.22295.70.0	ARV	PN	
			7.02604.37.0	LS	990 mm	
			7.21852.85.0	SLP	EL	
323 ti 120-141 kW (163-192 PS) M52 B25 (256S3)	01.1999→08.2000		7.22295.70.0	ARV	PN	
			7.21852.85.0	SLP	EL	

3 Compact (E46)

26

316 ti 85 kW (115 PS) N42 B18 A	06.2001→02.2005		7.02604.32.0	LS	450 mm	
			7.28124.20.0	SLP	EL	
			7.28238.55.0	SLV	PN	
316 ti 85 kW (115 PS) N46 B18 A	06.2001→02.2005		7.02604.32.0	LS	450 mm	
			7.28129.22.0*	SLP-M	EL	
			↳ 7.28124.20.0	SLP	EL	
			7.28238.55.0	SLV	PN	













3 Compact (E46)						26
316 ti 77-85 kW (105-115 PS) N40 B16 A	06.2002→02.2005		7.28129.22.0*	SLP-M	EL	
			↳7.28124.20.0 7.28238.55.0	SLP SLV	EL PN	
316 ti 77-85 kW (105-115 PS) N40 B16 A, N45 B16 A	06.2002→02.2005		7.28129.22.0*	SLP-M	EL	
			↳7.28124.20.0 7.28238.55.0	SLP SLV	EL PN	
318 td 85-120 kW (116-163 PS) M47 D20 (204D4)	03.2003→02.2005		7.28264.06.0	AGR	PN	
			7.02604.44.0	LS	500 mm	vor Katalysator in front of the catalyst Euro 4 Euro 4 Produktionsdatum ab: 01.03.2004 Production date from: 01.03.2004
318 ti 95-125 kW (129-170 PS) N42 B20 A, N46 B20 A	03.2001→12.2004		7.02604.32.0	LS	450 mm	
			7.28129.22.0*	SLP-M	EL	
			↳7.28124.20.0 7.28238.55.0	SLP SLV	EL PN	
318 ti 95-125 kW (129-170 PS) N42 B20 A, N46 B20 A	03.2001→12.2004		7.28124.20.0	SLP	EL	
			7.28238.55.0	SLV	PN	
320 td 85-120 kW (116-163 PS) M47 D20 (204D4)	09.2001→02.2005		7.28264.06.0	AGR	PN	
			7.02604.44.0	LS	500 mm	M47 D20 (204D4): vor Katalysator in front of the catalyst Euro 4 Euro 4 für Linkslenker for left-hand drive vehicles Produktionsdatum ab: 01.03.2004 Production date from: 01.03.2004 M47 D20 (204D4): vor Katalysator in front of the catalyst Euro 4 Euro 4 für Rechtslenker for right-hand drive vehicles Produktionsdatum ab: 01.01.2004 Production date from: 01.01.2004
325 ti 137-141 kW (186-192 PS) M54 B25 (256S5)	04.2001→12.2004		7.22295.62.0	ARV	PN	
			7.02604.21.0	LS	990 mm	
			7.02604.30.0	LS	980 mm	
			7.02604.31.0	LS	350 mm	
			7.28124.19.0	SLP	EL	03.2003→ USA USA
			7.28124.21.0	SLP	EL	
			7.22166.50.0*	SLP-M	EL	
			↳7.21852.24.0 7.28238.61.0	SLP SLV	EL PN	
3 Convertible (E36)						27
318 is 103 kW (140 PS) M44 B19 (194S1)	01.1996→09.1999		7.22295.66.0	ARV	PN	 USA USA
			7.22166.38.0	SLP-M	EL	



B









3 Convertible (E36)

27









320 i 100-110 kW (136-150 PS) M52 B20 (206S3)	12.1993→11.1999		7.02604.37.0	LS	990 mm	09.1995→ hinten, vorne Rear, Front
			7.02604.38.0	LS	975 mm	
323 i 120-141 kW (163-192 PS) M52 B25 (256S3)	05.1995→11.1999		7.22295.70.0	ARV	PN	 USA  USA
			7.02604.37.0	LS	990 mm	
			7.02604.38.0	LS	975 mm	
			7.21852.85.0	SLP	EL	
328 i 141-143 kW (192-194 PS) M52 B28 (286S1)	01.1995→11.1999		7.22295.70.0	ARV	PN	 USA  USA
			7.02604.37.0	LS	990 mm	
			7.02604.38.0	LS	975 mm	
			7.21852.85.0	SLP	EL	
M3 3.2 236 kW (321 PS) S50 B32 (326S1)	03.1996→09.1999		7.22295.70.0	ARV	PN	 USA  USA
			7.02604.37.0	LS	990 mm	
			7.02604.30.0	LS	980 mm	
			7.05270.03.0	LS	820 mm	
			7.02604.28.0	LS	1120 mm	
M3 3.2 176-179 kW (239-243 PS) S52 B32 (326S2)	01.1998→09.1999		7.22295.70.0	ARV	PN	 USA  USA
			7.21852.85.0	SLP	EL	

3 Convertible (E46)

28

318 Ci 95-125 kW (129-170 PS) N42 B20 A, N46 B20 A	12.2000→08.2006		7.28124.20.0	SLP	EL	
			7.28238.55.0	SLV	PN	
318 Ci 95-125 kW (129-170 PS) N42 B20 A, N46 B20 A	09.2001→12.2007		7.02604.32.0	LS	450 mm	
			7.28129.22.0*	SLP-M	EL	
			↳ 7.28124.20.0	SLP	EL	
			7.28238.55.0	SLV	PN	
318 Ci 95-125 kW (129-170 PS) N46 B20 A, N46 B20 C	03.2004→08.2006		7.02604.32.0	LS	450 mm	
			7.28129.22.0*	SLP-M	EL	
			↳ 7.28124.20.0	SLP	EL	
			7.28238.55.0	SLV	PN	
320 Cd 85-120 kW (116-163 PS) M47 D20 (204D4)	02.2005→12.2007		7.28264.06.0	AGR	PN	vor Katalysator in front of the catalyst Euro 4 Euro 4
			7.02604.44.0	LS	500 mm	
320 Ci 120-125 kW (163-170 PS) M54 B22 (226S1)	09.2000→12.2007		7.22295.62.0	ARV	PN	
			7.02604.21.0	LS	990 mm	

3 Convertible (E46) **28** **B**

			7.02604.30.0	LS	980 mm	
			7.02604.31.0	LS	350 mm	
			7.22166.50.0*	SLP-M	EL	
			↳ 7.21852.24.0	SLP	EL	
320 Ci 120-125 kW (163-170 PS) M54 B22 (226S1)	01.2006→12.2007		7.22295.62.0	ARV	PN	⊗
			7.21852.24.0	SLP	EL	
323 Ci 120-141 kW (163-192 PS) M52 B25 (256S4)	04.2000→09.2000		7.22295.62.0	ARV	PN	⊗
			7.02604.21.0	LS	990 mm	
			7.02604.30.0	LS	980 mm	
			7.02604.31.0	LS	350 mm	
			7.22166.50.0*	SLP-M	EL	
			↳ 7.21852.24.0	SLP	EL	
323 Ci 120-141 kW (163-192 PS) M52 B25 (256S4)	04.2000→09.2000		7.22295.62.0	ARV	PN	⊗
			7.21852.24.0	SLP	EL	
325 Ci 137-141 kW (186-192 PS) M54 B25 (256S5)	09.2000→12.2006		7.22295.62.0	ARV	PN	⊗ →03.2003 " USA " USA
			7.21852.24.0	SLP	EL	
			7.28238.61.0	SLV	PN	⊗ 03.2003→ " USA " USA
325 Ci 137-141 kW (186-192 PS) M54 B25 (256S5)	09.2000→08.2006		7.22295.62.0	ARV	PN	⊗
			7.02604.21.0	LS	990 mm	
			7.02604.30.0	LS	980 mm	
			7.02604.31.0	LS	350 mm	
			7.28124.19.0	SLP	EL	03.2003→ " USA " USA
			7.28124.21.0	SLP	EL	
			7.22166.50.0*	SLP-M	EL	
			↳ 7.21852.24.0	SLP	EL	
			7.28238.61.0	SLV	PN	⊗
330 Cd 150-160 kW (204-218 PS) M57 D30 (306D2)	08.2005→12.2007		7.28264.07.0	AGR	PN	
			7.02604.44.0	LS	500 mm	vor Katalysator in front of the catalyst Euro 4 Euro 4
330 Ci 163-170 kW (222-231 PS) M54 B30 (306S3)	06.2000→12.2006		7.22295.62.0	ARV	PN	⊗
			7.21852.24.0	SLP	EL	
			7.28238.61.0	SLV	PN	⊗
330 Ci 163-170 kW (222-231 PS) M54 B30 (306S3)	06.2000→08.2006		7.22295.62.0	ARV	PN	⊗
			7.02604.21.0	LS	990 mm	



B











3 Convertible (E46)

28

			7.02604.30.0	LS	980 mm	
			7.02604.31.0	LS	350 mm	
			7.28124.19.0	SLP	EL	03.2003→ USA USA
			7.22166.50.0*	SLP-M	EL	
			↳ 7.21852.24.0	SLP	EL	
			7.28238.61.0	SLV	PN	⊙
M3 235-265 kW (320-360 PS) S54 B32 (326S4)	03.2001→08.2006		7.05270.03.0	LS	820 mm	
			7.02604.28.0	LS	1120 mm	
			7.21852.79.0	SLP	EL	
			7.22748.18.0	SLV	PN	⊙

3 Convertible (E93)

29

318 i 90-125 kW (122-170 PS) N43 B20 A	03.2010→12.2013		7.24809.50.0	AGR	ET	⊙
			7.02604.41.0	LS	700 mm	
320 d 66-150 kW (90-204 PS) N47 D20 A, N47 D20 C	09.2007→02.2010		7.00684.14.0	AGR	PN	mit Potentiometer with potentiometer ⊙ ⊙
			7.10334.07.0	AGR	EL	⊙
320 d 66-150 kW (90-204 PS) N47 D20 C	01.2008→12.2013		7.00684.14.0	AGR	PN	mit Potentiometer with potentiometer ⊙ →09.2008 Euro 3 (D3) Euro 3 (D3)
			7.10334.07.0	AGR	EL	⊙
320 d 66-150 kW (90-204 PS) N47 D20 A, N47 D20 C	03.2008→02.2010		7.00684.14.0	AGR	PN	mit Potentiometer with potentiometer ⊙ ⊙
			7.10334.07.0	AGR	EL	⊙
320 d 66-150 kW (90-204 PS) N47 D20 C	03.2010→10.2013		7.10334.07.0	AGR	EL	⊙
320 d 66-150 kW (90-204 PS) N47 D20 C	03.2010→10.2013		7.10334.07.0	AGR	EL	⊙
320 i 90-125 kW (122-170 PS) N43 B20 A	09.2006→10.2013		7.24809.50.0	AGR	ET	⊙
			7.02604.41.0	LS	700 mm	
			7.02604.34.0	LS	600 mm	
320 i 90-125 kW (122-170 PS) N43 B20 A	03.2007→10.2013		7.24809.50.0	AGR	ET	⊙
			7.02604.41.0	LS	700 mm	für Zylinder: 2+3 for cylinder: 2+3
			7.02604.34.0	LS	600 mm	
			7.05270.21.0	LS	600 mm	vor Katalysator in front of the catalyst für Zylinder: 1+4 for cylinder: 1+4
323 i 130-160 kW (177-218 PS) N52 B25 A	03.2007→09.2011		7.01318.20.0	SLV	PN	⊙ China China
323 i 130-160 kW (177-218 PS) N52 B25 A	03.2007→09.2011		7.01318.20.0	SLV	PN	⊙ China China



3 Convertible (E93)						29
325 d 135-173 kW (184-235 PS) M57 D30 (306D3)	03.2007→12.2010		7.00450.09.0	AGR	PN	→01.2010 Euro 4 (D4) Euro 4 (D4)
325 d 150-210 kW (204-286 PS) N57 D30 A	09.2009→09.2013		7.10334.07.0	AGR	EL	
325 i 150-200 kW (204-272 PS) N53 B30 A	10.2006→12.2013		7.02604.34.0	LS	600 mm	
			7.02604.26.0	LS	500 mm	
			7.02604.42.0	LS	1050 mm	
325 i 130-160 kW (177-218 PS) N52 B25 A	12.2006→02.2010		7.02604.34.0	LS	600 mm	
			7.02604.26.0	LS	500 mm	
			7.02604.42.0	LS	1050 mm	
			7.01318.20.0	SLV	PN	 China China
325 i 150-200 kW (204-272 PS) N53 B30 A	03.2007→12.2013		7.02604.34.0	LS	600 mm	
			7.02604.26.0	LS	500 mm	
			7.02604.42.0	LS	1050 mm	
325 i 130-160 kW (177-218 PS) N52 B25 A	03.2010→10.2013		7.01318.20.0	SLV	PN	 China China
328 i 160-172 kW (218-234 PS) N51 B30 A	03.2007→12.2013		7.01318.20.0	SLV	PN	 N51 B30 A: USA, Korea (Republik) USA, Korea (Republic) N51 B30 A: Version: E93 LCI Version: E93 LCI
330 d 135-173 kW (184-235 PS) M57 D30 (306D3)	03.2007→12.2013		7.00450.09.0	AGR	PN	→01.2010 Euro 4 (D4) Euro 4 (D4)
			7.00512.03.0	AGR	PN	→01.2010 Euro 3 (D3) Euro 3 (D3)
330 d 150-210 kW (204-286 PS) N57 D30 A	01.2009→12.2013		7.10334.07.0	AGR	EL	
330 i 150-200 kW (204-272 PS) N53 B30 A	03.2007→10.2013		7.02604.34.0	LS	600 mm	
			7.02604.26.0	LS	500 mm	
			7.02604.42.0	LS	1050 mm	
330 i 155-200 kW (211-272 PS) N52 B30 A, N52 B30 AF	03.2010→10.2013		7.02604.34.0	LS	600 mm	
			7.02604.26.0	LS	500 mm	
			7.02604.42.0	LS	1050 mm	
335 i 200-272 kW (272-370 PS) N54 B30 A, N55 B30 A	12.2006→10.2013		7.02604.34.0	LS	600 mm	
			7.02604.26.0	LS	500 mm	
			7.02604.43.0	LS	1200 mm	
M3 309 kW (420 PS) S65 B40 A	03.2008→10.2013		7.02604.25.0	LS	425 mm	
			7.02604.99.0	LS	400 mm	



B



















3 Convertible (E93)

29

7.28124.30.0	SLP	EL
7.28238.62.0	SLV	PN 
7.28238.63.0	SLV	PN 









3 Coupe (E36)

30

318 is 103 kW (140 PS) M44 B19 (194S1)	09.1995→04.1999		7.22295.66.0	ARV	PN 	 USA  USA
			7.02604.31.0	LS	350 mm	
			7.22166.38.0	SLP-M	EL	
320 i 100-110 kW (136-150 PS) M52 B20 (206S3)	12.1991→11.1998		7.02604.37.0	LS	990 mm	09.1995→ hinten, vorne Rear, Front
			7.02604.38.0	LS	975 mm	
323 i 120-141 kW (163-192 PS) M52 B25 (256S3)	05.1995→04.1999		7.22295.70.0	ARV	PN 	 USA  USA
			7.02604.37.0	LS	990 mm	
			7.02604.38.0	LS	975 mm	
			7.21852.85.0	SLP	EL	
328 i 141-143 kW (192-194 PS) M52 B28 (286S1)	01.1995→04.1999		7.22295.70.0	ARV	PN 	 USA  USA
			7.02604.37.0	LS	990 mm	
			7.02604.38.0	LS	975 mm	
			7.21852.85.0	SLP	EL	
M3 3.2 236 kW (321 PS) S50 B32 (326S1)	10.1995→11.1998		7.02604.37.0	LS	990 mm	
			7.02604.30.0	LS	980 mm	
			7.05270.03.0	LS	820 mm	
			7.02604.28.0	LS	1120 mm	
M3 3.2 176-179 kW (239-243 PS) S52 B32 (326S2)	06.1996→04.1999		7.22295.70.0	ARV	PN 	 USA  USA
			7.21852.85.0	SLP	EL	

3 Coupe (E46)

31

316 Ci 77 kW (105 PS) M43 B16 (164E3)	04.2000→07.2006		7.22295.69.0	ARV	PN 
			7.02604.32.0	LS	450 mm
			7.22166.00.0	SLP-M	EL
316 Ci 85 kW (115 PS) N45 B16 A	06.2002→07.2006		7.28129.22.0*	SLP-M	EL
			↳ 7.28124.20.0	SLP	EL
			7.28238.55.0	SLV	PN 
318 Ci 77-87 kW (105-118 PS) M43 B19 (194E1)	12.1999→08.2001		7.22295.69.0	ARV	PN 
			7.02604.31.0	LS	350 mm
			7.22166.00.0	SLP-M	EL
318 Ci 77-87 kW (105-118 PS) M43 B19 (194E1)	12.1999→08.2001		7.22295.69.0	ARV	PN 

3 Coupe (E46)					31	B
318 Ci 95-125 kW (129-170 PS) N42 B20 A, N46 B20 A	12.2000→05.2006		7.22166.00.0 SLP-M EL			
			7.28124.20.0 SLP EL			
			7.28238.55.0 SLV PN			
318 Ci 100-110 kW (136-150 PS) N42 B20 A	09.2001→02.2004		7.02604.32.0 LS 450 mm			
			7.28129.22.0* SLP-M EL			
			↳ 7.28124.20.0 SLP EL			
318 Ci 95-125 kW (129-170 PS) N46 B20 A, N46 B20 C	03.2004→05.2006		7.28238.55.0 SLV PN			
			7.02604.32.0 LS 450 mm			
			7.28129.22.0* SLP-M EL			
↳ 7.28124.20.0 SLP EL						
320 Cd 85-120 kW (116-163 PS) M47 D20 (204D4)	11.2003→07.2006		7.28264.06.0 AGR PN			
			7.02604.44.0 LS 500 mm		M47 D20 (204D4): vor Katalysator in front of the catalyst Euro 4 für Rechtslenker for right-hand drive vehicles Produktionsdatum ab: 01.01.2004 Production date from: 01.01.2004	
					M47 D20 (204D4): vor Katalysator in front of the catalyst Euro 4 für Linkslenker for left-hand drive vehicles Produktionsdatum ab: 01.03.2004 Production date from: 01.03.2004	
320 Ci 100-110 kW (136-150 PS) M52 B20 (206S4)	02.1999→08.2001		7.22295.62.0 ARV PN			
			7.02604.21.0 LS 990 mm			
			7.02604.30.0 LS 980 mm			
			7.02604.31.0 LS 350 mm			
320 Ci 120-125 kW (163-170 PS) M54 B22 (226S1)	01.2000→05.2006		7.22295.62.0 ARV PN			
			7.02604.21.0 LS 990 mm			
			7.02604.30.0 LS 980 mm			
			7.02604.31.0 LS 350 mm			
			7.22166.50.0* SLP-M EL			
↳ 7.21852.24.0 SLP EL						
320 Ci 120-125 kW (163-170 PS) M54 B22 (226S1)	01.2000→05.2006		7.22295.62.0 ARV PN			
			7.21852.24.0 SLP EL			
323 Ci 120-141 kW (163-192 PS) M52 B25 (256S4)	04.1999→09.2000		7.22295.62.0 ARV PN			
			7.02604.21.0 LS 990 mm			
			7.02604.30.0 LS 980 mm			
			7.02604.31.0 LS 350 mm			
			7.22166.50.0* SLP-M EL			



















B

3 Coupe (E46)

31

			↳ 7.21852.24.0	SLP	EL	
323 Ci 120-141 kW (163-192 PS) M52 B25 (256S4)	04.1999→09.2000		7.22295.62.0	ARV	PN	⊗
			7.21852.24.0	SLP	EL	
325 Ci 137-141 kW (186-192 PS) M54 B25 (256S5)	09.2000→07.2006		7.22295.62.0	ARV	PN	⊗
						→03.2003 USA USA
			7.21852.24.0	SLP	EL	
			7.28238.61.0	SLV	PN	⊗ 03.2003→ USA USA
325 Ci 137 kW (186 PS) M56 B25 (256S6)	09.2000→07.2006		7.28124.21.0	SLP	EL	
325 Ci 137-141 kW (186-192 PS) M54 B25 (256S5)	09.2000→05.2006		7.22295.62.0	ARV	PN	⊗
			7.02604.21.0	LS	990 mm	
			7.02604.30.0	LS	980 mm	
			7.02604.31.0	LS	350 mm	
			7.28124.19.0	SLP	EL	03.2003→ USA USA
			7.28124.21.0	SLP	EL	
			7.22166.50.0*	SLP-M	EL	
			↳ 7.21852.24.0	SLP	EL	
7.28238.61.0	SLV	PN	⊗			
325 i 132 kW (179 PS) M56 B25 (256S6)	09.2002→05.2006		7.22295.65.0	ARV	PN	⊗
			7.28124.21.0	SLP	EL	
328 Ci 141-144 kW (192-196 PS) M52 B28 (286S2)	12.1998→05.2000		7.22295.62.0	ARV	PN	⊗
			7.02604.21.0	LS	990 mm	
			7.02604.30.0	LS	980 mm	
			7.02604.31.0	LS	350 mm	
			7.22166.50.0*	SLP-M	EL	
↳ 7.21852.24.0	SLP	EL				
330 Cd 150-160 kW (204-218 PS) M57 D30 (306D2)	03.2003→07.2006		7.28264.07.0	AGR	PN	
			7.02604.44.0	LS	500 mm	vor Katalysator in front of the catalyst Euro 4 Euro 4
330 Ci 163-170 kW (222-231 PS) M54 B30 (306S3)	06.2000→07.2006		7.22295.62.0	ARV	PN	⊗
			7.21852.24.0	SLP	EL	
			7.28238.61.0	SLV	PN	⊗
330 Ci 163-170 kW (222-231 PS) M54 B30 (306S3)	06.2000→05.2006		7.22295.62.0	ARV	PN	⊗
			7.02604.21.0	LS	990 mm	
			7.02604.30.0	LS	980 mm	
			7.02604.31.0	LS	350 mm	



























					
3 Coupe (E46)					
			7.28124.19.0	SLP	EL 03.2003→ USA USA
			7.22166.50.0*	SLP-M	EL
			↳ 7.21852.24.0	SLP	EL
			7.28238.61.0	SLV	PN ○
330 xi 163-170 kW (222-231 PS) M54 B30 (306S3)	06.2000→07.2006		7.22295.62.0	ARV	PN ○
			7.02604.21.0	LS	990 mm
			7.02604.30.0	LS	980 mm
			7.02604.31.0	LS	350 mm
			7.28124.19.0	SLP	EL 03.2003→ USA USA
			7.28238.61.0	SLV	PN ○
M3 235-265 kW (320-360 PS) S54 B32 (326S4)	07.2000→05.2006		7.05270.03.0	LS	820 mm
			7.02604.28.0	LS	1120 mm
			7.21852.79.0	SLP	EL
			7.22748.18.0	SLV	PN ○
M3 CSL 235-265 kW (320-360 PS) S54 B32 (326S4)	05.2003→12.2003		7.05270.03.0	LS	820 mm
			7.02604.28.0	LS	1120 mm
			7.21852.79.0	SLP	EL
			7.22748.18.0	SLV	PN ○
3 Coupe (E92)					
316 i 89-90 kW (121-122 PS) N43 B16 AA	09.2007→06.2013		7.24809.50.0	AGR	ET ○
			7.02604.41.0	LS	700 mm vor Katalysator in front of the catalyst
			7.02604.34.0	LS	600 mm
318 i 90-125 kW (122-170 PS) N43 B20 A	03.2010→12.2013		7.24809.50.0	AGR	ET ○
			7.02604.41.0	LS	700 mm
			7.02604.34.0	LS	600 mm
320 d 66-150 kW (90-204 PS) N47 D20 A, N47 D20 C	09.2006→02.2010		7.00684.14.0	AGR	PN mit Potentiometer with potentiometer ○
			7.10334.07.0	AGR	EL ○
320 d 66-150 kW (90-204 PS) N47 D20 A, N47 D20 C	09.2006→02.2010		7.00684.14.0	AGR	PN mit Potentiometer with potentiometer ○
			7.10334.07.0	AGR	EL ○
320 d 66-150 kW (90-204 PS) N47 D20 A, N47 D20 C	03.2007→06.2013		7.00684.14.0	AGR	PN mit Potentiometer with potentiometer ○
			7.10334.07.0	AGR	EL ○
320 d 66-150 kW (90-204 PS) N47 D20 C	03.2010→06.2013		7.10334.07.0	AGR	EL ○
320 d 66-150 kW (90-204 PS) N47 D20 C	03.2010→06.2013		7.10334.07.0	AGR	EL ○





























B

3 Coupe (E92)

32

320 d xDrive 66-150 kW (90-204 PS) N47 D20 C	09.2008→02.2010		7.10334.07.0	AGR	EL		
320 d xDrive 66-150 kW (90-204 PS) N47 D20 C	09.2008→02.2010		7.10334.07.0	AGR	EL		
320 d xDrive 66-150 kW (90-204 PS) N47 D20 C	09.2008→06.2013		7.10334.07.0	AGR	EL		
320 d xDrive 66-150 kW (90-204 PS) N47 D20 C	03.2010→06.2013		7.10334.07.0	AGR	EL		
320 d xDrive 66-150 kW (90-204 PS) N47 D20 C	03.2010→06.2013		7.10334.07.0	AGR	EL		
320 i 90-125 kW (122-170 PS) N43 B20 A	01.2007→12.2013		7.24809.50.0	AGR	ET		
			7.02604.41.0	LS	700 mm		
			7.02604.34.0	LS	600 mm		
320 i 90-125 kW (122-170 PS) N43 B20 A	03.2007→12.2013		7.24809.50.0	AGR	ET		
			7.02604.41.0	LS	700 mm	vor Katalysator in front of the catalyst für Zylinder: 2+3 for cylinder: 2+3	
			7.02604.34.0	LS	600 mm		
			7.05270.21.0	LS	600 mm	vor Katalysator in front of the catalyst für Zylinder: 1 + 4 for cylinder: 1 + 4	
320 i 95-125 kW (129-170 PS) N46 B20 B	06.2007→12.2013		7.02604.34.0	LS	600 mm		
320 i 95-125 kW (129-170 PS) N46 B20 B, N46 B20 CC, N46 B20 CD, N46 B20 E	01.2010→12.2013		7.02604.34.0	LS	600 mm		
323 i 130-160 kW (177-218 PS) N52 B25 A	06.2006→08.2008		7.02604.34.0	LS	600 mm		
			7.02604.26.0	LS	500 mm		
			7.02604.42.0	LS	1050 mm		
325 d 135-173 kW (184-235 PS) M57 D30 (306D3)	02.2007→02.2010		7.00450.09.0	AGR	PN		
325 d 135-173 kW (184-235 PS) M57 D30 (306D3)	02.2007→02.2010		7.00450.09.0	AGR	PN	Euro 4 (D4) Euro 4 (D4)	
325 d 150-210 kW (204-286 PS) N57 D30 A	09.2009→12.2013		7.10334.07.0	AGR	EL		
325 i 130-160 kW (177-218 PS) N52 B25 A, N52 B25 BF	06.2006→02.2010		7.02604.34.0	LS	600 mm		
			7.02604.26.0	LS	500 mm		
			7.02604.42.0	LS	1050 mm		
			7.01318.20.0	SLV	PN	  N52 B25 A, N52 B25 BF:  China  China	
325 i 150-160 kW (204-218 PS) N52 B25 AF	06.2006→02.2010		7.02604.34.0	LS	600 mm		

3 Coupe (E92) **32** **B**













			7.02604.26.0	LS	500 mm	
			7.02604.42.0	LS	1050 mm	
325 i 150-200 kW (204-272 PS) N53 B30 A	09.2007→06.2013		7.02604.34.0	LS	600 mm	
			7.02604.26.0	LS	500 mm	
			7.02604.42.0	LS	1050 mm	
325 i 130-160 kW (177-218 PS) N52 B25 A, N52 B25 BF	03.2010→06.2013		7.02604.34.0	LS	600 mm	
			7.02604.26.0	LS	500 mm	
			7.02604.42.0	LS	1050 mm	
			7.01318.20.0	SLV	PN	 N52 B25 A, N52 B25 BF:  China
325 i 150-160 kW (204-218 PS) N52 B25 AF	03.2010→06.2013		7.02604.34.0	LS	600 mm	
			7.02604.26.0	LS	500 mm	
			7.02604.42.0	LS	1050 mm	
325 i 150-200 kW (204-272 PS) N53 B30 A	03.2010→06.2013		7.02604.34.0	LS	600 mm	
			7.02604.26.0	LS	500 mm	
			7.02604.42.0	LS	1050 mm	
325 i 130-160 kW (177-218 PS) N52 B25 A, N52 B25 BF	03.2010→10.2013		7.01318.20.0	SLV	PN	 N52 B25 A, N52 B25 BF:  China
325 i xDrive 130-160 kW (177-218 PS) N52 B25 A	03.2010→04.2013		7.01318.20.0	SLV	PN	 China  China
328 i 160-172 kW (218-234 PS) N51 B30 A	09.2006→06.2013		7.01318.20.0	SLV	PN	 USA  USA
328 i xDrive 160-172 kW (218-234 PS) N51 B30 A	09.2008→06.2013		7.01318.20.0	SLV	PN	 USA  USA
328 xi 160-172 kW (218-234 PS) N51 B30 A	09.2006→08.2008		7.01318.20.0	SLV	PN	 USA  USA
330 d 135-173 kW (184-235 PS) M57 D30 (306D3)	03.2006→08.2008		7.00450.09.0	AGR	PN	Euro 4 (D4) Euro 4 (D4)
			7.00512.03.0	AGR	PN	Euro 3 (D3) Euro 3 (D3)
330 d 150-210 kW (204-286 PS) N57 D30 A	01.2009→12.2013		7.10334.07.0	AGR	EL	
330 d xDrive 150-210 kW (204-286 PS) N57 D30 A	02.2010→06.2013		7.10334.07.0	AGR	EL	
330 i 155-200 kW (211-272 PS) N52 B30 A, N52 B30 AF, N52 B30 BF	09.2006→02.2010		7.02604.34.0	LS	600 mm	
			7.02604.26.0	LS	500 mm	
			7.02604.42.0	LS	1050 mm	



B





3 Coupe (E92)





























32

330 i 155-200 kW (211-272 PS) N52 B30 A	03.2010→06.2013	 7.02604.34.0	LS	600 mm		
		7.02604.26.0	LS	500 mm		
		7.02604.42.0	LS	1050 mm		
330 xd 135-173 kW (184-235 PS) M57 D30 (306D3)	03.2006→08.2008	 7.00512.03.0	AGR	PN	Euro 3 (D3) Euro 3 (D3)	
330 xd 150-210 kW (204-286 PS) N57 D30 A	03.2008→02.2010	 7.10334.07.0	AGR	EL		
330 xi 155-200 kW (211-272 PS) N52 B30 A	09.2006→08.2007	 7.02604.34.0	LS	600 mm		
		7.02604.26.0	LS	500 mm		
		7.02604.42.0	LS	1050 mm		
330 xi 155-200 kW (211-272 PS) N52 B30 A	09.2006→08.2007	 7.02604.34.0	LS	600 mm		
		7.02604.26.0	LS	500 mm		
		7.02604.42.0	LS	1050 mm		
335 d 198-221 kW (269-301 PS) M57 D30 (306D5)	03.2006→03.2013	 7.00450.10.0	AGR	PN		
335 i 200-272 kW (272-370 PS) N54 B30 A, N55 B30 A	06.2006→06.2013	 7.02604.34.0	LS	600 mm		
		7.02604.26.0	LS	500 mm		
		7.02604.43.0	LS	1200 mm		
335 i xDrive 200-272 kW (272-370 PS) N54 B30 A, N55 B30 A	11.2008→12.2013	 7.02604.34.0	LS	600 mm		
		7.02604.26.0	LS	500 mm		
		7.02604.43.0	LS	1200 mm		
335 xi 200-272 kW (272-370 PS) N54 B30 A, N55 B30 A	03.2007→02.2010	 7.02604.34.0	LS	600 mm		
		7.02604.26.0	LS	500 mm		
		7.02604.43.0	LS	1200 mm		
M3 309 kW (420 PS) S65 B40 A	06.2007→06.2013	 7.02604.99.0	LS	400 mm		
		7.28124.30.0	SLP	EL		
		7.28238.62.0	SLV	PN		
		7.28238.63.0	SLV	PN		

3 Gran Turismo (F34)

33

318 d 66-150 kW (90-204 PS) N47 D20 C	03.2013→06.2015	 7.10992.00.0	AGR-K	EL	  Europa  Europe ohne Zubehör without accessories Euro 5 Euro 5 Produktionsdatum ab: 01.03.2014 Production date from: 01.03.2014
		 7.10334.07.0	AGR	EL	
		7.11190.12.0	DDS		





















						
3 Gran Turismo (F34)					33	B
			7.02604.44.0	LS	500 mm	nach Rußpartikelfilter after soot particulate filter Euro 6 Euro 6
318 d 66-150 kW (90-204 PS) N47 D20 C	03.2013→06.2015		7.10992.00.0	AGR-K	EL	 " Europa " Europe
			↳ 7.10334.07.0	AGR	EL	
318 d 85-155 kW (116-211 PS) B47 D20 A	07.2015→		7.11010.00.0	AGR-K	EL	 " Europa " Europe
			↳ 7.04493.17.0	AGR	EL	
318 d 85-155 kW (116-211 PS) B47 D20 A	07.2015→06.2015		7.10334.07.0	AGR	EL	
			7.11010.00.0	AGR-K	EL	 " Europa " Europe
320 d 66-150 kW (90-204 PS) N47 D20 C	03.2013→06.2015		7.10334.07.0	AGR	EL	
320 d 66-150 kW (90-204 PS) N47 D20 C	03.2013→06.2015		7.10992.00.0	AGR-K	EL	
			↳ 7.10334.07.0	AGR	EL	
320 d 66-150 kW (90-204 PS) N47 D20 C	03.2013→06.2015		7.10992.00.0	AGR-K	EL	
			↳ 7.10334.07.0	AGR	EL	
			7.02604.44.0	LS	500 mm	nach Rußpartikelfilter after soot particulate filter Euro 6 Euro 6
320 d 85-155 kW (116-211 PS) B47 D20 A	07.2015→		7.04493.17.0	AGR	EL	
320 d 85-155 kW (116-211 PS) B47 D20 A	07.2015→06.2015		7.11010.00.0	AGR-K	EL	 " Europa, Indien, Malaysia, Thailand " Europe, India, Malaysia, Thailand
			↳ 7.04493.17.0	AGR	EL	
320 d xDrive 66-150 kW (90-204 PS) N47 D20 C	07.2013→06.2015		7.10992.00.0	AGR-K	EL	 " Europa " Europe
			↳ 7.10334.07.0	AGR	EL	
			7.11190.12.0	DDS		ohne Zubehör without accessories Euro 5 Euro 5 nicht für Facelift: LCI not for facelift: LCI
			7.02604.44.0	LS	500 mm	nach Rußpartikelfilter after soot particulate filter Euro 5 Euro 5
320 d xDrive 66-150 kW (90-204 PS) N47 D20 C	07.2013→06.2015		7.10992.00.0	AGR-K	EL	 " Europa " Europe
			↳ 7.10334.07.0	AGR	EL	
			7.11190.12.0	DDS		ohne Zubehör without accessories Euro 5 Euro 5 nicht für Facelift: LCI not for facelift: LCI
320 d xDrive 66-150 kW (90-204 PS) N47 D20 C	07.2013→06.2015		7.10992.00.0	AGR-K	EL	 " Europa " Europe
			↳ 7.10334.07.0	AGR	EL	



B

3 Gran Turismo (F34)

33

320 d xDrive 85-155 kW (116-211 PS) B47 D20 A	07.2015→		7.11010.00.0	AGR-K	EL	
			↳ 7.04493.17.0	AGR	EL	
320 d xDrive 85-155 kW (116-211 PS) B47 D20 A	07.2015→06.2015		7.11010.00.0	AGR-K	EL	 Europa Europe
			↳ 7.04493.17.0	AGR	EL	
325 d 150-160 kW (204-218 PS) N47 D20 D	07.2013→06.2016		7.10992.00.0	AGR-K	EL	 Europa Europe ohne Zubehör without accessories für OE-Nummer: 13 62 7 805 758 for OE number: 13 62 7 805 758
			↳ 7.10334.07.0	AGR	EL	
			7.11190.12.0	DDS		
325 d 150-160 kW (204-218 PS) N47 D20 D	07.2013→06.2016		7.10992.00.0	AGR-K	EL	 Europa Europe ohne Zubehör without accessories für OE-Nummer: 13 62 7 805 758 for OE number: 13 62 7 805 758 nach Rußpartikelfilter after soot particulate filter
			↳ 7.10334.07.0	AGR	EL	
			7.11190.12.0	DDS		
7.02604.44.0	LS	500 mm				
325 d 85-170 kW (116-231 PS) B47 D20 B	07.2016→02.2018		7.04493.17.0	AGR	EL	
330 d 150-210 kW (204-286 PS) N57 D30 A	03.2014→		7.10992.00.0	AGR-K	EL	 Europa Europe
			↳ 7.10334.07.0	AGR	EL	
330 d 150-210 kW (204-286 PS) N57 D30 A	03.2014→		7.10992.00.0	AGR-K	EL	 Europa Europe ohne Zubehör without accessories  N57 D30 A: Euro 5 Euro 5 nicht für Facelift: LCI not for facelift: LCI  N57 D30 A: Ausstattungsvariante: Blue Performance Equipment Variant: Blue Performance für Facelift: LCI for facelift: LCI
			↳ 7.10334.07.0	AGR	EL	
			7.11190.12.0	DDS		
330 d xDrive 150-210 kW (204-286 PS) N57 D30 A	03.2014→		7.10992.00.0	AGR-K	EL	 Europa Europe
			↳ 7.10334.07.0	AGR	EL	
330 d xDrive 150-210 kW (204-286 PS) N57 D30 A	03.2014→		7.10992.00.0	AGR-K	EL	 Europa Europe
			↳ 7.10334.07.0	AGR	EL	
			7.11190.12.0	DDS		ohne Zubehör without accessories Ausstattungsvariante: Blue Performance Equipment Variant: Blue Performance













3 Gran Turismo (F34)					33	B
			7.02604.44.0	LS	500 mm N57 D30 A: nach Rußpartikelfilter after soot particulate filter Euro 6 N57 D30 A: vor Rußpartikelfilter before soot particulate filter	
335 d xDrive 220-230 kW (299-313 PS) N57 D30 B	03.2014→		7.10992.00.0	AGR-K	EL Europa Europe	
			↳ 7.10334.07.0 7.02604.44.0	AGR LS	EL 500 mm N57 D30 B: nach Rußpartikelfilter after soot particulate filter N57 D30 B: vor Rußpartikelfilter before soot particulate filter	
3 Touring (E36)					34	
318 tds 66 kW (90 PS) M41 D17 (174T1)	03.1995→04.1999		7.21920.62.0	AGR	PN mit Rohrstützen with pipe socket 	
320 i 100-110 kW (136-150 PS) M52 B20 (206S3)	01.1995→04.1999		7.02604.37.0	LS	990 mm 09.1995→ hinten, vorne Rear, Front	
			7.02604.38.0	LS	975 mm →09.1995 hinten, vorne Rear, Front	
323 i 120-141 kW (163-192 PS) M52 B25 (256S3)	12.1995→04.1999		7.02604.37.0	LS	990 mm	
			7.02604.38.0	LS	975 mm	
325 tds 85-105 kW (115-143 PS) M51 D25 (256T1)	03.1995→04.1999		7.21920.62.0	AGR	PN mit Rohrstützen with pipe socket 	
328 i 141-143 kW (192-194 PS) M52 B28 (286S1)	02.1995→04.1999		7.02604.37.0	LS	990 mm	
			7.02604.38.0	LS	975 mm	
3 Touring (E46)					35	
316 i 85 kW (115 PS) N42 B18 A	03.2002→02.2005		7.02604.32.0	LS	450 mm	
			7.28124.20.0	SLP	EL	
			7.28238.55.0	SLV	PN 	
316 i 85 kW (115 PS) N46 B18 A	03.2002→02.2005		7.02604.32.0	LS	450 mm	
			7.28129.22.0*	SLP-M	EL	
			↳ 7.28124.20.0 7.28238.55.0	SLP SLV	EL PN 	
318 d 85-100 kW (116-136 PS) M47 D20 (204D1)	10.2002→03.2003		7.28264.06.0	AGR	PN	
318 d 85-120 kW (116-163 PS) M47 D20 (204D4)	03.2003→02.2005		7.28264.06.0	AGR	PN	















B

3 Touring (E46)

35

			7.02604.44.0	LS	500 mm	 M47 D20 (204D4): vor Katalysator in front of the catalyst Euro 4 Euro 4 für Linkslenker for left-hand drive vehicles Produktionsdatum ab: 01.03.2004 Production date from: 01.03.2004  M47 D20 (204D4): vor Katalysator in front of the catalyst Euro 4 Euro 4 für Rechtslenker for right-hand drive vehicles Produktionsdatum ab: 01.01.2004 Production date from: 01.01.2004
318 i 77-87 kW (105-118 PS) M43 B19 (194E1)	10.1999→09.2001		7.22295.69.0	ARV	PN	
			7.02604.31.0	LS	350 mm	
318 i 77-87 kW (105-118 PS) M43 B19 (194E1)	10.1999→09.2001		7.22166.00.0	SLP-M	EL	
			7.22295.69.0	ARV	PN	
			7.02604.31.0	LS	350 mm	
318 i 95-125 kW (129-170 PS) N42 B20 A, N46 B20 A, N46 B20 C	09.2001→07.2005		7.22166.00.0	SLP-M	EL	
			7.02604.32.0	LS	450 mm	
			7.28129.22.0*	SLP-M	EL	
320 d 85-100 kW (116-136 PS) M47 D20 (204D1)	03.2000→09.2001		↳ 7.28124.20.0	SLP	EL	
			7.28238.55.0	SLV	PN	
			7.28264.06.0	AGR	PN	
320 d 85-120 kW (116-163 PS) M47 D20 (204D4)	09.2001→02.2005		7.28264.06.0	AGR	PN	
			7.02604.44.0	LS	500 mm	
320 i 100-110 kW (136-150 PS) M52 B20 (206S4)	10.1999→09.2000		7.22295.62.0	ARV	PN	
			7.02604.21.0	LS	990 mm	
			7.02604.30.0	LS	980 mm	
			7.02604.31.0	LS	350 mm	
320 i 120-125 kW (163-170 PS) M54 B22 (226S1)	09.2000→02.2005		7.02604.31.0	LS	350 mm	
			7.22295.62.0	ARV	PN	
			7.02604.21.0	LS	990 mm	

						
3 Touring (E46)					35	B
			7.02604.30.0	LS	980 mm	
			7.02604.31.0	LS	350 mm	
			7.22166.50.0*	SLP-M	EL	
			↳ 7.21852.24.0	SLP	EL	
320 i 120-125 kW (163-170 PS) M54 B22 (226S1)	09.2000→02.2005		7.22295.62.0	ARV	PN	⊙
			7.21852.24.0	SLP	EL	
325 i 137-141 kW (186-192 PS) M54 B25 (256S5)	09.2000→02.2005		7.22295.62.0	ARV	PN	⊙ →03.2003 " USA " USA
			7.21852.24.0	SLP	EL	
			7.28238.61.0	SLV	PN	⊙ 03.2003→ " USA " USA
325 i 137 kW (186 PS) M56 B25 (256S6)	09.2000→02.2005		7.28124.21.0	SLP	EL	
325 i 137-141 kW (186-192 PS) M54 B25 (256S5)	09.2000→02.2005		7.22295.62.0	ARV	PN	⊙
			7.02604.21.0	LS	990 mm	
			7.02604.30.0	LS	980 mm	
			7.02604.31.0	LS	350 mm	
			7.28124.19.0	SLP	EL	03.2003→ " USA " USA
			7.28124.21.0	SLP	EL	
			7.22166.50.0*	SLP-M	EL	
			↳ 7.21852.24.0	SLP	EL	
			7.28238.61.0	SLV	PN	⊙
325 i 132 kW (179 PS) M56 B25 (256S6)	09.2002→07.2005		7.22295.65.0	ARV	PN	⊙
			7.28124.21.0	SLP	EL	
325 xi 137-141 kW (186-192 PS) M54 B25 (256S5)	09.2000→02.2005		7.22295.62.0	ARV	PN	⊙ →03.2003 " USA " USA
			7.21852.24.0	SLP	EL	
			7.28238.61.0	SLV	PN	⊙ 03.2003→ " USA " USA
325 xi 137-141 kW (186-192 PS) M54 B25 (256S5)	09.2000→02.2005		7.22295.62.0	ARV	PN	⊙
			7.02604.21.0	LS	990 mm	
			7.02604.30.0	LS	980 mm	
			7.02604.31.0	LS	350 mm	
			7.28124.19.0	SLP	EL	03.2003→ " USA " USA
			7.28124.21.0	SLP	EL	
			7.22166.50.0*	SLP-M	EL	
			↳ 7.21852.24.0	SLP	EL	
			7.28238.61.0	SLV	PN	⊙



B

3 Touring (E46)



























35

328 i 141-144 kW (192-196 PS) M52 B28 (286S2)	06.1999→05.2000		7.22295.62.0	ARV	PN	
			7.02604.21.0	LS	990 mm	
			7.02604.30.0	LS	980 mm	
			7.02604.31.0	LS	350 mm	
			7.22166.50.0*	SLP-M	EL	
↳ 7.21852.24.0	SLP	EL				
330 d 135-142 kW (184-193 PS) M57 D30 (306D1)	10.1999→02.2005		7.28264.06.0	AGR	PN	
330 d 150-160 kW (204-218 PS) M57 D30 (306D2)	03.2003→02.2005		7.28264.07.0	AGR	PN	vor Katalysator in front of the catalyst Euro 4 Euro 4
			7.02604.44.0	LS	500 mm	
330 i 163-170 kW (222-231 PS) M54 B30 (306S3)	06.2000→02.2005		7.22295.62.0	ARV	PN	
			7.02604.21.0	LS	990 mm	
			7.02604.30.0	LS	980 mm	
			7.02604.31.0	LS	350 mm	
			7.28124.19.0	SLP	EL	
			7.22166.50.0*	SLP-M	EL	
↳ 7.21852.24.0	SLP	EL				
7.28238.61.0	SLV	PN	03.2003→ USA USA			
330 xd 135-142 kW (184-193 PS) M57 D30 (306D1)	01.2000→03.2003		7.28264.06.0	AGR	PN	
330 xd 150-160 kW (204-218 PS) M57 D30 (306D2)	08.2002→05.2005		7.28264.07.0	AGR	PN	
330 xi 163-170 kW (222-231 PS) M54 B30 (306S3)	06.2000→02.2005		7.22295.62.0	ARV	PN	
			7.02604.21.0	LS	990 mm	
			7.02604.30.0	LS	980 mm	
			7.02604.31.0	LS	350 mm	
			7.28124.19.0	SLP	EL	
			7.22166.50.0*	SLP-M	EL	
↳ 7.21852.24.0	SLP	EL				
7.28238.61.0	SLV	PN	03.2003→ USA USA			

3 Touring (E91)

36

316 d 66-150 kW (90-204 PS) N47 D20 C	09.2009→06.2012		7.10334.07.0	AGR	EL	
316 i 89-90 kW (121-122 PS) N43 B16 AA	09.2008→06.2012		7.24809.50.0	AGR	ET	
			7.02604.41.0	LS	700 mm	vor Katalysator in front of the catalyst
			7.02604.34.0	LS	600 mm	



















							
3 Touring (E91)						36	B
318 d 85-120 kW (116-163 PS) M47 D20 (204D4)	09.2005→08.2007		7.00450.09.0	AGR	PN	für Fahrzeuge mit Diesel-Partikel-Filter (DPF) for vehicles with diesel soot filter	
			7.00512.03.0	AGR	PN	für Fahrzeuge ohne Diesel-Partikel-Filter (DPF) for vehicles without diesel soot filter	
318 d 66-145 kW (90-197 PS) N47 D20 A	07.2007→08.2008		7.10334.07.0	AGR	EL		
318 d 66-150 kW (90-204 PS) N47 D20 A, N47 D20 C	09.2007→06.2012		7.00684.14.0	AGR	PN	mit Potentiometer with potentiometer	
			7.10334.07.0	AGR	EL	 	
318 d 66-150 kW (90-204 PS) N47 D20 C	09.2008→06.2012		7.00684.14.0	AGR	PN	mit Potentiometer with potentiometer	
			7.10334.07.0	AGR	EL	 Euro 3 (D3) Euro 3 (D3) 	
318 i 95-125 kW (129-170 PS) N46 B20 B	01.2006→08.2007		7.05271.23.0	LS	900 mm	vor Katalysator in front of the catalyst	
			7.02604.41.0	LS	700 mm		
			7.02604.34.0	LS	600 mm		
318 i 90-125 kW (122-170 PS) N43 B20 A	05.2007→05.2012		7.24809.50.0	AGR	ET		
			7.02604.41.0	LS	700 mm		
			7.02604.34.0	LS	600 mm		
318 i 95-125 kW (129-170 PS) N46 B20 B	09.2007→03.2012		7.05271.23.0	LS	900 mm		
			7.02604.34.0	LS	600 mm		
320 d 85-120 kW (116-163 PS) M47 D20 (204D4)	12.2004→08.2007		7.00450.09.0	AGR	PN	für Fahrzeuge mit Diesel-Partikel-Filter (DPF) for vehicles with diesel soot filter	
			7.00512.03.0	AGR	PN	für Fahrzeuge ohne Diesel-Partikel-Filter (DPF) for vehicles without diesel soot filter	
320 d 85-120 kW (116-163 PS) M47 D20 (204D4)	06.2005→08.2007		7.00450.09.0	AGR	PN	→07.2008 für Fahrzeuge mit Diesel-Partikel-Filter (DPF) for vehicles with diesel soot filter	
			7.00512.03.0	AGR	PN	für Fahrzeuge ohne Diesel-Partikel-Filter (DPF) for vehicles without diesel soot filter	
320 d 66-145 kW (90-197 PS) N47 D20 A	02.2007→12.2010		7.00684.14.0	AGR	PN	mit Potentiometer with potentiometer	
			7.10334.07.0	AGR	EL	 	
320 d 66-150 kW (90-204 PS) N47 D20 C	02.2007→12.2010		7.10334.07.0	AGR	EL		
			7.11190.12.0	DDS		ohne Zubehör without accessories Ausstattungsvariante: Blue Performance Equipment Variant: Blue Performance für Facelift: LCI for facelift: LCI	





























B

3 Touring (E91)

36

			7.02604.41.0	LS	700 mm	09.2008→ Ausstattungsvariante: Blue Performance Equipment Variant: Blue Performance nach Katalysator Post-catalyst ** Europa ** Europe
320 d 66-145 kW (90-197 PS) N47 D20 A	02.2007→02.2010		7.00684.14.0	AGR	PN	mit Potentiometer with potentiometer 
			7.10334.07.0	AGR	EL	
320 d 66-150 kW (90-204 PS) N47 D20 C	02.2007→02.2010		7.00684.14.0	AGR	PN	mit Potentiometer with potentiometer 
			7.10334.07.0	AGR	EL	
			7.11190.12.0	DDS		ohne Zubehör without accessories Ausstattungsvariante: Blue Performance Equipment Variant: Blue Performance
320 d 66-150 kW (90-204 PS) N47 D20 C	09.2008→06.2012		7.10334.07.0	AGR	EL	
			7.11190.12.0	DDS		ohne Zubehör without accessories Ausstattungsvariante: Blue Performance Equipment Variant: Blue Performance für Facelift: LCI for facelift: LCI
			7.02604.41.0	LS	700 mm	08.2008→ Ausstattungsvariante: Blue Performance Equipment Variant: Blue Performance nach Katalysator Post-catalyst ** Europa ** Europe
320 d 66-150 kW (90-204 PS) N47 D20 C	03.2010→05.2012		7.00684.14.0	AGR	PN	mit Potentiometer with potentiometer 
			7.10334.07.0	AGR	EL	Euro 3 (D3) Euro 3 (D3) 
			7.11190.12.0	DDS		ohne Zubehör without accessories Ausstattungsvariante: Blue Performance Equipment Variant: Blue Performance
			7.02604.41.0	LS	700 mm	Ausstattungsvariante: Blue Performance Equipment Variant: Blue Performance nach Katalysator Post-catalyst ** Europa ** Europe
320 d 66-150 kW (90-204 PS) N47 D20 C	03.2010→05.2012		7.00684.14.0	AGR	PN	mit Potentiometer with potentiometer 
			7.10334.07.0	AGR	EL	Euro 3 (D3) Euro 3 (D3) 
			7.11190.12.0	DDS		ohne Zubehör without accessories Ausstattungsvariante: Blue Performance Equipment Variant: Blue Performance
320 d xDrive 66-150 kW (90-204 PS) N47 D20 C	02.2008→02.2010		7.10334.07.0	AGR	EL	
320 d xDrive 66-150 kW (90-204 PS) N47 D20 C	09.2008→02.2010		7.10334.07.0	AGR	EL	













							
3 Touring (E91)						36	B
320 d xDrive 66-150 kW (90-204 PS) N47 D20 C	07.2009→06.2012		7.10334.07.0	AGR	EL		
320 d xDrive 66-150 kW (90-204 PS) N47 D20 C	03.2010→06.2012		7.10334.07.0	AGR	EL		
320 d xDrive 66-150 kW (90-204 PS) N47 D20 C	03.2010→05.2012		7.10334.07.0	AGR	EL		
320 i 95-125 kW (129-170 PS) N46 B20 B, N46 B20 C	09.2005→06.2012		7.02604.34.0	LS	600 mm		
320 i 95-125 kW (129-170 PS) N46 B20 B, N46 B20 BD, N46 B20 C	09.2005→06.2012		7.05271.22.0	LS	600 mm	 N46 B20 B: →08.2008 vor Katalysator in front of the catalyst für Zylinder: 1 + 4 for cylinder: 1 + 4  N46 B20 BD, N46 B20 C: →08.2008 vor Katalysator in front of the catalyst für Zylinder: 1 + 4 for cylinder: 1 + 4	
			7.02604.34.0	LS	600 mm		
320 i 90-125 kW (122-170 PS) N43 B20 A	02.2007→12.2012		7.24809.50.0	AGR	ET		
			7.02604.41.0	LS	700 mm	für Zylinder: 2+3 for cylinder: 2+3	
			7.02604.34.0	LS	600 mm		
			7.05270.21.0	LS	600 mm	vor Katalysator in front of the catalyst für Zylinder: 1 + 4 for cylinder: 1 + 4	
320 i 90-125 kW (122-170 PS) N43 B20 A	02.2007→05.2012		7.24809.50.0	AGR	ET		
			7.02604.41.0	LS	700 mm		
323 i 130-160 kW (177-218 PS) N52 B25 A	04.2006→06.2007		7.02604.34.0	LS	600 mm		
			7.02604.26.0	LS	500 mm		
			7.02604.42.0	LS	1050 mm		
323 i 130-160 kW (177-218 PS) N52 B25 A	09.2006→07.2008		7.02604.34.0	LS	600 mm		
			7.02604.26.0	LS	500 mm		
			7.02604.42.0	LS	1050 mm		
325 d 135-173 kW (184-235 PS) M57 D30 (306D3)	09.2006→06.2012		7.00450.09.0	AGR	PN	Euro 4 (D4) Euro 4 (D4)	
325 d 150-210 kW (204-286 PS) N57 D30 A	02.2010→06.2012		7.10334.07.0	AGR	EL		
325 i 130-160 kW (177-218 PS) N52 B25 A	12.2004→08.2008		7.02604.34.0	LS	600 mm		
			7.02604.26.0	LS	500 mm		
			7.02604.99.0	LS	400 mm		
			7.02604.42.0	LS	1050 mm		
325 i 150-200 kW (204-272 PS) N53 B30 A	09.2007→06.2012		7.02604.34.0	LS	600 mm		







B

3 Touring (E91)

36

			7.02604.26.0	LS	500 mm	
			7.02604.42.0	LS	1050 mm	
325 i 150-200 kW (204-272 PS) N53 B30 A	09.2007→06.2012		7.02604.34.0	LS	600 mm	
			7.02604.26.0	LS	500 mm	
			7.02604.42.0	LS	1050 mm	
325 i xDrive 150-200 kW (204-272 PS) N53 B30 A	09.2008→06.2012		7.02604.34.0	LS	600 mm	
			7.02604.26.0	LS	500 mm	
			7.02604.42.0	LS	1050 mm	
325 xi 130-160 kW (177-218 PS) N52 B25 A	08.2005→08.2008		7.02604.34.0	LS	600 mm	
			7.02604.26.0	LS	500 mm	
			7.02604.99.0	LS	400 mm	
			7.02604.42.0	LS	1050 mm	
325 xi 150-200 kW (204-272 PS) N53 B30 A	09.2007→08.2008		7.02604.34.0	LS	600 mm	
			7.02604.26.0	LS	500 mm	
			7.02604.42.0	LS	1050 mm	
330 d 135-173 kW (184-235 PS) M57 D30 (306D3)	12.2004→08.2008		7.00450.09.0	AGR	PN	Euro 4 (D4) Euro 4 (D4)
			7.00512.03.0	AGR	PN	Euro 3 (D3) Euro 3 (D3)
330 d 135-173 kW (184-235 PS) M57 D30 (306D3)	06.2005→05.2012		7.00450.09.0	AGR	PN	→07.2008 Euro 4 (D4) Euro 4 (D4)
			7.00512.03.0	AGR	PN	→07.2008 Euro 3 (D3) Euro 3 (D3)
330 d 150-210 kW (204-286 PS) N57 D30 A	06.2005→05.2012		7.10334.07.0	AGR	EL	
330 d 150-210 kW (204-286 PS) N57 D30 A	02.2008→05.2012		7.10334.07.0	AGR	EL	
330 d xDrive 150-210 kW (204-286 PS) N57 D30 A	01.2009→06.2012		7.10334.07.0	AGR	EL	
330 i 155-200 kW (211-272 PS) N52 B30 A	08.2005→08.2007		7.02604.34.0	LS	600 mm	
			7.02604.26.0	LS	500 mm	
			7.02604.99.0	LS	400 mm	
			7.02604.42.0	LS	1050 mm	
330 i 150-200 kW (204-272 PS) N53 B30 A	09.2007→06.2012		7.02604.34.0	LS	600 mm	
			7.02604.26.0	LS	500 mm	
			7.02604.42.0	LS	1050 mm	

3 Touring (E91)
36
B



























330 i xDrive 150-200 kW (204-272 PS) N53 B30 A	09.2007→06.2012		7.02604.34.0	LS	600 mm	
			7.02604.26.0	LS	500 mm	
			7.02604.42.0	LS	1050 mm	
330 xd 135-173 kW (184-235 PS) M57 D30 (306D3)	09.2005→06.2012		7.00450.09.0	AGR	PN	→07.2008 Euro 4 (D4) Euro 4 (D4)
			7.00512.03.0	AGR	PN	
330 xi 155-200 kW (211-272 PS) N52 B30 A	09.2005→08.2007		7.02604.34.0	LS	600 mm	
			7.02604.26.0	LS	500 mm	
			7.02604.99.0	LS	400 mm	
			7.02604.42.0	LS	1050 mm	
330 xi 150-200 kW (204-272 PS) N53 B30 A	09.2007→06.2012		7.02604.34.0	LS	600 mm	
			7.02604.26.0	LS	500 mm	
			7.02604.42.0	LS	1050 mm	
335 d 198-221 kW (269-301 PS) M57 D30 (306D5)	09.2006→06.2012		7.00450.10.0	AGR	PN	
335 i 200-264 kW (272-359 PS) N54 B30 A	09.2006→06.2012		7.02604.34.0	LS	600 mm	09.2008→
			7.02604.26.0	LS	500 mm	
			7.02604.43.0	LS	1200 mm	
335 i 200-272 kW (272-370 PS) N55 B30 A	09.2006→06.2012		7.02604.34.0	LS	600 mm	
			7.02604.26.0	LS	500 mm	
335 i xDrive 200-264 kW (272-359 PS) N54 B30 A	09.2008→06.2012		7.02604.34.0	LS	600 mm	
			7.02604.26.0	LS	500 mm	
			7.02604.43.0	LS	1200 mm	
335 i xDrive 200-272 kW (272-370 PS) N55 B30 A	09.2008→06.2012		7.02604.34.0	LS	600 mm	
			7.02604.26.0	LS	500 mm	
335 xi 200-272 kW (272-370 PS) N54 B30 A, N55 B30 A	03.2007→08.2008		7.02604.34.0	LS	600 mm	
			7.02604.26.0	LS	500 mm	



B

3 Touring (F31)

37

316 d 66-150 kW (90-204 PS) N47 D20 C	11.2012→06.2019	 7.10334.07.0	AGR	EL	 ohne Zubehör without accessories Ausstattungsvariante: Blue Performance Equipment Variant: Blue Performance nicht für Facelift: LCI not for facelift: LCI	
		7.11190.12.0	DDS			
		7.02604.44.0	LS	500 mm		→06.2015 Ausstattungsvariante: Blue Performance Equipment Variant: Blue Performance nach Rußpartikelfilter after soot particulate filter
316 d 85-155 kW (116-211 PS) B47 D20 A	11.2012→06.2019	 7.11010.00.0	AGR-K	EL	 Europa  Europe	
		↳ 7.04493.17.0	AGR	EL		
318 d 66-150 kW (90-204 PS) N47 D20 C	11.2012→06.2015	 7.10992.00.0	AGR-K	EL	  Europa  Europe	
		↳ 7.10334.07.0	AGR	EL		
		7.11190.12.0	DDS			ohne Zubehör without accessories Ausstattungsvariante: Blue Performance Equipment Variant: Blue Performance
7.02604.44.0 LS				500 mm	Ausstattungsvariante: Blue Performance Equipment Variant: Blue Performance nach Rußpartikelfilter after soot particulate filter	
	318 d 66-150 kW (90-204 PS) N47 D20 C	11.2012→06.2019	 7.10992.00.0	AGR-K	EL	 →05.2015  Europa  Europe
			↳ 7.10334.07.0	AGR	EL	
7.11190.12.0	DDS		ohne Zubehör without accessories Ausstattungsvariante: Blue Performance Equipment Variant: Blue Performance nicht für Facelift: LCI not for facelift: LCI			
318 d 85-155 kW (116-211 PS) B47 D20 A	11.2012→06.2019	 7.04493.17.0	AGR	EL		
318 d 85-155 kW (116-211 PS) B47 D20 A	07.2015→06.2019	 7.11010.00.0	AGR-K	EL	  Europa  Europe	
		↳ 7.04493.17.0	AGR	EL		
318 d xDrive 66-150 kW (90-204 PS) N47 D20 C	07.2013→06.2015	 7.10334.07.0	AGR	EL		
318 d xDrive 85-155 kW (116-211 PS) B47 D20 A	07.2015→02.2018	 7.11010.00.0	AGR-K	EL	  Europa  Europe	
		↳ 7.04493.17.0	AGR	EL		
320 d 66-150 kW (90-204 PS) N47 D20 C	07.2012→02.2016	 7.10334.07.0	AGR	EL	 ohne Zubehör without accessories Ausstattungsvariante: Blue Performance Equipment Variant: Blue Performance	
		7.11190.12.0	DDS			
		7.02604.44.0	LS	500 mm		Ausstattungsvariante: Blue Performance Equipment Variant: Blue Performance nach Rußpartikelfilter after soot particulate filter























3 Touring (F31)					
320 d 66-150 kW (90-204 PS) N47 D20 C	07.2012→06.2019	 7.10992.00.0 ↳ 7.10334.07.0 7.11190.12.0 7.02604.44.0	AGR-K AGR DDS LS	EL EL 500 mm	 Europa Europa ohne Zubehör without accessories Ausstattungsvariante: Blue Performance Equipment Variant: Blue Performance →06.2015 Ausstattungsvariante: Blue Performance Equipment Variant: Blue Performance nach Rußpartikelfilter after soot particulate filter
320 d 85-155 kW (116-211 PS) B47 D20 A	07.2012→06.2019	 7.11010.00.0 ↳ 7.04493.17.0	AGR-K AGR	EL EL	 07.2015→ Europa Europa
320 d 66-150 kW (90-204 PS) N47 D20 C	07.2012→02.2016	 7.10992.00.0 ↳ 7.10334.07.0 7.11190.12.0	AGR-K AGR DDS	EL EL	 Europa Europa ohne Zubehör without accessories Ausstattungsvariante: Blue Performance Equipment Variant: Blue Performance
320 d 85-155 kW (116-211 PS) B47 D20 A	07.2015→06.2019	 7.11010.00.0 ↳ 7.04493.17.0	AGR-K AGR	EL EL	 Europa Europa
320 d xDrive 66-150 kW (90-204 PS) N47 D20 C	03.2013→06.2015	 7.10334.07.0 7.02604.44.0	AGR LS	EL 500 mm	 Ausstattungsvariante: Blue Performance Equipment Variant: Blue Performance nach Rußpartikelfilter after soot particulate filter USA USA
320 d xDrive 66-150 kW (90-204 PS) N47 D20 C	03.2013→06.2015	 7.10334.07.0	AGR	EL	
320 d xDrive 66-150 kW (90-204 PS) N47 D20 C	03.2013→06.2015	 7.10334.07.0	AGR	EL	
320 d xDrive 85-155 kW (116-211 PS) B47 D20 A	07.2015→06.2019	 7.11010.00.0 ↳ 7.04493.17.0	AGR-K AGR	EL EL	 Europa Europa
320 d xDrive 85-155 kW (116-211 PS) B47 D20 A	07.2015→06.2019	 7.04493.17.0	AGR	EL	
325 d 150-160 kW (204-218 PS) N47 D20 D	03.2013→02.2016	 7.10992.00.0 ↳ 7.10334.07.0 7.11190.12.0	AGR-K AGR DDS	EL EL	 Europa Europa ohne Zubehör without accessories Ausstattungsvariante: Blue Performance Equipment Variant: Blue Performance Produktionsdatum ab: 01.07.2014 Production date from: 01.07.2014



B

3 Touring (F31)

37

			7.02604.44.0	LS	500 mm	Ausstattungsvariante: Blue Performance Equipment Variant: Blue Performance nach Rußpartikelfilter after soot particulate filter
325 d 150-160 kW (204-218 PS) N47 D20 D	03.2013→02.2016		7.10992.00.0	AGR-K	EL	 Europa Europa
			↳ 7.10334.07.0	AGR	EL	
325 d 85-170 kW (116-231 PS) B47 D20 B	03.2016→02.2018		7.04493.17.0	AGR	EL	
330 d 150-210 kW (204-286 PS) N57 D30 A	07.2012→06.2019		7.10992.00.0	AGR-K	EL	
			↳ 7.10334.07.0	AGR	EL	
330 d 150-210 kW (204-286 PS) N57 D30 A	07.2012→06.2019		7.10992.00.0	AGR-K	EL	 Europa Europa
			↳ 7.10334.07.0	AGR	EL	
			7.11190.12.0	DDS	EL	ohne Zubehör without accessories  N57 D30 A: Ausstattungsvariante: Blue Performance Equipment Variant: Blue Performance nicht für Facelift: LCI not for facelift: LCI  N57 D30 A: Euro 5 Euro 5 für Facelift: LCI for facelift: LCI
			7.02604.44.0	LS	500 mm	 N57 D30 A: Ausstattungsvariante: Blue Performance Equipment Variant: Blue Performance nach Rußpartikelfilter after soot particulate filter  N57 D30 A: vor Rußpartikelfilter before soot particulate filter
330 d xDrive 150-210 kW (204-286 PS) N57 D30 A	03.2013→06.2019		7.10992.00.0	AGR-K	EL	 Europa Europa
			↳ 7.10334.07.0	AGR	EL	
330 d xDrive 150-210 kW (204-286 PS) N57 D30 A	03.2013→06.2019		7.10992.00.0	AGR-K	EL	 Europa Europa
			↳ 7.10334.07.0	AGR	EL	
			7.11190.12.0	DDS	EL	ohne Zubehör without accessories  N57 D30 A: Euro 5 Euro 5 für Facelift: LCI for facelift: LCI  N57 D30 A: Ausstattungsvariante: Blue Performance Equipment Variant: Blue Performance nicht für Facelift: LCI not for facelift: LCI
			7.02604.44.0	LS	500 mm	 N57 D30 A: Ausstattungsvariante: Blue Performance Equipment Variant: Blue Performance nach Rußpartikelfilter after soot particulate filter  N57 D30 A: vor Rußpartikelfilter before soot particulate filter
335 d xDrive 220-230 kW (299-313 PS) N57 D30 B	11.2013→06.2019		7.10992.00.0	AGR-K	EL	 Europa Europa
			↳ 7.10334.07.0	AGR	EL	

3 Touring (F31)
37
B

			7.11190.12.0	DDS		ohne Zubehör without accessories
			7.02604.44.0	LS	500 mm	nach Rußpartikelfilter after soot particulate filter N57 D30 B: →06.2015 vor Rußpartikelfilter before soot particulate filter

3 Touring (G21, G81)
38

330 d 155-235 kW (211-320 PS) B57 D30 A	11.2019→		7.05343.18.0*	AGR-K	EL	ch. 11.2019→
			↳ 7.05343.17.0	AGR	EL	
330 d xDrive 155-235 kW (211-320 PS) B57 D30 A	07.2019→		7.05343.18.0*	AGR-K	EL	
			↳ 7.05343.17.0	AGR	EL	

4 Convertible (F33, F83)
39











420 d 66-150 kW (90-204 PS) N47 D20 C	10.2013→06.2015		7.10992.00.0	AGR-K	EL	Europa Europe
			↳ 7.10334.07.0	AGR	EL	
			7.11190.12.0	DDS		ohne Zubehör without accessories Euro 5 Euro 5
			7.02604.44.0	LS	500 mm	nach Rußpartikelfilter after soot particulate filter Euro 5 Euro 5
420 d 66-150 kW (90-204 PS) N47 D20 C	10.2013→06.2015		7.10992.00.0	AGR-K	EL	
			↳ 7.10334.07.0	AGR	EL	
420 d 66-150 kW (90-204 PS) N47 D20 C	11.2013→		7.10992.00.0	AGR-K	EL	→02.2017 Europa Europe
			↳ 7.10334.07.0	AGR	EL	
420 d 85-155 kW (116-211 PS) B47 D20 A	07.2015→		7.11010.00.0	AGR-K	EL	Europa Europe
			↳ 7.04493.17.0	AGR	EL	
420 d 85-155 kW (116-211 PS) B47 D20 A	07.2015→		7.11010.00.0	AGR-K	EL	Europa Europe
			↳ 7.04493.17.0	AGR	EL	
425 d 150-160 kW (204-218 PS) N47 D20 D	07.2014→02.2016		7.10992.00.0	AGR-K	EL	Europa Europe
			↳ 7.10334.07.0	AGR	EL	
			7.11190.12.0	DDS		ohne Zubehör without accessories Euro 5 Euro 5
			7.02604.44.0	LS	500 mm	nach Rußpartikelfilter after soot particulate filter Euro 5 Euro 5
425 d 150-160 kW (204-218 PS) N47 D20 D	07.2014→02.2016		7.10992.00.0	AGR-K	EL	Europa Europe
			↳ 7.10334.07.0	AGR	EL	
425 d 85-170 kW (116-231 PS) B47 D20 B	03.2016→02.2018		7.04493.17.0	AGR	EL	



B



















4 Convertible (F33, F83)

39

430 d 150-210 kW (204-286 PS) N57 D30 A	07.2014→		7.10992.00.0	AGR-K	EL	 Europa  Europe ohne Zubehör without accessories für OE-Nummer: 13 62 7 805 758 for OE number: 13 62 7 805 758 500 mm  N57 D30 A: nach Rußpartikelfilter after soot particulate filter Euro 6 Euro 6  N57 D30 A: vor Rußpartikelfilter before soot particulate filter
			↳ 7.10334.07.0	AGR	EL	
			7.11190.12.0	DDS		
430 d 150-210 kW (204-286 PS) N57 D30 A	07.2014→		7.10992.00.0	AGR-K	EL	 Europa  Europe
			↳ 7.10334.07.0	AGR	EL	
435 d xDrive 220-230 kW (299-313 PS) N57 D30 B	07.2014→		7.10992.00.0	AGR-K	EL	 Europa  Europe ohne Zubehör without accessories nach Rußpartikelfilter after soot particulate filter
			↳ 7.10334.07.0	AGR	EL	
			7.11190.12.0	DDS		
			7.02604.44.0	LS	500 mm	

4 Coupe (F32, F82)

40

418 d 85-155 kW (116-211 PS) B47 D20 A	03.2015→10.2017		7.11010.00.0	AGR-K	EL	 Europa  Europe
			↳ 7.04493.17.0	AGR	EL	
418 d 85-155 kW (116-211 PS) B47 D20 A	03.2015→10.2017		7.11010.00.0	AGR-K	EL	 Europa  Europe
			↳ 7.04493.17.0	AGR	EL	
420 d 66-150 kW (90-204 PS) N47 D20 C	07.2013→03.2015		7.10992.00.0	AGR-K	EL	 Europa  Europe ohne Zubehör without accessories Euro 5 Euro 5
			↳ 7.10334.07.0	AGR	EL	
			7.11190.12.0	DDS		
420 d 66-150 kW (90-204 PS) N47 D20 C	07.2013→02.2015		7.10992.00.0	AGR-K	EL	 Europa  Europe ohne Zubehör without accessories Euro 5 Euro 5 nach Rußpartikelfilter after soot particulate filter Euro 5 Euro 5
			↳ 7.10334.07.0	AGR	EL	
			7.11190.12.0	DDS		
			7.02604.44.0	LS	500 mm	
420 d 66-150 kW (90-204 PS) N47 D20 C	07.2013→02.2015		7.10992.00.0	AGR-K	EL	 Europa  Europe
			↳ 7.10334.07.0	AGR	EL	
420 d 85-155 kW (116-211 PS) B47 D20 A	03.2015→		7.11010.00.0	AGR-K	EL	 Europa  Europe
			↳ 7.04493.17.0	AGR	EL	

4 Coupe (F32, F82)					
420 d 85-155 kW (116-211 PS) B47 D20 A	03.2015→02.2015		7.11010.00.0 ↳ 7.04493.17.0	AGR-K AGR	EL EL ○ " Europa " Europe
420 d xDrive 66-150 kW (90-204 PS) N47 D20 C	11.2013→03.2015		7.10992.00.0 ↳ 7.10334.07.0	AGR-K AGR	EL EL ○
420 d xDrive 66-150 kW (90-204 PS) N47 D20 C	11.2013→02.2015		7.10992.00.0 ↳ 7.10334.07.0 7.11190.12.0 7.02604.44.0	AGR-K AGR DDS LS	EL EL EL 500 mm ○ " Europa " Europe ohne Zubehör without accessories Euro 5 Euro 5 nach Rußpartikelfilter after soot particulate filter Euro 5 Euro 5
420 d xDrive 66-150 kW (90-204 PS) N47 D20 C	11.2013→		7.10334.07.0	AGR	EL ○
420 d xDrive 85-155 kW (116-211 PS) B47 D20 A	03.2015→		7.11010.00.0 ↳ 7.04493.17.0	AGR-K AGR	EL EL ○ " Europa " Europe
420 d xDrive 85-155 kW (116-211 PS) B47 D20 A	03.2015→		7.10992.00.0 7.11010.00.0 ↳ 7.04493.17.0	AGR-K AGR-K AGR	EL EL EL →02.2017 " Europa " Europe ○ " Europa " Europe EL " Europa " Europe
425 d 150-160 kW (204-218 PS) N47 D20 D	03.2014→02.2016		7.10992.00.0 ↳ 7.10334.07.0 7.11190.12.0 7.02604.44.0	AGR-K AGR DDS LS	EL EL EL 500 mm ○ " Europa " Europe ohne Zubehör without accessories Euro 5 Euro 5 Ausstattungsvariante: Blue Performance Equipment Variant: Blue Performance nach Rußpartikelfilter after soot particulate filter
425 d 150-160 kW (204-218 PS) N47 D20 D	03.2014→02.2016		7.10992.00.0 ↳ 7.10334.07.0	AGR-K AGR	EL EL ○ " Europa " Europe
425 d 85-170 kW (116-231 PS) B47 D20 B	03.2016→10.2017		7.04493.17.0	AGR	EL ○
430 d 150-210 kW (204-286 PS) N57 D30 A	11.2013→		7.10992.00.0 ↳ 7.10334.07.0 7.11190.12.0	AGR-K AGR DDS	EL EL EL ○ " Europa " Europe ohne Zubehör without accessories Euro 5 Euro 5 Produktionsdatum bis: 28.09.2019 Production date to: 28.09.2019



















40
B



B











4 Coupe (F32, F82)

40

			7.02604.44.0	LS	500 mm	 N57 D30 A: vor Rußpartikelfilter before soot particulate filter  N57 D30 A: nach Rußpartikelfilter after soot particulate filter Euro 6 Euro 6
430 d 150-210 kW (204-286 PS) N57 D30 A	11.2013→		7.10992.00.0	AGR-K	EL	 Europa  Europe
			↳ 7.10334.07.0	AGR	EL	
430 d xDrive 150-210 kW (204-286 PS) N57 D30 A	03.2014→		7.10992.00.0	AGR-K	EL	 Europa  Europe
			↳ 7.10334.07.0	AGR	EL	
430 d xDrive 150-210 kW (204-286 PS) N57 D30 A	03.2014→		7.10992.00.0	AGR-K	EL	 Europa  Europe
			↳ 7.10334.07.0	AGR	EL	
			7.11190.12.0	DDS	EL	ohne Zubehör without accessories für OE-Nummer: 13 62 7 805 758 for OE number: 13 62 7 805 758
			7.02604.44.0	LS	500 mm	 N57 D30 A: 03.2017→ Ausstattungsvariante: Blue Performance Equipment Variant: Blue Performance nach Rußpartikelfilter after soot particulate filter  N57 D30 A: 03.2017→ vor Rußpartikelfilter before soot particulate filter
435 d xDrive 220-230 kW (299-313 PS) N57 D30 B	11.2013→12.2020		7.10992.00.0	AGR-K	EL	 →02.2017  Europa  Europe
			↳ 7.10334.07.0	AGR	EL	
			7.11190.12.0	DDS	EL	ohne Zubehör without accessories
			7.02604.44.0	LS	500 mm	 N57 D30 B: nach Rußpartikelfilter after soot particulate filter  N57 D30 B: →02.2017 vor Rußpartikelfilter before soot particulate filter

4 Gran Coupe (F36)

41

418 d 66-150 kW (90-204 PS) N47 D20 C	03.2014→06.2015		7.10992.00.0	AGR-K	EL	 Europa  Europe
			↳ 7.10334.07.0	AGR	EL	
			7.11190.12.0	DDS	EL	ohne Zubehör without accessories
			7.02604.44.0	LS	500 mm	nach Rußpartikelfilter after soot particulate filter
418 d 66-150 kW (90-204 PS) N47 D20 C	03.2014→06.2015		7.10992.00.0	AGR-K	EL	 Europa  Europe
			↳ 7.10334.07.0	AGR	EL	
418 d 85-155 kW (116-211 PS) B47 D20 A	07.2015→		7.11010.00.0	AGR-K	EL	 Europa  Europe
			↳ 7.04493.17.0	AGR	EL	
418 d 85-155 kW (116-211 PS) B47 D20 A	07.2015→06.2015		7.11010.00.0	AGR-K	EL	 Europa  Europe
			↳ 7.04493.17.0	AGR	EL	

4 Gran Coupe (F36)
41
B













420 d 66-150 kW (90-204 PS) N47 D20 C	03.2014→02.2015		7.10992.00.0	AGR-K	EL	 Europa Europe
			↳7.10334.07.0	AGR	EL	
			7.11190.12.0	DDS		ohne Zubehör without accessories Euro 5 Euro 5
			7.02604.44.0	LS	500 mm	nach Rußpartikelfilter after soot particulate filter Euro 6 Euro 6
420 d 66-150 kW (90-204 PS) N47 D20 C	03.2014→02.2015		7.10992.00.0	AGR-K	EL	 Europa Europe
			↳7.10334.07.0	AGR	EL	
420 d 66-150 kW (90-204 PS) N47 D20 C	03.2014→02.2015		7.10992.00.0	AGR-K	EL	 Europa Europe
			↳7.10334.07.0	AGR	EL	
420 d 85-155 kW (116-211 PS) B47 D20 A	03.2015→		7.11010.00.0	AGR-K	EL	 Europa Europe
			↳7.04493.17.0	AGR	EL	
420 d 85-155 kW (116-211 PS) B47 D20 A	03.2015→02.2015		7.11010.00.0	AGR-K	EL	 Europa Europe
			↳7.04493.17.0	AGR	EL	
420 d xDrive 66-150 kW (90-204 PS) N47 D20 C	03.2014→02.2015		7.10334.07.0	AGR	EL	
			7.11190.12.0	DDS		ohne Zubehör without accessories
			7.02604.44.0	LS	500 mm	nach Rußpartikelfilter after soot particulate filter
420 d xDrive 66-150 kW (90-204 PS) N47 D20 C	03.2014→02.2015		7.10992.00.0	AGR-K	EL	 Europa Europe
			↳7.10334.07.0	AGR	EL	
420 d xDrive 66-150 kW (90-204 PS) N47 D20 C	03.2014→02.2015		7.10992.00.0	AGR-K	EL	 Europa Europe
			↳7.10334.07.0	AGR	EL	
420 d xDrive 85-155 kW (116-211 PS) B47 D20 A	03.2015→		7.11010.00.0	AGR-K	EL	 Europa Europe
			↳7.04493.17.0	AGR	EL	
420 d xDrive 85-155 kW (116-211 PS) B47 D20 A	03.2015→02.2015		7.11010.00.0	AGR-K	EL	 Europa Europe
			↳7.04493.17.0	AGR	EL	
425 d 85-170 kW (116-231 PS) B47 D20 B	03.2016→02.2018		7.04493.17.0	AGR	EL	
425 d 85-170 kW (116-231 PS) B47 D20 B	03.2016→02.2018		7.04493.17.0	AGR	EL	
430 d 150-210 kW (204-286 PS) N57 D30 A	07.2014→		7.10992.00.0	AGR-K	EL	 Europa Europe
			↳7.10334.07.0	AGR	EL	



B

4 Gran Coupe (F36)

41

			7.11190.12.0	DDS		ohne Zubehör without accessories Ausstattungsvariante: Blue Performance Equipment Variant: Blue Performance
			7.02604.44.0	LS	500 mm	 N57 D30 A: nach Rußpartikelfilter after soot particulate filter Euro 6 Euro 6  N57 D30 A: vor Rußpartikelfilter before soot particulate filter
430 d 150-210 kW (204-286 PS) N57 D30 A	07.2014→		7.10992.00.0	AGR-K	EL	 Europa Europe
			↳ 7.10334.07.0	AGR	EL	
430 d xDrive 150-210 kW (204-286 PS) N57 D30 A	07.2014→		7.10992.00.0	AGR-K	EL	 Europa Europe
			↳ 7.10334.07.0	AGR	EL	
			7.11190.12.0	DDS		ohne Zubehör without accessories Ausstattungsvariante: Blue Performance Equipment Variant: Blue Performance
			7.02604.44.0	LS	500 mm	 N57 D30 A: nach Rußpartikelfilter after soot particulate filter Euro 6 Euro 6  N57 D30 A: vor Rußpartikelfilter before soot particulate filter
430 d xDrive 150-210 kW (204-286 PS) N57 D30 A	07.2014→		7.10992.00.0	AGR-K	EL	 Europa Europe
			↳ 7.10334.07.0	AGR	EL	
435 d xDrive 220-230 kW (299-313 PS) N57 D30 B	07.2014→		7.10992.00.0	AGR-K	EL	 Europa Europe
			↳ 7.10334.07.0	AGR	EL	
			7.11190.12.0	DDS		ohne Zubehör without accessories
			7.02604.44.0	LS	500 mm	nach Rußpartikelfilter after soot particulate filter

5 (E28)

42

525 e 90-95 kW (122-129 PS) M20 B27 (276KA), M20 B27 (276KB)	09.1981→12.1987		7.02604.01.0	LS	200 mm	
525 e 90-95 kW (122-129 PS) M20 B27 (276EA)	03.1983→12.1987		7.02604.01.0	LS	200 mm	
525 e 90-95 kW (122-129 PS) M20 B27 (276EB), M20 B27 (276KB)	09.1985→12.1987		7.02604.01.0	LS	200 mm	

5 (E34)

43

520 i 24V 110 kW (150 PS) M50 B20 (206S1), M50 B20 (206S2)	04.1990→08.1995		7.05271.70.0	LS	1400 mm	
---	-----------------	---	---------------------	----	---------	--

5 (E39)

44

520 d 85-100 kW (116-136 PS) M47 D20 (204D1)	02.2000→06.2003		7.28264.06.0	AGR	PN	
520 i 100-110 kW (136-150 PS) M52 B20 (206S3)	01.1996→08.1998		7.02604.37.0	LS	990 mm	
520 i 100-110 kW (136-150 PS) M52 B20 (206S4)	09.1998→06.2003		7.22295.61.0	ARV	PN	

















5 (E39)					44	B
			7.02604.37.0 LS 990 mm 7.02604.21.0 LS 990 mm 7.02604.30.0 LS 980 mm 7.02604.31.0 LS 350 mm 7.22166.66.0 SLP-M EL			
520 i 100-110 kW (136-150 PS) M52 B20 (206S4)	09.1998→06.2003		7.02604.21.0 LS 990 mm 7.02604.30.0 LS 980 mm 7.02604.31.0 LS 350 mm 7.22166.66.0 SLP-M EL			
520 i 120-125 kW (163-170 PS) M54 B22 (226S1)	09.2000→06.2003		7.22295.61.0 ARV PN 7.02604.21.0 LS 990 mm 7.02604.31.0 LS 350 mm 7.22166.66.0 SLP-M EL			
520 i 120-125 kW (163-170 PS) M54 B22 (226S1)	09.2000→06.2003		7.22295.61.0 ARV PN 7.22166.66.0 SLP-M EL			
523 i 120-141 kW (163-192 PS) M52 B25 (256S3)	09.1995→08.1998		7.02604.37.0 LS 990 mm		hinten, vorne Rear, Front	
523 i 120-141 kW (163-192 PS) M52 B25 (256S4)	09.1998→08.2000		7.22295.61.0 ARV PN 7.02604.21.0 LS 990 mm 7.02604.30.0 LS 980 mm 7.02604.31.0 LS 350 mm 7.22166.66.0 SLP-M EL			
525 d 120 kW (163 PS) M57 D25 (256D1)	02.2000→06.2003		7.28264.06.0 AGR PN			
525 i 137-141 kW (186-192 PS) M54 B25 (256S5)	09.2000→12.2002		7.22295.61.0 ARV PN 7.22166.66.0 SLP-M EL			
525 i 137-141 kW (186-192 PS) M54 B25 (256S5)	09.2000→06.2003		7.22295.61.0 ARV PN 7.02604.21.0 LS 990 mm 7.02604.31.0 LS 350 mm 7.22166.66.0 SLP-M EL			
525 td 85-105 kW (115-143 PS) M51 D25 (256T1)	01.1997→06.2003		7.21920.62.0 AGR PN		mit Rohrstutzen with pipe socket 	
525 tds 85-105 kW (115-143 PS) M51 D25 (256T1)	01.1996→06.2003		7.21920.62.0 AGR PN		mit Rohrstutzen with pipe socket 	
528 i 141-143 kW (192-194 PS) M52 B28 (286S1)	09.1995→08.2000		7.22295.61.0 ARV PN 7.22295.71.0 ARV PN		USA USA Produktionsdatum bis: 09.1998 Production date to: 09.1998	



B



5 (E39)



























44

			7.02604.21.0	LS	990 mm	
			7.02604.30.0	LS	980 mm	
			7.02604.31.0	LS	350 mm	
			7.22166.66.0	SLP-M	EL	
528 i 141-144 kW (192-196 PS) M52 B28 (286S2)	09.1995→08.2000		7.22295.61.0	ARV	PN	
			7.02604.21.0	LS	990 mm	
			7.02604.30.0	LS	980 mm	
			7.02604.31.0	LS	350 mm	
			7.22166.66.0	SLP-M	EL	
530 d 135-142 kW (184-193 PS) M57 D30 (306D1)	08.1998→09.2000		7.28264.06.0	AGR	PN	
530 d 135-142 kW (184-193 PS) M57 D30 (306D1)	09.1998→06.2003		7.28264.06.0	AGR	PN	
530 i 163-170 kW (222-231 PS) M54 B30 (306S3)	09.2000→06.2003		7.22295.61.0	ARV	PN	
			7.22166.66.0	SLP-M	EL	
530 i 163-170 kW (222-231 PS) M54 B30 (306S3)	09.2000→06.2003		7.22295.61.0	ARV	PN	
			7.02604.21.0	LS	990 mm	
			7.02604.31.0	LS	350 mm	
			7.22166.66.0	SLP-M	EL	
535 i 173 kW (235 PS) M62 B35 (358S1)	06.1996→08.1998		7.02604.31.0	LS	350 mm	
			7.22166.02.0	SLP-M	EL	
535 i 173-180 kW (235-245 PS) M62 B35 (358S2)	09.1998→06.2003		7.22295.68.0	ARV	PN	
			7.02604.31.0	LS	350 mm	
			7.22166.02.0	SLP-M	EL	
540 i 210 kW (286 PS) M62 B44 (448S1)	03.1996→06.2003		7.02604.31.0	LS	350 mm	
			7.22166.02.0	SLP-M	EL	
540 i 210 kW (286 PS) M62 B44 (448S2)	03.1996→06.2003		7.22295.68.0	ARV	PN	 09.1998→
			7.02604.31.0	LS	350 mm	
			7.22166.02.0	SLP-M	EL	
M5 294 kW (400 PS) S62 B50 (508S1)	10.1998→06.2003		7.22295.66.0	ARV	PN	
			7.02604.31.0	LS	350 mm	
			7.22166.02.0	SLP-M	EL	

5 (E60)

45

520 d 85-120 kW (116-163 PS) M47 D20 (204D4)	09.2005→12.2009		7.00450.09.0	AGR	PN	Euro 4 (D4) Euro 4 (D4)
			7.00512.03.0	AGR	PN	Euro 3 (D3) Euro 3 (D3)
520 d 85-120 kW (116-163 PS) M47 D20 (204D4)	09.2005→02.2007		7.00450.09.0	AGR	PN	Euro 4 (D4) Euro 4 (D4)
			7.00512.03.0	AGR	PN	Euro 3 (D3) Euro 3 (D3)













							
5 (E60)						45	B
520 d 66-145 kW (90-197 PS) N47 D20 A	09.2007→12.2009		7.00684.14.0	AGR	PN	mit Potentiometer with potentiometer →09.2008 Euro 3 (D3) Euro 3 (D3) für Linkslenker for left-hand drive vehicles	
			7.10334.07.0	AGR	EL		
520 d 66-145 kW (90-197 PS) N47 D20 A	09.2007→12.2009		7.10334.07.0	AGR	EL		
520 d 66-150 kW (90-204 PS) N47 D20 C	09.2008→12.2009		7.10334.07.0	AGR	EL		
520 i 120-125 kW (163-170 PS) M54 B22 (226S1)	07.2003→03.2010		7.02604.21.0	LS	990 mm		
			7.02604.31.0	LS	350 mm		
			7.28129.32.0*	SLP-M	EL		
			↳ 7.28124.20.0	SLP	EL		
			7.28238.58.0	SLV	PN		
520 i 90-125 kW (122-170 PS) N43 B20 A	12.2006→03.2010		7.24809.50.0	AGR	ET		
520 i 90-125 kW (122-170 PS) N43 B20 A	09.2007→12.2009		7.24809.50.0	AGR	ET		
520 i 95-125 kW (129-170 PS) N46 B20 B	09.2007→02.2010		7.28124.19.0	SLP	EL	für Linkslenker for left-hand drive vehicles " Republik Korea (Südkorea) " Republic of Korea (South Korea)	
			7.01318.24.0	SLV	PN	 " Korea (Republik) " Korea (Republic)	
523 i 130-160 kW (177-218 PS) N52 B25 A	10.2004→02.2007		7.02604.34.0	LS	600 mm		
			7.02604.26.0	LS	500 mm	hinten Rear	
			7.02604.25.0	LS	425 mm	vorne Front	
			7.02604.99.0	LS	400 mm	Diagnosesonde Diagnostic Probe	
			7.02604.42.0	LS	1050 mm		
523 i 130-160 kW (177-218 PS) N52 B25 B, N52 B25 BE	10.2004→02.2007		7.02604.34.0	LS	600 mm		
			7.02604.99.0	LS	400 mm		
			7.02604.42.0	LS	1050 mm		
523 i 130-160 kW (177-218 PS) N52 B25 A, N52 B25 BE	03.2007→12.2009		7.02604.34.0	LS	600 mm		
			7.02604.26.0	LS	500 mm	 N52 B25 A, N52 B25 BE: hinten Rear	
			7.02604.25.0	LS	425 mm	 N52 B25 A, N52 B25 BE: vorne Front	
			7.02604.42.0	LS	1050 mm	Diagnosesonde Diagnostic Probe	
525 d 120-130 kW (163-177 PS) M57 D25 (256D2)	06.2004→03.2010		7.00450.09.0	AGR	PN	Euro 4 (D4) Euro 4 (D4)	
			7.00512.03.0	AGR	PN	Euro 3 (D3) Euro 3 (D3)	



















B

5 (E60)

45

			7.02604.44.0	LS	500 mm	vor Katalysator in front of the catalyst
525 d 120-130 kW (163-177 PS) M57 D25 (256D2)	12.2004→03.2010		7.00512.03.0	AGR	PN	Euro 3 (D3) Euro 3 (D3)
525 d 135-173 kW (184-235 PS) M57 D30 (306D3)	01.2007→03.2010		7.00450.09.0	AGR	PN	Euro 4 (D4) Euro 4 (D4)
525 d xDrive 135-173 kW (184-235 PS) M57 D30 (306D3)	09.2007→12.2009		7.00450.09.0	AGR	PN	Euro 4 (D4) Euro 4 (D4)
525 i 137-141 kW (186-192 PS) M54 B25 (256S5)	07.2003→12.2009		7.02604.21.0	LS	990 mm	hinten, vorne Rear, Front
			7.02604.27.0	LS	750 mm	
			7.02604.31.0	LS	350 mm	hinten, vorne Rear, Front
			7.28124.19.0	SLP	EL	USA USA
			7.28124.20.0	SLP	EL	
			7.28238.58.0	SLV	PN	
525 i 137-141 kW (186-192 PS) M54 B25 (256S5)	09.2003→02.2005		7.02604.21.0	LS	990 mm	hinten, vorne Rear, Front
			7.02604.27.0	LS	750 mm	
			7.02604.31.0	LS	350 mm	hinten, vorne Rear, Front
			7.28124.19.0	SLP	EL	USA USA
			7.28238.58.0	SLV	PN	
525 i 130-160 kW (177-218 PS) N52 B25 A	03.2005→12.2009		7.02604.27.0	LS	750 mm	
			7.02604.34.0	LS	600 mm	vorne Front
			7.02604.26.0	LS	500 mm	hinten Rear
			7.02604.25.0	LS	425 mm	vorne Front
			7.02604.99.0	LS	400 mm	Diagnosesonde Diagnostic Probe
			7.02604.42.0	LS	1050 mm	hinten Rear
525 i 130-160 kW (177-218 PS) N52 B25 B, N52 B25 BF	03.2005→12.2009		7.02604.27.0	LS	750 mm	
			7.02604.99.0	LS	400 mm	
525 i 150-200 kW (204-272 PS) N53 B30 A	01.2007→03.2010		7.02604.27.0	LS	750 mm	
			7.02604.42.0	LS	1050 mm	
525 i xDrive 150-200 kW (204-272 PS) N53 B30 A	09.2008→03.2010		7.02604.27.0	LS	750 mm	
			7.02604.42.0	LS	1050 mm	
525 xd 135-173 kW (184-235 PS) M57 D30 (306D3)	11.2006→08.2007		7.00450.09.0	AGR	PN	Euro 4 (D4) Euro 4 (D4)
525 xi 130-160 kW (177-218 PS) N52 B25 A	04.2005→02.2007		7.02604.27.0	LS	750 mm	
			7.02604.34.0	LS	600 mm	vorne Front











						
5 (E60)					45	B
			7.02604.26.0	LS	500 mm	hinten Rear
			7.02604.25.0	LS	425 mm	vorne Front Diagnosesonde Diagnostic Probe
			7.02604.99.0	LS	400 mm	
			7.02604.42.0	LS	1050 mm	hinten Rear
525 xi 150-200 kW (204-272 PS) N53 B30 A	03.2007→12.2009		7.02604.27.0	LS	750 mm	
			7.02604.42.0	LS	1050 mm	
530 d 150-160 kW (204-218 PS) M57 D30 (306D2)	09.2002→09.2005		7.00450.09.0	AGR	PN	Euro 4 (D4) Euro 4 (D4)
			7.28264.07.0	AGR	PN	
			7.02604.44.0	LS	500 mm	vor Katalysator in front of the catalyst
530 d 135-173 kW (184-235 PS) M57 D30 (306D3)	09.2002→12.2009		7.00450.09.0	AGR	PN	
			7.00512.03.0	AGR	PN	Euro 3 (D3) Euro 3 (D3)
530 d 150-160 kW (204-218 PS) M57 D30 (306D2)	09.2002→12.2009		7.00450.09.0	AGR	PN	
			7.28264.07.0	AGR	PN	
530 d 135-173 kW (184-235 PS) M57 D30 (306D3)	09.2005→03.2007		7.00450.09.0	AGR	PN	Euro 4 (D4) Euro 4 (D4)
			7.00512.03.0	AGR	PN	Euro 3 (D3) Euro 3 (D3)
530 d 135-173 kW (184-235 PS) M57 D30 (306D3)	02.2007→12.2009		7.00450.09.0	AGR	PN	Euro 4 (D4) Euro 4 (D4)
			7.00512.03.0	AGR	PN	Euro 3 (D3) Euro 3 (D3)
530 d xDrive 135-173 kW (184-235 PS) M57 D30 (306D3)	09.2007→12.2009		7.00450.09.0	AGR	PN	Euro 4 (D4) Euro 4 (D4)
			7.00512.03.0	AGR	PN	Euro 3 (D3) Euro 3 (D3)
530 i 163-170 kW (222-231 PS) M54 B30 (306S3)	12.2001→02.2005		7.02604.21.0	LS	990 mm	hinten, vorne Rear, Front
			7.02604.31.0	LS	350 mm	hinten, vorne Rear, Front
			7.28124.19.0	SLP	EL	USA USA
			7.28129.32.0*	SLP-M	EL	
			↳ 7.28124.20.0	SLP	EL	
			7.28238.58.0	SLV	PN	⊙
530 i 163-170 kW (222-231 PS) M54 B30 (306S3)	01.2004→12.2005		7.28124.20.0	SLP	EL	
			7.28238.58.0	SLV	PN	⊙
530 i 155-200 kW (211-272 PS) N52 B30 A	03.2005→03.2007		7.02604.26.0	LS	500 mm	hinten Rear
			7.02604.25.0	LS	425 mm	vorne Front Diagnosesonde Diagnostic Probe
			7.02604.42.0	LS	1050 mm	11.2005→ hinten Rear für Rechtslenker for right-hand drive vehicles

















B

5 (E60)

45

530 i 155-200 kW (211-272 PS) N52 B30 A	03.2005→03.2010		7.02604.26.0	LS	500 mm	hinten Rear
			7.02604.25.0	LS	425 mm	vorne Front Diagnosesonde Diagnostic Probe
			7.02604.42.0	LS	1050 mm	11.2005→ hinten Rear für Rechtslenker for right-hand drive vehicles
530 i 150-200 kW (204-272 PS) N53 B30 A	03.2007→12.2009		7.02604.27.0	LS	750 mm	
			7.02604.34.0	LS	600 mm	vorne Front
			7.02604.42.0	LS	1050 mm	hinten Rear für Rechtslenker for right-hand drive vehicles
530 i 155-200 kW (211-272 PS) N52 B30 A, N52 B30 BF	03.2007→12.2009		7.02604.26.0	LS	500 mm	 N52 B30 A, N52 B30 BF: hinten Rear
			7.02604.25.0	LS	425 mm	 N52 B30 A, N52 B30 BF: vorne Front Diagnosesonde Diagnostic Probe
			7.02604.42.0	LS	1050 mm	 N52 B30 A, N52 B30 BF: hinten Rear für Rechtslenker for right-hand drive vehicles
530 i 155-200 kW (211-272 PS) N52 B30 A	09.2007→12.2009		7.02604.26.0	LS	500 mm	hinten Rear
			7.02604.25.0	LS	425 mm	vorne Front Diagnosesonde Diagnostic Probe
			7.02604.42.0	LS	1050 mm	hinten Rear für Rechtslenker for right-hand drive vehicles
530 i xDrive 150-200 kW (204-272 PS) N53 B30 A	09.2008→12.2009		7.02604.27.0	LS	750 mm	
			7.02604.34.0	LS	600 mm	vorne Front
			7.02604.42.0	LS	1050 mm	hinten Rear für Rechtslenker for right-hand drive vehicles
530 xd 135-173 kW (184-235 PS) M57 D30 (306D3)	02.2005→02.2007		7.00450.09.0	AGR	PN	Euro 4 (D4) Euro 4 (D4)
			7.00512.03.0	AGR	PN	Euro 3 (D3) Euro 3 (D3)
530 xd 135-173 kW (184-235 PS) M57 D30 (306D3)	03.2007→08.2007		7.00450.09.0	AGR	PN	Euro 4 (D4) Euro 4 (D4)
			7.00512.03.0	AGR	PN	Euro 3 (D3) Euro 3 (D3)
530 xi 155-200 kW (211-272 PS) N52 B30 A	09.2004→02.2007		7.02604.26.0	LS	500 mm	hinten Rear
			7.02604.25.0	LS	425 mm	vorne Front Diagnosesonde Diagnostic Probe
			7.02604.99.0	LS	400 mm	





						
5 (E60)					45	B
			7.02604.42.0	LS	1050 mm	11.2005→ hinten Rear für Rechtslenker for right-hand drive vehicles
535 d 198-200 kW (269-272 PS) M57 D30 (306D4)	09.2004→03.2010		7.00450.09.0	AGR	PN	vor Katalysator in front of the catalyst ■ Europa ■ Europe
			7.02604.41.0	LS	700 mm	
535 d 198-221 kW (269-301 PS) M57 D30 (306D5)	01.2007→03.2010		7.00450.10.0	AGR	PN	
535 i 200-264 kW (272-359 PS) N54 B30 A	09.2007→03.2010		7.02604.27.0	LS	750 mm	
			7.02604.43.0	LS	1200 mm	
535 i xDrive 200-264 kW (272-359 PS) N54 B30 A	09.2008→12.2009		7.02604.27.0	LS	750 mm	
			7.02604.43.0	LS	1200 mm	
535 xi 200-264 kW (272-359 PS) N54 B30 A	03.2007→08.2008		7.02604.27.0	LS	750 mm	
			7.02604.43.0	LS	1200 mm	
540 i 200-225 kW (272-306 PS) N62 B40 A	09.2005→02.2007		7.02604.34.0	LS	600 mm	
			7.02604.25.0	LS	425 mm	
			7.02604.42.0	LS	1050 mm	
540 i 200-225 kW (272-306 PS) N62 B40 A	03.2007→12.2009		7.02604.41.0	LS	700 mm	für OE-Nummer: 11 78 7 561 410, 7 561 410 for OE number: 11 78 7 561 410, 7 561 410 N62 B40 A: für OE-Nummer: 11 78 7 539 123 for OE number: 11 78 7 539 123 vor Katalysator, rechts in front of the catalyst, Right N62 B40 A: vor Katalysator, links in front of the catalyst, Left
			7.02604.34.0	LS	600 mm	
			7.05270.21.0	LS	600 mm	
			7.02604.25.0	LS	425 mm	
			7.02604.42.0	LS	1050 mm	
			7.05271.22.0	LS	600 mm	
545 i 235-245 kW (320-333 PS) N62 B44 A	09.2003→12.2005		7.05271.22.0	LS	600 mm	N62 B44 A: Automatikgetriebe Automatic Transmission vor Katalysator, links in front of the catalyst, Left N62 B44 A: Automatikgetriebe Automatic Transmission für OE-Nummer: 11 78 7 512 982, 7 512 982 for OE number: 11 78 7 512 982, 7 512 982 vor Katalysator, rechts in front of the catalyst, Right
			7.28124.19.0	SLP	EL	
545 i 235-245 kW (320-333 PS) N62 B44 A	09.2003→08.2005		7.28238.56.0	SLV	PN	
			7.05271.23.0	LS	900 mm	



B

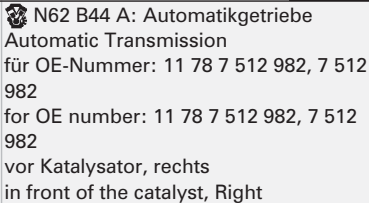
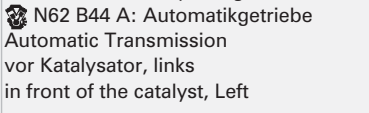

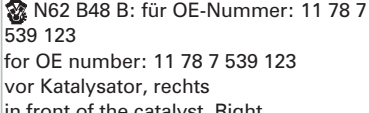
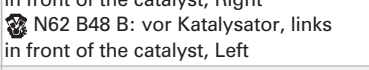







5 (E60)

45

			7.05271.22.0	LS	600 mm	 
			7.02604.32.0	LS	450 mm	
			7.28124.19.0	SLP	EL	
			7.28238.56.0	SLV	PN	
550 i 261-270 kW (355-367 PS) N62 B48 B	09.2005→12.2009		7.02604.41.0	LS	700 mm	für OE-Nummer: 11 78 7 561 410, 7 561 410 for OE number: 11 78 7 561 410, 7 561 410
			7.05270.21.0	LS	600 mm	 
M5 373 kW (507 PS) S85 B50 A	09.2004→12.2009		7.02604.32.0	LS	450 mm	
			7.28124.19.0	SLP	EL	

5 (F10)

46

518 d 66-150 kW (90-204 PS) N47 D20 C	07.2013→06.2014		7.10993.00.0	AGR-K	EL	 Europa Europe
			↳ 7.10334.07.0	AGR	EL	
			7.11190.12.0	DDS		ohne Zubehör without accessories Euro 5 Euro 5
			7.02604.44.0	LS	500 mm	nach Rußpartikelfilter after soot particulate filter Euro 6 Euro 6
518 d 66-150 kW (90-204 PS) N47 D20 C	07.2013→06.2014		7.10993.00.0	AGR-K	EL	 Europa Europe
			↳ 7.10334.07.0	AGR	EL	
518 d 85-155 kW (116-211 PS) B47 D20 A	10.2013→10.2016		7.04493.17.0	AGR	EL	
518 d 85-155 kW (116-211 PS) B47 D20 A	07.2014→10.2016		7.11010.00.0	AGR-K	EL	 Europa Europe
			↳ 7.04493.17.0	AGR	EL	
520 d 66-150 kW (90-204 PS) N47 D20 C	06.2010→06.2014		7.10992.00.0	AGR-K	EL	 für OE-Nummer: 11 71 7 823 210 for OE number: 11 71 7 823 210
			↳ 7.10334.07.0	AGR	EL	
			7.10993.00.0	AGR-K	EL	 für OE-Nummer: 11 71 8 517 724 for OE number: 11 71 8 517 724 Europa, Indien, Malaysia, Thailand, Indonesien Europe, India, Malaysia, Thailand, Indonesia
			↳ 7.10334.07.0	AGR	EL	

























5 (F10)					46	B
			7.11190.12.0	DDS	ohne Zubehör without accessories N47 D20 C: Ausstattungsvariante: Blue Performance Equipment Variant: Blue Performance nicht für Facelift: LCI not for facelift: LCI N47 D20 C: Euro 5 Euro 5 für Facelift: LCI for facelift: LCI	
			7.02604.44.0	LS	500 mm nach Rußpartikelfilter after soot particulate filter Euro 6 Euro 6	
520 d 66-150 kW (90-204 PS) N47 D20 C	06.2010→10.2016		7.10992.00.0	AGR-K	EL für OE-Nummer: 11 71 7 823 210 for OE number: 11 71 7 823 210	
			↳ 7.10334.07.0	AGR	EL	
			7.10993.00.0	AGR-K	EL für OE-Nummer: 11 71 8 517 724 for OE number: 11 71 8 517 724 " Europa, Indien, Malaysia, Thailand, Indonesien " Europe, India, Malaysia, Thailand, Indonesia	
			↳ 7.10334.07.0	AGR	EL	
			7.11190.12.0	DDS	ohne Zubehör without accessories N47 D20 C: Euro 5 Euro 5 für Facelift: LCI for facelift: LCI N47 D20 C: Ausstattungsvariante: Blue Performance Equipment Variant: Blue Performance nicht für Facelift: LCI not for facelift: LCI	
520 d 66-150 kW (90-204 PS) N47 D20 C	06.2010→06.2014		7.10993.00.0	AGR-K	EL " Europa, Indien, Malaysia, Thailand, Indonesien " Europe, India, Malaysia, Thailand, Indonesia	
			↳ 7.10334.07.0	AGR	EL	
520 d 66-150 kW (90-204 PS) N47 D20 C	01.2013→06.2014		7.10992.00.0	AGR-K	EL für OE-Nummer: 11 71 7 823 210 for OE number: 11 71 7 823 210	
			↳ 7.10334.07.0	AGR	EL	
			7.10993.00.0	AGR-K	EL für OE-Nummer: 11 71 8 517 724 for OE number: 11 71 8 517 724 " Europa, Indien, Malaysia, Thailand, Indonesien " Europe, India, Malaysia, Thailand, Indonesia	
			↳ 7.10334.07.0	AGR	EL	
520 d 85-155 kW (116-211 PS) B47 D20 A	10.2013→10.2016		7.04493.17.0	AGR	EL	
520 d 85-155 kW (116-211 PS) B47 D20 A	07.2014→10.2016		7.11010.00.0	AGR-K	EL " Russland, Europa, Indien, Malaysia, Thailand, Indonesien, Indonesien " Russia, Europe, India, Malaysia, Thailand, Indonesia, Indonesia	
			↳ 7.04493.17.0	AGR	EL	
520 d 85-155 kW (116-211 PS) B47 D20 A	07.2014→10.2016		7.04493.17.0	AGR	EL	



B

5 (F10)

46

520 d 85-155 kW (116-211 PS) B47 D20 A	07.2014→10.2016		7.11010.00.0	AGR-K	EL	 ■■ Russland, Europa, Indien, Malaysia, Thailand, Indonesien, Indonesien ■■ Russia, Europe, India, Malaysia, Thailand, Indonesia, Indonesia	
			↳ 7.04493.17.0	AGR	EL		
520 d xDrive 66-150 kW (90-204 PS) N47 D20 C	01.2013→06.2014		7.10334.07.0	AGR	EL		
520 d xDrive 66-150 kW (90-204 PS) N47 D20 C	01.2013→06.2014		7.10334.07.0	AGR	EL		
520 d xDrive 66-150 kW (90-204 PS) N47 D20 C	07.2013→06.2014		7.10334.07.0	AGR	EL		
			7.11190.12.0	DDS			ohne Zubehör without accessories
520 d xDrive 85-155 kW (116-211 PS) B47 D20 A	10.2013→10.2016		7.04493.17.0	AGR	EL		
520 d xDrive 85-155 kW (116-211 PS) B47 D20 A	10.2013→10.2016		7.04493.17.0	AGR	EL		
520 d xDrive 85-155 kW (116-211 PS) B47 D20 A	07.2014→10.2016		7.11010.00.0	AGR-K	EL	 ■■ Europa ■■ Europe	
			↳ 7.04493.17.0	AGR	EL		
520 d xDrive 85-155 kW (116-211 PS) B47 D20 A	07.2014→10.2016		7.11010.00.0	AGR-K	EL	 ■■ Europa ■■ Europe	
			↳ 7.04493.17.0	AGR	EL		
523 i 150-200 kW (204-272 PS) N53 B30 A	06.2009→08.2011		7.02604.34.0	LS	600 mm		
			7.02604.42.0	LS	1050 mm		
523 i 130-160 kW (177-218 PS) N52 B25 A, N52 B25 AF, N52 B25 B, N52 B25 BF	01.2010→08.2011		7.02604.27.0	LS	750 mm		
			7.02604.34.0	LS	600 mm		
			7.02604.42.0	LS	1050 mm		
525 d 150-210 kW (204-286 PS) N57 D30 A	03.2010→08.2011		7.10334.07.0	AGR	EL		
525 d 150-160 kW (204-218 PS) N47 D20 D	09.2011→10.2016		7.10993.00.0	AGR-K	EL	 07.2013→ für OE-Nummer: 11 71 8 517 724 for OE number: 11 71 8 517 724 ■■ Europa, Indien, Thailand ■■ Europe, India, Thailand	
			↳ 7.10334.07.0	AGR	EL		
			7.10992.00.0	AGR-K	EL		 für OE-Nummer: 11 71 7 823 210 for OE number: 11 71 7 823 210
			↳ 7.10334.07.0	AGR	EL		
525 d 150-160 kW (204-218 PS) N47 D20 D	09.2011→10.2016		7.10993.00.0	AGR-K	EL	 07.2013→ für OE-Nummer: 11 71 8 517 724 for OE number: 11 71 8 517 724 ■■ Europa, Indien, Thailand ■■ Europe, India, Thailand	
			↳ 7.10334.07.0	AGR	EL		





























5 (F10)					46	B
			7.10992.00.0 AGR-K EL für OE-Nummer: 11 71 7 823 210 for OE number: 11 71 7 823 210 ↳ 7.10334.07.0 AGR EL 7.11190.12.0 DDS 7.02604.44.0 LS 500 mm ohne Zubehör without accessories Euro 5 Euro 5 für Facelift: LCI for facelift: LCI 07.2013→ nach Rußpartikelfilter after soot particulate filter Euro 6 Euro 6			
525 d xDrive 150-160 kW (204-218 PS) N47 D20 D	09.2011→10.2016		7.10992.00.0 AGR-K EL ↳ 7.10334.07.0 AGR EL 7.10992.00.0 AGR-K EL ↳ 7.10334.07.0 AGR EL 7.11190.12.0 DDS 7.02604.44.0 LS 500 mm für OE-Nummer: 13 62 7 793 825 for OE number: 13 62 7 793 825 nach Rußpartikelfilter after soot particulate filter			
525 d xDrive 150-160 kW (204-218 PS) N47 D20 D	09.2011→10.2016		7.10992.00.0 AGR-K EL ↳ 7.10334.07.0 AGR EL 7.11190.12.0 DDS 7.02604.44.0 LS 500 mm für OE-Nummer: 13 62 7 793 825 for OE number: 13 62 7 793 825 nach Rußpartikelfilter after soot particulate filter			
528 i 155-200 kW (211-272 PS) N52 B30 A	10.2009→08.2011		7.02604.34.0 LS 600 mm 7.02604.42.0 LS 1050 mm			
528 i 150-200 kW (204-272 PS) N53 B30 A	03.2010→08.2011		7.02604.34.0 LS 600 mm 7.02604.42.0 LS 1050 mm			
530 d 150-210 kW (204-286 PS) N57 D30 A	01.2010→08.2011		7.10992.00.0 AGR-K EL für OE-Nummer: 11 71 7 823 210 for OE number: 11 71 7 823 210 ↳ 7.10334.07.0 AGR EL 7.10993.00.0 AGR-K EL für OE-Nummer: 11 71 8 517 724 for OE number: 11 71 8 517 724 ↳ 7.10334.07.0 AGR EL 7.11190.12.0 DDS ohne Zubehör without accessories N57 D30 A: Euro 5 Euro 5 für Facelift: LCI for facelift: LCI N57 D30 A: Ausstattungsvariante: Blue Performance Equipment Variant: Blue Performance nicht für Facelift: LCI not for facelift: LCI			



B

5 (F10)

46

		7.02604.44.0	LS	500 mm	 N57 D30 A: für OE-Nummer: 13 62 7 791 592, 13 62 7 793 825 for OE number: 13 62 7 791 592, 13 62 7 793 825 nach Rußpartikelfilter after soot particulate filter  N57 D30 A: vor Rußpartikelfilter before soot particulate filter
530 d 150-210 kW (204-286 PS) N57 D30 A	09.2010→10.2016	 7.10992.00.0	AGR-K	EL	 →06.2013  Europa, Indien  Europe, India
		↳ 7.10334.07.0	AGR	EL	
		7.10993.00.0	AGR-K	EL	 07.2013→  Russland, Europa, Indien  Russia, Europe, India
530 d 150-210 kW (204-286 PS) N57 D30 A	09.2011→10.2016	 7.10993.00.0	AGR-K	EL	 07.2013→ für OE-Nummer: 11 71 8 517 724 for OE number: 11 71 8 517 724  Russland, Europa, Indien  Russia, Europe, India
		↳ 7.10334.07.0	AGR	EL	
		7.10992.00.0	AGR-K	EL	 für OE-Nummer: 11 71 7 823 210 for OE number: 11 71 7 823 210  Europa, Indien  Europe, India
		↳ 7.10334.07.0	AGR	EL	
		7.11190.12.0	DDS		ohne Zubehör without accessories  N57 D30 A: Ausstattungsvariante: Blue Performance Equipment Variant: Blue Performance nicht für Facelift: LCI not for facelift: LCI  N57 D30 A: Euro 5 Euro 5 für Facelift: LCI for facelift: LCI
		7.02604.44.0	LS	500 mm	 N57 D30 A: vor Rußpartikelfilter before soot particulate filter  N57 D30 A: für OE-Nummer: 13 62 7 791 592, 13 62 7 793 825 for OE number: 13 62 7 791 592, 13 62 7 793 825 nach Rußpartikelfilter after soot particulate filter
530 d xDrive 150-210 kW (204-286 PS) N57 D30 A	03.2011→10.2016	 7.10992.00.0	AGR-K	EL	 Russland, Europa  Russia, Europe
		↳ 7.10334.07.0	AGR	EL	
		7.02604.41.0	LS	700 mm	→06.2012 vor Rußpartikelfilter before soot particulate filter  Russland, Europa  Russia, Europe
530 d xDrive 150-210 kW (204-286 PS) N57 D30 A	03.2011→10.2016	 7.10992.00.0	AGR-K	EL	 Russland, Europa  Russia, Europe
		↳ 7.10334.07.0	AGR	EL	















5 (F10)					46	B
			7.11190.12.0 DDS 7.02604.41.0 LS 700 mm 7.02604.44.0 LS 500 mm		ohne Zubehör without accessories Ausstattungsvariante: Blue Performance Equipment Variant: Blue Performance für Facelift: LCI for facelift: LCI vor Rußpartikelfilter before soot particulate filter " " Russland, Europa " " Russia, Europe Produktionsdatum bis: 30.06.2012 Production date to: 30.06.2012 N57 D30 A: nach Rußpartikelfilter after soot particulate filter " " USA " " USA N57 D30 A: nach Rußpartikelfilter after soot particulate filter Euro 6 Euro 6 N57 D30 A: vor Rußpartikelfilter before soot particulate filter Produktionsdatum ab: 01.07.2012 Production date from: 01.07.2012	
535 d 220-230 kW (299-313 PS) N57 D30 B	09.2010→08.2011	 ↳ 7.10334.07.0 7.10993.00.0 ↳ 7.10334.07.0 7.02604.44.0	AGR-K EL AGR EL AGR-K EL AGR EL LS 500 mm		für OE-Nummer: 11 71 7 823 210 for OE number: 11 71 7 823 210 " " Europa " " Europe für OE-Nummer: 11 71 8 517 724 for OE number: 11 71 8 517 724 " " Europa " " Europe vor Rußpartikelfilter before soot particulate filter Produktionsdatum ab: 01.07.2012 Production date from: 01.07.2012	
535 d 220-230 kW (299-313 PS) N57 D30 B	09.2011→10.2016	 ↳ 7.10334.07.0 7.10992.00.0 ↳ 7.10334.07.0 7.11190.12.0 7.02604.41.0	AGR-K EL AGR EL AGR-K EL AGR EL DDS LS 700 mm		07.2013→ für OE-Nummer: 11 71 8 517 724 for OE number: 11 71 8 517 724 " " Europa " " Europe für OE-Nummer: 11 71 7 823 210 for OE number: 11 71 7 823 210 " " Europa " " Europe ohne Zubehör without accessories für OE-Nummer: 13 62 7 805 758 for OE number: 13 62 7 805 758 vor Rußpartikelfilter before soot particulate filter " " Europa " " Europe Produktionsdatum bis: 30.06.2012 Production date to: 30.06.2012	



B















5 (F10)

46

			7.02604.44.0	LS	500 mm	 N57 D30 B: vor Rußpartikelfilter before soot particulate filter Produktionsdatum ab: 01.07.2012 Production date from: 01.07.2012  N57 D30 B: nach Rußpartikelfilter after soot particulate filter Euro 6 Euro 6
535 d xDrive 220-230 kW (299-313 PS) N57 D30 B	09.2011→10.2016		7.10992.00.0	AGR-K	EL	 Europa  Europe
			↳ 7.10334.07.0	AGR	EL	ohne Zubehör without accessories
			7.11190.12.0	DDS		
			7.02604.41.0	LS	700 mm	vor Rußpartikelfilter before soot particulate filter  Europa  Europe Produktionsdatum bis: 30.06.2012 Production date to: 30.06.2012
			7.02604.44.0	LS	500 mm	vor Rußpartikelfilter before soot particulate filter Produktionsdatum ab: 01.07.2012 Production date from: 01.07.2012
550 i 298-330 kW (405-449 PS) N63 B44 A	03.2010→06.2013		7.02604.34.0	LS	600 mm	
550 i 298-330 kW (405-449 PS) N63 B44 A	09.2010→06.2013		7.02604.34.0	LS	600 mm	
550 i 298-339 kW (405-461 PS) N63 B44 B	07.2013→10.2016		7.02604.34.0	LS	600 mm	
550 i 298-339 kW (405-461 PS) N63 B44 B	07.2013→10.2016		7.02604.34.0	LS	600 mm	
M 550 d xDrive 280 kW (381 PS) N57 D30 C	03.2012→10.2016		7.10992.00.0	AGR-K	EL	 Europa  Europe
			↳ 7.10334.07.0	AGR	EL	ohne Zubehör without accessories
			7.11190.12.0	DDS		
			7.02604.44.0	LS	500 mm	für OE-Nummer: 13 62 7 805 758 for OE number: 13 62 7 805 758 für OE-Nummer: 13 62 7 791 592, 13 62 7 793 825 for OE number: 13 62 7 791 592, 13 62 7 793 825

5 (G30, F90)

47

518 d 85-170 kW (116-231 PS) B47 D20 B	07.2018→06.2020		7.04493.17.0	AGR	EL	
518 d 85-170 kW (116-231 PS) B47 D20 B	07.2018→06.2020		7.04493.17.0	AGR	EL	
520 d 85-155 kW (116-211 PS) B47 D20 A	09.2016→10.2019		7.05838.08.0	AGR	EL	
			7.11010.00.0	AGR-K	EL	 02.2017→  Russland, Europa, Indien, Thailand, Indonesien, Indonesien  Russia, Europe, India, Thailand, Indonesia, Indonesia
520 d 85-170 kW (116-231 PS) B47 D20 B	09.2016→10.2019		7.05838.08.0	AGR	EL	
520 d 85-155 kW (116-211 PS) B47 D20 A	09.2016→10.2019		7.04493.17.0	AGR	EL	
			7.05838.08.0	AGR	EL	

5 (G30, F90) 47 **B**

520 d Mild-Hybrid 85-170 kW (116-231 PS) B47 D20 B	11.2019→	7.05838.08.0	AGR	EL	○
520 d Mild-Hybrid 85-170 kW (116-231 PS) B47 D20 B	11.2019→	7.05838.08.0	AGR	EL	○
520 d xDrive 85-155 kW (116-211 PS) B47 D20 A	09.2016→10.2019	7.05838.08.0	AGR	EL	○
		7.11010.00.0	AGR-K	EL	○ 02.2017→ " " Russland, Europa " " Russia, Europe
		↳ 7.04493.17.0	AGR	EL	
520 d xDrive 85-155 kW (116-211 PS) B47 D20 A	09.2016→10.2019	7.04493.17.0	AGR	EL	○
		7.05838.08.0	AGR	EL	○
525 d 85-170 kW (116-231 PS) B47 D20 B	07.2017→06.2019	7.05838.08.0	AGR	EL	○
525 d 85-170 kW (116-231 PS) B47 D20 B	07.2017→06.2019	7.05838.08.0	AGR	EL	○
530 d 155-235 kW (211-320 PS) B57 D30 A	09.2016→06.2020	7.04493.17.0	AGR	EL	○
		7.05343.18.0* ↳ 7.05343.17.0	AGR-K AGR	EL EL	11.2016→
530 d xDrive 155-235 kW (211-320 PS) B57 D30 A	09.2016→06.2020	7.04493.17.0	AGR	EL	○
		7.05343.18.0* ↳ 7.05343.17.0	AGR-K AGR	EL EL	11.2016→
530 d xDrive 155-235 kW (211-320 PS) B57 D30 A	09.2016→06.2020	7.04493.17.0	AGR	EL	○
		7.05343.18.0* ↳ 7.05343.17.0	AGR-K AGR	EL EL	11.2016→
540 d xDrive 155-235 kW (211-320 PS) B57 D30 A	07.2017→06.2020	7.05343.18.0*	AGR-K	EL	11.2016→
		↳ 7.05343.17.0	AGR	EL	
540 d xDrive 155-250 kW (211-340 PS) B57 D30 B	07.2017→06.2020	7.04493.17.0	AGR	EL	○
		7.05343.18.0* ↳ 7.05343.17.0	AGR-K AGR	EL EL	
M 550 d xDrive 294 kW (400 PS) B57 D30 C	06.2017→	7.04493.17.0	AGR	EL	○
		7.05838.08.0	AGR	EL	○

5 Gran Turismo (F07) 48















520 d 66-150 kW (90-204 PS) N47 D20 C	04.2011→02.2017	7.10992.00.0	AGR-K	EL	○ " " Europa " " Europe
		↳ 7.10334.07.0	AGR	EL	
		7.11190.12.0	DDS		ohne Zubehör without accessories Ausstattungsvariante: Blue Performance Equipment Variant: Blue Performance

















B

5 Gran Turismo (F07)

48

			7.02604.44.0	LS	500 mm	 N47 D20 C: 07.2013→ nach Rußpartikelfilter after soot particulate filter Euro 5 Euro 5  N47 D20 C: →06.2013 Ausstattungsvariante: Blue Performance Equipment Variant: Blue Performance nach Rußpartikelfilter after soot particulate filter
520 d 66-150 kW (90-204 PS) N47 D20 C	07.2012→06.2013		7.10992.00.0	AGR-K	EL	 <ul style="list-style-type: none"> ▣ Europa ▣ Europe
			↳ 7.10334.07.0	AGR	EL	
520 d 66-150 kW (90-204 PS) N47 D20 C	07.2013→02.2017		7.10992.00.0	AGR-K	EL	 für OE-Nummer: 11 71 7 823 210 for OE number: 11 71 7 823 210 <ul style="list-style-type: none"> ▣ Europa ▣ Europe
			↳ 7.10334.07.0	AGR	EL	
530 d 150-210 kW (204-286 PS) N57 D30 A	08.2009→06.2012		7.10992.00.0	AGR-K	EL	 für OE-Nummer: 11 71 7 823 210 for OE number: 11 71 7 823 210 <ul style="list-style-type: none"> ▣ Europa ▣ Europe
			↳ 7.10334.07.0	AGR	EL	
			7.10993.00.0	AGR-K	EL	 für OE-Nummer: 11 71 8 517 724 for OE number: 11 71 8 517 724 <ul style="list-style-type: none"> ▣ Europa ▣ Europe
			↳ 7.10334.07.0	AGR	EL	
			7.11190.12.0	DDS		ohne Zubehör without accessories  N57 D30 A: Euro 5 Euro 5 für Facelift: LCI for facelift: LCI  N57 D30 A: Ausstattungsvariante: Blue Performance Equipment Variant: Blue Performance nicht für Facelift: LCI not for facelift: LCI
			7.02604.41.0	LS	700 mm	für OE-Nummer: 13 62 7 794 634, 7 794 634 for OE number: 13 62 7 794 634, 7 794 634
			7.02604.44.0	LS	500 mm	Ausstattungsvariante: Blue Performance Equipment Variant: Blue Performance vor Rußpartikelfilter, nach Rußpartikelfilter before soot particulate filter, after soot particulate filter
530 d 150-210 kW (204-286 PS) N57 D30 A	09.2010→02.2017		7.10992.00.0	AGR-K	EL	 für OE-Nummer: 11 71 7 823 210 for OE number: 11 71 7 823 210 <ul style="list-style-type: none"> ▣ Europa ▣ Europe
			↳ 7.10334.07.0	AGR	EL	
			7.10993.00.0	AGR-K	EL	 für OE-Nummer: 11 71 8 517 724 for OE number: 11 71 8 517 724 <ul style="list-style-type: none"> ▣ Europa ▣ Europe
			↳ 7.10334.07.0	AGR	EL	

5 Gran Turismo (F07)
48
B



		7.02604.41.0	LS	700 mm	für OE-Nummer: 13 62 7 794 634, 7 794 634 for OE number: 13 62 7 794 634, 7 794 634
530 d 150-210 kW (204-286 PS) N57 D30 A	07.2012→02.2017	 7.10992.00.0	AGR-K	EL	 für OE-Nummer: 11 71 7 823 210 for OE number: 11 71 7 823 210 " Europa " Europe
		↳ 7.10334.07.0	AGR	EL	
		7.10993.00.0	AGR-K	EL	 für OE-Nummer: 11 71 8 517 724 for OE number: 11 71 8 517 724 " Europa " Europe
		↳ 7.10334.07.0	AGR	EL	
		7.11190.12.0	DDS		ohne Zubehör without accessories  N57 D30 A: Ausstattungsvariante: Blue Performance Equipment Variant: Blue Performance nicht für Facelift: LCI not for facelift: LCI  N57 D30 A: Euro 5 Euro 5 für Facelift: LCI for facelift: LCI
		7.02604.41.0	LS	700 mm	für OE-Nummer: 13 62 7 794 634, 7 794 634 for OE number: 13 62 7 794 634, 7 794 634
		7.02604.44.0	LS	500 mm	 N57 D30 A: nach Rußpartikelfilter after soot particulate filter Euro 6 Euro 6  N57 D30 A: vor Rußpartikelfilter before soot particulate filter
530 d xDrive 150-210 kW (204-286 PS) N57 D30 A	06.2010→06.2012	 7.10992.00.0	AGR-K	EL	 für OE-Nummer: 11 71 7 823 210 for OE number: 11 71 7 823 210 " Europa " Europe
		↳ 7.10334.07.0	AGR	EL	
		7.10993.00.0	AGR-K	EL	 für OE-Nummer: 11 71 8 517 724 for OE number: 11 71 8 517 724 " Europa " Europe
530 d xDrive 150-210 kW (204-286 PS) N57 D30 A	07.2012→02.2017	↳ 7.10334.07.0	AGR	EL	
		 7.10992.00.0	AGR-K	EL	 für OE-Nummer: 11 71 7 823 210 for OE number: 11 71 7 823 210 " Europa " Europe
		↳ 7.10334.07.0	AGR	EL	
		7.10993.00.0	AGR-K	EL	 für OE-Nummer: 11 71 8 517 724 for OE number: 11 71 8 517 724 " Europa " Europe
		↳ 7.10334.07.0	AGR	EL	
		7.02604.44.0	LS	500 mm	 N57 D30 A: vor Rußpartikelfilter before soot particulate filter  N57 D30 A: nach Rußpartikelfilter after soot particulate filter Euro 6 Euro 6



B

5 Gran Turismo (F07)

48

535 d 220-230 kW (299-313 PS) N57 D30 B	03.2010→06.2012		7.10992.00.0 AGR-K EL	für OE-Nummer: 11 71 7 823 210 for OE number: 11 71 7 823 210 # Europa # Europe
		↳ 7.10334.07.0 AGR EL		
		7.10993.00.0 AGR-K EL	für OE-Nummer: 11 71 8 517 724 for OE number: 11 71 8 517 724 # Europa # Europe	
		↳ 7.10334.07.0 AGR EL 7.02604.41.0 LS 700 mm	vor Rußpartikelfilter before soot particulate filter Euro 5 Euro 5 # Europa # Europe	
		7.02604.44.0 LS 500 mm	nach Rußpartikelfilter after soot particulate filter	
535 d 220-230 kW (299-313 PS) N57 D30 B	07.2012→02.2017		7.10992.00.0 AGR-K EL	für OE-Nummer: 11 71 7 823 210 for OE number: 11 71 7 823 210 # Europa # Europe
		↳ 7.10334.07.0 AGR EL		
		7.10993.00.0 AGR-K EL	für OE-Nummer: 11 71 8 517 724 for OE number: 11 71 8 517 724 # Europa # Europe	
		↳ 7.10334.07.0 AGR EL 7.11190.12.0 DDS	ohne Zubehör without accessories Euro 5 Euro 5	
		7.02604.41.0 LS 700 mm	vor Rußpartikelfilter before soot particulate filter # Europa # Europe	
		7.02604.44.0 LS 500 mm	N57 D30 B: vor Rußpartikelfilter before soot particulate filter N57 D30 B: nach Rußpartikelfilter after soot particulate filter Euro 5 Euro 5	
535 d xDrive 220-230 kW (299-313 PS) N57 D30 B	03.2010→06.2012		7.10992.00.0 AGR-K EL	für OE-Nummer: 11 71 7 823 210 for OE number: 11 71 7 823 210 # Europa # Europe
		↳ 7.10334.07.0 AGR EL		
		7.10993.00.0 AGR-K EL	für OE-Nummer: 11 71 8 517 724 for OE number: 11 71 8 517 724 # Europa # Europe	
		↳ 7.10334.07.0 AGR EL 7.02604.41.0 LS 700 mm	vor Rußpartikelfilter before soot particulate filter Euro 5 Euro 5 # Europa # Europe	
		7.02604.44.0 LS 500 mm	vor Rußpartikelfilter before soot particulate filter	



















5 Gran Turismo (F07)						48
535 d xDrive 220-230 kW (299-313 PS) N57 D30 B	07.2012→02.2017		7.10992.00.0	AGR-K	EL	für OE-Nummer: 11 71 7 823 210 for OE number: 11 71 7 823 210 Europa Europe
			↳ 7.10334.07.0	AGR	EL	
			7.10993.00.0	AGR-K	EL	
			↳ 7.10334.07.0	AGR	EL	
			7.11190.12.0	DDS		für OE-Nummer: 11 71 8 517 724 for OE number: 11 71 8 517 724 Europa Europe
			7.02604.44.0	LS	500 mm	ohne Zubehör without accessories Euro 5 Euro 5 N57 D30 B: vor Rußpartikelfilter before soot particulate filter N57 D30 B: nach Rußpartikelfilter after soot particulate filter Euro 5 Euro 5
550 i 298-330 kW (405-449 PS) N63 B44 A	08.2009→06.2012		7.02604.34.0	LS	600 mm	
550 i 298-339 kW (405-461 PS) N63 B44 A, N63 B44 B	07.2012→02.2017		7.02604.34.0	LS	600 mm	
5 Touring (E34)						49
520 i 110 kW (150 PS) M50 B20 (206S1), M50 B20 (206S2)	07.1991→07.1996		7.05271.70.0	LS	1400 mm	
5 Touring (E39)						50
520 d 85-100 kW (116-136 PS) M47 D20 (204D1)	02.2000→09.2003		7.28264.06.0	AGR	PN	
520 i 100-110 kW (136-150 PS) M52 B20 (206S3)	03.1997→08.1998		7.02604.37.0	LS	990 mm	
520 i 100-110 kW (136-150 PS) M52 B20 (206S4)	09.1998→08.2001		7.02604.37.0	LS	990 mm	
			7.02604.21.0	LS	990 mm	
			7.02604.30.0	LS	980 mm	
			7.02604.31.0	LS	350 mm	
			7.22166.66.0	SLP-M	EL	
520 i 100-110 kW (136-150 PS) M52 B20 (206S4)	09.1998→08.2001		7.02604.21.0	LS	990 mm	
			7.02604.30.0	LS	980 mm	
			7.02604.31.0	LS	350 mm	
			7.22166.66.0	SLP-M	EL	
520 i 120-125 kW (163-170 PS) M54 B22 (226S1)	09.2000→12.2003		7.22295.61.0	ARV	PN	
			7.02604.21.0	LS	990 mm	
			7.02604.31.0	LS	350 mm	
			7.22166.66.0	SLP-M	EL	
520 i 120-125 kW (163-170 PS) M54 B22 (226S1)	09.2000→12.2003		7.22295.61.0	ARV	PN	
523 i 120-141 kW (163-192 PS) M52 B25 (256S3)	03.1997→08.2000		7.22295.61.0	ARV	PN	



























B

5 Touring (E39)

50

			7.02604.21.0	LS	990 mm	
			7.02604.37.0	LS	990 mm	hinten, vorne
			7.02604.30.0	LS	980 mm	Rear, Front
			7.02604.31.0	LS	350 mm	
			7.22166.66.0	SLP-M	EL	09.1998→
523 i 120-141 kW (163-192 PS) M52 B25 (256S4)	09.1998→08.2000		7.22295.61.0	ARV	PN	
			7.02604.21.0	LS	990 mm	
			7.02604.30.0	LS	980 mm	
			7.02604.31.0	LS	350 mm	
			7.22166.66.0	SLP-M	EL	
523 i 120-141 kW (163-192 PS) M52 B25 (256S4)	09.1998→08.2000		7.22295.61.0	ARV	PN	
			7.22166.66.0	SLP-M	EL	
525 d 120 kW (163 PS) M57 D25 (256D1)	02.2000→05.2004		7.28264.06.0	AGR	PN	
525 i 137-141 kW (186-192 PS) M54 B25 (256S5)	09.2000→12.2003		7.22295.61.0	ARV	PN	
			7.22166.66.0	SLP-M	EL	
525 i 137-141 kW (186-192 PS) M54 B25 (256S5)	09.2000→05.2004		7.22295.61.0	ARV	PN	
			7.02604.21.0	LS	990 mm	
			7.02604.31.0	LS	350 mm	
			7.22166.66.0	SLP-M	EL	
525 tds 85-105 kW (115-143 PS) M51 D25 (256T1)	03.1997→05.2004		7.21920.62.0	AGR	PN	mit Rohrstützen with pipe socket 
528 i 141-144 kW (192-196 PS) M52 B28 (286S1), M52 B28 (286S2)	11.1996→08.2000		7.22295.61.0	ARV	PN	
			7.02604.21.0	LS	990 mm	
			7.02604.30.0	LS	980 mm	
			7.02604.31.0	LS	350 mm	
			7.22166.66.0	SLP-M	EL	
530 d 135-142 kW (184-193 PS) M57 D30 (306D1)	08.1998→09.2000		7.28264.06.0	AGR	PN	
530 d 135-142 kW (184-193 PS) M57 D30 (306D1)	09.2000→05.2004		7.28264.06.0	AGR	PN	
530 i 163-170 kW (222-231 PS) M54 B30 (306S3)	09.2000→12.2003		7.22295.61.0	ARV	PN	
			7.02604.21.0	LS	990 mm	
			7.02604.31.0	LS	350 mm	
			7.22166.66.0	SLP-M	EL	
540 i 210 kW (286 PS) M62 B44 (448S1)	04.1997→12.2003		7.02604.31.0	LS	350 mm	
			7.22166.02.0	SLP-M	EL	















							
5 Touring (E39)						50	B
540 i 210 kW (286 PS) M62 B44 (448S2)	04.1997→12.2003		7.22295.68.0	ARV	PN	 09.1998→	
			7.02604.31.0	LS	350 mm		
			7.22166.02.0	SLP-M	EL		
5 Touring (E61)						51	
520 d 85-120 kW (116-163 PS) M47 D20 (204D4)	04.2005→05.2010		7.00450.09.0	AGR	PN	Euro 4 (D4) Euro 4 (D4)	
			7.00512.03.0	AGR	PN	Euro 3 (D3) Euro 3 (D3)	
520 d 85-120 kW (116-163 PS) M47 D20 (204D4)	09.2005→02.2007		7.00450.09.0	AGR	PN	Euro 4 (D4) Euro 4 (D4)	
			7.00512.03.0	AGR	PN		
520 d 66-145 kW (90-197 PS) N47 D20 A	09.2007→05.2010		7.00684.14.0	AGR	PN	mit Potentiometer with potentiometer  →09.2008 Euro 3 (D3) Euro 3 (D3) für Linkslenker for left-hand drive vehicles	
			7.10334.07.0	AGR	EL		
520 d 66-150 kW (90-204 PS) N47 D20 C	09.2007→05.2010		7.10334.07.0	AGR	EL		
520 i 90-125 kW (122-170 PS) N43 B20 A	07.2007→08.2010		7.24809.50.0	AGR	ET		
520 i 90-125 kW (122-170 PS) N43 B20 A	09.2007→12.2010		7.24809.50.0	AGR	ET		
523 i 130-160 kW (177-218 PS) N52 B25 A	10.2004→02.2007		7.02604.26.0	LS	500 mm	hinten Rear	
			7.02604.25.0	LS	425 mm	vorne Front Diagnosesonde Diagnostic Probe	
			7.02604.99.0	LS	400 mm		
			7.02604.42.0	LS	1050 mm		
523 i 130-160 kW (177-218 PS) N52 B25 B, N52 B25 BE	10.2004→02.2007		7.02604.99.0	LS	400 mm		
			7.02604.42.0	LS	1050 mm		
			7.02604.26.0	LS	500 mm	hinten Rear	
523 i 130-160 kW (177-218 PS) N52 B25 A	03.2007→01.2010		7.02604.25.0	LS	425 mm	vorne Front Diagnosesonde Diagnostic Probe	
			7.02604.42.0	LS	1050 mm		
			7.02604.26.0	LS	500 mm	hinten Rear	
525 d 120-130 kW (163-177 PS) M57 D25 (256D2)	03.2004→03.2007		7.00450.09.0	AGR	PN	Euro 4 (D4) Euro 4 (D4)	
			7.00512.03.0	AGR	PN	Euro 3 (D3) Euro 3 (D3)	
525 d 120-130 kW (163-177 PS) M57 D25 (256D2)	03.2004→03.2007		7.00450.09.0	AGR	PN	Euro 4 (D4) Euro 4 (D4)	
			7.00512.03.0	AGR	PN	Euro 3 (D3) Euro 3 (D3)	
525 d 135-173 kW (184-235 PS) M57 D30 (306D3)	03.2007→05.2010		7.00450.09.0	AGR	PN	Euro 4 (D4) Euro 4 (D4)	

















B

5 Touring (E61)

51

525 d xDrive 135-173 kW (184-235 PS) M57 D30 (306D3)	09.2008→05.2010		7.00450.09.0	AGR	PN	
525 i 137-141 kW (186-192 PS) M54 B25 (256S5)	06.2004→12.2010		7.02604.21.0	LS	990 mm	hinten, vorne Rear, Front
			7.02604.31.0	LS	350 mm	hinten, vorne Rear, Front
			7.28124.20.0	SLP	EL	
			7.28238.58.0	SLV	PN	
525 i 130-160 kW (177-218 PS) N52 B25 A	03.2005→05.2010		7.02604.26.0	LS	500 mm	hinten Rear
			7.02604.25.0	LS	425 mm	vorne Front Diagnosesonde Diagnostic Probe
			7.02604.99.0	LS	400 mm	
			7.02604.42.0	LS	1050 mm	11.2005→ hinten Rear
525 i 130-160 kW (177-218 PS) N52 B25 B, N52 B25 BF	03.2005→05.2010		7.02604.99.0	LS	400 mm	
525 i 150-200 kW (204-272 PS) N53 B30 A	01.2007→12.2010		7.02604.34.0	LS	600 mm	
			7.02604.42.0	LS	1050 mm	
525 i xDrive 150-200 kW (204-272 PS) N53 B30 A	09.2008→12.2010		7.02604.34.0	LS	600 mm	
			7.02604.42.0	LS	1050 mm	
525 xd 135-173 kW (184-235 PS) M57 D30 (306D3)	09.2007→09.2008		7.00450.09.0	AGR	PN	Euro 4 (D4) Euro 4 (D4)
525 xi 130-160 kW (177-218 PS) N52 B25 A	07.2005→12.2010		7.02604.26.0	LS	500 mm	hinten Rear
			7.02604.25.0	LS	425 mm	vorne Front Diagnosesonde Diagnostic Probe
			7.02604.99.0	LS	400 mm	
			7.02604.42.0	LS	1050 mm	11.2005→ hinten Rear
525 xi 150-200 kW (204-272 PS) N53 B30 A	01.2007→12.2010		7.02604.34.0	LS	600 mm	
			7.02604.42.0	LS	1050 mm	
530 d 150-160 kW (204-218 PS) M57 D30 (306D2)	03.2004→09.2005		7.00450.09.0	AGR	PN	Euro 4 (D4) Euro 4 (D4)
			7.28264.07.0	AGR	PN	
530 d 135-173 kW (184-235 PS) M57 D30 (306D3)	03.2004→05.2010		7.00450.09.0	AGR	PN	
			7.00512.03.0	AGR	PN	Euro 3 (D3) Euro 3 (D3)
530 d 150-160 kW (204-218 PS) M57 D30 (306D2)	03.2004→05.2010		7.00450.09.0	AGR	PN	
			7.28264.07.0	AGR	PN	
530 d 135-173 kW (184-235 PS) M57 D30 (306D3)	02.2005→02.2007		7.00450.09.0	AGR	PN	Euro 4 (D4) Euro 4 (D4)
			7.00512.03.0	AGR	PN	Euro 3 (D3) Euro 3 (D3)

							
5 Touring (E61)						51	B
530 d 135-173 kW (184-235 PS) M57 D30 (306D3)	02.2007→05.2010		7.00450.09.0	AGR	PN	Euro 4 (D4) Euro 4 (D4)	
			7.00512.03.0	AGR	PN	Euro 3 (D3) Euro 3 (D3)	
530 d xDrive 135-173 kW (184-235 PS) M57 D30 (306D3)	09.2007→05.2010		7.00450.09.0	AGR	PN		
			7.00512.03.0	AGR	PN	Euro 3 (D3) Euro 3 (D3)	
530 i 155-200 kW (211-272 PS) N52 B30 A	09.2004→02.2007		7.02604.27.0	LS	750 mm		
			7.02604.26.0	LS	500 mm	hinten Rear	
			7.02604.25.0	LS	425 mm	vorne Front Diagnosesonde Diagnostic Probe	
530 i 155-200 kW (211-272 PS) N52 B30 A	09.2006→03.2010		7.02604.27.0	LS	750 mm		
			7.02604.26.0	LS	500 mm	hinten Rear	
			7.02604.25.0	LS	425 mm	vorne Front Diagnosesonde Diagnostic Probe	
			7.02604.99.0	LS	400 mm		
530 i 150-200 kW (204-272 PS) N53 B30 A	01.2007→12.2010		7.02604.27.0	LS	750 mm	hinten Rear Diagnosesonde Diagnostic Probe	
			7.02604.34.0	LS	600 mm	vorne Front	
			7.02604.99.0	LS	400 mm		
			7.02604.42.0	LS	1050 mm	hinten Rear für Rechtslenker for right-hand drive vehicles	
530 i xDrive 150-200 kW (204-272 PS) N53 B30 A	09.2008→05.2010		7.02604.27.0	LS	750 mm	hinten Rear Diagnosesonde Diagnostic Probe	
			7.02604.34.0	LS	600 mm	vorne Front	
			7.02604.42.0	LS	1050 mm	hinten Rear für Rechtslenker for right-hand drive vehicles	
530 xd 135-173 kW (184-235 PS) M57 D30 (306D3)	02.2005→02.2007		7.00450.09.0	AGR	PN	Euro 4 (D4) Euro 4 (D4)	
			7.00512.03.0	AGR	PN	Euro 3 (D3) Euro 3 (D3)	
530 xd 135-173 kW (184-235 PS) M57 D30 (306D3)	03.2007→08.2007		7.00450.09.0	AGR	PN	Euro 4 (D4) Euro 4 (D4)	
			7.00512.03.0	AGR	PN	Euro 3 (D3) Euro 3 (D3)	
530 xi 155-200 kW (211-272 PS) N52 B30 A	04.2005→02.2007		7.02604.27.0	LS	750 mm		
			7.02604.26.0	LS	500 mm	hinten Rear	



B

5 Touring (E61)

51

			7.02604.25.0	LS	425 mm	vorne Front Diagnosesonde Diagnostic Probe
			7.02604.99.0	LS	400 mm	
530 xi 155-200 kW (211-272 PS) N52 B30 A	03.2007→05.2010		7.02604.27.0	LS	750 mm	
			7.02604.26.0	LS	500 mm	hinten Rear
			7.02604.25.0	LS	425 mm	vorne Front Diagnosesonde Diagnostic Probe
535 d 198-200 kW (269-272 PS) M57 D30 (306D4)	09.2004→12.2010		7.00450.09.0	AGR	PN	Euro 4 (D4) Euro 4 (D4)
			7.02604.41.0	LS	700 mm	vor Katalysator in front of the catalyst ■ Europa ■ Europe
535 d 198-221 kW (269-301 PS) M57 D30 (306D5)	01.2007→12.2010		7.00450.10.0	AGR	PN	
545 i 235-245 kW (320-333 PS) N62 B44 A	06.2004→12.2010		7.05271.23.0	LS	900 mm	
			7.05271.22.0	LS	600 mm	N62 B44 A: Automatikgetriebe Automatic Transmission für OE-Nummer: 11787512982, 7 512 982 for OE number: 11787512982, 7 512 982 vor Katalysator, rechts in front of the catalyst, Right N62 B44 A: Automatikgetriebe Automatic Transmission vor Katalysator, links in front of the catalyst, Left
			7.02604.32.0	LS	450 mm	
			7.28124.19.0	SLP	EL	
550 i 261-270 kW (355-367 PS) N62 B48 B	07.2005→12.2010		7.02604.41.0	LS	700 mm	für OE-Nummer: 11 78 7 561 410, 7 561 410 for OE number: 11 78 7 561 410, 7 561 410
			7.05270.21.0	LS	600 mm	N62 B48 B: für OE-Nummer: 11 78 7 539 123 for OE number: 11 78 7 539 123 vor Katalysator, rechts in front of the catalyst, Right N62 B48 B: vor Katalysator, links in front of the catalyst, Left
			7.28238.56.0	SLV	PN	
M5 373 kW (507 PS) S85 B50 A	02.2007→12.2010		7.02604.32.0	LS	450 mm	
			7.28124.19.0	SLP	EL	

5 Touring (F11)

52

518 d 66-150 kW (90-204 PS) N47 D20 C	07.2013→06.2014		7.10993.00.0	AGR-K	EL	 ■ Europa ■ Europe
			↳ 7.10334.07.0	AGR	EL	
			7.11190.12.0	DDS		ohne Zubehör without accessories Euro 5 Euro 5

--	--	--	--	--	--

5 Touring (F11) **52** **B**









































			7.02604.44.0	LS	500 mm	nach Rußpartikelfilter after soot particulate filter Euro 6 Euro 6
518 d 66-150 kW (90-204 PS) N47 D20 C	07.2013→06.2014		7.10993.00.0	AGR-K	EL	Europa Europe
			↳ 7.10334.07.0 7.11190.12.0	AGR DDS	EL	ohne Zubehör without accessories Euro 5 Euro 5
518 d 85-155 kW (116-211 PS) B47 D20 A	07.2014→02.2017		7.11010.00.0	AGR-K	EL	Europa Europe
			↳ 7.04493.17.0	AGR	EL	
518 d 85-155 kW (116-211 PS) B47 D20 A	07.2014→02.2017		7.04493.17.0	AGR	EL	
518 d 85-155 kW (116-211 PS) B47 D20 A	07.2014→02.2017		7.11010.00.0	AGR-K	EL	Europa Europe
			↳ 7.04493.17.0	AGR	EL	
520 d 66-150 kW (90-204 PS) N47 D20 C	06.2010→06.2014		7.10992.00.0	AGR-K	EL	für OE-Nummer: 11 71 7 823 210 for OE number: 11 71 7 823 210 Europa Europe
			↳ 7.10334.07.0 7.10993.00.0	AGR AGR-K	EL EL	für OE-Nummer: 11 71 8 517 724 for OE number: 11 71 8 517 724 Europa Europe
			↳ 7.10334.07.0 7.11190.12.0	AGR DDS	EL	ohne Zubehör without accessories N47 D20 C: Ausstattungsvariante: Blue Performance Equipment Variant: Blue Performance nicht für Facelift: LCI not for facelift: LCI N47 D20 C: Euro 5 Euro 5 für Facelift: LCI for facelift: LCI
			7.02604.44.0	LS	500 mm	nach Rußpartikelfilter after soot particulate filter Euro 6 Euro 6
520 d 66-150 kW (90-204 PS) N47 D20 C	06.2010→02.2017		7.10992.00.0	AGR-K	EL	für OE-Nummer: 11 71 7 823 210 for OE number: 11 71 7 823 210 Europa Europe
			↳ 7.10334.07.0 7.10993.00.0	AGR AGR-K	EL EL	für OE-Nummer: 11 71 8 517 724 for OE number: 11 71 8 517 724 Europa Europe
			↳ 7.10334.07.0	AGR	EL	

























B

5 Touring (F11)

52

			7.11190.12.0	DDS		ohne Zubehör without accessories  N47 D20 C: Euro 5 Euro 5 für Facelift: LCI for facelift: LCI  N47 D20 C: Ausstattungsvariante: Blue Performance Equipment Variant: Blue Performance nicht für Facelift: LCI not for facelift: LCI
520 d 85-155 kW (116-211 PS) B47 D20 A	06.2010→02.2017		7.04493.17.0	AGR	EL	
520 d 66-150 kW (90-204 PS) N47 D20 C	06.2010→06.2014		7.10334.07.0	AGR	EL	
520 d 66-150 kW (90-204 PS) N47 D20 C	06.2010→06.2014		7.10992.00.0	AGR-K	EL	 für OE-Nummer: 11 71 7 823 210 for OE number: 11 71 7 823 210  Europa  Europe
			↳ 7.10334.07.0	AGR	EL	
			7.10993.00.0	AGR-K	EL	 für OE-Nummer: 11 71 8 517 724 for OE number: 11 71 8 517 724  Europa  Europe
			↳ 7.10334.07.0	AGR	EL	
520 d 85-155 kW (116-211 PS) B47 D20 A	07.2014→02.2017		7.11010.00.0	AGR-K	EL	  Europa  Europe
			↳ 7.04493.17.0	AGR	EL	
520 d 85-155 kW (116-211 PS) B47 D20 A	07.2014→02.2017		7.04493.17.0	AGR	EL	
520 d 85-155 kW (116-211 PS) B47 D20 A	07.2014→02.2017		7.11010.00.0	AGR-K	EL	  Europa  Europe
			↳ 7.04493.17.0	AGR	EL	
520 d xDrive 66-150 kW (90-204 PS) N47 D20 C	07.2013→06.2014		7.10334.07.0	AGR	EL	
			7.11190.12.0	DDS		ohne Zubehör without accessories
520 d xDrive 66-150 kW (90-204 PS) N47 D20 C	07.2013→06.2014		7.10334.07.0	AGR	EL	
520 d xDrive 66-150 kW (90-204 PS) N47 D20 C	07.2013→06.2014		7.10334.07.0	AGR	EL	
520 d xDrive 85-155 kW (116-211 PS) B47 D20 A	07.2014→02.2017		7.11010.00.0	AGR-K	EL	  Europa  Europe
			↳ 7.04493.17.0	AGR	EL	
520 d xDrive 85-155 kW (116-211 PS) B47 D20 A	07.2014→02.2017		7.04493.17.0	AGR	EL	
520 d xDrive 85-155 kW (116-211 PS) B47 D20 A	07.2014→02.2017		7.04493.17.0	AGR	EL	
520 d xDrive 85-155 kW (116-211 PS) B47 D20 A	07.2014→02.2017		7.11010.00.0	AGR-K	EL	  Europa  Europe
			↳ 7.04493.17.0	AGR	EL	











					
5 Touring (F11)					
525 d 150-210 kW (204-286 PS) N57 D30 A	09.2010→08.2011		7.10334.07.0	AGR	EL 
525 d 150-160 kW (204-218 PS) N47 D20 D	09.2011→02.2017		7.10993.00.0	AGR-K	EL  07.2013→ für OE-Nummer: 11 71 8 517 724 for OE number: 11 71 8 517 724 " Europa " Europe
			↳ 7.10334.07.0	AGR	EL 
			7.10992.00.0	AGR-K	EL  für OE-Nummer: 11 71 7 823 210 for OE number: 11 71 7 823 210 " Europa " Europe
			↳ 7.10334.07.0	AGR	EL
			7.11190.12.0	DDS	ohne Zubehör without accessories
			7.02604.44.0	LS	500 mm 07.2013→ nach Rußpartikelfilter after soot particulate filter
525 d 150-160 kW (204-218 PS) N47 D20 D	09.2011→02.2017		7.10993.00.0	AGR-K	EL  07.2013→ für OE-Nummer: 11 71 8 517 724 for OE number: 11 71 8 517 724 " Europa " Europe
			↳ 7.10334.07.0	AGR	EL
			7.10992.00.0	AGR-K	EL  für OE-Nummer: 11 71 7 823 210 for OE number: 11 71 7 823 210
			↳ 7.10334.07.0	AGR	EL
			7.11190.12.0	DDS	ohne Zubehör without accessories
525 d xDrive 150-160 kW (204-218 PS) N47 D20 D	07.2013→02.2017		7.10992.00.0	AGR-K	EL  " Europa " Europe
			↳ 7.10334.07.0	AGR	EL
			7.11190.12.0	DDS	ohne Zubehör without accessories
			7.02604.44.0	LS	500 mm für OE-Nummer: 13 62 7 791 592, 13 62 7 793 825 for OE number: 13 62 7 791 592, 13 62 7 793 825 nach Rußpartikelfilter after soot particulate filter
525 d xDrive 150-160 kW (204-218 PS) N47 D20 D	07.2013→02.2017		7.10992.00.0	AGR-K	EL  " Europa " Europe
			↳ 7.10334.07.0	AGR	EL
			7.11190.12.0	DDS	ohne Zubehör without accessories
530 d 150-210 kW (204-286 PS) N57 D30 A	06.2010→08.2011		7.10992.00.0	AGR-K	EL  für OE-Nummer: 11 71 7 823 210 for OE number: 11 71 7 823 210 " Europa " Europe
			↳ 7.10334.07.0	AGR	EL
			7.10993.00.0	AGR-K	EL  für OE-Nummer: 11 71 8 517 724 for OE number: 11 71 8 517 724 " Europa " Europe
			↳ 7.10334.07.0	AGR	EL



B

5 Touring (F11)

52

			7.11190.12.0	DDS		ohne Zubehör without accessories Ausstattungsvariante: Blue Performance Equipment Variant: Blue Performance
			7.02604.44.0	LS	500 mm	Ausstattungsvariante: Blue Performance Equipment Variant: Blue Performance nach Rußpartikelfilter after soot particulate filter
530 d 150-210 kW (204-286 PS) N57 D30 A	09.2011→02.2017		7.10992.00.0	AGR-K	EL	 →06.2013 Europa Europe
			↳ 7.10334.07.0	AGR	EL	
			7.10993.00.0	AGR-K	EL	 07.2013→ Europa Europe
530 d 150-210 kW (204-286 PS) N57 D30 A	09.2011→02.2017		7.10992.00.0	AGR-K	EL	 Europa Europe
			↳ 7.10334.07.0	AGR	EL	
			7.11190.12.0	DDS		ohne Zubehör without accessories  N57 D30 A: für Facelift: LCI for facelift: LCI  N57 D30 A: Ausstattungsvariante: Blue Performance Equipment Variant: Blue Performance nicht für Facelift: LCI not for facelift: LCI
			7.02604.44.0	LS	500 mm	vor Rußpartikelfilter, nach Rußpartikelfilter before soot particulate filter, after soot particulate filter
530 d xDrive 150-210 kW (204-286 PS) N57 D30 A	03.2011→02.2017		7.10992.00.0	AGR-K	EL	 Europa Europe
			↳ 7.10334.07.0	AGR	EL	
			7.11190.12.0	DDS		ohne Zubehör without accessories
			7.02604.41.0	LS	700 mm	→06.2012 vor Rußpartikelfilter before soot particulate filter Europa Russia, Europe Russia, Europe
530 d xDrive 150-210 kW (204-286 PS) N57 D30 A	03.2011→02.2017		7.10992.00.0	AGR-K	EL	 Europa Europe
			↳ 7.10334.07.0	AGR	EL	
			7.11190.12.0	DDS		ohne Zubehör without accessories
			7.02604.41.0	LS	700 mm	vor Rußpartikelfilter before soot particulate filter Europa Europe Produktionsdatum bis: 30.06.2012 Production date to: 30.06.2012







5 Touring (F11)					52	B
			7.02604.44.0	LS	500 mm N57 D30 A: →06.2013 vor Rußpartikelfilter before soot particulate filter Produktionsdatum ab: 01.07.2012 Production date from: 01.07.2012 N57 D30 A: 07.2013→ vor Rußpartikelfilter, nach Rußpartikelfilter before soot particulate filter, after soot particulate filter	
530 i 155-200 kW (211-272 PS) N52 B30 A	03.2010→05.2013		7.01318.20.0	SLV	PN " China " China	
535 d 220-230 kW (299-313 PS) N57 D30 B	09.2010→08.2011		7.10992.00.0	AGR-K	EL für OE-Nummer: 11 71 7 823 210 for OE number: 11 71 7 823 210 " Europa " Europe	
			↳ 7.10334.07.0	AGR	EL	
			7.10993.00.0	AGR-K	EL für OE-Nummer: 11 71 8 517 724 for OE number: 11 71 8 517 724 " Europa " Europe	
			↳ 7.10334.07.0	AGR	EL	
			7.02604.41.0	LS	700 mm vor Rußpartikelfilter before soot particulate filter " Europa " Europe	
			7.02604.44.0	LS	500 mm vor Rußpartikelfilter before soot particulate filter	
535 d 220-230 kW (299-313 PS) N57 D30 B	09.2011→02.2017		7.10993.00.0	AGR-K	EL 07.2013→ für OE-Nummer: 11 71 8 517 724 for OE number: 11 71 8 517 724 " Europa " Europe	
			↳ 7.10334.07.0	AGR	EL	
			7.10992.00.0	AGR-K	EL für OE-Nummer: 11 71 7 823 210 for OE number: 11 71 7 823 210 " Europa " Europe	
			↳ 7.10334.07.0	AGR	EL	
			7.11190.12.0	DDS	ohne Zubehör without accessories für Facelift: LCI for facelift: LCI	
			7.02604.44.0	LS	500 mm N57 D30 B: vor Rußpartikelfilter before soot particulate filter N57 D30 B: nach Rußpartikelfilter after soot particulate filter	
535 d xDrive 220-230 kW (299-313 PS) N57 D30 B	09.2011→02.2017		7.10992.00.0	AGR-K	EL " Europa " Europe	
			↳ 7.10334.07.0	AGR	EL	
			7.11190.12.0	DDS	ohne Zubehör without accessories für Facelift: LCI for facelift: LCI	
			7.02604.41.0	LS	700 mm vor Rußpartikelfilter before soot particulate filter " Europa " Europe Produktionsdatum bis: 30.06.2012 Production date to: 30.06.2012	



B

































5 Touring (F11)





















52

			7.02604.44.0	LS	500 mm	 N57 D30 B: vor Rußpartikelfilter before soot particulate filter Produktionsdatum ab: 01.07.2012 Production date from: 01.07.2012  N57 D30 B: nach Rußpartikelfilter after soot particulate filter  N57 D30 B: vor Rußpartikelfilter before soot particulate filter
M 550 d xDrive 280 kW (381 PS) N57 D30 C	03.2012→02.2017		7.10992.00.0	AGR-K	EL	 Europa  Europe ohne Zubehör without accessories für OE-Nummer: 13 62 7 805 758 for OE number: 13 62 7 805 758 für OE-Nummer: 13 62 7 791 592, 13 62 7 793 825 for OE number: 13 62 7 791 592, 13 62 7 793 825
			↳ 7.10334.07.0	AGR	EL	
			7.11190.12.0	DDS		
			7.02604.44.0	LS	500 mm	

5 Touring (G31)

53

518 d 85-170 kW (116-231 PS) B47 D20 B	07.2018→06.2020		7.04493.17.0	AGR	EL	
518 d 85-170 kW (116-231 PS) B47 D20 B	07.2018→06.2020		7.04493.17.0	AGR	EL	
520 d 85-155 kW (116-211 PS) B47 D20 A	03.2017→10.2019		7.05838.08.0	AGR	EL	
			7.11010.00.0	AGR-K	EL	 Europa  Europe
			↳ 7.04493.17.0	AGR	EL	
520 d 85-155 kW (116-211 PS) B47 D20 A	03.2017→10.2019		7.04493.17.0	AGR	EL	
			7.05838.08.0	AGR	EL	
520 d 85-170 kW (116-231 PS) B47 D20 B	07.2018→10.2019		7.05838.08.0	AGR	EL	
520 d 85-170 kW (116-231 PS) B47 D20 B	07.2018→10.2019		7.05838.08.0	AGR	EL	
520 d xDrive 85-155 kW (116-211 PS) B47 D20 A	07.2017→10.2019		7.05838.08.0	AGR	EL	
			7.11010.00.0	AGR-K	EL	 Europa  Europe
			↳ 7.04493.17.0	AGR	EL	
520 d xDrive 85-155 kW (116-211 PS) B47 D20 A	07.2017→10.2019		7.04493.17.0	AGR	EL	
			7.05838.08.0	AGR	EL	
520 d xDrive 85-170 kW (116-231 PS) B47 D20 B	07.2018→10.2019		7.05838.08.0	AGR	EL	
520 d xDrive 85-170 kW (116-231 PS) B47 D20 B	07.2018→10.2019		7.05838.08.0	AGR	EL	
525 d 85-170 kW (116-231 PS) B47 D20 B	07.2017→06.2019		7.04493.17.0	AGR	EL	
			7.05838.08.0	AGR	EL	
525 d 85-170 kW (116-231 PS) B47 D20 B	07.2017→06.2019		7.04493.17.0	AGR	EL	
			7.05838.08.0	AGR	EL	







							
5 Touring (G31)						53	B
530 d 155-235 kW (211-320 PS) B57 D30 A	03.2017→06.2020		7.04493.17.0	AGR	EL		
			7.05343.18.0* ↳ 7.05343.17.0	AGR-K AGR	EL EL		
530 d xDrive 155-235 kW (211-320 PS) B57 D30 A	03.2017→06.2020		7.04493.17.0	AGR	EL		
			7.05343.18.0* ↳ 7.05343.17.0	AGR-K AGR	EL EL		
540 d xDrive 155-250 kW (211-340 PS) B57 D30 B	07.2017→06.2020		7.04493.17.0	AGR	EL		
			7.05343.18.0* ↳ 7.05343.17.0	AGR-K AGR	EL EL		
M 550 d xDrive 294 kW (400 PS) B57 D30 C	07.2017→		7.04493.17.0	AGR	EL		
			7.05838.08.0	AGR	EL		
6 (E24)						54	
635 CSi 136-162 kW (185-220 PS) M30 B34 (346EC), M30 B34 (346KA), M30 B34 (346KB)	12.1977→04.1989		7.02604.03.0	LS	200 mm		
			7.02604.04.0	LS	200 mm		
M 635 CSi 191-211 kW (260-287 PS) S38 B35 (356ED)	04.1986→02.1989		7.02604.03.0	LS	200 mm		
			7.02604.04.0	LS	200 mm		
6 (E63)						55	
630 i 155-200 kW (211-272 PS) N52 B30 A, N52 B30 BF	09.2004→08.2007		7.02604.27.0	LS	750 mm		
			7.02604.34.0	LS	600 mm		
			7.02604.99.0	LS	400 mm		
			7.02604.42.0	LS	1050 mm		
630 i 150-200 kW (204-272 PS) N53 B30 A	09.2007→08.2010		7.02604.27.0	LS	750 mm		
			7.02604.34.0	LS	600 mm		
			7.02604.42.0	LS	1050 mm		
630 i 155-200 kW (211-272 PS) N52 B30 A, N52 B30 B, N52 B30 BF	09.2007→08.2010		7.02604.27.0	LS	750 mm		
			7.02604.34.0	LS	600 mm		
			7.02604.42.0	LS	1050 mm		
635 d 198-221 kW (269-301 PS) M57 D30 (306D5)	07.2007→07.2010		7.00450.10.0	AGR	PN		
645 Ci 235-245 kW (320-333 PS) N62 B44 A	09.2003→08.2005		7.05271.23.0	LS	900 mm		



B

6 (E63)

55

			7.05271.22.0	LS	600 mm	 N62 B44 A: Automatikgetriebe Automatic Transmission für OE-Nummer: 11 78 7 512 982, 7 512 982 for OE number: 11 78 7 512 982, 7 512 982 vor Katalysator, rechts in front of the catalyst, Right
			7.02604.32.0	LS	450 mm	
			7.28124.19.0	SLP	EL	
			7.28238.56.0	SLV	PN	
645 Ci 235-245 kW (320-333 PS) N62 B44 A	01.2004→12.2005		7.05271.22.0	LS	600 mm	 N62 B44 A: Automatikgetriebe Automatic Transmission für OE-Nummer: 11 78 7 530 282, 7 530 282 for OE number: 11 78 7 530 282, 7 530 282 vor Katalysator, rechts in front of the catalyst, Right
			7.28124.19.0	SLP	EL	
			7.28238.56.0	SLV	PN	
650 i 261-270 kW (355-367 PS) N62 B48 B	09.2005→08.2010		7.02604.41.0	LS	700 mm	für OE-Nummer: 11 78 7 561 410, 7 561 410 for OE number: 11 78 7 561 410, 7 561 410
			7.02604.34.0	LS	600 mm	
			7.02604.25.0	LS	425 mm	
			7.02604.42.0	LS	1050 mm	
M 373 kW (507 PS) S85 B50 A	09.2005→07.2010		7.02604.32.0	LS	450 mm	
			7.28124.19.0	SLP	EL	



6 (E64)

56

650i 4.8 32V 261-270 kW (355-367 PS) N62 B48 A, N62 B48 B	09.2005→07.2010		7.02604.34.0	LS	600 mm	
			7.02604.25.0	LS	425 mm	
			7.02604.42.0	LS	1050 mm	

6 Convertible (E64)

57

630 i 155-200 kW (211-272 PS) N52 B30 A	09.2004→08.2007		7.02604.27.0	LS	750 mm	
			7.02604.26.0	LS	500 mm	hinten Rear
			7.02604.25.0	LS	425 mm	vorne Front
			7.02604.99.0	LS	400 mm	Diagnosesonde Diagnostic Probe
630 i 160-200 kW (218-272 PS) N52 B30 B, N52 B30 BF	09.2004→08.2007		7.02604.27.0	LS	750 mm	





6 Convertible (E64)					57	B
			7.02604.99.0	LS	400 mm	
635 d 198-221 kW (269-301 PS) M57 D30 (306D5)	07.2007→07.2010		7.00450.10.0	AGR	PN	
645 Ci 235-245 kW (320-333 PS) N62 B44 A	04.2004→12.2005		7.05271.22.0	LS	600 mm	N62 B44 A: Automatikgetriebe Automatic Transmission vor Katalysator, links in front of the catalyst, Left N62 B44 A: Automatikgetriebe Automatic Transmission für OE-Nummer: 11 78 7 530 282, 7 530 282 for OE number: 11 78 7 530 282, 7 530 282 vor Katalysator, rechts in front of the catalyst, Right
			7.28124.19.0	SLP	EL	
			7.28238.56.0	SLV	PN	
645 Ci 235-245 kW (320-333 PS) N62 B44 A	04.2004→08.2005		7.05271.23.0	LS	900 mm	
			7.05271.22.0	LS	600 mm	N62 B44 A: Automatikgetriebe Automatic Transmission für OE-Nummer: 11 78 7 512 982, 7 512 982 for OE number: 11 78 7 512 982, 7 512 982 vor Katalysator, rechts in front of the catalyst, Right N62 B44 A: Automatikgetriebe Automatic Transmission vor Katalysator, links in front of the catalyst, Left
			7.02604.32.0	LS	450 mm	
			7.28124.19.0	SLP	EL	
			7.28238.56.0	SLV	PN	
650 i 261-270 kW (355-367 PS) N62 B48 B	09.2005→08.2010		7.02604.41.0	LS	700 mm	für OE-Nummer: 11 78 7 561 410, 7 561 410 for OE number: 11 78 7 561 410, 7 561 410
			7.05270.21.0	LS	600 mm	N62 B48 B: vor Katalysator, links in front of the catalyst, Left N62 B48 B: für OE-Nummer: 11 78 7 539 123 for OE number: 11 78 7 539 123 vor Katalysator, rechts in front of the catalyst, Right
M6 373 kW (507 PS) S85 B50 A	09.2006→08.2010		7.02604.32.0	LS	450 mm	
			7.28124.19.0	SLP	EL	
6 Convertible (F12)					58	
640 d 220-230 kW (299-313 PS) N57 D30 B	09.2011→06.2018		7.10992.00.0	AGR-K	EL	Europa Europe
			7.10334.07.0	AGR	EL	
			7.11190.12.0	DDS		ohne Zubehör without accessories N57 D30 B: Euro 5 Euro 5 für Facelift: LCI for facelift: LCI N57 D30 B: Ausstattungsvariante: Blue Performance Equipment Variant: Blue Performance nicht für Facelift: LCI not for facelift: LCI



B

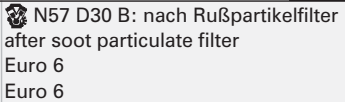
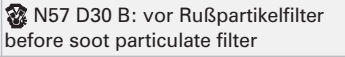



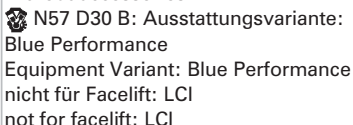
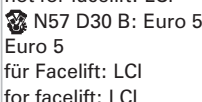
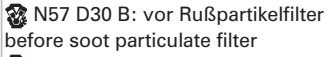
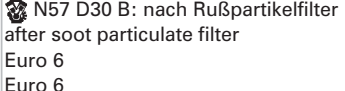

6 Convertible (F12)

58

		7.02604.44.0	LS	500 mm	 
640 d xDrive 220-230 kW (299-313 PS) N57 D30 B	03.2012→06.2018	 7.10992.00.0 ↳ 7.10334.07.0 7.11190.12.0	AGR-K	EL	 
			AGR	EL	ohne Zubehör without accessories
			DDS		 
		7.02604.44.0	LS	500 mm	 

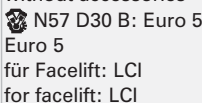
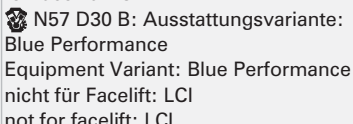
6 Coupe (F13)

59

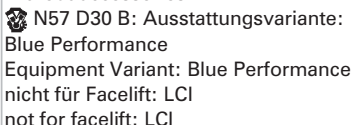
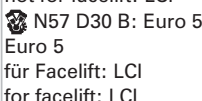
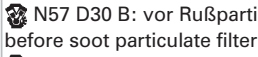
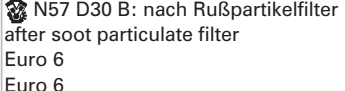
640 d 220-230 kW (299-313 PS) N57 D30 B	09.2011→10.2017	 7.10992.00.0 ↳ 7.10334.07.0 7.11190.12.0	AGR-K	EL	 
			AGR	EL	ohne Zubehör without accessories
			DDS		 
		7.02604.44.0	LS	500 mm	
640 d xDrive 220-230 kW (299-313 PS) N57 D30 B	03.2012→10.2017	 7.10992.00.0 ↳ 7.10334.07.0 7.11190.12.0	AGR-K	EL	 
			AGR	EL	ohne Zubehör without accessories
			DDS		 
		7.02604.44.0	LS	500 mm	 

6 Gran Coupe (F06)						60	
640 d 220-230 kW (299-313 PS) N57 D30 B	03.2012→10.2018		7.10992.00.0	AGR-K	EL	Europa Europe ohne Zubehör without accessories N57 D30 B: Ausstattungsvariante: Blue Performance Equipment Variant: Blue Performance nicht für Facelift: LCI not for facelift: LCI N57 D30 B: Euro 5 Euro 5 für Facelift: LCI for facelift: LCI N57 D30 B: nach Rußpartikelfilter after soot particulate filter Euro 6 Euro 6 N57 D30 B: vor Rußpartikelfilter before soot particulate filter	
			↳ 7.10334.07.0	AGR	EL		
			7.11190.12.0	DDS			
			7.02604.44.0	LS	500 mm		
640 d xDrive 220-230 kW (299-313 PS) N57 D30 B	03.2013→10.2018		7.10992.00.0	AGR-K	EL	Europa Europe ohne Zubehör without accessories Euro 5 Euro 5 N57 D30 B: nach Rußpartikelfilter after soot particulate filter Euro 6 Euro 6 N57 D30 B: vor Rußpartikelfilter before soot particulate filter	
			↳ 7.10334.07.0	AGR	EL		
			7.11190.12.0	DDS			
			7.02604.44.0	LS	500 mm		
6 Gran Turismo (G32)						61	
620 d 85-170 kW (116-231 PS) B47 D20 B	07.2018→06.2020		7.04493.17.0	AGR	EL		
620 d 85-170 kW (116-231 PS) B47 D20 B	07.2018→06.2020		7.04493.17.0	AGR	EL		
620 d xDrive 85-170 kW (116-231 PS) B47 D20 B	07.2018→06.2020		7.04493.17.0	AGR	EL		
620 d xDrive 85-170 kW (116-231 PS) B47 D20 B	07.2018→06.2020		7.04493.17.0	AGR	EL		
630 d 155-235 kW (211-320 PS) B57 D30 A	06.2017→06.2020		7.04493.17.0	AGR	EL		
			7.05343.18.0*	AGR-K	EL		07.2017→
			↳ 7.05343.17.0	AGR	EL		
630 d 155-235 kW (211-320 PS) B57 D30 A	06.2017→06.2020		7.04493.17.0	AGR	EL		
			7.05343.18.0*	AGR-K	EL		07.2017→
			↳ 7.05343.17.0	AGR	EL		
630 d xDrive 155-235 kW (211-320 PS) B57 D30 A	06.2017→06.2020		7.04493.17.0	AGR	EL		
			7.05343.18.0*	AGR-K	EL		07.2017→
			↳ 7.05343.17.0	AGR	EL		
630 d xDrive 155-235 kW (211-320 PS) B57 D30 A	06.2017→06.2020		7.04493.17.0	AGR	EL		



B

6 Gran Turismo (G32)

61

			7.05343.18.0* ↳ 7.05343.17.0	AGR-K AGR	EL EL	07.2017→
630 d xDrive 155-235 kW (211-320 PS) B57 D30 A	06.2017→06.2020		7.04493.17.0	AGR	EL	⊗
640 d xDrive 155-250 kW (211-340 PS) B57 D30 B	11.2017→06.2020		7.04493.17.0	AGR	EL	⊗
			7.05343.18.0* ↳ 7.05343.17.0	AGR-K AGR	EL EL	

7 (E32)

62

730 i,iL 131-147 kW (178-200 PS) M30 B30 (306EA)	03.1985→01.1989		7.02604.04.0	LS	200 mm	
730 i,iL 131-147 kW (178-200 PS) M30 B30 (306KA)	03.1987→03.1994		7.02604.04.0	LS	200 mm	
735 i,iL 136-160 kW (185-218 PS) M30 B34 (346KB)	06.1986→07.1992		7.02604.04.0	LS	200 mm	
735 i,iL 162 kW (220 PS) M30 B35 (Motronic,9.	07.1986→01.1989		7.02604.04.0	LS	200 mm	

7 (E38)

63

725 tds 85-105 kW (115-143 PS) M51 D25 (256T1)	04.1996→11.2001		7.21920.62.0	AGR	PN	mit Rohrstutzen with pipe socket ⊗
728 i, iL 141-144 kW (192-196 PS) M52 B28 (286S1), M52 B28 (286S2)	08.1995→11.2001		7.22295.61.0	ARV	PN	⊗
			7.02604.21.0	LS	990 mm	
			7.02604.30.0	LS	980 mm	
			7.02604.31.0	LS	350 mm	
728i X 141-143 kW (192-194 PS) M52 B28 (286S1)	11.1995→09.2001		7.22295.61.0	ARV	PN	⊗
			7.02604.21.0	LS	990 mm	
			7.02604.30.0	LS	980 mm	
			7.02604.31.0	LS	350 mm	
730 d 135-142 kW (184-193 PS) M57 D30 (306D1)	08.1998→04.2000		7.28264.06.0	AGR	PN	
730 d 135-142 kW (184-193 PS) M57 D30 (306D1)	04.2000→11.2001		7.28264.06.0	AGR	PN	
735 i, iL 173 kW (235 PS) M62 B35 (358S1)	03.1996→08.1998		7.02604.31.0	LS	350 mm	
735 i, iL 173-180 kW (235-245 PS) M62 B35 (358S2)	09.1998→07.2001		7.22295.68.0	ARV	PN	⊗
			7.21852.78.0	SLP	EL	
740 d 180-190 kW (245-258 PS) M67 D39 (398D1)	05.1999→11.2001		7.28264.06.0	AGR	PN	
740 i, iL 210 kW (286 PS) M60 B40 (408S1)	03.1994→02.1996		7.02604.31.0	LS	350 mm	links, rechts Left, Right für Rechtslenker for right-hand drive vehicles
740 i, iL 210 kW (286 PS) M62 B44 (448S1)	02.1996→08.1998		7.02604.31.0	LS	350 mm	links, rechts Left, Right
740 i, iL 210 kW (286 PS) M62 B44 (448S2)	09.1998→07.2001		7.22295.68.0	ARV	PN	⊗













7 (E38)					63	B
			7.02604.31.0	LS	350 mm	links, rechts Left, Right
			7.22166.01.0*	SLP-M	EL	09.1998→
			↳ 7.21852.78.0	SLP	EL	
			7.22166.20.0*	SLP-M	EL	09.1998→
			↳ 7.21852.78.0	SLP	EL	
750 i, iL 240-243 kW (326-330 PS) M73 B54 (54121), M73 B54 (54122)	11.1994→07.2001		7.02604.31.0	LS	350 mm	
740i 4.4 32V 210 kW (286 PS) M62 448 S2	09.1998→10.2001		7.02604.31.0	LS	350 mm	
7 (E65, E66, E67)					64	
730 Ld 135-173 kW (184-235 PS) M57 D30 (306D3)	07.2005→08.2008		7.00450.09.0	AGR	PN	Euro 4 (D4) Euro 4 (D4)
			7.00512.03.0	AGR	PN	Euro 3 (D3) Euro 3 (D3)
730 d 150-160 kW (204-218 PS) M57 D30 (306D2)	06.2002→02.2005		7.28264.07.0	AGR	PN	
730 d 150-160 kW (204-218 PS) M57 D30 (306D2)	09.2002→08.2003		7.28264.07.0	AGR	PN	
730 d 135-173 kW (184-235 PS) M57 D30 (306D3)	09.2003→08.2008		7.00450.09.0	AGR	PN	Euro 4 (D4) Euro 4 (D4)
			7.00512.03.0	AGR	PN	Euro 3 (D3) Euro 3 (D3)
730 d 150-160 kW (204-218 PS) M57 D30 (306D2)	09.2003→08.2008		7.28264.07.0	AGR	PN	
730 i, Li 163-170 kW (222-231 PS) M54 B30 (306S3)	03.2003→07.2008		7.02604.21.0	LS	990 mm	hinten, vorne Rear, Front
			7.02604.31.0	LS	350 mm	hinten, vorne Rear, Front
			7.28238.58.0	SLV	PN	
730 i, Li 155-200 kW (211-272 PS) N52 B30 A, N52 B30 BF	03.2005→08.2008		7.02604.99.0	LS	400 mm	
735 i, Li 200 kW (272 PS) N62 B36 A	11.2001→02.2005		7.05271.22.0	LS	600 mm	N62 B36 A: für OE-Nummer: 11 78 7 512 982, 7 512 982 for OE number: 11 78 7 512 982, 7 512 982 vor Katalysator in front of the catalyst für Zylinder: 1-4 for cylinder: 1-4 N62 B36 A: für OE-Nummer: 11 78 7 516 149, 7 516 149 for OE number: 11 78 7 516 149, 7 516 149 vor Katalysator in front of the catalyst für Zylinder: 5-8 for cylinder: 5-8 Produktionsdatum bis: 30.04.2002 Production date to: 30.04.2002 N62 B36 A: vor Katalysator, links in front of the catalyst, Left für Zylinder: 5-8 for cylinder: 5-8 Produktionsdatum ab: 01.05.2002 Production date from: 01.05.2002
			7.28238.56.0	SLV	PN	 Europa Europe
740 d 180-190 kW (245-258 PS) M67 D39 (398D1)	10.2002→02.2005		7.28264.06.0	AGR	PN	

























B

7 (E65, E66, E67)

64

<p>740 i, Li 200-225 kW (272-306 PS) N62 B40 A</p>	<p>03.2005→08.2008</p>	<p>7.02604.41.0 </p> <p>7.02604.34.0</p> <p>7.05270.21.0</p> <p>7.02604.25.0</p>	<p>LS</p> <p>LS</p> <p>LS</p> <p>LS</p>	<p>700 mm</p> <p>600 mm</p> <p>600 mm</p> <p>425 mm</p>	<p>für OE-Nummer: 11 78 7 561 410 for OE number: 11 78 7 561 410 vor Katalysator in front of the catalyst Thailand Thailand Produktionsdatum ab: 01.06.2006 Production date from: 01.06.2006</p> <p> N62 B40 A: für OE-Nummer: 11 78 7 539 123 for OE number: 11 78 7 539 123 vor Katalysator, rechts in front of the catalyst, Right  N62 B40 A: vor Katalysator, links in front of the catalyst, Left</p>
<p>745 d 220-242 kW (300-329 PS) M67 D44 (448D1)</p>	<p>07.2005→07.2008</p>	<p>7.02604.44.0 </p>	<p>LS</p>	<p>500 mm</p>	<p>vor Rußpartikelfilter, rechts before soot particulate filter, Right</p>
<p>745 i 235-245 kW (320-333 PS) N62 B44 A</p>	<p>11.2001→12.2003</p>	<p>7.05271.22.0 </p> <p>7.28238.56.0</p>	<p>LS</p> <p>SLV</p>	<p>600 mm</p> <p>PN</p>	<p> N62 B44 A: für OE-Nummer: 11 87 7 512 982, 7 512 982 for OE number: 11 87 7 512 982, 7 512 982 vor Katalysator, rechts in front of the catalyst, Right  N62 B44 A: vor Katalysator in front of the catalyst für Zylinder: 5-8 for cylinder: 5-8</p>
<p>745 i 235-245 kW (320-333 PS) N62 B44 A</p>	<p>09.2003→12.2005</p>	<p>7.05271.22.0 </p> <p>7.28238.56.0</p>	<p>LS</p> <p>SLV</p>	<p>600 mm</p> <p>PN</p>	<p> N62 B44 A: für OE-Nummer: 11 78 7 512 982, 7 512 982 for OE number: 11 78 7 512 982, 7 512 982 vor Katalysator, rechts in front of the catalyst, Right  N62 B44 A: vor Katalysator in front of the catalyst für Zylinder: 5-8 for cylinder: 5-8 nicht für OE-Nummer: 11 78 7 512 985, 7 512 985 not for OE number: 11 78 7 512 985, 7 512 985</p>
<p>745 i, Li 235-245 kW (320-333 PS) N62 B44 A</p>	<p>07.2001→03.2005</p>	<p>7.05271.23.0 </p> <p>7.05271.22.0</p> <p>7.02604.32.0</p> <p>7.28238.56.0</p>	<p>LS</p> <p>LS</p> <p>LS</p> <p>SLV</p>	<p>900 mm</p> <p>600 mm</p> <p>450 mm</p> <p>PN</p>	<p> N62 B44 A: für OE-Nummer: 11 78 7 512 982, 7 512 982 for OE number: 11 78 7 512 982, 7 512 982 vor Katalysator, rechts in front of the catalyst, Right  N62 B44 A: vor Katalysator in front of the catalyst für Zylinder: 5-8 for cylinder: 5-8 nicht für OE-Nummer: 11 78 7 512 985, 7 512 985 not for OE number: 11 78 7 512 985, 7 512 985</p>

























							
7 (E65, E66, E67)						64	B
750 i, Li 261-270 kW (355-367 PS) N62 B48 B	03.2005→08.2008		7.02604.41.0	LS	700 mm	für OE-Nummer: 11 78 7 561 410 for OE number: 11 78 7 561 410 vor Katalysator in front of the catalyst Produktionsdatum ab: 01.06.2006 Production date from: 01.06.2006	
			7.05270.21.0	LS	600 mm	 N62 B48 B: vor Katalysator, links in front of the catalyst, Left  N62 B48 B: für OE-Nummer: 11 78 7 539 123 for OE number: 11 78 7 539 123 vor Katalysator, rechts in front of the catalyst, Right	
760 i 320-327 kW (435-445 PS) N73 B60 A	02.2003→08.2005		7.05271.23.0	LS	900 mm		
			7.02604.32.0	LS	450 mm	links, rechts Left, Right	
			7.28238.57.0	SLV	PN		
760 i 320-327 kW (435-445 PS) N73 B60 B	02.2003→08.2005		7.05271.23.0	LS	900 mm		
			7.28238.57.0	SLV	PN		
760 i, Li 320-327 kW (435-445 PS) N73 B60 A	01.2003→08.2008		7.05271.23.0	LS	900 mm		
			7.02604.41.0	LS	700 mm	für OE-Nummer: 11 78 7 561 410, 7 561 410 for OE number: 11 78 7 561 410, 7 561 410	
			7.05271.22.0	LS	600 mm	vor Katalysator in front of the catalyst für Rechtslenker for right-hand drive vehicles  Europa  Europe für Zylinder: 1-6 for cylinder: 1-6 Produktionsdatum bis: 28.02.2005 Production date to: 28.02.2005	
			7.02604.32.0	LS	450 mm	links, rechts Left, Right	
			7.28238.57.0	SLV	PN		
760 i, Li 320-327 kW (435-445 PS) N73 B60 B	01.2003→08.2008		7.05271.23.0	LS	900 mm		
			7.05271.22.0	LS	600 mm	vor Katalysator in front of the catalyst für Rechtslenker for right-hand drive vehicles für Zylinder: 1 - 6 for cylinder: 1 - 6 Produktionsdatum ab: 01.03.2005 Production date from: 01.03.2005 Produktionsdatum bis: 31.07.2008 Production date to: 31.07.2008	
			7.28238.57.0	SLV	PN		
7 (F01, F02, F03, F04)						65	
730 d 150-210 kW (204-286 PS) N57 D30 A	02.2008→05.2015		7.10992.00.0	AGR-K	EL	 07.2012→ für OE-Nummer: 11 71 7 823 210 for OE number: 11 71 7 823 210  Europa  Europe	
			7.10334.07.0	AGR	EL		















B

7 (F01, F02, F03, F04)

65

			7.10993.00.0	AGR-K	EL	 07.2012→ für OE-Nummer: 11 71 8 517 724 for OE number: 11 71 8 517 724  Europa, Indien, Thailand  Europe, India, Thailand
			↳ 7.10334.07.0	AGR	EL	
			7.11190.12.0	DDS		ohne Zubehör without accessories Ausstattungsvariante: Blue Performance Equipment Variant: Blue Performance für Facelift: LCI for facelift: LCI
730 d 150-210 kW (204-286 PS) N57 D30 A	09.2008→06.2012		7.10334.07.0	AGR	EL	
730 d 150-210 kW (204-286 PS) N57 D30 A	07.2012→05.2015		7.10992.00.0	AGR-K	EL	 für OE-Nummer: 11 71 7 823 210 for OE number: 11 71 7 823 210  Europa  Europe
			↳ 7.10334.07.0	AGR	EL	
			7.10993.00.0	AGR-K	EL	 für OE-Nummer: 11 71 8 517 724 for OE number: 11 71 8 517 724  Europa, Indien, Thailand  Europe, India, Thailand
			↳ 7.10334.07.0	AGR	EL	
			7.11190.12.0	DDS		ohne Zubehör without accessories Ausstattungsvariante: Blue Performance Equipment Variant: Blue Performance
			7.02604.44.0	LS	500 mm	 N57 D30 A: Ausstattungsvariante: Blue Performance Equipment Variant: Blue Performance nach Rußpartikelfilter after soot particulate filter  N57 D30 A: vor Rußpartikelfilter before soot particulate filter
730 d xDrive 150-210 kW (204-286 PS) N57 D30 A	11.2011→05.2015		7.10992.00.0	AGR-K	EL	 07.2012→  Europa  Europe
			↳ 7.10334.07.0	AGR	EL	
			7.11190.12.0	DDS		ohne Zubehör without accessories Ausstattungsvariante: Blue Performance Equipment Variant: Blue Performance
			7.02604.44.0	LS	500 mm	 N57 D30 A: vor Rußpartikelfilter before soot particulate filter  N57 D30 A: Ausstattungsvariante: Blue Performance Equipment Variant: Blue Performance nach Rußpartikelfilter after soot particulate filter
730 d xDrive 150-210 kW (204-286 PS) N57 D30 A	11.2011→05.2015		7.10992.00.0	AGR-K	EL	 07.2012→  Europa  Europe
			↳ 7.10334.07.0	AGR	EL	
			7.11190.12.0	DDS		ohne Zubehör without accessories Ausstattungsvariante: Blue Performance Equipment Variant: Blue Performance
730 i, Li 155-200 kW (211-272 PS) N52 B30 A, N52 B30 AF, N52 B30 BF	09.2009→06.2015		7.02604.34.0	LS	600 mm	









7 (F01, F02, F03, F04) **65** **B**

			7.02604.42.0	LS	1050 mm	
740 d 220-230 kW (299-313 PS) N57 D30 B	09.2009→06.2012		7.10334.07.0	AGR	EL	
			7.11190.12.0	DDS		ohne Zubehör without accessories
			7.02604.41.0	LS	700 mm	für OE-Nummer: 13 62 7 794 634, 7 794 634 for OE number: 13 62 7 794 634, 7 794 634
740 d 220-230 kW (299-313 PS) N57 D30 B	07.2012→06.2015		7.10992.00.0	AGR-K	EL	 " " Europa " " Europe
			↳ 7.10334.07.0	AGR	EL	
			7.11190.12.0	DDS		ohne Zubehör without accessories
			7.02604.41.0	LS	700 mm	für OE-Nummer: 13 62 7 794 634, 7 794 634 for OE number: 13 62 7 794 634, 7 794 634
			7.02604.44.0	LS	500 mm	vor Rußpartikelfilter, nach Rußpartikelfilter before soot particulate filter, after soot particulate filter
740 d xDrive 220-230 kW (299-313 PS) N57 D30 B	09.2010→12.2012		7.10334.07.0	AGR	EL	
			7.11190.12.0	DDS		ohne Zubehör without accessories
			7.02604.41.0	LS	700 mm	für OE-Nummer: 13 62 7 794 634, 7 794 634 for OE number: 13 62 7 794 634, 7 794 634
740 d xDrive 220-230 kW (299-313 PS) N57 D30 B	07.2012→06.2015		7.10992.00.0	AGR-K	EL	 " " Europa " " Europe
			↳ 7.10334.07.0	AGR	EL	
			7.11190.12.0	DDS		ohne Zubehör without accessories
			7.02604.41.0	LS	700 mm	für OE-Nummer: 13 62 7 794 634, 7 794 634 for OE number: 13 62 7 794 634, 7 794 634
			7.02604.44.0	LS	500 mm	vor Rußpartikelfilter, nach Rußpartikelfilter before soot particulate filter, after soot particulate filter
740 i, Li 200-264 kW (272-359 PS) N54 B30 A	09.2008→06.2012		7.02604.27.0	LS	750 mm	
			7.02604.34.0	LS	600 mm	
740 i, Li 200-264 kW (272-359 PS) N54 B30 A	09.2010→12.2015		7.02604.27.0	LS	750 mm	
			7.02604.34.0	LS	600 mm	
740 i, Li 200-272 kW (272-370 PS) N55 B30 A	07.2012→12.2015		7.02604.27.0	LS	750 mm	
			7.02604.34.0	LS	600 mm	
740 i, Li xDrive 200-272 kW (272-370 PS) N55 B30 A	07.2012→12.2015		7.02604.27.0	LS	750 mm	
			7.02604.34.0	LS	600 mm	



















B

7 (F01, F02, F03, F04) 65

750 Li 298-339 kW (405-461 PS) N63 B44 B	09.2008→08.2015		7.02604.34.0	LS	600 mm	
750 d xDrive 280 kW (381 PS) N57 D30 C	07.2012→12.2015		7.10992.00.0 ↳ 7.10334.07.0 7.11190.12.0 7.02604.44.0	AGR-K AGR DDS LS	EL EL 500 mm	 Europa Europe ohne Zubehör without accessories für OE-Nummer: 13 62 7 805 758 for OE number: 13 62 7 805 758 für OE-Nummer: 13 62 7 791 592, 13 62 7 793 825 for OE number: 13 62 7 791 592, 13 62 7 793 825
750 i 298-339 kW (405-461 PS) N63 B44 B	09.2012→06.2015		7.02604.34.0	LS	600 mm	
750 i, Li 298-330 kW (405-449 PS) N63 B44 A	09.2008→06.2012		7.02604.34.0	LS	600 mm	
750 i, Li 298-339 kW (405-461 PS) N63 B44 B	07.2012→06.2015		7.02604.34.0	LS	600 mm	
750 i, Li xDrive 298-330 kW (405-449 PS) N63 B44 A	09.2009→06.2012		7.02604.34.0	LS	600 mm	
750 i, Li xDrive 298-339 kW (405-461 PS) N63 B44 B	07.2012→06.2015		7.02604.34.0	LS	600 mm	

7 (G11, G12) 66























725 d, Ld 85-170 kW (116-231 PS) B47 D20 B	07.2016→02.2019		7.04493.17.0	AGR	EL	
			7.05838.08.0	AGR	EL	
725 d, Ld 85-170 kW (116-231 PS) B47 D20 B	07.2016→02.2019		7.04493.17.0	AGR	EL	
			7.05838.08.0	AGR	EL	
730 d 155-235 kW (211-320 PS) B57 D30 A	07.2015→06.2020		7.04493.17.0	AGR	EL	
			7.05343.18.0*	AGR-K	EL	
			↳ 7.05343.17.0	AGR	EL	
730 d 155-235 kW (211-320 PS) B57 D30 A	09.2015→06.2020		7.04493.17.0	AGR	EL	
			7.05343.18.0*	AGR-K	EL	
			↳ 7.05343.17.0	AGR	EL	
730 d xDrive 155-235 kW (211-320 PS) B57 D30 A	09.2015→06.2020		7.04493.17.0	AGR	EL	
730 d, Ld xDrive 155-235 kW (211-320 PS) B57 D30 A	09.2015→06.2020		7.04493.17.0	AGR	EL	
			7.05343.18.0*	AGR-K	EL	
			↳ 7.05343.17.0	AGR	EL	
730 d, Ld xDrive 155-235 kW (211-320 PS) B57 D30 A	09.2015→06.2020		7.05343.18.0*	AGR-K	EL	
			↳ 7.05343.17.0	AGR	EL	
740 d, Ld xDrive 155-250 kW (211-340 PS) B57 D30 B	11.2015→06.2020		7.04493.17.0	AGR	EL	
			7.05343.18.0*	AGR-K	EL	
			↳ 7.05343.17.0	AGR	EL	

7 (G11, G12)						66
750 d, Ld xDrive 294 kW (400 PS) B57 D30 C	07.2016→		7.04493.17.0	AGR	EL	
			7.05838.08.0	AGR	EL	
8 (E31)						67
840 i 210 kW (286 PS) M60 B40 (408S1)	03.1993→02.1996		7.02604.31.0	LS	350 mm	Automatikgetriebe Automatic Transmission links, rechts Left, Right
850 Ci 240 kW (326 PS) M73 B54 (54121)	09.1994→12.1999		7.02604.31.0	LS	350 mm	
8 Convertible (G14, F91)						68
840 d xDrive 155-250 kW (211-340 PS) B57 D30 B	11.2018→10.2020		7.04493.17.0	AGR	EL	
			7.05343.18.0*	AGR-K	EL	
			↳7.05343.17.0	AGR	EL	
8 Coupe (G15, F92)						69
840 d xDrive 155-250 kW (211-340 PS) B57 D30 B	07.2018→10.2020		7.04493.17.0	AGR	EL	
			7.05343.18.0*	AGR-K	EL	
			↳7.05343.17.0	AGR	EL	
8 Gran Coupe (G16, F93)						70
840 d xDrive 155-250 kW (211-340 PS) B57 D30 B	07.2019→10.2020		7.05343.18.0*	AGR-K	EL	
			↳7.05343.17.0	AGR	EL	
X1 (E84)						71
sDrive 16 d 66-150 kW (90-204 PS) N47 D20 C	04.2012→06.2015		7.10334.07.0	AGR	EL	
sDrive 18 d 66-150 kW (90-204 PS) N47 D20 C	03.2009→06.2015		7.10334.07.0	AGR	EL	
sDrive 18 d 66-150 kW (90-204 PS) N47 D20 C	12.2009→06.2015		7.10334.07.0	AGR	EL	
sDrive 18 i 95-125 kW (129-170 PS) N46 B20 B	03.2010→06.2015		7.28124.19.0	SLP	EL	
			7.01318.24.0	SLV	PN	 07.2012→ China China
sDrive 18 i 95-125 kW (129-170 PS) N46 B20 BD	03.2010→06.2015		7.01318.24.0	SLV	PN	 07.2012→ China China
			7.28124.19.0	SLP	EL	
sDrive 18 i 95-125 kW (129-170 PS) N46 B20 B	03.2010→06.2015		7.28124.19.0	SLP	EL	
			7.01318.24.0	SLV	PN	 07.2012→ China, Korea (Republik) China, Korea (Republic)
sDrive 18 i 95-125 kW (129-170 PS) N46 B20 BD, N46 B20 E	03.2010→06.2015		7.01318.24.0	SLV	PN	 N46 B20 BD, N46 B20 E: 07.2012→ China China
			7.10334.07.0	AGR	EL	
sDrive 20 d 66-150 kW (90-204 PS) N47 D20 C	10.2009→06.2015		7.10334.07.0	AGR	EL	



























































B

X1 (E84) 71

sDrive 20 d 66-150 kW (90-204 PS) N47 D20 C	03.2010→06.2015		7.10334.07.0	AGR	EL	
sDrive 20 d 66-150 kW (90-204 PS) N47 D20 C	07.2012→06.2015		7.10334.07.0	AGR	EL	
xDrive 18 d 66-150 kW (90-204 PS) N47 D20 C	03.2009→06.2015		7.10334.07.0	AGR	EL	
xDrive 18 d 66-150 kW (90-204 PS) N47 D20 C	10.2009→06.2015		7.10334.07.0	AGR	EL	
xDrive 20 d 66-150 kW (90-204 PS) N47 D20 C	09.2009→06.2012		7.10334.07.0	AGR	EL	
xDrive 20 d 66-150 kW (90-204 PS) N47 D20 C	03.2010→06.2015		7.10334.07.0	AGR	EL	
xDrive 20 d 66-150 kW (90-204 PS) N47 D20 C	07.2012→06.2015		7.10334.07.0	AGR	EL	
xDrive 23 d 150-160 kW (204-218 PS) N47 D20 D	10.2009→06.2015		7.10334.07.0	AGR	EL	
xDrive 25 d 150-160 kW (204-218 PS) N47 D20 D	10.2009→06.2015		7.10992.00.0	AGR-K	EL	  Europa  Europe
xDrive 25 i 155-200 kW (211-272 PS) N52 B30 A	03.2010→08.2011		7.02604.34.0	LS	600 mm	
			7.02604.26.0	LS	500 mm	
			7.02604.42.0	LS	1050 mm	
xDrive 28 i 155-200 kW (211-272 PS) N52 B30 A	09.2009→08.2011		7.02604.34.0	LS	600 mm	
			7.02604.26.0	LS	500 mm	
			7.02604.42.0	LS	1050 mm	

X1 (F48) 72

sDrive 16 d 70-85 kW (95-116 PS) B37 C15 A	11.2014→		7.04493.17.0	AGR	EL	
			7.05838.08.0	AGR	EL	
			7.07417.39.0	AGR	EL	
						Produktionsdatum ab: 01.03.2019 Production date from: 01.03.2019
sDrive 18 d 100-170 kW (136-231 PS) B47 C20 A, B47 C20 B	07.2015→		7.04493.17.0	AGR	EL	
sDrive 18 d 100-140 kW (136-190 PS) B47 C20 A	07.2015→		7.04493.17.0	AGR	EL	
sDrive 20 d 100-170 kW (136-231 PS) B47 C20 A, B47 C20 B	11.2015→		7.04493.17.0	AGR	EL	
sDrive 20 d 100-140 kW (136-190 PS) B47 C20 A	11.2015→		7.04493.17.0	AGR	EL	
xDrive 18 d 100-170 kW (136-231 PS) B47 C20 A, B47 C20 B	11.2014→		7.04493.17.0	AGR	EL	
xDrive 18 d 100-140 kW (136-190 PS) B47 C20 A	11.2014→		7.04493.17.0	AGR	EL	













							
X1 (F48)						72	B
xDrive 20 d 100-170 kW (136-231 PS) B47 C20 A, B47 C20 B	07.2015→		7.04493.17.0	AGR	EL		
xDrive 20 d 100-140 kW (136-190 PS) B47 C20 A	07.2015→		7.04493.17.0	AGR	EL		
xDrive 25 d 100-170 kW (136-231 PS) B47 C20 B	11.2014→		7.04493.17.0	AGR	EL		
X2 (F39)						73	
sDrive 16 d 70-85 kW (95-116 PS) B37 C15 A	11.2018→		7.05838.08.0	AGR	EL		
			7.07417.39.0	AGR	EL	 Produktionsdatum ab: 01.03.2019 Production date from: 01.03.2019	
sDrive 18 d 100-170 kW (136-231 PS) B47 C20 A, B47 C20 B	03.2018→		7.04493.17.0	AGR	EL		
sDrive 18 d 100-170 kW (136-231 PS) B47 C20 A, B47 C20 B	03.2018→		7.04493.17.0	AGR	EL		
sDrive 20 d 100-170 kW (136-231 PS) B47 C20 A, B47 C20 B	11.2018→		7.04493.17.0	AGR	EL		
sDrive 20 d 100-170 kW (136-231 PS) B47 C20 A, B47 C20 B	11.2018→		7.04493.17.0	AGR	EL		
xDrive 18 d 100-170 kW (136-231 PS) B47 C20 B	03.2018→		7.04493.17.0	AGR	EL		
xDrive 18 d 100-170 kW (136-231 PS) B47 C20 B	03.2018→		7.04493.17.0	AGR	EL		
xDrive 20 d 100-170 kW (136-231 PS) B47 C20 A, B47 C20 B	11.2017→		7.04493.17.0	AGR	EL		
xDrive 20 d 100-170 kW (136-231 PS) B47 C20 A, B47 C20 B	11.2017→		7.04493.17.0	AGR	EL		
xDrive 25 d 100-170 kW (136-231 PS) B47 C20 B	11.2017→		7.04493.17.0	AGR	EL		
X3 (E83)						74	
2.0 d 85-120 kW (116-163 PS) M47 D20 (204D4)	09.2004→08.2007		7.00450.09.0	AGR	PN	Euro 4 (D4) Euro 4 (D4)	
			7.00512.03.0	AGR	PN	Euro 3 (D3) Euro 3 (D3)	
			7.02604.44.0	LS	500 mm	vor Katalysator in front of the catalyst	
2.0 i 95-125 kW (129-170 PS) N46 B20 B	07.2005→08.2008		7.28124.20.0	SLP	EL		
2.0 sd 66-145 kW (90-197 PS) N47 D20 A	09.2007→08.2008		7.00684.14.0	AGR	PN	mit Potentiometer with potentiometer	
			7.10334.07.0	AGR	EL	 	
2.5 i 137-141 kW (186-192 PS) M54 B25 (256S5)	01.2004→12.2006		7.28124.20.0	SLP	EL		
			7.28238.61.0	SLV	PN		
2.5 i 137-141 kW (186-192 PS) M54 B25 (256S5)	03.2004→07.2006		7.02604.21.0	LS	990 mm		



B

X3 (E83)

74

			7.02604.31.0	LS	350 mm	
			7.28124.20.0	SLP	EL	
			7.28238.61.0	SLV	PN	
2.5 si 130-160 kW (177-218 PS) N52 B25 A, N52 B25 AF, N52 B25 BF	08.2006→08.2008		7.02604.34.0	LS	600 mm	
			7.02604.26.0	LS	500 mm	
			7.02604.42.0	LS	1050 mm	
2.5 si xDrive 130-160 kW (177-218 PS) N52 B25 A, N52 B25 AF, N52 B25 BF	08.2006→08.2008		7.02604.34.0	LS	600 mm	
			7.02604.26.0	LS	500 mm	
			7.02604.42.0	LS	1050 mm	
3.0 d 150-160 kW (204-218 PS) M57 D30 (306D2)	01.2004→08.2005		7.00512.03.0	AGR	PN	
			7.02604.44.0	LS	500 mm	Automatikgetriebe Automatic Transmission vor Rußpartikelfilter before soot particulate filter Euro 3 Euro 3
3.0 d 135-173 kW (184-235 PS) M57 D30 (306D3)	09.2005→08.2008		7.00450.09.0	AGR	PN	Euro 4 (D4) Euro 4 (D4)
			7.00512.03.0	AGR	PN	Euro 3 (D3) Euro 3 (D3)
			7.02604.44.0	LS	500 mm	 M57 D30 (306D3): vor Rußpartikelfilter before soot particulate filter Euro 3 Euro 3  M57 D30 (306D3): vor Rußpartikelfilter before soot particulate filter für Rechtslenker for right-hand drive vehicles Euro 3 Euro 3
3.0 d 135-173 kW (184-235 PS) M57 D30 (306D3)	09.2005→08.2008		7.00450.09.0	AGR	PN	Euro 4 (D4) Euro 4 (D4)
			7.00512.03.0	AGR	PN	Euro 3 (D3) Euro 3 (D3)
3.0 i 163-170 kW (222-231 PS) M54 B30 (306S3)	01.2004→12.2006		7.28124.20.0	SLP	EL	
			7.28238.61.0	SLV	PN	
3.0 i xDrive 163-170 kW (222-231 PS) M54 B30 (306S3)	09.2003→07.2006		7.02604.21.0	LS	990 mm	
			7.02604.31.0	LS	350 mm	
			7.28124.19.0	SLP	EL	für Fahrzeuge mit Automatikgetriebe for vehicles with automatic transmission
			7.28238.61.0	SLV	PN	
3.0 sd 198-221 kW (269-301 PS) M57 D30 (306D5)	09.2006→08.2008		7.00450.10.0	AGR	PN	

















X3 (E83)						74	B
3.0 si 155-200 kW (211-272 PS) N52 B30 A, N52 B30 BF	08.2006→08.2008		7.02604.34.0	LS	600 mm		
			7.02604.26.0	LS	500 mm		
			7.02604.42.0	LS	1050 mm		
xDrive 18 d 66-150 kW (90-204 PS) N47 D20 C	09.2008→12.2011		7.10334.07.0	AGR	EL		
xDrive 18 d 66-150 kW (90-204 PS) N47 D20 C	04.2009→12.2011		7.10334.07.0	AGR	EL		
xDrive 20 d 66-150 kW (90-204 PS) N47 D20 A, N47 D20 C	09.2008→08.2010		7.10334.07.0	AGR	EL		
xDrive 20 d 66-150 kW (90-204 PS) N47 D20 A, N47 D20 C	09.2008→08.2010		7.10334.07.0	AGR	EL		
xDrive 25 i 130-160 kW (177-218 PS) N52 B25 A, N52 B25 AF, N52 B25 BF	09.2008→08.2010		7.02604.34.0	LS	600 mm		
			7.02604.26.0	LS	500 mm		
			7.02604.42.0	LS	1050 mm		
xDrive 30 d 135-173 kW (184-235 PS) M57 D30 (306D3)	09.2008→08.2010		7.00450.09.0	AGR	PN	Euro 4 (D4) Euro 4 (D4)	
			7.00512.03.0	AGR	PN	Euro 3 (D3) Euro 3 (D3)	
xDrive 30 d 135-173 kW (184-235 PS) M57 D30 (306D3)	09.2008→08.2010		7.00450.09.0	AGR	PN	Euro 4 (D4) Euro 4 (D4)	
			7.00512.03.0	AGR	PN	Euro 3 (D3) Euro 3 (D3)	
xDrive 30 i 155-200 kW (211-272 PS) N52 B30 A, N52 B30 BF	09.2008→08.2010		7.02604.34.0	LS	600 mm		
			7.02604.26.0	LS	500 mm		
			7.02604.42.0	LS	1050 mm		
X3 (F25)						75	
sDrive 18 d 66-150 kW (90-204 PS) N47 D20 C	10.2012→03.2014		7.10334.07.0	AGR	EL		
sDrive 18 d 66-150 kW (90-204 PS) N47 D20 C	10.2012→03.2014		7.10334.07.0	AGR	EL		
sDrive 18 d 85-155 kW (116-211 PS) B47 D20 A	04.2014→08.2017		7.04493.17.0	AGR	EL		
xDrive 20 d 66-150 kW (90-204 PS) N47 D20 C	09.2010→03.2014		7.10993.00.0	AGR-K	EL	 " Europa, Indien, Malaysia, Thailand, Indonesien " Europe, India, Malaysia, Thailand, Indonesia	
			↳ 7.10334.07.0 7.11190.12.0	AGR DDS	EL	ohne Zubehör without accessories Ausstattungsvariante: Blue Performance Equipment Variant: Blue Performance	
			7.02604.44.0	LS	500 mm	Ausstattungsvariante: Blue Performance Equipment Variant: Blue Performance nach Rußpartikelfilter after soot particulate filter	



B

X3 (F25)

75













<p>xDrive 20 d 66-150 kW (90-204 PS) N47 D20 C</p>	<p>09.2010→03.2014</p>	<p> 7.10993.00.0 ↳ 7.10334.07.0 7.11190.12.0</p>	<p>AGR-K AGR DDS</p>	<p>EL  ■■ Europa, Indien, Malaysia, Thailand, Indonesien ■■ Europe, India, Malaysia, Thailand, Indonesia ohne Zubehör without accessories Ausstattungsvariante: Blue Performance Equipment Variant: Blue Performance</p>
<p>xDrive 20 d 85-155 kW (116-211 PS) B47 D20 A</p>	<p>04.2014→08.2017</p>	<p> 7.04493.17.0</p>	<p>AGR</p>	<p>EL </p>
<p>xDrive 28 d 66-150 kW (90-204 PS) N47 D20 C</p>	<p>04.2014→12.2016</p>	<p> 7.11190.12.0</p>	<p>DDS</p>	<p>ohne Zubehör without accessories</p>
<p>xDrive 30 d 150-210 kW (204-286 PS) N57 D30 A</p>	<p>04.2011→08.2017</p>	<p> ↳ 7.10334.07.0 7.10992.00.0 ↳ 7.10334.07.0 7.10993.00.0 ↳ 7.10334.07.0 7.11190.12.0 7.02604.44.0</p>	<p>AGR-K AGR AGR-K AGR DDS LS</p>	<p>EL  →03.2014 für OE-Nummer: 11 71 7 823 210 for OE number: 11 71 7 823 210 EL  →06.2014 für OE-Nummer: 11 71 8 517 724 for OE number: 11 71 8 517 724 ■■ Russland, Europa, Indien ■■ Russia, Europe, India EL ohne Zubehör without accessories Euro 5 Euro 5 500 mm  N57 D30 A: nach Rußpartikelfilter after soot particulate filter Euro 6 Euro 6  N57 D30 A: vor Rußpartikelfilter before soot particulate filter</p>
<p>xDrive 30 d 150-210 kW (204-286 PS) N57 D30 A</p>	<p>04.2011→08.2017</p>	<p> ↳ 7.10334.07.0 7.10992.00.0 ↳ 7.10334.07.0 7.11190.12.0</p>	<p>AGR-K AGR AGR-K AGR DDS</p>	<p>EL  →03.2014 EL  →06.2014 für OE-Nummer: 11 71 8 517 724 for OE number: 11 71 8 517 724 ■■ Russland, Europa, Indien ■■ Russia, Europe, India EL ohne Zubehör without accessories Euro 5 Euro 5</p>
<p>xDrive 30 d 150-210 kW (204-286 PS) N57 D30 A</p>	<p>04.2011→05.2016</p>	<p> ↳ 7.10334.07.0 7.10992.00.0 ↳ 7.10334.07.0</p>	<p>AGR-K AGR AGR-K AGR</p>	<p>EL  →03.2014 für OE-Nummer: 11 71 7 823 210 for OE number: 11 71 7 823 210 EL  →06.2014 für OE-Nummer: 11 71 8 517 724 for OE number: 11 71 8 517 724 ■■ Russland, Europa, Indien ■■ Russia, Europe, India EL</p>

X3 (F25)					75	B
			7.11190.12.0	DDS		ohne Zubehör without accessories Euro 5 Euro 5
xDrive 30 d 150-210 kW (204-286 PS) N57 D30 A	06.2011→08.2017		7.10992.00.0	AGR-K	EL	○ →03.2014 für OE-Nummer: 11 71 7 823 210 for OE number: 11 71 7 823 210
			↳ 7.10334.07.0	AGR	EL	
			7.10993.00.0	AGR-K	EL	○ →06.2014 für OE-Nummer: 11 71 8 517 724 for OE number: 11 71 8 517 724 " " Russland, Europa, Indien " " Russia, Europe, India
			↳ 7.10334.07.0	AGR	EL	
			7.11190.12.0	DDS		ohne Zubehör without accessories Euro 5 Euro 5
xDrive 30 d 150-210 kW (204-286 PS) N57 D30 A	06.2016→08.2017		7.10992.00.0	AGR-K	EL	○
			↳ 7.10334.07.0	AGR	EL	
xDrive 35 d 220-230 kW (299-313 PS) N57 D30 B	10.2011→08.2017		7.10992.00.0	AGR-K	EL	○ →03.2014 für OE-Nummer: 11 71 7 823 210 for OE number: 11 71 7 823 210 " " Europa " " Europe
			↳ 7.10334.07.0	AGR	EL	
			7.10993.00.0	AGR-K	EL	○ →06.2014 für OE-Nummer: 11 71 8 517 724 for OE number: 11 71 8 517 724 " " Europa " " Europe
			↳ 7.10334.07.0	AGR	EL	
			7.11190.12.0	DDS		ohne Zubehör without accessories Euro 5 Euro 5
			7.02604.44.0	LS	500 mm	N57 D30 B: vor Rußpartikelfilter before soot particulate filter nicht für Ausstattungsvariante: Alpina Package not for equipment variant: Alpina Package N57 D30 B: nach Rußpartikelfilter after soot particulate filter Euro 6 Euro 6
X3 (G01, F97)					76	
sDrive 18 d 85-155 kW (116-211 PS) B47 D20 A	04.2018→06.2020		7.05838.08.0	AGR	EL	○
			7.11010.00.0	AGR-K	EL	○ " " Europa " " Europe
sDrive 18 d 85-170 kW (116-231 PS) B47 D20 A, B47 D20 B	04.2018→06.2020		7.05838.08.0	AGR	EL	○
sDrive 18 d 85-170 kW (116-231 PS) B47 D20 B	05.2019→06.2020		7.05838.08.0	AGR	EL	○































B

X3 (G01, F97) 76

xDrive 20 d 85-155 kW (116-211 PS) B47 D20 A	08.2017→04.2019	 7.05838.08.0	AGR	EL	
		7.11010.00.0	AGR-K	EL	 ■ Russland, Europa, Indien, Malaysia ■ Russia, Europe, India, Malaysia
xDrive 20 d 85-170 kW (116-231 PS) B47 D20 A, B47 D20 B	08.2017→03.2020	 7.05838.08.0	AGR	EL	
xDrive 20 d 85-170 kW (116-231 PS) B47 D20 B	05.2019→03.2020	 7.05838.08.0	AGR	EL	
xDrive 25 d 85-170 kW (116-231 PS) B47 D20 B	04.2018→	 7.05838.08.0	AGR	EL	
xDrive 25 d 85-170 kW (116-231 PS) B47 D20 B	04.2018→	 7.05838.08.0	AGR	EL	
xDrive 30d 155-235 kW (211-320 PS) B57 D30 A	08.2017→06.2020	 7.05343.18.0*	AGR-K	EL	
		↳ 7.05343.17.0	AGR	EL	
xDrive M40 d 155-250 kW (211-340 PS) B57 D30 B	08.2018→06.2020	 7.05343.18.0*	AGR-K	EL	
		↳ 7.05343.17.0	AGR	EL	

X4 (F26) 77

xDrive 20 d 85-155 kW (116-211 PS) B47 D20 A	04.2014→03.2018	 7.04493.17.0	AGR	EL	
xDrive 20 d 85-155 kW (116-211 PS) B47 D20 A	04.2014→03.2018	 7.04493.17.0	AGR	EL	
xDrive 30 d 150-210 kW (204-286 PS) N57 D30 A	04.2014→03.2018	 7.10992.00.0	AGR-K	EL	 für OE-Nummer: 11 71 7 823 210 for OE number: 11 71 7 823 210 ■ Russland, Europa ■ Russia, Europe
		↳ 7.10334.07.0	AGR	EL	
		7.10993.00.0	AGR-K	EL	 für OE-Nummer: 11 71 8 517 724 for OE number: 11 71 8 517 724 ■ Russland, Europa ■ Russia, Europe
		↳ 7.10334.07.0	AGR	EL	
		7.11190.12.0	DDS	EL	ohne Zubehör without accessories für OE-Nummer: 13 62 7 805 758 for OE number: 13 62 7 805 758
		7.02604.44.0	LS	500 mm	 N57 D30 A: nach Rußpartikelfilter after soot particulate filter Euro 6 Euro 6  N57 D30 A: vor Rußpartikelfilter before soot particulate filter
xDrive 30 d 150-210 kW (204-286 PS) N57 D30 A	04.2014→03.2018	 7.10992.00.0	AGR-K	EL	 für OE-Nummer: 11 71 7 823 210 for OE number: 11 71 7 823 210 ■ Russland, Europa ■ Russia, Europe
		↳ 7.10334.07.0	AGR	EL	

					
X4 (F26)					
			7.10993.00.0 AGR-K ↳ 7.10334.07.0 AGR 7.11190.12.0 DDS	EL	 für OE-Nummer: 11 71 8 517 724 for OE number: 11 71 8 517 724 ↳ Russland, Europa ↳ Russia, Europe ohne Zubehör without accessories für OE-Nummer: 13 62 7 805 758 for OE number: 13 62 7 805 758
xDrive 30 d 150-210 kW (204-286 PS) N57 D30 A	04.2014→03.2018		7.10992.00.0 AGR-K ↳ 7.10334.07.0 AGR 7.10993.00.0 AGR-K ↳ 7.10334.07.0 AGR 7.11190.12.0 DDS	EL	 für OE-Nummer: 11 71 7 823 210 for OE number: 11 71 7 823 210 ↳ Russland, Europa ↳ Russia, Europe  für OE-Nummer: 11 71 8 517 724 for OE number: 11 71 8 517 724 ↳ Russland, Europa ↳ Russia, Europe ohne Zubehör without accessories für OE-Nummer: 13 62 7 805 758 for OE number: 13 62 7 805 758
xDrive 30 d 150-210 kW (204-286 PS) N57 D30 A	04.2014→03.2018		7.10992.00.0 AGR-K ↳ 7.10334.07.0 AGR 7.10993.00.0 AGR-K ↳ 7.10334.07.0 AGR 7.11190.12.0 DDS	EL	 für OE-Nummer: 11 71 7 823 210 for OE number: 11 71 7 823 210 ↳ Russland, Europa ↳ Russia, Europe  für OE-Nummer: 11 71 8 517 724 for OE number: 11 71 8 517 724 ↳ Russland, Europa ↳ Russia, Europe ohne Zubehör without accessories für OE-Nummer: 13 62 7 805 758 for OE number: 13 62 7 805 758
xDrive 30 d 150-210 kW (204-286 PS) N57 D30 A	04.2015→03.2018		7.10992.00.0 AGR-K ↳ 7.10334.07.0 AGR 7.10993.00.0 AGR-K ↳ 7.10334.07.0 AGR 7.11190.12.0 DDS	EL	 für OE-Nummer: 11 71 7 823 210 for OE number: 11 71 7 823 210 ↳ Russland, Europa ↳ Russia, Europe  für OE-Nummer: 11 71 8 517 724 for OE number: 11 71 8 517 724 ↳ Russland, Europa ↳ Russia, Europe ohne Zubehör without accessories für OE-Nummer: 13 62 7 805 758 for OE number: 13 62 7 805 758
xDrive 35 d 220-230 kW (299-313 PS) N57 D30 B	04.2014→03.2018		7.10992.00.0 AGR-K ↳ 7.10334.07.0 AGR	EL	 für OE-Nummer: 11 71 7 823 210 for OE number: 11 71 7 823 210 ↳ Europa ↳ Europe

77
B





















B



X4 (F26) 77



















		7.10993.00.0	AGR-K	EL	 für OE-Nummer: 11 71 8 517 724 for OE number: 11 71 8 517 724 ■ Europa ■ Europe
		↳ 7.10334.07.0	AGR	EL	
		7.11190.12.0	DDS		ohne Zubehör without accessories Euro 5 Euro 5
		7.02604.44.0	LS	500 mm	vor Rußpartikelfilter, nach Rußpartikelfilter before soot particulate filter, after soot particulate filter

X4 (G02, F98) 78

M40 d xDrive 155-250 kW (211-340 PS) B57 D30 B	04.2018→06.2020	 7.04493.17.0	AGR	EL	
		7.05343.18.0*	AGR-K	EL	
		↳ 7.05343.17.0	AGR	EL	
xDrive 20 d 85-155 kW (116-211 PS) B47 D20 A	04.2018→03.2020	 7.05838.08.0	AGR	EL	
		7.11010.00.0	AGR-K	EL	 ■ Russland, Europa, Indien, Malaysia ■ Russia, Europe, India, Malaysia
		↳ 7.04493.17.0	AGR	EL	
xDrive 20 d 85-155 kW (116-211 PS) B47 D20 A	04.2018→03.2020	 7.04493.17.0	AGR	EL	
		7.05838.08.0	AGR	EL	
xDrive 25 d 85-170 kW (116-231 PS) B47 D20 B	04.2018→	 7.04493.17.0	AGR	EL	
		7.05838.08.0	AGR	EL	
xDrive 25 d 85-170 kW (116-231 PS) B47 D20 B	04.2018→	 7.04493.17.0	AGR	EL	
		7.05838.08.0	AGR	EL	
xDrive 30 d 155-235 kW (211-320 PS) B57 D30 A	04.2018→06.2020	 7.04493.17.0	AGR	EL	
		7.05343.18.0*	AGR-K	EL	
		↳ 7.05343.17.0	AGR	EL	
xDrive 30 d 155-235 kW (211-320 PS) B57 D30 A	09.2018→06.2020	 7.04493.17.0	AGR	EL	

X5 (E53) 79

3.0 d 135-142 kW (184-193 PS) M57 D30 (306D1)	04.2001→09.2003	 7.28264.06.0	AGR	PN	
3.0 d 150-160 kW (204-218 PS) M57 D30 (306D2)	10.2003→09.2006	 7.00450.09.0	AGR	PN	
		7.28264.07.0	AGR	PN	
3.0 d 150-160 kW (204-218 PS) M57 D30 (306D2)	10.2003→09.2006	 7.00450.09.0	AGR	PN	
		7.28264.07.0	AGR	PN	

						
X5 (E53)						
3.0 i 163-170 kW (222-231 PS) M54 B30 (306S3)	04.2000→10.2006		7.22295.63.0	ARV	PN 	für OE-Nummer: 11 72 1 437 015, 11 72 7 540 471 for OE number: 11 72 1 437 015, 11 72 7 540 471 USA USA
			7.02604.21.0	LS	990 mm	
			7.02604.31.0	LS	350 mm	
			7.28124.19.0	SLP	EL	10.2003→ USA USA
			7.22166.52.0*	SLP-M	EL	
			↳ 7.22166.39.0	SLP	EL	
			7.22166.64.0*	SLP-M	EL	
			↳ 7.22166.39.0	SLP	EL	
7.28238.58.0	SLV	PN 	10.2003→ für Fahrzeuge mit Automatikgetriebe for vehicles with automatic transmission USA USA			
3.0 i 163-170 kW (222-231 PS) M54 B30 (306S3)	06.2000→12.2006		7.22295.63.0	ARV	PN 	für OE-Nummer: 11 72 1 437 015, 11 72 7 540 471 for OE number: 11 72 1 437 015, 11 72 7 540 471 USA USA
			7.22166.39.0	SLP	EL	
4.4 i 210 kW (286 PS) M62 B44 (448S2)	01.2000→09.2003		7.22295.68.0	ARV	PN 	
			7.05271.23.0	LS	900 mm	
			7.22166.65.0*	SLP-M	EL	
			↳ 7.21852.78.0	SLP	EL	
4.4 i 235-245 kW (320-333 PS) N62 B44 A	10.2003→10.2006		7.05271.23.0	LS	900 mm	
			7.02604.32.0	LS	450 mm	rechts Right
4.6 is 255-261 kW (347-355 PS) M62 B46 (468S1)	10.2001→09.2003		7.22295.68.0	ARV	PN 	
			7.02604.31.0	LS	350 mm	
			7.22166.65.0*	SLP-M	EL	
			↳ 7.21852.78.0	SLP	EL	
4.8 is 261-270 kW (355-367 PS) N62 B48 A	04.2004→09.2006		7.05271.23.0	LS	900 mm	
			7.02604.32.0	LS	450 mm	
X5 (E70)						
3.0 3.0d 135-173 kW (184-235 PS) M57 D30 (306D3)	02.2007→09.2008		7.00450.09.0	AGR	PN	Euro 4 (D4) Euro 4 (D4)
			7.00512.03.0	AGR	PN	Euro 3 (D3) Euro 3 (D3)
3.0 d 135-173 kW (184-235 PS) M57 D30 (306D3)	12.2006→09.2008		7.00450.09.0	AGR	PN	Euro 4 (D4) Euro 4 (D4)
			7.00512.03.0	AGR	PN	Euro 3 (D3) Euro 3 (D3)

79

B

















80

















B

X5 (E70)

80

3.0 sd 198-221 kW (269-301 PS) M57 D30 (306D5)	10.2007→09.2008		7.00450.10.0 AGR PN	ohne Zubehör without accessories  USA  USA	
			7.11190.12.0 DDS		
3.0 si 155-200 kW (211-272 PS) N52 B30 A, N52 B30 AF, N52 B30 BF	10.2006→09.2008		7.02604.34.0 LS 600 mm		
			7.02604.26.0 LS 500 mm		
			7.02604.43.0 LS 1200 mm		
4.8 i xDrive 261-270 kW (355-367 PS) N62 B48 B	10.2006→09.2008		7.02604.41.0 LS 700 mm	vor Katalysator, rechts in front of the catalyst, Right	
			7.02604.25.0 LS 425 mm		
			7.02604.42.0 LS 1050 mm		
M 408-414 kW (555-563 PS) S63 B44 A	07.2009→07.2013		7.02604.25.0 LS 425 mm		
M 50 d 280 kW (381 PS) N57 D30 C	08.2011→06.2013		7.10992.00.0 AGR-K EL	 Europa  Europe	
			 7.10334.07.0 AGR EL		
xDrive 30 d 135-173 kW (184-235 PS) M57 D30 (306D3)	10.2008→03.2010		7.00450.09.0 AGR PN	Euro 4 (D4) Euro 4 (D4)	
			7.00512.03.0 AGR PN		Euro 3 (D3) Euro 3 (D3)
xDrive 30 d 135-173 kW (184-235 PS) M57 D30 (306D3)	10.2008→03.2010		7.00450.09.0 AGR PN	Euro 4 (D4) Euro 4 (D4)	
			7.00512.03.0 AGR PN		Euro 3 (D3) Euro 3 (D3)
xDrive 30 d 150-210 kW (204-286 PS) N57 D30 A	04.2010→07.2013		7.10334.07.0 AGR EL		
			7.11190.12.0 DDS		ohne Zubehör without accessories Ausstattungsvariante: Blue Performance Equipment Variant: Blue Performance
			7.02604.44.0 LS 500 mm		
xDrive 30 d 150-210 kW (204-286 PS) N57 D30 A	04.2010→07.2013		7.10334.07.0 AGR EL		
			7.11190.12.0 DDS		ohne Zubehör without accessories Ausstattungsvariante: Blue Performance Equipment Variant: Blue Performance
xDrive 30 i 155-200 kW (211-272 PS) N52 B30 A	10.2008→03.2010		7.02604.34.0 LS 600 mm		
			7.02604.26.0 LS 500 mm		
			7.02604.43.0 LS 1200 mm		



















							
X5 (E70)						80	B
xDrive 40 d 220-230 kW (299-313 PS) N57 D30 B	09.2010→06.2013		7.10334.07.0	AGR	EL	○	
			7.02604.41.0	LS	700 mm		vor Rußpartikelfilter before soot particulate filter " Europa " Europe
xDrive 48 i 261-270 kW (355-367 PS) N62 B48 B	10.2008→03.2010		7.02604.41.0	LS	700 mm	vor Katalysator, rechts in front of the catalyst, Right	
			7.02604.25.0	LS	425 mm		
			7.02604.42.0	LS	1050 mm		
xDrive 50 i 298-330 kW (405-449 PS) N63 B44 A	04.2010→07.2013		7.02604.34.0	LS	600 mm		
X5 (F15, F85)						81	
M 50 d 280 kW (381 PS) N57 D30 C	12.2013→07.2018		7.10334.07.0	AGR	EL	○	
			7.11190.12.0	DDS			ohne Zubehör without accessories für OE-Nummer: 13 62 7 805 758 for OE number: 13 62 7 805 758
			7.02604.44.0	LS	500 mm		für OE-Nummer: 13 62 7 791 592, 13 62 7 793 825 for OE number: 13 62 7 791 592, 13 62 7 793 825
sDrive 25 d 150-160 kW (204-218 PS) N47 D20 D	12.2013→07.2015		7.10993.00.0	AGR-K	EL	○ " Europa, Indien, Thailand " Europe, India, Thailand	
			↳ 7.10334.07.0	AGR	EL		ohne Zubehör without accessories nach Rußpartikelfilter after soot particulate filter " Europa, Indien, Thailand " Europe, India, Thailand
			7.11190.12.0	DDS			
sDrive 25 d 150-160 kW (204-218 PS) N47 D20 D	12.2013→07.2015		7.10993.00.0	AGR-K	EL	○ " Europa, Indien, Thailand " Europe, India, Thailand	
			↳ 7.10334.07.0	AGR	EL		
sDrive 25 d 85-170 kW (116-231 PS) B47 D20 B	08.2015→07.2018		7.04493.17.0	AGR	EL	○	
xDrive 25 d 150-160 kW (204-218 PS) N47 D20 D	12.2013→07.2015		7.10993.00.0	AGR-K	EL	○ " Russland, Europa, Indonesien " Russia, Europe, Indonesia	
			↳ 7.10334.07.0	AGR	EL		nach Rußpartikelfilter after soot particulate filter " Europa, Indien " Europe, India
			7.02604.41.0	LS	700 mm		
xDrive 25 d 150-160 kW (204-218 PS) N47 D20 D	12.2013→07.2015		7.10993.00.0	AGR-K	EL	○ " Russland, Europa, Indonesien " Russia, Europe, Indonesia	
			↳ 7.10334.07.0	AGR	EL		nach Rußpartikelfilter after soot particulate filter " Europa, Indien " Europe, India
			7.02604.41.0	LS	700 mm		



B

X5 (F15, F85)

81

xDrive 25 d 150-210 kW (204-286 PS) N57 D30 A	04.2014→07.2018		7.10992.00.0 AGR-K EL 	 Russland  Russia
			↳ 7.10334.07.0 AGR EL	ohne Zubehör without accessories
			7.11190.12.0 DDS 7.02604.44.0 LS 500 mm	
xDrive 25 d 85-170 kW (116-231 PS) B47 D20 B	08.2015→07.2018		7.04493.17.0 AGR EL 	
xDrive 30 d 150-210 kW (204-286 PS) N57 D30 A	08.2013→07.2018		7.10993.00.0 AGR-K EL 	 Russland, Europa, Indien, Malaysia, Thailand  Russia, Europe, India, Malaysia, Thailand
			↳ 7.10334.07.0 AGR EL	ohne Zubehör without accessories
			7.11190.12.0 DDS 7.02604.44.0 LS 500 mm	
xDrive 30 d 150-210 kW (204-286 PS) N57 D30 A	08.2013→07.2018		7.10992.00.0 AGR-K EL 	für OE-Nummer: 11 71 7 823 210 for OE number: 11 71 7 823 210
			↳ 7.10334.07.0 AGR EL	
			7.10993.00.0 AGR-K EL	
xDrive 30 d 150-210 kW (204-286 PS) N57 D30 A	08.2013→07.2018		7.10992.00.0 AGR-K EL 	für OE-Nummer: 11 71 7 823 210 for OE number: 11 71 7 823 210
			↳ 7.10334.07.0 AGR EL	
			7.10993.00.0 AGR-K EL	
xDrive 30 d 150-210 kW (204-286 PS) N57 D30 A	12.2013→07.2018		7.10992.00.0 AGR-K EL 	für OE-Nummer: 11 71 7 823 210 for OE number: 11 71 7 823 210
			↳ 7.10334.07.0 AGR EL	ohne Zubehör without accessories
			7.11190.12.0 DDS	
			↳ 7.10334.07.0 AGR EL	









X5 (F15, F85)					81	B
			7.10993.00.0	AGR-K	EL	für OE-Nummer: 11 71 8 517 724 for OE number: 11 71 8 517 724 " Russland, Europa, Indien, Malaysia, Thailand " Russia, Europe, India, Malaysia, Thailand
			↳ 7.10334.07.0	AGR	EL	
			7.11190.12.0	DDS		ohne Zubehör without accessories
xDrive 40 d 220-230 kW (299-313 PS) N57 D30 B	12.2013→07.2018		7.10992.00.0	AGR-K	EL	für OE-Nummer: 11 71 7 823 210 for OE number: 11 71 7 823 210 " Russland, Europa " Russia, Europe
			↳ 7.10334.07.0	AGR	EL	
			7.10993.00.0	AGR-K	EL	für OE-Nummer: 11 71 8 517 724 for OE number: 11 71 8 517 724 " Russland, Europa " Russia, Europe
			↳ 7.10334.07.0	AGR	EL	
			7.11190.12.0	DDS		ohne Zubehör without accessories Euro 5 Euro 5
			7.02604.44.0	LS	500 mm	N57 D30 B: nach Rußpartikelfilter after soot particulate filter Euro 6 Euro 6 N57 D30 B: vor Rußpartikelfilter before soot particulate filter
X5 (G05, F95)					82	
xDrive 30 d 155-235 kW (211-320 PS) B57 D30 A	08.2018→07.2020		7.04493.17.0	AGR	EL	
			7.05343.18.0*	AGR-K	EL	
			↳ 7.05343.17.0	AGR	EL	
xDrive 30 d 155-235 kW (211-320 PS) B57 D30 A	08.2018→07.2020		7.04493.17.0	AGR	EL	
xDrive M 50 d 294 kW (400 PS) B57 D30 C	08.2018→		7.04493.17.0	AGR	EL	
			7.05838.08.0	AGR	EL	
X6 (E71, E72)					83	
M 408-414 kW (555-563 PS) S63 B44 A	07.2009→07.2014		7.02604.25.0	LS	425 mm	
M 50 d 280 kW (381 PS) N57 D30 C	08.2011→06.2014		7.10334.07.0	AGR	EL	
xDrive 30 d 135-173 kW (184-235 PS) M57 D30 (306D3)	04.2008→03.2010		7.00450.09.0	AGR	PN	Euro 4 (D4) Euro 4 (D4)
			7.00512.03.0	AGR	PN	Euro 3 (D3) Euro 3 (D3)
xDrive 30 d 150-210 kW (204-286 PS) N57 D30 A	04.2010→07.2014		7.10334.07.0	AGR	EL	
			7.11190.12.0	DDS		ohne Zubehör without accessories Ausstattungsvariante: Blue Performance Equipment Variant: Blue Performance



B



















X6 (E71, E72)

83

xDrive 30 d 150-210 kW (204-286 PS) N57 D30 A	04.2010→07.2014		7.10334.07.0	AGR	EL	 ohne Zubehör without accessories Ausstattungsvariante: Blue Performance Equipment Variant: Blue Performance
			7.11190.12.0	DDS		
xDrive 35 d 198-221 kW (269-301 PS) M57 D30 (306D5)	01.2008→03.2010		7.00450.10.0	AGR	PN	
xDrive 40 d 220-230 kW (299-313 PS) N57 D30 B	07.2009→06.2014		7.10334.07.0	AGR	EL	 vor Rußpartikelfilter before soot particulate filter  Europa  Europe
			7.02604.41.0	LS	700 mm	
xDrive 50 i 298-330 kW (405-449 PS) N63 B44 A	07.2008→07.2014		7.02604.34.0	LS	600 mm	

X6 (F16, F86)

84



M 50 d 280 kW (381 PS) N57 D30 C	08.2014→07.2019		7.10334.07.0	AGR	EL	 ohne Zubehör without accessories für OE-Nummer: 13 62 7 805 758 for OE number: 13 62 7 805 758 7.02604.44.0 LS 500 mm für OE-Nummer: 13 62 7 791 592, 13 62 7 793 825 for OE number: 13 62 7 791 592, 13 62 7 793 825
			7.11190.12.0	DDS		
xDrive 30 d 150-210 kW (204-286 PS) N57 D30 A	08.2014→07.2019		7.10992.00.0	AGR-K	EL	 für OE-Nummer: 11 71 7 823 210 for OE number: 11 71 7 823 210  Russland, Europa  Russia, Europe
			↳ 7.10334.07.0	AGR	EL	
			7.10993.00.0	AGR-K	EL	 für OE-Nummer: 11 71 8 517 724 for OE number: 11 71 8 517 724  Russland, Europa  Russia, Europe
			↳ 7.10334.07.0	AGR	EL	
			7.11190.12.0	DDS		ohne Zubehör without accessories  N57 D30 A: nach Rußpartikelfilter after soot particulate filter Euro 6 Euro 6  N57 D30 A: vor Rußpartikelfilter before soot particulate filter
			7.02604.44.0	LS	500 mm	
xDrive 30 d 150-210 kW (204-286 PS) N57 D30 A	08.2014→07.2019		7.10992.00.0	AGR-K	EL	 für OE-Nummer: 11 71 7 823 210 for OE number: 11 71 7 823 210  Russland, Europa  Russia, Europe
			↳ 7.10334.07.0	AGR	EL	
			7.10993.00.0	AGR-K	EL	 für OE-Nummer: 11 71 8 517 724 for OE number: 11 71 8 517 724  Russland, Europa  Russia, Europe
			↳ 7.10334.07.0	AGR	EL	

X6 (F16, F86)					84	B
			7.11190.12.0	DDS	ohne Zubehör without accessories	
xDrive 30 d 150-210 kW (204-286 PS) N57 D30 A	08.2014→07.2019		7.10992.00.0	AGR-K	EL für OE-Nummer: 11 71 7 823 210 for OE number: 11 71 7 823 210 " " Russland, Europa " " Russia, Europe	
			↳ 7.10334.07.0	AGR	EL	
			7.10993.00.0	AGR-K	EL für OE-Nummer: 11 71 8 517 724 for OE number: 11 71 8 517 724 " " Russland, Europa " " Russia, Europe	
xDrive 30 d 150-210 kW (204-286 PS) N57 D30 A	12.2014→07.2019		7.10992.00.0	AGR-K	EL für OE-Nummer: 11 71 7 823 210 for OE number: 11 71 7 823 210 " " Russland, Europa " " Russia, Europe	
			↳ 7.10334.07.0	AGR	EL	
			7.10993.00.0	AGR-K	EL für OE-Nummer: 11 71 8 517 724 for OE number: 11 71 8 517 724 " " Russland, Europa " " Russia, Europe	
xDrive 30 d 150-210 kW (204-286 PS) N57 D30 A	09.2016→07.2019		7.10992.00.0	AGR-K	EL für OE-Nummer: 11 71 7 823 210 for OE number: 11 71 7 823 210 " " Russland, Europa " " Russia, Europe	
			↳ 7.10334.07.0	AGR	EL	
			7.10993.00.0	AGR-K	EL für OE-Nummer: 11 71 8 517 724 for OE number: 11 71 8 517 724 " " Russland, Europa " " Russia, Europe	
xDrive 40 d 220-230 kW (299-313 PS) N57 D30 B	12.2014→07.2019		7.10992.00.0	AGR-K	EL für OE-Nummer: 11 71 7 823 210 for OE number: 11 71 7 823 210 " " Russland, Europa " " Russia, Europe	
			↳ 7.10334.07.0	AGR	EL	
			7.10993.00.0	AGR-K	EL für OE-Nummer: 11 71 8 517 724 for OE number: 11 71 8 517 724 " " Russland, Europa " " Russia, Europe	
			↳ 7.10334.07.0	AGR	EL	
			7.11190.12.0	DDS	ohne Zubehör without accessories Euro 5	
			7.02604.44.0	LS	500 mm N57 D30 B: vor Rußpartikelfilter before soot particulate filter N57 D30 B: nach Rußpartikelfilter after soot particulate filter Euro 6 Euro 6	







B



X6 (G06, F96) 85

xDrive 30 d 155-235 kW (211-320 PS) B57 D30 A	08.2019→07.2020		7.05343.18.0*	AGR-K	EL	
			↳ 7.05343.17.0	AGR	EL	
xDrive 30 d 155-235 kW (211-320 PS) B57 D30 A	08.2019→07.2020		7.05343.18.0*	AGR-K	EL	
			↳ 7.05343.17.0	AGR	EL	
xDrive M 50 d 294 kW (400 PS) B57 D30 C	08.2019→		7.05838.08.0	AGR	EL	<input type="checkbox"/>



X7 (G07) 86

xDrive 30 d 155-235 kW (211-320 PS) B57 D30 A	03.2019→		7.04493.17.0	AGR	EL	<input type="checkbox"/>
			7.05343.18.0*	AGR-K	EL	
			↳ 7.05343.17.0	AGR	EL	
xDrive 30 d 155-235 kW (211-320 PS) B57 D30 A	03.2019→08.2020		7.04493.17.0	AGR	EL	<input type="checkbox"/>
			7.05343.18.0*	AGR-K	EL	
			↳ 7.05343.17.0	AGR	EL	
xDrive 30 d 155-235 kW (211-320 PS) B57 D30 A	03.2019→		7.04493.17.0	AGR	EL	<input type="checkbox"/>
			7.05343.18.0*	AGR-K	EL	
			↳ 7.05343.17.0	AGR	EL	
xDrive M 50 d 294 kW (400 PS) B57 D30 C	03.2019→		7.04493.17.0	AGR	EL	<input type="checkbox"/>
			7.05838.08.0	AGR	EL	<input type="checkbox"/>

Z3 (E36) 87

2.5i 24V (USA) 120-141 kW (163-192 PS) M52 B25 (256S3), M52 B25 (256S4)	01.1999→12.2002		7.02604.21.0	LS	990 mm	
			7.02604.31.0	LS	350 mm	
2.5i 24V (USA) 137-141 kW (186-192 PS) M54 B25 (256S5)	01.1999→12.2002		7.22295.67.0	ARV	PN	<input type="checkbox"/>
			7.02604.21.0	LS	990 mm	
			7.02604.31.0	LS	350 mm	

Z3 Coupe (E36) 88

2.8 i 141-143 kW (192-194 PS) M52 B28 (286S1)	01.1998→08.1998		7.22295.70.0	ARV	PN	<input type="checkbox"/>
2.8 i 141-144 kW (192-196 PS) M52 B28 (286S2)	09.1998→05.2000		7.22295.70.0	ARV	PN	<input type="checkbox"/>
			7.22295.67.0	ARV	PN	<input type="checkbox"/>
			7.02604.21.0	LS	990 mm	
			7.02604.30.0	LS	980 mm	
			7.02604.31.0	LS	350 mm	
3.0 i 163-170 kW (222-231 PS) M54 B30 (306S3)	06.2000→06.2003		7.22295.67.0	ARV	PN	<input type="checkbox"/>























Z3 Coupe (E36)					88	B
			7.02604.21.0	LS	990 mm	
			7.02604.30.0	LS	980 mm	
			7.02604.31.0	LS	350 mm	
3.0 i 163-170 kW (222-231 PS) M54 B30 (306S3)	01.2001→12.2002		7.22295.67.0	ARV	PN	
M 236 kW (321 PS) S50 B32 (326S1), S50 B32 (326S3)	02.1998→06.2001		7.05270.03.0	LS	820 mm	
			7.02604.28.0	LS	1120 mm	
M 235-265 kW (320-360 PS) S54 B32 (326S4)	09.2000→12.2002		7.22748.18.0	SLV	PN	
M 235-265 kW (320-360 PS) S54 B32 (326S4)	06.2001→06.2003		7.05270.03.0	LS	820 mm	
			7.02604.28.0	LS	1120 mm	
			7.22748.18.0	SLV	PN	
M 3.2 176-179 kW (239-243 PS) S52 B32 (326S2)	02.1998→06.2000		7.22295.70.0	ARV	PN	 " USA " USA Produktionsdatum bis: 31.08.1998 Production date to: 31.08.1998
Z3 Roadster (E36)					89	
1.9 i 103 kW (140 PS) M44 B19 (194S1)	11.1995→03.1999		7.22295.66.0	ARV	PN	 " USA " USA
			7.02604.31.0	LS	350 mm	
			7.22166.38.0	SLP-M	EL	
1.9 i 77-87 kW (105-118 PS) M43 B19 (194E1)	07.1998→01.2003		7.22295.69.0	ARV	PN	
			7.02604.31.0	LS	350 mm	
1.9 i 77-87 kW (105-118 PS) M43 B19 (194E1)	01.1999→01.2003		7.22295.69.0	ARV	PN	
			7.02604.31.0	LS	350 mm	
2.0 i 100-110 kW (136-150 PS) M52 B20 (206S4)	04.1999→01.2003		7.22295.67.0	ARV	PN	 für Rechtslenker for right-hand drive vehicles
			7.02604.21.0	LS	990 mm	
			7.02604.30.0	LS	980 mm	
			7.02604.31.0	LS	350 mm	
2.2 i 120-125 kW (163-170 PS) M54 B22 (226S1)	08.2000→01.2003		7.22295.67.0	ARV	PN	 für Linkslenker for left-hand drive vehicles
2.2 i 120-125 kW (163-170 PS) M54 B22 (226S1)	10.2000→06.2002		7.22295.67.0	ARV	PN	 für Linkslenker for left-hand drive vehicles
			7.02604.21.0	LS	990 mm	
			7.02604.30.0	LS	980 mm	
			7.02604.31.0	LS	350 mm	
2.5 i 137-141 kW (186-192 PS) M54 B25 (256S5)	10.2000→08.2002		7.22295.67.0	ARV	PN	

























B

Z3 Roadster (E36)

89

2.8 i 141-143 kW (192-194 PS) M52 B28 (286S1)	01.1996→07.2000		7.22295.70.0	ARV	PN	  Produktionsdatum bis: 31.08.1998 Production date to: 31.08.1998	
			7.02604.21.0	LS	990 mm		
			7.02604.30.0	LS	980 mm		
			7.02604.31.0	LS	350 mm		
2.8 i 141-144 kW (192-196 PS) M52 B28 (286S2)	01.1996→07.2000		7.22295.67.0	ARV	PN	  Produktionsdatum ab: 01.04.1999 Production date from: 01.04.1999	
			7.22295.70.0	ARV	PN		  Produktionsdatum bis: 31.08.1998 Production date to: 31.08.1998
			7.02604.21.0	LS	990 mm		
			7.02604.30.0	LS	980 mm		
2.8 i 141-143 kW (192-194 PS) M52 B28 (286S1)	11.1996→05.2000		7.02604.31.0	LS	350 mm		
			7.22295.70.0	ARV	PN	  Produktionsdatum bis: 31.08.1998 Production date to: 31.08.1998	
			7.02604.21.0	LS	990 mm		
3.0 i 163-170 kW (222-231 PS) M54 B30 (306S3)	06.2000→12.2002		7.02604.30.0	LS	980 mm		
			7.22295.67.0	ARV	PN	 	
			7.02604.21.0	LS	990 mm		
3.0 i 163-170 kW (222-231 PS) M54 B30 (306S3)	06.2000→01.2003		7.02604.31.0	LS	350 mm		
			7.02604.30.0	LS	980 mm		
			7.02604.21.0	LS	990 mm		
3.2 i 235-265 kW (320-360 PS) S54 B32 (326S4)	09.2000→12.2002		7.22748.18.0	SLV	PN		
M 3.2 236 kW (321 PS) S50 B32 (326S1)	01.1997→06.2000		7.22295.70.0	ARV	PN	  Produktionsdatum bis: 31.08.1998 Production date to: 31.08.1998	
			7.05270.03.0	LS	820 mm		
			7.02604.28.0	LS	1120 mm		
M 3.2 176-179 kW (239-243 PS) S52 B32 (326S2)	02.1998→06.2000		7.22295.70.0	ARV	PN	  Produktionsdatum bis: 31.08.1998 Production date to: 31.08.1998	

							
Z3 Roadster (E36)						89	B
M 3.2 235-265 kW (320-360 PS) S54 B32 (326S4)	06.2001→01.2003		7.05270.03.0	LS	820 mm		
			7.02604.28.0	LS	1120 mm		
			7.22748.18.0	SLV	PN		
Z4 Coupe (E86)						90	
3.0 si 155-200 kW (211-272 PS) N52 B30 A, N52 B30 BF	04.2006→08.2008		7.02604.34.0	LS	600 mm		
			7.02604.26.0	LS	500 mm		
			7.02604.42.0	LS	1050 mm		
M 235-265 kW (320-360 PS) S54 B32 (326S4)	03.2006→12.2008		7.22748.18.0	SLV	PN		
M 235-265 kW (320-360 PS) S54 B32 (326S4)	04.2006→08.2008		7.02604.28.0	LS	1120 mm		
			7.02604.42.0	LS	1050 mm		
			7.22748.18.0	SLV	PN		
Z4 Roadster (E85)						91	
2.0 i 95-125 kW (129-170 PS) N46 B20 B	03.2005→02.2009		7.28238.55.0	SLV	PN		
2.2 i 120-125 kW (163-170 PS) M54 B22 (226S1)	10.2003→10.2005		7.02604.21.0	LS	990 mm		
			7.02604.30.0	LS	980 mm		
			7.02604.31.0	LS	350 mm		
			7.28129.14.0*	SLP-M	EL		
			↳ 7.28124.20.0	SLP	EL		
			7.28129.52.0*	SLP-M	EL		
			↳ 7.28124.20.0	SLP	EL		
7.28238.58.0	SLV	PN					
2.5 i 137-141 kW (186-192 PS) M54 B25 (256S5)	12.2002→12.2005		7.02604.21.0	LS	990 mm	hinten, vorne Rear, Front	
			7.02604.30.0	LS	980 mm	hinten Rear für Rechtslenker for right-hand drive vehicles	
			7.02604.31.0	LS	350 mm	hinten, vorne Rear, Front	
			7.28124.20.0	SLP	EL		
			7.28238.58.0	SLV	PN		
2.5 i 130-160 kW (177-218 PS) N52 B25 A	09.2005→02.2009		7.02604.34.0	LS	600 mm	vorne Front	
			7.02604.26.0	LS	500 mm	hinten Rear	
			7.02604.42.0	LS	1050 mm	hinten Rear	
			7.28124.20.0	SLP	EL		
2.5 si 130-160 kW (177-218 PS) N52 B25 A	01.2006→08.2008		7.02604.34.0	LS	600 mm		
			7.02604.26.0	LS	500 mm		
			7.02604.42.0	LS	1050 mm		
3.0 i 163-170 kW (222-231 PS) M54 B30 (306S3)	12.2002→12.2005		7.02604.21.0	LS	990 mm	hinten, vorne Rear, Front	



B

Z4 Roadster (E85)

91



			7.02604.30.0	LS	980 mm	hinten Rear für Rechtslenker for right-hand drive vehicles
			7.02604.26.0	LS	500 mm	hinten Rear USA USA
			7.02604.31.0	LS	350 mm	hinten, vorne Rear, Front
			7.28129.14.0*	SLP-M	EL	
			↳ 7.28124.20.0	SLP	EL	
			7.28238.58.0	SLV	PN	
3.0 si 155-200 kW (211-272 PS) N52 B30 A, N52 B30 BF	01.2006→08.2008		7.02604.34.0	LS	600 mm	
			7.02604.26.0	LS	500 mm	
			7.02604.42.0	LS	1050 mm	
3.0 si 155-200 kW (211-272 PS) N52 B30 A, N52 B30 BF	01.2006→08.2008		7.02604.34.0	LS	600 mm	
			7.02604.26.0	LS	500 mm	
			7.02604.42.0	LS	1050 mm	
3.2 235-265 kW (320-360 PS) S54 B32 (326S4)	09.2005→12.2007		7.22748.18.0	SLV	PN	
M 235-265 kW (320-360 PS) S54 B32 (326S4)	01.2006→08.2008		7.02604.28.0	LS	1120 mm	
			7.02604.42.0	LS	1050 mm	
			7.22748.18.0	SLV	PN	

Z4 Roadster (E89)

92

sDrive 23 i 130-160 kW (177-218 PS) N52 B25 A, N52 B25 BF	03.2009→08.2011		7.02604.34.0	LS	600 mm	
			7.02604.26.0	LS	500 mm	
			7.02604.42.0	LS	1050 mm	
sDrive 30 i 155-200 kW (211-272 PS) N52 B30 A, N52 B30 B, N52 B30 BF	02.2009→08.2011		7.02604.34.0	LS	600 mm	
			7.02604.26.0	LS	500 mm	
			7.02604.42.0	LS	1050 mm	
sDrive 35 i 200-264 kW (272-359 PS) N54 B30 A	02.2009→08.2016		7.02604.34.0	LS	600 mm	
			7.02604.26.0	LS	500 mm	
			7.02604.43.0	LS	1200 mm	
sDrive 35 is 200-264 kW (272-359 PS) N54 B30 A	03.2010→08.2016		7.02604.34.0	LS	600 mm	
			7.02604.26.0	LS	500 mm	
			7.02604.43.0	LS	1200 mm	



Z8 Roadster (E52)						93	B
4.9 294 kW (400 PS) S62 B50 (508S1)	01.2000→12.2003		7.22295.66.0	ARV	PN		
			7.02604.31.0	LS	350 mm		
			7.21852.82.0	SLP	EL		
X3 Van (G01)						94	
xDrive 30 d 155-235 kW (211-320 PS) B57 D30 A	08.2017→		7.05343.18.0*	AGR-K	EL		
			↳7.05343.17.0	AGR	EL		



B

3 SERIES (E46)

1

318 i 105-107 kW (143-146 PS)
N42 B20 BZ, N46 B20 CA

06.2004→06.2005



7.28238.55.0

SLV

PN



3 SERIES (E90)

2

318 i 100-122 kW (136-166 PS)
N46 B20 E

01.2009→09.2012



7.01318.24.0

SLV

PN



320 i 100-115 kW (136-156 PS)
N46 B20 CC

12.2007→12.2010



7.01318.24.0

SLV

PN



für Linkslenker
for left-hand drive vehicles

325 i 150-160 kW (204-218 PS)
N52 B25 BF

06.2005→09.2012



7.01318.20.0

SLV

PN



5 SERIES (F10, F18)

3

520 Li 130-150 kW (177-204 PS)
N52 B25 AF

12.2010→12.2012



7.01318.20.0

SLV

PN



523 Li 130-160 kW (177-218 PS)
N52 B25 AF, N52 B25 BF

08.2010→09.2012



7.01318.20.0

SLV

PN



528 Li 190 kW (258 PS)
N52 B30 AF

08.2010→11.2011



7.01318.20.0

SLV

PN



530 Li 190 kW (258 PS)
N52 B30 AF

11.2011→05.2014



7.01318.20.0

SLV

PN



China
China

X1 (E84)

4

sDrive18 i 100-115 kW
(136-156 PS)
N46 B20 CC

03.2012→12.2014





































7.01318.24.0



SLV

PN

















							
F						1	B
F 800 GS (K72)		10.2006→06.2012	 7.01859.03.0	SLV	EL		
F 800 GS (K72)		10.2006→06.2012	 7.01859.03.0	SLV	EL		
F 800 GS (K72)		10.2006→06.2012	 7.01859.03.0	SLV	EL		
F 800 GS (K72)		01.2011→	 7.01859.03.0	SLV	EL		
F 800 GS (K72)		07.2011→	 7.01859.03.0	SLV	EL		
F 800 GS (K72)		07.2011→	 7.01859.03.0	SLV	EL		
F 800 GS (K72)		01.2016→	 7.01859.03.0	SLV	EL		
F 800 GS (K72)		01.2016→	 7.01859.03.0	SLV	EL		
F 800 GS (K72)		01.2016→	 7.01859.03.0	SLV	EL		
F 800 GS Adventure (K75)		05.2012→	 7.01859.03.0	SLV	EL		
F 800 GS Adventure (K75)		05.2012→	 7.01859.03.0	SLV	EL		
F 800 GS Adventure (K75)		05.2012→	 7.01859.03.0	SLV	EL		
F 800 GS Adventure (K75)		01.2016→	 7.01859.03.0	SLV	EL		
F 800 GS Adventure (K75)		01.2016→	 7.01859.03.0	SLV	EL		
F 800 GS Adventure (K75)		01.2016→	 7.01859.03.0	SLV	EL		
F 800 GS Triple Black (K72)		09.2011→06.2012	 7.01859.03.0	SLV	EL		
F 800 GS Trophy (K72)		09.2011→06.2012	 7.01859.03.0	SLV	EL		
F 800 GT (K71)		10.2011→	 7.01240.03.0	SLV	EL		
F 800 GT (K71)		10.2011→	 7.01240.03.0	SLV	EL		
F 800 GT (K71)		02.2013→	 7.01240.03.0	SLV	EL		
F 800 R (K73)		12.2005→	 7.01240.03.0	SLV	EL		
F 800 R (K73)		12.2005→12.2014	 7.01240.03.0	SLV	EL		
F 800 R (K73)		01.2015→	 7.01240.03.0	SLV	EL		
F 800 R (K73)		01.2015→	 7.01240.03.0	SLV	EL		
F 800 S (K71)		12.2004→05.2010	 7.01240.03.0	SLV	EL		
F 800 S (K71)		12.2004→05.2010	 7.01240.03.0	SLV	EL		
F 800 ST (K71)		10.2004→07.2012	 7.01240.03.0	SLV	EL		
F 800 ST (K71)		10.2004→07.2012	 7.01240.03.0	SLV	EL		
HP						2	
HP 4 (K42)		09.2011→	 7.00748.06.0	SLV	EL		

B
K
3

1200 GT (K44) 120-123 kW (160-167 PS) K1200 (4ZYL. REIHE)	11.2004→09.2008		7.00411.05.0	SLV	EL
1200 R (K43) 120-123 kW (160-167 PS) K1200 (4ZYL. REIHE)	03.2004→08.2008		7.00411.05.0	SLV	EL
1200 R Sport (K43) 120-123 kW (160-167 PS) K1200 (4ZYL. REIHE)	06.2005→07.2007		7.00411.05.0	SLV	EL
1200 S (K40) 120-123 kW (160-167 PS) K1200 (4ZYL. REIHE)	04.2003→08.2008		7.00411.05.0	SLV	EL
1600 GTL Exklusive (K48) 118 kW (160 PS) K1600 (6ZYL. REIHE)	01.2013→		7.01859.03.0	SLV	EL
K 1200 GT (K44)	11.2004→09.2008		7.00411.05.0	SLV	EL
K 1200 R (K43)	03.2004→08.2008		7.00411.05.0	SLV	EL
K 1200 R (K43)	03.2004→08.2008		7.00411.05.0	SLV	EL
K 1200 R (K43)	03.2004→08.2008		7.00411.05.0	SLV	EL
K 1200 R Sport (K43)	06.2005→07.2007		7.00411.05.0	SLV	EL
K 1200 S (K40)	04.2003→08.2008		7.00411.05.0	SLV	EL
K 1200 S (K40)	04.2003→08.2008		7.00411.05.0	SLV	EL
K 1200 S (K40)	04.2003→08.2008		7.00411.05.0	SLV	EL
K 1300 GT (K44)	12.2007→12.2011		7.00411.05.0	SLV	EL
K 1300 GT (K44)	12.2007→10.2010		7.00411.05.0	SLV	EL
K 1300 GT Exclusive Edition (K44)	12.2007→10.2010		7.00411.05.0	SLV	EL
K 1300 R (K43)	11.2007→		7.00411.05.0	SLV	EL
K 1300 R (K43)	11.2007→		7.00411.05.0	SLV	EL
K 1300 R Special Editon (K43)	11.2007→		7.00411.05.0	SLV	EL
K 1300 S „30 Jahre K-Modelle“ (K40)	10.2012→		7.00411.05.0	SLV	EL
K 1300 S (K40)	02.2009→		7.00411.05.0	SLV	EL
K 1300 S mit HP Paket (K40)	01.2012→		7.00411.05.0	SLV	EL
K 1600 Bagger	08.2017→		7.01859.03.0	SLV	EL
K 1600 GT (K48)	01.2010→		7.01859.03.0	SLV	EL
K 1600 GT (K48)	01.2010→		7.01859.03.0	SLV	EL
K 1600 GTL (K48)	01.2013→		7.01859.03.0	SLV	EL
K 1600 GTL (K48)	01.2013→		7.01859.03.0	SLV	EL



M						4	B
M 1000 RR	01.2021→		7.00748.06.0	SLV	EL		
S						5	
S 1000 R	09.2009→08.2011		7.00748.06.0	SLV	EL		
S 1000 R (2X10)	02.2017→		7.00748.06.0	SLV	EL		
S 1000 R (2X10r)	02.2017→		7.00748.06.0	SLV	EL		
S 1000 R (K47)	03.2013→02.2017		7.00748.06.0	SLV	EL		
S 1000 RR	09.2008→08.2011		7.00748.06.0	SLV	EL		
S 1000 RR	09.2009→08.2011		7.00748.06.0	SLV	EL		
S 1000 RR	01.2015→		7.00748.06.0	SLV	EL		
S 1000 RR (2R99)	10.2018→		7.00748.06.0	SLV	EL		
S 1000 RR (K46)	09.2008→08.2011		7.00748.06.0	SLV	EL		
S 1000 RR (K46)	10.2010→		7.00748.06.0	SLV	EL		
S 1000 XR	01.2014→		7.00748.06.0	SLV	EL		
S 1000 XR (2X10, 2X99)	02.2017→		7.00748.06.0	SLV	EL		
S 1000 XR (2X10r, 2X99R)	02.2017→		7.00748.06.0	SLV	EL		
S 1000 XR (K49) 146-154 kW (199-209 PS) S1000 (4ZYL. REIHE)	04.2015→		7.00748.06.0	SLV	EL		









B







RENDEZVOUZ

1

3.6 179-215 kW (243-292 PS) LY7	09.2004→09.2006	 7.05271.81.0	LS	210 mm	vor Katalysator in front of the catalyst
3.6 AWD 179-215 kW (243-292 PS) LY7	09.2005→12.2006	 7.05271.81.0	LS	210 mm	vor Katalysator in front of the catalyst







BLS						1
1.9 D 110 kW (150 PS) Z19DTH	04.2006→		7.08369.05.0	ATS	EL	 ch. 72350001→ ohne Zubehör without accessories  →ch. 72350000
			7.11190.04.0	DDS		
			7.11190.03.0	DDS		
1.9 D 132 kW (180 PS) Z 19 DTR	12.2007→		7.11190.04.0	DDS		 ch. 72350001→ ohne Zubehör without accessories  →ch. 72350000
			7.11190.03.0	DDS		
2.0 T 129 kW (175 PS) Z 20 NET	04.2006→12.2010		7.02604.11.0	LS	null mm	

BLS Wagon						2
1.9 D 110 kW (150 PS) Z19DTH	12.2007→		7.08369.05.0	ATS	EL	 ch. 72350001→ ohne Zubehör without accessories  →ch. 72350000
			7.11190.04.0	DDS		
			7.11190.03.0	DDS		
1.9 D 132 kW (180 PS) Z 19 DTR	12.2007→		7.11190.04.0	DDS		 ch. 72350001→ ohne Zubehör without accessories  →ch. 72350000
			7.11190.03.0	DDS		
2.0 T 129 kW (175 PS) Z 20 NET	12.2007→12.2010		7.02604.11.0	LS	null mm	

































































































ASPHALT PAVERS **1**





















































C

AP1000E 105-162 kW (140-220 PS) C 7.1		7.03761.09.0	AGR-M	EL	 ch. RTT00001→
AP1055E 105-162 kW (140-220 PS) C 7.1		7.03761.09.0	AGR-M	EL	 ch. FRR00001→

BACKHOE LOADER **2**





416F 54-56 kW (72-75 PS) C 4.4		7.03391.11.0	AGR-M	EL	 ch. KSF00001→
		7.03762.10.0	AGR-M	EL	 ch. KSF00001→
416F2 54-56 kW (72-75 PS) C 4.4		7.03391.11.0	AGR-M	EL	 ch. HWB00001→
		7.03762.10.0	AGR-M	EL	 ch. HWB00001→
420F 54-56 kW (72-75 PS) C 4.4		7.03391.11.0	AGR-M	EL	 C 4.4:  ch. JWJ00001→
		7.03762.10.0	AGR-M	EL	 C 4.4:  ch. SKR00001→
420F2 54-56 kW (72-75 PS) C 4.4		7.03391.11.0	AGR-M	EL	 Fahrgestellnummer ab: HWC00001, HWD00001 Vehicle Identification Number from: HWC00001, HWD00001
		7.03762.10.0	AGR-M	EL	
428F 54-56 kW (72-75 PS) C 4.4		7.03391.11.0	AGR-M	EL	 ch. RAK00001→
		7.03762.10.0	AGR-M	EL	 ch. RAK00001→
430F 54-56 kW (72-75 PS) C 4.4		7.03391.11.0	AGR-M	EL	 C 4.4:  ch. RGS00001→
		7.03762.10.0	AGR-M	EL	 C 4.4:  ch. RDF00001→
430F2 54-56 kW (72-75 PS) C 4.4		7.03391.11.0	AGR-M	EL	 Fahrgestellnummer ab: HWE00001, HWG00001 Vehicle Identification Number from: HWE00001, HWG00001
		7.03762.10.0	AGR-M	EL	
432F 54-56 kW (72-75 PS) C 4.4		7.03391.11.0	AGR-M	EL	
		7.03762.10.0	AGR-M	EL	
432F2 54-56 kW (72-75 PS) C 4.4		7.03391.11.0	AGR-M	EL	 ch. HWP00001→
		7.03762.10.0	AGR-M	EL	 ch. HWP00001→
434F 54-56 kW (72-75 PS) C 4.4		7.03391.11.0	AGR-M	EL	 ch. MTR00001→
		7.03762.10.0	AGR-M	EL	 ch. MTR00001→
434F2 54-56 kW (72-75 PS) C 4.4		7.03391.11.0	AGR-M	EL	 ch. HWR00001→
		7.03762.10.0	AGR-M	EL	 ch. HWR00001→
444F 54-56 kW (72-75 PS) C 4.4		7.03391.11.0	AGR-M	EL	 ch. JXR00001→
		7.03762.10.0	AGR-M	EL	 ch. JXR00001→

					
BACKHOE LOADER					
2					
444F2 54-56 kW (72-75 PS) C 4.4		7.03391.11.0	AGR-M	EL	 ch. HWS0001→
		7.03762.10.0	AGR-M	EL	 ch. HWS0001→
450F 54-56 kW (72-75 PS) C 4.4		7.03391.11.0	AGR-M	EL	 ch. HJR00001→
		7.03762.10.0	AGR-M	EL	 ch. HJR00001→
EXCAVATOR					
3					
320E 100-203 kW (136-276 PS) C 6.6		7.03761.09.0	AGR-M	EL	 ch. TNJ00001→
320E L 100-203 kW (136-276 PS) C 6.6		7.03761.09.0	AGR-M	EL	 ch. FH800001→
320E LN 100-203 kW (136-276 PS) C 6.6		7.03761.09.0	AGR-M	EL	 ch. DFG00001→
320E LRR 100-203 kW (136-276 PS) C 6.6		7.03761.09.0	AGR-M	EL	Fahrgestellnummer ab: PNL00001, TFX00001 Vehicle Identification Number from: PNL00001, TFX00001
320E RR 100-203 kW (136-276 PS) C 6.6		7.03761.09.0	AGR-M	EL	 ch. LHN00001→
323E L 100-203 kW (136-276 PS) C 6.6		7.03761.09.0	AGR-M	EL	 ch. RAP00001→
323E LN 100-203 kW (136-276 PS) C 6.6		7.03761.09.0	AGR-M	EL	 ch. RAP00001→
323E SA 100-203 kW (136-276 PS) C 6.6		7.03761.09.0	AGR-M	EL	 ch. RAP00001→
324E 105-162 kW (140-220 PS) C 7.1		7.03761.09.0	AGR-M	EL	 ch. JCZ00001→
324E L 105-162 kW (140-220 PS) C 7.1		7.03761.09.0	AGR-M	EL	 ch. PNW00001→
324E LN 105-162 kW (140-220 PS) C 7.1		7.03761.09.0	AGR-M	EL	 ch. LDG00001→
329E 105-162 kW (140-220 PS) C 7.1		7.03761.09.0	AGR-M	EL	 ch. PTY00001→
329E L 105-162 kW (140-220 PS) C 7.1		7.03761.09.0	AGR-M	EL	 C 7.1:  ch. PLW00001→  C 7.1:  ch. PTY00001→
329E LN 105-162 kW (140-220 PS) C 7.1		7.03761.09.0	AGR-M	EL	 ch. RLD00001→
FOREST MACHINES					
4					
2384C 100-203 kW (136-276 PS) C 6.6		7.03761.09.0	AGR-M	EL	 ch. KAW00001→
2484C 100-203 kW (136-276 PS) C 6.6		7.03761.09.0	AGR-M	EL	 ch. KAZ00001→
2670C 105-162 kW (140-220 PS) C 7.1		7.03761.09.0	AGR-M	EL	 ch. B3E00001→
559C 100-203 kW (136-276 PS) C 6.6		7.03761.09.0	AGR-M	EL	 ch. KAS00001→
573C 105-162 kW (140-220 PS) C 7.1		7.03761.09.0	AGR-M	EL	 ch. RJT00001→
579C 100-203 kW (136-276 PS) C 6.6		7.03761.09.0	AGR-M	EL	 ch. KAX00001→



			 PIERBURG				
MOTOR GRADER						5	
C	120M2 105-162 kW (140-220 PS) C 7.1		7.03761.09.0	AGR-M	EL 	Fahrgestellnummer ab: M9W0000, R9W0000 Vehicle Identification Number from: M9W0000, R9W0000 Allrad All-wheel Drive	
PAVING COMPACTOR						6	
	CB10 54-56 kW (72-75 PS) C 4.4		7.03391.11.0	AGR-M	EL 	C 4.4:  ch. P8P00001→ C 4.4:  ch. NPP00001→	
			7.03762.10.0	AGR-M	EL 		C 4.4:  ch. P8P00001→ C 4.4:  ch. NPP00001→
	CB44B 54-56 kW (72-75 PS) C 4.4		7.03391.11.0	AGR-M	EL 	 ch. JXL00001→	
			7.03762.10.0	AGR-M	EL 		 ch. JXL00001→
	CB54B 54-56 kW (72-75 PS) C 4.4		7.03391.11.0	AGR-M	EL 	 ch. JXL00001→	
			7.03762.10.0	AGR-M	EL 		 ch. JXL00001→
TELEHANDLADER						7	
	TH336C 54-56 kW (72-75 PS) C 4.4		7.03391.11.0	AGR-M	EL 	 ch. MJR00271→	
			7.03762.10.0	AGR-M	EL 		 ch. MJR00271→
	TL1055C 54-56 kW (72-75 PS) C 4.4		7.03391.11.0	AGR-M	EL 	 ch. KDE01628→	
			7.03762.10.0	AGR-M	EL 		 ch. KDE01628→
	TL1255C 54-56 kW (72-75 PS) C 4.4		7.03391.11.0	AGR-M	EL 	 ch. DHW01422→	
			7.03762.10.0	AGR-M	EL 		 ch. DHW01422→
TRACK-TYPE TRACTOR						8	
	D5K2 LGP 54-56 kW (72-75 PS) C 4.4		7.03391.11.0	AGR-M	EL 	Fahrgestellnummer ab: KW200001, KWW00001 Vehicle Identification Number from: KW200001, KWW00001	
			7.03762.10.0	AGR-M	EL 		
	D5K2 XL 54-56 kW (72-75 PS) C 4.4		7.03391.11.0	AGR-M	EL 	Fahrgestellnummer ab: KW200001, KWW00001 Vehicle Identification Number from: KW200001, KWW00001	
			7.03762.10.0	AGR-M	EL 		
WHEEL-TYPE-LOADER						9	
	924K 100-203 kW (136-276 PS) C 6.6		7.03761.09.0	AGR-M	EL 	 ch. PWR00001→	
			7.03761.09.0	AGR-M	EL 		 ch. RHN00001→
			7.03761.09.0	AGR-M	EL 		 ch. SWL00001→























































WHEEL-TYPE-LOADER **9**

950K 105-162 kW (140-220 PS) C 7.1		7.03761.09.0	AGR-M	EL  Fahrgestellnummer ab: J5M00001, R4A00001 Vehicle Identification Number from: J5M00001, R4A00001
962K 105-162 kW (140-220 PS) C 7.1		7.03761.09.0	AGR-M	EL  Fahrgestellnummer ab: T6A00001, X4T00001 Vehicle Identification Number from: T6A00001, X4T00001

ENGINE **10**

ENGINE 105-162 kW (140-220 PS) C 7.1		7.03390.09.0	AGR-M	EL 
--	---	---------------------	-------	--

















			 PIERBURG			
ASTRA Estate						1
1.8 90-92 kW (122-125 PS) 2H9	08.2002→06.2005		7.24809.10.0	AGR	EL 	
ASTRA Hatchback						2
1.7 Di 55 kW (75 PS) Y 17 DT	08.2000→08.2003		7.22772.12.0	AGR	PN 	
1.8 90-92 kW (122-125 PS) 2H9	08.2002→06.2005		7.24809.10.0	AGR	EL 	
1.8 102-106 kW (139-144 PS) 2H0	01.2006→12.2013		7.04879.00.0	AGR-TH	 Öffnungstemperatur/opening temperature 105C	
1.8 102-106 kW (139-144 PS) 2H0	08.2006→03.2009		7.04879.00.0	AGR-TH	 Öffnungstemperatur/opening temperature 105C	
ASTRA Saloon						3
1.8 90-92 kW (122-125 PS) 2H9	08.2002→06.2005		7.24809.10.0	AGR	EL 	
1.8 103 kW (140 PS) Z 18 XER	08.2006→03.2009		7.04879.00.0	AGR-TH	 Öffnungstemperatur/opening temperature 105C	
1.8 102-106 kW (139-144 PS) 2H0	09.2007→12.2008		7.04879.00.0	AGR-TH	 Öffnungstemperatur/opening temperature 105C	
AVEO / KALOS Hatchback (T250, T255)						4
1.2 53-65 kW (72-88 PS) LMU	04.2008→		7.05271.73.0	LS	528 mm	
1.4 74 kW (101 PS) LDT	04.2008→		7.04879.00.0	AGR-TH	 Öffnungstemperatur/opening temperature 105C →12.2011	
			7.05271.73.0	LS	528 mm	
1.4 16V 69-70 kW (94-95 PS) L14(85CUL4)	06.2006→05.2008		7.09002.04.0	AGR	ET 	
AVEO / KALOS Saloon (T200)						5
1.4 69-70 kW (94-95 PS) L14(85CUL4)	05.2003→05.2008		7.09002.04.0	AGR	ET 	
AVEO / KALOS Saloon (T250, T255)						6
1.2 53-56 kW (72-76 PS) LY4	03.2005→12.2007		7.05271.73.0	LS	528 mm	
1.2 53-65 kW (72-88 PS) LMU	01.2008→		7.05271.73.0	LS	528 mm	
1.4 69-70 kW (93-95 PS) L14(85CUL4), L95	03.2005→05.2013		7.09002.04.0	AGR	ET 	
			7.05271.73.0	LS	528 mm	
1.4 74 kW (101 PS) LDT	09.2008→		7.04879.00.0	AGR-TH	 Öffnungstemperatur/opening temperature 105C →12.2011	
1.4 CNG 69 kW (93 PS) L95	01.2008→		7.09002.04.0	AGR	ET 	
AVEO Hatchback (T300)						7
1.3 D 55-57 kW (75-78 PS) LDV	07.2011→12.2015		7.03622.10.0	AGR-K	EL 	
			7.03622.06.0	AGR-K		
			7.08369.46.0	ATS	EL	
			7.11190.04.0	DDS		
1.3 D 70 kW (95 PS) LSF	07.2011→12.2015		7.03622.10.0	AGR-K	EL 	

					
AVEO Hatchback (T300)					7
			7.03622.06.0	AGR-K	
			7.11190.04.0	DDS	
1.6 83-91 kW (113-124 PS) LDE	03.2011→		7.04879.00.0	AGR-TH	
			7.02604.07.0	LS	570 mm für OE-Nummer: 55562205 for OE number: 55562205 vor Katalysator in front of the catalyst
1.6 83-91 kW (113-124 PS) LDE	06.2011→		7.04879.00.0	AGR-TH	
					Öffnungstemperatur/opening temperature 105C →12.2016
1.8 101-106 kW (136-144 PS) LUW, LWE	09.2011→07.2015		7.02604.07.0	LS	570 mm  LUW, LWE: für OE-Nummer: 55572215 for OE number: 55572215
1.8 101-106 kW (136-144 PS) LUW, LWE	07.2015→		7.02604.07.0	LS	570 mm  LUW, LWE: für OE-Nummer: 55572215 for OE number: 55572215
1.8 Flexfuel 101-106 kW (136-144 PS) LUW	09.2013→07.2015		7.02604.07.0	LS	570 mm für OE-Nummer: 55572215 for OE number: 55572215
1.8 Flexfuel 101-106 kW (136-144 PS) LUW	07.2015→		7.02604.07.0	LS	570 mm für OE-Nummer: 55572215 for OE number: 55572215
AVEO Saloon (T300)					8
1.3 D 55-57 kW (75-78 PS) LDV	07.2011→12.2015		7.03622.10.0	AGR-K	EL 
			7.03622.06.0	AGR-K	
			7.08369.46.0	ATS	EL
			7.11190.04.0	DDS	
1.3 D 70 kW (95 PS) LSF	07.2011→12.2015		7.03622.10.0	AGR-K	EL 
			7.03622.06.0	AGR-K	
			7.11190.04.0	DDS	
1.6 83-91 kW (113-124 PS) LDE	03.2011→		7.04879.00.0	AGR-TH	
			7.02604.07.0	LS	570 mm Öffnungstemperatur/opening temperature 105C →12.2016 für OE-Nummer: 55562205 for OE number: 55562205 vor Katalysator in front of the catalyst
1.8 101-106 kW (136-144 PS) LUW, LWE	09.2011→07.2015		7.02604.07.0	LS	570 mm  LUW, LWE: für OE-Nummer: 55572215 for OE number: 55572215
1.8 101-103 kW (136-140 PS) LWE	07.2015→		7.02604.07.0	LS	570 mm für OE-Nummer: 55572215 for OE number: 55572215
1.8 Flexfuel 101-106 kW (136-144 PS) LUW, LWE	09.2013→07.2015		7.02604.07.0	LS	570 mm  LUW: für OE-Nummer: 55572215 for OE number: 55572215 vor Katalysator in front of the catalyst  LWE: für OE-Nummer: 55572215 for OE number: 55572215
1.8 Flexfuel 101-106 kW (136-144 PS) LUW	07.2015→		7.02604.07.0	LS	570 mm →12.2018 für OE-Nummer: 55572215 for OE number: 55572215 vor Katalysator in front of the catalyst





CAPTIVA (C100, C140) **9**



C

2.0 D 92-110 kW (125-150 PS) LLW	10.2006→12.2009		7.08369.54.0	ATS	EL	
			7.08369.70.0	ATS	EL	
2.0 D 92-110 kW (125-150 PS) LLW	09.2007→		7.08369.54.0	ATS	EL	
			7.08369.70.0	ATS	EL	
2.0 D 96-122 kW (131-166 PS) LNP	01.2011→		7.11020.49.0	ATS	EL	2012 2012
2.0 D 4WD 92-110 kW (125-150 PS) LLW	10.2006→12.2009		7.08369.54.0	ATS	EL	
			7.08369.70.0	ATS	EL	
2.0 D 4WD 92-110 kW (125-150 PS) LLW	10.2006→		7.08369.54.0	ATS	EL	
			7.08369.70.0	ATS	EL	
2.0 D 4WD 96-122 kW (131-166 PS) LNP	01.2011→		7.11020.49.0	ATS	EL	2012 2012
2.2 D 120-138 kW (163-188 PS) LNQ	03.2011→		7.11020.49.0	ATS	EL	
2.2 D 120-138 kW (163-188 PS) LNQ	07.2014→		7.11020.49.0	ATS	EL	
2.2 D 120-138 kW (163-188 PS) LNQ	10.2015→03.2016		7.11020.49.0	ATS	EL	
2.2 D 4WD 120-138 kW (163-188 PS) LNQ	03.2011→		7.11020.49.0	ATS	EL	
2.2 D 4WD 120-138 kW (163-188 PS) LNQ	03.2011→		7.11020.49.0	ATS	EL	
2.2 D 4WD 120-138 kW (163-188 PS) LNQ	01.2013→03.2016		7.11020.49.0	ATS	EL	
2.4 LPG 100-105 kW (136-143 PS) LD9(147CUL4)	01.2007→		7.09002.13.0	AGR	ET	
2.4 LPG 4WD 100-105 kW (136-143 PS) LD9(147CUL4)	01.2007→02.2011		7.09002.13.0	AGR	ET	
3.2 4WD 167-169 kW (227-230 PS) LU1	06.2006→		7.05271.81.0	LS	210 mm	für OE-Nummer: 12 571 768 for OE number: 12 571 768 nach Katalysator Post-catalyst

CHEVY **10**

































1.4 66 kW (90 PS) Z 14 XE	06.1995→07.2006		7.24809.10.0	AGR	EL	 →ch. 43999999
------------------------------	-----------------	---	---------------------	-----	----	---

COLORADO Crew Cab Pickup **11**

2.8 D 135-149 kW (184-203 PS) LWN	09.2015→		7.05012.01.0	AGR	EL	
2.8 D 4WD 135-149 kW (184-203 PS) LWN	09.2015→		7.05012.01.0	AGR	EL	

COLORADO Extended Cab Pickup **12**

2.8 D 135-149 kW (184-203 PS) LWN	09.2015→		7.05012.01.0	AGR	EL	
2.8 D 4WD 135-149 kW (184-203 PS) LWN	09.2015→		7.05012.01.0	AGR	EL	

					
COLORADO Standard Cab Pickup					13
2.8 D 135-149 kW (184-203 PS) LWN	01.2017→		7.05012.01.0	AGR	EL
CORSA Pickup					14
1.6 62-67 kW (84-91 PS) Z 16 SE	08.2001→12.2011		7.24809.10.0	AGR	EL  →ch. 46999999
1.7 DTi 55 kW (75 PS) Y 17 DT	08.2001→12.2011		7.22772.12.0	AGR	PN 
CRUZE (J300)					15
1.6 83-91 kW (113-124 PS) LDE	05.2009→		7.04879.00.0	AGR-TH	 Öffnungstemperatur/opening temperature 105C →12.2017
			7.02604.07.0	LS	570 mm vor Katalysator in front of the catalyst 2014 2014
1.6 74-81 kW (102-110 PS) LXT	05.2009→		7.09002.04.0	AGR	ET 
1.6 83-91 kW (113-124 PS) LDE	05.2009→		7.04879.00.0	AGR-TH	 Öffnungstemperatur/opening temperature 105C →12.2017
			7.02604.07.0	LS	570 mm vor Katalysator in front of the catalyst 2014 2014
1.6 83-91 kW (113-124 PS) LDE	12.2012→		7.02604.07.0	LS	570 mm vor Katalysator in front of the catalyst 2014 2014
1.7 D 96 kW (131 PS) LUD	01.2012→		7.11020.38.0	ATS	EL  Europa
1.8 101-106 kW (136-144 PS) LUW, LWE	05.2009→		7.02604.07.0	LS	570 mm  LUW, LWE: für OE-Nummer: 55572215 for OE number: 55572215
1.8 102-106 kW (139-144 PS) 2H0	05.2009→		7.04879.00.0	AGR-TH	 Öffnungstemperatur/opening temperature 105C →12.2017
1.8 101-106 kW (136-144 PS) LUW, LWE	11.2009→		7.02604.07.0	LS	570 mm  LUW, LWE: für OE-Nummer: 55572215 for OE number: 55572215
1.8 Flex 101-106 kW (136-144 PS) LUW	09.2013→		7.02604.07.0	LS	570 mm für OE-Nummer: 55572215 for OE number: 55572215
1.8 Flex 101-106 kW (136-144 PS) LUW	08.2015→		7.02604.07.0	LS	570 mm für OE-Nummer: 55572215 for OE number: 55572215
1.8 LPG 102-106 kW (139-144 PS) 2H0	06.2011→		7.04879.00.0	AGR-TH	 Öffnungstemperatur/opening temperature 105C →12.2017
2.0 CDI 96-122 kW (131-166 PS) LNP	08.2010→		7.11020.49.0	ATS	EL  LNP: Euro 5 Euro 5 2011 2011  LNP: 2012 2012

C











CRUZE Hatchback (J305) **16**

C

1.6 83-91 kW (113-124 PS) LDE	06.2011→		7.04879.00.0 7.02604.07.0	AGR-TH LS		570 mm	 Öffnungstemperatur/opening temperature 105C →12.2017 vor Katalysator in front of the catalyst 2013 2013
1.6 74-81 kW (102-110 PS) LXT	01.2012→		7.09002.04.0	AGR	ET		
1.6 83-91 kW (113-124 PS) LDE	12.2012→		7.04879.00.0 7.02604.07.0	AGR-TH LS		570 mm	 Öffnungstemperatur/opening temperature 105C →12.2017 vor Katalysator in front of the catalyst
1.6 83-91 kW (113-124 PS) LDE	12.2012→		7.04879.00.0 7.02604.07.0	AGR-TH LS		570 mm	 Öffnungstemperatur/opening temperature 105C →12.2017 vor Katalysator in front of the catalyst
1.7 D 96 kW (131 PS) LUD	01.2012→12.2015		7.11020.38.0 7.11190.04.0	ATS DDS	EL		 Europa Europe
1.7 TD 81 kW (110 PS) LKR	08.2013→12.2015		7.11190.04.0	DDS			
1.8 102-106 kW (139-144 PS) 2H0	06.2011→		7.04879.00.0	AGR-TH			 Öffnungstemperatur/opening temperature 105C →12.2017
1.8 102-106 kW (139-144 PS) 2H0	10.2011→		7.04879.00.0	AGR-TH			 Öffnungstemperatur/opening temperature 105C →12.2017
1.8 LPG 102-106 kW (139-144 PS) 2H0	06.2011→12.2015		7.04879.00.0	AGR-TH			 Öffnungstemperatur/opening temperature 105C
2.0 CDI 96-122 kW (131-166 PS) LNP	06.2011→		7.11020.49.0	ATS	EL		

























CRUZE Station Wagon (J308) **17**

1.6 83-91 kW (113-124 PS) LDE	08.2012→12.2015		7.04879.00.0 7.02604.07.0	AGR-TH LS		570 mm	 Öffnungstemperatur/opening temperature 105C vor Katalysator in front of the catalyst 2014 2014
1.6 83-91 kW (113-124 PS) LDE	12.2012→12.2015		7.04879.00.0 7.02604.07.0	AGR-TH LS		570 mm	 Öffnungstemperatur/opening temperature 105C vor Katalysator in front of the catalyst 2014 2014
1.7 TD 96 kW (131 PS) LUD	08.2012→		7.11020.38.0 7.11190.04.0	ATS DDS	EL		 Europa Europe
1.7 TD 81 kW (110 PS) LKR	11.2013→12.2015		7.11190.04.0	DDS			





















						
CRUZE Station Wagon (J308)						17
1.8 102-106 kW (139-144 PS) 2H0	08.2012→		7.04879.00.0	AGR-TH		Öffnungstemperatur/opening temperature 105C →12.2016
2.0 TD 96-122 kW (131-166 PS) LNP	08.2012→		7.11020.49.0	ATS	EL	Euro 5, Euro 4 Euro 5, Euro 4
EPICA (KL1_)						18
2.0 89-98 kW (121-133 PS) L88	01.2005→12.2006		7.09002.01.0	AGR	PN	
2.0 89-98 kW (121-133 PS) L88	01.2005→12.2006		7.09002.01.0	AGR	PN	
EPICA Saloon						19
2.5 115 kW (156 PS) LF4(152CUL6)	09.2003→12.2006		7.09002.04.0	AGR	ET	
			7.09002.13.0	AGR	ET	
EVANDA						20
2.0 89-98 kW (121-133 PS) L88	03.2005→12.2006		7.09002.13.0	AGR	ET	
LACETTI (J200)						21
1.4 16V 69-70 kW (94-95 PS) L14(85CUL4)	03.2005→03.2013		7.09002.04.0	AGR	ET	
			7.05271.73.0	LS	528 mm	
1.6 66-81 kW (90-110 PS) L44(96CUL4), LXT	03.2005→		7.09002.01.0	AGR	PN	
			7.09002.04.0	AGR	ET	
			7.05271.73.0	LS	528 mm	
1.8 66-90 kW (90-122 PS) LDA	03.2005→		7.09002.01.0	AGR	PN	
			7.09002.04.0	AGR	ET	
1.8 66-90 kW (90-122 PS) LDA	08.2005→12.2011		7.09002.04.0	AGR	ET	
LACETTI Estate (J200)						22
1.6 66-81 kW (90-110 PS) L44(96CUL4), LXT	03.2005→		7.09002.01.0	AGR	PN	
			7.09002.04.0	AGR	ET	
1.6 LPG 74-81 kW (102-110 PS) LXT	06.2009→12.2011		7.09002.01.0	AGR	PN	
			7.09002.04.0	AGR	ET	
1.8 66-90 kW (90-122 PS) LDA	08.2005→03.2013		7.09002.01.0	AGR	PN	
			7.09002.04.0	AGR	ET	
1.8 66-90 kW (90-122 PS) LDA	08.2005→		7.09002.01.0	AGR	PN	
			7.09002.04.0	AGR	ET	
LACETTI Saloon (J200)						23
1.4 69-70 kW (94-95 PS) L14(85CUL4)	03.2005→03.2013		7.09002.04.0	AGR	ET	
1.6 66-81 kW (90-110 PS) L44(96CUL4), LXT	03.2005→03.2013		7.09002.01.0	AGR	PN	
			7.09002.04.0	AGR	ET	
1.8 66-90 kW (90-122 PS) LDA	08.2005→03.2013		7.09002.01.0	AGR	PN	
			7.09002.04.0	AGR	ET	



































C

			 PIERBURG			
LANOS Saloon						24
C	1.5 62-64 kW (84-87 PS) LX6	11.2005→12.2018	 7.09002.02.0	AGR	PN	<input checked="" type="checkbox"/>
	1.5 62-64 kW (84-87 PS) LX6	11.2005→12.2010	 7.09002.02.0	AGR	PN	<input checked="" type="checkbox"/>
MALIBU (V300)						25
	2.0 D 115-118 kW (160 PS) LBS	04.2012→	 7.24809.78.0 7.11190.04.0 7.02604.44.0	AGR DDS LS	ET 500 mm	<input type="checkbox"/> vor Katalysator in front of the catalyst
MATIZ (M200, M250)						26
	0.8 37-38 kW (50-52 PS) LBF(49CUL3), LQ2(49CUL3)	03.2005→12.2013	 7.09002.10.0 7.05271.73.0	AGR LS	ET 528 mm	<input type="checkbox"/>
	0.8 LPG 37-38 kW (50-52 PS) LBF(49CUL3), LQ2(49CUL3)	03.2005→12.2007	 7.09002.10.0 7.05271.73.0	AGR LS	ET 528 mm	<input type="checkbox"/>
	1.0 47-49 kW (64-67 PS) LQ4(61CUL4)	03.2005→12.2007	 7.09002.10.0 7.05271.73.0	AGR LS	ET 528 mm	<input type="checkbox"/>
	1.0 47-49 kW (64-67 PS) LQ4(61CUL4)	03.2005→	 7.09002.10.0 7.05271.73.0	AGR LS	ET 528 mm	<input type="checkbox"/>
	1.0 LPG 44-49 kW (60-67 PS) LA2, LQ4(61CUL4)	03.2005→03.2011	 7.09002.10.0 7.05271.73.0	AGR LS	ET 528 mm	<input type="checkbox"/>
MERIVA						27
	1.8 90-92 kW (122-125 PS) 2H9	05.2003→05.2008	 7.24809.10.0	AGR	EL	<input type="checkbox"/>
NUBIRA Estate						28
	1.6 66-81 kW (90-110 PS) L44(96CUL4), LXT	03.2005→12.2011	 7.09002.04.0 7.05271.73.0	AGR LS	ET 528 mm	<input type="checkbox"/>
	1.6 LPG 66-81 kW (90-110 PS) L44(96CUL4), LXT	03.2005→12.2010	 7.09002.04.0	AGR	ET	<input type="checkbox"/>
	1.8 66-90 kW (90-122 PS) LDA	03.2005→12.2009	 7.09002.04.0	AGR	ET	<input type="checkbox"/>
	1.8 66-90 kW (90-122 PS) LDA	08.2005→12.2011	 7.09002.04.0	AGR	ET	<input type="checkbox"/>
NUBIRA Saloon						29
	1.4 69-70 kW (94-95 PS) L14(85CUL4)	01.2005→12.2007	 7.09002.04.0	AGR	ET	<input type="checkbox"/>
	1.4 69-70 kW (94-95 PS) L14(85CUL4)	01.2006→12.2008	 7.09002.04.0	AGR	ET	<input type="checkbox"/>
	1.6 66-81 kW (90-110 PS) L44(96CUL4), LXT	03.2005→12.2011	 7.09002.04.0 7.05271.73.0	AGR LS	ET 528 mm	<input type="checkbox"/>
	1.6 74-81 kW (102-110 PS) LXT	12.2008→12.2011	 7.09002.04.0	AGR	ET	<input type="checkbox"/>

						
NUBIRA Saloon						29
1.8 66-90 kW (90-122 PS) LDA	03.2005→12.2009		7.09002.04.0	AGR	ET <input type="radio"/>	
1.8 66-90 kW (90-122 PS) LDA	01.2006→09.2007		7.09002.04.0	AGR	ET <input type="radio"/>	
OPTRA (1J_)						30
1.6 66-81 kW (90-110 PS) L44(96CUL4), LXT	08.2003→12.2008		7.09002.01.0	AGR	PN <input type="radio"/>	
			7.09002.04.0	AGR	ET <input type="radio"/>	
1.6 CNG 74-80 kW (101-109 PS) F16D3	03.2005→12.2010		7.09002.01.0	AGR	PN <input type="radio"/>	
			7.09002.04.0	AGR	ET <input type="radio"/>	
1.8 66-90 kW (90-122 PS) LDA	08.2003→12.2009		7.09002.01.0	AGR	PN <input type="radio"/>	
			7.09002.04.0	AGR	ET <input type="radio"/>	
1.8 66-90 kW (90-122 PS) LDA	08.2003→12.2008		7.09002.01.0	AGR	PN <input type="radio"/>	
			7.09002.04.0	AGR	ET <input type="radio"/>	
OPTRA Estate						31
1.6 66-81 kW (90-110 PS) L44(96CUL4), LXT	06.2006→12.2008		7.09002.04.0	AGR	ET <input type="radio"/>	
OPTRA Hatchback						32
1.6 74-81 kW (102-110 PS) LXT	08.2003→11.2012		7.09002.01.0	AGR	PN <input type="radio"/>	
			7.09002.04.0	AGR	ET <input type="radio"/>	
1.6 SRV 74-80 kW (101-109 PS) F16D3	06.2006→		7.09002.04.0	AGR	ET <input type="radio"/>	
1.8 SRV 66-90 kW (90-122 PS) LDA	08.2003→12.2008		7.09002.04.0	AGR	ET <input type="radio"/>	
ORLANDO (J309)						33
1.8 102-106 kW (139-144 PS) 2H0	02.2011→		7.04879.00.0	AGR-TH	<input type="radio"/> Öffnungstemperatur/opening temperature 105C →12.2017	
1.8 LPG 102-106 kW (139-144 PS) 2H0	06.2011→12.2015		7.04879.00.0	AGR-TH	<input type="radio"/> Öffnungstemperatur/opening temperature 105C	
2.0 D 96-122 kW (131-166 PS) LNP	02.2011→12.2015		7.11020.49.0	ATS	EL Euro 5 Euro 5	
2.0 D 96-122 kW (131-166 PS) LNP	02.2011→		7.11020.49.0	ATS	EL Euro 5 Euro 5	
REZZO MPV (U100)						34
1.6 66-81 kW (90-110 PS) L44(96CUL4)	03.2005→		7.09002.04.0	AGR	ET <input type="radio"/>	
1.6 66-81 kW (90-110 PS) L44(96CUL4)	03.2005→03.2009		7.09002.04.0	AGR	ET <input type="radio"/>	
1.6 66-81 kW (90-110 PS) L44(96CUL4)	08.2005→		7.09002.04.0	AGR	ET <input type="radio"/>	
S10 Pickup						35
2.8 D 135-149 kW (184-203 PS) LWN	09.2013→		7.05012.01.0	AGR	EL	
2.8 D 4x4 135-149 kW (184-203 PS) LWN	09.2013→		7.05012.01.0	AGR	EL	

C

			 PIERBURG					
SPARK						36		
C	0.8 37-38 kW (50-52 PS) LBF(49CUL3), LQ2(49CUL3)	05.2005→02.2010	 7.09002.10.0	AGR	ET			
			7.05271.73.0	LS	528 mm			
	1.0 SX 44-49 kW (60-67 PS) B10S, LA2	05.2005→	 7.09002.10.0	AGR	ET			
			7.05271.73.0	LS	528 mm			
SPARK (M300)						37		
	1.0 48-50 kW (65-68 PS) LMT	03.2010→	 7.09002.10.0	AGR	ET	<input type="checkbox"/>		
	1.0 48-50 kW (65-68 PS) B10D1	07.2010→	 7.09002.10.0	AGR	ET	<input type="checkbox"/>		
	1.0 LPG 48-50 kW (65-68 PS) LMT	03.2010→	 7.09002.10.0	AGR	ET	<input type="checkbox"/>		
	1.0 LPG 48-50 kW (65-68 PS) LMT	07.2010→	 7.09002.10.0	AGR	ET	<input type="checkbox"/>		
TRAILBLAZER (31UX)						38		
	2.8 CRDI 128-144 kW (180-196 PS) LWH	08.2012→	 7.01317.10.0	AGR	PN	<input type="checkbox"/>		
	2.8 CRDI 4WD 128-144 kW (180-196 PS) LWH	08.2012→	 7.01317.10.0	AGR	PN	<input type="checkbox"/>		
	2.8 CRDI 4WD 135-149 kW (184-203 PS) LWN	07.2014→	 7.05012.01.0	AGR	EL			
TRAX						39		
	1.6 83-91 kW (113-124 PS) LDE	12.2012→	 7.04879.00.0	AGR-TH		<input type="checkbox"/> Öffnungstemperatur/opening temperature 105C →12.2015 vor Katalysator in front of the catalyst 2015 2015		
							7.02604.07.0	LS
	1.6 D 100 kW (136 PS) LVL	11.2014→12.2015	 7.24809.81.0	AGR	EL	<input type="checkbox"/>		
					7.11020.27.0		ATS	EL
					7.11020.42.0		ATS	EL
	1.6 D AWD 100 kW (136 PS) LVL	11.2014→12.2015	 7.24809.81.0	AGR	EL	<input type="checkbox"/>		
					7.11020.27.0		ATS	EL
					7.11020.42.0		ATS	EL
	1.7 TD 96 kW (131 PS) LUD	12.2012→	 7.11020.38.0	ATS	EL	<input type="checkbox"/> Europa Europe		
					7.11190.04.0		DDS	
	1.7 TD AWD 96 kW (131 PS) LUD	12.2012→	 7.11020.38.0	ATS	EL	<input type="checkbox"/> Europa Europe 2013 2013 2015 2015		
					7.11190.04.0		DDS	
					7.04879.00.0		AGR-TH	
	1.8 102-106 kW (139-144 PS) 2H0	03.2013→	 7.04879.00.0	AGR-TH		<input type="checkbox"/> Öffnungstemperatur/opening temperature 105C vor Katalysator in front of the catalyst 2020 2020		
					7.02604.07.0		LS	570 mm

						
TRAX						39
1.8 AWD 102-106 kW (139-144 PS) 2H0	03.2013→		7.04879.00.0	AGR-TH		Öffnungstemperatur/opening temperature 105C vor Katalysator in front of the catalyst 2020 2020
			7.02604.07.0	LS	570 mm	
VIVA						40
1.8 90-92 kW (122-125 PS) 2H9	09.2003→03.2008		7.24809.10.0	AGR	EL 	
1.8 90-92 kW (122-125 PS) 2H9	09.2003→03.2008		7.24809.10.0	AGR	EL 	
VIVANT						41
1.6 66-81 kW (90-110 PS) L44(96CUL4)	08.2001→		7.09002.01.0	AGR	PN 	
1.6 66-81 kW (90-110 PS) L44(96CUL4)	01.2005→03.2009		7.09002.01.0	AGR	PN 	
			7.09002.04.0	AGR	ET 	
2.0 89-98 kW (121-133 PS) X 20 SED	08.2000→12.2004		7.09002.01.0	AGR	PN 	Euro 2 Euro 2
ZAFIRA (F75)						42
1.8 90-92 kW (122-125 PS) 2H9	07.2000→06.2005		7.24809.10.0	AGR	EL 	
COMBO						43
1.4 66 kW (90 PS) Z 14 XEP	10.2006→10.2012		7.22875.16.0	AGR	EL 	
			7.22875.13.0	AGR	EL 	 →ch. 4399999
1.6 62-67 kW (84-91 PS) Z 16 SE	04.2001→09.2006		7.24809.10.0	AGR	EL 	 →ch. 46999999
1.7 D 44-48 kW (60-65 PS) Y 17 DTL	04.2001→09.2006		7.22772.11.0	AGR	PN	mit Potentiometer with potentiometer
			7.22772.12.0	AGR	PN 	 ch. 00782974→
					PN 	 →ch. 00782973
S10 Platform/Chassis						44
2.8 TD 135-149 kW (184-203 PS) LWN	04.2016→		7.05012.01.0	AGR	EL	
2.8 TD 4WD 135-149 kW (184-203 PS) LWN	04.2016→		7.05012.01.0	AGR	EL	

C



AVEO Hatchback (SET)

1

C

1.4 69 kW (93 PS)
L95



















07.2005→05.2010



































7.09002.04.0

AGR

ET 

						
200 Convertible						1
2.4 125-130 kW (170-177 PS) EDG	01.2011→12.2014		7.28247.13.0	SLP	EL	Getriebetyp: DFF, DG2 Transmission Type: DFF, DG2
200 Saloon						2
2.4 125-130 kW (170-177 PS) EDG	01.2011→12.2013		7.28247.13.0	SLP	EL	Getriebetyp: DFF, DG2 Transmission Type: DFF, DG2
2.4 125-130 kW (170-177 PS) EDG	07.2014→		7.28247.13.0	SLP	EL	Getriebetyp: DFF, DG2 Transmission Type: DFF, DG2 für OE-Nummer: 04891832AB for OE number: 04891832AB
300C						3
3.0 CRD 176 kW (239 PS) EXF	09.2011→		7.24809.80.0	AGR	ET	<input checked="" type="checkbox"/>
6.4 347-401 kW (472-545 PS) ESG	09.2011→		7.11190.04.0	DDS		
6.4 SRT8 347-401 kW (472-545 PS) ESG	09.2011→		7.11190.04.0	DDS		
300C (LX, LE)						4
3.0 CRD 132-160 kW (180-218 PS) EXL	09.2005→11.2012		7.24809.47.0	AGR	ET	<input type="checkbox"/>
			7.11190.01.0	DDS		<input checked="" type="checkbox"/> EXL: 2006 2006 <input checked="" type="checkbox"/> EXL: Ausstattungsvariante: C, Z, F Equipment Variant: C, Z, F 2009 2009 2010 2010
			7.11190.01.0	DDS		<input checked="" type="checkbox"/> EXL: 2006 2006 <input checked="" type="checkbox"/> EXL: Ausstattungsvariante: C, Z, F Equipment Variant: C, Z, F 2009 2009 2010 2010
3.0 V6 CRD 132-160 kW (180-218 PS) EXL	11.2010→11.2012		7.24809.47.0	AGR	ET	<input type="checkbox"/>
300C Touring (LX, LE)						5
3.0 CRD 132-160 kW (180-218 PS) EXL	09.2005→12.2010		7.24809.47.0	AGR	ET	<input type="checkbox"/>
			7.11190.01.0	DDS		Ausstattungsvariante: C, Z Equipment Variant: C, Z 2006, 2009, 2010 2006, 2009, 2010
			7.11190.01.0	DDS		Ausstattungsvariante: C, Z Equipment Variant: C, Z 2006, 2009, 2010 2006, 2009, 2010
ASPEN (HG)						6
4.7 167-231 kW (227-314 PS) EVE	09.2007→12.2009		7.02769.05.0	AGR	EL	<input type="checkbox"/> mit Befestigungsmaterial with fastening material
4.7 AWD 167-231 kW (227-314 PS) EVE	01.2008→12.2009		7.02769.05.0	AGR	EL	<input type="checkbox"/> mit Befestigungsmaterial with fastening material
CROSSFIRE						7
3.2 160 kW (218 PS) EGX	07.2003→12.2008		7.04389.00.0	SLP	EL	

			 PIERBURG			
CROSSFIRE Roadster						8
3.2 160 kW (218 PS) EGX	05.2004→12.2008		7.04389.00.0	SLP	EL	
DELTA						9
1.6 D Multijet 88 kW (120 PS) 198 A2.000	08.2011→		7.24809.77.0	AGR	ET <input checked="" type="checkbox"/>	
2.0 D Multijet 121 kW (165 PS) 198 A5.000	08.2011→		7.24809.77.0	AGR	ET <input checked="" type="checkbox"/>	
GRAND VOYAGER V (RT)						10
2.8 CRD 110-133 kW (150-181 PS) ENS	10.2007→		7.01317.10.0	AGR	PN <input type="checkbox"/>	
			7.03295.03.0	AGR	EL <input type="checkbox"/>	
			7.11190.01.0	DDS	Partikelfilter Particulate Filter 2008 2008 2015 2015 2010 2010	
			7.11190.01.0	DDS	Partikelfilter Particulate Filter 2008 2008 2015 2015 2010 2010	
2.8 CRD 110-133 kW (150-181 PS) ENS	10.2007→		7.01317.10.0	AGR	PN <input type="checkbox"/>	
			7.03295.03.0	AGR	EL <input type="checkbox"/>	
2.8 CRD 110-133 kW (150-181 PS) ENS	09.2012→		7.03295.03.0	AGR	EL <input type="checkbox"/>	
			7.11190.01.0	DDS	Partikelfilter Particulate Filter 2015 2015	
			7.11190.01.0	DDS	Partikelfilter Particulate Filter 2015 2015	
PT CRUISER (PT_)						11
2.2 CRD 89-110 kW (121-150 PS) EDJ	08.2005→12.2010		7.05270.21.0	LS	600 mm nach Katalysator Post-catalyst	
SEBRING (JS)						12
2.0 CRD 103 kW (140 PS) ECD	07.2007→12.2010		7.24809.16.0	AGR	PN <input type="checkbox"/>	
2.4 125-130 kW (170-177 PS) EDG	09.2006→12.2010		7.28247.13.0	SLP	EL	
2.4 AWD 125-130 kW (170-177 PS) EDG	09.2007→12.2008		7.28247.13.0	SLP	EL	
2.4 VVT 125-130 kW (170-177 PS) EDG	07.2007→12.2010		7.28247.13.0	SLP	EL	
SEBRING Convertible (JS)						13
2.0 CRD 103 kW (140 PS) ECD	07.2007→12.2010		7.24809.16.0	AGR	PN <input type="checkbox"/>	

					
SEBRING Convertible (JS)					
13					
2.4 125-130 kW (170-177 PS) EDG	05.2007→12.2010		7.28247.13.0	SLP	EL
2.4 AWD 125-130 kW (170-177 PS) EDG	05.2007→12.2008		7.28247.13.0	SLP	EL
VOYAGER IV (RG, RS)					
14					
2.5 CRD 105 kW (143 PS) ENJ	02.2000→12.2008		7.28270.14.0	AGR	PN  →12.2006
			7.28290.11.0	AGR	PN
2.8 CRD 110-120 kW (150-163 PS) ENR	06.2004→12.2008		7.28270.14.0	AGR	PN  →12.2006
			7.28290.11.0	AGR	PN 01.2007→
YPSILON					
15					
1.3 Multijet 70 kW (95 PS) 199 B1.000	05.2011→		7.01599.10.0	AGR	EL  07.2014→ Euro 6 Euro 6
			7.03622.10.0	AGR-K	EL  Euro 6 Euro 6 mit AGR-Ventil with EGR valve

C





AX (ZA-_) 1





C

1.4 GTi 69-74 kW (94-100 PS) KFZ (TU3FJ2)	06.1991→12.1996		7.05270.38.0	LS	1240 mm	
1.4 GTi 69-74 kW (94-100 PS) KFZ (TU3FJ2)	06.1991→12.1992		7.05270.38.0	LS	1240 mm	
1.4 GTi 66 kW (90 PS) KFY (TU3FJ2)	08.1991→12.1996		7.05270.38.0	LS	1240 mm	
10 33-37 kW (45-50 PS) CDZ (TU9M)	02.1987→12.1998		7.05270.38.0	LS	1240 mm	
10 33-37 kW (45-50 PS) CDY (TU9M)	07.1992→12.1998		7.05270.38.0	LS	1240 mm	
11 40-44 kW (55-60 PS) H1B, HDZ (TU1M)	09.1986→12.1997		7.05270.38.0	LS	1240 mm	
11 40-44 kW (54-60 PS) H1A, H1B	12.1986→04.1994		7.05270.38.0	LS	1240 mm	
11 4x4 40-44 kW (54-60 PS) H1A	06.1991→07.1992		7.05270.38.0	LS	1240 mm	
11 Cat (ZA_) 40 kW (54 PS) HAZ (TU1CP)	09.1988→12.1989		7.05270.38.0	LS	1240 mm	
14 (ZA) 55-59 kW (75-80 PS) KDX (TU3M/Z), KDY (TU3FM), KDY (TU3M), KDZ (TU3M/Z)	04.1987→04.1997		7.05270.38.0	LS	1240 mm	
14 4x4 55-59 kW (75-80 PS) KDX (TU3M/Z), KDY (TU3FM), KDY (TU3M), KDZ (TU3M/Z)	08.1991→12.1996		7.05270.38.0	LS	1240 mm	
14 GT 55-59 kW (75-80 PS) KDZ (TU3M/Z)	01.1989→12.1991		7.05270.38.0	LS	1240 mm	

BERLINGO (ER_, EC_) 2













1.5 BlueHDi 100 73-75 kW (99-102 PS) YHY (DV5RD)	06.2018→		7.07794.23.0	AGR	EL	mit Dichtring with O-ring
1.5 BlueHDi 130 (ECYHZJ, ECYHZR) 96 kW (131 PS) YHZ (DV5RC)	06.2018→		7.07794.23.0	AGR	EL	mit Dichtring with O-ring

BERLINGO / BERLINGO FIRST MPV (MF_, GJK_, GFK_) 3







1.1 i (MFHDZ, MFHFX) 40-44 kW (55-60 PS) HDZ (TU1M), HFX (TU1JP)	07.1996→05.2008		7.05270.39.0	LS	400 mm	
			7.02604.04.0	LS	200 mm	
1.4 47-57 kW (64-77 PS) KFW (TU3JP)	11.2002→10.2005		7.05270.36.0	LS	540 mm	Euro3/Euro4, Technische Schadstoffverringierung K Euro3/Euro4, Technical pollution reduction K
			7.05270.39.0	LS	400 mm	
			7.02604.04.0	LS	200 mm	
1.4 bivalent 47-57 kW (64-77 PS) KFW (TU3JP)	11.2002→12.2011		7.05270.36.0	LS	540 mm	Euro3/Euro4, Technische Schadstoffverringierung K Euro3/Euro4, Technical pollution reduction K
1.4 i (MFKFX, MFKFW, GJKFWB, GJKFWC, GFKFWC) 47-57 kW (64-77 PS) KFW (TU3JP)	07.1996→12.2011		7.05270.36.0	LS	540 mm	Euro3/Euro4, Technische Schadstoffverringierung K Euro3/Euro4, Technical pollution reduction K
			7.05270.39.0	LS	400 mm	
			7.02604.04.0	LS	200 mm	



BERLINGO / BERLINGO FIRST MPV (MF_, GJK_, GFK_) 3







1.4 i (MFKFX, MFKFW, GJKFWB, GJKFWC, GFKFWC) 53-57 kW (72-77 PS) KFX (TU3JP)	07.1996→12.2011		7.05270.39.0	LS	400 mm	
			7.02604.04.0	LS	200 mm	
1.4 i bivalent (MFKFW) 47-57 kW (64-77 PS) KFW (TU3JP)	04.2003→10.2008		7.05270.36.0	LS	540 mm	Euro3/Euro4, Technische Schadstoffverringierung K Euro3/Euro4, Technical pollution reduction K
			7.05270.39.0	LS	400 mm	
			7.02604.04.0	LS	200 mm	
1.6 HDI 75 (MF9HW, GJ9HWC, GF9HWC, GN9HWC) 55 kW (75 PS) 9HW (DV6BTED4), DV6B	07.2005→12.2011		7.24809.39.0	AGR	EL	
1.6 HDI 90 (MF9HX) 66-68 kW (90-92 PS) 9HX (DV6ATED4)	07.2005→05.2008		7.24809.39.0	AGR	EL	
1.6 HDI 92 68 kW (92 PS) 9HJ (DV6DTEDM)	11.2009→12.2010		7.03647.10.0	AGR-K	EL	 ohne Sensor without sensor
1.6 HDI 92 68-69 kW (92-94 PS) 9HP (DV6DTEd)	11.2009→12.2010		7.11492.01.0	DDS		ohne Zubehör without accessories Organisationsnummer ab: 11211FL, 11211FV RPO number from: 11211FL, 11211FV
2.0 HDI 90 (MFRHY) 66 kW (90 PS) RHY (DW10TD)	12.1999→10.2005		7.22843.06.0	AGR	PN	
			7.09730.01.0	AGR-K		
2.0 HDi 4x4 (MFRHY) 66 kW (90 PS) RHY (DW10TD)	11.2002→10.2005		7.22843.06.0	AGR	PN	
			7.09730.01.0	AGR-K		



















BERLINGO MULTISPACE (B9) 4

1.6 HDi 110 80 kW (109 PS) 9HZ (DV6TED4)	04.2008→		7.24809.39.0	AGR	EL		
1.6 HDi 110 82-84 kW (111-114 PS) 9HL (DV6C)	07.2010→		7.02209.11.0	AGR	EL		
			7.02156.35.0	AGR-K	EL		ohne Sensor without sensor 01.2013→ mit Sensor with sensor ohne Sensor without sensor 01.2013→ ohne AGR-Ventil without EGR valve ohne Zubehör without accessories Organisationsnummer ab: 11211FL, 11211FV RPO number from: 11211FL, 11211FV
			7.02156.33.0	AGR-K			
			7.02156.34.0	AGR-K			
		7.11492.01.0	DDS				
1.6 HDi 110 82-84 kW (111-114 PS) 9HR (DV6C)	07.2010→		7.02209.11.0	AGR	EL		
			7.02156.24.0	AGR-K	EL		mit Sensor with sensor  →11.2012



BERLINGO MULTISPACE (B9) **4**

C						
			7.02156.35.0	AGR-K	EL	ohne Sensor without sensor 01.2013→
			7.02156.33.0	AGR-K		mit Sensor with sensor
			7.02156.34.0	AGR-K		ohne Sensor without sensor 01.2013→
			7.11492.01.0	DDS		ohne AGR-Ventil without EGR valve ohne Zubehör without accessories Organisationsnummer ab: 11211FL, 11211FV RPO number from: 11211FL, 11211FV
1.6 HDi 115 82-84 kW (111-114 PS) 9HR (DV6C)	07.2010→		7.02209.11.0	AGR	EL	
			7.02156.24.0	AGR-K	EL	mit Sensor with sensor  →11.2012
			7.02156.35.0	AGR-K	EL	ohne Sensor without sensor 01.2013→ mit AGR-Ventil with EGR valve
			7.02156.33.0	AGR-K		mit Sensor with sensor →11.2012 ohne AGR-Ventil without EGR valve
			7.02156.34.0	AGR-K		ohne Sensor without sensor 01.2013→ ohne AGR-Ventil without EGR valve
			7.11492.01.0	DDS		ohne Zubehör without accessories Organisationsnummer ab: 11211FL, 11211FV RPO number from: 11211FL, 11211FV
1.6 HDi 115 4x4 82-84 kW (111-114 PS) 9HR (DV6C)	02.2012→		7.02209.11.0	AGR	EL	
			7.02156.24.0	AGR-K	EL	mit Sensor with sensor  →11.2012
			7.02156.35.0	AGR-K	EL	ohne Sensor without sensor 01.2013→ mit AGR-Ventil with EGR valve
			7.02156.33.0	AGR-K		mit Sensor with sensor →11.2012 ohne AGR-Ventil without EGR valve
			7.02156.34.0	AGR-K		ohne Sensor without sensor 01.2013→ ohne AGR-Ventil without EGR valve

					
BERLINGO MULTISPACE (B9)					4
			7.11492.01.0	DDS	ohne Zubehör without accessories Organisationsnummer ab: 11211FL, 11211FV RPO number from: 11211FL, 11211FV
1.6 HDi 75 / BlueHDi 75 55 kW (75 PS) 9HN (DV6ETED)	04.2008→		7.02209.11.0	AGR	EL 
			7.02156.24.0	AGR-K	EL mit Sensor with sensor  →11.2012
			7.02156.35.0	AGR-K	EL ohne Sensor without sensor 01.2013→ mit AGR-Ventil with EGR valve
			7.02156.33.0	AGR-K	EL mit Sensor with sensor →11.2012 ohne AGR-Ventil without EGR valve
			7.02156.34.0	AGR-K	EL ohne Sensor without sensor 01.2013→ ohne AGR-Ventil without EGR valve
			7.11492.01.0	DDS	EL ohne Zubehör without accessories Organisationsnummer ab: 11211FL, 11211FV RPO number from: 11211FL, 11211FV
1.6 HDi 75 16V 55 kW (75 PS) 9HT (DV6BTED4)	04.2008→		7.02604.99.0	LS	400 mm
1.6 HDi 90 66-68 kW (90-92 PS) 9HV (DV6TED4B), 9HX (DV6ATED4)	04.2008→		7.24809.39.0	AGR	EL 
1.6 HDi 90 68 kW (92 PS) 9HJ (DV6DTEDM)	07.2010→		7.02209.11.0	AGR	EL 
			7.02156.35.0	AGR-K	EL ohne Sensor without sensor 01.2013→ mit AGR-Ventil with EGR valve
			7.03647.10.0	AGR-K	EL  ohne Sensor without sensor
			7.02156.33.0	AGR-K	EL mit Sensor with sensor →11.2012 ohne AGR-Ventil without EGR valve
			7.02156.34.0	AGR-K	EL ohne Sensor without sensor 01.2013→ ohne AGR-Ventil without EGR valve
7.02604.99.0	LS	400 mm			
1.6 HDi 90 68-69 kW (92-94 PS) 9HP (DV6DTEED)	07.2010→		7.02209.11.0	AGR	EL 
			7.02156.24.0	AGR-K	EL mit Sensor with sensor  →11.2012





C



BERLINGO MULTISPACE (B9)

4





















C

			7.02156.35.0	AGR-K	EL	ohne Sensor without sensor 01.2013→ mit AGR-Ventil with EGR valve
			7.02156.33.0	AGR-K		mit Sensor with sensor →11.2012 ohne AGR-Ventil without EGR valve
			7.02156.34.0	AGR-K		ohne Sensor without sensor 01.2013→ ohne AGR-Ventil without EGR valve
			7.11492.01.0	DDS		ohne Zubehör without accessories Organisationsnummer ab: 11211FL, 11211FV RPO number from: 11211FL, 11211FV
			7.02604.99.0	LS	400 mm	
1.6 HDi 90 4x4 66 kW (90 PS) 9HF (DV6DTED)	02.2012→12.2014		7.02209.11.0	AGR	EL	
			7.02156.24.0	AGR-K	EL	mit Sensor with sensor  →11.2012
			7.02156.35.0	AGR-K	EL	ohne Sensor without sensor 01.2013→ mit AGR-Ventil with EGR valve
			7.02156.33.0	AGR-K		mit Sensor with sensor →11.2012 ohne AGR-Ventil without EGR valve
			7.02156.34.0	AGR-K		ohne Sensor without sensor 01.2013→ ohne AGR-Ventil without EGR valve
			7.11492.01.0	DDS		ohne Zubehör without accessories Organisationsnummer ab: 11211FL, 11211FV RPO number from: 11211FL, 11211FV
1.6 VTi 120 88 kW (120 PS) 5FS (EP6C)	11.2009→		7.05271.74.0	LS	450 mm	
1.6 VTi 95 72 kW (98 PS) 5FK (EP6CB)	07.2010→		7.05271.74.0	LS	450 mm	

BX (XB-)

5









19 GTi 16V 116 kW (158 PS) D6C (XU9J4)	09.1987→12.1988		7.02604.04.0	LS	200 mm	
19 GTi 16V 108-110 kW (147-150 PS) DFW (XU9J4)	03.1988→02.1993		7.02604.04.0	LS	200 mm	

					
C-CROSSER (VU_, VV_)					6
2.2 HDi 115 kW (156 PS) 4HK (DW12ME5)	02.2007→		7.00578.12.0	AGR	EL 
			7.11492.01.0	DDS	ohne Zubehör without accessories Schaltgetriebe 6 Gang, nicht für Getriebeautomatik 6 Gang 6-Speed Manual Transmission, not for 6-speed automatic transmission Allrad All-wheel Drive
2.2 HDi 115 kW (156 PS) 4HN (DW12MTED4)	02.2007→		7.00578.12.0	AGR	EL 
C-ELYSEE (DD_)					7
1.5 BlueHDi 100 73-75 kW (99-102 PS) YHY (DV5RD)	05.2018→		7.07794.23.0	AGR	EL mit Dichtring with O-ring
1.6 HDi 92 68 kW (92 PS) 9HJ (DV6DTEDM)	11.2012→		7.02209.11.0	AGR	EL 
			7.02156.35.0	AGR-K	EL ohne Sensor without sensor 01.2013→ mit AGR-Ventil with EGR valve
			7.03647.10.0	AGR-K	EL 
			7.02156.34.0	AGR-K	EL ohne Sensor without sensor ohne Sensor without sensor 01.2013→ ohne AGR-Ventil without EGR valve
1.6 HDi 92 68-69 kW (92-94 PS) 9HP (DV6DTED)	11.2012→		7.02209.11.0	AGR	EL 
			7.02156.24.0	AGR-K	EL mit Sensor with sensor  →11.2012
			7.02156.35.0	AGR-K	EL ohne Sensor without sensor 01.2013→ mit AGR-Ventil with EGR valve
			7.02156.33.0	AGR-K	EL mit Sensor with sensor →11.2012
			7.02156.34.0	AGR-K	EL ohne AGR-Ventil without EGR valve ohne Sensor without sensor 01.2013→ ohne AGR-Ventil without EGR valve
			7.11492.01.0	DDS	EL ohne Zubehör without accessories
			7.02604.99.0	LS	400 mm Motorcode: 9HP (DV6DTED) Engine Code: 9HP (DV6DTED) Produktionsdatum ab: 11.2012 Production date from: 11.2012
C1 (PM_, PN_)					8
1.0 50-53 kW (68-72 PS) CFA (384F), CFB (1KR)	06.2005→09.2014		7.05271.51.0	LS	300 mm
1.4 HDi 40 kW (54 PS) 8HT (DV4TD)	06.2005→09.2014		7.24809.76.0	AGR	EL 





C2 (JM_) **9**







C















1.4 16V 65 kW (88 PS) KFU (ET3J4)	04.2005→12.2009		7.02604.11.0	LS	null mm	
1.4 HDi 50-55 kW (68-75 PS) 8HX (DV4TD), 8HZ (DV4TD)	07.2003→12.2009		7.24809.06.0	AGR	PN	mit Rohrstützen with pipe socket  8HX (DV4TD), 8HZ (DV4TD): Euro 3 Euro 3
			7.24809.76.0	AGR	EL	 8HX (DV4TD), 8HZ (DV4TD): Euro 4 (D4) Euro 4 (D4)
1.4 HDi 50-55 kW (68-75 PS) 8HX (DV4TD)	09.2003→04.2005		7.24809.06.0	AGR	PN	mit Rohrstützen with pipe socket  Euro 3 Euro 3
			7.24809.76.0	AGR	EL	 Euro 4 (D4) Euro 4 (D4)
1.6 HDi 80 kW (109 PS) 9HZ (DV6TED4)	09.2005→12.2009		7.24809.39.0	AGR	EL	 Euro 4 (D4) Euro 4 (D4)
			7.11492.01.0	DDS		ohne Zubehör without accessories

C3 AIRCROSS II (2R_, 2C_) **10**

1.5 BlueHDi 100 (2CYHYJ) 73-75 kW (99-102 PS) YHY (DV5RD)	08.2018→		7.07794.23.0	AGR	EL	mit Dichtring with O-ring
1.5 BlueHDi 100 (2CYHYJ) 73-75 kW (99-102 PS) YHY (DV5RD)	08.2018→		7.07794.23.0	AGR	EL	mit Dichtring with O-ring
1.6 HDi 92 (2C9HPA) 68-69 kW (92-94 PS) 9HP (DV6DTED)	10.2017→		7.02156.35.0	AGR-K	EL	ohne Sensor without sensor mit AGR-Ventil with EGR valve
			7.02156.34.0	AGR-K		ohne Sensor without sensor ohne AGR-Ventil without EGR valve
			7.11492.01.0	DDS		ohne Zubehör without accessories

C3 I (FC_, FN_) **11**

1.1 i 44 kW (60 PS) HFX (TU1A), HFX (TU1JP)	02.2002→		7.02604.13.0	LS	1170 mm	
1.4 16V 65 kW (88 PS) KFU (ET3J4)	12.2003→		7.02604.11.0	LS	null mm	
			7.02604.12.0	LS	400 mm	
1.4 16V HDi 66 kW (90 PS) 8HY (DV4TED4)	02.2002→		7.24809.06.0	AGR	PN	mit Rohrstützen with pipe socket  Euro 3 Euro 3
1.4 HDi 50-55 kW (68-75 PS) 8HX (DV4TD), 8HZ (DV4TD)	02.2002→		7.24809.06.0	AGR	PN	mit Rohrstützen with pipe socket  8HX (DV4TD), 8HZ (DV4TD): Euro 3 Euro 3
			7.24809.76.0	AGR	EL	 8HX (DV4TD), 8HZ (DV4TD): Euro 4 (D4) Euro 4 (D4)











					
C3 I (FC_, FN_) 11					
1.4 HDi 50-52 kW (68-71 PS) 8HZ (DV4TD)	07.2003→02.2011		7.24809.06.0	AGR	PN mit Rohrstützen with pipe socket ○ Euro 3 Euro 3
			7.24809.76.0	AGR	EL ○ Euro 4 (D4) Euro 4 (D4)
1.4 HDi 50-55 kW (68-75 PS) 8HX (DV4TD)	05.2005→		7.24809.06.0	AGR	PN mit Rohrstützen with pipe socket ○ Euro 3 Euro 3
			7.24809.76.0	AGR	EL ○ Euro 4 (D4) Euro 4 (D4)
1.6 16V HDi 80 kW (109 PS) 9HZ (DV6TED4)	09.2005→		7.24809.39.0	AGR	EL ○
1.6 16V HDi 66-68 kW (90-92 PS) 9HX (DV6ATED4)	10.2005→		7.24809.39.0	AGR	EL ○
C3 II (SC_) 12					
1.4 HDi 70 50 kW (68 PS) 8HR (DV4C)	11.2009→		7.02209.11.0	AGR	EL ○
			7.02156.24.0	AGR-K	EL mit Sensor with sensor ○ →10.2012 Organisationsnummer bis: 13145 RPO number to: 13145
			7.02156.35.0	AGR-K	EL ohne Sensor without sensor 12.2012→
			7.02156.33.0	AGR-K	mit Sensor with sensor →10.2012 Organisationsnummer bis: 13145 RPO number to: 13145
			7.02156.34.0	AGR-K	ohne AGR-Ventil without EGR valve ohne Sensor without sensor 12.2012→ Organisationsnummer ab: 13146 RPO number from: 13146
7.11492.01.0	DDS	ohne AGR-Ventil without EGR valve ohne Zubehör without accessories			
1.4 HDi 70 50-52 kW (68-71 PS) 8HZ (DV4TD)	11.2009→		7.24809.76.0	AGR	EL ○ Euro 4 (D4) Euro 4 (D4)
1.4 VTi 95 70 kW (95 PS) 8FP (EP3C)	11.2009→		7.05271.74.0	LS	450 mm
1.6 BlueHDi 75 55 kW (75 PS) 9HK (DV6ETEDM)	04.2015→		7.02209.11.0	AGR	EL ○
			7.03647.10.0	AGR-K	EL ○ ohne Sensor without sensor
1.6 HDi 68 kW (92 PS) 9HJ (DV6DTEDM)	11.2009→09.2016		7.02209.11.0	AGR	EL ○
			7.02156.35.0	AGR-K	EL ohne Sensor without sensor 01.2013→ mit AGR-Ventil with EGR valve



















C3 II (SC_)

12

C

			7.03647.10.0	AGR-K	EL	 ohne Sensor without sensor
			7.02156.33.0	AGR-K		mit Sensor with sensor
			7.02156.34.0	AGR-K		ohne Sensor without sensor 01.2013→ ohne AGR-Ventil without EGR valve
			7.02604.99.0	LS	400 mm	
1.6 HDi 68-69 kW (92-94 PS) 9HP (DV6DTE)	11.2009→09.2016		7.02209.11.0	AGR	EL	
			7.02156.24.0	AGR-K	EL	mit Sensor with sensor  →11.2012
			7.02156.35.0	AGR-K	EL	ohne Sensor without sensor 01.2013→ mit AGR-Ventil with EGR valve
			7.02156.33.0	AGR-K		mit Sensor with sensor
			7.02156.34.0	AGR-K		ohne Sensor without sensor 01.2013→ ohne AGR-Ventil without EGR valve
			7.11492.01.0	DDS		ohne Zubehör without accessories
			7.02604.99.0	LS	400 mm	
1.6 HDi 110 82-84 kW (111-114 PS) 9HR (DV6C)	11.2009→		7.02209.11.0	AGR	EL	
			7.02156.24.0	AGR-K	EL	mit Sensor with sensor  →11.2012
			7.02156.35.0	AGR-K	EL	ohne Sensor without sensor 01.2013→ mit AGR-Ventil with EGR valve
			7.02156.33.0	AGR-K		mit Sensor with sensor →11.2012 ohne AGR-Ventil without EGR valve
			7.02156.34.0	AGR-K		ohne Sensor without sensor 01.2013→ ohne AGR-Ventil without EGR valve
			7.11492.01.0	DDS		ohne Zubehör without accessories
1.6 HDi 115 84 kW (114 PS) 9HD (DV6C)	09.2012→		7.02209.11.0	AGR	EL	
			7.02156.24.0	AGR-K	EL	mit Sensor with sensor  →11.2012









						
C3 II (SC_)						12
			7.02156.35.0	AGR-K	EL	ohne Sensor without sensor 01.2013→ mit AGR-Ventil with EGR valve
			7.02156.33.0	AGR-K		mit Sensor with sensor →11.2012 ohne AGR-Ventil without EGR valve
			7.02156.34.0	AGR-K		ohne Sensor without sensor 01.2013→ ohne AGR-Ventil without EGR valve
			7.11492.01.0	DDS		ohne Sensor without sensor 01.2013→ ohne AGR-Ventil without EGR valve ohne Zubehör without accessories
1.6 HDi 90 66-68 kW (90-92 PS) 9HX (DV6ATED4)	11.2009→		7.24809.39.0	AGR	EL	
1.6 VTi 120 88 kW (120 PS) 5FS (EP6C)	11.2009→		7.05271.74.0	LS	450 mm	
C3 III (SX)						13
1.5 BlueHDi 100 73-75 kW (99-102 PS) YHY (DV5RD)	05.2018→		7.07794.23.0	AGR	EL	mit Dichtring with O-ring
1.6 HDi 92 68 kW (92 PS) 9HJ (DV6DTEDM)	11.2017→		7.02156.35.0	AGR-K	EL	ohne Sensor without sensor mit AGR-Ventil with EGR valve
			7.03647.10.0	AGR-K	EL	 ohne Sensor without sensor
			7.02156.34.0	AGR-K		ohne Sensor without sensor ohne AGR-Ventil without EGR valve
C3 PICASSO (SH_)						14
1.4 VTi 95 70 kW (95 PS) 8FN (EP3), 8FP (EP3C), 8FS (EP3)	02.2009→		7.05271.74.0	LS	450 mm	
1.4 VTi 95 LPG 70 kW (95 PS) 8FN (EP3)	01.2012→		7.05271.74.0	LS	450 mm	
1.6 HDI 90 68-69 kW (92-94 PS) 9HP (DV6DTEd)	07.2010→		7.02209.11.0	AGR	EL	
			7.02156.24.0	AGR-K	EL	mit Sensor with sensor  →11.2012
			7.02156.35.0	AGR-K	EL	ohne Sensor without sensor 01.2013→
			7.02156.33.0	AGR-K		mit Sensor with sensor →11.2012 ohne AGR-Ventil without EGR valve
			7.02156.34.0	AGR-K		ohne Sensor without sensor 01.2013→ ohne AGR-Ventil without EGR valve
			7.11492.01.0	DDS		ohne Zubehör without accessories
			7.02604.99.0	LS	400 mm	

C





C3 PICASSO (SH_) 14

C

1.6 HDi 80 kW (109 PS) 9HZ (DV6TED4)	02.2009→	 7.24809.39.0	AGR	EL	
		7.11492.01.0	DDS		ohne Zubehör without accessories
	02.2009→	 7.24809.39.0	AGR	EL	
		05.2010→	 7.02209.11.0	AGR	EL
7.02156.24.0			AGR-K	EL	mit Sensor with sensor  →11.2012
7.02156.35.0			AGR-K	EL	ohne Sensor without sensor 01.2013→ mit AGR-Ventil with EGR valve
01.2013→	7.02156.33.0	AGR-K		mit Sensor with sensor →11.2012	
	7.02156.34.0	AGR-K		ohne AGR-Ventil without EGR valve	
	7.11492.01.0	DDS		ohne Sensor without sensor 01.2013→ ohne AGR-Ventil without EGR valve	
1.6 HDi 115 84 kW (114 PS) 9HD (DV6C)	01.2013→	 7.02209.11.0	AGR	EL	
		7.02156.35.0	AGR-K	EL	ohne Sensor without sensor mit AGR-Ventil with EGR valve
		7.02156.34.0	AGR-K		ohne Sensor without sensor ohne AGR-Ventil without EGR valve
		7.11492.01.0	DDS		ohne Sensor without sensor ohne AGR-Ventil without EGR valve ohne Zubehör without accessories
1.6 VTi 120 88 kW (120 PS) 5FS (EP6C), 5FW (EP6)	02.2009→	 7.05271.74.0	LS	450 mm	



C3 Pluriel (HB_) 15

1.4 HDi 50-55 kW (68-75 PS) 8HX (DV4TD)	04.2004→	 7.24809.06.0	AGR	PN	mit Rohrstützen with pipe socket  Euro 3 Euro 3
		7.24809.76.0	AGR	EL	 Euro 4 (D4) Euro 4 (D4)











C4 AIRCROSS 16

1.6 HDi 115 84 kW (114 PS) 9HD (DV6C)	04.2012→	 7.02209.11.0	AGR	EL	
		7.02156.35.0	AGR-K	EL	ohne Sensor without sensor 05.2013→ mit AGR-Ventil with EGR valve

C4 AIRCROSS **16**

			7.02156.33.0	AGR-K		mit Sensor with sensor →04.2013 ohne AGR-Ventil without EGR valve
			7.02156.34.0	AGR-K		ohne Sensor without sensor 01.2013→ ohne AGR-Ventil without EGR valve
			7.11492.01.0	DDS		ohne Zubehör without accessories
1.6 HDi 115 AWC 82-84 kW (111-114 PS) 9HL (DV6C)	05.2012→		7.02209.11.0	AGR	EL	
			7.02156.35.0	AGR-K	EL	ohne Sensor without sensor 05.2013→ mit AGR-Ventil with EGR valve
			7.02156.33.0	AGR-K		mit Sensor with sensor →04.2013 ohne AGR-Ventil without EGR valve
			7.02156.34.0	AGR-K		ohne Sensor without sensor 05.2013→ ohne AGR-Ventil without EGR valve
			7.11492.01.0	DDS		ohne Zubehör without accessories

C
C4 CACTUS **17**







1.5 BlueHDi 100 73-75 kW (99-102 PS) YHY (DV5RD)	06.2018→		7.07794.23.0	AGR	EL	mit Dichtring with O-ring
1.5 BlueHDi 100 73-75 kW (99-102 PS) YHY (DV5RD)	06.2018→		7.07794.23.0	AGR	EL	mit Dichtring with O-ring
1.5 BlueHDi 120 88 kW (120 PS) YHX (DV5RC)	09.2018→		7.07794.23.0	AGR	EL	mit Dichtring with O-ring
1.6 HDi 90 68 kW (92 PS) 9HJ (DV6DTEDM)	09.2014→		7.02209.11.0	AGR	EL	
			7.02156.35.0	AGR-K	EL	ohne Sensor without sensor mit AGR-Ventil with EGR valve
			7.03647.10.0	AGR-K	EL	
			7.02156.34.0	AGR-K		ohne Sensor without sensor ohne AGR-Ventil without EGR valve
1.6 HDi 90 68-69 kW (92-94 PS) 9HP (DV6D)	09.2014→		7.02209.11.0	AGR	EL	
			7.02604.99.0	LS	400 mm	
1.6 HDi 90 68-69 kW (92-94 PS) 9HP (DV6DTEd)	09.2014→		7.02209.11.0	AGR	EL	
			7.02604.99.0	LS	400 mm	





C4 CACTUS **17**

C			7.02156.35.0	AGR-K	EL	ohne Sensor without sensor mit AGR-Ventil with EGR valve ohne Sensor without sensor ohne AGR-Ventil without EGR valve ohne Zubehör without accessories
			7.02156.34.0	AGR-K		
			7.11492.01.0	DDS		
			7.02604.99.0	LS	400 mm	











C4 Coupe (LA_) **18**

1.4 16V 65 kW (88 PS) KFU (ET3J4)	11.2004→07.2011		7.02604.11.0	LS	null mm	
			7.02604.12.0	LS	400 mm	
1.6 HDi 66-68 kW (90-92 PS) 9HX (DV6ATED4)	11.2004→07.2011		7.24809.39.0	AGR	EL	
1.6 HDi 80-85 kW (109-116 PS) 9HY (DV6TED4), 9HZ (DV6TED4)	11.2004→07.2011		7.24809.39.0	AGR	EL	
			7.11492.01.0	DDS		ohne Zubehör without accessories  9HY (DV6TED4), 9HZ (DV6TED4): Organisationsnummer ab: 10948 RPO number from: 10948
1.6 THP 103 kW (140 PS) 5FT (EP6DT)	06.2008→07.2011		7.02604.41.0	LS	700 mm	nicht für Schaltgetriebe not for manual transmission vor Katalysator in front of the catalyst
1.6 THP 150 110 kW (150 PS) 5FX (EP6DT)	07.2008→07.2011		7.02604.41.0	LS	700 mm	nicht für Schaltgetriebe not for manual transmission vor Katalysator in front of the catalyst
1.6 VTi 120 88 kW (120 PS) 5FW (EP6)	07.2008→07.2011		7.05271.74.0	LS	450 mm	
2.0 16V 88-105 kW (136-143 PS) RFN (EW10J4)	11.2004→07.2007		7.05270.37.0	LS	1640 mm	
2.0 16V 130 kW (177 PS) RFK (EW10J4S)	11.2004→12.2010		7.05270.37.0	LS	1640 mm	
2.0 HDi 100-101 kW (136-138 PS) RHR (DW10BTED4)	11.2004→12.2010		7.24809.68.0	AGR	EL	
			7.09730.00.0	AGR-K		ohne Zubehör without accessories Organisationsnummer ab: 11074 RPO number from: 11074
			7.11492.01.0	DDS		
2.0 HDi 100-103 kW (136-140 PS) RHF (DW10BTED4)	07.2008→07.2011		7.24809.68.0	AGR	EL	
			7.09730.00.0	AGR-K		ohne Zubehör without accessories Organisationsnummer ab: 11074 RPO number from: 11074
			7.11492.01.0	DDS		
2.0 VTR 103-111 kW (140-151 PS) RFJ (EW10A)	10.2006→12.2007		7.05270.37.0	LS	1640 mm	



C4 GRAND PICASSO I (UA_) **19**

1.6 16V 103 kW (140 PS) 5FT (EP6DT)	07.2008→12.2010		7.02604.41.0	LS	700 mm	für OE-Nummer: 16 093 452 80, 1618 HG for OE number: 16 093 452 80, 1618 HG vor Katalysator in front of the catalyst
1.6 16V 110 kW (150 PS) 5FX (EP6DT)	10.2008→08.2013		7.02604.41.0	LS	700 mm	für OE-Nummer: 16 093 452 80, 1618 HG for OE number: 16 093 452 80, 1618 HG





C4 GRAND PICASSO I (UA_)
19

			7.05271.74.0	LS	450 mm	
1.6 HDi 80-85 kW (109-116 PS) 9HY (DV6TED4), 9HZ (DV6TED4)	10.2006→06.2011		7.24809.39.0	AGR	EL	
1.6 HDi 110 82-84 kW (111-114 PS) 9HR (DV6C)	09.2010→08.2013		7.02209.11.0	AGR	EL	
			7.02156.35.0	AGR-K	EL	ohne Sensor without sensor 01.2013→ mit AGR-Ventil with EGR valve mit Sensor with sensor ohne Sensor without sensor 01.2013→ ohne AGR-Ventil without EGR valve
			7.02156.33.0	AGR-K		
			7.02156.34.0	AGR-K		
1.6 THP 155 115 kW (156 PS) 5FV (EP6CDT)	09.2010→08.2013		7.05271.74.0	LS	450 mm	
1.6 VTi 120 88 kW (120 PS) 5FW (EP6)	07.2008→08.2013		7.05271.74.0	LS	450 mm	
2.0 HDi 138 100-101 kW (136-138 PS) RHJ (DW10BTED4), RHR (DW10BTED4)	10.2006→12.2013		7.24809.68.0	AGR	EL	
			7.09730.00.0	AGR-K		
2.0 HDi 150 110 kW (150 PS) RHE (DW10CTED4)	07.2009→08.2013		7.02604.99.0	LS	400 mm	
2.0 HDi 165 120 kW (163 PS) RHH (DW10CTED4)	09.2010→08.2013		7.02604.99.0	LS	400 mm	

C
C4 GRAND PICASSO II (DA_, DE_)
20

1.6 HDi / BlueHDi 115 82-85 kW (112-116 PS) 9HC (DV6C)	09.2013→		7.02209.11.0	AGR	EL	
			7.02156.35.0	AGR-K	EL	ohne Sensor without sensor mit AGR-Ventil with EGR valve ohne Sensor without sensor ohne AGR-Ventil without EGR valve
			7.02156.34.0	AGR-K		
1.6 HDi 90 68-69 kW (92-94 PS) 9HP (DV6DTED)	09.2013→		7.02209.11.0	AGR	EL	
			7.02156.35.0	AGR-K	EL	ohne Sensor without sensor mit AGR-Ventil with EGR valve ohne Sensor without sensor ohne AGR-Ventil without EGR valve
			7.02156.34.0	AGR-K		
			7.02604.99.0	LS	400 mm	

















C4 I (LC_)
21

1.4 16V 65 kW (88 PS) KFU (ET3J4)	11.2004→07.2011		7.02604.11.0	LS	null mm	
			7.02604.12.0	LS	400 mm	
1.6 HDi 66-68 kW (90-92 PS) 9HX (DV6ATED4)	11.2004→07.2011		7.24809.39.0	AGR	EL	









C4 I (LC_) 21

C

1.6 HDi 80-85 kW (109-116 PS) 9HY (DV6TED4), 9HZ (DV6TED4)	11.2004→07.2011		7.24809.39.0 7.11492.01.0	AGR DDS	EL	 ohne Zubehör without accessories  9HY (DV6TED4), 9HZ (DV6TED4): Organisationsnummer ab: 10948 RPO number from: 10948
1.6 HDi 80-85 kW (109-116 PS) 9HY (DV6TED4)	07.2006→07.2011		7.24809.39.0 7.11492.01.0	AGR DDS	EL	 ohne Zubehör without accessories Organisationsnummer ab: 10948 RPO number from: 10948
1.6 THP 140 103 kW (140 PS) 5FT (EP6DT)	07.2008→07.2011		7.02604.41.0	LS	700 mm	nicht für Schaltgetriebe not for manual transmission vor Katalysator in front of the catalyst
1.6 THP 150 110 kW (150 PS) 5FX (EP6DT)	07.2008→07.2011		7.02604.41.0 7.05271.74.0	LS LS	700 mm 450 mm	nicht für Schaltgetriebe not for manual transmission vor Katalysator in front of the catalyst
1.6 VTi 120 88 kW (120 PS) 5FW (EP6)	07.2008→07.2011		7.05271.74.0	LS	450 mm	
2.0 16V 88-105 kW (136-143 PS) RFN (EW10J4)	11.2004→07.2007		7.05270.37.0	LS	1640 mm	
2.0 16V 103-111 kW (140-151 PS) RFJ (EW10A)	11.2004→07.2011		7.05270.37.0	LS	1640 mm	
2.0 16V 130 kW (177 PS) RFK (EW10J4S)	11.2004→07.2008		7.05270.37.0	LS	1640 mm	
2.0 HDi 100-101 kW (136-138 PS) RHR (DW10BTED4)	11.2004→07.2011		7.24809.68.0 7.09730.00.0 7.11492.01.0	AGR AGR-K DDS	EL	 ohne Zubehör without accessories Organisationsnummer ab: 11074 RPO number from: 11074
2.0 HDi 79-81 kW (107-110 PS) RHZ (DW10ATED)	04.2007→07.2008		7.22843.06.0	AGR	PN	
2.0 HDi 100-103 kW (136-140 PS) RHF (DW10BTED4)	07.2008→07.2011		7.24809.68.0 7.09730.00.0 7.11492.01.0	AGR AGR-K DDS	EL	 ohne Zubehör without accessories Organisationsnummer ab: 11074 RPO number from: 11074

C4 I Saloon 22

1.6 HDi 80-85 kW (109-116 PS) 9HY (DV6TED4), 9HZ (DV6TED4)	07.2006→07.2011		7.24809.39.0 7.11492.01.0	AGR DDS	EL	 ohne Zubehör without accessories  9HY (DV6TED4), 9HZ (DV6TED4): Organisationsnummer ab: 10948 RPO number from: 10948
2.0 HDi 79-81 kW (107-110 PS) RHZ (DW10ATED)	04.2007→12.2011		7.22843.06.0	AGR	PN	
2.0 HDi 100-103 kW (136-140 PS) RHF (DW10BTED4)	06.2007→12.2010		7.24809.68.0	AGR	EL	













C4 I Saloon 22

			7.09730.00.0 7.11492.01.0	AGR-K DDS		ohne Zubehör without accessories Organisationsnummer ab: 11074 RPO number from: 11074
--	--	--	------------------------------	--------------	--	--

C

C4 II (B7) 23











1.4 VTi 95 70 kW (95 PS) 8FP (EP3C)	11.2009→		7.05271.74.0	LS	450 mm	
1.6 HDi 110 82-84 kW (111-114 PS) 9HR (DV6C)	11.2009→		7.02209.11.0	AGR	EL	
			7.02156.24.0	AGR-K	EL	mit Sensor with sensor 
			7.02156.35.0	AGR-K	EL	ohne Sensor without sensor →11.2012
			7.02156.33.0	AGR-K	EL	ohne AGR-Ventil without EGR valve mit Sensor with sensor →11.2012
			7.02156.34.0	AGR-K	EL	ohne AGR-Ventil without EGR valve ohne Sensor without sensor 01.2013→
			7.11492.01.0	DDS	EL	ohne AGR-Ventil without EGR valve ohne Zubehör without accessories
1.6 HDi 115 84 kW (114 PS) 9HD (DV6C)	07.2012→		7.02209.11.0	AGR	EL	
			7.02156.24.0	AGR-K	EL	mit Sensor with sensor 
			7.02156.35.0	AGR-K	EL	ohne Sensor without sensor 01.2013→
			7.02156.33.0	AGR-K	EL	mit AGR-Ventil with EGR valve mit Sensor with sensor
			7.02156.34.0	AGR-K	EL	ohne Sensor without sensor 01.2013→
			7.11492.01.0	DDS	EL	ohne AGR-Ventil without EGR valve ohne Zubehör without accessories
1.6 HDi 90 68 kW (92 PS) 9HJ (DV6DTEDM)	11.2009→		7.02209.11.0	AGR	EL	
			7.02156.35.0	AGR-K	EL	ohne Sensor without sensor 01.2013→
			7.03647.10.0	AGR-K	EL	mit AGR-Ventil with EGR valve 
					EL	ohne Sensor without sensor





















C4 II (B7)

23

C

			7.02156.33.0	AGR-K		mit Sensor with sensor →11.2012 ohne AGR-Ventil without EGR valve
			7.02156.34.0	AGR-K		ohne Sensor without sensor 01.2013→ ohne AGR-Ventil without EGR valve
			7.02604.99.0	LS	400 mm	
1.6 HDi 90 68-69 kW (92-94 PS) 9HP (DV6DTE)	11.2009→		7.02209.11.0	AGR	EL	
			7.02156.24.0	AGR-K	EL	mit Sensor with sensor  →11.2012
			7.02156.35.0	AGR-K	EL	ohne Sensor without sensor 01.2013→ mit AGR-Ventil with EGR valve
			7.02156.33.0	AGR-K		mit Sensor with sensor →11.2012 ohne AGR-Ventil without EGR valve
			7.02156.34.0	AGR-K		ohne Sensor without sensor 01.2013→ ohne AGR-Ventil without EGR valve
			7.11492.01.0	DDS		ohne Zubehör without accessories
			7.02604.99.0	LS	400 mm	
1.6 THP 155 115 kW (156 PS) 5FV (EP6CDT)	11.2009→12.2016		7.05271.74.0	LS	450 mm	
1.6 VTi 120 88 kW (120 PS) 5FS (EP6C)	11.2009→12.2016		7.05271.74.0	LS	450 mm	
1.6 VTi 120 LPG 88 kW (120 PS) 5FS (EP6C)	09.2011→		7.05271.74.0	LS	450 mm	
2.0 HDi / BlueHDi 150 110 kW (150 PS) AHR (DW10FD)	11.2009→		7.11492.01.0	DDS		ohne Zubehör without accessories
			7.02604.99.0	LS	400 mm	
2.0 HDi / BlueHDi 150 110 kW (150 PS) RHE (DW10CTED4)	11.2009→		7.24809.94.0	AGR-K	EL	 Organisationsnummer ab: 12775 RPO number from: 12775
			7.11492.01.0	DDS		ohne Zubehör without accessories
			7.02604.99.0	LS	400 mm	
2.0 HDi / BlueHDi 160 120 kW (163 PS) RHH (DW10CTED4)	10.2010→		7.24809.94.0	AGR-K	EL	 Organisationsnummer ab: 12775 RPO number from: 12775
			7.11492.01.0	DDS		ohne Zubehör without accessories









					
C4 II Saloon (NC_)					
24					
1.6 HDi 82-84 kW (111-114 PS) 9HR (DV6C)	08.2013->		7.02209.11.0	AGR	EL 
			7.02156.35.0	AGR-K	EL ohne Sensor without sensor mit AGR-Ventil with EGR valve
			7.02156.34.0	AGR-K	EL ohne Sensor without sensor ohne AGR-Ventil without EGR valve
1.6 HDi 84 kW (114 PS) 9HD (DV6C)	08.2013->		7.02156.35.0	AGR-K	EL ohne Sensor without sensor mit AGR-Ventil with EGR valve
			7.02156.34.0	AGR-K	EL ohne Sensor without sensor ohne AGR-Ventil without EGR valve
C4 PICASSO I MPV (UD_)					
25					
1.6 16V 110 kW (150 PS) 5FX (EP6DT)	07.2008->08.2013		7.02604.41.0	LS	700 mm nicht für Schaltgetriebe not for manual transmission vor Katalysator in front of the catalyst
			7.05271.74.0	LS	450 mm
1.6 HDi 80-85 kW (109-116 PS) 9HY (DV6TED4)	02.2007->08.2013		7.11492.01.0	DDS	ohne Zubehör without accessories Organisationsnummer ab: 11319 RPO number from: 11319
1.6 HDi 80 kW (109 PS) 9HZ (DV6TED4)	02.2007->08.2013		7.24809.39.0	AGR	EL 
			7.11492.01.0	DDS	EL Euro 4 (D4) Euro 4 (D4) ohne Zubehör without accessories Organisationsnummer ab: 11319 RPO number from: 11319
1.6 HDi 110 82-84 kW (111-114 PS) 9HR (DV6C)	09.2010->08.2013		7.02209.11.0	AGR	EL 
			7.02156.24.0	AGR-K	EL mit Sensor with sensor 
			7.02156.35.0	AGR-K	EL ohne Sensor without sensor ->11.2012
			7.02156.33.0	AGR-K	EL ohne Sensor without sensor 01.2013-> mit AGR-Ventil with EGR valve
			7.02156.34.0	AGR-K	EL mit Sensor with sensor ->11.2012 ohne AGR-Ventil without EGR valve
1.6 THP 140 103 kW (140 PS) 5FT (EP6DT)	07.2008->08.2013		7.02604.41.0	LS	700 mm nicht für Schaltgetriebe not for manual transmission vor Katalysator in front of the catalyst
			7.05271.74.0	LS	450 mm
1.6 THP 155 115 kW (156 PS) 5FV (EP6CDT)	09.2010->08.2013		7.05271.74.0	LS	450 mm

C



































C4 PICASSO I MPV (UD_) 25

C

1.6 VTi 120 88 kW (120 PS) 5FW (EP6)	07.2008→08.2013		7.05271.74.0	LS	450 mm	
2.0 HDi 138 100-101 kW (136-138 PS) RHJ (DW10BTED4), RHR (DW10BTED4)	10.2006→08.2013		7.24809.68.0	AGR	EL	
			7.09730.00.0	AGR-K		ohne Zubehör without accessories  RHJ (DW10BTED4), RHR (DW10BTED4): Organisationsnummer ab: 11193 RPO number from: 11193
			7.11492.01.0	DDS		
2.0 HDi 150 110 kW (150 PS) RHE (DW10CTED4)	07.2009→08.2013		7.24809.94.0	AGR-K	EL	
			7.11492.01.0	DDS		Organisationsnummer ab: 12775 RPO number from: 12775 ohne Zubehör without accessories
			7.02604.99.0	LS	400 mm	
2.0 HDi 165 120 kW (163 PS) RHH (DW10CTED4)	09.2010→08.2013		7.24809.94.0	AGR-K	EL	
			7.11492.01.0	DDS		Organisationsnummer ab: 12775 RPO number from: 12775 ohne Zubehör without accessories
			7.02604.99.0	LS	400 mm	

C4 PICASSO II 26















1.6 HDi / BlueHDi 115 82-85 kW (112-116 PS) 9HC (DV6C)	02.2013→		7.02209.11.0	AGR	EL	
			7.02156.35.0	AGR-K	EL	ohne Sensor without sensor mit AGR-Ventil with EGR valve ohne Sensor without sensor ohne AGR-Ventil without EGR valve ohne Zubehör without accessories
			7.02156.34.0	AGR-K		
			7.11492.01.0	DDS		
1.6 HDi 90 68-69 kW (92-94 PS) 9HP (DV6DTED)	02.2013→		7.02209.11.0	AGR	EL	
			7.02156.35.0	AGR-K	EL	ohne Sensor without sensor mit AGR-Ventil with EGR valve ohne Sensor without sensor ohne AGR-Ventil without EGR valve ohne Zubehör without accessories
			7.02156.34.0	AGR-K		
			7.11492.01.0	DDS		
			7.02604.99.0	LS	400 mm	
1.6 THP 155 115 kW (156 PS) 5FV (EP6CDT)	02.2013→		7.05271.74.0	LS	450 mm	
1.6 VTi 120 88 kW (120 PS) 5FS (EP6C)	02.2013→		7.05271.74.0	LS	450 mm	

						
C4 PICASSO II						26
2.0 BlueHDi 135 100 kW (136 PS) AHV (DW10FD)	09.2013→		7.11492.01.0	DDS	ohne Zubehör without accessories Organisationsnummer bis: 14496 RPO number to: 14496	
2.0 BlueHDi 150 110 kW (150 PS) AHE (DW10FD), AHR (DW10FD), AHX (DW10FD)	09.2013→		7.11492.01.0	DDS	ohne Zubehör without accessories  AHE (DW10FD), AHR (DW10FD), AHX (DW10FD): Organisationsnummer bis: 14496 RPO number to: 14496	
C4 SPACETOURER (3D_)						27
1.6 HDi 115 82-85 kW (112-116 PS) 9HC (DV6C)	04.2018→		7.02209.11.0	AGR	EL 	
			7.02156.35.0	AGR-K	EL ohne Sensor without sensor mit AGR-Ventil with EGR valve	
			7.02156.34.0	AGR-K	ohne Sensor without sensor ohne AGR-Ventil without EGR valve	
			7.11492.01.0	DDS	ohne Zubehör without accessories	
2.0 BlueHDi 150 110 kW (150 PS) AHX (DW10FD)	04.2018→		7.11492.01.0	DDS	ohne Zubehör without accessories Organisationsnummer ab: 14496 RPO number from: 14496	
C5 AIRCROSS						28
1.5 BlueHDi 130 96 kW (131 PS) YHZ (DV5RC)	11.2018→		7.07794.23.0	AGR	EL mit Dichtring with O-ring	
C5 I (DC_)						29
1.8 16V (DC6FZB, DC6FZE) 85 kW (115 PS) 6FZ (EW7J4)	03.2001→08.2004		7.05270.38.0	LS	1240 mm	
2.0 16V (DCRFNC, DCRFNF) 88-105 kW (136-143 PS) RFN (EW10J4)	03.2001→08.2004		7.05270.37.0	LS	1640 mm	
2.0 16V HPi (DCRLZB) 103 kW (140 PS) RLZ (EW10D)	03.2001→08.2004		7.05270.38.0	LS	1240 mm	
2.0 HDi 79-81 kW (107-110 PS) RHS (DW10ATED), RHZ (DW10ATED)	03.2001→08.2004		7.22843.06.0	AGR	PN 	
			7.22843.07.0	AGR	PN 	
2.0 HDi (DCRHYB) 66 kW (90 PS) RHY (DW10TD)	03.2001→08.2004		7.22843.06.0	AGR	PN 	
			7.09730.01.0	AGR-K		
2.0 HDi (DCRHZB, DCRHZE) 79-81 kW (107-110 PS) RHZ (DW10ATED)	03.2001→08.2004		7.22843.06.0	AGR	PN 	
			7.22843.07.0	AGR	PN 	
2.2 HDi (DC4HXB, DC4HXE) 98 kW (133 PS) 4HX (DW12TED4)	03.2001→08.2004		7.22888.02.0	AGR	PN 	
3.0 V6 150-173 kW (204-235 PS) XFX (ES9J4S)	08.2002→03.2005		7.05270.37.0	LS	1640 mm	
3.0 V6 (DCXFXC, DCXFXF) 150-173 kW (204-235 PS) XFX (ES9J4S)	03.2001→08.2004		7.05270.37.0	LS	1640 mm	













































C5 I Break (DE_) 30

C

1.8 16V (DE6FZB, DE6FZE) 85 kW (115 PS) 6FZ (EW7J4)	06.2001→08.2004		7.05270.38.0	LS	1240 mm	
2.0 16V (DERFNF, DERFNC, RERFNC) 88-105 kW (136-143 PS) RFN (EW10J4)	06.2001→08.2004		7.05270.37.0	LS	1640 mm	
2.0 16V HPI (DERLZB) 103 kW (140 PS) RLZ (EW10D)	06.2001→08.2004		7.05270.38.0	LS	1240 mm	
2.0 HDi (DERHSB, DERHSE) 79 kW (107 PS) RHS (DW10ATED)	06.2001→08.2004		7.22843.06.0	AGR	PN	
			7.22843.07.0	AGR	PN	
2.0 HDi (DERHYB) 66 kW (90 PS) RHY (DW10TD)	06.2001→08.2004		7.22843.06.0	AGR	PN	
			7.09730.01.0	AGR-K		
2.0 HDi (DERHZB, DERHZE) 79-81 kW (107-110 PS) RHZ (DW10ATED)	06.2001→08.2004		7.22843.06.0	AGR	PN	
			7.22843.07.0	AGR	PN	
2.2 HDi (DE4HXB, DE4HXE) 98 kW (133 PS) 4HX (DW12TED4)	06.2001→08.2004		7.22888.02.0	AGR	PN	
3.0 Carlsson 150-173 kW (204-235 PS) XFX (ES9J4S)	09.2003→08.2004		7.05270.37.0	LS	1640 mm	
3.0 V6 (DEXFXC, DEXFXF) 150-173 kW (204-235 PS) XFX (ES9J4S)	06.2001→08.2004		7.05270.37.0	LS	1640 mm	





















C5 II (RC_) 31

1.6 HDi (RC8HZB) 80-85 kW (109-116 PS) 9HY (DV6TED4), 9HZ (DV6TED4)	09.2004→		7.24809.39.0	AGR	EL	
			7.11492.01.0	DDS		 9HY (DV6TED4), 9HZ (DV6TED4): Euro 4 (D4) Euro 4 (D4) ohne Zubehör without accessories  9HY (DV6TED4), 9HZ (DV6TED4): Organisationsnummer ab: 11284 RPO number from: 11284
1.8 16V 86-92 kW (117-125 PS) 6FY (EW7A)	09.2005→		7.05270.38.0	LS	1240 mm	
1.8 16V (RC6FZB) 85 kW (115 PS) 6FZ (EW7J4)	09.2004→08.2005		7.05270.38.0	LS	1240 mm	
2.0 16V 103-111 kW (140-151 PS) RFJ (EW10A)	03.2005→11.2007		7.05270.37.0	LS	1640 mm	
2.0 16V (RCRFJB, RCRFJC) 103-111 kW (140-151 PS) RFJ (EW10A)	09.2004→		7.05270.37.0	LS	1640 mm	
2.0 HDi (RCRHRH) 100-101 kW (136-138 PS) RHR (DW10BTED4)	09.2004→		7.24809.68.0	AGR	EL	
			7.09730.00.0	AGR-K		
			7.11492.01.0	DDS		ohne Zubehör without accessories Organisationsnummer ab: 10948 RPO number from: 10948
2.2 HDi 125 kW (170 PS) 4HT (DW12BTED4)	04.2006→		7.00578.12.0	AGR	EL	 für Fahrzeuge mit Diesel-Partikel-Filter (DPF) for vehicles with diesel soot filter

						
C5 II (RC_)						31
2.2 HDi (RC4HXE) 98 kW (133 PS) 4HX (DW12TED4)	09.2004→		7.22888.02.0	AGR	PN 	
3.0 V6 (RCXFUF) 150-173 kW (204-235 PS) XFU (ES9A), XFX (ES9J4S)	09.2004→		7.05270.37.0	LS	1640 mm	
C5 II Break (RE_)						32
1.6 HDi (RE8HZB) 80-85 kW (109-116 PS) 9HY (DV6TED4), 9HZ (DV6TED4)	09.2004→		7.24809.39.0 7.11492.01.0	AGR DDS	EL   9HY (DV6TED4), 9HZ (DV6TED4): Euro 4 (D4) Euro 4 (D4) ohne Zubehör without accessories  9HY (DV6TED4), 9HZ (DV6TED4): Organisationsnummer ab: 11284 RPO number from: 11284	
1.8 16V 86-92 kW (117-125 PS) 6FY (EW7A)	09.2005→		7.05270.38.0	LS	1240 mm	
1.8 16V (RE6FZB) 85 kW (115 PS) 6FZ (EW7J4)	09.2004→		7.05270.38.0	LS	1240 mm	
2.0 16V (RERFJB, RERFJC) 103-111 kW (140-151 PS) RFJ (EW10A)	09.2004→		7.05270.37.0	LS	1640 mm	
2.0 HDi (RERHRH) 100-101 kW (136-138 PS) RHR (DW10BTED4)	09.2004→		7.24809.68.0 7.09730.00.0 7.11492.01.0	AGR AGR-K DDS	EL  ohne Zubehör without accessories Organisationsnummer ab: 10948 RPO number from: 10948	
2.2 HDi 125 kW (170 PS) 4HT (DW12BTED4)	04.2006→		7.00578.12.0	AGR	EL  für Fahrzeuge mit Diesel-Partikel-Filter (DPF) for vehicles with diesel soot filter	
2.2 HDi (RE4HXE) 98 kW (133 PS) 4HX (DW12TED4)	09.2004→		7.22888.02.0	AGR	PN 	
3.0 150-173 kW (204-235 PS) XFX (ES9J4S)	09.2004→		7.05270.37.0	LS	1640 mm	
3.0 V6 152-155 kW (207-211 PS) XFU (ES9A)	10.2004→04.2007		7.05270.37.0	LS	1640 mm	
3.0 V6 (REXFUF) 152-155 kW (207-211 PS) XFU (ES9A)	09.2004→		7.05270.37.0	LS	1640 mm	
C5 III (RD_)						33
1.6 HDi 110 80 kW (109 PS) 9HZ (DV6TED4)	02.2008→		7.24809.39.0 7.11492.01.0	AGR DDS	EL  Euro 4 (D4) Euro 4 (D4) ohne Zubehör without accessories	
1.6 HDi 110 82-84 kW (111-114 PS) 9HL (DV6C), 9HR (DV6C)	07.2010→		7.02209.11.0 7.02156.24.0 7.02156.35.0 7.02156.33.0	AGR AGR-K AGR-K AGR-K	EL  EL mit Sensor with sensor  9HL (DV6C), 9HR (DV6C): →11.2012 ohne Sensor without sensor  9HL (DV6C), 9HR (DV6C): 01.2013→ mit Sensor with sensor	













C5 III (RD_) 33













C						
			7.02156.34.0	AGR-K		ohne Sensor without sensor  9HL (DV6C), 9HR (DV6C): 01.2013→ ohne AGR-Ventil without EGR valve
			7.11492.01.0	DDS		ohne Zubehör without accessories
1.6 HDi 115 82-84 kW (111-114 PS) 9HL (DV6C), 9HR (DV6C)	01.2012→		7.02209.11.0	AGR	EL	
			7.02156.24.0	AGR-K	EL	mit Sensor with sensor 
			7.02156.35.0	AGR-K	EL	 9HL (DV6C), 9HR (DV6C): →11.2012 ohne Sensor without sensor
			7.02156.33.0	AGR-K		 9HL (DV6C), 9HR (DV6C): 01.2013→ mit AGR-Ventil with EGR valve
			7.02156.34.0	AGR-K		mit Sensor with sensor
			7.11492.01.0	DDS		ohne Sensor without sensor  9HL (DV6C), 9HR (DV6C): 01.2013→ ohne AGR-Ventil without EGR valve
			7.11492.01.0	DDS		ohne Zubehör without accessories
1.6 THP 155 115 kW (156 PS) 5FV (EP6CDT)	04.2009→		7.05271.74.0	LS	450 mm	
1.6 VTi 120 88 kW (120 PS) 5FS (EP6C)	07.2010→		7.05271.74.0	LS	450 mm	
1.8 16V 86-92 kW (117-125 PS) 6FY (EW7A)	02.2008→		7.05270.38.0	LS	1240 mm	
2.0 16V 103-111 kW (140-151 PS) RFJ (EW10A)	02.2008→		7.05270.37.0	LS	1640 mm	
2.0 16V BioFlex 103-111 kW (140-151 PS) RFJ (EW10A)	02.2008→		7.05270.37.0	LS	1640 mm	
2.0 HDi 100-103 kW (136-140 PS) RHF (DW10BTED4), RHR (DW10BTED4)	02.2008→		7.24809.68.0	AGR	EL	
			7.09730.00.0	AGR-K		
			7.11492.01.0	DDS		ohne Zubehör without accessories
2.0 HDi 100-101 kW (136-138 PS) RHR (DW10BTED4)	10.2014→		7.24809.68.0	AGR	EL	
			7.11492.01.0	DDS		ohne Zubehör without accessories
2.0 HDi 140 100-103 kW (136-140 PS) RHF (DW10BTED4)	11.2008→		7.24809.68.0	AGR	EL	
			7.09730.00.0	AGR-K		
			7.11492.01.0	DDS		ohne Zubehör without accessories
2.0 HDi 150 / BlueHDi 150 110 kW (150 PS) AHR (DW10FD)	04.2009→		7.11492.01.0	DDS		ohne Zubehör without accessories
2.0 HDi 150 / BlueHDi 150 110 kW (150 PS) RHE (DW10CTED4)	04.2009→		7.24809.94.0	AGR-K	EL	 Organisationsnummer ab: 12775 RPO number from: 12775
			7.11492.01.0	DDS		ohne Zubehör without accessories



C5 III (RD_) 33

			7.02604.99.0	LS	400 mm	09.2009→ Motorcode: RHE (DW10CTED4) Engine Code: RHE (DW10CTED4) Produktionsdatum ab: 09.2009 Production date from: 09.2009
2.0 HDi 165 120 kW (163 PS) RHH (DW10CTED4)	04.2009→		7.24809.94.0	AGR-K	EL	 Organisationsnummer ab: 12775 RPO number from: 12775 ohne Zubehör without accessories
			7.11492.01.0	DDS		
			7.02604.99.0	LS	400 mm	
2.0 HDi 180 133 kW (181 PS) AHW (DW10FC)	03.2015→		7.11492.01.0	DDS		ohne Zubehör without accessories
2.2 HDi 125 125 kW (170 PS) 4HT (DW12BTED4)	02.2008→		7.00578.12.0	AGR	EL	 für Fahrzeuge mit Diesel-Partikel-Filter (DPF) for vehicles with diesel soot filter ohne Zubehör without accessories
			7.11492.01.0	DDS		
2.2 HDi 120 120 kW (163 PS) 4HP (DW12BTED4), 4HR (DW12BTED4)	04.2009→12.2011		7.11492.01.0	DDS		ohne Zubehör without accessories
2.2 HDi 200 150 kW (204 PS) 4HL (DW12C)	07.2010→		7.11492.01.0	DDS		ohne Zubehör without accessories
			7.02604.99.0	LS	400 mm	
2.7 HDi 150 150 kW (204 PS) UHZ (DT17TED4)	02.2008→		7.11237.01.0	AGR	EL	 04.2008→07.2009
3.0 HDi 240 155-177 kW (211-241 PS) DT20C	04.2009→10.2014		7.11492.01.0	DDS		ohne Zubehör without accessories
			7.05270.37.0	LS	1640 mm	

C5 III Break (RW_) 34



















1.6 HDi 110 80 kW (109 PS) 9HZ (DV6TED4)	02.2008→		7.24809.39.0	AGR	EL	 Euro 4 (D4) Euro 4 (D4) ohne Zubehör without accessories
			7.11492.01.0	DDS		
1.6 HDi 110 82-84 kW (111-114 PS) 9HL (DV6C), 9HR (DV6C)	07.2010→		7.02209.11.0	AGR	EL	 mit Sensor with sensor  9HL (DV6C), 9HR (DV6C): →11.2012  ohne Sensor without sensor  9HL (DV6C), 9HR (DV6C): 01.2013→ mit Sensor with sensor  ohne Sensor without sensor  9HL (DV6C), 9HR (DV6C): 01.2013→ ohne AGR-Ventil without EGR valve ohne Zubehör without accessories
			7.02156.24.0	AGR-K	EL	
			7.02156.35.0	AGR-K	EL	
			7.02156.33.0	AGR-K		
			7.02156.34.0	AGR-K		
			7.11492.01.0	DDS		
1.6 HDi 115 82-84 kW (111-114 PS) 9HL (DV6C), 9HR (DV6C)	01.2012→		7.02209.11.0	AGR	EL	 mit Sensor with sensor  9HL (DV6C), 9HR (DV6C): →11.2012
			7.02156.24.0	AGR-K	EL	



C5 III Break (RW_)

34

C







			7.02156.35.0	AGR-K	EL	ohne Sensor without sensor  9HL (DV6C), 9HR (DV6C): 01.2013→ mit AGR-Ventil with EGR valve
			7.02156.33.0	AGR-K		mit Sensor with sensor
			7.02156.34.0	AGR-K		ohne Sensor without sensor  9HL (DV6C), 9HR (DV6C): 01.2013→ ohne AGR-Ventil without EGR valve
			7.11492.01.0	DDS		ohne Zubehör without accessories
1.6 THP 155 115 kW (156 PS) 5FV (EP6CDT)	04.2009→		7.05271.74.0	LS	450 mm	
1.6 VTI 120 88 kW (120 PS) 5FS (EP6C)	07.2010→		7.05271.74.0	LS	450 mm	
1.8 16V 86-92 kW (117-125 PS) 6FY (EW7A)	02.2008→		7.05270.38.0	LS	1240 mm	
2.0 16V 103-111 kW (140-151 PS) RFJ (EW10A)	02.2008→		7.05270.37.0	LS	1640 mm	
2.0 HDi 100-101 kW (136-138 PS) RHR (DW10BTED4)	02.2008→		7.24809.68.0	AGR	EL	
			7.09730.00.0	AGR-K		ohne Zubehör without accessories
			7.11492.01.0	DDS		
2.0 HDi 140 100-103 kW (136-140 PS) RHF (DW10BTED4)	04.2009→		7.24809.68.0	AGR	EL	
			7.09730.00.0	AGR-K		ohne Zubehör without accessories
			7.11492.01.0	DDS		
2.0 HDi 150 / BlueHDi 150 110 kW (150 PS) AHR (DW10FD)	04.2009→		7.11492.01.0	DDS		ohne Zubehör without accessories
2.0 HDi 150 / BlueHDi 150 110 kW (150 PS) RHE (DW10CTED4)	04.2009→		7.24809.94.0	AGR-K	EL	
			7.11492.01.0	DDS		ohne Zubehör without accessories
			7.02604.99.0	LS	400 mm	09.2009→ Motorcode: RHE (DW10CTED4) Engine Code: RHE (DW10CTED4) Produktionsdatum ab: 09.2009 Production date from: 09.2009
2.0 HDi 165 120 kW (163 PS) RHH (DW10CTED4)	04.2009→		7.24809.94.0	AGR-K	EL	
			7.11492.01.0	DDS		Organisationennummer ab: 12775 RPO number from: 12775 ohne Zubehör without accessories
			7.02604.99.0	LS	400 mm	
2.0 HDi 180 133 kW (181 PS) AHW (DW10FC)	03.2015→		7.11492.01.0	DDS		ohne Zubehör without accessories
2.2 HDi 125 kW (170 PS) 4HT (DW12BTED4)	02.2008→		7.00578.12.0	AGR	EL	
			7.11492.01.0	DDS		für Fahrzeuge mit Diesel-Partikel-Filter (DPF) for vehicles with diesel soot filter ohne Zubehör without accessories
2.2 HDi 165 120 kW (163 PS) 4HP (DW12BTED4)	02.2008→		7.11492.01.0	DDS		ohne Zubehör without accessories

C5 III Break (RW_)					34
2.2 HDi 200 150 kW (204 PS) 4HL (DW12C)	07.2010→		7.11492.01.0 DDS	400 mm	ohne Zubehör without accessories
			7.02604.99.0 LS		
2.7 HDi 150 kW (204 PS) UHZ (DT17TED4)	02.2008→		7.11237.01.0 AGR	EL	⊗ 04.2008→07.2009
			7.11492.01.0 DDS		ohne Zubehör without accessories
3.0 HDi 240 155-177 kW (211-241 PS) DT20C	04.2009→10.2014		7.11492.01.0 DDS		ohne Zubehör without accessories
3.0 V6 152-155 kW (207-211 PS) XFU (ES9A), XfV (ES9A)	02.2008→		7.05270.37.0 LS	1640 mm	
C6 (TD_)					35
2.2 HDi 125 kW (170 PS) 4HT (DW12BTED4)	06.2006→12.2012		7.00578.12.0 AGR	EL	⊗ für Fahrzeuge mit Diesel-Partikel-Filter (DPF) for vehicles with diesel soot filter
			7.11492.01.0 DDS		ohne Zubehör without accessories Organisationsnummer ab: 11284 RPO number from: 11284
2.2 HDi 120 kW (163 PS) 4HP (DW12BTED4)	06.2006→12.2010		7.11492.01.0 DDS		ohne Zubehör without accessories Organisationsnummer ab: 11284 RPO number from: 11284
2.7 HDi 150 kW (204 PS) UHZ (DT17TED4)	09.2005→12.2011		7.11237.01.0 AGR	EL	⊗ 11.2005→06.2009
			7.11492.01.0 DDS		ohne Zubehör without accessories Organisationsnummer ab: 11284 RPO number from: 11284
3.0 HDi 155-177 kW (211-241 PS) DT20C	04.2009→12.2012		7.11492.01.0 DDS		ohne Zubehör without accessories
C8 (EA_, EB_)					36
2.0 HDi 76-81 kW (103-110 PS) RHM (DW10ATED4), RHT (DW10ATED4)	07.2002→		7.28069.04.0 AGR	PN	⊗ ⊗ RHM (DW10ATED4), RHT (DW10ATED4): für Fahrzeuge mit Diesel-Partikel-Filter (DPF) for vehicles with diesel soot filter
2.0 HDi 79-80 kW (107-109 PS) RHW (DW10ATED4)	07.2002→		7.28069.03.0 AGR	PN	⊗ für Fahrzeuge ohne Diesel-Partikel-Filter (DPF) for vehicles without diesel soot filter
			7.28069.04.0 AGR	PN	⊗ für Fahrzeuge mit Diesel-Partikel-Filter (DPF) for vehicles with diesel soot filter
2.0 HDi 79-81 kW (107-110 PS) RHT (DW10ATED4)	07.2002→		7.28069.04.0 AGR	PN	⊗ für Fahrzeuge mit Diesel-Partikel-Filter (DPF) for vehicles with diesel soot filter
2.0 HDi 79-88 kW (107-120 PS) RHK (DW10UTED4)	07.2006→		7.24809.68.0 AGR	EL	⊗
2.0 HDi 135 100 kW (136 PS) RHD (DW10CB)	03.2006→		7.11492.01.0 DDS		ohne Zubehör without accessories
			7.05270.21.0 LS	600 mm	vor Katalysator in front of the catalyst für Fahrzeuge mit Diesel-Partikel-Filter (DPF) for vehicles with diesel soot filter







C8 (EA_, EB_) 36

C









2.0 HDi 135 100 kW (136 PS) RHD (DW10CTED4)	03.2006→		7.24809.94.0	AGR-K	EL	<input type="checkbox"/> Organisationsnummer ab: 12853 RPO number from: 12853 ohne Zubehör without accessories
			7.11492.01.0	DDS		
2.0 HDi 135 100-101 kW (136-138 PS) RHR (DW10BTED4)	03.2006→		7.24809.68.0	AGR	EL	<input type="checkbox"/> ohne Zubehör without accessories Organisationsnummer ab: 11207 RPO number from: 11207
			7.09730.00.0	AGR-K		
			7.11492.01.0	DDS		
2.0 HDi 165 120 kW (163 PS) RHH (DW10CTED4)	03.2006→		7.24809.94.0	AGR-K	EL	<input type="checkbox"/> Organisationsnummer ab: 12853 RPO number from: 12853 ohne Zubehör without accessories vor Katalysator in front of the catalyst
			7.11492.01.0	DDS		
			7.05270.21.0	LS	600 mm	
2.2 HDi 94 kW (128 PS) 4HW (DW12TED4)	07.2002→		7.28069.04.0	AGR	PN	<input type="checkbox"/>
2.2 HDi 125 kW (170 PS) 4HT (DW12BTED4)	06.2006→		7.28069.04.0	AGR	PN	<input type="checkbox"/>
			7.00578.12.0	AGR	EL	<input type="checkbox"/> für Fahrzeuge mit Diesel-Partikel-Filter (DPF) for vehicles with diesel soot filter ohne Zubehör without accessories
			7.11492.01.0	DDS		
2.2 HDi 120 kW (163 PS) 4HP (DW12BTED4), 4HR (DW12BTED4)	06.2007→		7.11492.01.0	DDS		ohne Zubehör without accessories

DS3 37

1.4 HDi 70 50 kW (68 PS) 8HR (DV4C)	04.2010→07.2015		7.02209.11.0	AGR	EL	<input type="checkbox"/>
			7.02156.24.0	AGR-K	EL	mit Sensor with sensor <input type="checkbox"/>
			7.02156.35.0	AGR-K	EL	→10.2012 ohne Sensor without sensor
			7.02156.33.0	AGR-K		12.2012→ mit AGR-Ventil with EGR valve
			7.02156.34.0	AGR-K		mit Sensor with sensor →10.2012 ohne AGR-Ventil without EGR valve
			7.11492.01.0	DDS		ohne Sensor without sensor 12.2012→ ohne AGR-Ventil without EGR valve ohne Zubehör without accessories
1.4 VTi 95 70 kW (95 PS) 8FP (EP3C)	04.2010→07.2015		7.05271.74.0	LS	450 mm	
1.4 VTi 95 LPG 70-72 kW (95-98 PS) 8FR (EP3C)	08.2012→07.2015		7.05271.74.0	LS	450 mm	
1.4 VTi 98 70-72 kW (95-98 PS) 8FR (EP3C)	11.2009→07.2015		7.05271.74.0	LS	450 mm	



DS3 **37**





1.6 HDi 110 82-84 kW (111-114 PS) 9HR (DV6C)	11.2009→07.2015		7.02209.11.0 AGR EL 	
			7.02156.24.0 AGR-K EL mit Sensor with sensor  →11.2012	
			7.02156.35.0 AGR-K EL ohne Sensor without sensor 01.2013→ mit AGR-Ventil with EGR valve	
			7.02156.33.0 AGR-K mit Sensor with sensor →11.2012 ohne AGR-Ventil without EGR valve	
			7.02156.34.0 AGR-K ohne Sensor without sensor 01.2013→ ohne AGR-Ventil without EGR valve	
			7.11492.01.0 DDS ohne Zubehör without accessories	
1.6 HDi 115 84 kW (114 PS) 9HD (DV6C)	08.2012→07.2015		7.02209.11.0 AGR EL 	
			7.02156.24.0 AGR-K EL mit Sensor with sensor  →11.2012	
			7.02156.35.0 AGR-K EL ohne Sensor without sensor 01.2013→ mit AGR-Ventil with EGR valve	
			7.02156.33.0 AGR-K mit Sensor with sensor	
			7.02156.34.0 AGR-K ohne Sensor without sensor	
			7.11492.01.0 DDS ohne Zubehör without accessories	
1.6 HDi 90 68-69 kW (92-94 PS) 9HP (DV6DTED)	11.2009→07.2015		7.02209.11.0 AGR EL 	
			7.02156.24.0 AGR-K EL mit Sensor with sensor  →11.2012	
			7.02156.35.0 AGR-K EL ohne Sensor without sensor 01.2013→ mit AGR-Ventil with EGR valve	
			7.02156.33.0 AGR-K mit Sensor with sensor →11.2012 ohne AGR-Ventil without EGR valve	
			7.02156.34.0 AGR-K ohne Sensor without sensor 01.2013→ ohne AGR-Ventil without EGR valve	
			7.11492.01.0 DDS ohne Zubehör without accessories	
			7.02604.99.0 LS 400 mm	

C









DS3 **37**





C

1.6 Racing 149 kW (203 PS) 5FF (EP6DTS)	02.2011→07.2015		7.02604.41.0	LS	700 mm	vor Katalysator in front of the catalyst
			7.05271.74.0	LS	450 mm	
1.6 Racing 152 kW (207 PS) 5FD (EP6DTS)	02.2011→07.2015		7.02604.41.0	LS	700 mm	vor Katalysator in front of the catalyst
			7.05271.74.0	LS	450 mm	
1.6 THP 155 115 kW (156 PS) 5FR (EP6DT), 5FV (EP6CDT)	04.2010→07.2015		7.05271.74.0	LS	450 mm	
1.6 VTi 120 88 kW (120 PS) 5FS (EP6C)	04.2010→07.2015		7.05271.74.0	LS	450 mm	

DS3 Convertible **38**

1.6 HDi 90 68-69 kW (92-94 PS) 9HP (DV6DTEd)	01.2013→07.2015		7.02209.11.0	AGR	EL	
			7.02156.35.0	AGR-K	EL	ohne Sensor without sensor mit AGR-Ventil with EGR valve
			7.02156.34.0	AGR-K		ohne Sensor without sensor ohne AGR-Ventil without EGR valve
			7.11492.01.0	DDS		ohne Zubehör without accessories
			7.02604.99.0	LS	400 mm	
1.6 Racing 152 kW (207 PS) 5FD (EP6DTS)	03.2014→07.2015		7.02604.41.0	LS	700 mm	vor Katalysator in front of the catalyst
1.6 Racing 149 kW (203 PS) 5FF (EP6DTS)	03.2014→07.2015		7.02604.41.0	LS	700 mm	vor Katalysator in front of the catalyst
1.6 THP 155 115 kW (156 PS) 5FV (EP6CDT)	01.2013→07.2015		7.05271.74.0	LS	450 mm	
1.6 VTi 120 88 kW (120 PS) 5FS (EP6C)	01.2013→07.2015		7.05271.74.0	LS	450 mm	













DS4 (NX_) **39**

1.6 HDi 110 82-84 kW (111-114 PS) 9HR (DV6C)	04.2011→07.2015		7.02209.11.0	AGR	EL	
			7.02156.24.0	AGR-K	EL	mit Sensor with sensor
			7.02156.35.0	AGR-K	EL	 →11.2012 ohne Sensor without sensor
			7.02156.33.0	AGR-K		01.2013→ mit AGR-Ventil with EGR valve
			7.02156.34.0	AGR-K		mit Sensor with sensor →11.2012 ohne AGR-Ventil without EGR valve
			7.11492.01.0	DDS		ohne Sensor without sensor 01.2013→ ohne AGR-Ventil without EGR valve
1.6 HDi 115 84 kW (114 PS) 9HD (DV6C)	08.2012→07.2015		7.02209.11.0	AGR	EL	



DS4 (NX_)

39
C















			7.02156.24.0	AGR-K	EL	mit Sensor with sensor  →11.2012
			7.02156.35.0	AGR-K	EL	ohne Sensor without sensor 01.2013→ mit AGR-Ventil with EGR valve
			7.02156.33.0	AGR-K		mit Sensor with sensor
			7.02156.34.0	AGR-K		ohne Sensor without sensor
			7.11492.01.0	DDS		ohne Zubehör without accessories
1.6 HDi 90 68-69 kW (92-94 PS) 9HP (DV6DTEd)	05.2011→07.2015		7.02209.11.0	AGR	EL	
			7.02156.24.0	AGR-K	EL	mit Sensor with sensor  →11.2012
			7.02156.35.0	AGR-K	EL	ohne Sensor without sensor 01.2013→ mit AGR-Ventil with EGR valve
			7.02156.33.0	AGR-K		mit Sensor with sensor →11.2012 ohne AGR-Ventil without EGR valve
			7.02156.34.0	AGR-K		ohne Sensor without sensor 01.2013→ ohne AGR-Ventil without EGR valve
			7.11492.01.0	DDS		ohne Zubehör without accessories
			7.02604.99.0	LS	400 mm	
1.6 THP 155 115 kW (156 PS) 5FV (EP6CDT)	04.2011→07.2015		7.05271.74.0	LS	450 mm	
1.6 THP 200 147 kW (200 PS) 5FU (EP6DTX)	04.2011→07.2015		7.05271.74.0	LS	450 mm	
1.6 VTi 120 88 kW (120 PS) 5FS (EP6C)	04.2011→07.2015		7.05271.74.0	LS	450 mm	
2.0 BlueHDi 150 110 kW (150 PS) AHX (DW10FD)	07.2014→07.2015		7.11492.01.0	DDS		ohne Zubehör without accessories
2.0 HDi / BlueHDi 135 100 kW (136 PS) AHS (DW10FD), AHV (DW10FD)	09.2011→07.2015		7.02604.99.0	LS	400 mm	
2.0 HDi / BlueHDi 135 100 kW (136 PS) RHD (DW10CB), RHD (DW10CTED4)	09.2011→07.2015		7.24809.94.0	AGR-K	EL	 Organisationsnummer ab: 12775 RPO number from: 12775
			7.11492.01.0	DDS		ohne Zubehör without accessories
			7.02604.99.0	LS	400 mm	
2.0 HDi 165 120 kW (163 PS) RHH (DW10CTED4)	04.2011→07.2015		7.24809.94.0	AGR-K	EL	 Organisationsnummer ab: 12775 RPO number from: 12775































DS4 (NX_) **39**

C			7.11492.01.0	DDS		ohne Zubehör without accessories
			7.02604.99.0	LS	400 mm	

DS5 **40**







1.6 HDi 110 82-84 kW (111-114 PS) 9HR (DV6C)	11.2011→07.2015		7.02209.11.0	AGR	EL	
			7.02156.24.0	AGR-K	EL	mit Sensor with sensor  →11.2012
			7.02156.35.0	AGR-K	EL	ohne Sensor without sensor 01.2013→ mit AGR-Ventil with EGR valve
			7.02156.33.0	AGR-K		mit Sensor with sensor
			7.02156.34.0	AGR-K		ohne Sensor without sensor 01.2013→ ohne AGR-Ventil without EGR valve
			7.11492.01.0	DDS		ohne Zubehör without accessories
1.6 HDi 115 84 kW (114 PS) 9HD (DV6C)	06.2012→07.2015		7.02209.11.0	AGR	EL	
			7.02156.24.0	AGR-K	EL	mit Sensor with sensor  →11.2012
			7.02156.35.0	AGR-K	EL	ohne Sensor without sensor 01.2013→ mit AGR-Ventil with EGR valve
			7.02156.33.0	AGR-K		mit Sensor with sensor
			7.02156.34.0	AGR-K		ohne Sensor without sensor 01.2013→ ohne AGR-Ventil without EGR valve
			7.11492.01.0	DDS		ohne Zubehör without accessories
1.6 THP 155 115 kW (156 PS) 5FV (EP6CDT)	11.2011→07.2015		7.05271.74.0	LS	450 mm	
1.6 THP 200 147 kW (200 PS) 5FU (EP6DTX)	11.2011→07.2015		7.05271.74.0	LS	450 mm	
2.0 BlueHDi 150 110 kW (150 PS) AHX (DW10FD)	07.2014→07.2015		7.11492.01.0	DDS		ohne Zubehör without accessories
2.0 BlueHDi 180 133 kW (181 PS) AHW (DW10FC)	08.2013→07.2015		7.11492.01.0	DDS		ohne Zubehör without accessories
2.0 HDi 135 100 kW (136 PS) RHD (DW10CB)	11.2011→07.2015		7.24809.94.0	AGR-K	EL	 Organisationsnummer ab: 12775 RPO number from: 12775
			7.11492.01.0	DDS		ohne Zubehör without accessories
			7.02604.99.0	LS	400 mm	
2.0 HDi 165 120 kW (163 PS) RHH (DW10CTED4)	11.2011→07.2015		7.24809.94.0	AGR-K	EL	 Organisationsnummer ab: 12775 RPO number from: 12775

					
DS5					40
			7.11492.01.0	DDS	ohne Zubehör without accessories
			7.02604.99.0	LS	400 mm
2.0 HDi 165 Hybrid4 4x4 120 kW (163 PS) RHC (DW10CTED4)	12.2011→07.2015		7.24809.94.0	AGR-K	EL Organisationsnummer ab: 12775 RPO number from: 12775
			7.11492.01.0	DDS	ohne Zubehör without accessories
			7.02604.99.0	LS	400 mm
ELYSEE					41
1.6i 16V 80-90 kW (109-122 PS) NFU (TU5JP4)	06.2002→		7.05270.37.0	LS	1640 mm
EVASION MPV (22, U6)					42
2.0 89 kW (121 PS) RFU (XU10J2/C)	06.1994→07.2002		7.02604.04.0	LS	200 mm
2.0 16V 97-99 kW (132-135 PS) RFV (XU10J4R)	05.1998→04.2000		7.05270.37.0	LS	1640 mm
2.0 16V 88-105 kW (136-143 PS) RFN (EW10J4)	05.2000→07.2002		7.05270.37.0	LS	1640 mm
2.0 HDI	08.1999→07.2002		7.28069.03.0	AGR	PN 
2.0 HDI 16V 79-80 kW (107-109 PS) RHW (DW10ATED4)	09.1999→07.2002		7.28069.03.0	AGR	PN  für Fahrzeuge ohne Diesel-Partikel-Filter (DPF) for vehicles without diesel soot filter
2.0 Turbo C.T. 108 kW (147 PS) RGX (XU10J2TE)	06.1994→07.2002		7.02604.04.0	LS	200 mm
GRAND C4 SPACETOURER (3A_, 3E_)					43
1.6 HDi 115 82-85 kW (112-116 PS) 9HC (DV6C)	04.2018→		7.02209.11.0	AGR	EL 
			7.02156.35.0	AGR-K	EL ohne Sensor without sensor
			7.02156.34.0	AGR-K	EL mit AGR-Ventil with EGR valve ohne Sensor without sensor
NEMO MPV					44
1.3 HDi 75 55 kW (75 PS) FHZ (F13DTE5)	10.2010→		7.01599.10.0	AGR	EL 
			7.03622.06.0	AGR-K	
			7.11190.03.0	DDS	ohne Zubehör without accessories
1.3 HDi 80 59-70 kW (80-95 PS) FHY (F13DTE6)	10.2015→		7.01599.10.0	AGR	EL 
			7.11190.03.0	DDS	ohne Zubehör without accessories für OE-Nummer: 16 105 313 80, 1618 SV for OE number: 16 105 313 80, 1618 SV
1.4 HDi 50 kW (68 PS) 8HS (DV4TED)	04.2009→		7.24809.76.0	AGR	EL 
SAXO (S0, S1)					45
1.0 X 33-37 kW (45-50 PS) CDY (TU9M)	05.1996→11.1998		7.05270.39.0	LS	400 mm
1.0 X 33-37 kW (45-50 PS) CDZ (TU9M)	05.1998→06.2003		7.05270.39.0	LS	400 mm
1.1 X,SX 40-44 kW (55-60 PS) HDZ (TU1M)	05.1996→09.2003		7.05270.39.0	LS	400 mm



SAXO (S0, S1) 45









C

1.1 X,SX 40-44 kW (55-60 PS) HDZ (TU1M), HFX (TU1JP)	05.1996→09.2003		7.05270.39.0	LS	400 mm	
1.4 VTS 47-57 kW (64-77 PS) KFW (TU3JP), KFX (TU3JP)	05.1996→06.2003		7.05270.36.0	LS	540 mm	 KFW (TU3JP), KFX (TU3JP): Euro 3, Technische Schadstoffverringierung K Euro 3, Technical pollution reduction K
			7.05270.39.0	LS	400 mm	
			7.02604.04.0	LS	200 mm	
1.6 65-67 kW (88-91 PS) NFZ (TU5JP)	02.1996→06.2003		7.05270.39.0	LS	400 mm	
1.6 72-74 kW (98-101 PS) NFT (TU5JP)	02.2001→04.2004		7.05270.39.0	LS	400 mm	
1.6 VTL,VTR 65-67 kW (88-91 PS) NFZ (TU5JP)	08.1997→06.2003		7.05270.39.0	LS	400 mm	
1.6 VTS 72-74 kW (98-101 PS) NFT (TU5JP)	09.2000→09.2003		7.05270.39.0	LS	400 mm	

VISA 46

14 44 kW (60 PS) 150D (XY7)	07.1984→03.1991		7.02604.03.0	LS	200 mm	
14 GT 55-59 kW (75-80 PS) 150B (XY8)	03.1982→03.1991		7.02604.03.0	LS	200 mm	
14 GT 55-59 kW (75-80 PS) 150B (XY8)	03.1982→03.1987		7.02604.03.0	LS	200 mm	



XANTIA (X1_, X2_) 47





























1.6 i 65-66 kW (88-90 PS) BFZ (XU5JP)	10.1993→03.2001		7.02604.04.0	LS	200 mm	
1.8 i 73-76 kW (99-103 PS) LFZ (XU7JP)	03.1993→01.1998		7.02604.04.0	LS	200 mm	
1.8 i 58-66 kW (90 PS) LFX (XU7JB)	05.1997→04.2003		7.02604.04.0	LS	200 mm	
1.8 i 16V 76-85 kW (110-116 PS) LFY (XU7JP4)	06.1995→12.2001		7.05270.37.0	LS	1640 mm	
2.0 i 89-90 kW (120-122 PS) RFX (XU10J2C)	03.1993→04.2003		7.02604.04.0	LS	200 mm	
2.0 i 16V 110-114 kW (150-155 PS) RFY (XU10J4/Z)	03.1993→01.1998		7.02604.04.0	LS	200 mm	
2.0 i 16V 110-114 kW (150-155 PS) RFT (XU10J4/Z)	06.1994→01.1998		7.02604.04.0	LS	200 mm	
2.0 i 16V 97-99 kW (132-135 PS) RFV (XU10J4R)	06.1995→04.2003		7.02604.04.0	LS	200 mm	

XANTIA Break (X1_, X2_) 48

1.8 i 73-76 kW (99-103 PS) LFZ (XU7JP)	06.1995→01.1998		7.02604.04.0	LS	200 mm	
1.8 i 58-66 kW (90 PS) LFX (XU7JB)	05.1997→04.2003		7.02604.04.0	LS	200 mm	
1.8 i 16V 76-85 kW (110-116 PS) LFY (XU7JP4)	06.1995→04.2003		7.05270.37.0	LS	1640 mm	
2.0 i 89-90 kW (120-122 PS) RFX (XU10J2C)	06.1995→04.2003		7.02604.04.0	LS	200 mm	
2.0 i 16V 97-99 kW (132-135 PS) RFV (XU10J4R)	06.1995→04.2003		7.02604.04.0	LS	200 mm	

XM (Y3) 49

2.0 90-96 kW (122-130 PS) R6A	05.1989→06.1994		7.02604.04.0	LS	200 mm	
2.0 i 89-90 kW (121-122 PS) RFZ (XU10J2)	05.1989→06.1994		7.02604.04.0	LS	200 mm	















						
XM (Y3)						49
2.0 i 79 kW (107 PS) RDZ (XU10MZ)	05.1989→04.1994		7.02604.04.0	LS	200 mm	
2.0 i Turbo 104-108 kW (141-147 PS) RGY (XU10J2TE/Z)	09.1992→06.1994		7.02604.04.0	LS	200 mm	
XM (Y4)						50
2.0 Turbo 108 kW (147 PS) RGX (XU10J2TE)	05.1994→10.2000		7.02604.04.0	LS	200 mm	
2.0 i 16V 97-99 kW (132-135 PS) RFV (XU10J4R)	05.1994→10.2000		7.02604.04.0	LS	200 mm	
XM Break (Y3)						51
2.0 90-96 kW (122-130 PS) R6A	05.1989→06.1994		7.02604.04.0	LS	200 mm	
2.0 Turbo 104-108 kW (141-147 PS) RGY (XU10J2TE/Z)	09.1992→04.1994		7.02604.04.0	LS	200 mm	
2.0 i 89-90 kW (121-122 PS) RFZ (XU10J2)	11.1991→04.1994		7.02604.04.0	LS	200 mm	
XM Break (Y4)						52
2.0 Turbo 104-108 kW (141-147 PS) RGX (XU10J2TE), RGY (XU10J2TE/Z)	05.1994→10.2000		7.02604.04.0	LS	200 mm	
2.0 i 16V 97-99 kW (132-135 PS) RFV (XU10J4R)	05.1994→10.2000		7.02604.04.0	LS	200 mm	
XSARA (N1)						53
1.4 HDi 50-55 kW (68-75 PS) 8HX (DV4TD)	01.2003→03.2005		7.24809.06.0	AGR	PN mit Rohrstützen with pipe socket Euro 3 Euro 3	
1.4 LPG 47-57 kW (64-77 PS) KFW (TU3JP)	05.1998→08.2000		7.05270.36.0	LS	540 mm	15-04 15-04
1.4 i 47-57 kW (64-77 PS) KFW (TU3JP), KFX (TU3JP)	04.1997→03.2005		7.05270.36.0	LS	540 mm	
			7.05270.39.0	LS	400 mm	
1.6 i 65-67 kW (88-91 PS) NFZ (TU5JP)	08.1997→09.2000		7.05270.36.0	LS	540 mm	Organisationsnummer bis: 07728 RPO number to: 07728 15-04 15-04
1.8 i 58-66 kW (90 PS) LFX (XU7JB)	05.1997→09.2000		7.05270.38.0	LS	1240 mm	
1.8 i Aut. 73-76 kW (99-103 PS) LFX (XU7JP)	04.1997→09.2000		7.05270.38.0	LS	1240 mm	
2.0 16V 97-99 kW (132-135 PS) RFV (XU10J4R)	07.1998→09.2000		7.05270.37.0	LS	1640 mm	
2.0 16V 88-105 kW (136-143 PS) RFN (EW10J4)	09.2000→03.2005		7.05270.37.0	LS	1640 mm	
			7.22843.06.0	AGR	PN	
2.0 HDi 109 79-81 kW (107-110 PS) RHZ (DW10ATED)	05.2001→03.2005		7.22843.06.0	AGR	PN	
			7.09730.01.0	AGR-K		
			7.22843.06.0	AGR	PN	
2.0 HDi 90 66 kW (90 PS) RHY (DW10TD)	02.1999→03.2005		7.22843.06.0	AGR	PN	
			7.09730.01.0	AGR-K		

C















XSARA Break (N2) 54

C

1.4 HDi 50-55 kW (68-75 PS) 8HX (DV4TD)	01.2003→08.2005	 7.24809.06.0	AGR	PN	mit Rohrstutzen with pipe socket ○ Euro 3 Euro 3
1.4 LPG 47-57 kW (64-77 PS) KFW (TU3JP), KFX (TU3JP)	05.1998→08.2000	 7.05270.36.0	LS	540 mm	
1.4 i 47-57 kW (64-77 PS) KFW (TU3JP), KFX (TU3JP)	10.1997→08.2005	 7.05270.36.0	LS	540 mm	
		 7.05270.39.0	LS	400 mm	
1.6 i 65-67 kW (88-91 PS) NFZ (TU5JP)	10.1997→09.2000	 7.05270.36.0	LS	540 mm	Organisationsnummer bis: 07728 RPO number to: 07728 15-04 15-04
1.8 LPG 76-85 kW (110-116 PS) LFY (XU7JP4)	05.1998→08.2000	 7.05270.37.0	LS	1640 mm	
1.8 i 58-66 kW (90 PS) LFX (XU7JB)	10.1997→09.2000	 7.05270.38.0	LS	1240 mm	
1.8 i Aut. 73-76 kW (99-103 PS) LFZ (XU7JP)	10.1997→09.2000	 7.05270.38.0	LS	1240 mm	
2.0 16V 97-99 kW (132-135 PS) RFV (XU10J4R)	07.1998→09.2000	 7.05270.37.0	LS	1640 mm	
2.0 16V 88-105 kW (136-143 PS) RFN (EW10J4)	09.2000→08.2005	 7.05270.37.0	LS	1640 mm	
2.0 HDi 90 66 kW (90 PS) RHY (DW10TD)	02.1999→08.2005	 7.22843.06.0	AGR	PN	○
		 7.09730.01.0	AGR-K		
2.0 HDi 109 79-81 kW (107-110 PS) RHZ (DW10ATED)	05.2001→08.2005	 7.22843.06.0	AGR	PN	○
		 7.09730.01.0	AGR-K		











XSARA Coupe (N0) 55

1.4 HDi 50-55 kW (68-75 PS) 8HX (DV4TD)	01.2003→03.2005	 7.24809.06.0	AGR	PN	mit Rohrstutzen with pipe socket ○ Euro 3 Euro 3
1.4 i 47-57 kW (64-77 PS) KFW (TU3JP), KFX (TU3JP)	03.1998→03.2005	 7.05270.36.0	LS	540 mm	
		 7.05270.39.0	LS	400 mm	
1.8 i 58-66 kW (90 PS) LFX (XU7JB)	02.1998→09.2000	 7.05270.38.0	LS	1240 mm	
1.8 i 73-76 kW (99-103 PS) LFZ (XU7JP)	02.1998→09.2000	 7.05270.38.0	LS	1240 mm	
2.0 97-99 kW (132-135 PS) RFV (XU10J4R)	08.1998→08.2000	 7.05270.37.0	LS	1640 mm	
2.0 16V 88-105 kW (136-143 PS) RFN (EW10J4)	09.2000→03.2005	 7.05270.37.0	LS	1640 mm	
2.0 HDi 90 66 kW (90 PS) RHY (DW10TD)	02.1999→03.2005	 7.22843.06.0	AGR	PN	○
		 7.09730.01.0	AGR-K		
2.0 HDi 109 79-81 kW (107-110 PS) RHZ (DW10ATED)	05.2001→03.2005	 7.22843.06.0	AGR	PN	○
		 7.09730.01.0	AGR-K		
2.0 i 16V 120-122 kW (163-166 PS) RFS (XU10J4RS)	02.1998→03.2005	 7.05270.37.0	LS	1640 mm	

XSARA PICASSO (N68)
56

1.6 HDi 80-85 kW (109-116 PS) 9HY (DV6TED4), 9HZ (DV6TED4)	05.2004→12.2011		7.24809.39.0 AGR EL 	ohne Zubehör without accessories  9HY (DV6TED4), 9HZ (DV6TED4): Organisationsnummer ab: 11319 RPO number from: 11319
			7.11492.01.0 DDS	
1.6 HDi 66-68 kW (90-92 PS) 9HX (DV6ATED4)	09.2005→12.2011		7.24809.39.0 AGR EL 	
1.8 16V 85 kW (115 PS) 6FZ (EW7J4)	02.2000→08.2005		7.05270.37.0 LS 1640 mm	
1.8 SX 76-85 kW (110-116 PS) LFY (XU7JP4)	06.2000→08.2005		7.05270.37.0 LS 1640 mm	
2.0 16V 88-105 kW (136-143 PS) RFN (EW10J4)	12.1999→11.2011		7.05270.37.0 LS 1640 mm	
2.0 16V 88-105 kW (136-143 PS) RFN (EW10J4)	01.2003→06.2012		7.05270.37.0 LS 1640 mm	
2.0 HDi 66 kW (90 PS) RHY (DW10TD)	12.1999→12.2011		7.22843.06.0 AGR PN 	
			7.09730.01.0 AGR-K	





C
ZX (N2)
57

1.1 40-44 kW (55-60 PS) HDZ (TU1M)	03.1991→06.1997		7.05270.39.0 LS 400 mm	
			7.05270.38.0 LS 1240 mm	
1.4 i 53-59 kW (72-80 PS) KDX (TU3M/Z), KDZ (TU3M/Z), KFX (TU3JP)	03.1991→06.1997		7.05270.39.0 LS 400 mm	
			7.02604.04.0 LS 200 mm	
			7.05270.38.0 LS 1240 mm	
1.6 65-66 kW (88-90 PS) BDY (XU5M), BFZ (XU5JP)	07.1994→10.1997		7.02604.04.0 LS 200 mm	
			7.05270.38.0 LS 1240 mm	
1.6 i 65-66 kW (88-90 PS) BDY (XU5M), BFZ (XU5JP)	03.1991→06.1997		7.02604.04.0 LS 200 mm	
			7.05270.38.0 LS 1240 mm	
1.8 73-76 kW (99-103 PS) LFZ (XU7JP)	03.1991→10.1997		7.02604.04.0 LS 200 mm	
			7.05270.38.0 LS 1240 mm	
1.8 i 73-76 kW (99-103 PS) LFZ (XU7JP)	07.1992→06.1997		7.02604.04.0 LS 200 mm	
			7.05270.38.0 LS 1240 mm	
1.9 93-96 kW (126-131 PS) D6E (XU9JA)	03.1991→06.1997		7.02604.04.0 LS 200 mm	
1.9 i 88 kW (120 PS) DKZ (XU9JA)	03.1991→06.1997		7.02604.04.0 LS 200 mm	
2.0 89-90 kW (120-122 PS) RFX (XU10J2C)	07.1994→10.1997		7.02604.04.0 LS 200 mm	
			7.05270.38.0 LS 1240 mm	
2.0 120-122 kW (163-166 PS) RFS (XU10J4RS)	09.1996→10.1997		7.02604.04.0 LS 200 mm	
			7.05270.38.0 LS 1240 mm	







ZX (N2) 57





C























2.0 i 89-90 kW (120-122 PS) RFX (XU10J2C)	07.1992→06.1997		7.02604.04.0	LS	200 mm
			7.05270.38.0	LS	1240 mm
2.0 i 16V 110-114 kW (150-155 PS) RFT (XU10J4/Z), RFY (XU10J4/Z)	07.1992→10.1994		7.02604.04.0	LS	200 mm
			7.05270.38.0	LS	1240 mm
2.0 i 16V 110-114 kW (150-155 PS) RFT (XU10J4/Z), RFY (XU10J4/Z)	07.1992→10.1997		7.02604.04.0	LS	200 mm
			7.05270.38.0	LS	1240 mm
2.0 i 16V 110-114 kW (150-155 PS) RFT (XU10J4/Z)	06.1994→06.1997		7.02604.04.0	LS	200 mm
			7.05270.38.0	LS	1240 mm
2.0 i 16V 120-122 kW (163-166 PS) RFS (XU10J4RS)	05.1996→06.1997		7.02604.04.0	LS	200 mm
			7.05270.38.0	LS	1240 mm

ZX Break (N2) 58

1.4 i 53-58 kW (72-79 PS) KDX (TU3M/Z), KDY (TU3M), KFX (TU3JP)	10.1993→10.1997		7.05270.39.0	LS	400 mm
			7.02604.04.0	LS	200 mm
			7.05270.38.0	LS	1240 mm
1.6 i 65-66 kW (88-90 PS) BDY (XU5M), BFZ (XU5JP)	10.1993→10.1997		7.02604.04.0	LS	200 mm
			7.05270.38.0	LS	1240 mm
1.8 i 73-76 kW (99-103 PS) LFZ (XU7JP)	10.1993→10.1997		7.02604.04.0	LS	200 mm
			7.05270.38.0	LS	1240 mm
2.0 89-95 kW (121-129 PS) RFX XU10J2C/Z L3	10.1993→11.1995		7.02604.04.0	LS	200 mm
			7.05270.38.0	LS	1240 mm

BERLINGO / BERLINGO FIRST Box Body/MPV (M_) 59

1.1 i (MAHDZ, MBHDZ, MBHFX) 40-44 kW (55-60 PS) HDZ (TU1M), HFX (TU1JP)	07.1996→03.2008		7.05270.39.0	LS	400 mm
			7.02604.04.0	LS	200 mm
1.4 bivalent 47-57 kW (64-77 PS) KFW (TU3JP)	11.2002→12.2011		7.05270.36.0	LS	540 mm Euro3/Euro4, Technische Schadstoffverringierung K Euro3/Euro4, Technical pollution reduction K
1.4 i 47-57 kW (64-77 PS) KFW (TU3JP)	08.1999→05.2008		7.05270.36.0	LS	540 mm Euro3/Euro4, Technische Schadstoffverringierung K Euro3/Euro4, Technical pollution reduction K
1.4 i (MBKFX, MBKFW) 47-57 kW (64-77 PS) KFW (TU3JP)	07.1996→12.2011		7.05270.36.0	LS	540 mm Euro3/Euro4, Technische Schadstoffverringierung K Euro3/Euro4, Technical pollution reduction K
			7.05270.39.0	LS	400 mm
			7.02604.04.0	LS	200 mm















					
BERLINGO / BERLINGO FIRST Box Body/MPV (M_)					
59					
1.4 i (MBKFX, MBKFW) 53-57 kW (72-77 PS) KFW (TU3A), KFX (TU3JP)	07.1996→12.2011		7.05270.39.0	LS	400 mm
			7.02604.04.0	LS	200 mm
1.4 i bivalent (MBKFW) 47-57 kW (64-77 PS) KFW (TU3JP)	04.2003→10.2005		7.05270.36.0	LS	540 mm
			7.05270.39.0	LS	400 mm
			7.02604.04.0	LS	200 mm
1.6 HDI 75 (MB9HW) 55 kW (75 PS) 9HW (DV6BTED4), DV6B	07.2005→12.2011		7.24809.39.0	AGR	EL 
			7.24809.39.0	AGR	EL 
1.6 HDI 90 (MB9HX, MC9HX) 66-68 kW (90-92 PS) 9HX (DV6ATED4)	07.2005→12.2011		7.03647.10.0	AGR-K	EL  ohne Sensor without sensor
			7.11492.01.0	DDS	ohne Zubehör without accessories Organisationsnummer ab: 11211FL, 11211FV RPO number from: 11211FL, 11211FV
2.0 HDI 90 (MBRHY, MCRHY) 66 kW (90 PS) RHY (DW10TD)	12.1999→12.2011		7.22843.06.0	AGR	PN 
			7.09730.01.0	AGR-K	
2.0 HDI 90 4WD (MBRHY, MCRHY) 66 kW (90 PS) RHY (DW10TD)	11.2000→10.2005		7.22843.06.0	AGR	PN 
			7.09730.01.0	AGR-K	
BERLINGO Box Body/MPV (B9)					
60					
1.6 HDi / BlueHDi 75 55 kW (75 PS) 9HN (DV6ETED)	07.2010→		7.02209.11.0	AGR	EL 
			7.02156.35.0	AGR-K	EL ohne Sensor without sensor 01.2013→ mit AGR-Ventil with EGR valve
			7.02156.33.0	AGR-K	mit Sensor with sensor →11.2012 ohne AGR-Ventil without EGR valve
			7.02156.34.0	AGR-K	ohne Sensor without sensor 01.2013→ ohne AGR-Ventil without EGR valve
			7.11492.01.0	DDS	ohne Zubehör without accessories Organisationsnummer ab: 11211FL, 11211FV RPO number from: 11211FL, 11211FV
1.6 HDi 110 80 kW (109 PS) 9HZ (DV6TED4)	04.2008→		7.24809.39.0	AGR	EL 
1.6 HDi 110 82-84 kW (111-114 PS) 9HL (DV6C), 9HR (DV6C)	07.2010→		7.02209.11.0	AGR	EL 















C



BERLINGO Box Body/MPV (B9) 60

C

			7.02156.24.0	AGR-K	EL	mit Sensor with sensor 
			7.02156.35.0	AGR-K	EL	ohne Sensor without sensor  9HL (DV6C), 9HR (DV6C): →11.2012
			7.02156.33.0	AGR-K		mit Sensor with sensor
			7.02156.34.0	AGR-K		ohne Sensor without sensor  9HL (DV6C), 9HR (DV6C): 01.2013→ mit AGR-Ventil with EGR valve
			7.11492.01.0	DDS		ohne Sensor without sensor  9HL (DV6C), 9HR (DV6C): 01.2013→ ohne AGR-Ventil without EGR valve ohne Zubehör without accessories  9HL (DV6C), 9HR (DV6C): Organisationsnummer ab: 11211FL, 11211FV RPO number from: 11211FL, 11211FV
1.6 HDi 115 82-84 kW (111-114 PS) 9HL (DV6C)	07.2010→		7.02209.11.0	AGR	EL	
			7.02156.24.0	AGR-K	EL	mit Sensor with sensor 
			7.02156.35.0	AGR-K	EL	ohne Sensor without sensor →11.2012
			7.02156.33.0	AGR-K		ohne Sensor without sensor 01.2013→ mit AGR-Ventil with EGR valve
			7.02156.34.0	AGR-K		mit Sensor with sensor →11.2012 ohne AGR-Ventil without EGR valve
			7.11492.01.0	DDS		ohne Sensor without sensor 01.2013→ ohne AGR-Ventil without EGR valve ohne Zubehör without accessories Organisationsnummer ab: 11211FL, 11211FV RPO number from: 11211FL, 11211FV
1.6 HDi 115 4x4 84 kW (114 PS) DV6CTED	02.2012→		7.02209.11.0	AGR	EL	
1.6 HDi 75 55 kW (75 PS) 9HT (DV6BTED4), 9HT (DV6BUTED4)	04.2008→		7.24809.39.0	AGR	EL	
			7.02604.99.0	LS	400 mm	
1.6 HDi 75 4x4 55 kW (75 PS) 9HN (DV6ETED)	02.2012→		7.02209.11.0	AGR	EL	
			7.02156.35.0	AGR-K	EL	ohne Sensor without sensor 01.2013→ mit AGR-Ventil with EGR valve
			7.02156.33.0	AGR-K		mit Sensor with sensor →11.2012 ohne AGR-Ventil without EGR valve

					
BERLINGO Box Body/MPV (B9)					60
			7.02156.34.0	AGR-K	ohne Sensor without sensor 01.2013→ ohne AGR-Ventil without EGR valve
			7.11492.01.0	DDS	ohne Zubehör without accessories Organisationsnummer ab: 11211FL, 11211FV RPO number from: 11211FL, 11211FV
1.6 HDi 90 66 kW (90 PS) 9HF (DV6DTED)	07.2010→		7.02209.11.0	AGR	EL 
			7.02156.24.0	AGR-K	EL mit Sensor with sensor  →11.2012
			7.02156.35.0	AGR-K	EL ohne Sensor without sensor 01.2013→ mit AGR-Ventil with EGR valve
			7.02156.33.0	AGR-K	mit Sensor with sensor →11.2012 ohne AGR-Ventil without EGR valve
			7.02156.34.0	AGR-K	ohne Sensor without sensor 01.2013→ ohne AGR-Ventil without EGR valve
			7.11492.01.0	DDS	ohne Zubehör without accessories Organisationsnummer ab: 11211FL, 11211FV RPO number from: 11211FL, 11211FV
			7.02604.99.0	LS	400 mm →12.2016 Motorcode: 9HF (DV6DTED) Engine Code: 9HF (DV6DTED) Produktionsdatum ab: 07.2010 Production date from: 07.2010 Produktionsdatum bis: 12.2016 Production date to: 12.2016
1.6 HDi 90 68 kW (92 PS) 9HJ (DV6DTEDM)	07.2010→		7.02209.11.0	AGR	EL 
			7.02156.35.0	AGR-K	EL ohne Sensor without sensor 01.2013→ mit AGR-Ventil with EGR valve
			7.03647.10.0	AGR-K	EL 
			7.02156.33.0	AGR-K	mit Sensor with sensor →11.2012 ohne AGR-Ventil without EGR valve
			7.02156.34.0	AGR-K	ohne Sensor without sensor 01.2013→ ohne AGR-Ventil without EGR valve
			7.02604.99.0	LS	400 mm
1.6 HDi 90 68-69 kW (92-94 PS) 9HP (DV6DTED)	07.2010→		7.02209.11.0	AGR	EL 









C









































BERLINGO Box Body/MPV (B9)





















60

C

			7.02156.24.0	AGR-K	EL	mit Sensor with sensor  →11.2012
			7.02156.35.0	AGR-K	EL	ohne Sensor without sensor 01.2013→ mit AGR-Ventil with EGR valve
			7.02156.33.0	AGR-K		mit Sensor with sensor →11.2012 ohne AGR-Ventil without EGR valve
			7.02156.34.0	AGR-K		ohne Sensor without sensor 01.2013→ ohne AGR-Ventil without EGR valve
			7.11492.01.0	DDS		ohne Zubehör without accessories Organisationsnummer ab: 11211FL, 11211FV RPO number from: 11211FL, 11211FV
			7.02604.99.0	LS	400 mm	
1.6 HDi 90 16V 66 kW (90 PS) 9HS (DV6TED4BU)	04.2008→		7.24809.39.0	AGR	EL	
			7.11492.01.0	DDS		ohne Zubehör without accessories Organisationsnummer ab: 11211FL, 11211FV RPO number from: 11211FL, 11211FV
1.6 HDi 90 16V 66 kW (90 PS) 9HX (DV6AUTED4)	04.2008→		7.24809.39.0	AGR	EL	
1.6 HDi 90 4x4 66 kW (90 PS) 9HF (DV6DTEd)	02.2012→		7.02209.11.0	AGR	EL	
			7.02156.24.0	AGR-K	EL	mit Sensor with sensor  →11.2012
			7.02156.35.0	AGR-K	EL	ohne Sensor without sensor 01.2013→ mit AGR-Ventil with EGR valve
			7.02156.33.0	AGR-K		mit Sensor with sensor →11.2012 ohne AGR-Ventil without EGR valve
			7.02156.34.0	AGR-K		ohne Sensor without sensor 01.2013→ ohne AGR-Ventil without EGR valve
			7.11492.01.0	DDS		ohne Zubehör without accessories Organisationsnummer ab: 11211FL, 11211FV RPO number from: 11211FL, 11211FV
1.6 VTi 95 72 kW (98 PS) 5FK (EP6CB)	07.2010→		7.05271.74.0	LS	450 mm	

						
BERLINGO Box Body/MPV (K9)						61
1.5 BlueHDi 100 73-75 kW (99-102 PS) YHY (DV5RD)	06.2018→		7.07794.23.0	AGR	EL	mit Dichtring with O-ring
1.5 BlueHDi 130 96 kW (131 PS) YHZ (DV5RC)	06.2018→		7.07794.23.0	AGR	EL	mit Dichtring with O-ring
BERLINGO Platform/Chassis (B9)						62
1.6 HDi 90 66 kW (90 PS) 9HF (DV6DTEd)	07.2010→		7.02209.11.0	AGR	EL	
			7.02156.24.0	AGR-K	EL	mit Sensor with sensor 
			7.02156.35.0	AGR-K	EL	ohne Sensor without sensor →11.2012
			7.02156.33.0	AGR-K	EL	ohne Sensor without sensor 01.2013→ mit AGR-Ventil with EGR valve mit Sensor with sensor →11.2012
			7.02156.34.0	AGR-K	EL	ohne AGR-Ventil without EGR valve ohne Sensor without sensor 01.2013→
			7.11492.01.0	DDS	EL	ohne Zubehör without accessories Organisationsnummer ab: 11211FL, 11211FV RPO number from: 11211FL, 11211FV
1.6 HDi 90 16V 66-68 kW (90-92 PS) 9HX (DV6ATED4)	04.2008→		7.24809.39.0	AGR	EL	
1.6 HDi 92 68 kW (92 PS) 9HJ (DV6DTEdM)	07.2010→		7.02209.11.0	AGR	EL	
			7.02156.35.0	AGR-K	EL	ohne Sensor without sensor 01.2013→ mit AGR-Ventil with EGR valve
			7.03647.10.0	AGR-K	EL	
			7.02156.33.0	AGR-K	EL	ohne Sensor without sensor mit Sensor with sensor →11.2012 ohne AGR-Ventil without EGR valve
7.02156.34.0	AGR-K	EL	ohne Sensor without sensor 01.2013→ ohne AGR-Ventil without EGR valve			
C-CROSSER ENTERPRISE (VU_, VV_)						63
2.2 HDi 115 kW (156 PS) 4HN (DW12MTED4)	01.2009→		7.00578.12.0	AGR	EL	 für Fahrzeuge mit Diesel-Partikel-Filter (DPF) for vehicles with diesel soot filter
C-CROSSER Van (VU_)						64
2.2 HDi (VU4HNH) 115 kW (156 PS) 4HN (DW12MTED4)	06.2007→12.2012		7.00578.12.0	AGR	EL	

			 PIERBURG			
C15 Box Body/MPV (VD_)						65
C	1.1 i 40-44 kW (55-60 PS) HDZ (TU1M)	07.1988→12.1996		7.05270.39.0	LS	400 mm
				7.02604.04.0	LS	200 mm
	1.4 i 55-58 kW (75-79 PS) KDY (TU3FM), KDY (TU3M)	05.1991→12.1996		7.05270.39.0	LS	400 mm
				7.02604.04.0	LS	200 mm
C2 ENTERPRISE (JG_)						66
	1.4 HDi 50-52 kW (68-71 PS) 8HZ (DV4TD)	11.2003→04.2005		7.24809.06.0	AGR	PN mit Rohrstützen with pipe socket ○ Euro 3 Euro 3
				7.24809.76.0	AGR	EL ○ Euro 4 (D4) Euro 4 (D4)
	1.4 HDi 50-55 kW (68-75 PS) 8HX (DV4TD)	09.2006→12.2009		7.24809.76.0	AGR	EL ○ Euro 4 (D4) Euro 4 (D4)
C25 Bus (280_, 290_)						67
	2.0 62 kW (84 PS) 170C (XN1T)	02.1991→02.1994		7.02604.04.0	LS	200 mm
	2.0 E 57-62 kW (78-84 PS) 170A (XN1T), 170B (XN1T)	09.1981→02.1994		7.02604.04.0	LS	200 mm
C25 Platform/Chassis (280_, 290_)						68
	2.0 62 kW (84 PS) 170C (XN1T)	01.1987→03.1994		7.02604.04.0	LS	200 mm
C25 Van (280_, 290_)						69
	2.0 57-62 kW (78-84 PS) 170A (XN1T), 170B (XN1T)	11.1981→12.1986		7.02604.04.0	LS	200 mm
	2.0 62 kW (84 PS) 170C (XN1T)	02.1991→03.1994		7.02604.04.0	LS	200 mm
	2.0 4x4 62 kW (84 PS) 170C (XN1T)	01.1990→01.1994		7.02604.04.0	LS	200 mm
	2.0 E 57-62 kW (78-84 PS) 170A (XN1T), 170B (XN1T)	09.1981→03.1994		7.02604.04.0	LS	200 mm
C3 AIRCROSS II Van (2C_, 2R_)						70
	1.5 BlueHDi 100 73-75 kW (99-102 PS) YHY (DV5RD)	05.2019→		7.07794.23.0	AGR	EL mit Dichtring with O-ring
C3 II Hatchback Van (SC_)						71
	1.4 HDi 50 kW (68 PS) 8HR (DV4C)	06.2010→09.2016		7.02156.35.0	AGR-K	EL ohne Sensor without sensor 12.2012→ mit AGR-Ventil with EGR valve
				7.02156.33.0	AGR-K	mit Sensor with sensor →10.2012 ohne AGR-Ventil without EGR valve
				7.02156.34.0	AGR-K	ohne Sensor without sensor 12.2012→ ohne AGR-Ventil without EGR valve
				7.11492.01.0	DDS	ohne Sensor without sensor 12.2012→ ohne AGR-Ventil without EGR valve ohne Zubehör without accessories















					
C3 III Van (SX_, SY_) 72					
BlueHDi 100 73-75 kW (99-102 PS) YHY (DV5RD)	03.2019→		7.07794.23.0	AGR	EL mit Dichtring with O-ring
C4 CACTUS Van (0B_, 0P_) 73					
BlueHDi 100 73-75 kW (99-102 PS) YHY (DV5RD)	05.2019→		7.07794.23.0	AGR	EL mit Dichtring with O-ring
C4 I Hatchback Van (LR_) 74					
2.0 HDi 100-101 kW (136-138 PS) RHR (DW10BTED4)	02.2005→12.2010		7.24809.68.0 7.11492.01.0	AGR DDS	EL  ohne Zubehör without accessories Organisationsnummer ab: 11074 RPO number from: 11074
C4 II Hatchback Van (NC_) 75					
1.6 HDi 82-84 kW (111-114 PS) 9HR (DV6C)	11.2009→		7.02209.11.0 7.02156.35.0 7.02156.33.0 7.02156.34.0	AGR AGR-K AGR-K AGR-K	EL  EL ohne Sensor without sensor 01.2013→ mit AGR-Ventil with EGR valve mit Sensor with sensor →11.2012 ohne AGR-Ventil without EGR valve ohne Sensor without sensor 01.2013→ ohne AGR-Ventil without EGR valve
1.6 HDi 68-69 kW (92-94 PS) 9HP (DV6DTE)	06.2010→		7.02209.11.0 7.02156.35.0 7.02156.33.0 7.02156.34.0	AGR AGR-K AGR-K AGR-K	EL  EL ohne Sensor without sensor 01.2013→ mit AGR-Ventil with EGR valve mit Sensor with sensor →11.2012 ohne AGR-Ventil without EGR valve ohne Sensor without sensor 01.2013→ ohne AGR-Ventil without EGR valve
GRAND C4 SPACETOURER Van (3A_, 3E_) 76					
BlueHDi 130 96 kW (131 PS) YHZ (DV5RC)	05.2019→		7.07794.23.0	AGR	EL mit Dichtring with O-ring
JUMPER Bus 77					
2.0 BlueHDi 110 80-81 kW (109-110 PS) AHM (DW10FUE)	07.2015→09.2019		7.11492.01.0	DDS	ohne Zubehör without accessories
2.0 BlueHDi 130 96 kW (130 PS) AHN (DW10FUD)	07.2015→09.2019		7.11492.01.0	DDS	ohne Zubehör without accessories
2.0 BlueHDi 160 120 kW (163 PS) AHP (DW10FUC)	07.2015→09.2019		7.11492.01.0	DDS	ohne Zubehör without accessories
2.2 HDi 100 74 kW (101 PS) 4HV (P22DTE)	04.2006→		7.24809.70.0	AGR	EL 

C





JUMPER Bus **77**



C

2.2 HDi 110 81 kW (110 PS) 4HG (P22DTE)	07.2011→		7.03784.34.0	AGR	EL	
2.2 HDi 120 88 kW (120 PS) 4HU (P22DTE)	04.2006→		7.24809.70.0	AGR	EL	
2.2 HDi 130 96 kW (130 PS) 4HH (P22DTE)	07.2011→		7.03784.34.0	AGR	EL	
2.2 HDi 150 110 kW (150 PS) 4HJ (P22DTE)	07.2011→		7.03784.34.0	AGR	EL	
3.0 HDi 155 115-130 kW (156-177 PS) F1CE0481D (F30DT)	07.2010→		7.08369.98.0	ATS	EL	Partikelfilter Particulate Filter
			7.08369.99.0	ATS	EL	ohne Zubehör without accessories  ch. 12421976→ Euro 5 Euro 5
			7.11190.03.0	DDS		
			7.02604.99.0	LS	400 mm	
3.0 HDi 160 115-130 kW (156-177 PS) F1CE0481D (F30DT)	09.2006→		7.24809.51.0	AGR	PN	
			7.08369.98.0	ATS	EL	Partikelfilter Particulate Filter
			7.08369.99.0	ATS	EL	ohne Zubehör without accessories  ch. 12421976→ Euro 5 Euro 5
			7.11190.03.0	DDS		
			7.02604.99.0	LS	400 mm	
3.0 HDi 180 130 kW (177 PS) F1CE3481E (F30DTE)	07.2011→		7.02604.99.0	LS	400 mm	



JUMPER Bus (230P) **78**



































2.0 80 kW (109 PS) RFW (XU10J2U)	02.1994→04.2002		7.02604.04.0	LS	200 mm	
2.0 4x4 80 kW (109 PS) RFW (XU10J2U)	08.1996→04.2002		7.02604.04.0	LS	200 mm	
2.8 D 64 kW (87 PS) 8140.63 (F28D)	01.1999→02.2002		7.24809.53.0	AGR	PN	

JUMPER Bus (244, Z_) **79**

2.0 81-89 kW (110-121 PS) XU10J2	04.2002→		7.05270.37.0	LS	1640 mm	
2.0 bivalent 81-89 kW (110-121 PS) XU10J2	02.2003→		7.05270.37.0	LS	1640 mm	
2.2 HDi 74 kW (101 PS) 4HY (DW12UTED)	04.2002→		7.11237.04.0	AGR	PN	→06.2006

JUMPER Platform/Chassis **80**















2.0 BlueHDi 110 80-81 kW (109-110 PS) AHM (DW10FUE)	04.2016→09.2019		7.11492.01.0	DDS		ohne Zubehör without accessories
2.0 BlueHDi 130 96 kW (130 PS) AHN (DW10FUD)	04.2016→09.2019		7.11492.01.0	DDS		ohne Zubehör without accessories
2.0 BlueHDi 130 4x4 96 kW (130 PS) AHN (DW10FUD)	04.2016→09.2019		7.11492.01.0	DDS		ohne Zubehör without accessories

						
JUMPER Platform/Chassis						80
2.0 BlueHDi 160 120 kW (163 PS) AHP (DW10FUC)	04.2016→09.2019		7.11492.01.0	DDS		ohne Zubehör without accessories
2.0 BlueHDi 160 4x4 120 kW (163 PS) AHP (DW10FUC)	04.2016→09.2019		7.11492.01.0	DDS		ohne Zubehör without accessories
2.2 HDi 100 74 kW (101 PS) 4HV (P22DTE)	04.2006→		7.24809.70.0	AGR	EL	
2.2 HDi 110 81 kW (110 PS) 4HG (P22DTE)	07.2011→		7.03784.34.0	AGR	EL	
2.2 HDi 120 88 kW (120 PS) 4HU (P22DTE)	04.2006→		7.24809.70.0	AGR	EL	
2.2 HDi 130 96 kW (130 PS) 4HH (P22DTE)	07.2011→		7.03784.34.0	AGR	EL	
2.2 HDi 150 110 kW (150 PS) 4HJ (P22DTE)	07.2011→		7.03784.34.0	AGR	EL	
3.0 HDi 145 107 kW (146 PS) F30DTE (F1CE3481N)	07.2010→		7.02604.99.0	LS	400 mm	
3.0 HDi 160 115-130 kW (156-177 PS) F1CE0481D (F30DT)	09.2006→		7.24809.51.0	AGR	PN	
			7.08369.98.0	ATS	EL	Partikelfilter Particulate Filter
			7.08369.99.0	ATS	EL	
			7.11190.03.0	DDS		ohne Zubehör without accessories  ch. 12421976→ Euro 5 Euro 5
			7.02604.99.0	LS	400 mm	
3.0 HDi 180 130 kW (177 PS) F1CE3481E (F30DTE)	07.2011→		7.02604.99.0	LS	400 mm	
JUMPER Platform/Chassis (230)						81
2.0 80 kW (109 PS) RFW (XU10J2U)	03.1994→04.2002		7.02604.04.0	LS	200 mm	
2.8 D 64 kW (87 PS) 8140.63 (F28D)	01.1999→02.2002		7.24809.53.0	AGR	PN	
JUMPER Platform/Chassis (244)						82
2.2 HDi 74 kW (101 PS) 4HY (DW12UTED)	02.2002→06.2006		7.11237.04.0	AGR	PN	
2.2 HDi 74 kW (101 PS) 4HY (DW12UTED)	04.2002→		7.11237.04.0	AGR	PN	→06.2006
JUMPER Van						83
2.0 BlueHDi 110 80-81 kW (109-110 PS) AHM (DW10FUE)	04.2016→09.2019		7.11492.01.0	DDS		ohne Zubehör without accessories
2.0 BlueHDi 130 96 kW (130 PS) AHN (DW10FUD)	04.2016→09.2019		7.11492.01.0	DDS		ohne Zubehör without accessories
2.0 BlueHDi 130 4x4 96 kW (130 PS) AHN (DW10FUD)	04.2016→09.2019		7.11492.01.0	DDS		ohne Zubehör without accessories
2.0 BlueHDi 160 120 kW (163 PS) AHP (DW10FUC)	04.2016→09.2019		7.11492.01.0	DDS		ohne Zubehör without accessories
2.0 BlueHDi 160 4x4 120 kW (163 PS) AHP (DW10FUC)	04.2016→09.2019		7.11492.01.0	DDS		ohne Zubehör without accessories
2.2 HDi 100 74 kW (101 PS) 4HV (P22DTE)	04.2006→12.2012		7.24809.70.0	AGR	EL	







JUMPER Van **83**



C

2.2 HDi 110 81 kW (110 PS) 4HG (P22DTE)	07.2011→		7.03784.34.0	AGR	EL	
2.2 HDi 120 88 kW (120 PS) 4HU (P22DTE)	04.2006→		7.24809.70.0	AGR	EL	
2.2 HDi 130 96 kW (130 PS) 4HH (P22DTE)	07.2011→		7.03784.34.0	AGR	EL	
2.2 HDi 150 110 kW (150 PS) 4HJ (P22DTE)	07.2011→		7.03784.34.0	AGR	EL	
3.0 HDi 145 107 kW (146 PS) F30DTE (F1CE3481N)	07.2010→		7.02604.99.0	LS	400 mm	
3.0 HDi 155 115-130 kW (156-177 PS) F1CE0481D (F30DT)	07.2010→		7.08369.98.0	ATS	EL	Partikelfilter Particulate Filter
			7.08369.99.0 7.11190.03.0	ATS DDS	EL	ohne Zubehör without accessories  ch. 12421976→ Euro 5 Euro 5
			7.02604.99.0	LS	400 mm	
3.0 HDi 160 115-130 kW (156-177 PS) F1CE0481D (F30DT)	09.2006→		7.24809.51.0	AGR	PN	
			7.08369.98.0	ATS	EL	Partikelfilter Particulate Filter
			7.08369.99.0 7.11190.03.0	ATS DDS	EL	ohne Zubehör without accessories  ch. 12421976→ Euro 5 Euro 5
			7.02604.99.0	LS	400 mm	
3.0 HDi 180 130 kW (177 PS) F1CE3481E (F30DTE)	07.2011→		7.02604.99.0	LS	400 mm	





JUMPER Van (230L) **84**





















2.0 80 kW (109 PS) RFW (XU10J2U)	03.1994→04.2002		7.02604.04.0	LS	200 mm	
2.0 4x4 80 kW (109 PS) RFW (XU10J2U)	10.1996→01.2002		7.02604.04.0	LS	200 mm	
2.0 HDi 62 kW (84 PS) RHV (DW10TD)	11.2001→04.2002		7.11237.04.0	AGR	PN	
2.8 D 64 kW (87 PS) 8140.63 (F28D)	01.1999→02.2002		7.24809.53.0	AGR	PN	

JUMPER Van (244) **85**

2.0 81-89 kW (110-121 PS) XU10J2	04.2002→		7.05270.37.0	LS	1640 mm	
2.2 HDi 74 kW (101 PS) 4HY (DW12UTED)	04.2002→		7.11237.04.0	AGR	PN	→06.2006

JUMPY (U6U_) **86**

1.6 58-60 kW (79-81 PS) 1580 SPI, 220 A2.000	10.1995→08.2000		7.02604.04.0	LS	200 mm	
2.0 HDi 110 79-80 kW (107-109 PS) RHW (DW10ATED4)	03.2000→10.2006		7.28069.03.0	AGR	PN	 für Fahrzeuge ohne Diesel-Partikel-Filter (DPF) for vehicles without diesel soot filter
2.0 HDi 95 69 kW (94 PS) RHX (DW10BTED)	10.1999→10.2006		7.22843.06.0	AGR	PN	
			7.09730.01.0	AGR-K		



					
JUMPY (VF7)					
87					
1.6 HDi 90 16V 66 kW (90 PS) 9HU (DV6UTED4)	01.2007→03.2016		7.24809.39.0	AGR	EL  Euro 4 (D4) Euro 4 (D4)
			7.02209.11.0	AGR	EL 
			7.02156.35.0	AGR-K	EL ohne Sensor without sensor 01.2016→ mit AGR-Ventil with EGR valve
			7.03647.10.0	AGR-K	EL  ohne Sensor without sensor
1.6 HDi 90 8V 66 kW (90 PS) 9HH (DV6DUM)	01.2007→03.2016		7.02156.34.0	AGR-K	ohne Sensor without sensor 01.2016→ ohne AGR-Ventil without EGR valve
			7.02209.11.0	AGR	EL 
			7.02156.35.0	AGR-K	EL ohne Sensor without sensor 01.2013→ mit AGR-Ventil with EGR valve
			7.02156.34.0	AGR-K	ohne Sensor without sensor 01.2013→ ohne AGR-Ventil without EGR valve
1.6 HDi 90 8V 66 kW (90 PS) 9HM (DV6UC)	01.2014→03.2016		7.11492.01.0	DDS	ohne Zubehör without accessories für OE-Nummer: 1618 Z9 for OE number: 1618 Z9
			7.05270.21.0	LS	600 mm für OE-Nummer: 1618AS for OE number: 1618AS vor Katalysator in front of the catalyst
			7.02209.11.0	AGR	EL 
			7.02156.35.0	AGR-K	EL ohne Sensor without sensor 01.2013→ mit AGR-Ventil with EGR valve
2.0 HDi 120 79-88 kW (107-120 PS) RHK (DW10UTED4)	01.2007→03.2016		7.09730.00.0	AGR-K	ohne Zubehör without accessories
			7.11492.01.0	DDS	
			7.24809.68.0	AGR	
2.0 HDi 125 94 kW (128 PS) AHZ (DW10CD)	07.2011→03.2016		7.05270.21.0	LS	600 mm vor Katalysator in front of the catalyst für Fahrzeuge mit Diesel-Partikel-Filter (DPF) for vehicles with diesel soot filter
			7.11492.01.0	DDS	ohne Zubehör without accessories
			7.24809.94.0	AGR-K	EL  Organisationsnummer ab: 12853 RPO number from: 12853
2.0 HDi 140 100-101 kW (136-138 PS) RHR (DW10BTED4)	01.2007→03.2016		7.11492.01.0	DDS	ohne Zubehör without accessories Organisationsnummer ab: 11319 RPO number from: 11319
			7.09730.00.0	AGR-K	
			7.24809.68.0	AGR	
2.0 HDi 165 120 kW (163 PS) RHH (DW10CTED4)	07.2010→03.2016		7.11492.01.0	DDS	ohne Zubehör without accessories
			7.24809.94.0	AGR-K	EL  Organisationsnummer ab: 12853 RPO number from: 12853

C





JUMPY (VF7) 87





C

			7.05270.21.0	LS	600 mm	vor Katalysator in front of the catalyst für Fahrzeuge mit Diesel-Partikel-Filter (DPF) for vehicles with diesel soot filter
2.0 HDi 95 72 kW (98 PS) AHY (DW10CE)	07.2011→03.2016		7.24809.94.0	AGR-K	EL	 Organisationsnummer ab: 12853 RPO number from: 12853
			7.11492.01.0	DDS		ohne Zubehör without accessories
			7.05270.21.0	LS	600 mm	vor Katalysator in front of the catalyst für Fahrzeuge mit Diesel-Partikel-Filter (DPF) for vehicles with diesel soot filter





JUMPY Bus (V_) 88























1.5 BlueHDi 100 75 kW (102 PS) YHR (DV5RUCd)	06.2018→		7.07794.23.0	AGR	EL	mit Dichtring with O-ring 10.2018→
2.0 BlueHDi 150 110 kW (150 PS) AHX (DW10FD)	04.2016→		7.11492.01.0	DDS		ohne Zubehör without accessories Organisationsnummer ab: 14299U9 RPO number from: 14299U9
2.0 BlueHDi 180 130 kW (177 PS) AHH (DW10FC)	04.2016→		7.11492.01.0	DDS		ohne Zubehör without accessories Organisationsnummer ab: 14299U9 RPO number from: 14299U9

JUMPY Platform/Chassis 89

1.6 HDi 90 8V 66 kW (90 PS) 9HH (DV6DUM)	06.2007→03.2016		7.02156.35.0	AGR-K	EL	ohne Sensor without sensor 01.2016→ mit AGR-Ventil with EGR valve
			7.03647.10.0	AGR-K	EL	 ohne Sensor without sensor
			7.02156.34.0	AGR-K		ohne Sensor without sensor 01.2016→ ohne AGR-Ventil without EGR valve
2.0 HDi 125 94 kW (128 PS) AHZ (DW10CD)	07.2011→		7.24809.94.0	AGR-K	EL	 Organisationsnummer ab: 12853 RPO number from: 12853
			7.11492.01.0	DDS		ohne Zubehör without accessories
			7.05270.21.0	LS	600 mm	vor Katalysator in front of the catalyst für Fahrzeuge mit Diesel-Partikel-Filter (DPF) for vehicles with diesel soot filter

JUMPY Platform/Chassis (BU_, BV_, BW_, BX_) 90

2.0 HDi 110 80 kW (109 PS) RHZ (DW10BTED)	12.2003→10.2006		7.22843.06.0	AGR	PN	 Euro 2, Euro 3 Euro 2, Euro 3
			7.09730.01.0	AGR-K		
2.0 HDi 110 80 kW (109 PS) RHZ (DW10BTED+)	12.2003→10.2006		7.22843.06.0	AGR	PN	 Euro 2, Euro 3 Euro 2, Euro 3
			7.28069.03.0	AGR	PN	 für Fahrzeuge ohne Diesel-Partikel-Filter (DPF) for vehicles without diesel soot filter

					
JUMPY Platform/Chassis (BU_, BV_, BW_, BX_)					90
2.0 HDi 95 69 kW (94 PS) RHX (DW10BTED)	10.1999→10.2006		7.22843.06.0	AGR	PN 
			7.09730.01.0	AGR-K	
JUMPY Platform/Chassis (V_)					91
2.0 BlueHDi 150 110 kW (150 PS) AHX (DW10FD)	09.2016→		7.11492.01.0	DDS	ohne Zubehör without accessories Organisationsnummer ab: 14299U9 RPO number from: 14299U9
JUMPY Van					92
1.6 HDi 90 16V 66 kW (90 PS) 9HU (DV6UTED4)	01.2007→03.2016		7.24809.39.0	AGR	EL  Euro 4 (D4) Euro 4 (D4)
			7.02209.11.0	AGR	EL 
1.6 HDi 90 8V 66 kW (90 PS) 9HH (DV6DUM)	01.2007→03.2016		7.02156.35.0	AGR-K	EL ohne Sensor without sensor 01.2016→ mit AGR-Ventil with EGR valve
			7.03647.10.0	AGR-K	EL  ohne Sensor without sensor
			7.02156.34.0	AGR-K	ohne Sensor without sensor
					ohne Sensor without sensor 01.2016→ ohne AGR-Ventil without EGR valve
1.6 HDi 90 8V 66 kW (90 PS) 9HM (DV6UC)	01.2014→03.2016		7.02209.11.0	AGR	EL 
			7.02156.35.0	AGR-K	EL ohne Sensor without sensor 01.2013→ mit AGR-Ventil with EGR valve
			7.02156.34.0	AGR-K	ohne Sensor without sensor 01.2013→ ohne AGR-Ventil without EGR valve
			7.11492.01.0	DDS	ohne Zubehör without accessories
			7.05270.21.0	LS	600 mm für OE-Nummer: 1618 AS for OE number: 1618 AS vor Katalysator in front of the catalyst
2.0 HDi 120 79-88 kW (107-120 PS) RHK (DW10UTED4)	01.2007→03.2016		7.24809.68.0	AGR	EL 
			7.09730.00.0	AGR-K	
			7.11492.01.0	DDS	ohne Zubehör without accessories
2.0 HDi 120 4x4 79-88 kW (107-120 PS) RHK (DW10UTED4)	01.2010→03.2016		7.24809.68.0	AGR	EL 
			7.09730.00.0	AGR-K	
			7.11492.01.0	DDS	ohne Zubehör without accessories
2.0 HDi 125 94 kW (128 PS) AHZ (DW10CD)	07.2011→03.2016		7.24809.94.0	AGR-K	EL 
			7.11492.01.0	DDS	Organisationsnummer ab: 12853 RPO number from: 12853 ohne Zubehör without accessories

C



JUMPY Van

92























C

			7.05270.21.0	LS	600 mm	vor Katalysator in front of the catalyst für Fahrzeuge mit Diesel-Partikel-Filter (DPF) for vehicles with diesel soot filter
2.0 HDi 125 4x4 94 kW (128 PS) AHZ (DW10CD)	07.2011→03.2016		7.24809.94.0	AGR-K	EL	☐ Organisationsnummer ab: 12853 RPO number from: 12853
			7.11492.01.0	DDS		ohne Zubehör without accessories
			7.05270.21.0	LS	600 mm	vor Katalysator in front of the catalyst für Fahrzeuge mit Diesel-Partikel-Filter (DPF) for vehicles with diesel soot filter
2.0 HDi 140 100-101 kW (136-138 PS) RHR (DW10BTED4)	01.2007→03.2016		7.24809.68.0	AGR	EL	☐
			7.09730.00.0	AGR-K		ohne Zubehör without accessories Organisationsnummer ab: 11319 RPO number from: 11319
			7.11492.01.0	DDS		
2.0 HDi 165 120 kW (163 PS) RHH (DW10CTED4)	07.2010→03.2016		7.24809.94.0	AGR-K	EL	☐ Organisationsnummer ab: 12853 RPO number from: 12853
			7.11492.01.0	DDS		ohne Zubehör without accessories
			7.05270.21.0	LS	600 mm	vor Katalysator in front of the catalyst für Fahrzeuge mit Diesel-Partikel-Filter (DPF) for vehicles with diesel soot filter
2.0 HDi 95 72 kW (98 PS) AHY (DW10CE)	07.2011→03.2016		7.24809.94.0	AGR-K	EL	☐ Organisationsnummer ab: 12853 RPO number from: 12853
			7.11492.01.0	DDS		ohne Zubehör without accessories
			7.05270.21.0	LS	600 mm	vor Katalysator in front of the catalyst für Fahrzeuge mit Diesel-Partikel-Filter (DPF) for vehicles with diesel soot filter

JUMPY Van (BS_, BT_, BY_, BZ_)

93

1.6 i 58-60 kW (79-81 PS) 1580 SPI, 220 A2.000	10.1995→08.2000		7.02604.04.0	LS	200 mm	
2.0 HDi 110 80 kW (109 PS) RHZ (DW10BTED)	10.2001→10.2006		7.22843.06.0	AGR	PN	☐ Euro 2, Euro 3 Euro 2, Euro 3
			7.09730.01.0	AGR-K		
2.0 HDi 110 80 kW (109 PS) RHZ (DW10BTED+)	10.2001→10.2006		7.22843.06.0	AGR	PN	☐ Euro 2, Euro 3 Euro 2, Euro 3
2.0 HDi 110 79-80 kW (107-109 PS) RHW (DW10ATED4)	01.2002→10.2006		7.28069.03.0	AGR	PN	☐ für Fahrzeuge ohne Diesel-Partikel-Filter (DPF) for vehicles without diesel soot filter
2.0 HDi 95 69 kW (94 PS) RHX (DW10BTED)	10.1999→10.2006		7.22843.06.0	AGR	PN	☐
			7.09730.01.0	AGR-K		





						
JUMPY Van (V_)						94
1.5 BlueHDi 120 88 kW (120 PS) YHV (DV5RUC)	06.2018→		7.07794.23.0	AGR	EL	mit Dichtring with O-ring 07.2018→
1.6 BlueHDi 90 66 kW (90 PS) 9HF (DV6DU)	09.2018→		7.02156.35.0	AGR-K	EL	ohne Sensor without sensor mit AGR-Ventil with EGR valve ohne Sensor without sensor ohne AGR-Ventil without EGR valve ohne Zubehör without accessories Organisationsnummer ab: 14299U9 RPO number from: 14299U9
			7.02156.34.0	AGR-K		
			7.11492.01.0	DDS		
2.0 BlueHDi 150 110 kW (150 PS) AHX (DW10FD)	04.2016→		7.11492.01.0	DDS		ohne Zubehör without accessories Organisationsnummer ab: 14299U9 RPO number from: 14299U9
NEMO Box Body/MPV (AA_)						95
1.3 BlueHDi 80 59-70 kW (80-95 PS) FHY (F13DTE6)	02.2016→		7.01599.10.0	AGR	EL	
			7.11190.03.0	DDS		ohne Zubehör without accessories für OE-Nummer: 16 105 313 80, 1618 SV for OE number: 16 105 313 80, 1618 SV
1.3 HDi 75 55 kW (75 PS) FHZ (F13DTE5)	10.2010→		7.01599.10.0	AGR	EL	
			7.03622.06.0	AGR-K		
			7.11190.03.0	DDS		ohne Zubehör without accessories
1.4 HDi 50 kW (68 PS) 8HS (DV4TED)	02.2008→		7.24809.76.0	AGR	EL	
SPACETOURER Bus (V_)						96
1.6 HDi 90 66 kW (90 PS) 9HF (DV6DU)	07.2018→		7.02156.35.0	AGR-K	EL	ohne Sensor without sensor mit AGR-Ventil with EGR valve ohne Sensor without sensor ohne AGR-Ventil without EGR valve ohne Zubehör without accessories Organisationsnummer ab: 14299U9 RPO number from: 14299U9
			7.02156.34.0	AGR-K		
			7.11492.01.0	DDS		
2.0 BlueHDi 150 110 kW (150 PS) AHX (DW10FD)	04.2016→		7.11492.01.0	DDS		ohne Zubehör without accessories für OE-Nummer: 1618 Z9 for OE number: 1618 Z9
2.0 BlueHDi 180 130 kW (177 PS) AHH (DW10FC)	04.2016→		7.11492.01.0	DDS		ohne Zubehör without accessories für OE-Nummer: 1618 Z9 for OE number: 1618 Z9
XSARA Estate Van						97
1.4 53-57 kW (72-77 PS) KFX (TU3JP)	09.2000→03.2005		7.05270.36.0	LS	540 mm	Technische Schadstoffverringerung K Technical pollution reduction K
2.0 HDi 66 kW (90 PS) RHY (DW10TD)	09.2000→03.2005		7.22843.06.0	AGR	PN	
			7.09730.01.0	AGR-K		













XSARA Hatchback Van (N3_)

98

C

1.4 53-57 kW (72-77 PS) KFX (TU3JP)	05.1998→10.2004		7.05270.36.0	LS	540 mm	Technische Schadstoffverringerung K Technical pollution reduction K
1.4 LPG 53-57 kW (72-77 PS) KFX (TU3JP)	06.1999→08.2000		7.05270.36.0	LS	540 mm	15-04 15-04
2.0 HDi 66 kW (90 PS) RHY (DW10TD)	09.2000→03.2005		7.22843.06.0	AGR	PN	
			7.09730.01.0	AGR-K		













						
NECTIS						
1						
247 45-74 kW (61-101 PS) NEF45 AM1		7.05500.02.0	AK	EL	für OE-Nummer: 5801602383 for OE number: 5801602383	
		7.05501.02.0	AK	EL	für OE-Nummer: 5801602385 for OE number: 5801602385	
		7.05502.02.0	AK	EL	für OE-Nummer: 5801602387 for OE number: 5801602387	
257 45-74 kW (61-101 PS) NEF45 AM1		7.05500.02.0	AK	EL	für OE-Nummer: 5801602383 for OE number: 5801602383	
		7.05501.02.0	AK	EL	für OE-Nummer: 5801602385 for OE number: 5801602385	
		7.05502.02.0	AK	EL	für OE-Nummer: 5801602387 for OE number: 5801602387	
267 45-74 kW (61-101 PS) NEF45 AM1		7.05500.02.0	AK	EL	für OE-Nummer: 5801602383 for OE number: 5801602383	
		7.05501.02.0	AK	EL	für OE-Nummer: 5801602385 for OE number: 5801602385	
		7.05502.02.0	AK	EL	für OE-Nummer: 5801602387 for OE number: 5801602387	
NEXOS						
2						
240 45-74 kW (61-101 PS) NEF45 AM1	11.2009→		7.05500.02.0	AK	EL	für OE-Nummer: 5801602383 for OE number: 5801602383
			7.05501.02.0	AK	EL	für OE-Nummer: 5801602385 for OE number: 5801602385
			7.05502.02.0	AK	EL	für OE-Nummer: 5801602387 for OE number: 5801602387

C











DOKKER MPV (KE_) **1**













D

1.5 Blue dCi 95 (KEJL) 55-85 kW (75-116 PS) K9K 872	12.2018→		7.11457.07.0* ↳7.11492.07.0	DDS DDS		
1.5 dCi (KEAJ, KEAH) 55-66 kW (75-90 PS) K9K 612	11.2012→		7.00368.16.0	AGR	EL	
1.5 dCi (KEAJ, KEAH) 55-66 kW (75-90 PS) K9K 626	11.2012→		7.05320.04.0	AGR	EL	
1.5 dCi (KEMW) 55-66 kW (75-90 PS) K9K 612	11.2012→		7.00368.16.0	AGR	EL	
1.5 dCi / Blue dCi 75 (KEAJ, KEAH, KEJW) 55-66 kW (75-90 PS) K9K 612	11.2012→		7.00368.16.0	AGR	EL	
1.5 dCi / Blue dCi 75 (KEAJ, KEAH, KEJW) 55-66 kW (75-90 PS) K9K 626	11.2012→		7.05320.04.0	AGR	EL	
1.5 dCi / Blue dCi 75 (KEAJ, KEAH, KEJW) 55-85 kW (75-116 PS) K9K 872	11.2012→		7.11457.07.0* ↳7.11492.07.0	DDS DDS		
			7.11457.07.0* ↳7.11492.07.0	DDS DDS		







DUSTER (HM_) **2**

1.5 dCi 110 (HMAB) 66-81 kW (90-110 PS) K9K 656	10.2017→		7.05320.04.0	AGR	EL	
			7.11457.07.0* ↳7.11492.07.0	DDS DDS		
1.5 dCi 110 (HMAB) 80 kW (109 PS) K9K 667	10.2017→		7.11457.07.0* ↳7.11492.07.0	DDS DDS		
1.5 dCi 110 4x4 (HMAB) 80 kW (109 PS) K9K 658	10.2017→		7.05320.04.0	AGR	EL	
			7.11457.07.0* ↳7.11492.07.0	DDS DDS		
1.5 dCi 115 (HMAD) 55-85 kW (75-116 PS) K9K 872, K9K 874	10.2017→		7.11457.07.0* ↳7.11492.07.0	DDS DDS		
1.5 dCi 115 4x4 (HMAD) 55-85 kW (75-116 PS) K9K 872, K9K 874	10.2017→		7.11457.07.0* ↳7.11492.07.0	DDS DDS		
1.5 dCi 90 (HMAA) 66-81 kW (90-110 PS) K9K 656	10.2017→		7.05320.04.0	AGR	EL	
			7.11457.07.0* ↳7.11492.07.0	DDS DDS		

DUSTER (HS_) **3**







1.5 dCi 63 kW (86 PS) K9K 796, K9K 830	04.2010→01.2018	 7.00368.15.0	AGR	EL	
1.5 dCi 79 kW (107 PS) K9K 896	06.2010→01.2018	 7.00368.16.0	AGR	EL	⊗
1.5 dCi 55-66 kW (75-90 PS) K9K 612, K9K 884, K9K 892	10.2010→01.2018	 7.00368.16.0	AGR	EL	⊗
1.5 dCi 80-81 kW (109-110 PS) K9K 658, K9K 666, K9K 667	08.2013→01.2018	 7.05320.04.0	AGR	EL	⊗
		7.11457.07.0* ↳ 7.11492.07.0	DDS DDS		
1.5 dCi 80 kW (109 PS) K9K 856, K9K 858	08.2013→01.2018	 7.00368.16.0	AGR	EL	⊗
1.5 dCi 79-81 kW (107-110 PS) K9K 856, K9K 858, K9K 898	08.2013→01.2018	 7.00368.16.0	AGR	EL	⊗
1.5 dCi 80 kW (109 PS) K9K 658	08.2013→01.2018	 7.05320.04.0	AGR	EL	⊗
		7.11457.07.0* ↳ 7.11492.07.0	DDS DDS		
1.5 dCi 4x4 66-67 kW (90-91 PS) K9K 884, K9K 894	10.2010→01.2018	 7.00368.16.0	AGR	EL	⊗
1.5 dCi 4x4 79-81 kW (107-110 PS) K9K 856, K9K 858, K9K 898	10.2010→01.2018	 7.00368.16.0	AGR	EL	⊗
1.5 dCi 4x4 79-81 kW (107-110 PS) K9K 856, K9K 858, K9K 898	08.2013→01.2018	 7.00368.16.0	AGR	EL	⊗
1.5 dCi 4x4 80 kW (109 PS) K9K 658	08.2013→01.2018	 7.05320.04.0	AGR	EL	⊗
		7.11457.07.0* ↳ 7.11492.07.0	DDS DDS		
1.6 16V 77 kW (105 PS) K4M 690	04.2010→01.2018	 7.05270.54.0	LS	450 mm	für OE-Nummer: 60 01 549 007, 82 00 052 063 for OE number: 60 01 549 007, 82 00 052 063 vor Katalysator in front of the catalystr

LODGY (JS_) **4**













1.5 Blue dCi 115 (JSJT) 55-85 kW (75-116 PS) K9K 872	08.2018→	 7.11457.07.0* ↳ 7.11492.07.0	DDS DDS		
1.5 Blue dCi 95 (JSJL) 55-85 kW (75-116 PS) K9K 872	08.2018→	 7.11457.07.0* ↳ 7.11492.07.0	DDS DDS		
1.5 dCi 55-66 kW (75-90 PS) K9K 612	03.2012→	 7.00368.16.0	AGR	EL	⊗
1.5 dCi 55-66 kW (75-90 PS) K9K 626	03.2012→	 7.05320.04.0	AGR	EL	⊗
		7.11457.07.0* ↳ 7.11492.07.0	DDS DDS		
1.5 dCi 79-81 kW (107-110 PS) K9K 846	03.2012→	 7.00368.16.0	AGR	EL	⊗
1.5 dCi 80-81 kW (109-110 PS) K9K 666	03.2012→	 7.05320.04.0	AGR	EL	⊗
		7.11457.07.0* ↳ 7.11492.07.0	DDS DDS		
1.5 dCi 79-81 kW (107-110 PS) K9K 846	01.2013→	 7.00368.16.0	AGR	EL	⊗









LODGY (JS_) **4**





























D	1.5 dCi 79-81 kW (107-110 PS) K9K 846	06.2015→		7.00368.16.0	AGR	EL	
	1.5 dCi 80-81 kW (109-110 PS) K9K 666	06.2015→		7.05320.04.0 7.11457.07.0* ↳ 7.11492.07.0	AGR DDS DDS	EL	
	1.5 dCi (JSMW) 55-66 kW (75-90 PS) K9K 612	11.2012→		7.00368.16.0	AGR	EL	

LOGAN (LS_) **5**

1.4 (LSOA, LSOC, LSOE, LSOG) 55 kW (75 PS) K7J 710	09.2004→		7.05270.54.0	LS	450 mm	Baumuster: LSOC, LSOE, LSOG Type: LSOC, LSOE, LSOG vor Katalysator in front of the catalyst Produktionsdatum bis: 05.12.2006 Production date to: 05.12.2006
			7.05270.56.0	LS	275 mm	
1.5 dCi (LS04) 55-66 kW (75-90 PS) K9K 892	05.2010→12.2012		7.00368.16.0	AGR	EL	
1.5 dCi (LS04) 55-66 kW (75-90 PS) K9K 892	05.2010→		7.00368.16.0	AGR	EL	
1.5 dCi (LS0J, LS0Y) 48 kW (65 PS) K9K 790	09.2005→		7.22818.58.0	AGR	EL	
1.5 dCi (LS0K) 50 kW (68 PS) K9K 792	01.2006→12.2012		7.00368.15.0	AGR	EL	
1.5 dCi (LS0W) 63 kW (86 PS) K9K 796	09.2007→12.2011		7.00368.15.0	AGR	EL	
1.6 (LSOB, LSOD, LSOF, LSOH) 64 kW (87 PS) K7M 710	09.2004→		7.05270.56.0	LS	275 mm	
1.6 16V (LS09, LS0L, LS0M, LS0P, LS0V, LS18, LS1S, LS1V,... 77 kW (105 PS) K4M 690	02.2006→		7.05270.54.0	LS	450 mm	für OE-Nummer: 60 01 549 007, 82 00 052 063 for OE number: 60 01 549 007, 82 00 052 063 vor Katalysator in front of the catalyst
			7.05270.56.0	LS	275 mm	
1.6 16V (LS09, LS0L, LS0M, LS0P, LS0V, LS18, LS1S, LS1V,... 77-82 kW (105-112 PS) K4M 694, K4M 696, K4M 697, K4M 698	02.2006→		7.05270.56.0	LS	275 mm	

LOGAN II **6**

1.5 Blue dCi 95 (L8JL) 55-85 kW (75-116 PS) K9K 872	05.2018→		7.11457.07.0* ↳ 7.11492.07.0	DDS DDS		
1.5 dCi 55-66 kW (75-90 PS) K9K 612	10.2012→		7.00368.16.0	AGR	EL	
1.5 dCi 55-66 kW (75-90 PS) K9K 626	10.2012→		7.05320.04.0 7.11457.07.0* ↳ 7.11492.07.0	AGR DDS DDS	EL	
1.5 dCi 55-63 kW (75-86 PS) K9K 830, K9K 838	01.2013→		7.00368.15.0	AGR	EL	



						
LOGAN II						6
1.5 dCi / Blue dCi 75 55-66 kW (75-90 PS) K9K 612	10.2012→		7.00368.16.0	AGR	EL 	
1.5 dCi / Blue dCi 75 55-66 kW (75-90 PS) K9K 626	10.2012→		7.05320.04.0	AGR	EL 	
			7.11457.07.0*	DDS		
			↳ 7.11492.07.0	DDS		
1.5 dCi / Blue dCi 75 55-85 kW (75-116 PS) K9K 872	10.2012→		7.11457.07.0*	DDS		
			↳ 7.11492.07.0	DDS		
LOGAN MCV (KS_)						7
1.4 55 kW (75 PS) K7J 710	02.2007→		7.05270.56.0	LS	275 mm	
1.5 dCi (KS04) 55-66 kW (75-90 PS) K9K 892	05.2010→06.2013		7.00368.16.0	AGR	EL 	
1.5 dCi (KS04) 55-66 kW (75-90 PS) K9K 892	05.2010→		7.00368.16.0	AGR	EL 	
1.5 dCi (KS0K) 50 kW (68 PS) K9K 792	02.2007→		7.00368.15.0	AGR	EL	
1.5 dCi (KS0W) 63 kW (86 PS) K9K 796	09.2007→12.2012		7.00368.15.0	AGR	EL	
1.6 64 kW (87 PS) K7M 710	02.2007→		7.05270.56.0	LS	275 mm	
1.6 16V (KS0L, KS0M, KS0P, KS1S) 77 kW (105 PS) K4M 690	02.2007→		7.05270.54.0	LS	450 mm für OE-Nummer: 60 01 549 007, 82 00 052 063 for OE number: 60 01 549 007, 82 00 052 063 vor Katalysator in front of the catalyst	
			7.05270.56.0	LS	275 mm	
1.6 16V (KS0L, KS0M, KS0P, KS1S) 77-82 kW (105-112 PS) K4M 696, K4M 697	02.2007→		7.05270.56.0	LS	275 mm	
1.6 16V Hi-Flex 77 kW (105 PS) K4M 690	11.2009→		7.05270.54.0	LS	450 mm für OE-Nummer: 60 01 549 007, 82 00 052 063 for OE number: 60 01 549 007, 82 00 052 063 vor Katalysator in front of the catalyst	
			7.05270.56.0	LS	275 mm	
1.6 Bifuel 64 kW (87 PS) K7M 710	11.2008→		7.05270.56.0	LS	275 mm	
1.6 MPI 85 62 kW (84 PS) K7M 800	05.2010→		7.05270.56.0	LS	275 mm	
LOGAN MCV II						8
1.5 Blue dCi 95 (K8JL) 55-85 kW (75-116 PS) K9K 872	10.2018→		7.11457.07.0*	DDS		
			↳ 7.11492.07.0	DDS		
1.5 dCi 55-66 kW (75-90 PS) K9K 612	02.2013→		7.00368.16.0	AGR	EL 	
1.5 dCi 55-66 kW (75-90 PS) K9K 626	02.2013→		7.05320.04.0	AGR	EL 	
			7.11457.07.0*	DDS		

D











LOGAN MCV II **8**





D

		↳ 7.11492.07.0	DDS		
1.5 dCi 55-63 kW (75-86 PS) K9K 830, K9K 838	02.2013→	 7.00368.15.0	AGR	EL	
1.5 dCi 55-66 kW (75-90 PS) K9K 612	02.2013→	 7.00368.16.0	AGR	EL	⊗
1.5 dCi 55-66 kW (75-90 PS) K9K 626	02.2013→	 7.05320.04.0	AGR	EL	⊗
		7.11457.07.0*	DDS		
		↳ 7.11492.07.0	DDS		





LOGAN Pickup (US_) **9**



































1.4 55 kW (75 PS) K7J 710	01.2009→	 7.05270.56.0	LS	275 mm	
1.5 dCi 55-66 kW (75-90 PS) K9K 892	05.2010→	 7.00368.16.0	AGR	EL	⊗
1.5 dCi 55-66 kW (75-90 PS) K9K 892	05.2010→	 7.00368.16.0	AGR	EL	⊗
1.5 dCi (US00, US0J, US0Y) 48 kW (65 PS) K9K 794	04.2008→12.2012	 7.22818.58.0	AGR	EL	⊗
1.5 dCi (US0K) 50 kW (68 PS) K9K 792	03.2008→	 7.00368.15.0	AGR	EL	
1.5 dCi (US0W) 63 kW (86 PS) K9K 796	03.2008→	 7.00368.15.0	AGR	EL	
1.6 64 kW (87 PS) K7M 710	03.2008→	 7.05270.56.0	LS	275 mm	
1.6 16V (US1Y) 77 kW (105 PS) K4M 690	01.2010→08.2013	 7.05270.54.0	LS	450 mm	für OE-Nummer: 60 01 549 007, 82 00 052 063 for OE number: 60 01 549 007, 82 00 052 063 vor Katalysator in front of the catalyst
1.6 MPI 85 62 kW (84 PS) K7M 800	05.2010→	 7.05270.56.0	LS	275 mm	

SANDERO **10**

1.5 dCi 50 kW (68 PS) K9K 792	11.2008→	 7.00368.15.0	AGR	EL	
1.5 dCi 63 kW (86 PS) K9K 796	11.2008→	 7.00368.15.0	AGR	EL	
1.5 dCi 48 kW (65 PS) K9K 790	11.2008→	 7.22818.58.0	AGR	EL	⊗
1.5 dCi 55-66 kW (75-90 PS) K9K 892	05.2010→	 7.00368.16.0	AGR	EL	⊗
1.5 dCi 55-66 kW (75-90 PS) K9K 892	05.2010→	 7.00368.16.0	AGR	EL	⊗

SANDERO II **11**



1.5 Blue dCi 95 (B8JL) 55-85 kW (75-116 PS) K9K 872	08.2018→	 7.11457.07.0*	DDS		
		↳ 7.11492.07.0	DDS		
1.5 dCi 55-66 kW (75-90 PS) K9K 612	10.2012→	 7.00368.16.0	AGR	EL	⊗
1.5 dCi 55-66 kW (75-90 PS) K9K 626	10.2012→	 7.05320.04.0	AGR	EL	⊗
		7.11457.07.0*	DDS		
		↳ 7.11492.07.0	DDS		
1.5 dCi 63 kW (86 PS) K9K 830	01.2013→	 7.00368.15.0	AGR	EL	

						
SANDERO II						11
1.5 dCi 75 / Blue dCi 75 (B8JW, B8M4, B8AH, B8M7, B8M6) 55-66 kW (75-90 PS) K9K 612	10.2012→		7.00368.16.0	AGR	EL 	
1.5 dCi 75 / Blue dCi 75 (B8JW, B8M4, B8AH, B8M7, B8M6) 55-66 kW (75-90 PS) K9K 626	10.2012→		7.05320.04.0	AGR	EL 	
			7.11457.07.0*	DDS		
			↳7.11492.07.0	DDS		
1.5 dCi 75 / Blue dCi 75 (B8JW, B8M4, B8AH, B8M7, B8M6) 55-85 kW (75-116 PS) K9K 872	10.2012→		7.11457.07.0*	DDS		
			↳7.11492.07.0	DDS		
SOLENZA (B41_)						12
1.9 D (B41E, B41F, B41G) 45-47 kW (61-64 PS) F8Q 636	02.2003→		7.22818.57.0	AGR	EL 	
DOKKER Express Box Body/MPV						13
1.5 Blue dCi 95 (FEJL) 55-85 kW (75-116 PS) K9K 872	06.2019→		7.11457.07.0*	DDS		
			↳7.11492.07.0	DDS		
1.5 dCi (FEAJ) 55-66 kW (75-90 PS) K9K 612	12.2012→		7.00368.16.0	AGR	EL 	
1.5 dCi (FEAJ) 55-66 kW (75-90 PS) K9K 626	12.2012→		7.05320.04.0	AGR	EL 	
1.5 dCi (FEMW) 55-66 kW (75-90 PS) K9K 612	12.2012→		7.00368.16.0	AGR	EL 	
1.5 dCi 75 / Blue dCi 75 (FEJW, FEAH) 55-66 kW (75-90 PS) K9K 612	12.2012→		7.00368.16.0	AGR	EL 	
1.5 dCi 75 / Blue dCi 75 (FEJW, FEAH) 55-66 kW (75-90 PS) K9K 626	12.2012→		7.05320.04.0	AGR	EL 	
			7.11457.07.0*	DDS		
			↳7.11492.07.0	DDS		
1.5 dCi 75 / Blue dCi 75 (FEJW, FEAH) 55-85 kW (75-116 PS) K9K 872	12.2012→		7.11457.07.0*	DDS		
			↳7.11492.07.0	DDS		
DUSTER SUV Van						14
1.5 dCi 55-66 kW (75-90 PS) K9K 884, K9K 892	04.2011→		7.00368.16.0	AGR	EL 	
1.5 dCi 80-81 kW (109-110 PS) K9K 666	04.2013→		7.05320.04.0	AGR	EL 	
			7.11457.07.0*	DDS		
			↳7.11492.07.0	DDS		
1.5 dCi 80 kW (109 PS) K9K 856	04.2013→		7.00368.16.0	AGR	EL 	
1.5 dCi 4x4 66 kW (90 PS) K9K 884	04.2011→		7.00368.16.0	AGR	EL 	
1.5 dCi 4x4 80 kW (109 PS) K9K 658	04.2013→		7.05320.04.0	AGR	EL 	

D



































DUSTER SUV Van **14**

			7.11457.07.0*	DDS		
			↳ 7.11492.07.0	DDS		
1.5 dCi 4x4 80 kW (109 PS) K9K 858	04.2013→		7.00368.16.0	AGR	EL	

D

LOGAN EXPRESS (FS_) **15**



1.4 55 kW (75 PS) K7J 710	03.2009→		7.05270.56.0	LS	275 mm	
1.5 dCi 55-66 kW (75-90 PS) K9K 892	05.2010→		7.00368.16.0	AGR	EL	
1.5 dCi 55-66 kW (75-90 PS) K9K 892	05.2010→		7.00368.16.0	AGR	EL	
1.5 dCi (FS0K) 50 kW (68 PS) K9K 792	03.2009→		7.00368.15.0	AGR	EL	
1.5 dCi (FS0W) 63 kW (86 PS) K9K 796	03.2009→		7.00368.15.0	AGR	EL	
1.6 64 kW (87 PS) K7M 710	03.2009→		7.05270.56.0	LS	275 mm	
1.6 MPI 85 62 kW (84 PS) K7M 800	05.2010→		7.05270.56.0	LS	275 mm	

						
CIELO						1
1.5 44-59 kW (55-80 PS) G15MF	08.1996→11.2000		7.09002.02.0	AGR	PN	<input checked="" type="checkbox"/>
ESPERO (KLEJ)						2
1.5 55 kW (75 PS) A15F	10.1997→08.1999		7.02604.01.0	LS	200 mm	
1.5 16V 65-70 kW (88-95 PS) A15MF	10.1993→09.1994		7.02604.01.0	LS	200 mm	
1.5 16V 65-70 kW (88-95 PS) A15MF	02.1995→06.1999		7.02604.01.0	LS	200 mm	
1.8 66-76 kW (90-103 PS) C18LE	02.1995→09.1999		7.02604.01.0	LS	200 mm	
1.8 66-76 kW (90-103 PS) C18LE	02.1995→06.1999		7.02604.01.0	LS	200 mm	
2.0 74 kW (101 PS) C20LZ	10.1991→09.1993		7.02604.01.0	LS	200 mm	
2.0 72-85 kW (98-116 PS) C20LE	10.1993→09.1994		7.02604.01.0	LS	200 mm	
2.0 72-85 kW (98-116 PS) C20LE	02.1995→06.1999		7.02604.01.0	LS	200 mm	
KALOS (KLAS)						3
1.2 53-56 kW (72-76 PS) B12S3	04.2003→		7.05271.73.0	LS	528 mm	
1.4 61 kW (83 PS) F14S3	09.2002→		7.09002.04.0	AGR	ET	<input type="checkbox"/>
1.4 16V 69-70 kW (94-95 PS) F14D3	04.2003→		7.05271.73.0	LS	528 mm	
KALOS Saloon (KLAS)						4
1.4 61 kW (83 PS) F14S3	11.2002→12.2004		7.09002.04.0	AGR	ET	<input type="checkbox"/>
LACETTI Hatchback (KLAN)						5
1.4 69-70 kW (94-95 PS) F14D3	02.2004→		7.09002.04.0	AGR	ET	<input type="checkbox"/>
			7.05271.73.0	LS	528 mm	
1.6 77-80 kW (105-109 PS) F16D3	02.2004→		7.09002.01.0	AGR	PN	<input type="checkbox"/>
			7.09002.04.0	AGR	ET	<input type="checkbox"/>
			7.05271.73.0	LS	528 mm	
1.8 89-90 kW (121-122 PS) T18SED	02.2004→		7.09002.01.0	AGR	PN	<input type="checkbox"/>
			7.09002.04.0	AGR	ET	<input type="checkbox"/>
LACETTI Saloon (J200)						6
1.8 89-90 kW (121-122 PS) T18SED	06.2002→12.2004		7.09002.01.0	AGR	PN	<input type="checkbox"/>
LANOS (KLAT)						7
1.5 62-73 kW (84-99 PS) LX6(91CUL4)	05.1997→		7.09002.02.0	AGR	PN	<input checked="" type="checkbox"/>
1.6 16V 76-78 kW (103-106 PS) L44(98CUL4)	05.1997→		7.09002.01.0	AGR	PN	<input type="checkbox"/>
LANOS Saloon (KLAT)						8
1.3 55 kW (75 PS) L13(82CUL4)	05.1997→		7.02604.15.0	LS	360 mm	
1.5 62-73 kW (84-99 PS) LX6(91CUL4)	05.1997→		7.09002.02.0	AGR	PN	<input checked="" type="checkbox"/>











D





LANOS Saloon (KLAT) **8**

D	1.5 73-81 kW (99-110 PS) L43(91CUL4)	10.1997→06.1999		7.02604.15.0	LS	360 mm	
	1.5 62-73 kW (84-99 PS) LX6(91CUL4)	10.1997→04.2001		7.09002.02.0	AGR	PN	☒
	1.6 16V 76-78 kW (103-106 PS) L44(98CUL4)	02.1997→		7.09002.01.0	AGR	PN	○
				7.09002.13.0	AGR	ET	○





LEGANZA (KLAV) **9**

D	1.8 CD 66-76 kW (90-103 PS) C18LE	06.1997→07.2003		7.09002.01.0	AGR	PN	○
	2.0 93-133 kW (126-181 PS) T20SED	01.2001→12.2002		7.09002.01.0	AGR	PN	○
	2.0 16V 85-98 kW (121-133 PS) X 20 SED	06.1997→12.2002		7.09002.01.0	AGR	PN	○
				7.02604.15.0	LS	360 mm	 X 20 SED:  →ch. 289553 Euro 2 Europa  Europe  X 20 SED:  →ch. 290284 Euro 2 Europa Europe
	2.0 16V 93-133 kW (126-181 PS) T20SED	07.2000→04.2004		7.09002.01.0	AGR	PN	○
				7.09002.13.0	AGR	ET	○
2.2 16V 100 kW (136 PS) T22SED	04.1999→12.2002		7.09002.13.0	AGR	ET	○	
			7.05271.52.0	LS	350 mm	 ch. 289554→ Diagnosesonde Diagnostic Probe	

MATIZ (M100, M150) **10**

D	0.8 27-38 kW (44-52 PS) F8CV	09.1998→		7.09002.10.0	AGR	ET	○
				7.05271.52.0	LS	350 mm	→01.2005,  →ch. 47162 Euro 2 Euro 2
1.0 47 kW (64 PS) B10S	01.2003→		7.05271.73.0	LS	528 mm		

NEXIA **11**









D	1.5 (08, 68) 44-59 kW (55-80 PS) G15MF	08.1996→08.1997		7.09002.02.0	AGR	PN	☒
				7.02604.01.0	LS	200 mm	
	1.5 (08, 68) 44-59 kW (55-80 PS) G15MF	08.1996→08.1997		7.09002.02.0	AGR	PN	☒
				7.02604.01.0	LS	200 mm	
1.5 (08, 68) 44-59 kW (55-80 PS) G15MF	08.1996→08.1997		7.09002.02.0	AGR	PN	☒	
			7.02604.01.0	LS	200 mm		
1.5 16V (08, 68) 65-70 kW (88-95 PS) A15MF	02.1995→08.1997		7.02604.01.0	LS	200 mm		

NEXIA Saloon						12
1.5 (19) 44-59 kW (55-80 PS) G15MF	08.1996→08.1997		7.09002.02.0	AGR	PN <input checked="" type="checkbox"/>	
			7.02604.01.0	LS	200 mm	
1.5 (19) 44-59 kW (55-80 PS) G15MF	08.1996→08.1997		7.09002.02.0	AGR	PN <input checked="" type="checkbox"/>	
			7.02604.01.0	LS	200 mm	
1.5 (19) 44-59 kW (55-80 PS) G15MF	08.1996→08.1997		7.09002.02.0	AGR	PN <input checked="" type="checkbox"/>	
			7.02604.01.0	LS	200 mm	
1.5 16V (19) 65-70 kW (88-95 PS) A15MF	02.1995→08.1997		7.02604.01.0	LS	200 mm	
NUBIRA (J100)						13
1.6 66-85 kW (90-106 PS) A16DMS	08.2002→07.2003		7.02604.01.0	LS	200 mm	
1.6 16V 66-85 kW (90-106 PS) A16DMS	05.1997→05.1999		7.09002.01.0	AGR	PN <input type="checkbox"/>	
			7.02604.15.0	LS	360 mm Euro 2 Euro 2	
2.0 85-98 kW (121-133 PS) X 20 SED	09.1998→12.1999		7.09002.01.0	AGR	PN <input type="checkbox"/>	
			7.02604.15.0	LS	360 mm 01.1999→ SOHC/OHC SOHC/OHC	
2.0 16V 98 kW (133 PS) Z20L	05.1997→		7.02604.15.0	LS	360 mm	
NUBIRA (J150)						14
1.6 16V 66-85 kW (90-106 PS) A16DMS	06.1999→07.2002		7.09002.01.0	AGR	PN <input type="checkbox"/>	
			7.02604.15.0	LS	360 mm Ausstattungsvariante: XDP: EMS-Sys. Delphi Equipment Variant: XDP: EMS-Sys. Delphi	
2.0 16V 85-98 kW (121-133 PS) X 20 SED	06.1999→07.2002		7.09002.01.0	AGR	PN <input type="checkbox"/>	
			7.02604.15.0	LS	360 mm X 20 SED: →ch. 580669 Ausstattungsvariante: CDX, SX Equipment Variant: CDX, SX SOHC/OHC SOHC/OHC Europa Europe X 20 SED: →ch. 579371 Ausstattungsvariante: CDX Equipment Variant: CDX SOHC/OHC SOHC/OHC Europa Europe X 20 SED: →12.2001 Euro 2 Euro 2 DOHC DOHC	
NUBIRA Estate (J150)						15
1.6 16V 66-85 kW (90-106 PS) A16DMS	06.1999→12.2002		7.09002.01.0	AGR	PN <input type="checkbox"/>	
			7.02604.15.0	LS	360 mm Ausstattungsvariante: XDP: EMS-Sys. Delphi Equipment Variant: XDP: EMS-Sys. Delphi	















D



NUBIRA Estate (J150) **15**

2.0 16V 85-98 kW (121-133 PS) X 20 SED	06.1999→07.2002		7.09002.01.0	AGR	PN	
			7.02604.15.0	LS	360 mm	 X 20 SED:  →ch. 579371 Ausstattungsvariante: CDX Equipment Variant: CDX SOHC/OHC SOHC/OHC Europa Europe  X 20 SED:  →ch. 580669 Ausstattungsvariante: CDX, SX Equipment Variant: CDX, SX SOHC/OHC SOHC/OHC  Europa  Europe  X 20 SED: Euro 2 Euro 2 DOHC DOHC

NUBIRA Saloon (J100) **16**

























1.6 16V 66-85 kW (90-106 PS) A16DMS	04.1997→04.1998		7.09002.01.0	AGR	PN	
1.6 16V 66-85 kW (90-106 PS) A16DMS	05.1997→05.1999		7.09002.01.0	AGR	PN	
			7.02604.15.0	LS	360 mm	Euro 2 Euro 2
1.6 16V 66-85 kW (90-106 PS) A16DMS	07.2000→		7.02604.01.0	LS	200 mm	
1.8 16V 100 kW (136 PS) X18XE1	04.1997→05.1999		7.09002.01.0	AGR	PN	
2.0 95-96 kW (129-131 PS) X 20 SE	09.1998→12.2002		7.02604.15.0	LS	360 mm	01.1999→12.1999 SOHC/OHC SOHC/OHC
2.0 81 kW (110 PS) C20SED	06.1999→07.2003		7.02604.15.0	LS	360 mm	→12.2001 Euro 2 Euro 2 DOHC DOHC
2.0 16V 85-98 kW (121-133 PS) X 20 SED	05.1997→		7.09002.01.0	AGR	PN	
			7.09002.13.0	AGR	ET	
			7.02604.15.0	LS	360 mm	01.1999→12.1999 SOHC/OHC SOHC/OHC
2.0 16V 93-133 kW (126-181 PS) T20SED	12.2000→		7.09002.13.0	AGR	ET	
			7.02604.15.0	LS	360 mm	→12.2001 Euro 2 Euro 2 DOHC DOHC

NUBIRA Saloon (J150) **17**

1.6 16V 66-85 kW (90-106 PS) A16DMS	06.1999→07.2002		7.09002.01.0	AGR	PN	
			7.02604.15.0	LS	360 mm	Ausstattungsvariante: XDP: EMS-Sys. Delphi Equipment Variant: XDP: EMS-Sys. Delphi

NUBIRA Saloon (J150)						17
2.0 16V 85-98 kW (121-133 PS) X 20 SED	06.1999→07.2002		7.09002.01.0	AGR	PN	
			7.02604.15.0	LS	360 mm X 20 SED: →ch. 579371 Ausstattungsvariante: CDX Equipment Variant: CDX SOHC/OHC SOHC/OHC Europa Europe X 20 SED: →ch. 580669 Ausstattungsvariante: CDX, SX Equipment Variant: CDX, SX SOHC/OHC SOHC/OHC Europa Europe X 20 SED: →12.2001 Euro 2 Euro 2 DOHC DOHC	
NUBIRA Saloon (J200)						18
1.6 77-80 kW (105-109 PS) F16D3	07.2003→		7.09002.04.0	AGR	ET	
			7.05271.73.0	LS	528 mm	
1.8 89-90 kW (121-122 PS) T18SED	07.2003→		7.09002.04.0	AGR	ET	
NUBIRA Wagon (J100)						19
1.6 16V 66-85 kW (90-106 PS) A16DMS	05.1997→05.1999		7.09002.01.0	AGR	PN	
			7.02604.15.0	LS	360 mm Euro 2 Euro 2	
1.6 16V 66-85 kW (90-106 PS) A16DMS	12.2000→		7.02604.01.0	LS	200 mm	
2.0 95-96 kW (129-131 PS) X 20 SE	09.1998→12.2002		7.02604.15.0	LS	360 mm 01.1999→12.1999 SOHC/OHC SOHC/OHC	
2.0 16V 85-98 kW (121-133 PS) X 20 SED	05.1997→		7.09002.01.0	AGR	PN	
			7.02604.15.0	LS	360 mm 01.1999→12.1999 SOHC/OHC SOHC/OHC	
NUBIRA Wagon (J200)						20
1.6 77-80 kW (105-109 PS) F16D3	07.2003→		7.09002.04.0	AGR	ET	
			7.05271.73.0	LS	528 mm	
1.8 89-90 kW (121-122 PS) T18SED	07.2003→		7.09002.04.0	AGR	ET	
CIELO LOAD RUNNER						21
1.5 44-59 kW (55-80 PS) G15MF	08.1996→08.1997		7.09002.02.0	AGR	PN	

D

						
APPLAUSE						1
1.6 16V 52-91 kW (71-90 PS) HD-C	06.1989→07.1997		7.02604.01.0	LS	200 mm	
APPLAUSE I Hatchback (A101, A111)						2
1.6 16V (A101) 69-77 kW (94-105 PS) HD-E	06.1989→07.1997		7.02604.01.0	LS	200 mm	
1.6 16V (A101) 66-67 kW (90-91 PS) HD	06.1989→07.1997		7.02604.01.0	LS	200 mm	
1.6 16V 4WD (A111) 69-77 kW (94-105 PS) HD-E	06.1989→07.1997		7.02604.01.0	LS	200 mm	
CHARADE						3
0.8 29 kW (39 PS) CD	05.1982→		7.02604.01.0	LS	200 mm	
CHARADE III (G100, G101, G102)						4
1.0 (G100) 40-41 kW (54-56 PS) CB 90	04.1989→12.1992		7.02604.01.0	LS	200 mm	
1.0 (G100) 40-41 kW (54-56 PS) CB 90	11.1990→12.1992		7.02604.01.0	LS	200 mm	
COPEN (L880_, L881_)						5
0.7 (L880) 47-50 kW (64-68 PS) JB, JB-DET	09.2003→12.2007		7.05271.32.0	LS	200 mm	
CUORE II (L80, L81)						6
0.8 (L80) 29-32 kW (39-44 PS) ED 10	09.1985→06.1990		7.02604.01.0	LS	200 mm	
0.8 (L80) 29-32 kW (39-44 PS) ED 10	11.1989→12.1990		7.02604.01.0	LS	200 mm	
0.8 4WD (L81) 29-32 kW (39-44 PS) ED 10	09.1986→10.1988		7.02604.01.0	LS	200 mm	
CUORE III (L201)						7
0.8 26-30 kW (35-41 PS) ED 10 K	10.1990→12.1994		7.02604.01.0	LS	200 mm	
0.8 30-32 kW (41-44 PS) ED	10.1990→09.1994		7.02604.01.0	LS	200 mm	
CUORE IV (L501)						8
0.8 31-32 kW (42-44 PS) ED 20	01.1995→08.1998		7.02604.01.0	LS	200 mm	
0.8 31-32 kW (42-44 PS) ED 20	11.1996→10.1998		7.02604.01.0	LS	200 mm	
CUORE VI (L251, L250_, L260_)						9
1.0 40-46 kW (56-63 PS) EJ-VE	05.2003→		7.05271.32.0	LS	200 mm	
MOVE (L9_)						10
1.0 i 30-46 kW (54-63 PS) EJ-DE	10.1998→09.2002		7.05271.32.0	LS	200 mm	
SIRION (M1)						11
1.0 i (M101) 40-46 kW (56-63 PS) EJ-VE	09.2000→01.2005		7.05271.32.0	LS	200 mm	
1.0 i 4WD 40-46 kW (56-63 PS) EJ-VE	09.2000→01.2005		7.05271.32.0	LS	200 mm	

TREVIS
12

 1.0 40-46 kW (56-63 PS)
 EJ-VE

06.2006→

7.05271.32.0

LS

 200
 mm

YRV (M2)
13

 1.0 40-46 kW (56-63 PS)
 EJ-VE

02.2001→

7.05271.32.0

LS

 200
 mm

















D



























ENGINE

1

D



ENGINE 36 kW (49 PS) D 2.9 L4		7.04371.07.0	AGR	PN	
		7.04256.36.0	AGR	EL	
		7.04257.20.0	AGR	EL	
ENGINE 55 kW (75 PS) TCD 2.9 L4		7.04371.07.0	AGR	PN	
		7.04433.02.0	AGR-K	EL	
ENGINE 55 kW (75 PS) TD 2.9 L4		7.04433.02.0	AGR-K	EL	
ENGINE 55 kW (75 PS) TD 3.6 L4		7.04256.35.0	AGR	EL	
		7.04257.19.0	AGR	EL	 Nennspannung [V]: 24 Rated Voltage [V]: 24
ENGINE 90 kW (122 PS) TCD 3.6 L4 interim		7.04371.07.0	AGR	PN	
ENGINE 100 kW (136 PS) TCD 3.6 L4		7.04371.07.0	AGR	PN	
		7.04256.35.0	AGR	EL	
		7.04257.19.0	AGR	EL	 Nennspannung [V]: 24 Rated Voltage [V]: 24
		7.04402.02.0	AGR-K	EL	
		7.04038.08.0	AGR-K		
ENGINE 115 kW (156 PS) TCD 4.1 L4		7.04371.07.0	AGR	PN	
		7.04448.18.0	AGR-K	EL	Spannung [V]: 24 Voltage [V]: 24
		7.03527.12.0	AGR-M	EL	
		7.04382.09.0	AGR-M	EL	
ENGINE 180 kW (245 PS) TCD 6.1 L6		7.03379.03.0	AGR	PN	
		7.04784.06.0	AGR-K	EL	
		7.04788.06.0	AGR-K	EL	
		7.05107.12.0	AGR-K	EL	Spannung [V]: 24 Voltage [V]: 24
ENGINE 250 kW (340 PS) TCD 7.8 L6		7.03379.03.0	AGR	PN	
		7.04723.10.0	AGR-K	EL	
		7.04787.12.0	AGR-K	EL	Spannung [V]: 24 Voltage [V]: 24

							
AVENGER							1
2.0 CRD 88-103 kW (120-140 PS) ECD	06.2007→12.2011		7.24809.16.0	AGR	PN	○	
2.4 125-129 kW (170-175 PS) EDG	06.2007→12.2014		7.28247.13.0	SLP	EL		
2.4 125-129 kW (170-175 PS) EDG	06.2007→12.2014		7.28247.13.0	SLP	EL		
CALIBER							2
2.0 CRD 88-103 kW (120-140 PS) ECD	06.2006→		7.24809.16.0	AGR	PN	○	
2.0 CRD 100-103 kW (136-140 PS) ECE	06.2006→		7.24809.16.0	AGR	PN	○	
			7.05270.21.0	LS	600 mm	vor Katalysator in front of the catalyst	
2.0 CRD 88-103 kW (120-140 PS) ECD	06.2006→11.2011		7.24809.16.0	AGR	PN	○	
2.2 CRD 120 kW (163 PS) ENE	07.2010→11.2011		7.11190.01.0	DDS		2012 2012	
			7.11190.01.0	DDS		2012 2012	
			7.05270.21.0	LS	600 mm	vor Katalysator in front of the catalyst	
CHARGER							3
6.4 SRT8 351-362 kW (477-492 PS) ESG	09.2011→		7.11190.04.0	DDS			
6.4 SRT8 351-362 kW (477-492 PS) ESG	09.2014→		7.11190.04.0	DDS			
DAKOTA							4
3.7 151-163 kW (205-222 PS) EKG	10.2003→		7.00992.36.0	AGR	EL	○ mit Befestigungsmaterial with fastening material	
3.7 AWD 151-163 kW (205-222 PS) EKG	10.2003→		7.00992.36.0	AGR	EL	○ mit Befestigungsmaterial with fastening material	
DAKOTA Crew Cab Pickup							5
3.7 151-163 kW (205-222 PS) EKG	09.2004→12.2010		7.00992.36.0	AGR	EL	○ mit Befestigungsmaterial with fastening material	
3.7 4WD 151-163 kW (205-222 PS) EKG	09.2004→12.2010		7.00992.36.0	AGR	EL	○ mit Befestigungsmaterial with fastening material	
DAKOTA Extended Cab Pickup							6
3.7 151-163 kW (205-222 PS) EKG	09.2004→12.2010		7.00992.36.0	AGR	EL	○ mit Befestigungsmaterial with fastening material	
3.7 4WD 151-163 kW (205-222 PS) EKG	09.2004→12.2010		7.00992.36.0	AGR	EL	○ mit Befestigungsmaterial with fastening material	
DURANGO (HB)							7
3.7 151-163 kW (205-222 PS) EKG	11.2003→12.2010		7.00992.36.0	AGR	EL	○ mit Befestigungsmaterial with fastening material	
3.7 AWD 151-163 kW (205-222 PS) EKG	11.2003→12.2010		7.00992.36.0	AGR	EL	○ mit Befestigungsmaterial with fastening material	
JOURNEY							8
2.0 CRD 100-103 kW (136-140 PS) ECE	06.2008→		7.05270.21.0	LS	600 mm	vor Katalysator in front of the catalyst	
2.0 CRD 100-103 kW (136-140 PS) ECE	06.2008→12.2011		7.05270.21.0	LS	600 mm	vor Katalysator in front of the catalyst	

D

















JOURNEY **8**





2.4 125-129 kW (170-175 PS) EDG	09.2008→		7.28247.13.0	SLP	EL	
2.4 ECO+ 125-129 kW (170-175 PS) EDG	06.2008→		7.28247.13.0	SLP	EL	

D

NITRO **9**





























2.8 CRD 110-130 kW (150-177 PS) ENR	06.2007→12.2012		7.02604.99.0	LS	400 mm	
2.8 CRD 110-130 kW (150-177 PS) ENS	06.2007→12.2012		7.01317.10.0	AGR	PN	 2010 2010
			7.03295.03.0	AGR	EL	 2011 2011
			7.11190.01.0	DDS		2009 2009
			7.11190.01.0	DDS		2009 2009
			7.02604.99.0	LS	400 mm	
2.8 CRD 4WD 110-130 kW (150-177 PS) ENR	06.2007→12.2012		7.02604.99.0	LS	400 mm	
2.8 CRD 4WD 110-130 kW (150-177 PS) ENS	06.2007→12.2012		7.01317.10.0	AGR	PN	 2010 2010
			7.03295.03.0	AGR	EL	 2011 2011
			7.11190.01.0	DDS		2009 2009
			7.11190.01.0	DDS		2009 2009
			7.02604.99.0	LS	400 mm	
3.7 151-163 kW (205-222 PS) EKG	09.2006→12.2012		7.00992.36.0	AGR	EL	 mit Befestigungsmaterial with fastening material
3.7 4WD 151-163 kW (205-222 PS) EKG	09.2006→12.2012		7.00992.36.0	AGR	EL	 mit Befestigungsmaterial with fastening material
3.7 V6 4WD 151-163 kW (205-222 PS) EKG	06.2007→12.2012		7.00992.36.0	AGR	EL	 mit Befestigungsmaterial with fastening material

RAM 1500 Crew Cab Pickup **10**

3.7 151-163 kW (205-222 PS) EKG	09.2008→12.2010		7.00992.36.0	AGR	EL	 mit Befestigungsmaterial with fastening material
3.7 4WD 151-163 kW (205-222 PS) EKG	09.2008→12.2010		7.00992.36.0	AGR	EL	 mit Befestigungsmaterial with fastening material

RAM 1500 Extended Cab Pickup **11**

3.7 151-163 kW (205-222 PS) EKG	09.2008→12.2010		7.00992.36.0	AGR	EL	 mit Befestigungsmaterial with fastening material
3.7 4WD 151-163 kW (205-222 PS) EKG	09.2008→12.2010		7.00992.36.0	AGR	EL	 mit Befestigungsmaterial with fastening material

						
RAM 1500 Extended Crew Cab Pickup						12
3.7 151-163 kW (205-222 PS) EKG	09.2007→12.2008		7.00992.36.0	AGR	EL	<input type="radio"/> mit Befestigungsmaterial with fastening material
3.7 4WD 151-163 kW (205-222 PS) EKG	09.2007→12.2008		7.00992.36.0	AGR	EL	<input type="radio"/> mit Befestigungsmaterial with fastening material
RAM 1500 Standard Cab Pickup						13
3.7 151-163 kW (205-222 PS) EKG	09.2008→12.2010		7.00992.36.0	AGR	EL	<input type="radio"/> mit Befestigungsmaterial with fastening material
3.7 4WD 151-163 kW (205-222 PS) EKG	09.2008→12.2010		7.00992.36.0	AGR	EL	<input type="radio"/> mit Befestigungsmaterial with fastening material
SPRINTER 2500 Cab & Chassis						14
2.7 D 115 kW (156 PS) EX8	09.2003→12.2006		7.24809.54.0	AGR	ET	<input type="radio"/>
3.0 D 115 kW (156 PS) EXM	09.2006→12.2007		7.24809.60.0	AGR	ET	<input type="radio"/>
3.5 190 kW (258 PS) EG2	09.2006→12.2007		7.04389.02.0	SLP	EL	
SPRINTER 2500 Standard Cargo Van						15
3.0 D 115 kW (156 PS) EXM	09.2006→12.2009		7.24809.60.0	AGR	ET	<input type="radio"/>
3.5 190 kW (258 PS) EG2	09.2006→12.2008		7.04389.02.0	SLP	EL	
SPRINTER 2500 Standard Cargo Van (VA)						16
2.7 D 115 kW (156 PS) EX8	09.2003→12.2006		7.24809.54.0	AGR	ET	<input type="radio"/>
SPRINTER 2500 Standard Passenger Van						17
2.7 D	09.2002→12.2003		7.24809.65.0	AGR	ET	<input type="radio"/>
2.7 D 115 kW (156 PS) EX8	09.2003→12.2006		7.24809.54.0	AGR	ET	<input type="radio"/>
3.0 D 115 kW (156 PS) EXM	09.2006→12.2009		7.24809.60.0	AGR	ET	<input type="radio"/>
3.5 190 kW (258 PS) EG2	09.2006→12.2008		7.04389.02.0	SLP	EL	
SPRINTER 3500 Cab & Chassis						18
2.7 D 115 kW (156 PS) EX8	01.2005→12.2006		7.24809.54.0	AGR	ET	<input type="radio"/>
3.0 D 115 kW (156 PS) EXM	09.2006→12.2009		7.24809.60.0	AGR	ET	<input type="radio"/>
3.5 190 kW (258 PS) EG2	09.2006→12.2008		7.04389.02.0	SLP	EL	
SPRINTER 3500 Standard Cargo Van						19
2.7 D 115 kW (156 PS) EX8	09.2002→12.2006		7.24809.65.0	AGR	ET	<input type="radio"/>
3.0 D 115 kW (156 PS) EXM	09.2006→12.2009		7.24809.60.0	AGR	ET	<input type="radio"/>
3.5 190 kW (258 PS) EG2	09.2006→12.2008		7.04389.02.0	SLP	EL	
SPRINTER 3500 Standard Passenger Van						20
3.0 D 115 kW (156 PS) EXM	09.2006→12.2007		7.24809.60.0	AGR	ET	<input type="radio"/>
3.5 190 kW (258 PS) EG2	09.2006→12.2007		7.04389.02.0	SLP	EL	

D



DS 3 (SA_)

1

1.6 e-HDi 92 68-69 kW (92-94 PS) 9HP (DV6DTED)	04.2015→07.2019		7.02209.11.0	AGR	EL	 ohne Sensor without sensor mit AGR-Ventil with EGR valve ohne Sensor without sensor ohne AGR-Ventil without EGR valve ohne Zubehör without accessories
			7.02156.35.0	AGR-K	EL	
			7.02156.34.0	AGR-K		
			7.11492.01.0	DDS		

DS 3 CROSSBACK (UR_, UC_, UJ_)

2

1.5 BlueHDi 100 75 kW (102 PS) YHY (DV5RD)	10.2018→		7.07794.23.0	AGR	EL	mit Dichtring with O-ring
1.5 BlueHDi 130 96 kW (130 PS) YHZ (DV5RC)	10.2018→		7.07794.23.0	AGR	EL	mit Dichtring with O-ring

DS 4 / DS 4 CROSSBACK (NX_)

3

1.6 e-HDi 115 82-84 kW (112-114 PS) 9HD (DV6C)	07.2015→12.2018		7.02209.11.0	AGR	EL	 ohne Sensor without sensor mit AGR-Ventil with EGR valve ohne Sensor without sensor ohne AGR-Ventil without EGR valve ohne Zubehör without accessories
			7.02156.35.0	AGR-K	EL	
			7.02156.34.0	AGR-K		
			7.11492.01.0	DDS		
2.0 BlueHDi 150 110 kW (150 PS) AHR (DW10FD)	07.2015→12.2018		7.11492.01.0	DDS		ohne Zubehör without accessories
2.0 BlueHDi 180 133 kW (181 PS) AHW (DW10FC)	07.2015→12.2018		7.11492.01.0	DDS		ohne Zubehör without accessories

DS 5 (KF_)

4



















































1.6 BlueHDi 115 85 kW (116 PS) BHX (DV6C)	06.2015→12.2018		7.02209.11.0	AGR	EL	 ohne Sensor without sensor mit AGR-Ventil with EGR valve ohne Sensor without sensor ohne AGR-Ventil without EGR valve ohne Zubehör without accessories
			7.02156.35.0	AGR-K	EL	
			7.02156.34.0	AGR-K		
			7.11492.01.0	DDS		
2.0 BlueHDi 150 110 kW (150 PS) AHR (DW10FD)	04.2015→12.2018		7.11492.01.0	DDS		ohne Zubehör without accessories
2.0 BlueHDi 180 133 kW (181 PS) AHW (DW10FC)	04.2015→12.2018		7.11492.01.0	DDS		ohne Zubehör without accessories
2.0 HDi 165 120 kW (163 PS) RHH (DW10CTED4)	06.2017→12.2018		7.11492.01.0	DDS		ohne Zubehör without accessories
2.0 Hybrid4 120 kW (163 PS) RHC (DW10CTED4)	04.2015→12.2018		7.11492.01.0	DDS		ohne Zubehör without accessories
2.0 Hybrid4 4x4 120 kW (163 PS) RHC (DW10CTED4)	04.2015→12.2018		7.11492.01.0	DDS		ohne Zubehör without accessories
			7.02604.99.0	LS	400 mm	





DS 7 Crossback (J_) **5**

1.5 BlueHDi 130 96 kW (130 PS) YHZ (DV5RC)	09.2017->	 7.07794.23.0	AGR	EL mit Dichtring with O-ring
---	-----------	---	-----	---------------------------------

D

			 PIERBURG			
360 (F131)						1
3.6 Challenge Stradale 305-316 kW (415-430 PS) F 131 B44	05.2003→03.2005		7.22296.02.0	ARV	PN 	
			7.22472.07.0	SLP	EL	
3.6 Modena 294 kW (400 PS) F 131 B40	03.1999→03.2005		7.22296.02.0	ARV	PN 	
			7.22472.07.0	SLP	EL USA USA	
3.6 Modena 305-316 kW (415-430 PS) F 131 B44	01.2002→03.2005		7.22296.02.0	ARV	PN 	
360 Spider (F131)						2
3.6 294 kW (400 PS) F 131 B40	02.2000→08.2005		7.22296.02.0	ARV	PN 	
			7.22472.07.0	SLP	EL USA, Kanada USA, Kanada 2000 2000 2001 2001	
458						3
4.5 419-425 kW (570-578 PS) F 136 FB	12.2009→		7.22296.02.0	ARV	PN 	
			7.22296.02.0	ARV	PN 	
4.5 425-445 kW (600-605 PS) F 136 FL	12.2009→12.2015		7.22296.02.0	ARV	PN 	
			7.22296.02.0	ARV	PN 	
4.5 425-445 kW (600-605 PS) F 136 FL	09.2013→		7.22296.02.0	ARV	PN 	
			7.22296.02.0	ARV	PN 	
4.5 425-445 kW (600-605 PS) F 136 FL	09.2013→		7.22296.02.0	ARV	PN 	
			7.22296.02.0	ARV	PN 	
458 Spider						4
4.5 419-425 kW (570-578 PS) F 136 FB	12.2009→12.2015		7.22296.02.0	ARV	PN 	
			7.22296.02.0	ARV	PN 	
4.5 419-425 kW (570-578 PS) F 136 FB	09.2011→		7.22296.02.0	ARV	PN 	
			7.22296.02.0	ARV	PN 	
4.5 425-445 kW (600-605 PS) F 136 FL	12.2014→		7.22296.02.0	ARV	PN 	
			7.22296.02.0	ARV	PN 	
512 TR						5
4.9 315 kW (428 PS) F 113 D 00/40	01.1992→10.1994		7.02604.04.0	LS	200 mm	
599 GTB/GTO						6
6.0 GTB 450-493 kW (612-670 PS) F134FB61	06.2006→		7.22296.02.0	ARV	PN 	
			7.22472.07.0	SLP	EL Assembly-Nummer bis: 87312 Assembly number to: 87312	
6.0 GTB 450-493 kW (612-670 PS) F134FB61	06.2006→		7.22296.02.0	ARV	PN 	
			7.22296.02.0	ARV	PN 	
6.0 GTO 489 kW (665 PS) F140CE	04.2010→		7.22296.02.0	ARV	PN 	
			7.22296.02.0	ARV	PN 	
6.0 GTO 450-493 kW (612-670 PS) F134FB61	04.2010→		7.22296.02.0	ARV	PN 	
			7.22296.02.0	ARV	PN 	
599 SA						7
6.0 450-493 kW (612-670 PS) F134FB61	09.2010→		7.22296.02.0	ARV	PN 	
5_MARANELLO						8
575 M 380 kW (517 PS) F133C47	04.2002→12.2006		7.22296.02.0	ARV	PN 	
			7.22472.07.0	SLP	EL	

					
612 SCAGLIETTI 9					
5.7 384-397 kW (522-540 PS) F 118 B 42	04.2004→06.2011		7.22296.02.0	ARV	PN <input type="radio"/>
			7.22472.07.0	SLP	EL
5.7 384-397 kW (522-540 PS) F 118 B 42	09.2004→12.2010		7.22296.02.0	ARV	PN <input type="radio"/>
CALIFORNIA 10					
4.3 338-360 kW (460-490 PS) F 131 B48	07.2008→		7.22296.02.0	ARV	PN <input type="radio"/>
			7.22472.07.0	SLP	EL
4.3 338-360 kW (460-490 PS) F 131 B48	09.2008→		7.22296.02.0	ARV	PN <input type="radio"/>
			7.22472.07.0	SLP	EL Assembly-Nummer bis: 88373 Assembly number to: 88373
F430 11					
4.3 372-375 kW (506-510 PS) F 136 ED	09.2007→12.2009		7.22296.02.0	ARV	PN <input type="radio"/>
4.3 375-376 kW (510-511 PS) F 131 B47	09.2007→12.2009		7.22296.02.0	ARV	PN <input type="radio"/>
			7.22472.07.0	SLP	EL
F430 Spider 12					
4.3 375-376 kW (510-511 PS) F 131 B47	04.2007→12.2009		7.22296.02.0	ARV	PN <input type="radio"/>
			7.22472.07.0	SLP	EL
4.3 372-375 kW (506-510 PS) F 136 ED	09.2007→12.2009		7.22296.02.0	ARV	PN <input type="radio"/>
FF 13					
6.3 478-485 kW (650-660 PS) F 140 EB	06.2011→12.2016		7.22296.02.0	ARV	PN <input type="radio"/>
6.3 478-485 kW (650-660 PS) F 140 EB	06.2011→02.2016		7.22296.02.0	ARV	PN <input type="radio"/>
SUPERAMERICA 14					
575 397 kW (540 PS) F133G	01.2005→04.2006		7.22296.02.0	ARV	PN <input type="radio"/>
			7.22472.07.0	SLP	EL









F



500 (312_) **1**



















1.3 D Multijet (312AXB1A) 55 kW (75 PS) 169 A1.000	10.2007→		7.00020.39.0	AGR	EL 	→12.2012  3320805→ Euro 4 (D4) Euro 4 (D4)	
			7.00020.24.0	AGR	EL 		→3320805 ohne Zubehör without accessories 2012 2012 2011 2011
			7.01599.10.0	AGR	EL 		
			7.08369.35.0	ATS	EL		
			7.11190.03.0	DDS			
1.3 D Multijet (312AXE1A) 64-70 kW (87-95 PS) 199 B1.000, 312 B1.000	12.2009→		7.01599.10.0	AGR	EL 	199 B1.000, 312 B1.000: Produktionsdatum bis: 2014 Production date to: 2014	
			7.03622.06.0	AGR-K			 199 B1.000, 312 B1.000: 2015 2015 ohne Zubehör without accessories 199 B1.000, 312 B1.000: 2012 2012
			7.11020.37.0	ATS	EL 		
1.3 D Multijet (312AYA1A) 57 kW (78 PS) 312 B5.000	06.2016→		7.03622.10.0	AGR-K	EL 	mit AGR-Ventil with EGR valve ohne Zubehör without accessories	
			7.11190.03.0	DDS			
1.4 (312AXC1B, 312CXC1B) 74-79 kW (100-107 PS) 169 A3.000	10.2007→		7.02604.53.0	LS	400 mm		

500 C (312_) **2**

1.3 D Multijet (312CXB1A) 55 kW (75 PS) 169 A1.000	09.2009→		7.00020.39.0	AGR	EL 	→12.2012  3320805→ Euro 4 (D4) Euro 4 (D4)	
			7.00020.24.0	AGR	EL 		→3320805 ohne Zubehör without accessories 2012 2012 2011 2011
			7.01599.10.0	AGR	EL 		
			7.08369.35.0	ATS	EL		
			7.11190.03.0	DDS			
1.3 D Multijet (312CXE1A, 312AXE1A) 64-70 kW (87-95 PS) 199 B1.000, 312 B1.000	09.2009→		7.01599.10.0	AGR	EL 	199 B1.000, 312 B1.000: Produktionsdatum bis: 2014 Production date to: 2014	
			7.03622.06.0	AGR-K			 199 B1.000, 312 B1.000: 2015 2015 ohne Zubehör without accessories 199 B1.000, 312 B1.000: 2012 2012
			7.11020.37.0	ATS	EL 		
7.11190.03.0	DDS						

















500L (351_, 352_) 3					
1.3 D Multijet (199.LYM11, 199.LYM1A) 70 kW (95 PS) 330 A1.000	06.2014→		7.04589.06.0	AGR	EL <input type="radio"/> 12.2017→ Euro 6 Euro 6
			7.01599.10.0	AGR	EL <input type="radio"/>
			7.07969.06.0	AGR-K	EL <input type="radio"/> 09.2018→ Euro 6d Euro 6d
			7.03622.10.0	AGR-K	EL <input type="radio"/> Euro 5 Euro 5 mit AGR-Ventil with EGR valve
			7.11020.37.0	ATS	EL Euro 5 Euro 5
			7.11190.03.0	DDS	ohne Zubehör without accessories
1.3 D Multijet (199LXY1A, 199LXY11) 62 kW (84 PS) 199 B4.000	09.2012→		7.01599.10.0	AGR	EL <input type="radio"/>
			7.03622.10.0	AGR-K	EL <input type="radio"/> Euro 5 Euro 5 mit AGR-Ventil with EGR valve
			7.11020.37.0	ATS	EL Euro 5 Euro 5
			7.11190.03.0	DDS	ohne Zubehör without accessories
1.6 D Multijet (199LYD1B) 77 kW (105 PS) 199 B5.000	09.2012→05.2018		7.24809.77.0	AGR	ET <input checked="" type="checkbox"/>
			7.11190.03.0	DDS	ohne Zubehör without accessories
1.6 D Multijet (199LYE1B) 88 kW (120 PS) 940 C1.000, 955 A3.000	09.2013→		7.24809.77.0	AGR	ET <input checked="" type="checkbox"/>
			7.11190.03.0	DDS	ohne Zubehör without accessories
500X (334_) 4					
1.3 D Multijet (334AXH1A) 70 kW (95 PS) 552 66 963	11.2014→		7.04589.06.0	AGR	EL <input type="radio"/> 12.2017→ Euro 6 Euro 6
			7.01599.10.0	AGR	EL <input type="radio"/> Euro 6 Euro 6
			7.07969.06.0	AGR-K	EL <input type="radio"/> 08.2018→ Euro 6d Euro 6d
			7.11190.03.0	DDS	ohne Zubehör without accessories
1.6 D Multijet (334AXA1B) 84-88 kW (114-120 PS) 552 60 384	09.2014→		7.24809.77.0	AGR	ET <input checked="" type="checkbox"/>
			7.07549.09.0	AGR	EL mit Dichtring with O-ring
			7.11190.03.0	DDS	ohne Zubehör without accessories

F











			 PIERBURG				
500X (334_)						4	
F	1.6 D Multijet (334AXA1B, 334AXA11) 84-88 kW (114-120 PS) 552 60 384	09.2014→	 7.24809.77.0	AGR	ET	<input checked="" type="checkbox"/>	
			7.07549.09.0	AGR	EL	mit Dichtring with O-ring	
			7.11190.03.0	DDS		ohne Zubehör without accessories	
	2.0 D Multijet 4x4 (334AX) 100-125 kW (136-170 PS) 552 63 088	09.2018→	 7.11190.03.0	DDS		ohne Zubehör without accessories	
		2.0 D Multijet 4x4 (334AXB22, 334AXD2B) 100-125 kW (136-170 PS) 552 63 087, 552 63 088	09.2014→	 7.24809.77.0	AGR	ET	<input checked="" type="checkbox"/>
				7.07549.09.0	AGR	EL	mit Dichtring with O-ring
			7.11190.03.0	DDS		ohne Zubehör without accessories	
	2.0 D Multijet 4x4 (334AXB22, 334AXD2B) 100-125 kW (136-170 PS) 552 63 087, 552 63 088	09.2014→	 7.24809.77.0	AGR	ET	<input checked="" type="checkbox"/>	
			7.07549.09.0	AGR	EL	mit Dichtring with O-ring	
			7.11190.03.0	DDS		ohne Zubehör without accessories	
	ALBEA						5
	1.5 62 kW (84 PS) 178 E5.022	06.2004→	 7.02604.53.0	LS	400 mm		
BARCETTA (183_)						6	
1.8 16V 92-97 kW (125-132 PS) 183 A1.000, 188 A6.000	04.1995→05.2005	 7.02604.47.0	LS	300 mm	 183 A1.000: 05.1998→ Regelsonde Regulating Probe  188 A6.000: links, rechts Left, Right Regelsonde Regulating Probe		
BRAVA (182_)						7	
1.2 16V 80 60-64 kW (82-87 PS) 182 B2.000	12.1998→12.2002	 7.02604.55.0	LS	650 mm			
		7.02604.53.0	LS	400 mm			
1.2 16V 80 57-60 kW (78-82 PS) 188 A5.000	10.2000→10.2001	 7.02604.55.0	LS	650 mm			
		7.02604.53.0	LS	400 mm			
1.4 (182.BG) 55 kW (75 PS) 182 A5.000	10.1995→10.2001	 7.02604.47.0	LS	300 mm			
		7.02604.04.0	LS	200 mm			
1.4 12 V (182.BA) 59 kW (80 PS) 182 A3.000	10.1995→08.1998	 7.02604.47.0	LS	300 mm			
		7.02604.04.0	LS	200 mm			
1.6 16V (182.BB) 76-85 kW (103-116 PS) 182 A4.000	02.1996→10.2001	 7.02604.49.0	LS	985 mm			
		7.02604.51.0	LS	630 mm			

					
BRAVA (182_)					
7					
1.6 16V (182.BH) 66 kW (90 PS) 182 A6.000	10.1995→10.2001		7.02604.49.0	LS	985 mm
			7.02604.51.0	LS	630 mm
1.6 16V (182.BU) 68-100 kW (92-136 PS) 182 B6.000	01.1999→12.2002		7.02604.49.0	LS	985 mm
			7.02604.51.0	LS	630 mm
1.8 GT 16V (182.BC) 83 kW (113 PS) 182 A2.000	10.1995→08.2001		7.02604.47.0	LS	300 mm
1.9 JTD 74-79 kW (100-107 PS) 182 B9.000	09.2000→10.2001		7.22946.34.0	AGR	EL 
1.9 JTD 105 77-79 kW (105-107 PS) 182 B4.000	12.1998→10.2001		7.22946.34.0	AGR	EL 
BRAVO I (182_)					
8					
1.2 16V 80 60-64 kW (82-87 PS) 182 B2.000	12.1998→10.2000		7.02604.55.0	LS	650 mm
			7.02604.53.0	LS	400 mm
1.2 16V 80 57-60 kW (78-82 PS) 188 A5.000	10.2000→10.2001		7.02604.55.0	LS	650 mm
			7.02604.53.0	LS	400 mm
1.4 (182.AA) 59 kW (80 PS) 182 A3.000	10.1995→10.2001		7.02604.47.0	LS	300 mm
			7.02604.04.0	LS	200 mm
1.4 (182.AG) 55 kW (75 PS) 182 A5.000	10.1995→10.2001		7.02604.47.0	LS	300 mm
			7.02604.04.0	LS	200 mm
1.6 68-100 kW (92-136 PS) 182 B6.000	09.2000→10.2001		7.02604.49.0	LS	985 mm
			7.02604.51.0	LS	630 mm
1.6 16V (182.AB) 76-85 kW (103-116 PS) 182 A4.000	03.1996→10.2001		7.02604.49.0	LS	985 mm
			7.02604.51.0	LS	630 mm
1.6 16V (182.AH) 66 kW (90 PS) 182 A6.000	10.1995→10.2001		7.02604.49.0	LS	985 mm
			7.02604.51.0	LS	630 mm
1.8 GT (182.AC) 83 kW (113 PS) 182 A2.000	10.1995→10.2001		7.02604.47.0	LS	300 mm
1.9 JTD 74-79 kW (100-107 PS) 182 B9.000	09.2000→10.2001		7.22946.34.0	AGR	EL 
1.9 JTD 105 77-79 kW (105-107 PS) 182 B4.000	12.1998→10.2001		7.22946.34.0	AGR	EL 
2.0 HGT 20V (182.AD) 108-113 kW (147-154 PS) 182 A1.000	10.1995→07.1998		7.02604.55.0	LS	650 mm
			7.02604.04.0	LS	200 mm





F

			 PIERBURG		
BRAVO I (182_)					8
2.0 HGT 20V (182AQ) 113 kW (154 PS) 182 B7.000	07.1998→10.2001		7.02604.55.0	LS	650 mm
			7.02604.04.0	LS	200 mm
BRAVO II (198_)					9
1.4 (198AXA1B) 66 kW (90 PS) 192 B2.000	04.2007→12.2014		7.02604.53.0	LS	400 mm
			7.02604.53.0	LS	400 mm
1.4 16V (198AXS1B) 103 kW (140 PS) 198 A7.000	04.2010→12.2014		7.02604.53.0	LS	400 mm
			7.02604.53.0	LS	400 mm
1.4 T-Jet (198AXF1B) 104-112 kW (141-152 PS) 198 A1.000	09.2007→12.2014		7.02604.55.0	LS	650 mm
			7.02604.53.0	LS	400 mm
1.4 T-Jet (198AXG1B) 88 kW (120 PS) 198 A4.000	10.2007→12.2014		7.02604.55.0	LS	650 mm
			7.02604.53.0	LS	400 mm
1.6 D Multijet (198AXH1B) 77 kW (105 PS) 198 A3.000, 844 A3.000	09.2007→12.2014		7.24809.77.0	AGR	ET <input checked="" type="checkbox"/>
			7.11020.10.0	ATS	EL <input checked="" type="checkbox"/> 198 A3.000, 844 A3.000: für OE-Nummer: 51822931, 51825681 for OE number: 51822931, 51825681 ohne Zubehör without accessories
			7.11190.03.0	DDS	
			7.02604.99.0	LS	400 mm
1.6 D Multijet (198AXL1B) 88 kW (120 PS) 198 A2.000	03.2008→12.2014		7.24809.77.0	AGR	ET <input checked="" type="checkbox"/>
			7.11020.10.0	ATS	EL für OE-Nummer: 51822931, 51825681 for OE number: 51822931, 51825681 ohne Zubehör without accessories
			7.11190.03.0	DDS	
			7.02604.99.0	LS	400 mm
1.6 D Multijet (198AXM1B) 66 kW (90 PS) 198 A6.000	03.2008→12.2014		7.24809.77.0	AGR	ET <input checked="" type="checkbox"/>
			7.11020.10.0	ATS	EL für OE-Nummer: 51822931, 51825681 for OE number: 51822931, 51825681 ohne Zubehör without accessories für OE-Nummer: 51908411 for OE number: 51908411
			7.11190.03.0	DDS	
			7.02604.99.0	LS	400 mm
1.9 D Multijet (198AXB1A) 88 kW (120 PS) 192 A8.000	04.2007→12.2014		7.24809.77.0	AGR	ET <input checked="" type="checkbox"/>
			7.22946.34.0	AGR	EL <input type="checkbox"/>
			7.11190.04.0	DDS	
			7.02604.99.0	LS	400 mm
1.9 D Multijet (198AXC1B) 110 kW (150 PS) 937 A5.000	04.2007→12.2014		7.00063.10.0	AGR	EL <input type="checkbox"/>
			7.11190.04.0	DDS	

BRAVO II (198_) 9

			7.02604.99.0	LS	400 mm	
1.9 D Multijet (198AXD1A) 85 kW (115 PS) 192 A1.000	11.2006→12.2009		7.22946.34.0	AGR	EL	
1.9 D Multijet (198AXD1A) 85 kW (116 PS) 192 B4.000	11.2006→12.2009		7.22946.34.0	AGR	EL	
			7.02604.99.0	LS	400 mm	03.2007→ Motorcode: 192 B4.000 Engine Code: 192 B4.000 Produktionsdatum ab: 03.2007 Production date from: 03.2007 Produktionsdatum bis: 12.2009 Production date to: 12.2009
1.9 D Multijet (198AXE1A) 66 kW (90 PS) 192 B5.000	04.2007→12.2008		7.22946.34.0	AGR	EL	
			7.11190.04.0	DDS		
			7.02604.99.0	LS	400 mm	
2.0 D Multijet (198AXN1B) 121 kW (165 PS) 198 A5.000	09.2008→12.2014		7.24809.77.0	AGR	ET	
			7.11020.10.0	ATS	EL	
			7.11190.03.0	DDS		ohne Zubehör without accessories
			7.02604.44.0	LS	500 mm	vor Katalysator in front of the catalyst
2.0 D Multijet (198AXPIB) 120 kW (163 PS) 198 A8.000, 844 A2.000	09.2008→12.2014		7.24809.77.0	AGR	ET	
			7.11020.10.0	ATS	EL	
			7.11190.03.0	DDS		ohne Zubehör without accessories
			7.02604.44.0	LS	500 mm	



F
CINQUECENTO (170_) 10











0.9 (170AB) 30 kW (41 PS) 170 A1.000	07.1991→12.1993		7.02604.04.0	LS	200 mm	
0.9 i.e. (170AC) 30 kW (41 PS) 170 A1.046	07.1991→09.1994		7.02604.04.0	LS	200 mm	
0.9 i.e. S (170AF, 170CF) 29-30 kW (39-41 PS) 1170 A1.000, 1170 A1.046	07.1991→07.1999		7.02604.04.0	LS	200 mm	
1.1 Sporting (170AH) 40 kW (54 PS) 176 B2.000	10.1994→01.1998		7.02604.47.0	LS	300 mm	
			7.02604.04.0	LS	200 mm	

COUPE (175_) 11























2.0 16V 102 kW (139 PS) 836 A3.000	11.1993→08.1996		7.02604.03.0	LS	200 mm	
2.0 16V Turbo 140 kW (190 PS) 175 A1.000	11.1993→08.1996		7.02604.03.0	LS	200 mm	
2.0 20V 113 kW (154 PS) 182 B3.000	05.1998→08.2000		7.02604.55.0	LS	650 mm	
2.0 20V (175AXC1A) 108-113 kW (147-154 PS) 182 A1.000	08.1996→09.1998		7.02604.55.0	LS	650 mm	



CROMA (154_)						12
2000 16V 93-101 kW (126-137 PS) 154 E1.000	08.1992→08.1996		7.02604.04.0	LS	200 mm	
2000 i.e. Turbo (154.AM) 114 kW (155 PS) 154 A2.000	12.1985→06.1990		7.02604.54.0	LS	980 mm	
2000 i.e. Turbo (154.AM, 154.LM) 110-112 kW (150-152 PS) 154 C4.046, 834 C.146	06.1987→08.1996		7.02604.54.0	LS	980 mm	

F CROMA (194_)						13
1.8 16V 96-103 kW (131-140 PS) 939 A4.000	12.2005→		7.04879.00.0	AGR-TH		 Öffnungstemperatur/opening temperature 105C
			7.05271.62.0	LS	500 mm	Regelsonde Regulating Probe vor Katalysator in front of the catalyst
1.9 D Multijet 85 kW (115 PS) 939 A7.000	06.2005→		7.11190.03.0	DDS		ohne Zubehör without accessories für OE-Nummer: 55200301 for OE number: 55200301
			7.11190.04.0	DDS		für OE-Nummer: 51792301 for OE number: 51792301
1.9 D Multijet 100 kW (136 PS) 939 A8.000	12.2005→		7.00063.10.0	AGR	EL	
			7.11190.03.0	DDS		ohne Zubehör without accessories für OE-Nummer: 55200301 for OE number: 55200301
			7.11190.04.0	DDS		für OE-Nummer: 51792301 for OE number: 51792301
1.9 D Multijet (194AXB1B) 88 kW (120 PS) 939 A1.000	06.2005→12.2011		7.22946.38.0	AGR	EL	
			7.11190.03.0	DDS		ohne Zubehör without accessories für OE-Nummer: 55200301 for OE number: 55200301
			7.11190.04.0	DDS		für OE-Nummer: 51792301 for OE number: 51792301
			7.02604.99.0	LS	400 mm	
1.9 D Multijet (194AXC1B, 194AXC12) 110 kW (150 PS) 939 A2.000	06.2005→12.2011		7.00063.10.0	AGR	EL	
			7.11190.03.0	DDS		ohne Zubehör without accessories für OE-Nummer: 55200301 for OE number: 55200301
			7.11190.04.0	DDS		für OE-Nummer: 51792301 for OE number: 51792301
			7.02604.99.0	LS	400 mm	
2.4 D Multijet 147 kW (200 PS) 939 A3.000	06.2005→		7.00063.10.0	AGR	EL	
			7.11190.03.0	DDS		ohne Zubehör without accessories für OE-Nummer: 55200301 for OE number: 55200301
			7.11190.04.0	DDS		für OE-Nummer: 51792301 for OE number: 51792301











DOBLO MPV (119_, 223_) 14

1.2 (223AXA1A) 48 kW (65 PS) 223 A5.000	03.2001→	 7.02604.53.0	LS	400 mm	
		7.02604.56.0	LS	1190 mm	
1.3 D Multijet 62 kW (84 PS) 223 A9.000	10.2005→	 7.00020.25.0	AGR	EL	
		7.11190.04.0	DDS		Euro 4 Euro 4
1.3 JTD 55-68 kW (75-93 PS) 199 A2.000	05.2005→	 7.00020.24.0	AGR	EL	
1.3 JTD 16V 51-66 kW (70-90 PS) 188 A9.000	12.2004→05.2005	 7.00020.24.0	AGR	EL	
1.4 51-63 kW (69-86 PS) 350 A1.000	10.2005→	 7.02604.53.0	LS	400 mm	
1.6 68-100 kW (92-136 PS) 182 B6.000	09.2002→	 7.02604.53.0	LS	400 mm	
		7.02604.47.0	LS	300 mm	
		7.02604.56.0	LS	1190 mm	
1.6 16V (223AXD1A) 68-100 kW (92-136 PS) 182 B6.000	10.2001→	 7.02604.53.0	LS	400 mm	
		7.02604.47.0	LS	300 mm	
		7.02604.56.0	LS	1190 mm	
1.6 Natural Power 68-100 kW (92-136 PS) 182 B6.000	09.2002→	 7.02604.53.0	LS	400 mm	
		7.02604.47.0	LS	300 mm	
		7.02604.56.0	LS	1190 mm	
1.9 D Multijet 88 kW (120 PS) 186 A9.000	10.2005→	 7.22946.33.0	AGR	EL	 6147321→ für Hersteller-Abgasnorm: CF4 for manufacturer exhaust norm: CF4
		7.22946.34.0	AGR	EL	
		7.11020.09.0	ATS	EL	
		7.11190.04.0	DDS		Euro 4 Euro 4
1.9 JTD 77 kW (105 PS) 223 A7.000, 223 B1.000	07.2003→	 7.22946.33.0	AGR	EL	 →12.2004 für Hersteller-Abgasnorm: CF3 for manufacturer exhaust norm: CF3
		7.22946.34.0	AGR	EL	 223 B1.000: →09.2009  223 B1.000: →12.2004 für Hersteller-Abgasnorm: CF3 for manufacturer exhaust norm: CF3
1.9 JTD (223AXE1A) 74-79 kW (100-107 PS) 182 B9.000	10.2001→	 7.22946.33.0	AGR	EL	
		7.22946.34.0	AGR	EL	
1.9 JTD (223AXE1A) 74 kW (100 PS) 223 B2.000	10.2001→	 7.22946.34.0	AGR	EL	





F



FREEMONT (345_) **15**

2.0 JTD 100-125 kW (140-170 PS) 939 B5.000	08.2011→		7.24809.77.0	AGR	ET	<input checked="" type="checkbox"/>
			7.11020.09.0	ATS	EL	für OE-Nummer: 05146223AA for OE number: 05146223AA
2.0 JTD 100-125 kW (140-170 PS) 939 B5.000, 940 A5.000	08.2011→		7.24809.77.0	AGR	ET	<input checked="" type="checkbox"/>
			7.11020.09.0	ATS	EL	 939 B5.000, 940 A5.000: für OE-Nummer: 05146223AA for OE number: 05146223AA
2.0 JTD 100-125 kW (140-170 PS) 939 B5.000, 940 A5.000	08.2011→		7.24809.77.0	AGR	ET	<input checked="" type="checkbox"/>
			7.11020.09.0	ATS	EL	 939 B5.000, 940 A5.000: für OE-Nummer: 05146223AA for OE number: 05146223AA
2.0 JTD 100-125 kW (140-170 PS) 939 B5.000	08.2011→		7.24809.77.0	AGR	ET	<input checked="" type="checkbox"/>
			7.11020.09.0	ATS	EL	für OE-Nummer: 05146223AA for OE number: 05146223AA
2.0 JTD 4x4 100-125 kW (140-170 PS) 939 B5.000	08.2011→		7.24809.77.0	AGR	ET	<input checked="" type="checkbox"/>
			7.11020.09.0	ATS	EL	für OE-Nummer: 05146223AA for OE number: 05146223AA
2.0 JTD 4x4 100-125 kW (140-170 PS) 939 B5.000, 940 A5.000	08.2011→		7.24809.77.0	AGR	ET	<input checked="" type="checkbox"/>
			7.11020.09.0	ATS	EL	 939 B5.000, 940 A5.000: für OE-Nummer: 05146223AA for OE number: 05146223AA

GRANDE PUNTO (199_) **16**

1.2 48-51 kW (65-69 PS) 199 A4.000	10.2005→		7.02604.53.0	LS	400 mm	
			7.02604.53.0	LS	400 mm	
1.2 LPG (199BXA1A, 199AXA1A) 48-51 kW (65-69 PS) 199 A4.000	06.2008→12.2012		7.02604.53.0	LS	400 mm	
			7.02604.53.0	LS	400 mm	
1.3 D Multijet 55-68 kW (75-93 PS) 199 A2.000	10.2005→		7.00020.24.0	AGR	EL	<input type="checkbox"/>
			7.01599.10.0	AGR	EL	<input type="checkbox"/> Euro 5 Euro 5
			7.03622.06.0	AGR-K		<input type="checkbox"/>
			7.11020.04.0	ATS	EL	Euro 5 Euro 5 2009 2009 2013 2013
			7.11020.08.0	ATS	EL	 199 A2.000: vor Katalysator in front of the catalyst für Fahrzeuge mit Diesel-Partikel-Filter (DPF) for vehicles with diesel soot filter 2013 2013
			7.11190.04.0	DDS		 199 A2.000: vor Rußpartikelfilter before soot particulate filter Euro 4 Euro 4 2009 2009 Euro 4 Euro 4

GRANDE PUNTO (199_)
16

1.3 D Multijet 51 kW (69 PS) 199 B2.000	07.2008→	7.01599.10.0	AGR	EL	<input type="radio"/> Euro 5 <input type="radio"/> Euro 5 <input type="radio"/> vor Katalysator in front of the catalyst Euro 4 Euro 4 für Fahrzeuge mit Diesel-Partikel-Filter (DPF) for vehicles with diesel soot filter 2009 2009 2013 2013 <input type="radio"/> ohne Zubehör without accessories Euro 5 Euro 5 <input type="radio"/> Euro 4 Euro 4
		7.03622.06.0	AGR-K		<input type="radio"/>
		7.11020.04.0	ATS	EL	
		7.11020.08.0	ATS	EL	vor Katalysator in front of the catalyst Euro 4 Euro 4 für Fahrzeuge mit Diesel-Partikel-Filter (DPF) for vehicles with diesel soot filter 2009 2009 2013 2013 <input type="radio"/> ohne Zubehör without accessories Euro 5 Euro 5 <input type="radio"/> Euro 4 Euro 4
		7.11190.03.0	DDS		<input type="radio"/> ohne Zubehör without accessories Euro 5 Euro 5
		7.11190.04.0	DDS		<input type="radio"/> Euro 4 Euro 4
1.3 D Multijet 55-68 kW (75-93 PS) 199 A2.000	06.2009→07.2014	7.00020.24.0	AGR	EL	<input type="radio"/>
		7.01599.10.0	AGR	EL	<input type="radio"/>
		7.03622.06.0	AGR-K		<input type="radio"/>
		7.11020.08.0	ATS	EL	vor Katalysator in front of the catalyst Euro 4 Euro 4 für Fahrzeuge mit Diesel-Partikel-Filter (DPF) for vehicles with diesel soot filter 2013 2013 <input type="radio"/> ohne Zubehör without accessories Euro 5 Euro 5
		7.11190.03.0	DDS		<input type="radio"/> ohne Zubehör without accessories Euro 5 Euro 5
1.3 D Multijet 62 kW (84 PS) 199 B4.000, 223 A9.000	04.2010→	7.01599.10.0	AGR	EL	<input type="radio"/>
		7.03622.06.0	AGR-K		<input type="radio"/>
		7.11020.08.0	ATS	EL	<input checked="" type="radio"/> 199 B4.000, 223 A9.000: vor Katalysator in front of the catalyst Euro 4 Euro 4 für Fahrzeuge mit Diesel-Partikel-Filter (DPF) for vehicles with diesel soot filter 2013 2013 <input type="radio"/> ohne Zubehör without accessories <input checked="" type="radio"/> 199 B4.000, 223 A9.000: Euro 5 Euro 5
		7.11190.03.0	DDS		<input type="radio"/> ohne Zubehör without accessories Euro 5 Euro 5
1.3 D Multijet 55-68 kW (75-93 PS) 199 A2.000	01.2012→01.2013	7.01599.10.0	AGR	EL	<input type="radio"/>
		7.11190.03.0	DDS		<input type="radio"/> ohne Zubehör without accessories Euro 5 Euro 5
1.3 D Multijet (199.AXD11, 199.AXD1A, 199.AXD1B,...) 63-70 kW (86-95 PS) 199 A3.000	10.2005→12.2010	7.00020.25.0	AGR	EL	<input type="radio"/>















F

































GRANDE PUNTO (199_)

16

F



			7.01599.10.0 7.11020.04.0	AGR ATS	EL EL		Euro 5 Euro 5 2009 2009
			7.11020.08.0	ATS	EL		199 A3.000: vor Katalysator in front of the catalyst Euro 4 Euro 4 für Fahrzeuge mit Diesel-Partikel-Filter (DPF) for vehicles with diesel soot filter 2013 2013 199 A3.000: vor Rußpartikelfilter before soot particulate filter Euro 4 Euro 4 2009 2009
			7.11190.04.0	DDS			Euro 4 Euro 4
1.4 (199AXB11, 199AXB1A, 199BxB1A, 199AXL1A) 51-63 kW (69-86 PS) 350 A1.000	06.2005→12.2015		7.02604.53.0	LS	400 mm		
1.4 16V (199BXG1B, 199AXG1B) 70-71 kW (95-97 PS) 199 A6.000	10.2005→08.2011		7.02604.53.0	LS	400 mm		
1.4 LPG 51-63 kW (69-86 PS) 350 A1.000	12.2008→		7.02604.53.0	LS	400 mm		
1.4 Natural Power 51-63 kW (69-86 PS) 350 A1.000	07.2008→		7.02604.53.0	LS	400 mm		
1.4 T-Jet (199AXM1A, 199BXM1A, 199BXN1A) 88 kW (120 PS) 198 A4.000	09.2007→		7.02604.53.0	LS	400 mm		
1.6 D Multijet 88 kW (120 PS) 955 A3.000	07.2008→		7.24809.77.0 7.11190.03.0 7.02604.44.0	AGR DDS LS	ET 500 mm		 ohne Zubehör without accessories vor Katalysator in front of the catalyst
1.9 D Multijet 88 kW (120 PS) 939 A1.000	10.2005→		7.22946.38.0 7.11190.04.0 7.02604.99.0	AGR DDS LS	EL 400 mm		Euro 4 Euro 4
1.9 D Multijet 96 kW (131 PS) 199 A5.000	10.2005→		7.22946.38.0 7.11190.04.0 7.02604.99.0	AGR DDS LS	EL 400 mm		Euro 4 Euro 4
1.9 D Multijet 85 kW (115 PS) 939 A7.000	06.2006→12.2009		7.22946.38.0 7.11190.04.0 7.02604.99.0	AGR DDS LS	EL 400 mm		Euro 4 Euro 4 Belgien Belgium

					
IDEA (350_)					
1.2 16V 57-60 kW (78-82 PS) 188 A5.000	01.2004→		7.02604.53.0	LS	400 mm
1.3 D Multijet 51-66 kW (70-90 PS) 188 A9.000	01.2004→		7.00020.24.0	AGR	EL  →04.2006
			7.00020.25.0	AGR	EL  →1359910
			7.00020.39.0	AGR	EL  1331881→  1359911→ Euro 4 (D4) Euro 4 (D4)
			7.01599.10.0	AGR	EL  Euro 5 Euro 5
1.3 D Multijet 63-70 kW (86-95 PS) 199 A3.000	10.2005→		7.00020.40.0	AGR	EL  05.2006→  1331881→
			7.00020.25.0	AGR	EL  →1331880
			7.01599.10.0	AGR	EL  Euro 5 Euro 5
			7.11190.04.0	DDS	Euro 4 Euro 4
1.3 D Multijet 64-70 kW (87-95 PS) 199 B1.000	05.2008→12.2012		7.01599.10.0	AGR	EL 
			7.03622.06.0	AGR-K	 ohne Zubehör without accessories Euro 5 Euro 5
			7.11190.03.0	DDS	
1.4 66 kW (90 PS) 192 B2.000	12.2003→		7.02604.53.0	LS	400 mm
1.4 51-63 kW (69-86 PS) 350 A1.000	10.2005→		7.02604.53.0	LS	400 mm
1.4 16V 65-71 kW (88-97 PS) 843 A1.000	01.2004→		7.02604.53.0	LS	400 mm
1.6 77-87 kW (109-118 PS) 310 A5.011	08.2010→		7.02604.44.0	LS	500 mm vor Katalysator in front of the catalyst 2012 2012
1.6 D Multijet 85-88 kW (116-120 PS) 350 A2.000	05.2008→		7.24809.77.0	AGR	ET 
			7.11190.03.0	DDS	ohne Zubehör without accessories
			7.02604.44.0	LS	500 mm vor Katalysator in front of the catalyst 2012 2012
1.9 JTD 74 kW (101 PS) 188 B2.000	01.2004→		7.22946.33.0	AGR	EL  →09.2008  6147321→ für Hersteller-Abgasnorm: CF3 for manufacturer exhaust norm: CF3

F



















IDEA (350_) **17**



			7.22946.34.0	AGR	EL	 188 B2.000: →06.2009 nicht für Hersteller-Abgasnorm: CF3 not for manufacturer emission norm: CF3  188 B2.000: →09.2008 6147321→ für Hersteller-Abgasnorm: CF3 for manufacturer exhaust norm: CF3
			7.02604.99.0	LS	400 mm	

F









LINEA (323_, 110_) **18**

1.3 D Multijet 63-70 kW (86-95 PS) 199 A3.000	11.2008→12.2019		7.01599.10.0	AGR	EL	
			7.03622.06.0	AGR-K		
1.3 D Multijet (323AXB11, 323AXB1A) 63-70 kW (86-95 PS) 199 A3.000	06.2007→		7.00020.25.0	AGR	EL	
			7.01599.10.0	AGR	EL	
1.3 D Multijet (323AXB1A) 63-70 kW (86-95 PS) 199 A3.000	09.2009→		7.00020.25.0	AGR	EL	
			7.01599.10.0	AGR	EL	
			7.03622.06.0	AGR-K		
			7.11190.03.0	DDS		ohne Zubehör without accessories Euro 5 Euro 5
1.3 JTD Multijet (323AXB1A) 63-70 kW (86-95 PS) 199 A3.000	10.2006→		7.00020.25.0	AGR	EL	
			7.01599.10.0	AGR	EL	
1.4 51-63 kW (69-86 PS) 350 A1.000	06.2007→		7.02604.53.0	LS	400 mm	
1.4 T-Jet (323AXC1A) 88 kW (120 PS) 198 A4.000	05.2007→		7.02604.55.0	LS	650 mm	
			7.02604.53.0	LS	400 mm	
1.6 D Multijet 77 kW (105 PS) 198 A3.000	06.2009→		7.24809.77.0	AGR	ET	
			7.11190.03.0	DDS		ohne Zubehör without accessories Euro 5 Euro 5
			7.02604.44.0	LS	500 mm	vor Katalysator in front of the catalyst









MAREA (185_) **19**

1.2 16V 60-64 kW (82-87 PS) 182 B2.000	10.1998→05.2002		7.02604.53.0	LS	400 mm	
1.4 80 12V 59 kW (80 PS) 182 A3.000	09.1996→05.2002		7.02604.47.0	LS	300 mm	
			7.02604.04.0	LS	200 mm	
1.6 68-100 kW (92-136 PS) 182 B6.000	09.2000→08.2002		7.02604.49.0	LS	985 mm	Diagnosesonde Diagnostic Probe
			7.02604.51.0	LS	630 mm	Euro 3 Euro 3 Regelsonde Regulating Probe





MAREA (185_)						19
1.6 100 16V 76-85 kW (103-116 PS) 182 A4.000	09.1996→05.2002		7.02604.51.0	LS	630 mm	11.1999→ Euro 2 Euro 2 Regelsonde Regulating Probe
1.8 115 16V 83 kW (113 PS) 182 A2.000	09.1996→05.2002		7.02604.47.0	LS	300 mm	
1.9 JTD 74-79 kW (100-107 PS) 182 B9.000	01.2001→12.2007		7.22946.34.0	AGR	EL	
1.9 JTD 110 (185AXT1A) 81 kW (110 PS) 186 A6.000	09.2000→08.2002		7.22946.34.0	AGR	EL	
2.0 150 20V 108-113 kW (147-154 PS) 182 A1.000	09.1996→04.1999		7.02604.55.0	LS	650 mm	
			7.02604.53.0	LS	400 mm	
			7.02604.04.0	LS	200 mm	
2.0 150 20V 110 kW (150 PS) 185 A8.000	01.2001→05.2002		7.02604.55.0	LS	650 mm	
			7.02604.53.0	LS	400 mm	
			7.02604.04.0	LS	200 mm	
2.0 155 20V 113 kW (154 PS) 182 B7.000	04.1999→01.2001		7.02604.55.0	LS	650 mm	Euro 3 (D3) Euro 3 (D3) Regelsonde Regulating Probe
			7.02604.53.0	LS	400 mm	
			7.02604.04.0	LS	200 mm	

F

MAREA Weekend (185_)						20
1.2 16V 60-64 kW (82-87 PS) 182 B2.000	10.1998→05.2002		7.02604.53.0	LS	400 mm	
1.4 80 12V 59 kW (80 PS) 182 A3.000	09.1996→05.2002		7.02604.47.0	LS	300 mm	
			7.02604.04.0	LS	200 mm	
1.6 68-100 kW (92-136 PS) 182 B6.000	09.2000→08.2002		7.02604.49.0	LS	985 mm	Diagnosesonde Diagnostic Probe
			7.02604.51.0	LS	630 mm	Euro 3 Euro 3 Regelsonde Regulating Probe
1.6 100 16V 76-85 kW (103-116 PS) 182 A4.000	09.1996→05.2002		7.02604.51.0	LS	630 mm	11.1999→ Euro 2 Euro 2 Regelsonde Regulating Probe
1.8 115 16V 83 kW (113 PS) 182 A2.000	09.1996→05.2002		7.02604.47.0	LS	300 mm	
1.9 JTD 110 (185BXT1A) 81 kW (110 PS) 186 A6.000	09.2000→08.2002		7.22946.34.0	AGR	EL	
2.0 150 20V 108-113 kW (147-154 PS) 182 A1.000	09.1996→04.1999		7.02604.55.0	LS	650 mm	
			7.02604.53.0	LS	400 mm	































MAREA Weekend (185_) **20**

			7.02604.04.0	LS	200 mm	
2.0 150 20V 110 kW (150 PS) 185 A8.000	01.2001→05.2002		7.02604.55.0	LS	650 mm	
			7.02604.53.0	LS	400 mm	
			7.02604.04.0	LS	200 mm	
F 2.0 155 20V 113 kW (154 PS) 182 B7.000	04.1999→02.2003		7.02604.55.0	LS	650 mm	Euro 3 (D3) Euro 3 (D3) Regelsonde Regulating Probe
			7.02604.53.0	LS	400 mm	
			7.02604.04.0	LS	200 mm	

MULTIPLA (186_) **21**

1.6 68-100 kW (92-136 PS) 182 B6.000	05.2004→08.2005		7.02604.49.0	LS	985 mm	
			7.02604.51.0	LS	630 mm	
1.6 (186AXC1A) 68-100 kW (92-136 PS) 182 B6.000	03.2001→08.2005		7.02604.49.0	LS	985 mm	
			7.02604.51.0	LS	630 mm	
1.6 (186AXC1A, 186BMC1A, 186BXC1A) 68-100 kW (92-136 PS) 182 B6.000	09.2000→06.2010		7.02604.49.0	LS	985 mm	
			7.02604.51.0	LS	630 mm	
1.6 100 16V (186AXA1A) 76-85 kW (103-116 PS) 182 A4.000	04.1999→06.2010		7.02604.49.0	LS	985 mm	
			7.02604.51.0	LS	630 mm	
1.6 16V (186AGB1A) 68-100 kW (92-136 PS) 182 B6.000	04.2002→06.2010		7.02604.49.0	LS	985 mm	
			7.02604.51.0	LS	630 mm	
1.6 16V Bipower (186AMB1A) 68-76 kW (92-103 PS) 186 A4.000	04.1999→06.2010		7.02604.49.0	LS	985 mm	
			7.02604.51.0	LS	630 mm	
1.6 16V Bipower (186AXC1A) 68-100 kW (92-136 PS) 182 B6.000	10.2001→06.2010		7.02604.49.0	LS	985 mm	
			7.02604.51.0	LS	630 mm	
1.6 16V Blupower (186AMA1A) 70 kW (95 PS) 186 A3.000	04.1999→06.2010		7.02604.49.0	LS	985 mm	
			7.02604.51.0	LS	630 mm	
1.6 16V GPL 68-100 kW (92-136 PS) 182 B6.000	10.2001→06.2010		7.02604.49.0	LS	985 mm	
			7.02604.51.0	LS	630 mm	















						
MULTIPLA (186_)						21
1.9 JTD (186AXE1A) 88 kW (120 PS) 186 A9.000	04.2002→06.2010		7.22946.34.0	AGR	EL	
			7.11190.04.0	DDS		Euro 4 Euro 4
1.9 JTD 110 81 kW (110 PS) 186 A6.000	03.2001→07.2002		7.22946.34.0	AGR	EL	
1.9 JTD 115 85 kW (115 PS) 186 A8.000	07.2002→06.2010		7.22946.34.0	AGR	EL	 →09.2009
			7.11190.04.0	DDS		Euro 4 Euro 4
PALIO (178 BX7DX)						22
1.0i 35-52 kW (47-71 PS) 146 A7.011, 178 D9.011			7.02604.47.0	LS	300 mm	
PALIO (178_)						23
1.2 38-60 kW (52-82 PS) 178 B7.045, 178 C4.066, 188 A4.000	07.1997→08.2002		7.02604.51.0	LS	630 mm	
			7.02604.53.0	LS	400 mm	
1.2 50-55 kW (68-75 PS) 176 A8.000, 178 B5.000, 178 E2.000	06.1998→		7.02604.51.0	LS	630 mm	
			7.02604.53.0	LS	400 mm	
1.2 50-54 kW (68-73 PS) 178 E2.000	06.1999→10.2000		7.02604.51.0	LS	630 mm	
1.3 JTD Multijet (178BYE1AAT) 51-66 kW (70-90 PS) 188 A9.000	06.2003→01.2012		7.00020.24.0	AGR	EL	 →0478673
1.4 51 kW (69 PS) 178 B2.000	04.1996→10.2002		7.02604.51.0	LS	630 mm	
1.4 Cat 51 kW (69 PS) 178 B2.016	04.1996→08.2001		7.02604.51.0	LS	630 mm	
1.5 62 kW (84 PS) 178 E5.022	06.2004→		7.02604.53.0	LS	400 mm	
1.6 16V 74-85 kW (100-116 PS) 178 B3.000	04.1996→10.2002		7.02604.51.0	LS	630 mm	
			7.02604.47.0	LS	300 mm	
1.9 D (178BYU1A) 46-48 kW (63-65 PS) 223 A6.000	01.2003→		7.22946.33.0	AGR	EL	 →09.2004
			7.22946.34.0	AGR	EL	 →09.2004
PALIO Weekend (178_, 173_, 373_, 374_, 171_)						24
1.2 50-55 kW (68-75 PS) 178 B5.000	04.1996→02.2004		7.02604.51.0	LS	630 mm	
1.2 (178BXZ1A) 50-54 kW (68-73 PS) 178 E2.000	06.1999→10.2002		7.02604.51.0	LS	630 mm	
			7.02604.53.0	LS	400 mm	
1.2 (178DYA1A, 178DXS1A) 38-46 kW (52-63 PS) 178 C4.066, 188 A4.000	07.1997→10.2004		7.02604.51.0	LS	630 mm	
			7.02604.53.0	LS	400 mm	

F











PALIO Weekend (178_, 173_, 373_, 374_, 171_)

































24

F	1.2 (178DYE1A, 178DYE1AAP, 178DYE1AAT) 57-60 kW (78-82 PS) 178 D6.011, 188 A5.000	09.2001→10.2004	 7.02604.53.0	LS	400 mm	
	1.4 51 kW (69 PS) 178 B2.000	07.1997→08.2001	 7.02604.51.0	LS	630 mm	
	1.5 62 kW (84 PS) 178 E5.022	02.2002→	 7.02604.53.0	LS	400 mm	
	1.6 16V 60-78 kW (82-106 PS) 178 C7.098, 178 D2.011	07.1997→10.2003	 7.02604.51.0 7.02604.47.0	LS LS	630 mm 300 mm	
	1.6 16V 68-100 kW (92-136 PS) 182 B6.000	02.2001→01.2012	 7.02604.51.0 7.02604.47.0	LS LS	630 mm 300 mm	
	1.6 16V (178DXD1A) 74-85 kW (100-116 PS) 178 B3.000	06.1996→02.2001	 7.02604.51.0	LS	630 mm	
	1.9 D 46-48 kW (63-65 PS) 223 A6.000	03.2001→	 7.22946.33.0 7.22946.34.0	AGR AGR	EL EL	 01.2002→09.2004  01.2002→09.2004
	1.9 D 46-48 kW (63-65 PS) 223 A6.000	03.2001→	 7.22946.33.0 7.22946.34.0	AGR AGR	EL EL	 01.2002→09.2004  01.2002→09.2004
	1.9 JTD 59 kW (80 PS) 188 A2.000	09.2001→	 7.22946.33.0 7.22946.34.0	AGR AGR	EL EL	 

PANDA (141_)

25





0.9 Fire S All-wheel Drive 33 kW (45 PS) 146 A.048	10.1980→04.1986	 7.02604.01.0	LS	200 mm	
1000 32-33 kW (44-45 PS) 156 A2.100	01.1986→04.1992	 7.02604.04.0	LS	200 mm	
1000 4x4 37 kW (50 PS) 156 A3.000	01.1986→12.1992	 7.02604.04.0	LS	200 mm	
1000 4x4 31-40 kW (42-54 PS) 141 C2.000, 156 A2.246	05.1986→12.1994	 7.02604.04.0	LS	200 mm	
1000 i.e. Cat 31-40 kW (42-54 PS) 141 C2.000, 156 A2.246	10.1987→08.1998	 7.02604.04.0	LS	200 mm	
1100 37-43 kW (50-58 PS) 156 C.046	03.1992→12.1999	 7.02604.47.0 7.02604.04.0	LS LS	300 mm 200 mm	
1100 40-42 kW (54-57 PS) 176 B2.000, 187 A1.000	02.1995→09.2003	 7.02604.47.0 7.02604.04.0	LS LS	300 mm 200 mm	Regelsonde Regulating Probe
1100 4x4 40 kW (54 PS) 176 B2.000	02.1995→07.2004	 7.02604.47.0 7.02604.04.0	LS LS	300 mm 200 mm	
1100 Trekking 4x4 37-43 kW (50-58 PS) 156 C.046	10.1991→07.2004	 7.02604.47.0 7.02604.04.0	LS LS	300 mm 200 mm	

					
PANDA (141_)					25
900 33 kW (45 PS) 100 GL3.000, 146 A.000	10.1980→06.1994		7.02604.01.0	LS	200 mm
900 29 kW (39 PS) 1170 A1.046	04.1992→12.1996		7.02604.04.0	LS	200 mm
PANDA (169_)					26
1.1 (169.AXA1A) 40-42 kW (54-57 PS) 187 A1.000	09.2003→		7.02604.47.0	LS	300 mm
1.2 (169.AXB11, 169.AXB1A) 38-44 kW (52-60 PS) 188 A4.000	09.2003→		7.02604.53.0	LS	400 mm
1.2 (169AXF2A, 169AXF1A) 51 kW (69 PS) 169 A4.000	03.2010→08.2013		7.02604.53.0	LS	400 mm
1.2 4x4 (169.AXB2A) 38-44 kW (52-60 PS) 188 A4.000	10.2004→		7.02604.53.0	LS	400 mm
1.2 4x4 (169AXF2A, 169AXF1A) 51 kW (69 PS) 169 A4.000	04.2010→08.2013		7.02604.53.0	LS	400 mm
1.2 Natural Power (169.AXB1A) 38-44 kW (52-60 PS) 188 A4.000	01.2007→12.2011		7.02604.53.0	LS	400 mm
1.3 D Multijet (169.AXC1A) 51 kW (70 PS) 188 A8.000	09.2003→		7.00020.39.0	AGR	EL  →12.2010  3320805→ Euro 4 (D4) Euro 4 (D4)
1.3 D Multijet (169AXG1A, 169AXD1A) 55 kW (75 PS) 169 A1.000	06.2006→08.2013		7.00020.24.0	AGR	EL 
			7.00020.39.0	AGR	EL  →12.2010  3320805→ Euro 4 (D4) Euro 4 (D4)
			7.00020.24.0	AGR	EL 
			7.01599.10.0	AGR	EL  Produktionsdatum ab: 2011 Production date from: 2011
			7.03622.06.0	AGR-K	EL 
1.3 D Multijet (169AXG1A, 169AXD1A) 55 kW (75 PS) 169 A5.000	06.2006→08.2013		7.00020.24.0	AGR	EL 
			7.01599.10.0	AGR	EL  Produktionsdatum ab: 2011 Production date from: 2011
			7.03622.06.0	AGR-K	EL 
			7.08369.35.0	ATS	EL
			7.11020.37.0	ATS	EL 2010 2010
1.3 D Multijet 4x4 (169.AXC2A) 51 kW (70 PS) 188 A8.000	10.2004→		7.00020.39.0	AGR	EL  →12.2010  3320805→ Euro 4 (D4) Euro 4 (D4)
			7.00020.24.0	AGR	EL 







F



PANDA (169_) **26**

F 1.3 JTD Multijet 4x4 (169AXG1A, 169AXG2A) 55 kW (75 PS) 169 A1.000	09.2010→08.2013		7.00020.39.0	AGR	EL	<input type="radio"/> →12.2010 <input checked="" type="radio"/> 3320805→ Euro 4 (D4) Euro 4 (D4)
			7.00020.24.0	AGR	EL	<input type="radio"/>
			7.01599.10.0	AGR	EL	<input type="radio"/>
			7.03622.06.0	AGR-K		<input type="radio"/>
			7.08369.35.0	ATS	EL	<input type="radio"/>
1.3 JTD Multijet 4x4 (169AXG1A, 169AXG2A) 55 kW (75 PS) 169 A5.000	09.2010→08.2013		7.00020.24.0	AGR	EL	<input type="radio"/>
			7.01599.10.0	AGR	EL	<input type="radio"/>
			7.03622.06.0	AGR-K		<input type="radio"/>
1.4 (169AXE1B) 74-79 kW (100-107 PS) 169 A3.000	10.2006→		7.02604.53.0	LS	400 mm	
			7.02604.53.0	LS	400 mm	
1.4 Natural Power (169AXHIA) 51-63 kW (69-86 PS) 350 A1.000	09.2010→08.2013		7.02604.53.0	LS	400 mm	

PANDA (312_, 319_) **27**













1.3 D Multijet (312PXL1A) 55-59 kW (75-80 PS) 199 A1.000, 199 A9.000	02.2012→		7.01599.10.0	AGR	EL	<input type="radio"/>
			7.03622.06.0	AGR-K		<input type="radio"/>
			7.11020.37.0	ATS	EL	<input checked="" type="radio"/> 199 A1.000, 199 A9.000: Euro 5 Euro 5 ohne Zubehör without accessories
			7.11190.03.0	DDS		
1.3 D Multijet (312PXU1A, 312PXW1A) 64-70 kW (87-95 PS) 199 B1.000, 312 B1.000, 330 A1.000	04.2015→		7.01599.10.0	AGR	EL	<input type="radio"/>
			7.03622.10.0	AGR-K	EL	<input type="radio"/>
			7.03622.06.0	AGR-K		<input type="radio"/>
			7.11190.03.0	DDS		ohne Zubehör without accessories
1.3 D Multijet 4x4 (312PXL1A) 55-59 kW (75-80 PS) 199 A1.000, 199 A9.000	06.2012→		7.01599.10.0	AGR	EL	<input checked="" type="radio"/> 199 A1.000, 199 A9.000: Euro 6 Euro 6
			7.11020.37.0	ATS	EL	<input checked="" type="radio"/> 199 A1.000, 199 A9.000: Euro 5 Euro 5 ohne Zubehör without accessories
			7.11190.03.0	DDS		
			7.01599.10.0	AGR	EL	<input type="radio"/>
1.3 D Multijet 4x4 (312PXS2A) 55-59 kW (75-80 PS) 199 A9.000, 225 A2.000, 312 A8.000, 312 B2.000	06.2014→		7.01599.10.0	AGR	EL	<input type="radio"/>
			7.11190.03.0	DDS		ohne Zubehör without accessories
1.3 D Multijet 4x4 (312PXU1A) 64-70 kW (87-95 PS) 199 B1.000	04.2015→		7.01599.10.0	AGR	EL	<input type="radio"/>
			7.11190.03.0	DDS		ohne Zubehör without accessories
1.3 D Multijet 4x4 (312PXU1A) 70 kW (95 PS) 312 B1.000, 330 A1.000	04.2015→		7.04589.06.0	AGR	EL	<input checked="" type="radio"/> 312 B1.000, 330 A1.000: 12.2017→

PANDA (312_, 319_)						27
			7.01599.10.0 7.11190.03.0	AGR DDS	EL ohne Zubehör without accessories	
PETRA						28
1.5 62 kW (84 PS) 178 E5.022	06.2004→		7.02604.53.0	LS	400 mm	
PUNTO (176_)						29
1.2 16V 63 kW (86 PS) 176 B9.000	04.1997→09.1999		7.02604.47.0	LS	300 mm	
60 1.2 43-44 kW (58-60 PS) 176 A7.000	01.1994→09.1999		7.02604.04.0	LS	200 mm	
60 1.2 (176AP, 176AR, 176AQ, 176BB) 44 kW (60 PS) 176 B1.000, 176 B4.000	09.1993→09.1999		7.02604.49.0	LS	985 mm	
75 1.2 54 kW (73 PS) 176 A8.000	10.1993→09.1999		7.02604.49.0	LS	985 mm	
PUNTO (188_)						30
1.2 16V 80 (188.233, .235, .253, .255, .333, .353, .639,... 57-60 kW) (78-82 PS) 188 A5.000	09.1999→04.2006		7.02604.53.0	LS	400 mm	
1.2 60 (188.030, .050, .130, .150, .230, .250) 38-44 kW (52-60 PS) 188 A4.000	09.1999→12.2010		7.02604.53.0	LS	400 mm	
1.2 Natural Power 38-44 kW (52-60 PS) 188 A4.000	09.2003→03.2012		7.02604.04.0	LS	200 mm	
1.3 JTD 16V 51-66 kW (70-90 PS) 188 A9.000	06.2003→03.2012		7.00020.24.0	AGR	EL	
1.4 65-71 kW (88-97 PS) 843 A1.000	09.2003→03.2012		7.02604.53.0	LS	400 mm	
1.8 130 HGT (188.738, .718) 92-97 kW (125-132 PS) 183 A1.000, 188 A6.000	09.1999→03.2012		7.02604.51.0 7.02604.47.0	LS LS	630 mm 300 mm	
1.9 JTD 63 kW (86 PS) 188 A7.000	10.2001→03.2012		7.22946.33.0 7.22946.34.0	AGR AGR	EL →06.2003 EL →06.2003	
1.9 JTD 80 (188.237, .257, .337, .357) 59 kW (80 PS) 188 A2.000	09.1999→03.2012		7.22946.33.0 7.22946.34.0	AGR AGR	EL EL	
PUNTO (199_)						31
1.2 (199AXZ1A, 199BXZ1A) 51 kW (69 PS) 169 A4.000	03.2012→		7.02604.53.0	LS	400 mm	
1.3 D Multijet 55-68 kW (75-93 PS) 199 A2.000, 199 A9.000	03.2012→		7.00020.24.0 7.01599.10.0 7.03622.06.0 7.11020.04.0	AGR AGR AGR-K ATS	EL EL 199 A2.000, 199 A9.000: Euro 5 Euro 5 EL 199 A2.000, 199 A9.000: Euro 5 Euro 5 2017 2017	



F





PUNTO (199_) **31**



















			7.11190.03.0	DDS		ohne Zubehör without accessories 199 A2.000, 199 A9.000: Euro 5 Euro 5
1.3 D Multijet 62 kW (84 PS) 199 B4.000	03.2012→		7.01599.10.0	AGR	EL	 Euro 5 Euro 5
			7.03622.06.0	AGR-K		
			7.11020.04.0	ATS	EL	Euro 5 Euro 5 2017 2017 ohne Zubehör without accessories Euro 5 Euro 5
1.3 D Multijet 64-70 kW (87-95 PS) 199 B1.000	03.2012→		7.01599.10.0	AGR	EL	
			7.03622.06.0	AGR-K		
			7.11020.04.0	ATS	EL	Euro 5 Euro 5 2017 2017 ohne Zubehör without accessories Euro 5 Euro 5
1.3 D Multijet 70 kW (95 PS) 330 A1.000	03.2012→		7.04589.06.0	AGR	EL	 12.2017→
			7.01599.10.0	AGR	EL	
			7.03622.06.0	AGR-K		
			7.11190.03.0	DDS		ohne Zubehör without accessories Euro 5 Euro 5
1.3 D Multijet 59 kW (80 PS) 199 B8.000	12.2013→		7.01599.10.0	AGR	EL	
			7.11020.04.0	ATS	EL	Euro 5 Euro 5 2017 2017 ohne Zubehör without accessories Euro 5, Euro 6 Euro 5, Euro 6
			7.11190.03.0	DDS		ohne Zubehör without accessories Euro 5, Euro 6 Euro 5, Euro 6
1.3 JTD Multijet (199.AYR1A, 199.BYR1A) 66 kW (90 PS) 955 B2.000	05.2018→		7.11190.03.0	DDS		ohne Zubehör without accessories Euro 6 Euro 6

PUNTO Convertible (176_) **32**

60 1.2 43-44 kW (58-60 PS) 176 A7.000	04.1994→06.2000		7.02604.49.0	LS		985 mm
60 1.2 (176AR_, 176BR_) 44 kW (60 PS) 176 B1.000, 176 B4.000	05.1995→06.2000		7.02604.49.0	LS		985 mm
85 16V 1.2 63 kW (86 PS) 176 B9.000	04.1997→06.2000		7.02604.47.0	LS		300 mm

PUNTO EVO (199_) **33**

















1.2 51 kW (69 PS) 169 A4.000	10.2009→02.2012		7.02604.53.0	LS		400 mm
1.2 48-51 kW (65-69 PS) 199 A4.000	10.2009→02.2012		7.02604.53.0	LS		400 mm

					
PUNTO EVO (199_)					
33					
1.3 D Multijet 51 kW (69 PS) 199 B2.000	07.2008→02.2012		7.01599.10.0 7.11020.04.0 7.11190.03.0	AGR ATS DDS	EL EL ohne Zubehör without accessories
1.3 D Multijet 62 kW (84 PS) 199 B4.000, 223 A9.000	10.2009→02.2012		7.01599.10.0 7.03622.06.0 7.11020.04.0 7.11190.03.0	AGR AGR-K ATS DDS	EL EL ohne Zubehör without accessories für OE-Nummer: 55200301 for OE number: 55200301
1.3 D Multijet 64-70 kW (87-95 PS) 199 B1.000	10.2009→02.2012		7.01599.10.0 7.03622.06.0 7.11020.04.0 7.11190.03.0	AGR AGR-K ATS DDS	EL EL ohne Zubehör without accessories
1.3 D Multijet 55-70 kW (75-95 PS) 199 A2.000, 199 A3.000	10.2014→		7.01599.10.0	AGR	EL
1.3 D Multijet (199AXC1A, 199BXC1A, 199AXT1A, 199BXT1A) 55-68 kW (75-93 PS) 199 A2.000, 199 A9.000	10.2009→02.2012		7.00020.24.0 7.01599.10.0 7.03622.06.0 7.11020.04.0 7.11190.03.0	AGR AGR AGR-K ATS DDS	EL EL EL ohne Zubehör without accessories
1.3 D Multijet (199AXD1B, 199AXD1A, 199BXD1B, 199BXD1A,...) 63-70 kW (86-95 PS) 199 A3.000	10.2009→02.2012		7.00020.25.0 7.01599.10.0 7.11020.04.0 7.11190.03.0	AGR AGR ATS DDS	EL EL EL ohne Zubehör without accessories Euro 4 Euro 4
1.3 D Multijet (199BXC1A) 55-68 kW (75-93 PS) 199 A2.000, 199 A9.000	09.2010→		7.00020.24.0 7.01599.10.0 7.03622.06.0 7.11190.03.0	AGR AGR AGR-K DDS	EL EL EL ohne Zubehör without accessories
1.4 (199AXB1A) 51-63 kW (69-86 PS) 350 A1.000	10.2009→02.2012		7.02604.53.0	LS	400 mm
1.4 (199AXH1A) 55 kW (75 PS) 199 A7.000	07.2009→02.2012		7.02604.53.0	LS	400 mm
1.4 LPG 51-63 kW (69-86 PS) 350 A1.000	06.2009→02.2012		7.02604.53.0	LS	400 mm
1.4 Natural Power 51-63 kW (69-86 PS) 350 A1.000	10.2009→02.2012		7.02604.53.0	LS	400 mm
1.6 D Multijet 88 kW (120 PS) 955 A3.000	10.2009→02.2012		7.24809.77.0 7.02604.44.0	AGR LS	ET 500 mm vor Katalysator in front of the catalyst



F



QUBO (225_) **34**

F	1.3 D Multijet (225AXE1A, 225CXE1A, 225AXH1A, 225AXL1A,... 64-70 kW (87-95 PS) 199 B1.000	07.2010→		7.01599.10.0	AGR	EL	 Euro 5 Euro 5
				7.03622.06.0	AGR-K		
				7.11020.36.0	ATS	EL	 Euro 5 Euro 5 Produktionsdatum ab: 01.08.2011 Production date from: 01.08.2011
	1.3 D Multijet (225AXG1A, 225CXG1A, 225AXG11, 225CXG11) 59 kW (80 PS) 225 A2.000	03.2015→		7.01599.10.0	AGR	EL	
				7.03622.10.0	AGR-K	EL	 Euro 5 Euro 5 mit AGR-Ventil with EGR valve
				7.11020.36.0	ATS	EL	Euro 5 Euro 5
	1.3 D Multijet (225CXB1A, 225AXB1A, 225CXB11, 225AXB11,... 55-68 kW (75-93 PS) 199 A2.000, 199 A9.000	02.2008→		7.00020.24.0	AGR	EL	
				7.00020.25.0	AGR	EL	  199 A2.000, 199 A9.000: Schaltgetriebe, automatisch betätigt Manual Transmission, automatically operated Euro 5 Euro 5
				7.01599.10.0	AGR	EL	  199 A2.000, 199 A9.000: Produktionsdatum bis: 2015 Production date to: 2015
				7.03622.06.0	AGR-K		
				7.11190.04.0	DDS		  199 A2.000, 199 A9.000: für OE-Nummer: 51792301 for OE number: 51792301
	1.4 (225AXA1A) 54 kW (73 PS) KFT, KfV	02.2008→		7.02604.53.0	LS	400 mm	
	1.4 (225AXA1A, 225CXA1A) 51-63 kW (69-86 PS) 350 A1.000	10.2009→		7.02604.53.0	LS	400 mm	
	1.4 Natural Power (225AXC1A) 51-63 kW (69-86 PS) 350 A1.000	10.2009→		7.02604.53.0	LS	400 mm	

RITMO (138_) **35**





























1.5 49-57 kW (67-78 PS) 138 A2.000, 138 C2.048, 138 C3.048, 149 C1.000	01.1978→12.1988		7.02604.01.0	LS	200 mm	
1.5 55-63 kW (75-86 PS) 138 B3.000	01.1983→12.1987		7.02604.01.0	LS	200 mm	

RITMO Convertible (138_) **36**

85 1.5 55-63 kW (75-86 PS) 138 B3.000	03.1983→12.1986		7.02604.01.0	LS	200 mm	
--	-----------------	---	--------------	----	-----------	--

SEDICI (189_) **37**

1.6 16V 78-88 kW (106-120 PS) M16A	06.2006→10.2014		7.05271.54.0	LS	500 mm	
			7.05271.63.0	LS	500 mm	

						
SEDICI (189_)						37
1.6 16V 78-88 kW (106-120 PS) M16A	06.2006→10.2014		7.05271.54.0	LS	500 mm	
1.6 16V 4x4 78-88 kW (106-120 PS) M16A	06.2006→10.2014		7.05271.54.0	LS	500 mm	
1.6 16V 4x4 78-88 kW (106-120 PS) M16A	06.2006→10.2014		7.05271.54.0	LS	500 mm	
1.9 D Multijet 88 kW (120 PS) D19AA	06.2006→10.2011		7.22946.38.0 7.11190.04.0	AGR DDS	EL  Euro 4 Euro 4	
1.9 D Multijet 4x4 88 kW (120 PS) D19AA	06.2006→10.2011		7.22946.38.0 7.11190.04.0	AGR DDS	EL  Euro 4 Euro 4	
2.0 D Multijet 99 kW (135 PS) D20AA	06.2006→10.2014		7.24809.77.0	AGR	ET 	
2.0 D Multijet 4x4 99 kW (135 PS) D20AA	06.2006→10.2014		7.24809.77.0	AGR	ET 	
SEICENTO / 600 (187_)						38
1.1 (187AXB, 187AXB1A, 187AXC1A02) 40-42 kW (54-57 PS) 176 B2.000, 187 A1.000	01.1998→01.2010		7.02604.47.0	LS	300 mm	
SIENA (178_, 172_)						39
1.2 57-60 kW (78-82 PS) 188 A5.000	09.2001→12.2009		7.02604.53.0	LS	400 mm	
1.2 (178CXG1AAM, 178CXG1AAP, 178CXG1AAT) 50-55 kW (68-75 PS) 178 B5.000	09.1998→12.2002		7.02604.51.0 7.02604.53.0	LS LS	630 mm 400 mm	
1.2 (178CXS1AAI, 178BYA1AAT, 178CYA1AAT) 38-46 kW (52-63 PS) 178 C4.066, 188 A4.000	09.2001→12.2012		7.02604.51.0 7.02604.53.0	LS LS	630 mm 400 mm	
1.3 JTD 51-66 kW (70-90 PS) 188 A9.000	09.2003→12.2009		7.00020.24.0	AGR	EL  →0478673	
1.4 51 kW (69 PS) 178 B2.000	04.1996→12.2009		7.02604.51.0 7.02604.53.0	LS LS	630 mm 400 mm	
1.4 51-63 kW (69-86 PS) 178 F3.011, 350 A1.000	01.2007→12.2009		7.02604.53.0	LS	400 mm	
1.4 Cat 51 kW (69 PS) 178 B2.016	04.1996→12.2009		7.02604.51.0 7.02604.53.0	LS LS	630 mm 400 mm	
1.5 62 kW (84 PS) 178 E5.022	06.2004→		7.02604.53.0	LS	400 mm	
1.6 (178CYC1AAT) 68-100 kW (92-136 PS) 182 B6.000	11.2000→12.2012		7.02604.55.0 7.02604.51.0	LS LS	650 mm 630 mm	

















F







SIENA (178_, 172_) 39

			7.02604.47.0	LS	300 mm	
1.6 16V 74-85 kW (100-116 PS) 178 B3.000	09.1998→12.2009		7.02604.55.0	LS	650 mm	
			7.02604.51.0	LS	630 mm	
			7.02604.47.0	LS	300 mm	



















F STILO (192_) 40

1.2 16V (192_XA1B) 57-60 kW (78-82 PS) 188 A5.000	02.2002→11.2006		7.02604.53.0	LS	400 mm	
1.4 16V 66 kW (90 PS) 192 B2.000	03.2005→11.2006		7.02604.53.0	LS	400 mm	
1.4 16V (192AXH1B, 192BXH1B) 65-71 kW (88-97 PS) 843 A1.000	10.2003→12.2006		7.02604.53.0	LS	400 mm	
1.6 16V (192_XB1A) 68-100 kW (92-136 PS) 182 B6.000	10.2001→11.2006		7.02604.55.0	LS	650 mm	
			7.02604.53.0	LS	400 mm	
1.8 16V (192AXC1A, 192BXC1A) 90-98 kW (122-133 PS) 192 A4.000	10.2001→04.2007		7.02604.51.0	LS	630 mm	
			7.02604.47.0	LS	300 mm	links, rechts Left, Right Regelsonde Regulating Probe
1.9 D Multijet 88 kW (120 PS) 192 A8.000	09.2005→11.2006		7.22946.34.0	AGR	EL	
			7.11190.04.0	DDS		Euro 4 Euro 4
			7.02604.99.0	LS	400 mm	
1.9 D Multijet 110 kW (150 PS) 937 A5.000	09.2005→11.2006		7.11190.04.0	DDS		Euro 4 Euro 4
			7.02604.99.0	LS	400 mm	
1.9 D Multijet 74 kW (100 PS) 192 A9.000	09.2005→11.2006		7.22946.34.0	AGR	EL	
1.9 JTD 103 kW (140 PS) 192 A5.000	01.2004→11.2006		7.00063.10.0	AGR	EL	
1.9 JTD (192AXS1B, 192BXS1B) 66 kW (90 PS) 192 B5.000	09.2004→11.2006		7.11190.04.0	DDS		Euro 4 Euro 4 Österreich Austria
			7.02604.99.0	LS	400 mm	
1.9 JTD (192_XE1A) 85 kW (115 PS) 192 A1.000	10.2001→11.2006		7.22946.34.0	AGR	EL	
			7.11190.04.0	DDS		Euro 4 Euro 4 Belgien Belgium
1.9 JTD (192_XE1A) 85 kW (115 PS) 937 A7.000	10.2001→11.2006		7.22946.34.0	AGR	EL	

STILO (192_)
40







			7.11190.04.0	DDS		Euro 4 Euro 4 Belgien Belgien
			7.02604.99.0	LS	400 mm	07.2005→ Motorcode: 937 A7000 Engine Code: 937 A7000 Produktionsdatum ab: 07.2005 Production date from: 07.2005 Produktionsdatum bis: 11.2006 Production date to: 11.2006
1.9 JTD (192_XF1A) 59 kW (80 PS) 192 A3.000	02.2002→11.2006		7.22946.34.0	AGR	EL	
2.4 20V (192_XD1A, 192AXD12) 117-125 kW (159-170 PS) 192 A2.000	10.2001→04.2007		7.02604.53.0	LS	400 mm	
Abarth 2.4i 20V 117-125 kW (159-170 PS) 192 A2.000	10.2001→09.2007		7.02604.53.0	LS	400 mm	

F
STILO Multi Wagon (192_)
41

1.4 16V 65-71 kW (88-97 PS) 843 A1.000	01.2004→08.2008		7.02604.53.0	LS	400 mm	
1.4 16V 66 kW (90 PS) 192 B2.000	03.2005→08.2008		7.02604.53.0	LS	400 mm	
1.6 16V 68-100 kW (92-136 PS) 182 B6.000	01.2003→08.2008		7.02604.55.0	LS	650 mm	
			7.02604.53.0	LS	400 mm	
1.8 16V 90-98 kW (122-133 PS) 192 A4.000	01.2003→08.2008		7.02604.51.0	LS	630 mm	
			7.02604.47.0	LS	300 mm	links, rechts Left, Right Regelsonde Regulating Probe
1.9 D 66 kW (90 PS) 192 B5.000	09.2004→08.2008		7.02604.99.0	LS	400 mm	
1.9 D Multijet 88 kW (120 PS) 192 A8.000	09.2005→08.2008		7.22946.34.0	AGR	EL	
			7.02604.99.0	LS	400 mm	
1.9 D Multijet 74 kW (100 PS) 192 A9.000	09.2005→08.2008		7.22946.34.0	AGR	EL	
1.9 D Multijet (192DXT1B) 110 kW (150 PS) 937 A5.000	09.2005→08.2008		7.02604.99.0	LS	400 mm	
1.9 JTD 59 kW (80 PS) 192 A3.000	01.2003→08.2008		7.22946.34.0	AGR	EL	
1.9 JTD 85 kW (115 PS) 192 A1.000	01.2003→08.2008		7.22946.34.0	AGR	EL	
1.9 JTD 85 kW (115 PS) 937 A7.000	01.2003→08.2008		7.22946.34.0	AGR	EL	
			7.02604.99.0	LS	400 mm	07.2005→12.2007 Motorcode: 937 A7000 Engine Code: 937 A7000 Produktionsdatum ab: 07.2005 Production date from: 07.2005 Produktionsdatum bis: 12.2007 Production date to: 12.2007
1.9 JTD 103 kW (140 PS) 192 A5.000	01.2004→08.2008		7.00063.10.0	AGR	EL	







STRADA Pickup (178_) **42**

1.2 50-55 kW (68-75 PS) 178 B5.000	06.1999→12.2006		7.02604.53.0	LS	400 mm	
1.2 38-44 kW (52-60 PS) 188 A4.000	04.2003→		7.02604.53.0	LS	400 mm	
1.3 D Multijet 62 kW (84 PS) 223 A9.000	05.2006→		7.00020.25.0	AGR	EL	⊗ →12.2011 für Fahrzeuge ohne Diesel-Partikel-Filter (DPF) for vehicles without diesel soot filter
F 1.3 D Multijet (278AYR1A) 64-70 kW (87-95 PS) 199 B1.000	03.2010→		7.00020.25.0	AGR	EL	⊗ →12.2011 für Fahrzeuge ohne Diesel-Partikel-Filter (DPF) for vehicles without diesel soot filter
			7.01599.10.0	AGR	EL	⊗ ohne Zubehör without accessories
			7.11190.03.0	DDS		
1.3 D Multijet (278AYR1A) 64-70 kW (87-95 PS) 199 B1.000	10.2010→		7.01599.10.0	AGR	EL	⊗ ohne Zubehör without accessories
1.9 D 46-48 kW (63-65 PS) 223 A6.000	12.2000→		7.22946.33.0	AGR	EL	⊗ →09.2005 für Hersteller-Abgasnorm: CF3 for manufacturer exhaust norm: CF3
			7.22946.34.0	AGR	EL	⊗ →09.2005 für Hersteller-Abgasnorm: CF3 for manufacturer exhaust norm: CF3
1.9 JTD 59 kW (80 PS) 188 A2.000	04.2003→		7.22946.33.0	AGR	EL	⊗
			7.22946.34.0	AGR	EL	⊗

TEMPRA (159_) **43**

1.4 i.e. (159.AC, 159.AX) 46-57 kW (67-78 PS) 159 A2.000, 160 A1.046, 836 A4.000	04.1990→08.1996		7.02604.04.0	LS	200 mm	
1.6 (159.AD) 62-69 kW (84-94 PS) 159 A3.000, 159 B9.000	03.1990→04.1994		7.02604.03.0	LS	200 mm	
2.0 i.e. (159.AP) 76-85 kW (103-116 PS) 159 A6.046	10.1990→09.1996		7.02604.03.0	LS	200 mm	

TEMPRA S.W. (159_) **44**

1.4 i.e. (159.AC, 159.AX) 46-57 kW (67-78 PS) 159 A2.000, 160 A1.046, 836 A4.000	10.1992→08.1996		7.02604.04.0	LS	200 mm	
1.6 62-69 kW (84-94 PS) 159 A3.000	12.1990→04.1993		7.02604.03.0	LS	200 mm	
2.0 i.e. (159.AP) 76-85 kW (103-116 PS) 159 A6.046	01.1991→03.1995		7.02604.03.0	LS	200 mm	
2.0 i.e. 4x4 (159.AP) 76-85 kW (103-116 PS) 159 A6.046	03.1992→03.1995		7.02604.03.0	LS	200 mm	

TIPO (160_) **45**









1.4 i.e. 51-57 kW (69-78 PS) 159 A2.000	05.1989→04.1995		7.02604.03.0	LS	200 mm
1.4 i.e. (160.AP, 160.AD, 160.EA) 46-57 kW (67-78 PS) 160 A1.046, 160 A1.048, 836 A4.000	05.1989→04.1995		7.02604.03.0	LS	200 mm
1.6 i.e. 66 kW (90 PS) 149 C2.046	02.1988→05.1991		7.02604.04.0	LS	200 mm
1.6 i.e. (160.A1, 160.EC, 160.EB) 51-69 kW (69-90 PS) 159 A3.048, 835 C1.000	10.1992→04.1995		7.02604.54.0	LS	980 mm
			7.02604.04.0	LS	200 mm
1.6 i.e. (160.AF) 56-65 kW (76-88 PS) 159 A3.046	07.1990→01.1993		7.02604.54.0	LS	980 mm
			7.02604.04.0	LS	200 mm
1.8 i.e 71-74 kW (97-101 PS) 836 A5.000	03.1993→04.1995		7.02604.04.0	LS	200 mm
1.8 i.e. 74-81 kW (101-110 PS) 159 A4.000	10.1990→06.1993		7.02604.04.0	LS	200 mm
1.8 i.e. 66 kW (90 PS) 835 C4.000	09.1993→04.1995		7.02604.04.0	LS	200 mm
1.8 i.e. (160.AY) 77 kW (105 PS) 159 A4.046	10.1990→06.1993		7.02604.04.0	LS	200 mm
1.8 i.e. (160.ED) 76 kW (103 PS) 835 C2.000	04.1993→04.1995		7.02604.04.0	LS	200 mm
1.8 i.e. (160.EQ, 160.AM) 71-81 kW (97-110 PS) 159 A4.000, 836 A5.000	10.1994→10.1995		7.02604.04.0	LS	200 mm

F
TIPO Estate (356_) **46**



1.3 D (356WXH1A) 59-70 kW (80-95 PS) 552 83 775	03.2016→		7.03622.10.0	AGR-K	EL
			7.11190.03.0	DDS	ohne Zubehör without accessories
1.3 D (356WXH1A) 70 kW (95 PS) 552 66 963	03.2016→		7.01599.10.0	AGR	EL Euro 6 Euro 6
			7.03622.10.0 7.11190.03.0	AGR-K DDS	EL ohne Zubehör without accessories
1.6 (356WXE11) 81 kW (110 PS) 552 68 036	07.2016→		7.07549.09.0	AGR	EL mit Dichtring with O-ring
1.6 D (356WXG11) 84-88 kW (114-120 PS) 552 60 384, 552 80 444	09.2016→		7.07549.09.0	AGR	EL mit Dichtring with O-ring
			7.11190.03.0	DDS	552 60 384: 01.2017→ 552 80 444: 01.2019→ ohne Zubehör without accessories
1.6 D (356WXG1B) 84-88 kW (114-120 PS) 552 60 384	03.2016→		7.24809.77.0	AGR	ET
			7.11190.03.0	DDS	ohne Zubehör without accessories
1.6 D (356WXG1B) 84-88 kW (114-120 PS) 552 80 444	03.2016→		7.07549.09.0	AGR	EL mit Dichtring with O-ring
			7.11190.03.0	DDS	ohne Zubehör without accessories



TIPO Hatchback (356_) 47

F	1.3 D (356HXH1A) 59-70 kW (80-95 PS) 552 83 775	03.2016→		7.04589.06.0 AGR EL <input type="radio"/>	12.2017→ Euro 6 Euro 6
				7.07969.06.0 AGR-K EL <input type="radio"/>	09.2018→ Euro 6d Euro 6d
				7.03622.10.0 AGR-K EL <input type="radio"/>	
F	1.3 D (356HXH1A) 70 kW (95 PS) 552 66 963	03.2016→		7.04589.06.0 AGR EL <input type="radio"/>	12.2017→ Euro 6 Euro 6
				7.01599.10.0 AGR EL <input type="radio"/>	Euro 6 Euro 6
				7.07969.06.0 AGR-K EL <input type="radio"/>	09.2018→ Euro 6d Euro 6d
				7.03622.10.0 AGR-K EL <input type="radio"/>	
			7.11190.03.0 DDS	ohne Zubehör without accessories	
	1.6 (356HXE11) 81 kW (110 PS) 552 68 036	07.2016→		7.07549.09.0 AGR EL <input type="radio"/>	mit Dichtring with O-ring
	1.6 D (356HXG11) 84-88 kW (114-120 PS) 552 60 384, 552 80 444	09.2016→		7.07549.09.0 AGR EL <input type="radio"/>	mit Dichtring with O-ring  552 60 384: 01.2017→  552 80 444: 01.2019→
				7.11190.03.0 DDS	ohne Zubehör without accessories
	1.6 D (356HXG1B, 356HXG11) 84-88 kW (114-120 PS) 552 60 384	03.2016→		7.24809.77.0 AGR ET <input checked="" type="checkbox"/>	
				7.11190.03.0 DDS	ohne Zubehör without accessories
	1.6 D (356HXG1B, 356HXG11) 84-88 kW (114-120 PS) 552 80 444	03.2016→		7.07549.09.0 AGR EL <input type="radio"/>	mit Dichtring with O-ring
				7.11190.03.0 DDS	ohne Zubehör without accessories

TIPO Saloon (356_) 48

	1.3 D (356SXB1A, 356SXH1A, 356SXD1A) 59-70 kW (80-95 PS) 552 83 775	10.2015→		7.04589.06.0 AGR EL <input type="radio"/>	12.2017→ Euro 6 Euro 6
				7.07969.06.0 AGR-K EL <input type="radio"/>	09.2018→ Euro 6d Euro 6d
				7.03622.10.0 AGR-K EL <input type="radio"/>	
				7.11190.03.0 DDS	ohne Zubehör without accessories
	1.3 D (356SXB1A, 356SXH1A, 356SXD1A) 64-70 kW (87-95 PS) 199 B1.000	10.2015→		7.01599.10.0 AGR EL <input type="radio"/>	Euro 6 Euro 6
				7.03622.10.0 AGR-K EL <input type="radio"/>	
				7.11190.03.0 DDS	ohne Zubehör without accessories
	1.3 D (356SXB1A, 356SXH1A, 356SXD1A) 70 kW (95 PS) 552 66 963	10.2015→		7.04589.06.0 AGR EL <input type="radio"/>	12.2017→ Euro 6 Euro 6

TIPO Saloon (356_) 48





























			7.01599.10.0	AGR	EL	Euro 6
			7.07969.06.0	AGR-K	EL	Euro 6
			7.03622.10.0	AGR-K	EL	09.2018→ Euro 6d
			7.11190.03.0	DDS		ohne Zubehör without accessories
1.6 (356SXE11) 81 kW (110 PS) 552 68 036	10.2015→		7.07549.09.0	AGR	EL	mit Dichtring with O-ring
1.6 D (356SXG1B) 84-88 kW (114-120 PS) 552 60 384	10.2015→		7.24809.77.0	AGR	ET	
			7.11190.03.0	DDS		ohne Zubehör without accessories
1.6 D (356SXG1B) 88 kW (120 PS) 940 C1.000	10.2015→		7.24809.77.0	AGR	ET	
			7.07549.09.0	AGR	EL	mit Dichtring with O-ring
			7.11190.03.0	DDS		ohne Zubehör without accessories
1.6 D (356SXG1B) 84-88 kW (114-120 PS) 552 60 384	09.2016→		7.11190.03.0	DDS		ohne Zubehör without accessories

F
ULYSSE (179_) 49

2.0 D Multijet 88 kW (120 PS) RHK	05.2006→06.2011		7.24809.68.0	AGR	EL	
2.0 D Multijet 100 kW (136 PS) RHR	05.2006→06.2011		7.24809.68.0	AGR	EL	
			7.11492.01.0	DDS		ohne Zubehör without accessories
2.0 JTD 80 kW (109 PS) RHW (DW10ATED4)	08.2002→08.2006		7.28069.03.0	AGR	PN	für Fahrzeuge ohne Diesel-Partikel-Filter (DPF) for vehicles without diesel soot filter
2.2 D Multijet 125 kW (170 PS) 4HS	03.2008→06.2011		7.11492.01.0	DDS		ohne Zubehör without accessories Euro 4
2.2 D Multijet 125 kW (170 PS) 4HT (DW12BTED4)	03.2008→06.2011		7.00578.12.0	AGR	EL	Euro 4
			7.11492.01.0	DDS		ohne Zubehör without accessories Euro 4
2.2 JTD 94 kW (128 PS) 4HW (DW12ATED4)	08.2002→08.2006		7.11492.01.0	DDS		ohne Zubehör without accessories Euro 4
2.2 JTD 120 kW (163 PS) 4HP, 4HR	03.2008→06.2011		7.11492.01.0	DDS		ohne Zubehör without accessories 4HP, 4HR: Euro 4
3.0 150-152 kW (204-207 PS) XFW	08.2002→06.2011		7.02604.11.0	LS	null mm	

ULYSSE (220_) 50

2.0 (220.AC5) 89 kW (121 PS) RFU (XU10J2C)	06.1994→08.2002		7.02604.04.0	LS	200 mm	
2.0 16V 97-100 kW (132-136 PS) RFV	07.1998→09.2000		7.05270.37.0	LS	1640 mm	





					
ULYSSE (220_) 50					
2.0 16V (220AQ5) 100 kW (136 PS) RFN (EW10J4)	09.2000→08.2002		7.05270.37.0	LS	1640 mm
2.0 JTD 80 kW (109 PS) RHZ	10.1999→08.2002		7.22843.06.0	AGR	PN 
2.0 JTD 16V 80 kW (109 PS) RHW (DW10ATED4)	05.1999→08.2002		7.28069.03.0	AGR	PN  für Fahrzeuge ohne Diesel-Partikel-Filter (DPF) for vehicles without diesel soot filter
F UNO (146_) 51					
1.3 Turbo i.e. 77 kW (105 PS) 146 A2.000	04.1985→08.1989		7.02604.03.0	LS	200 mm
1.3 Turbo i.e. 73 kW (100 PS) 146 A2.146	01.1987→12.1987		7.02604.03.0	LS	200 mm
1.3 Turbo i.e. 74 kW (100 PS) 146 A2.246	09.1989→03.1991		7.02604.03.0	LS	200 mm
1.4 74-87 kW (101-118 PS) 146 A8.000	01.1989→12.1991		7.02604.03.0	LS	200 mm
1.4 Turbo 74-87 kW (101-118 PS) 146 A8.000	10.1988→08.2000		7.02604.03.0	LS	200 mm
1.4 Turbo i.e. 82 kW (112 PS) 146 A8.046	09.1989→09.1993		7.02604.03.0	LS	200 mm
1.4 Turbo i.e. 74-87 kW (101-118 PS) 146 A8.000	12.1989→12.1996		7.02604.03.0	LS	200 mm
BRAVO Van (198_) 52					
1.6 JTD Multijet (198AXH1B) 77 kW (105 PS) 198 A3.000	03.2008→12.2014		7.11190.03.0	DDS	ohne Zubehör without accessories
CROMA Estate Van (194_) 53					
1.9 MJTD (194AXB1B) 88 kW (120 PS) 939 A1.000	04.2006→12.2011		7.11190.03.0	DDS	ohne Zubehör without accessories für OE-Nummer: 55200301 für OE number: 55200301
			7.11190.04.0	DDS	für OE-Nummer: 51792301 für OE number: 51792301
DOBLO Box Body/MPV (223_) 54					
1.2 (223ZX1A) 48 kW (65 PS) 223 A5.000	03.2001→01.2004		7.02604.53.0	LS	400 mm
			7.02604.56.0	LS	1190 mm
1.3 D Multijet 55-68 kW (75-93 PS) 199 A2.000	10.2005→01.2010		7.00020.24.0	AGR	EL 
1.3 JTD 16V 51-66 kW (70-90 PS) 188 A8.000, 188 A9.000	05.2004→12.2006		7.00020.24.0	AGR	EL 
1.3 JTD 16V Multijet 62 kW (84 PS) 223 A9.000	08.2006→		7.00020.25.0	AGR	EL 
			7.11190.04.0	DDS	Euro 4 Euro 4
1.4 51-63 kW (69-86 PS) 350 A1.000	10.2005→		7.02604.53.0	LS	400 mm
1.6 16V (223ZXD1A) 68-100 kW (92-136 PS) 182 B6.000	10.2001→		7.02604.53.0	LS	400 mm
			7.02604.47.0	LS	300 mm
			7.02604.56.0	LS	1190 mm

DOBLO Box Body/MPV (223_)						54
1.6 Natural Power 68-100 kW (92-136 PS) 182 B6.000	09.2002→		7.02604.53.0	LS	400 mm	
			7.02604.47.0	LS	300 mm	
			7.02604.56.0	LS	1190 mm	
1.9 JTD 77 kW (105 PS) 223 A7.000, 223 B1.000	07.2003→		7.22946.33.0	AGR	EL	
			7.22946.34.0	AGR	EL	
1.9 JTD (223ZXE1A) 74-79 kW (100-107 PS) 182 B9.000	10.2001→		7.22946.33.0	AGR	EL	
			7.22946.34.0	AGR	EL	
1.9 JTD Multijet 88 kW (120 PS) 186 A9.000	12.2006→		7.22946.34.0	AGR	EL	
			7.22946.33.0	AGR	EL	
			7.11020.09.0	ATS	EL	
7.11190.04.0	DDS	EL				
DOBLO Bus (263_)						55
1.3 D Multijet (263AXC1A) 63-70 kW (86-95 PS) 199 A3.000, 263 A2.000	02.2010→		7.00020.25.0	AGR	EL	
			7.01599.10.0	AGR	EL	
			7.03622.06.0	AGR-K		
			7.11190.03.0	DDS	ohne Zubehör without accessories	
1.3 D Multijet (263AXU1A) 70 kW (95 PS) 330 A1.000	03.2016→		7.04589.06.0	AGR	EL	
			7.01599.10.0	AGR	EL	
			7.07969.06.0	AGR-K	EL	
7.11190.03.0	DDS	09.2018→ Euro 6d Euro 6d ohne Zubehör without accessories für OE-Nummer: 51908411 für OE number: 51908411				
1.6 D Multijet (263AXD1B) 77 kW (105 PS) 198 A3.000, 263 A8.000	01.2010→		7.24809.77.0	AGR	ET	
			7.11020.41.0	ATS	EL	
			7.11190.03.0	DDS	ohne Zubehör without accessories	
7.02604.44.0	LS	500 mm				
1.6 D Multijet (263AXE1B) 74 kW (101 PS) 263 A3.000	03.2016→		7.24809.77.0	AGR	ET	

F

















DOBLO Bus (263_) **55**

		7.11190.03.0	DDS		ohne Zubehör without accessories für OE-Nummer: 51908411 for OE number: 51908411
1.6 D Multijet (263AXH1A, 263AXL11, 263AXH1B) 66 kW (90 PS) 263 A4.000	02.2010→	 7.24809.77.0	AGR	ET	<input checked="" type="checkbox"/>
		7.11020.41.0	ATS	EL	
		7.11190.03.0	DDS		ohne Zubehör without accessories
		7.02604.44.0	LS	500 mm	vor Katalysator in front of the catalyst ab Euro 5 From Euro 5
1.6 D Multijet (263AXN1B) 88 kW (120 PS) 940 C1.000	03.2015→	 7.24809.77.0	AGR	ET	<input checked="" type="checkbox"/>
		7.11020.41.0	ATS	EL	für OE-Nummer: 51825697, 51830436, 51891441 for OE number: 51825697, 51830436, 51891441
		7.11190.03.0	DDS		ohne Zubehör without accessories für OE-Nummer: 51908411 for OE number: 51908411
1.6 D Multijet (263AXP1B) 70 kW (95 PS) 263 A7.000	03.2015→	 7.24809.77.0	AGR	ET	<input checked="" type="checkbox"/>
		7.11020.41.0	ATS	EL	für OE-Nummer: 51825697, 51830436, 51891441 for OE number: 51825697, 51830436, 51891441
		7.11190.03.0	DDS		ohne Zubehör without accessories für OE-Nummer: 51908411 for OE number: 51908411
2.0 D Multijet (263AXF1B) 99 kW (135 PS) 263 A1.000	01.2010→	 7.24809.77.0	AGR	ET	<input checked="" type="checkbox"/>
		7.11020.41.0	ATS	EL	
		7.11190.03.0	DDS		ohne Zubehör without accessories
		7.02604.44.0	LS	500 mm	vor Katalysator in front of the catalyst ab Euro 5 From Euro 5 Produktionsdatum bis: 14.02.2014 Production date to: 14.02.2014

DOBLO Cargo (263_) **56**

1.3 D Multijet 63-70 kW (86-95 PS) 199 A3.000, 263 A2.000	02.2010→	 7.00020.25.0	AGR	EL	<input type="checkbox"/>
		7.01599.10.0	AGR	EL	<input checked="" type="checkbox"/>
		7.03622.06.0	AGR-K		<input checked="" type="checkbox"/>
		7.11190.03.0	DDS		ohne Zubehör without accessories

					
DOBLO Cargo (263_)					
56					
1.3 D Multijet 55 kW (75 PS) 263 A6.000	11.2013→		7.00020.25.0 7.01599.10.0 7.03622.06.0 7.11190.03.0	AGR AGR AGR-K DDS	EL <input type="radio"/> Euro 5, Euro 5b Euro 5, Euro 5b für Fahrzeuge mit Start-Stopp-Funktion for vehicles with start-stop function EL <input type="radio"/> <input type="radio"/> ohne Zubehör without accessories
1.3 D Multijet 59 kW (80 PS) 225 A2.000	03.2016→		7.04589.06.0 7.01599.10.0 7.07969.06.0 7.11190.03.0	AGR AGR AGR-K DDS	EL <input type="radio"/> 12.2017→ Euro 6 Euro 6 EL <input type="radio"/> EL <input type="radio"/> 09.2018→ Euro 6d Euro 6d ohne Zubehör without accessories für OE-Nummer: 51908411 for OE number: 51908411
1.3 D Multijet (263WXU1A) 70 kW (95 PS) 330 A1.000	03.2016→		7.04589.06.0 7.01599.10.0 7.07969.06.0 7.11190.03.0	AGR AGR AGR-K DDS	EL <input type="radio"/> 12.2017→ Euro 6 Euro 6 EL <input type="radio"/> EL <input type="radio"/> 09.2018→ Euro 6d Euro 6d ohne Zubehör without accessories für OE-Nummer: 51908411 for OE number: 51908411
1.6 D Multijet 77 kW (105 PS) 198 A3.000, 263 A8.000	02.2010→		7.24809.77.0 7.11020.41.0 7.11190.03.0	AGR ATS DDS	ET <input checked="" type="checkbox"/> EL ohne Zubehör without accessories
1.6 D Multijet 66 kW (90 PS) 263 A4.000, 263 A5.000	02.2010→		7.24809.77.0 7.11020.41.0 7.11190.03.0	AGR ATS DDS	ET <input checked="" type="checkbox"/> EL ohne Zubehör without accessories
1.6 D Multijet 74 kW (101 PS) 263 A3.000, 263 A9.000	02.2010→		7.24809.77.0 7.11190.03.0	AGR DDS	ET <input checked="" type="checkbox"/> ohne Zubehör without accessories
1.6 D Multijet (263.WXN1B, 263.ZXN1B) 88 kW (120 PS) 940 C1.000	02.2016→		7.24809.77.0 7.11020.41.0 7.11190.03.0	AGR ATS DDS	ET <input checked="" type="checkbox"/> EL für OE-Nummer: 51825697, 51830436, 51891441 for OE number: 51825697, 51830436, 51891441 ohne Zubehör without accessories für OE-Nummer: 51908411 for OE number: 51908411
1.6 D Multijet (263ZXR1B) 70 kW (95 PS) 263 A7.000	03.2015→		7.24809.77.0	AGR	ET <input checked="" type="checkbox"/>





F



















DOBLO Cargo (263_) 56

			7.11020.41.0	ATS	EL	für OE-Nummer: 51825697, 51830436, 51891441 for OE number: 51825697, 51830436, 51891441
			7.11190.03.0	DDS		ohne Zubehör without accessories für OE-Nummer: 51908411 for OE number: 51908411
F	2.0 D Multijet 99 kW (135 PS) 263 A1.000	02.2010→		7.24809.77.0	AGR	ET <input checked="" type="checkbox"/>
			7.11020.41.0	ATS	EL	
			7.11190.03.0	DDS		
			7.02604.44.0	LS	500 mm	vor Katalysator in front of the catalyst ab Euro 5 From Euro 5 Produktionsdatum bis: 14.02.2014 Production date to: 14.02.2014

DOBLO Platform/Chassis (263_) 57

	1.3 D Multijet 63-70 kW (86-95 PS) 199 A3.000, 263 A2.000	02.2010→		7.01599.10.0	AGR	EL <input type="checkbox"/>	<input checked="" type="checkbox"/> 199 A3.000, 263 A2.000: für Fahrzeuge mit Start-Stopp-Funktion for vehicles with start-stop function
				7.03622.06.0	AGR-K	<input type="checkbox"/>	ohne Zubehör without accessories
				7.11190.03.0	DDS		
	1.3 D Multijet 55 kW (75 PS) 263 A6.000	11.2013→		7.01599.10.0	AGR	EL <input type="checkbox"/>	<input type="checkbox"/>
				7.03622.06.0	AGR-K	<input type="checkbox"/>	ohne Zubehör without accessories
				7.11190.03.0	DDS		
	1.3 D Multijet (263.HXT1A, 263.YXT1A) 59 kW (80 PS) 225 A2.000	03.2016→		7.04589.06.0	AGR	EL <input type="checkbox"/>	12.2017→ Euro 6 Euro 6
				7.01599.10.0	AGR	EL <input type="checkbox"/>	
				7.07969.06.0	AGR-K	EL <input type="checkbox"/>	09.2018→ Euro 6d Euro 6d
				7.11190.03.0	DDS		ohne Zubehör without accessories für OE-Nummer: 51908411 for OE number: 51908411
	1.3 D Multijet (263.HXU1A, 263.YXU1A) 70 kW (95 PS) 330 A1.000	03.2016→		7.04589.06.0	AGR	EL <input type="checkbox"/>	12.2017→ Euro 6 Euro 6
				7.01599.10.0	AGR	EL <input type="checkbox"/>	
				7.07969.06.0	AGR-K	EL <input type="checkbox"/>	09.2018→ Euro 6d Euro 6d
				7.11190.03.0	DDS		ohne Zubehör without accessories für OE-Nummer: 51908411 for OE number: 51908411
	1.6 D Multijet 77 kW (105 PS) 198 A3.000, 263 A8.000	02.2010→		7.24809.77.0	AGR	ET <input checked="" type="checkbox"/>	
				7.11020.41.0	ATS	EL	ohne Zubehör without accessories
				7.11190.03.0	DDS		



















					
DOBLO Platform/Chassis (263_)					
57					
1.6 D Multijet 66 kW (90 PS) 263 A4.000, 263 A5.000	02.2010→		7.24809.77.0	AGR	ET <input checked="" type="checkbox"/>
			7.11020.41.0	ATS	EL
			7.11190.03.0	DDS	ohne Zubehör without accessories
1.6 D Multijet 74 kW (101 PS) 263 A3.000, 263 A9.000	02.2011→		7.24809.77.0	AGR	ET <input checked="" type="checkbox"/>
			7.11190.03.0	DDS	ohne Zubehör without accessories
1.6 D Multijet (263.HXN1B, 263.YXN1B) 88 kW (120 PS) 940 C1.000	02.2016→		7.24809.77.0	AGR	ET <input checked="" type="checkbox"/>
			7.11020.41.0	ATS	EL für OE-Nummer: 51825697, 51830436, 51891441 for OE number: 51825697, 51830436, 51891441
			7.11190.03.0	DDS	ohne Zubehör without accessories für OE-Nummer: 51908411 for OE number: 51908411
2.0 D Multijet 99 kW (135 PS) 263 A1.000	02.2010→		7.24809.77.0	AGR	ET <input checked="" type="checkbox"/>
			7.11020.41.0	ATS	EL
			7.11190.03.0	DDS	ohne Zubehör without accessories
DUCATO Bus (230_)					
58					
2.0 JTD 62 kW (84 PS) RHV	10.2001→04.2002		7.11237.04.0	AGR	PN
2.8 D 64 kW (87 PS) 8140.63	02.1998→04.2002		7.24809.53.0	AGR	PN <input type="checkbox"/>
DUCATO Bus (244_)					
59					
2.0 JTD 62 kW (84 PS) RHV	04.2002→		7.11237.04.0	AGR	PN →06.2006
DUCATO Bus (250_)					
60					
100 Multijet 2,2 D 74 kW (101 PS) 4HV	07.2006→05.2011		7.24809.70.0	AGR	EL <input type="checkbox"/>
110 Multijet 2,3 D 82-83 kW (111-113 PS) F1AE3481G	10.2011→		7.09002.00.0	AGR	PN <input type="checkbox"/>
			7.24809.86.0	AGR	EL
			7.11190.03.0	DDS	ohne Zubehör without accessories für OE-Nummer: 51908411 for OE number: 51908411
110 Multijet 2,3 D 82-83 kW (111-113 PS) F1AE3481G	05.2014→		7.24809.86.0	AGR	EL
			7.11190.03.0	DDS	ohne Zubehör without accessories für OE-Nummer: 51908411 for OE number: 51908411
115 Multijet 2,0 D 85 kW (116 PS) 250 A1.000, 250 A2.000	06.2011→		7.24809.77.0	AGR	ET <input checked="" type="checkbox"/>
			7.11020.15.0	ATS	EL <input checked="" type="checkbox"/> 250 A1.000, 250 A2.000: Euro 5 Produktionsdatum bis: 05.06.2016 Production date to: 05.06.2016



















F



DUCATO Bus (250_) **60**

F

			7.11190.03.0	DDS		ohne Zubehör without accessories 250 A1.000, 250 A2.000: für OE-Nummer: 51908411 for OE number: 51908411
120 Multijet 2,3 D 88 kW (120 PS) F1AE0481D	07.2006→		7.09002.00.0	AGR	PN	
			7.09720.05.0	AGR-K	PN	
			7.02604.99.0	LS	400 mm	
130 Multijet 2,3 D 96 kW (131 PS) F1AE0481N	06.2011→		7.09002.00.0	AGR	PN	 →715776
			7.11190.03.0	DDS		ohne Zubehör without accessories für OE-Nummer: 51908411 for OE number: 51908411
			7.02604.99.0	LS	400 mm	
130 Multijet 2,3 D 96 kW (131 PS) F1AE3481D, F1AGL411D	06.2011→		7.09002.00.0	AGR	PN	 F1AE3481D, F1AGL411D: →715776
			7.05052.03.0	AGR-K		
			↳ 7.24809.86.0	AGR	EL	 F1AE3481D, F1AGL411D: 09.2017→
			7.11190.03.0	DDS		ohne Zubehör without accessories F1AE3481D, F1AGL411D: für OE-Nummer: 51908411 for OE number: 51908411
			7.02604.99.0	LS	400 mm	
130 Multijet 2,3 D 4x4 96 kW (131 PS) F1AE0481N	06.2011→		7.09002.00.0	AGR	PN	 →715776
			7.11190.03.0	DDS		ohne Zubehör without accessories für OE-Nummer: 51908411 for OE number: 51908411
130 Multijet 2,3 D 4x4 96 kW (131 PS) F1AE3481D, F1AGL411D	06.2011→		7.09002.00.0	AGR	PN	 F1AE3481D, F1AGL411D: →715776
			7.05052.03.0	AGR-K		
			↳ 7.24809.86.0	AGR	EL	 F1AE3481D, F1AGL411D: 09.2017→
			7.11190.03.0	DDS		ohne Zubehör without accessories F1AE3481D, F1AGL411D: für OE-Nummer: 51908411 for OE number: 51908411
140 Multijet 2,3 D 103 kW (140 PS) F1AGL4113	05.2019→		7.11190.03.0	DDS		ohne Zubehör without accessories Euro 6d Euro 6d
140 Natural Power 100 kW (136 PS) F1CE0441A, F1CFA401A	04.2009→		7.11190.03.0	DDS		ohne Zubehör without accessories F1CE0441A, F1CFA401A: für OE-Nummer: 51908411 for OE number: 51908411
			7.02604.53.0	LS	400 mm	
140 Natural Power 100 kW (136 PS) F1CFA401C	05.2019→		7.02604.53.0	LS	400 mm	







					
DUCATO Bus (250_)					
60					
150 Multijet 2,3 D 109-110 kW (148-150 PS) F1AE3481E	06.2011→		7.05052.03.0	AGR-K	 09.2017→
			↳ 7.24809.86.0	AGR	EL
150 Multijet 2,3 D 110 kW (150 PS) F1AGL411A	04.2015→		7.24809.86.0	AGR	EL
			7.11190.03.0	DDS	ohne Zubehör without accessories für OE-Nummer: 51908411 for OE number: 51908411
150 Multijet 2,3 D 110 kW (150 PS) F1AGL411C	04.2015→		7.05052.03.0	AGR-K	 09.2017→
			↳ 7.24809.86.0	AGR	EL
			7.11190.03.0	DDS	ohne Zubehör without accessories für OE-Nummer: 51908411 for OE number: 51908411
150 Multijet 2,3 D 4x4 110 kW (150 PS) F1AGL411A	04.2015→		7.24809.86.0	AGR	EL
			7.11190.03.0	DDS	ohne Zubehör without accessories für OE-Nummer: 51908411 for OE number: 51908411
150 Multijet 2,3 D 4x4 110 kW (150 PS) F1AGL411C	04.2015→		7.05052.03.0	AGR-K	 09.2017→
			↳ 7.24809.86.0	AGR	EL
			7.11190.03.0	DDS	ohne Zubehör without accessories für OE-Nummer: 51908411 for OE number: 51908411
150 Multijet 3,0 D 103-107 kW (140-145 PS) F1CE3481N	04.2010→		7.08369.98.0	ATS	EL nach Rußpartikelfilter after soot particulate filter
			7.08369.99.0	ATS	EL
			7.11190.03.0	DDS	ohne Zubehör without accessories für OE-Nummer: 51908411 for OE number: 51908411
			7.02604.99.0	LS	400 mm
160 Multijet 2,3 D 118 kW (160 PS) F1AGL4112	05.2019→		7.11190.03.0	DDS	ohne Zubehör without accessories Euro 6d Euro 6d
160 Multijet 3,0 D 115-116 kW (156-158 PS) F1CE0481D	07.2006→		7.24809.51.0	AGR	PN 
			7.08369.98.0	ATS	EL nach Rußpartikelfilter after soot particulate filter
			7.08369.99.0	ATS	EL
			7.11190.03.0	DDS	ohne Zubehör without accessories für OE-Nummer: 51908411 for OE number: 51908411
			7.02604.99.0	LS	400 mm
160 Multijet 3,0 D 115 kW (156 PS) F1CE3481M	07.2006→		7.08369.98.0	ATS	EL nach Rußpartikelfilter after soot particulate filter
			7.08369.99.0	ATS	EL

F







DUCATO Bus (250_) **60**

F

			7.11190.03.0	DDS		ohne Zubehör without accessories für OE-Nummer: 51908411 for OE number: 51908411
			7.02604.99.0	LS	400 mm	
160 Multijet 3,0 D 115-116 kW (156-158 PS) F1CE0481D	10.2006→		7.24809.51.0	AGR	PN	
			7.08369.98.0	ATS	EL	nach Rußpartikelfilter after soot particulate filter
			7.08369.99.0	ATS	EL	
			7.11190.03.0	DDS		ohne Zubehör without accessories für OE-Nummer: 51908411 for OE number: 51908411
			7.02604.99.0	LS	400 mm	
160 Multijet 3,0 D 4x4 115-116 kW (156-158 PS) F1CE0481D	07.2006→		7.24809.51.0	AGR	PN	
			7.08369.98.0	ATS	EL	nach Rußpartikelfilter after soot particulate filter
			7.08369.99.0	ATS	EL	
			7.11190.03.0	DDS		ohne Zubehör without accessories für OE-Nummer: 51908411 for OE number: 51908411
160 Multijet 3,0 D 4x4 115 kW (156 PS) F1CE3481M	07.2006→		7.08369.98.0	ATS	EL	nach Rußpartikelfilter after soot particulate filter
			7.08369.99.0	ATS	EL	
			7.11190.03.0	DDS		ohne Zubehör without accessories für OE-Nummer: 51908411 for OE number: 51908411
180 Multijet 2,3 D 130 kW (177 PS) F1AGL4111	05.2019→		7.11190.03.0	DDS		ohne Zubehör without accessories Euro 6d Euro 6d
180 Multijet 3,0 D 130 kW (177 PS) F1CE3481E	06.2011→		7.08369.98.0	ATS	EL	nach Rußpartikelfilter after soot particulate filter
			7.08369.99.0	ATS	EL	
			7.11190.03.0	DDS		ohne Zubehör without accessories für OE-Nummer: 51908411 for OE number: 51908411
			7.02604.99.0	LS	400 mm	

DUCATO Platform/Chassis (230_) **61**

2.0 JTD 62 kW (84 PS) RHV	07.2001→04.2002		7.11237.04.0	AGR	PN	
2.8 D 64 kW (87 PS) 8140.63	02.1998→04.2002		7.24809.53.0	AGR	PN	
2.8 TD 4x4 64 kW (87 PS) 8140.63	05.1998→11.2001		7.24809.53.0	AGR	PN	

DUCATO Platform/Chassis (244_) **62**

2.0 JTD 62 kW (84 PS) RHV	04.2002→07.2006		7.11237.04.0	AGR	PN	→06.2006
-------------------------------------	-----------------	---	---------------------	-----	----	----------

DUCATO Platform/Chassis (250_) **63**

















100 Multijet 2,2 D 74 kW (101 PS) 4HV	07.2006→		7.24809.70.0	AGR	EL	
110 Multijet 2,3 D 82-83 kW (111-113 PS) F1AE3481G	08.2006→		7.09002.00.0	AGR	PN	
			7.24809.86.0	AGR	EL	
110 Multijet 2,3 D 82-83 kW (111-113 PS) F1AE3481G	10.2011→		7.09002.00.0	AGR	PN	
			7.24809.86.0	AGR	EL	
			7.11190.03.0	DDS	EL	ohne Zubehör without accessories für OE-Nummer: 51908411 for OE number: 51908411
115 Multijet 2,0 D 85 kW (116 PS) 250 A1.000, 250 A2.000	06.2011→		7.24809.77.0	AGR	ET	
			7.11020.15.0	ATS	EL	250 A1.000, 250 A2.000: Euro 5 Produktionsdatum bis: 05.06.2016 Production date to: 05.06.2016 ohne Zubehör without accessories
			7.11190.03.0	DDS		250 A1.000, 250 A2.000: für OE-Nummer: 51908411 for OE number: 51908411
120 Multijet 2,3 D 88 kW (120 PS) F1AE0481D	07.2006→		7.09002.00.0	AGR	PN	
			7.09720.05.0	AGR-K	PN	
			7.02604.99.0	LS	400 mm	
120 Multijet 2,3 D 88 kW (120 PS) F1AGL4114	07.2006→		7.09720.05.0	AGR-K	PN	
			7.02604.99.0	LS	400 mm	
120 Multijet 2,3 D 4x4 88 kW (120 PS) F1AE0481D	03.2010→		7.09002.00.0	AGR	PN	
			7.11190.03.0	DDS		ohne Zubehör without accessories für OE-Nummer: 51908411 for OE number: 51908411
			7.02604.99.0	LS	400 mm	
130 Multijet 2,3 D 96 kW (131 PS) F1AE0481N	07.2006→		7.09002.00.0	AGR	PN	→715776
			7.02604.99.0	LS	400 mm	→12.2014 Motorcode: 1FAE0481N Engine Code: 1FAE0481N Produktionsdatum ab: 07.2006 Production date from: 07.2006 Produktionsdatum bis: 12.2014 Production date to: 12.2014
130 Multijet 2,3 D 96 kW (131 PS) F1AE3481D, F1AGL411D	07.2006→		7.09002.00.0	AGR	PN	F1AE3481D, F1AGL411D: →715776
			7.05052.03.0	AGR-K		
			7.24809.86.0	AGR	EL	F1AE3481D, F1AGL411D: 09.2017→
140 Multijet 2,3 D 103 kW (140 PS) F1AGL4113	05.2019→		7.11190.03.0	DDS		ohne Zubehör without accessories Euro 6d Euro 6d





























F



DUCATO Platform/Chassis (250_)

63

140 Natural Power 100 kW (136 PS) F1CE0441A, F1CFA401A	04.2009→	 	7.11190.03.0 DDS		ohne Zubehör without accessories  F1CE0441A, F1CFA401A: für OE-Nummer: 51908411 for OE number: 51908411
			7.02604.53.0 LS	400 mm	
140 Natural Power 100 kW (136 PS) F1CFA401C	05.2019→		7.02604.53.0 LS	400 mm	
150 Multijet 2,3 D 109-110 kW (148-150 PS) F1AE3481E	06.2011→	 ↳ 7.24809.86.0	7.05052.03.0 AGR-K		 09.2017→
			7.11190.03.0 AGR DDS	EL	ohne Zubehör without accessories für OE-Nummer: 51908411 for OE number: 51908411
150 Multijet 2,3 D 110 kW (150 PS) F1AGL411C	12.2015→	 ↳ 7.24809.86.0	7.05052.03.0 AGR-K		 09.2017→
			7.11190.03.0 AGR DDS	EL	ohne Zubehör without accessories für OE-Nummer: 51908411 for OE number: 51908411
150 Multijet 3,0 D 103-107 kW (140-145 PS) F1CE3481N	04.2010→		7.08369.98.0 ATS	EL	nach Rußpartikelfilter after soot particulate filter
			7.08369.99.0 ATS 7.11190.03.0 DDS	EL	ohne Zubehör without accessories für OE-Nummer: 51908411 for OE number: 51908411
			7.02604.99.0 LS	400 mm	
160 Multijet 2,3 D 118 kW (160 PS) F1AGL4112	05.2019→		7.11190.03.0 DDS		ohne Zubehör without accessories Euro 6d Euro 6d
160 Multijet 3,0 D 115-116 kW (156-158 PS) F1CE0481D	07.2006→		7.24809.51.0 AGR	PN	
			7.08369.98.0 ATS	EL	nach Rußpartikelfilter after soot particulate filter
			7.08369.99.0 ATS 7.11190.03.0 DDS	EL	ohne Zubehör without accessories für OE-Nummer: 51908411 for OE number: 51908411
			7.02604.99.0 LS	400 mm	
160 Multijet 3,0 D 115 kW (156 PS) F1CE3481M	07.2006→12.2011		7.08369.98.0 ATS	EL	nach Rußpartikelfilter after soot particulate filter
			7.08369.99.0 ATS 7.02604.99.0 LS	EL	
				400 mm	
180 Multijet 2,3 D 130 kW (177 PS) F1AGL4111, F1AGL411B	12.2015→		7.11190.03.0 DDS		ohne Zubehör without accessories  F1AGL4111, F1AGL411B: für OE-Nummer: 51908411 for OE number: 51908411
180 Multijet 3,0 D 130 kW (177 PS) F1CE3481E	06.2011→		7.08369.98.0 ATS	EL	nach Rußpartikelfilter after soot particulate filter





















						
DUCATO Platform/Chassis (250_)					63	
			7.08369.99.0	ATS	EL	ohne Zubehör without accessories für OE-Nummer: 51908411 for OE number: 51908411
			7.11190.03.0	DDS		
			7.02604.99.0	LS	400 mm	
DUCATO Van (230_)					64	
2.8 D 64 kW (87 PS) 8140.63	05.1998→04.2002		7.24809.53.0	AGR	PN	
2.8 D 4x4 64 kW (87 PS) 8140.63	08.1998→04.2002		7.24809.53.0	AGR	PN	
DUCATO Van (244_)					65	
2.0 JTD 62 kW (84 PS) RHV	04.2002→		7.11237.04.0	AGR	PN	→06.2006
DUCATO Van (250_)					66	
100 Multijet 2,2 D 74 kW (101 PS) 4HV	07.2006→		7.24809.70.0	AGR	EL	
110 Multijet 2,3 D 82-83 kW (111-113 PS) F1AE3481G	10.2011→		7.09002.00.0	AGR	PN	
			7.24809.86.0 7.11190.03.0	AGR DDS	EL	ohne Zubehör without accessories für OE-Nummer: 51908411 for OE number: 51908411
110 Multijet 2,3 D 82-83 kW (111-113 PS) F1AE3481G	05.2014→		7.24809.86.0	AGR	EL	ohne Zubehör without accessories für OE-Nummer: 51908411 for OE number: 51908411
			7.11190.03.0	DDS		
115 Multijet 2,0 D 85 kW (116 PS) 250 A1.000, 250 A2.000	06.2011→		7.24809.77.0	AGR	ET	
			7.11020.15.0	ATS	EL	 250 A1.000, 250 A2.000: Euro 5 Produktionsdatum bis: 05.06.2016 Production date to: 05.06.2016
			7.11190.03.0	DDS		ohne Zubehör without accessories  250 A1.000, 250 A2.000: für OE-Nummer: 51908411 for OE number: 51908411
120 Multijet 2,3 D 88 kW (120 PS) F1AE0481D	07.2006→		7.09002.00.0	AGR	PN	
			7.09720.05.0	AGR-K	PN	
			7.02604.99.0	LS	400 mm	→12.2014 Motorcode: F1AE0481D Engine Code: F1AE0481D Produktionsdatum ab: 07.2006 Production date from: 07.2006 Produktionsdatum bis: 12.2014 Production date to: 12.2014
120 Multijet 2,3 D 88 kW (120 PS) F1AGL4114	07.2006→		7.09720.05.0	AGR-K	PN	
120 Multijet 2,3 D 4x4 88 kW (120 PS) F1AE0481D	03.2010→		7.09002.00.0	AGR	PN	
			7.09720.05.0	AGR-K	PN	

F











DUCATO Van (250_) **66**

F

			7.11190.03.0	DDS		ohne Zubehör without accessories für OE-Nummer: 51908411 for OE number: 51908411
			7.02604.99.0	LS	400 mm	
130 Multijet 2,3 D 96 kW (131 PS) F1AE0481N	06.2011→		7.09002.00.0	AGR	PN	 →715776
			7.11190.03.0	DDS		ohne Zubehör without accessories für OE-Nummer: 51908411 for OE number: 51908411
			7.02604.99.0	LS	400 mm	→12.2014 Motorcode: F1AE0481N Engine Code: F1AE0481N Produktionsdatum ab: 06.2011 Production date from: 06.2011 Produktionsdatum bis: 12.2014 Production date to: 12.2014
130 Multijet 2,3 D 96 kW (131 PS) F1AE3481D, F1AGL411D	06.2011→		7.09002.00.0	AGR	PN	 F1AE3481D, F1AGL411D: →715776
			7.05052.03.0	AGR-K		
			↳ 7.24809.86.0	AGR	EL	 F1AE3481D, F1AGL411D: 09.2017→
			7.11190.03.0	DDS		ohne Zubehör without accessories  F1AE3481D, F1AGL411D: für OE-Nummer: 51908411 for OE number: 51908411
130 Multijet 2,3 D 4x4 96 kW (131 PS) F1AE0481N	06.2011→		7.09002.00.0	AGR	PN	 →715776
			7.11190.03.0	DDS		ohne Zubehör without accessories für OE-Nummer: 51908411 for OE number: 51908411
130 Multijet 2,3 D 4x4 96 kW (131 PS) F1AE3481D, F1AGL411D	06.2011→		7.09002.00.0	AGR	PN	 F1AE3481D, F1AGL411D: →715776
			7.05052.03.0	AGR-K		
			↳ 7.24809.86.0	AGR	EL	 F1AE3481D: 09.2017→  F1AGL411D:  ch. 09.2017→
			7.11190.03.0	DDS		ohne Zubehör without accessories  F1AE3481D, F1AGL411D: für OE-Nummer: 51908411 for OE number: 51908411
140 Multijet 2,3 D 103 kW (140 PS) F1AGL4113	05.2019→		7.11190.03.0	DDS		ohne Zubehör without accessories Euro 6d Euro 6d
140 Natural Power 100 kW (136 PS) F1CE0441A, F1CFA401A	04.2009→		7.11190.03.0	DDS		ohne Zubehör without accessories  F1CE0441A, F1CFA401A: für OE-Nummer: 51908411 for OE number: 51908411
150 Multijet 2,3 D 109-110 kW (148-150 PS) F1AE3481E	06.2011→		7.05052.03.0	AGR-K		 09.2017→
			↳ 7.24809.86.0	AGR	EL	







DUCATO Van (250_) **66**

			7.11190.03.0	DDS		ohne Zubehör without accessories für OE-Nummer: 51908411 for OE number: 51908411
150 Multijet 2,3 D 110 kW (150 PS) F1AGL411A	12.2015→		7.24809.86.0	AGR	EL	ohne Zubehör without accessories für OE-Nummer: 51908411 for OE number: 51908411
			7.11190.03.0	DDS		
150 Multijet 2,3 D 110 kW (150 PS) F1AGL411C	12.2015→		7.05052.03.0	AGR-K		⊙ 09.2017→
			↳ 7.24809.86.0	AGR	EL	ohne Zubehör without accessories für OE-Nummer: 51908411 for OE number: 51908411
			7.11190.03.0	DDS		
150 Multijet 2,3 D 4x4 110 kW (150 PS) F1AGL411A	04.2015→		7.24809.86.0	AGR	EL	ohne Zubehör without accessories für OE-Nummer: 51908411 for OE number: 51908411
			7.11190.03.0	DDS		
150 Multijet 2,3 D 4x4 110 kW (150 PS) F1AGL411C	04.2015→		7.05052.03.0	AGR-K		⊙ 09.2017→
			↳ 7.24809.86.0	AGR	EL	ohne Zubehör without accessories für OE-Nummer: 51908411 for OE number: 51908411
			7.11190.03.0	DDS		
150 Multijet 3,0 D 103-107 kW (140-145 PS) F1CE3481N	04.2010→		7.08369.98.0	ATS	EL	nach Rußpartikelfilter after soot particulate filter
			7.08369.99.0	ATS	EL	ohne Zubehör without accessories für OE-Nummer: 51908411 for OE number: 51908411
			7.11190.03.0	DDS		
			7.02604.99.0	LS	400 mm	
160 Multijet 2,3 D 118 kW (160 PS) F1AGL4112	05.2019→		7.11190.03.0	DDS		ohne Zubehör without accessories Euro 6d Euro 6d
160 Multijet 3,0 D 115-116 kW (156-158 PS) F1CE0481D	07.2006→		7.24809.51.0	AGR	PN	⊙
			7.08369.98.0	ATS	EL	nach Rußpartikelfilter after soot particulate filter
			7.08369.99.0	ATS	EL	ohne Zubehör without accessories für OE-Nummer: 51908411 for OE number: 51908411
			7.11190.03.0	DDS		
			7.02604.99.0	LS	400 mm	
160 Multijet 3,0 D 115 kW (156 PS) F1CE3481M	07.2006→12.2011		7.08369.98.0	ATS	EL	nach Rußpartikelfilter after soot particulate filter
			7.08369.99.0	ATS	EL	
			7.02604.99.0	LS	400 mm	



F



DUCATO Van (250_) **66**

F	160 Multijet 3,0 D 4x4 115-116 kW (156-158 PS) F1CE0481D	07.2006→		7.24809.51.0	AGR	PN	
				7.08369.98.0	ATS	EL	nach Rußpartikelfilter after soot particulate filter
				7.08369.99.0	ATS	EL	
				7.11190.03.0	DDS		ohne Zubehör without accessories für OE-Nummer: 51908411 for OE number: 51908411
160 Multijet 3,0 D 4x4 115 kW (156 PS) F1CE3481M	07.2006→		7.08369.98.0	ATS	EL	nach Rußpartikelfilter after soot particulate filter	
			7.08369.99.0	ATS	EL		
			7.11190.03.0	DDS		ohne Zubehör without accessories für OE-Nummer: 51908411 for OE number: 51908411	
180 Multijet 2,3 D 130 kW (177 PS) F1AGL4111, F1AGL411B	12.2015→		7.11190.03.0	DDS		ohne Zubehör without accessories  F1AGL4111, F1AGL411B: für OE-Nummer: 51908411 for OE number: 51908411	
			7.08369.98.0	ATS	EL	nach Rußpartikelfilter after soot particulate filter	
180 Multijet 3,0 D 130 kW (177 PS) F1CE3481E	06.2011→		7.08369.98.0	ATS	EL	nach Rußpartikelfilter after soot particulate filter	
			7.08369.99.0	ATS	EL		
			7.11190.03.0	DDS		ohne Zubehör without accessories für OE-Nummer: 51908411 for OE number: 51908411	
			7.02604.99.0	LS	400 mm		

FIORINO Box Body/MPV (225_) **67**

1.3 D Multijet (225BXD1A, 225BXB1A, 225BXB11) 55-68 kW (75-93 PS) 199 A2.000, 199 A9.000	11.2007→		7.00020.24.0	AGR	EL	
			7.00020.25.0	AGR	EL	 199 A2.000, 199 A9.000: Schaltgetriebe, automatisch betätigt Manual Transmission, automatically operated Euro 5 Euro 5
			7.01599.10.0	AGR	EL	 199 A2.000, 199 A9.000: Produktionsdatum bis: 2015 Production date to: 2015
			7.03622.06.0	AGR-K		
			7.11020.36.0	ATS	EL	 199 A2.000, 199 A9.000: Euro 5 Euro 5 Produktionsdatum ab: 01.08.2011 Production date from: 01.08.2011
			7.11190.03.0	DDS		ohne Zubehör without accessories  199 A2.000, 199 A9.000: Euro 5, Euro 6, Euro 6d Euro 5, Euro 6, Euro 6d
			7.11190.04.0	DDS		 199 A2.000, 199 A9.000: für OE-Nummer: 51792301 for OE number: 51792301
1.3 D Multijet (225BXE1A) 64-70 kW (87-95 PS) 199 B1.000	07.2009→		7.01599.10.0	AGR	EL	

FIORINO Box Body/MPV (225_) **67**

			7.03622.06.0 AGR-K 7.11020.36.0 ATS 7.11190.03.0 DDS	<input type="radio"/> EL Euro 5 Euro 5 Produktionsdatum ab: 01.08.2011 Production date from: 01.08.2011 ohne Zubehör without accessories Euro 5, Euro 6, Euro 6d Euro 5, Euro 6, Euro 6d
1.3 D Multijet (225BXE1A) 70 kW (95 PS) 330 A1.000	07.2009→		7.04589.06.0 AGR 7.01599.10.0 AGR 7.07969.06.0 AGR-K 7.03622.06.0 AGR-K 7.11020.36.0 ATS 7.11190.03.0 DDS	<input type="radio"/> EL 12.2017→ Euro 6 Euro 6 <input type="radio"/> EL <input type="radio"/> EL 05.2019→ Euro 6d Euro 6d <input type="radio"/> EL Euro 5 Euro 5 Produktionsdatum ab: 01.08.2011 Production date from: 01.08.2011 ohne Zubehör without accessories Euro 5, Euro 6, Euro 6d Euro 5, Euro 6, Euro 6d
1.3 D Multijet (225CXG1A, 225AXL1A, 225AXG11, 225BXL1A,... 59 kW (80 PS)) 225 A2.000	03.2015→		7.04589.06.0 AGR 7.01599.10.0 AGR 7.07969.06.0 AGR-K 7.03622.10.0 AGR-K 7.11020.36.0 ATS 7.11190.03.0 DDS	<input type="radio"/> EL 12.2017→ Euro 6 Euro 6 <input type="radio"/> EL <input type="radio"/> EL 05.2019→ Euro 6d Euro 6d <input type="radio"/> EL Euro 5 Euro 5 ohne Zubehör without accessories Euro 5, Euro 6, Euro 6d Euro 5, Euro 6, Euro 6d
1.3 D Multijet (225CXG1A, 225AXL1A, 225AXG11, 225BXL1A,... 59-70 kW (80-95 PS)) 552 83 775	03.2015→		7.03622.10.0 AGR-K 7.11020.36.0 ATS	<input type="radio"/> EL EL Euro 5 Euro 5

F
GRANDE PUNTO Van (199_) **68**







1.3 JTD Multijet (199CXC1A) 55-68 kW (75-93 PS) 199 A2.000	02.2006→06.2013		7.00020.24.0 AGR 7.01599.10.0 AGR 7.03622.06.0 AGR-K 7.11020.04.0 ATS	<input type="radio"/> EL <input type="radio"/> EL <input type="radio"/> EL Euro 5 Euro 5 2009 2009 2013 2013
---	-----------------	--	--	--



GRANDE PUNTO Van (199_)

68

F

			7.11020.08.0	ATS	EL	 199 A2.000: vor Katalysator in front of the catalyst Euro 4 Euro 4 für Fahrzeuge mit Diesel-Partikel-Filter (DPF) for vehicles with diesel soot filter 2013 2013  199 A2.000: vor Rußpartikelfilter before soot particulate filter Euro 4 Euro 4 2009 2009 ohne Zubehör without accessories Euro 5 Euro 5 2009 2009 2013 2013 Euro 4 Euro 4 2009 2009
			7.11190.03.0	DDS		ohne Zubehör without accessories Euro 5 Euro 5 2009 2009 2013 2013
			7.11190.04.0	DDS		Euro 4 Euro 4 2009 2009
1.3 JTD Multijet (199CXD1B) 63-70 kW (86-95 PS) 199 A3.000	02.2006→08.2010		7.01599.10.0	AGR	EL	
			7.11020.04.0	ATS	EL	
			7.11020.08.0	ATS	EL	 199 A3.000: vor Katalysator in front of the catalyst Euro 4 Euro 4 für Fahrzeuge mit Diesel-Partikel-Filter (DPF) for vehicles with diesel soot filter 2013 2013  199 A3.000: vor Rußpartikelfilter before soot particulate filter Euro 4 Euro 4 2009 2009 Euro 4 Euro 4
			7.11190.04.0	DDS		Euro 4 Euro 4



PANDA Hatchback Van (141_)

69

1.1 37-43 kW (50-58 PS) 156 C.046	05.1991→03.1995		7.02604.47.0	LS	300 mm	
			7.02604.04.0	LS	200 mm	
1.1 40-42 kW (54-57 PS) 187 A1.000	09.2000→02.2004		7.02604.47.0	LS	300 mm	Regelsonde Regulating Probe
			7.02604.04.0	LS	200 mm	
1000 i.e 33-40 kW (45-54 PS) 156 A2.246	08.1992→02.2004		7.02604.04.0	LS	200 mm	

PANDA Hatchback Van (169_)

70





1.1 (169CXA1A) 40-42 kW (54-57 PS) 187 A1.000	09.2004→		7.02604.47.0	LS	300 mm	
1.2 38-44 kW (52-60 PS) 188 A4.000	09.2004→		7.02604.53.0	LS	400 mm	

PANDA Hatchback Van (169_)					70
1.2 51 kW (69 PS) 169 A4.000	09.2010→		7.02604.53.0	LS	400 mm
1.2 4x4 38-44 kW (52-60 PS) 188 A4.000	09.2004→		7.02604.53.0	LS	400 mm
1.2 4x4 51 kW (69 PS) 169 A4.000	09.2010→		7.02604.53.0	LS	400 mm
1.2 LPG 38-44 kW (52-60 PS) 188 A4.000	04.2009→		7.02604.53.0	LS	400 mm
1.2 Natural Power 38-44 kW (52-60 PS) 188 A4.000	01.2007→11.2009		7.02604.53.0	LS	400 mm
1.3 D Multijet 51 kW (70 PS) 188 A8.000	03.2004→		7.00020.39.0	AGR	EL →12.2010 3320805→ Euro 4 (D4) Euro 4 (D4)
1.3 D Multijet 55 kW (75 PS) 169 A1.000	01.2006→		7.00020.39.0	AGR	EL →12.2010 3320805→ Euro 4 (D4) Euro 4 (D4)
			7.00020.24.0	AGR	EL
			7.01599.10.0	AGR	EL Produktionsdatum ab: 2011 Production date from: 2011
			7.03622.06.0	AGR-K	
			7.08369.35.0	ATS	EL
			7.11020.37.0	ATS	EL 2010 2010
			7.11190.04.0	DDS	Euro 4 Euro 4 2010 2010
1.3 D Multijet 4x4 51 kW (70 PS) 188 A8.000	10.2004→12.2006		7.00020.24.0	AGR	EL
			7.00020.39.0	AGR	EL 3320805→ Euro 4 (D4) Euro 4 (D4)
1.3 D Multijet 4x4 55 kW (75 PS) 169 A1.000	01.2006→		7.00020.39.0	AGR	EL →12.2010 3320805→ Euro 4 (D4) Euro 4 (D4)
			7.00020.24.0	AGR	EL
			7.01599.10.0	AGR	EL Produktionsdatum ab: 2011 Production date from: 2011
			7.03622.06.0	AGR-K	
			7.08369.35.0	ATS	EL
			7.11020.37.0	ATS	EL 2010 2010
			7.11190.04.0	DDS	Euro 4 Euro 4 2010 2010
1.4 Natural Power 51-63 kW (69-86 PS) 350 A1.000	10.2009→		7.02604.53.0	LS	400 mm



F





PANDA VAN (312_, 519_) 71

1.3 D Multijet (312CXL1A, 312DXL1A) 55-59 kW (75-80 PS) 199 A9.000	02.2012→		7.01599.10.0	AGR	EL	<input type="checkbox"/> Produktionsdatum bis: 2015 Production date to: 2015
			7.03622.06.0	AGR-K		
			7.11020.37.0	ATS	EL	Euro 5 Euro 5
1.3 D Multijet (312PXS2A) 59 kW (80 PS) 225 A2.000, 312 B2.000	12.2015→		7.01599.10.0	AGR	EL	<input type="checkbox"/>
			7.03622.10.0	AGR-K	EL	<input type="checkbox"/>
			7.03622.06.0	AGR-K		<input type="checkbox"/>
1.3 D Multijet (312PXS2A) 59 kW (80 PS) 312 A8.000	12.2015→		7.03622.10.0	AGR-K	EL	<input type="checkbox"/>
			7.03622.06.0	AGR-K		<input type="checkbox"/>
1.3 D Multijet 4x4 (312CXL2A) 55-59 kW (75-80 PS) 199 A9.000	06.2012→		7.01599.10.0	AGR	EL	<input type="checkbox"/>
			7.11020.37.0	ATS	EL	Euro 5 Euro 5
1.3 D Multijet 4x4 (312PXS2A) 59 kW (80 PS) 225 A2.000	06.2014→		7.01599.10.0	AGR	EL	<input type="checkbox"/>

PUNTO EVO Hatchback Van (199_) 72

1.3 D Multijet (199.AXT1A, 199.AXC1A) 55-68 kW (75-93 PS) 199 A2.000, 199 A9.000	03.2009→02.2012		7.00020.24.0	AGR	EL	<input type="checkbox"/>
			7.01599.10.0	AGR	EL	<input type="checkbox"/>
			7.03622.06.0	AGR-K		<input type="checkbox"/>
			7.11020.04.0	ATS	EL	<input type="checkbox"/>
			7.01599.10.0	AGR	EL	<input type="checkbox"/>
1.3 D Multijet (199.AXU1A) 64-70 kW (87-95 PS) 199 B1.000	03.2009→02.2012		7.03622.06.0	AGR-K		<input type="checkbox"/>
			7.11020.04.0	ATS	EL	<input type="checkbox"/>
1.3 D Multijet (199CXD1B, 199CXD1A) 63-70 kW (86-95 PS) 199 A3.000	03.2009→02.2012		7.01599.10.0	AGR	EL	<input type="checkbox"/>
			7.11020.04.0	ATS	EL	<input type="checkbox"/>









PUNTO Hatchback Van (188_) 73

1.2 60 38-44 kW (52-60 PS) 188 A4.000	02.2000→10.2009		7.02604.49.0	LS	985 mm	
1.3 JTD 51-66 kW (70-90 PS) 188 A9.000	06.2003→10.2005		7.00020.24.0	AGR	EL	<input type="checkbox"/>
1.9 JTD 63 kW (86 PS) 188 A7.000	02.2000→10.2009		7.22946.33.0	AGR	EL	<input type="checkbox"/> 10.2001→06.2003
			7.22946.34.0	AGR	EL	<input type="checkbox"/> 10.2001→06.2003







PUNTO Hatchback Van (199_) 74

1.3 D Multijet 55-68 kW (75-93 PS) 199 A2.000, 199 A9.000	04.2008→		7.00020.24.0	AGR	EL	<input type="checkbox"/>
			7.01599.10.0	AGR	EL	<input type="checkbox"/>
			7.03622.06.0	AGR-K		<input type="checkbox"/>







PUNTO Hatchback Van (199_) 74

			7.11020.04.0	ATS	EL	 199 A2.000, 199 A9.000: Euro 5 Euro 5 2012 2012 2017 2017
1.3 D Multijet 64-70 kW (87-95 PS) 199 B1.000	03.2009→		7.01599.10.0	AGR	EL	
			7.03622.06.0	AGR-K		
			7.11020.04.0	ATS	EL	Euro 5 Euro 5 2012 2012 2017 2017
1.3 D Multijet 62 kW (84 PS) 199 B4.000	03.2012→		7.01599.10.0	AGR	EL	
			7.03622.06.0	AGR-K		
			7.11020.04.0	ATS	EL	Euro 5 Euro 5 2017 2017
			7.11190.03.0	DDS		ohne Zubehör without accessories Euro 5 Euro 5

F
SCUDO Bus (220_) 75

2.0 JTD 80 kW (109 PS) RHZ	12.1999→12.2006		7.22843.06.0	AGR	PN	
2.0 JTD 69 kW (94 PS) RHX	01.2004→12.2006		7.22843.06.0	AGR	PN	
2.0 JTD 16V 80 kW (109 PS) RHW (DW10ATED4)	05.1999→12.2006		7.28069.03.0	AGR	PN	 für Fahrzeuge ohne Diesel-Partikel-Filter (DPF) for vehicles without diesel soot filter

SCUDO Bus (270_, 272_) 76

















1.6 D Multijet 66 kW (90 PS) 9HU	01.2007→		7.24809.39.0	AGR	EL	 Euro 4 (D4) Euro 4 (D4)
			7.02156.24.0	AGR-K	EL	mit Sensor with sensor
			7.02156.33.0	AGR-K		 mit Sensor with sensor ohne AGR-Ventil without EGR valve
			7.11492.01.0	DDS		ohne Zubehör without accessories Euro 5 Euro 5
1.6 D Multijet 66 kW (90 PS) 9H07 (DV6UC), 9HM (DV6UC)	02.2011→		7.02209.11.0	AGR	EL	
			7.02156.24.0	AGR-K	EL	mit Sensor with sensor
			7.02156.35.0	AGR-K	EL	ohne Sensor without sensor  9H07 (DV6UC), 9HM (DV6UC): mit AGR-Ventil with EGR valve



SCUDO Bus (270_, 272_)

76

F

			7.02156.33.0	AGR-K		mit Sensor with sensor  9H07 (DV6UC), 9HM (DV6UC): ohne AGR-Ventil without EGR valve
			7.02156.34.0	AGR-K		ohne Sensor without sensor  9H07 (DV6UC), 9HM (DV6UC): ohne AGR-Ventil without EGR valve
			7.11492.01.0	DDS		ohne Zubehör without accessories  9H07 (DV6UC), 9HM (DV6UC): Euro 5 Euro 5
			7.05270.21.0	LS	600 mm	
2.0 D Multijet 88 kW (120 PS) RHK	01.2007→		7.24809.68.0	AGR	EL	
			7.11492.01.0	DDS		ohne Zubehör without accessories Euro 4 Euro 4
2.0 D Multijet 100 kW (136 PS) RHR	01.2007→		7.24809.68.0	AGR	EL	
2.0 D Multijet 94-120 kW (128-163 PS) RH02, RHH	07.2010→		7.24809.94.0	AGR-K	EL	 RH02, RHH: 01.2012→ Organisationsnummer ab: 12853 RPO number from: 12853
			7.11492.01.0	DDS		ohne Zubehör without accessories
			7.05270.21.0	LS	600 mm	
2.0 D Multijet 94-120 kW (128-163 PS) RH02	04.2011→		7.24809.94.0	AGR-K	EL	 01.2012→ Organisationsnummer ab: 12853 RPO number from: 12853
			7.11492.01.0	DDS		ohne Zubehör without accessories Euro 5 Euro 5
			7.05270.21.0	LS	600 mm	vor Katalysator in front of the catalyst
2.0 D Multijet 4x4 88 kW (120 PS) RHK	01.2007→		7.24809.68.0	AGR	EL	
			7.11492.01.0	DDS		ohne Zubehör without accessories Euro 4 Euro 4
2.0 D Multijet 4x4 100 kW (136 PS) RHR	01.2007→		7.24809.68.0	AGR	EL	
2.0 D Multijet 4x4 94-120 kW (128-163 PS) RH02	04.2011→		7.24809.94.0	AGR-K	EL	 01.2012→ Organisationsnummer ab: 12853 RPO number from: 12853
			7.11492.01.0	DDS		ohne Zubehör without accessories Euro 5 Euro 5

SCUDO Platform/Chassis (220_)

77

2.0 JTD 69 kW (94 PS) RHX	10.1999→12.2006		7.22843.06.0	AGR	PN	
------------------------------	-----------------	---	--------------	-----	----	--

















SCUDO Platform/Chassis (220_)						77
2.0 JTD 80 kW (109 PS) RHZ	12.2002→12.2006		7.22843.06.0	AGR	PN	
2.0 JTD 16V 80 kW (109 PS) RHW (DW10ATED4)	05.1999→12.2006		7.28069.03.0	AGR	PN für Fahrzeuge ohne Diesel-Partikel-Filter (DPF) for vehicles without diesel soot filter	
SCUDO Platform/Chassis (270_, 272_)						78
1.6 D Multijet 66 kW (90 PS) 9HU	01.2007→		7.24809.39.0	AGR	EL Euro 4 (D4) Euro 4 (D4)	
			7.02156.24.0	AGR-K	EL mit Sensor with sensor	
			7.02156.33.0	AGR-K	 mit Sensor with sensor ohne AGR-Ventil without EGR valve	
2.0 D Multijet 88 kW (120 PS) RHK	01.2007→		7.24809.68.0	AGR	EL	
2.0 D Multijet 100 kW (136 PS) DW10BTED4, RHR	01.2007→		7.24809.68.0	AGR	EL	
2.0 D Multijet 94-120 kW (128-163 PS) RH02, RHH	07.2010→		7.24809.94.0	AGR-K	EL RH02, RHH: 01.2012→ Organisationsnummer ab: 12853 RPO number from: 12853	
			7.05270.21.0	LS	600 mm	
2.0 D Multijet 94-120 kW (128-163 PS) RH02	05.2011→		7.24809.94.0	AGR-K	EL 01.2012→ Organisationsnummer ab: 12853 RPO number from: 12853	
			7.05270.21.0	LS	600 mm vor Katalysator in front of the catalyst Euro 5 Euro 5	
SCUDO Van (220_)						79
2.0 JTD 69 kW (94 PS) RHX	10.1999→12.2006		7.22843.06.0	AGR	PN	
2.0 JTD 80 kW (109 PS) RHZ	12.2002→12.2006		7.22843.06.0	AGR	PN	
2.0 JTD 16V 80 kW (109 PS) RHW (DW10ATED4)	05.1999→12.2006		7.28069.03.0	AGR	PN für Fahrzeuge ohne Diesel-Partikel-Filter (DPF) for vehicles without diesel soot filter	
SCUDO Van (270_, 272_)						80
1.6 D Multijet 66 kW (90 PS) 9HU	01.2007→		7.24809.39.0	AGR	EL Euro 4 (D4) Euro 4 (D4)	
			7.02156.24.0	AGR-K	EL mit Sensor with sensor	
			7.02156.33.0	AGR-K	 mit Sensor with sensor ohne AGR-Ventil without EGR valve	
1.6 D Multijet 66 kW (90 PS) 9H07 (DV6UC), 9HM (DV6UC)	02.2011→		7.02209.11.0	AGR	EL	
			7.02156.24.0	AGR-K	EL mit Sensor with sensor 	

F



SCUDO Van (270_, 272_)

80

			7.02156.35.0	AGR-K	EL	ohne Sensor without sensor  9H07 (DV6UC), 9HM (DV6UC): mit AGR-Ventil with EGR valve
			7.02156.33.0	AGR-K		mit Sensor with sensor  9H07 (DV6UC), 9HM (DV6UC): ohne AGR-Ventil without EGR valve
			7.02156.34.0	AGR-K		ohne Sensor without sensor  9H07 (DV6UC), 9HM (DV6UC): ohne AGR-Ventil without EGR valve
			7.05270.21.0	LS	600 mm	
2.0 D Multijet 88 kW (120 PS) RHK	01.2007→		7.24809.68.0	AGR	EL	
2.0 D Multijet 100 kW (136 PS) RHR	01.2007→		7.24809.68.0	AGR	EL	
2.0 D Multijet 94-120 kW (128-163 PS) RH02, RHH	07.2010→		7.24809.94.0	AGR-K	EL	 RH02, RHH: 01.2012→ Organisationsnummer ab: 12853 RPO number from: 12853
			7.05270.21.0	LS	600 mm	
2.0 D Multijet 94-120 kW (128-163 PS) RH02	05.2011→		7.24809.94.0	AGR-K	EL	 01.2012→ Organisationsnummer ab: 12853 RPO number from: 12853
			7.05270.21.0	LS	600 mm	vor Katalysator in front of the catalyst
2.0 D Multijet 4x4 88 kW (120 PS) RHK	01.2007→		7.24809.68.0	AGR	EL	
2.0 D Multijet 4x4 100 kW (136 PS) RHR	01.2007→		7.24809.68.0	AGR	EL	
2.0 D Multijet 4x4 94-120 kW (128-163 PS) RH02	05.2011→		7.24809.94.0	AGR-K	EL	 01.2012→ Organisationsnummer ab: 12853 RPO number from: 12853
			7.05270.21.0	LS	600 mm	vor Katalysator in front of the catalyst Euro 5 Euro 5



SEICENTO / 600 Hatchback Van (287_)

81

1.1 (187CXB/C) 40 kW (54 PS) 176 B2.000	01.1998→01.2010		7.02604.47.0	LS	300 mm	
--	-----------------	---	---------------------	----	-----------	--



STILO VAN (192_)















82

1.9 JTD (192DXS1A) 88 kW (120 PS) 192 A8.000	09.2005→08.2008		7.11190.04.0	DDS		Euro 4 Euro 4
1.9 JTD (192DXT1B) 110 kW (150 PS) 937 A5.000	09.2005→08.2008		7.11190.04.0	DDS		Euro 4 Euro 4

TALENTO Bus (296_)

83













1.6 D 70-89 kW (95-121 PS) R9M 413	06.2016→		7.11457.07.0*	DDS		ab Euro 6 From Euro 6
			↳ 7.11492.07.0	DDS		
1.6 D 92-107 kW (125-145 PS) R9M 452	06.2016→		7.11457.07.0*	DDS		ab Euro 6 From Euro 6
			↳ 7.11492.07.0	DDS		

					
TALENTO Bus (296_)					
83					
1.6 D 92-107 kW (125-145 PS) R9M 452	06.2016→		7.11457.07.0* ↳ 7.11492.07.0	DDS DDS	ab Euro 6 From Euro 6
TALENTO Platform/Chassis (296_)					
84					
1.6 D 92-107 kW (125-145 PS) R9M 452	06.2016→		7.11457.07.0* ↳ 7.11492.07.0	DDS DDS	ab Euro 6 From Euro 6
1.6 D 92-107 kW (125-145 PS) R9M 452	06.2016→		7.11457.07.0* ↳ 7.11492.07.0	DDS DDS	ab Euro 6 From Euro 6
1.6 D 70-89 kW (95-121 PS) R9M 413	06.2016→		7.11457.07.0* ↳ 7.11492.07.0	DDS DDS	ab Euro 6 From Euro 6
TALENTO Van (296_)					
85					
1.6 D 70-89 kW (95-121 PS) R9M 413	06.2016→		7.11457.07.0* ↳ 7.11492.07.0	DDS DDS	ab Euro 6 From Euro 6
1.6 D 70-89 kW (95-121 PS) R9M 413	06.2016→		7.11457.07.0* ↳ 7.11492.07.0	DDS DDS	ab Euro 6 From Euro 6
1.6 D 92-107 kW (125-145 PS) R9M 452	06.2016→		7.11457.07.0* ↳ 7.11492.07.0	DDS DDS	ab Euro 6 From Euro 6
1.6 D 92-107 kW (125-145 PS) R9M 452	06.2016→		7.11457.07.0* ↳ 7.11492.07.0	DDS DDS	ab Euro 6 From Euro 6









F















































B-MAX (JK) **1**

1.5 TDCi 55 kW (75 PS) UGJC	10.2012→		7.02209.11.0	AGR	EL	
			7.02156.35.0	AGR-K	EL	ohne Sensor without sensor
			7.02156.33.0	AGR-K		mit AGR-Ventil with EGR valve
			7.02156.34.0	AGR-K		mit Sensor with sensor
1.5 TDCi 55 kW (75 PS) UGJG, XUJA, XUJB	10.2012→		7.02156.35.0	AGR-K	EL	ohne Sensor without sensor  UGJG, XUJA, XUJB: mit AGR-Ventil with EGR valve
			7.02156.33.0	AGR-K		mit Sensor with sensor
			7.02156.34.0	AGR-K		ohne Sensor without sensor
1.5 TDCi 70 kW (95 PS) XVJA, XVJC	04.2015→		7.02209.20.0	AGR	EL	
			7.02156.35.0	AGR-K	EL	ohne Sensor without sensor  XVJA, XVJC: mit AGR-Ventil with EGR valve
			7.02156.33.0	AGR-K		mit Sensor with sensor
			7.02156.34.0	AGR-K		ohne Sensor without sensor  XVJA, XVJC: ohne AGR-Ventil without EGR valve
			7.04512.08.0	AGR-K		
1.6 TDCi 70 kW (95 PS) T3JB	10.2012→		7.02209.11.0	AGR	EL	
			7.02156.24.0	AGR-K	EL	mit Sensor with sensor
			7.02156.35.0	AGR-K	EL	
			7.02156.33.0	AGR-K		ohne Sensor without sensor mit AGR-Ventil with EGR valve
			7.02156.34.0	AGR-K		mit Sensor with sensor ohne Sensor without sensor ohne AGR-Ventil without EGR valve

C-MAX (DM2) **2**

1.6 TDCi 74 kW (100 PS) G8DC	02.2007→09.2010		7.24809.39.0	AGR	EL	
			7.11190.10.0	DDS		ohne Zubehör without accessories Euro 4 Euro 4
1.6 TDCi 74 kW (100 PS) MTDA	02.2007→09.2010		7.24809.39.0	AGR	EL	
1.6 TDCi 66 kW (90 PS) GPDA, HHDA, HHDB	02.2007→09.2010		7.24809.39.0	AGR	EL	
1.6 TDCi 80 kW (109 PS) G8DA, G8DB, G8DD	02.2007→09.2010		7.24809.39.0	AGR	EL	
			7.11190.10.0	DDS		ohne Zubehör without accessories  G8DA, G8DB, G8DD: Euro 4 Euro 4











					
C-MAX (DM2)					
2					
1.8 90 kW (122 PS) QQDC	02.2007→09.2010		7.24809.73.0	AGR	EL 
1.8 92 kW (125 PS) QQDA, QQDB	02.2007→09.2010		7.24809.73.0	AGR	EL 
1.8 Flexifuel 92 kW (125 PS) Q7DA	02.2007→09.2010		7.24809.73.0	AGR	EL 
1.8 TDCi 85 kW (115 PS) KKDA, KKDB	02.2007→09.2010		7.24809.71.0	AGR	EL mit Saugrohr with suction pipe 
			↳ 7.24809.89.0	AGR	EL 
2.0 104-109 kW (141-146 PS) AODA, AODB, AODE, SYDA	02.2007→09.2010		7.24809.73.0	AGR	EL 
2.0 CNG 104-109 kW (143-146 PS) SYDA	04.2009→09.2010		7.24809.73.0	AGR	EL 
2.0 LPG 104-109 kW (143-146 PS) SYDA	06.2008→09.2010		7.24809.73.0	AGR	EL 
2.0 TDCi 98 kW (133 PS) G6DC, G6DE, G6DF	02.2007→09.2010		7.24809.68.0	AGR	EL 
2.0 TDCi 100 kW (136 PS) G6DA, G6DB, G6DD	02.2007→09.2010		7.24809.68.0	AGR	EL 
			7.09730.00.0	AGR-K	ohne Zubehör without accessories  G6DA, G6DB, G6DD: Euro 4 Euro 4
			7.11190.10.0	DDS	
2.0 TDCi 100 kW (136 PS) G6DG	02.2007→09.2010		7.24809.68.0	AGR	EL 
			7.09730.00.0	AGR-K	
2.0 TDCi 81 kW (110 PS) IXDA	02.2008→09.2010		7.24809.68.0	AGR	EL 
			7.09730.00.0	AGR-K	
C-MAX II (DXA/CB7, DXA/CEU)					
3					
1.5 TDCi 70 kW (95 PS) XXDA, XXDC, XXDD	03.2015→		7.02209.20.0	AGR	EL 
			7.04512.08.0	AGR-K	
1.5 TDCi 88 kW (120 PS) XWDA, XWDB, XWDC, XWDD, XWDE	03.2015→		7.02209.20.0	AGR	EL 
			7.04512.08.0	AGR-K	
1.5 TDCi ECOnetic 77 kW (105 PS) AEDA	03.2015→		7.02209.20.0	AGR	EL 
			7.04512.08.0	AGR-K	
1.6 TDCi 70 kW (95 PS) T3DA, T3DB	12.2010→		7.02209.11.0	AGR	EL 
			7.02156.35.0	AGR-K	EL ohne Sensor without sensor  T3DA, T3DB: 05.2015→ mit AGR-Ventil with EGR valve
			7.02156.24.0	AGR-K	EL mit Sensor with sensor 
			7.02156.33.0	AGR-K	mit Sensor with sensor
			7.02156.34.0	AGR-K	ohne Sensor without sensor
1.6 TDCi 85 kW (115 PS) T1DA, T1DB	12.2010→		7.02209.11.0	AGR	EL 

F



C-MAX II (DXA/CB7, DXA/CEU)







3

			7.02156.35.0	AGR-K	EL	ohne Sensor without sensor  T1DA, T1DB: 05.2015→ mit AGR-Ventil with EGR valve
			7.02156.24.0	AGR-K	EL	mit Sensor with sensor 
			7.02156.33.0	AGR-K		mit Sensor with sensor
			7.02156.34.0	AGR-K		ohne Sensor without sensor
2.0 TDCi 103 kW (140 PS) UFDB	04.2010→		7.24809.94.0	AGR-K	EL	 08.2010→06.2015
2.0 TDCi 120 kW (163 PS) TXDB	12.2010→		7.24809.94.0	AGR-K	EL	 →06.2015
2.0 TDCi 85 kW (116 PS) TYDA	02.2011→		7.24809.94.0	AGR-K	EL	 →06.2015
2.0 TDCi 100 kW (136 PS) UKDB	02.2011→		7.24809.94.0	AGR-K	EL	 →06.2015

F

COUGAR (EC_)













4

2.0 16V 96 kW (131 PS) EDBA, EDBB, EDBC, EDBD	08.1998→12.2001		7.02604.64.0	LS	450 mm	
			7.02604.60.0	LS	400 mm	
2.5 ST 200 151 kW (205 PS) SGA	01.2000→12.2001		7.02604.60.0	LS	400 mm	
2.5 V6 24V 125 kW (170 PS) LCBA	08.1998→12.2001		7.02604.60.0	LS	400 mm	
			7.02604.61.0	LS	375 mm	links, rechts Left, Right
2.5 V6 24V 125 kW (170 PS) LCBB, LCBC, LCBE	08.1998→12.2001		7.02604.60.0	LS	400 mm	
2.5 V6 24V 125 kW (170 PS) LCBB, LCBC, LCBE	06.2000→12.2001		7.02604.60.0	LS	400 mm	
			7.02604.61.0	LS	375 mm	 LCBB, LCBC, LCBE: →09.2000 links, rechts Left, Right































ECOSPORT











5

1.5 EcoBlue TDCi 70 kW (95 PS) XVJD	05.2015→		7.02209.20.0	AGR	EL	
			7.02156.35.0	AGR-K	EL	ohne Sensor without sensor mit AGR-Ventil with EGR valve
			7.02156.34.0	AGR-K		ohne Sensor without sensor ohne AGR-Ventil without EGR valve
			7.04512.08.0	AGR-K		
1.5 EcoBlue TDCi 74 kW (100 PS) Z2JA	11.2017→		7.07794.22.0	AGR	EL	mit Dichtring with O-ring
			7.02156.35.0	AGR-K	EL	ohne Sensor without sensor mit AGR-Ventil with EGR valve
			7.02156.34.0	AGR-K		ohne Sensor without sensor ohne AGR-Ventil without EGR valve

						
ECOSPORT						
5						
1.5 TDCi 66-67 kW (90-91 PS) UGJE	10.2012→		7.02156.35.0	AGR-K	EL	ohne Sensor without sensor 10.2013→ mit AGR-Ventil with EGR valve ohne Sensor without sensor
			7.02156.34.0	AGR-K		
1.5 TDCi 66-67 kW (90-91 PS) UGJE	10.2013→		7.02209.11.0	AGR	EL	<input type="radio"/> ohne Sensor without sensor mit Sensor with sensor ohne Sensor without sensor
			7.02156.35.0	AGR-K	EL	
			7.02156.33.0	AGR-K		
			7.02156.34.0	AGR-K		
1.5 TDCi 74 kW (100 PS) UGJM	05.2015→		7.02209.20.0	AGR	EL	<input type="radio"/> ohne Sensor without sensor mit AGR-Ventil with EGR valve ohne Sensor without sensor
			7.02156.35.0	AGR-K	EL	
			7.02156.34.0	AGR-K		
			7.04512.08.0	AGR-K	<input checked="" type="checkbox"/>	
1.5 TDCi 74 kW (100 PS) XUJH	05.2015→		7.05742.11.0	AGR	EL	09.2017→ <input type="radio"/> ohne Sensor without sensor mit AGR-Ventil with EGR valve ohne Sensor without sensor
			7.02209.20.0	AGR	EL	
			7.02156.35.0	AGR-K	EL	
			7.02156.34.0	AGR-K		
			7.04512.08.0	AGR-K	<input checked="" type="checkbox"/>	
1.5 TDCi EcoBlue 92 kW (125 PS) ZTJA, ZTJB, ZTJC	11.2017→		7.02209.20.0	AGR	EL	<input type="radio"/> mit Dichtring with O-ring ohne Sensor without sensor <input checked="" type="checkbox"/> ZTJA, ZTJB, ZTJC: mit AGR-Ventil with EGR valve ohne Sensor without sensor
			7.07794.22.0	AGR	EL	
			7.02156.35.0	AGR-K	EL	
			7.02156.34.0	AGR-K		
			7.04512.08.0	AGR-K	<input checked="" type="checkbox"/>	
1.5 TDCi EcoBlue	11.2019→		7.07794.22.0	AGR	EL	mit Dichtring with O-ring
1.5 TDCi EcoBlue 4x4 92 kW (125 PS) ZTJA, ZTJB, ZTJC	11.2017→		7.02209.20.0	AGR	EL	<input type="radio"/> mit Dichtring with O-ring ohne Sensor without sensor <input checked="" type="checkbox"/> ZTJA, ZTJB, ZTJC: mit AGR-Ventil with EGR valve ohne Sensor without sensor
			7.07794.22.0	AGR	EL	
			7.02156.35.0	AGR-K	EL	
			7.02156.34.0	AGR-K		
			7.04512.08.0	AGR-K	<input checked="" type="checkbox"/>	

F

			 PIERBURG			
ESCORT IV (GAF, AWF, ABFT)						6
1.4 51-55 kW (69-75 PS) FUAA	10.1985→10.1990		7.02604.61.0	LS	375 mm	
1.4 52-54 kW (71-73 PS) F6B, F6D, FUC	01.1986→07.1990		7.02604.61.0	LS	375 mm	
1.4 55 kW (75 PS) FUA	01.1986→07.1990		7.02604.61.0	LS	375 mm	
ESCORT IV Convertible (ALF)						7
1.4 55 kW (75 PS) FUA	01.1986→07.1990		7.02604.61.0	LS	375 mm	
1.4 52-54 kW (71-73 PS) F6B, F6D, FUC	02.1987→07.1990		7.02604.61.0	LS	375 mm	
ESCORT IV Turnier (AWF, AVF)						8
1.4 51-55 kW (69-75 PS) FUAA	10.1985→10.1990		7.02604.61.0	LS	375 mm	
1.4 52-54 kW (71-73 PS) F6B, F6D, FUC	01.1986→07.1990		7.02604.61.0	LS	375 mm	
1.4 55 kW (75 PS) FUA	01.1986→07.1990		7.02604.61.0	LS	375 mm	
ESCORT V (AAL, ABL)						9
1.3 44 kW (60 PS) J4B, J6A	07.1990→01.1995		7.02604.62.0	LS	680 mm	 J4B, J6A: 12.1992→
			7.02604.61.0	LS	375 mm	
1.4 52 kW (71 PS) F6F, F6G	07.1990→01.1995		7.02604.62.0	LS	680 mm	 F6F, F6G: 01.1994→
			7.02604.61.0	LS	375 mm	
1.4 54-55 kW (71-75 PS) F4B, FUH	09.1990→12.1994		7.02604.62.0	LS	680 mm	 F4B, FUH: 01.1994→
			7.02604.61.0	LS	375 mm	
RS 2000 110 kW (150 PS) N7A	05.1991→01.1995		7.02604.62.0	LS	680 mm	
RS 2000 4x4 110 kW (150 PS) N7A	05.1991→01.1995		7.02604.62.0	LS	680 mm	
ESCORT V Convertible (ALL)						10
1.4 52 kW (71 PS) F6F, F6G	07.1990→04.1994		7.02604.62.0	LS	680 mm	 F6F, F6G: 01.1994→
			7.02604.61.0	LS	375 mm	
1.4 i 54-55 kW (73-75 PS) F4B	07.1993→01.1995		7.02604.62.0	LS	680 mm	01.1994→
			7.02604.61.0	LS	375 mm	
ESCORT V Saloon (AFL)						11
1.3 44 kW (60 PS) J4B, J6A	08.1993→01.1995		7.02604.62.0	LS	680 mm	
			7.02604.61.0	LS	375 mm	
1.4 54-55 kW (71-75 PS) F4B, FUH	08.1993→01.1995		7.02604.62.0	LS	680 mm	 F4B, FUH: 01.1994→
			7.02604.61.0	LS	375 mm	
1.4 52 kW (71 PS) F6F, F6G	08.1993→04.1994		7.02604.62.0	LS	680 mm	 F6F, F6G: 01.1994→
			7.02604.61.0	LS	375 mm	

						
ESCORT V Turnier (ANL)						12
1.3 44 kW (60 PS) J4B, J6A	09.1991→01.1995		7.02604.62.0	LS	680 mm	 J4B, J6A: 12.1992→
			7.02604.61.0	LS	375 mm	
1.4 52 kW (71 PS) F6F, F6G	07.1990→01.1995		7.02604.62.0	LS	680 mm	 F6F, F6G: 01.1994→
			7.02604.61.0	LS	375 mm	
1.4 54-55 kW (71-75 PS) F4B, FUH	01.1994→01.1995		7.02604.62.0	LS	680 mm	
			7.02604.61.0	LS	375 mm	
ESCORT VI (GAL, AAL, ABL)						13
1.3 44 kW (60 PS) J4B, J6A	01.1995→10.1998		7.02604.62.0	LS	680 mm	
			7.02604.61.0	LS	375 mm	
1.4 54-55 kW (73-75 PS) F4B	01.1995→10.1998		7.02604.62.0	LS	680 mm	→08.1995
			7.02604.61.0	LS	375 mm	
1.4 54-55 kW (71-75 PS) FUH	01.1995→10.1998		7.02604.61.0	LS	375 mm	
RS 2000 110 kW (150 PS) N7A	02.1995→02.1998		7.02604.62.0	LS	680 mm	
RS 2000 4x4 110 kW (150 PS) N7A	02.1995→10.1998		7.02604.62.0	LS	680 mm	
ESCORT VI Convertible (ALL)						14
1.4 54-55 kW (73-75 PS) F4B	02.1995→08.1998		7.02604.62.0	LS	680 mm	→08.1995
			7.02604.61.0	LS	375 mm	
ESCORT VI Saloon (GAL, AFL)						15
1.3 44 kW (60 PS) J4B, J6A	01.1995→02.1999		7.02604.62.0	LS	680 mm	
			7.02604.61.0	LS	375 mm	
1.4 54-55 kW (71-75 PS) F4B, FUH	01.1995→02.1999		7.02604.62.0	LS	680 mm	 F4B, FUH: →08.1995
			7.02604.61.0	LS	375 mm	
ESCORT VI Turnier (GAL, ANL)						16
1.3 44 kW (60 PS) J4B, J6A	01.1995→01.1999		7.02604.62.0	LS	680 mm	
			7.02604.61.0	LS	375 mm	
1.4 54-55 kW (71-75 PS) F4B, FUH	01.1995→02.1999		7.02604.62.0	LS	680 mm	 F4B, FUH: →08.1995
			7.02604.61.0	LS	375 mm	
FIESTA I (GFBT)						17
1.1 39-40 kW (53-54 PS) GLA	05.1976→08.1983		7.02604.61.0	LS	375 mm	
1.1 (WFBT) 39-40 kW (53-55 PS) GLW	02.1981→08.1983		7.02604.61.0	LS	375 mm	
1.3 49 kW (66 PS) J3E	08.1977→08.1983		7.02604.61.0	LS	375 mm	









F







FIESTA II (FBD) **18**

1.4 51 kW (69 PS) FUBA	09.1983→01.1987		7.02604.62.0	LS	680 mm	
1.4 (FBD) 55 kW (75 PS) FUB	10.1985→11.1989		7.02604.62.0	LS	680 mm	
1.4 (FBD) 52-54 kW (71-73 PS) F6A, F6C	10.1986→02.1989		7.02604.62.0	LS	680 mm	
1.4 (FBD) 54 kW (73 PS) FUD	02.1987→02.1989		7.02604.62.0	LS	680 mm	







F FIESTA III (GFJ) **19**

1.4 54 kW (73 PS) F4A, FUG, FUJ	03.1989→12.1995		7.02604.62.0	LS	680 mm	
1.4 52 kW (71 PS) F6E	03.1989→12.1995		7.02604.62.0	LS	680 mm	
1.4 55 kW (75 PS) FUF	11.1992→12.1996		7.02604.62.0	LS	680 mm	
1.6 65-66 kW (88-90 PS) LUH	01.1989→01.1994		7.02604.04.0	LS	200 mm	
1.6 65-66 kW (88-90 PS) LUH	03.1989→12.1992		7.02604.04.0	LS	200 mm	
1.6 XR2i 76 kW (103 PS) LJD	03.1989→03.1993		7.02604.04.0	LS	200 mm	
1.6 XR2i 81 kW (110 PS) LJC	03.1989→01.1994		7.02604.04.0	LS	200 mm	
1.8 16V 77 kW (105 PS) RDB	02.1992→12.1995		7.02604.61.0	LS	375 mm	
1.8 XR2i 16V 96 kW (130 PS) RQC	02.1992→12.1995		7.02604.61.0	LS	375 mm	

FIESTA IV (JA_, JB_) **20**

1.25 i 16V 55 kW (75 PS) DHA, DHB, DHC, DHD, DHE, DHF, DHG	08.1995→01.2002		7.02604.64.0	LS	450 mm	 DHA, DHB, DHC, DHD, DHE, DHF, DHG: Diagnosesonde Diagnostic Probe
			7.02604.60.0	LS	400 mm	
			7.02604.63.0	LS	375 mm	
1.3 i 37 kW (50 PS) JJA, JJC, JJE, JJJ, JJK, JJM	08.1995→01.2002		7.02604.60.0	LS	400 mm	
			7.02604.61.0	LS	375 mm	
1.3 i 44 kW (60 PS) J4C, J4J, J4L, J4Q, J4R, J4T, JBC	08.1995→01.2002		7.02604.60.0	LS	400 mm	
			7.02604.61.0	LS	375 mm	

FIESTA Saloon **21**

1.4 TDCi 50 kW (68 PS) F6JC	05.2002→11.2011		7.24809.06.0	AGR	PN	mit Rohrstützen with pipe socket
			7.24809.76.0	AGR	EL	 Euro 3  Euro 3
1.4 TDCi 50-51 kW (68-69 PS) KVJA	05.2002→11.2011		7.24809.76.0	AGR	EL	
1.5 TDCi 66-74 kW (91-101 PS) 15DSOX	01.2011→12.2016		7.02209.20.0	AGR	EL	 02.2015→
			7.02156.35.0	AGR-K	EL	ohne Sensor without sensor mit AGR-Ventil with EGR valve

FIESTA Saloon						21
			7.04512.08.0	AGR-K		02.2015→ mit Sensor with sensor ohne AGR-Ventil without EGR valve
			7.02156.33.0	AGR-K		
			7.02156.34.0	AGR-K		
1.6 TDCi 66 kW (90 PS) HHJC	10.2010→		7.02156.35.0	AGR-K	EL	ohne Sensor without sensor →07.2019 mit AGR-Ventil with EGR valve
			7.02156.33.0	AGR-K		mit Sensor with sensor
			7.02156.34.0	AGR-K		ohne Sensor without sensor →07.2019 ohne AGR-Ventil without EGR valve
FIESTA V (JH_, JD_)						22
1.4 TDCi 50-51 kW (68-69 PS) F6JA, F6JB	11.2001→06.2008		7.24809.06.0	AGR	PN	mit Rohrstützen with pipe socket F6JA, F6JB: Euro 3 Euro 3
			7.24809.76.0	AGR	EL	
1.6 16V 74 kW (100 PS) FYJA, FYJB	11.2001→06.2008		7.02604.62.0	LS	680 mm	
			7.02604.64.0	LS	450 mm	
			7.02604.61.0	LS	375 mm	
1.6 TDCi 66 kW (90 PS) HHJA, HHJB	11.2004→06.2008		7.24809.39.0	AGR	EL	
ST150 110 kW (150 PS) N4JB	03.2005→06.2008		7.24809.73.0	AGR	EL	
			7.02604.64.0	LS	450 mm	
FIESTA VI (CB1, CCN)						23
1.4 66-71 kW (90-97 PS) RTJA, RTJB, SPJA, SPJC, SPJE	10.2008→		7.02604.62.0	LS	680 mm	
			7.02604.63.0	LS	375 mm	
1.4 TDCi 50-51 kW (68-70 PS) F6JB, F6JD	01.2009→		7.24809.76.0	AGR	EL	 F6JB, F6JD: →12.2012 Euro 4 (D4) Euro 4 (D4)
			7.02209.11.0	AGR	EL	 F6JB, F6JD: 08.2010→
			7.02156.35.0	AGR-K	EL	ohne Sensor without sensor F6JB, F6JD: →07.2019 mit AGR-Ventil with EGR valve
			7.02156.33.0	AGR-K		mit Sensor with sensor
			7.02156.34.0	AGR-K		ohne Sensor without sensor
1.4 TDCi 50-51 kW (68-70 PS) F6JD, KVJA	07.2010→		7.24809.76.0	AGR	EL	





































F



FIESTA VI (CB1, CCN)

23

F



















			<p>7.02209.11.0 AGR EL </p> <p>7.02156.35.0 AGR-K EL  F6JD, KVJA: 08.2010→</p> <p>7.02156.24.0 AGR-K EL  ohne Sensor without sensor</p> <p>7.02156.33.0 AGR-K  F6JD, KVJA: →07.2019 mit AGR-Ventil with EGR valve</p> <p>7.02156.34.0 AGR-K  mit Sensor with sensor</p> <p> mit Sensor with sensor</p> <p> ohne Sensor without sensor</p>
<p>1.5 TDCi 55 kW (75 PS) UGJC, XUJA, XUJB</p>	<p>09.2012→</p>		<p>7.02209.11.0 AGR EL </p>
			<p>7.02156.35.0 AGR-K EL  ohne Sensor without sensor</p> <p> UGJC, XUJA, XUJB: →07.2019 mit AGR-Ventil with EGR valve</p>
			<p>7.02156.34.0 AGR-K  ohne Sensor without sensor</p>
			<p>7.02156.33.0 AGR-K  mit Sensor with sensor</p>
<p>1.5 TDCi 70 kW (95 PS) XVJB, XVJC</p>	<p>05.2015→</p>		<p>7.02209.20.0 AGR EL </p>
			<p>7.02156.35.0 AGR-K EL  ohne Sensor without sensor</p> <p> XVJB, XVJC: →07.2019 mit AGR-Ventil with EGR valve</p>
			<p>7.02156.34.0 AGR-K  ohne Sensor without sensor</p>
			<p>7.04512.08.0 AGR-K </p>
<p>1.6 TDCi 66 kW (90 PS) HHJC, HHJD, HHJE</p>	<p>06.2008→</p>		<p>7.24809.39.0 AGR EL  HHJC, HHJD, HHJE: Euro 4 (D4) Euro 4 (D4)</p>
			<p>7.02156.35.0 AGR-K EL  ohne Sensor without sensor</p> <p> HHJC, HHJD, HHJE: →07.2019 mit AGR-Ventil with EGR valve</p>
			<p>7.02156.33.0 AGR-K  mit Sensor with sensor</p>
			<p>7.02156.34.0 AGR-K  ohne Sensor without sensor</p>
<p>1.6 TDCi 55 kW (75 PS) HHJF, UBJA</p>	<p>06.2008→</p>		<p>7.02209.11.0 AGR EL  HHJF:  ch. 03.2010→</p> <p> UBJA: 03.2010→</p>
			<p>7.24809.39.0 AGR EL  HHJF, UBJA: Euro 4 (D4) Euro 4 (D4)</p>
			<p>7.02156.24.0 AGR-K EL  mit Sensor with sensor</p>
			<p> HHJF, UBJA: 03.2010→</p>
			<p>7.02156.35.0 AGR-K EL  ohne Sensor without sensor</p> <p> HHJF, UBJA: mit AGR-Ventil with EGR valve</p>
			<p>7.02156.33.0 AGR-K  mit Sensor with sensor</p> <p>7.02156.34.0 AGR-K  ohne Sensor without sensor</p>

FIESTA VI (CB1, CCN)						23
1.6 TDCi 70 kW (95 PS) T3JA	02.2010→		7.02209.11.0	AGR	EL	
			7.02156.35.0	AGR-K	EL ohne Sensor without sensor →07.2019 mit AGR-Ventil with EGR valve	
			7.02156.33.0	AGR-K	mit Sensor with sensor	
			7.02156.34.0	AGR-K	ohne Sensor without sensor	
1.6 TDCi 70 kW (95 PS) TZJA, TZJB	02.2010→		7.02209.11.0	AGR	EL	
			7.02156.35.0	AGR-K	EL ohne Sensor without sensor TZJA, TZJB: →07.2019 mit AGR-Ventil with EGR valve	
			7.02156.24.0	AGR-K	EL mit Sensor with sensor	
			7.02156.33.0	AGR-K	mit Sensor with sensor	
7.02156.34.0	AGR-K	ohne Sensor without sensor				
FIESTA VII (HJ, HF)						24
1.5 TDCi 63 kW (86 PS) XUJC, XUJD, XUJE, XUJF, XUJG, XUJK, XUJL, XUJM, XUJN	05.2017→		7.02209.20.0	AGR	EL	
			7.02156.35.0	AGR-K	EL ohne Sensor without sensor	
			7.02156.34.0	AGR-K	ohne Sensor without sensor	
			7.04512.08.0	AGR-K		
1.5 TDCi 88 kW (120 PS) XWJA, XWJB, XWJC	05.2017→		7.02209.20.0	AGR	EL	
			7.02156.35.0	AGR-K	EL ohne Sensor without sensor	
			7.02156.34.0	AGR-K	ohne Sensor without sensor	
			7.04512.08.0	AGR-K		
FOCUS C-MAX (DM2)						25
1.6 74 kW (100-101 PS) HWDA, HWDB, SHDA, SHDB, SHDC	10.2003→03.2007		7.02604.65.0	LS	525 mm	
			7.02604.64.0	LS	450 mm	
1.6 TDCi 80 kW (109 PS) G8DA, G8DB, G8DD, G8DE, G8DF	10.2003→03.2007		7.24809.92.0	AGR	EL G8DA, G8DB, G8DD, G8DD, G8DE, G8DF: →10.2004	
			7.24809.91.0	AGR	EL G8DA, G8DB, G8DD, G8DE, G8DF: 10.2004→10.2005	
			7.24809.39.0	AGR	EL	
1.6 TDCi 66 kW (90 PS) HHDA, HHDB	02.2005→03.2007		7.24809.91.0	AGR	EL HHDA, HHDB: →10.2005	
			7.24809.39.0	AGR	EL	
1.6 Ti 85 kW (115 PS) HXDA, SIDA	08.2004→03.2007		7.02604.65.0	LS	525 mm	
			7.02604.64.0	LS	450 mm	







F





FOCUS C-MAX (DM2) **25**

F	1.8 88 kW (120 PS) CSDA, CSDB	10.2003→03.2007		7.24809.73.0	AGR	EL	
	1.8 92 kW (125 PS) Q7DA, QQDA, QQDB	04.2004→03.2007		7.24809.73.0	AGR	EL	
	1.8 90 kW (122 PS) QQDC	09.2005→03.2007		7.24809.73.0	AGR	EL	
	1.8 Flexifuel 92 kW (125 PS) Q7DA	01.2006→03.2007		7.24809.73.0	AGR	EL	
	1.8 TDCi 85 kW (115 PS) KKDA, KKDB	01.2005→03.2007		7.24809.71.0	AGR	EL	mit Saugrohr with suction pipe 
				↳ 7.24809.89.0	AGR	EL	
	2.0 104-109 kW (141-146 PS) AODA, AODB, AODE, SYDA	03.2004→03.2007		7.24809.73.0	AGR	EL	
				7.02604.64.0	LS	450 mm	
	2.0 TDCi 98 kW (133 PS) G6DC, G6DE, G6DF	10.2003→03.2007		7.24809.68.0	AGR	EL	
	2.0 TDCi 100 kW (136 PS) G6DA, G6DB, G6DD	10.2003→03.2007		7.24809.68.0	AGR	EL	
				7.09730.00.0	AGR-K		
				7.11190.10.0	DDS		ohne Zubehör without accessories  G6DA, G6DB, G6DD: Euro 4 Euro 4
	2.0 TDCi 100 kW (136 PS) G6DG	10.2003→03.2007		7.24809.68.0	AGR	EL	
				7.09730.00.0	AGR-K		

FOCUS I (DAW, DBW) **26**

	1.4 16V 55 kW (75 PS) FXDA, FXDB, FXDC, FXDD	10.1998→11.2004		7.02604.65.0	LS	525 mm	
				7.02604.64.0	LS	450 mm	
	1.6 16V 74-75 kW (100-102 PS) FYDA, FYDB, FYDC, FYDD, FYDH	10.1998→11.2004		7.02604.65.0	LS	525 mm	
				7.02604.64.0	LS	450 mm	
	1.6 16V Flexifuel 74-75 kW (100-102 PS) FYDH	01.2002→11.2004		7.02604.65.0	LS	525 mm	
				7.02604.64.0	LS	450 mm	
	1.8 16V 82-85 kW (111-115 PS) EYDB, EYDC, EYDD, EYDE, EYDF, EYDG, EYDI, EYDJ, EYDL	10.1998→11.2004		7.02604.60.0	LS	400 mm	
	2.0 16V 85-96 kW (116-131 PS) EDDB, EDDC, EDDD, EDDF	10.1998→11.2004		7.02604.64.0	LS	450 mm	
	ST170 127 kW (173 PS) ALDA	03.2002→11.2004		7.02604.60.0	LS	400 mm	

FOCUS I Saloon (DFW) **27**

	1.4 16V 55 kW (75 PS) FXDA, FXDB, FXDC, FXDD	02.1999→11.2004		7.02604.65.0	LS	525 mm	
				7.02604.64.0	LS	450 mm	
	1.6 16V 74-75 kW (100-102 PS) FYDA, FYDB, FYDC, FYDD, FYDH	02.1999→11.2004		7.02604.65.0	LS	525 mm	
				7.02604.64.0	LS	450 mm	

FOCUS I Saloon (DFW)					27
1.8 16V 82-85 kW (111-115 PS) EYDB, EYDC, EYDD, EYDE, EYDF, EYDG, EYDI, EYDJ, EYDL	02.1999→11.2004		7.02604.60.0	LS	400 mm
2.0 16V 85-96 kW (116-131 PS) EDDB, EDDC, EDDD, EDDF	02.1999→11.2004		7.02604.64.0	LS	450 mm
FOCUS I Turnier (DNW)					28
1.4 16V 55 kW (75 PS) FXDA, FXDB, FXDC, FXDD	02.1999→11.2004		7.02604.65.0	LS	525 mm
			7.02604.64.0	LS	450 mm
1.6 16V 74-75 kW (100-102 PS) FYDA, FYDB, FYDC, FYDD, FYDH	02.1999→11.2004		7.02604.65.0	LS	525 mm
			7.02604.64.0	LS	450 mm
1.6 16V Flexifuel 74-75 kW (100-102 PS) FYDH	01.2002→11.2004		7.02604.65.0	LS	525 mm
			7.02604.64.0	LS	450 mm
1.8 16V 82-85 kW (111-115 PS) EYDB, EYDC, EYDD, EYDE, EYDF, EYDG, EYDI, EYDJ, EYDL	02.1999→11.2004		7.02604.60.0	LS	400 mm
2.0 16V 85-96 kW (116-131 PS) EDDB, EDDC, EDDD, EDDF	02.1999→11.2004		7.02604.64.0	LS	450 mm
ST170 127 kW (173 PS) ALDA	08.2002→11.2004		7.02604.60.0	LS	400 mm
FOCUS II (DA_, HCP, DP)					29
1.6 TDCi 74 kW (100 PS) G8DC, MTDA	07.2004→09.2012		7.24809.91.0	AGR	EL G8DC, MTDA: 10.2004→10.2005
			7.24809.39.0	AGR	EL
			7.11190.10.0	DDS	ohne Zubehör without accessories G8DC: Euro 5, Euro 4 Euro 5, Euro 4 MTDA: Euro 5, Euro 4 Euro 5, Euro 4 Produktionsdatum ab: 03.12.2007 Production date from: 03.12.2007 Produktionsdatum bis: 02.07.2011 Production date to: 02.07.2011
1.6 TDCi 80 kW (109 PS) G8DA, G8DB, G8DD, G8DE, G8DF	07.2004→09.2012		7.24809.91.0	AGR	EL G8DA, G8DB, G8DD, G8DE, G8DF: 10.2004→10.2005
			7.24809.39.0	AGR	EL
			7.11190.10.0	DDS	ohne Zubehör without accessories G8DA, G8DB, G8DD, G8DE, G8DF: Euro 5, Euro 4 Euro 5, Euro 4 Produktionsdatum bis: 23.07.2011 Production date to: 23.07.2011
1.6 TDCi 66 kW (90 PS) GPDA, GPDB, GPDC, HHDA, HHDB	01.2005→09.2012		7.24809.91.0	AGR	EL GPDA, GPDB, GPDC, HHDA, HHDB: →10.2005
			7.24809.39.0	AGR	EL





























F



FOCUS II (DA_, HCP, DP)

29

F







			7.11190.10.0	DDS		ohne Zubehör without accessories  GPDA, GPDB, GPDC, HHDB: Euro 5, Euro 4 Euro 5, Euro 4 Produktionsdatum ab: 03.12.2007 Production date from: 03.12.2007 Produktionsdatum bis: 02.07.2011 Production date to: 02.07.2011  HHDA: Euro 5, Euro 4 Euro 5, Euro 4 Produktionsdatum ab: 02.07.2011, 03.12.2007 Production date from: 02.07.2011, 03.12.2007
1.8 92 kW (125 PS) Q7DA, QQDA, QQDB	03.2006→09.2012		7.24809.73.0	AGR	EL	
			7.02604.64.0	LS	450 mm	
1.8 Flexifuel 96 kW (131 PS) QQDD	12.2005→01.2008		7.24809.73.0	AGR	EL	
1.8 Flexifuel 92 kW (125 PS) Q7DA, QQDA, QQDB	01.2006→09.2012		7.24809.73.0	AGR	EL	
1.8 TDCi 85 kW (115 PS) KKDA	01.2005→09.2012		7.24809.71.0	AGR	EL	mit Saugrohr with suction pipe 
			↳ 7.24809.89.0	AGR	EL	
2.0 104-107 kW (141-145 PS) AODA, AODB, AODE	07.2004→09.2012		7.24809.73.0	AGR	EL	
2.0 CNG 104-109 kW (143-146 PS) SYDA	04.2009→07.2011		7.24809.73.0	AGR	EL	
2.0 Flex 104-109 kW (143-146 PS) SYDA	10.2008→03.2010		7.24809.73.0	AGR	EL	
2.0 LPG 104-109 kW (143-146 PS) SYDA	06.2008→07.2011		7.24809.73.0	AGR	EL	
2.0 TDCi 98 kW (133 PS) G6DE, G6DF	07.2004→01.2008		7.24809.68.0	AGR	EL	
2.0 TDCi 100 kW (136 PS) G6DA, G6DB, G6DD	07.2004→09.2012		7.24809.68.0 7.09730.00.0 7.11190.10.0	AGR-K DDS	EL	 ohne Zubehör without accessories  G6DA, G6DB: Euro 4 Euro 4 Produktionsdatum bis: 29.07.2011 Production date to: 29.07.2011  G6DD: Euro 4 Euro 4 Produktionsdatum ab: 01.02.2006 Production date from: 01.02.2006 Produktionsdatum bis: 19.03.2007 Production date to: 19.03.2007
2.0 TDCi 100 kW (136 PS) G6DG	07.2004→09.2012		7.24809.68.0	AGR	EL	
			7.09730.00.0	AGR-K		
2.0 TDCi 81 kW (110 PS) IXDA	02.2008→07.2011		7.24809.68.0	AGR	EL	
			7.09730.00.0 7.11190.10.0	AGR-K DDS		ohne Zubehör without accessories Euro 4 Euro 4
2.5 ST 166 kW (225 PS) HYDA	10.2005→09.2012		7.05270.67.0	LS	770 mm	

FOCUS II Convertible					30
2.0 104-109 kW (141-146 PS) AODA, AODB, AODE, SYDA	10.2006→09.2010	7.24809.73.0	AGR	EL	
2.0 TDCi 100 kW (136 PS) G6DA, G6DB, G6DD	10.2006→09.2010	7.24809.68.0	AGR	EL	
		7.09730.00.0	AGR-K		
		7.11190.10.0	DDS		
2.0 TDCi 100 kW (136 PS) G6DG	10.2006→09.2010	7.24809.68.0	AGR	EL	
		7.09730.00.0	AGR-K		
FOCUS II Saloon (DB_, FCH, DH)					31
1.6 TDCi 74 kW (100 PS) G8DC, MTDA	04.2005→09.2012	7.24809.91.0	AGR	EL	 G8DC, MTDA: →10.2005
		7.24809.39.0	AGR	EL	
		7.11190.10.0	DDS		ohne Zubehör without accessories G8DC, MTDA: Euro 5, Euro 4 Euro 5, Euro 4
1.6 TDCi 66 kW (90 PS) GPDA, GPDB, GPDC	04.2005→09.2012	7.24809.91.0	AGR	EL	 GPDA, GPDB, GPDC: →10.2005
		7.24809.39.0	AGR	EL	
1.6 TDCi 66 kW (90 PS) HHDA, HHDB	04.2005→09.2012	7.24809.91.0	AGR	EL	 HHDA, HHDB: →10.2005
		7.24809.39.0	AGR	EL	
		7.11190.10.0	DDS		ohne Zubehör without accessories HHDA: Euro 5, Euro 4 Euro 5, Euro 4 HHDB: Euro 5, Euro 4 Euro 5, Euro 4 Produktionsdatum ab: 02.07.2011, 03.12.2007 Production date from: 02.07.2011, 03.12.2007
1.6 TDCi 80 kW (109 PS) G8DA, G8DB, G8DD, G8DE, G8DF	04.2005→09.2012	7.24809.91.0	AGR	EL	 G8DA, G8DB, G8DD, G8DE, G8DF: →10.2005
		7.24809.39.0	AGR	EL	
		7.11190.10.0	DDS		ohne Zubehör without accessories G8DA, G8DB, G8DD, G8DE, G8DF: Euro 5, Euro 4 Euro 5, Euro 4 Produktionsdatum ab: 03.12.2007 Production date from: 03.12.2007 Produktionsdatum bis: 02.07.2011 Production date to: 02.07.2011
1.8 92 kW (125 PS) Q7DA, QQDA, QQDB	03.2006→09.2012	7.24809.73.0	AGR	EL	
		7.02604.64.0	LS	450 mm	
1.8 Flexifuel	12.2005→01.2008	7.24809.73.0	AGR	EL	
1.8 Flexifuel 92 kW (125 PS) Q7DA, QQDA, QQDB	06.2006→07.2011	7.24809.73.0	AGR	EL	
1.8 TDCi 85 kW (115 PS) KKDA	04.2005→09.2012	7.24809.71.0	AGR	EL	mit Saugrohr with suction pipe
		7.24809.89.0	AGR	EL	

F













FOCUS II Saloon (DB_, FCH, DH) **31**

2.0 104-109 kW (141-146 PS) AODA, AODB, AODE, SYDA	04.2005→07.2011		7.24809.73.0	AGR	EL	<input type="checkbox"/>
			7.24809.68.0	AGR	EL	
2.0 TDCi 100 kW (136 PS) G6DA, G6DB, G6DD	04.2005→09.2012		7.24809.68.0	AGR	EL	ohne Zubehör without accessories  G6DA, G6DD: Euro 4 Euro 4 Produktionsdatum bis: 29.07.2011 Production date to: 29.07.2011  G6DB: Euro 4 Euro 4 Produktionsdatum ab: 01.03.2004 Production date from: 01.03.2004 Produktionsdatum bis: 29.07.2011 Production date to: 29.07.2011
			7.09730.00.0	AGR-K		
			7.11190.10.0	DDS		
2.0 TDCi 100 kW (136 PS) G6DG	04.2005→09.2012		7.24809.68.0	AGR	EL	<input type="checkbox"/>
2.0 TDCi 81 kW (110 PS) IXDA	02.2008→07.2011		7.24809.68.0	AGR	EL	<input type="checkbox"/>
			7.09730.00.0	AGR-K		
			7.11190.10.0	DDS		
ohne Zubehör without accessories Euro 4 Euro 4						

F

FOCUS II Turnier (DA_, FFS, DS) **32**

1.6 TDCi 74 kW (100 PS) G8DC, MTDA	07.2004→09.2012		7.24809.91.0	AGR	EL	<input type="checkbox"/>  G8DC, MTDA: 10.2004→10.2005 <input type="checkbox"/> ohne Zubehör without accessories  G8DC: Euro 5, Euro 4 Euro 5, Euro 4 Produktionsdatum ab: 03.12.2007 Production date from: 03.12.2007 Produktionsdatum bis: 02.07.2011 Production date to: 02.07.2011  MTDA: Euro 5, Euro 4 Euro 5, Euro 4
			7.24809.39.0	AGR	EL	
			7.11190.10.0	DDS		
1.6 TDCi 80 kW (109 PS) G8DA, G8DB, G8DD, G8DE, G8DF	07.2004→09.2012		7.24809.91.0	AGR	EL	<input type="checkbox"/>  G8DA, G8DB, G8DD, G8DE, G8DF: 10.2004→10.2005 <input type="checkbox"/> ohne Zubehör without accessories  G8DA, G8DB, G8DD, G8DE: Euro 5, Euro 4 Euro 5, Euro 4 Produktionsdatum ab: 03.12.2007 Production date from: 03.12.2007 Produktionsdatum bis: 02.07.2011 Production date to: 02.07.2011  G8DF: Euro 5, Euro 4 Euro 5, Euro 4 Produktionsdatum ab: 02.07.2011, 03.12.2007 Production date from: 02.07.2011, 03.12.2007
			7.24809.39.0	AGR	EL	
			7.11190.10.0	DDS		
1.6 TDCi 66 kW (90 PS) GPDA, GPDC, HHDA, HHDB	07.2004→09.2012		7.24809.91.0	AGR	EL	<input type="checkbox"/>  GPDA, GPDC, HHDA, HHDB: →10.2005 <input type="checkbox"/>
			7.24809.39.0	AGR	EL	

FOCUS II Turnier (DA_, FFS, DS)
32





























			7.11190.10.0	DDS		ohne Zubehör without accessories GPDA, GPDC, HHDA, HHDB: Euro 5, Euro 4 Euro 5, Euro 4 Produktionsdatum ab: 03.12.2007 Production date from: 03.12.2007 Produktionsdatum bis: 02.07.2011 Production date to: 02.07.2011
1.6 TDCi 66 kW (90 PS) GPDB	07.2004→09.2012		7.24809.91.0	AGR	EL	→10.2005
			7.24809.39.0	AGR	EL	
1.6 TDCi 80 kW (109 PS) G8DA	12.2007→09.2012		7.24809.91.0	AGR	EL	→07.2011
			7.24809.39.0	AGR	EL	
			7.11190.10.0	DDS		ohne Zubehör without accessories Euro 5, Euro 4 Euro 5, Euro 4 Produktionsdatum ab: 03.12.2007 Production date from: 03.12.2007 Produktionsdatum bis: 02.07.2011 Production date to: 02.07.2011
1.8 92 kW (125 PS) Q7DA, QQDA, QQDB	03.2006→09.2012		7.24809.73.0	AGR	EL	
			7.02604.64.0	LS	450 mm	
1.8 Flexifuel	12.2005→01.2008		7.24809.73.0	AGR	EL	
1.8 Flexifuel 92 kW (125 PS) Q7DA, QQDA, QQDB	01.2006→09.2012		7.24809.73.0	AGR	EL	
1.8 TDCi 85 kW (115 PS) KKDA	07.2004→09.2012		7.24809.71.0	AGR	EL	mit Saugrohr with suction pipe
			7.24809.89.0	AGR	EL	
2.0 104-109 kW (141-146 PS) AODA, AODB, AODE, SYDA	07.2004→09.2012		7.24809.73.0	AGR	EL	
2.0 LPG 104-109 kW (143-146 PS) SYDA	06.2008→07.2011		7.24809.73.0	AGR	EL	
2.0 TDCi 98 kW (133 PS) G6DE, G6DF	07.2004→01.2008		7.24809.68.0	AGR	EL	
2.0 TDCi 100 kW (136 PS) G6DA, G6DB, G6DD	07.2004→09.2012		7.24809.68.0	AGR	EL	
			7.09730.00.0	AGR-K		
			7.11190.10.0	DDS		ohne Zubehör without accessories G6DA, G6DB, G6DD: Euro 4 Euro 4 Produktionsdatum bis: 29.07.2011 Production date to: 29.07.2011
2.0 TDCi 100 kW (136 PS) G6DG	07.2004→09.2012		7.24809.68.0	AGR	EL	
			7.09730.00.0	AGR-K		
2.0 TDCi 81 kW (110 PS) IXDA	02.2008→07.2011		7.24809.68.0	AGR	EL	
			7.09730.00.0	AGR-K		
			7.11190.10.0	DDS		ohne Zubehör without accessories Euro 4 Euro 4

F





FOCUS III **33**

F

1.5 TDCi 70 kW (95 PS) XXDA, XXDC, XXDD	09.2014→		7.02209.20.0	AGR	EL	 XXDA, XXDC, XXDD: →05.2018
			7.04512.08.0	AGR-K		
1.5 TDCi 88 kW (120 PS) XWDA, XWDB, XWDC, XWDD, XWDE	09.2014→		7.02209.20.0	AGR	EL	 XWDA, XWDB, XWDC, XWDD, XWDE: →05.2018
			7.04512.08.0	AGR-K		
1.5 TDCi EConetic 77 kW (105 PS) AEDA, XXDB	09.2014→		7.02209.20.0	AGR	EL	 AEDA, XXDB: →05.2018
			7.04512.08.0	AGR-K		
1.6 TDCi 70 kW (95 PS) T3DA, T3DB	07.2010→		7.02209.11.0	AGR	EL	
			7.02156.35.0	AGR-K	EL	ohne Sensor without sensor  T3DA, T3DB: →05.2015 mit AGR-Ventil with EGR valve
			7.02156.24.0	AGR-K	EL	mit Sensor with sensor 
			7.02156.34.0	AGR-K	EL	ohne Sensor without sensor
1.6 TDCi 85 kW (115 PS) T1DA, T1DB	07.2010→		7.02209.11.0	AGR	EL	
			7.02156.35.0	AGR-K	EL	ohne Sensor without sensor  T1DA, T1DB: →05.2015 mit AGR-Ventil with EGR valve
			7.02156.24.0	AGR-K	EL	mit Sensor with sensor 
			7.02156.34.0	AGR-K	EL	ohne Sensor without sensor
1.6 TDCi EConetic 77 kW (105 PS) NGDA, NGDB	05.2012→		7.02209.11.0	AGR	EL	
			7.02156.35.0	AGR-K	EL	ohne Sensor without sensor  NGDA, NGDB: →05.2015 mit AGR-Ventil with EGR valve
			7.03991.12.0	AGR-K	EL	 NGDA, NGDB: 06.2012→07.2015
			7.02156.34.0	AGR-K	EL	ohne Sensor without sensor
2.0 TDCi 85 kW (116 PS) TYDA	07.2010→		7.24809.94.0	AGR-K	EL	 01.2011→07.2015
2.0 TDCi 103 kW (140 PS) UFDB	07.2010→		7.24809.94.0	AGR-K	EL	 01.2011→07.2015
2.0 TDCi 120 kW (163 PS) TXDB	07.2010→		7.24809.94.0	AGR-K	EL	 01.2011→07.2015
2.0 TDCi 100 kW (136 PS) UKDB	07.2010→		7.24809.94.0	AGR-K	EL	 01.2011→07.2015

FOCUS III Saloon **34**























1.5 TDCi 70 kW (95 PS) XXDA, XXDC, XXDD	11.2014→		7.02209.20.0	AGR	EL	 XXDA, XXDC, XXDD: →05.2018
			7.04512.08.0	AGR-K		

FOCUS III Saloon					
34					
1.5 TDCi 88 kW (120 PS) XWDA, XWDB, XWDC, XWDD, XWDE	11.2014→		7.02209.20.0	AGR	EL XWDA, XWDB, XWDC, XWDD, XWDE: →05.2018
			7.04512.08.0	AGR-K	
1.5 TDCi ECONetic 77 kW (105 PS) AEDA, XXDB	11.2014→		7.02209.20.0	AGR	EL AEDA, XXDB: →05.2018
			7.04512.08.0	AGR-K	
1.6 TDCi 70 kW (95 PS) T3DA, T3DB	07.2010→		7.02209.11.0	AGR	EL
			7.02156.35.0	AGR-K	EL ohne Sensor without sensor T3DA, T3DB: →07.2015 mit AGR-Ventil with EGR valve
			7.02156.24.0	AGR-K	EL mit Sensor with sensor
			7.02156.34.0	AGR-K	EL ohne Sensor without sensor
			7.02156.33.0	AGR-K	EL mit Sensor with sensor
1.6 TDCi 85 kW (115 PS) T1DA, T1DB	07.2010→		7.02209.11.0	AGR	EL
			7.02156.35.0	AGR-K	EL ohne Sensor without sensor T1DA, T1DB: →05.2015 mit AGR-Ventil with EGR valve
			7.02156.24.0	AGR-K	EL mit Sensor with sensor
			7.02156.34.0	AGR-K	EL ohne Sensor without sensor
			7.02156.33.0	AGR-K	EL mit Sensor with sensor
1.6 TDCi 77 kW (105 PS) NGDA, NGDB	05.2012→		7.02209.11.0	AGR	EL
			7.02156.35.0	AGR-K	EL ohne Sensor without sensor NGDA, NGDB: →05.2015 mit AGR-Ventil with EGR valve
			7.03991.12.0	AGR-K	EL NGDA, NGDB: 06.2012→07.2015
			7.02156.34.0	AGR-K	EL ohne Sensor without sensor
2.0 TDCi 85 kW (116 PS) TYDA	07.2010→		7.24809.94.0	AGR-K	EL 01.2011→07.2015
2.0 TDCi 103 kW (140 PS) UFDB	07.2010→		7.24809.94.0	AGR-K	EL 01.2011→07.2015
2.0 TDCi 120 kW (163 PS) TXDB	07.2010→		7.24809.94.0	AGR-K	EL 01.2011→07.2015
2.0 TDCi 100 kW (136 PS) UKDB	07.2010→		7.24809.94.0	AGR-K	EL 01.2011→07.2015
FOCUS III Turnier					
35					
1.5 TDCi 70 kW (95 PS) XXDA, XXDC	09.2014→		7.02209.20.0	AGR	EL XXDA, XXDC: →05.2018
			7.04512.08.0	AGR-K	
1.5 TDCi 88 kW (120 PS) XWDA, XWDB, XWDC, XWDD, XWDE	09.2014→		7.02209.20.0	AGR	EL XWDA, XWDB, XWDC, XWDD, XWDE: →05.2018
			7.04512.08.0	AGR-K	







F







































FOCUS III Turnier **35**

1.5 TDCi EOnetic 77 kW (105 PS) XXDB	09.2014→		7.02209.20.0	AGR	EL	 →05.2018
			7.04512.08.0	AGR-K		
1.6 TDCi 70 kW (95 PS) T3DA, T3DB	07.2010→		7.02209.11.0	AGR	EL	
			7.02156.35.0	AGR-K	EL	ohne Sensor without sensor  T3DA, T3DB: →05.2015 mit AGR-Ventil with EGR valve
			7.02156.24.0	AGR-K	EL	mit Sensor with sensor 
			7.02156.34.0	AGR-K		ohne Sensor without sensor
			7.02156.33.0	AGR-K		mit Sensor with sensor
1.6 TDCi 85 kW (115 PS) T1DA, T1DB	07.2010→		7.02209.11.0	AGR	EL	
			7.02156.35.0	AGR-K	EL	ohne Sensor without sensor  T1DA, T1DB: →05.2015 mit AGR-Ventil with EGR valve
			7.02156.24.0	AGR-K	EL	mit Sensor with sensor 
			7.02156.34.0	AGR-K		ohne Sensor without sensor
			7.02156.33.0	AGR-K		mit Sensor with sensor
1.6 TDCi EOnetic 77 kW (105 PS) NGDA, NGDB	05.2012→		7.02209.11.0	AGR	EL	
			7.02156.35.0	AGR-K	EL	ohne Sensor without sensor  NGDA, NGDB: →05.2015 mit AGR-Ventil with EGR valve
			7.03991.12.0	AGR-K	EL	 NGDA, NGDB: 06.2012→07.2015
			7.02156.34.0	AGR-K		ohne Sensor without sensor
2.0 TDCi 85 kW (116 PS) TYDA	07.2010→		7.24809.94.0	AGR-K	EL	 01.2011→07.2015
2.0 TDCi 103 kW (140 PS) UFDB	07.2010→		7.24809.94.0	AGR-K	EL	 01.2011→07.2015
2.0 TDCi 120 kW (163 PS) TXDB	07.2010→		7.24809.94.0	AGR-K	EL	 01.2011→07.2015
2.0 TDCi 100 kW (136 PS) UKDB	07.2010→		7.24809.94.0	AGR-K	EL	 01.2011→07.2015

FOCUS IV (HN) **36**

1.5 EcoBlue 70 kW (95 PS) Z2DA	01.2018→		7.07794.22.0	AGR	EL	mit Dichtring with O-ring
1.5 EcoBlue 88 kW (120 PS) ZTDA, ZTDB	01.2018→		7.07794.22.0	AGR	EL	mit Dichtring with O-ring
2.0 EcoBlue 110 kW (150 PS) YLDA	01.2018→		7.05578.15.0	AGR	EL	
			7.04511.29.0	AGR-M	EL	
2.0 ST EcoBlue 140 kW (190 PS) BCDA	04.2019→		7.05578.15.0	AGR	EL	
			7.04511.29.0	AGR-M	EL	





























						
FOCUS IV Saloon (HM)						37
1.5 EcoBlue 88 kW (120 PS) ZTDA, ZTDB	11.2018→		7.07794.22.0	AGR	EL	mit Dichtring with O-ring
1.5 EcoBlue 70 kW (95 PS) Z2DA	11.2018→		7.07794.22.0	AGR	EL	mit Dichtring with O-ring
FOCUS IV Turnier (HP)						38
1.5 EcoBlue 70 kW (95 PS) Z2DA	09.2018→		7.07794.22.0	AGR	EL	mit Dichtring with O-ring
1.5 EcoBlue 88 kW (120 PS) ZTDA, ZTDB	09.2018→		7.07794.22.0	AGR	EL	mit Dichtring with O-ring
2.0 EcoBlue 110 kW (150 PS) YLDA	09.2018→		7.05578.15.0	AGR	EL	
			7.04511.29.0	AGR-M	EL	
2.0 ST EcoBlue 140 kW (190 PS) BCDA	04.2019→		7.05578.15.0	AGR	EL	
			7.04511.29.0	AGR-M	EL	
FUSION (JU_)						39
1.25 55 kW (75 PS) FUJA, FUJB	08.2004→12.2012		7.02604.60.0	LS	400 mm	
1.4 TDCi 50-51 kW (68-69 PS) F6JA, F6JB	08.2002→12.2012		7.24809.06.0	AGR	PN	mit Rohrstützen with pipe socket   F6JA, F6JB: Euro 3 Euro 3
			7.24809.76.0	AGR	EL	
1.6 TDCi 66 kW (90 PS) HHJA, HHJB	11.2004→12.2012		7.24809.39.0	AGR	EL	
GALAXY I (WGR)						40
1.9 TDI 66 kW (90 PS) ANU	04.2000→05.2006		7.24809.19.0	AGR	PN	
1.9 TDI 85 kW (115 PS) AUY	04.2000→05.2006		7.24809.20.0	AGR	PN	
1.9 TDI 96 kW (130 PS) ASZ	02.2003→05.2006		7.24809.20.0	AGR	PN	
1.9 TDI 110 kW (150 PS) BTB	05.2005→05.2006		7.24809.20.0	AGR	PN	
2.0 i 85 kW (116 PS) NSE	11.1995→05.2006		7.02604.63.0	LS	375 mm	Regelsonde Regulating Probe
2.0 i 85 kW (116 PS) ZVSA	11.1995→05.2006		7.02604.64.0	LS	450 mm	
2.8 V6 150 kW (204 PS) AYL	04.2000→05.2006		7.22286.55.0	ARV	PN	
			7.22738.08.0	SLP	EL	
2.8 i V6 128 kW (174 PS) AAA, AMY	11.1995→04.2000		7.22090.11.0	ARV	PN	
			7.05270.88.0	LS	740 mm	01.1996→
			7.05270.96.0	LS	1440 mm	
2.8 i V6 4x4 128 kW (174 PS) AAA, AMY	04.1996→04.2000		7.22090.11.0	ARV	PN	
			7.05270.88.0	LS	740 mm	

F



GALAXY II (WA6) **41**

F

1.6 TDCi 85 kW (115 PS) T1WA, T1WB	02.2011→06.2015		7.02209.11.0	AGR	EL	 ohne Sensor without sensor T1WA, T1WB: mit AGR-Ventil with EGR valve mit Sensor with sensor ohne Sensor without sensor
			7.02156.35.0	AGR-K	EL	
			7.02156.33.0	AGR-K		
			7.02156.34.0	AGR-K		
1.8 TDCi 74 kW (100 PS) FFWA	05.2006→06.2015		7.24809.72.0	AGR	EL	mit Saugrohr with suction pipe  mit Saugrohr with suction pipe  mit Saugrohr with suction pipe  mit Saugrohr with suction pipe 
			↳ 7.24809.89.0	AGR	EL	
			7.24809.71.0	AGR	EL	
			↳ 7.24809.89.0	AGR	EL	
1.8 TDCi 92 kW (125 PS) QYWA	05.2006→06.2015		7.24809.72.0	AGR	EL	mit Saugrohr with suction pipe  mit Saugrohr with suction pipe  mit Saugrohr with suction pipe 
			↳ 7.24809.89.0	AGR	EL	
			7.24809.71.0	AGR	EL	
			↳ 7.24809.89.0	AGR	EL	
2.0 107 kW (145 PS) AOWA, AOWB, TBWA, TBWB	05.2006→06.2015		7.24809.73.0	AGR	EL	
2.0 Flexifuel 107 kW (145 PS) TBWA, TBWB	05.2006→06.2015		7.24809.73.0	AGR	EL	
2.0 TDCi 100 kW (136 PS) AZWC	05.2006→06.2015		7.24809.68.0	AGR	EL	
			7.09730.00.0	AGR-K		
2.0 TDCi 100 kW (136 PS) UKWA	05.2006→06.2015		7.24809.68.0	AGR	EL	
			7.24809.94.0	AGR-K	EL	
			7.09730.00.0	AGR-K		03.2010→04.2015
2.0 TDCi 96 kW (130 PS) AZWA	05.2006→06.2015		7.24809.68.0	AGR	EL	
			7.09730.00.0	AGR-K		ohne Zubehör without accessories Produktionsdatum bis: 08.04.2015 Production date to: 08.04.2015
			7.11190.10.0	DDS		
2.0 TDCi 103 kW (140 PS) UFWA	05.2006→06.2015		7.24809.94.0	AGR-K	EL	
2.0 TDCi 85 kW (115 PS) KLWA	11.2007→06.2015		7.24809.68.0	AGR	EL	
			7.09730.00.0	AGR-K		ohne Zubehör without accessories Produktionsdatum bis: 08.04.2015 Production date to: 08.04.2015
			7.11190.10.0	DDS		
2.0 TDCi 85 kW (115 PS) TYWA	11.2007→06.2015		7.24809.68.0	AGR	EL	
			7.24809.94.0	AGR-K	EL	
			7.09730.00.0	AGR-K		03.2010→04.2015

GALAXY II (WA6) 41

		7.11190.10.0	DDS		ohne Zubehör without accessories Produktionsdatum bis: 08.04.2015 Production date to: 08.04.2015
2.0 TDCi 118-120 kW (160-163 PS) TXWA	03.2010→06.2015	7.24809.94.0	AGR-K	EL	→04.2015
2.2 TDCi 129 kW (175 PS) Q4WA	03.2008→12.2012	7.00578.12.0	AGR	EL	
		7.11190.10.0	DDS		ohne Zubehör without accessories Produktionsdatum bis: 22.11.2010 Production date to: 22.11.2010
2.2 TDCi 147 kW (200 PS) KNWA	11.2010→06.2015	7.02604.99.0	LS	400 mm	
2.3 118 kW (160 PS) SEWA	09.2007→06.2015	7.24809.73.0	AGR	EL	

F
GALAXY III (CK) 42

2.0 EcoBlue 88 kW (120 PS) YNCA	07.2018→	7.05578.15.0	AGR	EL	nur in Verbindung mit: Motortyp EcoBlue B, Motortyp EcoBlue C, Motortyp EcoBlue D only in connection with: Motortyp EcoBlue B, Motortyp EcoBlue C, Motortyp EcoBlue D
		7.04511.29.0	AGR-M	EL	
2.0 EcoBlue 110 kW (150 PS) YMCB	07.2018→	7.05578.15.0	AGR	EL	nur in Verbindung mit: Motortyp EcoBlue B, Motortyp EcoBlue C, Motortyp EcoBlue D only in connection with: Motortyp EcoBlue B, Motortyp EcoBlue C, Motortyp EcoBlue D
		7.04511.29.0	AGR-M	EL	
2.0 EcoBlue 140 kW (190 PS) BCCC	07.2018→	7.05578.15.0	AGR	EL	nur in Verbindung mit: Motortyp EcoBlue B, Motortyp EcoBlue C, Motortyp EcoBlue D only in connection with: Motortyp EcoBlue B, Motortyp EcoBlue C, Motortyp EcoBlue D
		7.04511.29.0	AGR-M	EL	
2.0 EcoBlue 4x4 110 kW (150 PS) YMCB	07.2018→	7.05578.15.0	AGR	EL	nur in Verbindung mit: Motortyp EcoBlue B, Motortyp EcoBlue C, Motortyp EcoBlue D only in connection with: Motortyp EcoBlue B, Motortyp EcoBlue C, Motortyp EcoBlue D
		7.04511.29.0	AGR-M	EL	
2.0 EcoBlue 4x4 140 kW (190 PS) BCCC	07.2018→	7.05578.15.0	AGR	EL	nur in Verbindung mit: Motortyp EcoBlue B, Motortyp EcoBlue C, Motortyp EcoBlue D only in connection with: Motortyp EcoBlue B, Motortyp EcoBlue C, Motortyp EcoBlue D
		7.04511.29.0	AGR-M	EL	
2.0 EcoBlue Bi-Turbo 176 kW (240 PS) YLCB	07.2018→	7.05578.15.0	AGR	EL	nur in Verbindung mit: Motortyp EcoBlue B, Motortyp EcoBlue C, Motortyp EcoBlue D only in connection with: Motortyp EcoBlue B, Motortyp EcoBlue C, Motortyp EcoBlue D
		7.06036.14.0	AGR-K	EL	
		↳ 7.06036.15.0	AGR	EL	
		7.04511.29.0	AGR-M	EL	























GRANADA **43**







2.0i 85 kW (115 PS) N9F	02.1992→12.1994		7.02604.62.0	LS	680 mm	
----------------------------	-----------------	---	---------------------	----	--------	--

GRAND C-MAX (DXA/CB7, DXA/CEU) **44**

F

1.5 TDCi 70 kW (95 PS) XXDA, XXDC	03.2015→		7.02209.20.0	AGR	EL	
			7.04512.08.0	AGR-K		
1.5 TDCi 88 kW (120 PS) XWDA, XWDB, XWDC, XWDD, XWDE	03.2015→		7.02209.20.0	AGR	EL	
			7.04512.08.0	AGR-K		
1.6 TDCi 70 kW (95 PS) T3DA, T3DB	12.2010→		7.02209.11.0	AGR	EL	
			7.02156.35.0	AGR-K	EL	ohne Sensor without sensor  T3DA, T3DB: mit AGR-Ventil with EGR valve
			7.02156.33.0	AGR-K		mit Sensor with sensor
			7.02156.34.0	AGR-K		ohne Sensor without sensor
1.6 TDCi 85 kW (115 PS) T1DA, T1DB	12.2010→		7.02209.11.0	AGR	EL	
			7.02156.35.0	AGR-K	EL	ohne Sensor without sensor  T1DA, T1DB: mit AGR-Ventil with EGR valve
			7.02156.33.0	AGR-K		mit Sensor with sensor
			7.02156.34.0	AGR-K		ohne Sensor without sensor
2.0 TDCi 120 kW (163 PS) TXDB	12.2010→		7.24809.94.0	AGR-K	EL	 →06.2015
2.0 TDCi 85 kW (116 PS) TYDA	02.2011→		7.24809.94.0	AGR-K	EL	 →06.2015
2.0 TDCi 103 kW (140 PS) UFDB	02.2011→		7.24809.94.0	AGR-K	EL	 →06.2015
2.0 TDCi 100 kW (136 PS) UKDB	02.2011→		7.24809.94.0	AGR-K	EL	 →06.2015

KA (RB_) **45**







1.3 i 37 kW (50 PS) JJB	09.1996→10.2002		7.02604.62.0	LS	680 mm	
			7.02604.64.0	LS	450 mm	12.1998→
			7.02604.60.0	LS	400 mm	09.2000→ Diagnosesonde Diagnostic Probe
1.3 i 44 kW (60 PS) BAA	09.1996→11.2008		7.02604.62.0	LS	680 mm	
			7.02604.60.0	LS	400 mm	→09.2008 Diagnosesonde Diagnostic Probe
1.3 i 44 kW (60 PS) J4D, J4K, J4M, J4N, J4P, J4S	09.1996→11.2008		7.02604.62.0	LS	680 mm	
			7.02604.64.0	LS	450 mm	 J4D, J4K, J4M, J4N, J4P, J4S: 12.1998→
			7.02604.60.0	LS	400 mm	 J4D, J4K, J4M, J4N, J4P, J4S: 09.2000→ Diagnosesonde Diagnostic Probe
1.3 i 36 kW (49 PS) JJD, JJF, JJG, JJH, JJJ	06.1998→11.2008		7.02604.62.0	LS	680 mm	

KA (RB_)					45
			7.02604.64.0	LS	450 mm JJD, JJF, JJG, JJH, JJJ: 12.1998→
			7.02604.60.0	LS	400 mm JJD, JJF, JJG, JJH, JJJ: 09.2000→ Diagnosesonde Diagnostic Probe
1.3 i 51 kW (70 PS) A9A, A9B	08.2002→11.2008		7.02604.60.0	LS	400 mm A9A, A9B: →09.2008 Diagnosesonde Diagnostic Probe
1.6 i 70 kW (95 PS) CDB, CDC	02.2001→11.2008		7.02604.60.0	LS	400 mm
KA (RU8)					46
1.3 TDCi 55 kW (75 PS) 169A1000, FD4	10.2008→05.2016		7.00020.39.0	AGR	EL
			7.03622.06.0	AGR-K	
			7.11190.03.0	DDS	169A1000, FD4: 11.2010→ ohne Zubehör without accessories 169A1000: Produktionsdatum ab: 01.06.2016, 02.11.2010 Production date from: 01.06.2016, 02.11.2010 FD4: Produktionsdatum ab: 02.11.2010 Production date from: 02.11.2010 Produktionsdatum bis: 01.06.2016 Production date to: 01.06.2016 169A1000, FD4: Produktionsdatum bis: 02.11.2010 Production date to: 02.11.2010
			7.11190.04.0	DDS	169A1000, FD4: Produktionsdatum bis: 02.11.2010 Production date to: 02.11.2010
KA+ III (UK, FK)					47
1.5 TDCi 66-74 kW (91-101 PS) 15DSOX, DV5FD	09.2015→		7.02209.20.0	AGR	EL 15DSOX, DV5FD: 02.2018→
			7.02156.35.0	AGR-K	EL ohne Sensor without sensor 15DSOX, DV5FD: mit AGR-Ventil with EGR valve
			7.04512.08.0	AGR-K	
			7.02156.34.0	AGR-K	15DSOX, DV5FD: 02.2018→ ohne Sensor without sensor
1.5 TDCi 70 kW (95 PS) DV5FD	02.2018→		7.02209.20.0	AGR	EL
			7.02156.35.0	AGR-K	EL ohne Sensor without sensor mit AGR-Ventil with EGR valve
			7.02156.34.0	AGR-K	ohne Sensor without sensor ohne AGR-Ventil without EGR valve
			7.04512.08.0	AGR-K	
1.5 TDCi 70 kW (95 PS) DV5FD	02.2018→		7.02209.20.0	AGR	EL
			7.02156.35.0	AGR-K	EL ohne Sensor without sensor mit AGR-Ventil with EGR valve
			7.02156.34.0	AGR-K	ohne Sensor without sensor ohne AGR-Ventil without EGR valve
			7.04512.08.0	AGR-K	

F















KA+ III Saloon (TK, FK) 48















1.5 TDCi 66-74 kW (91-101 PS) 15DSOX, DV5FD	09.2015→	 7.02209.20.0	AGR	EL	
		 7.02156.35.0	AGR-K	EL	
		 7.04512.08.0	AGR-K		<input checked="" type="checkbox"/>
		 7.02156.34.0	AGR-K		<input checked="" type="checkbox"/>
15DSOX, DV5FD: 02.2018→ ohne Sensor without sensor 15DSOX, DV5FD: mit AGR-Ventil with EGR valve 15DSOX, DV5FD: 02.2018→ ohne Sensor without sensor					



























F

KUGA I 49

2.0 TDCi 100 kW (136 PS) G6DG, UKDA	03.2008→11.2012	 7.24809.68.0	AGR	EL	<input type="checkbox"/>
		 7.09730.00.0	AGR-K		
		 7.11190.10.0	DDS		
ohne Zubehör without accessories					
2.0 TDCi 103 kW (140 PS) UFDA	03.2010→11.2012	 7.24809.94.0	AGR-K	EL	<input type="checkbox"/>
05.2010→					
2.0 TDCi 4x4 100 kW (136 PS) G6DG	03.2008→11.2012	 7.24809.68.0	AGR	EL	<input type="checkbox"/>
		 7.09730.00.0	AGR-K		
		 7.11190.10.0	DDS		
ohne Zubehör without accessories					
2.0 TDCi 4x4 100 kW (136 PS) UKDA	03.2008→11.2012	 7.24809.68.0	AGR	EL	<input type="checkbox"/>
		 7.24809.94.0	AGR-K	EL	<input type="checkbox"/>
		 7.09730.00.0	AGR-K		
 7.11190.10.0	DDS				
05.2010→ ohne Zubehör without accessories					
2.0 TDCi 4x4 103 kW (140 PS) UFDA	03.2010→11.2012	 7.24809.94.0	AGR-K	EL	<input type="checkbox"/>
05.2010→					
2.0 TDCi 4x4 118-120 kW (160-163 PS) TXDA	03.2010→11.2012	 7.24809.94.0	AGR-K	EL	<input type="checkbox"/>
05.2010→					

KUGA II (DM2) 50







1.5 TDCi 88 kW (120 PS) XWMB, XWMC	07.2016→	 7.02209.20.0	AGR	EL	<input type="checkbox"/>
		 7.04512.08.0	AGR-K		<input checked="" type="checkbox"/>
2.0 TDCi 103 kW (140 PS) UFMA	03.2013→	 7.24809.94.0	AGR-K	EL	<input type="checkbox"/>
→02.2019					
2.0 TDCi 100 kW (136 PS) UKMA	03.2013→	 7.24809.94.0	AGR-K	EL	<input type="checkbox"/>
→02.2019					
2.0 TDCi 85 kW (115 PS) TYMA	03.2013→	 7.24809.94.0	AGR-K	EL	<input type="checkbox"/>
→02.2019					
2.0 TDCi 110 kW (150 PS) T7MA, T7MB	09.2014→	 7.24809.94.0	AGR-K	EL	<input type="checkbox"/>
 T7MA, T7MB: →02.2019					
2.0 TDCi 4x4 103 kW (140 PS) UFMA	03.2013→	 7.24809.94.0	AGR-K	EL	<input type="checkbox"/>
→02.2019					
2.0 TDCi 4x4 120 kW (163 PS) TXMA	03.2013→	 7.24809.94.0	AGR-K	EL	<input type="checkbox"/>
→02.2019					
2.0 TDCi 4x4 100 kW (136 PS) UKMA	03.2013→	 7.24809.94.0	AGR-K	EL	<input type="checkbox"/>
→02.2019					
2.0 TDCi 4x4 110 kW (150 PS) T7MA, T7MB	09.2014→	 7.24809.94.0	AGR-K	EL	<input type="checkbox"/>
 T7MA, T7MB: →02.2019					
2.0 TDCi 4x4 132 kW (180 PS) T8MA, T8MB	09.2014→	 7.24809.94.0	AGR-K	EL	<input type="checkbox"/>
 T8MA, T8MB: →02.2019					
2.5 110 kW (150 PS) YTMA	01.2014→	 7.24809.73.0	AGR	EL	<input type="checkbox"/>

						
KUGA III (DFK)						51
1.5 EcoBlue 88 kW (120 PS) ZTDA	07.2019→		7.07794.22.0	AGR	EL	mit Dichtring with O-ring
2.0 EcoBlue 4x4 140 kW (190 PS) YMDA	07.2019→		7.05578.15.0	AGR	EL	
2.0 EcoBlue mHEV 110 kW (150 PS) YLDC	07.2019→		7.05578.15.0	AGR	EL	nur in Verbindung mit: Motortyp EcoBlue A, Motortyp EcoBlue B only in connection with: Motortyp EcoBlue A, Motortyp EcoBlue B Produktionsdatum ab: 07.01.2020 Production date from: 07.01.2020
			7.04511.29.0	AGR-M	EL	
MAVERICK						52
2.3 16V 108-114 kW (147-155 PS) GZ	03.2004→		7.24809.73.0	AGR	EL	 →04.2006
3.0 V6 24V 145-149 kW (197-203 PS) AJ	02.2001→		7.02604.60.0	LS	400 mm	
3.0 V6 24V 145-149 kW (197-203 PS) AJ	03.2004→		7.02604.60.0	LS	400 mm	
MONDEO I (GBP)						53
1.6 i 16V 66 kW (90 PS) L1F	02.1993→08.1996		7.02604.64.0	LS	450 mm	
1.6 i 16V 65-66 kW (88-90 PS) L1J	07.1994→07.1996		7.02604.64.0	LS	450 mm	
1.8 i 16V 85 kW (115 PS) RKA	02.1993→08.1996		7.02604.64.0	LS	450 mm	
			7.02604.61.0	LS	375 mm	
1.8 i 16V 82-85 kW (111-116 PS) RKB	07.1994→08.1996		7.02604.64.0	LS	450 mm	
			7.02604.61.0	LS	375 mm	
1.8 i 16V 4x4 85 kW (115 PS) RKA	02.1993→08.1996		7.02604.64.0	LS	450 mm	
			7.02604.61.0	LS	375 mm	
2.0 i 16V 96-100 kW (131-136 PS) NGA	02.1993→08.1996		7.02604.64.0	LS	450 mm	
2.0 i 16V 96-100 kW (131-136 PS) NGA	12.1994→08.1996		7.02604.64.0	LS	450 mm	
2.0 i 16V 4x4 96-100 kW (131-136 PS) NGA	04.1993→08.1996		7.02604.64.0	LS	450 mm	
2.0 i 16V 4x4 96-100 kW (131-136 PS) NGA	12.1994→08.1996		7.02604.64.0	LS	450 mm	
2.5 i 24V 125 kW (170 PS) SEA	07.1994→08.1996		7.02604.60.0	LS	400 mm	
MONDEO I Saloon (GBP)						54
1.6 i 16V 66 kW (90 PS) L1F	02.1993→08.1996		7.02604.64.0	LS	450 mm	
1.6 i 16V 65-66 kW (88-90 PS) L1J	07.1994→07.1996		7.02604.64.0	LS	450 mm	
1.8 4x4 85 kW (115 PS) RKA	02.1993→08.1996		7.02604.64.0	LS	450 mm	
			7.02604.61.0	LS	375 mm	



MONDEO I Saloon (GBP)





54

1.8 i 16V 85 kW (115 PS) RKA	02.1993→08.1996		7.02604.64.0	LS	450 mm
			7.02604.61.0	LS	375 mm
1.8 i 16V 82-85 kW (111-116 PS) RKB	01.1994→08.1996		7.02604.64.0	LS	450 mm
			7.02604.61.0	LS	375 mm
2.0 i 16V 96-100 kW (131-136 PS) NGA	02.1993→08.1996		7.02604.64.0	LS	450 mm
2.0 i 16V 4x4 96-100 kW (131-136 PS) NGA	02.1993→08.1996		7.02604.64.0	LS	450 mm
2.0 i 16V 4x4 96-100 kW (131-136 PS) NGA	12.1994→08.1996		7.02604.64.0	LS	450 mm
2.5 i 24V 125 kW (170 PS) SEA	07.1994→08.1996		7.02604.60.0	LS	400 mm

F



MONDEO I Turnier (BNP)

55

1.6 i 16V 66 kW (90 PS) L1F	04.1993→08.1996		7.02604.64.0	LS	450 mm
1.6 i 16V 65-66 kW (88-90 PS) L1J	07.1994→07.1996		7.02604.64.0	LS	450 mm
1.8 i 16V 85 kW (115 PS) RKA	04.1993→08.1996		7.02604.64.0	LS	450 mm
			7.02604.61.0	LS	375 mm
1.8 i 16V 82-85 kW (111-116 PS) RKB	07.1994→08.1996		7.02604.64.0	LS	450 mm
			7.02604.61.0	LS	375 mm
1.8 i 16V 4x4 85 kW (115 PS) RKA	04.1993→08.1996		7.02604.64.0	LS	450 mm
			7.02604.61.0	LS	375 mm
2.0 i 16V 96-100 kW (131-136 PS) NGA	01.1993→08.1996		7.02604.64.0	LS	450 mm
2.0 i 16V 96-100 kW (131-136 PS) NGA	04.1993→08.1996		7.02604.64.0	LS	450 mm
2.0 i 16V 4x4 96-100 kW (131-136 PS) NGA	04.1993→08.1996		7.02604.64.0	LS	450 mm
2.0 i 16V 4x4 96-100 kW (131-136 PS) NGA	12.1994→08.1996		7.02604.64.0	LS	450 mm
2.5 i 24V 125 kW (170 PS) SEA	07.1994→08.1996		7.02604.60.0	LS	400 mm

MONDEO II (BAP)





































56

1.6 i 65-66 kW (88-90 PS) L1J	08.1996→09.2000		7.02604.61.0	LS	375 mm
1.6 i 16V 70 kW (95 PS) L1L, L1N, L1Q	05.1998→09.2000		7.02604.61.0	LS	375 mm
1.8 i 82-85 kW (111-116 PS) RKB, RKF, RKH, RKJ, RKK	08.1996→09.2000		7.02604.61.0	LS	375 mm

MONDEO II Saloon (BFP)

57







1.6 i 65-66 kW (88-90 PS) L1J	08.1996→09.2000		7.02604.61.0	LS	375 mm

						
MONDEO II Saloon (BFP)						57
1.6 i 16V 70 kW (95 PS) L1L, L1N, L1Q	05.1998→09.2000		7.02604.61.0	LS	375 mm	
1.8 i 82-85 kW (111-116 PS) RKB, RKF, RKH, RKJ, RKK	08.1996→09.2000		7.02604.61.0	LS	375 mm	
MONDEO II Turnier (BNP)						58
1.6 i 65-66 kW (88-90 PS) L1J	08.1996→09.2000		7.02604.61.0	LS	375 mm	
1.6 i 16V 70 kW (95 PS) L1L, L1N, L1Q	05.1998→09.2000		7.02604.61.0	LS	375 mm	
1.8 i 82-85 kW (111-116 PS) RKA, RKB, RKF, RKH, RKJ, RKK	08.1996→09.2000		7.02604.61.0	LS	375 mm	
MONDEO III (B5Y)						59
1.8 16V 81 kW (110 PS) CGBA, CGBB	10.2000→03.2007		7.24809.73.0	AGR	EL 	
1.8 16V 92 kW (125 PS) CHBA, CHBB	10.2000→03.2007		7.24809.73.0	AGR	EL 	
2.0 16V 106-107 kW (144-146 PS) CJBA, CJBB	10.2000→03.2007		7.24809.73.0	AGR	EL 	
2.0 16V DI / TDDi / TDCi 66 kW (90 PS) D5BA	10.2000→03.2007		7.24809.07.0	AGR	PN mit Potentiometer with potentiometer  05.2002→	
2.0 16V DI / TDDi / TDCi 66 kW (90 PS) SDBA	10.2000→03.2007		7.24809.07.0	AGR	PN mit Potentiometer with potentiometer  05.2002→	
			7.11190.10.0	DDS	ohne Zubehör without accessories Produktionsdatum ab: 01.02.2006 Production date from: 01.02.2006 Produktionsdatum bis: 19.03.2007 Production date to: 19.03.2007	
2.0 16V TDDi / TDCi 85 kW (115 PS) D6BA, HJBA, HJBB, HJBC	10.2000→03.2007		7.24809.07.0	AGR	PN mit Potentiometer with potentiometer 	
2.0 DI 92 kW (125 PS) PD20FMCR	10.2000→03.2007		7.24809.07.0	AGR	PN mit Potentiometer with potentiometer 	
2.0 TDCi 96 kW (130 PS) FMBA, N7BA	10.2001→03.2007		7.11190.10.0	DDS	ohne Zubehör without accessories  FMBA, N7BA: Produktionsdatum ab: 01.02.2006 Production date from: 01.02.2006	
2.2 TDCi 114 kW (155 PS) QJBA, QJBB	09.2004→03.2007		7.11190.10.0	DDS	ohne Zubehör without accessories  QJBA: Produktionsdatum ab: 01.02.2006 Production date from: 01.02.2006  QJBB: Produktionsdatum ab: 01.02.2006 Production date from: 01.02.2006 Produktionsdatum bis: 19.03.2007 Production date to: 19.03.2007	
3.0 V6 24V 150 kW (204 PS) REBA	09.2004→03.2007		7.02604.60.0	LS	400 mm	
MONDEO III Saloon (B4Y)						60
1.8 16V 81 kW (110 PS) CGBA, CGBB	10.2000→03.2007		7.24809.73.0	AGR	EL 	
1.8 16V 92 kW (125 PS) CHBA, CHBB	10.2000→03.2007		7.24809.73.0	AGR	EL 	
2.0 16V 106-107 kW (144-146 PS) CJBA, CJBB	10.2000→03.2007		7.24809.73.0	AGR	EL 	

F





































MONDEO III Saloon (B4Y) **60**

2.0 16V DI / TDDi / TDCi 66 kW (90 PS) D5BA	10.2000→03.2007		7.24809.07.0	AGR	PN	mit Potentiometer with potentiometer ○ 05.2002→
2.0 16V DI / TDDi / TDCi 66 kW (90 PS) SDBA	10.2000→03.2007		7.24809.07.0	AGR	PN	mit Potentiometer with potentiometer ○ 05.2002→
			7.11190.10.0	DDS		ohne Zubehör without accessories Produktionsdatum ab: 01.02.2006 Production date from: 01.02.2006 Produktionsdatum bis: 19.03.2007 Production date to: 19.03.2007
2.0 16V TDDi / TDCi 85 kW (115 PS) D6BA, HJBA, HJBB, HJBC	10.2000→03.2007		7.24809.07.0	AGR	PN	mit Potentiometer with potentiometer ○
2.0 DI 92 kW (125 PS) PD20FMCR	10.2000→03.2007		7.24809.07.0	AGR	PN	mit Potentiometer with potentiometer ○
2.0 TDCi 96 kW (130 PS) FMBA, N7BA	10.2001→03.2007		7.11190.10.0	DDS		ohne Zubehör without accessories FMBA, N7BA: Produktionsdatum ab: 01.02.2006 Production date from: 01.02.2006
2.2 TDCi 114 kW (155 PS) QJBA, QJBB	09.2004→03.2007		7.11190.10.0	DDS		ohne Zubehör without accessories QJBA: Produktionsdatum ab: 01.02.2006 Production date from: 01.02.2006 QJBB: Produktionsdatum ab: 01.02.2006 Production date from: 01.02.2006 Produktionsdatum bis: 19.03.2007 Production date to: 19.03.2007
3.0 V6 24V 150 kW (204 PS) REBA	09.2004→03.2007		7.02604.60.0	LS	400 mm	

















MONDEO III Turnier (BWY) **61**

1.8 16V 81 kW (110 PS) CGBA, CGBB	10.2000→03.2007		7.24809.73.0	AGR	EL	○
1.8 16V 92 kW (125 PS) CHBA, CHBB	10.2000→03.2007		7.24809.73.0	AGR	EL	○
2.0 16V 106-107 kW (144-146 PS) CJBA, CJBB	10.2000→03.2007		7.24809.73.0	AGR	EL	○
2.0 16V DI / TDDi / TDCi 66 kW (90 PS) D5BA	10.2000→03.2007		7.24809.07.0	AGR	PN	mit Potentiometer with potentiometer ○ 05.2002→
2.0 16V DI / TDDi / TDCi 66 kW (90 PS) SDBA	10.2000→03.2007		7.24809.07.0	AGR	PN	mit Potentiometer with potentiometer ○ 05.2002→
			7.11190.10.0	DDS		ohne Zubehör without accessories Produktionsdatum ab: 01.02.2006 Production date from: 01.02.2006
2.0 16V TDDi / TDCi 85 kW (115 PS) D6BA, HJBA, HJBB, HJBC	10.2000→03.2007		7.24809.07.0	AGR	PN	mit Potentiometer with potentiometer ○





















					
MONDEO III Turnier (BWY)					
61					
2.0 TDCi 96 kW (130 PS) FMBA, N7BA	10.2001→03.2007		7.11190.10.0	DDS	ohne Zubehör without accessories  FMBA: Produktionsdatum ab: 01.02.2006 Production date from: 01.02.2006  N7BA: Produktionsdatum ab: 01.02.2006 Production date from: 01.02.2006 Produktionsdatum bis: 19.03.2007 Production date to: 19.03.2007
2.2 TDCi 114 kW (155 PS) QJBA, QJBB	09.2004→03.2007		7.11190.10.0	DDS	ohne Zubehör without accessories  QJBA: Produktionsdatum ab: 01.02.2006 Production date from: 01.02.2006  QJBB: Produktionsdatum ab: 01.02.2006 Production date from: 01.02.2006 Produktionsdatum bis: 19.03.2007 Production date to: 19.03.2007
3.0 V6 24V 150 kW (204 PS) REBA	09.2004→03.2007		7.02604.60.0	LS	400 mm
MONDEO IV (BA7)					
62					
1.6 TDCi 85 kW (115-116 PS) T1BA, T1BB, T1BC	02.2011→01.2015		7.02209.11.0	AGR	EL 
			7.02156.24.0	AGR-K	EL mit Sensor with sensor 
			7.02156.35.0	AGR-K	EL ohne Sensor without sensor  T1BA, T1BB, T1BC: mit AGR-Ventil with EGR valve
			7.02156.33.0	AGR-K	mit Sensor with sensor
			7.02156.34.0	AGR-K	ohne Sensor without sensor
1.8 TDCi 74 kW (100 PS) FFBA	03.2007→01.2015		7.24809.71.0	AGR	EL mit Saugrohr with suction pipe 
			↳ 7.24809.89.0	AGR	EL
1.8 TDCi 92 kW (125 PS) KHBA, QYBA	06.2007→01.2015		7.24809.71.0	AGR	EL mit Saugrohr with suction pipe 
			↳ 7.24809.89.0	AGR	EL
2.0 107 kW (145 PS) AOBA, AOBC, TBBA, TBBA	03.2007→01.2015		7.24809.73.0	AGR	EL 
2.0 Flexifuel 107 kW (145 PS) TBBA, TBBA	03.2009→01.2015		7.24809.73.0	AGR	EL 
2.0 LPG 107 kW (145 PS) TBBA	07.2009→01.2015		7.24809.73.0	AGR	EL 
2.0 TDCi 100-103 kW (136-140 PS) AZBC	03.2007→12.2014		7.24809.68.0	AGR	EL 
			7.09730.00.0	AGR-K	
2.0 TDCi 100 kW (136 PS) UKBA, UKBB	03.2007→12.2014		7.24809.68.0	AGR	EL 
			7.24809.94.0	AGR-K	EL  UKBA, UKBB: 03.2010→
			7.09730.00.0	AGR-K	
2.0 TDCi 96 kW (131 PS) AZBA	03.2007→01.2015		7.24809.68.0	AGR	EL 
			7.09730.00.0	AGR-K	
			7.11190.10.0	DDS	ohne Zubehör without accessories



MONDEO IV (BA7) 62

F	2.0 TDCi 103 kW (140 PS) UFBA, UFBB	03.2007→01.2015		7.24809.94.0	AGR-K	EL	  UFBA, UFBB: 03.2010→12.2014
	2.0 TDCi 85 kW (115-116 PS) KLBA, LPBA	11.2007→01.2015		7.24809.68.0 7.09730.00.0 7.11190.10.0	AGR AGR-K DDS	EL	 ohne Zubehör without accessories
	2.0 TDCi 85 kW (115 PS) TYBA	11.2007→01.2015		7.24809.68.0 7.24809.94.0 7.09730.00.0 7.11190.10.0	AGR AGR-K AGR-K DDS	EL EL	  03.2010→12.2014 ohne Zubehör without accessories
	2.0 TDCi 120 kW (163 PS) TXBA, TXBB	03.2010→01.2015		7.24809.94.0	AGR-K	EL	  TXBA, TXBB: →12.2014
	2.2 TDCi 129 kW (175 PS) Q4BA	03.2008→10.2010		7.00578.12.0 7.11190.10.0	AGR DDS	EL	 ohne Zubehör without accessories
	2.2 TDCi 147 kW (200 PS) KNBA	07.2010→01.2015		7.02604.99.0	LS	400 mm	
	2.3 118 kW (160 PS) SEBA	07.2007→01.2015		7.24809.73.0	AGR	EL	
	2.5 162 kW (220 PS) HUBA	03.2007→01.2015		7.05270.67.0 7.05270.80.0	LS LS	770 mm 650 mm	

MONDEO IV Saloon (BA7) 63

F	1.6 TDCi 85 kW (115-116 PS) T1BA, T1BB, T1BC	12.2010→01.2015		7.02209.11.0 7.02156.35.0 7.02156.24.0 7.02156.34.0 7.02156.33.0	AGR AGR-K AGR-K AGR-K AGR-K	EL EL EL	 ohne Sensor without sensor mit Sensor with sensor  ohne Sensor without sensor mit Sensor with sensor
	1.8 TDCi 74 kW (100 PS) FFBA	03.2007→01.2015		7.24809.71.0 ↳ 7.24809.89.0	AGR AGR	EL EL	mit Saugrohr with suction pipe  
	1.8 TDCi 92 kW (125 PS) KHBA, QYBA	06.2007→01.2015		7.24809.71.0 ↳ 7.24809.89.0	AGR AGR	EL EL	mit Saugrohr with suction pipe  
	2.0 107 kW (145 PS) AOBA, AOBC, TBBA, TBBB	03.2007→01.2015		7.24809.73.0	AGR	EL	
	2.0 Flexifuel 107 kW (145 PS) TBBA, TBBB	03.2009→01.2015		7.24809.73.0	AGR	EL	
	2.0 LPG 107 kW (145 PS) TBBA	07.2009→01.2015		7.24809.73.0	AGR	EL	
	2.0 TDCi 96 kW (131 PS) AZBA	03.2007→01.2015		7.24809.68.0 7.11190.10.0	AGR DDS	EL	 ohne Zubehör without accessories
	2.0 TDCi 103 kW (140 PS) UFBA, UFBB	03.2007→01.2015		7.24809.94.0	AGR-K	EL	  UFBA, UFBB: 03.2010→12.2014

MONDEO IV Saloon (BA7)
63

2.0 TDCi 85 kW (115-116 PS) KLBA, LPBA	11.2007→01.2015		7.24809.68.0	AGR	EL	 ohne Zubehör without accessories KLBA, LPBA: Produktionsdatum ab: 19.02.2007 Production date from: 19.02.2007 Produktionsdatum bis: 22.12.2014 Production date to: 22.12.2014
			7.09730.00.0	AGR-K		
			7.11190.10.0	DDS		
2.0 TDCi 85 kW (115 PS) TYBA	11.2007→01.2015		7.24809.68.0	AGR	EL	 ohne Zubehör without accessories Produktionsdatum ab: 19.02.2007 Production date from: 19.02.2007 Produktionsdatum bis: 22.12.2014 Production date to: 22.12.2014
			7.24809.94.0	AGR-K	EL	
			7.09730.00.0	AGR-K		
			7.11190.10.0	DDS		
2.0 TDCi 100-103 kW (136-140 PS) AZBC	08.2008→12.2014		7.09730.00.0	AGR-K		
2.0 TDCi 100 kW (136 PS) UKBA, UKBB	08.2008→12.2014		7.24809.94.0	AGR-K	EL	UKBA, UKBB: 03.2010→
			7.09730.00.0	AGR-K		
2.0 TDCi 120 kW (163 PS) TXBA, TXBB	03.2010→01.2015		7.24809.94.0	AGR-K	EL	TXBA, TXBB: →12.2014
2.2 TDCi 129 kW (175 PS) Q4BA	03.2008→10.2010		7.00578.12.0	AGR	EL	 ohne Zubehör without accessories
			7.11190.10.0	DDS		
2.3 118 kW (160 PS) SEBA	07.2007→01.2015		7.24809.73.0	AGR	EL	
2.5 162 kW (220 PS) HUBA	03.2007→01.2015		7.05270.67.0	LS	770 mm	
			7.05270.80.0	LS	650 mm	















F
MONDEO IV Turnier (BA7)
64

1.6 TDCi 85 kW (115-116 PS) T1BA, T1BB, T1BC	02.2011→01.2015		7.02209.11.0	AGR	EL	 mit Sensor with sensor ohne Sensor without sensor T1BA, T1BB, T1BC: mit AGR-Ventil with EGR valve mit Sensor with sensor ohne Sensor without sensor
			7.02156.24.0	AGR-K	EL	
			7.02156.35.0	AGR-K	EL	
			7.02156.33.0	AGR-K		
			7.02156.34.0	AGR-K		
1.8 TDCi 74 kW (100 PS) FFBA	03.2007→12.2012		7.24809.71.0	AGR	EL	mit Saugrohr with suction pipe
			↳7.24809.89.0	AGR	EL	
1.8 TDCi 92 kW (125 PS) KHBA, QYBA	06.2007→12.2012		7.24809.71.0	AGR	EL	mit Saugrohr with suction pipe
			↳7.24809.89.0	AGR	EL	
2.0 107 kW (145 PS) AOBA, AOBC, TBBA, TBBB	03.2007→01.2015		7.24809.73.0	AGR	EL	





























MONDEO IV Turnier (BA7) **64**

F

























2.0 Flexifuel 107 kW (145 PS) TBBA, TBBB	03.2009→01.2015	 7.24809.73.0	AGR	EL	<input type="checkbox"/>
2.0 LPG 107 kW (145 PS) TBBA	07.2009→01.2015	 7.24809.73.0	AGR	EL	<input type="checkbox"/>
2.0 TDCi 100-103 kW (136-140 PS) AZBC	03.2007→12.2014	 7.24809.68.0	AGR	EL	<input type="checkbox"/>
2.0 TDCi 100 kW (136 PS) UKBA, UKBB	03.2007→12.2014	 7.09730.00.0	AGR-K		
		 7.24809.68.0	AGR	EL	<input type="checkbox"/>
		7.24809.94.0	AGR-K	EL	<input type="checkbox"/>
7.09730.00.0	AGR-K				
2.0 TDCi 96 kW (131 PS) AZBA	03.2007→12.2012	 7.24809.68.0	AGR	EL	<input type="checkbox"/>
		7.11190.10.0	DDS		ohne Zubehör without accessories
2.0 TDCi 103 kW (140 PS) UFBA, UFBB	03.2007→01.2015	 7.24809.94.0	AGR-K	EL	<input type="checkbox"/>
2.0 TDCi 85 kW (115-116 PS) KLBA, LPBA	11.2007→01.2015	 7.24809.68.0	AGR	EL	<input type="checkbox"/>
		7.09730.00.0	AGR-K		
		7.11190.10.0	DDS		ohne Zubehör without accessories  KLBA, LPBA: Produktionsdatum bis: 22.12.2014 Production date to: 22.12.2014
2.0 TDCi 85 kW (115 PS) TYBA	11.2007→01.2015	 7.24809.68.0	AGR	EL	<input type="checkbox"/>
		7.24809.94.0	AGR-K	EL	<input type="checkbox"/>
		7.09730.00.0	AGR-K		03.2010→12.2014
		7.11190.10.0	DDS		ohne Zubehör without accessories Produktionsdatum bis: 22.12.2014 Production date to: 22.12.2014
2.0 TDCi 120 kW (163 PS) TXBA, TXBB	03.2010→01.2015	 7.24809.94.0	AGR-K	EL	<input type="checkbox"/>
2.2 TDCi 129 kW (175 PS) Q4BA	03.2008→10.2010	 7.00578.12.0	AGR	EL	<input type="checkbox"/>
		7.11190.10.0	DDS		ohne Zubehör without accessories
2.2 TDCi 147 kW (200 PS) KNBA	07.2010→01.2015	 7.02604.99.0	LS	400 mm	
2.3 118 kW (160 PS) SEBA	07.2007→01.2015	 7.24809.73.0	AGR	EL	<input type="checkbox"/>
2.5 162 kW (220 PS) HUBA	03.2007→12.2012	 7.05270.67.0	LS	770 mm	
		7.05270.80.0	LS	650 mm	

MONDEO V Hatchback (CE) **65**

1.5 TDCi 88 kW (120 PS) UGCC, XUCA	03.2015→	 7.02209.20.0	AGR	EL	<input type="checkbox"/>
		7.04512.08.0	AGR-K		<input checked="" type="checkbox"/>
1.6 TDCi 85 kW (115 PS) NGCA	09.2014→	 7.02209.11.0	AGR	EL	<input type="checkbox"/>
		7.03991.12.0	AGR-K	EL	<input type="checkbox"/>
1.6 TDCi 85 kW (115 PS) U3CA	09.2014→	 7.02209.11.0	AGR	EL	<input type="checkbox"/>
2.0 EcoBlue 88 kW (120 PS) BCCD	01.2019→	 7.04511.29.0	AGR-M	EL	<input type="checkbox"/>

						
MONDEO V Hatchback (CE)						65
2.0 EcoBlue 110 kW (150 PS) YLCC	01.2019→		7.05578.15.0	AGR	EL	
			7.04511.29.0	AGR-M	EL	○
2.0 EcoBlue 140 kW (190 PS) YMCC	01.2019→		7.05578.15.0	AGR	EL	
			7.04511.29.0	AGR-M	EL	○
2.0 EcoBlue 4x4 140 kW (190 PS) YMCC	01.2019→		7.05578.15.0	AGR	EL	
			7.04511.29.0	AGR-M	EL	○
MONDEO V Saloon (CD)						66
1.5 TDCi 88 kW (120 PS) UGCC, XUCA	03.2015→		7.02209.20.0	AGR	EL	○
			7.04512.08.0	AGR-K		⊗
2.0 EcoBlue 88 kW (120 PS) BCCD	01.2019→		7.04511.29.0	AGR-M	EL	○
2.0 EcoBlue 140 kW (190 PS) YMCC	01.2019→		7.05578.15.0	AGR	EL	
			7.04511.29.0	AGR-M	EL	○
2.0 EcoBlue 110 kW (150 PS) YLCC	01.2019→		7.05578.15.0	AGR	EL	
			7.04511.29.0	AGR-M	EL	○
2.0 EcoBlue 4x4 140 kW (190 PS) YMCC	01.2019→		7.05578.15.0	AGR	EL	
			7.04511.29.0	AGR-M	EL	○
2.5 110 kW (149 PS) S7CB	05.2015→		7.24809.73.0	AGR	EL	○
MONDEO V Turnier (CF)						67
1.5 TDCi 88 kW (120 PS) UGCC, XUCA	03.2015→		7.02209.20.0	AGR	EL	○
			7.04512.08.0	AGR-K		⊗
1.6 TDCi 85 kW (115 PS) NGCA	09.2014→		7.02209.11.0	AGR	EL	○
			7.03991.12.0	AGR-K	EL	○
1.6 TDCi 85 kW (115 PS) U3CA	09.2014→		7.02209.11.0	AGR	EL	○
2.0 EcoBlue 88 kW (120 PS) BCCD	01.2019→		7.04511.29.0	AGR-M	EL	○
2.0 EcoBlue 110 kW (150 PS) YLCC	01.2019→		7.05578.15.0	AGR	EL	
			7.04511.29.0	AGR-M	EL	○
2.0 EcoBlue 140 kW (190 PS) YMCC	01.2019→		7.05578.15.0	AGR	EL	
			7.04511.29.0	AGR-M	EL	○
2.0 EcoBlue 4x4 140 kW (190 PS) YMCC	01.2019→		7.05578.15.0	AGR	EL	
			7.04511.29.0	AGR-M	EL	○
ORION III (GAL)						68
1.3 44 kW (60 PS) J4B, J6A	07.1990→12.1993		7.02604.62.0	LS	680 mm	
			7.02604.61.0	LS	375 mm	
2.0i 16V 85-100 kW (116-136 PS) EDDB, EDDC, EDDD, EDDF, NGA	08.1990→		7.02604.62.0	LS	680 mm	
PUMA						69
1.5 EcoBlue	04.2020→		7.07794.22.0	AGR	EL	mit Dichtring with O-ring

F

			 PIERBURG			
PUMA (EC_)						70
1.7 16V 92-114 kW (125-155 PS) MHA, MHB	03.1997→06.2002		7.02604.63.0	LS	375 mm	
Racing ST 160 92-114 kW (125-155 PS) MHA	06.1999→06.2002		7.02604.63.0	LS	375 mm	
RANGER (ET)						71
2.5 TDCi 4x4 105 kW (143 PS) WLAA	05.2006→07.2012		7.24809.75.0	AGR	PN <input type="checkbox"/> für Schaltgetriebe for manual transmission	
2.5 TDdi 105 kW (143 PS) WLAA	05.2006→07.2012		7.24809.75.0	AGR	PN <input type="checkbox"/> für Schaltgetriebe for manual transmission	
3.0 TDCi 115 kW (156 PS) MD30DITC	05.2006→07.2012		7.24809.75.0	AGR	PN <input type="checkbox"/>	
3.0 TDCi 4x4 115 kW (156 PS) WEC	05.2006→07.2012		7.24809.75.0	AGR	PN <input type="checkbox"/> für Schaltgetriebe for manual transmission	
RANGER (TKE)						72
2.0 EcoBlue 4x4 96-125 kW (131-170 PS) T20DD0J	09.2018→		7.05483.25.0	AGR-K	EL	
			↳ 7.06036.15.0	AGR	EL	
2.0 EcoBlue 4x4 96-125 kW (131-170 PS) T20DD0J	09.2018→		7.05483.25.0	AGR-K	EL	
			↳ 7.06036.15.0	AGR	EL	
2.0 EcoBlue 4x4 96-125 kW (131-170 PS) T20DD0J	03.2019→		7.05483.25.0	AGR-K	EL	
			↳ 7.06036.15.0	AGR	EL	
2.0 EcoBlue 4x4 96-125 kW (131-170 PS) T20DD0J	03.2019→		7.05483.25.0	AGR-K	EL	
			↳ 7.06036.15.0	AGR	EL	
2.2 TDCi 92 kW (125 PS) GBVAJQW	04.2011→		7.03784.34.0	AGR	EL <input type="checkbox"/>	
2.2 TDCi 88 kW (120 PS) GBVAJPF	04.2011→		7.03784.34.0	AGR	EL <input type="checkbox"/>	
2.2 TDCi 110-118 kW (150-160 PS) GBVAJQJ	11.2011→		7.03784.34.0	AGR	EL <input type="checkbox"/>	
2.2 TDCi	05.2015→		7.03784.34.0	AGR	EL <input type="checkbox"/>	
2.2 TDCi 4x4 92 kW (125 PS) GBVAJQW	04.2011→		7.03784.34.0	AGR	EL <input type="checkbox"/>	
2.2 TDCi 4x4 110-118 kW (150-160 PS) GBVAJQJ	04.2011→		7.03784.34.0	AGR	EL <input type="checkbox"/>	
2.2 TDCi 4x4	05.2015→		7.03784.34.0	AGR	EL <input type="checkbox"/>	
3.2 TDCi 147 kW (200 PS) SAFA	11.2011→		7.03784.34.0	AGR	EL <input type="checkbox"/>	
3.2 TDCi 4x4 147 kW (200 PS) ENSA, SA2R, SA2S, SA2W, SAFA	04.2011→		7.03784.34.0	AGR	EL <input type="checkbox"/>	

S-MAX (CJ, WA6)					
73					
2.0 EcoBlue 140 kW (190 PS) BCCC	07.2018→		7.05578.15.0	AGR	EL nur in Verbindung mit: Motortyp EcoBlue B, Motortyp EcoBlue C, Motortyp EcoBlue D only in connection with: Motortyp EcoBlue B, Motortyp EcoBlue C, Motortyp EcoBlue D
			7.04511.29.0	AGR-M	EL
2.0 EcoBlue 88 kW (120 PS) YNCA	07.2018→		7.05578.15.0	AGR	EL nur in Verbindung mit: Motortyp EcoBlue B, Motortyp EcoBlue C, Motortyp EcoBlue D only in connection with: Motortyp EcoBlue B, Motortyp EcoBlue C, Motortyp EcoBlue D
			7.04511.29.0	AGR-M	EL
2.0 EcoBlue 110 kW (150 PS) YMCB	07.2018→		7.05578.15.0	AGR	EL nur in Verbindung mit: Motortyp EcoBlue B, Motortyp EcoBlue C, Motortyp EcoBlue D only in connection with: Motortyp EcoBlue B, Motortyp EcoBlue C, Motortyp EcoBlue D
			7.04511.29.0	AGR-M	EL
2.0 EcoBlue 4x4 140 kW (190 PS) BCCC	07.2018→		7.05578.15.0	AGR	EL nur in Verbindung mit: Motortyp EcoBlue B, Motortyp EcoBlue C, Motortyp EcoBlue D only in connection with: Motortyp EcoBlue B, Motortyp EcoBlue C, Motortyp EcoBlue D
			7.04511.29.0	AGR-M	EL
2.0 EcoBlue 4x4 110 kW (150 PS) YMCB	07.2018→		7.05578.15.0	AGR	EL nur in Verbindung mit: Motortyp EcoBlue B, Motortyp EcoBlue C, Motortyp EcoBlue D only in connection with: Motortyp EcoBlue B, Motortyp EcoBlue C, Motortyp EcoBlue D
			7.04511.29.0	AGR-M	EL
2.0 EcoBlue BI-Turbo 176 kW (240 PS) YLCB	07.2018→		7.05578.15.0	AGR	EL nur in Verbindung mit: Motortyp EcoBlue B, Motortyp EcoBlue C, Motortyp EcoBlue D only in connection with: Motortyp EcoBlue B, Motortyp EcoBlue C, Motortyp EcoBlue D
			7.06036.14.0	AGR-K	EL
			↳7.06036.15.0	AGR	EL
			7.04511.29.0	AGR-M	EL
S-MAX (WA6)					
74					
1.6 TDCi 85 kW (115 PS) T1WA, T1WB	02.2011→12.2014		7.02209.11.0	AGR	EL
			7.02156.24.0	AGR-K	EL mit Sensor with sensor
			7.02156.35.0	AGR-K	EL ohne Sensor without sensor T1WA, T1WB: mit AGR-Ventil with EGR valve
			7.02156.33.0	AGR-K	EL mit Sensor with sensor
			7.02156.34.0	AGR-K	EL ohne Sensor without sensor
1.8 TDCi 92 kW (125 PS) QYWA	05.2006→12.2014		7.24809.72.0	AGR	EL mit Saugrohr with suction pipe
			↳7.24809.89.0	AGR	EL
			7.24809.71.0	AGR	EL mit Saugrohr with suction pipe





























F



S-MAX (WA6)



74































F

			↳ 7.24809.89.0	AGR	EL	
1.8 TDCi 74 kW (100 PS) FFWA	01.2007→12.2010		7.24809.71.0	AGR	EL	mit Saugrohr with suction pipe 
			↳ 7.24809.89.0	AGR	EL	
2.0 107 kW (145 PS) AOWA, AOWB, TBWA, TBWB	05.2006→12.2014		7.24809.73.0	AGR	EL	
2.0 Flexifuel 107 kW (145 PS) TBWA, TBWB	05.2006→12.2014		7.24809.73.0	AGR	EL	
2.0 TDCi 100 kW (136 PS) AZWC	05.2006→12.2014		7.24809.68.0	AGR	EL	
			7.09730.00.0	AGR-K		
2.0 TDCi 100 kW (136 PS) UKWA	05.2006→12.2014		7.24809.68.0	AGR	EL	
			7.24809.94.0	AGR-K	EL	 03.2010→
			7.09730.00.0	AGR-K		
2.0 TDCi 96 kW (130 PS) AZWA	05.2006→12.2014		7.24809.68.0	AGR	EL	
			7.09730.00.0	AGR-K		
			7.11190.10.0	DDS		ohne Zubehör without accessories
2.0 TDCi 103 kW (140 PS) UFWA	05.2006→12.2014		7.24809.94.0	AGR-K	EL	 03.2010→
2.0 TDCi 85 kW (115 PS) KLWA	11.2007→12.2014		7.24809.68.0	AGR	EL	
			7.09730.00.0	AGR-K		
			7.11190.10.0	DDS		ohne Zubehör without accessories
2.0 TDCi 85 kW (115 PS) TYWA	11.2007→12.2014		7.24809.68.0	AGR	EL	
			7.24809.94.0	AGR-K	EL	 03.2010→
			7.09730.00.0	AGR-K		
			7.11190.10.0	DDS		ohne Zubehör without accessories
2.0 TDCi 118-120 kW (160-163 PS) TXWA	03.2010→12.2014		7.24809.94.0	AGR-K	EL	
2.2 TDCi 129 kW (175 PS) Q4WA	03.2008→12.2012		7.00578.12.0	AGR	EL	
			7.11190.10.0	DDS		ohne Zubehör without accessories Produktionsdatum bis: 22.11.2010 Production date to: 22.11.2010
2.2 TDCi 147 kW (200 PS) KNWA	07.2010→12.2014		7.02604.99.0	LS	400 mm	
2.3 118 kW (160 PS) SEWA	07.2007→12.2014		7.24809.73.0	AGR	EL	
2.5 ST 162 kW (220 PS) HUWA	05.2006→12.2014		7.05270.67.0	LS	770 mm	
			7.05270.80.0	LS	650 mm	



















SCORPIO I (GAE, GGE)

75









2.9 i 107 kW (145 PS) BRD, BRE, BRF	09.1986→09.1994		7.02604.03.0	LS	200 mm	
2.9 i 110 kW (150 PS) BRC	09.1986→09.1994		7.02604.03.0	LS	200 mm	
2.9 i 24V 143 kW (195 PS) BOA	04.1991→09.1994		7.02604.62.0	LS	680 mm	

						
SCORPIO I (GAE, GGE)						75
2.9 i 4x4 110 kW (150 PS) BRC	09.1986→09.1994		7.02604.03.0	LS	200 mm	
2.9 i 4x4 107 kW (145 PS) BRD, BRE, BRF	05.1988→02.1993		7.02604.03.0	LS	200 mm	
2.9 i Cat 107 kW (145 PS) BRE	10.1987→09.1994		7.02604.03.0	LS	200 mm	
SCORPIO I Saloon (GGE)						76
2.0 i 85 kW (115 PS) N9F	02.1992→09.1994		7.02604.62.0	LS	680 mm	01.1993→
2.9 i 107 kW (145 PS) BRD, BRE, BRF	09.1986→12.1994		7.02604.03.0	LS	200 mm	
2.9 i 24V 143 kW (195 PS) BOA	04.1991→09.1994		7.02604.62.0	LS	680 mm	
2.9 i 4x4 107 kW (145 PS) BRD, BRE, BRF	12.1989→10.1994		7.02604.03.0	LS	200 mm	
SCORPIO I Turnier (GGE)						77
2.0 i 85 kW (115 PS) N9F	09.1991→09.1994		7.02604.62.0	LS	680 mm	01.1993→
2.9 24V 143 kW (195 PS) BOA	08.1993→09.1994		7.02604.62.0	LS	680 mm	
2.9 i 107 kW (145 PS) BRD, BRE, BRF	09.1991→09.1994		7.02604.03.0	LS	200 mm	
2.9 i 4x4 107 kW (145 PS) BRD, BRE, BRF	05.1988→02.1993		7.02604.03.0	LS	200 mm	
SCORPIO II (GFR, GGR)						78
2.0 i 85 kW (115 PS) NSD	10.1994→08.1998		7.02604.63.0	LS	375 mm	Regelsonde Regulating Probe
2.0 i 16V 100 kW (136 PS) N3A	10.1994→08.1998		7.02604.63.0	LS	375 mm	
2.3 i 16V 108 kW (147 PS) Y5A	06.1996→08.1998		7.02604.63.0	LS	375 mm	
2.9 i 110 kW (150 PS) BRG	02.1995→08.1998		7.02604.03.0	LS	200 mm	
2.9 i 24V 152 kW (207 PS) BOB	10.1994→08.1998		7.02604.62.0	LS	680 mm	
			7.02604.61.0	LS	375 mm	rechts Right
SCORPIO II Turnier (GNR, GGR)						79
2.0 i 85 kW (115 PS) NSD	10.1994→08.1998		7.02604.63.0	LS	375 mm	Regelsonde Regulating Probe
2.0 i 16V 100 kW (136 PS) N3A	10.1994→08.1998		7.02604.63.0	LS	375 mm	
2.3 i 16V 108 kW (147 PS) Y5A	06.1996→08.1998		7.02604.63.0	LS	375 mm	
2.9 i 110 kW (150 PS) BRG	02.1995→08.1998		7.02604.03.0	LS	200 mm	
2.9 i 24V 152 kW (207 PS) BOB	10.1994→08.1998		7.02604.62.0	LS	680 mm	
			7.02604.61.0	LS	375 mm	rechts Right
SIERRA I Hatchback (GBC)						80
1.8 66 kW (90 PS) REB	10.1984→12.1986		7.02604.62.0	LS	680 mm	
2.0 74 kW (100 PS) NRD	10.1985→12.1986		7.02604.04.0	LS	200 mm	
2.0 i 85 kW (115 PS) NR2, NRB	03.1985→12.1986		7.02604.04.0	LS	200 mm	









SIERRA II (GBG, GB4)
81

1.6 i 59 kW (80 PS) L6B	10.1989→02.1993		7.02604.04.0	LS	200 mm	
1.8 59-66 kW (80-90 PS) R2A, RED	01.1987→05.1988		7.02604.62.0	LS	680 mm	
1.8 59-66 kW (80-90 PS) RED, REF	10.1987→09.1989		7.02604.62.0	LS	680 mm	
1.8 64-66 kW (87-90 PS) R2C, R6A	05.1988→02.1993		7.02604.62.0	LS	680 mm	
2.0 4x4 88-92 kW (120-125 PS) N9C	01.1990→02.1993		7.02604.04.0	LS	200 mm	
2.0 4x4 88-92 kW (120-125 PS) N9C	01.1990→02.1993		7.02604.04.0	LS	200 mm	
2.0 i 85 kW (115 PS) N4A	01.1987→02.1993		7.02604.62.0 7.02604.04.0	LS LS	680 mm 200 mm	11.1991→
2.0 i 85 kW (115 PS) N4I	01.1987→02.1993		7.02604.04.0	LS	200 mm	
2.0 i 74 kW (100 PS) NE5, NEJ	01.1987→12.1989		7.02604.04.0	LS	200 mm	
2.0 i 88-92 kW (120-125 PS) N9C	01.1990→02.1993		7.02604.04.0	LS	200 mm	
2.0 i 88-92 kW (120-125 PS) N9C	01.1990→02.1993		7.02604.04.0	LS	200 mm	
2.0 i 90 kW (122 PS) N9A	01.1990→02.1993		7.02604.04.0	LS	200 mm	
2.0 i Cat 74 kW (100 PS) N4B	01.1987→02.1993		7.02604.04.0	LS	200 mm	
2.0 i DOHC 85 kW (115 PS) N9E	12.1991→02.1993		7.02604.62.0 7.02604.04.0	LS LS	680 mm 200 mm	
2.9 4x4 107-110 kW (145-150 PS) B4B, B4C	08.1988→02.1993		7.02604.03.0	LS	200 mm	
2.9 4x4 107-110 kW (145-150 PS) B4B, B4C	08.1988→02.1993		7.02604.03.0	LS	200 mm	
2.9 i 107-110 kW (145-150 PS) B4B, B4C	08.1988→02.1993		7.02604.03.0	LS	200 mm	
2.9 i 107-110 kW (145-150 PS) B4B, B4C	08.1988→02.1993		7.02604.03.0	LS	200 mm	

















SIERRA II Hatchback (GBC, GBG)
82

































1.6 i 59 kW (80 PS) L6B	10.1989→02.1993		7.02604.04.0	LS	200 mm	
1.8 59-66 kW (80-90 PS) R2A, RED	01.1987→05.1988		7.02604.62.0	LS	680 mm	
1.8 59-66 kW (80-90 PS) RED, REF	10.1987→05.1988		7.02604.62.0	LS	680 mm	
1.8 64-66 kW (87-90 PS) R2C, R6A	05.1988→02.1993		7.02604.62.0	LS	680 mm	
2.0 4x4 88-92 kW (120-125 PS) N9C	10.1991→03.1993		7.02604.04.0	LS	200 mm	
2.0 i 85 kW (115 PS) N4A	01.1987→02.1993		7.02604.62.0 7.02604.04.0	LS LS	680 mm 200 mm	11.1991→
2.0 i 85 kW (115 PS) N4I	01.1987→02.1993		7.02604.04.0	LS	200 mm	
2.0 i 74 kW (100 PS) NE5, NEJ	01.1987→02.1993		7.02604.04.0	LS	200 mm	

SIERRA II Hatchback (GBC, GBG)
82



2.0 i 88-92 kW (120-125 PS) N9C	06.1989→02.1993		7.02604.04.0	LS	200 mm	
2.0 i 92 kW (125 PS) N9B	06.1989→02.1993		7.02604.04.0	LS	200 mm	
2.0 i Cat 74 kW (100 PS) N4B	01.1987→02.1993		7.02604.04.0	LS	200 mm	
2.0 i DOHC 85 kW (115 PS) N9E	12.1991→02.1993		7.02604.62.0	LS	680 mm	
			7.02604.04.0	LS	200 mm	
2.9 i 107-110 kW (145-150 PS) B4B, B4C	08.1988→02.1993		7.02604.03.0	LS	200 mm	
2.9 i XR 4x4 110 kW (150 PS) B4A	08.1988→02.1993		7.02604.03.0	LS	200 mm	
2.9 i XR 4x4 107-110 kW (145-150 PS) B4B, B4C	08.1988→02.1993		7.02604.03.0	LS	200 mm	

F
SIERRA II Turnier (BNG)
83













1.6 i 59 kW (80 PS) L6B	10.1989→02.1993		7.02604.04.0	LS	200 mm	
1.8 59-66 kW (80-90 PS) R2A, RED	01.1987→05.1988		7.02604.62.0	LS	680 mm	
1.8 59-66 kW (80-90 PS) RED, REF	10.1987→05.1988		7.02604.62.0	LS	680 mm	
1.8 64-66 kW (87-90 PS) R2C, R6A	05.1988→02.1993		7.02604.62.0	LS	680 mm	
2.0 4x4 88-92 kW (120-125 PS) N9C	05.1989→02.1993		7.02604.04.0	LS	200 mm	
2.0 4x4 88-92 kW (120-125 PS) N9C	02.1990→02.1993		7.02604.04.0	LS	200 mm	
2.0 i 85 kW (115 PS) N4A	01.1987→02.1993		7.02604.62.0	LS	680 mm	11.1991→
			7.02604.04.0	LS	200 mm	
2.0 i 85 kW (115 PS) N4I	01.1987→02.1993		7.02604.04.0	LS	200 mm	
2.0 i 74 kW (100 PS) NE5, NEJ	01.1987→02.1993		7.02604.04.0	LS	200 mm	
2.0 i 88-92 kW (120-125 PS) N9C	05.1989→02.1993		7.02604.04.0	LS	200 mm	
2.0 i 88-92 kW (120-125 PS) N9C	05.1989→02.1993		7.02604.04.0	LS	200 mm	
2.0 i Cat 74 kW (100 PS) N4B	01.1987→02.1993		7.02604.04.0	LS	200 mm	
2.0 i DOHC 85 kW (115 PS) N9E	12.1991→02.1993		7.02604.62.0	LS	680 mm	
			7.02604.04.0	LS	200 mm	
2.9 107-110 kW (145-150 PS) B4B, B4C	08.1988→02.1993		7.02604.03.0	LS	200 mm	
2.9 4x4 107-110 kW (145-150 PS) B4B, B4C	08.1988→02.1993		7.02604.03.0	LS	200 mm	
2.9 4x4 107-110 kW (145-150 PS) B4B, B4C	08.1988→02.1993		7.02604.03.0	LS	200 mm	
2.9 i 107-110 kW (145-150 PS) B4B, B4C	08.1988→02.1993		7.02604.03.0	LS	200 mm	

			 PIERBURG			
SIERRA Turnier (BNC)						84
1.8 66 kW (90 PS) REB	10.1984→12.1986		7.02604.62.0	LS	680 mm	
2.0 85 kW (115 PS) NR2, NRB	03.1985→12.1986		7.02604.04.0	LS	200 mm	
2.0 74 kW (100 PS) NRD	10.1985→12.1986		7.02604.04.0	LS	200 mm	
STREET KA (RL2)						85
F 1.6 70 kW (95 PS) CDRA, CDRB	05.2003→07.2005		7.02604.60.0	LS	400 mm	
TOURNEO CONNECT						86
1.8 TDCi 66 kW (90 PS) HCPA, HCPB, HCPC, HCPD, P9PA, P9PB, P9PC, P9PD, R3PA, RWPE, RWPF	06.2002→12.2013		7.24809.72.0	AGR	EL mit Saugrohr with suction pipe 	
			↳ 7.24809.89.0	AGR	EL	
1.8 TDCi 81 kW (110 PS) RWPA, RWPB, RWPC, RWPD	08.2006→12.2013		7.24809.72.0	AGR	EL mit Saugrohr with suction pipe 	
			↳ 7.24809.89.0	AGR	EL	
			7.24809.71.0	AGR	EL mit Saugrohr with suction pipe 	
			↳ 7.24809.89.0	AGR	EL	
1.8 TDCi /TDDi /DI 55-57 kW (75-78 PS) BHPA, P7PA, P7PB, R2PA	06.2002→12.2013		7.24809.72.0	AGR	EL mit Saugrohr with suction pipe 	
			↳ 7.24809.89.0	AGR	EL	
			7.24809.71.0	AGR	EL mit Saugrohr with suction pipe 	
			↳ 7.24809.89.0	AGR	EL	
TOURNEO CONNECT / GRAND TOURNEO CONNECT V408 MPV						87
1.5 EcoBlue 74 kW (101 PS) Z2GA	05.2018→		7.07794.22.0	AGR	EL mit Dichtring with O-ring	
1.5 EcoBlue 55 kW (75 PS) BEGA	05.2018→		7.07794.22.0	AGR	EL mit Dichtring with O-ring	
1.5 TDCi 55 kW (75 PS) XUGA	05.2015→		7.04512.08.0	AGR-K		
1.5 TDCi 74 kW (101 PS) XVGA, XVGB, XVGC, XXGA	05.2015→		7.02209.20.0	AGR	EL 	
			7.04512.08.0	AGR-K		
1.5 TDCi 88 kW (120 PS) XWGA, XWGB, XWGC	05.2015→		7.02209.20.0	AGR	EL 	
			7.04512.08.0	AGR-K		
1.6 TDCi 55 kW (75 PS) UBGA	09.2013→		7.02209.11.0	AGR	EL 	
			7.02156.35.0	AGR-K	EL ohne Sensor without sensor mit AGR-Ventil with EGR valve	
			7.02156.33.0	AGR-K	mit Sensor with sensor	
			7.02156.34.0	AGR-K	ohne Sensor without sensor	
			7.11190.08.0	DDS		
1.6 TDCi 70 kW (95 PS) TZGA, TZGB	09.2013→		7.02209.11.0	AGR	EL 	

TOURNEO CONNECT / GRAND TOURNEO CONNECT V408 MPV
87

			7.02156.35.0	AGR-K	EL	ohne Sensor without sensor
			7.02156.33.0	AGR-K		 TZGA, TZGB: mit AGR-Ventil with EGR valve
			7.02156.34.0	AGR-K		mit Sensor with sensor
			7.11190.08.0	DDS		ohne Sensor without sensor
1.6 TDCi 85 kW (115 PS) T1GA	09.2013→		7.02209.11.0	AGR	EL	
			7.02156.35.0	AGR-K	EL	ohne Sensor without sensor
			7.02156.33.0	AGR-K		mit AGR-Ventil with EGR valve
			7.02156.34.0	AGR-K		mit Sensor with sensor
			7.11190.08.0	DDS		ohne Sensor without sensor

F
TOURNEO COURIER B460 MPV
88

1.5 TDCi 55 kW (75 PS) UGCA, UGCB, XUCC, XUCD	02.2014→		7.02209.11.0	AGR	EL	
			7.02156.35.0	AGR-K	EL	ohne Sensor without sensor
			7.02156.33.0	AGR-K		 UGCA, UGCB, XUCC, XUCD: 04.2014→ mit AGR-Ventil with EGR valve
			7.02156.34.0	AGR-K		mit Sensor with sensor
			7.04512.08.0	AGR-K		ohne Sensor without sensor
1.5 TDCi 55 kW (75 PS) XUCE, XWCA, XWCB	02.2014→		7.02156.35.0	AGR-K	EL	ohne Sensor without sensor
			7.02156.33.0	AGR-K		 XUCC: 04.2014→ mit AGR-Ventil with EGR valve
			7.02156.34.0	AGR-K		 XWCA, XWCB: mit AGR-Ventil with EGR valve
			7.04512.08.0	AGR-K		mit Sensor with sensor
			7.04512.08.0	AGR-K		ohne Sensor without sensor
1.5 TDCi 70 kW (95 PS) XVCA, XVCB, XVCC, XVCD	05.2015→		7.02209.20.0	AGR	EL	
			7.04512.08.0	AGR-K		
			7.02209.11.0	AGR	EL	
1.6 TDCi 70 kW (95 PS) T3CA, T3CB, T3CC	02.2014→		7.02209.11.0	AGR	EL	
			7.02156.35.0	AGR-K	EL	ohne Sensor without sensor























TOURNEO COURIER B460 MPV **88**

		7.02156.34.0	AGR-K	ohne Sensor without sensor
		7.02156.33.0	AGR-K	mit Sensor with sensor

TRANSIT CONNECT MPV **89**

F

1.5 EcoBlue 88 kW (120 PS) ZTGA	05.2015→	 7.07794.22.0	AGR	EL	mit Dichtring with O-ring Produktionsdatum ab: 06.2018 Production date from: 06.2018
1.5 EcoBlue 74 kW (101 PS) Z2GA	05.2018→	 7.07794.22.0	AGR	EL	mit Dichtring with O-ring
1.5 EcoBlue 55 kW (75 PS) BEGA	05.2018→	 7.07794.22.0	AGR	EL	mit Dichtring with O-ring
1.5 TDCi 74 kW (101 PS) XVGA, XVGB, XVGC, XXGA	05.2015→	 7.02209.20.0	AGR	EL	
			AGR-K		
1.5 TDCi 88 kW (120 PS) XWGA, XWGB, XWGC	05.2015→	 7.02209.20.0	AGR	EL	
			AGR-K		
1.5 TDCi 55 kW (75 PS) XUGA	08.2015→	 7.04512.08.0	AGR-K		
			AGR-K		
			AGR-K		
1.6 TDCi 55 kW (75 PS) UBGA	02.2013→	 7.02209.11.0	AGR	EL	
			AGR-K	EL	ohne Sensor without sensor 09.2013→ mit AGR-Ventil with EGR valve
			AGR-K		ohne Sensor without sensor
			AGR-K		mit Sensor with sensor
			DDS		Produktionsdatum ab: 30.09.2013 Production date from: 30.09.2013
1.6 TDCi 70 kW (95 PS) TZGA, TZGB	02.2013→	 7.02209.11.0	AGR	EL	
			AGR-K	EL	ohne Sensor without sensor  TZGA, TZGB: 09.2013→ mit AGR-Ventil with EGR valve
			AGR-K		ohne Sensor without sensor
			AGR-K		mit Sensor with sensor
			DDS		 TZGA, TZGB: Produktionsdatum ab: 30.09.2013 Production date from: 30.09.2013
1.6 TDCi 85 kW (115 PS) T1GA	02.2013→	 7.02209.11.0	AGR	EL	
			AGR-K	EL	ohne Sensor without sensor 09.2013→ mit AGR-Ventil with EGR valve
			AGR-K		ohne Sensor without sensor
			AGR-K		mit Sensor with sensor
			DDS		Produktionsdatum ab: 30.09.2013 Production date from: 30.09.2013

TRANSIT COURIER B460 MPV
90







1.5 TDCi 55 kW (75 PS) UGCA, UGCB, XUCC, XUCD, XWCA, XWCB	02.2014→		7.02209.11.0	AGR	EL	
			7.02156.35.0	AGR-K	EL	ohne Sensor without sensor UGCA, UGCB, XUCC, XUCD: 04.2014→ mit AGR-Ventil with EGR valve XWCA, XWCB: mit AGR-Ventil with EGR valve
			7.02156.33.0	AGR-K		mit Sensor with sensor
			7.02156.34.0	AGR-K		ohne Sensor without sensor UGCA, UGCB, XUCC, XUCD: 04.2014→ ohne AGR-Ventil without EGR valve XWCA, XWCB: ohne AGR-Ventil without EGR valve
			7.04512.08.0	AGR-K		
1.5 TDCi 55 kW (75 PS) XUCE	02.2014→		7.02156.35.0	AGR-K	EL	ohne Sensor without sensor 04.2014→ mit AGR-Ventil with EGR valve
			7.02156.33.0	AGR-K		mit Sensor with sensor
			7.02156.34.0	AGR-K		ohne Sensor without sensor 04.2014→ ohne AGR-Ventil without EGR valve
			7.04512.08.0	AGR-K		
1.5 TDCi 70 kW (95 PS) XVCA, XVCB, XVCC, XVCD	05.2015→		7.02209.20.0	AGR	EL	
			7.04512.08.0	AGR-K		
1.6 TDCi 70 kW (95 PS) T3CA, T3CB, T3CC	02.2014→		7.02209.11.0	AGR	EL	
			7.02156.35.0	AGR-K	EL	ohne Sensor without sensor
			7.02156.34.0	AGR-K		ohne Sensor without sensor
7.02156.33.0	AGR-K		mit Sensor with sensor			

B-MAX Van (JK)
91













1.5 TDCi 55 kW (75 PS) UGJC	10.2012→		7.02209.11.0	AGR	EL	
			7.02156.35.0	AGR-K	EL	ohne Sensor without sensor mit AGR-Ventil with EGR valve
			7.02156.33.0	AGR-K		mit Sensor with sensor
			7.02156.34.0	AGR-K		ohne Sensor without sensor
1.5 TDCi 55 kW (75 PS) UGJG, XUJA, XUJB	10.2012→		7.02156.35.0	AGR-K	EL	ohne Sensor without sensor UGJG, XUJA, XUJB: mit AGR-Ventil with EGR valve
			7.02156.33.0	AGR-K		mit Sensor with sensor
			7.02156.34.0	AGR-K		ohne Sensor without sensor



B-MAX Van (JK) **91**































F	1.5 TDCi 70 kW (95 PS) XVJA, XVJC	04.2015→		7.02209.20.0	AGR	EL	
				7.02156.35.0	AGR-K	EL	ohne Sensor without sensor  XVJA, XVJC: mit AGR-Ventil with EGR valve
				7.02156.33.0	AGR-K		mit Sensor with sensor
				7.02156.34.0	AGR-K		ohne Sensor without sensor
				7.04512.08.0	AGR-K		
1.6 TDCi 70 kW (95 PS) T3JB	10.2012→		7.02209.11.0	AGR	EL		
			7.02156.24.0	AGR-K	EL	mit Sensor with sensor 	
			7.02156.35.0	AGR-K	EL	ohne Sensor without sensor mit AGR-Ventil with EGR valve	
			7.02156.33.0	AGR-K		mit Sensor with sensor	
			7.02156.34.0	AGR-K		ohne Sensor without sensor	

C-MAX II Van **92**

1.5 TDCi 88 kW (120 PS) XWDA, XWDB, XWDC, XWDD, XWDE	03.2015→		7.02209.20.0	AGR	EL	
			7.04512.08.0	AGR-K		
1.5 TDCi ECOnetic 77 kW (105 PS) AEDA	03.2015→		7.02209.20.0	AGR	EL	
			7.04512.08.0	AGR-K		
1.6 TDCi 70 kW (95 PS) T3DA, T3DB	12.2010→		7.02209.11.0	AGR	EL	
			7.02156.35.0	AGR-K	EL	ohne Sensor without sensor  T3DA, T3DB: 05.2015→ mit AGR-Ventil with EGR valve
			7.02156.24.0	AGR-K	EL	mit Sensor with sensor 
			7.02156.33.0	AGR-K		mit Sensor with sensor
			7.02156.34.0	AGR-K		ohne Sensor without sensor
1.6 TDCi 85 kW (115 PS) T1DA, T1DB	12.2010→		7.02209.11.0	AGR	EL	
			7.02156.35.0	AGR-K	EL	ohne Sensor without sensor
			7.02156.24.0	AGR-K	EL	mit Sensor with sensor 
			7.02156.33.0	AGR-K		mit Sensor with sensor
			7.02156.34.0	AGR-K		ohne Sensor without sensor

ESCORT V Express (AVF) **93**











1.3 46 kW (63 PS) JBD	07.1990→12.1994		7.02604.62.0	LS	680 mm	12.1992→
			7.02604.61.0	LS	375 mm	

					
ESCORT V Express (AVF) 93					
1.4 52 kW (71 PS) F6F, F6G	07.1990→12.1994		7.02604.62.0	LS	680 mm
			7.02604.61.0	LS	375 mm
FIESTA Box Body/MPV (J5_, J3_) 94					
1.3 44 kW (60 PS) J4C, J4J, J4L, J4Q, J4R, J4T	02.1996→08.2003		7.02604.60.0	LS	400 mm
			7.02604.61.0	LS	375 mm
FIESTA V Van 95					
1.4 TDCi 50-51 kW (68-69 PS) F6JA, F6JB	10.2003→12.2010		7.24809.06.0	AGR	PN mit Rohrstützen with pipe socket
			7.24809.76.0	AGR	EL 
1.6 TDCi 66 kW (90 PS) HHJA, HHJB, HHJD	04.2007→09.2009		7.24809.39.0	AGR	EL 
FIESTA VI Van 96					
1.4 TDCi 50-51 kW (68-70 PS) F6JB, F6JD	01.2009→		7.02209.11.0	AGR	EL 
			7.24809.76.0	AGR	EL 
			7.02156.35.0	AGR-K	EL 
			7.02156.33.0	AGR-K	EL 
			7.02156.34.0	AGR-K	EL 
1.4 TDCi 50-51 kW (68-70 PS) F6JD, KVJA	07.2010→		7.24809.76.0	AGR	EL 
			7.02209.11.0	AGR	EL 
			7.02156.35.0	AGR-K	EL 
			7.02156.24.0	AGR-K	EL 
			7.02156.33.0	AGR-K	EL 
1.5 TDCi 55 kW (75 PS) UGJC, XUJA, XUJB	10.2012→		7.02209.11.0	AGR	EL 
			7.02156.35.0	AGR-K	EL 
			7.02156.34.0	AGR-K	EL 
			7.02156.33.0	AGR-K	EL 
1.5 TDCi 70 kW (95 PS) XVJB, XVJC	05.2015→		7.02209.20.0	AGR	EL 







F



FIESTA VI Van **96**

			7.02156.35.0	AGR-K	EL	ohne Sensor without sensor  XVJB, XVJC: →07.2019 mit AGR-Ventil with EGR valve
			7.02156.34.0	AGR-K		ohne Sensor without sensor
			7.04512.08.0	AGR-K		
F 1.6 TDCi 66 kW (90 PS) HHJC, HHJD, HHJE	01.2009→		7.24809.39.0	AGR	EL	 HHJC, HHJD, HHJE: Euro 4 (D4) Euro 4 (D4)
			7.02156.35.0	AGR-K	EL	ohne Sensor without sensor  HHJC, HHJD, HHJE: →07.2019 mit AGR-Ventil with EGR valve
			7.02156.33.0	AGR-K		mit Sensor with sensor
			7.02156.34.0	AGR-K		ohne Sensor without sensor
1.6 TDCi 70 kW (95 PS) T3JA	02.2010→		7.02209.11.0	AGR	EL	
			7.02156.35.0	AGR-K	EL	ohne Sensor without sensor →07.2019 mit AGR-Ventil with EGR valve
			7.02156.33.0	AGR-K		mit Sensor with sensor
			7.02156.34.0	AGR-K		ohne Sensor without sensor
1.6 TDCi 70 kW (95 PS) TZJA, TZJB	02.2010→		7.02209.11.0	AGR	EL	
			7.02156.35.0	AGR-K	EL	ohne Sensor without sensor  TZJA, TZJB: →07.2019 mit AGR-Ventil with EGR valve
			7.02156.24.0	AGR-K	EL	mit Sensor with sensor
			7.02156.33.0	AGR-K		 mit Sensor with sensor
			7.02156.34.0	AGR-K		ohne Sensor without sensor



FIESTA VII Van **97**

1.5 TDCi 88 kW (120 PS) XWJA, XWJB, XWJC	09.2018→		7.02209.20.0	AGR	EL	
			7.02156.35.0	AGR-K	EL	ohne Sensor without sensor
			7.02156.34.0	AGR-K		ohne Sensor without sensor
			7.04512.08.0	AGR-K		
1.5 TDCi 63 kW (86 PS) XUJC, XUJD, XUJE, XUJF, XUJG, XUJK, XUJL, XUJM, XUJN	04.2019→		7.02209.20.0	AGR	EL	
			7.04512.08.0	AGR-K		

FOCUS II Estate Van					98
1.6 TDCi 80 kW (109 PS) G8DA	07.2004→07.2011		7.11190.10.0	DDS	ohne Zubehör without accessories Euro 5, Euro 4 Euro 5, Euro 4 Produktionsdatum ab: 03.12.2007 Production date from: 03.12.2007 Produktionsdatum bis: 02.07.2011 Production date to: 02.07.2011
1.6 TDCi 74 kW (100 PS) G8DC, MTDA	11.2004→07.2011		7.11190.10.0	DDS	ohne Zubehör without accessories G8DC, MTDA: Euro 5, Euro 4 Euro 5, Euro 4
1.6 TDCi 66 kW (90 PS) HHDA	09.2005→07.2011		7.11190.10.0	DDS	ohne Zubehör without accessories Euro 5, Euro 4 Euro 5, Euro 4
2.0 TDCi 100 kW (136 PS) G6DB	09.2005→07.2011		7.11190.10.0	DDS	ohne Zubehör without accessories Euro 4 Euro 4 Produktionsdatum ab: 01.03.2004 Production date from: 01.03.2004 Produktionsdatum bis: 29.07.2011 Production date to: 29.07.2011
2.0 TDCi 81 kW (110 PS) IXDA	06.2009→07.2011		7.11190.10.0	DDS	ohne Zubehör without accessories Euro 4 Euro 4 Produktionsdatum ab: 03.12.2007 Production date from: 03.12.2007 Produktionsdatum bis: 29.07.2011 Production date to: 29.07.2011
FOCUS III Estate Van					99
1.5 TDCi 70 kW (95 PS) XXDA, XXDC	09.2014→		7.02209.20.0	AGR	EL
			7.04512.08.0	AGR-K	
1.5 TDCi 88 kW (120 PS) XWDA, XWDB, XWDC, XWDD	09.2014→		7.02209.20.0	AGR	EL
			7.04512.08.0	AGR-K	
1.5 TDCi ECOnetic 77 kW (105 PS) XXDB	09.2014→		7.02209.20.0	AGR	EL
			7.04512.08.0	AGR-K	
FOCUS III Hatchback Van					100
1.5 TDCi 70 kW (95 PS) XXDA, XXDC, XXDD	09.2014→		7.02209.20.0	AGR	EL
			7.04512.08.0	AGR-K	
1.5 TDCi 88 kW (120 PS) XWDA, XWDB, XWDC, XWDD, XWDE	09.2014→		7.02209.20.0	AGR	EL
			7.04512.08.0	AGR-K	
1.5 TDCi ECOnetic 77 kW (105 PS) AEDA, XXDB	09.2014→		7.02209.20.0	AGR	EL
			7.04512.08.0	AGR-K	
1.6 TDCi 70 kW (95 PS) T3DA, T3DB	01.2011→		7.02156.35.0	AGR-K	EL ohne Sensor without sensor T3DA, T3DB: →05.2015 mit AGR-Ventil with EGR valve
			7.02156.34.0	AGR-K	ohne Sensor without sensor
			7.02156.33.0	AGR-K	mit Sensor with sensor





FOCUS III Hatchback Van **100**





1.6 TDCi 85 kW (115 PS) T1DA, T1DB	02.2012→		7.02209.11.0	AGR	EL	
			7.02156.35.0	AGR-K	EL	ohne Sensor without sensor  T1DA, T1DB: →05.2015 mit AGR-Ventil with EGR valve
			7.02156.33.0	AGR-K		mit Sensor with sensor
			7.02156.34.0	AGR-K		ohne Sensor without sensor

F









GALAXY MK I VAN (WGR) **101**

2.8 128 kW (174 PS) AAA	11.1995→07.2000		7.22090.11.0	ARV	PN	
2.8 150 kW (204 PS) AYL	05.2000→03.2006		7.22286.55.0	ARV	PN	

GALAXY MK III VAN (CK) **102**

































2.0 EcoBlue 110 kW (150 PS) YMCB	03.2019→		7.05578.15.0	AGR	EL	nur in Verbindung mit: Motortyp EcoBlue B, Motortyp EcoBlue C, Motortyp EcoBlue D only in connection with: Motortyp EcoBlue B, Motortyp EcoBlue C, Motortyp EcoBlue D
			7.04511.29.0	AGR-M	EL	
2.0 EcoBlue AWD 140 kW (190 PS) BCCC	03.2019→		7.05578.15.0	AGR	EL	nur in Verbindung mit: Motortyp EcoBlue B, Motortyp EcoBlue C, Motortyp EcoBlue D only in connection with: Motortyp EcoBlue B, Motortyp EcoBlue C, Motortyp EcoBlue D
			7.04511.29.0	AGR-M	EL	

GRAND C-MAX Van **103**

1.5 TDCi 88 kW (120 PS) XWDA, XWDB, XWDC, XWDD, XWDE	03.2015→		7.02209.20.0	AGR	EL	
			7.04512.08.0	AGR-K		
1.6 TDCi 70 kW (95 PS) T3DA, T3DB	12.2010→		7.02209.11.0	AGR	EL	
			7.02156.35.0	AGR-K	EL	ohne Sensor without sensor  T3DA, T3DB: mit AGR-Ventil with EGR valve
			7.02156.33.0	AGR-K		mit Sensor with sensor
			7.02156.34.0	AGR-K		ohne Sensor without sensor
1.6 TDCi 85 kW (115 PS) T1DA, T1DB	12.2010→		7.02209.11.0	AGR	EL	
			7.02156.35.0	AGR-K	EL	ohne Sensor without sensor  T1DA, T1DB: mit AGR-Ventil with EGR valve
			7.02156.33.0	AGR-K		mit Sensor with sensor
			7.02156.34.0	AGR-K		ohne Sensor without sensor







































KA Van (RB) **104**

1.3 i 44 kW (60 PS) BAA	05.2002→05.2005		7.02604.60.0	LS	400 mm	Diagnosesonde Diagnostic Probe
----------------------------	-----------------	---	--------------	----	-----------	-----------------------------------

						
KA Van (RB)						104
1.3 i 44 kW (60 PS) J4D, J4K, J4M, J4N, J4P, J4S	05.2002→05.2005		7.02604.64.0	LS	450 mm	J4D, J4K, J4M, J4N, J4P, J4S: Diagnosesonde Diagnostic Probe
			7.02604.60.0	LS	400 mm	
KUGA II VAN						105
1.5 TDCi 88 kW (120 PS) XWMB, XWMC	01.2019→		7.02209.20.0	AGR	EL 	
			7.04512.08.0	AGR-K		
TOURNEO CUSTOM V362 Bus (F3)						106
2.0 EcoBlue 77 kW (105 PS) YLF6, YLFS	12.2015→		7.05483.25.0	AGR-K	EL	
			↳7.06036.15.0	AGR	EL	
2.0 EcoBlue 96 kW (130 PS) YMFS	12.2015→		7.05483.25.0	AGR-K	EL	
			↳7.06036.15.0	AGR	EL	
2.0 EcoBlue 125 kW (170 PS) YNF6, YNFS	12.2015→		7.05483.25.0	AGR-K	EL	
			↳7.06036.15.0	AGR	EL	
2.0 EcoBlue 136 kW (185 PS) BCFA, BCFB	05.2019→		7.05483.25.0	AGR-K	EL	
			↳7.06036.15.0	AGR	EL	
2.0 EcoBlue mHEV 136 kW (185 PS) BCFC, BCDF	05.2019→		7.05483.25.0	AGR-K	EL	
			↳7.06036.15.0	AGR	EL	
2.0 EcoBlue mHEV 96 kW (130 PS) BKFC, BKFD	05.2019→		7.05483.25.0	AGR-K	EL	
			↳7.06036.15.0	AGR	EL	
2.2 TDCi 74 kW (100-101 PS) DRF4, DRFF, DRFG	04.2012→12.2015		7.03784.34.0	AGR	EL 	
2.2 TDCi 92 kW (125 PS) CYF4, CYFF	04.2012→12.2015		7.03784.34.0	AGR	EL 	
2.2 TDCi 114 kW (155 PS) CVFF	04.2012→12.2015		7.03784.34.0	AGR	EL 	
TRANSIT Bus (E_ _)						107
2.0 CNG 74-84 kW (101-114 PS) NSH	06.1994→03.2000		7.02604.63.0	LS	375 mm	
TRANSIT Bus (FD_ _ , FB_ _ , FS_ _ , FZ_ _ , FC_ _)						108
2.0 DI (F_E_ , F_F_ , F_G_) 55 kW (75 PS) D3FA	08.2000→05.2006		7.24809.74.0	AGR	PN 	07.2005→
2.0 DI (F_E_ , F_F_ , F_G_) 74 kW (101 PS) ABFA	08.2000→05.2006		7.24809.07.0	AGR	PN	mit Potentiometer with potentiometer 
			7.24809.74.0	AGR	PN	04.2002→06.2005 
2.0 DI (F_E_ , F_F_ , F_G_) 63 kW (86 PS) F3FA	08.2000→05.2006		7.24809.07.0	AGR	PN	mit Potentiometer with potentiometer 
			7.24809.74.0	AGR	PN	04.2002→06.2005 
2.0 TDCi (F_F_ , F_E_ , F_G_) 92 kW (125 PS) FIFA	08.2002→05.2006		7.24809.74.0	AGR	PN	07.2005→ 



TRANSIT Bus (FD_ , FB_ , FS_ , FZ_ , FC_) **108**

2.2 TDCi 63 kW (85 PS) P8FA, P8FB	04.2006→08.2014		7.24809.70.0	AGR	EL	 P8FA, P8FB: →04.2008
			7.24809.69.0	AGR	EL	 P8FA, P8FB: 05.2008→03.2010
			7.24809.40.0	AGR	EL	
			7.01621.08.0	AGR	EL	 P8FA, P8FB: Produktionsdatum ab: 12.03.2010 Production date from: 12.03.2010
2.2 TDCi 81 kW (110 PS) QVFA	04.2006→08.2014		7.24809.70.0	AGR	EL	 →04.2008
			7.24809.69.0	AGR	EL	 05.2008→03.2010
			7.24809.40.0	AGR	EL	
			7.01621.08.0	AGR	EL	 Produktionsdatum ab: 12.03.2010 Production date from: 12.03.2010
2.2 TDCi 96 kW (130 PS) QWFA	04.2006→08.2014		7.24809.70.0	AGR	EL	 →04.2008
			7.24809.69.0	AGR	EL	 05.2008→03.2010
			7.24809.40.0	AGR	EL	
			7.01621.08.0	AGR	EL	 Produktionsdatum ab: 12.03.2010 Production date from: 12.03.2010
2.2 TDCi 103 kW (140 PS) PGFA, PGFB, UHFA, UHFB, UHFC	10.2007→08.2014		7.24809.70.0	AGR	EL	 PGFA, PGFB, UHFA, UHFB, UHFC: →04.2008
			7.24809.69.0	AGR	EL	 PGFA, PGFB, UHFA, UHFB, UHFC: 05.2008→03.2010
			7.24809.40.0	AGR	EL	
			7.03784.34.0	AGR	EL	
2.2 TDCi 85 kW (115 PS) SRFA, SRFB, SRFC, SRFD, SRFE	10.2008→08.2014		7.24809.69.0	AGR	EL	 SRFA, SRFB, SRFC, SRFD, SRFE: →03.2010
			7.24809.40.0	AGR	EL	
			7.01621.08.0	AGR	EL	 SRFA, SRFB, SRFC, SRFD, SRFE: Produktionsdatum ab: 12.03.2010 Production date from: 12.03.2010
			7.03784.34.0	AGR	EL	
2.2 TDCi 74 kW (101 PS) DRFA, DRFB, DRFC, DRFD, DRFE	10.2011→08.2014		7.03784.34.0	AGR	EL	
2.2 TDCi 92 kW (125 PS) CYFA, CYFB, CYFC, CYFD	10.2011→08.2014		7.03784.34.0	AGR	EL	
2.2 TDCi RWD 92 kW (125 PS) CYRA	09.2011→12.2014		7.03784.34.0	AGR	EL	
2.2 TDCi RWD 100 kW (136 PS) USRA, USRB	09.2011→08.2014		7.03784.34.0	AGR	EL	
2.2 TDCi RWD 74 kW (101 PS) DRRRA, DRRB, DRRC	10.2011→08.2014		7.03784.34.0	AGR	EL	
2.3 16V RWD (F_B_, F_C_, F_A_) 107 kW (146 PS) E5FA	08.2000→05.2006		7.02604.64.0	LS	450 mm	
2.4 DI (F_B_, F_C_, F_A_) 66 kW (90 PS) D2FA, D2FB	01.2000→05.2006		7.24809.07.0	AGR	PN	mit Potentiometer with potentiometer  D2FA, D2FB: 04.2003→04.2004











TRANSIT Bus (FD __, FB __, FS __, FZ __, FC __)
108

			7.24809.74.0	AGR	PN	D2FA, D2FB: 04.2004→
2.4 DI RWD (F_B_, F_C_, F_A_) 88 kW (120 PS) D4FA	01.2000→05.2006		7.24809.07.0	AGR	PN	mit Potentiometer with potentiometer 04.2003→04.2004
			7.24809.74.0	AGR	PN	04.2004→
2.4 TDCi 85 kW (115 PS) JXFA, JXFC	04.2006→08.2014		7.24809.70.0	AGR	EL	JXFA, JXFC: →04.2008
			7.24809.69.0	AGR	EL	JXFA, JXFC: 05.2008→03.2010
			7.24809.40.0	AGR	EL	JXFA, JXFC: 03.2010→
			7.01621.08.0	AGR	EL	JXFA, JXFC: Produktionsdatum ab: 12.03.2010 Production date from: 12.03.2010
2.4 TDCi 103 kW (140 PS) H9FD	04.2006→08.2014		7.24809.70.0	AGR	EL	→04.2008
			7.24809.69.0	AGR	EL	05.2008→03.2010
			7.24809.40.0	AGR	EL	
			7.01621.08.0	AGR	EL	Produktionsdatum ab: 12.03.2010 Production date from: 12.03.2010
2.4 TDCi 74 kW (100 PS) PHFA, PHFC	04.2006→08.2014		7.24809.70.0	AGR	EL	PHFA, PHFC: →04.2008
			7.24809.69.0	AGR	EL	PHFA, PHFC: 05.2008→03.2010
			7.24809.40.0	AGR	EL	
			7.01621.08.0	AGR	EL	PHFA, PHFC: Produktionsdatum ab: 12.03.2010 Production date from: 12.03.2010
2.4 TDCi 4x4 103 kW (140 PS) H9FB	11.2006→08.2014		7.24809.70.0	AGR	EL	→04.2008
			7.24809.69.0	AGR	EL	05.2008→03.2010
			7.01621.08.0	AGR	EL	03.2010→
			7.24809.40.0	AGR	EL	
2.4 TDCi RWD 88 kW (120 PS) SWFA	01.2007→12.2011		7.01621.08.0	AGR	EL	Produktionsdatum ab: 12.03.2010 Production date from: 12.03.2010
2.4 TDE 85 kW (115 PS) FXFA	03.2004→05.2006		7.24809.74.0	AGR	PN	04.2004→
2.4 TDE (F_C_, F_B_, F_A_) 92 kW (125 PS) DOFA	07.2001→05.2006		7.24809.07.0	AGR	PN	mit Potentiometer with potentiometer 04.2003→04.2004
			7.24809.74.0	AGR	PN	04.2004→
3.2 TDCi 147 kW (200 PS) SAFA, SAFB	02.2008→08.2014		7.24809.70.0	AGR	EL	SAFA, SAFB: →04.2008
			7.24809.69.0	AGR	EL	SAFA, SAFB: 05.2008→03.2010
			7.24809.40.0	AGR	EL	
			7.01621.08.0	AGR	EL	SAFA, SAFB: Produktionsdatum ab: 12.03.2010 Production date from: 12.03.2010
			7.03784.34.0	AGR	EL	















F





TRANSIT CONNECT (P65_, P70_, P80_) 109

1.8 16V 85 kW (115-116 PS) EYPA, EYPC, EYPD	06.2002→12.2013		7.02604.64.0	LS	450 mm	
			7.02604.60.0	LS	400 mm	
1.8 16V LPG 85 kW (115-116 PS) EYPA, EYPC, EYPD	06.2002→12.2013		7.02604.64.0	LS	450 mm	
			7.02604.60.0	LS	400 mm	
F 1.8 Di 55-57 kW (75-78 PS) BHPA, P7PA, P7PB, R2PA	06.2002→12.2013		7.24809.72.0	AGR	EL	mit Saugrohr with suction pipe 
			↳ 7.24809.89.0	AGR	EL	
			7.24809.71.0	AGR	EL	mit Saugrohr with suction pipe 
			↳ 7.24809.89.0	AGR	EL	
1.8 TDCi 66 kW (90 PS) HCPA, HCPB, HCPC, HCPD, P9PA, P9PB, P9PC, P9PD, R3PA, RWPE, RWPF	06.2002→12.2013		7.24809.72.0	AGR	EL	mit Saugrohr with suction pipe 
			↳ 7.24809.89.0	AGR	EL	
1.8 TDCi 81 kW (110 PS) RWPA, RWPB, RWPC, RWPD	08.2006→12.2013		7.24809.72.0	AGR	EL	mit Saugrohr with suction pipe 
			↳ 7.24809.89.0	AGR	EL	
			7.24809.71.0	AGR	EL	mit Saugrohr with suction pipe 
			↳ 7.24809.89.0	AGR	EL	















TRANSIT CONNECT V408 Box Body/MPV 110

1.5 EcoBlue 74 kW (101 PS) Z2GA	05.2018→		7.07794.22.0	AGR	EL	mit Dichtring with O-ring
1.5 EcoBlue 88 kW (120 PS) ZTGA	05.2018→		7.07794.22.0	AGR	EL	mit Dichtring with O-ring
1.5 EcoBlue 55 kW (75 PS) BEGA	05.2018→		7.07794.22.0	AGR	EL	mit Dichtring with O-ring
1.5 TDCi 74 kW (101 PS) XVGA, XVGB, XVGC, XXGA	05.2015→		7.02209.20.0	AGR	EL	
			7.04512.08.0	AGR-K		
1.5 TDCi 88 kW (120 PS) XWGA, XWGB, XWGC	05.2015→		7.02209.20.0	AGR	EL	
			7.04512.08.0	AGR-K		
1.5 TDCi 55 kW (75 PS) XUGA	08.2015→		7.04512.08.0	AGR-K		
1.6 TDCi 55 kW (75 PS) UBGA	02.2013→		7.02209.11.0	AGR	EL	
			7.02156.35.0	AGR-K	EL	ohne Sensor without sensor 09.2013→ mit AGR-Ventil with EGR valve
			7.02156.34.0	AGR-K		ohne Sensor without sensor
			7.02156.33.0	AGR-K		mit Sensor with sensor
1.6 TDCi 70 kW (95 PS) TZGA, TZGB	02.2013→		7.02209.11.0	AGR	EL	

TRANSIT CONNECT V408 Box Body/MPV
110

			7.02156.35.0	AGR-K	EL	ohne Sensor without sensor  TZGA, TZGB: 09.2013→ mit AGR-Ventil with EGR valve
			7.02156.34.0	AGR-K		ohne Sensor without sensor
			7.02156.33.0	AGR-K		mit Sensor with sensor
1.6 TDCi 85 kW (115 PS) T1GA	02.2013→		7.02209.11.0	AGR	EL	
			7.02156.35.0	AGR-K	EL	ohne Sensor without sensor 09.2013→ mit AGR-Ventil with EGR valve
			7.02156.34.0	AGR-K		ohne Sensor without sensor
			7.02156.33.0	AGR-K		mit Sensor with sensor

F
TRANSIT COURIER B460 Box Body/MPV
111

1.5 TDCi 55 kW (75 PS) UGCA, UGCB, XUCC, XUCD, XWCA, XWCB	02.2014→		7.02209.11.0	AGR	EL	
			7.02156.35.0	AGR-K	EL	ohne Sensor without sensor  UGCA, UGCB, XUCC, XUCD: 04.2014→ mit AGR-Ventil with EGR valve  XWCA, XWCB: mit AGR-Ventil with EGR valve
			7.02156.33.0	AGR-K		mit Sensor with sensor
			7.02156.34.0	AGR-K		ohne Sensor without sensor  UGCA, UGCB, XUCC, XUCD: 04.2014→ ohne AGR-Ventil without EGR valve  XWCA, XWCB: ohne AGR-Ventil without EGR valve
			7.04512.08.0	AGR-K		
1.5 TDCi 55 kW (75 PS) XUCE	02.2014→		7.02156.35.0	AGR-K	EL	ohne Sensor without sensor 04.2014→ mit AGR-Ventil with EGR valve
			7.02156.33.0	AGR-K		mit Sensor with sensor
			7.02156.34.0	AGR-K		ohne Sensor without sensor 04.2014→ ohne AGR-Ventil without EGR valve
			7.04512.08.0	AGR-K		
1.5 TDCi 70 kW (95 PS) XVCA, XVCB, XVCC, XVCD	05.2015→		7.02209.20.0	AGR	EL	
			7.04512.08.0	AGR-K		
1.6 TDCi 70 kW (95 PS) T3CA, T3CB, T3CC	02.2014→		7.02209.11.0	AGR	EL	
			7.02156.35.0	AGR-K	EL	ohne Sensor without sensor



TRANSIT COURIER B460 Box Body/MPV











111

7.02156.34.0	AGR-K	ohne Sensor without sensor
7.02156.33.0	AGR-K	mit Sensor with sensor

TRANSIT CUSTOM V362 Bus (F3)







112

F

2.0 EcoBlue 77 kW (105 PS) YLF6, YLFS	12.2015→		7.05483.25.0	AGR-K	EL	
			↳ 7.06036.15.0	AGR	EL	
2.0 EcoBlue 96 kW (130 PS) YMF6, YMFS	12.2015→		7.05483.25.0	AGR-K	EL	
			↳ 7.06036.15.0	AGR	EL	
2.0 EcoBlue 125 kW (170 PS) YNF6, YNFS	12.2015→		7.05483.25.0	AGR-K	EL	
			↳ 7.06036.15.0	AGR	EL	
2.0 EcoBlue 136 kW (185 PS) BCFA, BCFB	05.2019→		7.05483.25.0	AGR-K	EL	
			↳ 7.06036.15.0	AGR	EL	
2.0 EcoBlue mHEV 136 kW (185 PS) BCFC, BCFD	05.2019→		7.05483.25.0	AGR-K	EL	
			↳ 7.06036.15.0	AGR	EL	
2.0 EcoBlue mHEV 96 kW (130 PS) BKFC, BKFD	05.2019→		7.05483.25.0	AGR-K	EL	
			↳ 7.06036.15.0	AGR	EL	
2.0 EcoBlue mHEV 125 kW (170 PS) BLFC, BLFD	05.2019→		7.05483.25.0	AGR-K	EL	
			↳ 7.06036.15.0	AGR	EL	
2.0 EcoBlue mHEV 77 kW (105 PS) BJFC, BJFD	05.2019→		7.05483.25.0	AGR-K	EL	
			↳ 7.06036.15.0	AGR	EL	
2.2 TDCi 114 kW (155 PS) CVFF	04.2012→12.2015		7.03784.34.0	AGR	EL	⊗
2.2 TDCi 74 kW (100-101 PS) DRF4, DRFF, DRFG	04.2012→12.2015		7.03784.34.0	AGR	EL	⊗
2.2 TDCi 92 kW (125 PS) CYF4, CYFF	04.2012→12.2015		7.03784.34.0	AGR	EL	⊗

TRANSIT CUSTOM V362 Van (FY, FZ)

113

2.0 EcoBlue 77 kW (105 PS) YLF6, YLFS	12.2015→		7.05483.25.0	AGR-K	EL	
			↳ 7.06036.15.0	AGR	EL	
2.0 EcoBlue 96 kW (130 PS) YMF6, YMFS	12.2015→		7.05483.25.0	AGR-K	EL	
			↳ 7.06036.15.0	AGR	EL	
2.0 EcoBlue 125 kW (170 PS) YNF6, YNFS	12.2015→		7.05483.25.0	AGR-K	EL	
			↳ 7.06036.15.0	AGR	EL	
2.0 EcoBlue 136 kW (185 PS) BCFA, BCFB	05.2019→		7.05483.25.0	AGR-K	EL	
			↳ 7.06036.15.0	AGR	EL	
2.0 EcoBlue mHEV 96 kW (130 PS) BKFC, BKFD	05.2019→		7.05483.25.0	AGR-K	EL	
			↳ 7.06036.15.0	AGR	EL	
2.0 EcoBlue mHEV 125 kW (170 PS) BLFC	05.2019→		7.05483.25.0	AGR-K	EL	
			↳ 7.06036.15.0	AGR	EL	

TRANSIT CUSTOM V362 Van (FY, FZ)						113
2.0 EcoBlue mHEV 136 kW (185 PS) BCFC, BCFD	05.2019→		7.05483.25.0	AGR-K	EL	
			↳7.06036.15.0	AGR	EL	
2.2 TDCi 114 kW (155 PS) CVFF	04.2012→12.2015		7.03784.34.0	AGR	EL	⊗
2.2 TDCi 74 kW (100-101 PS) DRF4, DRFF, DRFG	04.2012→12.2015		7.03784.34.0	AGR	EL	⊗
2.2 TDCi 92 kW (125 PS) CYF4, CYFF	04.2012→12.2015		7.03784.34.0	AGR	EL	⊗
TRANSIT Platform/Chassis (FM_, FN_)						114
2.0 DI (F_E_, F_F_) 55 kW (75 PS) D3FA	08.2000→05.2006		7.24809.74.0	AGR	PN	⊗ 07.2005→
2.0 DI (F_E_, F_F_) 74 kW (101 PS) ABFA	08.2000→05.2006		7.24809.07.0	AGR	PN	mit Potentiometer with potentiometer ⊗ 04.2002→06.2005
			7.24809.74.0	AGR	PN	⊗ 07.2005→
2.0 DI (F_E_, F_F_) 63 kW (86 PS) F3FA	08.2000→05.2006		7.24809.07.0	AGR	PN	mit Potentiometer with potentiometer ⊗ 04.2002→06.2005
			7.24809.74.0	AGR	PN	⊗ 07.2005→
2.0 TDCi (F_E_, F_F_) 92 kW (125 PS) FIFA	08.2002→05.2006		7.24809.74.0	AGR	PN	⊗ 07.2005→
2.3 16V (F_A_, F_B_, F_C_, F_D_) 107 kW (146 PS) E5FA	04.2001→05.2006		7.02604.64.0	LS	450 mm	
2.4 DI (F_A_, F_B_, F_C_, F_D_) 66 kW (90 PS) D2FA, D2FB, D2FE	01.2000→05.2006		7.24809.07.0	AGR	PN	mit Potentiometer with potentiometer ⊗ D2FA, D2FB, D2FE: 04.2003→04.2004
			7.24809.74.0	AGR	PN	⊗ D2FA, D2FB, D2FE: 04.2004→
2.4 DI (F_A_, F_B_, F_C_, F_D_) 88 kW (120 PS) D4FA	01.2000→05.2006		7.24809.07.0	AGR	PN	mit Potentiometer with potentiometer ⊗ 04.2003→04.2004
			7.24809.74.0	AGR	PN	⊗ 04.2004→
2.4 TDE 92 kW (125 PS) DOFA	07.2001→05.2006		7.24809.07.0	AGR	PN	mit Potentiometer with potentiometer ⊗ 04.2003→04.2004
			7.24809.74.0	AGR	PN	⊗ 04.2004→
2.4 TDE 85 kW (115 PS) FXFA	03.2004→05.2006		7.24809.74.0	AGR	PN	⊗ 04.2004→
TRANSIT Platform/Chassis (FM_, FN_, FF_)						115
2.2 TDCi 81 kW (110 PS) QVFA	04.2006→08.2014		7.24809.70.0	AGR	EL	⊗ →04.2008
			7.24809.69.0	AGR	EL	⊗ 05.2008→03.2010
			7.24809.40.0	AGR	EL	⊗
			7.01621.08.0	AGR	EL	⊗ Produktionsdatum ab: 12.03.2010 Production date from: 12.03.2010
2.2 TDCi 63 kW (85 PS) P8FA, P8FB	04.2006→08.2014		7.24809.70.0	AGR	EL	⊗ P8FA, P8FB: →04.2008

F



TRANSIT Platform/Chassis (FM_-, FN_-, FF_-) **115**

F

			7.24809.69.0	AGR	EL		
			7.24809.40.0	AGR	EL		P8FA, P8FB: 05.2008→03.2010
			7.01621.08.0	AGR	EL		
							P8FA, P8FB: Produktionsdatum ab: 12.03.2010
							Production date from: 12.03.2010
2.2 TDCi 96 kW (130 PS) QWFA	04.2006→08.2014		7.24809.70.0	AGR	EL		→04.2008
			7.24809.69.0	AGR	EL		05.2008→03.2010
			7.24809.40.0	AGR	EL		
			7.01621.08.0	AGR	EL		Produktionsdatum ab: 12.03.2010
							Production date from: 12.03.2010
2.2 TDCi 103 kW (140 PS) PGFA, PGFB, UHFA, UHFB, UHFC	10.2007→09.2011		7.24809.70.0	AGR	EL		PGFA, PGFB, UHFA, UHFB, UHFC: →04.2008
			7.24809.69.0	AGR	EL		
			7.24809.40.0	AGR	EL		PGFA, PGFB, UHFA, UHFB, UHFC: 05.2008→03.2010
			7.01621.08.0	AGR	EL		
							PGFA, PGFB, UHFA, UHFB, UHFC: Produktionsdatum ab: 12.03.2010
			7.03784.34.0	AGR	EL		Production date from: 12.03.2010
2.2 TDCi 85 kW (115 PS) SRFA, SRFB, SRFC, SRFD, SRFE	10.2008→08.2014		7.24809.69.0	AGR	EL		SRFA, SRFB, SRFC, SRFD, SRFE: →03.2010
			7.24809.40.0	AGR	EL		
			7.01621.08.0	AGR	EL		SRFA, SRFB, SRFC, SRFD, SRFE: Produktionsdatum ab: 12.03.2010
							Production date from: 12.03.2010
2.2 TDCi 74 kW (101 PS) DRFA, DRFB, DRFC, DRFD, DRFE	10.2011→08.2014		7.03784.34.0	AGR	EL		
2.2 TDCi 92 kW (125 PS) CYFA, CYFB, CYFC, CYFD	10.2011→08.2014		7.03784.34.0	AGR	EL		
2.2 TDCi 4x4 92 kW (125 PS) CYRB, CYRC	10.2011→08.2014		7.03784.34.0	AGR	EL		
2.2 TDCi RWD 74 kW (101 PS) DRRA, DRRB, DRRC	10.2011→08.2014		7.03784.34.0	AGR	EL		
2.2 TDCi RWD 92 kW (125 PS) CYRA	10.2011→08.2014		7.03784.34.0	AGR	EL		
2.2 TDCi RWD 114 kW (155 PS) CVRA, CVRB, CVRC	10.2011→08.2014		7.03784.34.0	AGR	EL		
2.4 TDCi 4x4 103 kW (140 PS) H9FB	11.2006→08.2014		7.24809.70.0	AGR	EL		→04.2008
			7.24809.69.0	AGR	EL		05.2008→03.2010
			7.24809.40.0	AGR	EL		
			7.01621.08.0	AGR	EL		Produktionsdatum ab: 12.03.2010
							Production date from: 12.03.2010
2.4 TDCi RWD 74 kW (100 PS) PHFA, PHFC	04.2006→08.2014		7.24809.70.0	AGR	EL		PHFA, PHFC: →04.2008
			7.24809.69.0	AGR	EL		
			7.24809.40.0	AGR	EL		PHFA, PHFC: 05.2008→03.2010

TRANSIT Platform/Chassis (FM_-, FN_-, FF_-)
115

			7.01621.08.0	AGR	EL	PHFA, PHFC: Produktionsdatum ab: 12.03.2010 Production date from: 12.03.2010
2.4 TDCi RWD 85 kW (115 PS) JXFA, JXFC	04.2006→08.2014		7.24809.70.0	AGR	EL	JXFA, JXFC: →04.2008
			7.24809.69.0	AGR	EL	JXFA, JXFC: 05.2008→03.2010
			7.24809.40.0	AGR	EL	
			7.01621.08.0	AGR	EL	JXFA, JXFC: Produktionsdatum ab: 12.03.2010 Production date from: 12.03.2010
2.4 TDCi RWD 103 kW (140 PS) H9FB	04.2006→08.2014		7.24809.40.0	AGR	EL	
2.4 TDCi RWD 103 kW (140 PS) H9FD	04.2006→08.2014		7.24809.70.0	AGR	EL	→04.2008
			7.24809.69.0	AGR	EL	05.2008→03.2010
			7.24809.40.0	AGR	EL	
			7.01621.08.0	AGR	EL	Produktionsdatum ab: 12.03.2010 Production date from: 12.03.2010
3.2 TDCi RWD 147 kW (200 PS) SAFA, SAFB	09.2007→08.2014		7.24809.70.0	AGR	EL	SAFA, SAFB: →04.2008
			7.24809.69.0	AGR	EL	SAFA, SAFB: 05.2008→03.2010
			7.24809.40.0	AGR	EL	
			7.01621.08.0	AGR	EL	SAFA, SAFB: Produktionsdatum ab: 12.03.2010 Production date from: 12.03.2010
			7.03784.34.0	AGR	EL	

F
TRANSIT TOURNEO Bus
116

2.0 74-84 kW (101-114 PS) NSF, NSG, NSH	11.1994→12.2000		7.02604.63.0	LS	375 mm	
2.2 TDCi 81 kW (110 PS) QVFA	07.2006→08.2014		7.24809.70.0	AGR	EL	→04.2008
			7.24809.69.0	AGR	EL	05.2008→03.2010
			7.24809.40.0	AGR	EL	
			7.01621.08.0	AGR	EL	Produktionsdatum ab: 12.03.2010 Production date from: 12.03.2010
2.2 TDCi 96 kW (130 PS) QWFA	07.2006→08.2014		7.24809.70.0	AGR	EL	→04.2008
			7.24809.69.0	AGR	EL	05.2008→03.2010
			7.24809.40.0	AGR	EL	
			7.01621.08.0	AGR	EL	Produktionsdatum ab: 12.03.2010 Production date from: 12.03.2010
2.2 TDCi 103 kW (140 PS) PGFA, PGFB, UHFA, UHFB	10.2007→08.2014		7.24809.70.0	AGR	EL	PGFA, PGFB, UHFA, UHFB: →04.2008
			7.24809.69.0	AGR	EL	PGFA, PGFB, UHFA, UHFB: 05.2008→03.2010
			7.24809.40.0	AGR	EL	
			7.03784.34.0	AGR	EL	



TRANSIT TOURNEO Bus **116**

			7.01621.08.0	AGR	EL	PGFA, PGFB, UHFA, UHFB: Produktionsdatum ab: 12.03.2010 Production date from: 12.03.2010
2.2 TDCi 103 kW (140 PS) UHFC	10.2007→08.2014		7.24809.69.0	AGR	EL	05.2008→03.2010
			7.24809.40.0	AGR	EL	
			7.03784.34.0	AGR	EL	
			7.01621.08.0	AGR	EL	Produktionsdatum ab: 12.03.2010 Production date from: 12.03.2010
2.2 TDCi 85 kW (115 PS) SRFA, SRFB, SRFC, SRFD, SRFE	10.2008→08.2014		7.24809.69.0	AGR	EL	SRFA, SRFB, SRFC, SRFD, SRFE: →03.2010
			7.24809.40.0	AGR	EL	
			7.01621.08.0	AGR	EL	SRFA, SRFB, SRFC, SRFD, SRFE: Produktionsdatum ab: 12.03.2010 Production date from: 12.03.2010

TRANSIT TOURNEO Bus (FC_ _) **117**

2.0 92 kW (125 PS) FIFA	03.2002→03.2006		7.24809.74.0	AGR	PN	07.2005→
-----------------------------------	-----------------	--	---------------------	-----	----	----------

TRANSIT V363 Bus (FAD, FBD) **118**

2.0 EcoBlue 77 kW (105 PS) YLF6, YLFS	03.2016→		7.05483.25.0	AGR-K	EL	
			↳ 7.06036.15.0	AGR	EL	
2.0 EcoBlue 96 kW (130 PS) YMF6, YMFS	03.2016→		7.05483.25.0	AGR-K	EL	
			↳ 7.06036.15.0	AGR	EL	
2.0 EcoBlue 125 kW (170 PS) YNF6, YNFS	03.2016→		7.05483.25.0	AGR-K	EL	
			↳ 7.06036.15.0	AGR	EL	
2.0 EcoBlue mHEV 96 kW (130 PS) BKFC, BKFD	05.2019→		7.05483.25.0	AGR-K	EL	
			↳ 7.06036.15.0	AGR	EL	
2.0 EcoBlue mHEV 125 kW (170 PS) BLFC, BLFD	05.2019→		7.05483.25.0	AGR-K	EL	
			↳ 7.06036.15.0	AGR	EL	
2.2 TDCi 74 kW (100 PS) DRF5, DRFF, DRFG	08.2013→12.2018		7.03784.34.0	AGR	EL	
2.2 TDCi 92-99 kW (125-135 PS) CY14, CYF5, CYFG	08.2013→12.2018		7.03784.34.0	AGR	EL	
2.2 TDCi 114 kW (155 PS) CVF5	12.2014→12.2018		7.03784.34.0	AGR	EL	
2.2 TDCi 4x4 92 kW (125 PS) CY24, CYR5	08.2013→12.2018		7.03784.34.0	AGR	EL	
2.2 TDCi All-wheel Drive 114 kW (155 PS) CV24, CVR5	08.2015→12.2018		7.03784.34.0	AGR	EL	
2.2 TDCi RWD 92 kW (125 PS) USR6	08.2013→12.2018		7.03784.34.0	AGR	EL	
2.2 TDCi RWD 114 kW (155 PS) CV24, CVR5, UYR6	08.2013→12.2018		7.03784.34.0	AGR	EL	
2.2 TDCi RWD 74 kW (100 PS) DRR5	08.2013→12.2018		7.03784.34.0	AGR	EL	
2.2 TDCi RWD 99 kW (135 PS) UHR5	08.2013→12.2018		7.03784.34.0	AGR	EL	

TRANSIT V363 Platform/Chassis (FED, FFD)
119

2.0 EcoBlue 77 kW (105 PS) YLF6, YLFS	03.2016→		7.05483.25.0	AGR-K	EL	
			↳ 7.06036.15.0	AGR	EL	
2.0 EcoBlue 96 kW (130 PS) YMF6, YMFS	03.2016→		7.05483.25.0	AGR-K	EL	
			↳ 7.06036.15.0	AGR	EL	
2.0 EcoBlue 125 kW (170 PS) YNF6, YNFS	03.2016→		7.05483.25.0	AGR-K	EL	
			↳ 7.06036.15.0	AGR	EL	
2.0 EcoBlue 136 kW (185 PS) BCFB	05.2019→		7.05483.25.0	AGR-K	EL	
			↳ 7.06036.15.0	AGR	EL	
2.0 EcoBlue 4x4 96 kW (130 PS) YMR6	01.2017→		7.05483.25.0	AGR-K	EL	
			↳ 7.06036.15.0	AGR	EL	
2.0 EcoBlue 4x4 125 kW (170 PS) YNR6	01.2017→		7.05483.25.0	AGR-K	EL	
			↳ 7.06036.15.0	AGR	EL	
2.0 EcoBlue RWD 77 kW (105 PS) YLR6	03.2016→		7.05483.25.0	AGR-K	EL	
			↳ 7.06036.15.0	AGR	EL	
2.0 EcoBlue RWD 96 kW (130 PS) BKRA, YMHA, YMR6	03.2016→		7.05483.25.0	AGR-K	EL	
			↳ 7.06036.15.0	AGR	EL	
2.0 EcoBlue RWD 125 kW (170 PS) BLHA, BLRA, YNR6	03.2016→		7.05483.25.0	AGR-K	EL	
			↳ 7.06036.15.0	AGR	EL	
2.0 EcoBlue RWD 136 kW (185 PS) BCRA	05.2019→		7.05483.25.0	AGR-K	EL	
			↳ 7.06036.15.0	AGR	EL	
2.0 EcoBlue mHEV 96 kW (130 PS) BKFC, BKFD	05.2019→		7.05483.25.0	AGR-K	EL	
			↳ 7.06036.15.0	AGR	EL	
2.0 EcoBlue mHEV 125 kW (170 PS) BLFC, BLFD	05.2019→		7.05483.25.0	AGR-K	EL	
			↳ 7.06036.15.0	AGR	EL	
2.2 TDCi 74 kW (100 PS) DRF5, DRFF, DRFG	08.2013→12.2018		7.03784.34.0	AGR	EL	⊗
2.2 TDCi 92-99 kW (125-135 PS) CYF5	08.2013→12.2018		7.03784.34.0	AGR	EL	⊗
2.2 TDCi 114 kW (155 PS) CVF5	08.2013→12.2018		7.03784.34.0	AGR	EL	⊗
2.2 TDCi 4x4 92 kW (125 PS) CY24, CYR5	08.2013→12.2018		7.03784.34.0	AGR	EL	⊗
2.2 TDCi 4x4 114 kW (155 PS) CV24, CVR5	08.2013→12.2018		7.03784.34.0	AGR	EL	⊗
2.2 TDCi RWD 74 kW (100 PS) DRR5	08.2013→12.2018		7.03784.34.0	AGR	EL	⊗
2.2 TDCi RWD 92 kW (125 PS) USR6	08.2013→12.2018		7.03784.34.0	AGR	EL	⊗
2.2 TDCi RWD 114 kW (155 PS) CV24, CVR5, UYR6	08.2013→12.2018		7.03784.34.0	AGR	EL	⊗
2.2 TDCi RWD 99 kW (135 PS) UHR5	08.2013→12.2018		7.03784.34.0	AGR	EL	⊗

F



TRANSIT V363 Van (FCD, FDD)

120

F

2.0 EcoBlue 96 kW (130 PS) YMF6, YMFS	03.2016→		7.05483.25.0	AGR-K	EL	
			↳ 7.06036.15.0	AGR	EL	
2.0 EcoBlue 77 kW (105 PS) YLF6, YLFS	03.2016→		7.05483.25.0	AGR-K	EL	
			↳ 7.06036.15.0	AGR	EL	
2.0 EcoBlue 125 kW (170 PS) YNF6, YNFS	03.2016→		7.05483.25.0	AGR-K	EL	
			↳ 7.06036.15.0	AGR	EL	
2.0 EcoBlue 136 kW (185 PS) BCFB	05.2019→		7.05483.25.0	AGR-K	EL	
			↳ 7.06036.15.0	AGR	EL	
2.0 EcoBlue 4x4 96 kW (130 PS) YMR6	01.2017→		7.05483.25.0	AGR-K	EL	
			↳ 7.06036.15.0	AGR	EL	
2.0 EcoBlue 4x4 125 kW (170 PS) YNR6	01.2017→		7.05483.25.0	AGR-K	EL	
			↳ 7.06036.15.0	AGR	EL	
2.0 EcoBlue RWD 77 kW (105 PS) YLR6	03.2016→		7.05483.25.0	AGR-K	EL	
			↳ 7.06036.15.0	AGR	EL	
2.0 EcoBlue RWD 96 kW (130 PS) YMR6	03.2016→		7.05483.25.0	AGR-K	EL	
			↳ 7.06036.15.0	AGR	EL	
2.0 EcoBlue RWD 125 kW (170 PS) BLHA, BLRA, YNR6	03.2016→		7.05483.25.0	AGR-K	EL	
			↳ 7.06036.15.0	AGR	EL	
2.0 EcoBlue RWD 136 kW (185 PS) BCRA	05.2019→		7.05483.25.0	AGR-K	EL	
			↳ 7.06036.15.0	AGR	EL	
2.0 EcoBlue mHEV 96 kW (130 PS) BKFC, BKFD	05.2019→		7.05483.25.0	AGR-K	EL	
			↳ 7.06036.15.0	AGR	EL	
2.0 EcoBlue mHEV 125 kW (170 PS) BLFC, BLFD	05.2019→		7.05483.25.0	AGR-K	EL	
			↳ 7.06036.15.0	AGR	EL	
2.0 EcoBlue mHEV RWD 96 kW (130 PS) BKRB	05.2019→		7.05483.25.0	AGR-K	EL	
			↳ 7.06036.15.0	AGR	EL	
2.0 EcoBlue mHEV RWD 125 kW (170 PS) BLRB	05.2019→		7.05483.25.0	AGR-K	EL	
			↳ 7.06036.15.0	AGR	EL	
2.2 TDCi 114 kW (155 PS) CVF5	08.2013→12.2018		7.03784.34.0	AGR	EL	⊗
2.2 TDCi 92-99 kW (125-135 PS) CY14, CYF5, CYFG, USF6	08.2013→12.2018		7.03784.34.0	AGR	EL	⊗
2.2 TDCi 74 kW (100 PS) DRF5, DRFF, DRFG	08.2013→12.2018		7.03784.34.0	AGR	EL	⊗
2.2 TDCi 4x4 92 kW (125 PS) CY24, CYR5	08.2013→12.2018		7.03784.34.0	AGR	EL	⊗
2.2 TDCi 4x4 114 kW (155 PS) CV24, CVR5	08.2015→12.2018		7.03784.34.0	AGR	EL	⊗
2.2 TDCi RWD 114 kW (155 PS) CV24, CVR5, UYR6	08.2013→12.2018		7.03784.34.0	AGR	EL	⊗

















































TRANSIT V363 Van (FCD, FDD)					120
2.2 TDCi RWD 92 kW (125 PS) CYR5, USR6	08.2013→12.2018		7.03784.34.0	AGR	EL
2.2 TDCi RWD 74 kW (100 PS) DRR5	08.2013→12.2018		7.03784.34.0	AGR	EL
TRANSIT Van (E_ _)					121
2.0 (EAL, EAS) 74-84 kW (101-114 PS) NSF, NSG, NSH	06.1994→03.2000		7.02604.63.0	LS	375 mm
TRANSIT Van (FA_ _)					122
2.0 DI (FAE_ , FAF_ , FAG_) 55 kW (75 PS) D3FA	08.2000→05.2006		7.24809.74.0	AGR	PN 07.2005→
2.0 DI (FAE_ , FAF_ , FAG_) 74 kW (101 PS) ABFA	08.2000→05.2006		7.24809.07.0	AGR	PN mit Potentiometer with potentiometer 04.2002→06.2005
			7.24809.74.0	AGR	PN 07.2005→
2.0 DI (FAE_ , FAF_ , FAG_) 63 kW (86 PS) F3FA	08.2000→05.2006		7.24809.07.0	AGR	PN mit Potentiometer with potentiometer 04.2002→06.2005
			7.24809.74.0	AGR	PN 07.2005→
2.0 TDCi 92 kW (125 PS) FIFA	08.2002→05.2006		7.24809.74.0	AGR	PN 07.2005→
2.2 TDCi 81 kW (110 PS) QVFA	04.2006→08.2014		7.24809.70.0	AGR	EL →04.2008
			7.24809.69.0	AGR	EL 05.2008→03.2010
			7.24809.40.0	AGR	EL
			7.01621.08.0	AGR	EL Produktionsdatum ab: 12.03.2010 Production date from: 12.03.2010
2.2 TDCi 96 kW (130 PS) QWFA	04.2006→08.2014		7.24809.70.0	AGR	EL →04.2008
			7.24809.69.0	AGR	EL 05.2008→03.2010
			7.24809.40.0	AGR	EL
			7.01621.08.0	AGR	EL Produktionsdatum ab: 12.03.2010 Production date from: 12.03.2010
2.2 TDCi 63 kW (85 PS) P8FA, P8FB	04.2006→08.2014		7.24809.70.0	AGR	EL P8FA, P8FB: →04.2008
			7.24809.69.0	AGR	EL P8FA, P8FB: 05.2008→03.2010
			7.24809.40.0	AGR	EL
			7.01621.08.0	AGR	EL P8FA, P8FB: Produktionsdatum ab: 12.03.2010 Production date from: 12.03.2010
2.2 TDCi 103 kW (140 PS) PGFA, PGFB, UHFA, UHFB, UHFC	10.2007→08.2014		7.24809.70.0	AGR	EL PGFA, PGFB, UHFA, UHFB, UHFC: →04.2008
			7.24809.69.0	AGR	EL PGFA, PGFB, UHFA, UHFB, UHFC: 05.2008→03.2010
			7.24809.40.0	AGR	EL
			7.03784.34.0	AGR	EL

F



TRANSIT Van (FA_ _) **122**











F

			7.01621.08.0	AGR	EL	  PGFA, PGFB, UHFA, UHFB, UHFC: Produktionsdatum ab: 12.03.2010 Production date from: 12.03.2010
2.2 TDCi 85 kW (115 PS) SRFA, SRFB, SRFC, SRFD, SRFE	10.2008→08.2014		7.24809.69.0	AGR	EL	  SRFA, SRFB, SRFC, SRFD, SRFE: →03.2010
			7.24809.40.0	AGR	EL	
			7.01621.08.0	AGR	EL	 SRFA, SRFB, SRFC, SRFD, SRFE: Produktionsdatum ab: 12.03.2010 Production date from: 12.03.2010
2.2 TDCi 74 kW (101 PS) DRFA, DRFB, DRFC, DRFD, DRFE	10.2011→08.2014		7.03784.34.0	AGR	EL	
2.2 TDCi 92 kW (125 PS) CYFA, CYFB, CYFC, CYFD	10.2011→08.2014		7.03784.34.0	AGR	EL	
2.2 TDCi 4x4 92 kW (125 PS) CYRB, CYRC	10.2011→08.2014		7.03784.34.0	AGR	EL	
2.2 TDCi RWD 92 kW (125 PS) CYRA	09.2011→12.2014		7.03784.34.0	AGR	EL	
2.2 TDCi RWD 74 kW (101 PS) DRRA, DRRB, DRRC	10.2011→08.2014		7.03784.34.0	AGR	EL	
2.2 TDCi RWD 114 kW (155 PS) CVRA, CVRB, CVRC	10.2011→08.2014		7.03784.34.0	AGR	EL	
2.2 TDCi RWD 100 kW (136 PS) USRA, USRB	10.2011→08.2014		7.03784.34.0	AGR	EL	
2.3 16V RWD (FAA_, FAB_, FAC_) 107 kW (146 PS) E5FA	04.2001→05.2006		7.02604.64.0	LS	450 mm	
2.4 DI (FAA_, FAB_, FAC_, FAD_) 66 kW (90 PS) D2FA, D2FB	01.2000→05.2006		7.24809.07.0	AGR	PN	mit Potentiometer with potentiometer   D2FA, D2FB: 04.2003→04.2004
			7.24809.74.0	AGR	PN	  D2FA, D2FB: 04.2004→
2.4 DI RWD (FAA_, FAB_, FAC_, FAD_) 88 kW (120 PS) D4FA	01.2000→05.2006		7.24809.07.0	AGR	PN	mit Potentiometer with potentiometer  04.2003→04.2004
			7.24809.74.0	AGR	PN	 04.2004→
2.4 TDCi 4x4 103 kW (140 PS) H9FB	11.2006→08.2014		7.24809.70.0	AGR	EL	 →04.2008
			7.24809.69.0	AGR	EL	 05.2008→03.2010
			7.01621.08.0	AGR	EL	 03.2010→
			7.24809.40.0	AGR	EL	
2.4 TDCi RWD 85 kW (115 PS) JXFA, JXFC	04.2006→08.2014		7.24809.70.0	AGR	EL	  JXFA, JXFC: →04.2008
			7.24809.69.0	AGR	EL	  JXFA, JXFC: 05.2008→03.2010
			7.24809.40.0	AGR	EL	
			7.01621.08.0	AGR	EL	 JXFA, JXFC: Produktionsdatum ab: 12.03.2010 Production date from: 12.03.2010
2.4 TDCi RWD 103 kW (140 PS) H9FB	04.2006→08.2014		7.24809.40.0	AGR	EL	
2.4 TDCi RWD 103 kW (140 PS) H9FD	04.2006→08.2014		7.24809.70.0	AGR	EL	 →04.2008
			7.24809.69.0	AGR	EL	 05.2008→03.2010





















TRANSIT Van (FA_ _) **122**

			7.24809.40.0 AGR EL 7.01621.08.0 AGR EL Produktionsdatum ab: 12.03.2010 Production date from: 12.03.2010
2.4 TDCi RWD 74 kW (100 PS) PHFA, PHFC	04.2006→08.2014	7.24809.70.0 AGR EL PHFA, PHFC: →04.2008 7.24809.69.0 AGR EL PHFA, PHFC: 05.2008→03.2010 7.24809.40.0 AGR EL 7.01621.08.0 AGR EL PHFA, PHFC: Produktionsdatum ab: 12.03.2010 Production date from: 12.03.2010	
2.4 TDCi RWD 88 kW (120 PS) SWFA	01.2007→12.2011	7.01621.08.0 AGR EL Produktionsdatum ab: 12.03.2010 Production date from: 12.03.2010	
2.4 TDE 92 kW (125 PS) DOFA	07.2001→05.2006	7.24809.07.0 AGR PN mit Potentiometer with potentiometer 04.2003→04.2004 7.24809.74.0 AGR PN 04.2004→	
2.4 TDE 85 kW (115 PS) FXFA	03.2004→05.2006	7.24809.74.0 AGR PN 04.2004→	
3.2 TDCi RWD 147 kW (200 PS) SAFA, SAFB	09.2007→08.2014	7.24809.70.0 AGR EL SAFA, SAFB: →04.2008 7.24809.69.0 AGR EL SAFA, SAFB: 05.2008→03.2010 7.24809.40.0 AGR EL 7.01621.08.0 AGR EL SAFA, SAFB: Produktionsdatum ab: 12.03.2010 Production date from: 12.03.2010 7.03784.34.0 AGR EL	

F

					
EVEREST (25N_) 1					
2.5 TD 105 kW (143 PS) WLAA	09.2006→		7.24809.75.0	AGR	PN <input type="checkbox"/> für Schaltgetriebe for manual transmission
2.5 TD All-wheel Drive 105 kW (143 PS) WLAA	09.2006→		7.24809.75.0	AGR	PN <input type="checkbox"/> für Schaltgetriebe for manual transmission
3.0 TD All-wheel Drive 115 kW (156 PS) WEC	08.2006→		7.24809.75.0	AGR	PN <input type="checkbox"/> für Schaltgetriebe for manual transmission
3.0 TDCi 115 kW (156 PS) WEC	01.2010→		7.24809.75.0	AGR	PN <input type="checkbox"/> für Schaltgetriebe for manual transmission
FIESTA Saloon 2					
1.4 TDCi 50-61 kW (68-83 PS) F6JA	12.2005→		7.24809.06.0	AGR	PN mit Rohrstutzen with pipe socket <input type="checkbox"/> Euro 3 Euro 3







F

						
ENDURA (CA)						1
2.0 140 kW (190 PS) BCCA, BCCB	10.2018→12.2019		7.04511.29.0	AGR-M	EL	<input type="radio"/>
2.0 AWD 140 kW (190 PS) BCCA, BCCB	10.2018→12.2019		7.04511.29.0	AGR-M	EL	<input type="radio"/>
FOCUS Estate (SA)						2
2.0 EcoBlue 110 kW (150 PS) YLDA	08.2018→		7.04511.29.0	AGR-M	EL	<input type="radio"/>
MONDEO Hatchback (MA, MB, MC)						3
2.0 TDCi 96-103 kW (131-140 PS) AZBA	03.2007→01.2015		7.11190.10.0	DDS		ohne Zubehör without accessories
2.0 TDCi 96-103 kW (131-140 PS) AZBA	03.2007→07.2009		7.11190.10.0	DDS		ohne Zubehör without accessories
RANGER Pickup (PJ)						4
3.0 TD 115 kW (156 PS) WEAT	11.2006→03.2009		7.24809.75.0	AGR	PN	<input type="radio"/> für Schaltgetriebe for manual transmission
3.0 TD All-wheel Drive 115 kW (156 PS) WEAT	11.2006→03.2009		7.24809.75.0	AGR	PN	<input type="radio"/> für Schaltgetriebe for manual transmission
RANGER Pickup (PK)						5
3.0 TDdi 115 kW (156 PS) WEAT	03.2009→11.2011		7.24809.75.0	AGR	PN	<input type="radio"/> für Schaltgetriebe for manual transmission
3.0 TDdi 4x4 115 kW (156 PS) WEAT	03.2009→11.2011		7.24809.75.0	AGR	PN	<input type="radio"/> für Schaltgetriebe for manual transmission
RANGER Platform/Chassis (PJ)						6
3.0 TDdi 4x4 115 kW (156 PS) WEAT	11.2006→03.2009		7.24809.75.0	AGR	PN	<input type="radio"/> für Schaltgetriebe for manual transmission
RANGER Platform/Chassis (PK)						7
3.0 TDdi 115 kW (156 PS) WEAT	03.2009→11.2011		7.24809.75.0	AGR	PN	<input type="radio"/> für Schaltgetriebe for manual transmission
3.0 TDdi 4x4 115 kW (156 PS) WEAT	03.2009→11.2011		7.24809.75.0	AGR	PN	<input type="radio"/> für Schaltgetriebe for manual transmission
TRANSIT Platform/Chassis (VF, VG)						8
2.0 84 kW (114 PS) NSF, NSG	01.1996→12.2000		7.02604.63.0	LS	375 mm	
TRANSIT Van (VM)						9
2.2 TD 81 kW (110 PS) QVFA	09.2006→12.2014		7.24809.70.0	AGR	EL	<input type="radio"/>





































F

























					
FOCUS Hatchback 1					
1.8 91 kW (124 PS) CAF483Q0	05.2012→12.2017		7.24809.73.0	AGR	EL <input type="checkbox"/>
FOCUS Hatchback (CD5) 2					
1.8 91 kW (124 PS) CAF483Q, L8-DE	08.2006→12.2011		7.24809.73.0	AGR	EL <input type="checkbox"/>
2.0 104-110 kW (141-150 PS) CAF488Q, LF-DE	08.2006→12.2011		7.24809.73.0	AGR	EL <input type="checkbox"/>
F FOCUS Saloon 3					
1.8 91 kW (124 PS) CAF483Q0	04.2012→12.2014		7.24809.73.0	AGR	EL <input type="checkbox"/>
FOCUS Saloon (CD4) 4					
1.8 91 kW (124 PS) CAF483Q0	09.2005→12.2011		7.24809.73.0	AGR	EL <input type="checkbox"/>
2.0 104-110 kW (141-150 PS) CAF488Q, LF-DE	09.2005→12.2011		7.24809.73.0	AGR	EL <input type="checkbox"/>
MONDEO 5					
2.0 104-110 kW (141-150 PS) LF-DE	05.2003→12.2007		7.24809.73.0	AGR	EL <input type="checkbox"/>
MONDEO / ZHISHENG 6					
2.0 107 kW (146 PS) CAF488Q2	12.2007→12.2013		7.24809.73.0	AGR	EL <input type="checkbox"/>







































TRANSIT Bus						1
2.2 D 92 kW (125 PS) 4D22A5L	05.2016->	 7.24809.69.0	AGR	EL		
2.2 D 114 kW (155 PS) 4D225L	05.2016->	 7.24809.69.0	AGR	EL		
2.2 D 99 kW (135 PS) 4D225H	05.2016->	 7.24809.69.0	AGR	EL		

F

						
EDGE						1
2.0 EcoBlue 110 kW (150 PS) YMCA	08.2018→		7.05578.15.0	AGR	EL	nur in Verbindung mit: Motortyp EcoBlue B, Motortyp EcoBlue C, Motortyp EcoBlue D only in connection with: Motortyp EcoBlue B, Motortyp EcoBlue C, Motortyp EcoBlue D
2.0 EcoBlue AWD 140 kW (190 PS) BCCA, BCCB	08.2018→		7.05578.15.0	AGR	EL	 BCCA, BCCB: nur in Verbindung mit: Motortyp EcoBlue B, Motortyp EcoBlue C, Motortyp EcoBlue D only in connection with: Motortyp EcoBlue B, Motortyp EcoBlue C, Motortyp EcoBlue D
2.0 EcoBlue AWD 175 kW (238 PS) YLCA	08.2018→		7.04511.29.0	AGR-M	EL	
			7.05578.15.0	AGR	EL	nur in Verbindung mit: Motortyp EcoBlue B, Motortyp EcoBlue C, Motortyp EcoBlue D only in connection with: Motortyp EcoBlue B, Motortyp EcoBlue C, Motortyp EcoBlue D
			7.06036.14.0	AGR-K	EL	
			↳ 7.06036.15.0	AGR	EL	09.2018→
			7.04511.29.0	AGR-M	EL	
EXPLORER (U2, U_)						2
4.0 V6 4WD	03.1995→12.2001		7.02604.64.0	LS	450 mm	
F-250 SUPER DUTY						3
6.7 D 4x4 224-336 kW (305-457 PS) C67DVTX	06.2010→		7.02187.12.0	AGR	EL	
F-250 SUPER DUTY Crew Cab Pickup						4
6.4 D 261 kW (355 PS) 6.4HU2U, 6.4HU2Y	09.2007→12.2010		7.01293.38.0	AGR	EL	
6.4 D 4WD	09.2007→12.2010		7.01293.38.0	AGR	EL	
F-250 SUPER DUTY Crew Cab Pickup (W2A, W2B)						5
6.7 D	09.2010→12.2012		7.02187.12.0	AGR	EL	
			7.02738.13.0	AGR	EL	
6.7 D 224-336 kW (305-457 PS) C67DVTX	09.2012→		7.02738.13.0	AGR	EL	
			7.02187.12.0	AGR	EL	
6.7 D	07.2014→		7.02738.13.0	AGR	EL	
			7.02187.12.0	AGR	EL	
6.7 D 4WD	09.2010→12.2012		7.02187.12.0	AGR	EL	
			7.02738.13.0	AGR	EL	
6.7 D 4WD 224-336 kW (305-457 PS) C67DVTX	09.2012→		7.02738.13.0	AGR	EL	
			7.02187.12.0	AGR	EL	
6.7 D 4WD	07.2014→		7.02738.13.0	AGR	EL	
			7.02187.12.0	AGR	EL	

						
F-250 SUPER DUTY Extended Cab Pickup						6
6.4 D 261 kW (355 PS) 6.4HU2U, 6.4HU2Y	09.2007→12.2010		7.01293.38.0	AGR	EL	
6.4 D 4WD 261 kW (355 PS) 6.4HU2U, 6.4HU2Y	09.2007→12.2010		7.01293.38.0	AGR	EL	
F-250 SUPER DUTY Extended Cab Pickup (X2A, X2B)						7
6.7 D	09.2010→		7.02738.13.0	AGR	EL	<input type="radio"/>
			7.02187.12.0	AGR	EL	<input type="radio"/>
6.7 D 224-336 kW (305-457 PS) C67DVTX	09.2012→		7.02738.13.0	AGR	EL	<input type="radio"/>
			7.02187.12.0	AGR	EL	<input type="radio"/>
6.7 D	07.2014→		7.02738.13.0	AGR	EL	<input type="radio"/>
			7.02187.12.0	AGR	EL	<input type="radio"/>
6.7 D 4WD	09.2010→		7.02738.13.0	AGR	EL	<input type="radio"/>
			7.02187.12.0	AGR	EL	<input type="radio"/>
6.7 D 4WD 224-336 kW (305-457 PS) C67DVTX	09.2012→		7.02738.13.0	AGR	EL	<input type="radio"/>
			7.02187.12.0	AGR	EL	<input type="radio"/>
6.7 D 4WD	07.2014→		7.02738.13.0	AGR	EL	<input type="radio"/>
			7.02187.12.0	AGR	EL	<input type="radio"/>
F-250 SUPER DUTY Standard Cab Pickup						8
6.4 D 261 kW (355 PS) 6.4HU2U, 6.4HU2Y	09.2007→12.2010		7.01293.38.0	AGR	EL	
6.4 D 4WD 261 kW (355 PS) 6.4HU2U, 6.4HU2Y	09.2007→12.2010		7.01293.38.0	AGR	EL	
F-250 SUPER DUTY Standard Cab Pickup (F2A, F2B)						9
6.7 D	09.2011→		7.02738.13.0	AGR	EL	<input type="radio"/>
			7.02187.12.0	AGR	EL	<input type="radio"/>
6.7 D 224-336 kW (305-457 PS) C67DVTX	09.2012→		7.02738.13.0	AGR	EL	<input type="radio"/>
			7.02187.12.0	AGR	EL	<input type="radio"/>
6.7 D	07.2014→		7.02738.13.0	AGR	EL	<input type="radio"/>
			7.02187.12.0	AGR	EL	<input type="radio"/>
6.7 D 4WD	09.2010→		7.02738.13.0	AGR	EL	<input type="radio"/>
			7.02187.12.0	AGR	EL	<input type="radio"/>
6.7 D 4WD 224-336 kW (305-457 PS) C67DVTX	01.2012→		7.02738.13.0	AGR	EL	<input type="radio"/>
			7.02187.12.0	AGR	EL	<input type="radio"/>
6.7 D 4WD 224-336 kW (305-457 PS) C67DVTX	09.2012→		7.02738.13.0	AGR	EL	<input type="radio"/>
			7.02187.12.0	AGR	EL	<input type="radio"/>
6.7 D 4WD	07.2014→		7.02738.13.0	AGR	EL	<input type="radio"/>
			7.02187.12.0	AGR	EL	<input type="radio"/>
F-350 SUPER DUTY Crew Cab Pickup						10
6.4 D 4WD 261 kW (355 PS) 6.4HU2U, 6.4HU2Y	09.2007→12.2010		7.01293.38.0	AGR	EL	

F





















			 PIERBURG		
F-350 SUPER DUTY Extended Cab Pickup 11					
6.4 D 261 kW (355 PS) 6.4HU2U, 6.4HU2Y	09.2007→12.2010		7.01293.38.0	AGR	EL
6.4 D 4WD 261 kW (355 PS) 6.4HU2U, 6.4HU2Y	09.2007→12.2010		7.01293.38.0	AGR	EL
F-350 SUPER DUTY Standard Cab Pickup 12					
6.4 D 261 kW (355 PS) 6.4HU2U, 6.4HU2Y	09.2007→12.2010		7.01293.38.0	AGR	EL
6.4 D 4WD 261 kW (355 PS) 6.4HU2U, 6.4HU2Y	09.2007→12.2010		7.01293.38.0	AGR	EL
F-450 SUPER DUTY Cab & Chassis 13					
6.4 D 261 kW (355 PS) 6.4HU2U, 6.4HU2Y	09.2008→12.2010		7.01293.38.0	AGR	EL
6.4 D 4WD	09.2008→12.2010		7.01293.38.0	AGR	EL
F-450 SUPER DUTY Crew Cab Pickup 14					
6.4 D 261 kW (355 PS) 6.4HU2U, 6.4HU2Y	09.2007→12.2008		7.01293.38.0	AGR	EL
6.4 D 261 kW (355 PS) 6.4HU2U, 6.4HU2Y	09.2008→12.2010		7.01293.38.0	AGR	EL
6.4 D 4WD 261 kW (355 PS) 6.4HU2U, 6.4HU2Y	09.2007→12.2008		7.01293.38.0	AGR	EL
6.4 D 4WD 261 kW (355 PS) 6.4HU2U, 6.4HU2Y	09.2008→12.2010		7.01293.38.0	AGR	EL
PROBE II (ECP) 15					
2.5 V6 24V 119-120 kW (162-163 PS) KL	10.1993→03.1998		7.05271.73.0	LS	528 mm
2.5 V6 24V 119-120 kW (162-163 PS) KL	12.1994→03.1998		7.05271.73.0	LS	528 mm
F-350 SUPER DUTY Cab & Chassis 16					
6.4 D 261 kW (355 PS) 6.4HU2U, 6.4HU2Y	09.2007→12.2010		7.01293.38.0	AGR	EL
6.4 D 4WD 261 kW (355 PS) 6.4HU2U, 6.4HU2Y	09.2007→12.2010		7.01293.38.0	AGR	EL
F-550 SUPER DUTY Cab & Chassis 17					
6.4 D 261 kW (355 PS) 6.4HU2U, 6.4HU2Y	09.2007→12.2010		7.01293.38.0	AGR	EL
6.4 D 4WD 261 kW (355 PS) 6.4HU2U, 6.4HU2Y	09.2007→12.2010		7.01293.38.0	AGR	EL
6.7 D	09.2010→		7.02738.13.0	AGR	EL 
			7.02187.12.0	AGR	EL 
6.7 D	07.2014→		7.02738.13.0	AGR	EL 
			7.02187.12.0	AGR	EL 
6.7 D	07.2014→		7.02738.13.0	AGR	EL 
			7.02187.12.0	AGR	EL 
6.7 D 4WD	09.2010→		7.02738.13.0	AGR	EL 
			7.02187.12.0	AGR	EL 
6.7 D 4WD	07.2014→		7.02738.13.0	AGR	EL 
			7.02187.12.0	AGR	EL 

			 PIERBURG		
---	---	---	--	--	---



F-550 SUPER DUTY Cab & Chassis 17

6.7 D 4WD	07.2014->		7.02738.13.0 7.02187.12.0	AGR AGR	EL <input type="checkbox"/> EL <input type="checkbox"/>
------------------	-----------	---	--	------------	--

F

			 PIERBURG			
SPRINTER 2500 Cab & Chassis						1
2.7 D 115 kW (156 PS) OM 612.981	09.2004→12.2006		7.24809.54.0	AGR	ET <input type="checkbox"/>	
3.0 D 135 kW (184 PS) OM 642.993	09.2006→12.2007		7.24809.60.0	AGR	ET <input type="checkbox"/>	
3.5	09.2006→12.2007		7.04389.02.0	SLP	EL	
SPRINTER 2500 Standard Cargo Van						2
2.7 D	09.2001→12.2005		7.24809.65.0	AGR	ET <input type="checkbox"/>	
3.5 190-200 kW (258-272 PS) EG2	09.2006→12.2008		7.04389.02.0	SLP	EL	
SPRINTER 2500 Standard Passenger Van						3
2.7 D	09.2001→12.2005		7.24809.65.0	AGR	ET <input type="checkbox"/>	
3.5 190-200 kW (258-272 PS) EG2	09.2006→12.2008		7.04389.02.0	SLP	EL	
SPRINTER 3500 Cab & Chassis						4
2.7 D 115 kW (156 PS) OM 612.981	09.2004→12.2006		7.24809.54.0	AGR	ET <input type="checkbox"/>	
3.5	09.2006→12.2008		7.04389.02.0	SLP	EL	
SPRINTER 3500 Standard Cargo Van						5
2.7 D	09.2004→12.2005		7.24809.65.0	AGR	ET <input type="checkbox"/>	
3.5 190-200 kW (258-272 PS) EG2	09.2006→12.2008		7.04389.02.0	SLP	EL	
SPRINTER 3500 Standard Passenger Van						6
2.7 D	09.2004→12.2005		7.24809.65.0	AGR	ET <input type="checkbox"/>	
3.0 CDI 135 kW (184 PS) OM 642.993	09.2006→12.2007		7.24809.60.0	AGR	ET <input type="checkbox"/>	
3.5 190-200 kW (258-272 PS) EG2	09.2006→12.2007		7.04389.02.0	SLP	EL	















LANOS Hatchback						1
1.5 63 kW (86 PS) A15SM	05.2004→10.2008	 7.09002.02.0	AGR	PN	<input checked="" type="checkbox"/>	
LANOS Saloon						2
1.5 63 kW (86 PS) A15SM	05.2004→10.2008	 7.09002.02.0	AGR	PN	<input checked="" type="checkbox"/>	

F



CANTER **1**

F

3C13 96 kW (131 PS) 4P10-T2	11.2010→		7.02321.17.0	AK	EL	06.2011→03.2016
3C15 110 kW (150 PS) 4P10-T4	11.2010→		7.03692.11.0 ↳ 7.05632.04.0 7.02321.17.0	AGR-K AGR AK	EL EL EL	09.2012→ für Fahrzeuge mit Hybridantrieb for vehicles with hybrid drive 06.2011→03.2016
3C18 129 kW (175 PS) 4P10-T6	11.2010→		7.02321.17.0	AK	EL	06.2011→03.2016
3S13 96 kW (131 PS) 4P10-T2	11.2010→		7.02321.17.0	AK	EL	06.2011→03.2016
3S15 110 kW (150 PS) 4P10-T4	11.2010→		7.03692.11.0 ↳ 7.05632.04.0 7.02321.17.0	AGR-K AGR AK	EL EL EL	09.2012→ für Fahrzeuge mit Hybridantrieb for vehicles with hybrid drive 06.2011→03.2016
3S18 129 kW (175 PS) 4P10-T6	11.2010→		7.02321.17.0	AK	EL	06.2011→03.2016
6C18 129 kW (175 PS) 4P10-T6	06.2013→		7.02321.17.0	AK	EL	→03.2016
6S15 110 kW (150 PS) 4P10-T4	11.2010→		7.03692.11.0 ↳ 7.05632.04.0 7.02321.17.0	AGR-K AGR AK	EL EL EL	09.2012→ für Fahrzeuge mit Hybridantrieb for vehicles with hybrid drive 06.2011→04.2016
7C15 110 kW (150 PS) 4P10-T4	11.2010→		7.03692.11.0 ↳ 7.05632.04.0 7.02321.17.0	AGR-K AGR AK	EL EL EL	09.2012→ für Fahrzeuge mit Hybridantrieb for vehicles with hybrid drive 06.2011→03.2016
7C15 EcoHybrid 110 kW (150 PS) 4P10-T4	06.2013→		7.02321.17.0	AK	EL	→03.2016
7C18 129 kW (175 PS) 4P10-T6	11.2010→		7.02321.17.0	AK	EL	06.2011→03.2016
9C15 110 kW (150 PS) 4P10-T4	06.2013→		7.03692.11.0 ↳ 7.05632.04.0 7.02321.17.0	AGR-K AGR AK	EL EL EL	für Fahrzeuge mit Hybridantrieb for vehicles with hybrid drive →03.2016
9C18 129 kW (175 PS) 4P10-T6	06.2013→		7.02321.17.0	AK	EL	→03.2016

ENGINE **2**

ENGINE 120 kW (163 PS) 4P10-T5			7.04930.06.0	AGR-K	EL	04.2012→
--	--	---	---------------------	-------	----	----------













































CANYON Crew Cab Pickup **1**

2.8 D 135 kW (184 PS) LWN	09.2015->	 7.05012.01.0	AGR	EL
2.8 D 4WD 135 kW (184 PS) LWN	09.2015->	 7.05012.01.0	AGR	EL





CANYON Extended Cab Pickup **2**

2.8 D 135 kW (184 PS) LWN	09.2015->	 7.05012.01.0	AGR	EL
2.8 D 4WD 135 kW (184 PS) LWN	09.2015->	 7.05012.01.0	AGR	EL

G

						
ASTRA Hatchback (TR)						1
2.0 GSi 100 kW (136 PS) X 20 XEV	08.1995→09.1998		7.22296.02.0	ARV	PN 	
ASTRA Hatchback (TS)						2
1.8 i 85 kW (116 PS) X 18 XE1	02.1998→08.2000		7.24809.10.0	AGR	EL 	
ASTRA Saloon (TS)						3
1.8 i 85 kW (116 PS) X 18 XE1	02.1998→08.2000		7.24809.10.0	AGR	EL 	
BARINA Hatchback (SB)						4
1.6 i 78-80 kW (106-109 PS) X 16 XE	04.1994→08.1998		7.22296.02.0	ARV	PN 	
BARINA Hatchback (XC)						5
1.4 Efi 66 kW (90 PS) Z 14 XEP	01.2004→02.2005		7.22875.16.0	AGR	EL 	 ch. 53000001→  →ch. 43999999
			7.22875.13.0	AGR	EL 	
1.4 Sfi 66 kW (90 PS) X 14 XE	09.2000→12.2005		7.22296.02.0	ARV	PN 	
1.4 Sfi 66 kW (90 PS) Z 14 XE	09.2000→12.2005		7.24809.10.0	AGR	EL 	 →ch. 43999999
CALIBRA (YE)						6
2.0 i 16V 100 kW (136 PS) X 20 XEV	07.1995→11.1997		7.22296.02.0	ARV	PN 	
2.5 i V6 125-143 kW (170-194 PS) X 25 XE	07.1995→11.1997		7.22296.02.0	ARV	PN 	
COLORADO 7 (RG)						7
2.8 TD 4x4 (U156FH, U156MH) 147 kW (200 PS) LWN	10.2013→06.2016		7.05012.01.0	AGR	EL	
COLORADO Pickup (RG)						8
2.8 TD (U148CK, U148EK) 147 kW (200 PS) LWN	10.2013→10.2020		7.05012.01.0	AGR	EL	
2.8 TD 4x4 (U148DK, U148FK, U138FK) 147 kW (200 PS) LWN	10.2013→10.2020		7.05012.01.0	AGR	EL	
TIGRA (XC)						9
1.8 87-92 kW (118-125 PS) Z 18 XE	09.2005→12.2007		7.24809.10.0	AGR	EL 	
TRAILBLAZER (RG)						10
2.8 TDi 4x4 147 kW (200 PS) LWN	07.2016→10.2020		7.05012.01.0	AGR	EL	
VECTRA Hatchback (JR)						11
2.0 i 100 kW (136 PS) X 20 XEV	06.1997→12.1998		7.22296.02.0	ARV	PN 	
2.5 i 125-143 kW (170-194 PS) X 25 XE	06.1997→12.1998		7.22296.02.0	ARV	PN 	
VECTRA Hatchback (JS)						12
2.5 i 125-143 kW (170-194 PS) X 25 XE	08.1998→12.2002		7.22296.02.0	ARV	PN 	
VECTRA Saloon (JR)						13
2.5 i 125-143 kW (170-194 PS) X 25 XE	06.1997→12.1998		7.22296.02.0	ARV	PN 	

























COLORADO Platform/Chassis (RG)						14
2.8 TD (U143CK) 147 kW (200 PS) LWN	10.2013→10.2020		7.05012.01.0	AGR	EL	
2.8 TD 4x4 (U148MK) 147 kW (200 PS) LWN	10.2013→10.2020		7.05012.01.0	AGR	EL	
COMBO Van (XC)						15
1.4 i 66 kW (90 PS) Z 14 XEP	04.2005→12.2012		7.22875.16.0	AGR	EL	 ch. 53000001→  →ch. 43999999
			7.22875.13.0	AGR	EL	

G

						
ACCORD IV (CB)						1
2.2 i 16V (CB7) 108-110 kW (147-150 PS) F22A3	01.1990→03.1993		7.05271.71.0	LS	360 mm	
2.2 i 16V Automatik (CB7) 108-110 kW (147-150 PS) F22A3	01.1990→03.1993		7.05271.71.0	LS	360 mm	
ACCORD IV Aerodeck (CB)						2
2.2 i 16V (CB8) 108 kW (147 PS) F22A8	01.1991→12.1993		7.05271.71.0	LS	360 mm	
2.2 i 16V (CB8) 110 kW (150 PS) F22A7	01.1991→12.1993		7.05271.71.0	LS	360 mm	
ACCORD IV Coupe (CB, CC)						3
2.0 i 16V (CC1) 98 kW (133 PS) F20A7	01.1992→09.1993		7.05271.71.0	LS	360 mm	
CIVIC II Shuttle (EE)						4
1.6 4x4 79-96 kW (107-131 PS) D16A, D16A7	01.1988→12.1992		7.02604.01.0	LS	200 mm	
1.6 i 16V 4WD (EE4) 79-81 kW (107-110 PS) D16A6	01.1988→12.1989		7.02604.01.0	LS	200 mm	
1.6 i 16V 4WD (EE4) 79-81 kW (107-110 PS) D16A6	01.1988→02.1995		7.02604.01.0	LS	200 mm	
CIVIC IV Hatchback (EC, ED, EE)						5
1.6 i 16V 85-96 kW (115-131 PS) D16A7, D16A9	09.1987→09.1991		7.02604.01.0	LS	200 mm	
1.6 i 16V 85-96 kW (115-131 PS) D16A7	01.1988→12.1991		7.02604.01.0	LS	200 mm	
1.6 i 16V (ED7) 79-81 kW (107-110 PS) D16A6	10.1987→09.1991		7.02604.01.0	LS	200 mm	
1.6 i 16V (ED7) 78-88 kW (106-120 PS) D16Z2	10.1987→09.1991		7.02604.01.0	LS	200 mm	
1.6 i 16V Vtec (EE9) 110 kW (150 PS) B16A1	10.1989→09.1991		7.02604.01.0	LS	200 mm	
CIVIC IV Saloon (ED)						6
1.6 16V 4x4 79-81 kW (107-110 PS) D16A6	11.1987→09.1991		7.02604.01.0	LS	200 mm	
1.6 4x4 110 kW (150 PS) B16A1	01.1988→12.1991		7.02604.01.0	LS	200 mm	
1.6 i 16V 85-96 kW (115-131 PS) D16A7	09.1987→09.1991		7.02604.01.0	LS	200 mm	
1.6 i 16V (ED4) 78-88 kW (106-120 PS) D16Z2	10.1987→09.1991		7.02604.01.0	LS	200 mm	
1.6 i 16V (ED4) 79-81 kW (107-110 PS) D16A6	10.1989→09.1991		7.02604.01.0	LS	200 mm	
1.6 i 16V 4x4 79-81 kW (107-110 PS) D16A6	10.1989→09.1991		7.02604.01.0	LS	200 mm	





CIVIC V Coupe (EJ)						7
1.5 i LSi (EJ2) 67-77 kW (91-105 PS) D15B7	01.1994→11.1995		7.05271.71.0	LS	360 mm	
1.6 i Vtec (EJ1) 92 kW (125 PS) D16Y6, D16Z9	01.1994→03.1996		7.02604.01.0	LS	200 mm	
CIVIC V Hatchback (EG)						8
1.6 96 kW (131 PS) D16A9, D16Y1	10.1991→09.1995		7.02604.01.0	LS	200 mm	
1.6 16V Vtec (EG5) 91-96 kW (124-131 PS) D16Z6	10.1991→11.1995		7.02604.01.0	LS	200 mm	
1.6 VTi 16V (EG6) 118 kW (160 PS) B16A2	10.1991→11.1995		7.02604.01.0	LS	200 mm	
CIVIC V Saloon (EG, EH)						9
1.6 (EH9) 91-96 kW (124-131 PS) D16Y1, D16Z6	10.1991→10.1993		7.02604.01.0	LS	200 mm	
1.6 16V Vtec (EH9) 88-96 kW (120-131 PS) D16Z6, D16Z7	10.1991→11.1995		7.02604.01.0	LS	200 mm	
1.6 4x4 88-92 kW (120-125 PS) D16Z7	01.1992→10.1995		7.02604.01.0	LS	200 mm	
1.6 EX 85-96 kW (115-131 PS) D16A7	08.1993→10.1995		7.02604.01.0	LS	200 mm	
1.6 VTi (EG9) 118 kW (160 PS) B16A2	10.1991→11.1995		7.02604.01.0	LS	200 mm	
CIVIC VI Aerodeck (MB, MC)						10
1.4 16V (MB8) 55 kW (75 PS) D14A7	04.1998→02.2001		7.05271.71.0	LS	360 mm	
1.4 16V (MB8) 66 kW (90 PS) D14A8	04.1998→02.2001		7.05271.71.0	LS	360 mm	
1.5 16V (MB9) 84 kW (114 PS) D15Z8	04.1998→02.2001		7.05271.58.0	LS	410 mm	
1.6 16V (MC1) 85 kW (116 PS) D16B2	04.1998→02.2001		7.05271.71.0 7.02604.01.0	LS LS	360 mm 200 mm	
CIVIC VI Coupe (EJ, EM1)						11
1.6 77-79 kW (105-107 PS) D16Y7	05.1996→04.1999		7.02604.01.0	LS	200 mm	
1.6 i 77-79 kW (105-107 PS) D16Y7	03.1996→03.2000		7.02604.01.0	LS	200 mm	
1.6 i Vtec 118 kW (160 PS) B16A2	04.1999→12.2000		7.02604.01.0	LS	200 mm	
1.6 i Vtec (EM1) 84-95 kW (114-129 PS) D16Y8	03.1996→03.2000		7.02604.01.0	LS	200 mm	
CIVIC VI Fastback (MA, MB)						12
1.4 i (MA8, MB2) 66 kW (90 PS) D14A2, D14A6, D14A8, D14Z4	06.1995→02.2001		7.05271.71.0	LS	360 mm	
1.4 i (MA8, MB2) 55 kW (75 PS) D14A5, D14A7, D14Z3	09.1995→02.2001		7.05271.71.0	LS	360 mm	
1.5 16V (MB3) 84 kW (114 PS) D15Z8	01.1997→02.2001		7.05271.58.0	LS	410 mm	
1.6 92 kW (125 PS) D16W4	11.1998→10.2000		7.02604.01.0	LS	200 mm	
1.6 16V (MB4) 85 kW (116 PS) D16B2	01.1997→02.2001		7.05271.71.0	LS	360 mm	

H









CIVIC VI Fastback (MA, MB)

12

			7.02604.01.0	LS	200 mm
1.6 VTi 118 kW (160 PS) B16A2	01.1997→02.2001		7.02604.01.0	LS	200 mm
1.6 i (MB1) 83 kW (113 PS) D16Y3	09.1994→01.1997		7.05271.71.0	LS	360 mm
			7.02604.01.0	LS	200 mm
1.6 i Vtec (MB1) 93 kW (126 PS) D16Y2	09.1994→01.1997		7.02604.01.0	LS	200 mm

CIVIC VI Hatchback (EJ, EK)

13

1.5 i (EK3) 84 kW (114 PS) D15Z6	11.1995→02.2001		7.05271.58.0	LS	410 mm
1.6	10.1995→03.1999		7.02604.01.0	LS	200 mm
1.6 88 kW (120 PS) D16Y4	10.1995→09.2000		7.02604.01.0	LS	200 mm
1.6 93 kW (126 PS) D16Y2	10.1995→09.2000		7.02604.01.0	LS	200 mm
1.6 92 kW (125 PS) D16W4	11.1998→10.2000		7.02604.01.0	LS	200 mm
1.6 VTi (EK4) 118 kW (160 PS) B16A2	11.1995→02.2001		7.02604.01.0	LS	200 mm
1.6 i (EK1) 84-86 kW (114-117 PS) D16Y5	11.1995→02.2001		7.05271.71.0	LS	360 mm
			7.02604.01.0	LS	200 mm

CIVIC VI Saloon (EJ, EK)

14

1.5 i (EK3) 84 kW (114 PS) D15Z6	11.1995→02.2001		7.05271.58.0	LS	410 mm
1.6 93 kW (126 PS) D16Y2	10.1995→12.2000		7.02604.01.0	LS	200 mm
1.6	10.1995→09.2000		7.02604.01.0	LS	200 mm
1.6 VTi (EK4) 118 kW (160 PS) B16A2	11.1995→02.2001		7.02604.01.0	LS	200 mm
1.6 i Vtec 84-95 kW (114-129 PS) D16Y5, D16Y6, D16Y8	11.1995→02.2001		7.02604.01.0	LS	200 mm



CIVIC VII Coupe (EM2)







15

1.6 i 78-81 kW (106-110 PS) D16V1	02.2001→12.2005		7.05271.61.0	LS	550 mm
			7.02604.01.0	LS	200 mm
1.7 i 88 kW (120 PS) D17A8	05.2001→12.2005		7.05271.61.0	LS	550 mm
1.7 i VTEC 92-96 kW (125-131 PS) D17A5, D17A9	05.2001→12.2005		7.05271.61.0	LS	550 mm

CIVIC VII Hatchback (EU, EP, EV)



16

1.4 i 55-66 kW (75-90 PS) D14Z6	02.2001→09.2005		7.05271.61.0	LS	550 mm
1.4 iS (EP1) 55-66 kW (75-90 PS) D14Z5, D14Z6	02.2001→09.2005		7.05271.61.0	LS	550 mm
1.6 i 78-81 kW (106-110 PS) D16V1, D16W7	02.2001→09.2005		7.05271.61.0	LS	550 mm
			7.02604.01.0	LS	200 mm
1.7 CTDi 74 kW (101 PS) 4EE-2	01.2002→09.2005		7.22772.12.0	AGR	PN 

























						
CIVIC VII Saloon (ES, ET)						17
1.3 IMA (ED9, ES9) 61-69 kW (83-94 PS) LDA1	10.2003→09.2005		7.05271.61.0	LS	550 mm	
1.4 (ES4) 66 kW (90 PS) D14Z5	12.2000→09.2005		7.05271.61.0	LS	550 mm	
1.6 81 kW (110 PS) D16W7	02.2001→09.2005		7.05271.61.0	LS	550 mm	
			7.02604.01.0	LS	200 mm	
CIVIC VIII Hatchback (FN, FK)						18
1.8 (FN1, FK2) 103 kW (140 PS) R18A2	09.2005→		7.05271.46.0	LS	350 mm	
CONCERTO (HW, MA)						19
1.5 i 16V 61-74 kW (83-101 PS) D15B2	08.1989→09.1991		7.02604.01.0	LS	200 mm	
1.6 16V 78-88 kW (106-120 PS) D16Z2	08.1989→03.1995		7.02604.01.0	LS	200 mm	
1.6 i 16V 78-88 kW (106-120 PS) D16Z2	08.1989→09.1991		7.02604.01.0	LS	200 mm	
1.6 i 16V 81-96 kW (110-131 PS) D16A8, D16Z1, D16Z4	08.1989→03.1995		7.02604.01.0	LS	200 mm	
CONCERTO Saloon (HWW)						20
1.5 i 16V 61-74 kW (83-101 PS) D15B2	08.1989→09.1991		7.02604.01.0	LS	200 mm	
1.6 16V 78-88 kW (106-120 PS) D16Z2	08.1989→03.1995		7.02604.01.0	LS	200 mm	
1.6 i 16V 78-88 kW (106-120 PS) D16Z2	08.1989→09.1991		7.02604.01.0	LS	200 mm	
1.6 i 16V 81-96 kW (110-131 PS) D16A8, D16Z1, D16Z4	08.1989→03.1995		7.02604.01.0	LS	200 mm	
CRX III (EH, EG)						21
1.6 i VTi (EG2) 118 kW (160 PS) B16A2, B16A3	03.1992→12.1998		7.05271.71.0	LS	360 mm	
FR-V (BE)						22
1.8 (BE1) 97-104 kW (132-141 PS) R18A1	01.2007→		7.05271.46.0	LS	350 mm	
LEGEND I (HS, KA)						23
2.5 i (HS) 110-120 kW (150-163 PS) C25A1	01.1986→12.1987		7.02604.01.0	LS	200 mm	
2.5 i (HS) 124-127 kW (169-173 PS) C25A2	02.1987→06.1988		7.02604.01.0	LS	200 mm	
2.7 i 24V (KA4) 124-130 kW (169-177 PS) C27A1	01.1988→12.1990		7.02604.01.0	LS	200 mm	
LEGEND I Coupe (KA_)						24
2.7 i 24V (KA3) 124-130 kW (169-177 PS) C27A1	10.1987→12.1990		7.02604.01.0	LS	200 mm	
PRELUDE III (BA)						25
2.0 (BA4) 84 kW (114 PS) B20A4	08.1987→01.1992		7.02604.01.0	LS	200 mm	
2.0 EX (BA4) 78-80 kW (106-109 PS) B20A3	04.1987→01.1992		7.02604.01.0	LS	200 mm	

H





























PRELUDE V (BB_)						26
2.2 16V (BB6, BB8) 136-150 kW (185-204 PS) H22A2, H22A5	10.1996→10.2000		7.05271.61.0	LS	550 mm	
STREAM (RN)						27
1.7 16V (RN1) 92-96 kW (125-131 PS) D17A2, D17A5	05.2001→09.2006		7.05271.61.0	LS	550 mm	

H

						
ACCENT II (LC)						1
1.6 66-84 kW (90-114 PS) G4ED	12.2002→11.2005		7.02604.73.0	LS	375 mm	
ACCENT II Saloon (LC)						2
1.6 66-84 kW (90-114 PS) G4ED	12.2002→11.2005		7.02604.73.0	LS	375 mm	
ACCENT III (MC)						3
1.4 GL 71 kW (97 PS) G4EE	11.2005→11.2010		7.02604.73.0	LS	375 mm	
1.5 CRDi GLS 65-85 kW (88-116 PS) D4FA	11.2005→11.2010		7.09002.07.0	AGR	ET	
			7.02604.99.0	LS	400 mm	
ACCENT III Saloon (MC)						4
1.4 GL 71 kW (97 PS) G4EE	11.2005→11.2010		7.02604.73.0	LS	375 mm	
1.5 CRDi GLS 65-85 kW (88-116 PS) D4FA	11.2005→11.2010		7.09002.07.0	AGR	ET	
			7.02604.99.0	LS	400 mm	
ACCENT IV (RB)						5
1.4 66-80 kW (90-109 PS) G4FA	11.2010→		7.02604.73.0	LS	375 mm	
1.6 CRDi 66-100 kW (90-136 PS) D4FB	07.2011→		7.11237.07.0	AGR	EL	
			7.05052.00.0	AGR-K		→09.2014 Euro 5 Euro 5 →06.2015
ACCENT IV Saloon (RB)						6
1.6 CRDi 66-100 kW (90-136 PS) D4FB	04.2011→		7.05052.00.0	AGR-K		→06.2015
1.6 CRDi 66-100 kW (90-136 PS) D4FB	11.2010→12.2017		7.11237.07.0	AGR	EL	
			7.05052.00.0	AGR-K		→01.2015 Euro 5 Euro 5 →06.2015
			7.02604.99.0	LS	400 mm	
ATOS (MX)						7
1.0 i 40-46 kW (54-63 PS) G4HC	02.1998→12.2000		7.02604.96.0	LS	750 mm	
			7.02604.95.0	LS	550 mm	
1.0 i 40-46 kW (54-63 PS) G4HC	02.1998→03.2002		7.02604.96.0	LS	750 mm	
			7.02604.95.0	LS	550 mm	
1.0 i 40-46 kW (54-63 PS) G4HC	03.2001→07.2003		7.02604.96.0	LS	750 mm	
			7.02604.95.0	LS	550 mm	
1.1 43-49 kW (58-67 PS) G4HD	08.2003→12.2008		7.02604.96.0	LS	750 mm	
			7.02604.95.0	LS	550 mm	

H

			 PIERBURG			
COUPE (GK)						8
2.0 100-107 kW (136-146 PS) G4GC	08.2001→08.2009		7.02604.80.0	LS	220 mm	
2.0 100-105 kW (136-143 PS) G4GC-G	03.2002→08.2009		7.02604.80.0	LS	220 mm	
2.0 GLS 100-107 kW (136-146 PS) G4GC	02.2003→08.2009		7.02604.80.0	LS	220 mm	
COUPE (RD)						9
1.6 16V 66-87 kW (90-118 PS) G4GR	03.1998→04.2002		7.02604.73.0	LS	375 mm 06.2000→ Regelsonde Regulating Probe	
1.6 i 16V 76-79 kW (103-107 PS) G4ED-G	08.2000→01.2002		7.02604.73.0	LS	375 mm Regelsonde Regulating Probe	
2.0 16V 99-115 kW (135-154 PS) G4DF, G4GF	08.1996→04.2002		7.02604.80.0	LS	220 mm	
2.0 16V 99-103 kW (135-140 PS) G4DF	03.2001→04.2002		7.02604.80.0	LS	220 mm	
ELANTRA III (XD)						10
1.6 66-84 kW (90-114 PS) G4ED	06.2000→07.2006		7.02604.73.0	LS	375 mm	
1.6 66-84 kW (90-114 PS) G4ED	05.2003→07.2006		7.02604.73.0	LS	375 mm	
1.8 79-98 kW (107-133 PS) G4BB, G4GB	06.2000→07.2006		7.02604.80.0	LS	220 mm	
1.8 79-97 kW (107-132 PS) G4BB	06.2000→07.2003		7.02604.80.0	LS	220 mm	
1.8 90-98 kW (122-133 PS) G4GB	11.2002→07.2006		7.02604.80.0	LS	220 mm	
2.0 100-107 kW (136-146 PS) G4GC	06.2000→07.2006		7.02604.73.0	LS	375 mm	
			7.02604.80.0	LS	220 mm	
2.0 100-105 kW (136-143 PS) G4GC-G	06.2000→07.2006		7.02604.73.0	LS	375 mm	
			7.02604.80.0	LS	220 mm	
2.0 100-107 kW (136-146 PS) G4GC	10.2003→07.2006		7.02604.73.0	LS	375 mm	
			7.02604.80.0	LS	220 mm	
ELANTRA III Saloon (XD)						11
1.6 66-84 kW (90-114 PS) G4ED	06.2000→07.2006		7.02604.73.0	LS	375 mm	
1.6 66-84 kW (90-114 PS) G4ED	05.2003→05.2006		7.02604.73.0	LS	375 mm	
1.8 79-98 kW (107-133 PS) G4BB, G4GB	06.2000→07.2006		7.02604.80.0	LS	220 mm	
1.8 79-97 kW (107-132 PS) G4BB	06.2000→07.2003		7.02604.80.0	LS	220 mm	
2.0 100-107 kW (136-146 PS) G4GC	06.2000→07.2006		7.02604.73.0	LS	375 mm	
			7.02604.80.0	LS	220 mm	
2.0 100-105 kW (136-143 PS) G4GC-G	06.2000→07.2006		7.02604.73.0	LS	375 mm	
			7.02604.80.0	LS	220 mm	

						
ELANTRA III Saloon (XD)						11
2.0 100-107 kW (136-146 PS) G4GC	10.2003→07.2006		7.02604.73.0	LS	375 mm	
			7.02604.80.0	LS	220 mm	
ELANTRA IV Saloon (HD)						12
1.6 CRDi 66-100 kW (90-136 PS) D4FB	11.2005→12.2011		7.09002.07.0	AGR	ET 	
			7.02604.99.0	LS	400 mm	
Produktionsdatum bis: 11.02.2009 Production date to: 11.02.2009						
ELANTRA V Saloon (MD, UD)						13
1.6 CRDi 66-100 kW (90-136 PS) D4FB	02.2011→12.2015		7.02604.99.0	LS	400 mm	
EQUUS / CENTENNIAL						14
3.8 187-228 kW (254-310 PS) G6DA	03.2009→		7.02604.92.0	LS	750 mm	
GENESIS (BH)						15
3.8 V6 187-228 kW (254-310 PS) G6DA	01.2008→12.2014		7.02604.92.0	LS	750 mm	
GENESIS Coupe						16
3.8 V6 187-228 kW (254-310 PS) G6DA	01.2008→02.2014		7.02604.92.0	LS	750 mm	
3.8 V6 228-260 kW (310-354 PS) G6DJ	04.2012→		7.02604.92.0	LS	750 mm	
GETZ (TB)						17
1.4 i 71 kW (97 PS) G4EE	08.2005→12.2010		7.02604.73.0	LS	375 mm	
1.5 CRDi 60 kW (82 PS) D3EA	03.2003→09.2005		7.09002.03.0	AGR	PN 	
1.5 CRDi 65-85 kW (88-116 PS) D4FA	08.2005→06.2009		7.09002.07.0	AGR	ET 	
			7.02604.99.0	LS	400 mm	
1.5 CRDi GLS 65-85 kW (88-116 PS) D4FA	07.2004→08.2005		7.09002.03.0	AGR	PN 	
1.5 CRDi GLS 65-85 kW (88-116 PS) D4FA	08.2005→06.2009		7.09002.07.0	AGR	ET 	
			7.02604.99.0	LS	400 mm	
1.6 66-84 kW (90-114 PS) G4ED	09.2002→09.2005		7.02604.73.0	LS	375 mm	
1.6 66-84 kW (90-114 PS) G4ED	06.2005→06.2009		7.02604.73.0	LS	375 mm	
GRAND SANTA FÉ						18
2.2 CRDi All-wheel Drive 142-191 kW (193-260 PS) D4HB	06.2013→		7.09002.12.0	AGR	EL 	
					→05.2015	
2.2 CRDi All-wheel Drive 142-191 kW (193-260 PS) D4HB	09.2013→		7.09002.12.0	AGR	EL 	
					→05.2015	
2.2 CRDi All-wheel Drive 142-191 kW (193-260 PS) D4HB	01.2014→		7.09002.12.0	AGR	EL 	
					→05.2015	

H























						
GRANDEUR (TG)						19
2.2 CRDi 102-114 kW (139-155 PS) D4EB	06.2006→12.2011		7.09002.05.0	AGR	ET 	→10.2010
2.2 CRDi 102-114 kW (139-155 PS) D4EB	06.2006→10.2010		7.09002.05.0	AGR	ET 	
3.3 171-198 kW (233-269 PS) G6DB	04.2005→12.2010		7.02604.92.0	LS	750 mm	
LANTRA II (J-2)						20
1.6 16V 66-87 kW (90-118 PS) G4GR	11.1995→09.2000		7.02604.73.0	LS	375 mm	
1.6 i 66-87 kW (90-118 PS) G4GR	11.1995→09.2000		7.02604.73.0	LS	375 mm	
1.8 16V 94-101 kW (128-138 PS) G4GM	11.1995→09.2000		7.02604.80.0	LS	220 mm	06.2000→
LANTRA II Estate (J-2)						21
1.6 16V 66-87 kW (90-118 PS) G4GR	02.1996→10.2000		7.02604.73.0	LS	375 mm	
1.6 i 66-87 kW (90-118 PS) G4GR	02.1996→10.2000		7.02604.73.0	LS	375 mm	
1.8 16V 94-101 kW (128-138 PS) G4GM	02.1996→10.2000		7.02604.80.0	LS	220 mm	06.2000→
MATRIX (FC)						22
1.5 CRDi 65-85 kW (88-116 PS) D4FA	12.2004→08.2010		7.09002.09.0	AGR	ET 	
1.5 CRDi VGT 65-85 kW (88-116 PS) D4FA	08.2005→08.2010		7.09002.09.0	AGR	ET 	
1.6 66-84 kW (90-114 PS) G4ED	06.2001→08.2010		7.02604.73.0	LS	375 mm	
1.8 90-98 kW (122-133 PS) G4GB	06.2001→08.2010		7.02604.73.0	LS	375 mm	
			7.02604.80.0	LS	220 mm	
PONY (X-1)						23
1.5 (X-1) 51-63 kW (69-86 PS) G4DJ	10.1985→09.1989		7.02604.01.0	LS	200 mm	
PONY (X-2)						24
1.3 43-51 kW (58-69 PS) G4DG	10.1989→01.1995		7.02604.01.0	LS	200 mm	
1.3 43-51 kW (58-69 PS) G4DG	01.1990→01.1995		7.02604.01.0	LS	200 mm	
1.5 51-63 kW (69-86 PS) G15B, G4DJ	10.1989→01.1995		7.02604.01.0	LS	200 mm	
PONY / EXCEL Saloon (X-2)						25
1.3 43-51 kW (58-69 PS) G4DG	09.1989→08.1994		7.02604.01.0	LS	200 mm	
1.3 43-51 kW (58-69 PS) G4DG	01.1990→01.1995		7.02604.01.0	LS	200 mm	
1.3 43-51 kW (58-69 PS) G4DG	12.1992→09.1994		7.02604.01.0	LS	200 mm	
1.5 51-63 kW (69-86 PS) G15B, G4DJ	01.1990→01.1995		7.02604.01.0	LS	200 mm	
PONY Saloon (X-1)						26
1.5 51-63 kW (69-86 PS) G4DJ	10.1985→09.1989		7.02604.01.0	LS	200 mm	

						
S COUPE (SLC)						27
1.5 i 63-75 kW (85-102 PS) G4EK	04.1992→05.1996		7.02604.03.0	LS	200 mm	
1.5 i Turbo 85 kW (116 PS) G4EK-TC	04.1991→05.1996		7.02604.03.0	LS	200 mm	
SANTA FÉ I (SM)						28
2.0 92-102 kW (125-139 PS) G4JP	08.2001→03.2006		7.09002.14.0	AGR	PN 	
			7.02604.75.0	LS	575 mm	
			7.02604.79.0	LS	450 mm	
2.0 CRDi 83-110 kW (113-150 PS) D4EA	08.2001→03.2006		7.09002.06.0	AGR	PN 	
			7.09002.14.0	AGR	PN 	
2.0 CRDi 4x4 83-110 kW (113-150 PS) D4EA	04.2001→03.2006		7.09002.06.0	AGR	PN 	
			7.09002.14.0	AGR	PN 	
2.0 CRDi 4x4 83-110 kW (113-150 PS) D4EA	08.2003→03.2006		7.09002.06.0	AGR	PN 	
			7.09002.14.0	AGR	PN 	
2.4 16V 99-112 kW (135-152 PS) G4JS	02.2001→03.2006		7.09002.14.0	AGR	PN 	
			7.02604.75.0	LS	575 mm	
			7.02604.79.0	LS	450 mm	
2.4 16V 99-112 kW (135-152 PS) G4JS	02.2001→03.2006		7.09002.14.0	AGR	PN 	
			7.02604.75.0	LS	575 mm	
			7.02604.79.0	LS	450 mm	
2.4 16V 4x4 99-112 kW (135-152 PS) G4JS	02.2001→03.2006		7.09002.14.0	AGR	PN 	
			7.02604.75.0	LS	575 mm	
			7.02604.79.0	LS	450 mm	
2.4 16V 4x4 99-112 kW (135-152 PS) G4JS	02.2001→03.2006		7.09002.14.0	AGR	PN 	
			7.02604.75.0	LS	575 mm	
			7.02604.79.0	LS	450 mm	
2.7 V6 4x4 121-147 kW (165-200 PS) G6BA	02.2001→03.2006		7.09002.14.0	AGR	PN 	
SANTA FÉ II (CM)						29
2.0 CRDi 100-150 kW (136-204 PS) D4HA	01.2009→12.2012		7.09002.12.0	AGR	EL  09.2009→	
2.0 CRDi 100-150 kW (136-204 PS) D4HA	12.2010→12.2012		7.09002.12.0	AGR	EL 	
2.0 CRDi 4x4 100-150 kW (136-204 PS) D4HA	03.2006→12.2012		7.09002.12.0	AGR	EL  09.2009→	

H



SANTA FÉ II (CM) **29**

2.0 CRDi 4x4 100-150 kW (136-204 PS) D4HA	12.2010→12.2012		7.09002.12.0	AGR	EL	
2.2 CRDi 102-114 kW (139-155 PS) D4EB	03.2006→12.2012		7.09002.05.0	AGR	ET	 →08.2009
2.2 CRDi 102-114 kW (139-155 PS) D4EB	03.2006→12.2009		7.09002.05.0	AGR	ET	 →08.2009
2.2 CRDi 142-191 kW (193-260 PS) D4HB	01.2009→12.2012		7.09002.12.0	AGR	EL	 09.2009→
2.2 CRDi 142-191 kW (193-260 PS) D4HB	01.2009→12.2010		7.09002.12.0	AGR	EL	 09.2009→
2.2 CRDi 4x4 102-114 kW (139-155 PS) D4EB	03.2006→12.2012		7.09002.05.0	AGR	ET	 →08.2009
2.2 CRDi 4x4 102-114 kW (139-155 PS) D4EB	03.2006→12.2009		7.09002.05.0	AGR	ET	 →08.2009
2.2 CRDi 4x4 142-191 kW (193-260 PS) D4HB	01.2009→12.2012		7.09002.12.0	AGR	EL	 09.2009→
2.2 CRDi 4x4 142-191 kW (193-260 PS) D4HB	01.2009→12.2012		7.09002.12.0	AGR	EL	 09.2009→
2.2 CRDi GLS 102-114 kW (139-155 PS) D4EB	03.2006→12.2009		7.09002.05.0	AGR	ET	 →08.2009
2.2 CRDi GLS 4x4 102-114 kW (139-155 PS) D4EB	03.2006→12.2009		7.09002.05.0	AGR	ET	 →08.2009

SANTA FÉ III (DM, DMA) **30**







2.0 CRDi 100-150 kW (136-204 PS) D4HA	09.2012→		7.09002.12.0	AGR	EL	 →05.2015
2.0 CRDi 4WD 100-150 kW (136-204 PS) D4HA	09.2012→		7.09002.12.0	AGR	EL	 →05.2015
2.0 CRDi 4WD 100-150 kW (136-204 PS) D4HA	09.2012→		7.09002.12.0	AGR	EL	 →05.2015
2.2 CRDi 142-191 kW (193-260 PS) D4HB	09.2012→12.2015		7.09002.12.0	AGR	EL	 →05.2015
2.2 CRDi 4WD 142-191 kW (193-260 PS) D4HB	09.2012→12.2015		7.09002.12.0	AGR	EL	 →05.2015

SANTAMO **31**

































2.0 16V 92-102 kW (125-139 PS) G4JP	05.1999→12.2002		7.02604.75.0	LS	575 mm	
2.0 16V 4x4 96-104 kW (131-141 PS) G4CP-D	05.1999→12.2002		7.02604.75.0	LS	575 mm	

SANTRO I **32**

1.0i 12V 40-51 kW (54-69 PS) G4DG, G4HC	10.1997→		7.02604.96.0	LS	750 mm	
			7.02604.95.0	LS	550 mm	
1.1i 12V 43-49 kW (58-67 PS) G4HD	03.2002→		7.02604.96.0	LS	750 mm	
			7.02604.95.0	LS	550 mm	

						
SONATA II (Y-2)						33
2.0 i 74-110 kW (101-150 PS) G4CP	09.1988→08.1991		7.02604.01.0	LS	200 mm	
2.0 i 74-110 kW (101-150 PS) G4CP	01.1991→10.1993		7.02604.01.0	LS	200 mm	
2.4 i 82-106 kW (111-144 PS) G4CS	09.1988→08.1991		7.02604.75.0	LS	575 mm	
			7.02604.79.0	LS	450 mm	
SONATA III						34
2.0i 74-110 kW (101-150 PS) G4CP	05.1996→06.1998		7.02604.75.0	LS	575 mm	
SONATA III (Y-3)						35
1.8 i 70-73 kW (95-99 PS) G4CM	05.1993→06.1998		7.02604.75.0	LS	575 mm	
2.0 i 74-110 kW (101-150 PS) G4CP	06.1994→08.1996		7.02604.75.0	LS	575 mm	
2.0 i 70 kW (95 PS) G4EP	08.1996→06.1998		7.02604.01.0	LS	200 mm	
2.0 i 16V 92 kW (125 PS) G4CP-DM	06.1996→06.1998		7.02604.75.0	LS	575 mm	
SONATA IV						36
1.8i 98 kW (133 PS) G4CM (98 kW)	03.1998→03.2001		7.02604.75.0	LS	575 mm	
2.0i 16V 100 kW (136 PS) G4CP (100 kW)	03.1998→03.2001		7.02604.75.0	LS	575 mm	
			7.02604.79.0	LS	450 mm	
SONATA IV (EF)						37
2.0 16V 92-102 kW (125-139 PS) G4JP	06.1998→10.2001		7.09002.14.0	AGR	PN 	
			7.02604.75.0	LS	575 mm	
			7.02604.79.0	LS	450 mm	
2.0 16V 92-102 kW (125-139 PS) G4JP	10.2001→11.2004		7.09002.14.0	AGR	PN 	
			7.02604.75.0	LS	575 mm	
			7.02604.79.0	LS	450 mm	
2.4 16V 103-111 kW (140-151 PS) G4BS	03.1998→10.2001		7.09002.14.0	AGR	PN 	
			7.02604.75.0	LS	575 mm	
			7.02604.79.0	LS	450 mm	
2.5 V6 24V 118-127 kW (160-173 PS) G6BV	06.1998→10.2001		7.09002.14.0	AGR	PN 	
2.7 V6 121-147 kW (165-200 PS) G6BA	10.2001→11.2004		7.09002.14.0	AGR	PN 	
SONATA V (NF)						38
2.0 CRDi 83-110 kW (113-150 PS) D4EA	02.2006→12.2010		7.09002.05.0	AGR	ET 	
2.0 CRDi 83-110 kW (113-150 PS) D4EA	02.2006→12.2010		7.09002.05.0	AGR	ET 	
2.0 CRDi 83-110 kW (113-150 PS) D4EA	03.2009→12.2010		7.09002.05.0	AGR	ET 	

H



			 PIERBURG		
SONATA V (NF)					38
3.3 171-198 kW (233-269 PS) G6DB	01.2005→12.2010		7.02604.92.0	LS	750 mm
3.3 171-198 kW (233-269 PS) G6DB	06.2005→12.2010		7.02604.92.0	LS	750 mm
TRAJET (FO)					39
2.0 92-102 kW (125-139 PS) G4JP	03.2000→07.2008		7.02604.75.0	LS	575 mm
			7.02604.79.0	LS	450 mm
			7.02604.73.0	LS	375 mm
			7.02604.80.0	LS	220 mm
2.0 100-107 kW (136-146 PS) G4GC	01.2004→07.2008		7.02604.75.0	LS	575 mm
			7.02604.79.0	LS	450 mm
			7.02604.73.0	LS	375 mm
			7.02604.80.0	LS	220 mm
2.0 CRDi 83-110 kW (113-150 PS) D4EA	04.2001→07.2008		7.09002.06.0	AGR	PN 
TUCSON (JM)					40
2.0 100-107 kW (136-146 PS) G4GC	08.2004→		7.02604.73.0	LS	375 mm
			7.02604.80.0	LS	220 mm
2.0 100-107 kW (136-146 PS) G4GC	01.2007→01.2012		7.02604.73.0	LS	375 mm
			7.02604.80.0	LS	220 mm
2.0 All-wheel Drive 100-107 kW (136-146 PS) G4GC	08.2004→03.2010		7.02604.73.0	LS	375 mm
			7.02604.80.0	LS	220 mm
2.0 CRDi 83-110 kW (113-150 PS) D4EA	08.2004→03.2010		7.09002.03.0	AGR	PN 
			7.09002.05.0	AGR	ET  11.2005→
2.0 CRDi 83-110 kW (113-150 PS) D4EA	01.2006→03.2010		7.09002.03.0	AGR	PN 
			7.09002.05.0	AGR	ET 
2.0 CRDi 83-110 kW (113-150 PS) D4EA	01.2006→03.2010		7.09002.03.0	AGR	PN 
			7.09002.05.0	AGR	ET 
2.0 CRDi 83-110 kW (113-150 PS) D4EA	01.2007→03.2010		7.09002.03.0	AGR	PN 
			7.09002.05.0	AGR	ET 
2.0 CRDi 83-110 kW (113-150 PS) D4EA	01.2009→03.2010		7.09002.03.0	AGR	PN 
			7.09002.05.0	AGR	ET 
2.0 CRDi All-wheel Drive 83-110 kW (113-150 PS) D4EA	08.2004→03.2010		7.09002.03.0	AGR	PN 
			7.09002.05.0	AGR	ET  11.2005→

TUCSON (JM)						40
2.0 CRDi All-wheel Drive 83-110 kW (113-150 PS) D4EA	01.2006→03.2010		7.09002.03.0	AGR	PN	
			7.09002.05.0	AGR	ET	
2.0 CRDi All-wheel Drive 83-110 kW (113-150 PS) D4EA	01.2006→03.2010		7.09002.03.0	AGR	PN	
			7.09002.05.0	AGR	ET	
2.0 CRDi All-wheel Drive 83-110 kW (113-150 PS) D4EA	01.2007→03.2010		7.09002.03.0	AGR	PN	
			7.09002.05.0	AGR	ET	
2.0 CRDi All-wheel Drive 83-110 kW (113-150 PS) D4EA	01.2009→03.2010		7.09002.03.0	AGR	PN	
			7.09002.05.0	AGR	ET	
TUCSON (TL, TLE)						41
1.7 CRDi 85-104 kW (116-141 PS) D4FD	06.2015→09.2020		7.02604.99.0	LS	400 mm	
XG (XG)						42
30 134-153 kW (182-208 PS) G6CT	12.1998→12.2005		7.02604.79.0	LS	450 mm	
300 134-153 kW (182-208 PS) G6CT	09.1999→09.2003		7.02604.79.0	LS	450 mm	
350 143-155 kW (194-211 PS) G6CU	10.2002→12.2005		7.02604.79.0	LS	450 mm	
i10 I (PA)						43
1.1 43-51 kW (58-69 PS) G4HG	12.2007→12.2013		7.02604.96.0	LS	750 mm	
			7.02604.95.0	LS	550 mm	
1.1 43-51 kW (58-69 PS) G4HG	01.2008→12.2013		7.02604.96.0	LS	750 mm	
			7.02604.95.0	LS	550 mm	
1.1 43-51 kW (58-69 PS) G4HG	04.2011→12.2013		7.02604.96.0	LS	750 mm	
			7.02604.95.0	LS	550 mm	
1.1 CRDi 52-55 kW (71-75 PS) D3FA	01.2008→12.2011		7.09002.07.0	AGR	ET	
			7.02604.99.0	LS	400 mm	Produktionsdatum bis: 27.10.2010 Production date to: 27.10.2010
i20 ACTIVE (IB, GB)						44
1.4 CRDi 55-66 kW (75-90 PS) D4FC	09.2015→		7.02604.99.0	LS	400 mm	
i20 I (PB, PBT)						45
1.1 CRDi 52-55 kW (71-75 PS) D3FA	03.2012→12.2015		7.02604.99.0	LS	400 mm	
1.4 CRDi 55-66 kW (75-90 PS) D4FC	08.2008→12.2015		7.09002.08.0	AGR	ET	
			7.11237.07.0	AGR	EL	
						→07.2014 Euro 3 (D3), Euro 4 (D4) Euro 3 (D3), Euro 4 (D4) 10.2009→07.2014 Euro 5 Euro 5

H



i20 I (PB, PBT) 45

			7.05052.00.0 7.02604.99.0	AGR-K LS	400 mm	12.2010→12.2014
1.4 CRDi 55-66 kW (75-90 PS) D4FC	09.2008→12.2012		7.09002.08.0	AGR	ET	⊙ Euro 3 (D3), Euro 4 (D4) Euro 3 (D3), Euro 4 (D4)
			7.11237.07.0	AGR	EL	⊙ Euro 5 Euro 5
			7.05052.00.0 7.02604.99.0	AGR-K LS	400 mm	12.2010→
1.6 CRDi 66-100 kW (90-136 PS) D4FB	09.2008→12.2012		7.09002.08.0	AGR	ET	⊙ →03.2012
			7.11237.07.0	AGR	EL	⊙ 12.2008→03.2012 Euro 5 Euro 5
			7.05052.00.0 7.02604.99.0	AGR-K LS	400 mm	12.2010→03.2012
1.6 CRDi 66-100 kW (90-136 PS) D4FB	01.2009→12.2012		7.09002.08.0	AGR	ET	⊙ →03.2012
			7.11237.07.0	AGR	EL	⊙ →03.2012 Euro 5 Euro 5
			7.05052.00.0 7.02604.99.0	AGR-K LS	400 mm	12.2010→03.2012

H



i20 II (GB, IB) 46

1.4 CRDi 55-66 kW (75-90 PS) D4FC	11.2014→		7.02604.99.0	LS	400 mm	
---	----------	---	---------------------	----	-----------	--

i20 II Coupe (GB) 47

1.4 CRDi 55-66 kW (75-90 PS) D4FC	05.2015→		7.02604.99.0	LS	400 mm	
---	----------	---	---------------------	----	-----------	--

i30 (FD) 48

1.6 CRDi 66-100 kW (90-136 PS) D4FB	10.2007→11.2011		7.09002.08.0	AGR	ET	⊙ 03.2009→
			7.09002.07.0	AGR	ET	⊙ Produktionsdatum bis: 24.11.2010 Production date to: 24.11.2010
			7.05052.00.0 7.02604.99.0	AGR-K LS	400 mm	03.2011→
1.6 CRDi 66-100 kW (90-136 PS) D4FB	10.2007→11.2011		7.09002.08.0	AGR	ET	⊙ 03.2009→
			7.09002.07.0	AGR	ET	⊙ Produktionsdatum bis: 24.11.2010 Production date to: 24.11.2010
			7.05052.00.0 7.02604.99.0	AGR-K LS	400 mm	03.2011→
1.6 CRDi 66-100 kW (90-136 PS) D4FB	01.2010→11.2011		7.09002.07.0	AGR	ET	⊙ Produktionsdatum bis: 24.11.2010 Production date to: 24.11.2010
			7.09002.08.0	AGR	ET	⊙
			7.05052.00.0 7.02604.99.0	AGR-K LS	400 mm	03.2011→



i30 (FD) 48

1.6 CRDi VGT 66-100 kW (90-136 PS) D4FB	10.2007→11.2011		7.09002.08.0	AGR	ET	○ 03.2009→
			7.09002.07.0	AGR	ET	○ Produktionsdatum bis: 24.11.2010 Production date to: 24.11.2010
			7.05052.00.0	AGR-K		○ 03.2011→
2.0 100-107 kW (136-146 PS) G4GC	10.2007→11.2011		7.02604.73.0	LS	375 mm	
			7.02604.80.0	LS	220 mm	
2.0 CRDi 83-110 kW (113-150 PS) D4EA	10.2007→11.2011		7.09002.05.0	AGR	ET	○ →06.2010
2.0 CRDi 83-110 kW (113-150 PS) D4EA	10.2007→11.2011		7.09002.05.0	AGR	ET	○ →06.2010

















H









































i30 (GD) 49

1.4 CRDi 55-66 kW (75-90 PS) D4FC	12.2011→12.2016		7.09002.08.0	AGR	ET	○ →12.2014
			7.11237.07.0	AGR	EL	○ 05.2012→01.2015 Euro 5 Euro 5
1.6 CRDi 66-100 kW (90-136 PS) D4FB	11.2011→12.2016		7.09002.08.0	AGR	ET	○ →12.2014
			7.11237.07.0	AGR	EL	○ →01.2015 Euro 5 Euro 5
			7.05052.00.0	AGR-K		○ →05.2012
1.6 CRDi 66-100 kW (90-136 PS) D4FB	12.2011→12.2015		7.09002.08.0	AGR	ET	○ →12.2014
			7.11237.07.0	AGR	EL	○ →01.2015 Euro 5 Euro 5
			7.05052.00.0	AGR-K		○ →05.2012
			7.02604.99.0	LS	400 mm	
1.6 CRDi 66-100 kW (90-136 PS) D4FB	12.2011→12.2016		7.09002.08.0	AGR	ET	○ →12.2014
			7.11237.07.0	AGR	EL	○ →01.2015 Euro 5 Euro 5
			7.05052.00.0	AGR-K		○ →05.2012
			7.02604.99.0	LS	400 mm	

i30 Coupe 50

1.4 CRDi 55-66 kW (75-90 PS) D4FC	05.2013→		7.09002.08.0	AGR	ET	○ →12.2014
			7.11237.07.0	AGR	EL	○ →01.2015 Euro 5 Euro 5
1.6 CRDi 66-100 kW (90-136 PS) D4FB	05.2013→		7.09002.08.0	AGR	ET	○ →12.2014
			7.11237.07.0	AGR	EL	○ →01.2015 Euro 5 Euro 5













			 PIERBURG		
i30 Coupe					50
			7.02604.99.0	LS	400 mm
1.6 CRDi 66-100 kW (90-136 PS) D4FB	11.2015→		7.02604.99.0	LS	400 mm
i30 Estate (FD)					51
1.6 CRDi 66-100 kW (90-136 PS) D4FB	02.2008→06.2012		7.09002.08.0	AGR	ET <input type="checkbox"/> 03.2009→
			7.09002.07.0	AGR	ET <input type="checkbox"/> Produktionsdatum bis: 24.11.2010 Production date to: 24.11.2010
			7.05052.00.0	AGR-K	03.2011→05.2012
			7.02604.99.0	LS	400 mm
1.6 CRDi 66-100 kW (90-136 PS) D4FB	02.2008→06.2012		7.09002.08.0	AGR	ET <input type="checkbox"/> 03.2009→
			7.09002.07.0	AGR	ET <input type="checkbox"/> Produktionsdatum bis: 24.11.2010 Production date to: 24.11.2010
			7.05052.00.0	AGR-K	03.2011→05.2012
			7.02604.99.0	LS	400 mm
1.6 CRDi 66-100 kW (90-136 PS) D4FB	01.2010→06.2012		7.09002.07.0	AGR	ET <input type="checkbox"/> Produktionsdatum bis: 24.11.2010 Production date to: 24.11.2010
			7.09002.08.0	AGR	ET <input type="checkbox"/> 03.2011→05.2012
			7.05052.00.0	AGR-K	
			7.02604.99.0	LS	400 mm
2.0 100-107 kW (136-146 PS) G4GC	02.2008→06.2012		7.02604.73.0	LS	375 mm
			7.02604.80.0	LS	220 mm
2.0 CRDi 83-110 kW (113-150 PS) D4EA	02.2008→06.2012		7.09002.05.0	AGR	ET <input type="checkbox"/> →06.2010
2.0 CRDi 83-110 kW (113-150 PS) D4EA	10.2008→06.2012		7.09002.05.0	AGR	ET <input type="checkbox"/> →06.2010
i30 Estate (GD)					52
1.4 CRDi 55-66 kW (75-90 PS) D4FC	06.2012→		7.09002.08.0	AGR	ET <input type="checkbox"/> →12.2014
			7.11237.07.0	AGR	EL <input type="checkbox"/> →01.2015 Euro 5 Euro 5
1.6 CRDi 66-100 kW (90-136 PS) D4FB	06.2012→12.2015		7.09002.08.0	AGR	ET <input type="checkbox"/>
			7.11237.07.0	AGR	EL <input type="checkbox"/> →01.2015 Euro 5 Euro 5
			7.02604.99.0	LS	400 mm
1.6 CRDi 66-100 kW (90-136 PS) D4FB	06.2012→		7.09002.08.0	AGR	ET <input type="checkbox"/> →12.2014
			7.11237.07.0	AGR	EL <input type="checkbox"/> →01.2015 Euro 5 Euro 5
			7.02604.99.0	LS	400 mm

						
i40 I (VF)						53
1.7 CRDi 85-104 kW (116-141 PS) D4FD	01.2015→		7.02604.99.0	LS	400 mm	
1.7 CRDi 85-104 kW (116-141 PS) D4FD	03.2012→		7.02604.99.0	LS	400 mm	
1.7 CRDi 85-104 kW (116-141 PS) D4FD	03.2012→		7.02604.99.0	LS	400 mm	
i40 I CW (VF)						54
1.7 CRDi 85-104 kW (116-141 PS) D4FD	07.2011→		7.02604.99.0	LS	400 mm	
1.7 CRDi 85-104 kW (116-141 PS) D4FD	07.2011→		7.02604.99.0	LS	400 mm	
1.7 CRDi 85-104 kW (116-141 PS) D4FD	01.2015→		7.02604.99.0	LS	400 mm	
ix20 (JC)						55
1.4 CRDi 55-66 kW (75-90 PS) D4FC	11.2010→		7.09002.08.0	AGR	ET 	
					EL 	
			7.11237.07.0	AGR	EL 	
			7.05052.00.0 7.02604.99.0	AGR-K LS	EL 	
					01.2011→04.2015 Euro 4 (D4) Euro 4 (D4)	
					01.2011→05.2015 Euro 5 Euro 5	
					05.2011→04.2015	
1.4 CRDi 55-66 kW (75-90 PS) D4FC	06.2011→		7.09002.08.0	AGR	ET 	
					EL 	
			7.11237.07.0	AGR	EL 	
			7.05052.00.0 7.02604.99.0	AGR-K LS	EL 	
					→05.2015 Euro 5 Euro 5	
1.6 CRDi 66-100 kW (90-136 PS) D4FB	06.2011→		7.11237.07.0	AGR	EL 	
					EL 	
			7.05052.00.0 7.02604.99.0	AGR-K LS	EL 	
					EL 	
					→05.2015 Euro 5 Euro 5	
					→04.2015	
1.6 CRDi 66-100 kW (90-136 PS) D4FB	06.2011→		7.11237.07.0	AGR	EL 	
					EL 	
			7.05052.00.0 7.02604.99.0	AGR-K LS	EL 	
					EL 	
					→05.2015 Euro 5 Euro 5	
					→04.2015	
ix35 (LM, EL, ELH)						56
1.7 CRDi 85-104 kW (116-141 PS) D4FD	11.2010→		7.02604.99.0	LS	400 mm	
2.0 CRDi 100-150 kW (136-204 PS) D4HA	01.2010→		7.09002.12.0	AGR	EL 	
					→05.2015	
2.0 CRDi 100-150 kW (136-204 PS) D4HA	01.2010→06.2015		7.09002.12.0	AGR	EL 	
					→05.2015	
2.0 CRDi 100-150 kW (136-204 PS) D4HA	01.2012→		7.09002.12.0	AGR	EL 	
					→05.2015	
2.0 CRDi 100-150 kW (136-204 PS) D4HA	01.2012→		7.09002.12.0	AGR	EL 	
					→05.2015	

H















































ix35 (LM, EL, ELH) 56

2.0 CRDi 100-150 kW (136-204 PS) D4HA	10.2012→06.2015		7.09002.12.0	AGR	EL	 →05.2015
2.0 CRDi 4WD 100-150 kW (136-204 PS) D4HA	01.2010→		7.09002.12.0	AGR	EL	 →05.2015
2.0 CRDi 4WD 100-150 kW (136-204 PS) D4HA	01.2010→		7.09002.12.0	AGR	EL	 →05.2015
2.0 CRDi 4WD 100-150 kW (136-204 PS) D4HA	01.2010→06.2015		7.09002.12.0	AGR	EL	 →05.2015
2.0 CRDi 4WD 100-150 kW (136-204 PS) D4HA	01.2011→		7.09002.12.0	AGR	EL	 →05.2015
2.0 CRDi 4WD 100-150 kW (136-204 PS) D4HA	10.2012→06.2015		7.09002.12.0	AGR	EL	 →05.2015





H





















H-1 / STAREX Bus (A1) 57

2.5 CRDi 74-129 kW (110-175 PS) D4CB	12.2002→09.2007		7.09002.11.0	AGR	ET	 Euro 3 Euro 3 für Fahrzeuge ohne VTG-Lader for vehicles without VTG turbocharger
			7.02604.99.0	LS	400 mm	
2.5 CRDi 74-129 kW (110-175 PS) D4CB	12.2002→04.2004		7.09002.11.0	AGR	ET	 Euro 3 Euro 3 für Fahrzeuge ohne VTG-Lader for vehicles without VTG turbocharger
2.5 CRDi 74-129 kW (110-175 PS) D4CB	06.2006→12.2007		7.09002.11.0	AGR	ET	 Euro 3 Euro 3 für Fahrzeuge ohne VTG-Lader for vehicles without VTG turbocharger
			7.02604.99.0	LS	400 mm	
2.5 CRDi 4WD 74-129 kW (110-175 PS) D4CB	12.2002→04.2004		7.09002.11.0	AGR	ET	 Euro 3 Euro 3 für Fahrzeuge ohne VTG-Lader for vehicles without VTG turbocharger
			7.02604.99.0	LS	400 mm	
2.5 D 59-78 kW (80-106 PS) D4BH	10.1997→04.2004		7.09002.11.0	AGR	ET	 Produktionsdatum ab: 01.06.2002 Production date from: 01.06.2002
2.5 TCi 59-78 kW (80-106 PS) D4BH	10.1997→12.2007		7.09002.11.0	AGR	ET	 Produktionsdatum ab: 01.06.2002 Production date from: 01.06.2002
			7.02604.99.0	LS	400 mm	
2.5 TCi 59-78 kW (80-106 PS) D4BH	05.2004→12.2007		7.09002.11.0	AGR	ET	
			7.02604.99.0	LS	400 mm	
2.5 TD 4WD 59-78 kW (80-106 PS) D4BH	03.2001→04.2004		7.09002.11.0	AGR	ET	 Produktionsdatum ab: 01.06.2002 Production date from: 01.06.2002
			7.02604.99.0	LS	400 mm	







						
H-1 / STAREX Bus (A1)						57
2.5 TD 4WD 59-78 kW (80-106 PS) D4BH	11.2001→04.2004		7.09002.11.0	AGR	ET	 Produktionsdatum ab: 01.06.2002 Production date from: 01.06.2002
			7.02604.99.0	LS	400 mm	
H-1 Cargo (TQ)						58
2.5 CRDi 74-129 kW (110-175 PS) D4CB	02.2008→		7.02604.99.0	LS	400 mm	
2.5 CRDi 74-129 kW (110-175 PS) D4CB	02.2008→		7.02604.99.0	LS	400 mm	
2.5 CRDi 74-129 kW (110-175 PS) D4CB	02.2008→		7.02604.99.0	LS	400 mm	
2.5 CRDi 74-129 kW (110-175 PS) D4CB	01.2009→		7.02604.99.0	LS	400 mm	
2.5 CRDi 74-129 kW (110-175 PS) D4CB	08.2009→		7.02604.99.0	LS	400 mm	
H-1 Platform/Chassis						59
2.5 CRDi 74-129 kW (110-175 PS) D4CB	12.2002→10.2005		7.09002.11.0	AGR	ET	 Euro 3 Euro 3 für Fahrzeuge ohne VTG-Lader for vehicles without VTG turbocharger
2.5 D 59-78 kW (80-106 PS) D4BH	06.2000→10.2006		7.09002.11.0	AGR	ET	
H-1 Travel (TQ)						60
2.5 CRDi 74-129 kW (110-175 PS) D4CB	07.2008→		7.02604.99.0	LS	400 mm	
2.5 CRDi 74-129 kW (110-175 PS) D4CB	05.2008→		7.02604.99.0	LS	400 mm	
2.5 CRDi 74-129 kW (110-175 PS) D4CB	05.2008→		7.02604.99.0	LS	400 mm	
2.5 CRDi 74-129 kW (110-175 PS) D4CB	07.2010→		7.02604.99.0	LS	400 mm	
2.5 CRDi 74-129 kW (110-175 PS) D4CB	08.2011→		7.02604.99.0	LS	400 mm	
H-1 Van (A1)						61
2.4 82-106 kW (111-144 PS) G4CS	03.2000→04.2004		7.02604.01.0	LS	200 mm	
2.5 CRDi 74-129 kW (110-175 PS) D4CB	07.2001→04.2004		7.09002.11.0	AGR	ET	 Euro 3 Euro 3 für Fahrzeuge ohne VTG-Lader for vehicles without VTG turbocharger Produktionsdatum ab: 01.06.2002 Production date from: 01.06.2002
2.5 CRDi 74-129 kW (110-175 PS) D4CB	08.2003→12.2007		7.09002.11.0	AGR	ET	
			7.02604.99.0	LS	400 mm	
2.5 TD 59-78 kW (80-106 PS) D4BH	03.2000→10.2006		7.09002.11.0	AGR	ET	 Produktionsdatum ab: 01.06.2002 Production date from: 01.06.2002
2.5 TD 59-78 kW (80-106 PS) D4BH	10.2001→08.2007		7.09002.11.0	AGR	ET	
						 Produktionsdatum ab: 01.06.2002 Production date from: 01.06.2002

H























			 PIERBURG		
H100 Bus (P) 62					
2.4 82-106 kW (111-144 PS) G4CS	07.1993→03.2000		7.02604.01.0	LS	200 mm
2.4 82-106 kW (111-144 PS) G4CS	01.1997→03.2000		7.02604.01.0	LS	200 mm
H100 Platform/Chassis 63					
2.4 82-106 kW (111-144 PS) G4CS	05.1996→12.1997		7.02604.01.0	LS	200 mm
H100 Van 64					
2.4 82-106 kW (111-144 PS) G4CS	10.1997→12.2004		7.02604.01.0	LS	200 mm
SANTA FÉ II SUV Van (CM) 65					
H CRDi 102-114 kW (139-155 PS) D4EB	09.2006→12.2011		7.09002.05.0	AGR	ET  →08.2009
CRDi 142-191 kW (193-260 PS) D4HB	01.2009→05.2013		7.09002.12.0	AGR	EL  09.2009→
CRDi 4x4 102-114 kW (139-155 PS) D4EB	11.2005→12.2011		7.09002.05.0	AGR	ET  →08.2009
CRDi 4x4 102-114 kW (139-155 PS) D4EB	09.2006→12.2011		7.09002.05.0	AGR	ET  →08.2009
CRDi 4x4 142-191 kW (193-260 PS) D4HB	01.2009→05.2013		7.09002.12.0	AGR	EL  09.2009→
TUCSON SUV Van (JM) 66					
CRDi 83-110 kW (113-150 PS) D4EA	01.2006→03.2010		7.09002.05.0	AGR	ET 
CRDi VGT 83-110 kW (113-150 PS) D4EA	01.2009→03.2010		7.09002.05.0	AGR	ET 
ix35 Van 67					
CRDi 100-150 kW (136-204 PS) D4HA	08.2009→12.2015		7.09002.12.0	AGR	EL  →05.2015
CRDi 4WD 100-150 kW (136-204 PS) D4HA	08.2009→12.2015		7.09002.12.0	AGR	EL  →05.2015





























						
EX						1
30d 170-175 kW (231-238 PS) V9X	04.2010→		7.02014.07.0	AGR	EL 	
FX						2
30d AWD 170-175 kW (231-238 PS) V9X	04.2010→		7.02014.07.0	AGR	EL 	
M (Y51)						3
30d 170-175 kW (231-238 PS) V9X	03.2010→		7.02014.07.0	AGR	EL 	
Q30						4
1.5 D	11.2015→		7.05320.04.0 7.11457.07.0* ↳7.11492.07.0	AGR DDS DDS	EL 	
Q70 (Y51)						5
3.0 170-175 kW (231-238 PS) V9X	03.2013→		7.02014.07.0	AGR	EL 	
QX50 I						6
30d AWD 170-175 kW (231-238 PS) V9X	08.2013→		7.02014.07.0	AGR	EL 	
QX70						7
30d AWD 170-175 kW (231-238 PS) V9X	08.2013→		7.02014.07.0	AGR	EL 	





















SANTA FE (CM) 1					
2.2 CRDi 110 kW (150 PS) D4EB	09.2006→12.2012	 7.09002.05.0	AGR	ET	 →08.2009
2.2 CRDi AWD 110 kW (150 PS) D4EB	09.2006→12.2012	 7.09002.05.0	AGR	ET	 →08.2009
SANTA FE (DM) 2					
2.2 CRDi AWD 142-191 kW (193-260 PS) D4HB	01.2013→12.2017	 7.09002.12.0	AGR	EL	 →05.2015

I

						
MASSIF						1
3.0 HPI 16V	10.2008→		7.24809.51.0	AGR	PN 	
3.0 HPT 16V	10.2008→		7.24809.51.0	AGR	PN 	
MASSIF Pickup						2
3.0 HPI 107 kW (146 PS) F1CE0481F	10.2008→02.2011		7.24809.51.0	AGR	PN 	
			7.02604.99.0	LS	400 mm	
3.0 HPT 130 kW (177 PS) F1CE0481H	10.2008→02.2011		7.24809.51.0	AGR	PN 	
			7.02604.99.0	LS	400 mm	
MASSIF Station Wagon						3
3.0 HPI 107 kW (146 PS) F1CE0481F	10.2008→02.2011		7.24809.51.0	AGR	PN 	
			7.02604.99.0	LS	400 mm	
3.0 HPT 130 kW (177 PS) F1CE0481H	10.2008→02.2011		7.24809.51.0	AGR	PN 	
			7.02604.99.0	LS	400 mm	
DAILY CITYS Bus						4
50C15 107 kW (146 PS) F1CE3481J	06.2014→10.2016		7.02321.17.0	AK	EL	
50C15 107 kW (146 PS) F1CFL411E	06.2014→10.2016		7.04931.04.0	AGR-K	EL	
			↳ 7.05632.04.0	AGR	EL	
			7.02321.17.0	AK	EL	
			7.04239.04.0	AK	EL	
			7.11190.03.0	DDS	ohne Zubehör without accessories für OE-Nummer: 5801356473, 5801600484 for OE number: 5801356473, 5801600484	
50C17 125 kW (170 PS) F1CFL411F	06.2014→10.2016		7.04931.04.0	AGR-K	EL	
			↳ 7.05632.04.0	AGR	EL	
			7.02321.17.0	AK	EL	
			7.04239.04.0	AK	EL	
			7.11190.03.0	DDS	ohne Zubehör without accessories für OE-Nummer: 5801356473, 5801600484 for OE number: 5801356473, 5801600484	
			7.05270.21.0	LS	600 mm Fahrgestellnummer bis: 2015-5052011, 2015-D547072 Vehicle Identification Number to: 2015-5052011, 2015-D547072	
DAILY II Platform/Chassis						5
30-8 (10011131, 10011132, 10011231, 10011232, 10011237,... 62-64 kW (84-87 PS) 8140.63	09.1998→05.1999		7.24809.53.0	AGR	PN 	























						
DAILY II Platform/Chassis						5
30-8 (14911111, 14911117, 14911211, 14911215, 14911217,... 62-64 kW (84-87 PS) 8140.63	09.1998→05.1999		7.24809.53.0	AGR	PN 	
35-8 (14930304, 14931104, 14931111, 14931115, 14931204,... 62-64 kW (84-87 PS) 8140.63	09.1998→05.1999		7.24809.53.0	AGR	PN 	
DAILY II Van						6
30-8 (14914111, 14914117, 14914211, 14914217, 14915111,... 62-64 kW (84-87 PS) 8140.63	09.1998→05.1999		7.24809.53.0	AGR	PN 	
30-8 V (14914111, 14914117, 14914211, 14914217, 14915111... 62-64 kW (84-87 PS) 8140.63	09.1998→05.1999		7.24809.53.0	AGR	PN 	
35-8 (14934104, 14934111, 14934204, 14934205, 14934211,... 62-64 kW (84-87 PS) 8140.63	09.1998→05.1999		7.24809.53.0	AGR	PN 	
DAILY III Platform/Chassis						7
35 S 9,35 C 9 62-64 kW (84-87 PS) 8140.63	05.1999→04.2006		7.24809.53.0	AGR	PN 	
DAILY III Van						8
35 S 9 V,35 C 9 V 62-64 kW (84-87 PS) 8140.63	05.1999→07.2007		7.24809.53.0	AGR	PN 	
DAILY IV Bus						9
35S14, 35S14 /P 100 kW (136 PS) F1AE0481H	05.2006→08.2011		7.09002.00.0	AGR	PN  →635787	
			7.24809.88.0	AGR-K	PN	
DAILY IV Dump Truck						10
40C17 K, 40C17 DK 125 kW (170 PS) F1CE3481C	07.2007→08.2011		7.11190.03.0	DDS	ohne Zubehör without accessories für OE-Nummer: 5801356473, 5801600484 for OE number: 5801356473, 5801600484	
			7.02604.99.0	LS	400 mm	
DAILY IV Platform/Chassis						11
29L10 70 kW (95 PS) F1AE0481F	05.2006→08.2011		7.09002.00.0	AGR	PN  →635787	
			7.24809.88.0	AGR-K	PN	
			7.02604.99.0	LS	400 mm	
29L12 85 kW (116 PS) F1AE0481G	05.2006→08.2011		7.09002.00.0	AGR	PN  →635787	
			7.24809.88.0	AGR-K	PN	
			7.02604.99.0	LS	400 mm	
29L14 100 kW (136 PS) F1AE0481H	05.2006→08.2011		7.09002.00.0	AGR	PN  →635787	
			7.24809.88.0	AGR-K	PN	
			7.02604.99.0	LS	400 mm	

					
DAILY IV Platform/Chassis					
35C10, 35S10 70 kW (95 PS) F1AE0481F	05.2006→08.2011		7.09002.00.0 7.24809.88.0 7.02604.99.0	AGR AGR-K LS	PN PN 400 mm →635787
35C11, 35S11, 35S11 D, 35S11 /P 78 kW (106 PS) F1AE0481U	07.2007→08.2011		7.09002.00.0 7.24809.88.0	AGR AGR-K	PN PN →635787
35C12, 35S12 85 kW (116 PS) F1AE0481G, F1AE0481R	05.2006→08.2011		7.09002.00.0 7.24809.88.0 7.02604.99.0	AGR AGR-K LS	PN PN 400 mm F1AE0481G, F1AE0481R: →635787
35C13, 35C13 /P, 35S13 D, 35S13, 35S13 /P 93 kW (126 PS) F1AE0481V	07.2007→08.2011		7.09002.00.0 7.24809.88.0	AGR AGR-K	PN PN →635787
35C14 G, 35C14 G/P, 35S14 G, 35S14 G/P, 35C14 GD,... 100 kW (136 PS) F1CE0441A	07.2007→08.2011		7.24809.88.0	AGR-K	PN
35C14, 35C14 /P, 35S14, 35S14 /P, 35S14 D, 35S14 D/P 103-110 kW (140-150 PS) F1CE3481L	09.2009→08.2011		7.02604.99.0	LS	400 mm
35C14, 35S14, 35S14 /P 100 kW (136 PS) F1AE0481H	05.2006→08.2011		7.09002.00.0 7.24809.88.0 7.02604.99.0	AGR AGR-K LS	PN PN 400 mm →635787
35C15 107 kW (146 PS) F1CE0481F	05.2006→08.2011		7.24809.51.0 7.02604.99.0	AGR LS	PN 400 mm ○
35C17, 35C17 /P, 35S17, 35S17 /P, 35S17 D 125 kW (170 PS) F1CE3481C	07.2007→08.2011		7.11190.03.0 7.02604.99.0	DDS LS	400 mm ohne Zubehör without accessories Fahrgestellnummer ab: 5932207, D483835 Vehicle Identification Number from: 5932207, D483835 Baumuster: 35C17 Type: 35C17
35C18, 35S18 130 kW (177 PS) F1CE0481H	05.2006→08.2011		7.24809.51.0 7.11190.03.0 7.02604.99.0	AGR DDS LS	PN ohne Zubehör without accessories für OE-Nummer: 5801356473, 5801600484 for OE number: 5801356473, 5801600484 400 mm
35S18W 130 kW (177 PS) F1CE0481H	06.2006→08.2011		7.24809.51.0	AGR	PN ○
40C10 70 kW (95 PS) F1AE0481F	05.2006→08.2011		7.09002.00.0 7.24809.88.0	AGR AGR-K	PN PN →635787





























DAILY IV Platform/Chassis **11**

40C11, 40C11 D 78 kW (106 PS) F1AE0481U	07.2007→08.2011		7.09002.00.0	AGR	PN	 →635787 ohne Zubehör without accessories für OE-Nummer: 5801356473, 5801600484 for OE number: 5801356473, 5801600484
			7.24809.88.0	AGR-K	PN	
			7.11190.03.0	DDS		
40C12 85 kW (116 PS) F1AE0481G	05.2006→08.2011		7.09002.00.0	AGR	PN	 →635787
			7.24809.88.0	AGR-K	PN	
40C13, 40C13 /P 93 kW (126 PS) F1AE0481V	07.2007→08.2011		7.09002.00.0	AGR	PN	 →635787
			7.24809.88.0	AGR-K	PN	
40C14 G, 40C14 G/P 100 kW (136 PS) F1CE0441A	07.2007→08.2011		7.24809.88.0	AGR-K	PN	
40C14, 40C14 /P 103-110 kW (140-150 PS) F1CE3481L	09.2009→08.2011		7.24809.88.0	AGR-K	PN	
			7.02604.99.0	LS	400 mm	
40C15 107 kW (146 PS) F1CE0481F	05.2006→08.2011		7.24809.51.0	AGR	PN	
40C17, 40C17 /P 125 kW (170 PS) F1CE3481C	07.2007→08.2011		7.11190.03.0	DDS		ohne Zubehör without accessories für OE-Nummer: 5801356473, 5801600484 for OE number: 5801356473, 5801600484
			7.02604.99.0	LS	400 mm	
40C18 130 kW (177 PS) F1CE0481H	05.2006→08.2011		7.24809.51.0	AGR	PN	
45C15 107 kW (146 PS) F1CE0481F	05.2006→08.2011		7.24809.51.0	AGR	PN	
50C14 G, 50C14 G/P, 50C14 GD, 50C14 GD/P 100 kW (136 PS) F1CE0441A	07.2007→08.2011		7.02604.99.0	LS	400 mm	
			7.02604.99.0	LS	400 mm	
50C14, 50C14 /P 103-110 kW (140-150 PS) F1CE3481L	09.2009→08.2011		7.02604.99.0	LS	400 mm	
50C15 107 kW (146 PS) F1CE0481F	05.2006→08.2011		7.24809.51.0	AGR	PN	
50C17, 50C17 /P 125 kW (170 PS) F1CE3481C	07.2007→08.2011		7.11190.03.0	DDS		ohne Zubehör without accessories für OE-Nummer: 5801356473, 5801600484 for OE number: 5801356473, 5801600484
			7.02604.99.0	LS	400 mm	
50C18 130 kW (177 PS) F1CE0481H	05.2006→08.2011		7.24809.51.0	AGR	PN	
			7.11190.03.0	DDS		

DAILY IV Platform/Chassis
11

















55S17 W, 55S17 WD 125 kW (170 PS) F1CE3481C	07.2007→08.2011		7.11190.03.0	DDS		ohne Zubehör without accessories für OE-Nummer: 5801356473, 5801600484 for OE number: 5801356473, 5801600484
55S18W 130 kW (177 PS) F1CE0481H	06.2006→08.2011		7.24809.51.0	AGR	PN	
65C14, 65C14 /P 103-110 kW (140-150 PS) F1CE3481L	09.2009→08.2011		7.02604.99.0	LS	400 mm	
65C15, 65C15 /P, 65C15 D, 65C15 D/P 107 kW (146 PS) F1CE0481F	05.2006→08.2011		7.24809.51.0	AGR	PN	
65C17, 65C17 /P 125 kW (170 PS) F1CE3481C	07.2007→08.2011		7.02604.99.0	LS	400 mm	
65C18 130 kW (177 PS) F1CE0481H	05.2006→08.2011		7.24809.51.0 7.02604.99.0	AGR LS	PN 400 mm	
70C14, 70C14 /P 103-110 kW (140-150 PS) F1CE3481L	09.2009→08.2011		7.02604.99.0	LS	400 mm	
70C15 107 kW (146 PS) F1CE0481F	07.2008→08.2011		7.24809.51.0	AGR	PN	
70C17, 70C17 /P 125 kW (170 PS) F1CE3481C	07.2007→08.2011		7.02604.99.0	LS	400 mm	

DAILY IV Van
12





















29L10 V 70 kW (95 PS) F1AE0481F	05.2006→08.2011		7.09002.00.0 7.24809.88.0 7.02604.99.0	AGR AGR-K LS	PN PN 400 mm	 →635787
29L12 V, 29L12 V/P 85 kW (116 PS) F1AE0481G	05.2006→08.2011		7.09002.00.0 7.24809.88.0 7.02604.99.0	AGR AGR-K LS	PN PN 400 mm	 →635787
29L14 C, 29L14 C/P, 29L14 V, 29L14 V/P 100 kW (136 PS) F1AE0481H	05.2006→08.2011		7.09002.00.0 7.24809.88.0 7.02604.99.0	AGR AGR-K LS	PN PN 400 mm	 →635787
35C10, 35S10 70 kW (95 PS) F1AE0481F	05.2006→08.2011		7.09002.00.0 7.24809.88.0 7.02604.99.0	AGR AGR-K LS	PN PN 400 mm	 →635787
35C11 V, 35S11 V 78 kW (106 PS) F1AE0481U	07.2007→08.2011		7.09002.00.0 7.24809.88.0	AGR AGR-K	PN PN	 →635787
35C12 V, 35C12 V/P, 35S12 V, 35S12 V/P 85 kW (116 PS) F1AE0481G, F1AE0481R	05.2006→08.2011		7.09002.00.0 7.24809.88.0 7.02604.99.0	AGR AGR-K LS	PN PN 400 mm	 F1AE0481G, F1AE0481R: →635787



DAILY IV Van **12**





35C13 V, 35C13 V/P, 35S13 V, 35S13 V/P 93 kW (126 PS) F1AE0481V	07.2007→08.2011		7.09002.00.0	AGR	PN	 →635787
			7.24809.88.0	AGR-K	PN	
35C14 GV, 35C14 GV/P, 35S14 GV, 35S14 GV/P 100 kW (136 PS) F1CE0441A	07.2007→08.2011		7.24809.88.0	AGR-K	PN	
35C14 V, 35C14 V/P, 35S14 V, 35S14 V/P 103-110 kW (140-150 PS) F1CE3481L	09.2009→08.2011		7.24809.88.0	AGR-K	PN	
			7.02604.99.0	LS	400 mm	
35C15 V, 35C15 V/P 107 kW (146 PS) F1CE0481F	05.2006→08.2011		7.24809.51.0	AGR	PN	
			7.02604.99.0	LS	400 mm	
35C17 V, 35C17 V/P, 35S17 V, 35S17 V/P 125 kW (170 PS) F1CE3481C	07.2007→08.2011		7.11190.03.0	DDS		ohne Zubehör without accessories Fahrgestellnummer ab: 5932207, D483835 Vehicle Identification Number from: 5932207, D483835 Baumuster: 35C17 Type: 35C17
			7.02604.99.0	LS	400 mm	
35C18 V, 35C18 V/P, 35S18 V, 35S18 V/P 130 kW (177 PS) F1CE0481H	05.2006→08.2011		7.24809.51.0	AGR	PN	
			7.11190.03.0	DDS		ohne Zubehör without accessories für OE-Nummer: 5801356473, 5801600484 for OE number: 5801356473, 5801600484
			7.02604.99.0	LS	400 mm	
35S14 C, 35S14 C/P, 35S14 V, 35S14 V/P, 35C14 V,... 100 kW (136 PS) F1AE0481H	05.2006→08.2011		7.09002.00.0	AGR	PN	 →635787
			7.24809.88.0	AGR-K	PN	
			7.02604.99.0	LS	400 mm	
35S15 107-110 kW (146-150 PS) F1CE0481L	06.2006→08.2011		7.24809.51.0	AGR	PN	
40C10 V 70 kW (95 PS) F1AE0481F	05.2006→08.2011		7.09002.00.0	AGR	PN	 →635787
			7.24809.88.0	AGR-K	PN	
40C11 V 78 kW (106 PS) F1AE0481U	07.2007→08.2011		7.09002.00.0	AGR	PN	 →635787
			7.24809.88.0	AGR-K	PN	
			7.11190.03.0	DDS		ohne Zubehör without accessories für OE-Nummer: 5801356473, 5801600484 for OE number: 5801356473, 5801600484
7.02604.99.0	LS	400 mm				

DAILY IV Van
12



40C12 V, 40C14 V/P 85 kW (116 PS) F1AE0481G	05.2006→08.2011		7.09002.00.0 AGR PN  →635787
			7.24809.88.0 AGR-K PN
40C13 V, 40C13 V/P 93 kW (126 PS) F1AE0481V	07.2007→08.2011		7.09002.00.0 AGR PN  →635787
			7.24809.88.0 AGR-K PN
40C14 GV, 40C14 GV/P 100 kW (136 PS) F1CE0441A	07.2007→08.2011		7.24809.88.0 AGR-K PN
40C14 V, 40C14 V/P 103-110 kW (140-150 PS) F1CE3481L	09.2009→08.2011		7.24809.88.0 AGR-K PN
			7.02604.99.0 LS 400 mm
40C15 V, 40C15 V/P 107 kW (146 PS) F1CE0481F	05.2006→08.2011		7.24809.51.0 AGR PN 
40C17 V, 40C17 V/P 125 kW (170 PS) F1CE3481C	07.2007→08.2011		7.11190.03.0 DDS
			7.02604.99.0 LS 400 mm
ohne Zubehör without accessories für OE-Nummer: 5801356473, 5801600484 for OE number: 5801356473, 5801600484			
40C18 V, 40C18 V/P 130 kW (177 PS) F1CE0481H	05.2006→08.2011		7.24809.51.0 AGR PN 
45C15 V 107 kW (146 PS) F1CE0481F	05.2006→08.2011		7.24809.51.0 AGR PN 
50C14 GV, 50C14 GV/P 100 kW (136 PS) F1CE0441A	07.2007→08.2011		7.02604.99.0 LS 400 mm
50C14 V, 50C14 V/P 103-110 kW (140-150 PS) F1CE3481L	09.2009→08.2011		7.02604.99.0 LS 400 mm
50C15 V, 50C15 V/P 107 kW (146 PS) F1CE0481F	05.2006→08.2011		7.24809.51.0 AGR PN 
50C17 V, 50C17 V/P 125 kW (170 PS) F1CE3481C	07.2007→08.2011		7.11190.03.0 DDS
			7.02604.99.0 LS 400 mm
ohne Zubehör without accessories für OE-Nummer: 5801356473, 5801600484 for OE number: 5801356473, 5801600484 06.2009→ Motorcode: F1CE3481C Engine Code: F1CE3481C Produktionsdatum ab: 06.2009 Production date from: 06.2009 Produktionsdatum bis: 08.2011 Production date to: 08.2011			
50C18 V, 50C18 V/P 130 kW (177 PS) F1CE0481H	05.2006→08.2011		7.24809.51.0 AGR PN 
			7.11190.03.0 DDS
ohne Zubehör without accessories für OE-Nummer: 5801356473, 5801600484 for OE number: 5801356473, 5801600484			





DAILY IV Van **12**

55C17 125 kW (170 PS) F1CE3481C	08.2007→03.2012		7.02321.17.0	AK	EL	
60C15 V 107 kW (146 PS) F1CE0481F	05.2006→08.2011		7.11190.03.0	DDS		ohne Zubehör without accessories für OE-Nummer: 5801356473, 5801600484 for OE number: 5801356473, 5801600484
60C18 130 kW (177 PS) F1CE0481H	05.2006→08.2011		7.11190.03.0	DDS		ohne Zubehör without accessories für OE-Nummer: 5801356473, 5801600484 for OE number: 5801356473, 5801600484
65C14 V, 65C14 V/P 103-110 kW (140-150 PS) F1CE3481L	09.2009→08.2011		7.02604.99.0	LS	400 mm	
65C15 107 kW (146 PS) F1CE0481F	05.2006→08.2011		7.24809.51.0	AGR	PN	
65C17 V, 65C17 V/P 125 kW (170 PS) F1CE3481C	07.2007→08.2011		7.11190.03.0	DDS		ohne Zubehör without accessories für OE-Nummer: 5801356473, 5801600484 for OE number: 5801356473, 5801600484
			7.02604.99.0	LS	400 mm	06.2009→ Motorcode: F1CE3481C Engine Code: F1CE3481C Produktionsdatum ab: 06.2009 Production date from: 06.2009 Produktionsdatum bis: 08.2011 Production date to: 08.2011
65C18 130 kW (177 PS) F1CE0481H	05.2006→08.2011		7.24809.51.0	AGR	PN	
			7.02604.99.0	LS	400 mm	
70C14 V, 70C14 V/P 103-110 kW (140-150 PS) F1CE3481L	09.2009→08.2011		7.02604.99.0	LS	400 mm	
70C17V, 70C17 V/P 125 kW (170 PS) F1CE3481C	07.2007→08.2011		7.02604.99.0	LS	400 mm	11.2010→ Motorcode: F1CE3481C Engine Code: F1CE3481C Produktionsdatum ab: 11.2010 Production date from: 11.2010 Produktionsdatum bis: 08.2011 Production date to: 08.2011

DAILY LINE Bus **13**

40C15, 50C15, 60C15 107 kW (146 PS) F1CE3481J	06.2014→10.2016		7.02321.17.0	AK	EL	
			7.11190.03.0	DDS		ohne Zubehör without accessories für OE-Nummer: 5801356473, 5801600484 for OE number: 5801356473, 5801600484
40C15, 50C15, 60C15 107 kW (146 PS) F1CFL411E	06.2014→10.2016		7.04931.04.0	AGR-K	EL	
			↳ 7.05632.04.0	AGR	EL	
			7.02321.17.0	AK	EL	
			7.04239.04.0	AK	EL	



DAILY LINE Bus
13

			7.11190.03.0	DDS		ohne Zubehör without accessories für OE-Nummer: 5801356473, 5801600484 for OE number: 5801356473, 5801600484
40C17, 50C17, 60C17 125 kW (170 PS) F1CFL411F	06.2014→10.2016		7.04931.04.0	AGR-K	EL	ohne Zubehör without accessories für OE-Nummer: 5801356473, 5801600484 for OE number: 5801356473, 5801600484 Fahrgestellnummer bis: 2015-5052011, 2015-D547072 Vehicle Identification Number to: 2015-5052011, 2015-D547072
			↳ 7.05632.04.0	AGR	EL	
			7.02321.17.0	AK	EL	
			7.04239.04.0	AK	EL	
			7.11190.03.0	DDS		
			7.05270.21.0	LS	600 mm	
50C14 Natural Power 100 kW (136 PS) F1CFA401A	06.2014→		7.04239.04.0	AK	EL	



DAILY TOURYS Bus
14

50C17, 65C17 125 kW (170 PS) F1CFL411F	06.2014→10.2016		7.04931.04.0	AGR-K	EL	ohne Zubehör without accessories für OE-Nummer: 5801356473, 5801600484 for OE number: 5801356473, 5801600484 Fahrgestellnummer bis: 2015-5052011, 2015-D547072 Vehicle Identification Number to: 2015-5052011, 2015-D547072
			↳ 7.05632.04.0	AGR	EL	
			7.02321.17.0	AK	EL	
			7.11190.03.0	DDS		
			7.05270.21.0	LS	600 mm	

DAILY V Kasten
15







50 S 17 125 kW (170 PS) F1CE3481C, F1CE3481K	10.2011→		7.02321.17.0	AK	EL	
--	----------	---	---------------------	----	----	--

















DAILY V Platform/Chassis
16

26L11, 26L11D, 35C11D, 35S11, 40C11 78 kW (106 PS) F1AE3481A	09.2011→02.2014		7.05052.01.0	AGR-K		ohne Zubehör without accessories für OE-Nummer: 5801356473, 5801600484 for OE number: 5801356473, 5801600484
			↳ 7.24809.79.0	AGR	ET	
			7.11190.03.0	DDS		
29L13, 29L13D, 35C13D, 40C13 93 kW (126 PS) F1AE3481B	09.2011→02.2014		7.05052.01.0	AGR-K		
			↳ 7.24809.79.0	AGR	ET	







DAILY V Platform/Chassis **16**

		7.11190.03.0	DDS		ohne Zubehör without accessories Fahrgestellnummer ab: 5932207, D483835 Vehicle Identification Number from: 5932207, D483835 Baumuster: 29L13 Type: 29L13
29L15 V, 35S15, 35C15L V, 40C15L V, 50C15L V 107 kW (146 PS) F1AE3481C	09.2011→02.2014	 7.05052.01.0	AGR-K		
		↳ 7.24809.79.0 7.11190.03.0	AGR DDS	ET	ohne Zubehör without accessories Fahrgestellnummer ab: 5932207, D483835 Vehicle Identification Number from: 5932207, D483835 Baumuster: 29L15 Type: 29L15
35C15, 35C15D, 35S15, 40C15, 45C15, 50C15, 60C15,65C15,... 107 kW (145 PS) F1CE3481B	09.2011→02.2014	 7.02321.17.0	AK	EL	
		7.11190.03.0	DDS		ohne Zubehör without accessories für OE-Nummer: 5801356473, 5801600484 for OE number: 5801356473, 5801600484
35C15, 35C15D, 35S15, 40C15, 45C15, 50C15, 60C15,65C15,... 107 kW (146 PS) F1CE3481J	09.2011→02.2014	 7.02321.17.0	AK	EL	
		7.11190.03.0	DDS		ohne Zubehör without accessories für OE-Nummer: 5801356473, 5801600484 for OE number: 5801356473, 5801600484
		7.05270.21.0	LS	600 mm	Fahrgestellnummer bis: 2015-5052011 , 2015-D547071 Vehicle Identification Number to: 2015-5052011 , 2015-D547071
35C17, 35C17D, 35S17, 40C17, 45C17, 50C17, 60C17, 70C17 125 kW (170 PS) F1CE3481C	09.2011→02.2014	 7.02321.17.0	AK	EL	
		7.11190.03.0	DDS		ohne Zubehör without accessories für OE-Nummer: 5801356473, 5801600484 for OE number: 5801356473, 5801600484
		7.05270.21.0	LS	600 mm	Fahrgestellnummer bis: 2015-5052011 , 2015-D547071 Vehicle Identification Number to: 2015-5052011, 2015-D547071
35C17, 35C17D, 35S17, 40C17, 45C17, 50C17, 60C17, 70C17 125 kW (170 PS) F1CE3481K	09.2011→02.2014	 7.02321.17.0	AK	EL	





						
DAILY V Platform/Chassis						16
35C21, 35S21, 40C21, 45C21, 50C21, 60C21, 70C21 150 kW (205 PS) F1CE3481D	09.2011→02.2014		7.02321.17.0	AK	EL	
55S17W 4x4 125 kW (170 PS) F1CE3481C	09.2011→02.2014		7.02321.17.0 7.11190.03.0	AK DDS	EL	ohne Zubehör without accessories für OE-Nummer: 5801356473, 5801600484 for OE number: 5801356473, 5801600484
DAILY V Van						17
29L11 V, 35C11 V, 35S11 V, 40C11 V 78 kW (106 PS) F1AE3481A	09.2011→02.2014		7.05052.01.0 ↳ 7.24809.79.0 7.11190.03.0	AGR-K AGR DDS	ET	 ohne Zubehör without accessories für OE-Nummer: 5801356473, 5801600484 for OE number: 5801356473, 5801600484
29L13 V, 35C13 V, 35S13 V, 40C13 V, 40S13 V 93 kW (126 PS) F1AE3481B	09.2011→02.2014		7.05052.01.0 ↳ 7.24809.79.0 7.11190.03.0	AGR-K AGR DDS	ET	 ohne Zubehör without accessories Fahrgestellnummer ab: 5932207, D483835 Vehicle Identification Number from: 5932207, D483835 Baumuster: 29L13 Type: 29L13
29L15 V, 35S15 V, 35C15L V, 40C15L V, 50C15L V 107 kW (146 PS) F1AE3481C	09.2011→02.2014		7.05052.01.0 ↳ 7.24809.79.0 7.11190.03.0	AGR-K AGR DDS	ET	 ohne Zubehör without accessories Fahrgestellnummer ab: 5932207, D483835 Vehicle Identification Number from: 5932207, D483835 Baumuster: 29L15 Type: 29L15
35 S 14 103-110 kW (140-150 PS) F1CE3481L	04.2012→02.2014		7.02321.17.0	AK	EL	
35C15 V, 40C15 V, 45C15 V, 50C15 V, 60C15 V, 65C15 V 107 kW (145 PS) F1CE3481B	09.2011→02.2014		7.02321.17.0 7.11190.03.0	AK DDS	EL	ohne Zubehör without accessories für OE-Nummer: 5801356473, 5801600484 for OE number: 5801356473, 5801600484



DAILY V Van **17**

		7.05270.21.0	LS	600 mm	Fahrgestellnummer bis: 2015-5052011, 2015-D547071 Vehicle Identification Number to: 2015-5052011, 2015-D547071
35C15 V, 40C15 V, 45C15 V, 50C15 V, 60C15 V, 65C15 V 107 kW (146 PS) F1CE3481J	09.2011→02.2014	 7.02321.17.0 7.11190.03.0	AK DDS	EL	ohne Zubehör without accessories für OE-Nummer: 5801356473, 5801600484 for OE number: 5801356473, 5801600484
35C17 V, 35S17 V, 40C17 V, 45C17 V, 50C17 V, 60C17 V 125 kW (170 PS) F1CE3481C	09.2011→02.2014	 7.02321.17.0 7.11190.03.0 7.02604.99.0	AK DDS LS	EL 400 mm	ohne Zubehör without accessories für OE-Nummer: 5801356473, 5801600484 for OE number: 5801356473, 5801600484
35C17 V, 35S17 V, 40C17 V, 45C17 V, 50C17 V, 60C17 V 125 kW (170 PS) F1CE3481K	09.2011→02.2014	 7.02321.17.0 7.02604.99.0	AK LS	EL 400 mm	
35C21 V, 35S21 V, 40C21 V, 45C21 V, 50C21 V 150 kW (205 PS) F1CE3481D	09.2011→02.2014	 7.02321.17.0	AK	EL	





DAILY VI Platform/Chassis **18**

33S11, 35S11, 35C11 78 kW (106 PS) F1AFL411A	03.2014→04.2016	 7.05052.01.0 ↳ 7.24809.79.0 7.11190.03.0 7.05270.21.0	AGR-K AGR DDS LS	ET 600 mm	 ohne Zubehör without accessories Fahrgestellnummer bis: 2015-5052011, 2015-D547071 Vehicle Identification Number to: 2015-5052011, 2015-D547071
33S12, 35S12, 35C12 85 kW (116 PS) F1AGL411H	04.2016→	 7.11190.03.0	DDS		ohne Zubehör without accessories
33S13, 35S13, 35C13 93 kW (126 PS) F1AFL411B	03.2014→04.2016	 7.05052.01.0 ↳ 7.24809.79.0 7.11190.03.0 7.05270.21.0	AGR-K AGR DDS LS	ET 600 mm	 ohne Zubehör without accessories 2012 2012 Fahrgestellnummer bis: 2015-5052011, 2015-D547071 Vehicle Identification Number to: 2015-5052011, 2015-D547071

DAILY VI Platform/Chassis						
18						
33S14, 35S14, 35C14 100 kW (136 PS) F1AGL411J	04.2016→	 7.11190.03.0	DDS		ohne Zubehör without accessories Baumuster: 33S14 Type: 33S14	
33S15, 35S15, 35C15 107 kW (146 PS) F1AFL411C	03.2014→04.2016	 7.05052.01.0	AGR-K		 ohne Zubehör without accessories F1AFL411C: Baumuster: 33S15 Type: 33S15 F1AFL411C: Baumuster: 35C15 Type: 35C15 2012 2012 Fahrgestellnummer bis: 2015-5052011, 2015-D547071 Vehicle Identification Number to: 2015-5052011, 2015-D547071	
			↳ 7.24809.79.0	AGR		ET
			7.11190.03.0	DDS		
33S16, 35S16, 35C16 115 kW (156 PS) F1AGL411G	04.2016→	 7.05052.01.0	AGR-K		 ohne Zubehör without accessories	
			↳ 7.24809.79.0	AGR		ET
		7.11190.03.0	DDS			
35S14, 35S15, 35C15, 40S14, 40C15, 50C15, 65C15, 70C15 107 kW (146 PS) F1CE3481J	03.2014→04.2016	 7.02321.17.0	AK	EL	ohne Zubehör without accessories für OE-Nummer: 5801356473, 5801600484 for OE number: 5801356473, 5801600484	
			7.11190.03.0	DDS		
35S14, 35S15, 35C15, 40S14, 40C15, 50C15, 65C15, 70C15 107 kW (146 PS) F1CFL411E, F1CFL411J	03.2014→04.2016	 7.04931.04.0	AGR-K	EL	ohne Zubehör without accessories F1CFL411E: für OE-Nummer: 5801356473, 5801600484 for OE number: 5801356473, 5801600484 F1CFL411J: Baumuster: 35C15 Type: 35C15 2012 2012 F1CFL411E, F1CFL411J: Fahrgestellnummer bis: 2015-5052011, 2015-D547071 Vehicle Identification Number to: 2015-5052011, 2015-D547071	
			↳ 7.05632.04.0	AGR		EL
			7.02321.17.0	AK		EL
			7.04239.04.0	AK		EL
			7.11190.03.0	DDS		
35S17, 35C17, 40C17, 45S17, 45C17, 50C17, 55C17, 65C17, ... 125 kW (170 PS) F1CFL411F	03.2014→04.2016	 7.04931.04.0	AGR-K	EL		
			↳ 7.05632.04.0	AGR		EL
		7.02321.17.0	AK	EL		



DAILY VI Platform/Chassis **18**

			<p>7.04239.04.0 AK EL</p> <p>7.11190.03.0 DDS</p> <p>7.05270.21.0 LS 600 mm</p> <p>7.02604.99.0 LS 400 mm</p>	<p>ohne Zubehör without accessories für OE-Nummer: 5801356473, 5801600484 for OE number: 5801356473, 5801600484</p> <p>Fahrgestellnummer bis: 2015-5052011, 2015-D547072 Vehicle Identification Number to: 2015-5052011, 2015-D547072</p> <p>05.2014→ Motorcode: F1CFL411F Engine Code: F1CFL411F Baumuster: Daily 35 S 17 Type: Daily 35 S 17 Produktionsdatum ab: 05.2014 Production date from: 05.2014</p>
<p>35S17, 35C17, 40C17, 45S17,45C17, 50C17, 55C17, 65C17,... 125 kW (170 PS) F1CFL411H</p>	<p>03.2014→04.2016</p>		<p>7.04931.04.0 AGR-K EL</p>	<p>ohne Zubehör without accessories für OE-Nummer: 5801356473, 5801600484 for OE number: 5801356473, 5801600484</p> <p>Fahrgestellnummer bis: 2015-5052011, 2015-D547072 Vehicle Identification Number to: 2015-5052011, 2015-D547072</p>
			<p>↳ 7.05632.04.0 AGR EL</p>	
			<p>7.02321.17.0 AK EL</p>	
			<p>7.11190.03.0 DDS</p>	
<p>35S17, 55S17 4x4 125 kW (170 PS) F1CFL411F</p>	<p>08.2015→04.2016</p>		<p>7.04931.04.0 AGR-K EL</p>	<p>ohne Zubehör without accessories für OE-Nummer: 5801356473, 5801600484 for OE number: 5801356473, 5801600484</p>
			<p>↳ 7.05632.04.0 AGR EL</p>	
			<p>7.02321.17.0 AK EL</p>	
			<p>7.11190.03.0 DDS</p>	
<p>35S18, 35C18, 40C18, 50C18, 65C18, 70C18, 72C18 132 kW (179 PS) F1CFL411W, F1CGL411B</p>	<p>04.2016→</p>		<p>7.11190.03.0 DDS</p>	<p>ohne Zubehör without accessories F1CFL411W, F1CGL411B: für OE-Nummer: 5801356473, 5801600484 for OE number: 5801356473, 5801600484</p>
<p>35S21, 35C21, 40C21, 50C21, 65C21, 70C21 150 kW (205 PS) F1CFL411G</p>	<p>03.2014→</p>		<p>7.02321.17.0 AK EL</p>	<p>ohne Zubehör without accessories für OE-Nummer: 5801356473, 5801600484 for OE number: 5801356473, 5801600484</p> <p>Fahrgestellnummer bis: 2015-5052011, 2015-D547071 Vehicle Identification Number to: 2015-5052011, 2015-D547071</p>
			<p>7.11190.03.0 DDS</p>	
			<p>7.05270.21.0 LS 600 mm</p>	

DAILY VI Platform/Chassis
18



35S21, 35C21, 40C21, 50C21, 65C21, 70C21 150 kW (204 PS) F1CGL411C	03.2014→	7.02321.17.0	AK	EL	
NaturalPower 35S14, 35C14, 40C14, 50C14, 65C14, 70C14,... 100 kW (136 PS) F1CFA401A	03.2014→	7.04239.04.0	AK	EL	

DAILY VI Van
19

33S11, 35S11, 35C11 78 kW (106 PS) F1AFL411A	03.2014→04.2016	7.05052.01.0	AGR-K		
		↳ 7.24809.79.0	AGR	ET	ohne Zubehör without accessories Fahrgestellnummer bis: 2015-5052011 , 2015-D547071 Vehicle Identification Number to: 2015-5052011 , 2015-D547071
		7.11190.03.0	DDS		
		7.05270.21.0	LS	600 mm	
33S12, 35S12, 35C12 85 kW (116 PS) F1AGL411H	04.2016→	7.11190.03.0	DDS		ohne Zubehör without accessories
33S13, 35S13, 35C13 93 kW (126 PS) F1AFL411B	03.2014→04.2016	7.05052.01.0	AGR-K		
		↳ 7.24809.79.0	AGR	ET	ohne Zubehör without accessories 2012 2012 Fahrgestellnummer bis: 2015-5052011 , 2015-D547071 Vehicle Identification Number to: 2015-5052011 , 2015-D547071
		7.11190.03.0	DDS		
		7.05270.21.0	LS	600 mm	
33S14, 35S14, 35C14 100 kW (136 PS) F1AGL411J	04.2016→	7.11190.03.0	DDS		ohne Zubehör without accessories Baumuster: 33S14 Type: 33S14
33S15, 35S15, 35C15 107 kW (146 PS) F1AFL411C	03.2014→04.2016	7.24809.79.0	AGR	ET	
		7.11190.03.0	DDS		ohne Zubehör without accessories F1AFL411C: Baumuster: 33S15 Type: 33S15 F1AFL411C: Baumuster: 35C15 Type: 35C15 2012 2012 Fahrgestellnummer bis: 2015-5052011 , 2015-D547071 Vehicle Identification Number to: 2015-5052011 , 2015-D547071
		7.05270.21.0	LS	600 mm	
		7.05052.01.0	AGR-K		
33S16, 35S16, 35C16 115 kW (156 PS) F1AGL411G	04.2016→	7.05052.01.0	AGR-K		
		↳ 7.24809.79.0	AGR	ET	ohne Zubehör without accessories
		7.11190.03.0	DDS		
35S15, 35C15, 40C15, 50C15, 65C15, 70C15 107 kW (146 PS) F1CE3481J	03.2014→04.2016	7.02321.17.0	AK	EL	



DAILY VI Van **19**

			7.11190.03.0	DDS		ohne Zubehör without accessories für OE-Nummer: 5801356473, 5801600484 for OE number: 5801356473, 5801600484
35S15, 35C15, 40C15, 50C15, 65C15, 70C15 107 kW (146 PS) F1CFL411E	03.2014→04.2016		7.04931.04.0	AGR-K	EL	
			↳ 7.05632.04.0	AGR	EL	
			7.02321.17.0	AK	EL	
			7.04239.04.0	AK	EL	
			7.11190.03.0	DDS		
			7.05270.21.0	LS	600 mm	ohne Zubehör without accessories für OE-Nummer: 5801356473, 5801600484 for OE number: 5801356473, 5801600484 Fahrgestellnummer bis: 2015-5052011, 2015-D547071 Vehicle Identification Number to: 2015-5052011, 2015-D547071
35S15, 35C15, 40C15, 50C15, 65C15, 70C15 107 kW (146 PS) F1CFL411J	03.2014→04.2016		7.04931.04.0	AGR-K	EL	
			↳ 7.05632.04.0	AGR	EL	
			7.02321.17.0	AK	EL	
			7.11190.03.0	DDS		
			7.05270.21.0	LS	600 mm	
35S17, 35C17, 40C17, 50C17, 55C17, 65C17, 70C17 125 kW (170 PS) F1CFL411F	03.2014→04.2016		7.04931.04.0	AGR-K	EL	
			↳ 7.05632.04.0	AGR	EL	
			7.02321.17.0	AK	EL	
			7.04239.04.0	AK	EL	
			7.11190.03.0	DDS		
			7.05270.21.0	LS	600 mm	Fahrgestellnummer bis: 2015-5052011, 2015-D547072 Vehicle Identification Number to: 2015-5052011, 2015-D547072
			7.02604.99.0	LS	400 mm	05.2014→02.2016 Motorcode: F1CFL411F Engine Code: F1CFL411F Baumuster: Daily 35 S 17 Type: Daily 35 S 17 Produktionsdatum ab: 05.2014 Production date from: 05.2014 Produktionsdatum bis: 04.2016 Production date to: 04.2016

DAILY VI Van
19

35S17, 35C17, 40C17, 50C17, 55C17, 65C17, 70C17 125 kW (170 PS) F1CFL411H	03.2014→04.2016		7.04931.04.0 AGR-K EL	ohne Zubehör without accessories für OE-Nummer: 5801356473, 5801600484 for OE number: 5801356473, 5801600484 Fahrgestellnummer bis: 2015-5052011, 2015-D547072 Vehicle Identification Number to: 2015-5052011, 2015-D547072
			↳ 7.05632.04.0 AGR EL	
			7.02321.17.0 AK EL	
			7.11190.03.0 DDS	
35S21, 35C21, 40C21, 50C21, 65C21, 70C21 150 kW (205 PS) F1CFL411G	03.2014→		7.02321.17.0 AK EL	ohne Zubehör without accessories für OE-Nummer: 5801356473, 5801600484 for OE number: 5801356473, 5801600484 Fahrgestellnummer bis: 2015-5052011, 2015-D547072 Vehicle Identification Number to: 2015-5052011, 2015-D547072
			7.11190.03.0 DDS	
			7.05270.21.0 LS 600 mm	
35S21, 35C21, 40C21, 50C21, 65C21, 70C21 150 kW (204 PS) F1CGL411C	03.2014→		7.02321.17.0 AK EL	
Natural Power 35S14, 35C14, 40C14, 50C14, 65C14, 70C14 100 kW (136 PS) F1CFA401A, F1CFA401B	03.2014→		7.04239.04.0 AK EL	

MASSIF Single Cab
20





3.0 HPI 107 kW (146 PS) F1CE0481F	10.2008→02.2011		7.24809.51.0 AGR PN
			7.02604.99.0 LS 400 mm
3.0 HPT 130 kW (177 PS) F1CE0481H	10.2008→02.2011		7.24809.51.0 AGR PN
			7.02604.99.0 LS 400 mm



























ENGINE
21

















































ENGINE 67-72 kW (91-98 PS) F5BFL413A B007, F5BFL413A B009, F5BFL413A C001, F5BFL413E B002, F5GFL413A B006, F5GFL413A B007, F5GFL413A B013, F5GFL413A B019, F5GFL413A B021			7.05243.04.0 AGR-M EL	
ENGINE 52-55 kW (71-74 PS) F5HFL463A F001, F5HFL463A F012			7.03693.12.0 AGR-M EL	
ENGINE 66-104 kW (90-141 PS) N45 ENT (Tier III), N45 MNS, N45 MNT, N45 MSS, N45 MST			7.05500.02.0 AK EL	N45 ENT (Tier III), N45 MNS, N45 MNT, N45 MSS, N45 MST: für OE-Nummer: 5801602383 for OE number: 5801602383



ENGINE **21**

		7.05501.02.0	AK	EL	 N45 ENT (Tier III), N45 MNS, N45 MNT, N45 MSS, N45 MST: für OE-Nummer: 5801602385 for OE number: 5801602385
		7.05502.02.0	AK	EL	 N45 ENT (Tier III), N45 MNS, N45 MNT, N45 MSS, N45 MST: für OE-Nummer: 5801602387 for OE number: 5801602387
ENGINE 89-125 kW (121-170 PS) N45 ENT (Tier IV)		7.04275.09.0	AGR-M	EL	
		7.05500.02.0	AK	EL	für OE-Nummer: 5801602383 for OE number: 5801602383
		7.05501.02.0	AK	EL	für OE-Nummer: 5801602385 for OE number: 5801602385
		7.05502.02.0	AK	EL	für OE-Nummer: 5801602387 for OE number: 5801602387
ENGINE 107-130 kW (145-176 PS) F1CE3481F, F1CE3481G, F1CE3481H, F1CE3481Z, F1CFL411Y		7.02321.17.0	AK	EL	
ENGINE 243 kW (330 PS) N60 400		7.04799.08.0	AK	EL	für OE-Nummer: 5801726415 for OE number: 5801726415
		7.05499.05.0	AK	EL	für OE-Nummer: 5801726411 for OE number: 5801726411

					
E-PACE (X540)					
1					
2.0 D 110-132 kW (150-180 PS) 204DTD	09.2017→		7.04923.18.0	AGR	EL  mit Dichtring with O-ring
			7.04924.14.0	AGR	EL
2.0 D AWD 110-132 kW (150-180 PS) 204DTD	09.2017→		7.04923.18.0	AGR	EL  mit Dichtring with O-ring
			7.04924.14.0	AGR	EL
2.0 D AWD 110-132 kW (150-180 PS) 204DTD	09.2017→		7.04923.18.0	AGR	EL  mit Dichtring with O-ring
			7.04924.14.0	AGR	EL
2.0 D AWD 177 kW (241 PS) 204DTA	09.2017→		7.04923.18.0	AGR	EL  mit Dichtring with O-ring
			7.04924.14.0	AGR	EL
F-PACE (X761)					
2					
2.0 SD4 AWD 177 kW (241 PS) 204DTA	02.2017→		7.04923.17.0	AGR	EL mit Dichtring with O-ring  ch. HA886266→
			7.04924.15.0	AGR	EL  ch. JA269699→
2.0 TD4 110-132 kW (150-180 PS) 204DTD	09.2015→		7.04923.17.0	AGR	EL mit Dichtring with O-ring 01.2016→,  ch. HA886266→
			7.04924.15.0	AGR	EL 01.2016→,  ch. JA269699→
2.0 TD4 110-132 kW (150-180 PS) 204DTD	02.2017→		7.04923.17.0	AGR	EL mit Dichtring with O-ring  ch. HA886266→
			7.04924.15.0	AGR	EL  ch. JA269699→
2.0 TD4 AWD 110-132 kW (150-180 PS) 204DTD	09.2015→		7.04923.17.0	AGR	EL mit Dichtring with O-ring 01.2016→,  ch. HA886266→
			7.04924.15.0	AGR	EL 01.2016→,  ch. JA269699→
3.0 SDV6 AWD 177-221 kW (241-300 PS) 306DT	09.2015→		7.05264.04.0*	AGR-K	01.2016→
			↳ 7.05264.03.0	AGR	EL
			7.05590.04.0*	AGR-K	01.2016→
↳ 7.05590.03.0	AGR	EL			
S-TYPE II (X200)					
3					
2.5 V6 147 kW (200 PS) JB (AJ-V6)	04.2002→10.2007		7.00224.13.0	SLP	EL
2.7 D 152 kW (207 PS) AJD	06.2004→10.2007		7.11237.01.0	AGR	EL 
			7.24809.96.0	AGR	EL 
			7.11190.10.0	DDS	ohne Zubehör without accessories
3.0 V6 169-179 kW (230-243 PS) AJ-V6	01.1999→10.2007		7.00224.13.0	SLP	EL
4.2 Supercharged 218-298 kW (296-405 PS) AJ8FT	11.2001→12.2008		7.00224.13.0	SLP	EL
4.2 V8 218-298 kW (296-405 PS) AJ8FT	04.2002→10.2007		7.00224.13.0	SLP	EL
4.2 V8 218-298 kW (296-405 PS) AJ8FT	09.2007→12.2008		7.00224.13.0	SLP	EL
R 4,2 V8 218-298 kW (296-405 PS) AJ8FT	04.2002→10.2007		7.00224.13.0	SLP	EL

						
X-TYPE I (X400)						4
2.0 D 96 kW (130 PS) FMBA, FMBB	07.2003→11.2009		7.24809.07.0	AGR	PN mit Potentiometer with potentiometer 	
X-TYPE I Estate (X400)						5
2.0 D 96 kW (130 PS) FMBA, FMBB	02.2004→12.2009		7.24809.07.0	AGR	PN mit Potentiometer with potentiometer 	
XE (X760)						6
2.0 D 110-132 kW (150-180 PS) 204DTD	03.2015→		7.04923.17.0	AGR	EL mit Dichtring with O-ring  ch. HCP00001→  ch. JCP29153→	
			7.04924.15.0	AGR	EL  ch. JCP29153→	
2.0 D 110-132 kW (150-180 PS) 204DTD	03.2015→		7.04923.17.0	AGR	EL mit Dichtring with O-ring  ch. HCP00001→  ch. JCP29153→	
			7.04924.15.0	AGR	EL  ch. JCP29153→	
2.0 D AWD 110-132 kW (150-180 PS) 204DTD	10.2015→		7.04923.17.0	AGR	EL mit Dichtring with O-ring  ch. HCP00001→	
			7.04924.15.0	AGR	EL  ch. JCP29153→	
2.0 D AWD 177 kW (241 PS) 204DTA	02.2017→		7.04923.17.0	AGR	EL mit Dichtring with O-ring  ch. HCP00001→	
			7.04924.15.0	AGR	EL  ch. JCP29153→	
XF I (X250)						7
2.2 D 110-147 kW (150-200 PS) 224DT	04.2011→04.2015		7.00578.12.0	AGR	EL   ch. U09026→	
2.2 D 110-147 kW (150-200 PS) 224DT	05.2011→04.2015		7.00578.12.0	AGR	EL   ch. U09026→	
2.2 D 110-147 kW (150-200 PS) 224DT	03.2012→04.2015		7.00578.12.0	AGR	EL   ch. U09026→	
2.7 D 152 kW (207 PS) AJD	03.2008→04.2015		7.24809.96.0	AGR	EL  →03.2009,  ch. R45955→	
			7.11237.01.0	AGR	EL  →03.2009	
3.0 175-179 kW (238-243 PS) FB	03.2008→04.2015		7.00224.13.0	SLP	EL für OE-Nummer: 6R83-9A486-AA, XR850044 for OE number: 6R83-9A486-AA, XR850044	
3.0 175 kW (238 PS) AJ6WG	03.2008→04.2015		7.00224.13.0	SLP	EL	
3.0 250-294 kW (340-400 PS) 306PS	03.2012→04.2015		7.00224.13.0	SLP	EL	
3.0	01.2013→12.2014		7.00224.13.0	SLP	EL	
3.0 AWD 250-294 kW (340-400 PS) 306PS	10.2012→04.2015		7.00224.13.0	SLP	EL	
3.0 AWD 250-294 kW (340-400 PS) 306PS	09.2013→04.2015		7.00224.13.0	SLP	EL	
3.0 D 155-202 kW (211-275 PS) AJV6D	03.2009→04.2015		7.01881.08.0*	AGR-K	 Linke Einheit Left unit	
			↳ 7.01881.06.0	AGR-M	EL	
			7.01881.09.0*	AGR-K	 Rechte Einheit Right unit	
			↳ 7.01881.07.0	AGR-M	EL	
3.0 D 155-221 kW (211-300 PS) 306DT, AJV6D	03.2009→04.2015		7.01881.08.0*	AGR-K	 Linke Einheit Left unit	



XF I (X250) 7











































			7.01881.09.0*	AGR-K		⊙ Rechte Einheit Right unit
			↳7.01881.07.0	AGR-M	EL	
3.0 D 155-221 kW (211-300 PS) 306DT, AJV6D	03.2009→04.2015		7.01881.08.0*	AGR-K		⊙ Linke Einheit Left unit
			↳7.01881.06.0	AGR-M	EL	
			7.01881.09.0*	AGR-K		⊙ Rechte Einheit Right unit
			↳7.01881.07.0	AGR-M	EL	
4.2 218-219 kW (296-298 PS) SV82G	03.2008→04.2015		7.00224.13.0	SLP	EL	
4.2	09.2008→12.2009		7.00224.13.0	SLP	EL	
4.2 218-219 kW (296-298 PS) SV82G	09.2008→12.2010		7.00224.13.0	SLP	EL	
4.2 Kompressor 306-313 kW (416-426 PS) SV8TS	03.2008→04.2015		7.00224.13.0	SLP	EL	























XF II (X260) 8

2.0 D 110-132 kW (150-180 PS) 204DTD	05.2015→		7.04923.17.0	AGR	EL	mit Dichtring with O-ring 01.2016→, ch. HCY48840→
			7.04924.15.0	AGR	EL	01.2016→, ch. JCY60339→
2.0 D 110-132 kW (150-180 PS) 204DTD	05.2015→		7.04923.17.0	AGR	EL	mit Dichtring with O-ring 01.2016→, ch. HCY48840→
			7.04924.15.0	AGR	EL	01.2016→, ch. JCY60339→
2.0 D 177 kW (241 PS) 204DTA	03.2017→		7.04924.15.0	AGR	EL	ch. JCY60339→
2.0 D AWD 110-132 kW (150-180 PS) 204DTD	03.2016→		7.04923.17.0	AGR	EL	mit Dichtring with O-ring ch. HCY48840→
			7.04924.15.0	AGR	EL	
2.0 D AWD 177 kW (241 PS) 204DTA	03.2017→		7.04924.15.0	AGR	EL	ch. JCY60339→
			7.05264.04.0*	AGR-K		01.2016→
			↳7.05264.03.0	AGR	EL	
3.0 D 177-221 kW (241-300 PS) 306DT	05.2015→		7.05590.04.0*	AGR-K		01.2016→
			↳7.05590.03.0	AGR	EL	
			7.05590.04.0*	AGR-K		01.2016→

XF SPORTBRAKE (X250) 9

2.2 D 110-147 kW (150-200 PS) 224DT	09.2012→04.2014		7.00578.12.0	AGR	EL	⊙ ch. U09026→
2.2 D 110-147 kW (150-200 PS) 224DT	09.2012→04.2014		7.00578.12.0	AGR	EL	⊙ ch. U09026→
3.0 D 155-221 kW (211-300 PS) 306DT, AJV6D	09.2012→04.2014		7.01881.08.0*	AGR-K		⊙ Linke Einheit Left unit
			↳7.01881.06.0	AGR-M	EL	
			7.01881.09.0*	AGR-K		⊙ Rechte Einheit Right unit
			↳7.01881.07.0	AGR-M	EL	
3.0 D 155-221 kW (211-300 PS) 306DT, AJV6D	09.2012→04.2014		7.01881.08.0*	AGR-K		⊙ Linke Einheit Left unit
			↳7.01881.06.0	AGR-M	EL	



					
XF SPORTBRAKE (X250)					9
			7.01881.09.0*	AGR-K	 Rechte Einheit Right unit
			↳ 7.01881.07.0	AGR-M	EL
XF SPORTBRAKE (X260)					10
2.0 D 110-132 kW (150-180 PS) 204DTD	07.2017→		7.04923.17.0	AGR	EL mit Dichtring with O-ring  ch. HCY48840→
			7.04924.15.0	AGR	EL  ch. JCY60339→
2.0 D 110-132 kW (150-180 PS) 204DTD	07.2017→		7.04923.17.0	AGR	EL mit Dichtring with O-ring  ch. HCY48840→
			7.04924.15.0	AGR	EL  ch. JCY60339→
2.0 D AWD 110-132 kW (150-180 PS) 204DTD	07.2017→		7.04923.17.0	AGR	EL mit Dichtring with O-ring  ch. HCY48840→
			7.04924.15.0	AGR	EL  ch. JCY60339→
2.0 D AWD 177 kW (241 PS) 204DTA	07.2017→		7.04924.15.0	AGR	EL  ch. JCY60339→
3.0 D 177-221 kW (241-300 PS) 306DT	07.2017→		7.05264.04.0*	AGR-K	
			↳ 7.05264.03.0	AGR	EL
			7.05590.04.0*	AGR-K	
			↳ 7.05590.03.0	AGR	EL
XJ (X350, X358)					11
3.0 169-179 kW (230-243 PS) AJ-V6	05.2003→03.2009		7.00224.13.0	SLP	EL  ch. G00442→ch. H32732
3.0 169-179 kW (230-243 PS) AJ-V6	04.2004→01.2007		7.00224.13.0	SLP	EL  ch. G00442→ch. H32732
3.6 190-196 kW (258-266 PS) RG (AJ-V8)	05.2003→03.2009		7.00224.13.0	SLP	EL  ch. G00442→ch. H32732 für OE-Nummer: 6R83-9A486-AA, XR850044 for OE number: 6R83-9A486-AA, XR850044
4.2 218-298 kW (296-405 PS) AJ8FT	05.2003→03.2009		7.00224.13.0	SLP	EL  ch. G00442→ch. H32732
4.2 224 kW (305 PS) AJ8FR	05.2007→03.2009		7.00224.13.0	SLP	EL  ch. G00442→ch. H32732
D 2.7 152 kW (207 PS) AJD	10.2005→03.2009		7.24809.96.0	AGR	EL  ch. H00321→
			7.11237.01.0	AGR	EL 
			7.11190.10.0	DDS	ohne Zubehör without accessories  →ch. H06205
R 4.2 218-298 kW (296-405 PS) AJ8FT	03.2003→03.2009		7.00224.13.0	SLP	EL  ch. G00442→ch. H32732
XJ (X351)					12
3.0 SCV6 250-294 kW (340-400 PS) 306PS	03.2012→		7.00224.13.0	SLP	EL  ch. V00001→
3.0 SCV6 250-294 kW (340-400 PS) 306PS	09.2012→		7.00224.13.0	SLP	EL  ch. V00001→
3.0 SCV6 AWD 250-294 kW (340-400 PS) 306PS	10.2012→		7.00224.13.0	SLP	EL  ch. V00001→
3.0 SCV6 AWD 250-294 kW (340-400 PS) 306PS	09.2013→		7.00224.13.0	SLP	EL  ch. V00001→

						
XJ (X351)						12
3.0 SDV6 177-221 kW (241-300 PS) 306DT	04.2015→		7.01881.08.0*	AGR-K	 Linke Einheit Left unit  ch. V00001→	
			↳7.01881.06.0	AGR-M		EL
			7.01881.09.0*	AGR-K		 Rechte Einheit Right unit  ch. V00001→
3.0 V6 169-179 kW (230-243 PS) AJ-V6	01.2011→		7.00224.13.0	SLP	EL  ch. V00001→	
XJ (XJ40, XJ81)						13
6 4.0 163-187 kW (222-254 PS) 9EPCNA	09.1989→11.1994		7.02604.03.0	LS	200 mm	
XJ Coupe						14
3.6 162-168 kW (220-228 PS) AJ 6 (3.6, 162KW)	10.1983→10.1986		7.02604.03.0	LS	200 mm	
3.6 162-168 kW (220-228 PS) AJ 6 (3.6, 162KW)	10.1983→10.1986		7.02604.03.0	LS	200 mm	
3.6 156 kW (212 PS) AJ 6 (3.6, 156KW)	08.1987→12.1988		7.02604.03.0	LS	200 mm	
3.6 136-156 kW (185-212 PS) 9DPANA	01.1988→05.1992		7.02604.03.0	LS	200 mm	
3.6 136-156 kW (185-212 PS) 9DPALA, 9DPANA	01.1988→05.1991		7.02604.03.0	LS	200 mm	
4.0 163-187 kW (222-254 PS) 9EPCNA	05.1991→09.1994		7.02604.03.0	LS	200 mm	
XJSC Convertible (X27)						15
3.6 162-168 kW (220-228 PS) AJ 6 (3.6, 162KW)	10.1986→10.1986		7.02604.03.0	LS	200 mm	
3.6 156 kW (212 PS) AJ 6 (3.6, 156KW)	08.1987→12.1988		7.02604.03.0	LS	200 mm	
4.0 163-187 kW (222-254 PS) 9EPCNA	05.1991→09.1994		7.02604.03.0	LS	200 mm	





J

















CHEROKEE (KJ) **1**

2.8 CRD 110-120 kW (150-163 PS) ENR	09.2004→12.2006	 7.28270.14.0	AGR	PN	<input type="checkbox"/> →12.2004
		7.00632.13.0	AGR	EL	<input type="checkbox"/> →04.2006
2.8 CRD 4x4 110-120 kW (150-163 PS) ENR	11.2002→01.2008	 7.28270.14.0	AGR	PN	<input type="checkbox"/> →12.2004
		7.00632.13.0	AGR	EL	<input type="checkbox"/> →04.2006
2.8 CRD 4x4 110-120 kW (150-163 PS) ENR	11.2004→01.2008	 7.28270.14.0	AGR	PN	<input type="checkbox"/> →12.2004
		7.00632.13.0	AGR	EL	<input type="checkbox"/> →04.2006

CHEROKEE (KK) **2**







2.8 CRD 4x4 110-147 kW (150-200 PS) ENS	05.2008→	 7.01317.10.0	AGR	PN	<input type="checkbox"/> 2010 2010
		7.03295.03.0	AGR	EL	<input type="checkbox"/> 2011 2011
		7.11190.01.0	DDS		<input checked="" type="checkbox"/> ENS: Getriebetyp: DEH, DGS Transmission Type: DEH, DGS 2012 2012 <input checked="" type="checkbox"/> ENS: Getriebetyp: DGJ Transmission Type: DGJ 2011 2011
		7.11190.01.0	DDS		<input checked="" type="checkbox"/> ENS: Getriebetyp: DEH, DGS Transmission Type: DEH, DGS 2012 2012 <input checked="" type="checkbox"/> ENS: Getriebetyp: DGJ Transmission Type: DGJ 2011 2011
2.8 CRD 4x4 110-147 kW (150-200 PS) ENS	01.2010→	 7.01317.10.0	AGR	PN	<input type="checkbox"/> 2010 2010
		7.03295.03.0	AGR	EL	<input type="checkbox"/> 2011 2011
		7.11190.01.0	DDS		<input checked="" type="checkbox"/> ENS: Getriebetyp: DEH, DGS Transmission Type: DEH, DGS 2012 2012 <input checked="" type="checkbox"/> ENS: Getriebetyp: DGJ Transmission Type: DGJ 2011 2011
		7.11190.01.0	DDS		<input checked="" type="checkbox"/> ENS: Getriebetyp: DEH, DGS Transmission Type: DEH, DGS 2012 2012 <input checked="" type="checkbox"/> ENS: Getriebetyp: DGJ Transmission Type: DGJ 2011 2011
3.7 V6 148-157 kW (201-214 PS) EKG	01.2008→	 7.00992.36.0	AGR	EL	<input type="checkbox"/> mit Befestigungsmaterial with fastening material
		 7.00992.36.0	AGR	EL	<input type="checkbox"/> mit Befestigungsmaterial with fastening material

J

						
CHEROKEE (KK)						2
3.7 V6 4x4 148-157 kW (201-214 PS) EKG	01.2008→		7.00992.36.0	AGR	EL <input type="checkbox"/>	mit Befestigungsmaterial with fastening material
3.7 V6 All-wheel Drive 148-157 kW (201-214 PS) EKG	01.2008→08.2012		7.00992.36.0	AGR	EL <input type="checkbox"/>	mit Befestigungsmaterial with fastening material
CHEROKEE (KL)						3
2.0 CRD 88-127 kW (120-173 PS) EBT	04.2014→08.2018		7.24809.77.0	AGR	ET <input checked="" type="checkbox"/>	
			7.11020.09.0	ATS	EL	für OE-Nummer: 05146223AA, 55203808 for OE number: 05146223AA, 55203808
			7.11190.03.0	DDS		ohne Zubehör without accessories für OE-Nummer: 5146842AD, 68228804AA for OE number: 5146842AD, 68228804AA
2.0 CRD 88-127 kW (120-173 PS) EBT	04.2014→08.2018		7.11020.09.0	ATS	EL	für OE-Nummer: 05146223AA, 55203808 for OE number: 05146223AA, 55203808
			7.11190.03.0	DDS		ohne Zubehör without accessories für OE-Nummer: 5146842AD, 68228804AA for OE number: 5146842AD, 68228804AA
2.0 CRD 4x4 88-127 kW (120-173 PS) EBT	04.2014→08.2018		7.24809.77.0	AGR	ET <input checked="" type="checkbox"/>	
			7.11020.09.0	ATS	EL	für OE-Nummer: 05146223AA, 55203808 for OE number: 05146223AA, 55203808
			7.11190.03.0	DDS		ohne Zubehör without accessories für OE-Nummer: 5146842AD, 68228804AA for OE number: 5146842AD, 68228804AA
2.0 CRD 4x4 88-127 kW (120-173 PS) EBT	04.2014→08.2018		7.24809.77.0	AGR	ET <input checked="" type="checkbox"/>	
			7.11020.09.0	ATS	EL	für OE-Nummer: 05146223AA, 55203808 for OE number: 05146223AA, 55203808
			7.11190.03.0	DDS		ohne Zubehör without accessories für OE-Nummer: 5146842AD, 68228804AA for OE number: 5146842AD, 68228804AA
2.0 T-GDi 199-200 kW (270-272 PS) EC1	01.2019→		7.07044.12.0	AGR	EL	
COMMANDER (XK, XH)						4
3.0 CRD 4x4 132-165 kW (180-224 PS) EXL	04.2006→12.2010		7.24809.47.0	AGR	ET <input type="checkbox"/>	
			7.11190.01.0	DDS		2006, 2009
			7.11190.01.0	DDS		2006, 2009
			7.02604.99.0	LS	400 mm	2006, 2009
3.7 148-157 kW (201-214 PS) EKG	09.2005→12.2009		7.00992.36.0	AGR	EL <input type="checkbox"/>	mit Befestigungsmaterial with fastening material









COMMANDER (XK, XH) 4







3.7 V6 4x4 148-157 kW (201-214 PS) EKG	09.2005→12.2010		7.00992.36.0	AGR	EL	<input type="checkbox"/> mit Befestigungsmaterial with fastening material
4.7 167-228 kW (227-310 PS) EVE	09.2008→12.2010		7.02769.05.0	AGR	EL	<input type="checkbox"/> mit Befestigungsmaterial with fastening material
4.7 4x4 167-228 kW (227-310 PS) EVE	09.2007→12.2010		7.02769.05.0	AGR	EL	<input type="checkbox"/> mit Befestigungsmaterial with fastening material
4.7 Flexfuel 167-228 kW (227-310 PS) EVE	09.2007→12.2010		7.02769.05.0	AGR	EL	<input type="checkbox"/> mit Befestigungsmaterial with fastening material
4.7 Flexfuel 4x4 167-228 kW (227-310 PS) EVE	09.2007→12.2010		7.02769.05.0	AGR	EL	<input type="checkbox"/> mit Befestigungsmaterial with fastening material
4.7 V8 4x4 167-228 kW (227-310 PS) EVE	01.2008→12.2009		7.02769.05.0	AGR	EL	<input type="checkbox"/> mit Befestigungsmaterial with fastening material

COMPASS (MK49) 5

J

2.0 CRD 88-103 kW (120-140 PS) ECD	08.2006→		7.24809.16.0	AGR	PN	<input type="checkbox"/>
2.0 CRD 103 kW (140 PS) ECE	08.2006→		7.24809.16.0 7.05270.21.0	AGR LS	PN 600 mm	<input type="checkbox"/> vor Katalysator in front of the catalyst
2.0 CRD 4x4 103 kW (140 PS) ECE	09.2006→		7.05270.21.0	LS	600 mm	vor Katalysator in front of the catalyst
2.0 CRD 4x4 88-103 kW (120-140 PS) ECD	02.2007→		7.24809.16.0	AGR	PN	<input type="checkbox"/>
2.2 CRD 100-120 kW (136-163 PS) ENE	05.2011→		7.11190.01.0	DDS		
2.2 CRD 4x4 100-120 kW (136-163 PS) ENE	05.2011→		7.11190.01.0 7.11190.01.0	DDS DDS		

COMPASS (MP, M6) 6



1.6 CRD 70-88 kW (95-120 PS) EJJ	03.2017→		7.11190.03.0	DDS		ohne Zubehör without accessories 2020 2020
2.0 CRD 4x4 100-127 kW (136-173 PS) EBS	12.2016→		7.11190.03.0	DDS		ohne Zubehör without accessories 2018 2018 2020 2020
2.0 CRD 4x4 88-127 kW (120-173 PS) EBS, EBT	03.2017→		7.11190.03.0	DDS		ohne Zubehör without accessories  EBS: 2020 2020  EBT: Getriebetyp: DFH Transmission Type: DFH  Brasilien  Brazil 2018, 2019 2018, 2019

COMPASS (MP, M6)						6
2.0 Multijet II 88-127 kW (120-173 PS) EBS, EBT	10.2018→		7.11190.03.0	DDS	ohne Zubehör without accessories EBS: 2020 2020 EBT: Getriebetyp: DFH Transmission Type: DFH Brasilien Brazil 2018, 2019 2018, 2019	
2.0 Multijet II 4x4 88-127 kW (120-173 PS) EBS, EBT	03.2017→		7.11190.03.0	DDS	ohne Zubehör without accessories EBS: 2020 2020 EBT: Getriebetyp: DFH Transmission Type: DFH Brasilien Brazil 2018, 2019 2018, 2019	
GRAND CHEROKEE III (WH, WK)						7
3.0 CRD 132-165 kW (180-224 PS) EXL	06.2005→12.2010		7.24809.47.0	AGR	ET	
			7.11190.01.0	DDS	2009	
			7.11190.01.0	DDS	2009	
3.0 CRD 4x4 132-165 kW (180-224 PS) EXL	06.2005→12.2010		7.24809.47.0	AGR	ET	
			7.11190.01.0	DDS	2009	
			7.11190.01.0	DDS	2009	
			7.02604.99.0	LS	400 mm	
3.0 CRD 4x4 132-165 kW (180-224 PS) EXL	05.2006→12.2010		7.24809.47.0	AGR	ET	
			7.02604.99.0	LS	400 mm	
3.0 CRD 4x4 132-165 kW (180-224 PS) EXL	05.2006→12.2010		7.24809.47.0	AGR	ET	
3.7 V6 148-157 kW (201-214 PS) EKG	10.2004→12.2010		7.00992.36.0	AGR	EL mit Befestigungsmaterial with fastening material	
3.7 V6 4x4 148-157 kW (201-214 PS) EKG	10.2004→12.2010		7.00992.36.0	AGR	EL mit Befestigungsmaterial with fastening material	
3.7 V6 4x4 148-157 kW (201-214 PS) EKG	01.2008→12.2010		7.00992.36.0	AGR	EL mit Befestigungsmaterial with fastening material	
4.7 4WD 167-228 kW (227-310 PS) EVE	09.2007→12.2008		7.02769.05.0	AGR	EL mit Befestigungsmaterial with fastening material	
4.7 V8 167-228 kW (227-310 PS) EVE	10.2004→05.2010		7.02769.05.0	AGR	EL mit Befestigungsmaterial with fastening material	
4.7 V8 4x4 167-228 kW (227-310 PS) EVE	09.2007→02.2010		7.02769.05.0	AGR	EL mit Befestigungsmaterial with fastening material	









J



GRAND CHEROKEE III (WH, WK) **7**

4.7 V8 4x4 167-228 kW (227-310 PS) EVE	10.2007→05.2010		7.02769.05.0	AGR	EL	<input type="checkbox"/> mit Befestigungsmaterial with fastening material
4.7 V8 FLEX 167-228 kW (227-310 PS) EVE	10.2004→05.2010		7.02769.05.0	AGR	EL	<input type="checkbox"/> mit Befestigungsmaterial with fastening material



GRAND CHEROKEE IV (WK, WK2) **8**

















3.0 CRD 140-184 kW (190-250 PS) EXF	09.2013→		7.24809.80.0	AGR	ET	<input checked="" type="checkbox"/>
3.0 CRD V6 4x4 140-184 kW (190-250 PS) EXF	01.2011→		7.24809.80.0	AGR	ET	<input checked="" type="checkbox"/>
3.0 CRD V6 4x4 140-184 kW (190-250 PS) EXF	02.2011→		7.24809.80.0	AGR	ET	<input checked="" type="checkbox"/>
			7.11190.01.0	DDS		Partikelfilter Particulate Filter
			7.11190.01.0	DDS		Partikelfilter Particulate Filter
3.0 CRD V6 4x4 140-184 kW (190-250 PS) EXF	02.2011→		7.24809.80.0	AGR	ET	<input checked="" type="checkbox"/>
3.0 CRD V6 4x4 140-184 kW (190-250 PS) EXF	07.2013→		7.24809.80.0	AGR	ET	<input checked="" type="checkbox"/>
3.0 TD V6 4x4 140-184 kW (190-250 PS) EXF	04.2014→		7.24809.80.0	AGR	ET	<input checked="" type="checkbox"/>
6.4 SRT8 4x4 344-401 kW (468-545 PS) ESG	03.2011→		7.11190.04.0	DDS		
6.4 SRT8 4x4 344-401 kW (468-545 PS) ESG	06.2011→		7.11190.04.0	DDS		
6.4 SRT8 4x4 344-401 kW (468-545 PS) ESG	09.2011→		7.11190.04.0	DDS		

JEEP LIBERTY **9**

2.8 CRD 16V 110 kW (150 PS) ENO (110 kW)	03.2003→		7.28270.14.0	AGR	PN	<input type="checkbox"/> →12.2004
			7.00632.13.0	AGR	EL	<input type="checkbox"/> 01.2005→05.2006

PATRIOT (MK74) **10**

2.0 CRD 88-103 kW (120-140 PS) ECD	02.2007→12.2017		7.24809.16.0	AGR	PN	<input type="checkbox"/>
2.0 CRD 103 kW (140 PS) ECE	02.2007→12.2017		7.24809.16.0	AGR	PN	<input type="checkbox"/>
			7.05270.21.0	LS	600 mm	vor Katalysator in front of the catalyst
2.0 CRD 4x4 88-103 kW (120-140 PS) ECD	02.2007→12.2017		7.24809.16.0	AGR	PN	<input type="checkbox"/>
2.0 CRD 4x4 103 kW (140 PS) ECE	02.2007→12.2017		7.24809.16.0	AGR	PN	<input type="checkbox"/>
			7.05270.21.0	LS	600 mm	vor Katalysator in front of the catalyst
2.0 CRD 4x4 88-103 kW (120-140 PS) ECD	02.2007→12.2017		7.24809.16.0	AGR	PN	<input type="checkbox"/>

					
PATRIOT (MK74)					
10					
2.2 CRD 100-120 kW (136-163 PS) ENE	01.2011→12.2017		7.11190.01.0	DDS	
			7.11190.01.0	DDS	
2.2 CRD 4x4 100-120 kW (136-163 PS) ENE	01.2011→12.2017		7.11190.01.0	DDS	
			7.11190.01.0	DDS	
2.2 CRD 4x4 100-120 kW (136-163 PS) ENE	01.2011→12.2017		7.11190.01.0	DDS	
			7.11190.01.0	DDS	
RENEGADE SUV (BU, B1)					
11					
1.6 CRD 88 kW (120 PS) EJK	07.2014→		7.24809.77.0	AGR	ET <input checked="" type="checkbox"/>
1.6 CRD 70-88 kW (95-120 PS) EJJ	11.2016→		7.11190.03.0	DDS	ohne Zubehör without accessories Schaltgetriebe 6 Gang, für Getriebeautomatik 9 Gang, für Doppelkupplungsgetriebe 6 Gang 6-Speed Manual Transmission, for 9-speed automatic transmission, for 6-speed dual-clutch transmission 2019
2.0 CRD 4x4 88-127 kW (120-173 PS) 552 63 087, 552 63 088	07.2014→		7.11020.48.0	ATS	EL  552 63 087, 552 63 088: für OE-Nummer: 55259913 for OE number: 55259913
2.0 CRD 4x4 88-127 kW (120-173 PS) EBT	07.2014→		7.24809.77.0	AGR	ET <input checked="" type="checkbox"/>
			7.11190.03.0	DDS	ohne Zubehör without accessories Schaltgetriebe 6 Gang, Getriebeautomatik 9 Gang, Doppelkupplungsgetriebe 6 Gang 6-Speed Manual Transmission, 9-Speed Automatic Transmission, 6-Speed Dual-Clutch Transmission 2019
2.0 CRD 4x4 88-127 kW (120-173 PS) EBT	07.2014→		7.24809.77.0	AGR	ET <input checked="" type="checkbox"/>
			7.11190.03.0	DDS	ohne Zubehör without accessories Schaltgetriebe 6 Gang, Doppelkupplungsgetriebe 6 Gang, für Getriebeautomatik 9 Gang 6-Speed Manual Transmission, 6-Speed Dual-Clutch Transmission, for 9-speed automatic transmission 2019
2.0 CRD 4x4 88-127 kW (120-173 PS) EBT	07.2014→		7.24809.77.0	AGR	ET <input checked="" type="checkbox"/>

J





RENEGADE SUV (BU, B1) **11**

		7.11190.03.0	DDS		ohne Zubehör without accessories Schaltgetriebe 6 Gang, Doppelkupplungsgetriebe 6 Gang, nicht für Getriebeautomatik 9 Gang 6-Speed Manual Transmission, 6-Speed Dual-Clutch Transmission, not for 9-speed automatic transmission 2019 2019
2.0 CRD 4x4 88-127 kW (120-173 PS) EBT	04.2015→	7.11190.03.0 	DDS		ohne Zubehör without accessories Schaltgetriebe 6 Gang, Doppelkupplungsgetriebe 6 Gang, für Getriebeautomatik 9 Gang 6-Speed Manual Transmission, 6-Speed Dual-Clutch Transmission, for 9-speed automatic transmission 2019 2019

WRANGLER III (JK) **12**

J



2.8 CRD 110-147 kW (150-200 PS) ENS	04.2007→	 7.01317.10.0	AGR	PN	<input type="checkbox"/> 2010 <input type="checkbox"/> 2010
		7.03295.03.0	AGR	EL	<input type="checkbox"/> 2011 <input type="checkbox"/> 2011
		7.11190.01.0	DDS		Getriebetyp: DEH, DGJ Transmission Type: DEH, DGJ Partikelfilter Particulate Filter 2011 2011 2018 2018
		7.11190.01.0	DDS		Getriebetyp: DEH, DGJ Transmission Type: DEH, DGJ Partikelfilter Particulate Filter 2011 2011 2018 2018
2.8 CRD 110-147 kW (150-200 PS) ENS	07.2010→	 7.01317.10.0	AGR	PN	<input type="checkbox"/> 2010 <input type="checkbox"/> 2010
		7.03295.03.0	AGR	EL	<input type="checkbox"/> 2011 <input type="checkbox"/> 2011
2.8 CRD 110-147 kW (150-200 PS) ENS	11.2010→	 7.01317.10.0	AGR	PN	<input type="checkbox"/> 2010 <input type="checkbox"/> 2010
		7.03295.03.0	AGR	EL	<input type="checkbox"/> 2011 <input type="checkbox"/> 2011

					
---	---	---	---	--	---

WRANGLER III (JK)	12
--------------------------	-----------

		7.11190.01.0	DDS	Getriebetyp: DEH, DGJ Transmission Type: DEH, DGJ Partikelfilter Particulate Filter 2011 2011 2018 2018
		7.11190.01.0	DDS	Getriebetyp: DEH, DGJ Transmission Type: DEH, DGJ Partikelfilter Particulate Filter 2011 2011 2018 2018

















WRANGLER IV (JL)	13
-------------------------	-----------

2.0	07.2018→		7.07044.12.0	AGR	EL	
2.0 T-GDi (JL72, JL74) 199-200 kW (270-272 PS) EC1	11.2017→		7.07044.12.0	AGR	EL	
2.2 Multijet II (JL72, JL74) 147 kW (200 PS) EBH	11.2017→		7.11190.01.0	DDS		Partikelfilter Particulate Filter
			7.11190.01.0	DDS		Partikelfilter Particulate Filter

J









































ENGINE **1**



























ENGINE 33-106 kW (45-144 PS) 3029HFG03, 3029HPY58, 3029HPY61, 3029HPY62, 3029HPY65, 3029HPY80, 3029HPY81, 3029HPY84, 3029HPY85, 3029WG401, 4045HI551, 4045HL290		7.07419.06.0	AK	EL
ENGINE 36-108 kW (49-147 PS) 3029HI530, 4045HT105, 4045WG402		7.07420.09.0	AK	EL
ENGINE 50-104 kW (68-141 PS) 4045HB551, 4045HFC04, 4045TFG03		7.05448.07.0	AK	EL
ENGINE 54-104 kW (73-141 PS) 4045HDW57, 4045HFG04, 4045HFL07, 4045HI550, 4045HLC07, 4045HT076, 4045HT079, 4045TFC03		7.08965.03.0	AK	EL
ENGINE 62-104 kW (84-141 PS) 4045HAC04, 4045HAC05, 4045HAC07, 4045HFC07, 4045HFK04, 4045HL502, 4045HLV71, 4045HLV72, 4045HLV73, 4045HLV75, 4045HLV76, 4045HLV78, 4045HMC04, 4045HMC05, 4045HP073, 4045HT082, 4045HT083, 4045HT096		7.05448.07.0	AK	EL
ENGINE 73-116 kW (99-158 PS) 4045HG551		7.07420.09.0	AK	EL
ENGINE 75-129 kW (102-175 PS) 4045HDW56, 4045HDW58, 4045HFG93, 4045HFL93, 4045HP056, 4045HP057, 4045HT068, 4045HT069		7.10197.01.0	AK	EL
ENGINE 75-129 kW (102-175 PS) 4045HDW56, 4045HDW58, 4045HFG93, 4045HFL93, 4045HP056, 4045HP057, 4045HT068, 4045HT069		7.03803.03.0	AGR	PN
ENGINE 81-224 kW (110-305 PS) 4045CA550, 4045HL500, 4045HL503, 4045HL505, 4045HL555, 4045HN051, 4045HN052, 4045HN053, 4045HN054, 4045HN056, 6068HN062		7.05446.07.0	AK	EL
ENGINE 87 kW (118 PS) 4045HL050		7.10197.01.0	AK	EL
ENGINE 90-131 kW (122-178 PS) 4045HT077, 4045HTJ19		7.07420.09.0	AK	EL
ENGINE 93-129 kW (126-175 PS) 4045CI550		7.08965.03.0	AK	EL
ENGINE 93-129 kW (126-175 PS) 4045CI550		7.05446.07.0	AK	EL
ENGINE 93-129 kW (126-175 PS) 4045CI551, 4045HFC06, 4045HFG09		7.05447.08.0	AK	EL
ENGINE 93-129 kW (126-175 PS) 4045HFC09		7.08965.03.0	AK	EL
ENGINE 93-129 kW (126-175 PS) 4045HFC09		7.05447.08.0	AK	EL
ENGINE 93-129 kW (126-175 PS) 4045HFC09		7.05448.07.0	AK	EL

ENGINE
1

		7.08965.03.0	AK	EL
ENGINE 112-128 kW (152-174 PS) 4045CB551, 4045HFG06, 4045HFL09		7.05447.08.0	AK	EL

J





						
CARENS II MPV (FJ)						1
2.0 CRDi 83-110 kW (113-150 PS) D4EA	07.2002→		7.09002.06.0	AGR	PN 	
			7.09002.05.0	AGR	ET  06.2006→12.2012	
2.0 CRDi 83-110 kW (113-150 PS) D4EA	11.2005→		7.09002.05.0	AGR	ET  06.2006→12.2012	
2.0 CVVT 98-106 kW (133-144 PS) G4GC	08.2004→		7.02604.73.0	LS	375 mm	
CARENS III MPV (UN)						2
1.6 CRDi 110 66-100 kW (90-136 PS) D4FB	10.2010→		7.02604.99.0	LS	400 mm	
1.6 CRDi 128 66-100 kW (90-136 PS) D4FB	10.2010→		7.02604.99.0	LS	400 mm	
2.0 CRDi 83-110 kW (113-150 PS) D4EA	01.2008→04.2010		7.09002.05.0	AGR	ET 	
2.0 CRDi 115 83-110 kW (113-150 PS) D4EA	05.2007→		7.09002.05.0	AGR	ET  →12.2012	
2.0 CRDi 135 83-110 kW (113-150 PS) D4EA	08.2009→		7.09002.05.0	AGR	ET  →12.2012	
2.0 CRDi 140 83-110 kW (113-150 PS) D4EA	09.2006→		7.09002.05.0	AGR	ET  →12.2012	
CARENS IV						3
1.7 CRDi 85-104 kW (116-141 PS) D4FD	03.2013→		7.02604.99.0	LS	400 mm	
1.7 CRDi 85-104 kW (116-141 PS) D4FD	03.2013→		7.02604.99.0	LS	400 mm	
CARNIVAL / GRAND CARNIVAL III (VQ)						4
2.2 CRDi 110-149 kW (150-203 PS) D4HB	01.2010→		7.09002.12.0	AGR	EL  →12.2011	
2.2 CRDi 110-149 kW (150-203 PS) D4HB	01.2010→		7.09002.12.0	AGR	EL  →12.2011	
2.2 CRDi 110-149 kW (150-203 PS) D4HB	01.2010→06.2015		7.09002.12.0	AGR	EL  →12.2011	
2.2 CRDi 110-149 kW (150-203 PS) D4HB	01.2010→06.2015		7.09002.12.0	AGR	EL  →12.2011	
CEE'D (JD)						5
1.4 CRDi 90 55-66 kW (75-90 PS) D4FC	05.2012→		7.11237.07.0	AGR	EL  Euro 5 Euro 5	
			7.02604.99.0	LS	400 mm	
1.6 CRDi 110 66-100 kW (90-136 PS) D4FB	05.2012→		7.09002.08.0	AGR	ET  →07.2015 Euro 4 (D4) Euro 4 (D4)	
			7.02604.99.0	LS	400 mm	
1.6 CRDi 128 66-100 kW (90-136 PS) D4FB	05.2012→		7.09002.08.0	AGR	ET  →07.2015 Euro 4 (D4) Euro 4 (D4)	
			7.11237.07.0	AGR	EL  →07.2015 Euro 5 Euro 5	

					
CEE'D (JD)					5
			7.02604.99.0	LS	400 mm
1.6 CRDi 136 66-100 kW (90-136 PS) D4FB	07.2015→		7.02604.99.0	LS	400 mm
CEE'D Hatchback (ED)					6
1.6 CRDi 115 66-100 kW (90-136 PS) D4FB	12.2006→12.2012		7.09002.08.0	AGR	ET  03.2009→ Euro 4 (D4) Euro 4 (D4)
			7.09002.07.0	AGR	ET  Produktionsdatum bis: 30.06.2009 Production date to: 30.06.2009 05.2011→07.2012
			7.05052.00.0	AGR-K	
			7.02604.99.0	LS	400 mm
1.6 CRDi 128 66-100 kW (90-136 PS) D4FB	10.2010→12.2012		7.09002.08.0	AGR	ET  Euro 4 (D4) Euro 4 (D4)
			7.11237.07.0	AGR	EL  Euro 5 Euro 5 05.2011→07.2012
			7.05052.00.0	AGR-K	
			7.02604.99.0	LS	400 mm
1.6 CRDi 90 66-100 kW (90-136 PS) D4FB	12.2006→12.2012		7.09002.08.0	AGR	ET 
			7.09002.07.0	AGR	ET  Produktionsdatum bis: 30.06.2009 Production date to: 30.06.2009
			7.05052.00.0	AGR-K	
			7.02604.99.0	LS	400 mm
2.0 98-106 kW (133-144 PS) G4GC	12.2006→12.2012		7.02604.80.0	LS	220 mm
2.0 CRDi 83-110 kW (113-150 PS) D4EA	06.2007→12.2012		7.09002.05.0	AGR	ET  →07.2010
2.0 CRDi 140 83-110 kW (113-150 PS) D4EA	09.2007→12.2012		7.09002.05.0	AGR	ET  →07.2010
CEE'D SW (ED)					7
1.6 CRDi 115 66-100 kW (90-136 PS) D4FB	09.2007→12.2012		7.09002.08.0	AGR	ET  03.2009→ Euro 4 (D4) Euro 4 (D4)
			7.09002.07.0	AGR	ET  Produktionsdatum bis: 30.06.2009 Production date to: 30.06.2009 05.2011→07.2012
			7.05052.00.0	AGR-K	
			7.02604.99.0	LS	400 mm
1.6 CRDi 128 66-100 kW (90-136 PS) D4FB	10.2010→12.2012		7.09002.08.0	AGR	ET  Euro 4 (D4) Euro 4 (D4)
			7.11237.07.0	AGR	EL  Euro 5 Euro 5 05.2011→07.2012
			7.05052.00.0	AGR-K	
			7.02604.99.0	LS	400 mm

K







CEE'D SW (ED) **7**



1.6 CRDi 90 66-100 kW (90-136 PS) D4FB	09.2007→12.2012		7.09002.08.0	AGR	ET	<input type="radio"/> <input type="radio"/> Produktionsdatum bis: 30.06.2009 Production date to: 30.06.2009
			7.09002.07.0	AGR	ET	
			7.05052.00.0 7.02604.99.0	AGR-K LS	400 mm	
2.0 98-106 kW (133-144 PS) G4GC	09.2007→12.2012		7.02604.80.0	LS	220 mm	
2.0 CRDi 140 83-110 kW (113-150 PS) D4EA	07.2007→12.2012		7.09002.05.0	AGR	ET	<input type="radio"/> →07.2010
2.0 CRDi 140 83-110 kW (113-150 PS) D4EA	07.2007→12.2012		7.09002.05.0	AGR	ET	<input type="radio"/> →07.2010

CEE'D Sportswagon (JD) **8**































K

1.4 CRDi 90 55-66 kW (75-90 PS) D4FC	09.2012→		7.11237.07.0	AGR	EL	<input type="radio"/> →01.2015 Euro 5 Euro 5	
1.6 CRDi 110 66-100 kW (90-136 PS) D4FB	03.2013→		7.09002.08.0	AGR	ET	<input type="radio"/> →07.2015 Euro 4 (D4) Euro 4 (D4)	
			7.11237.07.0	AGR	EL		<input type="radio"/> →07.2015 Euro 5 Euro 5
			7.02604.99.0	LS	400 mm		
1.6 CRDi 128 66-100 kW (90-136 PS) D4FB	09.2012→		7.09002.08.0	AGR	ET	<input type="radio"/> →07.2015 Euro 4 (D4) Euro 4 (D4)	
			7.11237.07.0	AGR	EL		<input type="radio"/> →07.2015 Euro 5 Euro 5
			7.02604.99.0	LS	400 mm		
1.6 CRDi 136 66-100 kW (90-136 PS) D4FB	07.2015→		7.02604.99.0	LS	400 mm		







CERATO I Hatchback (LD) **9**

1.5 CRDi 54-85 kW (73-116 PS) D4FA	07.2005→		7.09002.09.0	AGR	ET	<input type="radio"/> →10.2006 Schaltgetriebe 5 Gang 5-Speed Manual Transmission
			7.09002.07.0	AGR	ET	
1.5 CRDi 54-85 kW (73-116 PS) D4FA	07.2005→		7.09002.09.0	AGR	ET	<input type="radio"/> →10.2006 Schaltgetriebe 5 Gang 5-Speed Manual Transmission
			7.09002.07.0	AGR	ET	
1.5 CRDi 54-85 kW (73-116 PS) D4FA	07.2005→08.2006		7.09002.07.0	AGR	ET	<input type="radio"/> Getriebeautomatik 4 Gang 4-Speed Automatic Transmission









CERATO I Hatchback (LD)					
			7.09002.09.0	AGR	ET Schaltgetriebe 5 Gang 5-Speed Manual Transmission
1.6 77-82 kW (105-112 PS) G4ED	07.2004→		7.02604.73.0	LS	375 mm
1.6 CRDi 66-100 kW (90-136 PS) D4FB	06.2005→		7.09002.09.0	AGR	ET →12.2009 Euro 4 (D4) Euro 4 (D4)
			7.02604.99.0	LS	400 mm
2.0 98-106 kW (133-144 PS) G4GC	03.2004→05.2007		7.02604.73.0	LS	375 mm
			7.02604.80.0	LS	220 mm
2.0 CRDi 83-110 kW (113-150 PS) D4EA	04.2004→		7.09002.06.0	AGR	PN
CERATO I Saloon (LD)					
			7.09002.07.0	AGR	ET Getriebeautomatik 4 Gang 4-Speed Automatic Transmission
1.5 CRDi 54-85 kW (73-116 PS) D4FA	07.2005→08.2006		7.09002.09.0	AGR	ET Schaltgetriebe 5 Gang 5-Speed Manual Transmission
1.5 CRDi 54-85 kW (73-116 PS) D4FA	07.2005→12.2009		7.09002.09.0	AGR	ET →10.2006 Schaltgetriebe 5 Gang 5-Speed Manual Transmission
			7.09002.07.0	AGR	ET Getriebeautomatik 4 Gang 4-Speed Automatic Transmission Produktionsdatum bis: 19.10.2006 Production date to: 19.10.2006
1.5 CRDi 54-85 kW (73-116 PS) D4FA	07.2005→08.2006		7.09002.07.0	AGR	ET Getriebeautomatik 4 Gang 4-Speed Automatic Transmission
			7.09002.09.0	AGR	ET Schaltgetriebe 5 Gang 5-Speed Manual Transmission
1.6 CRDi 66-100 kW (90-136 PS) D4FB	06.2005→12.2009		7.09002.09.0	AGR	ET Euro 4 (D4) Euro 4 (D4)
			7.02604.99.0	LS	400 mm
2.0 98-106 kW (133-144 PS) G4GC	04.2004→01.2007		7.02604.73.0	LS	375 mm
			7.02604.80.0	LS	220 mm
2.0 CRDi 83-110 kW (113-150 PS) D4EA	04.2004→05.2006		7.09002.06.0	AGR	PN
CLARUS (K9A)					
1.8 i 16V 81-85 kW (110-116 PS) T8	07.1996→08.2001		7.02604.03.0	LS	200 mm
2.0 i 16V 87-109 kW (118-148 PS) FE (16V)	07.1996→11.2001		7.02604.03.0	LS	200 mm
CLARUS Estate (GC)					
1.8 i 16V 81-85 kW (110-116 PS) T8	05.1998→		7.02604.03.0	LS	200 mm
2.0 i 16V 87-109 kW (118-148 PS) FE (16V)	05.1998→		7.02604.03.0	LS	200 mm

						
JOICE (MTE1P)						13
2.0 88-102 kW (120-139 PS) G4CP	02.2000→		7.02604.75.0	LS	575 mm	
2.0 88-102 kW (120-139 PS) G4CP	09.2001→		7.02604.75.0	LS	575 mm	
MAGENTIS (GD, MS)						14
2.0 100-103 kW (136-140 PS) G4JP	05.2001→09.2005		7.09002.14.0	AGR	PN 	
			7.02604.75.0	LS	575 mm	
			7.02604.79.0	LS	450 mm	
2.5 V6 118-127 kW (160-173 PS) G6BV	05.2001→		7.09002.14.0	AGR	PN 	
MAGENTIS (MG)						15
2.0 CRDi 83-110 kW (113-150 PS) D4EA	11.2005→12.2008		7.09002.05.0	AGR	ET  02.2006→	
2.0 CRDi 83-110 kW (113-150 PS) D4EA	04.2006→		7.09002.05.0	AGR	ET 	
2.0 CRDi 83-110 kW (113-150 PS) D4EA	04.2006→		7.09002.05.0	AGR	ET 	
K OPIRUS (GH)						16
3.5 143-155 kW (194-211 PS) G6CU	09.2003→		7.02604.79.0	LS	450 mm	
OPTIMA (FSGDS6B)						17
1.7 CRDi 85-104 kW (116-141 PS) D4FD	03.2012→		7.02604.99.0	LS	400 mm	
PICANTO (SA)						18
1.0 45-46 kW (61-63 PS) G4HE	04.2004→		7.02604.96.0	LS	750 mm	
			7.02604.95.0	LS	550 mm	
1.0 45-46 kW (61-63 PS) G4HE	09.2007→		7.02604.96.0	LS	750 mm	
			7.02604.95.0	LS	550 mm	
1.1 48 kW (65 PS) G4HG	04.2004→		7.02604.96.0	LS	750 mm	
			7.02604.95.0	LS	550 mm	
1.1 CRDi 55 kW (75 PS) D3FA	11.2005→		7.09002.07.0	AGR	ET  Produktionsdatum bis: 06.07.2010 Production date to: 06.07.2010	
			7.02604.99.0	LS	400 mm	
PRO CEE'D (ED)						19
1.6 CRDi 115 66-100 kW (90-136 PS) D4FB	02.2008→09.2012		7.09002.08.0	AGR	ET  03.2009→ Euro 4 (D4) Euro 4 (D4)	
			7.09002.07.0	AGR	ET  Produktionsdatum bis: 30.06.2009 Production date to: 30.06.2009	
			7.05052.00.0	AGR-K	05.2011→07.2012	
			7.02604.99.0	LS	400 mm	
1.6 CRDi 128 66-100 kW (90-136 PS) D4FB	10.2010→09.2012		7.09002.08.0	AGR	ET  Euro 4 (D4) Euro 4 (D4)	





PRO CEE'D (ED)
19

























			7.11237.07.0	AGR	EL	 →03.2012 Euro 5 Euro 5 05.2011→07.2012
			7.05052.00.0	AGR-K		
			7.02604.99.0	LS	400 mm	
1.6 CRDi 90 66-100 kW (90-136 PS) D4FB	02.2008→09.2012		7.09002.08.0	AGR	ET	 03.2009→ Euro 4 (D4) Euro 4 (D4)
			7.09002.07.0	AGR	ET	 Produktionsdatum bis: 30.06.2009 Production date to: 30.06.2009
			7.05052.00.0	AGR-K		
			7.02604.99.0	LS	400 mm	
2.0 CRDi 140 83-110 kW (113-150 PS) D4EA	02.2008→09.2012		7.09002.05.0	AGR	ET	 →07.2010

PRO CEE'D (JD)
20

1.4 CRDi 90 55-66 kW (75-90 PS) D4FC	03.2013→		7.11237.07.0	AGR	EL	 →01.2015 Euro 5 Euro 5
1.6 CRDi 110 66-100 kW (90-136 PS) D4FB	03.2013→		7.09002.08.0	AGR	ET	 →07.2015 Euro 4 (D4) Euro 4 (D4)
			7.11237.07.0	AGR	EL	 →07.2015 Euro 5 Euro 5
			7.02604.99.0	LS	400 mm	
1.6 CRDi 128 66-100 kW (90-136 PS) D4FB	03.2013→		7.09002.08.0	AGR	ET	 →07.2015 Euro 4 (D4) Euro 4 (D4)
			7.11237.07.0	AGR	EL	 →07.2015 Euro 5 Euro 5
			7.02604.99.0	LS	400 mm	
1.6 CRDi 136 66-100 kW (90-136 PS) D4FB	07.2015→		7.02604.99.0	LS	400 mm	

RIO Hatchback (DC)
21

1.3 55-60 kW (75-82 PS) A3E	08.2000→02.2005		7.02604.77.0	LS	440 mm	Diagnosesonde Diagnostic Probe
1.3 55-60 kW (75-82 PS) A3E	08.2000→02.2005		7.02604.77.0	LS	440 mm	
1.5 16V 70-72 kW (95-98 PS) A5D	08.2000→02.2005		7.02604.77.0	LS	440 mm	
1.5 16V 70-72 kW (95-98 PS) A5D	09.2002→02.2005		7.02604.77.0	LS	440 mm	

						
RIO II (JB)						22
1.4 16V 55-71 kW (75-97 PS) G4EE	03.2005→		7.02604.73.0	LS	375 mm	
1.5 CRDi 54-85 kW (73-116 PS) D4FA	03.2005→12.2011		7.09002.07.0	AGR	ET	 Produktionsdatum ab: 11.0.2006 Production date from: 11.0.2006 Produktionsdatum bis: 22.10.2010 Production date to: 22.10.2010
			7.02604.99.0	LS	400 mm	
1.5 CRDi 54-85 kW (73-116 PS) D4FA	06.2008→12.2011		7.09002.07.0	AGR	ET	 Produktionsdatum bis: 22.10.2010 Production date to: 22.10.2010
			7.02604.99.0	LS	400 mm	
1.6 CVVT 77-82 kW (105-112 PS) G4ED	03.2005→		7.02604.73.0	LS	375 mm	
RIO II Saloon (JB)						23
1.4 16V 55-71 kW (75-97 PS) G4EE	03.2005→		7.02604.73.0	LS	375 mm	
1.5 CRDi 54-85 kW (73-116 PS) D4FA	03.2005→12.2011		7.09002.07.0	AGR	ET	 Produktionsdatum ab: 11.09.2006 Production date from: 11.09.2006 Produktionsdatum bis: 22.10.2010 Production date to: 22.10.2010
			7.02604.99.0	LS	400 mm	
1.5 CRDi 54-85 kW (73-116 PS) D4FA	06.2008→12.2011		7.09002.07.0	AGR	ET	 Produktionsdatum bis: 22.10.2010 Production date to: 22.10.2010
			7.02604.99.0	LS	400 mm	
1.6 16V 77-82 kW (105-112 PS) G4ED	03.2005→		7.02604.73.0	LS	375 mm	
RIO III (UB)						24
1.4 CRDi 55-66 kW (75-90 PS) D4FC	09.2011→		7.05052.00.0	AGR-K		→10.2014
RIO Saloon (DC_)						25
1.3 55-60 kW (75-82 PS) A3E	09.2000→02.2005		7.02604.77.0	LS	440 mm	
1.3 55-60 kW (75-82 PS) A3E	08.2002→02.2005		7.02604.77.0	LS	440 mm	
1.5 16V 70-72 kW (95-98 PS) A5D	09.2000→02.2005		7.02604.77.0	LS	440 mm	
SEPHIA (FA)						26
1.6 i 59 kW (80 PS) B6	01.1995→10.1997		7.02604.01.0	LS	200 mm	
SEPHIA Saloon (FA)						27
1.6 i 59 kW (80 PS) B6	09.1993→10.1997		7.02604.01.0	LS	200 mm	

K

SORENTO I (JC) **28**



2.5 CRDi 95-131 kW (129-178 PS) D4CB	08.2002→	 7.09002.11.0	AGR	ET	 Produktionsdatum ab: 01.12.2003 Production date from: 01.12.2003 Produktionsdatum bis: 31.12.2006 Production date to: 31.12.2006
		 7.11237.08.0	AGR	EL	 D4CB: 04.2006→12.2008 Euro 4 für Linkslenker for left-hand drive vehicles D4CB: 04.2006→10.2008 Euro 4 für Rechtslenker for right-hand drive vehicles
2.5 CRDi 95-131 kW (129-178 PS) D4CB	05.2006→	 7.09002.11.0	AGR	ET	 Produktionsdatum bis: 31.12.2006 Production date to: 31.12.2006
		 7.02604.99.0	LS	400 mm	
2.5 CRDi 95-131 kW (129-178 PS) D4CB	09.2006→	 7.09002.11.0	AGR	ET	 Produktionsdatum bis: 31.12.2006 Production date to: 31.12.2006
2.5 CRDi 95-131 kW (129-178 PS) D4CB	12.2006→	 7.11237.08.0	AGR	EL	 D4CB: →12.2008 Euro 4 für Linkslenker for left-hand drive vehicles D4CB: →10.2008 Euro 4 für Rechtslenker for right-hand drive vehicles
		 7.02604.99.0	LS	400 mm	
2.5 CRDi 4WD 95-131 kW (129-178 PS) D4CB	09.2006→12.2011	 7.09002.11.0	AGR	ET	 Produktionsdatum bis: 31.12.2006 Production date to: 31.12.2006
3.3 V6 4WD 173-182 kW (245-248 PS) G6DB	02.2007→	 7.02604.92.0	LS	750 mm	

K
SORENTO II (XM) **29**

2.0 CRDi 100-137 kW (136-186 PS) D4HA	11.2009→12.2015	 7.09002.12.0	AGR	EL	 →05.2015
2.0 CRDi 100-137 kW (136-186 PS) D4HA	11.2010→	 7.09002.12.0	AGR	EL	 →05.2015
2.0 CRDi 4WD 100-137 kW (136-186 PS) D4HA	11.2009→12.2015	 7.09002.12.0	AGR	EL	 →05.2015
2.0 CRDi 4WD 100-137 kW (136-186 PS) D4HA	11.2010→	 7.09002.12.0	AGR	EL	 →05.2015
2.2 CRDi 110-149 kW (150-203 PS) D4HB	11.2009→	 7.09002.12.0	AGR	EL	 →05.2015
2.2 CRDi 110-149 kW (150-203 PS) D4HB	11.2009→12.2015	 7.09002.12.0	AGR	EL	 →05.2015
2.2 CRDi 4WD 110-149 kW (150-203 PS) D4HB	11.2009→	 7.09002.12.0	AGR	EL	 →05.2015
2.2 CRDi 4WD 110-149 kW (150-203 PS) D4HB	11.2009→12.2015	 7.09002.12.0	AGR	EL	 →05.2015



SOUL I (AM) 30









1.6 CRDi 115 66-100 kW (90-136 PS) D4FB	02.2009→		7.09002.08.0	AGR	ET	<input type="radio"/>	→10.2013 Euro 4 (D4) Euro 4 (D4)	
			7.11237.07.0	AGR	EL	<input type="radio"/>		
			7.05052.00.0 7.02604.99.0	AGR-K LS				→06.2011 Euro 5 Euro 5 12.2010→09.2013
1.6 CRDi 128 66-100 kW (90-136 PS) D4FB	02.2009→		7.09002.08.0	AGR	ET	<input type="radio"/>	→10.2013 Euro 4 (D4) Euro 4 (D4) 12.2010→09.2013	
			7.05052.00.0 7.02604.99.0	AGR-K LS				
								400 mm

SOUL II (PS) 31

1.6 CRDi 128 66-100 kW (90-136 PS) D4FB	02.2014→		7.02604.99.0	LS	400 mm	
1.6 CRDi 136 66-100 kW (90-136 PS) D4FB	04.2015→		7.02604.99.0	LS	400 mm	

















K





























SPORTAGE II (JE_, KM) 32

2.0 CRDi 83-110 kW (113-150 PS) D4EA	02.2005→		7.09002.03.0	AGR	PN	<input type="radio"/>
			7.09002.05.0	AGR	ET	<input type="radio"/>
2.0 CRDi 83-110 kW (113-150 PS) D4EA	01.2006→05.2010		7.09002.03.0	AGR	PN	<input type="radio"/>
			7.09002.05.0	AGR	ET	<input type="radio"/>
2.0 CRDi 83-110 kW (113-150 PS) D4EA	01.2006→		7.09002.03.0	AGR	PN	<input type="radio"/>
			7.09002.05.0	AGR	ET	<input type="radio"/>
2.0 CRDi 83-110 kW (113-150 PS) D4EA	09.2007→		7.09002.03.0	AGR	PN	<input type="radio"/>
			7.09002.05.0	AGR	ET	<input type="radio"/>
2.0 CRDi 100-137 kW (136-186 PS) D4HA	01.2009→05.2010		7.09002.03.0	AGR	PN	<input type="radio"/>
2.0 CRDi 4WD 83-110 kW (113-150 PS) D4EA	09.2004→		7.09002.03.0	AGR	PN	<input type="radio"/>
			7.09002.05.0	AGR	ET	<input type="radio"/>
2.0 CRDi 4WD 83-110 kW (113-150 PS) D4EA	01.2006→		7.09002.03.0	AGR	PN	<input type="radio"/>
			7.09002.05.0	AGR	ET	<input type="radio"/>
2.0 CRDi 4WD 83-110 kW (113-150 PS) D4EA	01.2006→05.2010		7.09002.03.0	AGR	PN	<input type="radio"/>
			7.09002.05.0	AGR	ET	<input type="radio"/>

SPORTAGE II (JE_, KM)						32
2.0 CRDi 4WD 83-110 kW (113-150 PS) D4EA	09.2008→05.2010		7.09002.03.0	AGR	PN	
			7.09002.05.0	AGR	ET	
SPORTAGE III (SL)						33
1.7 CRDi 85-104 kW (116-141 PS) D4FD	12.2010→		7.02604.99.0	LS	400 mm	
2.0 CRDi 100-137 kW (136-186 PS) D4HA	07.2010→		7.09002.12.0	AGR	EL →11.2015	
2.0 CRDi 100-137 kW (136-186 PS) D4HA	08.2010→		7.09002.12.0	AGR	EL →11.2015	
2.0 CRDi 100-137 kW (136-186 PS) D4HA	08.2012→		7.09002.12.0	AGR	EL →11.2015	
2.0 CRDi AWD 100-137 kW (136-186 PS) D4HA	07.2010→		7.09002.12.0	AGR	EL →11.2015	
2.0 CRDi AWD 100-137 kW (136-186 PS) D4HA	08.2010→		7.09002.12.0	AGR	EL →11.2015	
2.0 CRDi AWD 100-137 kW (136-186 PS) D4HA	08.2012→		7.09002.12.0	AGR	EL →11.2015	
SPORTAGE SUV (K00)						34
2.0 i 4WD 70-85 kW (95-116 PS) FE (8V)	04.1994→08.1999		7.02604.03.0	LS	200 mm	
VENGA (YN)						35
1.4 CRDi 75 55-66 kW (75-90 PS) D4FC	02.2010→		7.09002.08.0	AGR	ET →07.2014 Euro 4 (D4) Euro 4 (D4)	
			7.11237.07.0	AGR	EL →06.2011	
			7.05052.00.0	AGR-K	04.2011→05.2018	
1.4 CRDi 75 55-66 kW (75-90 PS) D4FC	02.2010→		7.09002.08.0	AGR	ET →07.2014 Euro 4 (D4) Euro 4 (D4)	
			7.11237.07.0	AGR	EL →06.2011 Euro 5 Euro 5	
			7.05052.00.0	AGR-K	04.2011→05.2018	
1.4 CRDi 90 55-66 kW (75-90 PS) D4FC	02.2010→		7.09002.08.0	AGR	ET →07.2014 Euro 4 (D4) Euro 4 (D4)	
			7.11237.07.0	AGR	EL →06.2011 Euro 5 Euro 5	
			7.05052.00.0	AGR-K	04.2011→05.2018	
1.6 CRDi 115 66-100 kW (90-136 PS) D4FB	02.2010→		7.11237.07.0	AGR	EL →06.2011 Euro 5 Euro 5	
			7.05052.00.0	AGR-K	04.2011→05.2018	
			7.02604.99.0	LS	400 mm	

K













					
VENGA (YN) 35					
1.6 CRDi 128 66-100 kW (90-136 PS) D4FB	02.2010→		7.11237.07.0 7.05052.00.0 7.02604.99.0	AGR AGR-K LS	EL →06.2011 Euro 5 Euro 5 04.2011→05.2018 400 mm
CEE'D Combi Van (JD) 36					
1.6 CRDi 66-100 kW (90-136 PS) D4FB	07.2012→		7.09002.08.0	AGR	ET →07.2015 Euro 4 (D4) Euro 4 (D4)
PRO CEE'D Hatchback Van (JD) 37					
1.6 CRDi 66-100 kW (90-136 PS) D4FB	10.2012→		7.09002.08.0	AGR	ET →07.2015 Euro 4 (D4) Euro 4 (D4)
SORENTO I VAN (JC) 38					
2.5 CRDi 4WD 95-131 kW (129-178 PS) D4CB	08.2005→10.2006		7.09002.11.0	AGR	ET
K SORENTO II SUV Van (XM) 39					
CRDi 110-149 kW (150-203 PS) D4HB	11.2009→12.2015		7.09002.12.0	AGR	EL →05.2015
CRDi 4WD 110-149 kW (150-203 PS) D4HB	11.2009→12.2015		7.09002.12.0	AGR	EL →05.2015
SPORTAGE II VAN (KM_) 40					
2.0 CRDi 83-110 kW (113-150 PS) D4EA	09.2008→05.2010		7.09002.05.0	AGR	ET
2.0 CRDi 4WD 83-110 kW (113-150 PS) D4EA	09.2008→05.2010		7.09002.05.0	AGR	ET
VENGA Hatchback Van (YN) 41					
CRDi 55-66 kW (75-90 PS) D4FC	04.2015→		7.05052.00.0	AGR-K	→05.2018
CRDi 55-66 kW (75-90 PS) D4FC	04.2015→		7.05052.00.0	AGR-K	→05.2018

						
AVENTADOR Coupe						1
6.5 LP 700-4 AWD 515 kW (700 PS) L539C	03.2011→		7.06714.24.0	ARV	PN	
6.5 LP 720-4 AWD 530-602 kW (740-818 PS) L 539	04.2013→		7.06714.24.0	ARV	PN	
6.5 LP 750-4 AWD 530-602 kW (740-818 PS) L 539	04.2015→		7.06714.24.0	ARV	PN	
AVENTADOR Targa						2
6.5 LP 700-4 AWD 515 kW (700 PS) L539C	04.2013→		7.06714.24.0	ARV	PN	
GALLARDO						3
5.0 Superleggera 375-390 kW (510-530 PS) L510R	03.2007→12.2009		7.22769.80.0	ARV	PN	
5.2 AWD 405-419 kW (551-570 PS) CEH	03.2010→		7.06714.24.0	ARV	PN	
5.2 LP 550-2 405-419 kW (551-570 PS) CEH	09.2009→09.2014		7.06714.24.0	ARV	PN	
5.2 LP560-4 412 kW (560 PS) CMPA	06.2008→		7.06714.24.0	ARV	PN	
GALLARDO SPYDER						4
5.0 375-390 kW (510-530 PS) L510R	08.2005→		7.22769.80.0	ARV	PN	
5.0 AWD	09.2005→12.2009		7.22769.80.0	ARV	PN	
5.2 405-419 kW (551-570 PS) CEH	09.2011→		7.06714.24.0	ARV	PN	
5.2 LP560-4 412 kW (560 PS) CMPA	11.2008→		7.06714.24.0	ARV	PN	
HURACÁN						5
5.2 LP 580-2 386-470 kW (525-639 PS) BUJ						



L









DEDRA (835_) **1**





















1.6 16V (835EI) 76 kW (103 PS) 182 A4.000	01.1996→07.1999		7.02604.51.0	LS	630 mm
1.6 LE Cat (835EB) 66 kW (90 PS) 159 B9.000	07.1994→07.1999		7.02604.04.0	LS	200 mm
1.6 i.e. (835AA) 65-66 kW (88-90 PS) 835 A1.000	08.1989→06.1994		7.02604.04.0	LS	200 mm
1.6 i.e. (835AB) 57 kW (77 PS) 835 A1.046	08.1989→03.1993		7.02604.04.0	LS	200 mm
1.6 i.e. (835AN) 55 kW (75 PS) 835 C1.000	04.1993→07.1999		7.02604.04.0	LS	200 mm
1.8 i.e. (835AC, 835BC) 80 kW (108 PS) 835 A2.000	09.1989→06.1994		7.02604.03.0	LS	200 mm
1.8 i.e. (835AT) 66 kW (90 PS) 835 C5.000	08.1993→07.1999		7.02604.03.0	LS	200 mm
1.8 i.e. (835BD, 835AD) 74-77 kW (101-105 PS) 835 A2.046	09.1989→07.1999		7.02604.03.0	LS	200 mm
1.8 i.e. (835FA) 74 kW (101 PS) 836 A5.000	07.1994→07.1999		7.02604.03.0	LS	200 mm
2.0 HF Integrale (835AP) 124 kW (169 PS) 835 A7.046	11.1990→07.1994		7.02604.03.0	LS	200 mm
2.0 Turbo (835AQ) 130-132 kW (177-180 PS) 835 A8.000	11.1990→06.1994		7.02604.03.0	LS	200 mm
2.0 i.e. Turbo (835AR) 119 kW (162 PS) 835 A8.046	04.1991→07.1999		7.02604.03.0	LS	200 mm
2.0 i.e. Turbo Integrale (835AO) 121 kW (165 PS) 835 A7.000	04.1990→08.1991		7.02604.03.0	LS	200 mm

DEDRA SW (835_) **2**

1.6 (835EB) 66 kW (90 PS) 159 B9.000	10.1994→07.1999		7.02604.04.0	LS	200 mm
1.6 16V (835EI) 76 kW (103 PS) 182 A4.000	01.1996→07.1999		7.02604.51.0	LS	630 mm
1.8 i.e. (835FA) 74 kW (101 PS) 836 A5.000	07.1994→07.1999		7.02604.03.0	LS	200 mm

DELTA I (831_) **3**





1.6 GT i.e. (831AB.010) 66 kW (90 PS) 149 C2.000	05.1987→08.1992		7.02604.04.0	LS	200 mm
1.6 GT i.e. (831AB.016) 80 kW (109 PS) 831 B7.000	08.1986→08.1988		7.02604.04.0	LS	200 mm
1.6 HF Turbo	08.1986→05.1993		7.02604.03.0	LS	200 mm
1.6 HF Turbo (831AB.0) 96 kW (130 PS) 831 A7.000	10.1983→12.1986		7.02604.03.0	LS	200 mm
1.6 HF Turbo (831AB.020) 103 kW (140 PS) 831 B3.000	08.1986→08.1988		7.02604.03.0	LS	200 mm
1.6 HF Turbo (831AB.020S) 97 kW (132 PS) 831 B7.046	04.1987→03.1989		7.02604.03.0	LS	200 mm

						
DELTA I (831_)						3
2.0 16V HF Evo Integrale (831AB.027) 151-158 kW (205-215 PS) 831 E5.000, 831 E5.046	06.1993→01.1994		7.02604.03.0	LS	200 mm	
2.0 16V HF Integrale (831AB.026) 144 kW (196 PS) 831 D5.000	03.1989→09.1991		7.02604.03.0	LS	200 mm	
DELTA II (836_)						4
1.6 i.e. (836AD) 55 kW (75 PS) 835 C1.000	06.1993→08.1999		7.02604.04.0	LS	200 mm	
1.6 i.e. (836AP) 66 kW (90 PS) 182 A6.000	03.1996→08.1999		7.02604.51.0	LS	630 mm	
1.6 i.e. 16V (836AO) 76 kW (103 PS) 182 A4.000	01.1996→08.1999		7.02604.51.0	LS	630 mm	
2.0 16V Turbo (836AB) 137 kW (186 PS) 836 A2.000	06.1993→08.1999		7.02604.03.0	LS	200 mm	
2.0 16V Turbo (836AS) 142 kW (193 PS) 175 A4.000	07.1996→08.1999		7.02604.03.0	LS	200 mm	
DELTA III (844_)						5
1.4 (844.AXA1A) 88 kW (120 PS) 198 A4.000	09.2008→08.2014		7.02604.55.0	LS	650 mm	
			7.02604.53.0	LS	400 mm	
1.4 (844.AXB1A) 110 kW (150 PS) 198 A1.000	09.2008→08.2014		7.02604.55.0	LS	650 mm	
			7.02604.53.0	LS	400 mm	
1.4 16V (844.AXL1A) 103 kW (140 PS) 198 A7.000	07.2010→08.2014		7.02604.55.0	LS	650 mm	
			7.02604.53.0	LS	400 mm	
1.4 Bifuel (844.AXA1A) 88 kW (120 PS) 198 A4.000	07.2011→08.2014		7.02604.55.0	LS	650 mm	
			7.02604.53.0	LS	400 mm	
1.6 D Multijet (844.AXC11, 844.AXC1A) 88 kW (120 PS) 198 A2.000	09.2008→08.2014		7.24809.77.0	AGR	ET	<input checked="" type="checkbox"/>
			7.11020.10.0	ATS	EL	ohne Zubehör without accessories
			7.11190.03.0	DDS		
7.02604.99.0	LS	400 mm				
1.6 D Multijet (844.AXF11, 844.AXF1A) 85 kW (116 PS) 955 A4.000	08.2008→08.2014		7.24809.77.0	AGR	ET	<input checked="" type="checkbox"/>
			7.11020.10.0	ATS	EL	ohne Zubehör without accessories
			7.11190.03.0	DDS		
7.02604.99.0	LS	400 mm				
1.6 D Multijet (844.AXP1A) 77 kW (105 PS) 944 A 3.000	04.2011→08.2014		7.24809.77.0	AGR	ET	<input checked="" type="checkbox"/>
			7.11020.10.0	ATS	EL	

L





DELTA III (844_) **5**









			7.11190.03.0	DDS		ohne Zubehör without accessories
			7.02604.99.0	LS	400 mm	
1.6 D Multijet (844.AXP1A) 88 kW (120 PS) 844 A3.000	04.2011→08.2014		7.02604.99.0	LS	400 mm	
1.9 D Multijet (844.AXE1A) 140 kW (190 PS) 844 A1.000	01.2009→08.2014		7.24809.77.0	AGR	ET	☒
			7.11020.10.0	ATS	EL	2011 2011
			7.11190.03.0	DDS		ohne Zubehör without accessories
			7.02604.99.0	LS	400 mm	
2.0 D Multijet (844.AXD1A, 844.AXM1A) 121 kW (165 PS) 198 A5.000	09.2008→08.2014		7.24809.77.0	AGR	ET	☒
			7.11020.10.0	ATS	EL	
			7.11190.03.0	DDS		ohne Zubehör without accessories
			7.02604.44.0	LS	500 mm	
			7.02604.99.0	LS	400 mm	Motorcode: 198 A5000 Engine Code: 198 A5000 Produktionsdatum ab: 09.2008 Production date from: 09.2008 Produktionsdatum bis: 08.2014 Production date to: 08.2014
2.0 D Multijet (844.AXD1A, 844.AXM1A) 121 kW (165 PS) 198 A8.000	09.2008→08.2014		7.24809.77.0	AGR	ET	☒
			7.11020.10.0	ATS	EL	
			7.11190.03.0	DDS		ohne Zubehör without accessories
			7.02604.44.0	LS	500 mm	
2.0 D Multijet (844.AXG1A, 844.AXN1A) 120 kW (163 PS) 844 A2.000	09.2008→08.2014		7.24809.77.0	AGR	ET	☒
			7.11020.10.0	ATS	EL	
			7.11190.03.0	DDS		ohne Zubehör without accessories
			7.02604.44.0	LS	500 mm	vor Katalysator in front of the catalyst
			7.02604.99.0	LS	400 mm	2011 2011

FLAVIA Convertible (JS_) **6**

2.4 (JK, JS) 125-129 kW (170-175 PS) EDG	03.2012→12.2014		7.28247.13.0	SLP	EL	Getriebetyp: DFF, DG2 Transmission Type: DFF, DG2
---	-----------------	---	---------------------	-----	----	--

KAPPA (838_) **7**











2.0 16V Turbo (838AB1AA) 151 kW (205 PS) 838 A4.000	02.1995→10.2001		7.02604.04.0	LS	200 mm	
2.0 20V (838AA1AA) 107 kW (146 PS) 838 A1.000	10.1994→10.2001		7.02604.04.0	LS	200 mm	

						
KAPPA (838_)						7
2.0 20V (838AG1AA, 838AG11A) 114 kW (155 PS) 838 A6.000	07.1996→10.2001		7.02604.55.0	LS	650 mm	Vett No. 2087519→ Regelsonde Regulating Probe
			7.02604.04.0	LS	200 mm	
2.4 20V (838AC1AA, 838AC11A) 129 kW (175 PS) 838 A2.000, 838 A2.027	08.1994→10.2001		7.02604.54.0	LS	980 mm	
3.0 24V (838AD1AA, 838AD11A, 838XD1AA, 838ZD1AA) 150 kW (204 PS) 838 B.000	10.1994→10.2001		7.02604.04.0	LS	200 mm	
			7.02604.56.0	LS	1190 mm	
KAPPA Coupe (838_)						8
2.0 16V Turbo (838CB) 151 kW (205 PS) 838 A4.000	11.1996→03.2001		7.02604.04.0	LS	200 mm	
2.4 20V (838CC) 129 kW (175 PS) 838 A2.000	11.1996→03.2001		7.02604.54.0	LS	980 mm	
3.0 24V (838CD, 838CD11A) 150 kW (204 PS) 838 B.000	09.1996→03.2001		7.02604.04.0	LS	200 mm	
			7.02604.56.0	LS	1190 mm	
KAPPA SW (838_)						9
2.0 16V Turbo (838BB1AA) 151 kW (205 PS) 838 A4.000	07.1996→10.2001		7.02604.04.0	LS	200 mm	
2.0 20V (838BG1AA) 114 kW (155 PS) 838 A6.000	07.1996→10.2001		7.02604.55.0	LS	650 mm	Vett No. 2087519→ Regelsonde Regulating Probe
			7.02604.04.0	LS	200 mm	
2.4 20V (838BC1AA, 838BC11A) 129 kW (175 PS) 838 A2.000	07.1996→10.2001		7.02604.54.0	LS	980 mm	
3.0 24V (838BD11A) 150 kW (204 PS) 838 B.000	07.1996→10.2001		7.02604.04.0	LS	200 mm	
			7.02604.56.0	LS	1190 mm	
LYBRA (839_)						10
1.6 76 kW (103 PS) 182 B6.000	10.2000→10.2005		7.02604.51.0	LS	630 mm	
			7.02604.47.0	LS	300 mm	
1.6 16V (839AXA1A) 76 kW (103 PS) 182 A4.000	07.1999→10.2005		7.02604.51.0	LS	630 mm	
			7.02604.47.0	LS	300 mm	
1.8 16V (839AXB1A, 839AXG1A) 96 kW (131 PS) 839 A4.000, 839 A7.000, 839 A9.000	07.1999→10.2005		7.02604.51.0	LS	630 mm	
			7.02604.47.0	LS	300 mm	

L



LYBRA (839_) 10

1.9 JTD (839.AXI1A, 839.AXN1A, 839.CXL1A) 85 kW (116 PS) 937 A2.000	05.2001→10.2005		7.22946.34.0	AGR	EL	
1.9 JTD (839.AXI1A) 80-85 kW (109-116 PS) AR 37101	09.2000→05.2001		7.22946.34.0	AGR	EL	
2.0 20V (839.AXC11, 839.AXC1A) 113 kW (154 PS) 182 B7.000	07.1999→09.2000		7.02604.55.0	LS	650 mm	
			7.02604.53.0	LS	400 mm	
2.0 20V (839.AXH1A) 110 kW (150 PS) 185 A8.000	09.2000→10.2005		7.02604.55.0	LS	650 mm	
			7.02604.53.0	LS	400 mm	
2.4 JTD (839.AXE1A) 110 kW (150 PS) 841 C.000	05.2002→10.2005		7.22946.34.0	AGR	EL	
2.4 JTD (839.AXL1A) 103 kW (140 PS) 839 A6.000	09.2000→05.2002		7.22946.34.0	AGR	EL	





















LYBRA SW (839_) 11

L

1.6 (839.BXF1A) 76 kW (103 PS) 182 B6.000	10.2000→10.2005		7.02604.51.0	LS	630 mm	
			7.02604.47.0	LS	300 mm	
1.6 16V (839.BXA1A) 76 kW (103 PS) 182 A4.000	07.1999→10.2005		7.02604.51.0	LS	630 mm	
			7.02604.47.0	LS	300 mm	
1.8 16V (839.BXB1A, 839.BXG1A) 96 kW (131 PS) 839 A4.000, 839 A7.000	07.1999→10.2005		7.02604.51.0	LS	630 mm	
			7.02604.47.0	LS	300 mm	
1.9 JTD (839.BXI1A, 839.BXN1A, 839.CXL1A) 85 kW (116 PS) 937 A2.000	05.2001→10.2005		7.22946.34.0	AGR	EL	
1.9 JTD (839.BXI1A) 80-85 kW (109-116 PS) AR 37101	09.2000→05.2001		7.22946.34.0	AGR	EL	
2.0 20V (839.BXC11, 839.BXC1A) 113 kW (154 PS) 182 B7.000	07.1999→09.2000		7.02604.55.0	LS	650 mm	
			7.02604.53.0	LS	400 mm	
2.0 20V (839.BXH1A) 110 kW (150 PS) 185 A8.000	09.2000→10.2005		7.02604.55.0	LS	650 mm	
			7.02604.53.0	LS	400 mm	
2.4 JTD (839.BXE1A) 110 kW (150 PS) 841 C.000	05.2002→10.2005		7.22946.34.0	AGR	EL	
2.4 JTD (839.BXL1A) 103 kW (140 PS) 839 A6.000	09.2000→10.2005		7.22946.34.0	AGR	EL	







MUSA (350_) 12

1.3 D Multijet (350.AXB11, 350.AXB1A) 51 kW (70 PS) 188 A9.000	10.2004→09.2012	 7.00020.24.0	AGR	EL	 →1359910
		7.00020.39.0	AGR	EL	 1359911→ Euro 4 (D4) Euro 4 (D4)
		7.01599.10.0	AGR	EL	
		7.11190.03.0	DDS		ohne Zubehör without accessories Euro 5 Euro 5
1.3 D Multijet (350.AXG11, 350.AXG1A) 66-77 kW (90-105 PS) 199 A3.000	09.2006→09.2012	 7.00020.25.0	AGR	EL	 →1331880
		7.00020.40.0	AGR	EL	 1331881→
		7.01599.10.0	AGR	EL	
		7.11190.03.0	DDS		ohne Zubehör without accessories Euro 5 Euro 5 Euro 4 Euro 4
1.3 D Multijet (350.AXM11, 350.AXM1A, 350.AX11A) 57-70 kW (77-95 PS) 199 B1.000	03.2009→09.2012	 7.01599.10.0	AGR	EL	
		7.03622.06.0 7.11190.03.0	AGR-K DDS		 ohne Zubehör without accessories Euro 5 Euro 5
1.4 (350.AXA11, 350.AXA1A) 70 kW (95 PS) 843 A 1.000	10.2004→09.2012	 7.02604.53.0	LS	400 mm	
1.4 (350.AXF1A) 55-57 kW (75-78 PS) 350 A1.000	09.2005→09.2012	 7.02604.53.0	LS	400 mm	
1.4 LPG (350.AXF1A) 55-57 kW (75-78 PS) 350 A1.000	11.2010→09.2012	 7.02604.53.0	LS	400 mm	
1.6 D Multijet (350.AXH1A) 85-88 kW (116-120 PS) 350 A2.000	07.2008→09.2012	 7.24809.77.0	AGR	ET	
		7.11190.03.0	DDS		ohne Zubehör without accessories
		7.02604.44.0	LS	500 mm	vor Katalysator in front of the catalyst
1.6 D Multijet (350.AXL1A, 350.AXH1A) 85-88 kW (116-120 PS) 350 A2.000, 350 A3.000	07.2008→09.2012	 7.24809.77.0	AGR	ET	
		7.11190.03.0	DDS		ohne Zubehör without accessories
		7.02604.44.0	LS	500 mm	
1.9 D Multijet (350.AXC1A) 74 kW (101 PS) 188 B2.000	10.2004→09.2012	 7.22946.33.0	AGR	EL	 →09.2007  6147321→ für Hersteller-Abgasnorm: CF3 for manufacturer exhaust norm: CF3











L



MUSA (350_) **12**

		7.22946.34.0	AGR	EL	  188 B2.000: →09.2009 nicht für Hersteller-Abgasnorm: CF3 not for manufacturer emission norm: CF3  188 B2.000: →09.2007  6147321→ für Hersteller-Abgasnorm: CF3 for manufacturer exhaust norm: CF3
		7.02604.99.0	LS	400 mm	

PHEDRA (179_) **13**

2.0 D Multijet (179.AXL1B, 179.BXL1B) 100 kW (136 PS) RHR (DW10BTED4)	07.2006→11.2010	 7.24809.68.0	AGR	EL	
		7.11492.01.0	DDS		ohne Zubehör without accessories
2.0 JTD (179AXB1A) 80-81 kW (109-110 PS) RHW (DW10ATED4)	09.2002→11.2010	 7.28069.03.0	AGR	PN	 für Fahrzeuge ohne Diesel-Partikel-Filter (DPF) for vehicles without diesel soot filter
		7.11492.01.0	DDS		ohne Zubehör without accessories Euro 4 Euro 4
2.2 D Multijet (179.AXM1B, 179.AXP11, 179.BXM1B,...) 125 kW (170 PS) 4HS	03.2008→11.2010	 7.11492.01.0	DDS		ohne Zubehör without accessories Euro 4 Euro 4
		7.00578.12.0	AGR	EL	 Euro 4 Euro 4
2.2 D Multijet (179.AXM1B, 179.AXP11, 179.BXM1B,...) 125 kW (170 PS) 4HT	03.2008→11.2010	 7.11492.01.0	DDS		ohne Zubehör without accessories Euro 4 Euro 4
		7.11492.01.0	DDS		ohne Zubehör without accessories Euro 4 Euro 4
2.2 JTD (179.AXN1B, 179.AXQ11, 179.BXN1B, 179.BXQ11) 120 kW (163 PS) 4HP, 4HR	04.2006→11.2010	 7.11492.01.0	DDS		ohne Zubehör without accessories  4HP, 4HR: Euro 4 Euro 4
		7.11492.01.0	DDS		ohne Zubehör without accessories Euro 4 Euro 4
2.2 JTD (179AXC1A) 94 kW (128 PS) 4HW (DW12ATED4)	09.2002→11.2010	 7.11492.01.0	DDS		ohne Zubehör without accessories Euro 4 Euro 4

PRISMA (831_) **14**

1.6 i.e. (831AB) 80 kW (109 PS) 831 B7.000	05.1986→12.1989	 7.02604.01.0	LS	200 mm	
1.6 i.e. Super (831AB) 66 kW (90 PS) 149 C2.000	05.1987→12.1989	 7.02604.01.0	LS	200 mm	
2.0 i.e. All-wheel Drive (831AB) 85 kW (115 PS) 831 B4.000	04.1986→12.1989	 7.02604.03.0	LS	200 mm	

THEMA (834_) **15**

2000 16V (834FA) 110-112 kW (150-152 PS) 834 F1.000	08.1992→12.1993	 7.02604.04.0	LS	200 mm	
2000 16V Turbo (834AC) 133 kW (181 PS) 834 C1.000	12.1988→06.1990	 7.02604.03.0	LS	200 mm	
2000 16V Turbo (834GC, 834FC) 148 kW (202 PS) 834 F2.000	10.1992→07.1994	 7.02604.03.0	LS	200 mm	
2000 i.e (834AB) 86 kW (117 PS) 834 B1.000	09.1988→05.1992	 7.02604.03.0	LS	200 mm	









THEMA (834_)						15
2000 i.e. (834AB) 83-85 kW (112-113 PS) 834 B.048	03.1986→09.1988		7.02604.03.0	LS	200 mm	
2000 i.e. (834B) 88 kW (120 PS) 834 B.000	11.1984→09.1988		7.02604.03.0	LS	200 mm	
2000 i.e. (834BV) 85 kW (116 PS) 834 B.146	09.1987→05.1992		7.02604.03.0	LS	200 mm	
2000 i.e. 16V (834AA) 108 kW (147 PS) 834 B2.000	05.1988→08.1992		7.02604.04.0	LS	200 mm	
2000 i.e. 16V (834AI) 104 kW (141 PS) 834 B2.246	02.1989→05.1992		7.02604.04.0	LS	200 mm	
2000 i.e. 16V Turbo (834AL) 130 kW (177 PS) 834 C1.246	04.1989→05.1992		7.02604.03.0	LS	200 mm	
3000 V6 (834GD, 834FD) 126 kW (171 PS) 834 F.000	08.1992→07.1994		7.02604.04.0	LS	200 mm	
THEMA (LX_)						16
3.0 D (48, LX) 140-176 kW (190-239 PS) EXF	09.2011→10.2014		7.24809.80.0	AGR	ET	<input checked="" type="checkbox"/>
3.0 D (LX, 48) 140-176 kW (190-239 PS) EXF	09.2011→10.2014		7.24809.80.0	AGR	ET	<input checked="" type="checkbox"/>
THEMA SW (834_)						17
2000 16V (834FA) 110-112 kW (150-152 PS) 834 F1.000	05.1992→07.1994		7.02604.04.0	LS	200 mm	
2000 Turbo 16V (834GC, 834FC) 148 kW (202 PS) 834 F2.000	11.1992→07.1994		7.02604.03.0	LS	200 mm	
2000 i.e. 16V (834AA) 108 kW (147 PS) 834 B2.000	05.1989→08.1992		7.02604.04.0	LS	200 mm	
2000 i.e. 16V (834AI) 104 kW (141 PS) 834 B2.246	02.1989→05.1992		7.02604.04.0	LS	200 mm	
2000 i.e. 16V Turbo (834AC) 133 kW (181 PS) 834 C1.000	12.1988→06.1990		7.02604.03.0	LS	200 mm	
2000 i.e. 16V Turbo (834AL) 130 kW (177 PS) 834 C1.246	04.1989→03.1993		7.02604.03.0	LS	200 mm	
3000 V6 (834GD, 834FD) 126 kW (171 PS) 834 F.000	09.1992→07.1994		7.02604.04.0	LS	200 mm	
THESIS (841_)						18
2.0 Turbo (841AXA1B03) 136 kW (185 PS) 841 E.000	07.2002→07.2009		7.02604.53.0	LS	400 mm	
2.4 (841AXB1B00) 125 kW (170 PS) 841 D.000	07.2002→07.2009		7.02604.53.0	LS	400 mm	
2.4 D Multijet (841.AXN111, 841.AXH110) 136 kW (185 PS) 841 P.000	04.2006→07.2009		7.22946.34.0	AGR	EL	<input type="checkbox"/>







L







THESIS (841_) **18**

2.4 JTD (841.AXE1B0, 841.AXH110) 129 kW (175 PS) 841 G.000	05.2003→07.2009	 7.00063.10.0	AGR	EL	
		7.11190.04.0	DDS		Euro 4 Euro 4
2.4 JTD (841.AXE1B0, 841.AXH110) 120-147 kW (163-200 PS) 841 M.000, 841 N.000	09.2003→07.2009	 7.00063.10.0	AGR	EL	
2.4 JTD (841AXD1B02) 110 kW (150 PS) 841 C.000	07.2002→07.2009	 7.22946.34.0	AGR	EL	
3.0 V6 (841AXC1101) 158 kW (215 PS) 841 A.000	07.2002→07.2009	 7.02604.53.0	LS	400 mm	





VOYAGER MPV (404_) **19**

























2.8 CRD (RT, 53) 120-131 kW (163-178 PS) ENS	09.2011→12.2014	 7.03295.03.0	AGR	EL	
2.8 CRD (RT, 53) 120-131 kW (163-178 PS) ENS	07.2012→12.2014	 7.03295.03.0	AGR	EL	
2.8 CRD (RT, 53) 120-131 kW (163-178 PS) ENS	08.2013→12.2014	 7.03295.03.0	AGR	EL	

Y (840_) **20**

1.2 (840AA, 840AF1A) 44 kW (60 PS) 188 A4.000, 840 A3.000	03.1996→09.2003	 7.02604.53.0	LS	400 mm	
1.2 16V (840AD) 63 kW (86 PS) 176 B9.000	04.1997→09.2003	 7.02604.53.0	LS	400 mm	01.2000→ Diagnosesonde Diagnostic Probe
		7.02604.47.0	LS	300 mm	Regelsonde Regulating Probe
		7.02604.04.0	LS	200 mm	
1.2 16V (840AG1A) 59 kW (80 PS) 188 A5.000	10.2000→09.2003	 7.02604.53.0	LS	400 mm	
1.4 12V (840AB) 55-59 kW (75-80 PS) 840 A2.000	10.1996→09.2003	 7.02604.04.0	LS	200 mm	
1.4 12V (840AC) 55 kW (75 PS) 840 A4.000	03.1996→09.2003	 7.02604.04.0	LS	200 mm	

Y10 (156_) **21**



1.0 (156C) 40-41 kW (54-56 PS) 156 A.000	03.1985→07.1989	 7.02604.03.0	LS	200 mm	
1.0 Fire (156AA) 33-37 kW (45-50 PS) 156 A2.000	03.1985→06.1989	 7.02604.03.0	LS	200 mm	
1.0 Fire (156AA, 156AD) 33-37 kW (45-50 PS) 156 A2.000	03.1985→02.1990	 7.02604.03.0	LS	200 mm	
1.0 Fire (156B, 156AD) 32 kW (44 PS) 156 A2.100	06.1985→06.1991	 7.02604.03.0	LS	200 mm	
1.0 Fire All-wheel Drive (156.AD) 32 kW (44 PS) 156 A2.100	12.1986→02.1989	 7.02604.03.0	LS	200 mm	

						
Y10 (156_)						21
1.0 Fire All-wheel Drive (156AA) 33-37 kW (45-50 PS) 156 A2.000	12.1987→02.1990		7.02604.03.0	LS	200 mm	
1.3 i.e. (156AB) 53-56 kW (72-76 PS) 156 B.000	11.1987→05.1993		7.02604.03.0	LS	200 mm	
1.3 i.e. (156AF) 53-56 kW (72-76 PS) 146 A 5.046, 156 B.000	02.1989→12.1995		7.02604.03.0	LS	200 mm	
YPSILON (312_)						22
1.3 D Multijet (312.YXE1A, 312.YXU1A) 57-70 kW (77-95 PS) 199 B1.000, 312 B1.000	05.2011→		7.01599.10.0	AGR	EL 	
			7.03622.10.0	AGR-K	EL 	
			7.11020.37.0	ATS	EL 	
			7.11190.03.0	DDS	199 B1.000, 312 B1.000: Euro 5 Euro 5 ohne Zubehör without accessories	
YPSILON (843_)						23
1.2 (843.AXA1A) 44 kW (60 PS) 188 A4.000	10.2003→12.2011		7.02604.53.0	LS	400 mm	
1.2 (843.AXB1A) 59 kW (80 PS) 188 A5.000	10.2003→12.2011		7.02604.53.0	LS	400 mm	
1.2 (843.AXL1A) 49-51 kW (67-69 PS) 169 A4.000	08.2010→12.2011		7.02604.53.0	LS	400 mm	
1.3 D Multijet (843.AXE11, 843.AXE1A) 66-77 kW (90-105 PS) 199 A3.000	09.2006→12.2011		7.00020.25.0	AGR	EL 	
			7.11190.03.0	DDS	ohne Zubehör without accessories Euro 5 Euro 5	
			7.11190.04.0	DDS	Euro 4 Euro 4	
1.3 D Multijet (843.AXF11, 843.AXF1A, 843.AXM11,...) 55 kW (75 PS) 199 A2.000	09.2006→12.2011		7.00020.24.0	AGR	EL 	
			7.01599.10.0	AGR	EL 	
			7.11190.03.0	DDS	ohne Zubehör without accessories Euro 5 Euro 5	
7.11190.04.0	DDS	Euro 4 Euro 4				
1.3 D Multijet (843.AXH1A, 843.AXE1A) 66-77 kW (90-105 PS) 199 A3.000	05.2007→12.2011		7.00020.25.0	AGR	EL 	
			7.11190.03.0	DDS	ohne Zubehör without accessories Euro 5 Euro 5	
1.3 JTD (843.AXD11, 843.AXD1A) 51 kW (70 PS) 188 A9.000	10.2003→12.2011		7.00020.24.0	AGR	EL 	







L



YPSILON (843_) **23**

		7.11190.03.0	DDS		ohne Zubehör without accessories Euro 5 Euro 5
1.4 (843.AXG1A) 55-57 kW (75-78 PS) 350 A1.000	02.2006→12.2011	 7.02604.53.0	LS	400 mm	
1.4 16V (843.AXC11, 843.AXC1B, 843.AXC1A) 70 kW (95 PS) 843 A 1.000	10.2003→12.2011	 7.02604.53.0	LS	400 mm	
1.4 LPG (843.AXG1A) 55-57 kW (75-78 PS) 350 A1.000	11.2010→12.2011	 7.02604.53.0	LS	400 mm	

ZETA (22_) **24**

2.0 16V (220AL5) 97 kW (132 PS) RFV (XU10J4R)	05.1998→07.2000	 7.05270.37.0	LS	1640 mm	
2.0 16V (220AQ5, 220AQ4) 100 kW (136 PS) RFN	07.2000→09.2002	 7.05270.37.0	LS	1640 mm	
2.0 JTD (220.AR5, 220.AN5) 80 kW (109 PS) RHZ (DW10ATED)	09.1999→09.2002	 7.22843.06.0	AGR	PN	
2.0 JTD 16V (220.AR5OOL) 80-81 kW (109-110 PS) RHW (DW10ATED4)	04.2001→10.2003	 7.28069.03.0	AGR	PN	 für Fahrzeuge ohne Diesel-Partikel-Filter (DPF) for vehicles without diesel soot filter



L

						
DEFENDER Cabrio (L316)						1
2.2 Td4 4x4 (L317) 90-110 kW (122-150 PS) DT224	08.2011→02.2016		7.03784.34.0	AGR	EL  ch. (V)CA 000 001→	
2.4 Td4 4x4 (L317) 90 kW (122 PS) DT244	05.2007→02.2016		7.24809.70.0	AGR	EL 	
DEFENDER II						2
2.2 Td4	08.2011→		7.03784.34.0	AGR	EL 	
DEFENDER Pick Up (L316)						3
2.2 Td4 4x4 (L317) 90-110 kW (122-150 PS) DT224	08.2011→02.2016		7.03784.34.0	AGR	EL  ch. (V)CA 000 001→	
2.4 Td4 4x4 (L317) 90 kW (122 PS) DT244	05.2007→02.2016		7.24809.70.0	AGR	EL 	
DEFENDER Station Wagon (L316)						4
2.2 Td4 4x4 (L317) 90-110 kW (122-150 PS) DT224	08.2011→02.2016		7.03784.34.0	AGR	EL  ch. (V)CA 000 001→	
2.2 Td4 4x4 (L317) 90-110 kW (122-150 PS) DT224	02.2015→02.2016		7.03784.34.0	AGR	EL 	
2.4 Td4 4x4 90 kW (122 PS) DT244	07.2007→02.2016		7.24809.70.0	AGR	EL 	
2.4 Td4 4x4 (L316) 90 kW (122 PS) DT244	10.2006→02.2016		7.24809.70.0	AGR	EL 	
DEFENDER Station Wagon (L663)						5
2.0 D200 SD4 4x4 147-177 kW (200-241 PS) 204DT	09.2019→		7.04924.15.0	AGR	EL  ch. K2000001→	
2.0 D240 SD4 4x4 147-177 kW (200-241 PS) 204DT	09.2019→		7.04924.15.0	AGR	EL  ch. K2000001→	
DISCOVERY II (L318)						6
4.0 4x4 136-140 kW (185-190 PS) 56 D	11.1998→12.2002		7.22427.03.0	ARV	PN 	
4.0 V8 4x4 134-140 kW (182-190 PS) 35 D, 56 D, 94 D	11.1998→06.2004		7.22427.03.0	ARV	PN 	
4.6 4x4 165-168 kW (224-228 PS) 46 D	09.1999→12.2002		7.22427.03.0	ARV	PN 	
4.6 4x4	09.2002→12.2003		7.22427.03.0	ARV	PN 	
4.6 4x4 160 kW (218 PS) 60 D	09.2002→06.2004		7.22427.03.0	ARV	PN 	
DISCOVERY III (L319)						7
2.7 TD 4x4 140 kW (190 PS) 276DT	07.2004→09.2009		7.11237.01.0	AGR	EL  11.2004→08.2009	
			7.11237.03.0	AGR	EL  ch. 7A000001→ch. 9A999999 Euro 4 Euro 4 für Fahrzeuge mit Diesel-Partikel-Filter (DPF) for vehicles with diesel soot filter	



























L



DISCOVERY III (L319) **7**

			7.24809.95.0	AGR	EL	 ch. 7A000001→ch. 9A999999 Euro 4 Euro 4 für Fahrzeuge mit Diesel-Partikel-Filter (DPF) for vehicles with diesel soot filter
			7.24809.96.0	AGR	EL	 ch. 9A508510→ch. 9A999999 Euro2/Euro3 Euro2/Euro3

DISCOVERY IV (L319) **8**























	09.2009→12.2018		7.11237.03.0	AGR	EL	 ch. AA000001→
			7.24809.95.0	AGR	EL	 ch. AA000001→
3.0 SDV6 4x4 155-250 kW (211-340 PS) 306DT	11.2009→12.2018		7.01881.08.0*	AGR-K		 Linke Einheit Left unit  ch. AA000001→
			↳ 7.01881.06.0	AGR-M	EL	
			7.01881.09.0*	AGR-K		 Rechte Einheit Right unit  ch. AA000001→
3.0 TD 4x4 155-250 kW (211-340 PS) 306DT	09.2009→12.2018		7.01881.08.0*	AGR-K		 Linke Einheit Left unit  ch. AA000001→
			↳ 7.01881.06.0	AGR-M	EL	
			7.01881.09.0*	AGR-K		 Rechte Einheit Right unit  ch. AA000001→
3.0 TD 4x4 155-250 kW (211-340 PS) 306DT	09.2009→12.2018		7.01881.08.0*	AGR-K		 Linke Einheit Left unit  ch. AA000001→
			↳ 7.01881.06.0	AGR-M	EL	
			7.01881.09.0*	AGR-K		 Rechte Einheit Right unit  ch. AA000001→
3.0 TD 4x4 155-250 kW (211-340 PS) 306DT	05.2010→12.2018		7.01881.08.0*	AGR-K		 Linke Einheit Left unit  ch. AA000001→
			↳ 7.01881.06.0	AGR-M	EL	
			7.01881.09.0*	AGR-K		 Rechte Einheit Right unit  ch. AA000001→
3.0 TD 4x4 155-250 kW (211-340 PS) 306DT	07.2012→12.2018		7.01881.08.0*	AGR-K		 Linke Einheit Left unit  ch. AA000001→
			↳ 7.01881.06.0	AGR-M	EL	

DISCOVERY IV (L319)					
			7.01881.09.0*	AGR-K	Rechte Einheit Right unit ch. AA000001→
			↳7.01881.07.0	AGR-M	EL
DISCOVERY SPORT (L550)					
2.0 D 110-132 kW (150-180 PS) 204DTD	08.2015→		7.04923.18.0	AGR	EL mit Dichtring with O-ring ch. HH000001→
			7.04924.14.0	AGR	EL ch. KH000001→
2.0 D 4x4 110-132 kW (150-180 PS) 204DTD	12.2014→		7.04923.18.0	AGR	EL mit Dichtring with O-ring ch. HH000001→
			7.04924.14.0	AGR	EL ch. KH000001→
2.0 D 4x4 110-132 kW (150-180 PS) 204DTD	06.2015→		7.04923.18.0	AGR	EL mit Dichtring with O-ring ch. HH000001→
			7.04924.14.0	AGR	EL ch. KH000001→
2.0 D 4x4 177 kW (241 PS) 204DTA	08.2017→		7.04923.18.0	AGR	EL mit Dichtring with O-ring ch. HH000001→
			7.04924.14.0	AGR	EL ch. KH000001→
2.0 D165 110-132 kW (150-180 PS) 204DTD	07.2020→		7.04923.18.0	AGR	EL mit Dichtring with O-ring ch. HH000001→
2.2 D 4x4 110-140 kW (150-190 PS) 224DT	09.2014→		7.00578.12.0	AGR	EL ch. (V)BH 000 001→
2.2 D 4x4 110-140 kW (150-190 PS) 224DT	09.2014→		7.00578.12.0	AGR	EL ch. (V)BH 000 001→
DISCOVERY V (L462)					
2.0 Sd4 4x4 177 kW (241 PS) 204DTA	09.2016→		7.04924.15.0	AGR	EL 01.2017→, ch. K2000001→
			7.04923.17.0	AGR	EL mit Dichtring with O-ring 01.2017→
2.0 Td4 4x4 110-132 kW (150-180 PS) 204DTD	09.2016→		7.04924.15.0	AGR	EL 01.2017→, ch. K2000001→
			7.04923.17.0	AGR	EL mit Dichtring with O-ring 01.2017→
3.0 D 4x4 155-250 kW (211-340 PS) 306DT	09.2016→		7.05264.04.0*	AGR-K	01.2017→, ch. FA000001→
			↳7.05264.03.0	AGR	EL
			7.05590.04.0*	AGR-K	01.2017→, ch. FA000001→
			↳7.05590.03.0	AGR	EL
			7.01881.09.0*	AGR-K	Rechte Einheit Right unit ch. AA000001→
			↳7.01881.07.0	AGR-M	EL





L



DISCOVERY V (L462) **10**

































			7.01881.08.0*	AGR-K		 Linke Einheit Left unit  ch. AA00001→
			↳ 7.01881.06.0	AGR-M	EL	
3.0 D 4x4 155-250 kW (211-340 PS) 306DT	09.2016→		7.05264.04.0*	AGR-K		01.2017→,  ch. FA000001→
			↳ 7.05264.03.0	AGR	EL	
			7.05590.04.0*	AGR-K		01.2017→,  ch. FA000001→
			↳ 7.05590.03.0	AGR	EL	
			7.01881.09.0*	AGR-K		 Rechte Einheit Right unit  ch. AA000001→
			↳ 7.01881.07.0	AGR-M	EL	
			7.01881.08.0*	AGR-K		 Linke Einheit Left unit  ch. AA00001→
			↳ 7.01881.06.0	AGR-M	EL	
3.0 SDV6 4x4 155-250 kW (211-340 PS) 306DT	09.2018→		7.01881.09.0*	AGR-K		 Rechte Einheit Right unit  ch. AA000001→
			↳ 7.01881.07.0	AGR-M	EL	
			7.01881.08.0*	AGR-K		 Linke Einheit Left unit  ch. AA00001→
			↳ 7.01881.06.0	AGR-M	EL	
			7.05264.04.0*	AGR-K		 ch. FA000001→
			↳ 7.05264.03.0	AGR	EL	
			7.05590.04.0*	AGR-K		 ch. FA000001→
			↳ 7.05590.03.0	AGR	EL	
3.0 Td6 4x4 155-250 kW (211-340 PS) 306DT	09.2016→		7.05264.04.0*	AGR-K		01.2017→,  ch. FA000001→
			↳ 7.05264.03.0	AGR	EL	
			7.05590.04.0*	AGR-K		01.2017→,  ch. FA000001→
			↳ 7.05590.03.0	AGR	EL	
			7.01881.09.0*	AGR-K		 Rechte Einheit Right unit  ch. AA000001→
			↳ 7.01881.07.0	AGR-M	EL	
			7.01881.08.0*	AGR-K		 Linke Einheit Left unit  ch. AA00001→
			↳ 7.01881.06.0	AGR-M	EL	

FREELANDER 2 (L359) **11**





2.2 SD4 4x4 110-140 kW (150-190 PS) 224DT	08.2010→10.2014		7.00578.12.0	AGR	EL	  ch. (V)BH 000 001→
			7.11190.10.0	DDS		ohne Zubehör without accessories  →ch. AH999999 Euro 5, Euro 4 Euro 5, Euro 4



FREELANDER 2 (L359) 11



2.2 TD4 4x4 110-140 kW (150-190 PS) 224DT, DW12BTED4	10.2006→10.2014	 7.00578.12.0  7.11190.10.0	AGR DDS	EL	 224DT:  ch. (V)BH 000 001→  DW12BTED4:  →ch. (V)AH 999 999 ohne Zubehör without accessories  224DT, DW12BTED4:  →ch. AH999999 Euro 5, Euro 4 Euro 5, Euro 4
2.2 TD4 4x4 110-140 kW (150-190 PS) 224DT, DW12BTED4	10.2006→10.2014	 7.00578.12.0  7.11190.10.0	AGR DDS	EL	 224DT:  ch. (V)BH 000 001→  DW12BTED4:  →ch. (V)AH 999 999 ohne Zubehör without accessories  224DT, DW12BTED4:  →ch. AH999999 Euro 5, Euro 4 Euro 5, Euro 4
2.2 TD4 4x4 110-140 kW (150-190 PS) 224DT	10.2006→10.2014	 7.00578.12.0  7.11190.10.0	AGR DDS	EL	 ch. (V)BH 000 001→ ohne Zubehör without accessories  →ch. AH999999 Euro 5, Euro 4 Euro 5, Euro 4
2.2 TD4 4x4 110-140 kW (150-190 PS) 224DT	01.2007→10.2014	 7.00578.12.0  7.11190.10.0	AGR DDS	EL	 ch. (V)BH 000 001→ ohne Zubehör without accessories  →ch. AH999999 Euro 5, Euro 4 Euro 5, Euro 4
2.2 eD4 110-140 kW (150-190 PS) 224DT, DW12BTED4	08.2010→10.2014	 7.00578.12.0  7.11190.10.0	AGR DDS	EL	 224DT:  ch. (V)BH 000 001→  DW12BTED4:  →ch. (V)AH 999 999 ohne Zubehör without accessories  224DT, DW12BTED4:  →ch. AH999999 Euro 5, Euro 4 Euro 5, Euro 4

FREELANDER I (L314) 12

























1.8 16V 4x4 85-88 kW (116-120 PS) 18 K4F	04.1998→10.2006	 7.05271.75.0	LS	540 mm	
1.8 i 16V 4x4 85-88 kW (116-120 PS) 18 K4F	02.1998→11.2000	 7.05271.75.0	LS	540 mm	
2.0 Td4 4x4 80-82 kW (109-112 PS) M 47	11.2000→10.2006	 7.28264.06.0	AGR	PN	
2.0 Td4 4x4 80-82 kW (109-112 PS) 204D3	03.2001→10.2006	 7.28264.06.0	AGR	PN	













FREELANDER I Soft Top (L314) **13**

1.8 i 16V 4x4 85-88 kW (116-120 PS) 18 K4F	02.1998→10.2006		7.05271.75.0	LS	540 mm
2.0 TD4 4x4 80-82 kW (109-112 PS) 204D3	10.2000→10.2006		7.28264.06.0	AGR	PN



RANGE ROVER EVOQUE (L538) **14**

2.0 D 110-132 kW (150-180 PS) 204DTD	06.2015→12.2019		7.04923.18.0	AGR	EL  mit Dichtring with O-ring  ch. GH000001→
			7.04924.14.0	AGR	EL  ch. KH000001→
2.0 D 4x4 110-132 kW (150-180 PS) 204DTD	05.2015→12.2019		7.04923.18.0	AGR	EL  mit Dichtring with O-ring  ch. GH000001→
			7.04924.14.0	AGR	EL  ch. KH000001→
2.0 D 4x4 110-132 kW (150-180 PS) 204DTD	06.2015→12.2019		7.04923.18.0	AGR	EL  mit Dichtring with O-ring  ch. GH000001→
			7.04924.14.0	AGR	EL  ch. KH000001→
2.0 D 4x4 177 kW (241 PS) 204DTA	08.2017→12.2019		7.04923.18.0	AGR	EL  mit Dichtring with O-ring  ch. GH000001→
			7.04924.14.0	AGR	EL  ch. KH000001→
2.2 D 110-140 kW (150-190 PS) 224DT	06.2011→12.2019		7.00578.12.0	AGR	EL   ch. (V)BH 000 001→
			7.00578.12.0	AGR	EL  ch. (V)BH 000 001→
2.2 D 4x4 110-140 kW (150-190 PS) 224DT	06.2011→12.2019		7.00578.12.0	AGR	EL   ch. (V)BH 000 001→
			7.00578.12.0	AGR	EL  ch. (V)BH 000 001→

RANGE ROVER EVOQUE (L551) **15**

2.0 D150 4x4 110-132 kW (150-180 PS) 204DTD	12.2018→		7.04923.18.0	AGR	EL  mit Dichtring with O-ring
			7.04924.14.0	AGR	EL
2.0 D165 120-150 kW (163-204 PS) AJ20D4	07.2020→		7.04923.18.0	AGR	EL  mit Dichtring with O-ring
			7.04923.18.0	AGR	EL
2.0 D165 4x4 120-150 kW (163-204 PS) AJ20D4	07.2020→		7.04923.18.0	AGR	EL  mit Dichtring with O-ring
			7.04923.18.0	AGR	EL
2.0 D180 4x4 110-132 kW (150-180 PS) 204DTD	12.2018→		7.04923.18.0	AGR	EL  mit Dichtring with O-ring
			7.04924.14.0	AGR	EL
2.0 D200 4x4 120-150 kW (163-204 PS) AJ20D4	07.2020→		7.04923.18.0	AGR	EL  mit Dichtring with O-ring
			7.04923.18.0	AGR	EL

RANGE ROVER EVOQUE Convertible (L538) **16**

2.0 D 4x4 110-132 kW (150-180 PS) 204DTD	11.2015→12.2019		7.04923.18.0	AGR	EL  mit Dichtring with O-ring  ch. GH000001→
			7.04924.14.0	AGR	EL  ch. KH000001→



RANGE ROVER EVOQUE Convertible (L538)

16

2.0 D 4x4 110-132 kW (150-180 PS) 204DTD	11.2015→12.2019		7.04923.18.0	AGR	EL	mit Dichtring with O-ring ch. GH000001→
			7.04924.14.0	AGR	EL	ch. KH000001→
2.0 D 4x4 177 kW (241 PS) 204DTA	08.2017→12.2019		7.04923.18.0	AGR	EL	mit Dichtring with O-ring ch. GH000001→
			7.04924.14.0	AGR	EL	ch. KH000001→

RANGE ROVER II (P38A)

17

3.9 4x4 136-142 kW (185-193 PS) 42 D	07.1994→03.2002		7.22427.03.0	ARV	PN	
3.9 4x4 136-142 kW (185-193 PS) 42 D	01.1995→03.2002		7.22427.03.0	ARV	PN	
4.0 4x4 136-142 kW (185-193 PS) 42 D	01.1995→03.2002		7.22427.03.0	ARV	PN	
4.6 4x4 157 kW (213 PS) 48 D	01.1995→12.1996		7.22427.03.0	ARV	PN	
4.6 4x4 165-168 kW (224-228 PS) 46 D	09.1995→03.2002		7.22427.03.0	ARV	PN	
4.6 4x4 165-168 kW (224-228 PS) 46 D	04.1997→03.2002		7.22427.03.0	ARV	PN	
4.6 4x4 160 kW (218 PS) 60 D	06.1998→03.2002		7.22427.03.0	ARV	PN	

RANGE ROVER III (L322)

18

3.0 D 4x4 130 kW (177 PS) 306D1	03.2002→08.2012		7.28264.06.0	AGR	PN	
3.6 D 4x4 200 kW (272 PS) 368DT	04.2006→08.2012		7.24809.97.0	AGR	EL	09.2006→07.2010
			7.11237.00.0	AGR	EL	ch. AA000001→
4.4 4x4 210-212 kW (286-288 PS) M62 B44	03.2002→08.2005		7.02604.31.0	LS	350 mm	
4.4 4x4 220-227 kW (299-309 PS) 448PN	08.2004→08.2012		7.02604.31.0	LS	350 mm	
4.4 4x4 220-227 kW (299-309 PS) 448PN	05.2005→08.2012		7.02604.31.0	LS	350 mm	
4.4 D 4x4 230-253 kW (313-344 PS) 448DT	07.2010→08.2012		7.02751.02.0	AGR-M	EL	





























RANGE ROVER IV (L405)

19

3.0 SDV6 4x4 155-250 kW (211-340 PS) 306DT	08.2012→		7.05264.04.0*	AGR-K		01.2013→, ch. FA000001→
			↳7.05264.03.0	AGR	EL	
			7.05590.04.0*	AGR-K		01.2013→, ch. FA000001→
			↳7.05590.03.0	AGR	EL	
			7.01881.09.0*	AGR-K		Rechte Einheit Right unit ch. AA000001→
			↳7.01881.07.0	AGR-M	EL	
7.01881.08.0*	AGR-K		Linke Einheit Left unit ch. AA000001→			
			↳7.01881.06.0	AGR-M	EL	



RANGE ROVER IV (L405) **19**

<p>3.0 SDV6 4x4 155-250 kW (211-340 PS) 306DT</p>	<p>10.2012→</p>	<p> 7.05264.04.0* AGR-K</p> <p>↳ 7.05264.03.0 AGR EL</p> <p>7.05590.04.0* AGR-K EL</p> <p>↳ 7.05590.03.0 AGR EL</p> <p>7.01881.09.0* AGR-K</p> <p>↳ 7.01881.07.0 AGR-M EL</p> <p>7.01881.08.0* AGR-K</p> <p>↳ 7.01881.06.0 AGR-M EL</p>	<p>01.2013→,  ch. FA000001→</p> <p>01.2013→,  ch. FA000001→</p> <p> Rechte Einheit Right unit  ch. AA000001→</p> <p> Linke Einheit Left unit  ch. AA000001→</p>
<p>3.0 SDV6 4x4 155-250 kW (211-340 PS) 306DT</p>	<p>12.2014→</p>	<p> 7.01881.09.0* AGR-K</p> <p>↳ 7.01881.07.0 AGR-M EL</p> <p>7.01881.08.0* AGR-K</p> <p>↳ 7.01881.06.0 AGR-M EL</p> <p>7.05264.04.0* AGR-K EL</p> <p>↳ 7.05264.03.0 AGR EL</p> <p>7.05590.04.0* AGR-K EL</p> <p>↳ 7.05590.03.0 AGR EL</p>	<p> Rechte Einheit Right unit  ch. AA000001→</p> <p> Linke Einheit Left unit  ch. AA000001→</p> <p> ch. FA000001→</p> <p> ch. FA000001→</p>
<p>3.0 SDV6 4x4 155-250 kW (211-340 PS) 306DT</p>	<p>10.2018→</p>	<p> 7.01881.09.0* AGR-K</p> <p>↳ 7.01881.07.0 AGR-M EL</p> <p>7.01881.08.0* AGR-K</p> <p>↳ 7.01881.06.0 AGR-M EL</p> <p>7.05264.04.0* AGR-K EL</p> <p>↳ 7.05264.03.0 AGR EL</p> <p>7.05590.04.0* AGR-K EL</p> <p>↳ 7.05590.03.0 AGR EL</p>	<p> Rechte Einheit Right unit  ch. AA000001→</p> <p> Linke Einheit Left unit  ch. AA000001→</p> <p> ch. FA000001→</p> <p> ch. FA000001→</p>
<p>3.0 SDV6 Hybrid 4x4 155-250 kW (211-340 PS) 306DT</p>	<p>10.2013→</p>	<p> 7.01881.09.0* AGR-K</p> <p>↳ 7.01881.07.0 AGR-M EL</p> <p>7.01881.08.0* AGR-K</p> <p>↳ 7.01881.06.0 AGR-M EL</p>	<p> Rechte Einheit Right unit  ch. AA000001→</p> <p> Linke Einheit Left unit  ch. AA000001→</p>
<p>3.0 SDV6 Hybrid 4x4 155-250 kW (211-340 PS) 306DT</p>	<p>06.2015→</p>	<p> 7.01881.09.0* AGR-K</p> <p>↳ 7.01881.07.0 AGR-M EL</p>	<p> Rechte Einheit Right unit  ch. AA000001→</p>

L





































RANGE ROVER IV (L405) **19**

			7.01881.08.0*	AGR-K	Linke Einheit Left unit ch. AA00001→
			↳7.01881.06.0	AGR-M	EL
3.0 SDV6 Hybrid 4x4 155-250 kW (211-340 PS) 306DT	06.2015→		7.01881.09.0*	AGR-K	Rechte Einheit Right unit ch. AA000001→
			↳7.01881.07.0	AGR-M	EL
			7.01881.08.0*	AGR-K	Linke Einheit Left unit ch. AA00001→
			↳7.01881.06.0	AGR-M	EL
3.0 TDV6 4x4 155-250 kW (211-340 PS) 306DT	08.2012→		7.05264.04.0*	AGR-K	01.2013→, ch. FA000001→
			↳7.05264.03.0	AGR	EL
			7.05590.04.0*	AGR-K	01.2013→, ch. FA000001→
			↳7.05590.03.0	AGR	EL
			7.01881.09.0*	AGR-K	Rechte Einheit Right unit ch. AA000001→
			↳7.01881.07.0	AGR-M	EL
			7.01881.08.0*	AGR-K	Linke Einheit Left unit ch. AA00001→
3.0 TDV6 4x4 155-250 kW (211-340 PS) 306DT	10.2013→		7.01881.09.0*	AGR-K	Rechte Einheit Right unit ch. AA000001→
			↳7.01881.07.0	AGR-M	EL
			7.01881.08.0*	AGR-K	Linke Einheit Left unit ch. AA00001→
			↳7.01881.06.0	AGR-M	EL
			7.05264.04.0*	AGR-K	ch. FA000001→
			↳7.05264.03.0	AGR	EL
			7.05590.04.0*	AGR-K	ch. FA000001→
4.4 SDV8 4x4 230-253 kW (313-344 PS) 448DT	08.2012→		7.02751.02.0	AGR-M	EL <input checked="" type="checkbox"/>
4.4 SDV8 4x4 230-253 kW (313-344 PS) 448DT	08.2013→		7.02751.02.0	AGR-M	EL <input checked="" type="checkbox"/>
4.4 SDV8 4x4 230-253 kW (313-344 PS) 448DT	08.2013→		7.02751.02.0	AGR-M	EL <input checked="" type="checkbox"/>

L



































RANGE ROVER SPORT I (L320) **20**

2.7 D 4x4 140 kW (190 PS) 276DT	02.2005→03.2013		7.11237.01.0 AGR EL 	09.2005→08.2009
			7.11237.03.0 AGR EL 	ch. 7A000001→ch. 9A999999 Euro 4 Euro 4 für Fahrzeuge mit Diesel-Partikel-Filter (DPF) for vehicles with diesel soot filter
			7.24809.95.0 AGR EL 	ch. 7A000001→ch. 9A999999 Euro 4 Euro 4 für Fahrzeuge mit Diesel-Partikel-Filter (DPF) for vehicles with diesel soot filter
			7.24809.96.0 AGR EL 	ch. 9A209067→ch. 9A999999 Euro2/Euro3 Euro2/Euro3
3.0 D 4x4 155-250 kW (211-340 PS) 306DT	09.2009→03.2013		7.01881.08.0* AGR-K EL 	Linke Einheit Left unit  ch. AA00001→
			↳ 7.01881.06.0 AGR-M EL  7.01881.09.0* AGR-K EL 	Rechte Einheit Right unit  ch. AA00001→
			↳ 7.01881.07.0 AGR-M EL 	
3.0 D 4x4 155-250 kW (211-340 PS) 306DT	05.2010→03.2013		7.01881.08.0* AGR-K EL 	Linke Einheit Left unit  ch. AA00001→
			↳ 7.01881.06.0 AGR-M EL  7.01881.09.0* AGR-K EL 	Rechte Einheit Right unit  ch. AA00001→
			↳ 7.01881.07.0 AGR-M EL 	
3.0 D 4x4 155-250 kW (211-340 PS) 306DT	06.2011→03.2013		7.01881.08.0* AGR-K EL 	Linke Einheit Left unit  ch. AA00001→
			↳ 7.01881.06.0 AGR-M EL  7.01881.09.0* AGR-K EL 	Rechte Einheit Right unit  ch. AA00001→
			↳ 7.01881.07.0 AGR-M EL 	
3.0 D 4x4 155-250 kW (211-340 PS) 306DT	08.2012→03.2013		7.01881.06.0 AGR-M EL 	Linke Einheit Left unit  ch. (V)AA000001→
			7.01881.07.0 AGR-M EL 	Rechte Einheit Right unit  ch. (V)AA000001→
3.6 D 4x4 200 kW (272 PS) 368DT	04.2006→03.2013		7.24809.97.0 AGR EL 	01.2007→10.2010
			7.11237.00.0 AGR EL 	ch. AA000001→

L



















RANGE ROVER SPORT II (L494) 21

2.0 SD4 4x4 177 kW (241 PS) 204DTA	08.2016→		7.04923.17.0	AGR	EL	mit Dichtring with O-ring  ch. HA000001→
			7.04924.15.0	AGR	EL	 ch. HA175919→
3.0 SDV6 4x4 155-250 kW (211-340 PS) 306DT	04.2013→12.2016		7.05264.04.0*	AGR-K		01.2014→,  ch. FA000001→
			↳7.05264.03.0	AGR	EL	
			7.05590.04.0*	AGR-K		01.2014→,  ch. FA000001→
			↳7.05590.03.0	AGR	EL	
			7.01881.09.0*	AGR-K		 Rechte Einheit Right unit  ch. AA000001→
↳7.01881.07.0	AGR-M	EL				
	7.01881.08.0*	AGR-K		 Linke Einheit Left unit  ch. AA000001→		
	↳7.01881.06.0	AGR-M	EL			
3.0 SDV6 4x4 155-250 kW (211-340 PS) 306DT	04.2013→		7.01881.09.0*	AGR-K		 Rechte Einheit Right unit  ch. AA000001→
			↳7.01881.07.0	AGR-M	EL	
			7.01881.08.0*	AGR-K		 Linke Einheit Left unit  ch. AA000001→
3.0 SDV6 4x4 155-250 kW (211-340 PS) 306DT	09.2014→		7.01881.09.0*	AGR-K		 Rechte Einheit Right unit  ch. AA000001→
			↳7.01881.07.0	AGR-M	EL	
			7.01881.08.0*	AGR-K		 Linke Einheit Left unit  ch. AA000001→
			↳7.01881.06.0	AGR-M	EL	
			7.05264.04.0*	AGR-K		 ch. FA000001→
			↳7.05264.03.0	AGR	EL	
			7.05590.04.0*	AGR-K		 ch. FA000001→
↳7.05590.03.0	AGR	EL				
3.0 SDV6 Hybrid 4x4 155-250 kW (211-340 PS) 306DT	10.2013→		7.01881.09.0*	AGR-K		 Rechte Einheit Right unit  ch. AA000001→
			↳7.01881.07.0	AGR-M	EL	
			7.01881.08.0*	AGR-K		 Linke Einheit Left unit  ch. AA000001→
			↳7.01881.06.0	AGR-M	EL	
3.0 SDV6 Hybrid 4x4 155-250 kW (211-340 PS) 306DT	12.2014→12.2017		7.01881.09.0*	AGR-K		 Rechte Einheit Right unit  ch. AA000001→
			↳7.01881.07.0	AGR-M	EL	
			7.01881.08.0*	AGR-K		 Linke Einheit Left unit  ch. AA000001→













L



































RANGE ROVER SPORT II (L494) **21**





















3.0 SDV6 Hybrid 4x4 155-250 kW (211-340 PS) 306DT	06.2015→12.2017		↳ 7.01881.06.0 AGR-M EL	
			7.01881.09.0* AGR-K	 Rechte Einheit Right unit  ch. AA000001→
			↳ 7.01881.07.0 AGR-M EL 7.01881.08.0* AGR-K	 Linke Einheit Left unit  ch. AA000001→
3.0 TDV6 4x4 155-250 kW (211-340 PS) 306DT	04.2013→		↳ 7.01881.06.0 AGR-M EL	
			7.01881.09.0* AGR-K	 Rechte Einheit Right unit  ch. AA000001→
			↳ 7.01881.07.0 AGR-M EL 7.01881.08.0* AGR-K	 Linke Einheit Left unit  ch. AA000001→
3.0 TDV6 4x4 155-250 kW (211-340 PS) 306DT	04.2013→12.2018		↳ 7.01881.06.0 AGR-M EL	
			7.01881.09.0* AGR-K	 Rechte Einheit Right unit  ch. AA000001→
			↳ 7.01881.07.0 AGR-M EL 7.01881.08.0* AGR-K	 Linke Einheit Left unit  ch. AA000001→
4.4 SDV8 4x4 230-253 kW (313-344 PS) 448DT	10.2013→		↳ 7.01881.06.0 AGR-M EL	EL 

RANGE ROVER VELAR (L560) **22**



2.0 D180 TD4 4x4 110-132 kW (150-180 PS) 204DTD	03.2017→		7.04923.17.0 AGR EL	mit Dichtring with O-ring  ch. JA000001→
			7.04924.15.0 AGR EL	 ch. JA731259→
2.0 D240 SD4 4x4 177 kW (241 PS) 204DTA	03.2017→		7.04923.17.0 AGR EL	mit Dichtring with O-ring  ch. JA000001→
			7.04924.15.0 AGR EL	 ch. JA731259→
3.0 D275 SDV6 4x4 155-250 kW (211-340 PS) 306DT	04.2018→		7.05264.04.0* AGR-K	 ch. FA000001→
			↳ 7.05264.03.0 AGR EL	
			7.05590.04.0* AGR-K EL	 ch. FA000001→
3.0 D300 SDV6 4x4 155-250 kW (211-340 PS) 306DT	03.2017→		7.05264.04.0* AGR-K	 ch. FA000001→
			↳ 7.05264.03.0 AGR EL	
			7.05590.04.0* AGR-K EL	 ch. FA000001→
			↳ 7.05590.03.0 AGR EL	

						
DEFENDER Platform/Chassis (L316)						23
2.2 Td4 4x4 (L317) 90-110 kW (122-150 PS) DT224	08.2011→02.2016		7.03784.34.0	AGR	EL  ch. (V)CA 000 001→	
2.4 TD4 4x4 90 kW (122 PS) DT244	05.2007→02.2016		7.24809.70.0	AGR	EL 	
DISCOVERY IV VAN (L319)						24
3.0 TD 4x4 155-250 kW (211-340 PS) 306DT	01.2011→12.2017		7.01881.08.0*	AGR-K	 Linke Einheit Left unit  ch. AA00001→	
			↳ 7.01881.06.0	AGR-M	EL	
			7.01881.09.0*	AGR-K	 Rechte Einheit Right unit  ch. AA00001→	
3.0 TD 4x4 155-250 kW (211-340 PS) 306DT	01.2011→12.2017		7.01881.08.0*	AGR-K	 Linke Einheit Left unit  ch. AA00001→	
			↳ 7.01881.06.0	AGR-M	EL	
			7.01881.09.0*	AGR-K	 Rechte Einheit Right unit  ch. AA00001→	
3.0 TD 4x4 155-250 kW (211-340 PS) 306DT	01.2011→12.2017		7.01881.08.0*	AGR-K	 Linke Einheit Left unit  ch. AA00001→	
			↳ 7.01881.06.0	AGR-M	EL	
			7.01881.09.0*	AGR-K	 Rechte Einheit Right unit  ch. AA00001→	
			↳ 7.01881.07.0	AGR-M	EL	
FREELANDER 2 VAN (L359)						25
2.2 TD4 4x4 110-140 kW (150-190 PS) 224DT	10.2006→10.2014		7.00578.12.0	AGR	EL  ch. (V)BH 000 001→	
RANGE ROVER EVOQUE VAN (L538)						26
SD4 4x4 110-140 kW (150-190 PS) 224DT	05.2015→12.2019		7.00578.12.0	AGR	EL  ch. (V)BH 000 001→	
TD4 110-140 kW (150-190 PS) 224DT	05.2015→12.2019		7.00578.12.0	AGR	EL  ch. (V)BH 000 001→	
TD4 4x4 110-140 kW (150-190 PS) 224DT	05.2015→12.2019		7.00578.12.0	AGR	EL  ch. (V)BH 000 001→	

L

					
GS (_S16_) 1					
430 (UZS161_) 207-244 kW (282-332 PS) 3UZ-FE	11.2000→12.2004		7.05271.38.0	LS	680 mm beidseitig Left and right Diagnosesonde Diagnostic Probe nach Katalysator Post-catalyst
GS (_S19_) 2					
4.3 VVTi (UZS190_) 207-244 kW (282-332 PS) 3UZ-FE	04.2005→11.2011		7.05271.38.0	LS	680 mm beidseitig Left and right Diagnosesonde Diagnostic Probe nach Katalysator Post-catalyst
430 (UZS190_) 207-244 kW (282-332 PS) 3UZ-FE	04.2005→11.2011		7.05271.38.0	LS	680 mm beidseitig Left and right Diagnosesonde Diagnostic Probe nach Katalysator Post-catalyst
ISI (_E1_) 3					
200 (GXE10) 114 kW (155 PS) 1G-FE	04.1999→07.2005		7.05271.56.0	LS	600 mm hinten Rear
300 (JCE10) 156-168 kW (212-228 PS) 2JZ-GE	09.2001→07.2005		7.05271.56.0	LS	600 mm hinten Rear
IS SportCross (_E1_) 4					
200 (GXE10_) 114 kW (155 PS) 1G-FE	10.2002→10.2005		7.05271.56.0	LS	600 mm  →ch. 07.2005
300 (JCE10_) 156-168 kW (212-228 PS) 2JZ-GE	10.2001→10.2005		7.05271.56.0	LS	600 mm
LS (_F4_) 5					
460 (USF40, USF41) 218-260 kW (296-354 PS) 1UR-FE	08.2006→		7.05271.38.0	LS	680 mm beidseitig Left and right Diagnosesonde Diagnostic Probe nach Katalysator Post-catalyst
600h AWD (UVF45, UVF46) 272-327 kW (370-445 PS) 2UR-FSE	04.2007→		7.05271.38.0	LS	680 mm rechts Right Diagnosesonde Diagnostic Probe nach Katalysator Post-catalyst
RX (_L1_) 6					
350 (GYL10_) 183-252 kW (249-343 PS) 2GR-FXE	12.2008→10.2015		7.05271.36.0	LS	360 mm
350 AWD (GGL15_) 183-252 kW (249-343 PS) 2GR-FE, 2GR-FXE	12.2008→08.2015		7.05271.36.0	LS	360 mm →12.2008 links Left
350 AWD (GGL15_) 183-220 kW (249-299 PS) 2GR-FE	03.2009→02.2012		7.05271.36.0	LS	360 mm
RX (_U3_) 7					
350 (GSU30_) 183-220 kW (249-299 PS) 2GR-FE	01.2006→12.2008		7.05271.36.0	LS	360 mm links Left
350 AWD (GSU35_) 183-220 kW (249-299 PS) 2GR-FE	02.2006→12.2008		7.05271.36.0	LS	360 mm links Left







RX (_U3_)
7

400h (MHU38_) 155-200 kW (211-272 PS) 3MZ-FE	09.2005→12.2008	 7.05271.36.0	LS	360 mm	links Left
400h AWD (MHU38_) 155-200 kW (211-272 PS) 3MZ-FE	09.2004→12.2008	 7.05271.36.0	LS	360 mm	links Left

L









TGE Bus **1**

2.0 TDI 75 kW (102 PS) DAUB	02.2017→		7.04999.35.0*	AGR-K	EL	ohne Zubehör without accessories
			↳ 7.04999.34.0 7.11492.05.0	AGR-M DDS	EL	
2.0 TDI 103 kW (140 PS) DAUA	02.2017→		7.04999.35.0*	AGR-K	EL	
			↳ 7.04999.34.0 7.11492.05.0	AGR-M DDS	EL	
2.0 TDI 130 kW (177 PS) DAVA	02.2017→		7.11492.05.0	DDS	EL	
2.0 TDI AWD 103 kW (140 PS) DAUA	02.2017→		7.04999.35.0*	AGR-K	EL	
			↳ 7.04999.34.0 7.11492.05.0	AGR-M DDS	EL	
2.0 TDI AWD 130 kW (177 PS) DAVA	02.2017→		7.11492.05.0	DDS	EL	

TGE Platform/Chassis (UZ_) **2**

M

2.0 TDI 75 kW (102 PS) DAUB	11.2016→		7.04999.35.0*	AGR-K	EL	ohne Zubehör without accessories
			↳ 7.04999.34.0 7.11492.05.0	AGR-M DDS	EL	
2.0 TDI 103 kW (140 PS) DAUA	11.2016→		7.04999.35.0*	AGR-K	EL	
			↳ 7.04999.34.0 7.11492.05.0	AGR-M DDS	EL	
2.0 TDI 130 kW (177 PS) DAVA	11.2016→		7.11492.05.0	DDS	EL	
2.0 TDI AWD 103 kW (140 PS) DAUA	11.2017→		7.04999.35.0*	AGR-K	EL	
			↳ 7.04999.34.0 7.11492.05.0	AGR-M DDS	EL	
2.0 TDI AWD 130 kW (177 PS) DAVA	11.2017→		7.11492.05.0	DDS	EL	
2.0 TDI RWD 130 kW (177 PS) DAWA	07.2017→		7.11492.05.0	DDS	EL	
2.0 TDI RWD 90 kW (122 PS) DASA	08.2017→		7.04999.35.0*	AGR-K	EL	
			↳ 7.04999.34.0 7.11492.05.0	AGR-M DDS	EL	
2.0 TDI RWD 103 kW (140 PS) DASB	11.2017→		7.04999.35.0*	AGR-K	EL	
			↳ 7.04999.34.0 7.11492.05.0	AGR-M DDS	EL	

TGE Van **3**

2.0 TDI (01V, 03V, 36V, UYB, UYC, UYD) 75 kW (102 PS) DAUB	02.2017→		7.04999.35.0*	AGR-K	EL	ohne Zubehör without accessories
			↳ 7.04999.34.0 7.11492.05.0	AGR-M DDS	EL	

TGE Van						3
2.0 TDI (01V, 03V, 36V, UYB, UYC, UYD) 103 kW (140 PS) DAUA	02.2017→		7.04999.35.0*	AGR-K	EL	ohne Zubehör without accessories
			↳7.04999.34.0 7.11492.05.0	AGR-M DDS	EL	
2.0 TDI (01V, 03V, 36V, UYB, UYC, UYD) 130 kW (177 PS) DAVA	02.2017→		7.11492.05.0	DDS		ohne Zubehör without accessories
2.0 TDI AWD (02V, 04V, 37V, UYB, UYC, UYD) 130 kW (177 PS) DAVA	03.2017→		7.11492.05.0	DDS		ohne Zubehör without accessories
2.0 TDI AWD (02V, 04V, 37V, UYB, UYC, UYD) 103 kW (140 PS) DAUA	04.2017→		7.04999.35.0*	AGR-K	EL	ohne Zubehör without accessories
			↳7.04999.34.0 7.11492.05.0	AGR-M DDS	EL	
2.0 TDI RWD (11V, 12V, 33V, 34V, UYB, UYC, UYD) 130 kW (177 PS) DAWA	05.2017→		7.11492.05.0	DDS		ohne Zubehör without accessories
2.0 TDI RWD (11V, 12V, 33V, 34V, UYB, UYC, UYD) 90 kW (122 PS) DASA	08.2017→		7.04999.35.0*	AGR-K	EL	ohne Zubehör without accessories
			↳7.04999.34.0 7.11492.05.0	AGR-M DDS	EL	
2.0 TDI RWD (11V, UYB, UYC) 103 kW (140 PS) DASB	10.2017→		7.04999.35.0*	AGR-K	EL	ohne Zubehör without accessories
			↳7.04999.34.0 7.11492.05.0	AGR-M DDS	EL	
18T-SERIES						4
18.260 191 kW (260 PS) D 2866 LOH 35	06.2001→		7.22841.08.0	AGR	PN	Rückschlagventil/non-return valve
18.260 191 kW (260 PS) D 2866 LUH 23	06.2001→		7.01268.03.0	AGR	PN	Rückschlagventil/non-return valve
18.310 228 kW (310 PS) D 2866 LOH 27	01.2001→		7.22841.08.0	AGR	PN	Rückschlagventil/non-return valve
18.310 228 kW (310 PS) D 2866 LUH 24	01.2001→		7.01268.03.0	AGR	PN	Rückschlagventil/non-return valve
18.360 265-338 kW (360-460 PS) D 2866 LOH 28, D 2876 LOH 02	01.1999→		7.22841.08.0	AGR	PN	Rückschlagventil/non-return valve
18.410 301 kW (410 PS) D 2866 LOH 29	09.2002→		7.22841.08.0	AGR	PN	Rückschlagventil/non-return valve
18.460 338 kW (460 PS) D 2876 LOH 02	01.2001→		7.22841.08.0	AGR	PN	Rückschlagventil/non-return valve
23T-SERIES						5
23.314 228 kW (310 PS) D 2866 LF34	07.1999→		7.22841.08.0	AGR	PN	Rückschlagventil/non-return valve
23.364 265 kW (360 PS) D 2866 LF35	07.1999→		7.22841.08.0	AGR	PN	Rückschlagventil/non-return valve
23.414 301 kW (409 PS) D 2866 LF31	07.1999→		7.22841.08.0	AGR	PN	Rückschlagventil/non-return valve
23.464 338 kW (460 PS) D 2876 LF 06	09.1998→		7.22841.08.0	AGR	PN	Rückschlagventil/non-return valve

						
24T-SERIES						6
24.310 228 kW (310 PS) D 2866 LOH 27	01.2001→09.2002		7.22841.08.0	AGR	PN	Rückschlagventil/non-return valve
24.314 228 kW (310 PS) D 2866 LF23, D 2866 LF34	07.1999→08.2002		7.22841.08.0	AGR	PN	Rückschlagventil/non-return valve
24.360 265 kW (360 PS) D 2866 LOH 28	09.2002→		7.22841.08.0	AGR	PN	Rückschlagventil/non-return valve
24.364 265 kW (360 PS) D 2866 LF35	07.1999→09.2001		7.22841.08.0	AGR	PN	Rückschlagventil/non-return valve
24.410 301 kW (409-410 PS) D 2866 LOH 29, D 2876 LOH 05	07.1998→		7.22841.08.0	AGR	PN	Rückschlagventil/non-return valve
24.414 301 kW (409 PS) D 2866 LF31	07.1999→12.2001		7.22841.08.0	AGR	PN	Rückschlagventil/non-return valve
24.460 338 kW (460 PS) D 2876 LOH 02	01.2001→		7.22841.08.0	AGR	PN	Rückschlagventil/non-return valve
24.464 338 kW (460 PS) D 2876 LF 06	07.1999→09.2001		7.22841.08.0	AGR	PN	Rückschlagventil/non-return valve
26T-SERIES						7
26.364 265 kW (360 PS) D 2866 LF35	07.1999→09.2001		7.22841.08.0	AGR	PN	Rückschlagventil/non-return valve
26.414 301 kW (409 PS) D 2866 LF31	09.1998→06.2002		7.22841.08.0	AGR	PN	Rückschlagventil/non-return valve
26.464 338 kW (460 PS) D 2876 LF 06	07.1999→06.2002		7.22841.08.0	AGR	PN	Rückschlagventil/non-return valve
27T-SERIES						8
27.314 228 kW (310 PS) D 2866 LF34	07.1999→09.2001		7.22841.08.0	AGR	PN	Rückschlagventil/non-return valve
27.364 265 kW (360 PS) D 2866 LF35	07.1999→09.2001		7.22841.08.0	AGR	PN	Rückschlagventil/non-return valve
27.414 301 kW (409 PS) D 2866 LF31	07.1999→12.2001		7.22841.08.0	AGR	PN	Rückschlagventil/non-return valve
28T-SERIES						9
28.314 228 kW (310 PS) D 2866 LF34	07.1999→		7.22841.08.0	AGR	PN	Rückschlagventil/non-return valve
28.364 265 kW (360 PS) D 2866 LF35	07.1999→09.2001		7.22841.08.0	AGR	PN	Rückschlagventil/non-return valve
28.403 294-309 kW (400-420 PS) D 2866 LF20	09.1996→09.2001		7.22841.08.0	AGR	PN	Rückschlagventil/non-return valve
28.414 301 kW (409 PS) D 2866 LF31	07.1999→12.2001		7.22841.08.0	AGR	PN	Rückschlagventil/non-return valve
28.463 338 kW (460 PS) D 2876 LF 02	09.1996→09.2001		7.22841.08.0	AGR	PN	Rückschlagventil/non-return valve
28.464 338 kW (460 PS) D 2876 LF 06	07.1999→09.2001		7.22841.08.0	AGR	PN	Rückschlagventil/non-return valve
29T-SERIES						10
29.414 301 kW (409 PS) D 2866 LF31	07.1999→		7.22841.08.0	AGR	PN	Rückschlagventil/non-return valve
29.464 338 kW (460 PS) D 2876 LF 06	07.1999→		7.22841.08.0	AGR	PN	Rückschlagventil/non-return valve
30T-SERIES						11
30.314 228 kW (310 PS) D 2866 LF34	06.1998→09.2001		7.22841.08.0	AGR	PN	Rückschlagventil/non-return valve
30.343 265 kW (360 PS) D 2866 LF35	03.1997→09.2001		7.22841.08.0	AGR	PN	Rückschlagventil/non-return valve
30.364 265 kW (360 PS) D 2866 LF35	06.1998→		7.22841.08.0	AGR	PN	Rückschlagventil/non-return valve



M

















30T-SERIES							11
30.403 294-309 kW (400-420 PS) D 2866 LF20	03.1997→09.2001		7.22841.08.0	AGR	PN	Rückschlagventil/non-return valve	
30.414 301 kW (409 PS) D 2866 LF31	06.1998→12.2001		7.22841.08.0	AGR	PN	Rückschlagventil/non-return valve	
30.463 338 kW (460 PS) D 2876 LF 02	03.1997→09.2001		7.22841.08.0	AGR	PN	Rückschlagventil/non-return valve	
30.464 338 kW (460 PS) D 2876 LF 06	06.1998→09.2001		7.22841.08.0	AGR	PN	Rückschlagventil/non-return valve	
32T-SERIES							12
32.314 228 kW (310 PS) D 2866 LF34	07.1999→09.2001		7.22841.08.0	AGR	PN	Rückschlagventil/non-return valve	
32.364 265 kW (360 PS) D 2866 LF35	09.1998→09.2001		7.22841.08.0	AGR	PN	Rückschlagventil/non-return valve	
32.414 301 kW (409 PS) D 2866 LF31	09.1998→12.2001		7.22841.08.0	AGR	PN	Rückschlagventil/non-return valve	
32.464 338 kW (460 PS) D 2876 LF 06	09.1998→09.2001		7.22841.08.0	AGR	PN	Rückschlagventil/non-return valve	
33T-SERIES							13
33.364 265 kW (360 PS) D 2866 LF35	10.1997→09.2001		7.22841.08.0	AGR	PN	Rückschlagventil/non-return valve	
33.414 301 kW (409 PS) D 2866 LF31	10.1997→12.2001		7.22841.08.0	AGR	PN	Rückschlagventil/non-return valve	
35T-SERIES							14
35.364 265 kW (360 PS) D 2866 LF35	06.1998→09.2001		7.22841.08.0	AGR	PN	Rückschlagventil/non-return valve	
35.414 301 kW (409 PS) D 2866 LF31	06.1998→12.2001		7.22841.08.0	AGR	PN	Rückschlagventil/non-return valve	
35.464 338 kW (460 PS) D 2876 LF 06	06.1998→09.2001		7.22841.08.0	AGR	PN	Rückschlagventil/non-return valve	
40T-SERIES							15
40.414 301 kW (409 PS) D 2866 LF31	12.1997→12.2001		7.22841.08.0	AGR	PN	Rückschlagventil/non-return valve	
40.464 338 kW (460 PS) D 2876 LF 06	12.1997→09.2001		7.22841.08.0	AGR	PN	Rückschlagventil/non-return valve	
41T-SERIES							16
41.364 265 kW (360 PS) D 2866 LF35	06.1998→09.2001		7.22841.08.0	AGR	PN	Rückschlagventil/non-return valve	
41.414 301 kW (409 PS) D 2866 LF31	06.1998→12.2001		7.22841.08.0	AGR	PN	Rückschlagventil/non-return valve	
41.464 338 kW (460 PS) D 2876 LF 06	06.1998→09.2001		7.22841.08.0	AGR	PN	Rückschlagventil/non-return valve	
42T-SERIES							17
42.414 301 kW (409 PS) D 2866 LF31	06.1998→08.2001		7.22841.08.0	AGR	PN	Rückschlagventil/non-return valve	
42.464 338 kW (460 PS) D 2876 LF 06	06.1998→08.2001		7.22841.08.0	AGR	PN	Rückschlagventil/non-return valve	
50T-SERIES							18
50.403 294-309 kW (400-420 PS) D 2866 LF20	06.1998→		7.22841.08.0	AGR	PN	Rückschlagventil/non-return valve	
50.414 301 kW (409 PS) D 2866 LF31	06.1998→09.2001		7.22841.08.0	AGR	PN	Rückschlagventil/non-return valve	
50.463 338 kW (460 PS) D 2876 LF 02	06.1997→		7.22841.08.0	AGR	PN	Rückschlagventil/non-return valve	
50.464 338 kW (460 PS) D 2876 LF 02, D 2876 LF 06	06.1997→		7.22841.08.0	AGR	PN	Rückschlagventil/non-return valve	



BUS **19**







Lion´s Coach 294-324 kW (400-440 PS) D 2066 LOH 03, D 2066 LOH 04	01.2006→		7.01268.03.0	AGR	PN	Rückschlagventil/non-return valve
Lion´s Regio 228-265 kW (310-360 PS) D 2866 LUH 28, D 2866 LUH 29	08.1999→		7.01268.03.0	AGR	PN	Rückschlagventil/non-return valve

CLA **20**













15.220 FRC 162 kW (220 PS) D 0836 LFL 10	01.2006→		7.01268.03.0	AGR	PN	Rückschlagventil/non-return valve
16.220 FC 162 kW (220 PS) D 0836 LFL 10	01.2006→		7.01268.03.0	AGR	PN	Rückschlagventil/non-return valve
16.220 FK 162 kW (220 PS) D 0836 LFL 10	01.2006→		7.01268.03.0	AGR	PN	Rückschlagventil/non-return valve
18.280 FC, FRC 206 kW (280 PS) D 0836 LFL 08	01.2006→		7.01268.03.0	AGR	PN	Rückschlagventil/non-return valve
18.280 FRS, FS 206 kW (280 PS) D 0836 LFL 08	01.2006→		7.01268.03.0	AGR	PN	Rückschlagventil/non-return valve
20.280 FC, FRC 206 kW (280 PS) D 0836 LFL 08	01.2006→		7.01268.03.0	AGR	PN	Rückschlagventil/non-return valve
25.280 FDK, FDRK 206 kW (280 PS) D 0836 LFL 08	01.2006→		7.01268.03.0	AGR	PN	Rückschlagventil/non-return valve
25.280 FDRC, FDC 206 kW (280 PS) D 0836 LFL 08	01.2006→		7.01268.03.0	AGR	PN	Rückschlagventil/non-return valve
25.280 FDS, FDRS 206 kW (280 PS) D 0836 LFL 08	01.2006→		7.01268.03.0	AGR	PN	Rückschlagventil/non-return valve
26.280 FDC, FDRC 206 kW (280 PS) D 0836 LFL 08	01.2006→		7.01268.03.0	AGR	PN	Rückschlagventil/non-return valve
26.280 FDK, FDRK 206 kW (280 PS) D 0836 LFL 08	01.2006→		7.01268.03.0	AGR	PN	Rückschlagventil/non-return valve
26.280 FDS, FDRS 206 kW (280 PS) D 0836 LFL 08	01.2006→		7.01268.03.0	AGR	PN	Rückschlagventil/non-return valve
26.280 FRC 206 kW (280 PS) D 0836 LFL 08	01.2006→		7.01268.03.0	AGR	PN	Rückschlagventil/non-return valve
31.280 FFDRK 206 kW (280 PS) D 0836 LFL 08	01.2006→		7.01268.03.0	AGR	PN	Rückschlagventil/non-return valve

M

E2000 **21**

19.310 FALK, FALK-L 228 kW (310 PS) D 2866 LF23	05.2000→06.2003		7.22841.08.0	AGR	PN	Rückschlagventil/non-return valve
19.360 FLK 265 kW (360 PS) D 2866 LF24	05.2000→06.2003		7.22841.08.0	AGR	PN	Rückschlagventil/non-return valve
19.460 FALK, FALK-L 338 kW (460 PS) D 2876 LF 03	05.2000→06.2003		7.22841.08.0	AGR	PN	Rückschlagventil/non-return valve
26.310 FAVLK 228 kW (310 PS) D 2866 LF23	05.2000→06.2003		7.22841.08.0	AGR	PN	Rückschlagventil/non-return valve
26.360 FAVLC 265 kW (360 PS) D 2866 LF24	05.2000→10.2003		7.22841.08.0	AGR	PN	Rückschlagventil/non-return valve
26.460 DFARC 338 kW (460 PS) D 2876 LF 03	05.2000→10.2003		7.22841.08.0	AGR	PN	Rückschlagventil/non-return valve
28.310 FNLC 228 kW (310 PS) D 2866 LF23	05.2000→12.2003		7.22841.08.0	AGR	PN	Rückschlagventil/non-return valve

E2000
21

28.360 FNALC 265 kW (360 PS) D 2866 LF24	05.2000→11.2003		7.22841.08.0	AGR	PN	Rückschlagventil/non-return valve
28.460 FANLC 338 kW (460 PS) D 2876 LF 03	05.2000→11.2003		7.22841.08.0	AGR	PN	Rückschlagventil/non-return valve
30.360 FANLC 265 kW (360 PS) D 2866 LF24	05.2000→06.2003		7.22841.08.0	AGR	PN	Rückschlagventil/non-return valve
30.460 FANLC 338 kW (460 PS) D 2876 LF 03	05.2000→06.2003		7.22841.08.0	AGR	PN	Rückschlagventil/non-return valve
32.360 VFCL 265 kW (360 PS) D 2866 LF24	05.2000→10.2003		7.22841.08.0	AGR	PN	Rückschlagventil/non-return valve
32.460 VFCL, VFRLC 338 kW (460 PS) D 2876 LF 03	05.2000→10.2003		7.22841.08.0	AGR	PN	Rückschlagventil/non-return valve
33.360 DFALC 265 kW (360 PS) D 2866 LF24	05.2000→06.2003		7.22841.08.0	AGR	PN	Rückschlagventil/non-return valve
33.460 DFALC 338 kW (460 PS) D 2876 LF 03	05.2000→06.2003		7.22841.08.0	AGR	PN	Rückschlagventil/non-return valve
35.360 VFAK 265 kW (360 PS) D 2866 LF24	05.2000→09.2003		7.22841.08.0	AGR	PN	Rückschlagventil/non-return valve
35.460 FVNLC 338 kW (460 PS) D 2876 LF 03	05.2000→10.2003		7.22841.08.0	AGR	PN	Rückschlagventil/non-return valve
41.460 VFAK 338 kW (460 PS) D 2876 LF 03	05.2000→09.2003		7.22841.08.0	AGR	PN	Rückschlagventil/non-return valve
50.460 VFAVK, VFAV-G, VFAVK-HK 338 kW (460 PS) D 2876 LF 03	03.2001→09.2003		7.22841.08.0	AGR	PN	Rückschlagventil/non-return valve

F2000
22
M





19.314 FC, FLC, FLLC, FLLW, FRC, FLRC, FLLRC, FLL, FLLR, F-N 228 kW (310 PS) D 2866 LF34	06.1998→12.2001		7.22841.08.0	AGR	PN	Rückschlagventil/non-return valve
19.364 FC, FLC, FLLC, FLLW, FRC, FLRC, FLLRC, FLL, FLLR, F-N 265 kW (360 PS) D 2866 LF35	06.1998→12.2001		7.22841.08.0	AGR	PN	Rückschlagventil/non-return valve
19.373 FC, FLC, FLLC, FRC, FLRC, F-NL 272 kW (370 PS) D 2866 LF21	01.1994→12.1995		7.22841.08.0	AGR	PN	Rückschlagventil/non-return valve
19.403 FC, FLC, FLLC, FRC, FLRC, F-NL 294-309 kW (400-420 PS) D 2866 LF20	01.1994→12.2001		7.22841.08.0	AGR	PN	Rückschlagventil/non-return valve
19.414 FC, FLC, FLLC, FRC, FLRC, FLLRC, FLL, FLLR, F-NL 301 kW (409 PS) D 2866 LF31	06.1998→12.2001		7.22841.08.0	AGR	PN	Rückschlagventil/non-return valve
19.423 FC, FLC, FLLC, F-NL 309 kW (420 PS) D 2866 LF22	01.1994→12.1995		7.22841.08.0	AGR	PN	Rückschlagventil/non-return valve
19.463 FC, FLC, FLLC, FRC, FLRC, F-NL 338 kW (460 PS) D 2876 LF 02	01.1994→12.2001		7.22841.08.0	AGR	PN	Rückschlagventil/non-return valve
19.464 FC, FLC, FLLC, FLL, FRC, FLLR, FLLRC, FLLW, F-NL 338 kW (460 PS) D 2876 LF 06	06.1998→09.2001		7.22841.08.0	AGR	PN	Rückschlagventil/non-return valve
23.403 FNLLC 294-309 kW (400-420 PS) D 2866 LF20	01.1994→		7.22841.08.0	AGR	PN	Rückschlagventil/non-return valve

F2000 **22**

23.463 FNLLC 338 kW (460 PS) D 2876 LF 02	01.1994→		7.22841.08.0	AGR	PN	Rückschlagventil/non-return valve
24.373 FNLLC 272 kW (370 PS) D 2866 LF21	01.1994→12.1995		7.22841.08.0	AGR	PN	Rückschlagventil/non-return valve
24.403 FNLLC 294-309 kW (400-420 PS) D 2866 LF20	01.1994→09.2001		7.22841.08.0	AGR	PN	Rückschlagventil/non-return valve
24.423 FNLLC 309 kW (420 PS) D 2866 LF22	01.1994→12.1995		7.22841.08.0	AGR	PN	Rückschlagventil/non-return valve
24.463 FNLLC 338 kW (460 PS) D 2876 LF 02	01.1994→		7.22841.08.0	AGR	PN	Rückschlagventil/non-return valve
26.314 FNLC, FNLLC, FNLLRC, FNLLW, FNLRC, FNLLRC, FVLC 228 kW (310 PS) D 2866 LF23	05.2001→06.2002		7.22841.08.0	AGR	PN	Rückschlagventil/non-return valve
26.373 DFC, 26.373 DFCL 272 kW (370 PS) D 2866 LF21	01.1994→12.1995		7.22841.08.0	AGR	PN	Rückschlagventil/non-return valve
26.403 DFC, 26.403 DFCL 294-309 kW (400-420 PS) D 2866 LF20	01.1994→09.2001		7.22841.08.0	AGR	PN	Rückschlagventil/non-return valve
26.423 DFC, 26.423 DFCL 309 kW (420 PS) D 2866 LF22	01.1994→12.1995		7.22841.08.0	AGR	PN	Rückschlagventil/non-return valve
26.463 DFC, DFCL 338 kW (460 PS) D 2876 LF 02	01.1994→09.2001		7.22841.08.0	AGR	PN	Rückschlagventil/non-return valve
26.463 DFK, DFLK, DFLK-L 338 kW (460 PS) D 2876 LF 02	08.1995→09.2001		7.22841.08.0	AGR	PN	Rückschlagventil/non-return valve
27.373 DFC 272 kW (370 PS) D 2866 LF21	01.1994→12.1995		7.22841.08.0	AGR	PN	Rückschlagventil/non-return valve
27.403 DFC 294-309 kW (400-420 PS) D 2866 LF20	01.1994→09.2001		7.22841.08.0	AGR	PN	Rückschlagventil/non-return valve
27.423 DFC 309 kW (420 PS) D 2866 LF22	01.1994→12.1995		7.22841.08.0	AGR	PN	Rückschlagventil/non-return valve
27.463 DFC 338 kW (460 PS) D 2876 LF 02	01.1994→09.2001		7.22841.08.0	AGR	PN	Rückschlagventil/non-return valve
27.464 DFC 338 kW (460 PS) D 2876 LF 06	06.1998→09.2001		7.22841.08.0	AGR	PN	Rückschlagventil/non-return valve
32.403 VFC 294-309 kW (400-420 PS) D 2866 LF20	08.1995→09.2001		7.22841.08.0	AGR	PN	Rückschlagventil/non-return valve
33.373 DFC 272 kW (370 PS) D 2866 LF21	01.1994→12.1995		7.22841.08.0	AGR	PN	Rückschlagventil/non-return valve
33.403 DFC 294-309 kW (400-420 PS) D 2866 LF20	01.1994→09.2001		7.22841.08.0	AGR	PN	Rückschlagventil/non-return valve
33.423 DFC 309 kW (420 PS) D 2866 LF22	01.1994→12.1995		7.22841.08.0	AGR	PN	Rückschlagventil/non-return valve
33.463 DFAK, DFAK-HK, DFA-KI 338 kW (460 PS) D 2876 LF 02	10.1997→09.2001		7.22841.08.0	AGR	PN	Rückschlagventil/non-return valve
33.463 DFC 338 kW (460 PS) D 2876 LF 02	01.1994→09.2001		7.22841.08.0	AGR	PN	Rückschlagventil/non-return valve
35.403 VF, VFC, VFRC 294-309 kW (400-420 PS) D 2866 LF20	08.1995→09.2001		7.22841.08.0	AGR	PN	Rückschlagventil/non-return valve

M



F2000
22

35.463 VF, VFC, VFRC 338 kW (460 PS) D 2876 LF 02	08.1995→09.2001		7.22841.08.0	AGR	PN	Rückschlagventil/non-return valve
40.403 DFAK 294-309 kW (400-420 PS) D 2866 LF20	02.1997→		7.22841.08.0	AGR	PN	Rückschlagventil/non-return valve
40.463 DFAK 338 kW (460 PS) D 2876 LF 02	08.1995→		7.22841.08.0	AGR	PN	Rückschlagventil/non-return valve
41.403 VF, VFC, VFRC 294-309 kW (400-420 PS) D 2866 LF20	08.1995→09.2001		7.22841.08.0	AGR	PN	Rückschlagventil/non-return valve
41.463 VF, VFC, VFRC 338 kW (460 PS) D 2876 LF 02	08.1995→		7.22841.08.0	AGR	PN	Rückschlagventil/non-return valve

FOCL
23

12.240 176 kW (239 PS) D 0836 LOH 56	08.2007→		7.01268.03.0	AGR	PN	Rückschlagventil/non-return valve
12.250 184 kW (250 PS) D 0836 LOH 65	08.2004→		7.01268.03.0	AGR	PN	Rückschlagventil/non-return valve

HOCL
24

12.240 HOCL-NL 176 kW (239 PS) D 0836 LOH 52, D 0836 LOH 56	05.2000→		7.01268.03.0	AGR	PN	Rückschlagventil/non-return valve
14.240 HOCL-NL 176 kW (239 PS) D 0836 LOH 52, D 0836 LOH 56	05.2000→		7.01268.03.0	AGR	PN	Rückschlagventil/non-return valve
14.250 HOCL-NL 184 kW (250 PS) D 0836 LOH 61	05.2007→		7.01268.03.0	AGR	PN	Rückschlagventil/non-return valve
14.280 HOCL 206 kW (280 PS) D 0836 LOH 40, D 0836 LOH 51, D 0836 LOH 55	08.2002→12.2014		7.01268.03.0	AGR	PN	Rückschlagventil/non-return valve
14.280 HOCL 206 kW (280 PS) D 0836 LOH 40, D 0836 LOH 55	08.2002→12.2014		7.01268.03.0	AGR	PN	Rückschlagventil/non-return valve
14.290 HOCL-NL 213 kW (290 PS) D 0836 LFL 61	05.2007→		7.01268.03.0	AGR	PN	Rückschlagventil/non-return valve
18.220 HOCL/R-NL, HOCL/SKD(SL) 162-169 kW (220-230 PS) D 0826 LOH 03, D 0826 LOH 04, D 0826 LOH 05, D 0826 LOH 15, D 0826 LOH 17, D 0836 LOH 03	08.1993→05.2001		7.01268.03.0	AGR	PN	Rückschlagventil/non-return valve
18.240 HOCL-NL 176 kW (239 PS) D 0836 LOH 52, D 0836 LOH 56	08.2002→10.2009		7.01268.03.0	AGR	PN	Rückschlagventil/non-return valve
18.250 HOCL-NL, HOCL-SKD(SL) 184 kW (250 PS) D 0826 LOH 10, D 0836 LOH 61	08.1993→05.2001		7.01268.03.0	AGR	PN	Rückschlagventil/non-return valve
18.280 HOCL-NL 206 kW (280 PS) D 0836 LOH 01, D 0836 LOH 02, D 0836 LOH 51, D 0836 LOH 55	05.2002→08.2008		7.01268.03.0	AGR	PN	Rückschlagventil/non-return valve
18.290 HOCL-NL 213 kW (290 PS) D 0836 LOH 60	05.2007→12.2014		7.01268.03.0	AGR	PN	Rückschlagventil/non-return valve
18.310 HOCL-NL 228 kW (310 PS) D 2066 LUH 07, D 2066 LUH 12, D 2066 LUH 22	01.2006→10.2009		7.01268.03.0	AGR	PN	Rückschlagventil/non-return valve
18.320 HOCL-NL 235 kW (320 PS) D 2066 LUH 42	05.2007→12.2014		7.01268.03.0	AGR	PN	Rückschlagventil/non-return valve
18.360 HOCL 265 kW (360 PS) D 2066 LOH 02, D 2066 LOH 06, D 2066 LOH 27	01.2006→12.2014		7.01268.03.0	AGR	PN	Rückschlagventil/non-return valve
18.400 HOCL 294 kW (400 PS) D 2066 LOH 03, D 2066 LOH 28	01.2006→12.2014		7.01268.03.0	AGR	PN	Rückschlagventil/non-return valve





























M

HOCL **24**

18.430 HOCL 316 kW (430 PS) D 2066 LOH 10	01.2006→10.2009		7.01268.03.0	AGR	PN	Rückschlagventil/non-return valve
18.440 HOCL 324 kW (440 PS) D 2066 LOH 04, D 2066 LOH 08	01.2006→10.2009		7.01268.03.0	AGR	PN	Rückschlagventil/non-return valve
18.460 HOCL 338 kW (460 PS) D 2676 LOH 10	03.2006→10.2009		7.01268.03.0	AGR	PN	Rückschlagventil/non-return valve
18.480 HOCL 353 kW (480 PS) D 2676 LOH 04, D 2676 LOH 27	05.2007→12.2014		7.01268.03.0	AGR	PN	Rückschlagventil/non-return valve
24.440 HOCLN 324 kW (440 PS) D 2066 LOH 04, D 2066 LOH 08	01.2006→10.2009		7.01268.03.0	AGR	PN	Rückschlagventil/non-return valve
24.440 HOCLN 316 kW (430 PS) D 2066 LOH 10	01.2006→10.2009		7.01268.03.0	AGR	PN	Rückschlagventil/non-return valve
24.460 HOCLN 338 kW (460 PS) D 2676 LOH 18	03.2006→12.2014		7.01268.03.0	AGR	PN	Rückschlagventil/non-return valve
24.480 HOCLN 353 kW (480 PS) D 2676 LOH 04	05.2007→12.2014		7.01268.03.0	AGR	PN	Rückschlagventil/non-return valve

L2000 **25**
M

10.225 LAC, LAEC, LARC, LAERC (LE220C) 162 kW (220 PS) D 0836 LFL 02	09.2000→		7.01268.03.0	AGR	PN	Rückschlagventil/non-return valve
10.225 LAEK, LAEK-L, LAERK, LAERK-L, LAK, LAK-L, LARK 162 kW (220 PS) D 0836 LFL 02	09.2000→		7.01268.03.0	AGR	PN	Rückschlagventil/non-return valve
10.225 LC, 10.225 LLC, LRC, LLRC 162 kW (220 PS) D 0836 LFL 02	09.2000→		7.01268.03.0	AGR	PN	Rückschlagventil/non-return valve
10.225 LC, 10.225 LLC, LRC, LLRC (LE220C) 162 kW (220 PS) D 0836 LFL 02	09.2000→		7.01268.03.0	AGR	PN	Rückschlagventil/non-return valve
10.225 LK, L-KI, LRK, LR-KI, LRK-L, LK-L (LE220C) 162 kW (220 PS) D 0836 LFL 02	09.2000→		7.01268.03.0	AGR	PN	Rückschlagventil/non-return valve
10.225 LLS, LLRS (LE220C) 162 kW (220 PS) D 0836 LFL 02	09.2000→		7.01268.03.0	AGR	PN	Rückschlagventil/non-return valve
8.225 LAC, LAEC, LARC, LAERC (LE220C) 162 kW (220 PS) D 0836 LFL 02	09.2000→		7.01268.03.0	AGR	PN	Rückschlagventil/non-return valve
8.225 LAEK, LAEK-L, LAERK, LAERK-L, LAK, LAK-L, LARK, LARK-L 162 kW (220 PS) D 0836 LFL 02	09.2000→		7.01268.03.0	AGR	PN	Rückschlagventil/non-return valve
8.225 LC, 8.225 LLC, LRC, LLRC (LE220C) 162 kW (220 PS) D 0826 LFL10, D 0836 LFL 02	09.2000→		7.01268.03.0	AGR	PN	Rückschlagventil/non-return valve
8.225 LK, L-KI, LRK, LR-KI, LRK-L, LK-L (LE220C) 162 kW (220 PS) D 0836 LFL 02	09.2000→		7.01268.03.0	AGR	PN	Rückschlagventil/non-return valve
8.225 LLS, LLRS (LE220C) 162 kW (220 PS) D 0836 LFL 02	09.2000→		7.01268.03.0	AGR	PN	Rückschlagventil/non-return valve
9.225 LC, 9.225 LLC, LRC, LLRC (LE220C) 162 kW (220 PS) D 0836 LFL 02	09.2000→		7.01268.03.0	AGR	PN	Rückschlagventil/non-return valve

						
L2000						25
9.225 LK, L-KI, LRK, LR-KI, LRK-KI, LK-L (LE220C) 162 kW (220 PS) D 0836 LFL 02	09.2000→		7.01268.03.0	AGR	PN	Rückschlagventil/non-return valve
9.225 LLS, LLRS (LE220C) 162 kW (220 PS) D 0836 LFL 02	09.2000→		7.01268.03.0	AGR	PN	Rückschlagventil/non-return valve
LION´S CITY						26
19.240 176 kW (239 PS) D 0836 LOH 52, D 0836 LOH 56, D 0836 LOH 58, D 0836 LUH 41	05.2004→10.2009		7.01268.03.0	AGR	PN	Rückschlagventil/non-return valve
19.280 206 kW (280 PS) D 0836 LOH 40, D 0836 LOH 50, D 0836 LOH 51, D 0836 LOH 55, D 0836 LOH 57, D 0836 LUH 40	05.2004→		7.01268.03.0	AGR	PN	Rückschlagventil/non-return valve
19.290 209-213 kW (284-290 PS) D 0836 LOH 60, D 0836 LOH 64, D 0836 LOH 66	05.2004→		7.01268.03.0	AGR	PN	Rückschlagventil/non-return valve
A 22 206 kW (280 PS) D 2066 LUH 46	10.2009→		7.01268.03.0	AGR	PN	Rückschlagventil/non-return valve
A 22 235 kW (320 PS) D 2066 LUH 47	10.2009→		7.01268.03.0	AGR	PN	Rückschlagventil/non-return valve
A 22 265 kW (360 PS) D 2066 LUH 48	10.2009→		7.01268.03.0	AGR	PN	Rückschlagventil/non-return valve
A 26 265 kW (360 PS) D 2866 LUH 25, D 2866 LUH 29	05.2004→10.2009		7.01268.03.0	AGR	PN	Rückschlagventil/non-return valve
A 35 213 kW (290 PS) D 0836 LOH 60	10.2009→		7.01268.03.0	AGR	PN	Rückschlagventil/non-return valve
A 35 184 kW (250 PS) D 0836 LOH 61	10.2009→		7.01268.03.0	AGR	PN	Rückschlagventil/non-return valve
A 37 206 kW (280 PS) D 0836 LUH 40, D 0836 LUH 50, D 0836 LUH 51	01.2002→10.2009		7.01268.03.0	AGR	PN	Rückschlagventil/non-return valve
A 39 228 kW (310 PS) D 2866 LUH 24, D 2866 LUH 51	08.2004→		7.01268.03.0	AGR	PN	Rückschlagventil/non-return valve
A 66 184 kW (250 PS) D 0836 LOH 61	02.2009→		7.01268.03.0	AGR	PN	Rückschlagventil/non-return valve
A 66 213 kW (290 PS) D 0836 LOH 60	02.2009→		7.01268.03.0	AGR	PN	Rückschlagventil/non-return valve
LION´S COACH						27
400 294 kW (400 PS) D 2066 LOH 32	10.2015→		7.01268.03.0	AGR	PN	Rückschlagventil/non-return valve
440 324 kW (440 PS) D 2676 LOH 30	10.2015→		7.01268.03.0	AGR	PN	Rückschlagventil/non-return valve
C 440, L 440 324 kW (440 PS) D 2676 LOH 30	10.2015→		7.01268.03.0	AGR	PN	Rückschlagventil/non-return valve
C 480, L 480 353 kW (480 PS) D 2676 LOH 31	10.2015→		7.01268.03.0	AGR	PN	Rückschlagventil/non-return valve
LION´S REGIO						28
320, C 320 235 kW (320 PS) D 2066 LUH 51	01.2015→		7.01268.03.0	AGR	PN	Rückschlagventil/non-return valve
360, C 360 265 kW (360 PS) D 2066 LUH 52	01.2015→		7.01268.03.0	AGR	PN	Rückschlagventil/non-return valve
400, C 400 294 kW (400 PS) D 2066 LUH 53	01.2015→		7.01268.03.0	AGR	PN	Rückschlagventil/non-return valve
L 320 235 kW (320 PS) D 2066 LUH 51	01.2015→		7.01268.03.0	AGR	PN	Rückschlagventil/non-return valve

M

						
LION ´S REGIO						28
L 360 265 kW (360 PS) D 2066 LUH 52	01.2015→		7.01268.03.0	AGR	PN	Rückschlagventil/non-return valve
L 400 294 kW (400 PS) D 2066 LUH 53	01.2015→		7.01268.03.0	AGR	PN	Rückschlagventil/non-return valve
LION ´S STAR						29
RH 464, RHS 464 338 kW (460 PS) D 2876 LOH 03	06.2001→04.2007		7.22841.08.0	AGR	PN	Rückschlagventil/non-return valve
M 2000 L						30
12.225 LC, LLC, LLLC, LRC, LLRC 162 kW (220 PS) D 0836 LFL 02	05.2001→		7.01268.03.0	AGR	PN	Rückschlagventil/non-return valve
12.255 LC, LLC, LLLC, LLRC, LRC 180 kW (245 PS) D 0836 LFL 05	08.2002→		7.01268.03.0	AGR	PN	Rückschlagventil/non-return valve
12.255 LK, LRK 180 kW (245 PS) D 0836 LFL 05	10.2003→		7.01268.03.0	AGR	PN	Rückschlagventil/non-return valve
12.285 LC, LLC, LLLC, LLRC, LRC 206-215 kW (280-292 PS) D 0836 LFL 01	08.2002→		7.01268.03.0	AGR	PN	Rückschlagventil/non-return valve
12.285 LK, LRK 206-215 kW (280-292 PS) D 0836 LFL 01, D 0836 LFL 03	10.2003→		7.01268.03.0	AGR	PN	Rückschlagventil/non-return valve
14.225 LAC, LARC, (LE220B) 162 kW (220 PS) D 0836 LFL 02	09.2000→		7.01268.03.0	AGR	PN	Rückschlagventil/non-return valve
M 14.225 LAK, LARK, LAK-L, (LE220B) 162 kW (220 PS) D 0836 LFL 02	09.2000→		7.01268.03.0	AGR	PN	Rückschlagventil/non-return valve
14.225 LC, LLC, LLLC, LRC, LLRC, LLLRC (LE220B) 162 kW (220 PS) D 0836 LFL 02	09.2000→		7.01268.03.0	AGR	PN	Rückschlagventil/non-return valve
14.225 LK, LRK (LE220B) 162 kW (220 PS) D 0836 LFL 02	09.2000→		7.01268.03.0	AGR	PN	Rückschlagventil/non-return valve
14.255 LAC, LARC 180 kW (245 PS) D 0836 LFL 05	11.2002→		7.01268.03.0	AGR	PN	Rückschlagventil/non-return valve
14.255 LAK, LARK, LAK-L 180 kW (245 PS) D 0836 LFL 05	11.2002→		7.01268.03.0	AGR	PN	Rückschlagventil/non-return valve
14.255 LC, LLC, LLLC, LRC, LLRC, LLLRC (LE250B) 180 kW (245 PS) D 0836 LFL 05	09.2000→		7.01268.03.0	AGR	PN	Rückschlagventil/non-return valve
14.255 LK, LRK 180 kW (245 PS) D 0836 LFL 05	11.2002→		7.01268.03.0	AGR	PN	Rückschlagventil/non-return valve
14.285 LC, LLC, LLLC, LRC, LLRC, LLLRC, (LE280B) 206 kW (280 PS) D 0836 LFL 03	09.2000→		7.01268.03.0	AGR	PN	Rückschlagventil/non-return valve
15.225 LC, LLC, LLLC, LRC, LLRC, LLLRC, (LE220B) 162 kW (220 PS) D 0836 LFL 02	09.1999→		7.01268.03.0	AGR	PN	Rückschlagventil/non-return valve
15.225 LK, LRK, LK-L, (LE220B) 162 kW (220 PS) D 0836 LFL 02	09.1999→		7.01268.03.0	AGR	PN	Rückschlagventil/non-return valve







M 2000 L
30

15.255 LC, LLC, LLLC, LRC, LLRC, LLLRC, (LE250B) 180 kW (245 PS) D 0836 LFL 05	09.1999→		7.01268.03.0	AGR	PN	Rückschlagventil/non-return valve
15.255 LK, LRK, LK-L, (LE250B) 180 kW (245 PS) D 0836 LFL 05	09.1999→		7.01268.03.0	AGR	PN	Rückschlagventil/non-return valve
15.285 LC, LLC, LLLC, LRC, LLRC, LLLRC, (LE280B) 206 kW (280 PS) D 0836 LFL 03	09.1999→		7.01268.03.0	AGR	PN	Rückschlagventil/non-return valve
15.285 LK, LRK, LK-L, (LE280B) 206 kW (280 PS) D 0836 LFL 03	09.1999→		7.01268.03.0	AGR	PN	Rückschlagventil/non-return valve
18.224, 18.225, LAC, LARC 162 kW (220 PS) D 0826 LFL03, D 0826 LFL10, D 0836 LFL 02	08.1995→		7.01268.03.0	AGR	PN	Rückschlagventil/non-return valve
18.224, 18.225, LC, LLC, LLLC, LRC, LLRC, LLLRC 162 kW (220 PS) D 0826 LFL03, D 0826 LFL10, D 0836 LFL 02	08.1995→09.2001		7.01268.03.0	AGR	PN	Rückschlagventil/non-return valve
18.255 LAC, LARC 180 kW (245 PS) D 0836 LFL 05	05.2001→		7.01268.03.0	AGR	PN	Rückschlagventil/non-return valve
18.255 LAK, LARK, LAK-L 180 kW (245 PS) D 0836 LFL 05	05.2001→		7.01268.03.0	AGR	PN	Rückschlagventil/non-return valve
18.255 LC, LLC, LLLC, LRC, LLRC, LLLRC, (LE250B) 180 kW (245 PS) D 0836 LFL 05	09.1999→		7.01268.03.0	AGR	PN	Rückschlagventil/non-return valve
18.255 LK, LK-L, LLK, LLK-L, LLRK, LRK 180 kW (245 PS) D 0836 LFL 05	11.2002→		7.01268.03.0	AGR	PN	Rückschlagventil/non-return valve
18.285 LAC, LARC (LE280B) 206 kW (280 PS) D 0836 LFL 03	09.1999→		7.01268.03.0	AGR	PN	Rückschlagventil/non-return valve
18.285 LAK, LARK, LAK-L, (LE280B) 206 kW (280 PS) D 0836 LFL 03	09.1999→		7.01268.03.0	AGR	PN	Rückschlagventil/non-return valve
18.285 LC, LLC, LLLC, LRC, LLRC, LLLRC, (LE280B) 206 kW (280 PS) D 0836 LFL 03	09.1999→		7.01268.03.0	AGR	PN	Rückschlagventil/non-return valve
19.224, 19.225, LC, LLC, LLLC, LLLRC, LLRC, LRC 162 kW (220 PS) D 0826 LFL03, D 0826 LFL06, D 0826 LFL08, D 0826 LFL10, D 0836 LFL 02	05.2001→		7.01268.03.0	AGR	PN	Rückschlagventil/non-return valve
19.255 LC, LLC, LLLC, LLLRC, LLRC, LRC 180 kW (245 PS) D 0836 LFL 05	05.2001→		7.01268.03.0	AGR	PN	Rückschlagventil/non-return valve
19.284, 19.285, LC, LLC, LLLC, LLLRC, LLRC, LRC 206 kW (280 PS) D 0836 LFL 03	05.2001→		7.01268.03.0	AGR	PN	Rückschlagventil/non-return valve

M



M 2000 L **30**





20.224 LNLC, LNLLC 162 kW (220 PS) D 0826 LFL03, D 0826 LFL06, D 0826 LFL08, D 0826 LFL10, D 0836 LFL 02	05.2001→		7.01268.03.0	AGR	PN	Rückschlagventil/non-return valve
20.224, 20.225 LNLC, LNLLC 162 kW (220 PS) D 0826 LFL03, D 0826 LFL06, D 0826 LFL08, D 0826 LFL10, D 0836 LFL 02	05.2001→		7.01268.03.0	AGR	PN	Rückschlagventil/non-return valve
20.255 LNLC, LNLLC 180 kW (245 PS) D 0836 LFL 05	05.2001→		7.01268.03.0	AGR	PN	Rückschlagventil/non-return valve
20.284, 20.285, LNLC, LNLLC 206-215 kW (280-292 PS) D 0836 LFL 01, D 0836 LFL 03	05.2001→		7.01268.03.0	AGR	PN	Rückschlagventil/non-return valve
26.255 DL-HK, DLR-HK 180 kW (245 PS) D 0836 LFL 05	11.2002→		7.01268.03.0	AGR	PN	Rückschlagventil/non-return valve
26.284, 26.285, DL-HK, DLR-HK 206-215 kW (280-292 PS) D 0836 LFL 01, D 0836 LFL 03	11.2002→		7.01268.03.0	AGR	PN	Rückschlagventil/non-return valve

M 2000 M **31**







M

14.225 MC, MLC, MLLC, MLRC, MRC, MLLRC 162 kW (220 PS) D 0836 LF 02, D 0836 LF 04	10.2000→12.2005		7.01268.03.0	AGR	PN	Rückschlagventil/non-return valve
14.225 MLS, MLRS 162 kW (220 PS) D 0836 LF 04	02.2003→12.2005		7.01268.03.0	AGR	PN	Rückschlagventil/non-return valve
14.285 MC, MLC, MLLC, MLRC, MRC, MLLRC (ME280C) 132-206 kW (180-280 PS) D 0834 LF 03, D 0836 LFL 03	09.1999→12.2005		7.01268.03.0	AGR	PN	Rückschlagventil/non-return valve
14.285 MLS, MLRS 206 kW (280 PS) D 0836 LF 03	02.2003→12.2005		7.01268.03.0	AGR	PN	Rückschlagventil/non-return valve
18.225 MAC, MARC 162 kW (220 PS) D 0836 LF 04	02.2003→12.2005		7.01268.03.0	AGR	PN	Rückschlagventil/non-return valve
18.225 MC, MLC, MLLC, MRC, MLRC, MLLRC 162 kW (220 PS) D 0836 LF 04	10.2000→12.2005		7.01268.03.0	AGR	PN	Rückschlagventil/non-return valve
18.285 MAC, MARC 206 kW (280 PS) D 0836 LF 03	02.2003→12.2005		7.01268.03.0	AGR	PN	Rückschlagventil/non-return valve
18.285 MC, MLC, MLLC, MLRC, MRC, MLLRC 206 kW (280 PS) D 0836 LF 03	06.1998→12.2005		7.01268.03.0	AGR	PN	Rückschlagventil/non-return valve
18.285 MLS, MLRS 206 kW (280 PS) D 0836 LF 03	02.2003→12.2005		7.01268.03.0	AGR	PN	Rückschlagventil/non-return valve
25.225 MNLC, MNLLC, MNLRC, MNLLRC, MVLC 162 kW (220 PS) D 0836 LF 04, D 0836 LFL 02	02.2003→12.2005		7.01268.03.0	AGR	PN	Rückschlagventil/non-return valve
25.225 MNLC, MNLLC, MNLRC, MNLLRC, MVLC 162 kW (220 PS) D 0836 LF 04, D 0836 LFL 02	02.2003→12.2005		7.01268.03.0	AGR	PN	Rückschlagventil/non-return valve









M 2000 M
31

25.255 MNLRC, MNLLC, MNLRC, MNLLRC, MVLC 180 kW (245 PS) D 0836 LF 05, D 0836 LFL 05	10.2000→12.2005		7.01268.03.0	AGR	PN	Rückschlagventil/non-return valve
25.255 MNLRC, MNLLC, MNLRC, MNLLRC, MVLC 180 kW (245 PS) D 0836 LF 05, D 0836 LFL 05	10.2000→12.2005		7.01268.03.0	AGR	PN	Rückschlagventil/non-return valve
25.285 MNLRC, MNLLC, MNLRC, MNLLRC, MVLC 206 kW (280 PS) D 0836 LF 03, D 0836 LFL 03	02.2003→12.2005		7.01268.03.0	AGR	PN	Rückschlagventil/non-return valve
25.285 MNLRC, MNLLC, MNLRC, MNLLRC, MVLC 206 kW (280 PS) D 0836 LF 03, D 0836 LFL 03	02.2003→12.2005		7.01268.03.0	AGR	PN	Rückschlagventil/non-return valve





NG
32





























273 199 kW (271 PS) D 2066 LUH 11	09.2007→		7.01268.03.0	AGR	PN	Rückschlagventil/non-return valve
333 265 kW (360 PS) D 2866 LUH 25	01.2001→		7.01268.03.0	AGR	PN	Rückschlagventil/non-return valve
363 265 kW (360 PS) D 2866 LUH 25	01.2001→		7.01268.03.0	AGR	PN	Rückschlagventil/non-return valve
NG 313 228 kW (310 PS) E 2876 LUH 02	05.2007→12.2014		7.01268.03.0	AGR	PN	Rückschlagventil/non-return valve
NG 323 235 kW (320 PS) D 2066 LUH 42	05.2007→12.2014		7.01268.03.0	AGR	PN	Rückschlagventil/non-return valve
NG 353 257 kW (350 PS) D 2066 LUH 13, D 2066 LUH 23	05.2007→12.2014		7.01268.03.0	AGR	PN	Rückschlagventil/non-return valve
NG 363 265 kW (360 PS) D 2066 LUH 48	05.2007→12.2014		7.01268.03.0	AGR	PN	Rückschlagventil/non-return valve

M
NL
33

283 206 kW (280 PS) D 0836 LOH 40, D 0836 LUH 40	01.2002→		7.01268.03.0	AGR	PN	Rückschlagventil/non-return valve
313 (EEV) 235 kW (320 PS) D 2066 LUH 47	09.2009→		7.01268.03.0	AGR	PN	Rückschlagventil/non-return valve
363 265 kW (360 PS) D 2866 LUH 25	01.2001→		7.01268.03.0	AGR	PN	Rückschlagventil/non-return valve
363 (EEV) 265 kW (360 PS) D 2066 LUH 48	09.2009→		7.01268.03.0	AGR	PN	Rückschlagventil/non-return valve
NL 273 199 kW (271 PS) D 2066 LUH 11	01.2006→10.2009		7.01268.03.0	AGR	PN	Rückschlagventil/non-return valve
NL 283 206 kW (280 PS) D 2066 LUH 41	08.2012→		7.01268.03.0	AGR	PN	Rückschlagventil/non-return valve
NL 313 228 kW (310 PS) D 2066 LUH 12, D 2066 LUH 22	01.2006→10.2009		7.01268.03.0	AGR	PN	Rückschlagventil/non-return valve
NL 323 235 kW (320 PS) D 2066 LUH 42	05.2007→		7.01268.03.0	AGR	PN	Rückschlagventil/non-return valve

NM
34

NM 243 176 kW (239 PS) D 0836 LOH 52, D 0836 LOH 56	08.2002→10.2009		7.01268.03.0	AGR	PN	Rückschlagventil/non-return valve
NM 253 184 kW (250 PS) D 0836 LOH 61	05.2007→06.2014		7.01268.03.0	AGR	PN	Rückschlagventil/non-return valve
NM 283 206 kW (280 PS) D 0836 LOH 51, D 0836 LOH 55	08.2002→10.2009		7.01268.03.0	AGR	PN	Rückschlagventil/non-return valve
NM 293 213 kW (290 PS) D 0836 LOH 60	05.2007→06.2014		7.01268.03.0	AGR	PN	Rückschlagventil/non-return valve

							
NÜ						35	
363 265 kW (360 PS) D 2866 LUH 25	01.2001→		7.01268.03.0	AGR	PN	Rückschlagventil/non-return valve	
SERIES FE						36	
310 228 kW (310 PS) D 2866 LF23	07.1999→08.2002		7.22841.08.0	AGR	PN	Rückschlagventil/non-return valve	
35.310 228 kW (310 PS) D 2866 LF23	09.2002→09.2003		7.22841.08.0	AGR	PN	Rückschlagventil/non-return valve	
360 265 kW (360 PS) D 2866 LF24	01.2000→09.2002		7.22841.08.0	AGR	PN	Rückschlagventil/non-return valve	
460 338 kW (460 PS) D 2876 LF 03	01.2000→09.2002		7.22841.08.0	AGR	PN	Rückschlagventil/non-return valve	
SERIES RHC						37	
464 338 kW (460 PS) D 2876 LOH 03	09.2002→		7.22841.08.0	AGR	PN	Rückschlagventil/non-return valve	
SERIES RHS						38	
464 338 kW (460 PS) D 2876 LOH 03	10.2001→		7.22841.08.0	AGR	PN	Rückschlagventil/non-return valve	
SERIES TG						39	
460 338 kW (460 PS) D 2876 LF 04	03.1999→08.2002		7.22841.08.0	AGR	PN	Rückschlagventil/non-return valve	
510 375 kW (510 PS) D 2876 LF 05	03.1999→08.2002		7.22841.08.0	AGR	PN	Rückschlagventil/non-return valve	
SG						40	
M	263 191-228 kW (260-310 PS) D 2866 LUH 23, D 2866 LUH 24	06.2003→		7.01268.03.0	AGR	PN	Rückschlagventil/non-return valve
	313 228 kW (310 PS) D 2866 LUH 24	06.2004→		7.01268.03.0	AGR	PN	Rückschlagventil/non-return valve
SL II						41	
SL 283 206 kW (280 PS) D 0836 LOH 55	07.2005→10.2006		7.01268.03.0	AGR	PN	Rückschlagventil/non-return valve	
SL 353 257 kW (350 PS) D 2066 LOH 12, D 2066 LOH 13	01.2006→10.2009		7.01268.03.0	AGR	PN	Rückschlagventil/non-return valve	
SL 363 265 kW (360 PS) D 2066 LOH 27	05.2007→05.2014		7.01268.03.0	AGR	PN	Rückschlagventil/non-return valve	
SÜ						42	
363 265 kW (360 PS) D 2866 LUH 25	06.2004→12.2004		7.01268.03.0	AGR	PN	Rückschlagventil/non-return valve	
383 265 kW (360 PS) D 2866 LUH 25	06.2004→		7.01268.03.0	AGR	PN	Rückschlagventil/non-return valve	
SÜ 243 176 kW (239 PS) D 0836 LOH 56	06.2005→10.2009		7.01268.03.0	AGR	PN	Rückschlagventil/non-return valve	
SÜ 263 265 kW (360 PS) D 2866 LUH 25	09.2003→		7.01268.03.0	AGR	PN	Rückschlagventil/non-return valve	
SÜ 263 191 kW (260 PS) D 0836 LOH 62	06.2005→10.2009		7.01268.03.0	AGR	PN	Rückschlagventil/non-return valve	
SÜ 273 199 kW (271 PS) D 2066 LUH 11, D 2066 LUH 21	01.2006→10.2009		7.01268.03.0	AGR	PN	Rückschlagventil/non-return valve	
SÜ 283 206 kW (280 PS) D 0836 LOH 02, D 0836 LOH 51, D 0836 LOH 55	09.2003→		7.01268.03.0	AGR	PN	Rückschlagventil/non-return valve	
SÜ 293 213 kW (290 PS) D 0836 LOH 60	09.2003→		7.01268.03.0	AGR	PN	Rückschlagventil/non-return valve	
SÜ 313 228 kW (310 PS) D 2866 LUH 24	06.2004→		7.01268.03.0	AGR	PN	Rückschlagventil/non-return valve	
SÜ 313 228 kW (310 PS) D 2066 LUH 12, D 2066 LUH 22	01.2006→10.2009		7.01268.03.0	AGR	PN	Rückschlagventil/non-return valve	



SÜ						42
SÜ 320 235 kW (320 PS) D 2066 LUH 32	09.2003→		7.01268.03.0	AGR	PN	Rückschlagventil/non-return valve
SÜ 353 257 kW (350 PS) D 2066 LUH 13, D 2066 LUH 23	01.2006→10.2009		7.01268.03.0	AGR	PN	Rückschlagventil/non-return valve
SÜ 360 265 kW (360 PS) D 2066 LUH 33	05.2007→		7.01268.03.0	AGR	PN	Rückschlagventil/non-return valve
TGA						43
18.310, 18.320 228 kW (310 PS) D 2866 LF26	09.2002→		7.22841.08.0	AGR	PN	Rückschlagventil/non-return valve
18.310, 18.320 228-235 kW (310-320 PS) D 2066 LF 14, D 2066 LF 35	05.2004→		7.01268.03.0	AGR	PN	Rückschlagventil/non-return valve
18.310, 18.320 228-235 kW (310-320 PS) D 2066 LF 04, D 2066 LF 14, D 2066 LF 35, D 2066 LF 39	05.2004→		7.01268.03.0	AGR	PN	Rückschlagventil/non-return valve
18.310, 18.320 228-235 kW (310-320 PS) D 2066 LF 04, D 2066 LF 14, D 2066 LF 35, D 2066 LF 39	05.2004→		7.01268.03.0	AGR	PN	Rückschlagventil/non-return valve
18.310, 18.320 228-235 kW (310-320 PS) D 2066 LF 04, D 2066 LF 14, D 2066 LF 28, D 2066 LF 35, D 2066 LF 39	05.2004→		7.01268.03.0	AGR	PN	Rückschlagventil/non-return valve
18.310, 18.320 228-235 kW (310-320 PS) D 2066 LF 04, D 2066 LF 14, D 2066 LF 35, D 2066 LF 39	05.2004→		7.01268.03.0	AGR	PN	Rückschlagventil/non-return valve
18.310, 18.320 228-235 kW (310-320 PS) D 2066 LF 04, D 2066 LF 14, D 2066 LF 35, D 2066 LF 39	05.2004→		7.01268.03.0	AGR	PN	Rückschlagventil/non-return valve
18.310, 18.320 228-235 kW (310-320 PS) D 2066 LF 04, D 2066 LF 14, D 2066 LF 35, D 2066 LF 39	05.2004→		7.01268.03.0	AGR	PN	Rückschlagventil/non-return valve
18.350 257 kW (350 PS) D 2066 LF 03, D 2066 LF 13	05.2004→		7.01268.03.0	AGR	PN	Rückschlagventil/non-return valve
18.350, 18.360 257-265 kW (350-360 PS) D 2066 LF 03, D 2066 LF 13, D 2066 LF 33	05.2004→		7.01268.03.0	AGR	PN	Rückschlagventil/non-return valve
18.350, 18.360 257-265 kW (350-360 PS) D 2066 LF 03, D 2066 LF 13, D 2066 LF 33, D 2066 LF 38	05.2004→		7.01268.03.0	AGR	PN	Rückschlagventil/non-return valve
18.350, 18.360 257-265 kW (350-360 PS) D 2066 LF 03, D 2066 LF 13, D 2066 LF 33, D 2066 LF 38	05.2004→		7.01268.03.0	AGR	PN	Rückschlagventil/non-return valve
18.350, 18.360 257-265 kW (350-360 PS) D 2066 LF 03, D 2066 LF 13, D 2066 LF 33, D 2066 LF 38	05.2004→		7.01268.03.0	AGR	PN	Rückschlagventil/non-return valve
18.350, 18.360 257-265 kW (350-360 PS) D 2066 LF 03, D 2066 LF 13, D 2066 LF 33, D 2066 LF 38	05.2004→		7.01268.03.0	AGR	PN	Rückschlagventil/non-return valve
18.350, 18.360 257-265 kW (350-360 PS) D 2066 LF 03, D 2066 LF 13, D 2066 LF 33, D 2066 LF 38	05.2004→		7.01268.03.0	AGR	PN	Rückschlagventil/non-return valve
18.360 265 kW (360 PS) D 2866 LF27	09.2002→		7.22841.08.0	AGR	PN	Rückschlagventil/non-return valve
18.360 265 kW (360 PS) D 2066 LF 07, D 2066 LF 27, D 2066 LF 38	01.2006→		7.01268.03.0	AGR	PN	Rückschlagventil/non-return valve























M

TGA **43**

18.390 287 kW (390 PS) D 2066 LF 02, D 2066 LF 12	05.2004→		7.01268.03.0	AGR	PN	Rückschlagventil/non-return valve
18.390, 18.400 287-294 kW (390-400 PS) D 2066 LF 02, D 2066 LF 12, D 2066 LF 26, D 2066 LF 32, D 2066 LF 37	05.2004→		7.01268.03.0	AGR	PN	Rückschlagventil/non-return valve
18.390, 18.400 287-294 kW (390-400 PS) D 2066 LF 02, D 2066 LF 12, D 2066 LF 32, D 2066 LF 37	05.2004→		7.01268.03.0	AGR	PN	Rückschlagventil/non-return valve
18.390, 18.400 287-294 kW (390-400 PS) D 2066 LF 02, D 2066 LF 12, D 2066 LF 32, D 2066 LF 37	05.2004→		7.01268.03.0	AGR	PN	Rückschlagventil/non-return valve
18.390, 18.400 287-294 kW (390-400 PS) D 2066 LF 02, D 2066 LF 12, D 2066 LF 32, D 2066 LF 37	05.2004→		7.01268.03.0	AGR	PN	Rückschlagventil/non-return valve
18.390, 18.400 287-294 kW (390-400 PS) D 2066 LF 02, D 2066 LF 12, D 2066 LF 32, D 2066 LF 37	05.2004→		7.01268.03.0	AGR	PN	Rückschlagventil/non-return valve
18.400 294 kW (400 PS) D 2066 LF 06, D 2066 LF 26, D 2066 LF 37	10.2005→		7.01268.03.0	AGR	PN	Rückschlagventil/non-return valve
18.410 301 kW (410 PS) D 2866 LF28	09.2002→12.2005		7.22841.08.0	AGR	PN	Rückschlagventil/non-return valve
18.410, 18.420 301 kW (410 PS) D 2866 LF28, D 2866 LF32	04.2000→		7.22841.08.0	AGR	PN	Rückschlagventil/non-return valve
18.430 316 kW (430 PS) D 2066 LF 01, D 2066 LF 11	05.2004→		7.01268.03.0	AGR	PN	Rückschlagventil/non-return valve
18.430, 18.440 316-324 kW (430-440 PS) D 2066 LF 01, D 2066 LF 11, D 2066 LF 31	05.2004→		7.01268.03.0	AGR	PN	Rückschlagventil/non-return valve
18.430, 18.440 316-324 kW (430-440 PS) D 2066 LF 01, D 2066 LF 11, D 2066 LF 31, D 2066 LF 36	05.2004→		7.01268.03.0	AGR	PN	Rückschlagventil/non-return valve
18.430, 18.440 316-324 kW (430-440 PS) D 2066 LF 01, D 2066 LF 11, D 2066 LF 31, D 2066 LF 36	05.2004→		7.01268.03.0	AGR	PN	Rückschlagventil/non-return valve
18.430, 18.440 316-324 kW (430-440 PS) D 2066 LF 01, D 2066 LF 11, D 2066 LF 31, D 2066 LF 36	05.2004→		7.01268.03.0	AGR	PN	Rückschlagventil/non-return valve
18.440 324 kW (440 PS) D 2066 LF 25, D 2066 LF 36	09.2005→		7.01268.03.0	AGR	PN	Rückschlagventil/non-return valve
18.460 338 kW (460 PS) D 2876 LF 04, D 2876 LF 07	04.2000→		7.22841.08.0	AGR	PN	Rückschlagventil/non-return valve
18.480 353 kW (480 PS) D 2876 LF 12	10.2002→		7.22841.08.0	AGR	PN	Rückschlagventil/non-return valve
18.480 353 kW (480 PS) D 2676 LF 01, D 2676 LF 05, D 2676 LF 14	01.2006→		7.01268.03.0	AGR	PN	Rückschlagventil/non-return valve

M

TGA
43















18.480 353 kW (480 PS) D 2676 LF 01, D 2676 LF 05	01.2006→		7.01268.03.0	AGR	PN	Rückschlagventil/non-return valve
18.480 353 kW (480 PS) D 2676 LF 05, D 2676 LF 14	01.2006→		7.01268.03.0	AGR	PN	Rückschlagventil/non-return valve
18.480 353 kW (480 PS) D 2676 LF 01, D 2676 LF 05, D 2676 LF 12	04.2006→		7.01268.03.0	AGR	PN	Rückschlagventil/non-return valve
18.480 353 kW (480 PS) D 2676 LF 01, D 2676 LF 05, D 2676 LF 12	04.2006→		7.01268.03.0	AGR	PN	Rückschlagventil/non-return valve
18.480 353 kW (480 PS) D 2676 LF 01, D 2676 LF 05, D 2676 LF 12	04.2006→		7.01268.03.0	AGR	PN	Rückschlagventil/non-return valve
18.510 375 kW (510 PS) D 2876 LF 05	09.2002→06.2003		7.22841.08.0	AGR	PN	Rückschlagventil/non-return valve
18.530 390 kW (530 PS) D 2876 LF 13	10.2002→		7.22841.08.0	AGR	PN	Rückschlagventil/non-return valve
18.540 397 kW (540 PS) D 2676 LF 13	08.2006→		7.01268.03.0	AGR	PN	Rückschlagventil/non-return valve
18.540 397 kW (540 PS) D 2676 LF 13	08.2006→		7.01268.03.0	AGR	PN	Rückschlagventil/non-return valve
19.350 257 kW (350 PS) D 2066 LF 03	05.2004→		7.01268.03.0	AGR	PN	Rückschlagventil/non-return valve
19.360 265 kW (360 PS) D 2066 LF 07	05.2004→		7.01268.03.0	AGR	PN	Rückschlagventil/non-return valve
19.390 287 kW (390 PS) D 2066 LF 02	05.2004→		7.01268.03.0	AGR	PN	Rückschlagventil/non-return valve
19.430 316 kW (430 PS) D 2066 LF 01	05.2004→		7.01268.03.0	AGR	PN	Rückschlagventil/non-return valve
19.440 324 kW (440-441 PS) D 2676 LF 04	02.2006→		7.01268.03.0	AGR	PN	Rückschlagventil/non-return valve
19.460 338 kW (460 PS) D 2876 LF 07	05.2004→		7.22841.08.0	AGR	PN	Rückschlagventil/non-return valve
19.480 353 kW (480 PS) D 2676 LF 02, D 2676 LF 03	02.2006→		7.01268.03.0	AGR	PN	Rückschlagventil/non-return valve
24.350, 24.360 257-265 kW (350-360 PS) D 2066 LF 03, D 2066 LF 13, D 2066 LF 33, D 2066 LF 38	02.2004→		7.01268.03.0	AGR	PN	Rückschlagventil/non-return valve
24.350, 24.360 257-265 kW (350-360 PS) D 2066 LF 13, D 2066 LF 33	05.2004→		7.01268.03.0	AGR	PN	Rückschlagventil/non-return valve
24.360 265 kW (360 PS) D 2866 LF27	11.2002→		7.22841.08.0	AGR	PN	Rückschlagventil/non-return valve
24.390, 24.400 287-294 kW (390-400 PS) D 2066 LF 02, D 2066 LF 12, D 2066 LF 26, D 2066 LF 32, D 2066 LF 37	05.2004→		7.01268.03.0	AGR	PN	Rückschlagventil/non-return valve
24.390, 24.400 287-294 kW (390-400 PS) D 2066 LF 02, D 2066 LF 12, D 2066 LF 32, D 2066 LF 37	05.2004→		7.01268.03.0	AGR	PN	Rückschlagventil/non-return valve
24.410 301 kW (410 PS) D 2866 LF28	09.2001→05.2004		7.22841.08.0	AGR	PN	Rückschlagventil/non-return valve
24.430, 24.440 316-324 kW (430-440 PS) D 2066 LF 01, D 2066 LF 11, D 2066 LF 23, D 2066 LF 31	05.2004→		7.01268.03.0	AGR	PN	Rückschlagventil/non-return valve

M

TGA **43**

24.430, 24.440 316-324 kW (430-440 PS) D 2066 LF 01, D 2066 LF 11, D 2066 LF 31, D 2066 LF 36	05.2004→		7.01268.03.0	AGR	PN	Rückschlagventil/non-return valve
24.460 338 kW (460 PS) D 2876 LF 04	09.2001→05.2004		7.22841.08.0	AGR	PN	Rückschlagventil/non-return valve
24.480 353 kW (480 PS) D 2876 LF 12	06.2003→		7.22841.08.0	AGR	PN	Rückschlagventil/non-return valve
24.480 353 kW (480 PS) D 2676 LF 01, D 2676 LF 05, D 2676 LF 12, D 2676 LF 14	01.2006→		7.01268.03.0	AGR	PN	Rückschlagventil/non-return valve
24.480 353 kW (480 PS) D 2676 LF 01, D 2676 LF 05, D 2676 LF 12	01.2006→		7.01268.03.0	AGR	PN	Rückschlagventil/non-return valve
24.510 375 kW (510 PS) D 2876 LF 05	11.2002→06.2003		7.22841.08.0	AGR	PN	Rückschlagventil/non-return valve
24.530 390 kW (530 PS) D 2876 LF 13	12.2002→		7.22841.08.0	AGR	PN	Rückschlagventil/non-return valve
24.540 397 kW (540 PS) D 2676 LF 11, D 2676 LF 13	01.2006→		7.01268.03.0	AGR	PN	Rückschlagventil/non-return valve
26.280 206 kW (280 PS) D 0836 LF 41	03.2003→09.2004		7.01268.03.0	AGR	PN	Rückschlagventil/non-return valve
26.310 228 kW (310 PS) D 2866 LF26	09.2000→		7.22841.08.0	AGR	PN	Rückschlagventil/non-return valve
26.310 228 kW (310 PS) D 2066 LF 04	02.2004→		7.01268.03.0	AGR	PN	Rückschlagventil/non-return valve
M 26.310 228 kW (310 PS) D 2066 LF 04	02.2004→		7.01268.03.0	AGR	PN	Rückschlagventil/non-return valve
26.310 228 kW (310 PS) D 2066 LF 04	02.2004→		7.01268.03.0	AGR	PN	Rückschlagventil/non-return valve
26.310, 26.320 228-235 kW (310-320 PS) D 2066 LF 04, D 2066 LF 14, D 2066 LF 35, D 2066 LF 39	02.2004→		7.01268.03.0	AGR	PN	Rückschlagventil/non-return valve
26.310, 26.320 228-235 kW (310-320 PS) D 2066 LF 14, D 2066 LF 35	05.2004→		7.01268.03.0	AGR	PN	Rückschlagventil/non-return valve
26.310, 26.320 228-235 kW (310-320 PS) D 2066 LF 04, D 2066 LF 14, D 2066 LF 35, D 2066 LF 39	05.2004→		7.01268.03.0	AGR	PN	Rückschlagventil/non-return valve
26.310, 26.320 228-235 kW (310-320 PS) D 2066 LF 04, D 2066 LF 14, D 2066 LF 35, D 2066 LF 39	05.2004→		7.01268.03.0	AGR	PN	Rückschlagventil/non-return valve
26.310, 26.320 228-235 kW (310-320 PS) D 2066 LF 04, D 2066 LF 14, D 2066 LF 35, D 2066 LF 39	05.2004→		7.01268.03.0	AGR	PN	Rückschlagventil/non-return valve
26.310, 26.320 228-235 kW (310-320 PS) D 2066 LF 04, D 2066 LF 14, D 2066 LF 35, D 2066 LF 39	05.2004→		7.01268.03.0	AGR	PN	Rückschlagventil/non-return valve
26.310, 26.320 228-235 kW (310-320 PS) D 2066 LF 04, D 2066 LF 14, D 2066 LF 35, D 2066 LF 39	05.2004→		7.01268.03.0	AGR	PN	Rückschlagventil/non-return valve
26.310, 26.320 228-235 kW (310-320 PS) D 2066 LF 04, D 2066 LF 35, D 2066 LF 39	06.2005→		7.01268.03.0	AGR	PN	Rückschlagventil/non-return valve























TGA
43

26.310, 26.320 228-235 kW (310-320 PS) D 2066 LF 04, D 2066 LF 35, D 2066 LF 39	06.2005→	 7.01268.03.0	AGR	PN	Rückschlagventil/non-return valve
26.310, 26.320 228-235 kW (310-320 PS) D 2066 LF 04, D 2066 LF 35, D 2066 LF 39	06.2005→	 7.01268.03.0	AGR	PN	Rückschlagventil/non-return valve
26.320 235 kW (320 PS) D 2066 LF 39	04.2006→	 7.01268.03.0	AGR	PN	Rückschlagventil/non-return valve
26.320 235 kW (320 PS) D 2066 LF 39	04.2006→	 7.01268.03.0	AGR	PN	Rückschlagventil/non-return valve
26.320 235 kW (320 PS) D 2066 LF 39	04.2006→	 7.01268.03.0	AGR	PN	Rückschlagventil/non-return valve
26.330 240 kW (326 PS) D 0836 LF 44	11.2002→09.2004	 7.01268.03.0	AGR	PN	Rückschlagventil/non-return valve
26.350 257 kW (350 PS) D 2066 LF 03, D 2066 LF 13	02.2004→	 7.01268.03.0	AGR	PN	Rückschlagventil/non-return valve
26.350 257 kW (350 PS) D 2066 LF 03, D 2066 LF 13	02.2004→	 7.01268.03.0	AGR	PN	Rückschlagventil/non-return valve
26.350 257 kW (350 PS) D 2066 LF 03, D 2066 LF 13	02.2004→	 7.01268.03.0	AGR	PN	Rückschlagventil/non-return valve
26.350 257 kW (350 PS) D 2066 LF 03, D 2066 LF 13	04.2005→	 7.01268.03.0	AGR	PN	Rückschlagventil/non-return valve
26.350 257 kW (350 PS) D 2066 LF 03	04.2005→	 7.01268.03.0	AGR	PN	Rückschlagventil/non-return valve
26.350 257 kW (350 PS) D 2066 LF 13	06.2005→	 7.01268.03.0	AGR	PN	Rückschlagventil/non-return valve
26.350 257 kW (350 PS) D 2066 LF 03, D 2066 LF 13	07.2005→	 7.01268.03.0	AGR	PN	Rückschlagventil/non-return valve
26.350 257 kW (350 PS) D 2066 LF 13	07.2005→	 7.01268.03.0	AGR	PN	Rückschlagventil/non-return valve
26.350, 26.360 257-265 kW (350-360 PS) D 2066 LF 03, D 2066 LF 13, D 2066 LF 27, D 2066 LF 33, D 2066 LF 38	05.2004→	 7.01268.03.0	AGR	PN	Rückschlagventil/non-return valve
26.350, 26.360 257-265 kW (350-360 PS) D 2066 LF 03, D 2066 LF 13, D 2066 LF 33, D 2066 LF 38	05.2004→	 7.01268.03.0	AGR	PN	Rückschlagventil/non-return valve
26.350, 26.360 257-265 kW (350-360 PS) D 2066 LF 03, D 2066 LF 07, D 2066 LF 13, D 2066 LF 33, D 2066 LF 38	05.2004→	 7.01268.03.0	AGR	PN	Rückschlagventil/non-return valve
26.350, 26.360 257-265 kW (350-360 PS) D 2066 LF 03, D 2066 LF 13, D 2066 LF 33, D 2066 LF 38	05.2004→	 7.01268.03.0	AGR	PN	Rückschlagventil/non-return valve
26.350, 26.360 257-265 kW (350-360 PS) D 2066 LF 03, D 2066 LF 07, D 2066 LF 13, D 2066 LF 33, D 2066 LF 38	05.2004→	 7.01268.03.0	AGR	PN	Rückschlagventil/non-return valve
26.350, 26.360 257-265 kW (350-360 PS) D 2066 LF 03, D 2066 LF 13, D 2066 LF 33, D 2066 LF 38	05.2004→	 7.01268.03.0	AGR	PN	Rückschlagventil/non-return valve
26.350, 26.360 257-265 kW (350-360 PS) D 2066 LF 03, D 2066 LF 13, D 2066 LF 33, D 2066 LF 38	05.2004→	 7.01268.03.0	AGR	PN	Rückschlagventil/non-return valve

M



TGA **43**

26.360 265 kW (360 PS) D 2866 LF27	09.2002→		7.22841.08.0	AGR	PN	Rückschlagventil/non-return valve
26.360 265 kW (360 PS) D 2066 LF 07	05.2004→		7.01268.03.0	AGR	PN	Rückschlagventil/non-return valve
26.360 265 kW (360 PS) D 2066 LF 07, D 2066 LF 38	05.2004→		7.01268.03.0	AGR	PN	Rückschlagventil/non-return valve
26.360 265 kW (360 PS) D 2066 LF 38	04.2006→		7.01268.03.0	AGR	PN	Rückschlagventil/non-return valve
26.360 265 kW (360 PS) D 2066 LF 38	04.2006→		7.01268.03.0	AGR	PN	Rückschlagventil/non-return valve
26.360 265 kW (360 PS) D 2066 LF 38	04.2006→		7.01268.03.0	AGR	PN	Rückschlagventil/non-return valve
26.360 265 kW (360 PS) D 2066 LF 38	04.2006→		7.01268.03.0	AGR	PN	Rückschlagventil/non-return valve
26.360 265 kW (360 PS) D 2066 LF 38	04.2006→		7.01268.03.0	AGR	PN	Rückschlagventil/non-return valve
26.360 265 kW (360 PS) D 2066 LF 38	04.2006→		7.01268.03.0	AGR	PN	Rückschlagventil/non-return valve
26.360 265 kW (360 PS) D 2066 LF 38	04.2006→		7.01268.03.0	AGR	PN	Rückschlagventil/non-return valve
26.390 287 kW (390 PS) D 2066 LF 02, D 2066 LF 12	02.2004→		7.01268.03.0	AGR	PN	Rückschlagventil/non-return valve
26.390 287 kW (390 PS) D 2066 LF 02, D 2066 LF 12	02.2004→		7.01268.03.0	AGR	PN	Rückschlagventil/non-return valve
26.390 287 kW (390 PS) D 2066 LF 02, D 2066 LF 12	02.2004→		7.01268.03.0	AGR	PN	Rückschlagventil/non-return valve
26.390 287 kW (390 PS) D 2066 LF 02, D 2066 LF 12	07.2005→		7.01268.03.0	AGR	PN	Rückschlagventil/non-return valve
26.390, 26.400 287-294 kW (390-400 PS) D 2066 LF 02, D 2066 LF 12, D 2066 LF 24, D 2066 LF 26, D 2066 LF 32, D 2066 LF 37	05.2004→		7.01268.03.0	AGR	PN	Rückschlagventil/non-return valve
26.390, 26.400 287-294 kW (390-400 PS) D 2066 LF 02, D 2066 LF 12, D 2066 LF 32, D 2066 LF 37	05.2004→		7.01268.03.0	AGR	PN	Rückschlagventil/non-return valve
26.390, 26.400 287-294 kW (390-400 PS) D 2066 LF 02, D 2066 LF 06, D 2066 LF 12, D 2066 LF 32, D 2066 LF 37	05.2004→		7.01268.03.0	AGR	PN	Rückschlagventil/non-return valve
26.390, 26.400 287-294 kW (390-400 PS) D 2066 LF 02, D 2066 LF 12, D 2066 LF 32, D 2066 LF 37	05.2004→		7.01268.03.0	AGR	PN	Rückschlagventil/non-return valve
26.390, 26.400 287-294 kW (390-400 PS) D 2066 LF 02, D 2066 LF 06, D 2066 LF 12, D 2066 LF 32, D 2066 LF 37	05.2004→		7.01268.03.0	AGR	PN	Rückschlagventil/non-return valve
26.390, 26.400 287-294 kW (390-400 PS) D 2066 LF 02, D 2066 LF 12, D 2066 LF 32, D 2066 LF 37	06.2005→		7.01268.03.0	AGR	PN	Rückschlagventil/non-return valve
26.390, 26.400 287-294 kW (390-400 PS) D 2066 LF 02, D 2066 LF 12, D 2066 LF 32, D 2066 LF 37	06.2005→		7.01268.03.0	AGR	PN	Rückschlagventil/non-return valve

M



TGA
43

26.390, 26.400 287-294 kW (390-400 PS) D 2066 LF 02, D 2066 LF 12, D 2066 LF 32, D 2066 LF 37	06.2005→		7.01268.03.0	AGR	PN	Rückschlagventil/non-return valve
26.400 294 kW (400 PS) D 2066 LF 37	04.2006→		7.01268.03.0	AGR	PN	Rückschlagventil/non-return valve
26.400 294 kW (400 PS) D 2066 LF 37	04.2006→		7.01268.03.0	AGR	PN	Rückschlagventil/non-return valve
26.400 294 kW (400 PS) D 2066 LF 37	04.2006→		7.01268.03.0	AGR	PN	Rückschlagventil/non-return valve
26.400 294 kW (400 PS) D 2066 LF 37	04.2006→		7.01268.03.0	AGR	PN	Rückschlagventil/non-return valve
26.400 294 kW (400 PS) D 2066 LF 37	04.2006→		7.01268.03.0	AGR	PN	Rückschlagventil/non-return valve
26.410 301 kW (410 PS) D 2866 LF28	04.2000→06.2004		7.22841.08.0	AGR	PN	Rückschlagventil/non-return valve
26.430 316 kW (430 PS) D 2066 LF 01	02.2004→		7.01268.03.0	AGR	PN	Rückschlagventil/non-return valve
26.430 316 kW (430 PS) D 2066 LF 01, D 2066 LF 11	02.2004→		7.01268.03.0	AGR	PN	Rückschlagventil/non-return valve
26.430 316 kW (430 PS) D 2066 LF 01, D 2066 LF 11	02.2004→		7.01268.03.0	AGR	PN	Rückschlagventil/non-return valve
26.430 316 kW (430 PS) D 2066 LF 01, D 2066 LF 11	02.2004→		7.01268.03.0	AGR	PN	Rückschlagventil/non-return valve
26.430 316 kW (430 PS) D 2066 LF 01, D 2066 LF 11	07.2005→		7.01268.03.0	AGR	PN	Rückschlagventil/non-return valve
26.430, 26.440 316-324 kW (430-440 PS) D 2066 LF 01, D 2066 LF 11, D 2066 LF 23, D 2066 LF 31, D 2066 LF 36	02.2004→		7.01268.03.0	AGR	PN	Rückschlagventil/non-return valve
26.430, 26.440 316-324 kW (430-440 PS) D 2066 LF 11, D 2066 LF 23, D 2066 LF 31	05.2004→		7.01268.03.0	AGR	PN	Rückschlagventil/non-return valve
26.430, 26.440 316-324 kW (430-440 PS) D 2066 LF 01, D 2066 LF 11, D 2066 LF 31, D 2066 LF 36	05.2004→		7.01268.03.0	AGR	PN	Rückschlagventil/non-return valve
26.430, 26.440 316-324 kW (430-440 PS) D 2066 LF 01, D 2066 LF 11, D 2066 LF 31, D 2066 LF 36	05.2004→		7.01268.03.0	AGR	PN	Rückschlagventil/non-return valve
26.430, 26.440 316-324 kW (430-440 PS) D 2066 LF 01, D 2066 LF 11, D 2066 LF 31, D 2066 LF 36	05.2004→		7.01268.03.0	AGR	PN	Rückschlagventil/non-return valve
26.430, 26.440 316-324 kW (430-440 PS) D 2066 LF 01, D 2066 LF 11, D 2066 LF 31, D 2066 LF 36	05.2004→		7.01268.03.0	AGR	PN	Rückschlagventil/non-return valve
26.430, 26.440 316-324 kW (430-440 PS) D 2066 LF 01, D 2066 LF 11, D 2066 LF 23, D 2066 LF 25, D 2066 LF 31, D 2066 LF 36	05.2004→		7.01268.03.0	AGR	PN	Rückschlagventil/non-return valve
26.430, 26.440 316-324 kW (430-440 PS) D 2066 LF 01, D 2066 LF 11, D 2066 LF 31	06.2005→		7.01268.03.0	AGR	PN	Rückschlagventil/non-return valve
26.430, 26.440 316-324 kW (430-440 PS) D 2066 LF 01, D 2066 LF 11, D 2066 LF 31, D 2066 LF 36	06.2005→		7.01268.03.0	AGR	PN	Rückschlagventil/non-return valve

M



























TGA **43**

26.430, 26.440 316-324 kW (430-440 PS) D 2066 LF 01, D 2066 LF 11, D 2066 LF 31, D 2066 LF 36	06.2005→		7.01268.03.0	AGR	PN	Rückschlagventil/non-return valve
26.430, 26.440 316-324 kW (430-440 PS) D 2066 LF 01, D 2066 LF 11, D 2066 LF 31, D 2066 LF 36	06.2005→		7.01268.03.0	AGR	PN	Rückschlagventil/non-return valve
26.440 324 kW (440 PS) D 2066 LF 36	09.2005→		7.01268.03.0	AGR	PN	Rückschlagventil/non-return valve
26.440 324 kW (440 PS) D 2066 LF 36	09.2005→		7.01268.03.0	AGR	PN	Rückschlagventil/non-return valve
26.440 324 kW (440 PS) D 2066 LF 36	09.2005→		7.01268.03.0	AGR	PN	Rückschlagventil/non-return valve
26.440 324 kW (440 PS) D 2066 LF 36	09.2005→		7.01268.03.0	AGR	PN	Rückschlagventil/non-return valve
26.440 324 kW (440-441 PS) D 2676 LF 04	02.2006→		7.01268.03.0	AGR	PN	Rückschlagventil/non-return valve
26.440 324 kW (440-441 PS) D 2676 LF 04	02.2006→		7.01268.03.0	AGR	PN	Rückschlagventil/non-return valve
26.460 338 kW (460 PS) D 2876 LF 04, D 2876 LF 07	04.2000→		7.22841.08.0	AGR	PN	Rückschlagventil/non-return valve
26.480 353 kW (480 PS) D 2876 LF 12	09.2002→		7.22841.08.0	AGR	PN	Rückschlagventil/non-return valve
26.480 353 kW (480 PS) D 2676 LF 01, D 2676 LF 02, D 2676 LF 03, D 2676 LF 05	02.2006→		7.01268.03.0	AGR	PN	Rückschlagventil/non-return valve
26.480 353 kW (480 PS) D 2676 LF 01, D 2676 LF 05	02.2006→		7.01268.03.0	AGR	PN	Rückschlagventil/non-return valve
26.480 353 kW (480 PS) D 2676 LF 01, D 2676 LF 02, D 2676 LF 03, D 2676 LF 05	02.2006→		7.01268.03.0	AGR	PN	Rückschlagventil/non-return valve
26.480 353 kW (480 PS) D 2676 LF 01, D 2676 LF 02, D 2676 LF 05, D 2676 LF 12, D 2676 LF 14	02.2006→		7.01268.03.0	AGR	PN	Rückschlagventil/non-return valve
26.480 353 kW (480 PS) D 2676 LF 01, D 2676 LF 02, D 2676 LF 05, D 2676 LF 12	02.2006→		7.01268.03.0	AGR	PN	Rückschlagventil/non-return valve
26.480 353 kW (480 PS) D 2676 LF 01, D 2676 LF 05, D 2676 LF 12	02.2006→		7.01268.03.0	AGR	PN	Rückschlagventil/non-return valve
26.480 353 kW (480 PS) D 2676 LF 01, D 2676 LF 05	02.2006→		7.01268.03.0	AGR	PN	Rückschlagventil/non-return valve
26.480 353 kW (480 PS) D 2676 LF 01, D 2676 LF 02, D 2676 LF 05, D 2676 LF 12, D 2676 LF 14	02.2006→		7.01268.03.0	AGR	PN	Rückschlagventil/non-return valve
26.510 375 kW (510 PS) D 2876 LF 05	09.2002→06.2003		7.22841.08.0	AGR	PN	Rückschlagventil/non-return valve
26.530 390 kW (530 PS) D 2876 LF 13	09.2002→		7.22841.08.0	AGR	PN	Rückschlagventil/non-return valve
26.540 397 kW (540 PS) D 2676 LF 13	08.2006→		7.01268.03.0	AGR	PN	Rückschlagventil/non-return valve
26.540 397 kW (540 PS) D 2676 LF 13	08.2006→		7.01268.03.0	AGR	PN	Rückschlagventil/non-return valve

M

TGA
43

27.440 324 kW (440-441 PS) D 2676 LF 04	10.2008→		7.01268.03.0	AGR	PN	Rückschlagventil/non-return valve
28.310 228 kW (310 PS) D 2866 LF26	09.2002→05.2004		7.22841.08.0	AGR	PN	Rückschlagventil/non-return valve
28.310 228 kW (310 PS) D 2066 LF 04, D 2066 LF 14	02.2004→		7.01268.03.0	AGR	PN	Rückschlagventil/non-return valve
28.310 228 kW (310 PS) D 2066 LF 04, D 2066 LF 14	06.2004→		7.01268.03.0	AGR	PN	Rückschlagventil/non-return valve
28.310 228 kW (310 PS) D 2866 LF26	07.2006→		7.01268.03.0	AGR	PN	Rückschlagventil/non-return valve
28.310 228-235 kW (310-320 PS) D 2066 LF 04, D 2066 LF 14, D 2066 LF 28, D 2066 LF 39	07.2006→		7.01268.03.0	AGR	PN	Rückschlagventil/non-return valve
28.310, 28.320 228-235 kW (310-320 PS) D 2066 LF 04, D 2066 LF 14, D 2066 LF 28, D 2066 LF 39	07.2006→		7.01268.03.0	AGR	PN	Rückschlagventil/non-return valve
28.320 235 kW (320 PS) D 2066 LF 28, D 2066 LF 39	06.2004→		7.01268.03.0	AGR	PN	Rückschlagventil/non-return valve
28.320 235 kW (320 PS) D 2066 LF 28, D 2066 LF 39	04.2006→		7.01268.03.0	AGR	PN	Rückschlagventil/non-return valve
28.320 228-235 kW (310-320 PS) D 2066 LF 04, D 2066 LF 14, D 2066 LF 28, D 2066 LF 39	07.2006→		7.01268.03.0	AGR	PN	Rückschlagventil/non-return valve
28.320 228-235 kW (310-320 PS) D 2066 LF 04, D 2066 LF 14, D 2066 LF 28, D 2066 LF 39	07.2006→		7.01268.03.0	AGR	PN	Rückschlagventil/non-return valve
28.350 257 kW (350 PS) D 2066 LF 03, D 2066 LF 13	02.2004→		7.01268.03.0	AGR	PN	Rückschlagventil/non-return valve
28.350 257 kW (350 PS) D 2066 LF 03, D 2066 LF 13	07.2006→		7.01268.03.0	AGR	PN	Rückschlagventil/non-return valve
28.350 257 kW (350 PS) D 2066 LF 03, D 2066 LF 13	07.2006→		7.01268.03.0	AGR	PN	Rückschlagventil/non-return valve
28.350, 28.360 257-265 kW (350-360 PS) D 2066 LF 03, D 2066 LF 13, D 2066 LF 27, D 2066 LF 38	06.2004→		7.01268.03.0	AGR	PN	Rückschlagventil/non-return valve
28.350, 28.360 257-265 kW (350-360 PS) D 2066 LF 03, D 2066 LF 13, D 2066 LF 27, D 2066 LF 38	06.2004→		7.01268.03.0	AGR	PN	Rückschlagventil/non-return valve
28.350, 28.360 257-265 kW (350-360 PS) D 2066 LF 03, D 2066 LF 13, D 2066 LF 27, D 2066 LF 38	07.2006→		7.01268.03.0	AGR	PN	Rückschlagventil/non-return valve
28.360 265 kW (360 PS) D 2866 LF27	09.2002→		7.22841.08.0	AGR	PN	Rückschlagventil/non-return valve
28.360 265 kW (360 PS) D 2066 LF 27, D 2066 LF 38	04.2006→		7.01268.03.0	AGR	PN	Rückschlagventil/non-return valve
28.360 265 kW (360 PS) D 2066 LF 38	07.2006→		7.01268.03.0	AGR	PN	Rückschlagventil/non-return valve
28.360 265 kW (360 PS) D 2066 LF 38	07.2006→		7.01268.03.0	AGR	PN	Rückschlagventil/non-return valve
28.360 265 kW (360 PS) D 2866 LF27	07.2006→		7.01268.03.0	AGR	PN	Rückschlagventil/non-return valve
28.390 287 kW (390 PS) D 2066 LF 02, D 2066 LF 12	06.2004→		7.01268.03.0	AGR	PN	Rückschlagventil/non-return valve
28.390 287 kW (390 PS) D 2066 LF 02, D 2066 LF 12	07.2006→		7.01268.03.0	AGR	PN	Rückschlagventil/non-return valve

M

























TGA **43**

28.390 287 kW (390 PS) D 2066 LF 02, D 2066 LF 12	07.2006→		7.01268.03.0	AGR	PN	Rückschlagventil/non-return valve
28.390 287 kW (390 PS) D 2066 LF 02, D 2066 LF 12	07.2006→		7.01268.03.0	AGR	PN	Rückschlagventil/non-return valve
28.390, 28.400 287-294 kW (390-400 PS) D 2066 LF 02, D 2066 LF 12, D 2066 LF 26, D 2066 LF 37	06.2004→		7.01268.03.0	AGR	PN	Rückschlagventil/non-return valve
28.390, 28.400 287-294 kW (390-400 PS) D 2066 LF 02, D 2066 LF 12, D 2066 LF 26, D 2066 LF 37	06.2004→		7.01268.03.0	AGR	PN	Rückschlagventil/non-return valve
28.400 294 kW (400 PS) D 2066 LF 26, D 2066 LF 37	04.2006→		7.01268.03.0	AGR	PN	Rückschlagventil/non-return valve
28.400 294 kW (400 PS) D 2066 LF 37	07.2006→		7.01268.03.0	AGR	PN	Rückschlagventil/non-return valve
28.400 294 kW (400 PS) D 2066 LF 37	07.2006→		7.01268.03.0	AGR	PN	Rückschlagventil/non-return valve
28.400 294 kW (400 PS) D 2066 LF 26, D 2066 LF 37	07.2006→		7.01268.03.0	AGR	PN	Rückschlagventil/non-return valve
28.410 301 kW (410 PS) D 2866 LF28	09.2002→06.2005		7.22841.08.0	AGR	PN	Rückschlagventil/non-return valve
28.410 301 kW (410 PS) D 2866 LF28	07.2006→		7.01268.03.0	AGR	PN	Rückschlagventil/non-return valve
28.430 316 kW (430 PS) D 2066 LF 01, D 2066 LF 11	06.2004→		7.01268.03.0	AGR	PN	Rückschlagventil/non-return valve
28.430 316 kW (430 PS) D 2066 LF 01, D 2066 LF 11	07.2006→		7.01268.03.0	AGR	PN	Rückschlagventil/non-return valve
28.430 316 kW (430 PS) D 2066 LF 01, D 2066 LF 11	07.2006→		7.01268.03.0	AGR	PN	Rückschlagventil/non-return valve
28.430 316 kW (430 PS) D 2066 LF 01, D 2066 LF 11	07.2006→		7.01268.03.0	AGR	PN	Rückschlagventil/non-return valve
28.430, 28.440 316 kW (430 PS) D 2066 LF 01	06.2004→		7.01268.03.0	AGR	PN	Rückschlagventil/non-return valve
28.430, 28.440 316-324 kW (430-440 PS) D 2066 LF 01, D 2066 LF 11, D 2066 LF 25, D 2066 LF 36	06.2004→		7.01268.03.0	AGR	PN	Rückschlagventil/non-return valve
28.440 324 kW (440 PS) D 2066 LF 25, D 2066 LF 36	09.2005→		7.01268.03.0	AGR	PN	Rückschlagventil/non-return valve
28.440 324 kW (440 PS) D 2066 LF 36	07.2006→		7.01268.03.0	AGR	PN	Rückschlagventil/non-return valve
28.440 324 kW (440 PS) D 2066 LF 36	07.2006→		7.01268.03.0	AGR	PN	Rückschlagventil/non-return valve
28.440 324 kW (440 PS) D 2066 LF 23, D 2066 LF 31	07.2006→		7.01268.03.0	AGR	PN	Rückschlagventil/non-return valve
28.460 338 kW (460 PS) D 2876 LF 04	09.2002→05.2004		7.22841.08.0	AGR	PN	Rückschlagventil/non-return valve
28.480 353 kW (480 PS) D 2876 LF 12	06.2003→		7.22841.08.0	AGR	PN	Rückschlagventil/non-return valve
28.480 353 kW (480 PS) D 2676 LF 02, D 2676 LF 05, D 2676 LF 14	02.2006→		7.01268.03.0	AGR	PN	Rückschlagventil/non-return valve
28.480 353 kW (480 PS) D 2676 LF 02, D 2676 LF 05, D 2676 LF 14	02.2006→		7.01268.03.0	AGR	PN	Rückschlagventil/non-return valve
28.480 353 kW (480 PS) D 2676 LF 05	07.2006→		7.01268.03.0	AGR	PN	Rückschlagventil/non-return valve

M

TGA
43

28.480 353 kW (480 PS) D 2676 LF 05	07.2006→		7.01268.03.0	AGR	PN	Rückschlagventil/non-return valve
28.510 375 kW (510 PS) D 2876 LF 05	09.2002→06.2003		7.22841.08.0	AGR	PN	Rückschlagventil/non-return valve
28.530 390 kW (530 PS) D 2876 LF 13	09.2002→		7.22841.08.0	AGR	PN	Rückschlagventil/non-return valve
28.540 397 kW (540 PS) D 2676 LF 13	08.2006→		7.01268.03.0	AGR	PN	Rückschlagventil/non-return valve
28.540 397 kW (540 PS) D 2676 LF 13	08.2006→		7.01268.03.0	AGR	PN	Rückschlagventil/non-return valve
32.310 228 kW (310 PS) D 2866 LF26	01.2002→		7.22841.08.0	AGR	PN	Rückschlagventil/non-return valve
32.350, 32.360 257-265 kW (350-360 PS) D 2066 LF 03, D 2066 LF 13, D 2066 LF 33, D 2066 LF 38	05.2004→		7.01268.03.0	AGR	PN	Rückschlagventil/non-return valve
32.360 265 kW (360 PS) D 2866 LF27	09.2002→		7.22841.08.0	AGR	PN	Rückschlagventil/non-return valve
32.390, 32.400 287-294 kW (390-400 PS) D 2066 LF 02, D 2066 LF 12, D 2066 LF 32, D 2066 LF 37	05.2004→		7.01268.03.0	AGR	PN	Rückschlagventil/non-return valve
32.410 301 kW (410 PS) D 2866 LF28	01.2002→06.2005		7.22841.08.0	AGR	PN	Rückschlagventil/non-return valve
32.430, 32.440 316-324 kW (430-440 PS) D 2066 LF 11, D 2066 LF 31	08.2005→		7.01268.03.0	AGR	PN	Rückschlagventil/non-return valve
32.460 338 kW (460 PS) D 2876 LF 04	01.2002→06.2005		7.22841.08.0	AGR	PN	Rückschlagventil/non-return valve
32.480 353 kW (480 PS) D 2676 LF 01	02.2006→		7.01268.03.0	AGR	PN	Rückschlagventil/non-return valve
32.530 390 kW (530 PS) D 2876 LF 13	05.2004→09.2004		7.22841.08.0	AGR	PN	Rückschlagventil/non-return valve
33.310 228 kW (310 PS) D 2066 LF 04	07.2008→04.2012		7.01268.03.0	AGR	PN	Rückschlagventil/non-return valve
33.350, 33.360 257 kW (350 PS) D 2066 LF 03	05.2004→		7.01268.03.0	AGR	PN	Rückschlagventil/non-return valve
33.350, 33.360 257-265 kW (350-360 PS) D 2066 LF 03, D 2066 LF 07, D 2066 LF 13, D 2066 LF 33, D 2066 LF 38	05.2004→		7.01268.03.0	AGR	PN	Rückschlagventil/non-return valve
33.350, 33.360 257-265 kW (350-360 PS) D 2066 LF 03, D 2066 LF 07, D 2066 LF 13, D 2066 LF 33, D 2066 LF 38	05.2004→		7.01268.03.0	AGR	PN	Rückschlagventil/non-return valve
33.350, 33.360 257-265 kW (350-360 PS) D 2066 LF 03, D 2066 LF 07, D 2066 LF 13, D 2066 LF 33, D 2066 LF 38	06.2005→		7.01268.03.0	AGR	PN	Rückschlagventil/non-return valve
33.350, 33.360 257-265 kW (350-360 PS) D 2066 LF 03, D 2066 LF 07, D 2066 LF 13, D 2066 LF 33, D 2066 LF 38	06.2005→		7.01268.03.0	AGR	PN	Rückschlagventil/non-return valve
33.350, 33.360 257-265 kW (350-360 PS) D 2066 LF 03, D 2066 LF 07, D 2066 LF 13, D 2066 LF 33, D 2066 LF 38	06.2005→		7.01268.03.0	AGR	PN	Rückschlagventil/non-return valve
33.360 265 kW (360 PS) D 2866 LF27	09.2002→05.2004		7.22841.08.0	AGR	PN	Rückschlagventil/non-return valve

M



















TGA **43**

33.390, 33.400 287-294 kW (390-400 PS) D 2066 LF 02, D 2066 LF 06, D 2066 LF 12, D 2066 LF 32, D 2066 LF 37	05.2004→		7.01268.03.0	AGR	PN	Rückschlagventil/non-return valve
33.390, 33.400 287-294 kW (390-400 PS) D 2066 LF 02, D 2066 LF 06, D 2066 LF 12, D 2066 LF 32, D 2066 LF 37	05.2004→		7.01268.03.0	AGR	PN	Rückschlagventil/non-return valve
33.390, 33.400 287-294 kW (390-400 PS) D 2066 LF 02, D 2066 LF 06, D 2066 LF 12, D 2066 LF 32, D 2066 LF 37	05.2004→		7.01268.03.0	AGR	PN	Rückschlagventil/non-return valve
33.390, 33.400 287-294 kW (390-400 PS) D 2066 LF 02, D 2066 LF 06, D 2066 LF 12, D 2066 LF 32, D 2066 LF 37	06.2005→		7.01268.03.0	AGR	PN	Rückschlagventil/non-return valve
33.390, 33.400 287-294 kW (390-400 PS) D 2066 LF 02, D 2066 LF 06, D 2066 LF 12, D 2066 LF 32, D 2066 LF 37	06.2005→		7.01268.03.0	AGR	PN	Rückschlagventil/non-return valve
33.390, 33.400 287-294 kW (390-400 PS) D 2066 LF 02, D 2066 LF 06, D 2066 LF 12, D 2066 LF 32, D 2066 LF 37	06.2005→		7.01268.03.0	AGR	PN	Rückschlagventil/non-return valve
33.410 301 kW (410 PS) D 2866 LF28	10.2000→05.2004		7.22841.08.0	AGR	PN	Rückschlagventil/non-return valve
33.430, 33.440 316 kW (430 PS) D 2066 LF 01	05.2004→		7.01268.03.0	AGR	PN	Rückschlagventil/non-return valve
33.430, 33.440 316-324 kW (430-440 PS) D 2066 LF 01, D 2066 LF 11, D 2066 LF 31, D 2066 LF 36	05.2004→		7.01268.03.0	AGR	PN	Rückschlagventil/non-return valve
33.430, 33.440 316-324 kW (430-440 PS) D 2066 LF 01, D 2066 LF 11, D 2066 LF 31, D 2066 LF 36	05.2004→		7.01268.03.0	AGR	PN	Rückschlagventil/non-return valve
33.430, 33.440 316-324 kW (430-440 PS) D 2066 LF 01, D 2066 LF 11, D 2066 LF 31, D 2066 LF 36	06.2005→		7.01268.03.0	AGR	PN	Rückschlagventil/non-return valve
33.430, 33.440 316-324 kW (430-440 PS) D 2066 LF 01, D 2066 LF 11, D 2066 LF 31, D 2066 LF 36	06.2005→		7.01268.03.0	AGR	PN	Rückschlagventil/non-return valve
33.440 324 kW (440-441 PS) D 2676 LF 04	06.2005→		7.01268.03.0	AGR	PN	Rückschlagventil/non-return valve
33.440 324 kW (440-441 PS) D 2676 LF 04	06.2005→		7.01268.03.0	AGR	PN	Rückschlagventil/non-return valve
33.440 324 kW (440-441 PS) D 2676 LF 04	06.2005→		7.01268.03.0	AGR	PN	Rückschlagventil/non-return valve
33.440 324 kW (440-441 PS) D 2676 LF 04	06.2005→		7.01268.03.0	AGR	PN	Rückschlagventil/non-return valve
33.440 324 kW (440-441 PS) D 2676 LF 04	06.2005→		7.01268.03.0	AGR	PN	Rückschlagventil/non-return valve

M





TGA
43

33.480 353 kW (480 PS) D 2876 LF 12	10.2002→		7.22841.08.0	AGR	PN	Rückschlagventil/non-return valve
33.480 353 kW (480 PS) D 2676 LF 01, D 2676 LF 02, D 2676 LF 03, D 2676 LF 05	01.2006→		7.01268.03.0	AGR	PN	Rückschlagventil/non-return valve
33.480 353 kW (480 PS) D 2676 LF 01, D 2676 LF 02, D 2676 LF 03, D 2676 LF 05	01.2006→		7.01268.03.0	AGR	PN	Rückschlagventil/non-return valve
33.480 353 kW (480 PS) D 2676 LF 01, D 2676 LF 02, D 2676 LF 03, D 2676 LF 05	01.2006→		7.01268.03.0	AGR	PN	Rückschlagventil/non-return valve
33.480 353 kW (480 PS) D 2676 LF 01, D 2676 LF 02, D 2676 LF 03, D 2676 LF 05	02.2006→		7.01268.03.0	AGR	PN	Rückschlagventil/non-return valve
33.480 353 kW (480 PS) D 2676 LF 01, D 2676 LF 02, D 2676 LF 03, D 2676 LF 05	02.2006→		7.01268.03.0	AGR	PN	Rückschlagventil/non-return valve
33.480 353 kW (480 PS) D 2676 LF 01, D 2676 LF 02, D 2676 LF 03, D 2676 LF 05	02.2006→		7.01268.03.0	AGR	PN	Rückschlagventil/non-return valve
33.510 375 kW (510 PS) D 2876 LF 05	09.2002→06.2003		7.22841.08.0	AGR	PN	Rückschlagventil/non-return valve
33.530 390 kW (530 PS) D 2876 LF 13	10.2002→		7.22841.08.0	AGR	PN	Rückschlagventil/non-return valve
35.310, 35.320 235 kW (320 PS) D 2066 LF 35	02.2004→		7.01268.03.0	AGR	PN	Rückschlagventil/non-return valve
35.310, 35.320 228-235 kW (310-320 PS) D 2066 LF 04, D 2066 LF 35, D 2066 LF 39	02.2004→		7.01268.03.0	AGR	PN	Rückschlagventil/non-return valve
35.350 257 kW (350 PS) D 2066 LF 03, D 2066 LF 13	07.2006→		7.01268.03.0	AGR	PN	Rückschlagventil/non-return valve
35.350 257 kW (350 PS) D 2066 LF 03, D 2066 LF 13	07.2006→		7.01268.03.0	AGR	PN	Rückschlagventil/non-return valve
35.350, 35.360 257-265 kW (350-360 PS) D 2066 LF 03, D 2066 LF 13, D 2066 LF 33	02.2004→		7.01268.03.0	AGR	PN	Rückschlagventil/non-return valve
35.350, 35.360 257-265 kW (350-360 PS) D 2066 LF 03, D 2066 LF 13, D 2066 LF 33, D 2066 LF 38	02.2004→		7.01268.03.0	AGR	PN	Rückschlagventil/non-return valve
35.360 265 kW (360 PS) D 2066 LF 38	07.2006→		7.01268.03.0	AGR	PN	Rückschlagventil/non-return valve
35.360 265 kW (360 PS) D 2066 LF 38	07.2006→		7.01268.03.0	AGR	PN	Rückschlagventil/non-return valve
35.360 265 kW (360 PS) D 2066 LF 38	11.2006→		7.01268.03.0	AGR	PN	Rückschlagventil/non-return valve
35.360 265 kW (360 PS) D 2066 LF 38	11.2006→		7.01268.03.0	AGR	PN	Rückschlagventil/non-return valve
35.390 287 kW (390 PS) D 2066 LF 02, D 2066 LF 12	02.2004→		7.01268.03.0	AGR	PN	Rückschlagventil/non-return valve
35.390 287 kW (390 PS) D 2066 LF 02, D 2066 LF 12	07.2006→		7.01268.03.0	AGR	PN	Rückschlagventil/non-return valve
35.390 287 kW (390 PS) D 2066 LF 02, D 2066 LF 12	07.2006→		7.01268.03.0	AGR	PN	Rückschlagventil/non-return valve
35.390 287 kW (390 PS) D 2066 LF 02, D 2066 LF 12	07.2006→		7.01268.03.0	AGR	PN	Rückschlagventil/non-return valve

M



TGA **43**

35.390, 35.400 287-294 kW (390-400 PS) D 2066 LF 02, D 2066 LF 12, D 2066 LF 32	02.2004→		7.01268.03.0	AGR	PN	Rückschlagventil/non-return valve
35.390, 35.400 287-294 kW (390-400 PS) D 2066 LF 02, D 2066 LF 12, D 2066 LF 32, D 2066 LF 37	02.2004→		7.01268.03.0	AGR	PN	Rückschlagventil/non-return valve
35.400 294 kW (400 PS) D 2066 LF 37	07.2006→		7.01268.03.0	AGR	PN	Rückschlagventil/non-return valve
35.400 294 kW (400 PS) D 2066 LF 37	07.2006→		7.01268.03.0	AGR	PN	Rückschlagventil/non-return valve
35.400 294 kW (400 PS) D 2066 LF 37	07.2006→		7.01268.03.0	AGR	PN	Rückschlagventil/non-return valve
35.400 294 kW (400 PS) D 2066 LF 37	07.2006→		7.01268.03.0	AGR	PN	Rückschlagventil/non-return valve
35.400 294 kW (400 PS) D 2066 LF 37	11.2006→		7.01268.03.0	AGR	PN	Rückschlagventil/non-return valve
35.400 294 kW (400 PS) D 2066 LF 37	11.2006→		7.01268.03.0	AGR	PN	Rückschlagventil/non-return valve
35.410 301 kW (410 PS) D 2866 LF28	10.2003→12.2005		7.22841.08.0	AGR	PN	Rückschlagventil/non-return valve
35.430 316 kW (430 PS) D 2066 LF 01, D 2066 LF 11	07.2006→		7.01268.03.0	AGR	PN	Rückschlagventil/non-return valve
35.430 316 kW (430 PS) D 2066 LF 01, D 2066 LF 11	07.2006→		7.01268.03.0	AGR	PN	Rückschlagventil/non-return valve
35.430 316 kW (430 PS) D 2066 LF 01, D 2066 LF 11	07.2006→		7.01268.03.0	AGR	PN	Rückschlagventil/non-return valve
35.430, 35.440 316-324 kW (430-440 PS) D 2066 LF 01, D 2066 LF 11, D 2066 LF 31	02.2004→		7.01268.03.0	AGR	PN	Rückschlagventil/non-return valve
35.430, 35.440 316-324 kW (430-440 PS) D 2066 LF 01, D 2066 LF 11, D 2066 LF 31, D 2066 LF 36	02.2004→		7.01268.03.0	AGR	PN	Rückschlagventil/non-return valve
35.440 324 kW (440 PS) D 2066 LF 36	07.2006→		7.01268.03.0	AGR	PN	Rückschlagventil/non-return valve
35.440 324 kW (440 PS) D 2066 LF 36	07.2006→		7.01268.03.0	AGR	PN	Rückschlagventil/non-return valve
35.440 324 kW (440 PS) D 2066 LF 36	07.2006→		7.01268.03.0	AGR	PN	Rückschlagventil/non-return valve
35.440 324 kW (440 PS) D 2066 LF 36	07.2006→		7.01268.03.0	AGR	PN	Rückschlagventil/non-return valve
35.440 324 kW (440 PS) D 2066 LF 36	11.2006→		7.01268.03.0	AGR	PN	Rückschlagventil/non-return valve
35.440 324 kW (440 PS) D 2066 LF 36	11.2006→		7.01268.03.0	AGR	PN	Rückschlagventil/non-return valve
35.460 338 kW (460 PS) D 2876 LF 04	10.2003→12.2005		7.22841.08.0	AGR	PN	Rückschlagventil/non-return valve
35.480 353 kW (480 PS) D 2876 LF 12	10.2003→		7.22841.08.0	AGR	PN	Rückschlagventil/non-return valve
35.480 353 kW (480 PS) D 2676 LF 01, D 2676 LF 05, D 2676 LF 12	02.2004→		7.01268.03.0	AGR	PN	Rückschlagventil/non-return valve
35.480 353 kW (480 PS) D 2676 LF 01, D 2676 LF 05	02.2004→		7.01268.03.0	AGR	PN	Rückschlagventil/non-return valve

M

TGA
43

35.480 353 kW (480 PS) D 2676 LF 02, D 2676 LF 05	07.2006→		7.01268.03.0	AGR	PN	Rückschlagventil/non-return valve
35.480 353 kW (480 PS) D 2676 LF 05	07.2006→		7.01268.03.0	AGR	PN	Rückschlagventil/non-return valve
35.480 353 kW (480 PS) D 2676 LF 05	07.2006→		7.01268.03.0	AGR	PN	Rückschlagventil/non-return valve
35.480 353 kW (480 PS) D 2676 LF 01, D 2676 LF 05, D 2676 LF 12	11.2006→		7.01268.03.0	AGR	PN	Rückschlagventil/non-return valve
35.480 353 kW (480 PS) D 2676 LF 05	11.2006→		7.01268.03.0	AGR	PN	Rückschlagventil/non-return valve
35.530 390 kW (530 PS) D 2876 LF 13	04.2006→		7.22841.08.0	AGR	PN	Rückschlagventil/non-return valve
360 265 kW (360 PS) D 2866 LF24, D 2866 LF35, D 2866 LF37	02.2000→		7.22841.08.0	AGR	PN	Rückschlagventil/non-return valve
37.310, 37.320 228-235 kW (310-320 PS) D 2066 LF 04, D 2066 LF 35, D 2066 LF 39	12.2004→		7.01268.03.0	AGR	PN	Rückschlagventil/non-return valve
37.310, 37.320 228-235 kW (310-320 PS) D 2066 LF 04, D 2066 LF 35, D 2066 LF 39	12.2004→		7.01268.03.0	AGR	PN	Rückschlagventil/non-return valve
37.350, 37.360 257-265 kW (350-360 PS) D 2066 LF 13, D 2066 LF 33	12.2004→		7.01268.03.0	AGR	PN	Rückschlagventil/non-return valve
37.350, 37.360 257-265 kW (350-360 PS) D 2066 LF 03, D 2066 LF 13, D 2066 LF 33, D 2066 LF 38	12.2004→		7.01268.03.0	AGR	PN	Rückschlagventil/non-return valve
37.390, 37.400 287-294 kW (390-400 PS) D 2066 LF 02, D 2066 LF 12, D 2066 LF 32, D 2066 LF 37	12.2004→		7.01268.03.0	AGR	PN	Rückschlagventil/non-return valve
37.390, 37.400 287-294 kW (390-400 PS) D 2066 LF 02, D 2066 LF 12, D 2066 LF 32, D 2066 LF 37	12.2004→		7.01268.03.0	AGR	PN	Rückschlagventil/non-return valve
37.410 301 kW (410 PS) D 2866 LF28	12.2004→12.2005		7.22841.08.0	AGR	PN	Rückschlagventil/non-return valve
37.430, 37.440 316-324 kW (430-440 PS) D 2066 LF 01, D 2066 LF 11, D 2066 LF 31	12.2004→		7.01268.03.0	AGR	PN	Rückschlagventil/non-return valve
37.430, 37.440 316-324 kW (430-440 PS) D 2066 LF 01, D 2066 LF 11, D 2066 LF 31, D 2066 LF 36	12.2004→		7.01268.03.0	AGR	PN	Rückschlagventil/non-return valve
37.460 338 kW (460 PS) D 2876 LF 04	12.2004→06.2005		7.22841.08.0	AGR	PN	Rückschlagventil/non-return valve
37.480 353 kW (480 PS) D 2676 LF 01	02.2006→		7.01268.03.0	AGR	PN	Rückschlagventil/non-return valve
37.480 353 kW (480 PS) D 2676 LF 01, D 2676 LF 05	02.2006→		7.01268.03.0	AGR	PN	Rückschlagventil/non-return valve
37.530 390 kW (530 PS) D 2876 LF 13	12.2004→		7.22841.08.0	AGR	PN	Rückschlagventil/non-return valve
39.390 287 kW (390 PS) D 2066 LF 02, D 2066 LF 12	07.2006→		7.01268.03.0	AGR	PN	Rückschlagventil/non-return valve

M



TGA **43**

39.400 294 kW (400 PS) D 2066 LF 37	07.2006→		7.01268.03.0	AGR	PN	Rückschlagventil/non-return valve
39.430 316 kW (430 PS) D 2066 LF 01, D 2066 LF 11	07.2006→		7.01268.03.0	AGR	PN	Rückschlagventil/non-return valve
39.440 324 kW (440 PS) D 2066 LF 36	07.2006→		7.01268.03.0	AGR	PN	Rückschlagventil/non-return valve
39.480 353 kW (480 PS) D 2676 LF 05	07.2006→		7.01268.03.0	AGR	PN	Rückschlagventil/non-return valve
40.390, 40.400 287 kW (390 PS) D 2066 LF 02	06.2005→		7.01268.03.0	AGR	PN	Rückschlagventil/non-return valve
40.390, 40.400 287-294 kW (390-400 PS) D 2066 LF 02, D 2066 LF 06, D 2066 LF 12, D 2066 LF 37	06.2005→		7.01268.03.0	AGR	PN	Rückschlagventil/non-return valve
40.390, 40.400 287-294 kW (390-400 PS) D 2066 LF 02, D 2066 LF 06, D 2066 LF 12, D 2066 LF 37	06.2005→		7.01268.03.0	AGR	PN	Rückschlagventil/non-return valve
40.410 301 kW (410 PS) D 2866 LF28	04.2004→12.2005		7.22841.08.0	AGR	PN	Rückschlagventil/non-return valve
40.430 316 kW (430 PS) D 2066 LF 01	06.2005→		7.01268.03.0	AGR	PN	Rückschlagventil/non-return valve
40.430 316 kW (430 PS) D 2066 LF 01	06.2005→		7.01268.03.0	AGR	PN	Rückschlagventil/non-return valve
40.430, 40.440 316-324 kW (430-440 PS) D 2066 LF 01, D 2066 LF 11, D 2066 LF 36	06.2005→		7.01268.03.0	AGR	PN	Rückschlagventil/non-return valve
40.430, 40.440 316-324 kW (430-440 PS) D 2066 LF 01, D 2066 LF 11, D 2066 LF 36	06.2005→		7.01268.03.0	AGR	PN	Rückschlagventil/non-return valve
40.440 324 kW (440-441 PS) D 2676 LF 04	06.2005→		7.01268.03.0	AGR	PN	Rückschlagventil/non-return valve
40.440 324 kW (440-441 PS) D 2676 LF 04	06.2005→		7.01268.03.0	AGR	PN	Rückschlagventil/non-return valve
40.440 324 kW (440-441 PS) D 2676 LF 04	06.2005→		7.01268.03.0	AGR	PN	Rückschlagventil/non-return valve
40.440 324 kW (440-441 PS) D 2676 LF 04	06.2005→		7.01268.03.0	AGR	PN	Rückschlagventil/non-return valve
40.460 338 kW (460 PS) D 2876 LF 07	04.2004→		7.22841.08.0	AGR	PN	Rückschlagventil/non-return valve
40.480 353 kW (480 PS) D 2876 LF 12	10.2004→		7.22841.08.0	AGR	PN	Rückschlagventil/non-return valve
40.480 353 kW (480 PS) D 2676 LF 02, D 2676 LF 03	06.2005→		7.01268.03.0	AGR	PN	Rückschlagventil/non-return valve
40.480 353 kW (480 PS) D 2676 LF 02, D 2676 LF 03	06.2005→		7.01268.03.0	AGR	PN	Rückschlagventil/non-return valve
40.480 353 kW (480 PS) D 2676 LF 02, D 2676 LF 03	06.2005→		7.01268.03.0	AGR	PN	Rückschlagventil/non-return valve
40.480 353 kW (480 PS) D 2676 LF 02, D 2676 LF 03, D 2676 LF 12	06.2005→		7.01268.03.0	AGR	PN	Rückschlagventil/non-return valve
41.350, 41.360 257-265 kW (350-360 PS) D 2066 LF 13, D 2066 LF 33	12.2004→		7.01268.03.0	AGR	PN	Rückschlagventil/non-return valve
41.350, 41.360 257-265 kW (350-360 PS) D 2066 LF 03, D 2066 LF 07, D 2066 LF 13, D 2066 LF 33, D 2066 LF 38	12.2004→		7.01268.03.0	AGR	PN	Rückschlagventil/non-return valve

M

TGA
43



41.360 265 kW (360 PS) D 2066 LF 07	12.2008→		7.01268.03.0	AGR	PN	Rückschlagventil/non-return valve
41.390 287-294 kW (390-400 PS) D 2066 LF 02, D 2066 LF 12, D 2066 LF 32	03.2004→		7.01268.03.0	AGR	PN	Rückschlagventil/non-return valve
41.390 287 kW (390 PS) D 2066 LF 02	12.2004→		7.01268.03.0	AGR	PN	Rückschlagventil/non-return valve
41.390, 41.400 287-294 kW (390-400 PS) D 2066 LF 02, D 2066 LF 06, D 2066 LF 12, D 2066 LF 32, D 2066 LF 37	12.2004→		7.01268.03.0	AGR	PN	Rückschlagventil/non-return valve
41.390, 41.400 287-294 kW (390-400 PS) D 2066 LF 02, D 2066 LF 06, D 2066 LF 12, D 2066 LF 32, D 2066 LF 37	12.2004→		7.01268.03.0	AGR	PN	Rückschlagventil/non-return valve
41.400 294 kW (400 PS) D 2066 LF 06	12.2008→		7.01268.03.0	AGR	PN	Rückschlagventil/non-return valve
41.410 301 kW (410 PS) D 2866 LF28	09.2003→05.2004		7.22841.08.0	AGR	PN	Rückschlagventil/non-return valve
41.430 316 kW (430 PS) D 2066 LF 01, D 2066 LF 11	12.2004→		7.01268.03.0	AGR	PN	Rückschlagventil/non-return valve
41.430 316 kW (430 PS) D 2066 LF 01, D 2066 LF 11	07.2006→		7.01268.03.0	AGR	PN	Rückschlagventil/non-return valve
41.430, 41.440 316-324 kW (430-440 PS) D 2066 LF 01, D 2066 LF 11, D 2066 LF 31	12.2004→		7.01268.03.0	AGR	PN	Rückschlagventil/non-return valve
41.430, 41.440 316-324 kW (430-440 PS) D 2066 LF 01, D 2066 LF 11, D 2066 LF 31, D 2066 LF 36	12.2004→		7.01268.03.0	AGR	PN	Rückschlagventil/non-return valve
41.440 324 kW (440-441 PS) D 2676 LF 04	12.2004→		7.01268.03.0	AGR	PN	Rückschlagventil/non-return valve
41.440 324 kW (440-441 PS) D 2676 LF 04	12.2004→		7.01268.03.0	AGR	PN	Rückschlagventil/non-return valve
41.440 324 kW (440 PS) D 2066 LF 36	07.2006→		7.01268.03.0	AGR	PN	Rückschlagventil/non-return valve
41.440 324 kW (440 PS) D 2066 LF 36	07.2006→		7.01268.03.0	AGR	PN	Rückschlagventil/non-return valve
41.460 338 kW (460 PS) D 2876 LF 04, D 2876 LF 07	09.2003→		7.22841.08.0	AGR	PN	Rückschlagventil/non-return valve
41.480 353 kW (480 PS) D 2676 LF 01, D 2676 LF 02, D 2676 LF 03, D 2676 LF 05	02.2006→		7.01268.03.0	AGR	PN	Rückschlagventil/non-return valve
41.480 353 kW (480 PS) D 2676 LF 01, D 2676 LF 02, D 2676 LF 03, D 2676 LF 05	02.2006→		7.01268.03.0	AGR	PN	Rückschlagventil/non-return valve
41.480 353 kW (480 PS) D 2676 LF 02, D 2676 LF 05	07.2006→		7.01268.03.0	AGR	PN	Rückschlagventil/non-return valve
41.480 353 kW (480 PS) D 2676 LF 05	07.2006→		7.01268.03.0	AGR	PN	Rückschlagventil/non-return valve
41.530 390 kW (530 PS) D 2876 LF 13	06.2003→		7.22841.08.0	AGR	PN	Rückschlagventil/non-return valve

M
TGL
44

















10.240 176 kW (240 PS) D 0836 LFL 40, D 0836 LFL 50	04.2005→		7.01268.03.0	AGR	PN	Rückschlagventil/non-return valve
10.240 176 kW (240 PS) D 0836 LFL 40, D 0836 LFL 50, D 0836 LFL 53	04.2005→		7.01268.03.0	AGR	PN	Rückschlagventil/non-return valve



TGL **44**

10.250 184 kW (250 PS) D 0836 LFL 63, D 0836 LFL 66	04.2005→		7.01268.03.0	AGR	PN	Rückschlagventil/non-return valve
10.250 184 kW (250 PS) D 0836 LFL 63, D 0836 LFL 66	04.2005→		7.01268.03.0	AGR	PN	Rückschlagventil/non-return valve
12.240 176 kW (240 PS) D 0836 LFL 40, D 0836 LFL 50	04.2005→		7.01268.03.0	AGR	PN	Rückschlagventil/non-return valve
12.240 176 kW (240 PS) D 0836 LFL 40, D 0836 LFL 50, D 0836 LFL 53	04.2005→		7.01268.03.0	AGR	PN	Rückschlagventil/non-return valve
12.250 184 kW (250 PS) D 0836 LFL 60, D 0836 LFL 63, D 0836 LFL 66, D 0836 LFL 75	04.2005→		7.01268.03.0	AGR	PN	Rückschlagventil/non-return valve
12.250 184 kW (250 PS) D 0836 LFL 63, D 0836 LFL 66	04.2005→		7.01268.03.0	AGR	PN	Rückschlagventil/non-return valve
8.240 176 kW (240 PS) D 0836 LFL 40, D 0836 LFL 50	04.2005→		7.01268.03.0	AGR	PN	Rückschlagventil/non-return valve
8.240 176 kW (240 PS) D 0836 LFL 40, D 0836 LFL 50, D 0836 LFL 53	04.2005→		7.01268.03.0	AGR	PN	Rückschlagventil/non-return valve
8.250 184 kW (250 PS) D 0836 LFL 63, D 0836 LFL 66	04.2005→		7.01268.03.0	AGR	PN	Rückschlagventil/non-return valve

TGM **45**

12.240 176 kW (240 PS) D 0836 LFL 50	12.2005→		7.01268.03.0	AGR	PN	Rückschlagventil/non-return valve
12.250 184 kW (250 PS) D 0836 LFL 63, D 0836 LFL 66	10.2005→		7.01268.03.0	AGR	PN	Rückschlagventil/non-return valve
12.280 206 kW (280 PS) D 0836 LFL 51	12.2005→		7.01268.03.0	AGR	PN	Rückschlagventil/non-return valve
12.290 202-213 kW (275-290 PS) D 0836 LFL 64, D 0836 LFL 67	10.2005→		7.01268.03.0	AGR	PN	Rückschlagventil/non-return valve
13.240 176 kW (240 PS) D 0836 LFL 40, D 0836 LFL 50, D 0836 LFL 53	04.2006→		7.01268.03.0	AGR	PN	Rückschlagventil/non-return valve
13.240 176 kW (240 PS) D 0836 LFL 40, D 0836 LFL 50	05.2006→		7.01268.03.0	AGR	PN	Rückschlagventil/non-return valve
13.250 184 kW (250 PS) D 0836 LFL 63, D 0836 LFL 66	10.2005→		7.01268.03.0	AGR	PN	Rückschlagventil/non-return valve
13.250 184 kW (250 PS) D 0836 LFL 63, D 0836 LFL 66	10.2005→		7.01268.03.0	AGR	PN	Rückschlagventil/non-return valve
13.280 206 kW (280 PS) D 0836 LFL 41, D 0836 LFL 51, D 0836 LFL 54	04.2006→		7.01268.03.0	AGR	PN	Rückschlagventil/non-return valve
13.280 206 kW (280 PS) D 0836 LFL 41, D 0836 LFL 51	05.2006→		7.01268.03.0	AGR	PN	Rückschlagventil/non-return valve
13.290 202-213 kW (275-290 PS) D 0836 LFL 64, D 0836 LFL 67	10.2005→		7.01268.03.0	AGR	PN	Rückschlagventil/non-return valve
13.290 202-213 kW (275-290 PS) D 0836 LFL 64, D 0836 LFL 67	10.2005→		7.01268.03.0	AGR	PN	Rückschlagventil/non-return valve
15.240 176 kW (240 PS) D 0836 LFL 50	10.2005→		7.01268.03.0	AGR	PN	Rückschlagventil/non-return valve
15.240 176 kW (240 PS) D 0836 LFL 40, D 0836 LFL 53	10.2005→		7.01268.03.0	AGR	PN	Rückschlagventil/non-return valve
15.250 184 kW (250 PS) D 0836 LFL 63, D 0836 LFL 66	10.2005→		7.01268.03.0	AGR	PN	Rückschlagventil/non-return valve
15.250 184 kW (250 PS) D 0836 LFL 63, D 0836 LFL 66	10.2005→		7.01268.03.0	AGR	PN	Rückschlagventil/non-return valve
15.280 206 kW (280 PS) D 0836 LFL 51	10.2005→		7.01268.03.0	AGR	PN	Rückschlagventil/non-return valve

M

















TGM
45

15.280 206 kW (280 PS) D 0836 LFL 41, D 0836 LFL 54	10.2005→		7.01268.03.0	AGR	PN	Rückschlagventil/non-return valve
15.290 202-213 kW (275-290 PS) D 0836 LFL 64, D 0836 LFL 67	10.2005→		7.01268.03.0	AGR	PN	Rückschlagventil/non-return valve
15.290 202-213 kW (275-290 PS) D 0836 LFL 64, D 0836 LFL 67	10.2005→		7.01268.03.0	AGR	PN	Rückschlagventil/non-return valve
15.330 240 kW (326 PS) D 0836 LFL 44, D 0836 LFL 55	10.2005→		7.01268.03.0	AGR	PN	Rückschlagventil/non-return valve
15.330 240 kW (326 PS) D 0836 LFL 44, D 0836 LFL 55	10.2005→		7.01268.03.0	AGR	PN	Rückschlagventil/non-return valve
15.340 250 kW (340 PS) D 0836 LFL 65, D 0836 LFL 68	10.2005→		7.01268.03.0	AGR	PN	Rückschlagventil/non-return valve
15.340 250 kW (340 PS) D 0836 LFL 65, D 0836 LFL 68	10.2005→		7.01268.03.0	AGR	PN	Rückschlagventil/non-return valve
18.240 176 kW (240 PS) D 0836 LFL 40	10.2005→		7.01268.03.0	AGR	PN	Rückschlagventil/non-return valve
18.240 176 kW (240 PS) D 0836 LFL 40, D 0836 LFL 53	10.2005→		7.01268.03.0	AGR	PN	Rückschlagventil/non-return valve
18.240 176 kW (240 PS) D 0836 LFL 40, D 0836 LFL 53	10.2005→		7.01268.03.0	AGR	PN	Rückschlagventil/non-return valve
18.240 176 kW (240 PS) D 0836 LFL 40, D 0836 LFL 53	05.2006→		7.01268.03.0	AGR	PN	Rückschlagventil/non-return valve
18.250 184 kW (250 PS) D 0836 LFL 63, D 0836 LFL 66	10.2005→		7.01268.03.0	AGR	PN	Rückschlagventil/non-return valve
18.250 184 kW (250 PS) D 0836 LFL 63, D 0836 LFL 66	10.2005→		7.01268.03.0	AGR	PN	Rückschlagventil/non-return valve
18.250 184 kW (250 PS) D 0836 LFL 63, D 0836 LFL 66	10.2005→		7.01268.03.0	AGR	PN	Rückschlagventil/non-return valve
18.250 184 kW (250 PS) D 0836 LFL 63, D 0836 LFL 66	10.2005→		7.01268.03.0	AGR	PN	Rückschlagventil/non-return valve
18.280 206 kW (280 PS) D 0836 LFL 41	10.2005→		7.01268.03.0	AGR	PN	Rückschlagventil/non-return valve
18.280 206 kW (280 PS) D 0836 LFL 41, D 0836 LFL 54	10.2005→		7.01268.03.0	AGR	PN	Rückschlagventil/non-return valve
18.280 206 kW (280 PS) D 0836 LFL 41, D 0836 LFL 51, D 0836 LFL 54	10.2005→		7.01268.03.0	AGR	PN	Rückschlagventil/non-return valve
18.280 206 kW (280 PS) D 0836 LFL 41, D 0836 LFL 54	10.2005→		7.01268.03.0	AGR	PN	Rückschlagventil/non-return valve
18.290 202-213 kW (275-290 PS) D 0836 LFL 64, D 0836 LFL 67	10.2005→		7.01268.03.0	AGR	PN	Rückschlagventil/non-return valve
18.290 202-213 kW (275-290 PS) D 0836 LFL 64, D 0836 LFL 67	10.2005→		7.01268.03.0	AGR	PN	Rückschlagventil/non-return valve
18.290 202-213 kW (275-290 PS) D 0836 LFL 64, D 0836 LFL 67	10.2005→		7.01268.03.0	AGR	PN	Rückschlagventil/non-return valve
18.290 202-213 kW (275-290 PS) D 0836 LFL 64, D 0836 LFL 67	10.2005→		7.01268.03.0	AGR	PN	Rückschlagventil/non-return valve
18.330 240 kW (326 PS) D 0836 LFL 44	10.2005→		7.01268.03.0	AGR	PN	Rückschlagventil/non-return valve
18.330 240 kW (326 PS) D 0836 LFL 44, D 0836 LFL 55	10.2005→		7.01268.03.0	AGR	PN	Rückschlagventil/non-return valve
18.330 240 kW (326 PS) D 0836 LFL 44, D 0836 LFL 52, D 0836 LFL 55	10.2005→		7.01268.03.0	AGR	PN	Rückschlagventil/non-return valve
18.330 240 kW (326 PS) D 0836 LFL 44, D 0836 LFL 55	10.2005→		7.01268.03.0	AGR	PN	Rückschlagventil/non-return valve
18.340 250 kW (340 PS) D 0836 LFL 65, D 0836 LFL 68	10.2005→		7.01268.03.0	AGR	PN	Rückschlagventil/non-return valve

M











TGM **45**

18.340 250 kW (340 PS) D 0836 LFL 65, D 0836 LFL 68	10.2005→		7.01268.03.0	AGR	PN	Rückschlagventil/non-return valve
18.340 250 kW (340 PS) D 0836 LFL 65, D 0836 LFL 68	10.2005→		7.01268.03.0	AGR	PN	Rückschlagventil/non-return valve
22.240 176 kW (240 PS) D 0836 LFL 53	10.2005→		7.01268.03.0	AGR	PN	Rückschlagventil/non-return valve
22.280 206 kW (280 PS) D 0836 LFL 54	10.2005→		7.01268.03.0	AGR	PN	Rückschlagventil/non-return valve
22.290 202-213 kW (275-290 PS) D 0836 LFL 64	10.2005→		7.01268.03.0	AGR	PN	Rückschlagventil/non-return valve
26.280 206 kW (280 PS) D 0836 LFL 51	04.2006→		7.01268.03.0	AGR	PN	Rückschlagventil/non-return valve
26.290 202-213 kW (275-290 PS) D 0836 LFL 64, D 0836 LFL 67	10.2005→		7.01268.03.0	AGR	PN	Rückschlagventil/non-return valve
26.290 202-213 kW (275-290 PS) D 0836 LFL 64	10.2005→		7.01268.03.0	AGR	PN	Rückschlagventil/non-return valve
26.290 202-213 kW (275-290 PS) D 0836 LFL 64, D 0836 LFL 67	10.2005→		7.01268.03.0	AGR	PN	Rückschlagventil/non-return valve
26.330 240 kW (326 PS) D 0836 LFL 55	10.2005→		7.01268.03.0	AGR	PN	Rückschlagventil/non-return valve
26.330 240 kW (326 PS) D 0836 LFL 52	04.2006→		7.01268.03.0	AGR	PN	Rückschlagventil/non-return valve
26.340 250 kW (340 PS) D 0836 LFL 65, D 0836 LFL 68	10.2005→		7.01268.03.0	AGR	PN	Rückschlagventil/non-return valve
26.340 250 kW (340 PS) D 0836 LFL 65	10.2005→		7.01268.03.0	AGR	PN	Rückschlagventil/non-return valve
26.340 250 kW (340 PS) D 0836 LFL 65, D 0836 LFL AC	10.2005→		7.01268.03.0	AGR	PN	Rückschlagventil/non-return valve
8.240 176 kW (240 PS) D 0836 LFL 40	04.2005→		7.01268.03.0	AGR	PN	Rückschlagventil/non-return valve

M

TGS **46**

18.320 235 kW (320 PS) D 2066 LF 28, D 2066 LF 39, D 2066 LF 43, D 2066 LF 86	10.2007→		7.01268.03.0	AGR	PN	Rückschlagventil/non-return valve
18.320 235 kW (320 PS) D 2066 LF 39, D 2066 LF 43, D 2066 LF 68, D 2066 LF 86	10.2007→		7.01268.03.0	AGR	PN	Rückschlagventil/non-return valve
18.320 235 kW (320 PS) D 2066 LF 39, D 2066 LF 43, D 2066 LF 53, D 2066 LF 68, D 2066 LF 86	10.2007→		7.01268.03.0	AGR	PN	Rückschlagventil/non-return valve
18.320 235 kW (320 PS) D 2066 LF 39, D 2066 LF 43, D 2066 LF 68, D 2066 LF 86	10.2007→		7.01268.03.0	AGR	PN	Rückschlagventil/non-return valve
18.320 235 kW (320 PS) D 2066 LF 28, D 2066 LF 39, D 2066 LF 43, D 2066 LF 68	10.2007→		7.01268.03.0	AGR	PN	Rückschlagventil/non-return valve
18.320 235 kW (320 PS) D 2066 LF 28, D 2066 LF 39, D 2066 LF 43, D 2066 LF 68	10.2007→		7.01268.03.0	AGR	PN	Rückschlagventil/non-return valve
18.350 257 kW (350 PS) D 2066 LF 03	10.2007→		7.01268.03.0	AGR	PN	Rückschlagventil/non-return valve
18.350 257 kW (350 PS) D 2066 LF 03	10.2007→		7.01268.03.0	AGR	PN	Rückschlagventil/non-return valve
18.350 257 kW (350 PS) D 2066 LF 03	10.2007→		7.01268.03.0	AGR	PN	Rückschlagventil/non-return valve

TGS
46

18.360 265 kW (360 PS) D 2066 LF 27, D 2066 LF 38, D 2066 LF 42, D 2066 LF 52, D 2066 LF 67, D 2066 LF 85	10.2007→	 7.01268.03.0	AGR	PN	Rückschlagventil/non-return valve
18.360 265 kW (360 PS) D 2066 LF 38, D 2066 LF 42, D 2066 LF 67, D 2066 LF 85	10.2007→	 7.01268.03.0	AGR	PN	Rückschlagventil/non-return valve
18.360 265 kW (360 PS) D 2066 LF 38, D 2066 LF 42, D 2066 LF 52, D 2066 LF 67	10.2007→	 7.01268.03.0	AGR	PN	Rückschlagventil/non-return valve
18.360 265 kW (360 PS) D 2066 LF 27, D 2066 LF 38, D 2066 LF 42, D 2066 LF 48, D 2066 LF 64, D 2066 LF 67	10.2007→	 7.01268.03.0	AGR	PN	Rückschlagventil/non-return valve
18.360 265 kW (360 PS) D 2066 LF 27, D 2066 LF 38, D 2066 LF 42, D 2066 LF 48, D 2066 LF 64, D 2066 LF 67	10.2007→	 7.01268.03.0	AGR	PN	Rückschlagventil/non-return valve
18.360 265 kW (360 PS) D 2066 LF 27, D 2066 LF 38, D 2066 LF 42, D 2066 LF 48, D 2066 LF 64, D 2066 LF 67	10.2007→	 7.01268.03.0	AGR	PN	Rückschlagventil/non-return valve
18.390 287 kW (390 PS) D 2066 LF 02	06.2008→	 7.01268.03.0	AGR	PN	Rückschlagventil/non-return valve
18.390 287 kW (390 PS) D 2066 LF 02	06.2008→	 7.01268.03.0	AGR	PN	Rückschlagventil/non-return valve
18.390 287 kW (390 PS) D 2066 LF 02	06.2008→	 7.01268.03.0	AGR	PN	Rückschlagventil/non-return valve
18.400 294 kW (400 PS) D 2066 LF 37	10.2007→	 7.01268.03.0	AGR	PN	Rückschlagventil/non-return valve
18.400 294 kW (400 PS) D 2066 LF 26, D 2066 LF 37, D 2066 LF 41, D 2066 LF 61	10.2007→	 7.01268.03.0	AGR	PN	Rückschlagventil/non-return valve
18.400 294 kW (400 PS) D 2066 LF 26, D 2066 LF 37, D 2066 LF 41, D 2066 LF 51, D 2066 LF 61	10.2007→	 7.01268.03.0	AGR	PN	Rückschlagventil/non-return valve
18.400 294 kW (400 PS) D 2066 LF 26, D 2066 LF 37, D 2066 LF 41, D 2066 LF 49, D 2066 LF 61, D 2066 LF 63	10.2007→	 7.01268.03.0	AGR	PN	Rückschlagventil/non-return valve
18.400 294 kW (400 PS) D 2066 LF 26, D 2066 LF 37, D 2066 LF 41, D 2066 LF 49, D 2066 LF 61, D 2066 LF 63	10.2007→	 7.01268.03.0	AGR	PN	Rückschlagventil/non-return valve
18.400 294 kW (400 PS) D 2066 LF 26, D 2066 LF 37, D 2066 LF 41, D 2066 LF 49, D 2066 LF 61, D 2066 LF 63	10.2007→	 7.01268.03.0	AGR	PN	Rückschlagventil/non-return valve
18.420 309 kW (420 PS) D 2676 LF 53	09.2016→	 7.01268.03.0	AGR	PN	Rückschlagventil/non-return valve
18.420 309 kW (420 PS) D 2676 LF 53	09.2016→	 7.01268.03.0	AGR	PN	Rückschlagventil/non-return valve
18.420 309 kW (420 PS) D 2676 LF 53	09.2016→	 7.01268.03.0	AGR	PN	Rückschlagventil/non-return valve
18.420 309 kW (420 PS) D 2676 LF 53	09.2016→	 7.01268.03.0	AGR	PN	Rückschlagventil/non-return valve
18.420 309 kW (420 PS) D 2676 LF 53	09.2016→	 7.01268.03.0	AGR	PN	Rückschlagventil/non-return valve

M























TGS **46**

18.420 309 kW (420 PS) D 2676 LF 53	09.2016→		7.01268.03.0	AGR	PN	Rückschlagventil/non-return valve
18.430 316 kW (430 PS) D 2066 LF 01	10.2007→		7.01268.03.0	AGR	PN	Rückschlagventil/non-return valve
18.430 316 kW (430 PS) D 2066 LF 01	10.2007→		7.01268.03.0	AGR	PN	Rückschlagventil/non-return valve
18.430 316 kW (430 PS) D 2066 LF 01	10.2007→		7.01268.03.0	AGR	PN	Rückschlagventil/non-return valve
18.440 324 kW (440 PS) D 2066 LF 25, D 2066 LF 36, D 2066 LF 40	10.2007→		7.01268.03.0	AGR	PN	Rückschlagventil/non-return valve
18.440 324 kW (440 PS) D 2066 LF 25, D 2066 LF 36, D 2066 LF 40	10.2007→		7.01268.03.0	AGR	PN	Rückschlagventil/non-return valve
18.440 324 kW (440 PS) D 2066 LF 25, D 2066 LF 36, D 2066 LF 40	10.2007→		7.01268.03.0	AGR	PN	Rückschlagventil/non-return valve
18.440 324 kW (440-441 PS) D 2066 LF 25, D 2066 LF 36, D 2066 LF 40, D 2066 LF 50, D 2066 LF 62	10.2007→		7.01268.03.0	AGR	PN	Rückschlagventil/non-return valve
18.440 324 kW (440-441 PS) D 2066 LF 25, D 2066 LF 36, D 2066 LF 40, D 2066 LF 50, D 2066 LF 62	10.2007→		7.01268.03.0	AGR	PN	Rückschlagventil/non-return valve
18.440 324 kW (440-441 PS) D 2066 LF 25, D 2066 LF 36, D 2066 LF 40, D 2066 LF 50, D 2066 LF 62	10.2007→		7.01268.03.0	AGR	PN	Rückschlagventil/non-return valve
18.440 324 kW (441 PS) D 2676 LF 26	10.2007→		7.01268.03.0	AGR	PN	Rückschlagventil/non-return valve
18.440 324 kW (441 PS) D 2676 LF 26	10.2007→		7.01268.03.0	AGR	PN	Rückschlagventil/non-return valve
18.440 324 kW (441 PS) D 2676 LF 22, D 2676 LF 26	10.2007→		7.01268.03.0	AGR	PN	Rückschlagventil/non-return valve
18.440 324 kW (441 PS) D 2676 LF 26	10.2007→		7.01268.03.0	AGR	PN	Rückschlagventil/non-return valve
18.440 324 kW (441 PS) D 2676 LF 26	10.2007→		7.01268.03.0	AGR	PN	Rückschlagventil/non-return valve
18.440 324 kW (441 PS) D 2676 LF 26	10.2007→		7.01268.03.0	AGR	PN	Rückschlagventil/non-return valve
18.440 324 kW (441 PS) D 2676 LF 26	10.2007→		7.01268.03.0	AGR	PN	Rückschlagventil/non-return valve
18.460 338 kW (460 PS) D 2676 LF 52	09.2016→		7.01268.03.0	AGR	PN	Rückschlagventil/non-return valve
18.460 338 kW (460 PS) D 2676 LF 52	09.2016→		7.01268.03.0	AGR	PN	Rückschlagventil/non-return valve
18.460 338 kW (460 PS) D 2676 LF 52	09.2016→		7.01268.03.0	AGR	PN	Rückschlagventil/non-return valve
18.460 338 kW (460 PS) D 2676 LF 52	09.2016→		7.01268.03.0	AGR	PN	Rückschlagventil/non-return valve
18.460 338 kW (460 PS) D 2676 LF 52	09.2016→		7.01268.03.0	AGR	PN	Rückschlagventil/non-return valve
18.460 338 kW (460 PS) D 2676 LF 52	09.2016→		7.01268.03.0	AGR	PN	Rückschlagventil/non-return valve
18.480 353 kW (480 PS) D 2676 LF 05, D 2676 LF 07, D 2676 LF 14, D 2676 LF 25	10.2007→		7.01268.03.0	AGR	PN	Rückschlagventil/non-return valve
18.480 353 kW (480 PS) D 2676 LF 05, D 2676 LF 07, D 2676 LF 14, D 2676 LF 25	10.2007→		7.01268.03.0	AGR	PN	Rückschlagventil/non-return valve

M

TGS
46

18.480 353 kW (480 PS) D 2676 LF 05, D 2676 LF 07, D 2676 LF 14, D 2676 LF 25	10.2007→		7.01268.03.0	AGR	PN	Rückschlagventil/non-return valve
18.480 353 kW (480 PS) D 2676 LF 02, D 2676 LF 05, D 2676 LF 07, D 2676 LF 20, D 2676 LF 25	10.2007→		7.01268.03.0	AGR	PN	Rückschlagventil/non-return valve
18.480 353 kW (480 PS) D 2676 LF 02, D 2676 LF 05, D 2676 LF 07, D 2676 LF 20, D 2676 LF 25	10.2007→		7.01268.03.0	AGR	PN	Rückschlagventil/non-return valve
18.480 353 kW (480 PS) D 2676 LF 02, D 2676 LF 05, D 2676 LF 07, D 2676 LF 20, D 2676 LF 25	10.2007→		7.01268.03.0	AGR	PN	Rückschlagventil/non-return valve
18.500 368 kW (500 PS) D 2676 LF 51	09.2016→		7.01268.03.0	AGR	PN	Rückschlagventil/non-return valve
18.500 368 kW (500 PS) D 2676 LF 51	09.2016→		7.01268.03.0	AGR	PN	Rückschlagventil/non-return valve
18.500 368 kW (500 PS) D 2676 LF 51	09.2016→		7.01268.03.0	AGR	PN	Rückschlagventil/non-return valve
18.500 368 kW (500 PS) D 2676 LF 51	09.2016→		7.01268.03.0	AGR	PN	Rückschlagventil/non-return valve
18.500 368 kW (500 PS) D 2676 LF 51	09.2016→		7.01268.03.0	AGR	PN	Rückschlagventil/non-return valve
18.500 368 kW (500 PS) D 2676 LF 51	09.2016→		7.01268.03.0	AGR	PN	Rückschlagventil/non-return valve
18.540 397 kW (540 PS) D 2676 LF 06, D 2676 LF 13	10.2007→		7.01268.03.0	AGR	PN	Rückschlagventil/non-return valve
18.540 397 kW (540 PS) D 2676 LF 06, D 2676 LF 13	10.2007→		7.01268.03.0	AGR	PN	Rückschlagventil/non-return valve
18.540 397 kW (540 PS) D 2676 LF 06, D 2676 LF 13	10.2007→		7.01268.03.0	AGR	PN	Rückschlagventil/non-return valve
18.540 397 kW (540 PS) D 2676 LF 06, D 2676 LF 13	10.2007→		7.01268.03.0	AGR	PN	Rückschlagventil/non-return valve
18.540 397 kW (540 PS) D 2676 LF 06, D 2676 LF 13	10.2007→		7.01268.03.0	AGR	PN	Rückschlagventil/non-return valve
18.540 397 kW (540 PS) D 2676 LF 06, D 2676 LF 13	10.2007→		7.01268.03.0	AGR	PN	Rückschlagventil/non-return valve
19.350 257 kW (350 PS) D 2066 LF 03	10.2007→		7.01268.03.0	AGR	PN	Rückschlagventil/non-return valve
19.360 265 kW (360 PS) D 2066 LF 07, D 2066 LF 48, D 2066 LF 64	02.2011→		7.01268.03.0	AGR	PN	Rückschlagventil/non-return valve
19.390 287 kW (390 PS) D 2066 LF 02	06.2008→		7.01268.03.0	AGR	PN	Rückschlagventil/non-return valve
19.400 294 kW (400 PS) D 2066 LF 06, D 2066 LF 49, D 2066 LF 63	02.2011→		7.01268.03.0	AGR	PN	Rückschlagventil/non-return valve
19.430 316 kW (430 PS) D 2066 LF 01	10.2007→		7.01268.03.0	AGR	PN	Rückschlagventil/non-return valve
19.440 324 kW (441 PS) D 2066 LF 50, D 2066 LF 62	02.2011→		7.01268.03.0	AGR	PN	Rückschlagventil/non-return valve
19.440 324 kW (440-441 PS) D 2676 LF 04	02.2011→		7.01268.03.0	AGR	PN	Rückschlagventil/non-return valve
19.480 353 kW (480 PS) D 2676 LF 02, D 2676 LF 03, D 2676 LF 20, D 2676 LF 31	02.2011→		7.01268.03.0	AGR	PN	Rückschlagventil/non-return valve







M



TGS **46**





















21.360 265 kW (360 PS) D 2066 LF 07, D 2066 LF 48, D 2066 LF 64	10.2007→		7.01268.03.0	AGR	PN	Rückschlagventil/non-return valve
21.400 294 kW (400 PS) D 2066 LF 06, D 2066 LF 49, D 2066 LF 63	10.2007→		7.01268.03.0	AGR	PN	Rückschlagventil/non-return valve
21.440 324 kW (441 PS) D 2066 LF 50, D 2066 LF 62	10.2007→		7.01268.03.0	AGR	PN	Rückschlagventil/non-return valve
21.440 324 kW (440-441 PS) D 2676 LF 04	10.2007→		7.01268.03.0	AGR	PN	Rückschlagventil/non-return valve
21.480 353 kW (480 PS) D 2676 LF 02, D 2676 LF 03, D 2676 LF 20	10.2007→		7.01268.03.0	AGR	PN	Rückschlagventil/non-return valve
24.320 235 kW (320 PS) D 2066 LF 39, D 2066 LF 43, D 2066 LF 53, D 2066 LF 68	10.2007→		7.01268.03.0	AGR	PN	Rückschlagventil/non-return valve
24.320 235 kW (320 PS) D 2066 LF 28, D 2066 LF 43, D 2066 LF 68	10.2007→		7.01268.03.0	AGR	PN	Rückschlagventil/non-return valve
24.320 235 kW (320 PS) D 2066 LF 86	09.2016→		7.01268.03.0	AGR	PN	Rückschlagventil/non-return valve
24.360 265 kW (360 PS) D 2066 LF 27, D 2066 LF 38, D 2066 LF 42, D 2066 LF 52, D 2066 LF 67	10.2007→		7.01268.03.0	AGR	PN	Rückschlagventil/non-return valve
M 24.360 265 kW (360 PS) D 2066 LF 27, D 2066 LF 38, D 2066 LF 42, D 2066 LF 67	10.2007→		7.01268.03.0	AGR	PN	Rückschlagventil/non-return valve
24.360 265 kW (360 PS) D 2066 LF 85	09.2016→		7.01268.03.0	AGR	PN	Rückschlagventil/non-return valve
24.400 294 kW (400 PS) D 2066 LF 26, D 2066 LF 37, D 2066 LF 41, D 2066 LF 61	10.2007→		7.01268.03.0	AGR	PN	Rückschlagventil/non-return valve
24.400 294 kW (400 PS) D 2066 LF 26, D 2066 LF 37, D 2066 LF 41, D 2066 LF 61	10.2007→		7.01268.03.0	AGR	PN	Rückschlagventil/non-return valve
24.420 309 kW (420 PS) D 2676 LF 53	09.2016→		7.01268.03.0	AGR	PN	Rückschlagventil/non-return valve
24.420 309 kW (420 PS) D 2676 LF 53	09.2016→		7.01268.03.0	AGR	PN	Rückschlagventil/non-return valve
24.420 309 kW (420 PS) D 2676 LF 53	09.2016→		7.01268.03.0	AGR	PN	Rückschlagventil/non-return valve
24.440 324 kW (440 PS) D 2066 LF 25, D 2066 LF 36, D 2066 LF 40	10.2007→		7.01268.03.0	AGR	PN	Rückschlagventil/non-return valve
24.440 324 kW (440 PS) D 2066 LF 25, D 2066 LF 36, D 2066 LF 40	10.2007→		7.01268.03.0	AGR	PN	Rückschlagventil/non-return valve
24.440 324 kW (441 PS) D 2676 LF 26	10.2007→		7.01268.03.0	AGR	PN	Rückschlagventil/non-return valve
24.440 324 kW (441 PS) D 2676 LF 22, D 2676 LF 26	10.2007→		7.01268.03.0	AGR	PN	Rückschlagventil/non-return valve
24.460 338 kW (460 PS) D 2676 LF 52	09.2016→		7.01268.03.0	AGR	PN	Rückschlagventil/non-return valve
24.460 338 kW (460 PS) D 2676 LF 52	09.2016→		7.01268.03.0	AGR	PN	Rückschlagventil/non-return valve
24.460 338 kW (460 PS) D 2676 LF 52	09.2016→		7.01268.03.0	AGR	PN	Rückschlagventil/non-return valve

TGS
46

24.480 353 kW (480 PS) D 2676 LF 05, D 2676 LF 07, D 2676 LF 14, D 2676 LF 25	10.2007→		7.01268.03.0	AGR	PN	Rückschlagventil/non-return valve
24.480 353 kW (480 PS) D 2676 LF 25	10.2007→		7.01268.03.0	AGR	PN	Rückschlagventil/non-return valve
24.500 368 kW (500 PS) D 2676 LF 51	09.2016→		7.01268.03.0	AGR	PN	Rückschlagventil/non-return valve
24.500 368 kW (500 PS) D 2676 LF 51	09.2016→		7.01268.03.0	AGR	PN	Rückschlagventil/non-return valve
24.500 368 kW (500 PS) D 2676 LF 51	09.2016→		7.01268.03.0	AGR	PN	Rückschlagventil/non-return valve
24.540 397 kW (540 PS) D 2676 LF 06, D 2676 LF 13	10.2007→		7.01268.03.0	AGR	PN	Rückschlagventil/non-return valve
26.320 235 kW (320 PS) D 2066 LF 28, D 2066 LF 39, D 2066 LF 43	10.2007→		7.01268.03.0	AGR	PN	Rückschlagventil/non-return valve
26.320 235 kW (320 PS) D 2066 LF 39	10.2007→		7.01268.03.0	AGR	PN	Rückschlagventil/non-return valve
26.320 235 kW (320 PS) D 2066 LF 28, D 2066 LF 39, D 2066 LF 43	10.2007→		7.01268.03.0	AGR	PN	Rückschlagventil/non-return valve
26.320 235 kW (320 PS) D 2066 LF 39, D 2066 LF 43, D 2066 LF 53, D 2066 LF 68	07.2008→		7.01268.03.0	AGR	PN	Rückschlagventil/non-return valve
26.320 235 kW (320 PS) D 2066 LF 39, D 2066 LF 43, D 2066 LF 68	07.2008→		7.01268.03.0	AGR	PN	Rückschlagventil/non-return valve
26.320 235 kW (320 PS) D 2066 LF 39, D 2066 LF 43, D 2066 LF 68	07.2008→		7.01268.03.0	AGR	PN	Rückschlagventil/non-return valve
26.320 235 kW (320 PS) D 2066 LF 39, D 2066 LF 43, D 2066 LF 68	07.2008→		7.01268.03.0	AGR	PN	Rückschlagventil/non-return valve
26.320 235 kW (320 PS) D 2066 LF 39, D 2066 LF 43, D 2066 LF 68	07.2008→		7.01268.03.0	AGR	PN	Rückschlagventil/non-return valve
26.320 235 kW (320 PS) D 2066 LF 39, D 2066 LF 43, D 2066 LF 68	07.2008→		7.01268.03.0	AGR	PN	Rückschlagventil/non-return valve
26.320 235 kW (320 PS) D 2066 LF 28, D 2066 LF 39, D 2066 LF 43, D 2066 LF 68	07.2008→		7.01268.03.0	AGR	PN	Rückschlagventil/non-return valve
26.320 235 kW (320 PS) D 2066 LF 39, D 2066 LF 43, D 2066 LF 53, D 2066 LF 68	07.2008→		7.01268.03.0	AGR	PN	Rückschlagventil/non-return valve
26.350 257 kW (350 PS) D 2066 LF 03	10.2007→		7.01268.03.0	AGR	PN	Rückschlagventil/non-return valve
26.350 257 kW (350 PS) D 2066 LF 03	10.2007→		7.01268.03.0	AGR	PN	Rückschlagventil/non-return valve
26.350 257 kW (350 PS) D 2066 LF 03	10.2007→		7.01268.03.0	AGR	PN	Rückschlagventil/non-return valve
26.360 265 kW (360 PS) D 2066 LF 27, D 2066 LF 38, D 2066 LF 42, D 2066 LF 48, D 2066 LF 52, D 2066 LF 64, D 2066 LF 67	10.2007→		7.01268.03.0	AGR	PN	Rückschlagventil/non-return valve
26.360 265 kW (360 PS) D 2066 LF 38	10.2007→		7.01268.03.0	AGR	PN	Rückschlagventil/non-return valve
26.360 265 kW (360 PS) D 2066 LF 27, D 2066 LF 38, D 2066 LF 42, D 2066 LF 48, D 2066 LF 52, D 2066 LF 64, D 2066 LF 67	10.2007→		7.01268.03.0	AGR	PN	Rückschlagventil/non-return valve





















M

TGS **46**

26.360 265 kW (360 PS) D 2066 LF 38	05.2008→		7.01268.03.0	AGR	PN	Rückschlagventil/non-return valve
26.360 265 kW (360 PS) D 2066 LF 38, D 2066 LF 42, D 2066 LF 67	08.2008→		7.01268.03.0	AGR	PN	Rückschlagventil/non-return valve
26.360 265 kW (360 PS) D 2066 LF 38, D 2066 LF 42	08.2008→		7.01268.03.0	AGR	PN	Rückschlagventil/non-return valve
26.360 265 kW (360 PS) D 2066 LF 27, D 2066 LF 38, D 2066 LF 42, D 2066 LF 67	08.2008→		7.01268.03.0	AGR	PN	Rückschlagventil/non-return valve
26.360 265 kW (360 PS) D 2066 LF 07, D 2066 LF 38, D 2066 LF 42, D 2066 LF 48, D 2066 LF 67	08.2008→		7.01268.03.0	AGR	PN	Rückschlagventil/non-return valve
26.360 265 kW (360 PS) D 2066 LF 38, D 2066 LF 42, D 2066 LF 67	08.2008→		7.01268.03.0	AGR	PN	Rückschlagventil/non-return valve
26.360 265 kW (360 PS) D 2066 LF 27, D 2066 LF 38, D 2066 LF 42, D 2066 LF 67	08.2008→		7.01268.03.0	AGR	PN	Rückschlagventil/non-return valve
26.360 265 kW (360 PS) D 2066 LF 38, D 2066 LF 42, D 2066 LF 48, D 2066 LF 52, D 2066 LF 64, D 2066 LF 67	08.2008→		7.01268.03.0	AGR	PN	Rückschlagventil/non-return valve
26.360 265 kW (360 PS) D 2066 LF 38, D 2066 LF 42, D 2066 LF 48, D 2066 LF 52, D 2066 LF 64, D 2066 LF 67	08.2008→		7.01268.03.0	AGR	PN	Rückschlagventil/non-return valve
26.390 287 kW (390 PS) D 2066 LF 02	06.2008→		7.01268.03.0	AGR	PN	Rückschlagventil/non-return valve
26.390 287 kW (390 PS) D 2066 LF 02	06.2008→		7.01268.03.0	AGR	PN	Rückschlagventil/non-return valve
26.390 287 kW (390 PS) D 2066 LF 02	06.2008→		7.01268.03.0	AGR	PN	Rückschlagventil/non-return valve
26.390 287 kW (390 PS) D 2066 LF 02	06.2008→		7.01268.03.0	AGR	PN	Rückschlagventil/non-return valve
26.400 294 kW (400 PS) D 2066 LF 26, D 2066 LF 37, D 2066 LF 41, D 2066 LF 61	09.2007→		7.01268.03.0	AGR	PN	Rückschlagventil/non-return valve
26.400 294 kW (400 PS) D 2066 LF 26, D 2066 LF 37, D 2066 LF 41, D 2066 LF 49, D 2066 LF 51, D 2066 LF 61, D 2066 LF 63	10.2007→		7.01268.03.0	AGR	PN	Rückschlagventil/non-return valve
26.400 294 kW (400 PS) D 2066 LF 37	10.2007→		7.01268.03.0	AGR	PN	Rückschlagventil/non-return valve
26.400 294 kW (400 PS) D 2066 LF 26, D 2066 LF 37, D 2066 LF 41, D 2066 LF 49, D 2066 LF 51, D 2066 LF 61, D 2066 LF 63	10.2007→		7.01268.03.0	AGR	PN	Rückschlagventil/non-return valve
26.400 294 kW (400 PS) D 2066 LF 06, D 2066 LF 37, D 2066 LF 41, D 2066 LF 49, D 2066 LF 61, D 2066 LF 63	05.2008→		7.01268.03.0	AGR	PN	Rückschlagventil/non-return valve
26.400 294 kW (400 PS) D 2066 LF 37	05.2008→		7.01268.03.0	AGR	PN	Rückschlagventil/non-return valve
26.400 294 kW (400 PS) D 2066 LF 06, D 2066 LF 37, D 2066 LF 41, D 2066 LF 49, D 2066 LF 61	08.2008→		7.01268.03.0	AGR	PN	Rückschlagventil/non-return valve

M

TGS
46

26.400 294 kW (400 PS) D 2066 LF 37, D 2066 LF 41, D 2066 LF 61	02.2009→		7.01268.03.0	AGR	PN	Rückschlagventil/non-return valve
26.400 294 kW (400 PS) D 2066 LF 37, D 2066 LF 41, D 2066 LF 61	02.2009→		7.01268.03.0	AGR	PN	Rückschlagventil/non-return valve
26.400 294 kW (400 PS) D 2066 LF 26, D 2066 LF 37, D 2066 LF 41, D 2066 LF 61	02.2009→		7.01268.03.0	AGR	PN	Rückschlagventil/non-return valve
26.400 294 kW (400 PS) D 2066 LF 37, D 2066 LF 41, D 2066 LF 49, D 2066 LF 51, D 2066 LF 61, D 2066 LF 63	02.2009→		7.01268.03.0	AGR	PN	Rückschlagventil/non-return valve
26.420 309 kW (420 PS) D 2676 LF 53	09.2016→		7.01268.03.0	AGR	PN	Rückschlagventil/non-return valve
26.420 309 kW (420 PS) D 2676 LF 53	09.2016→		7.01268.03.0	AGR	PN	Rückschlagventil/non-return valve
26.420 309 kW (420 PS) D 2676 LF 53	09.2016→		7.01268.03.0	AGR	PN	Rückschlagventil/non-return valve
26.420 309 kW (420 PS) D 2676 LF 53	09.2016→		7.01268.03.0	AGR	PN	Rückschlagventil/non-return valve
26.420 309 kW (420 PS) D 2676 LF 53	09.2016→		7.01268.03.0	AGR	PN	Rückschlagventil/non-return valve
26.420 309 kW (420 PS) D 2676 LF 53	09.2016→		7.01268.03.0	AGR	PN	Rückschlagventil/non-return valve
26.420 309 kW (420 PS) D 2676 LF 53	09.2016→		7.01268.03.0	AGR	PN	Rückschlagventil/non-return valve
26.420 309 kW (420 PS) D 2676 LF 53	09.2016→		7.01268.03.0	AGR	PN	Rückschlagventil/non-return valve
26.420 309 kW (420 PS) D 2676 LF 53	09.2016→		7.01268.03.0	AGR	PN	Rückschlagventil/non-return valve
26.420 309 kW (420 PS) D 2676 LF 53	09.2016→		7.01268.03.0	AGR	PN	Rückschlagventil/non-return valve
26.420 309 kW (420 PS) D 2676 LF 53	09.2016→		7.01268.03.0	AGR	PN	Rückschlagventil/non-return valve
26.430 316 kW (430 PS) D 2066 LF 01	10.2007→		7.01268.03.0	AGR	PN	Rückschlagventil/non-return valve
26.430 316 kW (430 PS) D 2066 LF 01	10.2007→		7.01268.03.0	AGR	PN	Rückschlagventil/non-return valve
26.430 316 kW (430 PS) D 2066 LF 01	10.2007→		7.01268.03.0	AGR	PN	Rückschlagventil/non-return valve
26.430 316 kW (430 PS) D 2066 LF 01	10.2007→		7.01268.03.0	AGR	PN	Rückschlagventil/non-return valve
26.440 324 kW (440-441 PS) D 2066 LF 25, D 2066 LF 36, D 2066 LF 40, D 2066 LF 50, D 2066 LF 62	10.2007→		7.01268.03.0	AGR	PN	Rückschlagventil/non-return valve
26.440 324 kW (440 PS) D 2066 LF 36	10.2007→		7.01268.03.0	AGR	PN	Rückschlagventil/non-return valve
26.440 324 kW (441 PS) D 2676 LF 22, D 2676 LF 26	10.2007→		7.01268.03.0	AGR	PN	Rückschlagventil/non-return valve
26.440 324 kW (441 PS) D 2676 LF 22, D 2676 LF 26	10.2007→		7.01268.03.0	AGR	PN	Rückschlagventil/non-return valve
26.440 324 kW (440-441 PS) D 2066 LF 25, D 2066 LF 36, D 2066 LF 40, D 2066 LF 50, D 2066 LF 62	10.2007→		7.01268.03.0	AGR	PN	Rückschlagventil/non-return valve
26.440 324 kW (441 PS) D 2676 LF 22, D 2676 LF 26	10.2007→		7.01268.03.0	AGR	PN	Rückschlagventil/non-return valve





















M



TGS **46**

26.440 324 kW (441 PS) D 2676 LF 22, D 2676 LF 26	10.2007→		7.01268.03.0	AGR	PN	Rückschlagventil/non-return valve
26.440 324 kW (440 PS) D 2066 LF 25, D 2066 LF 36, D 2066 LF 40	11.2007→		7.01268.03.0	AGR	PN	Rückschlagventil/non-return valve
26.440 324 kW (440-441 PS) D 2066 LF 36, D 2066 LF 40, D 2066 LF 50, D 2066 LF 62	05.2008→		7.01268.03.0	AGR	PN	Rückschlagventil/non-return valve
26.440 324 kW (440-441 PS) D 2676 LF 04, D 2676 LF 26	05.2008→		7.01268.03.0	AGR	PN	Rückschlagventil/non-return valve
26.440 324 kW (440 PS) D 2066 LF 36, D 2066 LF 40	07.2008→		7.01268.03.0	AGR	PN	Rückschlagventil/non-return valve
26.440 324 kW (441 PS) D 2676 LF 26	07.2008→		7.01268.03.0	AGR	PN	Rückschlagventil/non-return valve
26.440 324 kW (440-441 PS) D 2066 LF 36, D 2066 LF 40, D 2066 LF 50, D 2066 LF 62	02.2009→		7.01268.03.0	AGR	PN	Rückschlagventil/non-return valve
26.440 324 kW (440-441 PS) D 2066 LF 36, D 2066 LF 40, D 2066 LF 50	02.2009→		7.01268.03.0	AGR	PN	Rückschlagventil/non-return valve
26.440 324 kW (440 PS) D 2066 LF 36, D 2066 LF 40	02.2009→		7.01268.03.0	AGR	PN	Rückschlagventil/non-return valve
26.440 324 kW (440 PS) D 2066 LF 36, D 2066 LF 40	02.2009→		7.01268.03.0	AGR	PN	Rückschlagventil/non-return valve
26.440 324 kW (440-441 PS) D 2676 LF 04, D 2676 LF 26	02.2009→		7.01268.03.0	AGR	PN	Rückschlagventil/non-return valve
M 26.440 324 kW (441 PS) D 2676 LF 26	02.2009→		7.01268.03.0	AGR	PN	Rückschlagventil/non-return valve
26.440 324 kW (441 PS) D 2676 LF 26	02.2009→		7.01268.03.0	AGR	PN	Rückschlagventil/non-return valve
26.440 324 kW (441 PS) D 2676 LF 26	02.2009→		7.01268.03.0	AGR	PN	Rückschlagventil/non-return valve
26.440 324 kW (440-441 PS) D 2066 LF 36, D 2066 LF 40, D 2066 LF 50, D 2066 LF 62	02.2009→		7.01268.03.0	AGR	PN	Rückschlagventil/non-return valve
26.460 338 kW (460 PS) D 2676 LF 52	09.2016→		7.01268.03.0	AGR	PN	Rückschlagventil/non-return valve
26.460 338 kW (460 PS) D 2676 LF 52	09.2016→		7.01268.03.0	AGR	PN	Rückschlagventil/non-return valve
26.460 338 kW (460 PS) D 2676 LF 52	09.2016→		7.01268.03.0	AGR	PN	Rückschlagventil/non-return valve
26.460 338 kW (460 PS) D 2676 LF 52	09.2016→		7.01268.03.0	AGR	PN	Rückschlagventil/non-return valve
26.460 338 kW (460 PS) D 2676 LF 52	09.2016→		7.01268.03.0	AGR	PN	Rückschlagventil/non-return valve
26.460 338 kW (460 PS) D 2676 LF 52	09.2016→		7.01268.03.0	AGR	PN	Rückschlagventil/non-return valve
26.460 338 kW (460 PS) D 2676 LF 52	09.2016→		7.01268.03.0	AGR	PN	Rückschlagventil/non-return valve
26.460 338 kW (460 PS) D 2676 LF 52	09.2016→		7.01268.03.0	AGR	PN	Rückschlagventil/non-return valve
26.460 338 kW (460 PS) D 2676 LF 52	09.2016→		7.01268.03.0	AGR	PN	Rückschlagventil/non-return valve

TGS
46

26.480 353 kW (480 PS) D 2676 LF 02, D 2676 LF 05, D 2676 LF 07, D 2676 LF 14, D 2676 LF 20, D 2676 LF 25	10.2007→		7.01268.03.0	AGR	PN	Rückschlagventil/non-return valve
26.480 353 kW (480 PS) D 2676 LF 05	10.2007→		7.01268.03.0	AGR	PN	Rückschlagventil/non-return valve
26.480 353 kW (480 PS) D 2676 LF 02, D 2676 LF 05, D 2676 LF 07, D 2676 LF 14, D 2676 LF 20, D 2676 LF 25	10.2007→		7.01268.03.0	AGR	PN	Rückschlagventil/non-return valve
26.480 353 kW (480 PS) D 2676 LF 02, D 2676 LF 03, D 2676 LF 05, D 2676 LF 07, D 2676 LF 20, D 2676 LF 25	05.2008→		7.01268.03.0	AGR	PN	Rückschlagventil/non-return valve
26.480 353 kW (480 PS) D 2676 LF 05	05.2008→		7.01268.03.0	AGR	PN	Rückschlagventil/non-return valve
26.480 353 kW (480 PS) D 2676 LF 05, D 2676 LF 07, D 2676 LF 25	07.2008→		7.01268.03.0	AGR	PN	Rückschlagventil/non-return valve
26.480 353 kW (480 PS) D 2676 LF 02, D 2676 LF 05, D 2676 LF 07, D 2676 LF 20, D 2676 LF 25	02.2009→		7.01268.03.0	AGR	PN	Rückschlagventil/non-return valve
26.480 353 kW (480 PS) D 2676 LF 02, D 2676 LF 03, D 2676 LF 05, D 2676 LF 07, D 2676 LF 25	02.2009→		7.01268.03.0	AGR	PN	Rückschlagventil/non-return valve
26.480 353 kW (480 PS) D 2676 LF 05, D 2676 LF 07, D 2676 LF 25	02.2009→		7.01268.03.0	AGR	PN	Rückschlagventil/non-return valve
26.480 353 kW (480 PS) D 2676 LF 05, D 2676 LF 07, D 2676 LF 14, D 2676 LF 25	02.2009→		7.01268.03.0	AGR	PN	Rückschlagventil/non-return valve
26.480 353 kW (480 PS) D 2676 LF 05, D 2676 LF 07, D 2676 LF 25	02.2009→		7.01268.03.0	AGR	PN	Rückschlagventil/non-return valve
26.480 353 kW (480 PS) D 2676 LF 02, D 2676 LF 05, D 2676 LF 07, D 2676 LF 20, D 2676 LF 25	02.2009→		7.01268.03.0	AGR	PN	Rückschlagventil/non-return valve
26.500 368 kW (500 PS) D 2676 LF 51	09.2016→		7.01268.03.0	AGR	PN	Rückschlagventil/non-return valve
26.500 368 kW (500 PS) D 2676 LF 51	09.2016→		7.01268.03.0	AGR	PN	Rückschlagventil/non-return valve
26.500 368 kW (500 PS) D 2676 LF 51	09.2016→		7.01268.03.0	AGR	PN	Rückschlagventil/non-return valve
26.500 368 kW (500 PS) D 2676 LF 51	09.2016→		7.01268.03.0	AGR	PN	Rückschlagventil/non-return valve
26.500 368 kW (500 PS) D 2676 LF 51	09.2016→		7.01268.03.0	AGR	PN	Rückschlagventil/non-return valve
26.500 368 kW (500 PS) D 2676 LF 51	09.2016→		7.01268.03.0	AGR	PN	Rückschlagventil/non-return valve
26.500 368 kW (500 PS) D 2676 LF 51	09.2016→		7.01268.03.0	AGR	PN	Rückschlagventil/non-return valve
26.500 368 kW (500 PS) D 2676 LF 51	09.2016→		7.01268.03.0	AGR	PN	Rückschlagventil/non-return valve

























M



TGS **46**

26.500 368 kW (500 PS) D 2676 LF 51	09.2016→		7.01268.03.0	AGR	PN	Rückschlagventil/non-return valve
26.540 397 kW (540 PS) D 2676 LF 06, D 2676 LF 13	10.2007→		7.01268.03.0	AGR	PN	Rückschlagventil/non-return valve
26.540 397 kW (540 PS) D 2676 LF 06, D 2676 LF 13	10.2007→		7.01268.03.0	AGR	PN	Rückschlagventil/non-return valve
26.540 397 kW (540 PS) D 2676 LF 06, D 2676 LF 13	11.2007→		7.01268.03.0	AGR	PN	Rückschlagventil/non-return valve
26.540 397 kW (540 PS) D 2676 LF 06	05.2008→		7.01268.03.0	AGR	PN	Rückschlagventil/non-return valve
26.540 397 kW (540 PS) D 2676 LF 06	02.2009→		7.01268.03.0	AGR	PN	Rückschlagventil/non-return valve
26.540 397 kW (540 PS) D 2676 LF 06	02.2009→		7.01268.03.0	AGR	PN	Rückschlagventil/non-return valve
26.540 397 kW (540 PS) D 2676 LF 06	02.2009→		7.01268.03.0	AGR	PN	Rückschlagventil/non-return valve
26.540 397 kW (540 PS) D 2676 LF 06	02.2009→		7.01268.03.0	AGR	PN	Rückschlagventil/non-return valve
26.540 397 kW (540 PS) D 2676 LF 06	02.2009→		7.01268.03.0	AGR	PN	Rückschlagventil/non-return valve
26.540 397 kW (540 PS) D 2676 LF 06	02.2009→		7.01268.03.0	AGR	PN	Rückschlagventil/non-return valve
28.320 235 kW (320 PS) D 2066 LF 39, D 2066 LF 43, D 2066 LF 68	07.2008→		7.01268.03.0	AGR	PN	Rückschlagventil/non-return valve
M 28.320 235 kW (320 PS) D 2066 LF 39, D 2066 LF 43, D 2066 LF 68	07.2008→		7.01268.03.0	AGR	PN	Rückschlagventil/non-return valve
28.320 235 kW (320 PS) D 2066 LF 39, D 2066 LF 43, D 2066 LF 68	07.2008→		7.01268.03.0	AGR	PN	Rückschlagventil/non-return valve
28.320 235 kW (320 PS) D 2066 LF 39, D 2066 LF 43, D 2066 LF 68	07.2008→		7.01268.03.0	AGR	PN	Rückschlagventil/non-return valve
28.320 235 kW (320 PS) D 2066 LF 39, D 2066 LF 43, D 2066 LF 68	07.2008→		7.01268.03.0	AGR	PN	Rückschlagventil/non-return valve
28.350 257 kW (350 PS) D 2066 LF 03	08.2008→		7.01268.03.0	AGR	PN	Rückschlagventil/non-return valve
28.350 257 kW (350 PS) D 2066 LF 03	08.2008→		7.01268.03.0	AGR	PN	Rückschlagventil/non-return valve
28.360 265 kW (360 PS) D 2066 LF 38, D 2066 LF 42, D 2066 LF 48, D 2066 LF 64, D 2066 LF 67	08.2008→		7.01268.03.0	AGR	PN	Rückschlagventil/non-return valve
28.360 265 kW (360 PS) D 2066 LF 38, D 2066 LF 42, D 2066 LF 48, D 2066 LF 64, D 2066 LF 67	08.2008→		7.01268.03.0	AGR	PN	Rückschlagventil/non-return valve
28.360 265 kW (360 PS) D 2066 LF 38, D 2066 LF 42, D 2066 LF 67	08.2008→		7.01268.03.0	AGR	PN	Rückschlagventil/non-return valve
28.360 265 kW (360 PS) D 2066 LF 38, D 2066 LF 42, D 2066 LF 67	08.2008→		7.01268.03.0	AGR	PN	Rückschlagventil/non-return valve
28.360 265 kW (360 PS) D 2066 LF 38, D 2066 LF 42, D 2066 LF 48, D 2066 LF 64, D 2066 LF 67	08.2008→		7.01268.03.0	AGR	PN	Rückschlagventil/non-return valve







TGS
46

28.390 287 kW (390 PS) D 2066 LF 02	06.2008→		7.01268.03.0	AGR	PN	Rückschlagventil/non-return valve
28.390 287 kW (390 PS) D 2066 LF 02	06.2008→		7.01268.03.0	AGR	PN	Rückschlagventil/non-return valve
28.400 294 kW (400 PS) D 2066 LF 37, D 2066 LF 41, D 2066 LF 49, D 2066 LF 61, D 2066 LF 63	08.2008→		7.01268.03.0	AGR	PN	Rückschlagventil/non-return valve
28.400 294 kW (400 PS) D 2066 LF 37, D 2066 LF 41, D 2066 LF 49, D 2066 LF 61, D 2066 LF 63	08.2008→		7.01268.03.0	AGR	PN	Rückschlagventil/non-return valve
28.400 294 kW (400 PS) D 2066 LF 37, D 2066 LF 41, D 2066 LF 61	08.2008→		7.01268.03.0	AGR	PN	Rückschlagventil/non-return valve
28.400 294 kW (400 PS) D 2066 LF 37, D 2066 LF 41, D 2066 LF 61	08.2008→		7.01268.03.0	AGR	PN	Rückschlagventil/non-return valve
28.400 294 kW (400 PS) D 2066 LF 37, D 2066 LF 41, D 2066 LF 49, D 2066 LF 61, D 2066 LF 63	08.2008→		7.01268.03.0	AGR	PN	Rückschlagventil/non-return valve
28.420 309 kW (420 PS) D 2676 LF 53	09.2016→		7.01268.03.0	AGR	PN	Rückschlagventil/non-return valve
28.420 309 kW (420 PS) D 2676 LF 53	09.2016→		7.01268.03.0	AGR	PN	Rückschlagventil/non-return valve
28.420 309 kW (420 PS) D 2676 LF 53	09.2016→		7.01268.03.0	AGR	PN	Rückschlagventil/non-return valve
28.420 309 kW (420 PS) D 2676 LF 53	09.2016→		7.01268.03.0	AGR	PN	Rückschlagventil/non-return valve
28.420 309 kW (420 PS) D 2676 LF 53	09.2016→		7.01268.03.0	AGR	PN	Rückschlagventil/non-return valve
28.430 316 kW (430 PS) D 2066 LF 01	08.2008→		7.01268.03.0	AGR	PN	Rückschlagventil/non-return valve
28.430 316 kW (430 PS) D 2066 LF 01	08.2008→		7.01268.03.0	AGR	PN	Rückschlagventil/non-return valve
28.440 324 kW (440-441 PS) D 2066 LF 36, D 2066 LF 40, D 2066 LF 50, D 2066 LF 62	08.2008→		7.01268.03.0	AGR	PN	Rückschlagventil/non-return valve
28.440 324 kW (440-441 PS) D 2066 LF 36, D 2066 LF 40, D 2066 LF 50, D 2066 LF 62	08.2008→		7.01268.03.0	AGR	PN	Rückschlagventil/non-return valve
28.440 324 kW (440 PS) D 2066 LF 36, D 2066 LF 40	08.2008→		7.01268.03.0	AGR	PN	Rückschlagventil/non-return valve
28.440 324 kW (440 PS) D 2066 LF 36, D 2066 LF 40	08.2008→		7.01268.03.0	AGR	PN	Rückschlagventil/non-return valve
28.440 324 kW (441 PS) D 2676 LF 26	08.2008→		7.01268.03.0	AGR	PN	Rückschlagventil/non-return valve
28.440 324 kW (441 PS) D 2676 LF 26	08.2008→		7.01268.03.0	AGR	PN	Rückschlagventil/non-return valve
28.440 324 kW (441 PS) D 2676 LF 26	08.2008→		7.01268.03.0	AGR	PN	Rückschlagventil/non-return valve
28.440 324 kW (441 PS) D 2676 LF 26	08.2008→		7.01268.03.0	AGR	PN	Rückschlagventil/non-return valve
28.440 324 kW (440-441 PS) D 2066 LF 36, D 2066 LF 40, D 2066 LF 50, D 2066 LF 62	08.2008→		7.01268.03.0	AGR	PN	Rückschlagventil/non-return valve
28.460 338 kW (460 PS) D 2676 LF 52	09.2016→		7.01268.03.0	AGR	PN	Rückschlagventil/non-return valve

M

























TGS **46**

28.460 338 kW (460 PS) D 2676 LF 52	09.2016→		7.01268.03.0	AGR	PN	Rückschlagventil/non-return valve
28.460 338 kW (460 PS) D 2676 LF 52	09.2016→		7.01268.03.0	AGR	PN	Rückschlagventil/non-return valve
28.460 338 kW (460 PS) D 2676 LF 52	09.2016→		7.01268.03.0	AGR	PN	Rückschlagventil/non-return valve
28.460 338 kW (460 PS) D 2676 LF 52	09.2016→		7.01268.03.0	AGR	PN	Rückschlagventil/non-return valve
28.480 353 kW (480 PS) D 2676 LF 02, D 2676 LF 05, D 2676 LF 07, D 2676 LF 20, D 2676 LF 25	08.2008→		7.01268.03.0	AGR	PN	Rückschlagventil/non-return valve
28.480 353 kW (480 PS) D 2676 LF 02, D 2676 LF 05, D 2676 LF 07, D 2676 LF 20, D 2676 LF 25	08.2008→		7.01268.03.0	AGR	PN	Rückschlagventil/non-return valve
28.480 353 kW (480 PS) D 2676 LF 05, D 2676 LF 07, D 2676 LF 25	08.2008→		7.01268.03.0	AGR	PN	Rückschlagventil/non-return valve
28.480 353 kW (480 PS) D 2676 LF 05, D 2676 LF 07, D 2676 LF 25	08.2008→		7.01268.03.0	AGR	PN	Rückschlagventil/non-return valve
28.480 353 kW (480 PS) D 2676 LF 02, D 2676 LF 05, D 2676 LF 07, D 2676 LF 20, D 2676 LF 25	08.2008→		7.01268.03.0	AGR	PN	Rückschlagventil/non-return valve
28.500 368 kW (500 PS) D 2676 LF 51	09.2016→		7.01268.03.0	AGR	PN	Rückschlagventil/non-return valve
28.500 368 kW (500 PS) D 2676 LF 51	09.2016→		7.01268.03.0	AGR	PN	Rückschlagventil/non-return valve
28.500 368 kW (500 PS) D 2676 LF 51	09.2016→		7.01268.03.0	AGR	PN	Rückschlagventil/non-return valve
28.500 368 kW (500 PS) D 2676 LF 51	09.2016→		7.01268.03.0	AGR	PN	Rückschlagventil/non-return valve
28.500 368 kW (500 PS) D 2676 LF 51	09.2016→		7.01268.03.0	AGR	PN	Rückschlagventil/non-return valve
28.540 397 kW (540 PS) D 2676 LF 06	06.2008→		7.01268.03.0	AGR	PN	Rückschlagventil/non-return valve
28.540 397 kW (540 PS) D 2676 LF 06	06.2008→		7.01268.03.0	AGR	PN	Rückschlagventil/non-return valve
28.540 397 kW (540 PS) D 2676 LF 06	02.2009→		7.01268.03.0	AGR	PN	Rückschlagventil/non-return valve
28.540 397 kW (540 PS) D 2676 LF 06	02.2009→		7.01268.03.0	AGR	PN	Rückschlagventil/non-return valve
28.540 397 kW (540 PS) D 2676 LF 06	02.2009→		7.01268.03.0	AGR	PN	Rückschlagventil/non-return valve
32.320 235 kW (320 PS) D 2066 LF 39, D 2066 LF 53, D 2066 LF 68	08.2008→		7.01268.03.0	AGR	PN	Rückschlagventil/non-return valve
32.350 257 kW (350 PS) D 2066 LF 03	08.2008→		7.01268.03.0	AGR	PN	Rückschlagventil/non-return valve
32.360 265 kW (360 PS) D 2066 LF 38, D 2066 LF 42, D 2066 LF 52, D 2066 LF 67	08.2008→		7.01268.03.0	AGR	PN	Rückschlagventil/non-return valve
32.390 287 kW (390 PS) D 2066 LF 02	06.2008→		7.01268.03.0	AGR	PN	Rückschlagventil/non-return valve
32.400 294 kW (400 PS) D 2066 LF 37, D 2066 LF 41, D 2066 LF 49, D 2066 LF 51, D 2066 LF 61	08.2008→		7.01268.03.0	AGR	PN	Rückschlagventil/non-return valve

M



















TGS
46

32.420 309 kW (420 PS) D 2676 LF 53	09.2016→		7.01268.03.0	AGR	PN	Rückschlagventil/non-return valve
32.440 324 kW (440 PS) D 2066 LF 36, D 2066 LF 40	08.2008→		7.01268.03.0	AGR	PN	Rückschlagventil/non-return valve
32.440 324 kW (441 PS) D 2676 LF 22, D 2676 LF 26	08.2008→		7.01268.03.0	AGR	PN	Rückschlagventil/non-return valve
32.460 338 kW (460 PS) D 2676 LF 52	09.2016→		7.01268.03.0	AGR	PN	Rückschlagventil/non-return valve
32.480 353 kW (480 PS) D 2676 LF 25	08.2008→		7.01268.03.0	AGR	PN	Rückschlagventil/non-return valve
32.500 368 kW (500 PS) D 2676 LF 51	09.2016→		7.01268.03.0	AGR	PN	Rückschlagventil/non-return valve
33.320 235 kW (320 PS) D 2066 LF 39, D 2066 LF 43, D 2066 LF 68	06.2008→		7.01268.03.0	AGR	PN	Rückschlagventil/non-return valve
33.320 235 kW (320 PS) D 2066 LF 39, D 2066 LF 43, D 2066 LF 68	06.2008→		7.01268.03.0	AGR	PN	Rückschlagventil/non-return valve
33.320 235 kW (320 PS) D 2066 LF 39, D 2066 LF 43, D 2066 LF 68	06.2008→		7.01268.03.0	AGR	PN	Rückschlagventil/non-return valve
33.320 235 kW (320 PS) D 2066 LF 39, D 2066 LF 43, D 2066 LF 68	06.2008→		7.01268.03.0	AGR	PN	Rückschlagventil/non-return valve
33.320 235 kW (320 PS) D 2066 LF 39, D 2066 LF 43, D 2066 LF 68	06.2008→		7.01268.03.0	AGR	PN	Rückschlagventil/non-return valve
33.320 235 kW (320 PS) D 2066 LF 39, D 2066 LF 43, D 2066 LF 68	06.2008→		7.01268.03.0	AGR	PN	Rückschlagventil/non-return valve
33.350 257 kW (350 PS) D 2066 LF 03	06.2008→		7.01268.03.0	AGR	PN	Rückschlagventil/non-return valve
33.350 257 kW (350 PS) D 2066 LF 03	06.2008→		7.01268.03.0	AGR	PN	Rückschlagventil/non-return valve
33.350 257 kW (350 PS) D 2066 LF 03	06.2008→		7.01268.03.0	AGR	PN	Rückschlagventil/non-return valve
33.350 257 kW (350 PS) D 2066 LF 03	06.2008→		7.01268.03.0	AGR	PN	Rückschlagventil/non-return valve
33.350 257 kW (350 PS) D 2066 LF 03	06.2008→		7.01268.03.0	AGR	PN	Rückschlagventil/non-return valve
33.360 265 kW (360 PS) D 2066 LF 07, D 2066 LF 27, D 2066 LF 38, D 2066 LF 42, D 2066 LF 48, D 2066 LF 64, D 2066 LF 67	10.2007→		7.01268.03.0	AGR	PN	Rückschlagventil/non-return valve
33.360 265 kW (360 PS) D 2066 LF 07, D 2066 LF 38, D 2066 LF 42, D 2066 LF 48, D 2066 LF 64, D 2066 LF 67	10.2007→		7.01268.03.0	AGR	PN	Rückschlagventil/non-return valve
33.360 265 kW (360 PS) D 2066 LF 07, D 2066 LF 38, D 2066 LF 42, D 2066 LF 48, D 2066 LF 64, D 2066 LF 67	06.2008→		7.01268.03.0	AGR	PN	Rückschlagventil/non-return valve
33.360 265 kW (360 PS) D 2066 LF 07, D 2066 LF 38, D 2066 LF 42, D 2066 LF 48, D 2066 LF 64, D 2066 LF 67	06.2008→		7.01268.03.0	AGR	PN	Rückschlagventil/non-return valve
33.360 265 kW (360 PS) D 2066 LF 07, D 2066 LF 38, D 2066 LF 42, D 2066 LF 48, D 2066 LF 64, D 2066 LF 67	06.2008→		7.01268.03.0	AGR	PN	Rückschlagventil/non-return valve

M





















TGS **46**

33.360 265 kW (360 PS) D 2066 LF 07, D 2066 LF 38, D 2066 LF 42, D 2066 LF 48, D 2066 LF 64, D 2066 LF 67	02.2009→		7.01268.03.0	AGR	PN	Rückschlagventil/non-return valve
33.390 287 kW (390 PS) D 2066 LF 02	06.2008→		7.01268.03.0	AGR	PN	Rückschlagventil/non-return valve
33.390 287 kW (390 PS) D 2066 LF 02	06.2008→		7.01268.03.0	AGR	PN	Rückschlagventil/non-return valve
33.390 287 kW (390 PS) D 2066 LF 02	06.2008→		7.01268.03.0	AGR	PN	Rückschlagventil/non-return valve
33.390 287 kW (390 PS) D 2066 LF 02	06.2008→		7.01268.03.0	AGR	PN	Rückschlagventil/non-return valve
33.390 287 kW (390 PS) D 2066 LF 02	06.2008→		7.01268.03.0	AGR	PN	Rückschlagventil/non-return valve
33.390 287 kW (390 PS) D 2066 LF 02	06.2008→		7.01268.03.0	AGR	PN	Rückschlagventil/non-return valve
33.400 294 kW (400 PS) D 2066 LF 06, D 2066 LF 37, D 2066 LF 41, D 2066 LF 49, D 2066 LF 61, D 2066 LF 63	06.2008→		7.01268.03.0	AGR	PN	Rückschlagventil/non-return valve
33.400 294 kW (400 PS) D 2066 LF 06, D 2066 LF 37, D 2066 LF 41, D 2066 LF 49, D 2066 LF 61, D 2066 LF 63	07.2008→		7.01268.03.0	AGR	PN	Rückschlagventil/non-return valve
33.400 294 kW (400 PS) D 2066 LF 06, D 2066 LF 37, D 2066 LF 41, D 2066 LF 49, D 2066 LF 61, D 2066 LF 63	07.2008→		7.01268.03.0	AGR	PN	Rückschlagventil/non-return valve
33.400 294 kW (400 PS) D 2066 LF 26, D 2066 LF 37, D 2066 LF 41, D 2066 LF 49, D 2066 LF 61, D 2066 LF 63	07.2008→		7.01268.03.0	AGR	PN	Rückschlagventil/non-return valve
33.400 294 kW (400 PS) D 2066 LF 06, D 2066 LF 37, D 2066 LF 41, D 2066 LF 49, D 2066 LF 61, D 2066 LF 63	07.2008→		7.01268.03.0	AGR	PN	Rückschlagventil/non-return valve
33.400 294 kW (400 PS) D 2066 LF 06, D 2066 LF 37, D 2066 LF 41, D 2066 LF 49, D 2066 LF 61, D 2066 LF 63	07.2008→		7.01268.03.0	AGR	PN	Rückschlagventil/non-return valve
33.420 309 kW (420 PS) D 2676 LF 53	09.2016→		7.01268.03.0	AGR	PN	Rückschlagventil/non-return valve
33.420 309 kW (420 PS) D 2676 LF 53	09.2016→		7.01268.03.0	AGR	PN	Rückschlagventil/non-return valve
33.420 309 kW (420 PS) D 2676 LF 53	09.2016→		7.01268.03.0	AGR	PN	Rückschlagventil/non-return valve
33.420 309 kW (420 PS) D 2676 LF 53	09.2016→		7.01268.03.0	AGR	PN	Rückschlagventil/non-return valve
33.420 309 kW (420 PS) D 2676 LF 53	09.2016→		7.01268.03.0	AGR	PN	Rückschlagventil/non-return valve
33.420 309 kW (420 PS) D 2676 LF 53	09.2016→		7.01268.03.0	AGR	PN	Rückschlagventil/non-return valve
33.430 316 kW (430 PS) D 2066 LF 01	06.2008→		7.01268.03.0	AGR	PN	Rückschlagventil/non-return valve
33.430 316 kW (430 PS) D 2066 LF 01	06.2008→		7.01268.03.0	AGR	PN	Rückschlagventil/non-return valve
33.430 316 kW (430 PS) D 2066 LF 01	06.2008→		7.01268.03.0	AGR	PN	Rückschlagventil/non-return valve
33.430 316 kW (430 PS) D 2066 LF 01	07.2008→		7.01268.03.0	AGR	PN	Rückschlagventil/non-return valve

M





TGS
46

33.430 316 kW (430 PS) D 2066 LF 01	07.2008→		7.01268.03.0	AGR	PN	Rückschlagventil/non-return valve
33.430 316 kW (430 PS) D 2066 LF 01	07.2008→		7.01268.03.0	AGR	PN	Rückschlagventil/non-return valve
33.440 324 kW (440-441 PS) D 2066 LF 36, D 2066 LF 40, D 2066 LF 50, D 2066 LF 62	10.2007→		7.01268.03.0	AGR	PN	Rückschlagventil/non-return valve
33.440 324 kW (440-441 PS) D 2676 LF 04, D 2676 LF 26	10.2007→		7.01268.03.0	AGR	PN	Rückschlagventil/non-return valve
33.440 324 kW (440-441 PS) D 2676 LF 04, D 2676 LF 26	10.2007→		7.01268.03.0	AGR	PN	Rückschlagventil/non-return valve
33.440 324 kW (440-441 PS) D 2066 LF 25, D 2066 LF 36, D 2066 LF 40, D 2066 LF 50, D 2066 LF 62	11.2007→		7.01268.03.0	AGR	PN	Rückschlagventil/non-return valve
33.440 324 kW (440-441 PS) D 2066 LF 36, D 2066 LF 40, D 2066 LF 50, D 2066 LF 62	06.2008→		7.01268.03.0	AGR	PN	Rückschlagventil/non-return valve
33.440 324 kW (440-441 PS) D 2066 LF 36, D 2066 LF 40, D 2066 LF 50, D 2066 LF 62	06.2008→		7.01268.03.0	AGR	PN	Rückschlagventil/non-return valve
33.440 324 kW (440-441 PS) D 2066 LF 36, D 2066 LF 40, D 2066 LF 50, D 2066 LF 62	06.2008→		7.01268.03.0	AGR	PN	Rückschlagventil/non-return valve
33.440 324 kW (440-441 PS) D 2066 LF 36, D 2066 LF 40, D 2066 LF 50, D 2066 LF 62	07.2008→		7.01268.03.0	AGR	PN	Rückschlagventil/non-return valve
33.440 324 kW (440-441 PS) D 2676 LF 04, D 2676 LF 26	07.2008→		7.01268.03.0	AGR	PN	Rückschlagventil/non-return valve
33.440 324 kW (440-441 PS) D 2676 LF 04, D 2676 LF 26	07.2008→		7.01268.03.0	AGR	PN	Rückschlagventil/non-return valve
33.440 324 kW (440-441 PS) D 2676 LF 04, D 2676 LF 26	07.2008→		7.01268.03.0	AGR	PN	Rückschlagventil/non-return valve
33.440 324 kW (440-441 PS) D 2676 LF 04, D 2676 LF 26	07.2008→		7.01268.03.0	AGR	PN	Rückschlagventil/non-return valve
33.440 324 kW (440-441 PS) D 2676 LF 04, D 2676 LF 26	08.2008→		7.01268.03.0	AGR	PN	Rückschlagventil/non-return valve
33.460 338 kW (460 PS) D 2676 LF 52	09.2016→		7.01268.03.0	AGR	PN	Rückschlagventil/non-return valve
33.460 338 kW (460 PS) D 2676 LF 52	09.2016→		7.01268.03.0	AGR	PN	Rückschlagventil/non-return valve
33.460 338 kW (460 PS) D 2676 LF 52	09.2016→		7.01268.03.0	AGR	PN	Rückschlagventil/non-return valve
33.460 338 kW (460 PS) D 2676 LF 52	09.2016→		7.01268.03.0	AGR	PN	Rückschlagventil/non-return valve
33.460 338 kW (460 PS) D 2676 LF 52	09.2016→		7.01268.03.0	AGR	PN	Rückschlagventil/non-return valve
33.460 338 kW (460 PS) D 2676 LF 52	09.2016→		7.01268.03.0	AGR	PN	Rückschlagventil/non-return valve
33.480 353 kW (480 PS) D 2676 LF 02, D 2676 LF 03, D 2676 LF 05, D 2676 LF 07, D 2676 LF 20, D 2676 LF 25	10.2007→		7.01268.03.0	AGR	PN	Rückschlagventil/non-return valve
33.480 353 kW (480 PS) D 2676 LF 02, D 2676 LF 03, D 2676 LF 05, D 2676 LF 07, D 2676 LF 20, D 2676 LF 25	08.2008→		7.01268.03.0	AGR	PN	Rückschlagventil/non-return valve
33.480 353 kW (480 PS) D 2676 LF 02, D 2676 LF 03, D 2676 LF 05, D 2676 LF 07, D 2676 LF 20, D 2676 LF 25	08.2008→		7.01268.03.0	AGR	PN	Rückschlagventil/non-return valve

























M



TGS **46**

33.480 353 kW (480 PS) D 2676 LF 02, D 2676 LF 03, D 2676 LF 05, D 2676 LF 07, D 2676 LF 14, D 2676 LF 20, D 2676 LF 25	08.2008→		7.01268.03.0	AGR	PN	Rückschlagventil/non-return valve
33.480 353 kW (480 PS) D 2676 LF 02, D 2676 LF 03, D 2676 LF 05, D 2676 LF 07, D 2676 LF 20, D 2676 LF 25	08.2008→		7.01268.03.0	AGR	PN	Rückschlagventil/non-return valve
33.480 353 kW (480 PS) D 2676 LF 02, D 2676 LF 03, D 2676 LF 05, D 2676 LF 07, D 2676 LF 20, D 2676 LF 25	08.2008→		7.01268.03.0	AGR	PN	Rückschlagventil/non-return valve
33.500 368 kW (500 PS) D 2676 LF 51	09.2016→		7.01268.03.0	AGR	PN	Rückschlagventil/non-return valve
33.500 368 kW (500 PS) D 2676 LF 51	09.2016→		7.01268.03.0	AGR	PN	Rückschlagventil/non-return valve
33.500 368 kW (500 PS) D 2676 LF 51	09.2016→		7.01268.03.0	AGR	PN	Rückschlagventil/non-return valve
33.500 368 kW (500 PS) D 2676 LF 51	09.2016→		7.01268.03.0	AGR	PN	Rückschlagventil/non-return valve
33.500 368 kW (500 PS) D 2676 LF 51	09.2016→		7.01268.03.0	AGR	PN	Rückschlagventil/non-return valve
33.500 368 kW (500 PS) D 2676 LF 51	09.2016→		7.01268.03.0	AGR	PN	Rückschlagventil/non-return valve
33.540 397 kW (540 PS) D 2676 LF 06	02.2009→		7.01268.03.0	AGR	PN	Rückschlagventil/non-return valve
M 33.540 397 kW (540 PS) D 2676 LF 06	02.2009→		7.01268.03.0	AGR	PN	Rückschlagventil/non-return valve
33.540 397 kW (540 PS) D 2676 LF 06, D 2676 LF 13	02.2009→		7.01268.03.0	AGR	PN	Rückschlagventil/non-return valve
33.540 397 kW (540 PS) D 2676 LF 06	02.2009→		7.01268.03.0	AGR	PN	Rückschlagventil/non-return valve
33.540 397 kW (540 PS) D 2676 LF 06	02.2009→		7.01268.03.0	AGR	PN	Rückschlagventil/non-return valve
33.540 397 kW (540 PS) D 2676 LF 06	02.2009→		7.01268.03.0	AGR	PN	Rückschlagventil/non-return valve
35.320 235 kW (320 PS) D 2066 LF 39, D 2066 LF 43, D 2066 LF 68	06.2008→		7.01268.03.0	AGR	PN	Rückschlagventil/non-return valve
35.320 235 kW (320 PS) D 2066 LF 39, D 2066 LF 43, D 2066 LF 68	06.2008→		7.01268.03.0	AGR	PN	Rückschlagventil/non-return valve
35.320 235 kW (320 PS) D 2066 LF 39, D 2066 LF 43, D 2066 LF 68	06.2008→		7.01268.03.0	AGR	PN	Rückschlagventil/non-return valve
35.320 235 kW (320 PS) D 2066 LF 39, D 2066 LF 43, D 2066 LF 53, D 2066 LF 68	08.2008→		7.01268.03.0	AGR	PN	Rückschlagventil/non-return valve
35.320 235 kW (320 PS) D 2066 LF 39, D 2066 LF 43, D 2066 LF 68	01.2009→		7.01268.03.0	AGR	PN	Rückschlagventil/non-return valve
35.320 235 kW (320 PS) D 2066 LF 86	09.2016→		7.01268.03.0	AGR	PN	Rückschlagventil/non-return valve
35.350 257 kW (350 PS) D 2066 LF 03	06.2008→		7.01268.03.0	AGR	PN	Rückschlagventil/non-return valve
35.360 265 kW (360 PS) D 2066 LF 42, D 2066 LF 67	10.2007→		7.01268.03.0	AGR	PN	Rückschlagventil/non-return valve
35.360 265 kW (360 PS) D 2066 LF 38, D 2066 LF 42, D 2066 LF 67	06.2008→		7.01268.03.0	AGR	PN	Rückschlagventil/non-return valve























TGS
46

35.360 265 kW (360 PS) D 2066 LF 38, D 2066 LF 42, D 2066 LF 48, D 2066 LF 64, D 2066 LF 67	06.2008→		7.01268.03.0	AGR	PN	Rückschlagventil/non-return valve
35.360 265 kW (360 PS) D 2066 LF 38, D 2066 LF 42, D 2066 LF 67	06.2008→		7.01268.03.0	AGR	PN	Rückschlagventil/non-return valve
35.360 265 kW (360 PS) D 2066 LF 38, D 2066 LF 42, D 2066 LF 67	06.2008→		7.01268.03.0	AGR	PN	Rückschlagventil/non-return valve
35.360 265 kW (360 PS) D 2066 LF 38, D 2066 LF 42, D 2066 LF 52, D 2066 LF 67	08.2008→		7.01268.03.0	AGR	PN	Rückschlagventil/non-return valve
35.360 265 kW (360 PS) D 2066 LF 85	09.2016→		7.01268.03.0	AGR	PN	Rückschlagventil/non-return valve
35.390 287 kW (390 PS) D 2066 LF 02	06.2008→		7.01268.03.0	AGR	PN	Rückschlagventil/non-return valve
35.400 294 kW (400 PS) D 2066 LF 26, D 2066 LF 37, D 2066 LF 41, D 2066 LF 61	10.2007→		7.01268.03.0	AGR	PN	Rückschlagventil/non-return valve
35.400 294 kW (400 PS) D 2066 LF 26, D 2066 LF 37	10.2007→		7.01268.03.0	AGR	PN	Rückschlagventil/non-return valve
35.400 294 kW (400 PS) D 2066 LF 37, D 2066 LF 41, D 2066 LF 61	06.2008→		7.01268.03.0	AGR	PN	Rückschlagventil/non-return valve
35.400 294 kW (400 PS) D 2066 LF 37, D 2066 LF 41, D 2066 LF 61	06.2008→		7.01268.03.0	AGR	PN	Rückschlagventil/non-return valve
35.400 294 kW (400 PS) D 2066 LF 37, D 2066 LF 41, D 2066 LF 61, D 2066 LF 63	06.2008→		7.01268.03.0	AGR	PN	Rückschlagventil/non-return valve
35.400 294 kW (400 PS) D 2066 LF 37, D 2066 LF 41, D 2066 LF 61	06.2008→		7.01268.03.0	AGR	PN	Rückschlagventil/non-return valve
35.400 294 kW (400 PS) D 2066 LF 37, D 2066 LF 41, D 2066 LF 51, D 2066 LF 61	08.2008→		7.01268.03.0	AGR	PN	Rückschlagventil/non-return valve
35.420 309 kW (420 PS) D 2676 LF 53	09.2016→		7.01268.03.0	AGR	PN	Rückschlagventil/non-return valve
35.420 309 kW (420 PS) D 2676 LF 53	09.2016→		7.01268.03.0	AGR	PN	Rückschlagventil/non-return valve
35.420 309 kW (420 PS) D 2676 LF 53	09.2016→		7.01268.03.0	AGR	PN	Rückschlagventil/non-return valve
35.420 309 kW (420 PS) D 2676 LF 53	09.2016→		7.01268.03.0	AGR	PN	Rückschlagventil/non-return valve
35.420 309 kW (420 PS) D 2676 LF 53	09.2016→		7.01268.03.0	AGR	PN	Rückschlagventil/non-return valve
35.420 309 kW (420 PS) D 2676 LF 53	09.2016→		7.01268.03.0	AGR	PN	Rückschlagventil/non-return valve
35.420 309 kW (420 PS) D 2676 LF 53	09.2016→		7.01268.03.0	AGR	PN	Rückschlagventil/non-return valve
35.430 316 kW (430 PS) D 2066 LF 01	06.2008→		7.01268.03.0	AGR	PN	Rückschlagventil/non-return valve
35.440 324 kW (440 PS) D 2066 LF 25, D 2066 LF 36	10.2007→		7.01268.03.0	AGR	PN	Rückschlagventil/non-return valve
35.440 324 kW (440 PS) D 2066 LF 36, D 2066 LF 40	06.2008→		7.01268.03.0	AGR	PN	Rückschlagventil/non-return valve
35.440 324 kW (440 PS) D 2066 LF 36, D 2066 LF 40	06.2008→		7.01268.03.0	AGR	PN	Rückschlagventil/non-return valve

M



TGS **46**

35.440 324 kW (440 PS) D 2066 LF 36, D 2066 LF 40	06.2008→		7.01268.03.0	AGR	PN	Rückschlagventil/non-return valve
35.440 324 kW (440-441 PS) D 2066 LF 36, D 2066 LF 40, D 2066 LF 50, D 2066 LF 62	06.2008→		7.01268.03.0	AGR	PN	Rückschlagventil/non-return valve
35.440 324 kW (441 PS) D 2676 LF 26	06.2008→		7.01268.03.0	AGR	PN	Rückschlagventil/non-return valve
35.440 324 kW (441 PS) D 2676 LF 26	06.2008→		7.01268.03.0	AGR	PN	Rückschlagventil/non-return valve
35.440 324 kW (440 PS) D 2066 LF 25, D 2066 LF 36, D 2066 LF 40	06.2008→		7.01268.03.0	AGR	PN	Rückschlagventil/non-return valve
35.440 324 kW (441 PS) D 2676 LF 26	06.2008→		7.01268.03.0	AGR	PN	Rückschlagventil/non-return valve
35.440 324 kW (441 PS) D 2676 LF 26	06.2008→		7.01268.03.0	AGR	PN	Rückschlagventil/non-return valve
35.440 324 kW (440 PS) D 2066 LF 36, D 2066 LF 40	08.2008→		7.01268.03.0	AGR	PN	Rückschlagventil/non-return valve
35.440 324 kW (441 PS) D 2676 LF 22, D 2676 LF 26	08.2008→		7.01268.03.0	AGR	PN	Rückschlagventil/non-return valve
35.460 338 kW (460 PS) D 2676 LF 52	09.2016→		7.01268.03.0	AGR	PN	Rückschlagventil/non-return valve
35.460 338 kW (460 PS) D 2676 LF 52	09.2016→		7.01268.03.0	AGR	PN	Rückschlagventil/non-return valve
35.460 338 kW (460 PS) D 2676 LF 52	09.2016→		7.01268.03.0	AGR	PN	Rückschlagventil/non-return valve
35.460 338 kW (460 PS) D 2676 LF 52	09.2016→		7.01268.03.0	AGR	PN	Rückschlagventil/non-return valve
35.460 338 kW (460 PS) D 2676 LF 52	09.2016→		7.01268.03.0	AGR	PN	Rückschlagventil/non-return valve
35.460 338 kW (460 PS) D 2676 LF 52	09.2016→		7.01268.03.0	AGR	PN	Rückschlagventil/non-return valve
35.460 338 kW (460 PS) D 2676 LF 52	09.2016→		7.01268.03.0	AGR	PN	Rückschlagventil/non-return valve
35.480 353 kW (480 PS) D 2676 LF 05, D 2676 LF 14	10.2007→		7.01268.03.0	AGR	PN	Rückschlagventil/non-return valve
35.480 353 kW (480 PS) D 2676 LF 05, D 2676 LF 07, D 2676 LF 25	06.2008→		7.01268.03.0	AGR	PN	Rückschlagventil/non-return valve
35.480 353 kW (480 PS) D 2676 LF 05, D 2676 LF 07, D 2676 LF 25	06.2008→		7.01268.03.0	AGR	PN	Rückschlagventil/non-return valve
35.480 353 kW (480 PS) D 2676 LF 05, D 2676 LF 07, D 2676 LF 25	06.2008→		7.01268.03.0	AGR	PN	Rückschlagventil/non-return valve
35.480 353 kW (480 PS) D 2676 LF 02, D 2676 LF 05, D 2676 LF 07, D 2676 LF 20, D 2676 LF 25	06.2008→		7.01268.03.0	AGR	PN	Rückschlagventil/non-return valve
35.480 353 kW (480 PS) D 2676 LF 05, D 2676 LF 07, D 2676 LF 14, D 2676 LF 25	06.2008→		7.01268.03.0	AGR	PN	Rückschlagventil/non-return valve
35.480 353 kW (480 PS) D 2676 LF 05, D 2676 LF 07, D 2676 LF 14, D 2676 LF 25	08.2008→		7.01268.03.0	AGR	PN	Rückschlagventil/non-return valve
35.500 368 kW (500 PS) D 2676 LF 51	09.2016→		7.01268.03.0	AGR	PN	Rückschlagventil/non-return valve
35.500 368 kW (500 PS) D 2676 LF 51	09.2016→		7.01268.03.0	AGR	PN	Rückschlagventil/non-return valve

M

TGS
46

35.500 368 kW (500 PS) D 2676 LF 51	09.2016→		7.01268.03.0	AGR	PN	Rückschlagventil/non-return valve
35.500 368 kW (500 PS) D 2676 LF 51	09.2016→		7.01268.03.0	AGR	PN	Rückschlagventil/non-return valve
35.500 368 kW (500 PS) D 2676 LF 51	09.2016→		7.01268.03.0	AGR	PN	Rückschlagventil/non-return valve
35.500 368 kW (500 PS) D 2676 LF 51	09.2016→		7.01268.03.0	AGR	PN	Rückschlagventil/non-return valve
35.500 368 kW (500 PS) D 2676 LF 51	09.2016→		7.01268.03.0	AGR	PN	Rückschlagventil/non-return valve
35.540 397 kW (540 PS) D 2676 LF 06	06.2008→		7.01268.03.0	AGR	PN	Rückschlagventil/non-return valve
35.540 397 kW (540 PS) D 2676 LF 06	06.2008→		7.01268.03.0	AGR	PN	Rückschlagventil/non-return valve
35.540 397 kW (540 PS) D 2676 LF 06	02.2009→		7.01268.03.0	AGR	PN	Rückschlagventil/non-return valve
35.540 397 kW (540 PS) D 2676 LF 06	02.2009→		7.01268.03.0	AGR	PN	Rückschlagventil/non-return valve
35.540 397 kW (540 PS) D 2676 LF 06	02.2009→		7.01268.03.0	AGR	PN	Rückschlagventil/non-return valve
35.540 397 kW (540 PS) D 2676 LF 06, D 2676 LF 13	02.2009→		7.01268.03.0	AGR	PN	Rückschlagventil/non-return valve
37.320 235 kW (320 PS) D 2066 LF 39, D 2066 LF 43, D 2066 LF 68	07.2008→		7.01268.03.0	AGR	PN	Rückschlagventil/non-return valve
37.320 235 kW (320 PS) D 2066 LF 39, D 2066 LF 43, D 2066 LF 68	07.2008→		7.01268.03.0	AGR	PN	Rückschlagventil/non-return valve
37.360 265 kW (360 PS) D 2066 LF 38, D 2066 LF 42, D 2066 LF 67	07.2008→		7.01268.03.0	AGR	PN	Rückschlagventil/non-return valve
37.360 265 kW (360 PS) D 2066 LF 38, D 2066 LF 42, D 2066 LF 67	07.2008→		7.01268.03.0	AGR	PN	Rückschlagventil/non-return valve
37.400 294 kW (400 PS) D 2066 LF 37, D 2066 LF 41, D 2066 LF 61	07.2008→		7.01268.03.0	AGR	PN	Rückschlagventil/non-return valve
37.400 294 kW (400 PS) D 2066 LF 37, D 2066 LF 41, D 2066 LF 61	07.2008→		7.01268.03.0	AGR	PN	Rückschlagventil/non-return valve
37.420 309 kW (420 PS) D 2676 LF 53	09.2016→		7.01268.03.0	AGR	PN	Rückschlagventil/non-return valve
37.420 309 kW (420 PS) D 2676 LF 53	09.2016→		7.01268.03.0	AGR	PN	Rückschlagventil/non-return valve
37.440 324 kW (440 PS) D 2066 LF 36, D 2066 LF 40	07.2008→		7.01268.03.0	AGR	PN	Rückschlagventil/non-return valve
37.440 324 kW (440 PS) D 2066 LF 36, D 2066 LF 40	07.2008→		7.01268.03.0	AGR	PN	Rückschlagventil/non-return valve
37.440 324 kW (441 PS) D 2676 LF 26	07.2008→		7.01268.03.0	AGR	PN	Rückschlagventil/non-return valve
37.440 324 kW (441 PS) D 2676 LF 26	07.2008→		7.01268.03.0	AGR	PN	Rückschlagventil/non-return valve
37.460 338 kW (460 PS) D 2676 LF 52	09.2016→		7.01268.03.0	AGR	PN	Rückschlagventil/non-return valve
37.460 338 kW (460 PS) D 2676 LF 52	09.2016→		7.01268.03.0	AGR	PN	Rückschlagventil/non-return valve
37.480 353 kW (480 PS) D 2676 LF 05, D 2676 LF 07, D 2676 LF 25	07.2008→		7.01268.03.0	AGR	PN	Rückschlagventil/non-return valve

M

























TGS **46**

37.480 353 kW (480 PS) D 2676 LF 05, D 2676 LF 07, D 2676 LF 25	07.2008→		7.01268.03.0	AGR	PN	Rückschlagventil/non-return valve
37.500 368 kW (500 PS) D 2676 LF 51	09.2016→		7.01268.03.0	AGR	PN	Rückschlagventil/non-return valve
37.500 368 kW (500 PS) D 2676 LF 51	09.2016→		7.01268.03.0	AGR	PN	Rückschlagventil/non-return valve
37.540 397 kW (540 PS) D 2676 LF 06	02.2009→		7.01268.03.0	AGR	PN	Rückschlagventil/non-return valve
37.540 397 kW (540 PS) D 2676 LF 06	02.2009→		7.01268.03.0	AGR	PN	Rückschlagventil/non-return valve
40.320 235 kW (320 PS) D 2066 LF 43	05.2009→		7.01268.03.0	AGR	PN	Rückschlagventil/non-return valve
40.320 235 kW (320 PS) D 2066 LF 43	05.2009→		7.01268.03.0	AGR	PN	Rückschlagventil/non-return valve
40.360 265 kW (360 PS) D 2066 LF 48, D 2066 LF 64	10.2007→		7.01268.03.0	AGR	PN	Rückschlagventil/non-return valve
40.360 265 kW (360 PS) D 2066 LF 48, D 2066 LF 64	06.2008→		7.01268.03.0	AGR	PN	Rückschlagventil/non-return valve
40.360 265 kW (360 PS) D 2066 LF 07	06.2008→		7.01268.03.0	AGR	PN	Rückschlagventil/non-return valve
40.360 265 kW (360 PS) D 2066 LF 07, D 2066 LF 48, D 2066 LF 64	06.2008→		7.01268.03.0	AGR	PN	Rückschlagventil/non-return valve
40.390 287 kW (390 PS) D 2066 LF 02	10.2007→		7.01268.03.0	AGR	PN	Rückschlagventil/non-return valve
40.390 287 kW (390 PS) D 2066 LF 02	10.2007→		7.01268.03.0	AGR	PN	Rückschlagventil/non-return valve
40.390 287 kW (390 PS) D 2066 LF 02	06.2008→		7.01268.03.0	AGR	PN	Rückschlagventil/non-return valve
40.390 287 kW (390 PS) D 2066 LF 02	06.2008→		7.01268.03.0	AGR	PN	Rückschlagventil/non-return valve
40.400 294 kW (400 PS) D 2066 LF 06, D 2066 LF 49, D 2066 LF 63	06.2008→		7.01268.03.0	AGR	PN	Rückschlagventil/non-return valve
40.400 294 kW (400 PS) D 2066 LF 06, D 2066 LF 49, D 2066 LF 63	06.2008→		7.01268.03.0	AGR	PN	Rückschlagventil/non-return valve
40.400 294 kW (400 PS) D 2066 LF 06, D 2066 LF 49, D 2066 LF 63	02.2011→		7.01268.03.0	AGR	PN	Rückschlagventil/non-return valve
40.400 294 kW (400 PS) D 2066 LF 06, D 2066 LF 49, D 2066 LF 63	02.2011→		7.01268.03.0	AGR	PN	Rückschlagventil/non-return valve
40.430 316 kW (430 PS) D 2066 LF 01	06.2008→		7.01268.03.0	AGR	PN	Rückschlagventil/non-return valve
40.430 316 kW (430 PS) D 2066 LF 01	06.2008→		7.01268.03.0	AGR	PN	Rückschlagventil/non-return valve
40.430 316 kW (430 PS) D 2066 LF 01	06.2008→		7.01268.03.0	AGR	PN	Rückschlagventil/non-return valve
40.430 316 kW (430 PS) D 2066 LF 01	06.2008→		7.01268.03.0	AGR	PN	Rückschlagventil/non-return valve
40.440 324 kW (441 PS) D 2066 LF 50, D 2066 LF 62	06.2008→		7.01268.03.0	AGR	PN	Rückschlagventil/non-return valve
40.440 324 kW (440-441 PS) D 2676 LF 04	06.2008→		7.01268.03.0	AGR	PN	Rückschlagventil/non-return valve
40.440 324 kW (440-441 PS) D 2676 LF 04	06.2008→		7.01268.03.0	AGR	PN	Rückschlagventil/non-return valve

M







TGS
46

40.440 324 kW (441 PS) D 2066 LF 50, D 2066 LF 62	06.2008→		7.01268.03.0	AGR	PN	Rückschlagventil/non-return valve
40.440 324 kW (441 PS) D 2066 LF 50, D 2066 LF 62	02.2011→		7.01268.03.0	AGR	PN	Rückschlagventil/non-return valve
40.440 324 kW (441 PS) D 2066 LF 50, D 2066 LF 62	02.2011→		7.01268.03.0	AGR	PN	Rückschlagventil/non-return valve
40.440 324 kW (440-441 PS) D 2676 LF 04	02.2011→		7.01268.03.0	AGR	PN	Rückschlagventil/non-return valve
40.440 324 kW (440-441 PS) D 2676 LF 04	02.2011→		7.01268.03.0	AGR	PN	Rückschlagventil/non-return valve
40.480 353 kW (480 PS) D 2676 LF 02, D 2676 LF 03, D 2676 LF 20	06.2008→		7.01268.03.0	AGR	PN	Rückschlagventil/non-return valve
40.480 353 kW (480 PS) D 2676 LF 02, D 2676 LF 03, D 2676 LF 20	06.2008→		7.01268.03.0	AGR	PN	Rückschlagventil/non-return valve
40.480 353 kW (480 PS) D 2676 LF 02, D 2676 LF 03, D 2676 LF 20	06.2008→		7.01268.03.0	AGR	PN	Rückschlagventil/non-return valve
40.480 353 kW (480 PS) D 2676 LF 02, D 2676 LF 03, D 2676 LF 20	06.2008→		7.01268.03.0	AGR	PN	Rückschlagventil/non-return valve
41.320 235 kW (320 PS) D 2066 LF 39, D 2066 LF 43, D 2066 LF 68	06.2008→		7.01268.03.0	AGR	PN	Rückschlagventil/non-return valve
41.320 235 kW (320 PS) D 2066 LF 39, D 2066 LF 43, D 2066 LF 68	06.2008→		7.01268.03.0	AGR	PN	Rückschlagventil/non-return valve
41.320 235 kW (320 PS) D 2066 LF 39, D 2066 LF 43, D 2066 LF 68	06.2008→		7.01268.03.0	AGR	PN	Rückschlagventil/non-return valve
41.320 235 kW (320 PS) D 2066 LF 39, D 2066 LF 43, D 2066 LF 68	06.2008→		7.01268.03.0	AGR	PN	Rückschlagventil/non-return valve
41.320 235 kW (320 PS) D 2066 LF 39, D 2066 LF 43, D 2066 LF 68	06.2008→		7.01268.03.0	AGR	PN	Rückschlagventil/non-return valve
41.350 257 kW (350 PS) D 2066 LF 03	06.2008→		7.01268.03.0	AGR	PN	Rückschlagventil/non-return valve
41.350 257 kW (350 PS) D 2066 LF 03	06.2008→		7.01268.03.0	AGR	PN	Rückschlagventil/non-return valve
41.360 265 kW (360 PS) D 2066 LF 07, D 2066 LF 38, D 2066 LF 42, D 2066 LF 48, D 2066 LF 64, D 2066 LF 67	07.2008→		7.01268.03.0	AGR	PN	Rückschlagventil/non-return valve
41.360 265 kW (360 PS) D 2066 LF 07, D 2066 LF 38, D 2066 LF 42, D 2066 LF 48, D 2066 LF 64, D 2066 LF 67	07.2008→		7.01268.03.0	AGR	PN	Rückschlagventil/non-return valve
41.360 265 kW (360 PS) D 2066 LF 38, D 2066 LF 42, D 2066 LF 67	07.2008→		7.01268.03.0	AGR	PN	Rückschlagventil/non-return valve
41.360 265 kW (360 PS) D 2066 LF 38, D 2066 LF 42, D 2066 LF 48, D 2066 LF 64, D 2066 LF 67	07.2008→		7.01268.03.0	AGR	PN	Rückschlagventil/non-return valve
41.390 287 kW (390 PS) D 2066 LF 02	06.2008→		7.01268.03.0	AGR	PN	Rückschlagventil/non-return valve
41.390 287 kW (390 PS) D 2066 LF 02	06.2008→		7.01268.03.0	AGR	PN	Rückschlagventil/non-return valve
41.390 287 kW (390 PS) D 2066 LF 02	06.2008→		7.01268.03.0	AGR	PN	Rückschlagventil/non-return valve

M

















TGS **46**







41.400 294 kW (400 PS) D 2066 LF 06, D 2066 LF 37, D 2066 LF 41, D 2066 LF 49, D 2066 LF 61, D 2066 LF 63	07.2008→		7.01268.03.0	AGR	PN	Rückschlagventil/non-return valve
41.400 294 kW (400 PS) D 2066 LF 06, D 2066 LF 37, D 2066 LF 41, D 2066 LF 49, D 2066 LF 61, D 2066 LF 63	07.2008→		7.01268.03.0	AGR	PN	Rückschlagventil/non-return valve
41.400 294 kW (400 PS) D 2066 LF 06, D 2066 LF 37, D 2066 LF 41, D 2066 LF 61	07.2008→		7.01268.03.0	AGR	PN	Rückschlagventil/non-return valve
41.400 294 kW (400 PS) D 2066 LF 37, D 2066 LF 41, D 2066 LF 49, D 2066 LF 61, D 2066 LF 63	07.2008→		7.01268.03.0	AGR	PN	Rückschlagventil/non-return valve
41.420 309 kW (420 PS) D 2676 LF 53	09.2016→		7.01268.03.0	AGR	PN	Rückschlagventil/non-return valve
41.420 309 kW (420 PS) D 2676 LF 53	09.2016→		7.01268.03.0	AGR	PN	Rückschlagventil/non-return valve
41.420 309 kW (420 PS) D 2676 LF 53	09.2016→		7.01268.03.0	AGR	PN	Rückschlagventil/non-return valve
41.420 309 kW (420 PS) D 2676 LF 53	09.2016→		7.01268.03.0	AGR	PN	Rückschlagventil/non-return valve
41.430 316 kW (430 PS) D 2066 LF 01	10.2007→		7.01268.03.0	AGR	PN	Rückschlagventil/non-return valve
41.430 316 kW (430 PS) D 2066 LF 01	10.2007→		7.01268.03.0	AGR	PN	Rückschlagventil/non-return valve
41.430 316 kW (430 PS) D 2066 LF 01	07.2008→		7.01268.03.0	AGR	PN	Rückschlagventil/non-return valve
41.440 324 kW (440-441 PS) D 2066 LF 36, D 2066 LF 40, D 2066 LF 50, D 2066 LF 62	10.2007→		7.01268.03.0	AGR	PN	Rückschlagventil/non-return valve
41.440 324 kW (441 PS) D 2676 LF 26	06.2008→		7.01268.03.0	AGR	PN	Rückschlagventil/non-return valve
41.440 324 kW (441 PS) D 2676 LF 26	06.2008→		7.01268.03.0	AGR	PN	Rückschlagventil/non-return valve
41.440 324 kW (440-441 PS) D 2066 LF 36, D 2066 LF 40, D 2066 LF 50, D 2066 LF 62	06.2008→		7.01268.03.0	AGR	PN	Rückschlagventil/non-return valve
41.440 324 kW (440-441 PS) D 2676 LF 04, D 2676 LF 26	06.2008→		7.01268.03.0	AGR	PN	Rückschlagventil/non-return valve
41.440 324 kW (440 PS) D 2066 LF 36	06.2008→		7.01268.03.0	AGR	PN	Rückschlagventil/non-return valve
41.440 324 kW (440-441 PS) D 2676 LF 04, D 2676 LF 26	06.2008→		7.01268.03.0	AGR	PN	Rückschlagventil/non-return valve
41.440 324 kW (440 PS) D 2066 LF 36, D 2066 LF 40	07.2008→		7.01268.03.0	AGR	PN	Rückschlagventil/non-return valve
41.440 324 kW (440-441 PS) D 2066 LF 36, D 2066 LF 40, D 2066 LF 50, D 2066 LF 62	07.2008→		7.01268.03.0	AGR	PN	Rückschlagventil/non-return valve
41.440 324 kW (440 PS) D 2066 LF 36, D 2066 LF 40	07.2008→		7.01268.03.0	AGR	PN	Rückschlagventil/non-return valve
41.460 338 kW (460 PS) D 2676 LF 52	09.2016→		7.01268.03.0	AGR	PN	Rückschlagventil/non-return valve
41.460 338 kW (460 PS) D 2676 LF 52	09.2016→		7.01268.03.0	AGR	PN	Rückschlagventil/non-return valve
41.460 338 kW (460 PS) D 2676 LF 52	09.2016→		7.01268.03.0	AGR	PN	Rückschlagventil/non-return valve

M

TGS
46























41.460 338 kW (460 PS) D 2676 LF 52	09.2016→		7.01268.03.0	AGR	PN	Rückschlagventil/non-return valve
41.480 353 kW (480 PS) D 2676 LF 05, D 2676 LF 07, D 2676 LF 25	06.2008→		7.01268.03.0	AGR	PN	Rückschlagventil/non-return valve
41.480 353 kW (480 PS) D 2676 LF 02, D 2676 LF 05, D 2676 LF 07, D 2676 LF 20, D 2676 LF 25	06.2008→		7.01268.03.0	AGR	PN	Rückschlagventil/non-return valve
41.480 353 kW (480 PS) D 2676 LF 05, D 2676 LF 07	06.2008→		7.01268.03.0	AGR	PN	Rückschlagventil/non-return valve
41.480 353 kW (480 PS) D 2676 LF 02, D 2676 LF 03, D 2676 LF 05, D 2676 LF 07, D 2676 LF 20, D 2676 LF 25	07.2008→		7.01268.03.0	AGR	PN	Rückschlagventil/non-return valve
41.480 353 kW (480 PS) D 2676 LF 02, D 2676 LF 03, D 2676 LF 05, D 2676 LF 07, D 2676 LF 20, D 2676 LF 25	07.2008→		7.01268.03.0	AGR	PN	Rückschlagventil/non-return valve
41.500 368 kW (500 PS) D 2676 LF 51	09.2016→		7.01268.03.0	AGR	PN	Rückschlagventil/non-return valve
41.500 368 kW (500 PS) D 2676 LF 51	09.2016→		7.01268.03.0	AGR	PN	Rückschlagventil/non-return valve
41.500 368 kW (500 PS) D 2676 LF 51	09.2016→		7.01268.03.0	AGR	PN	Rückschlagventil/non-return valve
41.500 368 kW (500 PS) D 2676 LF 51	09.2016→		7.01268.03.0	AGR	PN	Rückschlagventil/non-return valve
41.540 397 kW (540 PS) D 2676 LF 06	02.2009→		7.01268.03.0	AGR	PN	Rückschlagventil/non-return valve
41.540 397 kW (540 PS) D 2676 LF 06	02.2009→		7.01268.03.0	AGR	PN	Rückschlagventil/non-return valve
41.540 397 kW (540 PS) D 2676 LF 06	02.2009→		7.01268.03.0	AGR	PN	Rückschlagventil/non-return valve
41.540 397 kW (540 PS) D 2676 LF 06	02.2009→		7.01268.03.0	AGR	PN	Rückschlagventil/non-return valve

M
TGX
47

18.360 265 kW (360 PS) D 2066 LF 27, D 2066 LF 38, D 2066 LF 42, D 2066 LF 52, D 2066 LF 67	10.2007→		7.01268.03.0	AGR	PN	Rückschlagventil/non-return valve
18.360 265 kW (360 PS) D 2066 LF 27, D 2066 LF 38, D 2066 LF 42, D 2066 LF 52, D 2066 LF 67	10.2007→		7.01268.03.0	AGR	PN	Rückschlagventil/non-return valve
18.360 265 kW (360 PS) D 2066 LF 27, D 2066 LF 38	10.2007→		7.01268.03.0	AGR	PN	Rückschlagventil/non-return valve
18.360 265 kW (360 PS) D 2066 LF 27, D 2066 LF 38, D 2066 LF 42, D 2066 LF 67	10.2007→		7.01268.03.0	AGR	PN	Rückschlagventil/non-return valve
18.400 294 kW (400 PS) D 2066 LF 26, D 2066 LF 37, D 2066 LF 41, D 2066 LF 51, D 2066 LF 61	10.2007→		7.01268.03.0	AGR	PN	Rückschlagventil/non-return valve
18.400 294 kW (400 PS) D 2066 LF 26, D 2066 LF 37, D 2066 LF 41, D 2066 LF 51, D 2066 LF 61	10.2007→		7.01268.03.0	AGR	PN	Rückschlagventil/non-return valve
18.400 294 kW (400 PS) D 2066 LF 26, D 2066 LF 37	10.2007→		7.01268.03.0	AGR	PN	Rückschlagventil/non-return valve



TGX **47**

18.400 294 kW (400 PS) D 2066 LF 26, D 2066 LF 37, D 2066 LF 41, D 2066 LF 61	10.2007→		7.01268.03.0	AGR	PN	Rückschlagventil/non-return valve
18.400 294 kW (400 PS) D 2676 LF 47	08.2012→		7.01268.03.0	AGR	PN	Rückschlagventil/non-return valve
18.400 294 kW (400 PS) D 2676 LF 47	08.2012→		7.01268.03.0	AGR	PN	Rückschlagventil/non-return valve
18.400 294 kW (400 PS) D 2676 LF 47	08.2012→		7.01268.03.0	AGR	PN	Rückschlagventil/non-return valve
18.400 294 kW (400 PS) D 2676 LF 47	08.2012→		7.01268.03.0	AGR	PN	Rückschlagventil/non-return valve
18.420 309 kW (420 PS) D 2676 LF 53	09.2016→		7.01268.03.0	AGR	PN	Rückschlagventil/non-return valve
18.420 309 kW (420 PS) D 2676 LF 53	09.2016→		7.01268.03.0	AGR	PN	Rückschlagventil/non-return valve
18.420 309 kW (420 PS) D 2676 LF 53	09.2016→		7.01268.03.0	AGR	PN	Rückschlagventil/non-return valve
18.440 324 kW (440 PS) D 2066 LF 25, D 2066 LF 36, D 2066 LF 40	10.2007→		7.01268.03.0	AGR	PN	Rückschlagventil/non-return valve
18.440 324 kW (440 PS) D 2066 LF 25, D 2066 LF 36, D 2066 LF 40	10.2007→		7.01268.03.0	AGR	PN	Rückschlagventil/non-return valve
18.440 324 kW (440 PS) D 2066 LF 25, D 2066 LF 36	10.2007→		7.01268.03.0	AGR	PN	Rückschlagventil/non-return valve
18.440 324 kW (440 PS) D 2066 LF 25, D 2066 LF 36, D 2066 LF 40	10.2007→		7.01268.03.0	AGR	PN	Rückschlagventil/non-return valve
18.440 324 kW (441 PS) D 2676 LF 22, D 2676 LF 26	10.2007→		7.01268.03.0	AGR	PN	Rückschlagventil/non-return valve
18.440 324 kW (441 PS) D 2676 LF 22, D 2676 LF 26	10.2007→		7.01268.03.0	AGR	PN	Rückschlagventil/non-return valve
18.440 324 kW (441 PS) D 2676 LF 26	10.2012→		7.01268.03.0	AGR	PN	Rückschlagventil/non-return valve
18.460 338 kW (460 PS) D 2676 LF 52	09.2016→		7.01268.03.0	AGR	PN	Rückschlagventil/non-return valve
18.460 338 kW (460 PS) D 2676 LF 52	09.2016→		7.01268.03.0	AGR	PN	Rückschlagventil/non-return valve
18.460 338 kW (460 PS) D 2676 LF 52	09.2016→		7.01268.03.0	AGR	PN	Rückschlagventil/non-return valve
18.480 353 kW (480 PS) D 2676 LF 05, D 2676 LF 07, D 2676 LF 14, D 2676 LF 21, D 2676 LF 25	10.2007→		7.01268.03.0	AGR	PN	Rückschlagventil/non-return valve
18.480 353 kW (480 PS) D 2676 LF 05, D 2676 LF 07, D 2676 LF 14, D 2676 LF 21, D 2676 LF 25	10.2007→		7.01268.03.0	AGR	PN	Rückschlagventil/non-return valve
18.480 353 kW (480 PS) D 2676 LF 05, D 2676 LF 14	10.2007→		7.01268.03.0	AGR	PN	Rückschlagventil/non-return valve
18.480 353 kW (480 PS) D 2676 LF 05, D 2676 LF 07, D 2676 LF 14, D 2676 LF 25	10.2007→		7.01268.03.0	AGR	PN	Rückschlagventil/non-return valve
18.500 368 kW (500 PS) D 2676 LF 51	09.2016→		7.01268.03.0	AGR	PN	Rückschlagventil/non-return valve
18.500 368 kW (500 PS) D 2676 LF 51	09.2016→		7.01268.03.0	AGR	PN	Rückschlagventil/non-return valve
18.500 368 kW (500 PS) D 2676 LF 51	09.2016→		7.01268.03.0	AGR	PN	Rückschlagventil/non-return valve

M

						
TGX						47
18.520 383 kW (521 PS) D 3876 LF02	09.2014→		7.01268.03.0	AGR	PN	Rückschlagventil/non-return valve
18.540 397 kW (540 PS) D 2676 LF 13	10.2007→		7.01268.03.0	AGR	PN	Rückschlagventil/non-return valve
18.540 397 kW (540 PS) D 2676 LF 06, D 2676 LF 13	10.2007→		7.01268.03.0	AGR	PN	Rückschlagventil/non-return valve
18.540 397 kW (540 PS) D 2676 LF 13	10.2007→		7.01268.03.0	AGR	PN	Rückschlagventil/non-return valve
18.540 397 kW (540 PS) D 2676 LF 06, D 2676 LF 13	10.2007→		7.01268.03.0	AGR	PN	Rückschlagventil/non-return valve
18.540 397 kW (540 PS) D 3876 LF08	09.2016→		7.01268.03.0	AGR	PN	Rückschlagventil/non-return valve
18.540 397 kW (540 PS) D 3876 LF08	09.2016→		7.01268.03.0	AGR	PN	Rückschlagventil/non-return valve
18.560 412 kW (560 PS) D 3876 LF01	09.2014→		7.01268.03.0	AGR	PN	Rückschlagventil/non-return valve
18.580 427 kW (580 PS) D 3876 LF07	09.2016→		7.01268.03.0	AGR	PN	Rückschlagventil/non-return valve
18.580 427 kW (580 PS) D 3876 LF07	09.2016→		7.01268.03.0	AGR	PN	Rückschlagventil/non-return valve
18.640 471 kW (640 PS) D 3876 LF09	09.2016→		7.01268.03.0	AGR	PN	Rückschlagventil/non-return valve
24.360 265 kW (360 PS) D 2066 LF 27, D 2066 LF 38, D 2066 LF 42, D 2066 LF 67	10.2007→		7.01268.03.0	AGR	PN	Rückschlagventil/non-return valve
24.360 265 kW (360 PS) D 2066 LF 27, D 2066 LF 38, D 2066 LF 42, D 2066 LF 52, D 2066 LF 67	10.2007→		7.01268.03.0	AGR	PN	Rückschlagventil/non-return valve
24.400 294 kW (400 PS) D 2066 LF 26, D 2066 LF 37, D 2066 LF 41, D 2066 LF 61	10.2007→		7.01268.03.0	AGR	PN	Rückschlagventil/non-return valve
24.400 294 kW (400 PS) D 2066 LF 26, D 2066 LF 37, D 2066 LF 41, D 2066 LF 51, D 2066 LF 61	10.2007→		7.01268.03.0	AGR	PN	Rückschlagventil/non-return valve
24.400 294 kW (400 PS) D 2676 LF 47	08.2012→		7.01268.03.0	AGR	PN	Rückschlagventil/non-return valve
24.400 294 kW (400 PS) D 2676 LF 47	08.2012→		7.01268.03.0	AGR	PN	Rückschlagventil/non-return valve
24.420 309 kW (420 PS) D 2676 LF 53	09.2016→		7.01268.03.0	AGR	PN	Rückschlagventil/non-return valve
24.420 309 kW (420 PS) D 2676 LF 53	09.2016→		7.01268.03.0	AGR	PN	Rückschlagventil/non-return valve
24.440 324 kW (441 PS) D 2676 LF 22, D 2676 LF 26	10.2007→		7.01268.03.0	AGR	PN	Rückschlagventil/non-return valve
24.440 324 kW (440 PS) D 2066 LF 25, D 2066 LF 36, D 2066 LF 40	10.2007→		7.01268.03.0	AGR	PN	Rückschlagventil/non-return valve
24.440 324 kW (440 PS) D 2066 LF 25, D 2066 LF 36, D 2066 LF 40	10.2007→		7.01268.03.0	AGR	PN	Rückschlagventil/non-return valve
24.440 324 kW (441 PS) D 2676 LF 26	10.2012→		7.01268.03.0	AGR	PN	Rückschlagventil/non-return valve
24.460 338 kW (460 PS) D 2676 LF 52	09.2016→		7.01268.03.0	AGR	PN	Rückschlagventil/non-return valve
24.460 338 kW (460 PS) D 2676 LF 52	09.2016→		7.01268.03.0	AGR	PN	Rückschlagventil/non-return valve

M



TGX **47**

24.480 353 kW (480 PS) D 2676 LF 05, D 2676 LF 07, D 2676 LF 14, D 2676 LF 25	10.2007→		7.01268.03.0	AGR	PN	Rückschlagventil/non-return valve
24.480 353 kW (480 PS) D 2676 LF 05, D 2676 LF 07, D 2676 LF 14, D 2676 LF 21, D 2676 LF 25	10.2007→		7.01268.03.0	AGR	PN	Rückschlagventil/non-return valve
24.500 368 kW (500 PS) D 2676 LF 51	09.2016→		7.01268.03.0	AGR	PN	Rückschlagventil/non-return valve
24.500 368 kW (500 PS) D 2676 LF 51	09.2016→		7.01268.03.0	AGR	PN	Rückschlagventil/non-return valve
24.540 397 kW (540 PS) D 2676 LF 06, D 2676 LF 13	10.2007→		7.01268.03.0	AGR	PN	Rückschlagventil/non-return valve
24.540 397 kW (540 PS) D 2676 LF 06	02.2009→		7.01268.03.0	AGR	PN	Rückschlagventil/non-return valve
26.320 235 kW (320 PS) D 2066 LF 28, D 2066 LF 43	10.2007→		7.01268.03.0	AGR	PN	Rückschlagventil/non-return valve
26.320 235 kW (320 PS) D 2066 LF 28, D 2066 LF 35, D 2066 LF 39, D 2066 LF 43, D 2066 LF 53, D 2066 LF 60, D 2066 LF 65, D 2066 LF 68	10.2007→		7.01268.03.0	AGR	PN	Rückschlagventil/non-return valve
26.360 265 kW (360 PS) D 2066 LF 27, D 2066 LF 38, D 2066 LF 42, D 2066 LF 52, D 2066 LF 67	10.2007→		7.01268.03.0	AGR	PN	Rückschlagventil/non-return valve
26.360 265 kW (360 PS) D 2066 LF 27, D 2066 LF 38, D 2066 LF 42, D 2066 LF 67, D 2066 LF 85	10.2007→		7.01268.03.0	AGR	PN	Rückschlagventil/non-return valve
26.360 265 kW (360 PS) D 2066 LF 38	10.2007→		7.01268.03.0	AGR	PN	Rückschlagventil/non-return valve
26.360 265 kW (360 PS) D 2066 LF 38	10.2007→		7.01268.03.0	AGR	PN	Rückschlagventil/non-return valve
26.360 265 kW (360 PS) D 2066 LF 38, D 2066 LF 42, D 2066 LF 67	10.2007→		7.01268.03.0	AGR	PN	Rückschlagventil/non-return valve
26.360 265 kW (360 PS) D 2066 LF 27, D 2066 LF 38, D 2066 LF 42, D 2066 LF 52, D 2066 LF 67	10.2007→		7.01268.03.0	AGR	PN	Rückschlagventil/non-return valve
26.360 265 kW (360 PS) D 2066 LF 38	05.2008→		7.01268.03.0	AGR	PN	Rückschlagventil/non-return valve
26.360 265 kW (360 PS) D 2066 LF 38, D 2066 LF 42, D 2066 LF 67	07.2008→		7.01268.03.0	AGR	PN	Rückschlagventil/non-return valve
26.360 265 kW (360 PS) D 2066 LF 85	09.2016→		7.01268.03.0	AGR	PN	Rückschlagventil/non-return valve
26.400 294 kW (400 PS) D 2066 LF 37, D 2066 LF 41, D 2066 LF 61	06.2006→		7.01268.03.0	AGR	PN	Rückschlagventil/non-return valve
26.400 294 kW (400 PS) D 2066 LF 26, D 2066 LF 37, D 2066 LF 41, D 2066 LF 61	10.2007→		7.01268.03.0	AGR	PN	Rückschlagventil/non-return valve
26.400 294 kW (400 PS) D 2066 LF 26, D 2066 LF 37, D 2066 LF 41, D 2066 LF 51, D 2066 LF 61	10.2007→		7.01268.03.0	AGR	PN	Rückschlagventil/non-return valve
26.400 294 kW (400 PS) D 2066 LF 37	10.2007→		7.01268.03.0	AGR	PN	Rückschlagventil/non-return valve

M

TGX
47

26.400 294 kW (400 PS) D 2066 LF 37	10.2007→		7.01268.03.0	AGR	PN	Rückschlagventil/non-return valve
26.400 294 kW (400 PS) D 2066 LF 26, D 2066 LF 37, D 2066 LF 41, D 2066 LF 51, D 2066 LF 61	10.2007→		7.01268.03.0	AGR	PN	Rückschlagventil/non-return valve
26.400 294 kW (400 PS) D 2066 LF 37	05.2008→		7.01268.03.0	AGR	PN	Rückschlagventil/non-return valve
26.400 294 kW (400 PS) D 2066 LF 37, D 2066 LF 41, D 2066 LF 61	07.2008→		7.01268.03.0	AGR	PN	Rückschlagventil/non-return valve
26.420 309 kW (420 PS) D 2676 LF 53	09.2016→		7.01268.03.0	AGR	PN	Rückschlagventil/non-return valve
26.420 309 kW (420 PS) D 2676 LF 53	09.2016→		7.01268.03.0	AGR	PN	Rückschlagventil/non-return valve
26.420 309 kW (420 PS) D 2676 LF 53	09.2016→		7.01268.03.0	AGR	PN	Rückschlagventil/non-return valve
26.420 309 kW (420 PS) D 2676 LF 53	09.2016→		7.01268.03.0	AGR	PN	Rückschlagventil/non-return valve
26.420 309 kW (420 PS) D 2676 LF 53	09.2016→		7.01268.03.0	AGR	PN	Rückschlagventil/non-return valve
26.420 309 kW (420 PS) D 2676 LF 53	09.2016→		7.01268.03.0	AGR	PN	Rückschlagventil/non-return valve
26.420 309 kW (420 PS) D 2676 LF 53	09.2016→		7.01268.03.0	AGR	PN	Rückschlagventil/non-return valve
26.440 324 kW (440 PS) D 2066 LF 36	09.2007→		7.01268.03.0	AGR	PN	Rückschlagventil/non-return valve
26.440 324 kW (440 PS) D 2066 LF 25, D 2066 LF 36, D 2066 LF 40, D 2066 LF 57	10.2007→		7.01268.03.0	AGR	PN	Rückschlagventil/non-return valve
26.440 324 kW (440 PS) D 2066 LF 25, D 2066 LF 36, D 2066 LF 40	10.2007→		7.01268.03.0	AGR	PN	Rückschlagventil/non-return valve
26.440 324 kW (440 PS) D 2066 LF 36	10.2007→		7.01268.03.0	AGR	PN	Rückschlagventil/non-return valve
26.440 324 kW (440 PS) D 2066 LF 25, D 2066 LF 36, D 2066 LF 40	10.2007→		7.01268.03.0	AGR	PN	Rückschlagventil/non-return valve
26.440 324 kW (440 PS) D 2066 LF 36	05.2008→		7.01268.03.0	AGR	PN	Rückschlagventil/non-return valve
26.440 324 kW (440 PS) D 2066 LF 36, D 2066 LF 40	07.2008→		7.01268.03.0	AGR	PN	Rückschlagventil/non-return valve
26.440 324 kW (440 PS) D 2066 LF 36, D 2066 LF 40	07.2008→		7.01268.03.0	AGR	PN	Rückschlagventil/non-return valve
26.440 324 kW (441 PS) D 2676 LF 22, D 2676 LF 26	07.2008→		7.01268.03.0	AGR	PN	Rückschlagventil/non-return valve
26.440 324 kW (441 PS) D 2676 LF 26	10.2012→		7.01268.03.0	AGR	PN	Rückschlagventil/non-return valve
26.440 324 kW (441 PS) D 2676 LF 26	10.2012→		7.01268.03.0	AGR	PN	Rückschlagventil/non-return valve
26.440 324 kW (441 PS) D 2676 LF 26	10.2012→		7.01268.03.0	AGR	PN	Rückschlagventil/non-return valve
26.440 324 kW (441 PS) D 2676 LF 22, D 2676 LF 26	10.2012→		7.01268.03.0	AGR	PN	Rückschlagventil/non-return valve
26.440 324 kW (441 PS) D 2676 LF 26	01.2014→		7.01268.03.0	AGR	PN	Rückschlagventil/non-return valve
26.460 338 kW (460 PS) D 2676 LF 52	09.2016→		7.01268.03.0	AGR	PN	Rückschlagventil/non-return valve

M









TGX **47**

26.460 338 kW (460 PS) D 2676 LF 52	09.2016→		7.01268.03.0	AGR	PN	Rückschlagventil/non-return valve
26.460 338 kW (460 PS) D 2676 LF 52	09.2016→		7.01268.03.0	AGR	PN	Rückschlagventil/non-return valve
26.460 338 kW (460 PS) D 2676 LF 52	09.2016→		7.01268.03.0	AGR	PN	Rückschlagventil/non-return valve
26.460 338 kW (460 PS) D 2676 LF 52	09.2016→		7.01268.03.0	AGR	PN	Rückschlagventil/non-return valve
26.460 338 kW (460 PS) D 2676 LF 52	09.2016→		7.01268.03.0	AGR	PN	Rückschlagventil/non-return valve
26.460 338 kW (460 PS) D 2676 LF 52	09.2016→		7.01268.03.0	AGR	PN	Rückschlagventil/non-return valve
26.480 353 kW (480 PS) D 2676 LF 05	09.2007→		7.01268.03.0	AGR	PN	Rückschlagventil/non-return valve
26.480 353 kW (480 PS) D 2676 LF 05, D 2676 LF 07, D 2676 LF 14, D 2676 LF 21, D 2676 LF 25	10.2007→		7.01268.03.0	AGR	PN	Rückschlagventil/non-return valve
26.480 353 kW (480 PS) D 2676 LF 05, D 2676 LF 07, D 2676 LF 14, D 2676 LF 25	10.2007→		7.01268.03.0	AGR	PN	Rückschlagventil/non-return valve
26.480 353 kW (480 PS) D 2676 LF 05, D 2676 LF 07, D 2676 LF 14, D 2676 LF 21, D 2676 LF 25	10.2007→		7.01268.03.0	AGR	PN	Rückschlagventil/non-return valve
26.480 353 kW (480 PS) D 2676 LF 05	10.2007→		7.01268.03.0	AGR	PN	Rückschlagventil/non-return valve
26.480 353 kW (480 PS) D 2676 LF 05	12.2007→		7.01268.03.0	AGR	PN	Rückschlagventil/non-return valve
26.480 353 kW (480 PS) D 2676 LF 05	12.2007→		7.01268.03.0	AGR	PN	Rückschlagventil/non-return valve
26.480 353 kW (480 PS) D 2676 LF 05, D 2676 LF 07	05.2008→		7.01268.03.0	AGR	PN	Rückschlagventil/non-return valve
26.480 353 kW (480 PS) D 2676 LF 05, D 2676 LF 07, D 2676 LF 25	07.2008→		7.01268.03.0	AGR	PN	Rückschlagventil/non-return valve
26.500 368 kW (500 PS) D 2676 LF 51	09.2016→		7.01268.03.0	AGR	PN	Rückschlagventil/non-return valve
26.500 368 kW (500 PS) D 2676 LF 51	09.2016→		7.01268.03.0	AGR	PN	Rückschlagventil/non-return valve
26.500 368 kW (500 PS) D 2676 LF 51	09.2016→		7.01268.03.0	AGR	PN	Rückschlagventil/non-return valve
26.500 368 kW (500 PS) D 2676 LF 51	09.2016→		7.01268.03.0	AGR	PN	Rückschlagventil/non-return valve
26.500 368 kW (500 PS) D 2676 LF 51	09.2016→		7.01268.03.0	AGR	PN	Rückschlagventil/non-return valve
26.500 368 kW (500 PS) D 2676 LF 51	09.2016→		7.01268.03.0	AGR	PN	Rückschlagventil/non-return valve
26.500 368 kW (500 PS) D 2676 LF 51	09.2016→		7.01268.03.0	AGR	PN	Rückschlagventil/non-return valve
26.500 368 kW (500 PS) D 2676 LF 51	09.2016→		7.01268.03.0	AGR	PN	Rückschlagventil/non-return valve
26.540 397 kW (540 PS) D 2676 LF 06, D 2676 LF 13	10.2007→		7.01268.03.0	AGR	PN	Rückschlagventil/non-return valve
26.540 397 kW (540 PS) D 2676 LF 06, D 2676 LF 13	10.2007→		7.01268.03.0	AGR	PN	Rückschlagventil/non-return valve
26.540 397 kW (540 PS) D 2676 LF 06, D 2676 LF 13	10.2007→		7.01268.03.0	AGR	PN	Rückschlagventil/non-return valve
26.540 397 kW (540 PS) D 2676 LF 06	02.2009→		7.01268.03.0	AGR	PN	Rückschlagventil/non-return valve

M

TGX
47

























26.540 397 kW (540 PS) D 2676 LF 06	02.2009→		7.01268.03.0	AGR	PN	Rückschlagventil/non-return valve
26.540 397 kW (540 PS) D 2676 LF 06	10.2012→		7.01268.03.0	AGR	PN	Rückschlagventil/non-return valve
26.540 397 kW (540 PS) D 3876 LF08	09.2016→		7.01268.03.0	AGR	PN	Rückschlagventil/non-return valve
26.540 397 kW (540 PS) D 3876 LF08	09.2016→		7.01268.03.0	AGR	PN	Rückschlagventil/non-return valve
26.540 397 kW (540 PS) D 3876 LF08	09.2016→		7.01268.03.0	AGR	PN	Rückschlagventil/non-return valve
26.540 397 kW (540 PS) D 3876 LF08	09.2016→		7.01268.03.0	AGR	PN	Rückschlagventil/non-return valve
26.540 397 kW (540 PS) D 3876 LF08	09.2016→		7.01268.03.0	AGR	PN	Rückschlagventil/non-return valve
26.540 397 kW (540 PS) D 3876 LF08	09.2016→		7.01268.03.0	AGR	PN	Rückschlagventil/non-return valve
26.540 397 kW (540 PS) D 3876 LF08	09.2016→		7.01268.03.0	AGR	PN	Rückschlagventil/non-return valve
26.580 427 kW (580 PS) D 3876 LF07	09.2016→		7.01268.03.0	AGR	PN	Rückschlagventil/non-return valve
26.580 427 kW (580 PS) D 3876 LF07	09.2016→		7.01268.03.0	AGR	PN	Rückschlagventil/non-return valve
26.580 427 kW (580 PS) D 3876 LF07	09.2016→		7.01268.03.0	AGR	PN	Rückschlagventil/non-return valve
26.580 427 kW (580 PS) D 3876 LF07	09.2016→		7.01268.03.0	AGR	PN	Rückschlagventil/non-return valve
26.580 427 kW (580 PS) D 3876 LF07	09.2016→		7.01268.03.0	AGR	PN	Rückschlagventil/non-return valve
26.580 427 kW (580 PS) D 3876 LF07	09.2016→		7.01268.03.0	AGR	PN	Rückschlagventil/non-return valve
26.580 427 kW (580 PS) D 3876 LF07	09.2016→		7.01268.03.0	AGR	PN	Rückschlagventil/non-return valve
26.640 471 kW (640 PS) D 3876 LF09	09.2016→		7.01268.03.0	AGR	PN	Rückschlagventil/non-return valve
26.640 471 kW (640 PS) D 3876 LF09	09.2016→		7.01268.03.0	AGR	PN	Rückschlagventil/non-return valve
26.640 471 kW (640 PS) D 3876 LF09	09.2016→		7.01268.03.0	AGR	PN	Rückschlagventil/non-return valve
26.640 471 kW (640 PS) D 3876 LF09	09.2016→		7.01268.03.0	AGR	PN	Rückschlagventil/non-return valve
26.640 471 kW (640 PS) D 3876 LF09	09.2016→		7.01268.03.0	AGR	PN	Rückschlagventil/non-return valve
27.440 324 kW (440 PS) D 2676 LF 28	10.2012→		7.01268.03.0	AGR	PN	Rückschlagventil/non-return valve
28.360 265 kW (360 PS) D 2066 LF 27, D 2066 LF 38, D 2066 LF 42, D 2066 LF 67	10.2007→		7.01268.03.0	AGR	PN	Rückschlagventil/non-return valve
28.360 265 kW (360 PS) D 2066 LF 27, D 2066 LF 38, D 2066 LF 42, D 2066 LF 67	10.2007→		7.01268.03.0	AGR	PN	Rückschlagventil/non-return valve
28.400 294 kW (400 PS) D 2066 LF 26, D 2066 LF 37, D 2066 LF 41, D 2066 LF 61	10.2007→		7.01268.03.0	AGR	PN	Rückschlagventil/non-return valve
28.400 294 kW (400 PS) D 2066 LF 26, D 2066 LF 37, D 2066 LF 41, D 2066 LF 61	10.2007→		7.01268.03.0	AGR	PN	Rückschlagventil/non-return valve
28.400 294 kW (400 PS) D 2676 LF 47	08.2012→		7.01268.03.0	AGR	PN	Rückschlagventil/non-return valve

M

TGX **47**

28.420 309 kW (420 PS) D 2676 LF 53	09.2016→		7.01268.03.0	AGR	PN	Rückschlagventil/non-return valve
28.420 309 kW (420 PS) D 2676 LF 53	09.2016→		7.01268.03.0	AGR	PN	Rückschlagventil/non-return valve
28.440 324 kW (440 PS) D 2066 LF 25, D 2066 LF 36, D 2066 LF 40	10.2007→		7.01268.03.0	AGR	PN	Rückschlagventil/non-return valve
28.440 324 kW (440 PS) D 2066 LF 25, D 2066 LF 36, D 2066 LF 40	10.2007→		7.01268.03.0	AGR	PN	Rückschlagventil/non-return valve
28.440 324 kW (440-441 PS) D 2676 440, D 2676 LF 26	10.2012→		7.01268.03.0	AGR	PN	Rückschlagventil/non-return valve
28.440 324 kW (440 PS) D 2676 LF 10, D 2676 LF 28	10.2012→		7.01268.03.0	AGR	PN	Rückschlagventil/non-return valve
28.440 324 kW (441 PS) D 2676 LF 26	10.2012→		7.01268.03.0	AGR	PN	Rückschlagventil/non-return valve
28.460 338 kW (460 PS) D 2676 LF 52	09.2016→		7.01268.03.0	AGR	PN	Rückschlagventil/non-return valve
28.460 338 kW (460 PS) D 2676 LF 52	09.2016→		7.01268.03.0	AGR	PN	Rückschlagventil/non-return valve
28.480 353 kW (480 PS) D 2676 LF 05, D 2676 LF 07, D 2676 LF 14, D 2676 LF 25	10.2007→		7.01268.03.0	AGR	PN	Rückschlagventil/non-return valve
28.480 353 kW (480 PS) D 2676 LF 05, D 2676 LF 07, D 2676 LF 14, D 2676 LF 25	10.2007→		7.01268.03.0	AGR	PN	Rückschlagventil/non-return valve
M 28.480 353 kW (480 PS) D 2676 LF 23	09.2016→		7.01268.03.0	AGR	PN	Rückschlagventil/non-return valve
28.500 368 kW (500 PS) D 2676 LF 51	09.2016→		7.01268.03.0	AGR	PN	Rückschlagventil/non-return valve
28.500 368 kW (500 PS) D 2676 LF 51	09.2016→		7.01268.03.0	AGR	PN	Rückschlagventil/non-return valve
28.540 397 kW (540 PS) D 2676 LF 06, D 2676 LF 13	10.2007→		7.01268.03.0	AGR	PN	Rückschlagventil/non-return valve
28.540 397 kW (540 PS) D 2676 LF 06	02.2009→		7.01268.03.0	AGR	PN	Rückschlagventil/non-return valve
28.540 397 kW (540 PS) D 3876 LF08	09.2016→		7.01268.03.0	AGR	PN	Rückschlagventil/non-return valve
28.540 397 kW (540 PS) D 3876 LF08	09.2016→		7.01268.03.0	AGR	PN	Rückschlagventil/non-return valve
28.580 427 kW (580 PS) D 3876 LF07	09.2016→		7.01268.03.0	AGR	PN	Rückschlagventil/non-return valve
28.580 427 kW (580 PS) D 3876 LF07	09.2016→		7.01268.03.0	AGR	PN	Rückschlagventil/non-return valve
29.480 353 kW (480 PS) D 2676 LF 05, D 2676 LF 07, D 2676 LF 14, D 2676 LF 25	08.2015→		7.01268.03.0	AGR	PN	Rückschlagventil/non-return valve
32.440 265 kW (360 PS) D 2066 LF 38, D 2066 LF 42, D 2066 LF 67	10.2007→		7.01268.03.0	AGR	PN	Rückschlagventil/non-return valve
33.360 265 kW (360 PS) D 2066 LF 27, D 2066 LF 38, D 2066 LF 42, D 2066 LF 67	10.2007→		7.01268.03.0	AGR	PN	Rückschlagventil/non-return valve
33.360 265 kW (360 PS) D 2066 LF 27, D 2066 LF 38, D 2066 LF 42, D 2066 LF 67	10.2007→		7.01268.03.0	AGR	PN	Rückschlagventil/non-return valve
33.400 294 kW (400 PS) D 2066 LF 26, D 2066 LF 37, D 2066 LF 41, D 2066 LF 61	10.2007→		7.01268.03.0	AGR	PN	Rückschlagventil/non-return valve

















TGX
47

33.400 294 kW (400 PS) D 2066 LF 26, D 2066 LF 37, D 2066 LF 41, D 2066 LF 61	10.2007→		7.01268.03.0	AGR	PN	Rückschlagventil/non-return valve
33.420 309 kW (420 PS) D 2676 LF 53	09.2016→		7.01268.03.0	AGR	PN	Rückschlagventil/non-return valve
33.420 309 kW (420 PS) D 2676 LF 53	09.2016→		7.01268.03.0	AGR	PN	Rückschlagventil/non-return valve
33.420 309 kW (420 PS) D 2676 LF 53	09.2016→		7.01268.03.0	AGR	PN	Rückschlagventil/non-return valve
33.440 324 kW (440 PS) D 2066 LF 25, D 2066 LF 36, D 2066 LF 40	10.2007→		7.01268.03.0	AGR	PN	Rückschlagventil/non-return valve
33.440 324 kW (440 PS) D 2066 LF 25, D 2066 LF 36, D 2066 LF 40	10.2007→		7.01268.03.0	AGR	PN	Rückschlagventil/non-return valve
33.440 324 kW (441 PS) D 2676 LF 26	10.2012→		7.01268.03.0	AGR	PN	Rückschlagventil/non-return valve
33.440 324 kW (441 PS) D 2676 LF 26	01.2014→		7.01268.03.0	AGR	PN	Rückschlagventil/non-return valve
33.460 338 kW (460 PS) D 2676 LF 52	09.2016→		7.01268.03.0	AGR	PN	Rückschlagventil/non-return valve
33.460 338 kW (460 PS) D 2676 LF 52	09.2016→		7.01268.03.0	AGR	PN	Rückschlagventil/non-return valve
33.460 338 kW (460 PS) D 2676 LF 52	09.2016→		7.01268.03.0	AGR	PN	Rückschlagventil/non-return valve
33.480 353 kW (480 PS) D 2676 LF 05, D 2676 LF 07, D 2676 LF 14, D 2676 LF 16, D 2676 LF 25	10.2007→		7.01268.03.0	AGR	PN	Rückschlagventil/non-return valve
33.480 353 kW (480 PS) D 2676 LF 05, D 2676 LF 07, D 2676 LF 14, D 2676 LF 25	10.2007→		7.01268.03.0	AGR	PN	Rückschlagventil/non-return valve
33.480 353 kW (480 PS) D 2676 LF 05, D 2676 LF 07, D 2676 LF 14, D 2676 LF 16, D 2676 LF 25	01.2014→		7.01268.03.0	AGR	PN	Rückschlagventil/non-return valve
33.500 368 kW (500 PS) D 2676 LF 51	09.2016→		7.01268.03.0	AGR	PN	Rückschlagventil/non-return valve
33.500 368 kW (500 PS) D 2676 LF 51	09.2016→		7.01268.03.0	AGR	PN	Rückschlagventil/non-return valve
33.500 368 kW (500 PS) D 2676 LF 51	09.2016→		7.01268.03.0	AGR	PN	Rückschlagventil/non-return valve
33.540 397 kW (540 PS) D 2676 LF 06, D 2676 LF 13	10.2007→		7.01268.03.0	AGR	PN	Rückschlagventil/non-return valve
33.540 397 kW (540 PS) D 2676 LF 06, D 2676 LF 13	10.2007→		7.01268.03.0	AGR	PN	Rückschlagventil/non-return valve
33.540 397 kW (540 PS) D 3876 LF08	09.2016→		7.01268.03.0	AGR	PN	Rückschlagventil/non-return valve
33.540 397 kW (540 PS) D 3876 LF08	09.2016→		7.01268.03.0	AGR	PN	Rückschlagventil/non-return valve
33.540 397 kW (540 PS) D 3876 LF08	09.2016→		7.01268.03.0	AGR	PN	Rückschlagventil/non-return valve
33.580 427 kW (580 PS) D 3876 LF07	09.2016→		7.01268.03.0	AGR	PN	Rückschlagventil/non-return valve
33.580 427 kW (580 PS) D 3876 LF07	09.2016→		7.01268.03.0	AGR	PN	Rückschlagventil/non-return valve
33.580 427 kW (580 PS) D 3876 LF07	09.2016→		7.01268.03.0	AGR	PN	Rückschlagventil/non-return valve



M



TGX **47**

33.640 471 kW (640 PS) D 3876 LF09	09.2016→		7.01268.03.0	AGR	PN	Rückschlagventil/non-return valve
35.360 265 kW (360 PS) D 2066 LF 27, D 2066 LF 38, D 2066 LF 42, D 2066 LF 67	06.2008→		7.01268.03.0	AGR	PN	Rückschlagventil/non-return valve
35.400 294 kW (400 PS) D 2066 LF 26, D 2066 LF 37, D 2066 LF 41, D 2066 LF 61	06.2008→		7.01268.03.0	AGR	PN	Rückschlagventil/non-return valve
35.420 309 kW (420 PS) D 2676 LF 53	09.2016→		7.01268.03.0	AGR	PN	Rückschlagventil/non-return valve
35.440 324 kW (441 PS) D 2676 LF 26	06.2008→		7.01268.03.0	AGR	PN	Rückschlagventil/non-return valve
35.440 324 kW (440 PS) D 2066 LF 25, D 2066 LF 36, D 2066 LF 40	06.2008→		7.01268.03.0	AGR	PN	Rückschlagventil/non-return valve
35.460 338 kW (460 PS) D 2676 LF 52	09.2016→		7.01268.03.0	AGR	PN	Rückschlagventil/non-return valve
35.480 353 kW (480 PS) D 2676 LF 05, D 2676 LF 07, D 2676 LF 14, D 2676 LF 25	06.2008→		7.01268.03.0	AGR	PN	Rückschlagventil/non-return valve
35.500 368 kW (500 PS) D 2676 LF 51	09.2016→		7.01268.03.0	AGR	PN	Rückschlagventil/non-return valve
35.540 397 kW (540 PS) D 2676 LF 06, D 2676 LF 13	06.2008→		7.01268.03.0	AGR	PN	Rückschlagventil/non-return valve
35.540 397 kW (540 PS) D 3876 LF08	09.2016→		7.01268.03.0	AGR	PN	Rückschlagventil/non-return valve
M 35.580 427 kW (580 PS) D 3876 LF07	09.2016→		7.01268.03.0	AGR	PN	Rückschlagventil/non-return valve
41.540 397 kW (540 PS) D 2676 LF 06, D 2676 LF 13	06.2008→		7.01268.03.0	AGR	PN	Rückschlagventil/non-return valve
41.580 427 kW (580 PS) D 3876 LF07	09.2016→		7.01268.03.0	AGR	PN	Rückschlagventil/non-return valve
41.640 471 kW (640 PS) D 3876 LF03	09.2014→		7.01268.03.0	AGR	PN	Rückschlagventil/non-return valve

ÜL **48**

363 265 kW (360 PS) D 2866 LUH 25	01.2001→05.2005		7.01268.03.0	AGR	PN	Rückschlagventil/non-return valve
364 265 kW (360 PS) D 2866 LUH 25	06.2004→		7.01268.03.0	AGR	PN	Rückschlagventil/non-return valve



CLA **49**

26.280 FD-TM, FDR-TM 206 kW (280 PS) D 0836 LFL 08	01.2006→		7.01268.03.0	AGR	PN	Rückschlagventil/non-return valve
---	----------	---	---------------------	-----	----	-----------------------------------





L2000 **50**

10.225 LAE-GT, LAE-LF 162 kW (220 PS) D 0836 LFL 02	09.2000→		7.01268.03.0	AGR	PN	Rückschlagventil/non-return valve
--	----------	---	---------------------	-----	----	-----------------------------------

M 2000 L **51**

14.224, 14.225, LA-LF 162 kW (220 PS) D 0826 LFL03, D 0826 LFL10, D 0836 LFL 02	07.2003→		7.01268.03.0	AGR	PN	Rückschlagventil/non-return valve
14.255 LA-LF 180 kW (245 PS) D 0836 LFL 05	07.2003→		7.01268.03.0	AGR	PN	Rückschlagventil/non-return valve

M 2000 L **51**





















18.224, 18.225, L-KO, LR-KO 162 kW (220 PS) D 0826 LFL03, D 0826 LFL06, D 0826 LFL08, D 0826 LFL10, D 0836 LFL 02	05.2001→	 7.01268.03.0	AGR	PN	Rückschlagventil/non-return valve
18.255 L-KO, LR-KO 180 kW (245 PS) D 0836 LFL 05	05.2001→	 7.01268.03.0	AGR	PN	Rückschlagventil/non-return valve
26.284 DL-TM, DLR-TM 206-215 kW (280-292 PS) D 0836 LFL 01, D 0836 LFL 03	05.2001→	 7.01268.03.0	AGR	PN	Rückschlagventil/non-return valve
26.285 DL-TM, DLR-TM 206-215 kW (280-292 PS) D 0836 LFL 01	05.2001→	 7.01268.03.0	AGR	PN	Rückschlagventil/non-return valve

TGA **52**

26.310, 26.320 228-235 kW (310-320 PS) D 2066 LF 04, D 2066 LF 14, D 2066 LF 35, D 2066 LF 39	02.2004→	 7.01268.03.0	AGR	PN	Rückschlagventil/non-return valve
26.310, 26.320 228-235 kW (310-320 PS) D 2066 LF 04, D 2066 LF 35, D 2066 LF 39	06.2005→	 7.01268.03.0	AGR	PN	Rückschlagventil/non-return valve
26.310, 26.320 228-235 kW (310-320 PS) D 2066 LF 04, D 2066 LF 14, D 2066 LF 35, D 2066 LF 39	06.2005→	 7.01268.03.0	AGR	PN	Rückschlagventil/non-return valve
26.310, 26.320 228-235 kW (310-320 PS) D 2066 LF 04, D 2066 LF 35, D 2066 LF 39	06.2005→	 7.01268.03.0	AGR	PN	Rückschlagventil/non-return valve
26.350, 26.360 257-265 kW (350-360 PS) D 2066 LF 03, D 2066 LF 13, D 2066 LF 33, D 2066 LF 38	02.2004→	 7.01268.03.0	AGR	PN	Rückschlagventil/non-return valve
26.350, 26.360 257-265 kW (350-360 PS) D 2066 LF 03, D 2066 LF 13, D 2066 LF 33, D 2066 LF 38	02.2004→	 7.01268.03.0	AGR	PN	Rückschlagventil/non-return valve
26.350, 26.360 257-265 kW (350-360 PS) D 2066 LF 03, D 2066 LF 13, D 2066 LF 33, D 2066 LF 38	05.2004→	 7.01268.03.0	AGR	PN	Rückschlagventil/non-return valve
26.350, 26.360 257-265 kW (350-360 PS) D 2066 LF 03, D 2066 LF 13, D 2066 LF 33, D 2066 LF 38	06.2005→	 7.01268.03.0	AGR	PN	Rückschlagventil/non-return valve
26.390 287 kW (390 PS) D 2066 LF 02, D 2066 LF 12	06.2005→	 7.01268.03.0	AGR	PN	Rückschlagventil/non-return valve
26.390, 26.400 287-294 kW (390-400 PS) D 2066 LF 02, D 2066 LF 12, D 2066 LF 32, D 2066 LF 37	02.2004→	 7.01268.03.0	AGR	PN	Rückschlagventil/non-return valve
26.390, 26.400 287-294 kW (390-400 PS) D 2066 LF 02, D 2066 LF 12, D 2066 LF 32, D 2066 LF 37	05.2004→	 7.01268.03.0	AGR	PN	Rückschlagventil/non-return valve























M

TGA **52**

26.390, 26.400 287-294 kW (390-400 PS) D 2066 LF 02, D 2066 LF 12, D 2066 LF 32, D 2066 LF 37	06.2005→		7.01268.03.0	AGR	PN	Rückschlagventil/non-return valve
26.400 294 kW (400 PS) D 2066 LF 37	04.2006→		7.01268.03.0	AGR	PN	Rückschlagventil/non-return valve
26.430 316 kW (430 PS) D 2066 LF 01, D 2066 LF 11	02.2004→		7.01268.03.0	AGR	PN	Rückschlagventil/non-return valve
26.430, 26.440 316-324 kW (430-440 PS) D 2066 LF 01, D 2066 LF 11, D 2066 LF 31, D 2066 LF 36	05.2004→		7.01268.03.0	AGR	PN	Rückschlagventil/non-return valve
26.430, 26.440 316-324 kW (430-440 PS) D 2066 LF 01, D 2066 LF 11, D 2066 LF 31, D 2066 LF 36	06.2005→		7.01268.03.0	AGR	PN	Rückschlagventil/non-return valve
26.430, 26.440 316-324 kW (430-440 PS) D 2066 LF 01, D 2066 LF 11, D 2066 LF 31, D 2066 LF 36	06.2005→		7.01268.03.0	AGR	PN	Rückschlagventil/non-return valve
26.440 324 kW (440 PS) D 2066 LF 36	09.2005→		7.01268.03.0	AGR	PN	Rückschlagventil/non-return valve
26.480 353 kW (480 PS) D 2676 LF 05	01.2006→		7.01268.03.0	AGR	PN	Rückschlagventil/non-return valve
26.480 353 kW (480 PS) D 2676 LF 01, D 2676 LF 05	02.2006→		7.01268.03.0	AGR	PN	Rückschlagventil/non-return valve
26.480 353 kW (480 PS) D 2676 LF 01, D 2676 LF 05	02.2006→		7.01268.03.0	AGR	PN	Rückschlagventil/non-return valve
26.480 353 kW (480 PS) D 2676 LF 01, D 2676 LF 05	02.2006→		7.01268.03.0	AGR	PN	Rückschlagventil/non-return valve
32.350, 32.360 257-265 kW (350-360 PS) D 2066 LF 13, D 2066 LF 33	08.2005→		7.01268.03.0	AGR	PN	Rückschlagventil/non-return valve
32.390, 32.400 287-294 kW (390-400 PS) D 2066 LF 02, D 2066 LF 12, D 2066 LF 32, D 2066 LF 37	05.2004→		7.01268.03.0	AGR	PN	Rückschlagventil/non-return valve
32.430, 32.440 316-324 kW (430-440 PS) D 2066 LF 01, D 2066 LF 11, D 2066 LF 31, D 2066 LF 36	05.2004→		7.01268.03.0	AGR	PN	Rückschlagventil/non-return valve
33.350 257 kW (350 PS) D 2066 LF 03	09.2007→		7.01268.03.0	AGR	PN	Rückschlagventil/non-return valve
33.360 265 kW (360 PS) D 2066 LF 07	09.2007→		7.01268.03.0	AGR	PN	Rückschlagventil/non-return valve
33.390, 33.400 287-294 kW (390-400 PS) D 2066 LF 02, D 2066 LF 06	09.2007→		7.01268.03.0	AGR	PN	Rückschlagventil/non-return valve
33.430 316 kW (430 PS) D 2066 LF 01	09.2007→		7.01268.03.0	AGR	PN	Rückschlagventil/non-return valve
33.440 324 kW (440-441 PS) D 2676 LF 04	09.2007→		7.01268.03.0	AGR	PN	Rückschlagventil/non-return valve
33.460 338 kW (460 PS) D 2876 LF 04	09.2002→		7.22841.08.0	AGR	PN	Rückschlagventil/non-return valve
33.480 353 kW (480 PS) D 2676 LF 02, D 2676 LF 03	09.2007→		7.01268.03.0	AGR	PN	Rückschlagventil/non-return valve
35.310, 35.320 228-235 kW (310-320 PS) D 2066 LF 04, D 2066 LF 35, D 2066 LF 39	02.2004→		7.01268.03.0	AGR	PN	Rückschlagventil/non-return valve

M

TGA
52



35.350 257 kW (350 PS) D 2066 LF 03, D 2066 LF 13	07.2006→		7.01268.03.0	AGR	PN	Rückschlagventil/non-return valve
35.350, 35.360 257-265 kW (350-360 PS) D 2066 LF 03, D 2066 LF 13, D 2066 LF 33, D 2066 LF 38	02.2004→		7.01268.03.0	AGR	PN	Rückschlagventil/non-return valve
35.360 265 kW (360 PS) D 2066 LF 38	07.2006→		7.01268.03.0	AGR	PN	Rückschlagventil/non-return valve
35.390 287 kW (390 PS) D 2066 LF 02, D 2066 LF 12	07.2006→		7.01268.03.0	AGR	PN	Rückschlagventil/non-return valve
35.390, 35.400 287-294 kW (390-400 PS) D 2066 LF 02, D 2066 LF 12, D 2066 LF 32, D 2066 LF 37	02.2004→		7.01268.03.0	AGR	PN	Rückschlagventil/non-return valve
35.400 294 kW (400 PS) D 2066 LF 37	07.2006→		7.01268.03.0	AGR	PN	Rückschlagventil/non-return valve
35.430 316 kW (430 PS) D 2066 LF 01, D 2066 LF 11	07.2006→		7.01268.03.0	AGR	PN	Rückschlagventil/non-return valve
35.430, 35.440 316-324 kW (430-440 PS) D 2066 LF 01, D 2066 LF 11, D 2066 LF 31, D 2066 LF 36	02.2004→		7.01268.03.0	AGR	PN	Rückschlagventil/non-return valve
35.440 324 kW (440 PS) D 2066 LF 36	07.2006→		7.01268.03.0	AGR	PN	Rückschlagventil/non-return valve
35.480 353 kW (480 PS) D 2676 LF 01, D 2676 LF 05	02.2004→		7.01268.03.0	AGR	PN	Rückschlagventil/non-return valve
35.480 353 kW (480 PS) D 2676 LF 05	07.2006→		7.01268.03.0	AGR	PN	Rückschlagventil/non-return valve
37.350, 37.360 257-265 kW (350-360 PS) D 2066 LF 03, D 2066 LF 13, D 2066 LF 33, D 2066 LF 38	12.2004→		7.01268.03.0	AGR	PN	Rückschlagventil/non-return valve
37.390, 37.400 287-294 kW (390-400 PS) D 2066 LF 02, D 2066 LF 12, D 2066 LF 32, D 2066 LF 37	12.2004→		7.01268.03.0	AGR	PN	Rückschlagventil/non-return valve
37.430, 37.440 316-324 kW (430-440 PS) D 2066 LF 01, D 2066 LF 11, D 2066 LF 31, D 2066 LF 36	12.2004→		7.01268.03.0	AGR	PN	Rückschlagventil/non-return valve
37.480 353 kW (480 PS) D 2676 LF 01, D 2676 LF 05	02.2006→		7.01268.03.0	AGR	PN	Rückschlagventil/non-return valve
41.350 257 kW (350 PS) D 2066 LF 03	09.2007→		7.01268.03.0	AGR	PN	Rückschlagventil/non-return valve
41.350, 41.360 257-265 kW (350-360 PS) D 2066 LF 03, D 2066 LF 07, D 2066 LF 13, D 2066 LF 33, D 2066 LF 38	12.2004→		7.01268.03.0	AGR	PN	Rückschlagventil/non-return valve
41.360 265 kW (360 PS) D 2066 LF 07	09.2007→		7.01268.03.0	AGR	PN	Rückschlagventil/non-return valve
41.390 287 kW (390 PS) D 2066 LF 02	09.2007→		7.01268.03.0	AGR	PN	Rückschlagventil/non-return valve
41.390, 41.400 287-294 kW (390-400 PS) D 2066 LF 02, D 2066 LF 06, D 2066 LF 12, D 2066 LF 32, D 2066 LF 37	12.2004→		7.01268.03.0	AGR	PN	Rückschlagventil/non-return valve
41.400 294 kW (400 PS) D 2066 LF 06	09.2007→		7.01268.03.0	AGR	PN	Rückschlagventil/non-return valve
41.430 316 kW (430 PS) D 2066 LF 01	09.2007→		7.01268.03.0	AGR	PN	Rückschlagventil/non-return valve

M











TGA

52

41.430, 41.440 316-324 kW (430-440 PS) D 2066 LF 01, D 2066 LF 11, D 2066 LF 31, D 2066 LF 36	12.2004→		7.01268.03.0	AGR	PN	Rückschlagventil/non-return valve
41.440 324 kW (440-441 PS) D 2676 LF 04	12.2004→		7.01268.03.0	AGR	PN	Rückschlagventil/non-return valve
41.480 353 kW (480 PS) D 2676 LF 01, D 2676 LF 02, D 2676 LF 03, D 2676 LF 05	02.2006→		7.01268.03.0	AGR	PN	Rückschlagventil/non-return valve

TGM











53

13.240 176 kW (240 PS) D 0836 LFL 53	10.2005→		7.01268.03.0	AGR	PN	Rückschlagventil/non-return valve
13.250 184 kW (250 PS) D 0836 LFL 63, D 0836 LFL 66	10.2005→		7.01268.03.0	AGR	PN	Rückschlagventil/non-return valve
13.280 206 kW (280 PS) D 0836 LFL 54	10.2005→		7.01268.03.0	AGR	PN	Rückschlagventil/non-return valve
13.290 202-213 kW (275-290 PS) D 0836 LFL 64, D 0836 LFL 67	10.2005→		7.01268.03.0	AGR	PN	Rückschlagventil/non-return valve
26.280 206 kW (280 PS) D 0836 LFL 51, D 0836 LFL 54	04.2006→		7.01268.03.0	AGR	PN	Rückschlagventil/non-return valve
26.290 202-213 kW (275-290 PS) D 0836 LFL 64, D 0836 LFL 67	07.2008→		7.01268.03.0	AGR	PN	Rückschlagventil/non-return valve
26.330 240 kW (326 PS) D 0836 LFL 52, D 0836 LFL 55	04.2006→		7.01268.03.0	AGR	PN	Rückschlagventil/non-return valve
26.340 250 kW (340 PS) D 0836 LFL 65, D 0836 LFL 68	07.2008→		7.01268.03.0	AGR	PN	Rückschlagventil/non-return valve

M

TGS

54

26.320 235 kW (320 PS) D 2066 LF 28, D 2066 LF 39	10.2007→		7.01268.03.0	AGR	PN	Rückschlagventil/non-return valve
26.320 235 kW (320 PS) D 2066 LF 39, D 2066 LF 43, D 2066 LF 68	07.2008→		7.01268.03.0	AGR	PN	Rückschlagventil/non-return valve
26.360 265 kW (360 PS) D 2066 LF 27, D 2066 LF 38	10.2007→		7.01268.03.0	AGR	PN	Rückschlagventil/non-return valve
26.360 265 kW (360 PS) D 2066 LF 38, D 2066 LF 42, D 2066 LF 67	07.2008→		7.01268.03.0	AGR	PN	Rückschlagventil/non-return valve
26.400 294 kW (400 PS) D 2066 LF 26, D 2066 LF 37	10.2007→		7.01268.03.0	AGR	PN	Rückschlagventil/non-return valve
26.400 294 kW (400 PS) D 2066 LF 37, D 2066 LF 41, D 2066 LF 61	07.2008→		7.01268.03.0	AGR	PN	Rückschlagventil/non-return valve
26.420 309 kW (420 PS) D 2676 LF 53	09.2016→		7.01268.03.0	AGR	PN	Rückschlagventil/non-return valve
26.440 324 kW (440 PS) D 2066 LF 36, D 2066 LF 40	07.2008→		7.01268.03.0	AGR	PN	Rückschlagventil/non-return valve
26.440 324 kW (441 PS) D 2676 LF 26	07.2008→		7.01268.03.0	AGR	PN	Rückschlagventil/non-return valve
26.460 338 kW (460 PS) D 2676 LF 52	09.2016→		7.01268.03.0	AGR	PN	Rückschlagventil/non-return valve
26.480 353 kW (480 PS) D 2676 LF 01, D 2676 LF 05, D 2676 LF 07, D 2676 LF 09, D 2676 LF 12, D 2676 LF 14, D 2676 LF 16, D 2676 LF 18, D 2676 LF 20, D 2676 LF 25, D 2676 LF 31, D 2676 LF 33, D 2676 LF 35, D 2676 LF 45	10.2007→		7.01268.03.0	AGR	PN	Rückschlagventil/non-return valve
26.480 353 kW (480 PS) D 2676 LF 25	05.2008→		7.01268.03.0	AGR	PN	Rückschlagventil/non-return valve

TGS
54

26.500 368 kW (500 PS) D 2676 LF 51	09.2016→		7.01268.03.0	AGR	PN	Rückschlagventil/non-return valve
26.540 397 kW (540 PS) D 2676 LF 06, D 2676 LF 08, D 2676 LF 11, D 2676 LF 13, D 2676 LF 15, D 2676 LF 17, D 2676 LF 19, D 2676 LF 32	10.2007→		7.01268.03.0	AGR	PN	Rückschlagventil/non-return valve
32.320 235 kW (320 PS) D 2066 LF 39, D 2066 LF 43, D 2066 LF 68	02.2009→		7.01268.03.0	AGR	PN	Rückschlagventil/non-return valve
32.360 265 kW (360 PS) D 2066 LF 27, D 2066 LF 38, D 2066 LF 42, D 2066 LF 67	10.2007→		7.01268.03.0	AGR	PN	Rückschlagventil/non-return valve
32.400 294 kW (400 PS) D 2066 LF 26, D 2066 LF 37, D 2066 LF 41, D 2066 LF 61	10.2007→		7.01268.03.0	AGR	PN	Rückschlagventil/non-return valve
32.420 309 kW (420 PS) D 2676 LF 53	09.2016→		7.01268.03.0	AGR	PN	Rückschlagventil/non-return valve
32.440 324 kW (440 PS) D 2066 LF 25, D 2066 LF 36, D 2066 LF 40	10.2007→		7.01268.03.0	AGR	PN	Rückschlagventil/non-return valve
32.440 324 kW (441 PS) D 2676 LF 26	08.2008→		7.01268.03.0	AGR	PN	Rückschlagventil/non-return valve
32.460 338 kW (460 PS) D 2676 LF 52	09.2016→		7.01268.03.0	AGR	PN	Rückschlagventil/non-return valve
32.480 353 kW (480 PS) D 2676 LF 05, D 2676 LF 07, D 2676 LF 25	08.2008→		7.01268.03.0	AGR	PN	Rückschlagventil/non-return valve
32.500 368 kW (500 PS) D 2676 LF 51	09.2016→		7.01268.03.0	AGR	PN	Rückschlagventil/non-return valve
33.320 235 kW (320 PS) D 2066 LF 43	05.2009→		7.01268.03.0	AGR	PN	Rückschlagventil/non-return valve
33.350 257 kW (350 PS) D 2066 LF 03	06.2008→		7.01268.03.0	AGR	PN	Rückschlagventil/non-return valve
33.360 265 kW (360 PS) D 2066 LF 07, D 2066 LF 48, D 2066 LF 64	06.2008→		7.01268.03.0	AGR	PN	Rückschlagventil/non-return valve
33.390 287 kW (390 PS) D 2066 LF 02	06.2008→		7.01268.03.0	AGR	PN	Rückschlagventil/non-return valve
33.400 294 kW (400 PS) D 2066 LF 06, D 2066 LF 49, D 2066 LF 63	07.2008→		7.01268.03.0	AGR	PN	Rückschlagventil/non-return valve
33.430 316 kW (430 PS) D 2066 LF 01	06.2008→		7.01268.03.0	AGR	PN	Rückschlagventil/non-return valve
33.440 324 kW (440-441 PS) D 2676 LF 04	10.2007→		7.01268.03.0	AGR	PN	Rückschlagventil/non-return valve
33.440 324 kW (441 PS) D 2066 LF 50, D 2066 LF 62	06.2008→		7.01268.03.0	AGR	PN	Rückschlagventil/non-return valve
33.480 353 kW (480 PS) D 2676 LF 02	08.2008→		7.01268.03.0	AGR	PN	Rückschlagventil/non-return valve
35.320 235 kW (320 PS) D 2066 LF 28, D 2066 LF 39, D 2066 LF 43, D 2066 LF 68	10.2007→		7.01268.03.0	AGR	PN	Rückschlagventil/non-return valve
35.360 265 kW (360 PS) D 2066 LF 27, D 2066 LF 38, D 2066 LF 42, D 2066 LF 67	10.2007→		7.01268.03.0	AGR	PN	Rückschlagventil/non-return valve
35.400 294 kW (400 PS) D 2066 LF 26, D 2066 LF 37, D 2066 LF 41, D 2066 LF 61	10.2007→		7.01268.03.0	AGR	PN	Rückschlagventil/non-return valve

M









TGS **54**

35.420 309 kW (420 PS) D 2676 LF 53	09.2016→		7.01268.03.0	AGR	PN	Rückschlagventil/non-return valve
35.440 324 kW (440 PS) D 2066 LF 25, D 2066 LF 36, D 2066 LF 40	10.2007→		7.01268.03.0	AGR	PN	Rückschlagventil/non-return valve
35.440 324 kW (441 PS) D 2676 LF 26	08.2008→		7.01268.03.0	AGR	PN	Rückschlagventil/non-return valve
35.460 338 kW (460 PS) D 2676 LF 52	09.2016→		7.01268.03.0	AGR	PN	Rückschlagventil/non-return valve
35.480 353 kW (480 PS) D 2676 LF 05, D 2676 LF 07, D 2676 LF 14, D 2676 LF 25	10.2007→		7.01268.03.0	AGR	PN	Rückschlagventil/non-return valve
35.500 368 kW (500 PS) D 2676 LF 51	09.2016→		7.01268.03.0	AGR	PN	Rückschlagventil/non-return valve
35.540 397 kW (540 PS) D 2676 LF 06, D 2676 LF 13	10.2007→		7.01268.03.0	AGR	PN	Rückschlagventil/non-return valve
37.320 235 kW (320 PS) D 2066 LF 28, D 2066 LF 39, D 2066 LF 43, D 2066 LF 68	10.2007→		7.01268.03.0	AGR	PN	Rückschlagventil/non-return valve
37.360 265 kW (360 PS) D 2066 LF 27, D 2066 LF 38, D 2066 LF 42, D 2066 LF 67	10.2007→		7.01268.03.0	AGR	PN	Rückschlagventil/non-return valve
37.400 294 kW (400 PS) D 2066 LF 26, D 2066 LF 37, D 2066 LF 41, D 2066 LF 61	10.2007→		7.01268.03.0	AGR	PN	Rückschlagventil/non-return valve
37.420 309 kW (420 PS) D 2676 LF 53	09.2016→		7.01268.03.0	AGR	PN	Rückschlagventil/non-return valve
37.440 324 kW (440 PS) D 2066 LF 25, D 2066 LF 36, D 2066 LF 40	10.2007→		7.01268.03.0	AGR	PN	Rückschlagventil/non-return valve
37.440 324 kW (441 PS) D 2676 LF 26	07.2008→		7.01268.03.0	AGR	PN	Rückschlagventil/non-return valve
37.460 338 kW (460 PS) D 2676 LF 52	09.2016→		7.01268.03.0	AGR	PN	Rückschlagventil/non-return valve
37.480 353 kW (480 PS) D 2676 LF 05, D 2676 LF 07, D 2676 LF 14, D 2676 LF 25	10.2007→		7.01268.03.0	AGR	PN	Rückschlagventil/non-return valve
37.500 368 kW (500 PS) D 2676 LF 51	09.2016→		7.01268.03.0	AGR	PN	Rückschlagventil/non-return valve
37.540 397 kW (540 PS) D 2676 LF 06, D 2676 LF 13	10.2007→		7.01268.03.0	AGR	PN	Rückschlagventil/non-return valve
41.320 235 kW (320 PS) D 2066 LF 39, D 2066 LF 43, D 2066 LF 68	06.2008→		7.01268.03.0	AGR	PN	Rückschlagventil/non-return valve
41.350 257 kW (350 PS) D 2066 LF 03	06.2008→		7.01268.03.0	AGR	PN	Rückschlagventil/non-return valve
41.360 265 kW (360 PS) D 2066 LF 07, D 2066 LF 27, D 2066 LF 38, D 2066 LF 42, D 2066 LF 48, D 2066 LF 64, D 2066 LF 67	10.2007→		7.01268.03.0	AGR	PN	Rückschlagventil/non-return valve
41.390 287 kW (390 PS) D 2066 LF 02	06.2008→		7.01268.03.0	AGR	PN	Rückschlagventil/non-return valve
41.400 294 kW (400 PS) D 2066 LF 06, D 2066 LF 26, D 2066 LF 37, D 2066 LF 41, D 2066 LF 49, D 2066 LF 61, D 2066 LF 63	10.2007→		7.01268.03.0	AGR	PN	Rückschlagventil/non-return valve
41.420 309 kW (420 PS) D 2676 LF 53	09.2016→		7.01268.03.0	AGR	PN	Rückschlagventil/non-return valve
41.430 316 kW (430 PS) D 2066 LF 01	10.2007→		7.01268.03.0	AGR	PN	Rückschlagventil/non-return valve



M

TGS
54

41.440 324 kW (440-441 PS) D 2066 LF 25, D 2066 LF 36, D 2066 LF 40, D 2066 LF 50, D 2066 LF 62	10.2007->	 7.01268.03.0	AGR	PN	Rückschlagventil/non-return valve
41.440 324 kW (440-441 PS) D 2676 LF 04, D 2676 LF 26	06.2008->	 7.01268.03.0	AGR	PN	Rückschlagventil/non-return valve
41.460 338 kW (460 PS) D 2676 LF 52	09.2016->	 7.01268.03.0	AGR	PN	Rückschlagventil/non-return valve
41.480 353 kW (480 PS) D 2676 LF 02, D 2676 LF 03, D 2676 LF 05, D 2676 LF 07, D 2676 LF 14, D 2676 LF 20, D 2676 LF 25	10.2007->	 7.01268.03.0	AGR	PN	Rückschlagventil/non-return valve
41.500 368 kW (500 PS) D 2676 LF 51	09.2016->	 7.01268.03.0	AGR	PN	Rückschlagventil/non-return valve
41.540 397 kW (540 PS) D 2676 LF 06, D 2676 LF 13	10.2007->	 7.01268.03.0	AGR	PN	Rückschlagventil/non-return valve



ENGINE **55**







<p>ENGINE 176-353 kW (239-480 PS) D 0836 LOH 40, D 0836 LOH 50, D 0836 LOH 51, D 0836 LOH 52, D 0836 LOH 53, D 0836 LOH 54, D 0836 LOH 55, D 0836 LOH 56, D 0836 LOH 57, D 0836 LOH 58, D 0836 LUH 41, D 0836 LUH 50, D 2066 LOH 01, D 2066 LOH 02, D 2066 LOH 10, D 2066 LUH 11, D 2066 LUH 12, D 2066 LUH 14, D 2676 LOH 01, D 2676 LOH 02, D 2866 LUH 27</p>		<p>7.01268.03.0</p>	<p>AGR PN</p>	<p>Rückschlagventil/non-return valve</p>
<p>ENGINE 228-397 kW (310-540 PS) D 2066 LF 01, D 2066 LF 02, D 2066 LF 03, D 2066 LF 05, D 2066 LF 11, D 2066 LF 12, D 2066 LF 13, D 2066 LF 14, D 2066 LF 15, D 2066 LF 16, D 2066 LF 17, D 2066 LF 18, D 2066 LF 19, D 2066 LF 20, D 2066 LF 21, D 2066 LF 22, D 2066 LF 23, D 2066 LF 24, D 2066 LF 25, D 2066 LF 26, D 2066 LF 27, D 2066 LF 28, D 2066 LF 29, D 2066 LF 30, D 2066 LF 31, D 2066 LF 32, D 2066 LF 33, D 2066 LF 34, D 2066 LF 35, D 2066 LF 36, D 2066 LF 38, D 2066 LF 39, D 2066 LF 40, D 2066 LF 42, D 2066 LF 43, D 2066 LF 44, D 2066 LF 45, D 2066 LF 46, D 2066 LF 47, D 2066 LF 49, D 2066 LF 50, D 2066 LF 51, D 2066 LF 52, D 2066 LF 53, D 2066 LF 54, D 2066 LF 55, D 2066 LF 56, D 2066 LF 57, D 2066 LF 58, D 2066 LF 59, D 2066 LF 60, D 2066 LF 61, D 2066 LF 62, D 2066 LF 63, D 2066 LF 64, D 2066 LF 65, D 2066 LF 67, D 2066 LF 68, D 2066 LF 69, D 2066 LF 70, D 2066 LF 71, D 2066 LF 76, D 2066 LF 77, D 2066 LF 78, D 2066 LF 80, D 2066 LF 81, D 2066 LF 82, D 2066 LF 83, D 2066 LF 84, D 2676 LF 01, D 2676 LF 02, D 2676 LF 03, D 2676 LF 04, D 2676 LF 05, D 2676 LF 06, D 2676 LF 07, D 2676 LF 08, D 2676 LF 09, D 2676 LF 10, D 2676 LF 11, D 2676 LF 12, D 2676 LF 13, D 2676 LF 14, D 2676 LF 17, D 2676 LF 18, D 2676 LF 19, D 2676 LF 20, D 2676 LF 21, D 2676 LF 22, D 2676 LF 23, D 2676 LF 24, D 2676 LF 27, D 2676 LF 28, D 2676 LF 31, D 2676 LF 32, D 2676 LF 33, D 2676 LF 35, D 2676 LF 36, D 2676 LF 38, D 2676 LF 39, D 2676 LF 40, D 2676 LF 41, D 2676 LF 42, D 2676 LF 43, D 2676 LF 44, D 2676 LF 45, D 2676 LF 46, D 2676 LF 47, D 2676 LF 48, D 2676 LF 50, D 2676 LF 54, D 2676 LF 55, D 2676 LF 56, D 2676 LF 57, D 2676 LF 58</p>		<p>7.05454.07.0</p>	<p>AGR PN</p>	<p>  D 2066 LF 01, D 2066 LF 02, D 2066 LF 03, D 2066 LF 05, D 2066 LF 11, D 2066 LF 12, D 2066 LF 13, D 2066 LF 14, D 2066 LF 15, D 2066 LF 16, D 2066 LF 18, D 2066 LF 20, D 2066 LF 21, D 2066 LF 21, D 2066 LF 22, D 2066 LF 23, D 2066 LF 24, D 2066 LF 25, D 2066 LF 26, D 2066 LF 27, D 2066 LF 28, D 2066 LF 29, D 2066 LF 30, D 2066 LF 31, D 2066 LF 32, D 2066 LF 33, D 2066 LF 34, D 2066 LF 35, D 2066 LF 36, D 2066 LF 38, D 2066 LF 38, D 2066 LF 39, D 2066 LF 40, D 2066 LF 42, D 2066 LF 43, D 2066 LF 44, D 2066 LF 45, D 2066 LF 46, D 2066 LF 47, D 2066 LF 49, D 2066 LF 50, D 2066 LF 51, D 2066 LF 52, D 2066 LF 53, D 2066 LF 54, D 2066 LF 55, D 2066 LF 56, D 2066 LF 57, D 2066 LF 58, D 2066 LF 59, D 2066 LF 60, D 2066 LF 61, D 2066 LF 62, D 2066 LF 63, D 2066 LF 64, D 2066 LF 65, D 2066 LF 67, D 2066 LF 68, D 2066 LF 69, D 2066 LF 70, D 2066 LF 71, D 2066 LF 76, D 2066 LF 77, D 2066 LF 78, D 2066 LF 80, D 2066 LF 81, D 2066 LF 81, D 2066 LF 82, D 2066 LF 83, D 2066 LF 84: 02.2003→  D 2066 LF 17:  ch. 02.2003→  D 2676 LF 01, D 2676 LF 02, D 2676 LF 03, D 2676 LF 03, D 2676 LF 04, D 2676 LF 05, D 2676 LF 06, D 2676 LF 07, D 2676 LF 08, D 2676 LF 09, D 2676 LF 09, D 2676 LF 10, D 2676 LF 11, D 2676 LF 12, D 2676 LF 13, D 2676 LF 14, D 2676 LF 17, D 2676 LF 18, D 2676 LF 19, D 2676 LF 20, D 2676 LF 21, D 2676 LF 22, D 2676 LF 23, D 2676 LF 24, D 2676 LF 27, D 2676 LF 28, D 2676 LF 31, D 2676 LF 32, D 2676 LF 33, D 2676 LF 35, D 2676 LF 35, D 2676 LF 36, D 2676 LF 38, D 2676 LF 39, D 2676 LF 40, D 2676 LF 41, D 2676 LF 42, D 2676 LF 43, D 2676 LF 44, D 2676 LF 45, D 2676 LF 46, D 2676 LF 47, D 2676 LF 47, D 2676 LF 48, D 2676 LF 50, D 2676 LF 54, D 2676 LF 55, D 2676 LF 55, D 2676 LF 56, D 2676 LF 57, D 2676 LF 58: 03.2006→ </p>

M

























ENGINE

















55

<p>ENGINE 228-375 kW (310-510 PS) D 2866 LF28, D 2866 LF29, D 2866 LF30, D 2866 LF31, D 2866 LF34, D 2866 LF35, D 2866 LF37, D 2866 LFG, D 2866 LFG 01, D 2866 LFG 02, D 2866 LFG 03, D 2866 LFG 04, D 2866 LFG 05, D 2866 LFG 06, D 2866 LFG 07, D 2866 LOH 32, D 2866 LOH 39, D 2866 LOH 40, D 2866 LOH 50, D 2866 LOH 51, D 2866 LXFG, D 2876 LE 101, D 2876 LE 103, D 2876 LE 104, D 2876 LE 105, D 2876 LF 01, D 2876 LF 08, D 2876 LF 09, D 2876 LF 10, D 2876 LF 11, D 2876 LF 14, D 2876 LF 17, D 2876 LF 18, D 2876 LF 19, D 2876 LF 20, D 2876 LF 23, D 2876 LFG 01, D 2876 LOH 02, D 2876 LOH 04, D 2876 LOH 20</p>		<p>7.22841.08.0</p>	<p>AGR</p>	<p>PN</p>	<p>Rückschlagventil/non-return valve</p>
<p>ENGINE 228-397 kW (310-540 PS) D 2066 LF 04, D 2066 LF 06, D 2066 LF 07, D 2676 LF 15, D 2676 LF 16</p>		<p>7.05454.07.0</p>	<p>AGR</p>	<p>PN</p>	<p> D 2066 LF 04, D 2066 LF 06, D 2066 LF 07: 02.2003→  D 2676 LF 15: 03.2006→  D 2676 LF 16:  ch. 03.2006→</p>
		<p>7.01268.03.0</p>	<p>AGR</p>	<p>PN</p>	<p>Rückschlagventil/non-return valve</p>

M



			 PIERBURG		
3200 GT Coupe 1					
3.2 Biturbo V8 32V 271 kW (369 PS) AM 585	10.1998→03.2002		7.22296.02.0	ARV	PN <input type="checkbox"/>
			7.22472.07.0	SLP	EL <input type="checkbox"/>
Assembly-Nummer ab: 4446 Assembly number from: 4446					
4200 GT / COUPE Coupe 2					
4.2 287 kW (390 PS) M 138	03.2002→12.2007		7.22296.02.0	ARV	PN <input type="checkbox"/>
			7.22472.07.0	SLP	EL <input type="checkbox"/>
4.2 287-291 kW (390-396 PS) AM138	05.2002→11.2007		7.22296.02.0	ARV	PN <input type="checkbox"/>
4200 GT SPYDER Convertible 3					
4.2 287-291 kW (390-396 PS) AM138	10.2001→12.2006		7.22296.02.0	ARV	PN <input type="checkbox"/>
			7.22472.07.0	SLP	EL <input type="checkbox"/>
4.2 287 kW (390 PS) M 138	10.2001→		7.22296.02.0	ARV	PN <input type="checkbox"/>
			7.22472.07.0	SLP	EL <input type="checkbox"/>
GHIBLI III (M157) 4					
3.0 D 202 kW (275 PS) A630HP	08.2013→		7.11190.03.0	DDS	<input type="checkbox"/>
			ohne Zubehör without accessories Euro 6 Euro 6		
3.0 D 184-202 kW (250-275 PS) M 15746 D	08.2013→		7.11190.03.0	DDS	<input type="checkbox"/>
			ohne Zubehör without accessories Euro 6 Euro 6		
GRAN TURISMO 5					
4.2 298 kW (405 PS) M 139 P	09.2007→		7.22296.02.0	ARV	PN <input type="checkbox"/>
			7.22472.07.0	SLP	EL <input type="checkbox"/>
4.7 331 kW (450 PS) M 145 T	09.2010→		7.22296.02.0	ARV	PN <input type="checkbox"/>
			7.22472.07.0	SLP	EL <input type="checkbox"/>
4.7 338 kW (460 PS) M 145 A, M 145 B	05.2012→		7.22296.02.0	ARV	PN <input type="checkbox"/>
			7.22472.07.0	SLP	EL <input type="checkbox"/>
4.7 S 323 kW (439 PS) M 139 S, M 145	08.2008→12.2012		7.22296.02.0	ARV	PN <input type="checkbox"/>
			7.22472.07.0	SLP	EL <input type="checkbox"/>
GRANCABRIO 6					
4.7 323 kW (439 PS) M 139 S	03.2010→		7.22296.02.0	ARV	PN <input type="checkbox"/>
			7.22472.07.0	SLP	EL <input type="checkbox"/>
4.7 323 kW (439 PS) M 139 S	06.2010→		7.22296.02.0	ARV	PN <input type="checkbox"/>
			7.22472.07.0	SLP	EL <input type="checkbox"/>
4.7 331 kW (450 PS) M 145 S	01.2011→		7.22296.02.0	ARV	PN <input type="checkbox"/>
			7.22472.07.0	SLP	EL <input type="checkbox"/>
4.7 338 kW (460 PS) M 145 B	02.2013→		7.22296.02.0	ARV	PN <input type="checkbox"/>
			7.22472.07.0	SLP	EL <input type="checkbox"/>
GRANSPORT Convertible 7					
4.2 295 kW (400 PS) M 138 P	10.2004→		7.22296.02.0	ARV	PN <input type="checkbox"/>
			7.22472.07.0	SLP	EL <input type="checkbox"/>

M

						
GRANSPORT Coupe						8
4.2 295 kW (400 PS) M 138 P	06.2004→11.2007		7.22296.02.0	ARV	PN 	
			7.22472.07.0	SLP	EL	
LEVANTE SUV (M161)						9
3.0 D Q4 184-202 kW (250-275 PS) B630WM	06.2016→		7.11190.03.0	DDS	ohne Zubehör without accessories	
3.0 D Q4 184-202 kW (250-275 PS) B630WM	06.2016→		7.11190.03.0	DDS	ohne Zubehör without accessories	
QUATTROPORTE V						10
4.2 294-295 kW (401 PS) M139 A	03.2004→		7.22296.02.0	ARV	PN 	
			7.22472.07.0	SLP	EL	
4.7 GT S 323 kW (439 PS) M 139 L, M 139 S	06.2008→		7.22472.07.0	SLP	EL	
4.7 S 317 kW (431 PS) M 139 R	06.2008→		7.22296.02.0	ARV	PN 	
			7.22472.07.0	SLP	EL	
QUATTROPORTE VI						11
3.0 D 184-202 kW (250-275 PS) M 15746 D	09.2013→		7.11190.03.0	DDS	ohne Zubehör without accessories Euro 6 Euro 6	
3.0 D 184-202 kW (250-275 PS) M 15746 D	09.2013→		7.11190.03.0	DDS	ohne Zubehör without accessories Euro 6 Euro 6	









































57 (W240) **1**

5.5 (240.078) 405 kW (551 PS) M 285.950	09.2002→12.2012		7.05270.12.0	LS	500 mm	vor Katalysator, beidseitig in front of the catalyst, Left and right
S 6.0 (240.079, 240.077) 450-471 kW (612-641 PS) M 285.980	09.2005→12.2012		7.05270.12.0	LS	500 mm	nach Katalysator, beidseitig Post-catalyst, Left and right

62 (V240) **2**

5.5 (240.178) 405 kW (551 PS) M 285.950	09.2002→12.2012		7.05270.12.0	LS	500 mm	nach Katalysator, beidseitig Post-catalyst, Left and right
6.0 S (240.177) 450-471 kW (612-641 PS) M 285.980	01.2011→12.2012		7.05270.12.0	LS	500 mm	nach Katalysator, beidseitig Post-catalyst, Left and right
S 6.0 (240.179) 450-471 kW (612-641 PS) M 285.980	09.2005→12.2012		7.05270.12.0	LS	500 mm	nach Katalysator, beidseitig Post-catalyst, Left and right





















































M

						
121 I (DA)						1
1.3 40-44 kW (54-60 PS) B3	10.1987→06.1991		7.02604.03.0	LS	200 mm	
121 II (DB)						2
1.3 16V 39-54 kW (53-73 PS) B3 (16V)	11.1990→03.1996		7.02604.03.0	LS	200 mm	
1.3 i 16V 39-54 kW (53-73 PS) B3 (16V)	11.1990→03.1996		7.02604.03.0	LS	200 mm	
2 (DY)						3
1.4 CD 50 kW (68 PS) F6JA, F6JB	04.2003→06.2007		7.24809.06.0	AGR	PN mit Rohrstützen with pipe socket  F6JA, F6JB: Euro 3 Euro 3	
			7.24809.76.0	AGR	EL 	
3 (BK)						4
1.6 DI Turbo 80-81 kW (109-110 PS) Y601	06.2004→06.2009		7.24809.39.0	AGR	EL  03.2006→	
1.6 MZ-CD 66-80 kW (90-109 PS) Y406	06.2006→12.2009		7.24809.39.0	AGR	EL 	
2.0 102-118 kW (139-160 PS) LF50, LF72, LFDE, LFN7, LFN8, LFVE	10.2003→12.2009		7.24809.73.0	AGR	EL 	
2.0 104-110 kW (141-150 PS) LF72	10.2003→06.2006		7.24809.73.0	AGR	EL 	
2.0 AWD 102-110 kW (139-150 PS) LFVE	06.2004→03.2009		7.24809.73.0	AGR	EL 	
3 (BL)						5
1.6 MZ-CD 80 kW (109 PS) Y642	12.2008→05.2013		7.24809.39.0	AGR	EL 	
			7.11190.10.0	DDS	ohne Zubehör without accessories	
1.6 MZR CD 70-85 kW (95-116 PS) Y650, Y655	09.2010→05.2013		7.24809.39.0	AGR	EL 	
			7.11190.10.0	DDS	ohne Zubehör without accessories	
2.0 DISI (BLEFP) 110 kW (150 PS) LF-VDS	05.2009→02.2012		7.24809.73.0	AGR	EL 	
2.0 MZR 108-111 kW (147-151 PS) LF5H, LF5W	01.2009→09.2014		7.24809.73.0	AGR	EL 	
2.0 MZR 108-111 kW (147-151 PS) LF5H, LF5W	04.2009→09.2014		7.24809.73.0	AGR	EL 	
2.0 MZR DISI 110-111 kW (150-151 PS) LFZ2	12.2008→05.2013		7.24809.73.0	AGR	EL 	
3 (BM, BN)						6
1.5 74-88 kW (100-120 PS) P5Y1	09.2013→		7.05662.07.0	AK	EL	
1.5 74-88 kW (100-120 PS) P5Y1	10.2013→		7.05662.07.0	AK	EL	
3 Saloon (BK)						7
1.6 DI Turbo (BK12Y) 80-81 kW (109-110 PS) Y601	06.2004→06.2009		7.24809.39.0	AGR	EL  03.2006→	



M

						
3 Saloon (BK)						7
2.0 102-118 kW (139-160 PS) LF50, LF72, LFDE, LFN7, LFN8, LFVE	10.2003→12.2009		7.24809.73.0	AGR	EL 	
2.0 104-110 kW (141-150 PS) LF72	10.2003→06.2006		7.24809.73.0	AGR	EL 	
3 Saloon (BL)						8
1.6 MZR CD 70-85 kW (95-116 PS) Y650, Y655	09.2010→05.2013		7.24809.39.0	AGR	EL 	
			7.11190.10.0	DDS	ohne Zubehör without accessories	
1.6 MZR CD (BL12) 80 kW (109 PS) Y642	12.2008→05.2013		7.24809.39.0	AGR	EL 	
			7.11190.10.0	DDS	→07.2011 ohne Zubehör without accessories	
2.0 MZR 108-111 kW (147-151 PS) LF5H, LF5W	04.2009→09.2014		7.24809.73.0	AGR	EL 	
2.0 MZR (BL12) 108-111 kW (147-151 PS) LF5H, LF5W	03.2009→09.2014		7.24809.73.0	AGR	EL 	
2.0 MZR DISI (BL12) 110-111 kW (150-151 PS) LFZ2	02.2009→05.2013		7.24809.73.0	AGR	EL 	
323 C IV (BG)						9
1.6 16V 64-66 kW (87-90 PS) B6	03.1991→10.1994		7.02604.01.0	LS	200 mm	
323 C V (BA)						10
1.3 16V 39-54 kW (53-73 PS) B3 (16V)	08.1994→09.1998		7.02604.01.0	LS	200 mm	
323 F IV (BG)						11
1.6 16V 64-66 kW (87-90 PS) B6	03.1991→10.1994		7.02604.01.0	LS	200 mm	
323 F VI (BJ)						12
1.6 70-78 kW (95-106 PS) ZM	01.2001→05.2004		7.02604.01.0	LS	200 mm	
1.6 70-78 kW (95-106 PS) ZM	01.2001→05.2004		7.02604.01.0	LS	200 mm	
323 III (BF)						13
1.6 GT 63-77 kW (86-105 PS) B6 (SOHC)	01.1986→06.1988		7.02604.01.0	LS	200 mm	
1.6 GT 63-77 kW (86-105 PS) B6 (SOHC)	11.1986→10.1989		7.02604.01.0	LS	200 mm	
323 III Hatchback (BF)						14
1.6 GT 63-77 kW (86-105 PS) B6 (SOHC)	08.1985→06.1988		7.02604.01.0	LS	200 mm	
1.6 GT 63-77 kW (86-105 PS) B6 (SOHC)	09.1987→10.1989		7.02604.01.0	LS	200 mm	
323 III Station Wagon (BW)						15
1.6 62-77 kW (84-105 PS) B6 (SOHC), B65M, B6E	09.1986→10.1995		7.02604.01.0	LS	200 mm	
323 S IV (BG)						16
1.6 16V 64-66 kW (87-90 PS) B6	10.1989→10.1994		7.02604.01.0	LS	200 mm	





















M

						
323 S VI (BJ)						17
1.6 70-78 kW (95-106 PS) ZM	01.2001→05.2004		7.02604.01.0	LS	200 mm	
1.6 70-78 kW (95-106 PS) ZM	01.2001→05.2004		7.02604.01.0	LS	200 mm	
5 (CR19)						18
1.8 85-88 kW (116-120 PS) L823	02.2005→05.2010		7.24809.73.0	AGR	EL 	
2.0 107 kW (146 PS) LFF7	02.2005→05.2010		7.24809.73.0	AGR	EL 	
5 (CW)						19
1.6 CD 70-85 kW (95-116 PS) Y650, Y655, Y6Y1	07.2010→		7.11190.10.0	DDS	ohne Zubehör without accessories	
1.8 MZR 85 kW (116 PS) L850	09.2010→		7.24809.73.0	AGR	EL 	
2.0 106-110 kW (144-150 PS) LF-ZB	06.2010→		7.24809.73.0	AGR	EL 	
2.0 106-110 kW (144-150 PS) LF-ZB	09.2010→		7.24809.73.0	AGR	EL 	
2.0 106-110 kW (144-150 PS) LF-ZB	01.2011→		7.24809.73.0	AGR	EL 	→03.2012
6 Estate (GH)						20
1.8 MZR 75-88 kW (102-120 PS) L813	02.2008→07.2013		7.24809.73.0	AGR	EL 	
2.0 MZR 104-110 kW (141-150 PS) LF17	12.2007→07.2013		7.24809.73.0	AGR	EL 	
2.0 MZR 104-118 kW (141-160 PS) LFDE	01.2010→07.2013		7.24809.73.0	AGR	EL 	
2.5 MZR 117-125 kW (159-170 PS) L5-VE	02.2008→07.2013		7.24809.73.0	AGR	EL 	
6 Hatchback (GG)						21
1.8 75-88 kW (102-120 PS) L813	08.2002→08.2007		7.24809.73.0	AGR	EL 	
2.0 104-110 kW (141-150 PS) LF17, LF18	08.2002→08.2007		7.24809.73.0	AGR	EL 	
2.0 107 kW (146 PS) LFF7	03.2005→08.2007		7.24809.73.0	AGR	EL 	
2.3 116-122 kW (162-166 PS) L3C1	08.2002→08.2007		7.24809.73.0	AGR	EL 	
2.3 114-119 kW (155-162 PS) L3X	09.2003→12.2006		7.24809.73.0	AGR	EL 	
6 Hatchback (GH)						22
1.8 MZR 75-88 kW (102-120 PS) L813	08.2007→07.2013		7.24809.73.0	AGR	EL 	
2.0 MZR 104-110 kW (141-150 PS) LF17	08.2007→07.2013		7.24809.73.0	AGR	EL 	
2.0 MZR 104-118 kW (141-160 PS) LFDE	01.2010→12.2012		7.24809.73.0	AGR	EL 	
2.5 MZR 117-125 kW (159-170 PS) L5-VE	08.2007→03.2013		7.24809.73.0	AGR	EL 	
6 Saloon (GG)						23
1.8 75-88 kW (102-120 PS) L813, L829	08.2002→08.2007		7.24809.73.0	AGR	EL 	
2.0 104-110 kW (141-150 PS) LF17, LF18	06.2002→08.2007		7.24809.73.0	AGR	EL 	
2.0 107 kW (146 PS) LFF7	03.2005→08.2007		7.24809.73.0	AGR	EL 	

			 PIERBURG			
6 Saloon (GG)						23
2.3 116-122 kW (162-166 PS) L3C1	06.2002→08.2007		7.24809.73.0	AGR	EL 	
2.3 114-119 kW (155-162 PS) L3X	07.2003→02.2005		7.24809.73.0	AGR	EL 	
2.3 116-122 kW (162-166 PS) L3C1	03.2005→07.2007		7.24809.73.0	AGR	EL 	
2.3 114-119 kW (155-162 PS) L3X	09.2006→12.2008		7.24809.73.0	AGR	EL 	
2.3 MPS Turbo 191 kW (260 PS) L3KG	12.2005→08.2007		7.24809.73.0	AGR	EL 	
6 Saloon (GH)						24
1.8 MZR 75-88 kW (102-120 PS) L813	08.2007→07.2013		7.24809.73.0	AGR	EL 	
2.0 MZR 108 kW (147 PS) LF4J, LF4K, LFYA, LFYB	08.2007→12.2012		7.24809.73.0	AGR	EL 	
2.0 MZR 104-118 kW (141-160 PS) LFDE	01.2010→12.2012		7.24809.73.0	AGR	EL 	
2.5 MZR 117-125 kW (159-170 PS) L5-VE	08.2007→07.2013		7.24809.73.0	AGR	EL 	
6 Station Wagon (GY)						25
1.8 75-88 kW (102-120 PS) L813	08.2002→08.2007		7.24809.73.0	AGR	EL 	
2.0 104-110 kW (141-150 PS) LF17, LF18	08.2002→08.2007		7.24809.73.0	AGR	EL 	
2.0 107 kW (146 PS) LFF7	03.2005→08.2007		7.24809.73.0	AGR	EL 	
2.3 116-122 kW (162-166 PS) L3C1	01.2002→02.2008		7.24809.73.0	AGR	EL 	
2.3 AWD 116-122 kW (162-166 PS) L3C1	11.2002→08.2007		7.24809.73.0	AGR	EL 	
626 II (GC)						26
2.0 60-88 kW (82-120 PS) FE (8V)	01.1986→09.1987		7.02604.01.0	LS	200 mm	
626 II Coupe (GC)						27
2.0 60-88 kW (82-120 PS) FE (8V)	02.1983→10.1987		7.02604.01.0	LS	200 mm	
626 II Hatchback (GC)						28
2.0 60-88 kW (82-120 PS) FE (8V)	01.1986→09.1987		7.02604.01.0	LS	200 mm	
626 III (GD)						29
2.0 66-81 kW (90-110 PS) FE (12V)	09.1987→10.1990		7.02604.01.0	LS	200 mm	
626 III Coupe (GD)						30
2.0 60-88 kW (82-120 PS) FE (8V)	09.1987→10.1990		7.02604.01.0	LS	200 mm	
626 IV Hatchback (GE)						31
2.5 24V 120-123 kW (163-167 PS) KL	01.1992→04.1997		7.05271.73.0	LS	528 mm	
2.5 24V 120-123 kW (163-167 PS) KL	08.1994→04.1997		7.05271.73.0	LS	528 mm	

						
BT-50 Pickup (CD, UN)						32
2.5 MRZ-CD 105 kW (143 PS) WLAA	08.2006→06.2013		7.24809.75.0	AGR	PN  für Schaltgetriebe for manual transmission	
2.5 MRZ-CD 4x4 105 kW (143 PS) WLAA	12.2006→12.2015		7.24809.75.0	AGR	PN  für Schaltgetriebe for manual transmission	
3.0 CDVi 115 kW (156 PS) WEAT	12.2006→12.2015		7.24809.75.0	AGR	PN  für Schaltgetriebe for manual transmission	
3.0 CDVi 4x4 115 kW (156 PS) WEAT	10.2006→12.2015		7.24809.75.0	AGR	PN  für Schaltgetriebe for manual transmission	
CX-7 (ER)						33
2.5 MZR 117-125 kW (159-170 PS) L5-VE	07.2009→03.2013		7.24809.73.0	AGR	EL 	
2.5 MZR AWD 117-125 kW (159-170 PS) L5-VE	09.2010→12.2012		7.24809.73.0	AGR	EL 	
MPV II (LW)						34
2.3 104-109 kW (141-148 PS) L3	07.2002→02.2006		7.24809.73.0	AGR	EL 	
MPV III (LY)						35
2.3 110-126 kW (150-171 PS) L3-VE	02.2006→		7.24809.73.0	AGR	EL 	
2.3 110-126 kW (150-171 PS) L3-VE	02.2006→		7.24809.73.0	AGR	EL 	
2.3 4WD 110-126 kW (150-171 PS) L3-VE	02.2006→		7.24809.73.0	AGR	EL 	
MX-3 (EC)						36
1.6 66 kW (90 PS) B67K	05.1991→10.1993		7.02604.01.0	LS	200 mm	
1.6i	01.1994→		7.02604.01.0	LS	200 mm	
MX-5 I (NA)						37
1.6	09.1989→		7.02604.01.0	LS	200 mm	
MX-5 II (NB)						38
1.6 16V 81 kW (110 PS) B6MC, B6MU	05.1998→10.2005		7.02604.01.0	LS	200 mm	
MX-6 (GE)						39
2.5 24V 120-123 kW (163-167 PS) KL	02.1992→09.1997		7.05271.73.0	LS	528 mm	
2.5 i 24V 120-123 kW (163-167 PS) KL	08.1994→02.1997		7.05271.73.0	LS	528 mm	
RX-7 I (SA)						40
1.0 77-85 kW (105-116 PS) 12AN2	05.1979→05.1981		7.02604.01.0	LS	200 mm	
1.1 77-85 kW (105-116 PS) 12AN2	01.1981→03.1984		7.02604.01.0	LS	200 mm	
1.1 77-85 kW (105-116 PS) 12AN2	03.1984→03.1986		7.02604.01.0	LS	200 mm	

M

			 PIERBURG			
RX-7 II (FC)						41
1.3 109-176 kW (148-239 PS) RE13B	11.1985→04.1989		7.02604.01.0	LS	200 mm	
1.3 Turbo 109-176 kW (148-239 PS) RE13B	03.1989→12.1991		7.02604.01.0	LS	200 mm	
TRIBUTE (EP)						42
2.3 AWD 110-126 kW (150-171 PS) L3-VE	04.2004→05.2008		7.24809.73.0	AGR	EL 	
2.3 All-wheel Drive 104-109 kW (141-148 PS) L3	07.2006→05.2008		7.24809.73.0	AGR	EL 	
2.3 GX 110-126 kW (150-171 PS) L3-VE	12.2003→10.2004		7.24809.73.0	AGR	EL 	
XEDOS 6 (CA)						43
1.6 16V 79 kW (107 PS) B6EW	04.1994→10.1999		7.05271.73.0	LS	528 mm	
2.0 V6 103-106 kW (140-144 PS) KF1	01.1992→05.1994		7.05271.73.0	LS	528 mm	
BT-50 Platform/Chassis (CD, UN)						44
3.0 CDVi 115 kW (156 PS) WEAT	12.2006→		7.24809.75.0	AGR	PN  für Schaltgetriebe for manual transmission	
3.0 CDVi 4x4 115 kW (156 PS) WEAT	12.2006→		7.24809.75.0	AGR	PN  für Schaltgetriebe for manual transmission	



















M

							
123 Coupe (C123)							1
230 CE (123.243) 100 kW (136 PS) M 102.980	04.1980→12.1985		7.02604.01.0	LS	200 mm		
300 C Turbo-D (123.153) 92 kW (125 PS) OM 617.952	09.1981→07.1985		7.21949.51.0	AGR	PN	☒	
123 Saloon (W123)							2
230 E (123.223) 100 kW (136 PS) M 102.980	04.1980→12.1985		7.02604.01.0	LS	200 mm		
300 Turbo-D (123.133) 92 kW (125 PS) OM 617.952	08.1981→07.1985		7.21949.51.0	AGR	PN	☒	
123 T-Model (S123)							3
230 TE (123.283) 100 kW (136 PS) M 102.980	04.1980→11.1985		7.02604.01.0	LS	200 mm		
300 T Turbo-D (123.193) 92 kW (125 PS) OM 617.952	10.1980→11.1985		7.21949.51.0	AGR	PN	☒	
124 Convertible (A124)							4
300 CE-24 (124.061) 162-170 kW (220-231 PS) M 104.980	04.1992→06.1993		7.02604.03.0	LS	200 mm		
124 Coupe (C124)							5
230 CE (124.043) 97-100 kW (132-136 PS) M 102.982	03.1987→12.1992		7.02604.03.0	LS	200 mm		
230 CE (124.043) 97-100 kW (132-136 PS) M 102.982	03.1987→12.1992		7.02604.03.0	LS	200 mm		
230 CE Cat (124.043) 97-100 kW (132-136 PS) M 102.982	06.1989→12.1992		7.02604.03.0	LS	200 mm		
300 CE 132-138 kW (179-188 PS) M 103.983	03.1987→12.1989		7.02604.03.0	LS	200 mm		
300 CE (124.050) 132-138 kW (179-188 PS) M 103.983	03.1987→05.1993		7.02604.03.0	LS	200 mm		
300 CE-24 (124.051) 162-170 kW (220-231 PS) M 104.980	09.1989→12.1992		7.02604.03.0	LS	200 mm		
124 Saloon (W124)							6
200 E (124.019) 100 kW (136 PS) M 111.940	10.1992→06.1993		7.02604.04.0	LS	200 mm		
200 E (124.021) 87-90 kW (118-122 PS) M 102.963	09.1988→08.1993		7.02604.04.0	LS	200 mm		
200 E (124.021) 87-90 kW (118-122 PS) M 102.963	09.1988→12.1989		7.02604.04.0	LS	200 mm		
230 E (124.023) 97-100 kW (132-136 PS) M 102.982	12.1984→03.1992		7.02604.03.0	LS	200 mm		
230 E (124.023) 97-100 kW (132-136 PS) M 102.982	01.1985→06.1993		7.02604.03.0	LS	200 mm		
230 E Cat (124.023) 97-100 kW (132-136 PS) M 102.982	06.1989→06.1993		7.02604.03.0	LS	200 mm		























M



124 Saloon (W124) **6**

250 D (124.125) 66-69 kW (90-94 PS) OM 602.912	04.1985→06.1993		7.21949.51.0	AGR	PN	☒ →07.1989 ☐☐ Japan, Schweden, Australien ☐☐ Japan, Sweden, Australia
250 D (124.125) 66-69 kW (90-94 PS) OM 602.912	01.1989→06.1993		7.21949.51.0	AGR	PN	☒ →07.1989 ☐☐ Japan, Schweden, Australien ☐☐ Japan, Sweden, Australia
250 Turbo-D (124.128) 90-93 kW (126 PS) OM 602.962	09.1988→06.1993		7.21949.51.0	AGR	PN	☒ ☒ OM 602.962: ☐☐ Finnland ☐☐ Finland 1991 ☒ OM 602.962: ☐☐ Österreich ☐☐ Austria
260 E (124.026) 118-122 kW (160-166 PS) M 103.940	09.1985→08.1992		7.02604.03.0	LS	200 mm	
260 E (124.026) 118-122 kW (160-166 PS) M 103.940	09.1985→12.1989		7.02604.03.0	LS	200 mm	
260 E 4-matic (124.226) 118 kW (160 PS) M 103.943	09.1986→08.1992		7.02604.03.0	LS	200 mm	
260 E 4-matic (124.226) 118-122 kW (160-166 PS) M 103.940	12.1986→12.1989		7.02604.03.0	LS	200 mm	
280 E (124.028) 142-145 kW (193-197 PS) M 104.942	10.1992→06.1993		7.02604.03.0	LS	200 mm	
300 D (124.130) 80-83 kW (109-113 PS) OM 603.912	12.1984→08.1989		7.21949.51.0	AGR	PN	☒ 08.1988→ ☐☐ Japan, Schweden ☐☐ Japan, Sweden
300 D (124.130) 80-83 kW (109-113 PS) OM 603.912	08.1989→06.1993		7.21949.51.0	AGR	PN	☒ ☐☐ Japan, Schweden ☐☐ Japan, Sweden
300 D (124.130) 80-83 kW (109-113 PS) OM 603.912	06.1990→06.1993		7.21949.51.0	AGR	PN	☒ ☐☐ Japan, Schweden ☐☐ Japan, Sweden
300 D 4-matic (124.330) 80-83 kW (109-113 PS) OM 603.913	09.1986→08.1992		7.21949.51.0	AGR	PN	☒ ☐☐ Japan ☐☐ Japan
300 D 4-matic (124.330) 80-83 kW (109-113 PS) OM 603.913	08.1989→06.1993		7.21949.51.0	AGR	PN	☒ ☐☐ Japan ☐☐ Japan
300 E 138 kW (188 PS) M 103.980	01.1985→12.1985		7.02604.03.0	LS	200 mm	
300 E 132-138 kW (179-188 PS) M 103.983	06.1985→12.1989		7.02604.03.0	LS	200 mm	
300 E (124.030) 132-138 kW (179-188 PS) M 103.983	08.1985→08.1992		7.02604.03.0	LS	200 mm	
300 E 4-matic 132-138 kW (179-188 PS) M 103.983	09.1986→12.1989		7.02604.03.0	LS	200 mm	
300 E 4-matic (124.230) 132 kW (180 PS) M 103.985	09.1986→06.1993		7.02604.03.0	LS	200 mm	
300 Turbo-D (124.133) 100-108 kW (136-147 PS) OM 603.960, OM 603.963	09.1986→09.1988		7.21949.51.0	AGR	PN	☒ 08.1988→











M

						
124 Saloon (W124)						6
300 Turbo-D (124.133) 100-108 kW (136-147 PS) OM 603.960	09.1988→06.1993		7.21949.51.0	AGR	PN <input checked="" type="checkbox"/>	
300 Turbo-D 4-matic (124.333) 100-108 kW (136-147 PS) OM 603.960, OM 603.963	09.1986→09.1988		7.21949.51.0	AGR	PN <input checked="" type="checkbox"/> 08.1988→	
300 Turbo-D 4-matic (124.333) 105-108 kW (143-147 PS) OM 603.963	01.1988→06.1993		7.21949.51.0	AGR	PN <input checked="" type="checkbox"/> 08.1988→	
400 E 4.2 (124.034) 205 kW (279 PS) M 119.975	10.1992→06.1993		7.05270.00.0	LS	350 mm	
500 E (124.036) 235-240 kW (320-326 PS) M 119.974	01.1991→06.1993		7.05270.00.0	LS	350 mm	
124 T-Model (S124)						7
200 TE (124.079) 100 kW (136 PS) M 111.940	05.1986→06.1993		7.02604.04.0	LS	200 mm	
200 TE (124.081) 87-90 kW (118-122 PS) M 102.963	09.1988→08.1992		7.02604.04.0	LS	200 mm	
230 TE (124.083) 97-100 kW (132-136 PS) M 102.982	09.1985→08.1992		7.02604.03.0	LS	200 mm	
230 TE (124.083) 97-100 kW (132-136 PS) M 102.982	09.1985→08.1992		7.02604.03.0	LS	200 mm	
230 TE Cat (124.083) 97-100 kW (132-136 PS) M 102.982	06.1989→08.1992		7.02604.03.0	LS	200 mm	
250 T D (124.185) 66-69 kW (90-94 PS) OM 602.912	09.1985→06.1993		7.21949.51.0	AGR	PN <input checked="" type="checkbox"/> →07.1989 Japan, Schweden, Australien Japan, Sweden, Australia	
250 T D (124.185) 66-69 kW (90-94 PS) OM 602.912	01.1989→06.1993		7.21949.51.0	AGR	PN <input checked="" type="checkbox"/> →07.1989 Japan, Schweden, Australien Japan, Sweden, Australia	
250 TD Turbo (124.188) 90-93 kW (126 PS) OM 602.962	03.1988→07.1993		7.21949.51.0	AGR	PN <input checked="" type="checkbox"/> OM 602.962: Finland Finland 1991 1991 OM 602.962: Österreich Austria	
260 TE FGST. 118-122 kW (160-166 PS) M 103.940	09.1985→12.1989		7.02604.03.0	LS	200 mm	
260 TE FGST. 118-122 kW (160-166 PS) M 103.940	09.1989→08.1992		7.02604.03.0	LS	200 mm	
280 TE (124.088) 142-145 kW (193-197 PS) M 104.942	10.1992→06.1993		7.02604.03.0	LS	200 mm	
300 T D (124.190) 80-83 kW (109-113 PS) OM 603.912	09.1986→06.1993		7.21949.51.0	AGR	PN <input checked="" type="checkbox"/> 08.1988→ Japan, Schweden Japan, Sweden	
300 T D (124.190) 80-83 kW (109-113 PS) OM 603.912	01.1989→06.1993		7.21949.51.0	AGR	PN <input checked="" type="checkbox"/> Japan, Schweden Japan, Sweden	









M



124 T-Model (S124) **7**

300 T D (124.190) 80-83 kW (109-113 PS) OM 603.912	01.1989→06.1993		7.21949.51.0	AGR	PN	<input checked="" type="checkbox"/> Japan, Schweden <input checked="" type="checkbox"/> Japan, Sweden
300 T Turbo-D 100-108 kW (136-147 PS) OM 603.960, OM 603.963	09.1986→01.1989		7.21949.51.0	AGR	PN	<input checked="" type="checkbox"/> 08.1988→
300 T Turbo-D (124.193) 100-108 kW (136-147 PS) OM 603.960	01.1989→06.1993		7.21949.51.0	AGR	PN	<input checked="" type="checkbox"/>
300 T Turbo-D 4-matic (124.393) 105-108 kW (143-147 PS) OM 603.963	09.1986→01.1989		7.21949.51.0	AGR	PN	<input checked="" type="checkbox"/> 08.1988→
300 T Turbo-D 4-matic (124.393) 100-108 kW (136-147 PS) OM 603.960	01.1989→06.1993		7.21949.51.0	AGR	PN	<input checked="" type="checkbox"/>
300 TD T 100-108 kW (136-147 PS) OM 603.960	06.1992→05.1993		7.21949.51.0	AGR	PN	<input checked="" type="checkbox"/>
300 TE (124.090) 132-138 kW (179-188 PS) M 103.983	01.1986→08.1992		7.02604.03.0	LS	200 mm	
300 TE (124.090) 132-138 kW (179-188 PS) M 103.983	01.1986→12.1989		7.02604.03.0	LS	200 mm	
300 TE 4-matic (124.290) 132 kW (180 PS) M 103.985	09.1986→06.1993		7.02604.03.0	LS	200 mm	
M 300 TE 4-matic (124.290) 132-138 kW (179-188 PS) M 103.983	09.1986→12.1989		7.02604.03.0	LS	200 mm	
300 TE-24 (124.091) 162-170 kW (220-231 PS) M 104.980	09.1989→08.1992		7.02604.03.0	LS	200 mm	

190 (W201) **8**









2.6 118-122 kW (160-166 PS) M 103.942	10.1982→09.1988		7.02604.03.0	LS	200 mm	
E 1.8 (201.018) 80 kW (109 PS) M 102.910	04.1990→08.1993		7.02604.03.0	LS	200 mm	
E 2.3-16 125-136 kW (170-185 PS) M 102.983	09.1985→12.1987		7.02604.03.0	LS	200 mm	
E 2.3-16 125-136 kW (170-185 PS) M 102.983	09.1985→08.1988		7.02604.03.0	LS	200 mm	
E 2.3-16 (201.034) 125-136 kW (170-185 PS) M 102.983	04.1984→01.1987		7.02604.03.0	LS	200 mm	
E 2.5-16 143-150 kW (195-204 PS) M 102.990	09.1988→08.1993		7.02604.03.0	LS	200 mm	
E 2.6 118-122 kW (160-166 PS) M 103.942	09.1986→12.1989		7.02604.03.0	LS	200 mm	
E 2.6 (201.029) 118-122 kW (160-166 PS) M 103.942	09.1986→08.1993		7.02604.03.0	LS	200 mm	

190 (W201)						8
Turbo-D 2.5 (201.128) 90-93 kW (122-126 PS) OM 602.961	02.1988→08.1993		7.21949.51.0	AGR	PN OM 602.961: Finland Finland 1991 1991 OM 602.961: Österreich Austria	
Turbo-D 2.5 (201.128) 90-93 kW (122-126 PS) OM 602.961	02.1988→08.1993		7.21949.51.0	AGR	PN OM 602.961: Finland Finland 1991 1991 OM 602.961: Österreich Austria	
300						9
GE (463) 125-128 kW (170-174 PS) M 103.987	09.1989→10.1994		7.02604.03.0	LS	200 mm	
SE 2.8 (140) 142-145 kW (193-197 PS) M 104.944	09.1992→05.1993		7.05270.00.0	LS	350 mm	
SE 3.2 (140) 162-170 kW (220-231 PS) M 104.990	03.1991→05.1993		7.05270.00.0	LS	350 mm	
500						10
SL 6.0 AMG (129)	01.1989→08.1992		7.05270.03.0	LS	820 mm	
			7.05270.15.0	LS	380 mm	
			7.05270.00.0	LS	350 mm	
A-CLASS (W168)						11
A 160 CDI (168.006) 55-66 kW (75-90 PS) OM 668.940	02.2001→08.2004		7.24809.49.0	AGR	PN	
A 160 CDI (168.007) 44 kW (60 PS) OM 668.941	07.1998→02.2001		7.24809.49.0	AGR	PN	
A 170 CDI (168.008) 55-66 kW (75-90 PS) OM 668.940	09.1998→02.2001		7.24809.49.0	AGR	PN	
A 170 CDI (168.009, 168.109) 70 kW (95 PS) OM 668.942	02.2001→08.2004		7.24809.49.0	AGR	PN	
A-CLASS (W169)						12
A 150 (169.031, 169.331) 70 kW (95 PS) M 266.920	09.2004→06.2012		7.05270.17.0	LS	null mm	
A 160 CDI (169.006, 169.306) 60 kW (82 PS) OM 640.942	09.2004→06.2012		7.00306.37.0	AGR	PN 04.2007→02.2008, ch. 30336961→ch. 30455955 Euro 5 Euro 5 für Fahrzeuge mit Diesel-Partikel-Filter (DPF) for vehicles with diesel soot filter	
			7.24809.33.0	AGR	ET →02.2008, →ch. 30455955 für Fahrzeuge mit Diesel-Partikel-Filter (DPF) for vehicles with diesel soot filter	
			7.24809.46.0	AGR	ET	

M















A-CLASS (W169) 12

			7.08369.60.0	ATS	EL	Abgaskrümmer Exhaust Manifold Euro 5 Euro 5 für Fahrzeuge mit Diesel-Partikel-Filter (DPF) for vehicles with diesel soot filter Produktionsdatum bis: 19.04.2011 Production date to: 19.04.2011
			7.11020.05.0	ATS	EL	für OE-Nummer: A 001 905 24 00 for OE number: A 001 905 24 00
			7.11020.12.0	ATS	EL	AGR-Ventil EGR Valve Euro 5 Euro 5
			7.11190.01.0	DDS		Luftfiltergehäuse Air Filter Housing
			7.05270.21.0	LS	600 mm	
			7.02604.99.0	LS	400 mm	
A 170 (169.032, 169.332) 85 kW (116 PS) M 266.940	09.2004→06.2012		7.05270.17.0	LS	null mm	
A 180 CDI (169.007, 169.307) 80 kW (109 PS) OM 640.940	09.2004→06.2012		7.00306.37.0	AGR	PN	 04.2007→02.2008,  ch. 30336961→ch. 30455955 Euro 5 Euro 5 für Fahrzeuge mit Diesel-Partikel-Filter (DPF) for vehicles with diesel soot filter
			7.24809.33.0	AGR	ET	 →02.2008,  →ch. 30455955 für Fahrzeuge mit Diesel-Partikel-Filter (DPF) for vehicles with diesel soot filter
			7.24809.46.0	AGR	ET	
			7.08369.60.0	ATS	EL	Abgaskrümmer Exhaust Manifold Euro 5 Euro 5 für Fahrzeuge mit Diesel-Partikel-Filter (DPF) for vehicles with diesel soot filter Produktionsnummer: 19.04.2011 Production Number: 19.04.2011
			7.11020.05.0	ATS	EL	für OE-Nummer: A 001 905 24 00 for OE number: A 001 905 24 00
			7.11020.12.0	ATS	EL	AGR-Ventil EGR Valve Euro 5 Euro 5
			7.11190.01.0	DDS		Luftfiltergehäuse Air Filter Housing
			7.05270.21.0	LS	600 mm	
			7.02604.99.0	LS	400 mm	
A 200 (169.033, 169.333) 85-100 kW (116-136 PS) M 266.960	09.2004→06.2012		7.05270.17.0	LS	null mm	

M

















A-CLASS (W169) 12

A 200 CDI (169.008, 169.308) 100-103 kW (136-140 PS) OM 640.941	09.2004→06.2012	7.00306.37.0 	AGR	PN	 04.2007→02.2008,  ch. 30336961→ch. 30455955 Euro 5 Euro 5 für Fahrzeuge mit Diesel-Partikel-Filter (DPF) for vehicles with diesel soot filter
		7.24809.33.0	AGR	ET	 →02.2008,  →ch. 30455955 für Fahrzeuge mit Diesel-Partikel-Filter (DPF) for vehicles with diesel soot filter
		7.24809.46.0	AGR	ET	
		7.08369.60.0	ATS	EL	Abgaskrümmer Exhaust Manifold Euro 5 Euro 5 für Fahrzeuge mit Diesel-Partikel-Filter (DPF) for vehicles with diesel soot filter Produktionsdatum bis: 19.04.2011 Production date to: 19.04.2011
		7.11020.05.0	ATS	EL	für OE-Nummer: A 001 905 24 00 for OE number: A 001 905 24 00
		7.11020.12.0	ATS	EL	AGR-Ventil EGR Valve Euro 5 Euro 5
		7.11190.01.0	DDS		Luftfiltergehäuse Air Filter Housing
		7.05270.21.0	LS	600 mm	
7.02604.99.0	LS	400 mm			
A 200 CDI (169.308, 169.008) 100-103 kW (136-140 PS) OM 640.941	09.2004→06.2012	7.00306.37.0 	AGR	PN	 04.2007→02.2008,  ch. 30336961→ch. 30455955 Euro 5 Euro 5 für Fahrzeuge mit Diesel-Partikel-Filter (DPF) for vehicles with diesel soot filter
		7.24809.33.0	AGR	ET	 →02.2008,  →ch. 30455955 für Fahrzeuge mit Diesel-Partikel-Filter (DPF) for vehicles with diesel soot filter
		7.24809.46.0	AGR	ET	
		7.08369.60.0	ATS	EL	Abgaskrümmer Exhaust Manifold Euro 5 Euro 5 für Fahrzeuge mit Diesel-Partikel-Filter (DPF) for vehicles with diesel soot filter Produktionsdatum bis: 19.04.2011 Production date to: 19.04.2011
		7.11190.01.0	DDS		Luftfiltergehäuse Air Filter Housing
		7.05270.21.0	LS	600 mm	
7.02604.99.0	LS	400 mm			

M



A-CLASS (W176) **13**















A 160 (176.041) 75-115 kW (102-156 PS) M 270.910	07.2015→05.2018		7.05270.21.0	LS	600 mm	vor Katalysator in front of the catalyst
A 160 CDI / d (176.011) 55-81 kW (75-110 PS) OM 607.951	06.2013→05.2018		7.03435.05.0	AGR	EL	 Euro 5 Euro 5
			7.05320.04.0	AGR	EL	 Euro 6 Euro 6
			7.03571.16.0 ↳ 7.03083.20.0	AK SRM-AK	EL EL	
			7.11190.08.0	DDS		Euro 6 Euro 6
A 180 (176.042) 75-115 kW (102-156 PS) M 270.910	09.2012→05.2018		7.05270.21.0	LS	600 mm	vor Katalysator in front of the catalyst
A 180 CDI (176.000) 80-100 kW (109-136 PS) OM 651.901	06.2012→10.2014		7.08369.89.0	ATS	EL	Katalysator Catalytic Converter Euro 6 Euro 6
			7.11020.01.0	ATS	EL	
			7.11020.32.0	ATS	EL	
A 180 CDI (176.007) 80-130 kW (109-177 PS) OM 651.930	06.2013→10.2014		7.24809.82.0	AGR	EL	mit Dichtring with O-ring
			7.08369.89.0	ATS	EL	Katalysator Catalytic Converter Euro 6 Euro 6
			7.11020.01.0 7.11020.32.0	ATS ATS	EL EL	
A 180 CDI / d (176.012) 55-81 kW (75-110 PS) OM 607.951	06.2012→05.2018		7.03435.05.0	AGR	EL	 Euro 5 Euro 5
			7.05320.04.0	AGR	EL	 Euro 6 Euro 6
			7.03571.16.0 ↳ 7.03083.20.0	AK SRM-AK	EL EL	
			7.11190.08.0	DDS		Euro 6 Euro 6
A 200 (176.043) 75-115 kW (102-156 PS) M 270.910	06.2012→05.2018		7.05270.21.0	LS	600 mm	vor Katalysator in front of the catalyst
A 200 CDI (176.001) 80-100 kW (109-136 PS) OM 651.901	06.2012→10.2014		7.08369.89.0	ATS	EL	Katalysator Catalytic Converter Euro 6 Euro 6
			7.11020.01.0	ATS	EL	
			7.11020.32.0	ATS	EL	
A 200 CDI / d (176.008) 80-130 kW (109-177 PS) OM 651.930	02.2014→05.2018		7.24809.82.0	AGR	EL	mit Dichtring with O-ring
			7.08369.89.0	ATS	EL	Katalysator Catalytic Converter Euro 6 Euro 6
			7.11020.01.0 7.11020.32.0	ATS ATS	EL EL	
A 200 CDI / d 4-matic (176.002) 80-130 kW (109-177 PS) OM 651.930	02.2014→05.2018		7.24809.82.0	AGR	EL	mit Dichtring with O-ring

M























A-CLASS (W176)

13















			7.08369.89.0	ATS	EL	Katalysator Catalytic Converter Euro 6 Euro 6
			7.11020.01.0	ATS	EL	
			7.11020.32.0	ATS	EL	
A 220 4-matic (176.047) 115-160 kW (156-218 PS) M 270.920	05.2014→05.2018		7.24809.84.0	AGR	EL	
			7.05270.21.0	LS	600 mm	vor Katalysator in front of the catalyst
A 220 CDI (176.003) 80-130 kW (109-177 PS) OM 651.930	09.2012→05.2018		7.24809.82.0	AGR	EL	mit Dichtring with O-ring
			7.08369.89.0	ATS	EL	Katalysator Catalytic Converter Euro 6 Euro 6
			7.11020.01.0	ATS	EL	
			7.11020.32.0	ATS	EL	
A 220 CDI (176.003) 80-130 kW (109-177 PS) OM 651.930	01.2014→05.2018		7.24809.82.0	AGR	EL	mit Dichtring with O-ring
			7.11020.01.0	ATS	EL	
A 220 CDI 4-matic (176.005) 80-130 kW (109-177 PS) OM 651.930	02.2014→05.2018		7.24809.82.0	AGR	EL	mit Dichtring with O-ring
			7.08369.89.0	ATS	EL	Katalysator Catalytic Converter Euro 6 Euro 6
			7.11020.01.0	ATS	EL	
			7.11020.32.0	ATS	EL	
A 220 d (176.003) 80-130 kW (109-177 PS) OM 651.930	07.2015→05.2018		7.24809.82.0	AGR	EL	mit Dichtring with O-ring
			7.11020.01.0	ATS	EL	
A 220 d 4-matic (176.005) 80-130 kW (109-177 PS) OM 651.930	07.2015→05.2018		7.24809.82.0	AGR	EL	mit Dichtring with O-ring
			7.11020.01.0	ATS	EL	
A 250 (176.044) 115-160 kW (156-218 PS) M 270.920	06.2012→05.2018		7.24809.84.0	AGR	EL	
			7.05270.21.0	LS	600 mm	vor Katalysator in front of the catalyst
A 250 (176.050) 115-160 kW (156-218 PS) M 270.920	07.2015→05.2018		7.24809.84.0	AGR	EL	
			7.05270.21.0	LS	600 mm	vor Katalysator in front of the catalyst
A 250 4-matic (176.046) 115-160 kW (156-218 PS) M 270.920	06.2013→05.2018		7.24809.84.0	AGR	EL	
			7.05270.21.0	LS	600 mm	vor Katalysator in front of the catalyst
A 250 4-matic (176.051) 115-160 kW (156-218 PS) M 270.920	07.2015→05.2018		7.24809.84.0	AGR	EL	
			7.05270.21.0	LS	600 mm	vor Katalysator in front of the catalyst

M

			 PIERBURG				
A-CLASS (W176)						13	
A 45 AMG 4-matic (176.052) 250-280 kW (340-381 PS) M 133.980	06.2013→05.2018		7.05270.21.0	LS	600 mm	für OE-Nummer: A 009 542 56 18 for OE number: A 009 542 56 18 vor Katalysator in front of the catalyst	
AMG A 45 4-matic (176.052) 250-280 kW (340-381 PS) M 133.980	07.2015→05.2018		7.05270.21.0	LS	600 mm	für OE-Nummer: A 009 542 56 18 for OE number: A 009 542 56 18 vor Katalysator in front of the catalyst	
A-CLASS (W177)						14	
A 160 d (177.002) 59-85 kW (80-116 PS) OM 608.915	05.2019→		7.11457.07.0*	DDS			
			↳ 7.11492.07.0	DDS			
A 180 d (177.003) 59-85 kW (80-116 PS) OM 608.915	03.2018→		7.11457.07.0*	DDS			
			↳ 7.11492.07.0	DDS			
A-CLASS Saloon (V177)						15	
A 160 d (177.102) 59-85 kW (80-116 PS) OM 608.915	10.2019→		7.11457.07.0*	DDS			
			↳ 7.11492.07.0	DDS			
A 180 d (177.103) 59-85 kW (80-116 PS) OM 608.915	09.2018→		7.11457.07.0*	DDS			
			↳ 7.11492.07.0	DDS			
M	B-CLASS Sports Tourer (W245)						16
B 150 (245.231) 70 kW (95 PS) M 266.920	03.2005→11.2011		7.05270.17.0	LS	null mm		
B 170 (245.232) 85 kW (116 PS) M 266.940	03.2005→11.2011		7.05270.17.0	LS	null mm		
B 180 CDI (245.207) 80 kW (109 PS) OM 640.940	03.2005→11.2011		7.00306.37.0	AGR	PN	 04.2007→02.2008,  ch. 30336961→ch. 30455955 Euro 5 Euro 5 für Fahrzeuge mit Diesel-Partikel-Filter (DPF) for vehicles with diesel soot filter	
			7.24809.33.0	AGR	ET	 →02.2008,  →ch. 30455955 für Fahrzeuge mit Diesel-Partikel-Filter (DPF) for vehicles with diesel soot filter	
			7.24809.46.0	AGR	ET		
			7.08369.60.0	ATS	EL	Abgaskrümmer Exhaust Manifold Euro 5 Euro 5 für Fahrzeuge mit Diesel-Partikel-Filter (DPF) for vehicles with diesel soot filter Produktionsdatum bis: 19.04.2011 Production date to: 19.04.2011	
			7.11020.05.0	ATS	EL	für OE-Nummer: A 001 905 24 00 for OE number: A 001 905 24 00	
			7.11020.12.0	ATS	EL	AGR-Ventil EGR Valve Euro 5 Euro 5	
			7.05270.21.0	LS	600 mm		















B-CLASS Sports Tourer (W245) 16

		7.02604.99.0	LS	400 mm	
B 200 (245.233) 85-100 kW (116-136 PS) M 266.960	03.2005→11.2011	 7.05270.17.0	LS	null mm	
B 200 CDI (245.208) 100-103 kW (136-140 PS) OM 640.941	03.2005→11.2011		7.00306.37.0	AGR	PN  04.2007→02.2008,  ch. 30336961→ch. 30455955 Euro 5 Euro 5 für Fahrzeuge mit Diesel-Partikel-Filter (DPF) for vehicles with diesel soot filter
			7.24809.33.0	AGR	ET  →02.2008,  →ch. 30455955 für Fahrzeuge mit Diesel-Partikel-Filter (DPF) for vehicles with diesel soot filter
			7.24809.46.0	AGR	ET 
			7.11020.05.0	ATS	EL für OE-Nummer: A 001 905 24 00 for OE number: A 001 905 24 00
			7.11020.12.0	ATS	EL AGR-Ventil EGR Valve Euro 5 Euro 5
			7.05270.21.0	LS	600 mm
		7.02604.99.0	LS	400 mm	
B 200 CDI (245.208) 100-103 kW (136-140 PS) OM 640.941	03.2005→11.2011		7.00306.37.0	AGR	PN  04.2007→02.2008,  ch. 30336961→ch. 30455955 Euro 5 Euro 5 für Fahrzeuge mit Diesel-Partikel-Filter (DPF) for vehicles with diesel soot filter
			7.24809.33.0	AGR	ET  →02.2008,  →ch. 30455955 für Fahrzeuge mit Diesel-Partikel-Filter (DPF) for vehicles with diesel soot filter
			7.24809.46.0	AGR	ET 
			7.08369.60.0	ATS	EL Abgaskrümmer Exhaust Manifold Euro 5 Euro 5 für Fahrzeuge mit Diesel-Partikel-Filter (DPF) for vehicles with diesel soot filter Produktionsdatum bis: 19.04.2011 Production date to: 19.04.2011
			7.05270.21.0	LS	600 mm
			7.02604.99.0	LS	400 mm
B 200 TURBO (245.234) 142 kW (193 PS) M 266.980	03.2005→11.2011	 7.05270.17.0	LS	null mm	

M













B-CLASS Sports Tourer (W246, W242) 17

B 160 (246.241) 75-115 kW (102-156 PS) M 270.910	07.2015→12.2018		7.05270.21.0	LS	600 mm	vor Katalysator in front of the catalyst
B 160 CDI / d (246.211) 55-81 kW (75-110 PS) OM 607.951	05.2013→12.2018		7.03435.05.0	AGR	EL	 Euro 5 Euro 5
			7.05320.04.0	AGR	EL	 Euro 6 Euro 6
			7.03571.16.0 ↳ 7.03083.20.0	AK SRM-AK	EL EL	
			7.11190.08.0	DDS		Euro 6 Euro 6
B 180 (246.242) 75-115 kW (102-156 PS) M 270.910	11.2011→12.2018		7.05270.21.0	LS	600 mm	Regelsonde Regulating Probe
B 180 CDI (246.200) 80-100 kW (109-136 PS) OM 651.901	11.2011→08.2014		7.08369.89.0	ATS	EL	Katalysator Catalytic Converter ■ Australien ■ Australia
			7.08369.97.0	ATS	EL	für OE-Nummer: A 008 153 41 28 for OE number: A 008 153 41 28 vor Rußpartikelfilter before soot particulate filter
			7.11020.01.0	ATS	EL	
			7.11020.32.0	ATS	EL	Euro 6 Euro 6
M B 180 CDI (246.207) 80-130 kW (109-177 PS) OM 651.930	06.2013→08.2014		7.24809.82.0	AGR	EL	mit Dichtring with O-ring
			7.08369.89.0	ATS	EL	Katalysator Catalytic Converter Euro 6 Euro 6
			7.11020.01.0	ATS	EL	
			7.11020.32.0	ATS	EL	Euro 6 Euro 6
B 180 CDI / d (246.212) 55-81 kW (75-110 PS) OM 607.951	02.2013→12.2018		7.03435.05.0	AGR	EL	 Euro 5 Euro 5
			7.05320.04.0	AGR	EL	 Euro 6 Euro 6
			7.03571.16.0 ↳ 7.03083.20.0	AK SRM-AK	EL EL	
			7.11190.08.0	DDS		Euro 6 Euro 6
B 200 (246.243) 75-115 kW (102-156 PS) M 270.910	11.2011→12.2018		7.05270.21.0	LS	600 mm	
B 200 CDI (246.201) 80-100 kW (109-136 PS) OM 651.901	11.2011→08.2014		7.08369.89.0	ATS	EL	für OE-Nummer: A 000 905 85 01 for OE number: A 000 905 85 01 Katalysator Catalytic Converter Euro 6 Euro 6
			7.08369.97.0	ATS	EL	für OE-Nummer: A 000 905 52 05, A 008 153 41 28 for OE number: A 000 905 52 05, A 008 153 41 28 vor Rußpartikelfilter before soot particulate filter
			7.11020.01.0	ATS	EL	









B-CLASS Sports Tourer (W246, W242) 17

			7.11020.32.0	ATS	EL	Euro 6 Euro 6
B 200 CDI / d (246.208) 80-130 kW (109-177 PS) OM 651.930	08.2014→12.2018		7.24809.82.0	AGR	EL	mit Dichtring with O-ring
			7.08369.89.0	ATS	EL	Katalysator Catalytic Converter Euro 6 Euro 6
			7.11020.01.0	ATS	EL	Euro 6
			7.11020.32.0	ATS	EL	Euro 6
B 200 CDI / d 4-matic (246.202) 80-130 kW (109-177 PS) OM 651.930	08.2014→12.2018		7.24809.82.0	AGR	EL	mit Dichtring with O-ring
			7.08369.89.0	ATS	EL	Katalysator Catalytic Converter Euro 6 Euro 6
			7.11020.01.0	ATS	EL	Euro 6
			7.11020.32.0	ATS	EL	Euro 6
B 200 Natural Gas Drive / B 200 c (242.848) 115-160 kW (156-218 PS) M 270.920	11.2012→12.2017		7.24809.84.0	AGR	EL	
			7.05270.21.0	LS	600 mm	vor Katalysator in front of the catalyst
B 220 (246.245) 115-160 kW (156-218 PS) M 270.920	08.2014→12.2018		7.05270.21.0	LS	600 mm	vor Katalysator in front of the catalyst
B 220 4-matic (246.247) 115-160 kW (156-218 PS) M 270.920	05.2013→12.2018		7.24809.84.0	AGR	EL	
			7.05270.21.0	LS	600 mm	vor Katalysator in front of the catalyst
B 220 CDI / d (246.203) 80-130 kW (109-177 PS) OM 651.930	11.2011→12.2018		7.24809.82.0	AGR	EL	mit Dichtring with O-ring
			7.08369.89.0	ATS	EL	Katalysator Catalytic Converter Euro 6 Euro 6
			7.11020.01.0	ATS	EL	
			7.11020.32.0	ATS	EL	für OE-Nummer: A 000 905 07 01, A 000 905 81 05, A 000 905 91 05 for OE number: A 000 905 07 01, A 000 905 81 05, A 000 905 91 05
B 220 CDI / d (246.203) 80-130 kW (109-177 PS) OM 651.930	06.2013→12.2018		7.24809.82.0	AGR	EL	mit Dichtring with O-ring
			7.11020.01.0	ATS	EL	
B 220 CDI / d (246.203) 80-130 kW (109-177 PS) OM 651.930	08.2014→12.2018		7.24809.82.0	AGR	EL	mit Dichtring with O-ring
			7.08369.89.0	ATS	EL	Katalysator Catalytic Converter Euro 6 Euro 6
			7.11020.01.0	ATS	EL	



M





B-CLASS Sports Tourer (W246, W242) 17

			7.11020.32.0	ATS	EL	für OE-Nummer: A 000 905 07 01, A 000 905 81 05, A 000 905 91 05 for OE number: A 000 905 07 01, A 000 905 81 05, A 000 905 91 05
B 220 CDI / d 4-matic (246.205) 80-130 kW (109-177 PS) OM 651.930	08.2014→12.2018		7.24809.82.0	AGR	EL	mit Dichtring with O-ring
			7.08369.89.0	ATS	EL	Katalysator Catalytic Converter Euro 6 Euro 6
			7.11020.01.0	ATS	EL	
			7.11020.32.0	ATS	EL	für OE-Nummer: A 000 905 07 01, A 000 905 81 05, A 000 905 91 05 for OE number: A 000 905 07 01, A 000 905 81 05, A 000 905 91 05
B 220 d 4-matic (246.205) 80-130 kW (109-177 PS) OM 651.930	06.2018→12.2018		7.24809.82.0	AGR	EL	mit Dichtring with O-ring
			7.08369.89.0	ATS	EL	Katalysator Catalytic Converter Euro 6 Euro 6
			7.11020.01.0	ATS	EL	
			7.11020.32.0	ATS	EL	für OE-Nummer: A 000 905 07 01, A 000 905 81 05, A 000 905 91 05 for OE number: A 000 905 07 01, A 000 905 81 05, A 000 905 91 05
M B 250 (246.244) 115-160 kW (156-218 PS) M 270.920	05.2012→12.2018		7.24809.84.0	AGR	EL	
			7.05270.21.0	LS	600 mm	vor Katalysator in front of the catalyst
B 250 4-matic (246.246) 115-160 kW (156-218 PS) M 270.920	08.2014→12.2018		7.24809.84.0	AGR	EL	
			7.05270.21.0	LS	600 mm	vor Katalysator in front of the catalyst

B-CLASS Sports Tourer (W247) 18

B 160 d (247.002) 59-85 kW (80-116 PS) OM 608.915	05.2019→		7.11457.07.0*	DDS		
			↳ 7.11492.07.0	DDS		
B 180 d (247.003) 59-85 kW (80-116 PS) OM 608.915	12.2018→		7.11457.07.0*	DDS		
			↳ 7.11492.07.0	DDS		





C-CLASS (W202) 19

C 240 (202.026) 125 kW (170 PS) M 112.910	06.1997→05.2000		7.22136.50.0	AGR	PN	<input checked="" type="checkbox"/>
			7.05270.03.0	LS	820 mm	
			7.02604.27.0	LS	750 mm	
			7.02604.25.0	LS	425 mm	
			7.04389.00.0	SLP	EL	
C 280 (202.028) 142 kW (193 PS) M 104.941	05.1993→05.2000		7.05270.03.0	LS	820 mm	
			7.02604.27.0	LS	750 mm	



C-CLASS (W202)





19

			7.02604.25.0	LS	425 mm	
			7.05270.15.0	LS	380 mm	
			7.05270.00.0	LS	350 mm	 →ch. F483847
C 280 (202.029) 145-150 kW (197-204 PS) M 112.920	06.1997→05.2000		7.22136.50.0	AGR	PN	<input checked="" type="checkbox"/>
			7.05270.03.0	LS	820 mm	
			7.02604.27.0	LS	750 mm	
			7.02604.25.0	LS	425 mm	
			7.05270.15.0	LS	380 mm	
			7.04389.00.0	SLP	EL	
C 36 AMG (202.028) 200-206 kW (272-280 PS) M 104.941 (AMG 3.6)	05.1994→05.2000		7.05270.15.0	LS	380 mm	
			7.05270.00.0	LS	350 mm	
C 43 AMG 205-225 kW (279-306 PS) M 113.944	09.1997→12.1998		7.22136.50.0	AGR	PN	<input checked="" type="checkbox"/>
			7.04389.00.0	SLP	EL	
C 43 AMG (202.033) 205-225 kW (279-306 PS) M 113.944	08.1997→05.2000		7.22136.50.0	AGR	PN	<input checked="" type="checkbox"/>
			7.05270.03.0	LS	820 mm	
			7.02604.27.0	LS	750 mm	
			7.02604.25.0	LS	425 mm	
			7.04389.00.0	SLP	EL	

M

















C-CLASS (W203)

20

3.5 (203.056) 170-200 kW (231-272 PS) M 272.960	01.2005→02.2007		7.04389.02.0	SLP	EL	
C 180 (203.035) 95 kW (129 PS) M 111.951	10.2000→05.2002		7.05270.11.0	LS	750 mm	nach Katalysator Post-catalyst Kompressor Compressor Euro 4 Euro 4
			7.05270.12.0	LS	500 mm	vor Katalysator in front of the catalyst Euro 4 Euro 4
			7.04389.04.0	SLP	EL	
C 180 Kompressor (203.046) 105-125 kW (143-170 PS) M 271.946	05.2002→02.2007		7.05271.23.0	LS	900 mm	
			7.05270.11.0	LS	750 mm	nach Katalysator Post-catalyst
C 200 CDI (203.004) 75-105 kW (102-143 PS) OM 611.962	09.2000→06.2003		7.05270.22.0	LS	825 mm	









C-CLASS (W203) 20

C 200 CDI (203.004) 75-105 kW (102-143 PS) OM 611.962	02.2001→06.2003		7.05270.22.0	LS	825 mm	
C 200 CDI (203.007) 75-110 kW (102-150 PS) OM 646.962, OM 646.963	04.2003→02.2007		7.24809.36.0	AGR	ET	
			7.08369.30.0	ATS	EL	
			7.08369.80.0	ATS	EL	 OM 646.962, OM 646.963: Abgaskrümmer Exhaust Manifold Euro 4 Euro 4 für Fahrzeuge mit Diesel-Partikel-Filter (DPF) for vehicles with diesel soot filter
			7.08369.94.0	ATS	EL	 OM 646.962, OM 646.963: Partikelfilter Particulate Filter für Linkslenker for left-hand drive vehicles Produktionsdatum bis: 30.06.2007 Production date to: 30.06.2007
			7.08369.97.0	ATS	EL	 OM 646.962, OM 646.963: Partikelfilter Particulate Filter für Rechtslenker for right-hand drive vehicles
			7.11190.01.0	DDS		 OM 646.962, OM 646.963: Luftfiltergehäuse Air Filter Housing
			7.05270.22.0	LS	825 mm	
C 200 CGI Kompressor (203.043) 125 kW (170 PS) M 271.942	07.2003→02.2007		7.05271.23.0	LS	900 mm	
			7.05270.11.0	LS	750 mm	nach Katalysator Post-catalyst
C 200 Kompressor (203.042) 120 kW (163 PS) M 271.940	05.2002→02.2007		7.05270.11.0	LS	750 mm	vor Katalysator in front of the catalyst
C 200 Kompressor (203.045) 120 kW (163 PS) M 111.955	05.2000→06.2002		7.05270.11.0	LS	750 mm	nach Katalysator Post-catalyst Euro 4 Euro 4
C 220 CDI (203.006) 75-105 kW (102-143 PS) OM 611.962	05.2000→02.2007		7.05270.22.0	LS	825 mm	
C 220 CDI (203.006) 90-110 kW (122-150 PS) OM 646.963	05.2000→02.2007		7.24809.36.0	AGR	ET	
			7.05270.22.0	LS	825 mm	
C 220 CDI (203.006) 75-105 kW (102-143 PS) OM 611.962	05.2000→02.2007		7.05270.22.0	LS	825 mm	
C 220 CDI (203.008) 90-110 kW (122-150 PS) OM 646.963	02.2003→02.2007		7.24809.36.0	AGR	ET	
			7.08369.30.0	ATS	EL	

M















C-CLASS (W203) **20**

			7.08369.80.0	ATS	EL	Abgaskrümmer Exhaust Manifold Euro 4 Euro 4 für Fahrzeuge mit Diesel-Partikel-Filter (DPF) for vehicles with diesel soot filter
			7.08369.94.0	ATS	EL	Partikelfilter Particulate Filter für Linkslenker for left-hand drive vehicles Produktionsdatum bis: 30.06.2007 Production date to: 30.06.2007
			7.08369.97.0	ATS	EL	Partikelfilter Particulate Filter für Rechtslenker for right-hand drive vehicles
			7.11190.01.0	DDS		Luftfiltergehäuse Air Filter Housing
			7.05270.22.0	LS	825 mm	
C 230 (203.052) 150 kW (204 PS) M 272.920	01.2005→02.2007		7.05270.17.0	LS	null mm	
			7.05270.22.0	LS	825 mm	
			7.04389.02.0	SLP	EL	
C 230 Kompressor (203.040) 141 kW (192 PS) M 271.948	02.2004→02.2007		7.05270.11.0	LS	750 mm	nach Katalysator Post-catalyst
C 240 (203.061) 120-125 kW (163-170 PS) M 112.912	05.2000→02.2007		7.22136.50.0	AGR	PN	<input checked="" type="checkbox"/>
			7.02604.27.0	LS	750 mm	
			7.05270.11.0	LS	750 mm	vor Katalysator, links in front of the catalyst, Left
			7.02604.26.0	LS	500 mm	
			7.05270.12.0	LS	500 mm	vor Katalysator, rechts in front of the catalyst, Right
			7.04389.00.0	SLP	EL	PKW, Kombi/ Passenger car, estate
C 240 4-matic (203.081) 125 kW (170 PS) M 112.916	07.2002→02.2007		7.22136.50.0	AGR	PN	<input checked="" type="checkbox"/>
			7.02604.27.0	LS	750 mm	
			7.05270.11.0	LS	750 mm	vor Katalysator, beidseitig in front of the catalyst, Left and right
			7.02604.26.0	LS	500 mm	
			7.04389.00.0	SLP	EL	PKW, Stufenheck/ Passenger car, notchback
C 280 (203.054) 170 kW (231 PS) M 272.940	01.2005→02.2007		7.05270.17.0	LS	null mm	
			7.05270.22.0	LS	825 mm	
			7.04389.02.0	SLP	EL	
C 280 4-matic (203.092) 170 kW (231 PS) M 272.941	01.2005→02.2007		7.05270.17.0	LS	null mm	
			7.05270.22.0	LS	825 mm	
			7.05270.11.0	LS	750 mm	nach Katalysator, links Post-catalyst, Left

M





C-CLASS (W203) 20

			7.04389.02.0	SLP	EL	
C 30 CDI AMG (203.018) 170 kW (231 PS) OM 612.990	01.2003→02.2007		7.24809.37.0	AGR	ET	
C 32 AMG Kompressor (203.065) 260 kW (354 PS) M 112.961	02.2001→02.2007		7.05270.11.0	LS	750 mm	vor Katalysator, links in front of the catalyst, Left
			7.02604.26.0	LS	500 mm	
			7.05270.12.0	LS	500 mm	vor Katalysator, rechts in front of the catalyst, Right
			7.04389.04.0	SLP	EL	
C 320 (203.064) 160 kW (218 PS) M 112.946	05.2000→02.2007		7.22136.50.0	AGR	PN	
			7.02604.27.0	LS	750 mm	
			7.05270.11.0	LS	750 mm	vor Katalysator, links in front of the catalyst, Left
			7.02604.26.0	LS	500 mm	
			7.05270.12.0	LS	500 mm	vor Katalysator, rechts in front of the catalyst, Right
C 320 4-matic (203.084) 160 kW (218 PS) M 112.953	07.2002→02.2007		7.22136.50.0	AGR	PN	
			7.02604.27.0	LS	750 mm	
			7.05270.11.0	LS	750 mm	vor Katalysator, beidseitig in front of the catalyst, Left and right
			7.02604.26.0	LS	500 mm	
			7.04389.00.0	SLP	EL	PKW, Kombi/ Passenger car, estate
C 320 CDI (203.020) 165 kW (224 PS) OM 642.910	01.2005→02.2007		7.24809.47.0	AGR	ET	
			7.11190.01.0	DDS		Luftfiltergehäuse Air Filter Housing
			7.05270.21.0	LS	600 mm	
C 350 (203.056) 170-200 kW (231-272 PS) M 272.960	01.2005→02.2007		7.05270.17.0	LS	null mm	
			7.05270.22.0	LS	825 mm	
			7.04389.02.0	SLP	EL	
C 350 4-matic (203.087) 170-200 kW (231-272 PS) M 272.960	01.2005→02.2007		7.05270.17.0	LS	null mm	
			7.05270.22.0	LS	825 mm	
			7.04389.02.0	SLP	EL	
C 350 4-matic (203.087) 200 kW (272 PS) M 272.970	01.2005→02.2007		7.05270.17.0	LS	null mm	
			7.05270.22.0	LS	825 mm	
			7.05270.11.0	LS	750 mm	nach Katalysator, links Post-catalyst, Left
			7.04389.02.0	SLP	EL	







M























C-CLASS (W203) 20

C 55 AMG 260-270 kW (354-367 PS) M 113.988	09.2004→12.2005	 7.22136.50.0	AGR	PN	<input checked="" type="checkbox"/>	
C 55 AMG (203.076) 260-270 kW (354-367 PS) M 113.988	02.2004→02.2007	 7.22136.50.0	AGR	PN	<input checked="" type="checkbox"/>	
			7.05270.11.0	LS	750 mm	vor Katalysator, links in front of the catalyst, Left für Rechtslenker for right-hand drive vehicles
			7.02604.26.0	LS	500 mm	
			7.05270.12.0	LS	500 mm	vor Katalysator, rechts in front of the catalyst, Right
		7.04389.06.0	SLP	EL		

C-CLASS (W204) 21

C 180 CDI (204.000) 88-105 kW (120-143 PS) OM 651.913	04.2010→03.2014		7.08369.90.0	ATS	EL	 ch. F747898→ vor Rußpartikelfilter before soot particulate filter für Linkslenker for left-hand drive vehicles Produktionsdatum ab: 31.07.2011 Production date from: 31.07.2011 Fahrzeugproduktionsstadt: Bremen City of vehicle production: Bremen				
						 ch. A637723→ vor Rußpartikelfilter before soot particulate filter für Linkslenker for left-hand drive vehicles Produktionsdatum ab: 05.10.2011 Production date from: 05.10.2011 Fahrzeugproduktionsstadt: Sindelfingen City of vehicle production: Sindelfingen				
				7.08369.06.0	ATS	EL				
				7.11020.00.0	ATS	EL	 ch. A637723 vor Rußpartikelfilter before soot particulate filter für Linkslenker for left-hand drive vehicles Produktionsdatum bis: 05.10.2011 Production date to: 05.10.2011 Fahrzeugproduktionsstadt: Sindelfingen City of vehicle production: Sindelfingen			
C 180 CGI (204.031) 95-115 kW (129-156 PS) M 274.910	01.2008→01.2014		7.02604.44.0	LS	500 mm	vor Katalysator in front of the catalyst				
				C 180 CGI (204.049) 115-137 kW (156-186 PS) M 271.820	01.2007→01.2014		7.04389.07.0	SLP	EL	
				C 180 Kompressor (204.044, 204.045) 105-115 kW (143-156 PS) M 271.910				01.2008→01.2014		7.05270.11.0

M













			 PIERBURG		
C-CLASS (W204)					
C 180 Kompressor (204.046) 115 kW (156 PS) M 271.952	01.2007→01.2014		7.05270.11.0	LS	750 mm nach Katalysator Post-catalyst
C 200 (204.048) 115-137 kW (156-186 PS) M 271.820	05.2011→01.2014		7.04389.07.0	SLP	EL
C 200 CDI (204.001) 88-105 kW (120-143 PS) OM 651.913	11.2009→03.2014		7.08369.90.0	ATS	EL  ch. F747898→ vor Rußpartikelfilter before soot particulate filter für Linkslenker for left-hand drive vehicles Produktionsdatum ab: 31.07.2011 Production date from: 31.07.2011 Fahrzeugproduktionsstadt: Bremen City of vehicle production: Bremen
			7.08369.06.0	ATS	EL
			7.08369.12.0	ATS	EL
			7.11020.00.0	ATS	EL  OM 651.913:  →ch. A637723 vor Rußpartikelfilter before soot particulate filter für Linkslenker for left-hand drive vehicles Produktionsdatum bis: 05.10.2011 Production date to: 05.10.2011 Fahrzeugproduktionsstadt: Sindelfingen City of vehicle production: Sindelfingen  OM 651.913:  →ch. F747898 vor Rußpartikelfilter before soot particulate filter für Linkslenker for left-hand drive vehicles Produktionsdatum bis: 31.07.2011 Production date to: 31.07.2011 Fahrzeugproduktionsstadt: Bremen City of vehicle production: Bremen
			7.05270.22.0	LS	825 mm
			7.05270.21.0	LS	600 mm
C 200 CDI (204.007, 204.006) 100-125 kW (136-170 PS) OM 646.811, OM 646.812	01.2007→12.2009		7.24809.48.0	AGR	ET 
			7.11190.01.0	DDS	 OM 646.811, OM 646.812: für OE-Nummer: A 006 153 49 28, A 007 153 61 28 for OE number: A 006 153 49 28, A 007 153 61 28 Luftfiltergehäuse Air Filter Housing
			7.05270.22.0	LS	825 mm
			7.05270.21.0	LS	600 mm
C 200 CGI (204.048) 115-150 kW (156-204 PS) M 271.820, M 271.860	01.2007→01.2014		7.04389.07.0	SLP	EL
C 200 Kompressor (204.041) 120-135 kW (163-184 PS) M 271.950	01.2007→01.2014		7.05270.11.0	LS	750 mm nach Katalysator Post-catalyst
C 220 CDI (204.002) 120-150 kW (163-204 PS) OM 651.911	10.2008→01.2014		7.08369.06.0	ATS	EL
			7.08369.12.0	ATS	EL
			7.05270.22.0	LS	825 mm

M

21











C-CLASS (W204) **21**

		7.05270.21.0	LS	600 mm	für Fahrzeuge ohne Start-Stopp-Funktion for vehicles without start-stop function Regelsonde Regulating Probe	
C 220 CDI (204.002) 120-150 kW (163-204 PS) OM 651.911	12.2008→01.2014		7.08369.90.0	ATS	EL	 OM 651.911:  ch. F747898→ vor Rußpartikelfilter before soot particulate filter für Linkslenker for left-hand drive vehicles Produktionsdatum ab: 31.07.2011 Production date from: 31.07.2011 Fahrzeugproduktionsstadt: Bremen City of vehicle production: Bremen  OM 651.911:  ch. A637723→ vor Rußpartikelfilter before soot particulate filter für Linkslenker for left-hand drive vehicles Produktionsdatum ab: 05.10.2011 Production date from: 05.10.2011 Fahrzeugproduktionsstadt: Sindelfingen City of vehicle production: Sindelfingen
			7.08369.06.0	ATS	EL	
			7.08369.12.0	ATS	EL	
			7.11020.00.0	ATS	EL	 OM 651.911:  →ch. F747898 vor Rußpartikelfilter before soot particulate filter für Linkslenker for left-hand drive vehicles Produktionsdatum bis: 31.07.2011 Production date to: 31.07.2011 Fahrzeugproduktionsstadt: Bremen City of vehicle production: Bremen  OM 651.911:  →ch. A637723 vor Rußpartikelfilter before soot particulate filter für Linkslenker for left-hand drive vehicles Produktionsdatum bis: 05.10.2011 Production date to: 05.10.2011 Fahrzeugproduktionsstadt: Sindelfingen City of vehicle production: Sindelfingen
			7.05270.22.0	LS	825 mm	
7.05270.21.0	LS	600 mm	für Fahrzeuge ohne Start-Stopp-Funktion for vehicles without start-stop function Regelsonde Regulating Probe			
C 220 CDI (204.008) 100-125 kW (136-170 PS) OM 646.811	01.2007→11.2008		7.24809.48.0	AGR	ET	
			7.11190.01.0	DDS		für OE-Nummer: A 006 153 49 28, A 007 153 61 28 for OE number: A 006 153 49 28, A 007 153 61 28 Luftfiltergehäuse Air Filter Housing
			7.05270.22.0	LS	825 mm	
			7.05270.21.0	LS	600 mm	
C 220 CDI (204.008) 100-125 kW (136-170 PS) OM 646.811	01.2007→11.2008		7.24809.48.0	AGR	ET	

M

















C-CLASS (W204) 21

			7.11190.01.0	DDS		für OE-Nummer: A 006 153 49 28, A 007 153 61 28 for OE number: A 006 153 49 28, A 007 153 61 28 Luftfiltergehäuse Air Filter Housing
			7.05270.22.0	LS	825 mm	
			7.05270.21.0	LS	600 mm	
C 220 CDI 4-matic (204.084) 120-150 kW (163-204 PS) OM 651.912	02.2013→01.2014		7.08369.06.0	ATS	EL	vor Katalysator in front of the catalyst für Fahrzeuge ohne Start-Stopp-Funktion for vehicles without start-stop function
			7.08369.12.0	ATS	EL	
			7.05270.21.0	LS	600 mm	
C 230 (204.052) 150 kW (204 PS) M 272.921	01.2007→01.2014		7.05270.21.0	LS	600 mm	
			7.05270.18.0	LS	500 mm	
			7.04389.02.0	SLP	EL	
C 230 4-matic (204.085) 150 kW (204 PS) M 272.911	07.2007→01.2014		7.05270.21.0	LS	600 mm	
			7.05270.18.0	LS	500 mm	
			7.04389.02.0	SLP	EL	
C 250 CDI (204.003) 120-150 kW (163-204 PS) OM 651.911	08.2008→01.2014		7.08369.90.0	ATS	EL	 OM 651.911:  ch. A637723→ vor Rußpartikelfilter before soot particulate filter für Linkslenker for left-hand drive vehicles Produktionsdatum ab: 05.10.2011 Production date from: 05.10.2011 Fahrzeugproduktionsstadt: Sindelfingen City of vehicle production: Sindelfingen  OM 651.911:  ch. F747898→ vor Rußpartikelfilter before soot particulate filter für Linkslenker for left-hand drive vehicles Produktionsdatum ab: 31.07.2011 Production date from: 31.07.2011 Fahrzeugproduktionsstadt: Bremen City of vehicle production: Bremen
			7.08369.06.0	ATS	EL	
			7.08369.12.0	ATS	EL	

M



C-CLASS (W204) 21













			7.11020.00.0	ATS	EL	 OM 651.911:  →ch. F747898 vor Rußpartikelfilter before soot particulate filter für Linkslenker for left-hand drive vehicles Produktionsdatum bis: 31.07.2011 Production date to: 31.07.2011 Fahrzeugproduktionsstadt: Bremen City of vehicle production: Bremen  OM 651.911:  →ch. A637723 vor Rußpartikelfilter before soot particulate filter für Linkslenker for left-hand drive vehicles Produktionsdatum bis: 10.05.2011 Production date to: 10.05.2011 Fahrzeugproduktionsstadt: Sindelfingen City of vehicle production: Sindelfingen
			7.05270.21.0	LS	600 mm	für Fahrzeuge ohne Start-Stopp-Funktion for vehicles without start-stop function
C 250 CDI 4-matic (204.082) 120-150 kW (163-204 PS) OM 651.912	01.2011→01.2014		7.08369.06.0	ATS	EL	
			7.08369.12.0	ATS	EL	
			7.05270.21.0	LS	600 mm	vor Katalysator in front of the catalyst für Fahrzeuge ohne Start-Stopp-Funktion for vehicles without start-stop function
C 250 CGI (204.047) 135-150 kW (184-204 PS) M 271.860	07.2009→01.2014		7.04389.07.0	SLP	EL	
C 280 (204.054) 170 kW (231 PS) M 272.947	01.2007→01.2014		7.05270.21.0	LS	600 mm	
			7.05270.18.0	LS	500 mm	
			7.04389.02.0	SLP	EL	
C 280 4-matic (204.081) 170 kW (231 PS) M 272.948	07.2007→01.2014		7.05270.21.0	LS	600 mm	beidseitig Left and right Regelsonde Regulating Probe
			7.05270.18.0	LS	500 mm	
			7.04389.02.0	SLP	EL	
C 300 (204.054) 170 kW (231 PS) M 272.947	07.2009→01.2014		7.05270.21.0	LS	600 mm	
			7.04389.02.0	SLP	EL	
C 300 (204.055) 182-225 kW (248-306 PS) M 276.957	02.2011→01.2014		7.02604.44.0	LS	500 mm	für OE-Nummer: A 008 542 29 18, A 009 542 59 18 for OE number: A 008 542 29 18, A 009 542 59 18
			7.02604.44.0	LS	500 mm	für OE-Nummer: A 008 542 29 18, A 009 542 59 18 for OE number: A 008 542 29 18, A 009 542 59 18 vor Katalysator in front of the catalyst
C 300 4-matic (204.080) 182-225 kW (248-306 PS) M 276.957	02.2011→01.2014		7.02604.44.0	LS	500 mm	für OE-Nummer: A 008 542 29 18, A 009 542 59 18 for OE number: A 008 542 29 18, A 009 542 59 18 vor Katalysator in front of the catalyst
			7.02604.44.0	LS	500 mm	für OE-Nummer: A 008 542 29 18, A 009 542 59 18 for OE number: A 008 542 29 18, A 009 542 59 18 vor Katalysator in front of the catalyst
C 300 4-matic (204.081) 170 kW (231 PS) M 272.948	07.2007→01.2014		7.05270.21.0	LS	600 mm	
			7.04389.02.0	SLP	EL	
C 300 CDI 4-matic (204.092) 150-170 kW (204-231 PS) OM 642.832	01.2011→01.2014		7.11020.16.0	ATS	EL	 ch. F349084→ch. F401031 vor Rußpartikelfilter before soot particulate filter Euro 5, Euro 6 Euro 5, Euro 6
			7.11020.16.0	ATS	EL	 ch. F349084→ch. F401031 vor Rußpartikelfilter before soot particulate filter Euro 5, Euro 6 Euro 5, Euro 6

M















C-CLASS (W204)

21

			7.08369.51.0	ATS	EL	
			7.08369.61.0	ATS	EL	
			7.02604.99.0	LS	400 mm	
C 320 CDI (204.022) 165 kW (224 PS) OM 642.960	01.2007→01.2014		7.24809.47.0	AGR	ET	 USA  USA
			7.11020.16.0	ATS	EL	 OM 642.960:  ch. A292621→ch. A324554 vor Rußpartikelfilter before soot particulate filter Euro 5, Euro 6 Euro 5, Euro 6  OM 642.960:  ch. F349084→ch. F401031 vor Rußpartikelfilter before soot particulate filter Euro 5, Euro 6 Euro 5, Euro 6
			7.08369.61.0	ATS	EL	Katalysator Catalytic Converter
			7.11020.11.0	ATS	EL	vor Abgasturbolader in front of exhaust turbocharger
			7.11190.01.0	DDS		Luftfiltergehäuse Air Filter Housing
			7.05270.21.0	LS	600 mm	
			7.02604.99.0	LS	400 mm	
			C 320 CDI 4-matic (204.089) 165 kW (224 PS) OM 642.961	07.2007→01.2014		7.24809.47.0
7.11020.16.0	ATS	EL				 OM 642.961: vor Rußpartikelfilter before soot particulate filter Euro 5, Euro 6 Euro 5, Euro 6  OM 642.961:  ch. F349084→ch. F401031 vor Rußpartikelfilter before soot particulate filter Euro 5, Euro 6 Euro 5, Euro 6
7.08369.61.0	ATS	EL				Katalysator Catalytic Converter
7.11190.01.0	DDS					Luftfiltergehäuse Air Filter Housing
7.05270.21.0	LS	600 mm				
7.02604.99.0	LS	400 mm				
C 350 (204.056) 200 kW (272 PS) M 272.961	01.2007→01.2014		7.05270.17.0	LS	null mm	links, rechts Left, Right Diagnosesonde Diagnostic Probe
			7.05270.21.0	LS	600 mm	links, rechts Left, Right Regelsonde Regulating Probe
			7.04389.02.0	SLP	EL	
C 350 (204.057) 182-225 kW (248-306 PS) M 276.957	01.2011→01.2014		7.02604.44.0	LS	500 mm	für OE-Nummer: A 008 542 29 18, A 009 542 59 18 for OE number: A 008 542 29 18, A 009 542 59 18 vor Katalysator in front of the catalyst











C-CLASS (W204) 21

		7.02604.99.0	LS	400 mm	
C 350 4-matic (204.087) 200 kW (272 PS) M 272.971	07.2007→01.2014	 7.05270.18.0	LS	500 mm	links, rechts Left, Right Diagnosesonde Diagnostic Probe
		7.04389.02.0	SLP	EL	
C 350 4-matic (204.088) 182-225 kW (248-306 PS) M 276.957	01.2011→01.2014	 7.02604.44.0	LS	500 mm	für OE-Nummer: A 008 542 29 18, A 009 542 59 18 for OE number: A 008 542 29 18, A 009 542 59 18 vor Katalysator in front of the catalyst
		7.02604.99.0	LS	400 mm	
C 350 CDI (204.022) 165 kW (224 PS) OM 642.960	07.2009→01.2014	 7.24809.47.0	AGR	ET	 USA USA
		7.11020.16.0	ATS	EL	 OM 642.960:  ch. A292621→ch. A324554 vor Rußpartikelfilter before soot particulate filter Euro 5, Euro 6 Euro 5, Euro 6  OM 642.960:  ch. F349084→ch. F401031 vor Rußpartikelfilter before soot particulate filter Euro 5, Euro 6 Euro 5, Euro 6
		7.08369.61.0	ATS	EL	
		7.11020.11.0	ATS	EL	vor Abgasturbolader in front of exhaust turbocharger
		7.11190.01.0	DDS		Luftfiltergehäuse Air Filter Housing
		7.05270.21.0	LS	600 mm	
		7.02604.99.0	LS	400 mm	
C 350 CDI (204.023) 195 kW (265 PS) OM 642.834	06.2011→01.2014	 7.08369.61.0	ATS	EL	
		7.11020.01.0	ATS	EL	
		7.05270.21.0	LS	600 mm	
		7.02604.99.0	LS	400 mm	
C 350 CDI (204.025) 165-170 kW (224-231 PS) OM 642.830	10.2009→01.2014	 7.11020.16.0	ATS	EL	 ch. F349084→ch. F401031 vor Rußpartikelfilter before soot particulate filter Euro 5, Euro 6 Euro 5, Euro 6
		7.08369.51.0	ATS	EL	
		7.08369.61.0	ATS	EL	
		7.05270.21.0	LS	600 mm	
		7.02604.99.0	LS	400 mm	
C 350 CDI 4-matic (204.089) 165 kW (224 PS) OM 642.961	07.2009→01.2014	 7.24809.47.0	AGR	ET	 USA USA



M



C-CLASS (W204) 21













			7.11020.16.0	ATS	EL	 OM 642.961:  ch. A292621→ch. A324554 vor Rußpartikelfilter before soot particulate filter Euro 5, Euro 6 Euro 5, Euro 6  OM 642.961:  ch. F349084→ch. F401031 vor Rußpartikelfilter before soot particulate filter Euro 5, Euro 6 Euro 5, Euro 6
			7.08369.61.0	ATS	EL	
			7.11190.01.0	DDS		Luftfiltergehäuse Air Filter Housing
			7.05270.21.0	LS	600 mm	
			7.02604.99.0	LS	400 mm	
C 350 CDI 4-matic (204.092) 150-170 kW (204-231 PS) OM 642.832	10.2009→01.2014		7.08369.51.0	ATS	EL	
			7.08369.61.0	ATS	EL	Katalysator Catalytic Converter
			7.11020.16.0	ATS	EL	vor Rußpartikelfilter before soot particulate filter Euro 5, Euro 6 Euro 5, Euro 6
			7.05270.21.0	LS	600 mm	
			7.02604.99.0	LS	400 mm	
C 350 CGI (204.065) 215 kW (292 PS) M 272.982	09.2008→01.2014		7.05270.17.0	LS	null mm	
			7.04389.02.0	SLP	EL	
C 63 AMG (204.077) 336-410 kW (457-558 PS) M 156.985	02.2008→01.2014		7.05270.17.0	LS	null mm	
			7.05270.21.0	LS	600 mm	links, rechts Left, Right Regelsonde Regulating Probe
			7.04389.09.0	SLP	EL	
C 63 AMG (204.077) 336-410 kW (457-558 PS) M 156.985	02.2008→01.2014		7.05270.17.0	LS	null mm	
			7.05270.21.0	LS	600 mm	
			7.04389.09.0	SLP	EL	
C 63 AMG (204.077) 336-410 kW (457-558 PS) M 156.985	02.2008→01.2014		7.05270.17.0	LS	null mm	
			7.05270.21.0	LS	600 mm	

C-CLASS (W205) 22

AMG C 43 4-matic (205.064) 200-295 kW (272-401 PS) M 276.823	04.2016→05.2018		7.02604.44.0	LS	500 mm	vor Katalysator, links in front of the catalyst, Left
C 180 BlueTEC / d (205.036) 85-100 kW (116-136 PS) OM 626.951	05.2014→05.2018		7.24809.90.0	AGR	EL	
			7.11457.07.0*	DDS		















C-CLASS (W205) 22

C 200 (205.042) 115-245 kW (156-333 PS) M 274.920	12.2013→08.2018	 7.11492.07.0 DDS	AGR	EL	 für OE-Nummer: A 274 142 05 19 for OE number: A 274 142 05 19
		7.24809.83.0	AGR	EL	 für OE-Nummer: A 274 142 04 19, A 274 142 06 19 for OE number: A 274 142 04 19, A 274 142 06 19
C 200 4-matic (205.043) 115-245 kW (156-333 PS) M 274.920	04.2015→08.2018	 7.24809.83.0	AGR	EL	 für OE-Nummer: A 274 142 05 19 for OE number: A 274 142 05 19
		7.24809.85.0	AGR	EL	 für OE-Nummer: A 274 142 04 19, A 274 142 06 19 for OE number: A 274 142 04 19, A 274 142 06 19
C 200 BlueTEC / d (205.037) 85-100 kW (116-136 PS) OM 626.951	05.2014→05.2018	 7.24809.90.0	AGR	EL	
		7.11457.07.0*	DDS		
		 7.11492.07.0	DDS		
C 200 d (205.007) 100-150 kW (136-204 PS) OM 651.921	10.2015→05.2018	 7.24809.82.0	AGR	EL	mit Dichtring with O-ring
		7.08369.76.0	ATS	EL	vor Katalysator in front of the catalyst für Fahrzeuge mit SCR-System for vehicles with SCR system
		7.08369.88.0	ATS	EL	Katalysator Catalytic Converter für Linkslenker for left-hand drive vehicles für Fahrzeuge mit SCR-System for vehicles with SCR system
C 220 BlueTEC / d (205.002, 205.004) 100-150 kW (136-204 PS) OM 651.921	02.2014→05.2018	 7.24809.82.0	AGR	EL	mit Dichtring with O-ring
		7.08369.12.0	ATS	EL	Katalysator Catalytic Converter für Rechtslenker for right-hand drive vehicles
		7.08369.76.0	ATS	EL	vor Katalysator in front of the catalyst
		7.08369.88.0	ATS	EL	Katalysator Catalytic Converter für Linkslenker for left-hand drive vehicles für Fahrzeuge mit SCR-System for vehicles with SCR system
C 220 BlueTEC / d (205.003) 100-150 kW (136-204 PS) OM 651.921	03.2014→05.2016	 7.24809.82.0	AGR	EL	mit Dichtring with O-ring
		7.08369.12.0	ATS	EL	
		7.08369.76.0	ATS	EL	vor Katalysator in front of the catalyst
		7.08369.88.0	ATS	EL	Katalysator Catalytic Converter für Linkslenker for left-hand drive vehicles für Fahrzeuge mit SCR-System for vehicles with SCR system

M







C-CLASS (W205) **22**

C 220 d 4-matic (205.005) 100-150 kW (136-204 PS) OM 651.921	04.2015→05.2018		7.24809.82.0 AGR EL mit Dichtring with O-ring
			7.08369.76.0 ATS EL vor Katalysator in front of the catalyst für Fahrzeuge mit SCR-System for vehicles with SCR system
			7.11020.33.0 ATS EL Katalysator Catalytic Converter für Fahrzeuge mit SCR-System for vehicles with SCR system
C 250 (205.045) 115-245 kW (156-333 PS) M 274.920	03.2014→05.2018		7.24809.83.0 AGR EL  für OE-Nummer: A 274 142 05 19 for OE number: A 274 142 05 19
			7.24809.85.0 AGR EL  für OE-Nummer: A 274 142 04 19, A 274 142 06 19 for OE number: A 274 142 04 19, A 274 142 06 19
C 250 BlueTEC / d (205.008, 205.006) 100-150 kW (136-204 PS) OM 651.921	02.2014→05.2018		7.24809.82.0 AGR EL mit Dichtring with O-ring
			7.08369.12.0 ATS EL
			7.08369.76.0 ATS EL vor Katalysator in front of the catalyst
			7.08369.88.0 ATS EL Katalysator Catalytic Converter für Linkslenker for left-hand drive vehicles für Fahrzeuge mit SCR-System for vehicles with SCR system
C 250 BlueTEC / d 4-matic (205.009) 100-150 kW (136-204 PS) OM 651.921	02.2014→05.2018		7.24809.82.0 AGR EL mit Dichtring with O-ring
			7.08369.76.0 ATS EL vor Katalysator in front of the catalyst
			7.11020.33.0 ATS EL Katalysator Catalytic Converter für Fahrzeuge mit SCR-System for vehicles with SCR system
C 300 (205.048) 115-245 kW (156-333 PS) M 274.920	09.2015→08.2018		7.24809.83.0 AGR EL  für OE-Nummer: A 274 142 05 19 for OE number: A 274 142 05 19
			7.24809.85.0 AGR EL  für OE-Nummer: A 274 142 04 19, A 274 142 06 19 for OE number: A 274 142 04 19, A 274 142 06 19
C 300 4-matic (205.049) 115-245 kW (156-333 PS) M 274.920	12.2013→08.2018		7.24809.85.0 AGR EL  für OE-Nummer: A 274 142 04 19, A 274 142 06 19 for OE number: A 274 142 04 19, A 274 142 06 19
C 300 BlueTEC Hybrid / h (205.012) 100-150 kW (136-204 PS) OM 651.921	05.2014→05.2018		7.24809.82.0 AGR EL mit Dichtring with O-ring
			7.08369.12.0 ATS EL
			7.08369.76.0 ATS EL vor Katalysator in front of the catalyst





M



C-CLASS (W205) 22













		7.08369.88.0	ATS	EL	Katalysator Catalytic Converter für Linkslenker for left-hand drive vehicles für Fahrzeuge mit SCR-System for vehicles with SCR system
C 350 e (205.047) 115-245 kW (156-333 PS) M 274.920	02.2015→08.2018	 7.24809.83.0	AGR	EL	⊗ für OE-Nummer: A 274 142 05 19 for OE number: A 274 142 05 19
		7.24809.85.0	AGR	EL	⊗ für OE-Nummer: A 274 142 04 19, A 274 142 06 19 for OE number: A 274 142 04 19, A 274 142 06 19
C 350 e (205.047) 115-245 kW (156-333 PS) M 274.920	02.2015→08.2018	 7.24809.83.0	AGR	EL	⊗ für OE-Nummer: A 274 142 05 19 for OE number: A 274 142 05 19
		7.24809.85.0	AGR	EL	⊗ für OE-Nummer: A 274 142 04 19, A 274 142 06 19 for OE number: A 274 142 04 19, A 274 142 06 19
C 400 4-matic (205.066) 200-295 kW (272-401 PS) M 276.823	10.2014→	 7.02604.44.0	LS	500 mm	vor Katalysator, links in front of the catalyst, Left
C 450 AMG 4-matic (205.064) 200-295 kW (272-401 PS) M 276.823	04.2015→05.2018	 7.02604.44.0	LS	500 mm	vor Katalysator, links in front of the catalyst, Left

C-CLASS Convertible (A205) 23

AMG C 43 4-matic (205.464) 200-295 kW (272-401 PS) M 276.823	10.2016→05.2018	 7.02604.44.0	LS	500 mm	vor Katalysator, links in front of the catalyst, Left
C 200 (205.442) 115-245 kW (156-333 PS) M 274.920	06.2016→05.2018	 7.24809.83.0	AGR	EL	⊗ für OE-Nummer: A 274 142 05 19 for OE number: A 274 142 05 19
		7.24809.85.0	AGR	EL	⊗ für OE-Nummer: A 274 142 04 19, A 274 142 06 19 for OE number: A 274 142 04 19, A 274 142 06 19
C 200 4-matic (205.443) 115-245 kW (156-333 PS) M 274.920	06.2016→05.2018	 7.24809.83.0	AGR	EL	⊗ für OE-Nummer: A 274 142 05 19 for OE number: A 274 142 05 19
		7.24809.85.0	AGR	EL	⊗ für OE-Nummer: A 274 142 04 19, A 274 142 06 19 for OE number: A 274 142 04 19, A 274 142 06 19
C 220 d (205.404) 100-150 kW (136-204 PS) OM 651.921	06.2016→05.2018	 7.24809.82.0	AGR	EL	mit Dichtring with O-ring
		7.08369.12.0	ATS	EL	
		7.08369.76.0	ATS	EL	vor Katalysator in front of the catalyst für Fahrzeuge mit SCR-System for vehicles with SCR system
		7.08369.88.0	ATS	EL	Katalysator Catalytic Converter für Linkslenker for left-hand drive vehicles für Fahrzeuge mit SCR-System for vehicles with SCR system



C-CLASS Convertible (A205) **23**









C 220 d (205.404) 100-150 kW (136-204 PS) OM 651.921	06.2016→05.2018		7.24809.82.0	AGR	EL	mit Dichtring with O-ring
			7.08369.12.0	ATS	EL	
C 220 d 4-matic (205.405) 100-150 kW (136-204 PS) OM 651.921	06.2016→05.2018		7.24809.82.0	AGR	EL	mit Dichtring with O-ring
			7.08369.76.0	ATS	EL	vor Katalysator in front of the catalyst für Fahrzeuge mit SCR-System for vehicles with SCR system
C 250 (205.445) 115-245 kW (156-333 PS) M 274.920	06.2016→05.2018		7.24809.83.0	AGR	EL	 für OE-Nummer: A 274 142 05 19 for OE number: A 274 142 05 19
			7.24809.85.0	AGR	EL	 für OE-Nummer: A 274 142 04 19, A 274 142 06 19 for OE number: A 274 142 04 19, A 274 142 06 19
C 250 d (205.408) 100-150 kW (136-204 PS) OM 651.921	06.2016→05.2018		7.24809.82.0	AGR	EL	mit Dichtring with O-ring
			7.08369.12.0	ATS	EL	
			7.08369.76.0	ATS	EL	vor Katalysator in front of the catalyst für Fahrzeuge mit SCR-System for vehicles with SCR system
			7.08369.88.0	ATS	EL	Katalysator Catalytic Converter für Linkslenker for left-hand drive vehicles für Fahrzeuge mit SCR-System for vehicles with SCR system
C 300 (205.448) 115-245 kW (156-333 PS) M 274.920	06.2016→05.2018		7.24809.83.0	AGR	EL	 für OE-Nummer: A 274 142 05 19 for OE number: A 274 142 05 19
			7.24809.85.0	AGR	EL	 für OE-Nummer: A 274 142 04 19, A 274 142 06 19 for OE number: A 274 142 04 19, A 274 142 06 19
C 300 4-matic (205.449) 115-245 kW (156-333 PS) M 274.920	01.2017→12.2018		7.24809.83.0	AGR	EL	 für OE-Nummer: A 274 142 05 19 for OE number: A 274 142 05 19
			7.24809.85.0	AGR	EL	 für OE-Nummer: A 274 142 04 19, A 274 142 06 19 for OE number: A 274 142 04 19, A 274 142 06 19
C 400 4-matic (205.466) 200-295 kW (272-401 PS) M 276.823	06.2016→		7.02604.44.0	LS	500 mm	vor Katalysator, links in front of the catalyst, Left

C-CLASS Coupe (C204) **24**

C 180 (204.331) 95-115 kW (129-156 PS) M 274.910	01.2013→		7.02604.44.0	LS	500 mm	vor Katalysator in front of the catalyst
C 180 (204.349) 115-137 kW (156-186 PS) M 271.820	06.2011→		7.04389.07.0	SLP	EL	
C 200 CGI (204.348) 135-150 kW (184-204 PS) M 271.860	06.2011→		7.04389.07.0	SLP	EL	







C-CLASS Coupe (C204) 24

C 220 CDI (204.302) 120-150 kW (163-204 PS) OM 651.911	06.2011→		7.08369.90.0	ATS	EL	 ch. F747898→ vor Rußpartikelfilter before soot particulate filter für Linkslenker for left-hand drive vehicles Produktionsdatum ab: 31.07.2011 Production date from: 31.07.2011
			7.08369.06.0	ATS	EL	
			7.08369.12.0	ATS	EL	
			7.11020.00.0	ATS	EL	 →ch. F747898 vor Rußpartikelfilter before soot particulate filter für Linkslenker for left-hand drive vehicles Produktionsdatum bis: 31.07.2011 Production date to: 31.07.2011
			7.05270.22.0	LS	825 mm	
			7.05270.21.0	LS	600 mm	
C 220 CDI (204.302) 120-150 kW (163-204 PS) OM 651.911	06.2011→		7.08369.06.0	ATS	EL	für Fahrzeuge ohne Start-Stopp-Funktion for vehicles without start-stop function Regelsonde Regulating Probe
			7.08369.12.0	ATS	EL	
			7.05270.22.0	LS	825 mm	
			7.05270.21.0	LS	600 mm	
C 250 (204.347) 135-150 kW (184-204 PS) M 271.860	06.2011→		7.05270.17.0	LS	null mm	
			7.05270.21.0	LS	600 mm	
			7.04389.07.0	SLP	EL	
C 250 CDI (204.303) 120-150 kW (163-204 PS) OM 651.911	06.2011→		7.08369.90.0	ATS	EL	 ch. F747898→ vor Rußpartikelfilter before soot particulate filter für Linkslenker for left-hand drive vehicles Produktionsdatum ab: 31.07.2011 Production date from: 31.07.2011
			7.08369.06.0	ATS	EL	
			7.08369.12.0	ATS	EL	
			7.11020.00.0	ATS	EL	 →ch. F747898 vor Rußpartikelfilter before soot particulate filter für Linkslenker for left-hand drive vehicles Produktionsdatum bis: 31.07.2011 Production date to: 31.07.2011
			7.05270.21.0	LS	600 mm	vor Katalysator in front of the catalyst für Fahrzeuge ohne Start-Stopp-Funktion for vehicles without start-stop function
C 350 (204.357) 182-225 kW (248-306 PS) M 276.957	06.2011→		7.02604.44.0	LS	500 mm	für OE-Nummer: A 008 542 29 18, A 009 542 59 18 for OE number: A 008 542 29 18, A 009 542 59 18 vor Katalysator in front of the catalyst
			7.02604.99.0	LS	400 mm	

M





























C-CLASS Coupe (C204) **24**

C 63 AMG (204.377) 336-410 kW (457-558 PS) M 156.985	06.2011→		7.05270.17.0	LS	null mm	
			7.05270.21.0	LS	600 mm	
			7.04389.09.0	SLP	EL	
C 63 AMG (204.377) 336-410 kW (457-558 PS) M 156.985	01.2012→		7.05270.17.0	LS	null mm	
			7.05270.21.0	LS	600 mm	
			7.04389.09.0	SLP	EL	
C 63 AMG (204.377) 336-410 kW (457-558 PS) M 156.985	01.2012→		7.05270.17.0	LS	null mm	
			7.05270.21.0	LS	600 mm	
			7.04389.09.0	SLP	EL	
C 63 AMG (204.377) 336-410 kW (457-558 PS) M 156.985	11.2012→		7.05270.17.0	LS	null mm	
			7.05270.21.0	LS	600 mm	
			7.04389.09.0	SLP	EL	















C-CLASS Coupe (C205) **25**

M



















AMG C 43 4-matic (205.364) 200-295 kW (272-401 PS) M 276.823	04.2016→05.2018		7.02604.44.0	LS	500 mm	vor Katalysator, links in front of the catalyst, Left
C 200 (205.342) 115-245 kW (156-333 PS) M 274.920	10.2015→05.2018		7.24809.83.0	AGR	EL	 für OE-Nummer: A 274 142 05 19 for OE number: A 274 142 05 19
			7.24809.85.0	AGR	EL	 für OE-Nummer: A 274 142 04 19, A 274 142 06 19 for OE number: A 274 142 04 19, A 274 142 06 19
C 200 4-matic (205.343) 115-245 kW (156-333 PS) M 274.920	04.2016→05.2018		7.24809.83.0	AGR	EL	 für OE-Nummer: A 274 142 05 19 for OE number: A 274 142 05 19
			7.24809.85.0	AGR	EL	 für OE-Nummer: A 274 142 04 19, A 274 142 06 19 for OE number: A 274 142 04 19, A 274 142 06 19
C 220 d (205.304) 100-150 kW (136-204 PS) OM 651.921	10.2015→05.2018		7.24809.82.0	AGR	EL	mit Dichtring with O-ring
			7.08369.12.0	ATS	EL	Katalysator Catalytic Converter für Rechtslenker for right-hand drive vehicles für Fahrzeuge mit SCR-System for vehicles with SCR system
			7.08369.76.0	ATS	EL	vor Katalysator in front of the catalyst für Fahrzeuge mit SCR-System for vehicles with SCR system
			7.08369.88.0	ATS	EL	Katalysator Catalytic Converter für Linkslenker for left-hand drive vehicles für Fahrzeuge mit SCR-System for vehicles with SCR system

					
C-CLASS Coupe (C205)					
C 220 d (205.304) 100-150 kW (136-204 PS) OM 651.921	10.2015→05.2018		7.24809.82.0	AGR	EL mit Dichtring with O-ring
			7.08369.12.0	ATS	EL
C 220 d 4-matic (205.305) 100-150 kW (136-204 PS) OM 651.921	04.2016→05.2018		7.24809.82.0	AGR	EL mit Dichtring with O-ring
			7.11020.33.0	ATS	EL Katalysator Catalytic Converter für Fahrzeuge mit SCR-System for vehicles with SCR system
C 250 (205.345) 115-245 kW (156-333 PS) M 274.920	10.2015→05.2018		7.24809.83.0	AGR	EL  für OE-Nummer: A 274 142 05 19 for OE number: A 274 142 05 19
			7.24809.85.0	AGR	EL  für OE-Nummer: A 274 142 04 19, A 274 142 06 19 for OE number: A 274 142 04 19, A 274 142 06 19
C 250 d (205.308) 100-150 kW (136-204 PS) OM 651.921	10.2015→05.2018		7.24809.82.0	AGR	EL mit Dichtring with O-ring
			7.08369.12.0	ATS	EL Katalysator Catalytic Converter für Rechtslenker for right-hand drive vehicles für Fahrzeuge mit SCR-System for vehicles with SCR system
			7.08369.76.0	ATS	EL vor Katalysator in front of the catalyst für Fahrzeuge mit SCR-System for vehicles with SCR system
			7.08369.88.0	ATS	EL Katalysator Catalytic Converter für Linkslenker for left-hand drive vehicles für Fahrzeuge mit SCR-System for vehicles with SCR system
C 250 d 4-matic (205.309) 100-150 kW (136-204 PS) OM 651.921	04.2016→05.2018		7.24809.82.0	AGR	EL mit Dichtring with O-ring
			7.08369.76.0	ATS	EL vor Katalysator in front of the catalyst für Fahrzeuge mit SCR-System for vehicles with SCR system
			7.11020.33.0	ATS	EL Katalysator Catalytic Converter für Fahrzeuge mit SCR-System for vehicles with SCR system
C 300 (205.348) 115-245 kW (156-333 PS) M 274.920	10.2015→12.2018		7.24809.83.0	AGR	EL  für OE-Nummer: A 274 142 05 19 for OE number: A 274 142 05 19
			7.24809.85.0	AGR	EL  für OE-Nummer: A 274 142 04 19, A 274 142 06 19 for OE number: A 274 142 04 19, A 274 142 06 19
C 300 4-matic (205.349) 115-245 kW (156-333 PS) M 274.920	09.2016→12.2018		7.24809.83.0	AGR	EL  für OE-Nummer: A 274 142 05 19 for OE number: A 274 142 05 19

M

					
C-CLASS Coupe (C205)					25
			7.24809.85.0	AGR	EL  für OE-Nummer: A 274 142 04 19, A 274 142 06 19 for OE number: A 274 142 04 19, A 274 142 06 19
C 400 4-matic (205.366) 200-295 kW (272-401 PS) M 276.823	04.2016→		7.02604.44.0	LS	500 mm vor Katalysator, links in front of the catalyst, Left
C-CLASS Coupe (CL203)					26
C 160 Kompressor (203.730) 90-95 kW (122-129 PS) M 271.921	05.2002→05.2008		7.05271.23.0	LS	900 mm
			7.05270.11.0	LS	750 mm nach Katalysator Post-catalyst
C 180 (203.735) 95 kW (129 PS) M 111.951	03.2001→05.2002		7.05270.11.0	LS	750 mm nach Katalysator Post-catalyst Kompressor Compressor Euro 4 Euro 4
			7.05270.12.0	LS	500 mm vor Katalysator in front of the catalyst Euro 4 Euro 4
			7.04389.04.0	SLP	EL
C 180 Kompressor (203.746) 105-125 kW (143-170 PS) M 271.946	05.2002→05.2008		7.05271.23.0	LS	900 mm
			7.05270.11.0	LS	750 mm nach Katalysator Post-catalyst
C 200 CDI (203.707) 75-110 kW (102-150 PS) OM 646.962	03.2003→05.2008		7.24809.36.0	AGR	ET 
			7.08369.30.0	ATS	EL
			7.08369.80.0	ATS	EL Abgaskrümmer Exhaust Manifold Euro 4 Euro 4 für Fahrzeuge mit Diesel-Partikel-Filter (DPF) for vehicles with diesel soot filter
			7.08369.94.0	ATS	EL für OE-Nummer: A 005 153 11 28, A 007 153 63 28 for OE number: A 005 153 11 28, A 007 153 63 28 Partikelfilter Particulate Filter
			7.08369.97.0	ATS	EL Partikelfilter Particulate Filter für Rechtslenker for right-hand drive vehicles
			7.05270.22.0	LS	825 mm
C 200 CGI Kompressor (203.743) 125 kW (170 PS) M 271.942	03.2003→05.2008		7.05271.23.0	LS	900 mm
			7.05270.11.0	LS	750 mm nach Katalysator Post-catalyst
C 200 Kompressor (203.742) 120 kW (163 PS) M 271.940	05.2002→05.2008		7.05270.11.0	LS	750 mm nach Katalysator Post-catalyst

M

					
C-CLASS Coupe (CL203)					
26					
C 200 Kompressor (203.745) 120 kW (163 PS) M 111.955	03.2001→05.2002		7.05270.11.0	LS	750 mm nach Katalysator Post-catalyst Euro 4 Euro 4
C 220 CDI 75-105 kW (102-143 PS) OM 611.962	03.2001→01.2004		7.05270.22.0	LS	825 mm
C 220 CDI (203.706) 75-105 kW (102-143 PS) OM 611.962	03.2001→01.2004		7.05270.22.0	LS	825 mm
C 220 CDI (203.708) 90-110 kW (122-150 PS) OM 646.963	02.2004→05.2008		7.24809.36.0	AGR	ET 
			7.08369.30.0	ATS	EL
			7.08369.80.0	ATS	EL
			7.08369.94.0	ATS	EL
			7.08369.97.0	ATS	EL
7.11190.01.0	DDS				
7.05270.22.0	LS	825 mm			
C 230 (203.752) 150 kW (204 PS) M 272.920	01.2005→05.2008		7.05270.17.0	LS	null mm
			7.05270.22.0	LS	825 mm
			7.04389.02.0	SLP	EL
C 230 Kompressor (203.740) 141 kW (192 PS) M 271.948	05.2002→05.2008		7.05270.11.0	LS	750 mm nach Katalysator Post-catalyst
C 230 Kompressor (203.747) 143-145 kW (194-197 PS) M 111.981	03.2001→05.2002		7.05270.11.0	LS	750 mm nach Katalysator Post-catalyst Euro 4 Euro 4
C 30 CDI AMG (203.718) 170 kW (231 PS) OM 612.990	09.2002→05.2008		7.24809.37.0	AGR	ET 
C 32 AMG Kompressor (203.765) 260 kW (354 PS) M 112.961	05.2002→05.2008		7.02604.26.0	LS	500 mm
			7.04389.04.0	SLP	EL
C 320 (203.764) 160 kW (218 PS) M 112.946	09.2002→05.2008		7.22136.50.0	AGR	PN 
			7.02604.27.0	LS	750 mm
			7.05270.11.0	LS	750 mm
			7.02604.26.0	LS	500 mm
vor Katalysator, links in front of the catalyst, Left					







M



C-CLASS Coupe (CL203) 26

			7.05270.12.0	LS	500 mm	vor Katalysator, rechts in front of the catalyst, Right Heckantrieb Rear Wheel Drive
			7.04389.00.0	SLP	EL	
C 350 (203.756) 170-200 kW (231-272 PS) M 272.960	01.2005→05.2008		7.05270.17.0	LS	null mm	
			7.05270.22.0	LS	825 mm	
			7.04389.02.0	SLP	EL	

C-CLASS T-Model (S202) 27

C 180 T (202.081) 95 kW (129 PS) M 111.952	09.2000→03.2001		7.04389.04.0	SLP	EL	PKW, Kombi/ Passenger car, estate
			C 200 T (202.080) 100 kW (136 PS) M 111.941, M 111.945	06.1996→03.2001		7.04389.04.0
C 200 T Kompressor (202.087) 120 kW (163 PS) M 111.956	09.2000→03.2001		7.05270.11.0			LS
			7.05270.12.0	LS	500 mm	vor Katalysator in front of the catalyst für Rechtslenker for right-hand drive vehicles
C 240 T (202.086) 125 kW (170 PS) M 112.910	06.1997→09.2000		7.22136.50.0	AGR	PN	<input checked="" type="checkbox"/>
			7.05270.03.0	LS	820 mm	
			7.02604.27.0	LS	750 mm	
			7.02604.25.0	LS	425 mm	
			7.04389.00.0	SLP	EL	
C 240 T (202.088) 125 kW (170 PS) M 112.915	09.2000→03.2001		7.22136.50.0	AGR	PN	<input checked="" type="checkbox"/>
			7.05270.03.0	LS	820 mm	
			7.02604.27.0	LS	750 mm	
			7.05270.11.0	LS	750 mm	für OE-Nummer: A 001 540 74 17 for OE number: A 001 540 74 17
			7.02604.25.0	LS	425 mm	
C 280 T (202.089) 145-150 kW (197-204 PS) M 112.920	06.1997→03.2001		7.04389.00.0	SLP	EL	PKW, Kombi/ Passenger car, estate
			7.22136.50.0	AGR	PN	<input checked="" type="checkbox"/>
			7.05270.03.0	LS	820 mm	
			7.02604.27.0	LS	750 mm	
			7.05270.11.0	LS	750 mm	für OE-Nummer: A 001 540 74 17 for OE number: A 001 540 74 17
			7.02604.25.0	LS	425 mm	
C 43 AMG (202.093) 205-225 kW (279-306 PS) M 113.944	08.1997→03.2001		7.05270.15.0	LS	380 mm	
			7.04389.00.0	SLP	EL	
			7.22136.50.0	AGR	PN	<input checked="" type="checkbox"/>









M



C-CLASS T-Model (S202) 27

		7.05270.03.0	LS	820 mm	
		7.02604.27.0	LS	750 mm	
		7.05270.11.0	LS	750 mm	für OE-Nummer: A 001 540 74 17 for OE number: A 001 540 74 17
		7.02604.25.0	LS	425 mm	
		7.04389.00.0	SLP	EL	

C-CLASS T-Model (S203) 28









C 180 (203.235) 95 kW (129 PS) M 111.951	03.2001→05.2002	 7.05270.11.0	LS	750 mm	nach Katalysator Post-catalyst Kompressor Compressor Euro 4 Euro 4
		7.05270.12.0	LS	500 mm	vor Katalysator in front of the catalyist Euro 4 Euro 4
		7.04389.04.0	SLP	EL	
C 180 Kompressor (203.246) 105-125 kW (143-170 PS) M 271.946	05.2002→08.2007	 7.05271.23.0	LS	900 mm	
		7.05270.11.0	LS	750 mm	nach Katalysator Post-catalyst
C 200 CDI (203.204) 75-105 kW (102-143 PS) OM 611.962	03.2001→08.2007	 7.05270.22.0	LS	825 mm	
C 200 CDI (203.204, 203.207) 75-105 kW (102-143 PS) OM 611.962	03.2001→08.2007	 7.08369.94.0	ATS	EL	Partikelfilter Particulate Filter für Linkslenker for left-hand drive vehicles Produktionsdatum bis: 30.06.2007 Production date to: 30.06.2007
		7.11190.01.0	DDS		Luftfiltergehäuse Air Filter Housing
		7.05270.22.0	LS	825 mm	
C 200 CDI (203.204, 203.207) 75-110 kW (102-150 PS) OM 646.962	03.2001→08.2007	 7.24809.36.0	AGR	ET	
		7.08369.97.0	ATS	EL	Partikelfilter Particulate Filter für Rechtslenker for right-hand drive vehicles
		7.11190.01.0	DDS		Luftfiltergehäuse Air Filter Housing
		7.05270.22.0	LS	825 mm	
C 200 CDI (203.207) 75-110 kW (102-150 PS) OM 646.962	04.2003→08.2007	 7.24809.36.0	AGR	ET	
		7.08369.30.0	ATS	EL	
		7.08369.80.0	ATS	EL	Abgaskrümmer Exhaust Manifold Euro 4 Euro 4 für Fahrzeuge mit Diesel-Partikel-Filter (DPF) for vehicles with diesel soot filter

M



C-CLASS T-Model (S203)









28

			7.08369.94.0	ATS	EL	Partikelfilter Particulate Filter für Linkslenker for left-hand drive vehicles Produktionsdatum bis: 30.06.2007 Production date to: 30.06.2007
			7.08369.97.0	ATS	EL	Partikelfilter Particulate Filter für Rechtslenker for right-hand drive vehicles
			7.11190.01.0	DDS		Luftfiltergehäuse Air Filter Housing
			7.05270.22.0	LS	825 mm	
C 200 CDI (203.207) 90-110 kW (122-150 PS) OM 646.963	04.2003→08.2007		7.24809.36.0	AGR	ET	
			7.08369.30.0	ATS	EL	
			7.08369.80.0	ATS	EL	Abgaskrümmer Exhaust Manifold Euro 4 Euro 4 für Fahrzeuge mit Diesel-Partikel-Filter (DPF) for vehicles with diesel soot filter
			7.08369.94.0	ATS	EL	Partikelfilter Particulate Filter für Linkslenker for left-hand drive vehicles Produktionsdatum bis: 30.06.2007 Production date to: 30.06.2007
			7.08369.97.0	ATS	EL	Partikelfilter Particulate Filter für Rechtslenker for right-hand drive vehicles
			7.05270.22.0	LS	825 mm	
C 200 CGI Kompressor (203.243) 125 kW (170 PS) M 271.942	07.2003→08.2007		7.05271.23.0	LS	900 mm	
			7.05270.11.0	LS	750 mm	nach Katalysator Post-catalyst
C 200 Kompressor (203.242) 120 kW (163 PS) M 271.940	05.2002→08.2007		7.05270.11.0	LS	750 mm	nach Katalysator Post-catalyst
C 200 Kompressor (203.245) 120 kW (163 PS) M 111.955	03.2001→05.2002		7.05270.11.0	LS	750 mm	nach Katalysator Post-catalyst Kompressor Compressor Euro 4 Euro 4
C 220 CDI (203.206) 75-105 kW (102-143 PS) OM 611.962	03.2001→08.2007		7.05270.22.0	LS	825 mm	
C 220 CDI (203.208) 90-110 kW (122-150 PS) OM 646.963	02.2004→08.2007		7.24809.36.0	AGR	ET	
			7.08369.30.0	ATS	EL	
			7.08369.80.0	ATS	EL	Abgaskrümmer Exhaust Manifold Euro 4 Euro 4 für Fahrzeuge mit Diesel-Partikel-Filter (DPF) for vehicles with diesel soot filter

M















C-CLASS T-Model (S203) **28**

			7.08369.94.0	ATS	EL	Partikelfilter Particulate Filter für Linkslenker for left-hand drive vehicles Produktionsdatum bis: 30.06.2007 Production date to: 30.06.2007
			7.08369.97.0	ATS	EL	Partikelfilter Particulate Filter für Rechtslenker for right-hand drive vehicles
			7.05270.22.0	LS	825 mm	
C 220 CDI (203.208) 90-110 kW (122-150 PS) OM 646.963	08.2006→08.2007		7.24809.36.0	AGR	ET	
			7.08369.94.0	ATS	EL	Partikelfilter Particulate Filter für Linkslenker for left-hand drive vehicles Produktionsdatum bis: 30.06.2007 Production date to: 30.06.2007
			7.08369.97.0	ATS	EL	Partikelfilter Particulate Filter für Rechtslenker for right-hand drive vehicles
			7.11190.01.0 7.05270.22.0	DDS LS	 825 mm	
C 230 (203.252) 150 kW (204 PS) M 272.920	01.2005→08.2007		7.05270.17.0	LS	null mm	
			7.05270.22.0	LS	825 mm	
			7.04389.02.0	SLP	EL	
C 230 Kompressor (203.240) 141 kW (192 PS) M 271.948	02.2004→08.2007		7.05270.11.0	LS	750 mm	nach Katalysator Post-catalyst
C 240 (203.261) 120-125 kW (163-170 PS) M 112.912	03.2001→08.2007		7.22136.50.0	AGR	PN	
			7.02604.27.0	LS	750 mm	
			7.05270.11.0	LS	750 mm	vor Katalysator, links in front of the catalyst, Left
			7.02604.26.0	LS	500 mm	
			7.05270.12.0	LS	500 mm	vor Katalysator, rechts in front of the catalyst, Right
			7.04389.00.0	SLP	EL	PKW, Kombi/ Passenger car, estate
C 240 4-matic (203.281) 125 kW (170 PS) M 112.916	07.2002→08.2007		7.22136.50.0	AGR	PN	
			7.02604.27.0	LS	750 mm	
			7.05270.11.0	LS	750 mm	vor Katalysator, links in front of the catalyst, Left
			7.02604.26.0	LS	500 mm	
			7.04389.00.0	SLP	EL	PKW, Kombi/ Passenger car, estate
C 280 (203.254) 170 kW (231 PS) M 272.940	01.2005→08.2007		7.05270.17.0	LS	null mm	
			7.05270.22.0	LS	825 mm	
			7.04389.02.0	SLP	EL	





















M



C-CLASS T-Model (S203) 28

C 280 4-matic (203.292) 170 kW (231 PS) M 272.941	01.2005→08.2007		7.05270.17.0	LS	null mm	nach Katalysator, links Post-catalyst, Left
			7.05270.22.0	LS	825 mm	
			7.05270.11.0	LS	750 mm	
			7.04389.02.0	SLP	EL	
C 30 CDI AMG (203.218) 170 kW (231 PS) OM 612.990	01.2003→08.2007		7.24809.37.0	AGR	ET	
C 32 AMG Kompressor (203.265) 260 kW (354 PS) M 112.961	03.2001→08.2007		7.05270.11.0	LS	750 mm	vor Katalysator, links in front of the catalyst, Left
			7.02604.26.0	LS	500 mm	vor Katalysator, rechts in front of the catalyst, Right
			7.05270.12.0	LS	500 mm	
			7.04389.04.0	SLP	EL	
C 320 (203.264) 160 kW (218 PS) M 112.946	03.2001→08.2007		7.22136.50.0	AGR	PN	
			7.02604.27.0	LS	750 mm	vor Katalysator, links in front of the catalyst, Left
			7.05270.11.0	LS	750 mm	
			7.02604.26.0	LS	500 mm	
			7.05270.12.0	LS	500 mm	vor Katalysator, rechts in front of the catalyst, Right
			7.04389.00.0	SLP	EL	
C 320 4-matic (203.284) 160 kW (218 PS) M 112.953	07.2002→08.2007		7.22136.50.0	AGR	PN	
			7.02604.27.0	LS	750 mm	vor Katalysator, beidseitig in front of the catalyst, Left and right
			7.05270.11.0	LS	750 mm	
			7.02604.26.0	LS	500 mm	
			7.04389.00.0	SLP	EL	PKW, Kombi/ Passenger car, estate
C 320 CDI (203.220) 165 kW (224 PS) OM 642.910	06.2005→08.2007		7.24809.47.0	AGR	ET	
			7.11190.01.0	DDS		Luftfiltergehäuse Air Filter Housing
			7.05270.21.0	LS	600 mm	
C 350 (203.256) 170-200 kW (231-272 PS) M 272.960	01.2005→08.2007		7.05270.17.0	LS	null mm	
			7.05270.22.0	LS	825 mm	
			7.04389.02.0	SLP	EL	
C 350 4-matic (203.287) 200 kW (272 PS) M 272.970	01.2005→08.2007		7.05270.17.0	LS	null mm	vor Katalysator, links in front of the catalyst, Left
			7.05270.22.0	LS	825 mm	
			7.05270.11.0	LS	750 mm	
			7.04389.02.0	SLP	EL	













M

					
C-CLASS T-Model (S203)					
28					
C 55 AMG (203.276) 260-270 kW (354-367 PS) M 113.988	02.2004→08.2007		7.22136.50.0	AGR	PN 
			7.05270.11.0	LS	750 mm vor Katalysator, links in front of the catalyst, Left
			7.02604.26.0	LS	500 mm
			7.05270.12.0	LS	500 mm vor Katalysator, rechts in front of the catalyst, Right
			7.04389.06.0	SLP	EL
C-CLASS T-Model (S204)					
29					
C 180 (204.231) 95-115 kW (129-156 PS) M 274.910	02.2012→08.2014		7.02604.44.0	LS	500 mm vor Katalysator in front of the catalyst
C 180 CDI (204.200) 88-105 kW (120-143 PS) OM 651.913	01.2011→08.2014		7.08369.90.0	ATS	EL  ch. F747898→ vor Rußpartikelfilter before soot particulate filter für Linkslenker for left-hand drive vehicles Produktionsdatum ab: 31.07.2011 Production date from: 31.07.2011
			7.08369.06.0	ATS	EL
			7.11020.00.0	ATS	EL  →ch. F747898 vor Rußpartikelfilter before soot particulate filter für Linkslenker for left-hand drive vehicles Produktionsdatum bis: 31.07.2011 Production date to: 31.07.2011
C 180 CGI (204.249) 115-137 kW (156-186 PS) M 271.820	11.2009→08.2014		7.04389.07.0	SLP	EL
C 180 Kompressor (204.245) 105-115 kW (143-156 PS) M 271.910	01.2008→08.2014		7.05270.11.0	LS	750 mm nach Katalysator Post-catalyst
C 180 Kompressor (204.246) 115 kW (156 PS) M 271.952	08.2007→08.2014		7.05270.11.0	LS	750 mm nach Katalysator Post-catalyst
C 200 CDI (204.201) 88-105 kW (120-143 PS) OM 651.913	08.2010→08.2014		7.08369.06.0	ATS	EL
			7.08369.12.0	ATS	EL
			7.05270.22.0	LS	825 mm
					600 mm
C 200 CDI (204.207) 100-125 kW (136-170 PS) OM 646.811	08.2007→12.2009		7.24809.48.0	AGR	ET 
			7.05270.22.0	LS	825 mm
			7.05270.21.0	LS	600 mm
C 200 CGI (204.248) 115-150 kW (156-204 PS) M 271.820, M 271.860	08.2007→08.2014		7.04389.07.0	SLP	EL
C 200 Kompressor (204.241) 120-135 kW (163-184 PS) M 271.950	08.2007→08.2014		7.05270.11.0	LS	750 mm nach Katalysator Post-catalyst
C 220 CDI (204.202) 120-150 kW (163-204 PS) OM 651.911	12.2008→08.2014		7.08369.06.0	ATS	EL

M















C-CLASS T-Model (S204) 29

			7.08369.12.0 7.05270.21.0	ATS LS	EL 600 mm	vor Katalysator in front of the catalyst für Fahrzeuge ohne Start-Stopp-Funktion for vehicles without start-stop function
C 220 CDI (204.202) 120-150 kW (163-204 PS) OM 651.911	12.2008→08.2014		7.08369.90.0	ATS	EL	 ch. F747898→ Partikelfilter Particulate Filter für Linkslenker for left-hand drive vehicles Produktionsdatum ab: 31.07.2011 Production date from: 31.07.2011
			7.08369.06.0	ATS	EL	
			7.08369.12.0	ATS	EL	
			7.11020.00.0	ATS	EL	 →ch. F747898 Partikelfilter Particulate Filter für Linkslenker for left-hand drive vehicles Produktionsdatum bis: 31.07.2011 Production date to: 31.07.2011
			7.05270.22.0	LS	825 mm	
			7.05270.21.0	LS	600 mm	für Fahrzeuge ohne Start-Stopp-Funktion for vehicles without start-stop function Regelsonde Regulating Probe
C 220 CDI (204.208) 100-125 kW (136-170 PS) OM 646.811	08.2007→11.2008		7.24809.48.0	AGR	ET	
			7.05270.22.0	LS	825 mm	
			7.05270.21.0	LS	600 mm	
C 220 CDI (204.208) 100-125 kW (136-170 PS) OM 646.811	08.2007→11.2008		7.24809.48.0	AGR	ET	
			7.05270.22.0	LS	825 mm	
			7.05270.21.0	LS	600 mm	
C 220 CDI 4-matic (204.284) 120-150 kW (163-204 PS) OM 651.912	02.2013→08.2014		7.08369.06.0	ATS	EL	
			7.08369.12.0	ATS	EL	vor Rußpartikelfilter before soot particulate filter für Linkslenker for left-hand drive vehicles
			7.05270.21.0	LS	600 mm	vor Katalysator in front of the catalyst für Fahrzeuge ohne Start-Stopp-Funktion for vehicles without start-stop function
C 230 (204.252) 150 kW (204 PS) M 272.921	08.2007→08.2014		7.05270.21.0	LS	600 mm	
			7.05270.18.0	LS	500 mm	
			7.04389.02.0	SLP	EL	
C 250 115-245 kW (156-333 PS) M 274.920	03.2014→08.2014		7.24809.83.0	AGR	EL	 für OE-Nummer: A 274 142 05 19 for OE number: A 274 142 05 19
			7.24809.85.0	AGR	EL	 für OE-Nummer: A 274 142 04 19, A 274 142 06 19 for OE number: A 274 142 04 19, A 274 142 06 19



C-CLASS T-Model (S204) 29











C 250 (204.252) 150 kW (204 PS) M 272.921	02.2008→12.2012		7.04389.02.0	SLP	EL	
C 250 CDI (204.203) 120-150 kW (163-204 PS) OM 651.911	01.2009→08.2014		7.08369.90.0	ATS	EL	 ch. F747898→ vor Rußpartikelfilter before soot particulate filter für Linkslenker for left-hand drive vehicles Produktionsdatum ab: 31.07.2011 Production date from: 31.07.2011
			7.08369.06.0	ATS	EL	
			7.08369.12.0	ATS	EL	
			7.11020.00.0	ATS	EL	 →ch. F747898 vor Rußpartikelfilter before soot particulate filter für Linkslenker for left-hand drive vehicles Produktionsdatum bis: 31.07.2011 Production date to: 31.07.2011
C 250 CDI 4-matic (204.282) 120-150 kW (163-204 PS) OM 651.912	04.2010→08.2014		7.08369.06.0	ATS	EL	
			7.08369.12.0	ATS	EL	
			7.05270.21.0	LS	600 mm	vor Katalysator in front of the catalyst für Fahrzeuge ohne Start-Stopp-Funktion for vehicles without start-stop function
C 250 CGI (204.247) 135-150 kW (184-204 PS) M 271.860	07.2009→08.2014		7.04389.07.0	SLP	EL	
C 280 (204.254) 170 kW (231 PS) M 272.947	08.2007→08.2014		7.05270.21.0	LS	600 mm	
			7.05270.18.0	LS	500 mm	
			7.04389.02.0	SLP	EL	
C 300 (204.254) 170 kW (231 PS) M 272.947	08.2007→08.2014		7.05270.21.0	LS	600 mm	
			7.04389.02.0	SLP	EL	
C 300 CDI 4-matic (204.292) 150-170 kW (204-231 PS) OM 642.832	06.2011→08.2014		7.11020.16.0	ATS	EL	 ch. F349084→ch. F401031 vor Rußpartikelfilter before soot particulate filter Euro 5, Euro 6 Euro 5, Euro 6
C 320 CDI (204.222) 165 kW (224 PS) OM 642.960	08.2007→08.2014		7.24809.47.0	AGR	ET	 USA USA
			7.11020.16.0	ATS	EL	 ch. F349084→ch. F401031 vor Rußpartikelfilter before soot particulate filter Euro 5, Euro 6 Euro 5, Euro 6
			7.08369.61.0	ATS	EL	Fahrgestellnummer ab: F 349084 Vehicle Identification Number from: F 349084 Fahrgestellnummer bis: F 401030 Vehicle Identification Number to: F 401030 Katalysator Catalytic Converter
			7.11020.11.0	ATS	EL	vor Abgasturbolader in front of exhaust turbocharger

M



C-CLASS T-Model (S204)





29

			7.11190.01.0	DDS		Luftfiltergehäuse Air Filter Housing
			7.05270.21.0	LS	600 mm	
			7.02604.99.0	LS	400 mm	
C 320 CDI 4-matic (204.289) 165 kW (224 PS) OM 642.961	08.2007→12.2011		7.24809.47.0	AGR	ET	 USA USA
			7.11020.16.0	ATS	EL	 ch. F349084→ch. F401031 vor Rußpartikelfilter before soot particulate filter Euro 5, Euro 6 Euro 5, Euro 6
			7.08369.61.0	ATS	EL	
			7.11190.01.0	DDS		Luftfiltergehäuse Air Filter Housing
			7.05270.21.0	LS	600 mm	
			7.02604.99.0	LS	400 mm	
C 350 (204.256) 200 kW (272 PS) M 272.961	08.2007→08.2014		7.05270.17.0	LS	null mm	links, rechts Left, Right Diagnosesonde Diagnostic Probe
			7.05270.21.0	LS	600 mm	links, rechts Left, Right Regelsonde Regulating Probe
			7.04389.02.0	SLP	EL	
C 350 CDI (204.223) 195 kW (265 PS) OM 642.834	06.2011→08.2014		7.08369.61.0	ATS	EL	
			7.11020.01.0	ATS	EL	
			7.05270.21.0	LS	600 mm	
			7.02604.99.0	LS	400 mm	
C 350 CDI (204.225) 165-170 kW (224-231 PS) OM 642.830	08.2007→08.2014		7.11020.16.0	ATS	EL	 ch. F349084→ch. F401031 vor Rußpartikelfilter before soot particulate filter Euro 5, Euro 6 Euro 5, Euro 6
			7.08369.51.0	ATS	EL	
			7.08369.61.0	ATS	EL	
			7.05270.21.0	LS	600 mm	
C 350 CDI (204.225) 165-170 kW (224-231 PS) OM 642.830	10.2009→08.2014		7.08369.51.0	ATS	EL	
			7.08369.61.0	ATS	EL	
			7.11020.16.0	ATS	EL	vor Rußpartikelfilter before soot particulate filter Euro 5, Euro 6 Euro 5, Euro 6
			7.05270.21.0	LS	600 mm	
			7.02604.99.0	LS	400 mm	
C 350 CDI 4-matic (204.289) 165 kW (224 PS) OM 642.961	08.2007→12.2011		7.24809.47.0	AGR	ET	 USA USA

M











C-CLASS T-Model (S204) 29

			7.11020.16.0	ATS	EL	 ch. F349084→ch. F401031 vor Rußpartikelfilter before soot particulate filter Euro 5, Euro 6 Euro 5, Euro 6
			7.11190.01.0	DDS		Luftfiltergehäuse Air Filter Housing
C 350 CDI 4-matic (204.292) 150-170 kW (204-231 PS) OM 642.832	10.2009→08.2014		7.08369.51.0	ATS	EL	
			7.08369.61.0	ATS	EL	
			7.11020.16.0	ATS	EL	vor Rußpartikelfilter before soot particulate filter Euro 5, Euro 6 Euro 5, Euro 6
			7.05270.21.0	LS	600 mm	
			7.02604.99.0	LS	400 mm	
C 350 CGI (204.257) 182-225 kW (248-306 PS) M 276.957	06.2011→08.2014		7.05270.17.0	LS	null mm	
			7.02604.44.0	LS	500 mm	für OE-Nummer: A 008 542 29 18, A 009 542 59 18 for OE number: A 008 542 29 18, A 009 542 59 18 vor Katalysator in front of the catalyst
			7.02604.99.0	LS	400 mm	
C 63 AMG (204.277) 336-410 kW (457-558 PS) M 156.985	02.2008→08.2014		7.05270.17.0	LS	null mm	
			7.05270.21.0	LS	600 mm	
			7.04389.09.0	SLP	EL	
C 63 AMG (204.277) 336-410 kW (457-558 PS) M 156.985	01.2012→08.2014		7.05270.17.0	LS	null mm	
			7.05270.21.0	LS	600 mm	
			7.04389.09.0	SLP	EL	











M

C-CLASS T-Model (S205) 30

AMG C 43 4-matic (205.264) 200-295 kW (272-401 PS) M 276.823	04.2016→05.2018		7.02604.44.0	LS	500 mm	vor Katalysator, links in front of the catalyst, Left
C 180 BlueTEC / d (205.236) 85-100 kW (116-136 PS) OM 626.951	09.2014→05.2018		7.24809.90.0	AGR	EL	
			7.11457.07.0* ↳ 7.11492.07.0	DDS DDS		
C 200 (205.242) 115-245 kW (156-333 PS) M 274.920	09.2014→05.2018		7.24809.83.0	AGR	EL	 für OE-Nummer: A 274 142 05 19 for OE number: A 274 142 05 19
			7.24809.85.0	AGR	EL	 für OE-Nummer: A 274 142 04 19, A 274 142 06 19 for OE number: A 274 142 04 19, A 274 142 06 19
C 200 4-matic (205.243) 115-245 kW (156-333 PS) M 274.920	04.2015→05.2018		7.24809.83.0	AGR	EL	 für OE-Nummer: A 274 142 05 19 for OE number: A 274 142 05 19















C-CLASS T-Model (S205) **30**

			7.24809.85.0	AGR	EL	 für OE-Nummer: A 274 142 04 19, A 274 142 06 19 for OE number: A 274 142 04 19, A 274 142 06 19
C 200 BlueTEC / d (205.237) 85-100 kW (116-136 PS) OM 626.951	09.2014→05.2018		7.24809.90.0	AGR	EL	
			7.11457.07.0*	DDS		
			↳ 7.11492.07.0	DDS		
C 200 d (205.207) 100-150 kW (136-204 PS) OM 651.921	10.2015→05.2018		7.24809.82.0	AGR	EL	mit Dichtring with O-ring
			7.08369.76.0	ATS	EL	vor Katalysator in front of the catalyst für Fahrzeuge mit SCR-System for vehicles with SCR system
			7.08369.88.0	ATS	EL	Katalysator Catalytic Converter für Linkslenker for left-hand drive vehicles für Fahrzeuge mit SCR-System for vehicles with SCR system
C 220 BlueTEC / d (205.204) 100-150 kW (136-204 PS) OM 651.921	09.2014→05.2018		7.24809.82.0	AGR	EL	mit Dichtring with O-ring
			7.08369.06.0	ATS	EL	
			7.08369.12.0	ATS	EL	
			7.08369.76.0	ATS	EL	vor Katalysator in front of the catalyst
			7.08369.88.0	ATS	EL	Katalysator Catalytic Converter für Linkslenker for left-hand drive vehicles für Fahrzeuge mit SCR-System for vehicles with SCR system
C 220 BlueTEC / d (205.204) 100-150 kW (136-204 PS) OM 651.921	09.2014→05.2018		7.24809.82.0	AGR	EL	mit Dichtring with O-ring
			7.08369.12.0	ATS	EL	
C 220 d 4-matic (205.205) 100-150 kW (136-204 PS) OM 651.921	04.2015→05.2018		7.24809.82.0	AGR	EL	mit Dichtring with O-ring
			7.08369.76.0	ATS	EL	vor Katalysator in front of the catalyst für Fahrzeuge mit SCR-System for vehicles with SCR system
			7.11020.33.0	ATS	EL	Katalysator Catalytic Converter für Fahrzeuge mit SCR-System for vehicles with SCR system
C 250 (205.245) 115-245 kW (156-333 PS) M 274.920	09.2014→05.2018		7.24809.83.0	AGR	EL	 für OE-Nummer: A 274 142 05 19 for OE number: A 274 142 05 19
			7.24809.85.0	AGR	EL	 für OE-Nummer: A 274 142 04 19, A 274 142 06 19 for OE number: A 274 142 04 19, A 274 142 06 19
C 250 BlueTEC / d (205.208) 100-150 kW (136-204 PS) OM 651.921	09.2014→05.2018		7.24809.82.0	AGR	EL	mit Dichtring with O-ring
			7.08369.12.0	ATS	EL	



M



C-CLASS T-Model (S205) 30





			7.08369.76.0	ATS	EL	vor Katalysator in front of the catalyst
			7.08369.88.0	ATS	EL	Katalysator Catalytic Converter für Linkslenker for left-hand drive vehicles für Fahrzeuge mit SCR-System for vehicles with SCR system
C 250 BlueTEC / d 4-matic (205.209) 100-150 kW (136-204 PS) OM 651.921	10.2014→05.2018		7.24809.82.0	AGR	EL	mit Dichtring with O-ring
			7.08369.76.0	ATS	EL	vor Katalysator in front of the catalyst
			7.11020.33.0	ATS	EL	Katalysator Catalytic Converter für Fahrzeuge mit SCR-System for vehicles with SCR system
C 300 (205.248) 115-245 kW (156-333 PS) M 274.920	09.2015→05.2018		7.24809.83.0	AGR	EL	 für OE-Nummer: A 274 142 05 19 for OE number: A 274 142 05 19
			7.24809.85.0	AGR	EL	 für OE-Nummer: A 274 142 04 19, A 274 142 06 19 for OE number: A 274 142 04 19, A 274 142 06 19
C 300 BlueTEC Hybrid / h (205.212) 100-150 kW (136-204 PS) OM 651.921	10.2014→05.2018		7.08369.12.0	ATS	EL	
			7.08369.76.0	ATS	EL	vor Katalysator in front of the catalyst
			7.08369.88.0	ATS	EL	Katalysator Catalytic Converter für Linkslenker for left-hand drive vehicles für Fahrzeuge mit SCR-System for vehicles with SCR system
C 350 e (205.247) 115-245 kW (156-333 PS) M 274.920	02.2015→05.2018		7.24809.83.0	AGR	EL	 für OE-Nummer: A 274 142 05 19 for OE number: A 274 142 05 19
			7.24809.85.0	AGR	EL	 für OE-Nummer: A 274 142 04 19, A 274 142 06 19 for OE number: A 274 142 04 19, A 274 142 06 19
C 350 e (205.247) 115-245 kW (156-333 PS) M 274.920	02.2015→05.2018		7.24809.83.0	AGR	EL	 für OE-Nummer: A 274 142 05 19 for OE number: A 274 142 05 19
			7.24809.85.0	AGR	EL	 für OE-Nummer: A 274 142 04 19, A 274 142 06 19 for OE number: A 274 142 04 19, A 274 142 06 19
C 400 4-matic (205.266) 200-295 kW (272-401 PS) M 276.823	10.2014→		7.02604.44.0	LS	500 mm	vor Katalysator, links in front of the catalyst, Left

CITAN MPV (415) 31

108 CDI (415.703) 55-81 kW (75-110 PS) OM 607.951	11.2012→		7.03435.05.0	AGR	EL	 Euro 5 Euro 5
			7.05320.04.0	AGR	EL	 Euro 6 Euro 6



CITAN MPV (415) **31**



			7.03571.16.0 AK EL ↳ 7.03083.20.0 SRM-AK EL 7.11190.08.0 DDS 7.11457.07.0* DDS ↳ 7.11492.07.0 DDS		für OE-Nummer: A 607 905 05 00 for OE number: A 607 905 05 00 Euro 6 Euro 6
108 CDI (415.703) 59-85 kW (80-116 PS) OM 608.915	02.2019→		7.11457.07.0* DDS ↳ 7.11492.07.0 DDS		
109 CDI (415.703) 55-81 kW (75-110 PS) OM 607.951	11.2012→		7.03435.05.0 AGR EL 7.05320.04.0 AGR EL 7.03571.16.0 AK EL ↳ 7.03083.20.0 SRM-AK EL 7.11190.08.0 DDS 7.11457.07.0* DDS ↳ 7.11492.07.0 DDS	○ Euro 5 Euro 5 ○ Euro 6 Euro 6 EL EL für OE-Nummer: A 607 905 05 00 for OE number: A 607 905 05 00 Euro 6 Euro 6	
109 CDI (415.703) 59-85 kW (80-116 PS) OM 608.915	02.2019→		7.11457.07.0* DDS ↳ 7.11492.07.0 DDS		
111 CDI (415.703) 59-85 kW (80-116 PS) OM 608.915	02.2019→		7.11457.07.0* DDS ↳ 7.11492.07.0 DDS		
111 CDI (415.703, 415.705) 55-81 kW (75-110 PS) OM 607.951	06.2013→		7.03435.05.0 AGR EL 7.05320.04.0 AGR EL 7.03571.16.0 AK EL ↳ 7.03083.20.0 SRM-AK EL 7.11190.08.0 DDS 7.11457.07.0* DDS ↳ 7.11492.07.0 DDS	○ Euro 5 Euro 5 ○ Euro 6 Euro 6 EL EL für OE-Nummer: A 607 905 05 00 for OE number: A 607 905 05 00 Euro 6 Euro 6	

M

CLA (C118) **32**













CLA 180 d (118.303) 59-85 kW (80-116 PS) OM 608.915	03.2019→		7.11457.07.0* DDS ↳ 7.11492.07.0 DDS		
---	----------	---	--	--	--

CLA Coupe (C117) **33**

AMG CLA 45 4-matic (117.352) 250-280 kW (340-381 PS) M 133.980	07.2015→03.2019		7.05270.21.0 LS	600 mm	für OE-Nummer: A 009 542 56 18 for OE number: A 009 542 56 18 vor Katalysator in front of the catalyst
CLA 180 (117.342) 75-115 kW (102-156 PS) M 270.910	01.2013→03.2019		7.05270.21.0 LS	600 mm	vor Katalysator in front of the catalyst











CLA Coupe (C117) 33

CLA 180 CDI / d (117.312) 55-81 kW (75-110 PS) OM 607.951	10.2013→05.2018		7.03435.05.0	AGR	EL	 Euro 5
			7.05320.04.0	AGR	EL	 Euro 6
			7.03571.16.0	AK	EL	
			7.03083.20.0 ↳ 7.11190.08.0	SRM-AK DDS	EL	Euro 6
CLA 200 (117.343) 75-115 kW (102-156 PS) M 270.910	01.2013→03.2019		7.05270.21.0	LS	600 mm	vor Katalysator in front of the catalyst
			7.11020.01.0	ATS	EL	
CLA 200 CDI (117.301) 80-100 kW (109-136 PS) OM 651.901	06.2013→08.2014		7.11020.32.0	ATS	EL	für OE-Nummer: A 000 905 07 01, A 000 905 77 05, A 000 905 81 05, A 000 905 91 05 for OE number: A 000 905 07 01, A 000 905 77 05, A 000 905 81 05, A 000 905 91 05
			7.11020.01.0	ATS	EL	
CLA 200 CDI / d (117.308) 80-130 kW (109-177 PS) OM 651.930	07.2014→03.2019		7.24809.82.0	AGR	EL	mit Dichtring with O-ring
			7.08369.89.0	ATS	EL	vor Katalysator in front of the catalyst Euro 6
			7.11020.01.0	ATS	EL	
			7.11020.32.0	ATS	EL	für OE-Nummer: A 000 905 07 01, A 000 905 81 05, A 000 905 91 05 for OE number: A 000 905 07 01, A 000 905 81 05, A 000 905 91 05
CLA 200 CDI / d 4-matic (117.302) 80-130 kW (109-177 PS) OM 651.930	07.2014→03.2019		7.24809.82.0	AGR	EL	mit Dichtring with O-ring
			7.08369.89.0	ATS	EL	vor Katalysator in front of the catalyst Euro 6
			7.11020.01.0	ATS	EL	
			7.11020.32.0	ATS	EL	für OE-Nummer: A 000 905 07 01, A 000 905 81 05, A 000 905 91 05 for OE number: A 000 905 07 01, A 000 905 81 05, A 000 905 91 05
CLA 220 (117.345) 115-160 kW (156-218 PS) M 270.920	04.2016→03.2019		7.24809.84.0	AGR	EL	
			7.05270.21.0	LS	600 mm	vor Katalysator in front of the catalyst
CLA 220 4-matic (117.347) 115-160 kW (156-218 PS) M 270.920	04.2016→03.2019		7.24809.84.0	AGR	EL	
			7.05270.21.0	LS	600 mm	vor Katalysator in front of the catalyst
CLA 220 CDI / d (117.303) 80-130 kW (109-177 PS) OM 651.930	01.2013→03.2019		7.24809.82.0	AGR	EL	mit Dichtring with O-ring

M









CLA Coupe (C117) **33**

			7.08369.89.0	ATS	EL	vor Katalysator in front of the catalyst Euro 6 Euro 6
			7.11020.01.0	ATS	EL	
			7.11020.32.0	ATS	EL	für OE-Nummer: A 000 905 07 01, A 000 905 81 05, A 000 905 91 05 for OE number: A 000 905 07 01, A 000 905 81 05, A 000 905 91 05
CLA 220 CDI / d (117.303) 80-130 kW (109-177 PS) OM 651.930	01.2013→03.2019		7.24809.82.0	AGR	EL	mit Dichtring with O-ring
			7.11020.01.0	ATS	EL	
CLA 220 CDI / d (117.303) 80-130 kW (109-177 PS) OM 651.930	09.2014→03.2019		7.24809.82.0	AGR	EL	mit Dichtring with O-ring
			7.08369.89.0	ATS	EL	vor Katalysator in front of the catalyst Euro 6 Euro 6
			7.11020.01.0	ATS	EL	
			7.11020.32.0	ATS	EL	für OE-Nummer: A 000 905 07 01, A 000 905 81 05, A 000 905 91 05 for OE number: A 000 905 07 01, A 000 905 81 05, A 000 905 91 05
CLA 220 CDI / d 4-matic (117.305) 80-130 kW (109-177 PS) OM 651.930	08.2014→03.2019		7.24809.82.0	AGR	EL	mit Dichtring with O-ring
			7.11020.01.0	ATS	EL	
CLA 220 CDI / d 4-matic (117.305) 80-130 kW (109-177 PS) OM 651.930	09.2014→03.2019		7.24809.82.0	AGR	EL	mit Dichtring with O-ring
			7.08369.89.0	ATS	EL	vor Katalysator in front of the catalyst Euro 6 Euro 6
			7.11020.01.0	ATS	EL	
			7.11020.32.0	ATS	EL	für OE-Nummer: A 000 905 07 01, A 000 905 81 05, A 000 905 91 05 for OE number: A 000 905 07 01, A 000 905 81 05, A 000 905 91 05
CLA 220 CDI 4-matic (117.305) 80-130 kW (109-177 PS) OM 651.930	07.2014→03.2019		7.24809.82.0	AGR	EL	mit Dichtring with O-ring
			7.08369.89.0	ATS	EL	vor Katalysator in front of the catalyst Euro 6 Euro 6
			7.11020.01.0	ATS	EL	
			7.11020.32.0	ATS	EL	für OE-Nummer: A 000 905 07 01, A 000 905 77 05, A 000 905 81 05, A 000 905 91 05 for OE number: A 000 905 07 01, A 000 905 77 05, A 000 905 81 05, A 000 905 91 05
CLA 250 (117.344) 115-160 kW (156-218 PS) M 270.920	01.2013→03.2019		7.24809.84.0	AGR	EL	
			7.05270.21.0	LS	600 mm	vor Katalysator in front of the catalyst
CLA 250 (117.350) 115-160 kW (156-218 PS) M 270.920	07.2015→03.2019		7.24809.84.0	AGR	EL	



CLA Coupe (C117) 33

			7.05270.21.0	LS	600 mm	vor Katalysator in front of the catalyst
CLA 250 4-matic (117.346) 115-160 kW (156-218 PS) M 270.920	07.2013→03.2019		7.24809.84.0	AGR	EL	
			7.05270.21.0	LS	600 mm	vor Katalysator in front of the catalyst
CLA 250 4-matic (117.351) 115-160 kW (156-218 PS) M 270.920	07.2015→03.2019		7.24809.84.0	AGR	EL	
			7.05270.21.0	LS	600 mm	vor Katalysator in front of the catalyst
CLA 45 AMG 4-matic (117.352) 250-280 kW (340-381 PS) M 133.980	07.2013→03.2019		7.05270.21.0	LS	600 mm	für OE-Nummer: A 009 542 56 18 for OE number: A 009 542 56 18 vor Katalysator in front of the catalyst











CLA Shooting Brake (X117) 34

AMG CLA 45 4-matic (117.952) 250-280 kW (340-381 PS) M 133.980	07.2015→03.2019		7.05270.21.0	LS	600 mm	für OE-Nummer: A 009 542 56 18 for OE number: A 009 542 56 18 vor Katalysator in front of the catalyst	
			7.05270.21.0	LS	600 mm	vor Katalysator in front of the catalyst	
			7.03435.05.0	AGR	EL		Euro 5 Euro 5
CLA 180 (117.942) 75-115 kW (102-156 PS) M 270.910	01.2015→03.2019		7.05270.21.0	LS	600 mm	vor Katalysator in front of the catalyst	
			7.05320.04.0	AGR	EL		Euro 6 Euro 6
			7.03571.16.0 ↳ 7.03083.20.0 7.11190.08.0	AK SRM-AK DDS	EL EL		Euro 6 Euro 6
CLA 200 (117.943) 75-115 kW (102-156 PS) M 270.910	01.2015→03.2019		7.05270.21.0	LS	600 mm	vor Katalysator in front of the catalyst	
CLA 200 CDI / d (117.908) 80-130 kW (109-177 PS) OM 651.930	01.2015→03.2019		7.24809.82.0	AGR	EL	mit Dichtring with O-ring	
			7.08369.89.0	ATS	EL	vor Katalysator in front of the catalyst Euro 6 Euro 6	
			7.11020.01.0 7.11020.32.0	ATS ATS	EL EL		für OE-Nummer: A 000 905 07 01, A 000 905 77 05, A 000 905 81 05, A 000 905 91 05 for OE number: A 000 905 07 01, A 000 905 77 05, A 000 905 81 05, A 000 905 91 05
			7.24809.82.0	AGR	EL	mit Dichtring with O-ring	
CLA 200 CDI / d 4-matic (117.902) 80-130 kW (109-177 PS) OM 651.930	01.2015→03.2019		7.08369.89.0	ATS	EL	vor Katalysator in front of the catalyst Euro 6 Euro 6	
			7.11020.01.0 7.11020.32.0	ATS ATS	EL EL		für OE-Nummer: A 000 905 81 05, A 000 905 91 05 for OE number: A 000 905 81 05, A 000 905 91 05



















M



CLA Shooting Brake (X117) **34**

CLA 220 4-matic (117.947) 115-160 kW (156-218 PS) M 270.920	04.2016→03.2019		7.24809.84.0	AGR	EL	
			7.05270.21.0	LS	600 mm	vor Katalysator in front of the catalyst
CLA 220 CDI / d (117.903) 80-130 kW (109-177 PS) OM 651.930	01.2015→03.2019		7.24809.82.0	AGR	EL	mit Dichtring with O-ring
			7.08369.89.0	ATS	EL	vor Katalysator in front of the catalyst Euro 6
			7.11020.01.0	ATS	EL	
			7.11020.32.0	ATS	EL	für OE-Nummer: A 000 905 07 01, A 000 905 81 05, A 000 905 91 05 for OE number: A 000 905 07 01, A 000 905 81 05, A 000 905 91 05
CLA 220 CDI / d (117.903) 80-130 kW (109-177 PS) OM 651.930	01.2015→03.2019		7.24809.82.0	AGR	EL	mit Dichtring with O-ring
			7.11020.01.0	ATS	EL	
CLA 220 CDI / d 4-matic (117.905) 80-130 kW (109-177 PS) OM 651.930	01.2015→03.2019		7.24809.82.0	AGR	EL	mit Dichtring with O-ring
			7.08369.89.0	ATS	EL	vor Katalysator in front of the catalyst Euro 6
			7.11020.01.0	ATS	EL	Euro 6
CLA 220 CDI / d 4-matic (117.905) 80-130 kW (109-177 PS) OM 651.930	09.2015→03.2019		7.24809.82.0	AGR	EL	mit Dichtring with O-ring
			7.11020.01.0	ATS	EL	
CLA 220 d (117.903) 80-130 kW (109-177 PS) OM 651.930	07.2018→03.2019		7.24809.82.0	AGR	EL	mit Dichtring with O-ring
			7.08369.89.0	ATS	EL	vor Katalysator in front of the catalyst Euro 6
			7.11020.01.0	ATS	EL	Euro 6
			7.11020.32.0	ATS	EL	für OE-Nummer: A 000 905 07 01, A 000 905 81 05, A 000 905 91 05 for OE number: A 000 905 07 01, A 000 905 81 05, A 000 905 91 05
CLA 220 d 4-matic (117.905) 80-130 kW (109-177 PS) OM 651.930	07.2018→03.2019		7.24809.82.0	AGR	EL	mit Dichtring with O-ring
			7.08369.89.0	ATS	EL	Katalysator Catalytic Converter Euro 6
			7.11020.01.0	ATS	EL	Euro 6
			7.11020.32.0	ATS	EL	für OE-Nummer: A 000 905 81 05, A 000 905 91 05 for OE number: A 000 905 81 05, A 000 905 91 05
CLA 250 (117.944) 115-160 kW (156-218 PS) M 270.920	01.2015→03.2019		7.24809.84.0	AGR	EL	
			7.05270.21.0	LS	600 mm	vor Katalysator in front of the catalyst





M

						
CLA Shooting Brake (X117)						34
CLA 250 4-matic (117.946) 115-160 kW (156-218 PS) M 270.920	01.2015→03.2019		7.24809.84.0	AGR	EL 	
			7.05270.21.0	LS	600 mm vor Katalysator in front of the catalyst	
CLA 250 4-matic (117.951) 115-160 kW (156-218 PS) M 270.920	07.2015→03.2019		7.05270.21.0	LS	600 mm vor Katalysator in front of the catalyst	
CLA 45 AMG 4-matic (117.952) 250-280 kW (340-381 PS) M 133.980	01.2015→07.2015		7.05270.21.0	LS	600 mm für OE-Nummer: A 009 542 56 18 for OE number: A 009 542 56 18 vor Katalysator in front of the catalyst	
CLA Shooting Brake (X118)						35
CLA 180 d (118.603) 59-85 kW (80-116 PS) OM 608.915	06.2019→		7.11457.07.0*	DDS		
			↳7.11492.07.0	DDS		
CLC-CLASS (CL203)						36
CLC 160 (203.731) 95 kW (129 PS) M 271.911	02.2009→06.2011		7.05270.11.0	LS	750 mm nach Katalysator Post-catalyst	
CLC 180 Kompressor (203.746) 105-125 kW (143-170 PS) M 271.946	05.2008→06.2011		7.05271.23.0	LS	900 mm	
			7.05270.11.0	LS	750 mm nach Katalysator Post-catalyst	
CLC 200 CDI (203.707) 75-110 kW (102-150 PS) OM 646.962	05.2008→06.2011		7.24809.36.0	AGR	ET 	
			7.08369.30.0	ATS	EL vor Katalysator in front of the catalyst	
			7.08369.80.0	ATS	EL Abgaskrümmer Exhaust Manifold Euro 4 Euro 4 für Fahrzeuge mit Diesel-Partikel-Filter (DPF) for vehicles with diesel soot filter	
			7.08369.94.0	ATS	EL für OE-Nummer: A 005 153 11 28, A 007 153 63 28 for OE number: A 005 153 11 28, A 007 153 63 28 Partikelfilter Particulate Filter	
			7.08369.97.0	ATS	EL Partikelfilter Particulate Filter für Rechtslenker for right-hand drive vehicles	
7.05270.22.0	LS	825 mm				
CLC 200 Kompressor (203.741) 120-135 kW (163-184 PS) M 271.957	05.2008→06.2011		7.05271.23.0	LS	900 mm	
			7.05270.11.0	LS	750 mm nach Katalysator Post-catalyst	
CLC 220 CDI (203.708) 90-110 kW (122-150 PS) OM 646.963	05.2008→06.2011		7.24809.36.0	AGR	ET 	
			7.08369.30.0	ATS	EL vor Katalysator in front of the catalyst	

M







CLC-CLASS (CL203) 36

			7.08369.94.0	ATS	EL	für OE-Nummer: A 005 153 11 28, A 007 153 63 28 for OE number: A 005 153 11 28, A 007 153 63 28 Partikelfilter Particulate Filter
			7.08369.97.0	ATS	EL	Partikelfilter Particulate Filter für Rechtslenker for right-hand drive vehicles
			7.11190.01.0	DDS		Luftfiltergehäuse Air Filter Housing
			7.05270.22.0	LS	825 mm	
CLC 220 CDI (203.708) 90-110 kW (122-150 PS) OM 646.963	05.2008→06.2011		7.08369.94.0	ATS	EL	für OE-Nummer: A 005 153 11 28, A 007 153 63 28 for OE number: A 005 153 11 28, A 007 153 63 28 Partikelfilter Particulate Filter
			7.08369.97.0	ATS	EL	Partikelfilter Particulate Filter für Rechtslenker for right-hand drive vehicles
			7.11190.01.0	DDS		Luftfiltergehäuse Air Filter Housing
CLC 230 (203.752) 150 kW (204 PS) M 272.920	05.2008→06.2011		7.05270.17.0	LS	null mm	
			7.05270.22.0	LS	825 mm	
			7.04389.02.0	SLP	EL	
CLC 250 150 kW (204 PS) M 272.920	06.2009→06.2011		7.04389.02.0	SLP	EL	
CLC 350 (203.756) 170-200 kW (231-272 PS) M 272.960	05.2008→06.2011		7.05270.17.0	LS	null mm	
			7.05270.22.0	LS	825 mm	
			7.04389.02.0	SLP	EL	





M

CLK (C208) 37

200 Kompressor (208.344) 120 kW (163 PS) M 111.956	06.2000→06.2002		7.05270.12.0	LS	500 mm	vor Katalysator in front of the catalyst
230 Kompressor (208.347) 138-142 kW (188-193 PS) M 111.975	06.1997→06.2000		7.05270.11.0	LS	750 mm	vor Katalysator in front of the catalyst für Linkslenker for left-hand drive vehicles
			7.05270.12.0	LS	500 mm	vor Katalysator in front of the catalyst für Rechtslenker for right-hand drive vehicles
230 Kompressor (208.348) 145 kW (197 PS) M 111.982	06.2000→06.2002		7.05270.11.0	LS	750 mm	vor Katalysator in front of the catalyst für Linkslenker for left-hand drive vehicles
			7.05270.12.0	LS	500 mm	vor Katalysator in front of the catalyst für Rechtslenker for right-hand drive vehicles
320 (208.365) 160-162 kW (218-220 PS) M 112.940	06.1997→06.2002		7.22136.50.0	AGR	PN	<input checked="" type="checkbox"/>



CLK (C208) 37

			7.05270.03.0	LS	820 mm	für OE-Nummer: A 001 540 74 17 for OE number: A 001 540 74 17
			7.02604.27.0	LS	750 mm	
			7.05270.11.0	LS	750 mm	
			7.02604.25.0	LS	425 mm	
			7.04389.00.0	SLP	EL	
430 (208.370) 205 kW (279 PS) M 113.943	07.1998→06.2002		7.22136.50.0	AGR	PN	<input checked="" type="checkbox"/>
			7.05270.03.0	LS	820 mm	für OE-Nummer: A 001 540 74 17 for OE number: A 001 540 74 17
			7.02604.27.0	LS	750 mm	
			7.05270.11.0	LS	750 mm	
			7.02604.25.0	LS	425 mm	
			7.04389.00.0	SLP	EL	
5.4 255-260 kW (347-354 PS) M 113.984	10.1998→07.2002		7.22136.50.0	AGR	PN	<input checked="" type="checkbox"/>
			7.05270.03.0	LS	820 mm	Fahrgestellnummer bis: 208 F 198564, 208 T 102653 Vehicle Identification Number to: 208 F 198564, 208 T 102653
			7.02604.27.0	LS	750 mm	
			7.02604.25.0	LS	425 mm	
			7.04389.00.0	SLP	EL	
			7.05270.11.0	LS	750 mm	
55 AMG (208.374) 255 kW (347 PS) M 113.981	08.1999→06.2002		7.22136.50.0	AGR	PN	<input checked="" type="checkbox"/>
			7.05270.03.0	LS	820 mm	Fahrgestellnummer bis: 208 F 198564, 208 T 102653 Vehicle Identification Number to: 208 F 198564, 208 T 102653
			7.02604.27.0	LS	750 mm	
			7.02604.25.0	LS	425 mm	
			7.04389.00.0	SLP	EL	
			7.05270.11.0	LS	750 mm	
55 AMG (208.374) 255-260 kW (347-354 PS) M 113.984	08.1999→06.2002		7.22136.50.0	AGR	PN	<input checked="" type="checkbox"/>
			7.05270.03.0	LS	820 mm	für OE-Nummer: A 001 540 74 17 for OE number: A 001 540 74 17
			7.02604.27.0	LS	750 mm	
			7.05270.11.0	LS	750 mm	
			7.02604.25.0	LS	425 mm	
			7.04389.00.0	SLP	EL	











M

CLK (C209) 38

200 CGI (209.343) 125 kW (170 PS) M 271.942	07.2003→05.2009		7.05271.23.0	LS	900 mm	nach Katalysator Post-catalyst
			7.05270.11.0	LS	750 mm	

















CLK (C209) **38**

200 Kompressor (209.341) 135 kW (184 PS) M 271.955	10.2006→05.2009		7.05271.23.0	LS	900 mm	
			7.05270.11.0	LS	750 mm	nach Katalysator Post-catalyst
200 Kompressor (209.342) 120 kW (163 PS) M 271.940	09.2002→05.2009		7.05271.23.0	LS	900 mm	
			7.05270.11.0	LS	750 mm	nach Katalysator Post-catalyst
220 CDI (209.308) 100-110 kW (136-150 PS) OM 646.966	01.2005→05.2009		7.24809.36.0	AGR	ET	
			7.08369.80.0	ATS	EL	Abgaskrümmer Exhaust Manifold Euro 4 Euro 4 für Fahrzeuge mit Diesel-Partikel-Filter (DPF) for vehicles with diesel soot filter
			7.08369.94.0	ATS	EL	Partikelfilter Particulate Filter für Linkslenker for left-hand drive vehicles
			7.05270.22.0	LS	825 mm	
220 CDI (209.308) 100-110 kW (136-150 PS) OM 646.966	01.2005→05.2009		7.24809.36.0	AGR	ET	
			7.08369.94.0	ATS	EL	Partikelfilter Particulate Filter für Linkslenker for left-hand drive vehicles
			7.05270.22.0	LS	825 mm	
240 (209.361) 120-125 kW (163-170 PS) M 112.912	06.2002→05.2009		7.22136.50.0	AGR	PN	<input checked="" type="checkbox"/>
			7.05270.11.0	LS	750 mm	vor Katalysator, links in front of the catalyst, Left
			7.02604.26.0	LS	500 mm	
			7.05270.12.0	LS	500 mm	vor Katalysator, rechts in front of the catalyst, Right
			7.04389.00.0	SLP	EL	
240 (209.361) 120-125 kW (163-170 PS) M 112.912	06.2002→05.2009		7.22136.50.0	AGR	PN	<input checked="" type="checkbox"/>
			7.02604.26.0	LS	500 mm	
			7.05270.12.0	LS	500 mm	vor Katalysator, rechts in front of the catalyst, Right
			7.04389.00.0	SLP	EL	
280 (209.354) 170 kW (231 PS) M 272.940	01.2005→05.2009		7.05270.17.0	LS	null mm	
			7.05270.22.0	LS	825 mm	
			7.04389.02.0	SLP	EL	
320 (209.365) 160 kW (218 PS) M 112.955	06.2002→05.2009		7.22136.50.0	AGR	PN	<input checked="" type="checkbox"/>
			7.05270.11.0	LS	750 mm	vor Katalysator, links in front of the catalyst, Left















M



CLK (C209) **38**

			7.02604.26.0	LS	500 mm	
			7.05270.12.0	LS	500 mm	vor Katalysator, rechts in front of the catalyst, Right
			7.04389.00.0	SLP	EL	
320 CDI (209.320) 165 kW (224 PS) OM 642.910	01.2005→05.2009		7.24809.47.0	AGR	ET	
			7.11190.01.0	DDS		Luftfiltergehäuse Air Filter Housing
			7.05270.21.0	LS	600 mm	
			7.02604.99.0	LS	400 mm	
350 (209.356) 170-200 kW (231-272 PS) M 272.960	01.2005→05.2009		7.05270.17.0	LS	null mm	
			7.05270.22.0	LS	825 mm	
			7.04389.02.0	SLP	EL	
500 215-225 kW (292-306 PS) M 113.968	09.2002→12.2005		7.22136.50.0	AGR	PN	
			7.04389.00.0	SLP	EL	
500 (209.372) 285 kW (388 PS) M 273.965	06.2006→05.2009		7.05270.17.0	LS	null mm	links, rechts Left, Right Diagnosesonde Diagnostic Probe
			7.05270.22.0	LS	825 mm	links, rechts Left, Right
			7.04389.02.0	SLP	EL	
500 (209.375) 215-225 kW (292-306 PS) M 113.968	06.2002→05.2009		7.22136.50.0	AGR	PN	
			7.05270.11.0	LS	750 mm	vor Katalysator, links in front of the catalyst, Left
			7.02604.26.0	LS	500 mm	links, rechts Left, Right
			7.05270.12.0	LS	500 mm	vor Katalysator, rechts in front of the catalyst, Right
			7.04389.00.0	SLP	EL	
55 AMG 260-270 kW (354-367 PS) M 113.987	09.2002→12.2005		7.22136.50.0	AGR	PN	
			7.04389.00.0	SLP	EL	→12.2004
55 AMG (209.376) 260-270 kW (354-367 PS) M 113.987	09.2002→05.2009		7.22136.50.0	AGR	PN	
			7.05270.11.0	LS	750 mm	 M 113.987: vor Katalysator, links in front of the catalyst, Left für Rechtslenker for right-hand drive vehicles  M 113.987: vor Katalysator, links in front of the catalyst, Left für Linkslenker for left-hand drive vehicles Produktionsdatum bis: 01.08.2004 Production date to: 01.08.2004
			7.02604.26.0	LS	500 mm	
			7.05270.12.0	LS	500 mm	vor Katalysator, rechts in front of the catalyst, Right
			7.04389.00.0	SLP	EL	→12.2004
			7.04389.06.0	SLP	EL	2005 2005

M











			 PIERBURG			
CLK (C209)						38
63 AMG (209.377) 354-373 kW (481-507 PS) M 156.982	04.2006→05.2009		7.05270.22.0	LS	825 mm	für OE-Nummer: A 000 140 42 85 for OE number: A 000 140 42 85 nicht für Ausstattungsvariante: AMG Black Series not for equipment variant: AMG Black Series
			7.04389.04.0	SLP	EL	
			7.04389.06.0	SLP	EL	
63 AMG (209.377) 354-373 kW (481-507 PS) M 156.982	05.2007→05.2009		7.05270.22.0	LS	825 mm	
			7.04389.04.0	SLP	EL	
			7.04389.06.0	SLP	EL	
CLK Convertible (A208)						39
200 Kompressor (208.444) 120 kW (163 PS) M 111.956	06.2000→03.2002		7.05270.12.0	LS	500 mm	vor Katalysator in front of the catalyst
230 Kompressor (208.448) 145 kW (197 PS) M 111.982	06.2000→03.2002		7.05270.11.0	LS	750 mm	vor Katalysator in front of the catalyst für Linkslenker for left-hand drive vehicles
			7.05270.12.0	LS	500 mm	vor Katalysator in front of the catalyst für Rechtslenker for right-hand drive vehicles
M 320 (208.465) 160-162 kW (218-220 PS) M 112.940	03.1998→03.2002		7.22136.50.0	AGR	PN	<input checked="" type="checkbox"/>
			7.05270.03.0	LS	820 mm	
			7.02604.27.0	LS	750 mm	
			7.02604.25.0	LS	425 mm	
			7.04389.00.0	SLP	EL	
430 (208.470) 205 kW (279 PS) M 113.943	09.1998→03.2002		7.22136.50.0	AGR	PN	<input checked="" type="checkbox"/>
			7.05270.03.0	LS	820 mm	für OE-Nummer: A 001 540 74 17 for OE number: A 001 540 74 17
			7.02604.27.0	LS	750 mm	
			7.05270.11.0	LS	750 mm	
			7.02604.25.0	LS	425 mm	
7.04389.00.0	SLP	EL				
55 AMG (208.474) 255 kW (347 PS) M 113.981	01.2000→03.2002		7.22136.50.0	AGR	PN	<input checked="" type="checkbox"/>
			7.05270.03.0	LS	820 mm	
			7.02604.27.0	LS	750 mm	
			7.02604.25.0	LS	425 mm	
			7.04389.00.0	SLP	EL	
55 AMG (208.474) 255-260 kW (347-354 PS) M 113.984	01.2000→03.2002		7.22136.50.0	AGR	PN	<input checked="" type="checkbox"/>
			7.05270.03.0	LS	820 mm	



CLK Convertible (A208) 39

		7.02604.27.0	LS	750 mm	
		7.05270.11.0	LS	750 mm	vorne links Left Front 2001 2001
		7.02604.25.0	LS	425 mm	
		7.04389.00.0	SLP	EL	Fahrgestellnummer bis: 208 F 198564, 208 T 102653 Vehicle Identification Number to: 208 F 198564, 208 T 102653

















CLK Convertible (A209) 40

CLK 200 CGI (209.343) 125 kW (170 PS) M 271.942	07.2003→03.2010	 7.05271.23.0	LS	900 mm	
CLK 200 Kompressor (209.441) 135 kW (184 PS) M 271.955	10.2006→03.2010	 7.05271.23.0	LS	900 mm	
		7.05270.11.0	LS	750 mm	nach Katalysator Post-catalyst
CLK 200 Kompressor (209.442) 120 kW (163 PS) M 271.940	02.2003→03.2010	 7.05271.23.0	LS	900 mm	
		7.05270.11.0	LS	750 mm	nach Katalysator Post-catalyst
CLK 240 (209.461) 120-125 kW (163-170 PS) M 112.912	02.2003→03.2010	 7.22136.50.0	AGR	PN	<input checked="" type="checkbox"/>
		7.05270.11.0	LS	750 mm	 M 112.912: vor Katalysator, links in front of the catalyst, Left für Rechtslenker for right-hand drive vehicles Produktionsdatum ab: 18.10.2002 Production date from: 18.10.2002  M 112.912: vor Katalysator, links in front of the catalyst, Left für Linkslenker for left-hand drive vehicles
		7.02604.26.0	LS	500 mm	
		7.05270.12.0	LS	500 mm	vor Katalysator, rechts in front of the catalyst, Right
		7.04389.00.0	SLP	EL	
CLK 280 (209.454) 170 kW (231 PS) M 272.940	01.2005→03.2010	 7.05270.17.0	LS	null mm	
		7.05270.22.0	LS	825 mm	
		7.04389.02.0	SLP	EL	
CLK 320 (209.465) 160 kW (218 PS) M 112.955	02.2003→03.2010	 7.22136.50.0	AGR	PN	<input checked="" type="checkbox"/>
		7.05270.11.0	LS	750 mm	 M 112.955: vor Katalysator, links in front of the catalyst, Left für Rechtslenker for right-hand drive vehicles Produktionsdatum ab: 18.10.2002 Production date from: 18.10.2002  M 112.955: vor Katalysator, links in front of the catalyst, Left für Linkslenker for left-hand drive vehicles

M



CLK Convertible (A209) **40**

			7.02604.26.0	LS	500 mm	vor Katalysator, rechts in front of the catalyst, Right		
			7.05270.12.0	LS	500 mm			
			7.04389.00.0	SLP	EL			
CLK 320 CDI (209.420) 165 kW (224 PS) OM 642.910	03.2005→03.2010		7.24809.47.0	AGR	ET			
			7.11190.01.0	DDS		Luftfiltergehäuse Air Filter Housing		
			7.11190.01.0	DDS				
			7.05270.21.0	LS	600 mm			
CLK 350 (209.456) 170-200 kW (231-272 PS) M 272.960	01.2005→03.2010		7.05270.17.0	LS	null mm			
			7.05270.22.0	LS	825 mm			
			7.04389.02.0	SLP	EL			
CLK 500 215-225 kW (292-306 PS) M 113.968	09.2003→12.2005		7.22136.50.0	AGR	PN			
			7.04389.00.0	SLP	EL			
CLK 500 (209.472) 285 kW (388 PS) M 273.967	06.2006→03.2010		7.04389.02.0	SLP	EL			
M CLK 500 (209.475) 215-225 kW (292-306 PS) M 113.968	02.2003→03.2010		7.22136.50.0	AGR	PN			
			7.05270.11.0	LS	750 mm	 M 113.968: vor Katalysator, links in front of the catalyst, Left für Linkslenker for left-hand drive vehicles		
								 M 113.968: vor Katalysator, links in front of the catalyst, Left für Rechtslenker for right-hand drive vehicles
								Produktionsdatum ab: 18.10.2002 Production date from: 18.10.2002
			7.02604.26.0	LS	500 mm	links, rechts Left, Right		
			7.05270.12.0	LS	500 mm	vor Katalysator, rechts in front of the catalyst, Right		
			7.04389.00.0	SLP	EL			
CLK 55 AMG 260-270 kW (354-367 PS) M 113.987	09.2003→12.2005		7.22136.50.0	AGR	PN			
			7.04389.00.0	SLP	EL	→12.2004		
CLK 55 AMG (209.476) 260-270 kW (354-367 PS) M 113.987	06.2002→03.2010		7.22136.50.0	AGR	PN			
			7.05270.11.0	LS	750 mm	 M 113.987: vor Katalysator, links in front of the catalyst, Left für Linkslenker for left-hand drive vehicles Produktionsdatum bis: 28.05.2004 Production date to: 28.05.2004		
						 M 113.987: vor Katalysator, links in front of the catalyst, Left für Rechtslenker for right-hand drive vehicles		
			7.02604.26.0	LS	500 mm			



CLK Convertible (A209) 40

		7.05270.12.0	LS	500 mm	vor Katalysator, rechts in front of the catalyst, Right
		7.04389.00.0	SLP	EL	→12.2004
		7.04389.06.0	SLP	EL	2005 2005
CLK 63 AMG (209.477) 354-373 kW (481-507 PS) M 156.982	04.2006→03.2010	 7.05270.22.0	LS	825 mm	
		7.04389.04.0	SLP	EL	für OE-Nummer: A 000 140 42 85 for OE number: A 000 140 42 85
		7.04389.06.0	SLP	EL	nicht für Ausstattungsvariante: AMG Black Series not for equipment variant: AMG Black Series



CLS (C218) 41

CLS 220 BlueTEC / d (218.301) 120-150 kW (163-204 PS) OM 651.924	05.2014→12.2017	 7.08369.06.0	ATS	EL	
		7.08369.12.0	ATS	EL	
		7.08369.76.0	ATS	EL	für OE-Nummer: A 000 905 52 02, A 000 905 89 04 for OE number: A 000 905 52 02, A 000 905 89 04 vor Rußpartikelfilter before soot particulate filter
		7.08369.90.0	ATS	EL	für OE-Nummer: A 000 905 65 04, A 001 905 07 00 for OE number: A 000 905 65 04, A 001 905 07 00 vor Rußpartikelfilter before soot particulate filter
		7.08369.97.0	ATS	EL	für OE-Nummer: A 000 905 52 05, A 008 153 41 28 for OE number: A 000 905 52 05, A 008 153 41 28 vor Rußpartikelfilter before soot particulate filter
CLS 220 BlueTEC / d (218.301) 120-150 kW (163-204 PS) OM 651.924	05.2014→12.2017	 7.08369.06.0	ATS	EL	
		7.08369.12.0	ATS	EL	
		7.08369.76.0	ATS	EL	für OE-Nummer: A 000 905 52 02, A 000 905 89 04 for OE number: A 000 905 52 02, A 000 905 89 04 vor Rußpartikelfilter before soot particulate filter
		7.08369.89.0	ATS	EL	Partikelfilter Particulate Filter für Fahrzeuge mit SCR-System for vehicles with SCR system
		7.08369.90.0	ATS	EL	für OE-Nummer: A 000 905 65 04, A 001 905 07 00 for OE number: A 000 905 65 04, A 001 905 07 00 vor Rußpartikelfilter before soot particulate filter
		7.08369.97.0	ATS	EL	für OE-Nummer: A 000 905 52 05, A 008 153 41 28 for OE number: A 000 905 52 05, A 008 153 41 28 vor Rußpartikelfilter before soot particulate filter

M









CLS (C218) 41

CLS 220 BlueTEC / d (218.301) 120-150 kW (163-204 PS) OM 651.924	05.2014→12.2017		7.08369.06.0	ATS	EL	
			7.08369.12.0	ATS	EL	
			7.08369.76.0	ATS	EL	für OE-Nummer: A 000 905 52 02, A 000 905 89 04 for OE number: A 000 905 52 02, A 000 905 89 04 vor Rußpartikelfilter before soot particulate filter
			7.08369.90.0	ATS	EL	für OE-Nummer: A 000 905 65 04, A 001 905 07 00 for OE number: A 000 905 65 04, A 001 905 07 00 vor Rußpartikelfilter before soot particulate filter
CLS 250 BlueTEC / d 4-matic (218.397) 120-150 kW (163-204 PS) OM 651.924	05.2014→12.2017		7.08369.06.0	ATS	EL	
			7.08369.12.0	ATS	EL	für OE-Nummer: A 000 905 68 04, A 008 153 27 28 for OE number: A 000 905 68 04, A 008 153 27 28 vor Rußpartikelfilter before soot particulate filter
			7.08369.89.0	ATS	EL	für OE-Nummer: A 000 905 70 04, A 000 905 85 01 for OE number: A 000 905 70 04, A 000 905 85 01 nach Rußpartikelfilter after soot particulate filter
			7.08369.90.0	ATS	EL	für OE-Nummer: A 000 905 65 04, A 001 905 07 00 for OE number: A 000 905 65 04, A 001 905 07 00 vor Rußpartikelfilter before soot particulate filter
CLS 250 CDI / BlueTEC / d (218.303, 218.304) 120-150 kW (163-204 PS) OM 651.924	04.2011→12.2017		7.08369.06.0	ATS	EL	
			7.08369.12.0	ATS	EL	
			7.08369.76.0	ATS	EL	für OE-Nummer: A 000 905 52 02, A 000 905 89 04 for OE number: A 000 905 52 02, A 000 905 89 04 vor Rußpartikelfilter before soot particulate filter für Linkslenker for left-hand drive vehicles
			7.08369.97.0	ATS	EL	für OE-Nummer: A 000 905 52 05, A 008 153 41 28 for OE number: A 000 905 52 05, A 008 153 41 28 für Rechtslenker for right-hand drive vehicles

















M



CLS (C218) **41**

			7.08369.89.0	ATS	EL	für OE-Nummer: A 000 905 70 04, A 000 905 85 01 for OE number: A 000 905 70 04, A 000 905 85 01 Partikelfilter Particulate Filter
			7.08369.90.0	ATS	EL	für OE-Nummer: A 000 905 65 04, A 001 905 07 00 for OE number: A 000 905 65 04, A 001 905 07 00 vor Rußpartikelfilter before soot particulate filter für Linkslenker for left-hand drive vehicles
			7.08369.97.0	ATS	EL	für OE-Nummer: A 000 905 52 05, A 008 153 41 28 for OE number: A 000 905 52 05, A 008 153 41 28 vor Rußpartikelfilter before soot particulate filter für Rechtslenker for right-hand drive vehicles
			7.11020.00.0	ATS	EL	für OE-Nummer: A 007 153 94 28 for OE number: A 007 153 94 28 vor Rußpartikelfilter before soot particulate filter für Linkslenker for left-hand drive vehicles
CLS 260 (218.336) 115-245 kW (156-333 PS) M 274.920	01.2015→12.2017		7.24809.85.0	AGR	EL	 Produktionsdatum bis: 29.09.2017 Production date to: 29.09.2017
			7.02604.44.0	LS	500 mm	vor Katalysator in front of the catalyst
CLS 300 (218.355) 185-245 kW (252-333 PS) M 276.952	10.2011→05.2014		7.02604.44.0	LS	500 mm	für OE-Nummer: A 008 542 29 18, A 009 542 59 18 for OE number: A 008 542 29 18, A 009 542 59 18 vor Katalysator in front of the catalyst
			7.05270.21.0	LS	600 mm	für OE-Nummer: A 009 542 56 18 for OE number: A 009 542 56 18
CLS 320 (218.362) 200-245 kW (272-333 PS) M 276.820	01.2015→12.2017		7.02604.44.0	LS	500 mm	für OE-Nummer: A 009 542 59 18, A 009 542 63 18 for OE number: A 009 542 59 18, A 009 542 63 18 vor Katalysator in front of the catalyst
			7.02604.44.0	LS	500 mm	für OE-Nummer: A 008 542 29 18, A 009 542 59 18 for OE number: A 008 542 29 18, A 009 542 59 18 vor Katalysator in front of the catalyst
CLS 350 (218.359) 185-245 kW (252-333 PS) M 276.952	01.2011→08.2014		7.02604.44.0	LS	500 mm	für OE-Nummer: A 008 542 29 18, A 009 542 59 18 for OE number: A 008 542 29 18, A 009 542 59 18 vor Katalysator in front of the catalyst
			7.08369.61.0	ATS	EL	
CLS 350 BlueTEC / d (218.326) 170-195 kW (231-265 PS) OM 642.852, OM 642.853	02.2013→12.2017		7.08369.61.0	ATS	EL	
			7.08369.89.0	ATS	EL	 OM 642.852, OM 642.853: für OE-Nummer: A 000 905 70 04, A 000 905 85 01 for OE number: A 000 905 70 04, A 000 905 85 01 Partikelfilter Particulate Filter
			7.11020.01.0	ATS	EL	

M

					
CLS (C218)					41
CLS 350 BlueTEC / d (218.326) 170-195 kW (231-265 PS) OM 642.852, OM 642.853	06.2014→12.2017		7.08369.61.0	ATS	EL
			7.11020.01.0	ATS	EL
CLS 350 BlueTEC / d 4-matic (218.394) 185-195 kW (252-265 PS) OM 642.854, OM 642.858	02.2013→12.2017		7.08369.61.0	ATS	EL
			7.08369.89.0	ATS	EL  OM 642.854, OM 642.858: für OE-Nummer: A 000 905 70 04, A 000 905 85 01 for OE number: A 000 905 70 04, A 000 905 85 01 nach Rußpartikelfilter after soot particulate filter
			7.11020.01.0	ATS	EL
CLS 350 CDI / d (218.323) 170-195 kW (231-265 PS) OM 642.852, OM 642.853	01.2011→08.2014		7.08369.61.0	ATS	EL
			7.08369.89.0	ATS	EL  OM 642.852: für OE-Nummer: A 000 905 70 04, A 000 905 85 01 for OE number: A 000 905 70 04, A 000 905 85 01 Partikelfilter Particulate Filter  OM 642.853: für OE-Nummer: A 000 905 70 04, A 000 905 85 01 for OE number: A 000 905 70 04, A 000 905 85 01 Partikelfilter Particulate Filter
			7.11020.01.0	ATS	EL
CLS 350 CDI / d 4-matic (218.393) 185-195 kW (252-265 PS) OM 642.854, OM 642.858	09.2011→08.2014		7.08369.61.0	ATS	EL
			7.08369.89.0	ATS	EL  OM 642.854, OM 642.858: für OE-Nummer: A 000 905 70 04, A 000 905 85 01 for OE number: A 000 905 70 04, A 000 905 85 01 nach Rußpartikelfilter after soot particulate filter
			7.11020.01.0	ATS	EL
CLS 350 d 4-matic (218.394) 185-195 kW (252-265 PS) OM 642.854, OM 642.858	04.2015→12.2017		7.11020.01.0	ATS	EL
CLS 400 (218.361) 245 kW (333 PS) M 276.850	07.2014→12.2017		7.05270.21.0	LS	600 mm für OE-Nummer: A 009 542 56 18 for OE number: A 009 542 56 18
			7.02604.44.0	LS	500 mm für OE-Nummer: A 009 542 59 18, A 009 542 63 18 for OE number: A 009 542 59 18, A 009 542 63 18 vor Katalysator in front of the catalyst
CLS 400 (218.365) 200-245 kW (272-333 PS) M 276.820	05.2014→12.2017		7.05270.21.0	LS	600 mm für OE-Nummer: A 009 542 56 18 for OE number: A 009 542 56 18
			7.02604.44.0	LS	500 mm für OE-Nummer: A 009 542 59 18, A 009 542 63 18 for OE number: A 009 542 59 18, A 009 542 63 18 vor Katalysator, rechts in front of the catalyst, Right















M

						
CLS (C218)						41
CLS 400 4-matic (218.367) 200-245 kW (272-333 PS) M 276.820	05.2014→12.2017		7.02604.44.0	LS	500 mm für OE-Nummer: A 009 542 59 18, A 009 542 63 18 for OE number: A 009 542 59 18, A 009 542 63 18 vor Katalysator in front of the catalyst	
CLS 400 4-matic (218.368) 245 kW (333 PS) M 276.850	07.2014→12.2017		7.05270.21.0	LS	600 mm für OE-Nummer: A 009 542 56 18 for OE number: A 009 542 56 18	
			7.02604.44.0	LS	500 mm für OE-Nummer: A 009 542 59 18, A 009 542 63 18 for OE number: A 009 542 59 18, A 009 542 63 18 vor Katalysator in front of the catalyst	
CLS 500 (218.373) 300-320 kW (408-435 PS) M 278.922	02.2011→12.2017		7.02604.44.0	LS	500 mm für OE-Nummer: A 009 542 63 18 for OE number: A 009 542 63 18 vor Katalysator in front of the catalyst	
CLS 500 4-matic (218.391) 300-320 kW (408-435 PS) M 278.922	09.2011→12.2017		7.02604.44.0	LS	500 mm für Getriebeautomatik 7 Gang for 7-speed automatic transmission für OE-Nummer: A 009 542 63 18 for OE number: A 009 542 63 18 vor Katalysator in front of the catalyst	
CLS 63 AMG (218.374) 386-430 kW (525-585 PS) M 157.980, M 157.981	01.2011→12.2017		7.02604.44.0	LS	500 mm	
CLS 63 AMG (218.374) 386-430 kW (525-585 PS) M 157.980, M 157.981	01.2011→12.2017		7.02604.44.0	LS	500 mm	
CLS 63 AMG (218.375) 386-430 kW (525-585 PS) M 157.981	02.2013→12.2017		7.02604.44.0	LS	500 mm für OE-Nummer: A 009 542 63 18 for OE number: A 009 542 63 18 vor Katalysator in front of the catalyst	
CLS 63 AMG 4-matic (218.376) 386-430 kW (525-585 PS) M 157.981	02.2013→12.2017		7.02604.44.0	LS	500 mm für OE-Nummer: A 009 542 63 18 for OE number: A 009 542 63 18 vor Katalysator in front of the catalyst	
CLS 63 AMG 4-matic (218.392) 386-430 kW (525-585 PS) M 157.981	05.2013→12.2017		7.02604.44.0	LS	500 mm für OE-Nummer: A 009 542 63 18 for OE number: A 009 542 63 18 vor Katalysator in front of the catalyst	
CLS (C219)						42
CLS 280 (219.354) 170 kW (231 PS) M 272.943	07.2008→12.2010		7.05270.17.0	LS	null mm	
			7.05270.21.0	LS	600 mm	
			7.04389.02.0	SLP	EL	
CLS 300 (219.354) 170 kW (231 PS) M 272.943	04.2009→12.2010		7.04389.02.0	SLP	EL	
CLS 320 CDI 140-200 kW (190-272 PS) OM 642.920	01.2005→12.2010		7.24809.47.0	AGR	ET 	
			7.11190.01.0	DDS	Luftfiltergehäuse Air Filter Housing	
			7.05270.21.0	LS	600 mm	
CLS 320 CDI (219.322) 140-200 kW (190-272 PS) OM 642.920	01.2005→12.2010		7.24809.47.0	AGR	ET 	

M





CLS (C219) **42**

			7.11190.01.0	DDS		Luftfiltergehäuse Air Filter Housing
			7.05270.21.0	LS	600 mm	
CLS 350 (219.356) 200 kW (272 PS) M 272.964	10.2004→12.2010		7.05270.17.0	LS	null mm	
			7.05270.21.0	LS	600 mm	
			7.04389.02.0	SLP	EL	
CLS 350 (219.357) 215 kW (292 PS) M 272.985	04.2006→12.2010		7.08369.12.0	ATS	EL	 ch. A 158234→
			7.05270.17.0	LS	null mm	
			7.05270.21.0	LS	600 mm	
			7.04389.02.0	SLP	EL	
CLS 350 CDI 140-200 kW (190-272 PS) OM 642.920	04.2009→12.2010		7.24809.47.0	AGR	ET	 USA USA
			7.11190.01.0	DDS		Luftfiltergehäuse Air Filter Housing
CLS 350 CDI (219.322) 140-200 kW (190-272 PS) OM 642.920	04.2009→12.2010		7.24809.47.0	AGR	ET	
			7.11190.01.0	DDS		Luftfiltergehäuse Air Filter Housing
CLS 500 215-225 kW (292-306 PS) M 113.967	09.2005→12.2006		7.22136.50.0	AGR	PN	
			7.04389.00.0	SLP	EL	
CLS 500 (219.372) 285 kW (388 PS) M 273.960	04.2006→12.2010		7.05270.17.0	LS	null mm	links, rechts Left, Right
			7.05270.21.0	LS	600 mm	links Left
			7.04389.02.0	SLP	EL	Regelsonde Regulating Probe
CLS 500 (219.375) 215-225 kW (292-306 PS) M 113.967	10.2004→12.2010		7.22136.50.0	AGR	PN	
			7.02604.26.0	LS	500 mm	links, rechts Left, Right
			7.04389.00.0	SLP	EL	
CLS 55 AMG (219.376) 350 kW (476 PS) M 113.990	01.2005→12.2010		7.02604.26.0	LS	500 mm	
			7.04389.06.0	SLP	EL	
CLS 63 AMG (219.377) 378 kW (514 PS) M 156.983	04.2006→12.2010		7.05270.22.0	LS	825 mm	
			7.05270.21.0	LS	600 mm	
			7.05270.18.0	LS	500 mm	
			7.04389.06.0	SLP	EL	für Fahrzeuge mit Luftfederung for pneumatic suspension vehicles

M





CLS Shooting Brake (X218) 43

CLS 220 BlueTEC / d (218.901) 120-150 kW (163-204 PS) OM 651.924	05.2014→12.2017		7.08369.06.0	ATS	EL	
			7.08369.12.0	ATS	EL	für OE-Nummer: A 000 905 68 04, A 008 153 27 28 for OE number: A 000 905 68 04, A 008 153 27 28 vor Rußpartikelfilter before soot particulate filter für Rechtslenker for right-hand drive vehicles
			7.08369.76.0	ATS	EL	für OE-Nummer: A 000 905 52 02, A 000 905 89 04 for OE number: A 000 905 52 02, A 000 905 89 04 vor Rußpartikelfilter before soot particulate filter für Linkslenker for left-hand drive vehicles
			7.08369.89.0	ATS	EL	für OE-Nummer: A 000 905 70 04, A 000 905 85 01 for OE number: A 000 905 70 04, A 000 905 85 01 nach Rußpartikelfilter after soot particulate filter
			7.08369.90.0	ATS	EL	für OE-Nummer: A 000 905 65 04, A 001 905 07 00 for OE number: A 000 905 65 04, A 001 905 07 00 vor Rußpartikelfilter before soot particulate filter für Linkslenker for left-hand drive vehicles
			7.08369.97.0	ATS	EL	für OE-Nummer: A 000 905 52 05, A 008 153 41 28 for OE number: A 000 905 52 05, A 008 153 41 28 vor Rußpartikelfilter before soot particulate filter
CLS 220 BlueTEC / d (218.901) 120-150 kW (163-204 PS) OM 651.924	05.2014→12.2017		7.08369.06.0	ATS	EL	
			7.08369.12.0	ATS	EL	
			7.08369.76.0	ATS	EL	für OE-Nummer: A 000 905 52 02, A 000 905 89 04 for OE number: A 000 905 52 02, A 000 905 89 04 vor Rußpartikelfilter before soot particulate filter
			7.08369.90.0	ATS	EL	für OE-Nummer: A 000 905 65 04, A 001 905 07 00 for OE number: A 000 905 65 04, A 001 905 07 00 vor Rußpartikelfilter before soot particulate filter
			7.08369.97.0	ATS	EL	für OE-Nummer: A 000 905 52 05, A 008 153 41 28 for OE number: A 000 905 52 05, A 008 153 41 28 für Rechtslenker for right-hand drive vehicles
CLS 220 BlueTEC / d (218.901) 120-150 kW (163-204 PS) OM 651.924	05.2014→12.2017		7.08369.06.0	ATS	EL	
			7.08369.12.0	ATS	EL	

M











CLS Shooting Brake (X218) 43

			7.08369.76.0	ATS	EL	für OE-Nummer: A 000 905 52 02, A 000 905 89 04 for OE number: A 000 905 52 02, A 000 905 89 04 vor Rußpartikelfilter before soot particulate filter
			7.08369.90.0	ATS	EL	für OE-Nummer: A 000 905 65 04, A 001 905 07 00 for OE number: A 000 905 65 04, A 001 905 07 00 vor Rußpartikelfilter before soot particulate filter
			7.08369.97.0	ATS	EL	für OE-Nummer: A 000 905 52 05, A 008 153 41 28 for OE number: A 000 905 52 05, A 008 153 41 28 vor Rußpartikelfilter before soot particulate filter
CLS 250 BlueTEC / d 4-matic (218.997) 120-150 kW (163-204 PS) OM 651.924	05.2014→12.2017		7.08369.06.0	ATS	EL	
			7.08369.12.0	ATS	EL	
			7.08369.89.0	ATS	EL	für OE-Nummer: A 000 905 70 04, A 000 905 85 01 for OE number: A 000 905 70 04, A 000 905 85 01 nach Rußpartikelfilter after soot particulate filter
			7.08369.90.0	ATS	EL	für OE-Nummer: A 000 905 65 04, A 001 905 07 00 for OE number: A 000 905 65 04, A 001 905 07 00 vor Rußpartikelfilter before soot particulate filter
			7.08369.97.0	ATS	EL	für OE-Nummer: A 000 905 52 05, A 008 153 41 28 for OE number: A 000 905 52 05, A 008 153 41 28 vor Rußpartikelfilter before soot particulate filter
CLS 250 CDI / BlueTEC / d (218.903, 218.904) 120-150 kW (163-204 PS) OM 651.924	10.2012→12.2017		7.08369.06.0	ATS	EL	
			7.08369.12.0	ATS	EL	für OE-Nummer: A 000 905 68 04, A 008 153 27 28 for OE number: A 000 905 68 04, A 008 153 27 28 vor Rußpartikelfilter before soot particulate filter
			7.08369.76.0	ATS	EL	für OE-Nummer: A 000 905 52 02, A 000 905 89 04 for OE number: A 000 905 52 02, A 000 905 89 04 vor Rußpartikelfilter before soot particulate filter
						für OE-Nummer: A 000 905 52 02, A 000 905 89 04 for OE number: A 000 905 52 02, A 000 905 89 04 vor Rußpartikelfilter before soot particulate filter für Linkslenker for left-hand drive vehicles

M









CLS Shooting Brake (X218) **43**

			7.08369.89.0	ATS	EL	für OE-Nummer: A 000 905 70 04, A 000 905 85 01 for OE number: A 000 905 70 04, A 000 905 85 01 nach Rußpartikelfilter after soot particulate filter
			7.08369.90.0	ATS	EL	für OE-Nummer: A 000 905 65 04, A 001 905 07 00 for OE number: A 000 905 65 04, A 001 905 07 00 vor Rußpartikelfilter before soot particulate filter für Linkslenker for left-hand drive vehicles
			7.08369.97.0	ATS	EL	für OE-Nummer: A 000 905 52 05, A 008 153 41 28 for OE number: A 000 905 52 05, A 008 153 41 28 vor Rußpartikelfilter before soot particulate filter für Rechtslenker for right-hand drive vehicles
CLS 350 (218.959) 185-245 kW (252-333 PS) M 276.952	10.2012→08.2014		7.02604.44.0	LS	500 mm	für OE-Nummer: A 009 542 59 18 for OE number: A 009 542 59 18 vor Katalysator in front of the catalyst
CLS 350 BlueTEC / d (218.926) 170-195 kW (231-265 PS) OM 642.852, OM 642.853	05.2014→12.2017		7.11020.01.0	ATS	EL	
CLS 350 BlueTEC / d (218.926) 170-195 kW (231-265 PS) OM 642.852, OM 642.853	05.2014→12.2017		7.08369.89.0	ATS	EL	 OM 642.852, OM 642.853: für OE-Nummer: A 000 905 70 04, A 000 905 85 01 for OE number: A 000 905 70 04, A 000 905 85 01 nach Rußpartikelfilter after soot particulate filter
			7.11020.01.0	ATS	EL	
CLS 350 BlueTEC / d 4-matic (218.994) 185-195 kW (252-265 PS) OM 642.854, OM 642.858	05.2014→12.2017		7.08369.61.0	ATS	EL	
			7.08369.89.0	ATS	EL	 OM 642.854, OM 642.858: für OE-Nummer: A 000 905 70 04, A 000 905 85 01 for OE number: A 000 905 70 04, A 000 905 85 01 nach Rußpartikelfilter after soot particulate filter
			7.11020.01.0	ATS	EL	
CLS 350 CDI / d (218.923) 170-195 kW (231-265 PS) OM 642.852	10.2012→08.2014		7.08369.89.0	ATS	EL	für OE-Nummer: A 000 905 70 04, A 000 905 85 01 for OE number: A 000 905 70 04, A 000 905 85 01 nach Rußpartikelfilter after soot particulate filter
			7.11020.01.0	ATS	EL	
CLS 350 CDI / d (218.923) 185-195 kW (252-265 PS) OM 642.853	10.2012→08.2014		7.08369.61.0	ATS	EL	
			7.08369.89.0	ATS	EL	für OE-Nummer: A 000 905 70 04, A 000 905 85 01 for OE number: A 000 905 70 04, A 000 905 85 01 nach Rußpartikelfilter after soot particulate filter
			7.11020.01.0	ATS	EL	

M











CLS Shooting Brake (X218) 43

CLS 350 CDI / d 4-matic (218.993) 185-195 kW (252-265 PS) OM 642.853	10.2012→08.2014	 7.08369.61.0	ATS	EL	für OE-Nummer: A 000 905 70 04, A 000 905 85 01 for OE number: A 000 905 70 04, A 000 905 85 01 nach Rußpartikelfilter after soot particulate filter
			ATS	EL	
CLS 350 CDI / d 4-matic (218.993) 185-195 kW (252-265 PS) OM 642.854	10.2012→08.2014	 7.08369.61.0	ATS	EL	für OE-Nummer: A 000 905 70 04, A 000 905 85 01 for OE number: A 000 905 70 04, A 000 905 85 01 nach Rußpartikelfilter after soot particulate filter
			ATS	EL	
			ATS	EL	
CLS 350 d 4-matic (218.994) 185-195 kW (252-265 PS) OM 642.854, OM 642.858	04.2015→12.2017	 7.11020.01.0	ATS	EL	
			ATS	EL	
CLS 400 (218.961) 245 kW (333 PS) M 276.850	07.2014→12.2017	 7.05270.21.0	LS	600 mm	für OE-Nummer: A 009 542 56 18 for OE number: A 009 542 56 18
			LS	500 mm	
CLS 400 (218.965) 200-245 kW (272-333 PS) M 276.820	05.2014→12.2017	 7.05270.21.0	LS	600 mm	für OE-Nummer: A 009 542 56 18 for OE number: A 009 542 56 18
			LS	500 mm	
CLS 400 4-matic (218.967) 200-245 kW (272-333 PS) M 276.820	05.2014→12.2017	 7.05270.21.0	LS	600 mm	für OE-Nummer: A 009 542 56 18 for OE number: A 009 542 56 18
			LS	500 mm	
CLS 400 4-matic (218.968) 245 kW (333 PS) M 276.850	07.2014→12.2017	 7.05270.21.0	LS	600 mm	für OE-Nummer: A 009 542 56 18 for OE number: A 009 542 56 18
			LS	500 mm	

M























CLS Shooting Brake (X218) 43

CLS 500 (218.973) 300-320 kW (408-435 PS) M 278.922	10.2012→12.2017	 7.02604.44.0	LS	500 mm	 M 278.922: für Getriebeautomatik 7 Gang for 7-speed automatic transmission vor Katalysator, links in front of the catalyst, Left  M 278.922: für Getriebeautomatik 7 Gang for 7-speed automatic transmission vor Katalysator, rechts in front of the catalyst, Right  M 278.922: für Getriebeautomatik 9 Gang for 9-speed automatic transmission vor Katalysator, rechts in front of the catalyst, Right Heckantrieb Rear Wheel Drive
CLS 500 4-matic (218.991) 300-320 kW (408-435 PS) M 278.922	10.2012→12.2017	 7.02604.44.0	LS	500 mm	für OE-Nummer: A 009 542 63 18 for OE number: A 009 542 63 18 vor Katalysator in front of the catalyst
CLS 63 AMG (218.974) 386-430 kW (525-585 PS) M 157.981	10.2012→12.2017	 7.02604.44.0	LS	500 mm	für OE-Nummer: A 009 542 63 18 for OE number: A 009 542 63 18 vor Katalysator in front of the catalyst
CLS 63 AMG (218.975) 386-430 kW (525-585 PS) M 157.981	02.2013→12.2017	 7.02604.44.0	LS	500 mm	für OE-Nummer: A 009 542 63 18 for OE number: A 009 542 63 18 vor Katalysator in front of the catalyst
CLS 63 AMG 4-matic (218.976) 386-430 kW (525-585 PS) M 157.981	02.2013→12.2017	 7.02604.44.0	LS	500 mm	für OE-Nummer: A 009 542 63 18 for OE number: A 009 542 63 18 vor Katalysator in front of the catalyst
CLS 63 AMG 4-matic (218.992) 386-430 kW (525-585 PS) M 157.981	05.2013→12.2017	 7.02604.44.0	LS	500 mm	vor Katalysator, beidseitig in front of the catalyst, Left and right

M







E-CLASS (W124) 44

E 250 Turbo-D (124.128) 90-93 kW (126 PS) OM 602.962	06.1993→06.1995	 7.21949.51.0	AGR	PN	<input checked="" type="checkbox"/> Finland, Österreich <input checked="" type="checkbox"/> Finland, Austria
E 280 (124.028) 142-145 kW (193-197 PS) M 104.942	06.1993→06.1995	 7.02604.03.0	LS	200 mm	
E 280 (124.029) 142-145 kW (193-197 PS) M 104.942	06.1993→06.1995	 7.02604.03.0	LS	200 mm	
E 300 4-matic (124.230) 132 kW (180 PS) M 103.985	06.1993→06.1995	 7.02604.03.0	LS	200 mm	
E 300 Turbo-D (124.133) 100-108 kW (136-147 PS) OM 603.960	06.1993→06.1995	 7.21949.51.0	AGR	PN	<input checked="" type="checkbox"/>
E 300 Turbo-D 4-matic (124.333) 105-108 kW (143-147 PS) OM 603.963	06.1993→06.1995	 7.21949.51.0	AGR	PN	<input checked="" type="checkbox"/>
E 420 (124.034) 205 kW (279 PS) M 119.975	06.1993→06.1995	 7.05270.00.0	LS	350 mm	
E 60 AMG (124.036) 275-280 kW (374-381 PS) M 119.974 (AMG 6.0)	05.1994→06.1995	 7.05270.00.0	LS	350 mm	

			 PIERBURG		
E-CLASS (W210)					45
E 200 Kompressor (210.048) 120 kW (163 PS) M 111.957	08.2000→03.2002		7.05270.12.0	LS	500 mm vor Katalysator in front of the catalyst
E 230 (210.037) 110 kW (150 PS) M 111.970	06.1995→06.1997		7.02604.04.0	LS	200 mm
E 240 (210.061) 125 kW (170 PS) M 112.911	06.1997→08.2000		7.22136.50.0	AGR	PN <input checked="" type="checkbox"/>
			7.05270.03.0	LS	820 mm
			7.05270.12.0	LS	500 mm für OE-Nummer: A 001 540 51 17 for OE number: A 001 540 51 17 vor Katalysator, links in front of the catalyst, Left
			7.05270.15.0	LS	380 mm
			7.04389.00.0	SLP	EL
E 240 (210.062) 125 kW (170 PS) M 112.914	08.2000→03.2002		7.22136.50.0	AGR	PN <input checked="" type="checkbox"/>
			7.05270.12.0	LS	500 mm vor Katalysator, links in front of the catalyst, Left für Linkslenker for left-hand drive vehicles
			7.04389.00.0	SLP	EL
E 280 (210.053) 142 kW (193 PS) M 104.945	01.1996→06.1997		7.05270.03.0	LS	820 mm
			7.05270.15.0	LS	380 mm
M E 280 (210.063) 150 kW (204 PS) M 112.921	12.1996→03.2002		7.22136.50.0	AGR	PN <input checked="" type="checkbox"/>
			7.05270.03.0	LS	820 mm
			7.05270.12.0	LS	500 mm für OE-Nummer: A 001 540 51 17 for OE number: A 001 540 51 17
			7.05270.15.0	LS	380 mm
			7.04389.00.0	SLP	EL
E 280 4-matic (210.081) 150 kW (204 PS) M 112.921	12.1996→03.2002		7.22136.50.0	AGR	PN <input checked="" type="checkbox"/>
			7.05270.03.0	LS	820 mm
			7.05270.12.0	LS	500 mm für OE-Nummer: A 001 540 51 17 for OE number: A 001 540 51 17
			7.05270.15.0	LS	380 mm
			7.04389.00.0	SLP	EL
E 320 (210.055) 162 kW (220 PS) M 104.995	06.1995→06.1997		7.05270.03.0	LS	820 mm
			7.05270.15.0	LS	380 mm
E 320 (210.065) 160-165 kW (218-224 PS) M 112.941	06.1997→03.2002		7.22136.50.0	AGR	PN <input checked="" type="checkbox"/>
			7.05270.03.0	LS	820 mm
			7.05270.12.0	LS	500 mm für OE-Nummer: A 001 540 51 17 for OE number: A 001 540 51 17
			7.05270.15.0	LS	380 mm
			7.04389.00.0	SLP	EL









E-CLASS (W210) 45

E 320 4-matic (210.082) 160-165 kW (218-224 PS) M 112.941	06.1997→03.2002		7.22136.50.0	AGR	PN	☒
			7.05270.03.0	LS	820 mm	
			7.05270.12.0	LS	500 mm	für OE-Nummer: A 001 540 51 17 for OE number: A 001 540 51 17
			7.05270.15.0	LS	380 mm	
			7.04389.00.0	SLP	EL	
E 430 (210.070) 205 kW (279 PS) M 113.940	06.1997→03.2002		7.22136.50.0	AGR	PN	☒
			7.05270.03.0	LS	820 mm	
			7.05270.12.0	LS	500 mm	für OE-Nummer: A 001 540 51 17 for OE number: A 001 540 51 17
			7.05270.15.0	LS	380 mm	
			7.04389.00.0	SLP	EL	
E 430 4-matic (210.083) 205 kW (279 PS) M 113.940	05.1999→03.2002		7.22136.50.0	AGR	PN	☒
			7.05270.03.0	LS	820 mm	
			7.05270.12.0	LS	500 mm	für OE-Nummer: A 001 540 51 17 for OE number: A 001 540 51 17
			7.05270.15.0	LS	380 mm	
			7.04389.00.0	SLP	EL	
E 55 AMG 255-260 kW (347-354 PS) M 113.980	09.1997→02.2002		7.22136.50.0	AGR	PN	☒
			7.04389.00.0	SLP	EL	
E 55 AMG (210.074) 255-260 kW (347-354 PS) M 113.980	08.1997→03.2002		7.22136.50.0	AGR	PN	☒
			7.05270.03.0	LS	820 mm	 →ch. B173999 rechts Right für Rechtslenker für right-hand drive vehicles Regelsonde Regulating Probe
			7.05270.12.0	LS	500 mm	für OE-Nummer: A 001 540 51 17 for OE number: A 001 540 51 17
			7.05270.15.0	LS	380 mm	links, rechts Left, Right Euro 3 (D3) Euro 3 (D3) Diagnosesonde Diagnostic Probe
			7.04389.00.0	SLP	EL	

M





E-CLASS (W211) **46**

E 200 CDI (211.004) 75-90 kW (102-122 PS) OM 646.951	07.2002→12.2008	 7.24809.36.0	AGR	ET	
		7.11020.35.0	ATS	EL	 ch. B350084→ nach Katalysator Post-catalyst für Linkslenker for left-hand drive vehicles für Fahrzeuge mit Diesel-Partikel-Filter (DPF) for vehicles with diesel soot filter Produktionsdatum ab: 30.04.2008 Production date from: 30.04.2008
		7.08369.30.0	ATS	EL	vor Katalysator in front of the catalyst
		7.08369.80.0	ATS	EL	Abgaskrümmer Exhaust Manifold Euro 4 Euro 4 für Fahrzeuge mit Diesel-Partikel-Filter (DPF) for vehicles with diesel soot filter
		7.08369.91.0	ATS	EL	Partikelfilter Particulate Filter für Rechtslenker for right-hand drive vehicles
		7.08369.94.0	ATS	EL	nach Katalysator Post-catalyst für Linkslenker for left-hand drive vehicles für Fahrzeuge mit Diesel-Partikel-Filter (DPF) for vehicles with diesel soot filter
		7.11190.01.0	DDS		für OE-Nummer: A 004 153 95 28, A 005 153 74 28, A 005 153 77 28, A 006 153 49 28 for OE number: A 004 153 95 28, A 005 153 74 28, A 005 153 77 28, A 006 153 49 28 Luftfiltergehäuse Air Filter Housing
		7.05270.22.0	LS	825 mm	
		7.05270.21.0	LS	600 mm	für OE-Nummer: A 004 542 73 18 for OE number: A 004 542 73 18 vor Katalysator in front of the catalyst
E 200 CDI (211.004) 75-90 kW (102-122 PS) OM 646.951	07.2002→12.2008	 7.24809.36.0	AGR	ET	
		7.11020.35.0	ATS	EL	 ch. B350084→ nach Katalysator Post-catalyst für Linkslenker for left-hand drive vehicles für Fahrzeuge mit Diesel-Partikel-Filter (DPF) for vehicles with diesel soot filter Produktionsdatum ab: 30.04.2008 Production date from: 30.04.2008
		7.08369.30.0	ATS	EL	vor Katalysator in front of the catalyst

M









E-CLASS (W211) 46

		7.08369.80.0	ATS	EL	Abgaskrümmer Exhaust Manifold Euro 4 Euro 4 für Fahrzeuge mit Diesel-Partikel-Filter (DPF) for vehicles with diesel soot filter
		7.08369.91.0	ATS	EL	Partikelfilter Particulate Filter für Rechtslenker for right-hand drive vehicles
		7.08369.94.0	ATS	EL	nach Katalysator Post-catalyst für Linkslenker for left-hand drive vehicles für Fahrzeuge mit Diesel-Partikel-Filter (DPF) for vehicles with diesel soot filter 2006 2006
		7.11190.01.0	DDS		für OE-Nummer: A 004 153 95 28, A 005 153 74 28, A 005 153 77 28, A 006 153 49 28 for OE number: A 004 153 95 28, A 005 153 74 28, A 005 153 77 28, A 006 153 49 28 Luftfiltergehäuse Air Filter Housing
		7.05270.22.0	LS	825 mm	
		7.05270.21.0	LS	600 mm	für OE-Nummer: A 004 542 73 18 for OE number: A 004 542 73 18 vor Katalysator in front of the catalyst
E 200 CDI (211.007) 100 kW (136 PS) OM 646.820	04.2006→12.2008	 7.24809.48.0	AGR	ET	
		7.11020.35.0	ATS	EL	 ch. B350084→ nach Katalysator Post-catalyst für Linkslenker for left-hand drive vehicles für Fahrzeuge mit Diesel-Partikel-Filter (DPF) for vehicles with diesel soot filter Produktionsdatum ab: 30.04.2008 Production date from: 30.04.2008
		7.08369.91.0	ATS	EL	Partikelfilter Particulate Filter
		7.08369.94.0	ATS	EL	nach Katalysator Post-catalyst für Linkslenker for left-hand drive vehicles für Fahrzeuge mit Diesel-Partikel-Filter (DPF) for vehicles with diesel soot filter 2006 2006
		7.11190.01.0	DDS		für OE-Nummer: A 004 153 95 28, A 006 153 49 28, A 007 153 61 28 for OE number: A 004 153 95 28, A 006 153 49 28, A 007 153 61 28 Luftfiltergehäuse Air Filter Housing
		7.05270.22.0	LS	825 mm	

M



E-CLASS (W211) 46







		7.05270.21.0	LS	600 mm	für OE-Nummer: A 004 542 73 18 for OE number: A 004 542 73 18 vor Katalysator in front of the catalyst
E 200 Kompressor (211.041) 135 kW (184 PS) M 271.956	04.2006→12.2008	 7.05271.23.0	LS	900 mm	
		7.05270.11.0	LS	750 mm	nach Katalysator Post-catalyst
E 200 Kompressor (211.042) 120 kW (163 PS) M 271.941	11.2002→12.2008	 7.05271.23.0	LS	900 mm	
		7.05270.11.0	LS	750 mm	nach Katalysator Post-catalyst
E 220 CDI 100-125 kW (136-170 PS) OM 646.821	03.2003→12.2008	 7.24809.48.0	AGR	ET	
		7.05270.22.0	LS	825 mm	
E 220 CDI (211.006) 100-110 kW (136-150 PS) OM 646.961	03.2002→12.2008	 7.24809.36.0	AGR	ET	
		7.11020.35.0	ATS	EL	 ch. B350084→ nach Katalysator Post-catalyst für Linkslenker for left-hand drive vehicles für Fahrzeuge mit Diesel-Partikel-Filter (DPF) for vehicles with diesel soot filter Produktionsdatum ab: 30.04.2008 Production date from: 30.04.2008
		7.08369.30.0	ATS	EL	vor Katalysator in front of the catalyst
		7.08369.80.0	ATS	EL	Abgaskrümmer Exhaust Manifold Euro 4 Euro 4 für Fahrzeuge mit Diesel-Partikel-Filter (DPF) for vehicles with diesel soot filter
		7.08369.91.0	ATS	EL	Partikelfilter Particulate Filter für Rechtslenker for right-hand drive vehicles
		7.08369.94.0	ATS	EL	nach Katalysator Post-catalyst für Linkslenker for left-hand drive vehicles für Fahrzeuge mit Diesel-Partikel-Filter (DPF) for vehicles with diesel soot filter 2006 2006
		7.11190.01.0	DDS		für OE-Nummer: A 004 153 95 28, A 005 153 74 28, A 005 153 77 28, A 006 153 49 28 for OE number: A 004 153 95 28, A 005 153 74 28, A 005 153 77 28, A 006 153 49 28
		7.05270.22.0	LS	825 mm	
7.05270.21.0	LS	600 mm	für OE-Nummer: A 004 542 73 18 for OE number: A 004 542 73 18 vor Katalysator in front of the catalyst		

M



E-CLASS (W211)





46

E 220 CDI (211.006) 100-110 kW (136-150 PS) OM 646.961	03.2002→12.2008		7.24809.36.0	AGR	ET	
			7.11020.35.0	ATS	EL	 ch. B350084→ nach Katalysator Post-catalyst für Linkslenker for left-hand drive vehicles für Fahrzeuge mit Diesel-Partikel-Filter (DPF) for vehicles with diesel soot filter Produktionsdatum ab: 30.04.2008 Production date from: 30.04.2008
			7.08369.30.0	ATS	EL	vor Katalysator in front of the catalyst
			7.08369.91.0	ATS	EL	Partikelfilter Particulate Filter für Rechtslenker for right-hand drive vehicles
			7.08369.94.0	ATS	EL	nach Katalysator Post-catalyst für Linkslenker for left-hand drive vehicles für Fahrzeuge mit Diesel-Partikel-Filter (DPF) for vehicles with diesel soot filter 2006 2006
			7.11190.01.0	DDS		für OE-Nummer: A 004 153 95 28, A 005 153 74 28, A 005 153 77 28, A 006 153 49 28 for OE number: A 004 153 95 28, A 005 153 74 28, A 005 153 77 28, A 006 153 49 28 Luftfiltergehäuse Air Filter Housing
			7.05270.22.0	LS	825 mm	
7.05270.21.0	LS	600 mm	für OE-Nummer: A 004 542 73 18 for OE number: A 004 542 73 18 vor Katalysator in front of the catalyst			
E 220 CDI (211.008) 100-125 kW (136-170 PS) OM 646.821	04.2006→12.2008		7.24809.48.0	AGR	ET	
			7.11020.35.0	ATS	EL	 ch. B350084→ nach Katalysator Post-catalyst für Linkslenker for left-hand drive vehicles für Fahrzeuge mit Diesel-Partikel-Filter (DPF) for vehicles with diesel soot filter Produktionsdatum ab: 30.04.2008 Production date from: 30.04.2008
			7.08369.91.0	ATS	EL	Partikelfilter Particulate Filter für Rechtslenker for right-hand drive vehicles
			7.08369.94.0	ATS	EL	nach Katalysator Post-catalyst für Linkslenker for left-hand drive vehicles für Fahrzeuge mit Diesel-Partikel-Filter (DPF) for vehicles with diesel soot filter 2006 2006

M











E-CLASS (W211) **46**

			7.11190.01.0	DDS		für OE-Nummer: A 004 153 95 28, A 006 153 49 28, A 007 153 61 28 for OE number: A 004 153 95 28, A 006 153 49 28, A 007 153 61 28 Luftfiltergehäuse Air Filter Housing
			7.05270.22.0	LS	825 mm	
			7.05270.21.0	LS	600 mm	für OE-Nummer: A 004 542 73 18 for OE number: A 004 542 73 18 vor Katalysator in front of the catalyst
E 230 (211.052) 150 kW (204 PS) M 272.922	09.2007→12.2008		7.05270.17.0	LS	null mm	
			7.05270.21.0	LS	600 mm	
			7.04389.02.0	SLP	EL	
E 240 (211.061) 130 kW (177 PS) M 112.913, M 112.917	03.2002→12.2008		7.22136.50.0	AGR	PN	<input checked="" type="checkbox"/>
			7.04389.00.0	SLP	EL	
E 240 4-matic (211.080) 130 kW (177 PS) M 112.917	03.2003→12.2008		7.22136.50.0	AGR	PN	<input checked="" type="checkbox"/>
			7.05270.11.0	LS	750 mm	vor Katalysator, rechts in front of the catalyst, Right
			7.04389.00.0	SLP	EL	
E 270 CDI (211.016) 120-130 kW (163-177 PS) OM 647.961	03.2002→12.2008		7.24809.37.0	AGR	ET	<input type="checkbox"/>
E 270 CDI (211.016) 120-130 kW (163-177 PS) OM 647.961	03.2002→12.2008		7.24809.37.0	AGR	ET	<input type="checkbox"/>
E 280 (211.054) 170 kW (231 PS) M 272.943	03.2005→12.2008		7.05270.17.0	LS	null mm	 ch. X175299→ links, rechts Left, Right Diagnosesonde Diagnostic Probe
			7.05270.22.0	LS	825 mm	rechts Right Allrad All-wheel Drive
			7.05270.21.0	LS	600 mm	links, rechts Left, Right Regelsonde Regulating Probe
			7.04389.02.0	SLP	EL	
E 280 4-matic (211.092) 170 kW (231 PS) M 272.943	01.2006→12.2008		7.05270.17.0	LS	null mm	 ch. X175299→ links, rechts Left, Right Diagnosesonde Diagnostic Probe
			7.05270.22.0	LS	825 mm	rechts Right Allrad All-wheel Drive
			7.05270.21.0	LS	600 mm	links, rechts Left, Right Regelsonde Regulating Probe
			7.04389.02.0	SLP	EL	
E 280 4-matic (211.092) 170 kW (231 PS) M 272.944	01.2006→12.2008		7.05270.12.0	LS	500 mm	nach Katalysator, beidseitig Post-catalyst, Left and right
			7.04389.02.0	SLP	EL	









E-CLASS (W211) 46

E 280 CDI (211.020) 140-200 kW (190-272 PS) OM 642.920	03.2005→12.2008		7.24809.47.0 AGR ET 	USA
			7.08369.94.0 ATS EL	Katalysator Catalytic Converter für Linkslenker for left-hand drive vehicles für Fahrzeuge ohne Diesel-Partikel-Filter (DPF) for vehicles without diesel soot filter
			7.11190.01.0 DDS	Luftfiltergehäuse Air Filter Housing
			7.05270.21.0 LS	600 mm
E 280 CDI (211.023) 130-150 kW (177-204 PS) OM 648.961	05.2004→12.2008		7.24809.37.0 AGR ET 	
			7.24809.59.0 AGR ET 	USA
			7.08369.30.0 ATS EL	für OE-Nummer: A 005 153 10 28 for OE number: A 005 153 10 28 vor Katalysator in front of the catalyst
			7.08369.80.0 ATS EL	für OE-Nummer: A 005 153 80 28 for OE number: A 005 153 80 28 vor Katalysator in front of the catalyst
			7.08369.91.0 ATS EL	Partikelfilter Particulate Filter für Rechtslenker for right-hand drive vehicles
7.05270.21.0 LS	600 mm			
E 280 CDI 4-matic (211.084) 140-165 kW (190-224 PS) OM 642.921	03.2005→12.2008		7.24809.47.0 AGR ET 	USA
			7.08369.87.0 ATS EL	Katalysator Catalytic Converter für Linkslenker for left-hand drive vehicles für Fahrzeuge mit Diesel-Partikel-Filter (DPF) for vehicles with diesel soot filter Produktionsdatum ab: 06.05.2008 Production date from: 06.05.2008
			7.08369.94.0 ATS EL	Katalysator Catalytic Converter für Linkslenker for left-hand drive vehicles für Fahrzeuge mit Diesel-Partikel-Filter (DPF) for vehicles with diesel soot filter Produktionsdatum bis: 05.06.2008 Production date to: 05.06.2008
			7.11190.01.0 DDS	Luftfiltergehäuse Air Filter Housing
7.05270.21.0 LS	600 mm			
E 300 BlueTEC (211.024) 140-200 kW (190-272 PS) OM 642.920	09.2007→12.2008		7.24809.47.0 AGR ET 	

M











E-CLASS (W211) **46**

			7.08369.94.0	ATS	EL	Katalysator Catalytic Converter für Linkslenker for left-hand drive vehicles für Fahrzeuge ohne Diesel-Partikel-Filter (DPF) for vehicles without diesel soot filter
			7.11190.01.0	DDS		Luftfiltergehäuse Air Filter Housing
			7.05270.21.0	LS	600 mm	
E 320 (211.065) 165 kW (224 PS) M 112.949	03.2002→12.2008		7.22136.50.0	AGR	PN	<input checked="" type="checkbox"/>
			7.02604.26.0	LS	500 mm	
			7.04389.00.0	SLP	EL	
E 320 4-matic (211.082) 165 kW (224 PS) M 112.954	03.2003→12.2008		7.22136.50.0	AGR	PN	<input checked="" type="checkbox"/>
			7.05270.11.0	LS	750 mm	vor Katalysator, rechts in front of the catalyst, Right
			7.02604.26.0	LS	500 mm	
			7.04389.00.0	SLP	EL	
E 320 BlueTEC (211.022) 140-200 kW (190-272 PS) OM 642.920	09.2008→03.2009		7.24809.47.0	AGR	ET	<input type="checkbox"/> USA USA
M E 320 CDI (211.022) 140-200 kW (190-272 PS) OM 642.920	03.2005→12.2008		7.24809.47.0	AGR	ET	<input type="checkbox"/> USA USA
			7.08369.94.0	ATS	EL	Katalysator Catalytic Converter für Linkslenker for left-hand drive vehicles für Fahrzeuge ohne Diesel-Partikel-Filter (DPF) for vehicles without diesel soot filter
			7.11190.01.0	DDS		Luftfiltergehäuse Air Filter Housing
			7.05270.21.0	LS	600 mm	
E 320 CDI (211.026) 130-150 kW (177-204 PS) OM 648.961	11.2002→12.2008		7.24809.37.0	AGR	ET	<input type="checkbox"/>
			7.24809.59.0	AGR	ET	<input type="checkbox"/> USA USA
			7.08369.30.0	ATS	EL	für OE-Nummer: A 005 153 10 28 for OE number: A 005 153 10 28 vor Katalysator in front of the catalyst
			7.08369.80.0	ATS	EL	für OE-Nummer: A 005 153 80 28 for OE number: A 005 153 80 28 vor Katalysator in front of the catalyst
			7.08369.91.0	ATS	EL	vor Rußpartikelfilter before soot particulate filter für Rechtslenker for right-hand drive vehicles
			7.05270.21.0	LS	600 mm	
E 320 CDI 4-matic (211.089) 140-165 kW (190-224 PS) OM 642.921	03.2005→12.2008		7.24809.47.0	AGR	ET	<input type="checkbox"/>











E-CLASS (W211) 46

			7.08369.87.0	ATS	EL	Katalysator Catalytic Converter für Linkslenker for left-hand drive vehicles für Fahrzeuge mit Diesel-Partikel-Filter (DPF) for vehicles with diesel soot filter Produktionsdatum ab: 05.06.2008 Production date from: 05.06.2008
			7.08369.94.0	ATS	EL	Katalysator Catalytic Converter für Linkslenker for left-hand drive vehicles für Fahrzeuge mit Diesel-Partikel-Filter (DPF) for vehicles with diesel soot filter Produktionsdatum bis: 05.06.2008 Production date to: 05.06.2008
			7.11190.01.0	DDS		Luftfiltergehäuse Air Filter Housing
			7.05270.21.0	LS	600 mm	
E 320 CDI 4-matic (211.089) 165 kW (224 PS) OM 642.910	03.2005→12.2008		7.24809.47.0	AGR	ET	
			7.11190.01.0	DDS		Luftfiltergehäuse Air Filter Housing
			7.05270.21.0	LS	600 mm	
E 350 (211.056) 200 kW (272 PS) M 272.964	03.2005→12.2008		7.05270.17.0	LS	null mm	 ch. X175299→ links, rechts Left, Right Diagnosesonde Diagnostic Probe
			7.05270.22.0	LS	825 mm	
			7.05270.21.0	LS	600 mm	links, rechts Left, Right Regelsonde Regulating Probe
			7.04389.02.0	SLP	EL	
E 350 4-matic (211.087) 200-205 kW (272-279 PS) M 272.972	08.2004→08.2006		7.05270.22.0	LS	825 mm	
			7.04389.02.0	SLP	EL	
E 350 4-matic (211.087) 200-205 kW (272-279 PS) M 272.972	03.2005→12.2008		7.05270.22.0	LS	825 mm	
			7.05270.12.0	LS	500 mm	nach Katalysator, beidseitig Post-catalyst, Left and right
			7.04389.02.0	SLP	EL	
E 350 CGI (211.057) 215 kW (292 PS) M 272.985	09.2007→12.2008		7.08369.12.0	ATS	EL	
			7.05270.17.0	LS	null mm	
			7.04389.02.0	SLP	EL	
E 420 CDI (211.029) 231 kW (314 PS) OM 629.910	01.2006→12.2008		7.11020.35.0	ATS	EL	vor Rußpartikelfilter before soot particulate filter für Linkslenker for left-hand drive vehicles
			7.05270.21.0	LS	600 mm	



M



E-CLASS (W211) 46









E 500 (211.070) 215-225 kW (292-306 PS) M 113.967	03.2002→12.2008	 7.22136.50.0	AGR	PN	<input checked="" type="checkbox"/>
		7.02604.26.0	LS	500 mm	links, rechts Left, Right
		7.04389.00.0	SLP	EL	
E 500 (211.070) 215-225 kW (292-306 PS) M 113.967	09.2002→12.2005	 7.22136.50.0	AGR	PN	<input checked="" type="checkbox"/>
		7.04389.00.0	SLP	EL	
E 500 (211.072) 285 kW (388 PS) M 273.960	04.2006→12.2008	 7.05270.17.0	LS	null mm	 ch. A786704→ links, rechts Left, Right Diagnosesonde Diagnostic Probe
		7.05270.21.0	LS	600 mm	links, rechts Left, Right Regelsonde Regulating Probe
		7.04389.02.0	SLP	EL	
E 500 4-matic (211.083) 225 kW (306 PS) M 113.969	10.2003→12.2008	 7.22136.50.0	AGR	PN	<input checked="" type="checkbox"/>
		7.05270.11.0	LS	750 mm	vor Katalysator, rechts in front of the catalyst, Right
		7.04389.00.0	SLP	EL	
E 500 4-matic (211.090) 285 kW (388 PS) M 273.962	04.2006→12.2008	 7.05270.22.0	LS	825 mm	rechts Right Allrad All-wheel Drive
		7.05270.12.0	LS	500 mm	nach Katalysator, beidseitig Post-catalyst, Left and right
		7.04389.02.0	SLP	EL	
E 55 AMG Kompressor (211.076) 350 kW (476 PS) M 113.990	10.2002→12.2008	 7.02604.26.0	LS	500 mm	
		7.04389.04.0	SLP	EL	
E 63 AMG (211.077) 378 kW (514 PS) M 156.983	03.2006→12.2008	 7.05270.22.0	LS	825 mm	
		7.05270.21.0	LS	600 mm	
		7.05270.18.0	LS	500 mm	
		7.04389.06.0	SLP	EL	für Fahrzeuge mit Luftfederung for pneumatic suspension vehicles
E320 CDI (211.022) 140-200 kW (190-272 PS) OM 642.920	09.2006→12.2008	 7.24809.47.0	AGR	ET	<input type="checkbox"/> USA USA

E-CLASS (W212) 47

E 180 (212.040) 95-115 kW (129-156 PS) M 274.910	08.2013→12.2015	 7.02604.44.0	LS	500 mm	vor Katalysator in front of the catalyst
E 200 (212.034) 115-245 kW (156-333 PS) M 274.920	01.2013→12.2016	 7.24809.83.0	AGR	EL	<input type="checkbox"/> für OE-Nummer: A 274 142 05 19 for OE number: A 274 142 05 19
		7.24809.85.0	AGR	EL	<input type="checkbox"/> für OE-Nummer: A 274 142 04 19, A 274 142 06 19 for OE number: A 274 142 04 19, A 274 142 06 19







E-CLASS (W212) 47

		7.02604.44.0	LS	500 mm	vor Katalysator in front of the catalyst
E 200 CDI / BlueTEC (212.005, 212.006) 100 kW (136 PS) OM 651.925	01.2009→12.2015	 7.08369.06.0	ATS	EL	
		7.08369.12.0	ATS	EL	
		7.08369.76.0	ATS	EL	vor Katalysator in front of the catalyst für Linkslenker for left-hand drive vehicles für Fahrzeuge mit SCR-System for vehicles with SCR system
		7.08369.89.0	ATS	EL	für OE-Nummer: A 000 905 70 04, A 000 905 85 01 for OE number: A 000 905 70 04, A 000 905 85 01 nach Rußpartikelfilter after soot particulate filter
		7.08369.90.0	ATS	EL	für OE-Nummer: A 000 905 65 04, A 001 905 07 00 for OE number: A 000 905 65 04, A 001 905 07 00 vor Rußpartikelfilter before soot particulate filter
		7.08369.97.0	ATS	EL	 OM 651.925: für OE-Nummer: A 000 905 52 05, A 008 153 41 28 for OE number: A 000 905 52 05, A 008 153 41 28 vor Katalysator in front of the catalyst für Linkslenker for left-hand drive vehicles  OM 651.925: vor Katalysator in front of the catalyst für Rechtslenker for right-hand drive vehicles für Fahrzeuge mit SCR-System for vehicles with SCR system
		7.11020.00.0	ATS	EL	für OE-Nummer: A 007 153 94 28 for OE number: A 007 153 94 28 vor Rußpartikelfilter before soot particulate filter
E 200 CGI (212.048, 212.148) 115-150 kW (156-204 PS) M 271.820, M 271.860	08.2009→12.2015	 7.04389.07.0	SLP	EL	
E 200 NGT (212.035) 115-245 kW (156-333 PS) M 274.920	07.2013→12.2015	 7.24809.83.0	AGR	EL	 für OE-Nummer: A 274 142 05 19 for OE number: A 274 142 05 19
		7.24809.85.0	AGR	EL	 für OE-Nummer: A 274 142 04 19, A 274 142 06 19 for OE number: A 274 142 04 19, A 274 142 06 19
E 200 NGT (212.041) 120-135 kW (163-184 PS) M 271.958	03.2011→12.2015	 7.05270.11.0	LS	750 mm	für OE-Nummer: A 002 540 06 17 for OE number: A 002 540 06 17
		7.04389.07.0	SLP	EL	
E 220 BlueTEC (212.001) 120-150 kW (163-204 PS) OM 651.924	05.2014→12.2015	 7.08369.06.0	ATS	EL	
		7.08369.12.0	ATS	EL	

M







E-CLASS (W212) **47**

			7.08369.89.0	ATS	EL	für OE-Nummer: A 000 905 70 04, A 000 905 85 01 for OE number: A 000 905 70 04, A 000 905 85 01 nach Rußpartikelfilter after soot particulate filter
			7.08369.90.0	ATS	EL	für OE-Nummer: A 000 905 65 04, A 001 905 07 00 for OE number: A 000 905 65 04, A 001 905 07 00 vor Rußpartikelfilter before soot particulate filter
E 220 BlueTEC 4-matic (212.011) 120-150 kW (163-204 PS) OM 651.924	01.2015→12.2015		7.08369.06.0	ATS	EL	
			7.08369.12.0	ATS	EL	 OM 651.924: vor Rußpartikelfilter before soot particulate filter für Rechtslenker for right-hand drive vehicles  OM 651.924: vor Rußpartikelfilter before soot particulate filter für Linkslenker for left-hand drive vehicles für Fahrzeuge mit SCR-System for vehicles with SCR system
			7.08369.89.0	ATS	EL	nach Rußpartikelfilter after soot particulate filter
			7.05270.21.0	LS	600 mm	vor Katalysator in front of the catalyst
M E 220 CDI 120-150 kW (163-204 PS) OM 651.924	01.2009→12.2015		7.08369.06.0	ATS	EL	
E 220 CDI / BlueTEC (212.001, 212.002) 120-150 kW (163-204 PS) OM 651.924	01.2009→12.2016		7.08369.06.0	ATS	EL	
			7.08369.12.0	ATS	EL	
			7.08369.76.0	ATS	EL	vor Katalysator in front of the catalyst für Linkslenker for left-hand drive vehicles für Fahrzeuge mit SCR-System for vehicles with SCR system
			7.08369.89.0	ATS	EL	für OE-Nummer: A 000 905 70 04, A 000 905 85 01 for OE number: A 000 905 70 04, A 000 905 85 01 nach Rußpartikelfilter after soot particulate filter
			7.08369.90.0	ATS	EL	für OE-Nummer: A 000 905 65 04, A 001 905 07 00 for OE number: A 000 905 65 04, A 001 905 07 00 vor Rußpartikelfilter before soot particulate filter
			7.08369.97.0	ATS	EL	vor Katalysator in front of the catalyst für Rechtslenker for right-hand drive vehicles für Fahrzeuge mit SCR-System for vehicles with SCR system
			7.11020.00.0	ATS	EL	für OE-Nummer: A 007 153 94 28 for OE number: A 007 153 94 28 vor Rußpartikelfilter before soot particulate filter
			7.05270.21.0	LS	600 mm	vor Katalysator in front of the catalyst



E-CLASS (W212)









47

E 250 (212.036) 115-245 kW (156-333 PS) M 274.920	01.2013→12.2016		7.24809.83.0 AGR EL	für OE-Nummer: A 274 142 05 19 for OE number: A 274 142 05 19
			7.24809.85.0 AGR EL	für OE-Nummer: A 274 142 04 19, A 274 142 06 19 for OE number: A 274 142 04 19, A 274 142 06 19
			7.02604.44.0 LS 500 mm	vor Katalysator in front of the catalyst
E 250 CDI / BlueTEC (212.003, 212.004) 120-150 kW (163-204 PS) OM 651.924	01.2009→12.2016		7.08369.06.0 ATS EL	
			7.08369.12.0 ATS EL	
			7.08369.76.0 ATS EL	vor Katalysator in front of the catalyst für Linkslenker for left-hand drive vehicles für Fahrzeuge mit SCR-System for vehicles with SCR system
			7.08369.89.0 ATS EL	für OE-Nummer: A 000 905 70 04, A 000 905 85 01 for OE number: A 000 905 70 04, A 000 905 85 01 Abgaskrümmer Exhaust Manifold
			7.08369.90.0 ATS EL	für OE-Nummer: A 000 905 65 04, A 001 905 07 00 for OE number: A 000 905 65 04, A 001 905 07 00 vor Rußpartikelfilter before soot particulate filter
			7.08369.97.0 ATS EL	vor Katalysator in front of the catalyst für Rechtslenker for right-hand drive vehicles für Fahrzeuge mit SCR-System for vehicles with SCR system
			7.11020.00.0 ATS EL	für OE-Nummer: A 007 153 94 28 for OE number: A 007 153 94 28 vor Rußpartikelfilter before soot particulate filter
7.05270.21.0 LS 600 mm	vor Katalysator in front of the catalyst			
E 250 CDI / BlueTEC (212.004) 120-150 kW (163-204 PS) OM 651.924	01.2014→12.2015		7.08369.06.0 ATS EL	
			7.08369.89.0 ATS EL	für OE-Nummer: A 000 905 70 04, A 000 905 85 01 for OE number: A 000 905 70 04, A 000 905 85 01 nach Rußpartikelfilter after soot particulate filter
E 250 CDI / BlueTEC 4-matic (212.082, 212.097) 120-150 kW (163-204 PS) OM 651.924	01.2011→12.2015		7.08369.06.0 ATS EL	
			7.08369.12.0 ATS EL	
			7.08369.89.0 ATS EL	für OE-Nummer: A 000 905 70 04, A 000 905 85 01 for OE number: A 000 905 70 04, A 000 905 85 01 Partikelfilter Particulate Filter

M







E-CLASS (W212) **47**

		7.05270.21.0	LS	600 mm	vor Katalysator in front of the catalyst
E 250 CDI / BlueTEC 4-matic (212.097) 120-150 kW (163-204 PS) OM 651.924	07.2014→12.2015	 7.08369.06.0	ATS	EL	
		7.08369.89.0	ATS	EL	für OE-Nummer: A 000 905 70 04, A 000 905 85 01 for OE number: A 000 905 70 04, A 000 905 85 01 nach Rußpartikelfilter after soot particulate filter
E 250 CGI (212.047, 212.147) 135-150 kW (184-204 PS) M 271.860	01.2009→12.2015	 7.05270.17.0	LS	null mm	
		7.05270.21.0	LS	600 mm	
		7.04389.07.0	SLP	EL	
E 300 (212.054) 161-170 kW (219-231 PS) M 272.952	01.2009→12.2013	 7.05270.17.0	LS	null mm	
		7.05270.21.0	LS	600 mm	
		7.04389.02.0	SLP	EL	
E 300 (212.054) 161-170 kW (219-231 PS) M 272.952	01.2011→12.2015	 7.04389.02.0	SLP	EL	
E 300 (212.055) 185-245 kW (252-333 PS) M 276.952	07.2011→12.2015	 7.05270.17.0	LS	null mm	
		7.05270.21.0	LS	600 mm	
		7.02604.44.0	LS	500 mm	für OE-Nummer: A 008 542 29 18, A 009 542 59 18 for OE number: A 008 542 29 18, A 009 542 59 18 vor Katalysator in front of the catalyst
		7.02604.99.0	LS	400 mm	
E 300 4-matic (212.080) 185-245 kW (252-333 PS) M 276.952	07.2011→12.2015	 7.05270.17.0	LS	null mm	
		7.05270.21.0	LS	600 mm	
		7.02604.44.0	LS	500 mm	für OE-Nummer: A 008 542 29 18, A 009 542 59 18 for OE number: A 008 542 29 18, A 009 542 59 18 vor Katalysator in front of the catalyst
		7.02604.99.0	LS	400 mm	
E 300 CDI (212.020) 150-170 kW (204-231 PS) OM 642.850	12.2009→12.2010	 7.08369.51.0	ATS	EL	
		7.08369.61.0	ATS	EL	
		7.05270.21.0	LS	600 mm	
E 300 CDI / BlueTEC (212.020, 212.021, 212.027) 150-170 kW (204-231 PS) OM 642.850	03.2011→12.2015	 7.08369.51.0	ATS	EL	

M











E-CLASS (W212) 47

		7.08369.61.0 ATS 7.08369.89.0 ATS 7.05270.21.0 LS	EL EL 600 mm	für OE-Nummer: A 000 905 70 04, A 000 905 85 01 for OE number: A 000 905 70 04, A 000 905 85 01 nach Rußpartikelfilter after soot particulate filter
E 300 CDI / BlueTEC (212.020, 212.021, 212.027) 170-195 kW (231-265 PS) OM 642.852	03.2011→12.2015	 7.08369.51.0 ATS 7.08369.61.0 ATS 7.08369.89.0 ATS 7.11020.01.0 ATS 7.05270.21.0 LS	EL EL EL EL 600 mm	für OE-Nummer: A 000 905 70 04, A 000 905 85 01 for OE number: A 000 905 70 04, A 000 905 85 01 nach Rußpartikelfilter after soot particulate filter nicht für Baumuster: 212.020 not for code: 212.020
E 300 Hybrid / BlueTEC Hybrid (212.098) 120-150 kW (163-204 PS) OM 651.924	12.2011→12.2016	 7.08369.06.0 ATS 7.08369.12.0 ATS 7.08369.76.0 ATS 7.08369.89.0 ATS 7.08369.90.0 ATS 7.08369.97.0 ATS	EL EL EL EL EL	vor Katalysator in front of the catalyst für Linkslenker for left-hand drive vehicles für OE-Nummer: A 000 905 70 04, A 000 905 85 01 for OE number: A 000 905 70 04, A 000 905 85 01 nach Rußpartikelfilter after soot particulate filter für OE-Nummer: A 000 905 65 04, A 001 905 07 00 for OE number: A 000 905 65 04, A 001 905 07 00 vor Rußpartikelfilter before soot particulate filter vor Katalysator in front of the catalyst für Rechtslenker for right-hand drive vehicles für Fahrzeuge mit SCR-System for vehicles with SCR system
E 350 (212.056) 200 kW (272 PS) M 272.980	01.2009→12.2013	 7.05270.17.0 LS 7.05270.21.0 LS 7.04389.02.0 SLP	null mm 600 mm EL	links, rechts Left, Right Diagnosesonde Diagnostic Probe links, rechts Left, Right Regelsonde Regulating Probe
E 350 (212.059) 185-245 kW (252-333 PS) M 276.952	09.2011→12.2015	 7.02604.44.0 LS	500 mm	für OE-Nummer: A 008 542 29 18, A 009 542 59 18 for OE number: A 008 542 29 18, A 009 542 59 18 vor Katalysator in front of the catalyst

M



E-CLASS (W212) **47**







		7.02604.99.0	LS	400 mm	
E 350 4-matic (212.087) 200 kW (272 PS) M 272.977	01.2009→08.2011	 7.05270.18.0	LS	500 mm	links, rechts Left, Right Diagnosesonde Diagnostic Probe
		7.04389.02.0	SLP	EL	
E 350 4-matic (212.088) 185-245 kW (252-333 PS) M 276.952	09.2011→12.2015	 7.02604.44.0	LS	500 mm	für OE-Nummer: A 008 542 29 18, A 009 542 59 18 for OE number: A 008 542 29 18, A 009 542 59 18 vor Katalysator in front of the catalystr
		7.02604.99.0	LS	400 mm	
E 350 BlueTEC 170-195 kW (231-265 PS) OM 642.852	01.2013→12.2015	 7.08369.61.0	ATS	EL	
E 350 BlueTEC (212.024) 150-170 kW (204-231 PS) OM 642.850	01.2009→12.2015	 7.08369.51.0	ATS	EL	für OE-Nummer: A 000 905 70 04, A 000 905 85 01 for OE number: A 000 905 70 04, A 000 905 85 01 nach Rußpartikelfilter after soot particulate filter
		7.08369.61.0	ATS	EL	
		7.08369.89.0	ATS	EL	
E 350 BlueTEC (212.026) 170-195 kW (231-265 PS) OM 642.852	05.2014→12.2015	 7.08369.61.0	ATS	EL	für OE-Nummer: A 000 905 70 04, A 000 905 85 01 for OE number: A 000 905 70 04, A 000 905 85 01 nach Rußpartikelfilter after soot particulate filter
		7.08369.89.0	ATS	EL	
E 350 BlueTEC 4-matic (212.094) 185-195 kW (252-265 PS) OM 642.858	01.2013→12.2015	 7.08369.61.0	ATS	EL	für OE-Nummer: A 000 905 70 04, A 000 905 85 01 for OE number: A 000 905 70 04, A 000 905 85 01 nach Rußpartikelfilter after soot particulate filter
		7.08369.89.0	ATS	EL	
		7.11020.01.0	ATS	EL	
E 350 BlueTEC 4-matic (212.094) 185-195 kW (252-265 PS) OM 642.858	05.2014→12.2015	 7.08369.61.0	ATS	EL	für OE-Nummer: A 000 905 70 04, A 000 905 85 01 for OE number: A 000 905 70 04, A 000 905 85 01 nach Rußpartikelfilter after soot particulate filter
		7.08369.89.0	ATS	EL	
		7.11020.01.0	ATS	EL	
E 350 CDI (212.023) 170-195 kW (231-265 PS) OM 642.852	03.2011→12.2015	 7.08369.61.0	ATS	EL	

M



E-CLASS (W212)

47

			7.08369.89.0	ATS	EL	für OE-Nummer: A 000 905 70 04, A 000 905 85 01 for OE number: A 000 905 70 04, A 000 905 85 01 nach Rußpartikelfilter after soot particulate filter
			7.11020.01.0	ATS	EL	
			7.05270.21.0	LS	600 mm	
E 350 CDI (212.025) 150-170 kW (204-231 PS) OM 642.850	01.2009→12.2015		7.08369.51.0	ATS	EL	
			7.08369.61.0	ATS	EL	
			7.08369.89.0	ATS	EL	für OE-Nummer: A 000 905 70 04, A 000 905 85 01 for OE number: A 000 905 70 04, A 000 905 85 01 nach Rußpartikelfilter after soot particulate filter
			7.05270.21.0	LS	600 mm	
E 350 CDI 4-matic (212.089) 170 kW (231 PS) OM 642.856	09.2009→08.2011		7.08369.51.0	ATS	EL	
			7.08369.61.0	ATS	EL	
			7.05270.21.0	LS	600 mm	
E 350 CDI 4-matic (212.093) 185-195 kW (252-265 PS) OM 642.858	03.2011→12.2015		7.08369.61.0	ATS	EL	
			7.08369.89.0	ATS	EL	für OE-Nummer: A 000 905 70 04, A 000 905 85 01 for OE number: A 000 905 70 04, A 000 905 85 01 nach Rußpartikelfilter after soot particulate filter
			7.11020.01.0	ATS	EL	
			7.05270.21.0	LS	600 mm	
E 350 CGI (212.057) 215 kW (292 PS) M 272.982	01.2009→08.2011		7.05270.17.0	LS	null mm	
E 350 CGI (212.057) 215 kW (292 PS) M 272.983	01.2009→08.2011		7.05270.17.0	LS	null mm	
			7.04389.02.0	SLP	EL	
E 400 4-matic (212.067) 200-245 kW (272-333 PS) M 276.820	01.2013→12.2016		7.02604.44.0	LS	500 mm	vor Katalysator, beidseitig in front of the catalyst, Left and right
E 400 4-matic (212.099) 245 kW (333 PS) M 276.850	07.2014→12.2015		7.02604.44.0	LS	500 mm	vor Katalysator, beidseitig in front of the catalyst, Left and right
E 500 (212.072) 285 kW (388 PS) M 273.971	01.2009→12.2011		7.05270.21.0	LS	600 mm	
			7.05270.18.0	LS	500 mm	
			7.04389.02.0	SLP	EL	
E 500 (212.073) 300-320 kW (408-435 PS) M 278.922	09.2011→12.2015		7.05270.21.0	LS	600 mm	

M



E-CLASS (W212) **47**

			7.02604.44.0	LS	500 mm	für OE-Nummer: A 009 542 60 18, A 009 542 63 18 for OE number: A 009 542 60 18, A 009 542 63 18 vor Katalysator, beidseitig in front of the catalyst, Left and right
			7.05270.18.0	LS	500 mm	
E 500 4-matic (212.090) 285 kW (388 PS) M 273.970	01.2009→12.2011		7.05270.21.0	LS	600 mm	
			7.05270.18.0	LS	500 mm	
			7.04389.02.0	SLP	EL	
E 500 4-matic (212.091) 300-320 kW (408-435 PS) M 278.922	09.2011→12.2015		7.05270.21.0	LS	600 mm	
			7.02604.44.0	LS	500 mm	für OE-Nummer: A 009 542 60 18, A 009 542 63 18 for OE number: A 009 542 60 18, A 009 542 63 18
			7.05270.18.0	LS	500 mm	
E 63 AMG (212.074) 386-430 kW (525-585 PS) M 157.980, M 157.981	02.2011→12.2016		7.05270.22.0	LS	825 mm	
			7.05270.18.0	LS	500 mm	
E 63 AMG (212.074) 386-430 kW (525-585 PS) M 157.981	02.2011→12.2016		7.05270.22.0	LS	825 mm	
			7.02604.44.0	LS	500 mm	vor Katalysator, beidseitig in front of the catalyst, Left and right 2014
			7.05270.18.0	LS	500 mm	
E 63 AMG (212.075) 386-430 kW (525-585 PS) M 157.981	02.2013→12.2016		7.05270.22.0	LS	825 mm	
			7.02604.44.0	LS	500 mm	vor Katalysator, beidseitig in front of the catalyst, Left and right 2014
			7.05270.18.0	LS	500 mm	
E 63 AMG (212.077) 336-410 kW (457-558 PS) M 156.985	12.2009→12.2015		7.05270.22.0	LS	825 mm	
			7.05270.18.0	LS	500 mm	
			7.04389.09.0	SLP	EL	
E 63 AMG 4-matic (212.076) 386-430 kW (525-585 PS) M 157.981	02.2013→12.2016		7.05270.22.0	LS	825 mm	
			7.02604.44.0	LS	500 mm	vor Katalysator, beidseitig in front of the catalyst, Left and right 2014
			7.05270.18.0	LS	500 mm	
E 63 AMG 4-matic (212.092) 386-430 kW (525-585 PS) M 157.981	01.2013→12.2016		7.05270.22.0	LS	825 mm	



E-CLASS (W212) 47

		7.02604.44.0	LS	500 mm	vor Katalysator, beidseitig in front of the catalyst, Left and right 2014
		7.05270.18.0	LS	500 mm	2014













E-CLASS (W213) 48

AMG E 43 4-matic (213.064) 200-295 kW (272-401 PS) M 276.823	07.2016→	 7.02604.44.0	LS	500 mm	für OE-Nummer: A 009 542 59 18, A 009 542 60 18, A 009 542 63 18 for OE number: A 009 542 59 18, A 009 542 60 18, A 009 542 63 18
E 200 (213.042) 115-245 kW (156-333 PS) M 274.920	01.2016→	 7.24809.83.0	AGR	EL 	für OE-Nummer: A 274 142 05 19 for OE number: A 274 142 05 19
		7.24809.85.0	AGR	EL 	für OE-Nummer: A 274 142 04 19, A 274 142 06 19 for OE number: A 274 142 04 19, A 274 142 06 19
E 200 4-matic (213.043) 115-245 kW (156-333 PS) M 274.920	07.2016→	 7.24809.83.0	AGR	EL 	für OE-Nummer: A 274 142 05 19 for OE number: A 274 142 05 19
		7.24809.85.0	AGR	EL 	für OE-Nummer: A 274 142 04 19, A 274 142 06 19 for OE number: A 274 142 04 19, A 274 142 06 19
E 250 (213.045) 115-245 kW (156-333 PS) M 274.920	07.2016→	 7.24809.83.0	AGR	EL 	für OE-Nummer: A 274 142 05 19 for OE number: A 274 142 05 19
		7.24809.85.0	AGR	EL 	für OE-Nummer: A 274 142 04 19, A 274 142 06 19 for OE number: A 274 142 04 19, A 274 142 06 19
E 300 (213.048) 115-245 kW (156-333 PS) M 274.920	07.2016→	 7.24809.83.0	AGR	EL 	für OE-Nummer: A 274 142 05 19 for OE number: A 274 142 05 19
		7.24809.85.0	AGR	EL 	für OE-Nummer: A 274 142 04 19, A 274 142 06 19 for OE number: A 274 142 04 19, A 274 142 06 19
E 300 (213.048) 115-245 kW (156-333 PS) M 274.920	02.2019→	 7.24809.83.0	AGR	EL 	für OE-Nummer: A 274 142 05 19 for OE number: A 274 142 05 19
		7.24809.85.0	AGR	EL 	für OE-Nummer: A 274 142 04 19, A 274 142 06 19 for OE number: A 274 142 04 19, A 274 142 06 19
E 300 4-matic (213.049) 115-245 kW (156-333 PS) M 274.920	09.2016→	 7.24809.83.0	AGR	EL 	für OE-Nummer: A 274 142 05 19 for OE number: A 274 142 05 19
		7.24809.85.0	AGR	EL 	für OE-Nummer: A 274 142 04 19, A 274 142 06 19 for OE number: A 274 142 04 19, A 274 142 06 19
E 300 e (213.053) 115-245 kW (156-333 PS) M 274.920	11.2018→	 7.24809.83.0	AGR	EL 	für OE-Nummer: A 274 142 05 19 for OE number: A 274 142 05 19

M







E-CLASS (W213) 48

			7.24809.85.0	AGR	EL	 für OE-Nummer: A 274 142 04 19, A 274 142 06 19 for OE number: A 274 142 04 19, A 274 142 06 19
E 350 d (213.033) 190 kW (258 PS) OM 642.855	01.2016→05.2018		7.11020.01.0	ATS	EL	
E 350 d 4-matic (213.034) 190 kW (258 PS) OM 642.873	06.2017→05.2018		7.11020.01.0	ATS	EL	
E 350 e (213.050) 115-245 kW (156-333 PS) M 274.920	07.2016→		7.24809.83.0	AGR	EL	 für OE-Nummer: A 274 142 05 19 for OE number: A 274 142 05 19
			7.24809.85.0	AGR	EL	 für OE-Nummer: A 274 142 04 19, A 274 142 06 19 for OE number: A 274 142 04 19, A 274 142 06 19
E 350 e (213.050) 115-245 kW (156-333 PS) M 274.920	07.2016→		7.24809.83.0	AGR	EL	 für OE-Nummer: A 274 142 05 19 for OE number: A 274 142 05 19
			7.24809.85.0	AGR	EL	 für OE-Nummer: A 274 142 04 19, A 274 142 06 19 for OE number: A 274 142 04 19, A 274 142 06 19
M E 400 4-matic (213.066) 200-295 kW (272-401 PS) M 276.823	06.2016→		7.02604.44.0	LS	500 mm	für OE-Nummer: A 009 542 59 18, A 009 542 60 18, A 009 542 63 18 for OE number: A 009 542 59 18, A 009 542 60 18, A 009 542 63 18
	07.2016→		7.02604.44.0	LS	500 mm	für OE-Nummer: A 009 542 59 18, A 009 542 60 18, A 009 542 63 18 for OE number: A 009 542 59 18, A 009 542 60 18, A 009 542 63 18
	08.2018→		7.02604.44.0	LS	500 mm	für OE-Nummer: A 009 542 59 18, A 009 542 60 18, A 009 542 63 18 for OE number: A 009 542 59 18, A 009 542 60 18, A 009 542 63 18

E-CLASS All-Terrain (S213) 49



E 350 d 4-matic (213.237) 190 kW (258 PS) OM 642.873	06.2017→		7.11020.01.0	ATS	EL	
--	----------	---	---------------------	-----	----	--

E-CLASS Convertible (A207) 50

E 200 (207.434) 115-245 kW (156-333 PS) M 274.920	03.2013→12.2016		7.24809.83.0	AGR	EL	 für OE-Nummer: A 274 142 05 19 for OE number: A 274 142 05 19
			7.24809.85.0	AGR	EL	 für OE-Nummer: A 274 142 04 19, A 274 142 06 19 for OE number: A 274 142 04 19, A 274 142 06 19
			7.02604.44.0	LS	500 mm	vor Katalysator in front of the catalyst
E 200 CGI (207.448) 115-150 kW (156-204 PS) M 271.820, M 271.860	01.2010→12.2016		7.04389.07.0	SLP	EL	
			E 220 BlueTEC (207.401) 120-150 kW (163-204 PS) OM 651.911	05.2014→12.2016		7.08369.06.0
		7.08369.12.0	ATS	EL		











E-CLASS Convertible (A207) **50**

			7.08369.76.0	ATS	EL	für OE-Nummer: A 000 905 52 02, A 000 905 89 04 for OE number: A 000 905 52 02, A 000 905 89 04 vor Katalysator in front of the catalyst
			7.08369.89.0	ATS	EL	nach Rußpartikelfilter after soot particulate filter für Fahrzeuge mit SCR-System for vehicles with SCR system
			7.08369.90.0	ATS	EL	vor Rußpartikelfilter before soot particulate filter für Linkslenker for left-hand drive vehicles
			7.08369.97.0	ATS	EL	vor Katalysator in front of the catalyst für Rechtslenker for right-hand drive vehicles für Fahrzeuge mit SCR-System for vehicles with SCR system
			7.05270.21.0	LS	600 mm	vor Katalysator in front of the catalyst für Fahrzeuge ohne Start-Stopp-Funktion for vehicles without start-stop function
E 220 CDI (207.402) 120-150 kW (163-204 PS) OM 651.911	02.2010→12.2016		7.08369.06.0	ATS	EL	
			7.08369.12.0	ATS	EL	
			7.08369.76.0	ATS	EL	für OE-Nummer: A 000 905 52 02, A 000 905 89 04 for OE number: A 000 905 52 02, A 000 905 89 04
			7.11190.01.0	DDS		Partikelfilter Particulate Filter für Fahrzeuge ohne SCR-System for vehicles without SCR system
			7.11190.01.0	DDS		Partikelfilter Particulate Filter für Fahrzeuge ohne SCR-System for vehicles without SCR system
E 220 CDI / BlueTEC / d (207.402, 207.401) 120-150 kW (163-204 PS) OM 651.911	01.2010→12.2016		7.08369.06.0	ATS	EL	
			7.08369.12.0	ATS	EL	
			7.08369.61.0	ATS	EL	
			7.08369.76.0	ATS	EL	für OE-Nummer: A 000 905 52 02, A 000 905 89 04 for OE number: A 000 905 52 02, A 000 905 89 04 vor Katalysator in front of the catalyst
			7.08369.89.0	ATS	EL	nach Rußpartikelfilter after soot particulate filter für Fahrzeuge mit SCR-System for vehicles with SCR system
			7.08369.90.0	ATS	EL	vor Rußpartikelfilter before soot particulate filter für Linkslenker for left-hand drive vehicles
			7.08369.97.0	ATS	EL	vor Katalysator in front of the catalyst für Rechtslenker for right-hand drive vehicles für Fahrzeuge mit SCR-System for vehicles with SCR system

M









E-CLASS Convertible (A207) 50

			7.05270.21.0	LS	600 mm	vor Katalysator in front of the catalyst für Fahrzeuge ohne Start-Stopp-Funktion for vehicles without start-stop function
E 250 (207.436) 115-245 kW (156-333 PS) M 274.920	06.2013→12.2016		7.24809.83.0	AGR	EL	 für OE-Nummer: A 274 142 05 19 for OE number: A 274 142 05 19
			7.24809.85.0	AGR	EL	 für OE-Nummer: A 274 142 04 19, A 274 142 06 19 for OE number: A 274 142 04 19, A 274 142 06 19
			7.02604.44.0	LS	500 mm	vor Katalysator in front of the catalyst
E 250 CDI / BlueTEC / d (207.403, 207.404) 120-150 kW (163-204 PS) OM 651.911	01.2010→12.2016		7.08369.06.0	ATS	EL	
			7.08369.12.0	ATS	EL	
			7.08369.61.0	ATS	EL	
			7.08369.76.0	ATS	EL	für OE-Nummer: A 000 905 52 02, A 000 905 89 04 for OE number: A 000 905 52 02, A 000 905 89 04 vor Katalysator in front of the catalyst
			7.08369.89.0	ATS	EL	nach Rußpartikelfilter after soot particulate filter für Fahrzeuge mit SCR-System for vehicles with SCR system
			7.08369.90.0	ATS	EL	vor Rußpartikelfilter before soot particulate filter für Linkslenker for left-hand drive vehicles
			7.08369.97.0	ATS	EL	für Rechtslenker for right-hand drive vehicles für Fahrzeuge mit SCR-System for vehicles with SCR system
			7.05270.21.0	LS	600 mm	vor Katalysator in front of the catalyst für Fahrzeuge ohne Start-Stopp-Funktion for vehicles without start-stop function
E 250 CGI (207.447) 135-150 kW (184-204 PS) M 271.860	01.2010→12.2016		7.04389.07.0	SLP	EL	
E 300 (207.455) 182-225 kW (248-306 PS) M 276.957	04.2011→12.2016		7.02604.44.0	LS	500 mm	für OE-Nummer: A 008 542 29 18, A 009 542 59 18 for OE number: A 008 542 29 18, A 009 542 59 18 vor Katalysator in front of the catalyst
			7.02604.99.0	LS	400 mm	
E 350 (207.456) 200-215 kW (272-292 PS) M 272.961, M 272.988	03.2010→12.2011		7.04389.02.0	SLP	EL	
E 350 (207.459) 182-225 kW (248-306 PS) M 276.957	04.2011→12.2014		7.02604.44.0	LS	500 mm	für OE-Nummer: A 008 542 29 18, A 009 542 59 18 for OE number: A 008 542 29 18, A 009 542 59 18
			7.02604.99.0	LS	400 mm	
E 350 BlueTEC (207.426) 185-195 kW (252-265 PS) OM 642.838	06.2013→12.2016		7.08369.61.0	ATS	EL	

M

























E-CLASS Convertible (A207) 50

			7.08369.89.0	ATS	EL	für OE-Nummer: A 000 905 70 04, A 000 905 85 01 for OE number: A 000 905 70 04, A 000 905 85 01 Partikelfilter Particulate Filter
			7.11020.01.0	ATS	EL	
E 350 BlueTEC/ d (207.426) 185-195 kW (252-265 PS) OM 642.838	05.2014→12.2016		7.08369.61.0	ATS	EL	
			7.08369.89.0	ATS	EL	für OE-Nummer: A 000 905 70 04, A 000 905 85 01 for OE number: A 000 905 70 04, A 000 905 85 01 Partikelfilter Particulate Filter
			7.11020.01.0	ATS	EL	
E 350 CDI (207.422) 170 kW (231 PS) OM 642.836	01.2010→12.2011		7.08369.51.0	ATS	EL	
			7.08369.61.0	ATS	EL	
			7.05270.21.0	LS	600 mm	
E 350 CDI (207.423) 185-195 kW (252-265 PS) OM 642.838	04.2011→12.2013		7.08369.61.0	ATS	EL	
			7.08369.89.0	ATS	EL	für OE-Nummer: A 000 905 70 04, A 000 905 85 01 for OE number: A 000 905 70 04, A 000 905 85 01 Partikelfilter Particulate Filter
			7.11020.01.0	ATS	EL	
			7.05270.21.0	LS	600 mm	
E 350 CGI (207.457) 215 kW (292 PS) M 272.982, M 272.984	01.2010→12.2014		7.05270.17.0	LS	null mm	
			7.04389.02.0	SLP	EL	
E 500 (207.472) 285 kW (388 PS) M 273.966	01.2010→12.2011		7.04389.02.0	SLP	EL	
E 500 (207.473) 300-320 kW (408-435 PS) M 278.922	09.2011→12.2016		7.02604.44.0	LS	500 mm	vor Katalysator, beidseitig in front of the catalyst, Left and right

M

E-CLASS Convertible (A238) 51





E 200 (238.442) 115-245 kW (156-333 PS) M 274.920	06.2017→		7.24809.83.0	AGR	EL	 für OE-Nummer: A 274 142 05 19 for OE number: A 274 142 05 19
			7.24809.85.0	AGR	EL	 für OE-Nummer: A 274 142 04 19, A 274 142 06 19 for OE number: A 274 142 04 19, A 274 142 06 19
E 200 4-matic (238.443) 115-245 kW (156-333 PS) M 274.920	10.2017→		7.24809.83.0	AGR	EL	 für OE-Nummer: A 274 142 05 19 for OE number: A 274 142 05 19
			7.24809.85.0	AGR	EL	 für OE-Nummer: A 274 142 04 19, A 274 142 06 19 for OE number: A 274 142 04 19, A 274 142 06 19

					
E-CLASS Convertible (A238)					
E 300 (238.448) 115-245 kW (156-333 PS) M 274.920	06.2017→		7.24809.83.0	AGR	EL  für OE-Nummer: A 274 142 05 19 for OE number: A 274 142 05 19
			7.24809.85.0	AGR	EL  für OE-Nummer: A 274 142 04 19, A 274 142 06 19 for OE number: A 274 142 04 19, A 274 142 06 19
E 350 d 4-matic (238.434) 190 kW (258 PS) OM 642.873	06.2017→		7.11020.01.0	ATS	EL
E-CLASS Coupe (C207)					
E 200 (207.334) 115-245 kW (156-333 PS) M 274.920	06.2013→12.2016		7.24809.83.0	AGR	EL  für OE-Nummer: A 274 142 05 19 for OE number: A 274 142 05 19
			7.24809.85.0	AGR	EL  für OE-Nummer: A 274 142 04 19, A 274 142 06 19 for OE number: A 274 142 04 19, A 274 142 06 19
			7.02604.44.0	LS	500 mm vor Katalysator in front of the catalyst
E 200 CGI (207.348) 115-150 kW (156-204 PS) M 271.820, M 271.860	01.2010→12.2016		7.04389.07.0	SLP	EL
E 220 BlueTEC (207.301) 120-150 kW (163-204 PS) OM 651.911	05.2014→12.2016		7.08369.06.0	ATS	EL
			7.08369.12.0	ATS	EL
			7.08369.76.0	ATS	EL für OE-Nummer: A 000 905 52 02, A 000 905 89 04 for OE number: A 000 905 52 02, A 000 905 89 04 vor Katalysator in front of the catalyst
			7.08369.89.0	ATS	EL nach Rußpartikelfilter after soot particulate filter
			7.08369.90.0	ATS	EL vor Rußpartikelfilter before soot particulate filter für Linkslenker for left-hand drive vehicles
			7.08369.97.0	ATS	EL vor Katalysator in front of the catalyst für Rechtslenker for right-hand drive vehicles für Fahrzeuge mit SCR-System for vehicles with SCR system
			7.05270.21.0	LS	600 mm vor Katalysator in front of the catalyst für Fahrzeuge ohne Start-Stopp-Funktion for vehicles without start-stop function
E 220 CDI (207.302) 120-150 kW (163-204 PS) OM 651.911	02.2010→12.2014		7.08369.06.0	ATS	EL
			7.08369.76.0	ATS	EL für OE-Nummer: A 000 905 52 02, A 000 905 89 04 for OE number: A 000 905 52 02, A 000 905 89 04 vor Katalysator in front of the catalyst

M











E-CLASS Coupe (C207) 52

			7.08369.97.0	ATS	EL	vor Katalysator in front of the catalyst für Rechtslenker for right-hand drive vehicles für Fahrzeuge mit SCR-System for vehicles with SCR system
E 220 CDI / d (207.302, 207.301) 120-150 kW (163-204 PS) OM 651.911	01.2010→12.2016		7.08369.06.0	ATS	EL	
			7.08369.12.0	ATS	EL	
			7.08369.61.0	ATS	EL	
			7.08369.76.0	ATS	EL	für OE-Nummer: A 000 905 52 02, A 000 905 89 04 for OE number: A 000 905 52 02, A 000 905 89 04 vor Katalysator in front of the catalyst
			7.08369.89.0	ATS	EL	nach Rußpartikelfilter after soot particulate filter
			7.08369.90.0	ATS	EL	vor Rußpartikelfilter before soot particulate filter für Linkslenker for left-hand drive vehicles
			7.08369.97.0	ATS	EL	vor Katalysator in front of the catalyst für Rechtslenker for right-hand drive vehicles
			7.05270.21.0	LS	600 mm	vor Katalysator in front of the catalyst für Fahrzeuge ohne Start-Stopp-Funktion for vehicles without start-stop function
E 250 (207.336) 115-245 kW (156-333 PS) M 274.920	06.2013→12.2016		7.24809.83.0	AGR	EL	 für OE-Nummer: A 274 142 05 19 for OE number: A 274 142 05 19
			7.24809.85.0	AGR	EL	 für OE-Nummer: A 274 142 04 19, A 274 142 06 19 for OE number: A 274 142 04 19, A 274 142 06 19
			7.02604.44.0	LS	500 mm	vor Katalysator in front of the catalyst
E 250 CDI / BlueTEC / d (207.303, 207.304) 120-150 kW (163-204 PS) OM 651.911	01.2009→12.2016		7.08369.06.0	ATS	EL	
			7.08369.12.0	ATS	EL	
			7.08369.61.0	ATS	EL	
			7.08369.76.0	ATS	EL	für OE-Nummer: A 000 905 52 02, A 000 905 89 04 for OE number: A 000 905 52 02, A 000 905 89 04 vor Katalysator in front of the catalyst
			7.08369.89.0	ATS	EL	nach Rußpartikelfilter after soot particulate filter für Fahrzeuge mit SCR-System for vehicles with SCR system
			7.08369.90.0	ATS	EL	vor Rußpartikelfilter before soot particulate filter für Linkslenker for left-hand drive vehicles
			7.08369.97.0	ATS	EL	vor Katalysator in front of the catalyst für Fahrzeuge mit SCR-System for vehicles with SCR system































M



E-CLASS Coupe (C207) **52**

			7.05270.21.0	LS	600 mm	vor Katalysator in front of the catalyst für Fahrzeuge ohne Start-Stopp-Funktion for vehicles without start-stop function
E 250 CGI (207.347) 135-150 kW (184-204 PS) M 271.860	01.2009→12.2016		7.04389.07.0	SLP	EL	
E 300 (207.355) 182-225 kW (248-306 PS) M 276.957	04.2011→06.2016		7.02604.44.0	LS	500 mm	für OE-Nummer: A 008 542 29 18, A 009 542 59 18 for OE number: A 008 542 29 18, A 009 542 59 18 vor Katalysator in front of the catalyst
			7.02604.99.0	LS	400 mm	
E 350 (207.356) 200-215 kW (272-292 PS) M 272.961, M 272.988	01.2010→12.2011		7.04389.02.0	SLP	EL	
E 350 (207.359) 182-225 kW (248-306 PS) M 276.957	04.2011→12.2014		7.02604.44.0	LS	500 mm	für OE-Nummer: A 008 542 29 18, A 009 542 59 18 for OE number: A 008 542 29 18, A 009 542 59 18 vor Katalysator in front of the catalyst
			7.02604.99.0	LS	400 mm	
E 350 4-matic (207.388) 182-225 kW (248-306 PS) M 276.957	02.2013→12.2016		7.02604.44.0	LS	500 mm	für OE-Nummer: A 008 542 29 18, A 009 542 59 18 for OE number: A 008 542 29 18, A 009 542 59 18 vor Katalysator in front of the catalyst
E 350 BlueTEC / d (207.326) 185-195 kW (252-265 PS) OM 642.838	05.2014→12.2016		7.08369.61.0	ATS	EL	
			7.08369.89.0	ATS	EL	für OE-Nummer: A 000 905 70 04, A 000 905 85 01 for OE number: A 000 905 70 04, A 000 905 85 01 Partikelfilter Particulate Filter
E 350 CDI (207.322) 170 kW (231 PS) OM 642.836	01.2009→06.2011		7.08369.51.0	ATS	EL	
			7.08369.61.0	ATS	EL	
			7.05270.21.0	LS	600 mm	
E 350 CDI (207.323) 185-195 kW (252-265 PS) OM 642.838	06.2011→06.2013		7.08369.61.0	ATS	EL	
			7.08369.89.0	ATS	EL	für OE-Nummer: A 000 905 70 04, A 000 905 85 01 for OE number: A 000 905 70 04, A 000 905 85 01 Partikelfilter Particulate Filter
			7.11020.01.0	ATS	EL	
			7.05270.21.0	LS	600 mm	
E 350 CGI (207.357) 215 kW (292 PS) M 272.982, M 272.984	01.2009→12.2011		7.05270.17.0	LS	null mm	
			7.04389.02.0	SLP	EL	







M

						
E-CLASS Coupe (C207)						52
E 400 4-matic (207.367) 200-245 kW (272-333 PS) M 276.820	09.2014→12.2016		7.02604.44.0	LS	500 mm	
E 500 (207.372) 285 kW (388 PS) M 273.966	01.2009→12.2016		7.04389.02.0	SLP	EL	
E 500 (207.373) 300-320 kW (408-435 PS) M 278.922	09.2011→12.2016		7.02604.44.0	LS	500 mm vor Katalysator, beidseitig in front of the catalyst, Left and right	
E-CLASS Coupe (C238)						53
E 200 (238.342) 115-245 kW (156-333 PS) M 274.920	12.2016→		7.24809.83.0	AGR	EL  für OE-Nummer: A 274 142 05 19 for OE number: A 274 142 05 19	
			7.24809.85.0	AGR	EL  für OE-Nummer: A 274 142 04 19, A 274 142 06 19 for OE number: A 274 142 04 19, A 274 142 06 19	
E 200 4-matic (238.343) 115-245 kW (156-333 PS) M 274.920	06.2017→		7.24809.83.0	AGR	EL  für OE-Nummer: A 274 142 05 19 for OE number: A 274 142 05 19	
			7.24809.85.0	AGR	EL  für OE-Nummer: A 274 142 04 19, A 274 142 06 19 for OE number: A 274 142 04 19, A 274 142 06 19	
E 300 (238.348) 115-245 kW (156-333 PS) M 274.920	12.2016→		7.24809.83.0	AGR	EL  für OE-Nummer: A 274 142 05 19 for OE number: A 274 142 05 19	
			7.24809.85.0	AGR	EL  für OE-Nummer: A 274 142 04 19, A 274 142 06 19 for OE number: A 274 142 04 19, A 274 142 06 19	
E 350 d 4-matic (238.334) 190 kW (258 PS) OM 642.873	06.2017→		7.11020.01.0	ATS	EL	
E-CLASS T-Model (S124)						54
E 250 Turbo D 90-93 kW (126 PS) OM 602.962	06.1993→06.1996		7.21949.51.0	AGR	PN  " " Finnland, Österreich " " Finland, Austria	
E 280 T (124.088) 142-145 kW (193-197 PS) M 104.942	06.1993→06.1996		7.02604.03.0	LS	200 mm	
E 280 T (124.088) 142-145 kW (193-197 PS) M 104.942	06.1993→06.1996		7.02604.03.0	LS	200 mm	
E 300 T 4-matic (124.290) 132 kW (180 PS) M 103.985	06.1993→06.1996		7.02604.03.0	LS	200 mm	
E 300 T Turbo-D (124.193) 100-108 kW (136-147 PS) OM 603.960	06.1993→06.1996		7.21949.51.0	AGR	PN 	
E 300 T Turbo-D 4-matic (124.393) 105-108 kW (143-147 PS) OM 603.963	06.1993→06.1996		7.21949.51.0	AGR	PN 	
E-CLASS T-Model (S210)						55
E 230 T (210.237) 110 kW (150 PS) M 111.970	06.1996→06.1997		7.02604.04.0	LS	200 mm	
E 240 T (210.261) 125 kW (170 PS) M 112.911	06.1997→03.2003		7.22136.50.0	AGR	PN 	

M





E-CLASS T-Model (S210) **55**

			7.05270.03.0	LS	820 mm	für OE-Nummer: A 001 540 51 17 for OE number: A 001 540 51 17
			7.05270.12.0	LS	500 mm	
			7.05270.15.0	LS	380 mm	
			7.04389.00.0	SLP	EL	
E 240 T (210.262) 125 kW (170 PS) M 112.914	08.2000→03.2003		7.22136.50.0	AGR	PN	<input checked="" type="checkbox"/>
			7.05270.12.0	LS	500 mm	vor Katalysator, links in front of the catalyst, Left für Linkslenker for left-hand drive vehicles USA, Kanada USA, Canada Produktionsdatum ab: 2000-06-30 Production date from: 2000-06-30
			7.04389.00.0	SLP	EL	
E 280 T (210.263) 150 kW (204 PS) M 112.921	12.1996→03.2003		7.22136.50.0	AGR	PN	<input checked="" type="checkbox"/>
			7.05270.03.0	LS	820 mm	vor Katalysator, links in front of the catalyst, Left für Linkslenker for left-hand drive vehicles Produktionsdatum ab: 2000-06-30 Production date from: 2000-06-30
			7.05270.12.0	LS	500 mm	
			7.05270.15.0	LS	380 mm	
			7.04389.00.0	SLP	EL	
E 280 T 4-matic (210.281) 150 kW (204 PS) M 112.921	12.1996→03.2003		7.22136.50.0	AGR	PN	<input checked="" type="checkbox"/>
			7.05270.03.0	LS	820 mm	für OE-Nummer: A 001 540 51 17 for OE number: A 001 540 51 17
			7.05270.12.0	LS	500 mm	
			7.05270.15.0	LS	380 mm	
			7.04389.00.0	SLP	EL	
E 320 T (210.265) 160-165 kW (218-224 PS) M 112.941	12.1996→03.2003		7.22136.50.0	AGR	PN	<input checked="" type="checkbox"/>
			7.05270.03.0	LS	820 mm	für OE-Nummer: A 001 540 51 17 for OE number: A 001 540 51 17
			7.05270.12.0	LS	500 mm	
			7.05270.15.0	LS	380 mm	
			7.04389.00.0	SLP	EL	
E 320 T 4-matic (210.282) 160-165 kW (218-224 PS) M 112.941	12.1996→03.2003		7.22136.50.0	AGR	PN	<input checked="" type="checkbox"/>
			7.05270.03.0	LS	820 mm	für OE-Nummer: A 001 540 51 17 for OE number: A 001 540 51 17
			7.05270.12.0	LS	500 mm	
			7.05270.15.0	LS	380 mm	
			7.04389.00.0	SLP	EL	
E 430 T (210.270) 205 kW (279 PS) M 113.940	06.1997→03.2003		7.22136.50.0	AGR	PN	<input checked="" type="checkbox"/>

M





E-CLASS T-Model (S210) 55

			7.05270.03.0	LS	820 mm	
			7.05270.12.0	LS	500 mm	für OE-Nummer: A 001 540 51 17 for OE number: A 001 540 51 17
			7.05270.15.0	LS	380 mm	
			7.04389.00.0	SLP	EL	
E 430 T 4-matic (210.283) 205 kW (279 PS) M 113.940	05.1999→03.2003		7.22136.50.0	AGR	PN	☒
			7.05270.03.0	LS	820 mm	
			7.05270.12.0	LS	500 mm	vor Katalysator, links in front of the catalyst, Left für Linkslenker for left-hand drive vehicles Produktionsdatum ab: 30.06.2000 Production date from: 30.06.2000
			7.05270.15.0	LS	380 mm	
			7.04389.00.0	SLP	EL	
E 55 T AMG (210.274) 255-260 kW (347-354 PS) M 113.980	08.1997→03.2003		7.22136.50.0	AGR	PN	☒
			7.05270.03.0	LS	820 mm	 →ch. B173999 rechts Right für Rechtslenker for right-hand drive vehicles Regelsonde Regulating Probe
			7.05270.12.0	LS	500 mm	für OE-Nummer: A 001 540 51 17 for OE number: A 001 540 51 17
			7.05270.15.0	LS	380 mm	links, rechts Left, Right Euro 3 (D3) Euro 3 (D3) Diagnosesonde Diagnostic Probe
			7.04389.00.0	SLP	EL	







M

E-CLASS T-Model (S211) 56

3.5 4-matic 200-205 kW (272-279 PS) M 272.972	08.2004→08.2006		7.04389.02.0	SLP	EL	
350 CGI (211.257) 215 kW (292 PS) M 272.985	05.2006→07.2009		7.08369.12.0	ATS	EL	
			7.05270.17.0	LS	null mm	
			7.04389.02.0	SLP	EL	
E 200 CDI (211.207) 100-125 kW (136-170 PS) OM 646.821	04.2006→07.2009		7.24809.48.0	AGR	ET	☉
			7.08369.91.0	ATS	EL	Partikelfilter Particulate Filter für Rechtslenker for right-hand drive vehicles









E-CLASS T-Model (S211) 56

			7.11020.35.0	ATS	EL	nach Katalysator Post-catalyst für Linkslenker for left-hand drive vehicles für Fahrzeuge mit Diesel-Partikel-Filter (DPF) for vehicles with diesel soot filter Produktionsdatum ab: 30.04.2008 Production date from: 30.04.2008
			7.11190.01.0	DDS		für OE-Nummer: A 006 153 49 28, A 006 153 95 28, A 007 153 61 28 for OE number: A 006 153 49 28, A 006 153 95 28, A 007 153 61 28 Luftfiltergehäuse Air Filter Housing
			7.05270.22.0	LS	825 mm	
			7.05270.21.0	LS	600 mm	für OE-Nummer: A 004 542 73 18 for OE number: A 004 542 73 18 vor Katalysator in front of the catalyst
E 200 Kompressor (211.241) 135 kW (184 PS) M 271.956	04.2006→07.2009		7.05271.23.0	LS	900 mm	
			7.05270.11.0	LS	750 mm	vor Katalysator in front of the catalyst
E 200 T Kompressor (211.242) 120 kW (163 PS) M 271.941	03.2003→07.2009		7.05271.23.0	LS	900 mm	
			7.05270.11.0	LS	750 mm	nach Katalysator Post-catalyst
E 220 CDI (211.206) 100-110 kW (136-150 PS) OM 646.961	03.2003→07.2009		7.24809.36.0	AGR	ET	
			7.08369.30.0	ATS	EL	vor Katalysator in front of the catalyst
			7.08369.91.0	ATS	EL	Partikelfilter Particulate Filter für Rechtslenker for right-hand drive vehicles
			7.08369.94.0	ATS	EL	nach Katalysator Post-catalyst für Linkslenker for left-hand drive vehicles für Fahrzeuge mit Diesel-Partikel-Filter (DPF) for vehicles with diesel soot filter 2006 2006
			7.11190.01.0	DDS		für OE-Nummer: A 004 153 95 28, A 005 153 74 28, A 005 153 77 28, A 006 153 49 28 for OE number: A 004 153 95 28, A 005 153 74 28, A 005 153 77 28, A 006 153 49 28 Luftfiltergehäuse Air Filter Housing
			7.05270.22.0	LS	825 mm	
			7.05270.21.0	LS	600 mm	für OE-Nummer: A 004 542 73 18 for OE number: A 004 542 73 18 vor Katalysator in front of the catalyst
E 220 T CDI 100-125 kW (136-170 PS) OM 646.821	03.2003→07.2009		7.24809.48.0	AGR	ET	













E-CLASS T-Model (S211) 56

			7.05270.22.0	LS	825 mm	
E 220 T CDI (211.206) 100-110 kW (136-150 PS) OM 646.961	03.2003→07.2009		7.24809.36.0	AGR	ET	
			7.11020.35.0	ATS	EL	 ch. B350084→ nach Katalysator Post-catalyst für Linkslenker for left-hand drive vehicles für Fahrzeuge mit Diesel-Partikel-Filter (DPF) for vehicles with diesel soot filter Produktionsdatum ab: 30.04.2008 Production date from: 30.04.2008
			7.08369.30.0	ATS	EL	vor Katalysator in front of the catalyst
			7.08369.91.0	ATS	EL	vor Rußpartikelfilter before soot particulate filter für Rechtslenker for right-hand drive vehicles
			7.08369.94.0	ATS	EL	nach Katalysator Post-catalyst für Linkslenker for left-hand drive vehicles für Fahrzeuge mit Diesel-Partikel-Filter (DPF) for vehicles with diesel soot filter 2006 2006
			7.05270.22.0	LS	825 mm	
			7.05270.21.0	LS	600 mm	für OE-Nummer: A 004 542 73 18 for OE number: A 004 542 73 18 vor Katalysator in front of the catalyst
E 220 T CDI (211.208) 100-125 kW (136-170 PS) OM 646.821	04.2006→07.2009		7.24809.48.0	AGR	ET	
			7.11020.35.0	ATS	EL	 ch. B350084→ nach Katalysator Post-catalyst für Linkslenker for left-hand drive vehicles für Fahrzeuge mit Diesel-Partikel-Filter (DPF) for vehicles with diesel soot filter Produktionsdatum ab: 30.04.2008 Production date from: 30.04.2008
			7.08369.91.0	ATS	EL	Partikelfilter Particulate Filter für Rechtslenker for right-hand drive vehicles
			7.08369.94.0	ATS	EL	nach Katalysator Post-catalyst für Linkslenker for left-hand drive vehicles für Fahrzeuge mit Diesel-Partikel-Filter (DPF) for vehicles with diesel soot filter 2006 2006
			7.11190.01.0	DDS		für OE-Nummer: A 006 153 49 28, A 006 153 95 28, A 007 153 61 28 for OE number: A 006 153 49 28, A 006 153 95 28, A 007 153 61 28 Luftfiltergehäuse Air Filter Housing

M











E-CLASS T-Model (S211) 56

			7.05270.22.0	LS	825 mm	
			7.05270.21.0	LS	600 mm	für OE-Nummer: A 004 542 73 18 for OE number: A 004 542 73 18 vor Katalysator in front of the catalyst
E 230 T (211.252) 150 kW (204 PS) M 272.922	05.2007→07.2009		7.05270.17.0	LS	null mm	
			7.05270.21.0	LS	600 mm	
			7.04389.02.0	SLP	EL	
E 240 T (211.261) 130 kW (177 PS) M 112.913	03.2003→07.2009		7.22136.50.0	AGR	PN	<input checked="" type="checkbox"/>
			7.04389.00.0	SLP	EL	
E 240 T 4-matic (211.280) 130 kW (177 PS) M 112.917	07.2003→07.2009		7.22136.50.0	AGR	PN	<input checked="" type="checkbox"/>
			7.05270.11.0	LS	750 mm	vor Katalysator, rechts in front of the catalyst, Right
			7.04389.00.0	SLP	EL	
E 270 T CDI (211.216) 120-130 kW (163-177 PS) OM 647.961	03.2003→07.2009		7.24809.37.0	AGR	ET	<input type="checkbox"/>
E 270 T CDI (211.216) 120-130 kW (163-177 PS) OM 647.961	03.2003→07.2009		7.24809.37.0	AGR	ET	<input type="checkbox"/>
E 280 T (211.254) 170 kW (231 PS) M 272.943	03.2005→07.2009		7.05270.17.0	LS	null mm	 ch. X175299→ links, rechts Left, Right Diagnosesonde Diagnostic Probe
			7.05270.22.0	LS	825 mm	rechts Right Allrad All-wheel Drive
			7.05270.21.0	LS	600 mm	links, rechts Left, Right Regelsonde Regulating Probe
			7.04389.02.0	SLP	EL	
E 280 T 4-matic (211.292) 170 kW (231 PS) M 272.943	03.2005→07.2009		7.05270.17.0	LS	null mm	 ch. X175299→ links, rechts Left, Right Diagnosesonde Diagnostic Probe
			7.05270.22.0	LS	825 mm	rechts Right Allrad All-wheel Drive
			7.05270.21.0	LS	600 mm	links, rechts Left, Right Regelsonde Regulating Probe
			7.04389.02.0	SLP	EL	
E 280 T 4-matic (211.292) 170 kW (231 PS) M 272.944	03.2005→07.2009		7.05270.12.0	LS	500 mm	nach Katalysator, beidseitig Post-catalyst, Left and right
			7.04389.02.0	SLP	EL	
E 280 T CDI (211.220) 140-200 kW (190-272 PS) OM 642.920	03.2005→07.2009		7.24809.47.0	AGR	ET	<input type="checkbox"/> USA USA











E-CLASS T-Model (S211) 56

			7.08369.94.0	ATS	EL	Katalysator Catalytic Converter für Linkslenker for left-hand drive vehicles für Fahrzeuge ohne Diesel-Partikel-Filter (DPF) for vehicles without diesel soot filter
			7.11190.01.0	DDS		Luftfiltergehäuse Air Filter Housing
			7.05270.21.0	LS	600 mm	
E 280 T CDI (211.223) 130-150 kW (177-204 PS) OM 648.961	05.2004→07.2009		7.24809.37.0	AGR	ET	
			7.24809.59.0	AGR	ET	 USA USA
			7.08369.30.0	ATS	EL	für OE-Nummer: A 005 153 10 28 for OE number: A 005 153 10 28 vor Katalysator in front of the catalyst
			7.08369.80.0	ATS	EL	für OE-Nummer: A 005 153 80 28 for OE number: A 005 153 80 28 vor Katalysator in front of the catalyst
			7.08369.91.0	ATS	EL	Partikelfilter Particulate Filter für Rechtslenker for right-hand drive vehicles
			7.05270.21.0	LS	600 mm	
E 280 T CDI 4-matic (211.284) 140-165 kW (190-224 PS) OM 642.921	03.2005→07.2009		7.24809.47.0	AGR	ET	 USA USA
			7.08369.87.0	ATS	EL	Katalysator Catalytic Converter für Linkslenker for left-hand drive vehicles für Fahrzeuge mit Diesel-Partikel-Filter (DPF) for vehicles with diesel soot filter Produktionsdatum ab: 05.06.2008 Production date from: 05.06.2008
			7.08369.94.0	ATS	EL	Katalysator Catalytic Converter für Linkslenker for left-hand drive vehicles für Fahrzeuge mit Diesel-Partikel-Filter (DPF) for vehicles with diesel soot filter Produktionsdatum bis: 05.06.2008 Production date to: 05.06.2008
			7.11190.01.0	DDS		Luftfiltergehäuse Air Filter Housing
			7.05270.21.0	LS	600 mm	
E 320 T (211.265) 165 kW (224 PS) M 112.949	03.2003→07.2009		7.22136.50.0	AGR	PN	
			7.02604.26.0	LS	500 mm	
			7.04389.00.0	SLP	EL	
E 320 T 4-matic (211.282) 165 kW (224 PS) M 112.954	07.2003→07.2009		7.22136.50.0	AGR	PN	
			7.05270.11.0	LS	750 mm	vor Katalysator, rechts in front of the catalyst, Right

M













E-CLASS T-Model (S211) 56

			7.02604.26.0	LS	500 mm	
			7.04389.00.0	SLP	EL	
E 320 T CDI (211.222) 140-200 kW (190-272 PS) OM 642.920	03.2005→07.2009		7.24809.47.0	AGR	ET	 USA USA
			7.08369.94.0	ATS	EL	Katalysator Catalytic Converter für Linkslenker for left-hand drive vehicles für Fahrzeuge ohne Diesel-Partikel-Filter (DPF) for vehicles without diesel soot filter
			7.11190.01.0	DDS		Luftfiltergehäuse Air Filter Housing
			7.05270.21.0	LS	600 mm	
E 320 T CDI (211.222) 140-200 kW (190-272 PS) OM 642.920	11.2007→07.2009		7.24809.47.0	AGR	ET	 USA USA
E 320 T CDI (211.226) 130-150 kW (177-204 PS) OM 648.961	03.2003→07.2009		7.24809.37.0	AGR	ET	
			7.24809.59.0	AGR	ET	 USA USA
			7.08369.30.0	ATS	EL	für OE-Nummer: A 005 153 10 28 for OE number: A 005 153 10 28 vor Katalysator in front of the catalyst
			7.08369.80.0	ATS	EL	für OE-Nummer: A 005 153 80 28 for OE number: A 005 153 80 28 vor Katalysator in front of the catalyst
			7.08369.91.0	ATS	EL	Partikelfilter Particulate Filter für Rechtslenker for right-hand drive vehicles
			7.05270.21.0	LS	600 mm	
E 320 T CDI 4-matic (211.289) 140-165 kW (190-224 PS) OM 642.921	03.2005→07.2009		7.24809.47.0	AGR	ET	 USA USA
			7.08369.87.0	ATS	EL	Katalysator Catalytic Converter für Linkslenker for left-hand drive vehicles für Fahrzeuge mit Diesel-Partikel-Filter (DPF) for vehicles with diesel soot filter Produktionsdatum ab: 05.06.2008 Production date from: 05.06.2008
			7.08369.94.0	ATS	EL	Katalysator Catalytic Converter für Linkslenker for left-hand drive vehicles für Fahrzeuge mit Diesel-Partikel-Filter (DPF) for vehicles with diesel soot filter Produktionsdatum bis: 05.06.2008 Production date to: 05.06.2008
			7.11190.01.0	DDS		Luftfiltergehäuse Air Filter Housing
			7.05270.21.0	LS	600 mm	

M









E-CLASS T-Model (S211) 56

E 350 T (211.256) 200 kW (272 PS) M 272.964	03.2005→07.2009		7.05270.17.0	LS	null mm	 ch. X175299→ links, rechts Left, Right Diagnosesonde Diagnostic Probe
			7.05270.22.0	LS	825 mm	
			7.05270.21.0	LS	600 mm	links, rechts Left, Right Regelsonde Regulating Probe
			7.04389.02.0	SLP	EL	
E 350 T 4-matic (211.287) 200-205 kW (272-279 PS) M 272.972	03.2005→07.2009		7.05270.22.0	LS	825 mm	nach Katalysator, beidseitig Post-catalyst, Left and right
			7.05270.12.0	LS	500 mm	
			7.04389.02.0	SLP	EL	
E 500 T (211.270) 215-225 kW (292-306 PS) M 113.967	10.2003→07.2009		7.22136.50.0	AGR	PN	<input checked="" type="checkbox"/>
			7.02604.26.0	LS	500 mm	links, rechts Left, Right
			7.04389.00.0	SLP	EL	
E 500 T (211.272) 285 kW (388 PS) M 273.960	04.2006→07.2009		7.05270.17.0	LS	null mm	 ch. A786704→ links, rechts Left, Right Diagnosesonde Diagnostic Probe
			7.05270.21.0	LS	600 mm	links, rechts Left, Right Regelsonde Regulating Probe
			7.04389.02.0	SLP	EL	
E 500 T 4-matic (211.283) 225 kW (306 PS) M 113.969	10.2003→07.2009		7.22136.50.0	AGR	PN	<input checked="" type="checkbox"/>
			7.05270.11.0	LS	750 mm	vor Katalysator, rechts in front of the catalyst, Right
			7.04389.00.0	SLP	EL	
E 500 T 4-matic (211.290) 285 kW (388 PS) M 273.962	04.2006→07.2009		7.05270.22.0	LS	825 mm	rechts Right Allrad All-wheel Drive
			7.05270.12.0	LS	500 mm	nach Katalysator, beidseitig Post-catalyst, Left and right
			7.04389.02.0	SLP	EL	
E 55 T AMG Kompressor (211.276) 350 kW (476 PS) M 113.990	07.2003→07.2009		7.02604.26.0	LS	500 mm	
			7.04389.04.0	SLP	EL	
E 63 AMG (211.277) 378 kW (514 PS) M 156.983	03.2006→07.2009		7.05270.22.0	LS	825 mm	für Fahrzeuge mit Luftfederung für pneumatic suspension vehicles
			7.05270.21.0	LS	600 mm	
			7.05270.18.0	LS	500 mm	
			7.04389.06.0	SLP	EL	

M









E-CLASS T-Model (S212) **57**

E 200 (212.234) 115-245 kW (156-333 PS) M 274.920	11.2012→12.2016	 7.24809.83.0	AGR	EL	<input type="checkbox"/> für OE-Nummer: A 274 142 05 19 for OE number: A 274 142 05 19
		7.24809.85.0	AGR	EL	<input type="checkbox"/> für OE-Nummer: A 274 142 04 19, A 274 142 06 19 for OE number: A 274 142 04 19, A 274 142 06 19
		7.02604.44.0	LS	500 mm	vor Katalysator in front of the catalyst
E 200 CDI / BlueTEC (212.205, 212.206) 100 kW (136 PS) OM 651.925	11.2009→12.2016	 7.08369.06.0	ATS	EL	
		7.08369.12.0	ATS	EL	
		7.08369.89.0	ATS	EL	für OE-Nummer: A 000 905 70 04, A 000 905 85 01 for OE number: A 000 905 70 04, A 000 905 85 01 nach Rußpartikelfilter after soot particulate filter
		7.08369.90.0	ATS	EL	für OE-Nummer: A 000 905 70 04, A 000 905 85 01 for OE number: A 000 905 70 04, A 000 905 85 01 vor Rußpartikelfilter before soot particulate filter
		7.08369.97.0	ATS	EL	vor Katalysator in front of the catalyst für Fahrzeuge mit SCR-System for vehicles with SCR system
7.11020.00.0	ATS	EL	für OE-Nummer: A 007 153 94 28 for OE number: A 007 153 94 28 vor Rußpartikelfilter before soot particulate filter		
E 200 CGI (212.248) 135-150 kW (184-204 PS) M 271.860	11.2009→12.2016	 7.04389.07.0	SLP	EL	
E 220 BlueTEC 120-150 kW (163-204 PS) OM 651.924	05.2015→12.2016	 7.08369.06.0	ATS	EL	
E 220 BlueTEC 4-matic (212.211) 120-150 kW (163-204 PS) OM 651.924	12.2014→12.2016	 7.08369.06.0	ATS	EL	
		7.08369.12.0	ATS	EL	
		7.08369.89.0	ATS	EL	nach Rußpartikelfilter after soot particulate filter
7.05270.21.0	LS	600 mm	vor Katalysator in front of the catalyst		
E 220 CDI (212.202) 120-150 kW (163-204 PS) OM 651.924	08.2009→08.2014	 7.08369.06.0	ATS	EL	
		7.08369.12.0	ATS	EL	
		7.08369.76.0	ATS	EL	für OE-Nummer: A 000 905 52 02, A 000 905 89 04 for OE number: A 000 905 52 02, A 000 905 89 04 vor Katalysator in front of the catalyst
		7.08369.89.0	ATS	EL	für OE-Nummer: A 000 905 70 04, A 000 905 85 01 for OE number: A 000 905 70 04, A 000 905 85 01 nach Rußpartikelfilter after soot particulate filter

M







E-CLASS T-Model (S212) 57

		7.08369.90.0	ATS	EL	für OE-Nummer: A 000 905 65 04, A 001 905 07 00 for OE number: A 000 905 65 04, A 001 905 07 00 vor Rußpartikelfilter before soot particulate filter
E 220 CDI / BlueTEC (212.202, 212.201) 120-150 kW (163-204 PS) OM 651.924	11.2009→12.2016	 7.08369.06.0	ATS	EL	
		7.08369.12.0	ATS	EL	
		7.08369.76.0	ATS	EL	für OE-Nummer: A 000 905 52 02, A 000 905 89 04 for OE number: A 000 905 52 02, A 000 905 89 04 vor Katalysator in front of the catalyst
		7.08369.89.0	ATS	EL	für OE-Nummer: A 000 905 70 04, A 000 905 85 01 for OE number: A 000 905 70 04, A 000 905 85 01 nach Rußpartikelfilter after soot particulate filter
		7.08369.90.0	ATS	EL	für OE-Nummer: A 000 905 65 04, A 001 905 07 00 for OE number: A 000 905 65 04, A 001 905 07 00 vor Rußpartikelfilter before soot particulate filter
		7.08369.97.0	ATS	EL	 OM 651.924: für OE-Nummer: A 000 905 52 05, A008 153 41 28 for OE number: A 000 905 52 05, A008 153 41 28 vor Katalysator in front of the catalyst für Linkslenker for left-hand drive vehicles  OM 651.924: vor Katalysator in front of the catalyst für Fahrzeuge mit SCR-System for vehicles with SCR system 2015 2017 2017
		7.05270.21.0	LS	600 mm	vor Katalysator in front of the catalyst
E 250 (212.236) 115-245 kW (156-333 PS) M 274.920	11.2012→12.2016	 7.24809.83.0	AGR	EL	 für OE-Nummer: A 274 142 05 19 for OE number: A 274 142 05 19
		7.24809.85.0	AGR	EL	 für OE-Nummer: A 274 142 04 19, A 274 142 06 19 for OE number: A 274 142 04 19, A 274 142 06 19
		7.02604.44.0	LS	500 mm	vor Katalysator in front of the catalyst
E 250 CDI / BlueTEC (212.203, 212.204) 120-150 kW (163-204 PS) OM 651.924	11.2009→12.2016	 7.08369.06.0	ATS	EL	
		7.08369.12.0	ATS	EL	

M







E-CLASS T-Model (S212) 57

			7.08369.76.0	ATS	EL	für OE-Nummer: A 000 905 52 02, A 000 905 89 04 for OE number: A 000 905 52 02, A 000 905 89 04 vor Katalysator in front of the catalyst
			7.08369.89.0	ATS	EL	für OE-Nummer: A 000 905 70 04, A 000 905 85 01 for OE number: A 000 905 70 04, A 000 905 85 01 nach Rußpartikelfilter after soot particulate filter
			7.08369.90.0	ATS	EL	für OE-Nummer: A 000 905 65 04, A 001 905 07 00 for OE number: A 000 905 65 04, A 001 905 07 00 vor Rußpartikelfilter before soot particulate filter
			7.08369.97.0	ATS	EL	für OE-Nummer: A 000 905 52 05, A008 153 41 28 for OE number: A 000 905 52 05, A008 153 41 28 vor Katalysator in front of the catalyst
			7.11020.00.0	ATS	EL	für OE-Nummer: A 007 153 94 28 for OE number: A 007 153 94 28 vor Rußpartikelfilter before soot particulate filter
			7.05270.21.0	LS	600 mm	vor Katalysator in front of the catalyst
M	E 250 CDI / BlueTEC 4-matic (212.282, 212.297) 120-150 kW (163-204 PS) OM 651.924	07.2010→12.2016	 7.08369.06.0	ATS	EL	
			7.08369.12.0	ATS	EL	
			7.08369.89.0	ATS	EL	für OE-Nummer: A 000 905 70 04, A 000 905 85 01 for OE number: A 000 905 70 04, A 000 905 85 01 nach Rußpartikelfilter after soot particulate filter
			7.05270.21.0	LS	600 mm	vor Katalysator in front of the catalyst
E 250 CGI (212.247) 135-150 kW (184-204 PS) M 271.860	11.2009→12.2013		7.05270.17.0	LS	null mm	
			7.05270.21.0	LS	600 mm	
			7.04389.07.0	SLP	EL	
E 300 (212.254) 161-170 kW (219-231 PS) M 272.952	11.2009→12.2011		7.05270.17.0	LS	null mm	
			7.05270.21.0	LS	600 mm	
			7.04389.02.0	SLP	EL	
E 300 (212.255) 185-245 kW (252-333 PS) M 276.952	07.2011→12.2016		7.05270.17.0	LS	null mm	
			7.05270.21.0	LS	600 mm	



E-CLASS T-Model (S212) 57

			7.02604.44.0	LS	500 mm	für OE-Nummer: A 008 542 29 18, A 009 542 59 18 for OE number: A 008 542 29 18, A 009 542 59 18 vor Katalysator in front of the catalyst
			7.02604.99.0	LS	400 mm	
E 300 4-matic (212.280) 185-245 kW (252-333 PS) M 276.952	07.2011→12.2016		7.05270.17.0	LS	null mm	
			7.05270.21.0	LS	600 mm	
			7.02604.44.0	LS	500 mm	für OE-Nummer: A 008 542 29 18, A 009 542 59 18 for OE number: A 008 542 29 18, A 009 542 59 18 vor Katalysator in front of the catalyst
			7.02604.99.0	LS	400 mm	
E 300 CDI (212.220) 150-170 kW (204-231 PS) OM 642.850	12.2009→12.2010		7.08369.51.0	ATS	EL	
			7.08369.61.0	ATS	EL	
			7.08369.89.0	ATS	EL	für OE-Nummer: A 000 905 70 04, A 000 905 85 01 for OE number: A 000 905 70 04, A 000 905 85 01 nach Rußpartikelfilter after soot particulate filter
			7.05270.21.0	LS	600 mm	
E 300 CDI / BlueTEC (212.227, 212.221) 150-170 kW (204-231 PS) OM 642.850	11.2009→12.2016		7.08369.51.0	ATS	EL	
			7.08369.61.0	ATS	EL	
			7.08369.89.0	ATS	EL	für OE-Nummer: A 000 905 70 04, A 000 905 85 01 for OE number: A 000 905 70 04, A 000 905 85 01 nach Rußpartikelfilter after soot particulate filter
			7.05270.21.0	LS	600 mm	
E 300 CDI / BlueTEC (212.227, 212.221) 170-195 kW (231-265 PS) OM 642.852	11.2009→12.2016		7.08369.51.0	ATS	EL	
			7.08369.61.0	ATS	EL	
			7.08369.89.0	ATS	EL	für OE-Nummer: A 000 905 70 04, A 000 905 85 01 for OE number: A 000 905 70 04, A 000 905 85 01 nach Rußpartikelfilter after soot particulate filter
			7.11020.01.0	ATS	EL	
			7.05270.21.0	LS	600 mm	
E 300 Hybrid / BlueTEC Hybrid (212.298) 120-150 kW (163-204 PS) OM 651.924	12.2011→12.2016		7.08369.06.0	ATS	EL	

M



E-CLASS T-Model (S212) 57

			7.08369.12.0	ATS	EL	
			7.08369.76.0	ATS	EL	für OE-Nummer: A 000 905 52 02, A 000 905 89 04 for OE number: A 000 905 52 02, A 000 905 89 04 vor Katalysator in front of the catalyst
			7.08369.89.0	ATS	EL	für OE-Nummer: A 000 905 70 04, A 000 905 85 01 for OE number: A 000 905 70 04, A 000 905 85 01 nach Rußpartikelfilter after soot particulate filter
			7.08369.97.0	ATS	EL	für OE-Nummer: A 000 905 52 05, A 008 153 41 28 for OE number: A 000 905 52 05, A 008 153 41 28 vor Katalysator in front of the catalyst
E 350 (212.256) 200 kW (272 PS) M 272.980	08.2009→12.2011		7.05270.17.0	LS	null mm	links, rechts Left, Right Diagnosesonde Diagnostic Probe
			7.05270.21.0	LS	600 mm	links, rechts Left, Right Regelsonde Regulating Probe
			7.04389.02.0	SLP	EL	
E 350 (212.259) 185-245 kW (252-333 PS) M 276.952	09.2011→12.2014		7.02604.44.0	LS	500 mm	für OE-Nummer: A 008 542 29 18, A 009 542 59 18 for OE number: A 008 542 29 18, A 009 542 59 18 vor Katalysator in front of the catalyst
			7.02604.99.0	LS	400 mm	
E 350 4-matic (212.287) 200 kW (272 PS) M 272.977	11.2009→12.2011		7.05270.18.0	LS	500 mm	links, rechts Left, Right Diagnosesonde Diagnostic Probe
			7.04389.02.0	SLP	EL	
E 350 4-matic (212.288) 185-245 kW (252-333 PS) M 276.952	09.2011→12.2016		7.02604.44.0	LS	500 mm	für OE-Nummer: A 008 542 29 18, A 009 542 59 18 for OE number: A 008 542 29 18, A 009 542 59 18 vor Katalysator in front of the catalyst
			7.02604.99.0	LS	400 mm	
E 350 BlueTEC 170-195 kW (231-265 PS) OM 642.852	11.2012→12.2016		7.08369.61.0	ATS	EL	
E 350 BlueTEC (212.224) 150-170 kW (204-231 PS) OM 642.850	11.2009→12.2013		7.08369.51.0	ATS	EL	
			7.08369.61.0	ATS	EL	
			7.08369.89.0	ATS	EL	für OE-Nummer: A 000 905 70 04, A 000 905 85 01 for OE number: A 000 905 70 04, A 000 905 85 01 nach Rußpartikelfilter after soot particulate filter
			7.05270.21.0	LS	600 mm	











E-CLASS T-Model (S212) 57

E 350 BlueTEC (212.226) 170-195 kW (231-265 PS) OM 642.852	07.2014→12.2016		7.08369.61.0	ATS	EL	
			7.08369.89.0	ATS	EL	für OE-Nummer: A 000 905 70 04, A 000 905 85 01 for OE number: A 000 905 70 04, A 000 905 85 01 nach Rußpartikelfilter after soot particulate filter
			7.11020.01.0	ATS	EL	
E 350 BlueTEC 4-matic (212.294) 185-195 kW (252-265 PS) OM 642.858	11.2012→12.2016		7.08369.61.0	ATS	EL	
			7.08369.89.0	ATS	EL	für OE-Nummer: A 000 905 70 04, A 000 905 85 01 for OE number: A 000 905 70 04, A 000 905 85 01 nach Rußpartikelfilter after soot particulate filter
			7.11020.01.0	ATS	EL	
E 350 BlueTEC 4-matic (212.294) 170-195 kW (231-265 PS) OM 642.852, OM 642.858	07.2014→12.2016		7.08369.61.0	ATS	EL	
			7.08369.89.0	ATS	EL	 OM 642.852, OM 642.858: für OE-Nummer: A 000 905 70 04, A 000 905 85 01 for OE number: A 000 905 70 04, A 000 905 85 01 nach Rußpartikelfilter after soot particulate filter
			7.11020.01.0	ATS	EL	
E 350 CDI (212.223) 170-195 kW (231-265 PS) OM 642.852	07.2011→12.2013		7.08369.61.0	ATS	EL	
			7.08369.89.0	ATS	EL	nach Rußpartikelfilter after soot particulate filter für Fahrzeuge mit SCR-System for vehicles with SCR system
			7.11020.01.0	ATS	EL	
			7.05270.21.0	LS	600 mm	
E 350 CDI (212.225) 150-170 kW (204-231 PS) OM 642.850	11.2009→12.2011		7.08369.51.0	ATS	EL	
			7.08369.61.0	ATS	EL	
			7.08369.89.0	ATS	EL	für OE-Nummer: A 000 905 70 04, A 000 905 85 01 for OE number: A 000 905 70 04, A 000 905 85 01 nach Rußpartikelfilter after soot particulate filter
			7.05270.21.0	LS	600 mm	
E 350 CDI 4-matic (212.289) 170 kW (231 PS) OM 642.856	11.2009→12.2011		7.08369.51.0	ATS	EL	
			7.08369.61.0	ATS	EL	
			7.08369.89.0	ATS	EL	für OE-Nummer: A 000 905 70 04, A 000 905 85 01 for OE number: A 000 905 70 04, A 000 905 85 01 nach Rußpartikelfilter after soot particulate filter

M







E-CLASS T-Model (S212) 57

			7.05270.21.0	LS	600 mm	
E 350 CDI 4-matic (212.293) 185-195 kW (252-265 PS) OM 642.858	07.2011→12.2013		7.08369.61.0	ATS	EL	
			7.08369.89.0	ATS	EL	für OE-Nummer: A 000 905 70 04, A 000 905 85 01 for OE number: A 000 905 70 04, A 000 905 85 01 nach Rußpartikelfilter after soot particulate filter
			7.11020.01.0 7.05270.21.0	ATS LS	EL 600 mm	
E 350 CGI (212.257) 215 kW (292 PS) M 272.983	11.2009→12.2011		7.05270.17.0	LS	null mm	
			7.04389.02.0	SLP	EL	
E 400 4-matic (212.267) 200-245 kW (272-333 PS) M 276.820	01.2013→12.2016		7.02604.44.0	LS	500 mm	vor Katalysator, beidseitig in front of the catalyst, Left and right Abgasturbolader, für Fahrzeuge mit Ladeluftkühler Exhaust Turbocharger, for vehicles with intercooler
			7.02604.44.0	LS	500 mm	vor Katalysator, beidseitig in front of the catalyst, Left and right
E 400 4-matic (212.299) 245 kW (333 PS) M 276.850	07.2014→12.2016		7.02604.44.0	LS	500 mm	vor Katalysator, beidseitig in front of the catalyst, Left and right
			7.05270.21.0	LS	600 mm	
			7.05270.18.0	LS	500 mm	
E 500 (212.272) 285 kW (388 PS) M 273.971	11.2009→12.2011		7.04389.02.0	SLP	EL	
			7.05270.21.0	LS	600 mm	
			7.02604.44.0	LS	500 mm	
E 500 (212.273) 300-320 kW (408-435 PS) M 278.922	09.2011→12.2016		7.05270.21.0	LS	600 mm	
			7.02604.44.0	LS	500 mm	für OE-Nummer: A 009 542 60 18, A 009 542 63 18 for OE number: A 009 542 60 18, A 009 542 63 18 vor Katalysator in front of the catalyst
			7.05270.18.0	LS	500 mm	
E 500 4-matic (212.291) 300-320 kW (408-435 PS) M 278.922	09.2011→12.2016		7.05270.21.0	LS	600 mm	
			7.02604.44.0	LS	500 mm	für OE-Nummer: A 009 542 60 18, A 009 542 63 18 for OE number: A 009 542 60 18, A 009 542 63 18 vor Katalysator in front of the catalyst
			7.05270.18.0	LS	500 mm	
E 63 AMG (212.274) 386-430 kW (525-585 PS) M 157.981	02.2011→12.2016		7.05270.22.0	LS	825 mm	
			7.02604.44.0	LS	500 mm	für OE-Nummer: A 009 542 63 18 for OE number: A 009 542 63 18 vor Katalysator in front of the catalyst
			7.05270.18.0	LS	500 mm	



















E-CLASS T-Model (S212) 57



























E 63 AMG (212.274) 386-430 kW (525-585 PS) M 157.981	02.2011→12.2016		7.05270.22.0 LS 825 mm	für OE-Nummer: A 009 542 63 18 for OE number: A 009 542 63 18 vor Katalysator in front of the catalyst
			7.02604.44.0 LS 500 mm	
			7.05270.18.0 LS 500 mm	
E 63 AMG (212.275) 386-430 kW (525-585 PS) M 157.981	02.2013→12.2016		7.05270.22.0 LS 825 mm	für OE-Nummer: A 009 542 63 18 for OE number: A 009 542 63 18 vor Katalysator in front of the catalyst
			7.02604.44.0 LS 500 mm	
			7.05270.18.0 LS 500 mm	
E 63 AMG (212.277) 336-410 kW (457-558 PS) M 156.985	08.2009→12.2011		7.05270.22.0 LS 825 mm	
			7.05270.18.0 LS 500 mm	
			7.04389.09.0 SLP EL	
E 63 AMG 4-matic (212.276) 386-430 kW (525-585 PS) M 157.981	02.2013→12.2016		7.05270.22.0 LS 825 mm	für OE-Nummer: A 009 542 63 18 for OE number: A 009 542 63 18 vor Katalysator in front of the catalyst
			7.02604.44.0 LS 500 mm	
			7.05270.18.0 LS 500 mm	
E 63 AMG 4-matic (212.292) 386-430 kW (525-585 PS) M 157.981	02.2011→12.2016		7.05270.22.0 LS 825 mm	vor Katalysator, beidseitig in front of the catalyst, Left and right 2012 2012
			7.02604.44.0 LS 500 mm	
			7.05270.18.0 LS 500 mm	

M

E-CLASS T-Model (S213) 58

AMG E 43 4-matic (213.264) 200-295 kW (272-401 PS) M 276.823	10.2016→		7.02604.44.0 LS 500 mm	für OE-Nummer: A 009 542 59 18, A 009 542 60 18, A 009 542 63 18 for OE number: A 009 542 59 18, A 009 542 60 18, A 009 542 63 18
E 200 (213.242) 115-245 kW (156-333 PS) M 274.920	07.2016→		7.24809.83.0 AGR EL 	für OE-Nummer: A 274 142 05 19 for OE number: A 274 142 05 19
			7.24809.85.0 AGR EL 	für OE-Nummer: A 274 142 04 19, A 274 142 06 19 for OE number: A 274 142 04 19, A 274 142 06 19
E 200 4-matic (213.243) 115-245 kW (156-333 PS) M 274.920	01.2017→		7.24809.83.0 AGR EL 	für OE-Nummer: A 274 142 05 19 for OE number: A 274 142 05 19
			7.24809.85.0 AGR EL 	für OE-Nummer: A 274 142 04 19, A 274 142 06 19 for OE number: A 274 142 04 19, A 274 142 06 19













								
E-CLASS T-Model (S213)						58		
E 250 (213.245) 115-245 kW (156-333 PS) M 274.920	07.2016→		7.24809.83.0	AGR	EL  für OE-Nummer: A 274 142 05 19 for OE number: A 274 142 05 19			
			7.24809.85.0	AGR	EL  für OE-Nummer: A 274 142 04 19, A 274 142 06 19 for OE number: A 274 142 04 19, A 274 142 06 19			
E 350 d (213.233) 190 kW (258 PS) OM 642.855	10.2016→		7.11020.01.0	ATS	EL			
E 350 d 4-matic (213.234) 190 kW (258 PS) OM 642.873	06.2017→		7.11020.01.0	ATS	EL			
E 400 4-matic (213.271) 245 kW (333 PS) M 276.853	10.2016→		7.02604.44.0	LS	500 mm für OE-Nummer: A 009 542 59 18, A 009 542 60 18, A 009 542 63 18 for OE number: A 009 542 59 18, A 009 542 60 18, A 009 542 63 18			
E 450 4-matic (213.268) 200-295 kW (272-401 PS) M 276.823	08.2018→		7.02604.44.0	LS	500 mm für OE-Nummer: A 009 542 59 18, A 009 542 60 18, A 009 542 63 18 for OE number: A 009 542 59 18, A 009 542 60 18, A 009 542 63 18			
G-CLASS (W460)						59		
230 GE (460,2) 90-93 kW (122-126 PS) M 102.981, M 102.987, M 102.989	04.1982→08.1992		7.02604.03.0	LS	200 mm			
G-CLASS (W461)						60		
M G 270 CDI 115 kW (156 PS) OM 612.966	01.2003→		7.08369.12.0	ATS	EL  ch. X172095→			
			G 280 CDI (461.304, 461.346, 461.370, 461.334, 461.339,...) 135 kW (184 PS) OM 642.884	04.2009→		7.08369.12.0	ATS	EL  ch. X172095→
						7.11020.40.0	ATS	EL Abgasturbolader Exhaust Turbocharger
						7.11190.01.0	DDS	für OE-Nummer: A 006 153 49 28, A 642 905 01 00 for OE number: A 006 153 49 28, A 642 905 01 00 Partikelfilter Particulate Filter
G 280 CDI (461.304, 461.346, 461.370, 461.334, 461.339,...) 135 kW (184 PS) OM 642.975	04.2009→		7.24809.60.0	AGR	ET 			
			7.08369.87.0	ATS	EL  OM 642.975: Baumuster: 461.334, 461.339, 461.346, 461.370 Type: 461.334, 461.339, 461.346, 461.370 Produktionsdatum ab: 05.07.2011 Production date from: 05.07.2011  OM 642.975: Baumuster: 461.304, 461.344, 461.370 Type: 461.304, 461.344, 461.370 Algerien Algeria Produktionsdatum ab: 05.07.2011 Production date from: 05.07.2011			























					
G-CLASS (W461)					60
			7.08369.94.0	ATS	EL Baumuster: 461.304, 461.334, 461.344, 461.346 Type: 461.304, 461.334, 461.344, 461.346 Partikelfilter Particulate Filter Produktionsdatum bis: 05.07.2011 Production date to: 05.07.2011
			7.11190.01.0	DDS	Baumuster: 461.344, 461.346, 461.370, 461.390 Type: 461.344, 461.346, 461.370, 461.390 Luftfiltergehäuse Air Filter Housing
G 300 CDI (461.333) 135 kW (184 PS) OM 642.884	04.2010→		7.11020.40.0	ATS	EL Abgasturbolader Exhaust Turbocharger
G-CLASS (W463)					61
300 GD (463.327, 463.328) 83 kW (113 PS) OM 603.931	09.1989→08.1993		7.21949.51.0	AGR	PN 
350 Turbo GD (463.320, 463.321) 100 kW (136 PS) OM 603.972	09.1991→08.1996		7.21949.51.0	AGR	PN 
AMG G 63 (463.276, 463.277) 350-470 kW (476-639 PS) M 177.980	03.2018→		7.05270.21.0	LS	600 mm vor Katalysator, links in front of the catalyst, Left
AMG G 65 (463.274, 463.275) 450-463 kW (612-630 PS) M 279.982	06.2015→		7.02604.44.0	LS	500 mm vor Katalysator, beidseitig in front of the catalyst, Left and right
			7.04389.08.0	SLP	EL  M 279.982:  ch. X 160817→ Produktionsdatum ab: 27.10.2015 Production date from: 27.10.2015  M 279.982:  ch. X246390 → Produktionsdatum ab: 27.10.2015 Production date from: 27.10.2015
			7.04389.06.0	SLP	EL  M 279.982:  →ch. X 160816 Produktionsdatum bis: 27.10.2015 Production date to: 27.10.2015  M 279.982:  →ch. X 246390 Produktionsdatum bis: 27.10.2015 Production date to: 27.10.2015
G 320 (463.232, 463.233, 463.244, 463.245) 158 kW (215 PS) M 112.945	11.1997→08.2004		7.22136.50.0	AGR	PN 
			7.05270.11.0	LS	750 mm für OE-Nummer: A 001 540 07 17, A 001 540 74 17 for OE number: A 001 540 07 17, A 001 540 74 17
			7.04389.00.0	SLP	EL
G 320 CDI (463.340, 463.341, 463.343) 165 kW (224 PS) OM 642.970	09.2006→		7.08369.12.0	ATS	EL  ch. X192671→
			7.08369.87.0	ATS	EL Katalysator Catalytic Converter Produktionsdatum bis: 31.10.2012 Production date to: 31.10.2012
			7.11190.01.0	DDS	Luftfiltergehäuse Air Filter Housing
			7.05270.21.0	LS	600 mm
G 350 CDI 155 kW (211 PS) OM 642.886	07.2011→		7.08369.51.0	ATS	EL

M





























G-CLASS (W463) **61**

G 350 CDI (463.306) 165 kW (224 PS) OM 642.970	06.2009→12.2011	 	7.08369.77.0	ATS	EL	Ausstattungsvariante: BLUETEC Equipment Variant: BLUETEC nach Rußpartikelfilter after soot particulate filter 2010 2010 2012 2012
			7.11020.28.0	ATS	EL	 →ch. X191362 Ausstattungsvariante: Bluetec Equipment Variant: Bluetec 2010 2010 2013 2013 Produktionsdatum bis: 22.04.2011 Production date to: 22.04.2011
G 350 d (463.348) 180 kW (245 PS) OM 642.887	06.2015→		7.08369.12.0	ATS	EL	 ch. X 204078→
			7.08369.51.0	ATS	EL	
			7.08369.77.0	ATS	EL	Ausstattungsvariante: BLUETEC Equipment Variant: BLUETEC nach Rußpartikelfilter after soot particulate filter
G 500 (463.222, 463.236, 463.237, 463.242) 285-320 kW (388-435 PS) M 273.963	05.2008→		7.05270.21.0	LS	600 mm	vor Katalysator, beidseitig in front of the catalyst, Left and right
			7.04389.02.0	SLP	EL	
G 500 (463.222, 463.236, 463.237, 463.242) 285 kW (388 PS) M 273.969	05.2008→		7.05270.21.0	LS	600 mm	vor Katalysator, beidseitig in front of the catalyst, Left and right
G 500 (463.247, 463.248, 463.249, 463.240, 463.241,...) 215-218 kW (292-296 PS) M 113.962	04.1998→		7.22136.50.0	AGR	PN	<input checked="" type="checkbox"/>
			7.05270.11.0	LS	750 mm	für OE-Nummer: A 001 540 07 17, A 001 540 74 17 for OE number: A 001 540 07 17, A 001 540 74 17
			7.04389.00.0	SLP	EL	
G 500 (463.249) 215-218 kW (292-296 PS) M 113.962	09.2004→12.2005		7.22136.50.0	AGR	PN	<input checked="" type="checkbox"/>
			7.04389.00.0	SLP	EL	
G 500 (463.260, 463.261) 310-390 kW (422-530 PS) M 176.980	01.2018→		7.05270.21.0	LS	600 mm	vor Katalysator, links in front of the catalyst, Left
			7.02604.44.0	LS	500 mm	vor Katalysator, links in front of the catalyst, Left Produktionsdatum bis: 07.05.2018 Production date to: 07.05.2018
G 55 AMG (463.243, 463.246) 260 kW (354 PS) M 113.982	04.1999→		7.22136.50.0	AGR	PN	<input checked="" type="checkbox"/>
			7.05270.11.0	LS	750 mm	 →ch. 144225 nach Katalysator Post-catalyst
			7.04389.00.0	SLP	EL	
G 55 AMG (463.270, 463.271) 350-373 kW (476-507 PS) M 113.993	06.2004→		7.04389.06.0	SLP	EL	

						
G-CLASS (W463)						61
G 55 AMG (463.270, 463.271) 350-373 kW (476-507 PS) M 113.993	08.2006→12.2012		7.04389.06.0	SLP	EL	
G 55 AMG (463.270, 463.271) 350-373 kW (476-507 PS) M 113.993	08.2008→		7.05270.11.0	LS	750 mm	 M 113.993:  ch. 144226→ nach Katalysator, links Post-catalyst, Left  M 113.993:  ch. 144226→ für OE-Nummer: A 001 540 74 17 for OE number: A 001 540 74 17 nach Katalysator, rechts Post-catalyst, Right
			7.04389.06.0	SLP	EL	
G 63 AMG (463.273) 400-420 kW (544-571 PS) M 157.984	05.2012→		7.02604.99.0	LS	400 mm	
G 63 AMG 6x6 400-420 kW (544-571 PS) M 157.984	12.2014→		7.02604.99.0	LS	400 mm	
G-CLASS Cabrio (W463)						62
300 GD (463.307) 83 kW (113 PS) OM 603.931	09.1989→08.1993		7.21949.51.0	AGR	PN	<input checked="" type="checkbox"/>
350 G Turbo-D (463.300) 100 kW (136 PS) OM 603.972	09.1991→09.1997		7.21949.51.0	AGR	PN	<input checked="" type="checkbox"/>
G 320 (463.209, 463.250) 158 kW (215 PS) M 112.945	11.1997→		7.22136.50.0	AGR	PN	<input checked="" type="checkbox"/>
			7.04389.00.0	SLP	EL	
G 320 CDI (463.303) 165 kW (224 PS) OM 642.970	09.2006→		7.08369.12.0	ATS	EL	 ch. X192671→
			7.08369.87.0	ATS	EL	Katalysator Catalytic Converter Produktionsdatum bis: 31.10.2012 Production date to: 31.10.2012
			7.11190.01.0	DDS		Luftfiltergehäuse Air Filter Housing
			7.05270.21.0	LS	600 mm	
G 350 CDI 155 kW (211 PS) OM 642.886	07.2011→		7.08369.51.0	ATS	EL	
G 350 CDI (463.306) 165 kW (224 PS) OM 642.970	06.2009→12.2011		7.08369.12.0	ATS	EL	 ch. X191362→
			7.08369.77.0	ATS	EL	Ausstattungsvariante: BLUETEC Equipment Variant: BLUETEC nach Rußpartikelfilter after soot particulate filter 2010 2010 2012 2012
			7.11020.28.0	ATS	EL	 →ch. X191362 Ausstattungsvariante: Bluetec Equipment Variant: Bluetec 2011 2011 2013 2013 Produktionsdatum bis: 22.04.2011 Production date to: 22.04.2011
			7.11190.01.0	DDS		Luftfiltergehäuse Air Filter Housing









M

			 PIERBURG		
G-CLASS Cabrio (W463)					62
G 500 (463) 215-218 kW (292-296 PS) M 113.962	04.1998→		7.22136.50.0	AGR	PN 
			7.04389.00.0	SLP	EL
G 500 (463.202) 285-320 kW (388-435 PS) M 273.963, M 273.969	12.2009→		7.05270.21.0	LS	600 mm  M 273.963, M 273.969: vor Katalysator, beidseitig in front of the catalyst, Left and right
			7.04389.02.0	SLP	EL
GL-CLASS (X164)					63
GL 320 CDI / 350 BlueTEC 4-matic (164.824, 164.825) 150-170 kW (204-231 PS) OM 642.820	12.2009→08.2012		7.08369.12.0	ATS	EL  ch. A 506721→
			7.08369.77.0	ATS	EL  OM 642.820: für Fahrzeuge mit SCR-System for vehicles with SCR system  OM 642.820: Euro 6 Euro 6
			7.08369.87.0	ATS	EL Katalysator Catalytic Converter für Fahrzeuge ohne SCR-System for vehicles without SCR system Produktionsdatum ab: 08.05.2008 Production date from: 08.05.2008
			7.08369.94.0	ATS	EL Katalysator Catalytic Converter für Fahrzeuge ohne SCR-System for vehicles without SCR system Produktionsdatum bis: 08.05.2008 Production date to: 08.05.2008
			7.11020.11.0	ATS	EL  OM 642.820: Abgaskrümmer Exhaust Manifold  Japan, USA, Kanada  Japan, USA, Kanada  OM 642.820: vor Abgasturbolader in front of exhaust turbocharger  USA  USA
			7.11020.28.0	ATS	EL  →ch. A506721 vor Rußpartikelfilter before soot particulate filter Euro 5, Euro 6 Euro 5, Euro 6 Produktionsdatum bis: 10.02.2009 Production date to: 10.02.2009 nicht für SA Code: U42 not for SA code: U42
GL 320 CDI 4-matic 140-170 kW (190-231 PS) OM 642.940	09.2006→12.2009		7.24809.47.0	AGR	ET  USA USA
			7.11190.01.0	DDS	für OE-Nummer: A 006 153 49 28 for OE number: A 006 153 49 28 Luftfiltergehäuse Air Filter Housing
GL 320 CDI 4-matic (164.822) 140-170 kW (190-231 PS) OM 642.940	09.2006→05.2009		7.24809.47.0	AGR	ET  USA USA
			7.08369.12.0	ATS	EL  ch. A 506721→

M













GL-CLASS (X164) **63**

			7.08369.77.0	ATS	EL	 OM 642.940: nach Rußpartikelfilter after soot particulate filter für Fahrzeuge mit SCR-System for vehicles with SCR system  OM 642.940: nach Rußpartikelfilter after soot particulate filter Euro 6 Euro 6
			7.08369.87.0	ATS	EL	Katalysator Catalytic Converter für Fahrzeuge ohne SCR-System for vehicles without SCR system Produktionsdatum ab: 08.05.2008 Production date from: 08.05.2008
			7.08369.94.0	ATS	EL	Katalysator Catalytic Converter für Fahrzeuge ohne SCR-System for vehicles without SCR system Produktionsdatum bis: 08.05.2008 Production date to: 08.05.2008
			7.11190.01.0	DDS		Luftfiltergehäuse Air Filter Housing
			7.05270.21.0	LS	600 mm	
GL 350 CDI 4-matic (164.822) 140-170 kW (190-231 PS) OM 642.940	05.2009→08.2012		7.24809.47.0	AGR	ET	 USA USA USA
			7.08369.12.0	ATS	EL	 ch. A 506721→
			7.08369.77.0	ATS	EL	 OM 642.940: nach Rußpartikelfilter after soot particulate filter Euro 6 Euro 6  OM 642.940: nach Rußpartikelfilter after soot particulate filter für Fahrzeuge mit SCR-System for vehicles with SCR system
			7.08369.87.0	ATS	EL	Katalysator Catalytic Converter für Fahrzeuge ohne SCR-System for vehicles without SCR system Produktionsdatum ab: 08.05.2008 Production date from: 08.05.2008
			7.08369.94.0	ATS	EL	Katalysator Catalytic Converter für Fahrzeuge ohne SCR-System for vehicles without SCR system Produktionsdatum bis: 08.05.2008 Production date to: 08.05.2008
			7.11020.28.0	ATS	EL	 →ch. A506721 vor Rußpartikelfilter before soot particulate filter Euro 5, Euro 6 Euro 5, Euro 6 Produktionsdatum bis: 10.02.2009 Production date to: 10.02.2009 nicht für SA Code: U42 not for SA code: U42
			7.11190.01.0	DDS		Luftfiltergehäuse Air Filter Housing
GL 350 CDI 4-matic (164.823) 165-195 kW (224-265 PS) OM 642.822	10.2010→08.2012		7.08369.12.0	ATS	EL	



















M



GL-CLASS (X164) 63

			7.08369.77.0	ATS	EL	<ul style="list-style-type: none">  OM 642.822: nach Rußpartikelfilter after soot particulate filter für Fahrzeuge mit SCR-System for vehicles with SCR system  OM 642.822: nach Rußpartikelfilter after soot particulate filter Euro 6 Euro 6
			7.08369.87.0	ATS	EL	<ul style="list-style-type: none"> Katalysator Catalytic Converter für Fahrzeuge ohne SCR-System for vehicles without SCR system
			7.11020.11.0	ATS	EL	<ul style="list-style-type: none">  OM 642.822: Abgaskrümmer Exhaust Manifold Japan, USA, Kanada Japan, USA, Kanada  OM 642.822: vor Abgasturbolader in front of exhaust turbocharger USA USA
			7.11020.30.0	ATS	EL	<ul style="list-style-type: none">  OM 642.822: Euro 5, Euro 6 Euro 5, Euro 6  OM 642.822: für Fahrzeuge mit SCR-System for vehicles with SCR system
GL 420 CDI 4-matic (164.828) 225 kW (306 PS) OM 629.912	09.2006→05.2009		7.08369.61.0	ATS	EL	links Left für Fahrzeuge mit Diesel-Partikel-Filter (DPF) for vehicles with diesel soot filter
			7.08369.77.0	ATS	EL	rechts Right für Fahrzeuge mit Diesel-Partikel-Filter (DPF) for vehicles with diesel soot filter
			7.11190.01.0	DDS		Luftfiltergehäuse Air Filter Housing
			7.05270.22.0	LS	825 mm	
GL 450 4-matic (164.871) 250 kW (340 PS) M 273.923	09.2006→08.2012		7.05270.17.0	LS	null mm	
			7.05270.21.0	LS	600 mm	
			7.05270.18.0	LS	500 mm	
			7.04389.02.0	SLP	EL	
GL 450 CDI 4-matic (164.828) 225 kW (306 PS) OM 629.912	05.2009→08.2012		7.08369.61.0	ATS	EL	links Left für Fahrzeuge mit Diesel-Partikel-Filter (DPF) for vehicles with diesel soot filter
			7.08369.77.0	ATS	EL	rechts Right für Fahrzeuge mit Diesel-Partikel-Filter (DPF) for vehicles with diesel soot filter
			7.11190.01.0	DDS		Luftfiltergehäuse Air Filter Housing
GL 500 4-matic (164.886) 285-320 kW (388-435 PS) M 273.963	09.2006→12.2012		7.05270.17.0	LS	null mm	
			7.05270.21.0	LS	600 mm	











M

					
GL-CLASS (X164)					63
			7.05270.18.0	LS	500 mm
			7.04389.02.0	SLP	EL
GL-CLASS (X166)					64
GL 350 CDI / BlueTec 4-matic (166.823, 166.824) 179-190 kW (243-258 PS) OM 642.826	07.2012→10.2015		7.08369.77.0	ATS	EL vor Katalysator in front of the catalyst für Fahrzeuge mit SCR-System for vehicles with SCR system
			7.11020.01.0	ATS	EL
			7.11020.29.0	ATS	EL für OE-Nummer: A 000 905 69 04, A 001 905 22 00 for OE number: A 000 905 69 04, A 001 905 22 00
			7.11020.30.0	ATS	EL für OE-Nummer: A 000 905 71 04, A 001 905 23 00 for OE number: A 000 905 71 04, A 001 905 23 00
GL 63 AMG 4-matic (166.874) 386-430 kW (525-585 PS) M 157.982	07.2012→10.2015		7.02604.99.0	LS	400 mm
GLA-CLASS (X156)					65
AMG GLA 45 4-matic (156.952) 250-280 kW (340-381 PS) M 133.980	07.2015→		7.05270.21.0	LS	600 mm für OE-Nummer: A 009 542 56 18 for OE number: A 009 542 56 18 vor Katalysator in front of the catalyst
GLA 180 (156.942) 75-115 kW (102-156 PS) M 270.910	02.2015→		7.05270.21.0	LS	600 mm vor Katalysator in front of the catalyst
GLA 180 CDI / d (156.912) 55-81 kW (75-110 PS) OM 607.951	07.2014→		7.03435.05.0	AGR	EL  Euro 5
			7.05320.04.0	AGR	EL  Euro 6
			7.03571.16.0	AK	EL
			7.03083.20.0	SRM-AK	EL
			7.11190.08.0	DDS	EL Euro 6
GLA 200 (156.943) 75-115 kW (102-156 PS) M 270.910	12.2013→		7.05270.21.0	LS	600 mm vor Katalysator in front of the catalyst
GLA 200 (156.945) 115-160 kW (156-218 PS) M 270.920	09.2014→		7.24809.84.0	AGR	EL 
GLA 200 CDI / d (156.908) 80-130 kW (109-177 PS) OM 651.930	12.2013→		7.24809.82.0	AGR	EL mit Dichtring with O-ring
			7.08369.89.0	ATS	EL Katalysator Catalytic Converter Euro 6 Euro 6
			7.11020.01.0	ATS	EL
			7.11020.32.0	ATS	EL für OE-Nummer: A 000 905 07 01, A 000 905 81 05, A 000 905 91 05 for OE number: A 000 905 07 01, A 000 905 81 05, A 000 905 91 05
GLA 200 CDI 4-matic (156.902) 80-130 kW (109-177 PS) OM 651.930	12.2013→		7.24809.82.0	AGR	EL mit Dichtring with O-ring



























M





























GLA-CLASS (X156) 65

			7.08369.89.0	ATS	EL	Katalysator Catalytic Converter Euro 6 Euro 6
			7.11020.01.0	ATS	EL	
			7.11020.32.0	ATS	EL	Euro 6 Euro 6
GLA 220 (156.945) 115-160 kW (156-218 PS) M 270.920	01.2017→		7.24809.84.0	AGR	EL	
			7.05270.21.0	LS	600 mm	vor Katalysator in front of the catalyst
GLA 220 4-matic (156.947) 115-160 kW (156-218 PS) M 270.920	01.2017→		7.24809.84.0	AGR	EL	
			7.05270.21.0	LS	600 mm	vor Katalysator in front of the catalyst
GLA 220 CDI (156.903) 80-130 kW (109-177 PS) OM 651.930	12.2013→		7.24809.82.0	AGR	EL	mit Dichtring with O-ring
			7.08369.89.0	ATS	EL	Katalysator Catalytic Converter Euro 6 Euro 6
			7.11020.01.0	ATS	EL	
			7.11020.32.0	ATS	EL	für OE-Nummer: A 000 905 07 01, A 000 905 81 05, A 000 905 91 05 for OE number: A 000 905 07 01, A 000 905 81 05, A 000 905 91 05
GLA 220 CDI / d (156.903) 80-130 kW (109-177 PS) OM 651.930	12.2013→		7.24809.82.0	AGR	EL	mit Dichtring with O-ring
			7.11020.01.0	ATS	EL	
GLA 220 CDI / d 4-matic (156.905) 80-130 kW (109-177 PS) OM 651.930	12.2013→		7.24809.82.0	AGR	EL	mit Dichtring with O-ring
			7.11020.01.0	ATS	EL	
GLA 220 CDI 4-matic (156.905) 80-130 kW (109-177 PS) OM 651.930	12.2013→		7.24809.82.0	AGR	EL	mit Dichtring with O-ring
			7.08369.89.0	ATS	EL	Euro 6 Euro 6
			7.11020.01.0	ATS	EL	
			7.11020.32.0	ATS	EL	für OE-Nummer: A 000 905 07 01, A 000 905 81 05, A 000 905 91 05 for OE number: A 000 905 07 01, A 000 905 81 05, A 000 905 91 05
GLA 220 d (156.903) 80-130 kW (109-177 PS) OM 651.930	07.2015→		7.24809.82.0	AGR	EL	mit Dichtring with O-ring
			7.08369.89.0	ATS	EL	Katalysator Catalytic Converter Euro 6 Euro 6
			7.11020.01.0	ATS	EL	
GLA 220 d 4-matic (156.905) 80-130 kW (109-177 PS) OM 651.930	07.2015→		7.24809.82.0	AGR	EL	mit Dichtring with O-ring
			7.08369.89.0	ATS	EL	Katalysator Catalytic Converter Euro 6 Euro 6
			7.11020.01.0	ATS	EL	

M

					
GLA-CLASS (X156)					
65					
GLA 250 (156.944) 115-160 kW (156-218 PS) M 270.920	12.2013→		7.24809.84.0 AGR EL 		
			7.05270.21.0 LS 600 mm vor Katalysator in front of the catalyst		
GLA 250 4-matic (156.946) 115-160 kW (156-218 PS) M 270.920	12.2013→		7.24809.84.0 AGR EL 		
			7.05270.21.0 LS 600 mm vor Katalysator in front of the catalyst		
GLA 45 AMG 4-matic (156.952) 250-280 kW (340-381 PS) M 133.980	05.2014→		7.05270.21.0 LS 600 mm für OE-Nummer: A 009 542 56 18 for OE number: A 009 542 56 18 vor Katalysator in front of the catalyst		
GLC (X253)					
66					
200 4-matic (253.943) 115-245 kW (156-333 PS) M 274.920	06.2016→04.2019		7.24809.85.0 AGR EL 		
			Produktionsdatum bis: 29.09.2017 Production date to: 29.09.2017		
220 d 4-matic (253.905, 253.903) 100-150 kW (136-204 PS) OM 651.921	06.2015→04.2019		7.24809.82.0 AGR EL mit Dichtring with O-ring		
			7.08369.76.0 ATS EL vor Katalysator in front of the catalyst für Fahrzeuge mit SCR-System for vehicles with SCR system		
			7.11020.33.0 ATS EL vor Rußpartikelfilter before soot particulate filter für Fahrzeuge mit SCR-System for vehicles with SCR system		
220 d 4-matic (253.905, 253.903) 100-150 kW (136-204 PS) OM 651.921	06.2015→04.2019		7.24809.82.0 AGR EL mit Dichtring with O-ring		
			7.11020.33.0 ATS EL vor Rußpartikelfilter before soot particulate filter für Fahrzeuge mit SCR-System for vehicles with SCR system		
250 4-matic (253.946) 115-245 kW (156-333 PS) M 274.920	06.2015→04.2019		7.24809.85.0 AGR EL 		
			Produktionsdatum bis: 29.09.2017 Production date to: 29.09.2017		
250 d 4-matic (253.909) 100-150 kW (136-204 PS) OM 651.921	06.2015→04.2019		7.24809.82.0 AGR EL mit Dichtring with O-ring		
			7.08369.76.0 ATS EL vor Katalysator in front of the catalyst für Fahrzeuge mit SCR-System for vehicles with SCR system		
300 (253.948) 115-245 kW (156-333 PS) M 274.920	01.2016→04.2019		7.24809.85.0 AGR EL 		
		Produktionsdatum bis: 29.07.2017 Production date to: 29.07.2017			
300 4-matic (253.949) 115-245 kW (156-333 PS) M 274.920	07.2015→04.2019		7.24809.85.0 AGR EL 		
		Produktionsdatum bis: 29.09.2017 Production date to: 29.09.2017			
300 4-matic (253.949) 115-245 kW (156-333 PS) M 274.920	07.2015→04.2019		7.24809.85.0 AGR EL 		
		Produktionsdatum bis: 29.09.2017 Production date to: 29.09.2017			
350 d 4-matic (253.925) 190 kW (258 PS) OM 642.873	10.2016→04.2019		7.11020.01.0 ATS EL		
350 e 4-matic (253.954) 115-245 kW (156-333 PS) M 274.920	01.2016→04.2019		7.24809.85.0 AGR EL 		
		Produktionsdatum bis: 29.09.2017 Production date to: 29.09.2017			





M

					
GLC (X253)					66
350 e 4-matic (253.954) 115-245 kW (156-333 PS) M 274.920	01.2016→04.2019		7.24809.85.0	AGR	EL  Produktionsdatum bis: 29.09.2017 Production date to: 29.09.2017
AMG 43 4-matic (253.964) 200-295 kW (272-401 PS) M 276.823	04.2016→08.2019		7.02604.44.0	LS	500 mm vor Katalysator, links in front of the catalyst, Left
GLC Coupe (C253)					67
200 (253.342) 115-245 kW (156-333 PS) M 274.920	06.2016→04.2019		7.24809.85.0	AGR	EL  Produktionsdatum bis: 29.09.2017 Production date to: 29.09.2017
200 4-matic (253.343) 115-245 kW (156-333 PS) M 274.920	11.2016→04.2019		7.24809.85.0	AGR	EL  Produktionsdatum bis: 29.09.2017 Production date to: 29.09.2017
220 d 4-matic (253.303, 253.305) 100-150 kW (136-204 PS) OM 651.921	06.2016→04.2019		7.24809.82.0	AGR	EL mit Dichtring with O-ring
			7.08369.76.0	ATS	EL vor Katalysator in front of the catalyst für Fahrzeuge mit SCR-System for vehicles with SCR system
			7.11020.33.0	ATS	EL vor Rußpartikelfilter before soot particulate filter für Fahrzeuge mit SCR-System for vehicles with SCR system
220 d 4-matic (253.303, 253.305) 100-150 kW (136-204 PS) OM 651.921	06.2016→04.2019		7.24809.82.0	AGR	EL mit Dichtring with O-ring
250 4-matic (253.346) 115-245 kW (156-333 PS) M 274.920	06.2016→04.2019		7.24809.85.0	AGR	EL  Produktionsdatum bis: 29.07.2017 Production date to: 29.07.2017
			7.08369.76.0	ATS	EL vor Katalysator in front of the catalyst für Fahrzeuge mit SCR-System for vehicles with SCR system
				ATS	EL vor Rußpartikelfilter before soot particulate filter für Fahrzeuge mit SCR-System for vehicles with SCR system
250 d 4-matic (253.309) 100-150 kW (136-204 PS) OM 651.921	06.2016→04.2019		7.24809.82.0	AGR	EL mit Dichtring with O-ring
300 4-matic (253.349) 115-245 kW (156-333 PS) M 274.920	10.2016→04.2019		7.24809.85.0	AGR	EL  Produktionsdatum bis: 29.09.2017 Production date to: 29.09.2017
			7.11020.01.0	ATS	EL
				ATS	EL
350 d 4-matic (253.325) 190 kW (258 PS) OM 642.873	10.2016→04.2019		7.11020.01.0	ATS	EL
350 e 4-matic (253.354) 115-245 kW (156-333 PS) M 274.920	10.2016→04.2019		7.24809.85.0	AGR	EL  Produktionsdatum bis: 29.09.2017 Production date to: 29.09.2017
350 e 4-matic (253.354) 115-245 kW (156-333 PS) M 274.920	10.2016→04.2019		7.24809.85.0	AGR	EL  Produktionsdatum bis: 29.09.2017 Production date to: 29.09.2017
AMG 43 4-matic (253.364) 200-295 kW (272-401 PS) M 276.823	10.2016→08.2019		7.02604.44.0	LS	500 mm vor Katalysator, links in front of the catalyst, Left

















M



















GLE (W166) **68**

250 d (166.006) 150-152 kW (204-207 PS) OM 651.960	04.2015→10.2018		7.08369.06.0	ATS	EL	
			7.08369.77.0	ATS	EL	vor Katalysator in front of the catalyst Euro 6 Euro 6 Produktionsdatum bis: 31.05.2019 Production date to: 31.05.2019
			7.08369.90.0	ATS	EL	 OM 651.960: nicht für Getriebeautomatik 9 Gang not for 9-speed automatic transmission vor Rußpartikelfilter before soot particulate filter für Fahrzeuge mit SCR-System for vehicles with SCR system Produktionsdatum ab: 10.01.2013 Production date from: 10.01.2013  OM 651.960: nicht für Getriebeautomatik 9 Gang not for 9-speed automatic transmission vor Rußpartikelfilter before soot particulate filter USA, Kanada USA, Kanada Produktionsdatum ab: 10.01.2013 Production date from: 10.01.2013
			7.11020.29.0	ATS	EL	für Getriebeautomatik 9 Gang for 9-speed automatic transmission für Fahrzeuge mit SCR-System for vehicles with SCR system
			7.11020.30.0	ATS	EL	für Getriebeautomatik 9 Gang for 9-speed automatic transmission für Fahrzeuge mit SCR-System for vehicles with SCR system
250 d 4-matic (166.004) 150-152 kW (204-207 PS) OM 651.960	04.2015→10.2018		7.08369.06.0	ATS	EL	
			7.08369.77.0	ATS	EL	vor Katalysator in front of the catalyst Euro 6 Euro 6
			7.08369.90.0	ATS	EL	für OE-Nummer: A 000 905 65 04, A 001 905 07 00 for OE number: A 000 905 65 04, A 001 905 07 00 vor Rußpartikelfilter before soot particulate filter
			7.11020.30.0	ATS	EL	für Getriebeautomatik 9 Gang for 9-speed automatic transmission für Fahrzeuge mit SCR-System for vehicles with SCR system
350 d 4-matic (166.024) 179-190 kW (243-258 PS) OM 642.826	04.2015→10.2018		7.08369.77.0	ATS	EL	vor Katalysator in front of the catalyst für Fahrzeuge mit SCR-System for vehicles with SCR system
			7.11020.01.0	ATS	EL	
			7.11020.29.0	ATS	EL	für OE-Nummer: A 000 905 69 04, A 001 905 22 00 for OE number: A 000 905 69 04, A 001 905 22 00
			7.11020.30.0	ATS	EL	für OE-Nummer: A 000 905 71 04, A 001 905 23 00 for OE number: A 000 905 71 04, A 001 905 23 00

M

					
GLE (W166)					68
500 e 4-matic (166.063) 200-325 kW (272-442 PS) M 276.821	04.2015→10.2018	 7.02604.44.0	LS	500 mm	vor Katalysator, beidseitig in front of the catalyst, Left and right
500 e 4-matic (166.063) 200-325 kW (272-442 PS) M 276.821	04.2015→10.2018	 7.02604.44.0	LS	500 mm	
GLE Coupe (C292)					69
350 d 4-matic (292.323, 292.324) 179-190 kW (243-258 PS) OM 642.826	03.2015→10.2019	 7.08369.77.0	ATS	EL	vor Katalysator in front of the catalyst für Fahrzeuge mit SCR-System for vehicles with SCR system
		7.11020.01.0	ATS	EL	
		7.11020.29.0	ATS	EL	für OE-Nummer: A 000 905 69 04, A 001 905 22 00 for OE number: A 000 905 69 04, A 001 905 22 00
		7.11020.30.0	ATS	EL	für OE-Nummer: A 000 905 71 04, A 001 905 23 00 for OE number: A 000 905 71 04, A 001 905 23 00
350 d 4-matic (292.323, 292.324) 190 kW (258 PS) OM 642.824	03.2015→10.2019	 7.08369.77.0	ATS	EL	vor Katalysator in front of the catalyst für Fahrzeuge mit SCR-System for vehicles with SCR system
		7.11020.29.0	ATS	EL	für OE-Nummer: A 000 905 69 04, A 001 905 22 00 for OE number: A 000 905 69 04, A 001 905 22 00
		7.11020.30.0	ATS	EL	für OE-Nummer: A 000 905 71 04, A 001 905 23 00 for OE number: A 000 905 71 04, A 001 905 23 00
GLK-CLASS (X204)					70
200 (204.934) 115-245 kW (156-333 PS) M 274.920	08.2013→06.2015	 7.24809.85.0	AGR	EL	 Produktionsdatum bis: 29.09.2017 Production date to: 29.09.2017
		7.02604.44.0	LS	500 mm	vor Katalysator in front of the catalyst
200 CDI (204.901) 88-125 kW (120-170 PS) OM 651.913, OM 651.916	07.2010→06.2015	 7.08369.06.0	ATS	EL	
		7.08369.12.0	ATS	EL	
		7.05270.21.0	LS	600 mm	 OM 651.913, OM 651.916: für OE-Nummer: A 004 542 73 18 for OE number: A 004 542 73 18 vor Katalysator in front of the catalyst
200 CDI (204.901) 100-125 kW (136-170 PS) OM 651.916	12.2013→06.2015	 7.08369.06.0	ATS	EL	
		7.08369.12.0	ATS	EL	
		7.05270.21.0	LS	600 mm	für OE-Nummer: A 004 542 73 18 for OE number: A 004 542 73 18 vor Katalysator in front of the catalyst
220 CDI (204.902) 100-125 kW (136-170 PS) OM 651.916	12.2008→06.2015	 7.08369.06.0	ATS	EL	
		7.08369.12.0	ATS	EL	
		7.05270.21.0	LS	600 mm	für OE-Nummer: A 004 542 73 18 for OE number: A 004 542 73 18 vor Katalysator in front of the catalyst







M

					
GLK-CLASS (X204)					
220 CDI (204.902) 100-125 kW (136-170 PS) OM 651.916	12.2008→06.2015		7.08369.06.0	ATS	EL
			7.08369.12.0	ATS	EL
			7.05270.21.0	LS	600 mm
für OE-Nummer: A 004 542 73 18 for OE number: A 004 542 73 18 vor Katalysator in front of the catalyst					
220 CDI 4-matic (204.984) 120-150 kW (163-204 PS) OM 651.912	12.2008→06.2015		7.08369.06.0	ATS	EL
			7.08369.12.0	ATS	EL
			7.05270.21.0	LS	600 mm
für OE-Nummer: A 004 542 73 18 for OE number: A 004 542 73 18 vor Katalysator in front of the catalyst					
220 CDI 4-matic (204.984, 204.997) 120-150 kW (163-204 PS) OM 651.912	12.2008→06.2015		7.08369.06.0	ATS	EL
			7.08369.12.0	ATS	EL
			7.05270.21.0	LS	600 mm
für OE-Nummer: A 004 542 73 18 for OE number: A 004 542 73 18 vor Katalysator in front of the catalyst					
250 (204.936) 115-245 kW (156-333 PS) M 274.920	08.2013→06.2015		7.24809.85.0	AGR	EL
			7.02604.44.0	LS	500 mm
Produktionsdatum bis: 29.09.2017 Production date to: 29.09.2017 vor Katalysator in front of the catalyst					
250 4-matic (204.937) 115-245 kW (156-333 PS) M 274.920	08.2013→06.2015		7.24809.85.0	AGR	EL
			7.02604.44.0	LS	500 mm
Produktionsdatum bis: 29.09.2017 Production date to: 29.09.2017 vor Katalysator in front of the catalyst					
250 CDI 4-matic 120-150 kW (163-204 PS) OM 651.912	09.2012→06.2015		7.08369.06.0	ATS	EL
250 CDI 4-matic (204.982, 204.904) 120-150 kW (163-204 PS) OM 651.912	09.2009→06.2015		7.08369.06.0	ATS	EL
			7.08369.12.0	ATS	EL
			7.05270.21.0	LS	600 mm
für OE-Nummer: A 004 542 73 18 for OE number: A 004 542 73 18 vor Katalysator in front of the catalyst					
280 4-matic (204.981) 170 kW (231 PS) M 272.948	06.2008→06.2009		7.05270.21.0	LS	600 mm
			7.05270.18.0	LS	500 mm
			7.04389.02.0	SLP	EL
300 4-matic (204.981) 170 kW (231 PS) M 272.948	07.2009→12.2015		7.04389.02.0	SLP	EL
320 CDI 4-matic (204.983) 165 kW (224 PS) OM 642.961	06.2008→06.2015		7.24809.47.0	AGR	ET
			7.08369.61.0	ATS	EL
USA USA					

M



GLK-CLASS (X204) 70

			7.11020.16.0	ATS	EL	für OE-Nummer: A 000 905 39 05, A 007 153 67 28 for OE number: A 000 905 39 05, A 007 153 67 28
			7.05270.21.0	LS	600 mm	
350 (204.956) 200 kW (272 PS) M 272.991	04.2009→06.2015		7.05270.17.0	LS	null mm	links, rechts Left, Right Diagnosesonde Diagnostic Probe
			7.05270.21.0	LS	600 mm	links, rechts Left, Right Regelsonde Regulating Probe
			7.04389.02.0	SLP	EL	
350 4-matic (204.987) 200 kW (272 PS) M 272.971	06.2008→04.2011		7.05270.18.0	LS	500 mm	links, rechts Left, Right Diagnosesonde Diagnostic Probe
			7.04389.02.0	SLP	EL	
350 4-matic (204.988) 182-225 kW (248-306 PS) M 276.957	06.2008→06.2015		7.02604.44.0	LS	500 mm	für OE-Nummer: A 008 542 29 18, A 009 542 59 18 for OE number: A 008 542 29 18, A 009 542 59 18 vor Katalysator in front of the catalyst
			7.02604.99.0	LS	400 mm	
M 350 CDI 4-matic (204.992) 150-170 kW (204-231 PS) OM 642.832	07.2009→01.2010		7.08369.51.0	ATS	EL	
			7.08369.61.0	ATS	EL	
			7.05270.21.0	LS	600 mm	
350 CDI 4-matic (204.992) 150-170 kW (204-231 PS) OM 642.832	02.2010→06.2015		7.08369.51.0	ATS	EL	
			7.08369.61.0	ATS	EL	
			7.05270.21.0	LS	600 mm	
350 CDI 4-matic (204.993) 195 kW (265 PS) OM 642.835	07.2012→06.2015		7.08369.61.0	ATS	EL	
			7.11020.01.0	ATS	EL	
			7.05270.21.0	LS	600 mm	

GLS (X166) 71





350 d 4-matic (166.824) 179-190 kW (243-258 PS) OM 642.826	11.2015→04.2019		7.11020.01.0	ATS	EL	
			7.11020.29.0	ATS	EL	für OE-Nummer: A 000 905 69 04, A 001 905 22 00 for OE number: A 000 905 69 04, A 001 905 22 00
			7.11020.30.0	ATS	EL	für OE-Nummer: A 000 905 71 04, A 001 905 23 00 for OE number: A 000 905 71 04, A 001 905 23 00

M-CLASS (W163) 72



ML 230 (163.136) 110 kW (150 PS) M 111.977	02.1998→06.2005		7.05270.03.0	LS	820 mm	
ML 320 (163.154) 160 kW (218 PS) M 112.942	02.1998→08.2002		7.22136.50.0	AGR	PN	<input checked="" type="checkbox"/>



M-CLASS (W163) 72

			7.05270.15.0	LS	380 mm	
			7.04389.00.0	SLP	EL	
ML 350 173-180 kW (235-245 PS) M 112.970	02.2003→06.2005		7.22136.50.0	AGR	PN	☒
			7.04389.00.0	SLP	EL	
ML 350 (163.157) 173-180 kW (235-245 PS) M 112.970	08.2002→06.2005		7.22136.50.0	AGR	PN	☒
			7.04389.00.0	SLP	EL	
ML 430 (163.172) 199 kW (271 PS) M 113.942	02.1998→06.2005		7.22136.50.0	AGR	PN	☒
			7.05270.15.0	LS	380 mm	
			7.04389.00.0	SLP	EL	
ML 500 (163.175) 215-225 kW (292-306 PS) M 113.964, M 113.965	09.2001→06.2005		7.22136.50.0	AGR	PN	☒
			7.04389.00.0	SLP	EL	
ML 55 AMG (163.174) 255 kW (347 PS) M 113.981	02.2000→06.2005		7.22136.50.0	AGR	PN	☒
			7.05270.15.0	LS	380 mm	
			7.04389.00.0	SLP	EL	







M-CLASS (W164) 73

450 Hybrid	07.2009→10.2011		7.05270.22.0	LS	825 mm	
			7.05270.21.0	LS	600 mm	
ML 280 CDI 4-matic (164.120) 140-170 kW (190-231 PS) OM 642.940	07.2005→07.2009		7.24809.47.0	AGR	ET	⊙
			7.08369.12.0	ATS	EL	Fahrgestellnummer ab: A506721 Vehicle Identification Number from: A506721 Euro5/Euro6 Euro5/Euro6
			7.08369.77.0	ATS	EL	für OE-Nummer: A 008 153 34 28 for OE number: A 008 153 34 28 nach Rußpartikelfilter after soot particulate filter
			7.08369.87.0	ATS	EL	Katalysator Catalytic Converter für Fahrzeuge ohne SCR-System for vehicles without SCR system Produktionsdatum ab: 08.05.2008 Production date from: 08.05.2008
			7.08369.91.0	ATS	EL	für OE-Nummer: A 005 153 41 28, A 007 153 75 28 for OE number: A 005 153 41 28, A 007 153 75 28 nach Rußpartikelfilter after soot particulate filter
			7.08369.94.0	ATS	EL	Katalysator Catalytic Converter für Fahrzeuge ohne SCR-System for vehicles without SCR system Produktionsdatum bis: 08.05.2008 Production date to: 08.05.2008

M











M-CLASS (W164) 73

			7.11020.28.0	ATS	EL	 →ch. A506721 vor Rußpartikelfilter before soot particulate filter Euro 5, Euro 6 Euro 5, Euro 6 Produktionsdatum bis: 10.02.2009 Production date to: 10.02.2009 nicht für SA Code: U42 not for SA code: U42
			7.11190.01.0	DDS		Luftfiltergehäuse Air Filter Housing
			7.05270.21.0	LS	600 mm	
ML 300 4-matic (164.182) 170-180 kW (231-245 PS) M 272.945	03.2010→12.2011		7.04389.02.0	SLP	EL	
ML 300 CDI 4-matic (164.120) 140-170 kW (190-231 PS) OM 642.940	07.2009→12.2011		7.24809.47.0	AGR	ET	 USA USA
			7.08369.12.0	ATS	EL	 ch. A 506721→
			7.08369.77.0	ATS	EL	für OE-Nummer: A 008 153 34 28 for OE number: A 008 153 34 28 nach Rußpartikelfilter after soot particulate filter
			7.08369.87.0	ATS	EL	Katalysator Catalytic Converter für Fahrzeuge ohne SCR-System for vehicles without SCR system Produktionsdatum ab: 08.05.2008 Production date from: 08.05.2008
			7.08369.91.0	ATS	EL	für OE-Nummer: A 005 153 41 28, A 007 153 75 28 for OE number: A 005 153 41 28, A 007 153 75 28 nach Rußpartikelfilter after soot particulate filter
			7.08369.94.0	ATS	EL	Katalysator Catalytic Converter für Fahrzeuge ohne SCR-System for vehicles without SCR system Produktionsdatum bis: 08.05.2008 Production date to: 08.05.2008
			7.11190.01.0	DDS		Luftfiltergehäuse Air Filter Housing
			7.05270.21.0	LS	600 mm	
ML 300 CDI 4-matic (164.121) 150-170 kW (204-231 PS) OM 642.820	02.2010→12.2011		7.08369.12.0	ATS	EL	 ch. A 506721→
			7.08369.77.0	ATS	EL	für OE-Nummer: A 008 153 34 28 for OE number: A 008 153 34 28 nach Rußpartikelfilter after soot particulate filter
			7.08369.87.0	ATS	EL	Katalysator Catalytic Converter für Fahrzeuge ohne SCR-System for vehicles without SCR system Produktionsdatum ab: 08.05.2008 Production date from: 08.05.2008
			7.08369.91.0	ATS	EL	für OE-Nummer: A 005 153 41 28, A 007 153 75 28 for OE number: A 005 153 41 28, A 007 153 75 28 nach Rußpartikelfilter after soot particulate filter

M













M-CLASS (W164) **73**

			7.08369.94.0	ATS	EL	Katalysator Catalytic Converter für Fahrzeuge ohne SCR-System for vehicles without SCR system Produktionsdatum bis: 08.05.2008 Production date to: 08.05.2008
			7.11020.11.0	ATS	EL	 OM 642.820: Abgaskrümmer Exhaust Manifold Japan, USA, Kanada Japan, USA, Kanada  OM 642.820: vor Abgasturbolader in front of exhaust turbocharger USA USA
			7.11020.28.0	ATS	EL	 →ch. A506721 vor Rußpartikelfilter before soot particulate filter Euro 5, Euro 6 Euro 5, Euro 6 Produktionsdatum bis: 10.02.2009 Production date to: 10.02.2009 nicht für SA Code: U42 not for SA code: U42
			7.05270.21.0	LS	600 mm	
ML 320 CDI 4-matic 140-170 kW (190-231 PS) OM 642.940	09.2006→12.2008		7.24809.47.0	AGR	ET	 USA USA
			7.11190.01.0	DDS		für OE-Nummer: A 006 153 49 28 for OE number: A 006 153 49 28 Luftfiltergehäuse Air Filter Housing
ML 320 CDI 4-matic (164.122) 140-170 kW (190-231 PS) OM 642.940	07.2005→07.2009		7.24809.47.0	AGR	ET	 USA USA
			7.08369.12.0	ATS	EL	 ch. A 506721→
			7.08369.77.0	ATS	EL	für OE-Nummer: A 008 153 34 28 for OE number: A 008 153 34 28 nach Rußpartikelfilter after soot particulate filter
			7.08369.87.0	ATS	EL	Katalysator Catalytic Converter für Fahrzeuge ohne SCR-System for vehicles without SCR system Produktionsdatum ab: 08.05.2008 Production date from: 08.05.2008
			7.08369.91.0	ATS	EL	für OE-Nummer: A 005 153 41 28, A 007 153 75 28 for OE number: A 005 153 41 28, A 007 153 75 28 nach Rußpartikelfilter after soot particulate filter
			7.08369.94.0	ATS	EL	Katalysator Catalytic Converter für Fahrzeuge ohne SCR-System for vehicles without SCR system Produktionsdatum bis: 08.05.2008 Production date to: 08.05.2008
			7.11020.28.0	ATS	EL	vor Rußpartikelfilter before soot particulate filter Euro 5, Euro 6 Euro 5, Euro 6 Produktionsdatum bis: 10.02.2009 Production date to: 10.02.2009 nicht für SA Code: U42 not for SA code: U42

M









M-CLASS (W164) **73**

			7.11190.01.0	DDS		Luftfiltergehäuse Air Filter Housing
			7.05270.21.0	LS	600 mm	
ML 320 CDI 4-matic (164.124, 164.125, 164.122) 140-170 kW (190-231 PS) OM 642.940	07.2005→07.2011		7.24809.47.0	AGR	ET	 USA USA
ML 320 CDI 4-matic (164.124, 164.125, 164.122) 150-170 kW (204-231 PS) OM 642.820	07.2005→07.2011		7.08369.12.0	ATS	EL	
			7.08369.87.0	ATS	EL	Katalysator Catalytic Converter für Fahrzeuge ohne SCR-System for vehicles without SCR system Produktionsdatum ab: 08.05.2008 Production date from: 08.05.2008
			7.08369.94.0	ATS	EL	Katalysator Catalytic Converter für Fahrzeuge ohne SCR-System for vehicles without SCR system Produktionsdatum bis: 08.05.2008 Production date to: 08.05.2008
			7.11020.11.0	ATS	EL	 OM 642.820: Abgaskrümmer Exhaust Manifold Japan, USA, Kanada Japan, USA, Canada  OM 642.820: vor Abgasturbolader in front of exhaust turbocharger USA USA
			7.11020.28.0	ATS	EL	 →ch. A506721 vor Rußpartikelfilter before soot particulate filter Euro 5, Euro 6 Euro 5, Euro 6 Produktionsdatum bis: 10.02.2009 Production date to: 10.02.2009 nicht für SA Code: U42 not for SA code: U42
ML 350 (164.156) 200 kW (272 PS) M 272.967	01.2009→12.2011		7.04389.02.0	SLP	EL	
ML 350 4-matic (164.186) 200 kW (272 PS) M 272.967	02.2005→12.2011		7.05270.17.0	LS	null mm	
			7.05270.21.0	LS	600 mm	
			7.05270.18.0	LS	500 mm	
			7.04389.02.0	SLP	EL	
ML 350 CDI 4-matic (164.122) 140-170 kW (190-231 PS) OM 642.940	07.2009→12.2011		7.24809.47.0	AGR	ET	 USA USA
			7.08369.12.0	ATS	EL	 ch. A 506721→
			7.08369.77.0	ATS	EL	für OE-Nummer: A 008 153 34 28 for OE number: A 008 153 34 28 nach Rußpartikelfilter after soot particulate filter
			7.08369.87.0	ATS	EL	Katalysator Catalytic Converter für Fahrzeuge ohne SCR-System for vehicles without SCR system Produktionsdatum ab: 08.05.2008 Production date from: 08.05.2008

M









M-CLASS (W164) **73**

			7.08369.91.0	ATS	EL	für OE-Nummer: A 005 153 41 28, A 007 153 75 28 for OE number: A 005 153 41 28, A 007 153 75 28 nach Rußpartikelfilter after soot particulate filter
			7.08369.94.0	ATS	EL	Katalysator Catalytic Converter für Fahrzeuge ohne SCR-System for vehicles without SCR system Produktionsdatum bis: 08.05.2008 Production date to: 08.05.2008
			7.11190.01.0	DDS		Luftfiltergehäuse Air Filter Housing
			7.05270.21.0	LS	600 mm	
ML 350 CDI 4-matic (164.125, 164.124) 150-170 kW (204-231 PS) OM 642.820	09.2009→12.2011		7.08369.12.0	ATS	EL	 ch. A 506721→
			7.08369.77.0	ATS	EL	für OE-Nummer: A 008 153 34 28 for OE number: A 008 153 34 28 nach Rußpartikelfilter after soot particulate filter
			7.08369.87.0	ATS	EL	Katalysator Catalytic Converter für Fahrzeuge ohne SCR-System for vehicles without SCR system Produktionsdatum ab: 08.05.2008 Production date from: 08.05.2008
			7.08369.91.0	ATS	EL	für OE-Nummer: A 005 153 41 28, A 007 153 75 28 for OE number: A 005 153 41 28, A 007 153 75 28 nach Rußpartikelfilter after soot particulate filter
			7.08369.94.0	ATS	EL	Katalysator Catalytic Converter für Fahrzeuge ohne SCR-System for vehicles without SCR system Produktionsdatum bis: 08.05.2008 Production date to: 08.05.2008
			7.11020.11.0	ATS	EL	 OM 642.820: Abgaskrümmer Exhaust Manifold Japan, USA, Kanada Japan, USA, Kanada  OM 642.820: vor Abgasturbolader in front of exhaust turbocharger USA USA
			7.05270.21.0	LS	600 mm	
ML 350 CDI 4-matic (164.125, 164.124) 150-170 kW (204-231 PS) OM 642.820	02.2010→12.2011		7.05270.21.0	LS	600 mm	
ML 420 CDI 4-matic (164.128) 225 kW (306 PS) OM 629.912	02.2006→09.2009		7.08369.61.0	ATS	EL	
			7.08369.77.0	ATS	EL	rechts Right für Fahrzeuge mit Diesel-Partikel-Filter (DPF) for vehicles with diesel soot filter
			7.11190.01.0	DDS		Luftfiltergehäuse Air Filter Housing

M



M-CLASS (W164) 73







			7.05270.22.0	LS	825 mm	
ML 450 CDI 4-matic (164.128) 225 kW (306 PS) OM 629.912	09.2009→12.2011		7.08369.61.0	ATS	EL	
			7.08369.77.0	ATS	EL	rechts Right für Fahrzeuge mit Diesel-Partikel-Filter (DPF) for vehicles with diesel soot filter
			7.11190.01.0	DDS		Luftfiltergehäuse Air Filter Housing
ML 450 Hybrid 4-matic (164.195) 200-208 kW (272-283 PS) M 272.973	09.2009→12.2011		7.05270.21.0	LS	600 mm	für OE-Nummer: A 003 542 70 18, A 004 542 73 18 for OE number: A 003 542 70 18, A 004 542 73 18
			7.04389.02.0	SLP	EL	
ML 500 4-matic (164.172) 285-320 kW (388-435 PS) M 273.963	12.2007→12.2011		7.05270.17.0	LS	null mm	rechts Right Diagnosesonde Diagnostic Probe
			7.05270.21.0	LS	600 mm	links, rechts Left, Right Regelsonde Regulating Probe
			7.05270.18.0	LS	500 mm	links Left Diagnosesonde Diagnostic Probe
			7.04389.02.0	SLP	EL	
ML 500 4-matic (164.175) 215-225 kW (292-306 PS) M 113.964	07.2005→12.2011		7.22136.50.0	AGR	PN	<input checked="" type="checkbox"/>
			7.05270.11.0	LS	750 mm	vor Katalysator, beidseitig in front of the catalyst, Left and right
			7.02604.26.0	LS	500 mm	rechts Right
			7.04389.00.0	SLP	EL	
ML 500 4-matic (164.175) 215-225 kW (292-306 PS) M 113.964	09.2005→12.2006		7.22136.50.0	AGR	PN	<input checked="" type="checkbox"/>
			7.04389.00.0	SLP	EL	
ML 63 AMG 4-matic (164.177) 375 kW (510 PS) M 156.980	01.2006→12.2011		7.05270.21.0	LS	600 mm	
			7.05270.18.0	LS	500 mm	
			7.04389.05.0	SLP	EL	

M-CLASS (W166) 74

ML 250 CDI / BlueTEC 4-matic (166.004, 166.003) 150-152 kW (204-207 PS) OM 651.960	06.2011→12.2015		7.08369.06.0	ATS	EL	
			7.08369.77.0	ATS	EL	vor Katalysator in front of the catalyst Euro 6 Euro 6
			7.08369.90.0	ATS	EL	für OE-Nummer: A 001 905 07 00 for OE number: A 001 905 07 00 vor Rußpartikelfilter before soot particulate filter





M-CLASS (W166) 74

			7.11020.29.0	ATS	EL	für Getriebeautomatik 9 Gang for 9-speed automatic transmission für Fahrzeuge mit SCR-System for vehicles with SCR system
			7.11020.30.0	ATS	EL	für Getriebeautomatik 9 Gang for 9-speed automatic transmission für Fahrzeuge mit SCR-System for vehicles with SCR system
ML 350 4-matic (166.057) 183-225 kW (249-306 PS) M 276.955	06.2011→12.2015		7.02604.99.0	LS	400 mm	
ML 350 BlueTEC 4-matic (166.024) 179-190 kW (243-258 PS) OM 642.826	06.2011→02.2015		7.08369.77.0	ATS	EL	vor Katalysator in front of the catalyst für Fahrzeuge mit SCR-System for vehicles with SCR system
			7.11020.01.0 7.11020.29.0	ATS ATS	EL EL	für OE-Nummer: A 000 905 69 04, A 001 905 22 00 for OE number: A 000 905 69 04, A 001 905 22 00
ML 350 BlueTEC 4-matic (166.024) 190 kW (258 PS) OM 642.864	06.2011→02.2015		7.08369.77.0	ATS	EL	vor Katalysator in front of the catalyst für Fahrzeuge mit SCR-System for vehicles with SCR system
			7.11020.01.0	ATS	EL	
ML 350 CDI 4-matic (166.023) 140-170 kW (190-231 PS) OM 642.940	06.2011→02.2015		7.08369.77.0	ATS	EL	vor Katalysator in front of the catalyst für Fahrzeuge mit SCR-System for vehicles with SCR system
			7.11020.01.0 7.11020.29.0	ATS ATS	EL EL	für OE-Nummer: A 000 905 69 04, A 001 905 22 00 for OE number: A 000 905 69 04, A 001 905 22 00
ML 63 AMG 4-matic (166.074) 386-430 kW (525-585 PS) M 157.982	11.2011→02.2015		7.02604.99.0	LS	400 mm	
ML 63 AMG 4-matic (166.074) 386-430 kW (525-585 PS) M 157.982	11.2011→02.2015		7.02604.99.0	LS	400 mm	





M

R-CLASS (W251, V251) 75

R 280 (251.054, 251.154) 170-180 kW (231-245 PS) M 272.945	01.2007→12.2014		7.05270.17.0	LS	null mm	
			7.05270.21.0	LS	600 mm	
			7.05270.18.0	LS	500 mm	
			7.04389.02.0	SLP	EL	
R 280 4-matic (251.062) 170-180 kW (231-245 PS) M 272.945	05.2007→12.2011		7.05270.17.0	LS	null mm	
			7.05270.21.0	LS	600 mm	
			7.05270.18.0	LS	500 mm	
			7.04389.02.0	SLP	EL	
R 280 CDI (251.121, 251.026, 251.126) 140-157 kW (190-214 PS) OM 642.870	05.2006→12.2012		7.08369.87.0	ATS	EL	für OE-Nummer: A 007 153 96 28 for OE number: A 007 153 96 28 Katalysator Catalytic Converter











R-CLASS (W251, V251) 75

			7.08369.91.0	ATS	EL	für OE-Nummer: A 005 153 41 28, A 007 153 75 28 for OE number: A 005 153 41 28, A 007 153 75 28 Katalysator Catalytic Converter
			7.08369.94.0	ATS	EL	Katalysator Catalytic Converter für Fahrzeuge mit Diesel-Partikel-Filter (DPF), für Fahrzeuge ohne SCR-System for vehicles with diesel soot filter, for vehicles without SCR system Produktionsdatum ab: 04.12.2007 Production date from: 04.12.2007 Produktionsdatum bis: 24.06.2009 Production date to: 24.06.2009
			7.11020.11.0	ATS	EL	 OM 642.870: Abgaskrümmer Exhaust Manifold Japan, USA, Kanada Japan, USA, Kanada nicht für Baumuster: 251.026, 251.126 not for code: 251.026, 251.126  OM 642.870: Baumuster: 251.121 Type: 251.121 vor Abgasturbolader in front of exhaust turbocharger USA USA
			7.05270.21.0	LS	600 mm	
M	R 280 CDI (251.121, 251.026, 251.126) 140-195 kW (190-265 PS) OM 642.872	05.2006→12.2012		7.08369.87.0	ATS	EL für OE-Nummer: A 007 153 96 28 for OE number: A 007 153 96 28 Katalysator Catalytic Converter
				7.08369.91.0	ATS	EL für OE-Nummer: A 005 153 41 28, A 007 153 75 28 for OE number: A 005 153 41 28, A 007 153 75 28 Katalysator Catalytic Converter
				7.08369.94.0	ATS	EL Katalysator Catalytic Converter für Fahrzeuge mit Diesel-Partikel-Filter (DPF), für Fahrzeuge ohne SCR-System for vehicles with diesel soot filter, for vehicles without SCR system Produktionsdatum ab: 04.12.2007 Production date from: 04.12.2007 Produktionsdatum bis: 24.06.2009 Production date to: 24.06.2009
				7.11020.01.0	ATS	EL nicht für Baumuster: 251.026, 251.126 not for code: 251.026, 251.126 USA USA
				7.11020.11.0	ATS	EL  OM 642.872: Abgaskrümmer Exhaust Manifold Japan, USA, Kanada Japan, USA, Kanada nicht für Baumuster: 251.026, 251.126 not for code: 251.026, 251.126  OM 642.872: Baumuster: 251.121 Type: 251.121 vor Abgasturbolader in front of exhaust turbocharger USA USA
				7.05270.21.0	LS	600 mm









R-CLASS (W251, V251) 75

R 280 CDI (251.121, 251.026, 251.126) 140-165 kW (190-224 PS) OM 642.950	05.2006→12.2012		7.24809.47.0	AGR	ET  USA USA
			7.08369.87.0	ATS	EL für OE-Nummer: A 007 153 96 28 for OE number: A 007 153 96 28 Katalysator Catalytic Converter
			7.08369.91.0	ATS	EL für OE-Nummer: A 005 153 41 28, A 007 153 75 28 for OE number: A 005 153 41 28, A 007 153 75 28 Katalysator Catalytic Converter
			7.08369.94.0	ATS	EL Katalysator Catalytic Converter für Fahrzeuge mit Diesel-Partikel-Filter (DPF), für Fahrzeuge ohne SCR-System for vehicles with diesel soot filter, for vehicles without SCR system Produktionsdatum ab: 25.10.2007 Production date from: 25.10.2007 Produktionsdatum bis: 24.06.2009 Production date to: 24.06.2009
			7.11190.01.0	DDS	Luftfiltergehäuse Air Filter Housing
R 280 CDI 4-matic (251.020) 140-165 kW (190-224 PS) OM 642.950	05.2006→12.2012		7.24809.47.0	AGR	ET  USA USA
			7.08369.12.0	ATS	EL  →ch. A 014280
			7.08369.87.0	ATS	EL für OE-Nummer: A 007 153 96 28 for OE number: A 007 153 96 28 Katalysator Catalytic Converter
			7.08369.91.0	ATS	EL für OE-Nummer: A 007 153 75 28, A 005 153 41 28 for OE number: A 007 153 75 28, A 005 153 41 28 Katalysator Catalytic Converter
			7.08369.94.0	ATS	EL Katalysator Catalytic Converter für Fahrzeuge ohne SCR-System for vehicles without SCR system Produktionsdatum ab: 04.12.2007 Production date from: 04.12.2007 Produktionsdatum bis: 24.06.2009 Production date to: 24.06.2009
			7.11190.01.0	DDS	Luftfiltergehäuse Air Filter Housing
R 300 (251.054, 251.154) 170-180 kW (231-245 PS) M 272.945	07.2009→12.2014		7.04389.02.0	SLP	EL
			7.04389.02.0	SLP	EL
R 300 (251.154) 170-180 kW (231-245 PS) M 272.945	01.2011→12.2014		7.04389.02.0	SLP	EL
R 300 CDI (251.021, 251.121, 251.026, 251.126) 140-157 kW (190-214 PS) OM 642.870	07.2009→12.2012		7.08369.87.0	ATS	EL für OE-Nummer: A 007 153 96 28 for OE number: A 007 153 96 28 Katalysator Catalytic Converter

M











R-CLASS (W251, V251) 75

			7.08369.91.0	ATS	EL	für OE-Nummer: A 005 153 41 28, A 007 153 75 28 for OE number: A 005 153 41 28, A 007 153 75 28 Katalysator Catalytic Converter	
			7.08369.94.0	ATS	EL	Katalysator Catalytic Converter für Fahrzeuge mit Diesel-Partikel-Filter (DPF), für Fahrzeuge ohne SCR-System for vehicles with diesel soot filter, for vehicles without SCR system Produktionsdatum ab: 04.12.2007 Production date from: 04.12.2007 Produktionsdatum bis: 24.06.2009 Production date to: 24.06.2009	
			7.11020.11.0	ATS	EL	 OM 642.870: Abgaskrümmer Exhaust Manifold Japan, USA, Kanada Japan, USA, Kanada nicht für Baumuster: 251.026, 251.126 not for code: 251.026, 251.126  OM 642.870: vor Abgasturbolader in front of exhaust turbocharger USA USA nicht für Baumuster: 251.026, 251.126 not for code: 251.026, 251.126	
M	R 300 CDI (251.021, 251.121, 251.026, 251.126) 140-195 kW (190-265 PS) OM 642.872	07.2009→12.2012		7.08369.87.0	ATS	EL	für OE-Nummer: A 007 153 96 28 for OE number: A 007 153 96 28 Katalysator Catalytic Converter
				7.08369.91.0	ATS	EL	für OE-Nummer: A 005 153 41 28, A 007 153 75 28 for OE number: A 005 153 41 28, A 007 153 75 28 Katalysator Catalytic Converter
				7.08369.94.0	ATS	EL	Katalysator Catalytic Converter für Fahrzeuge mit Diesel-Partikel-Filter (DPF), für Fahrzeuge ohne SCR-System for vehicles with diesel soot filter, for vehicles without SCR system Produktionsdatum ab: 04.12.2007 Production date from: 04.12.2007 Produktionsdatum bis: 24.06.2009 Production date to: 24.06.2009
				7.11020.01.0	ATS	EL	nicht für Baumuster: 251.026, 251.126 not for code: 251.026, 251.126 USA USA
				7.11020.11.0	ATS	EL	 OM 642.872: Abgaskrümmer Exhaust Manifold Japan, USA, Kanada Japan, USA, Kanada nicht für Baumuster: 251.026, 251.126 not for code: 251.026, 251.126  OM 642.872: vor Abgasturbolader in front of exhaust turbocharger USA USA nicht für Baumuster: 251.026, 251.126 not for code: 251.026, 251.126
	R 300 CDI (251.021, 251.121, 251.026, 251.126) 140-165 kW (190-224 PS) OM 642.950	07.2009→12.2012		7.24809.47.0	AGR	ET	 USA USA











R-CLASS (W251, V251) **75**

			7.08369.87.0	ATS	EL	für OE-Nummer: A 007 153 96 28 for OE number: A 007 153 96 28 Katalysator Catalytic Converter
			7.08369.91.0	ATS	EL	für OE-Nummer: A 005 153 41 28, A 007 153 75 28 for OE number: A 005 153 41 28, A 007 153 75 28 Katalysator Catalytic Converter
			7.08369.94.0	ATS	EL	Katalysator Catalytic Converter für Fahrzeuge mit Diesel-Partikel-Filter (DPF), für Fahrzeuge ohne SCR-System for vehicles with diesel soot filter, for vehicles without SCR system Produktionsdatum ab: 25.10.2007 Production date from: 25.10.2007 Produktionsdatum bis: 24.06.2009 Production date to: 24.06.2009
			7.11190.01.0	DDS		Luftfiltergehäuse Air Filter Housing
R 300 CDI 4-matic (251.020) 140-165 kW (190-224 PS) OM 642.950	07.2009→12.2012		7.24809.47.0	AGR	ET	 USA USA
			7.08369.12.0	ATS	EL	 →ch. A 014280
			7.08369.87.0	ATS	EL	für OE-Nummer: A 007 153 96 28 for OE number: A 007 153 96 28 Katalysator Catalytic Converter
			7.08369.91.0	ATS	EL	für OE-Nummer: A 005 153 41 28, A 007 153 75 28 for OE number: A 005 153 41 28, A 007 153 75 28 Katalysator Catalytic Converter
			7.08369.94.0	ATS	EL	Katalysator Catalytic Converter für Fahrzeuge ohne SCR-System for vehicles without SCR system Produktionsdatum ab: 04.12.2007 Production date from: 04.12.2007 Produktionsdatum bis: 24.06.2009 Production date to: 24.06.2009
			7.11190.01.0	DDS		Luftfiltergehäuse Air Filter Housing
R 320 CDI 4-matic 140-165 kW (190-224 PS) OM 642.950	09.2006→12.2008		7.24809.47.0	AGR	ET	 USA USA
R 320 CDI 4-matic (251.022, 251.122) 140-165 kW (190-224 PS) OM 642.950	01.2006→07.2010		7.24809.47.0	AGR	ET	 USA USA
			7.08369.12.0	ATS	EL	 →ch. A 014280
			7.08369.87.0	ATS	EL	für OE-Nummer: A 007 153 96 28 for OE number: A 007 153 96 28 Katalysator Catalytic Converter
			7.08369.91.0	ATS	EL	für OE-Nummer: A 005 153 41 28, A 007 153 75 28 for OE number: A 005 153 41 28, A 007 153 75 28 Katalysator Catalytic Converter

M











R-CLASS (W251, V251) 75

			7.08369.94.0	ATS	EL	Katalysator Catalytic Converter für Fahrzeuge ohne SCR-System for vehicles without SCR system Produktionsdatum ab: 25.10.2007 Production date from: 25.10.2007 Produktionsdatum bis: 24.06.2009 Production date to: 24.06.2009
			7.11190.01.0	DDS		Luftfiltergehäuse Air Filter Housing
			7.05270.21.0	LS	600 mm	
R 320 CDI 4-matic (251.125) 140-157 kW (190-214 PS) OM 642.870	01.2006→12.2012		7.08369.91.0	ATS	EL	für OE-Nummer: A 005 153 41 28, A 007 153 75 28 for OE number: A 005 153 41 28, A 007 153 75 28 Katalysator Catalytic Converter
			7.11020.11.0	ATS	EL	 OM 642.870: Abgaskrümmer Exhaust Manifold Japan, USA, Kanada Japan, USA, Kanada OM 642.870: vor Abgasturbolader in front of exhaust turbocharger USA USA
			7.05270.21.0	LS	600 mm	
R 320 CDI 4-matic (251.125) 140-165 kW (190-224 PS) OM 642.950	01.2006→12.2012		7.24809.47.0	AGR	ET	 USA USA
			7.05270.21.0	LS	600 mm	
R 350 (251.056, 251.156) 200 kW (272 PS) M 272.967	01.2007→12.2012		7.05270.17.0	LS	null mm	rechts Right Diagnosesonde Diagnostic Probe
			7.05270.21.0	LS	600 mm	links, rechts Left, Right Regelsonde Regulating Probe
			7.05270.18.0	LS	500 mm	links Left Diagnosesonde Diagnostic Probe
			7.04389.02.0	SLP	EL	
R 350 4-matic (251.065, 251.165) 200 kW (272 PS) M 272.967	08.2005→12.2012		7.05270.17.0	LS	null mm	rechts Right Diagnosesonde Diagnostic Probe
			7.05270.21.0	LS	600 mm	links, rechts Left, Right Regelsonde Regulating Probe
			7.05270.18.0	LS	500 mm	links Left Diagnosesonde Diagnostic Probe
			7.04389.02.0	SLP	EL	
R 350 CDI 4-matic (251.022, 251.122) 140-165 kW (190-224 PS) OM 642.950	07.2009→12.2012		7.24809.47.0	AGR	ET	 USA USA
			7.08369.12.0	ATS	EL	 →ch. A 014280





















R-CLASS (W251, V251) **75**

			7.08369.87.0	ATS	EL	für OE-Nummer: A 007 153 96 28 for OE number: A 007 153 96 28 Katalysator Catalytic Converter
			7.08369.91.0	ATS	EL	für OE-Nummer: A 005 153 41 28, A 007 153 75 28 for OE number: A 005 153 41 28, A 007 153 75 28 Katalysator Catalytic Converter
			7.08369.94.0	ATS	EL	Katalysator Catalytic Converter für Fahrzeuge mit Diesel-Partikel-Filter (DPF), für Fahrzeuge ohne SCR-System for vehicles with diesel soot filter, for vehicles without SCR system Produktionsdatum ab: 25.10.2007 Production date from: 25.10.2007 Produktionsdatum bis: 24.06.2009 Production date to: 24.06.2009
			7.11190.01.0	DDS		Luftfiltergehäuse Air Filter Housing
R 350 CDI 4-matic (251.023, 251.123) 140-195 kW (190-265 PS) OM 642.872	08.2010→12.2014		7.08369.87.0	ATS	EL	für OE-Nummer: A 007 153 96 28 for OE number: A 007 153 96 28 Katalysator Catalytic Converter
			7.08369.91.0	ATS	EL	für OE-Nummer: A 005 153 41 28, A 007 153 75 28 for OE number: A 005 153 41 28, A 007 153 75 28 Katalysator Catalytic Converter
			7.11020.01.0	ATS	EL	USA USA
			7.11020.11.0	ATS	EL	 OM 642.872: Abgaskrümmer Exhaust Manifold  Japan, USA, Kanada  Japan, USA, Canada  OM 642.872: vor Abgasturbolader in front of exhaust turbocharger  USA  USA
R 350 CDI 4-matic (251.124, 251.125) 140-157 kW (190-214 PS) OM 642.870	01.2006→12.2014		7.08369.87.0	ATS	EL	für OE-Nummer: A 007 153 96 28 for OE number: A 007 153 96 28 Katalysator Catalytic Converter
			7.08369.91.0	ATS	EL	für OE-Nummer: A 005 153 41 28, A 007 153 75 28 for OE number: A 005 153 41 28, A 007 153 75 28 Katalysator Catalytic Converter
			7.08369.94.0	ATS	EL	Katalysator Catalytic Converter für Fahrzeuge mit Diesel-Partikel-Filter (DPF), für Fahrzeuge ohne SCR-System for vehicles with diesel soot filter, for vehicles without SCR system Produktionsdatum ab: 04.12.2007 Production date from: 04.12.2007 Produktionsdatum bis: 24.06.2009 Production date to: 24.06.2009



M



R-CLASS (W251, V251) 75

			7.11020.11.0	ATS	EL	 OM 642.870: Abgaskrümmer Exhaust Manifold  Japan, USA, Kanada  Japan, USA, Kanada  OM 642.870: vor Abgasturbolader in front of exhaust turbocharger  USA  USA
			7.02604.99.0	LS	400 mm	
R 350 CDI 4-matic (251.124, 251.125) 140-165 kW (190-224 PS) OM 642.950	01.2006→12.2014		7.24809.47.0	AGR	ET	 USA  USA
			7.02604.99.0	LS	400 mm	
R 350 CGI 4-matic (251.057, 251.157) 225 kW (306 PS) M 276.958	10.2011→12.2014		7.02604.99.0	LS	400 mm	
R 500 4-matic 218-225 kW (296-306 PS) M 113.971	01.2006→12.2006		7.22136.50.0	AGR	PN	
			7.04389.00.0	SLP	EL	
R 500 4-matic (251.072, 251.172) 285-320 kW (388-435 PS) M 273.963	05.2007→12.2014		7.05270.17.0	LS	null mm	rechts Right Diagnosesonde Diagnostic Probe
			7.05270.21.0	LS	600 mm	links, rechts Left, Right Regelsonde Regulating Probe
			7.05270.18.0	LS	500 mm	links Left Diagnosesonde Diagnostic Probe
			7.04389.02.0	SLP	EL	
R 500 4-matic (251.075, 251.175) 215-225 kW (292-306 PS) M 113.960	08.2005→12.2014		7.22136.50.0	AGR	PN	
			7.04389.00.0	SLP	EL	
R 500 4-matic (251.075, 251.175) 218-225 kW (296-306 PS) M 113.971	08.2005→12.2014		7.22136.50.0	AGR	PN	
			7.05270.11.0	LS	750 mm	vor Katalysator, beidseitig in front of the catalyst, Left and right
			7.02604.26.0	LS	500 mm	links, rechts Left, Right
			7.04389.00.0	SLP	EL	
R 63 AMG 4-matic (251.077, 251.177) 375 kW (510 PS) M 156.980	02.2006→12.2010		7.05270.21.0	LS	600 mm	
			7.05270.18.0	LS	500 mm	
			7.04389.04.0	SLP	EL	
			7.04389.06.0	SLP	EL	







S-CLASS (W126) 76

260 SE (126.020) 118-122 kW (160-166 PS) M 103.941	09.1985→06.1991		7.02604.03.0	LS	200 mm	
260 SE (126.020) 118-122 kW (160-166 PS) M 103.941	09.1985→06.1991		7.02604.03.0	LS	200 mm	











S-CLASS (W126)

76

300 SD (126.120) 92 kW (125 PS) OM 617.951	09.1980→12.1985		7.21949.51.0	AGR	PN	<input checked="" type="checkbox"/>
300 SDL (126.125) 107-110 kW (143-148 PS) OM 603.961	09.1985→12.1986		7.21949.51.0	AGR	PN	<input checked="" type="checkbox"/>
300 SDL (126.125) 107-110 kW (143-148 PS) OM 603.961	09.1986→12.1987		7.21949.51.0	AGR	PN	<input checked="" type="checkbox"/>
560 SE, SEL 178-220 kW (242-300 PS) M 117.968	10.1985→06.1991		7.02604.03.0	LS	200 mm	
560 SE, SEL 178-220 kW (242-300 PS) M 117.968	08.1987→06.1991		7.02604.03.0	LS	200 mm	
560 SE, SEL (126.038) 178-220 kW (242-300 PS) M 117.968	10.1985→12.1987		7.02604.03.0	LS	200 mm	
560 SE, SEL (126.038, 126.039) 178-220 kW (242-300 PS) M 117.968	10.1985→06.1991		7.02604.03.0	LS	200 mm	

S-CLASS (W140)

77

300 SE 2.8 (140.028) 142-145 kW (193-197 PS) M 104.944	01.1993→10.1998		7.05270.00.0	LS	350 mm	
300 SE, SEL/S320 (140.032, 140.033) 162-170 kW (220-231 PS) M 104.990, M 104.994	03.1991→10.1998		7.05270.00.0	LS	350 mm	
400 SE, SEL/S420 (140.042, 140.043) 205-214 kW (279-291 PS) M 119.971	02.1991→10.1998		7.05270.00.0	LS	350 mm	
600 SE, SEL (140.056, 140.057) 270-300 kW (394-408 PS) M 120.980, M 120.982	04.1991→12.1992		7.05270.15.0	LS	380 mm	
			7.05270.00.0	LS	350 mm	
S 280 (140.028) 142-145 kW (193-197 PS) M 104.944	02.1993→10.1998		7.05270.00.0	LS	350 mm	
S 350 Turbo-D (140.134) 100-110 kW (136-150 PS) OM 603.971	01.1993→10.1998		7.21949.51.0	AGR	PN	<input checked="" type="checkbox"/>
S 420 (140.042) 205-214 kW (279-291 PS) M 119.971	01.1993→10.1998		7.05270.00.0	LS	350 mm	
S 600 (140.056, 140.057) 270-300 kW (394-408 PS) M 120.980, M 120.982	01.1993→10.1998		7.05270.15.0	LS	380 mm	
			7.05270.00.0	LS	350 mm	

S-CLASS (W220)







78

S 280 (220.063, 220.163) 150 kW (204 PS) M 112.922	10.1998→08.2005		7.22136.50.0	AGR	PN	<input checked="" type="checkbox"/>
			7.05270.12.0	LS	500 mm	vor Katalysator, beidseitig in front of the catalyst, Left and right Produktionsdatum ab: 30.06.2000 Production date from: 30.06.2000

M











S-CLASS (W220) 78

			7.05270.15.0	LS	380 mm	
			7.04389.00.0	SLP	EL	
S 320 (220.065, 220.165) 165 kW (224 PS) M 112.944	10.1998→08.2005		7.22136.50.0	AGR	PN	<input checked="" type="checkbox"/>
			7.05270.12.0	LS	500 mm	vor Katalysator, links in front of the catalyst, Left Produktionsdatum ab: 30.06.2000 Production date from: 30.06.2000
			7.05270.15.0	LS	380 mm	
			7.04389.00.0	SLP	EL	
			7.24809.37.0	AGR	ET	<input type="checkbox"/>
S 320 CDI (220.025, 220.125) 150 kW (204 PS) OM 648.960	09.2002→08.2005		7.08369.91.0	ATS	EL	Partikelfilter Particulate Filter Euro 4 Euro 4 für Rechtslenker for right-hand drive vehicles
S 350 (220.067, 220.167) 180 kW (245 PS) M 112.972	09.2002→08.2005		7.22136.50.0	AGR	PN	<input checked="" type="checkbox"/>
			7.05270.12.0	LS	500 mm	vor Katalysator, beidseitig in front of the catalyst, Left and right
			7.04389.00.0	SLP	EL	
S 350 4-matic (220.087, 220.187) 180 kW (245 PS) M 112.975	06.2003→08.2005		7.22136.50.0	AGR	PN	<input checked="" type="checkbox"/>
			7.05270.12.0	LS	500 mm	vor Katalysator, beidseitig in front of the catalyst, Left and right
			7.04389.00.0	SLP	EL	
S 430 (220.070, 220.170) 205 kW (279 PS) M 113.941	10.1998→08.2005		7.22136.50.0	AGR	PN	<input checked="" type="checkbox"/>
			7.05270.12.0	LS	500 mm	vor Katalysator, beidseitig in front of the catalyst, Left and right Produktionsdatum ab: 30.06.2000 Production date from: 30.06.2000
			7.05270.15.0	LS	380 mm	
			7.04389.00.0	SLP	EL	
S 430 4-matic (220.083, 220.183) 205 kW (279 PS) M 113.948	09.2002→08.2005		7.22136.50.0	AGR	PN	<input checked="" type="checkbox"/>
			7.05270.12.0	LS	500 mm	vor Katalysator, beidseitig in front of the catalyst, Left and right
			7.05270.15.0	LS	380 mm	
S 500 (220.075, 220.175, 220.875) 215-225 kW (292-306 PS) M 113.960	10.1998→08.2005		7.04389.00.0	SLP	EL	
			7.22136.50.0	AGR	PN	<input checked="" type="checkbox"/>
			7.05270.12.0	LS	500 mm	vor Katalysator, beidseitig in front of the catalyst, Left and right Produktionsdatum ab: 30.06.2000 Production date from: 30.06.2000
			7.05270.15.0	LS	380 mm	
			7.04389.00.0	SLP	EL	

M







S-CLASS (W220) 78

S 500 (220.075, 220.175, 220.875) 225 kW (306 PS) M 113.966	10.1998→08.2005		7.22136.50.0	AGR	PN	☒
			7.05270.15.0	LS	380 mm	
			7.04389.00.0	SLP	EL	
S 500 (220.075, 220.175, 220.875) 215-225 kW (292-306 PS) M 113.960	10.1998→12.2003		7.22136.50.0	AGR	PN	☒
			7.04389.00.0	SLP	EL	
S 500 4-matic (220.084, 220.184) 225 kW (306 PS) M 113.966	09.2002→08.2005		7.22136.50.0	AGR	PN	☒
			7.05270.12.0	LS	500 mm	vor Katalysator, beidseitig
			7.05270.15.0	LS	380 mm	in front of the catalyst, Left and right
			7.04389.00.0	SLP	EL	
S 55 AMG (220.073, 220.173) 265 kW (360 PS) M 113.986	04.1999→08.2005		7.22136.50.0	AGR	PN	☒
			7.05270.12.0	LS	500 mm	vor Katalysator, beidseitig
			7.04389.00.0	SLP	EL	Produktionsdatum ab: 30.06.2000 Production date from: 30.06.2000
S 55 AMG Kompressor (220.074, 220.174) 349-368 kW (475-500 PS) M 113.991	06.2002→08.2005		7.05270.12.0	LS	500 mm	vor Katalysator, beidseitig
			7.04389.06.0	SLP	EL	in front of the catalyst, Left and right
S 600 (220.176) 368 kW (500 PS) M 275.950	09.2002→08.2005		7.05270.12.0	LS	500 mm	nach Katalysator, beidseitig
			7.04389.04.0	SLP	EL	Post-catalyst, Left and right
S 600 (220.878, 220.178) 270 kW (367 PS) M 137.970	01.2000→08.2005		7.05270.12.0	LS	500 mm	vor Katalysator, beidseitig
			7.04389.04.0	SLP	EL	in front of the catalyst, Left and right
S 65 AMG (220.179) 450 kW (612 PS) M 275.980	03.2004→08.2005		7.05270.12.0	LS	500 mm	nach Katalysator, beidseitig
			7.04389.06.0	SLP	EL	Post-catalyst, Left and right









M

S-CLASS (W221) 79

S 250 CDI (221.003, 221.103) 150 kW (204 PS) OM 651.961	01.2011→12.2013		7.08369.06.0	ATS	EL	
S 280 (221.054) 170-180 kW (231-245 PS) M 272.946	08.2006→12.2013		7.05270.21.0	LS	600 mm	
			7.05270.18.0	LS	500 mm	
			7.04389.02.0	SLP	EL	
S 300 (221.054, 221.154) 170-180 kW (231-245 PS) M 272.946	08.2006→12.2013		7.04389.02.0	SLP	EL	
S 300 (221.154) 170-180 kW (231-245 PS) M 272.946	04.2012→12.2013		7.04389.02.0	SLP	EL	













S-CLASS (W221) 79

S 320 CDI 155-173 kW (211-235 PS) OM 642.930	10.2005→12.2013		7.24809.47.0 AGR ET 	für OE-Nummer: A 006 153 49 28 for OE number: A 006 153 49 28 Luftfiltergehäuse Air Filter Housing
			7.11190.01.0 DDS	
			7.05270.21.0 LS 600 mm	
S 320 CDI (221.022, 221.122) 155-173 kW (211-235 PS) OM 642.930	12.2005→06.2009		7.24809.47.0 AGR ET 	Partikelfilter Particulate Filter für Rechtslenker for right-hand drive vehicles Produktionsdatum ab: 05.02.2009 Production date from: 05.02.2009
			7.08369.88.0 ATS EL	
			7.08369.94.0 ATS EL	
			7.11020.11.0 ATS EL	
			7.11190.01.0 DDS	
			7.05270.21.0 LS 600 mm	
			7.02604.99.0 LS 400 mm	
S 320 CDI 4-matic (221.080, 221.180) 155-173 kW (211-235 PS) OM 642.932	10.2005→12.2013		7.24809.47.0 AGR ET 	Partikelfilter Particulate Filter für Rechtslenker for right-hand drive vehicles Produktionsdatum ab: 05.02.2009 Production date from: 05.02.2009
			7.08369.88.0 ATS EL	
			7.08369.94.0 ATS EL	
			7.11020.11.0 ATS EL	
			7.11190.01.0 DDS	
			7.05270.21.0 LS 600 mm	
S 320 CDI 4-matic (221.080, 221.180) 155-173 kW (211-235 PS) OM 642.932	10.2006→12.2013		7.24809.47.0 AGR ET 	Partikelfilter Particulate Filter für Rechtslenker for right-hand drive vehicles Produktionsdatum ab: 05.02.2009 Production date from: 05.02.2009
			7.08369.88.0 ATS EL	

M











S-CLASS (W221) 79

			7.08369.94.0	ATS	EL	Partikelfilter Particulate Filter für Rechtslenker for right-hand drive vehicles Produktionsdatum bis: 05.02.2009 Production date to: 05.02.2009
			7.11020.11.0	ATS	EL	vor Abgasturbolader in front of exhaust turbocharger
			7.11190.01.0	DDS		Luftfiltergehäuse Air Filter Housing
			7.05270.21.0	LS	600 mm	
			7.02604.99.0	LS	400 mm	
S 350 (221.056, 221.156) 200 kW (272 PS) M 272.965	10.2005→12.2013		7.05270.21.0	LS	600 mm	links, rechts Left, Right Regelsonde Regulating Probe
			7.05270.18.0	LS	500 mm	links, rechts Left, Right Diagnosesonde Diagnostic Probe
			7.04389.02.0	SLP	EL	
S 350 4-matic (221.087, 221.187) 200 kW (272 PS) M 272.975	02.2008→12.2013		7.04389.02.0	SLP	EL	
S 350 BlueTEC 4-matic (221.083, 221.183) 190 kW (258 PS) OM 642.868	04.2011→12.2013		7.08369.88.0	ATS	EL	Partikelfilter Particulate Filter für Rechtslenker for right-hand drive vehicles
			7.11020.01.0	ATS	EL	
			7.02604.99.0	LS	400 mm	
S 350 BlueTec (221.026, 221.126) 190 kW (258 PS) OM 642.862	04.2011→12.2013		7.08369.30.0	ATS	EL	vor Katalysator in front of the catalyst
			7.08369.88.0	ATS	EL	Partikelfilter Particulate Filter für Rechtslenker for right-hand drive vehicles
			7.11020.01.0	ATS	EL	
S 350 CDI 155-173 kW (211-235 PS) OM 642.930	06.2009→12.2013		7.24809.47.0	AGR	ET	 USA USA
			7.11190.01.0	DDS		für OE-Nummer: A 006 153 49 28 for OE number: A 006 153 49 28 Luftfiltergehäuse Air Filter Housing
S 350 CDI 155-173 kW (211-235 PS) OM 642.930	06.2009→12.2013		7.24809.47.0	AGR	ET	 USA USA
			7.11190.01.0	DDS		für OE-Nummer: A 006 153 49 28 for OE number: A 006 153 49 28 Luftfiltergehäuse Air Filter Housing
S 350 CDI 4-matic (221.080, 221.081) 155-173 kW (211-235 PS) OM 642.932	01.2009→12.2010		7.24809.47.0	AGR	ET	 USA USA
			7.08369.88.0	ATS	EL	Partikelfilter Particulate Filter für Rechtslenker for right-hand drive vehicles Produktionsdatum ab: 05.02.2009 Production date from: 05.02.2009

M













S-CLASS (W221) 79

			7.08369.94.0	ATS	EL	Partikelfilter Particulate Filter Produktionsdatum bis: 05.02.2009 Production date to: 05.02.2009
			7.11020.11.0	ATS	EL	vor Abgasturbolader in front of exhaust turbocharger nicht für Baumuster: 221.081 not for code: 221.081
			7.11190.01.0	DDS		Luftfiltergehäuse Air Filter Housing
S 350 CDI 4-matic (221.080, 221.180) 155-173 kW (211-235 PS) OM 642.932	06.2009→07.2013		7.24809.47.0	AGR	ET	 USA USA
			7.08369.88.0	ATS	EL	Partikelfilter Particulate Filter für Rechtslenker for right-hand drive vehicles Produktionsdatum ab: 05.02.2009 Production date from: 05.02.2009
			7.08369.94.0	ATS	EL	Partikelfilter Particulate Filter für Rechtslenker for right-hand drive vehicles Produktionsdatum bis: 05.02.2009 Production date to: 05.02.2009
			7.11020.11.0	ATS	EL	Abgaskrümmer Exhaust Manifold
			7.11190.01.0	DDS		Luftfiltergehäuse Air Filter Housing
S 350 CGI (221.057, 221.157) 225 kW (306 PS) M 276.950	04.2011→12.2013		7.02604.44.0	LS	500 mm	für OE-Nummer: A 008 542 30 18, A 009 542 60 18 for OE number: A 008 542 30 18, A 009 542 60 18 vor Katalysator in front of the catalyst
			7.02604.99.0	LS	400 mm	
S 350 CGI 4-matic (221.082, 221.182) 225 kW (306 PS) M 276.950	04.2011→12.2013		7.08369.61.0	ATS	EL	
			7.02604.44.0	LS	500 mm	für OE-Nummer: A 008 542 30 18, A 009 542 60 18 for OE number: A 008 542 30 18, A 009 542 60 18
			7.02604.99.0	LS	400 mm	
S 400 4-matic 250 kW (340 PS) M 273.924	09.2008→12.2009		7.04389.02.0	SLP	EL	
S 400 Hybrid (221.095, 221.195) 200-205 kW (272-279 PS) M 272.974	01.2009→12.2013		7.05270.18.0	LS	500 mm	
			7.02604.99.0	LS	400 mm	
			7.04389.02.0	SLP	EL	
S 420 CDI (221.028, 221.128) 235 kW (320 PS) OM 629.911	10.2006→12.2009		7.05270.21.0	LS	600 mm	
S 450 (221.070, 221.170) 250 kW (340 PS) M 273.922	12.2005→12.2013		7.05270.21.0	LS	600 mm	links, rechts Left, Right Regelsonde Regulating Probe



S-CLASS (W221) 79

			7.05270.18.0	LS	500 mm	links, rechts Left, Right Diagnosesonde Diagnostic Probe
			7.04389.02.0	SLP	EL	
S 450 4-matic (221.084, 221.184) 250 kW (340 PS) M 273.924	12.2005→12.2013		7.02604.99.0	LS	400 mm	
			7.04389.02.0	SLP	EL	
S 500 271-285 kW (369-388 PS) M 273.961	05.2011→12.2013		7.04389.02.0	SLP	EL	
S 500 (221.071, 221.171) 271-285 kW (369-388 PS) M 273.961	10.2005→12.2013		7.05270.21.0	LS	600 mm	
			7.05270.18.0	LS	500 mm	
			7.04389.02.0	SLP	EL	
S 500 4-matic (221.086, 221.186) 271-285 kW (369-388 PS) M 273.961	10.2005→12.2013		7.05270.21.0	LS	600 mm	
			7.05270.18.0	LS	500 mm	
			7.04389.02.0	SLP	EL	
S 500 4-matic (221.086, 221.186) 285 kW (388 PS) M 273.968	10.2005→12.2013		7.05270.21.0	LS	600 mm	
			7.05270.18.0	LS	500 mm	
			7.02604.99.0	LS	400 mm	06.2006→01.2011 Motorcode: M 273.968 Engine Code: M 273.968 rechts Right Produktionsdatum ab: 06.2006 Production date from: 06.2006 Produktionsdatum bis: 01.2011 Production date to: 01.2011
			7.04389.02.0	SLP	EL	
S 500 CGI (221.073, 221.173) 320 kW (435 PS) M 278.932	04.2011→12.2013		7.02604.44.0	LS	500 mm	für OE-Nummer: A 008 542 30 18, A 008 542 44 18, A 009 542 60 18 for OE number: A 008 542 30 18, A 008 542 44 18, A 009 542 60 18
S 500 CGI 4-matic (221.094, 221.194) 320 kW (435 PS) M 278.932	03.2011→12.2013		7.02604.44.0	LS	500 mm	für OE-Nummer: A 008 542 30 18, A 008 542 44 18, A 009 542 60 18 for OE number: A 008 542 30 18, A 008 542 44 18, A 009 542 60 18
S 600 (221.176) 380 kW (517 PS) M 275.953	12.2005→12.2013		7.04389.06.0	SLP	EL	
S 63 AMG (221.074, 221.174) 386-420 kW (525-571 PS) M 157.980	03.2011→12.2013		7.05270.22.0	LS	825 mm	
			7.02604.44.0	LS	500 mm	vor Katalysator, beidseitig in front of the catalyst, Left and right
			7.05270.18.0	LS	500 mm	
S 63 AMG (221.074, 221.174) 386-420 kW (525-571 PS) M 157.980	02.2012→12.2013		7.05270.22.0	LS	825 mm	
			7.05270.18.0	LS	500 mm	
S 63 AMG (221.077, 221.177) 386 kW (525 PS) M 156.984	10.2006→12.2013		7.05270.22.0	LS	825 mm	













M























S-CLASS (W221) 79

		7.05270.18.0	LS	500 mm	
		7.04389.05.0	SLP	EL	
S 65 AMG (221.179) 450-463 kW (612-630 PS) M 275.982	12.2005→12.2013	 7.04389.06.0	SLP	EL	
S 65 AMG (221.179) 450-463 kW (612-630 PS) M 275.982	10.2010→12.2013	 7.04389.06.0	SLP	EL	

S-CLASS (W222, V222, X222) 80

S 300 BlueTEC Hybrid / h (222.004, 222.104) 100-150 kW (136-204 PS) OM 651.921	02.2014→05.2017	 7.08369.06.0	ATS	EL	
		7.08369.61.0	ATS	EL	
S 300 BlueTEC Hybrid / h (222.104) 100-150 kW (136-204 PS) OM 651.921	02.2014→05.2017	 7.08369.06.0	ATS	EL	
S 320 (222.162) 200-350 kW (272-476 PS) M 276.824	05.2014→	 7.02604.44.0	LS	500 mm	für OE-Nummer: A 009 542 59 18, A 009 542 60 18 for OE number: A 009 542 59 18, A 009 542 60 18
S 350 BlueTEC / d (222.132, 222.032, 222.123) 190 kW (258 PS) OM 642.861	05.2013→05.2017	 7.11020.01.0	ATS	EL	USA, Kanada USA, Kanada
S 350 BlueTEC / d 4-matic (222.033, 222.133) 185-190 kW (252-258 PS) OM 642.861, OM 642.867	02.2014→05.2017	 7.11020.01.0	ATS	EL	 OM 642.861, OM 642.867: USA, Kanada USA, Kanada
S 350 BlueTEC 4-matic (222.133) 185-190 kW (252-258 PS) OM 642.867	02.2014→05.2017	 7.11020.01.0	ATS	EL	USA, Kanada USA, Kanada
S 350 L (222.155) 200-350 kW (272-476 PS) M 276.824	09.2017→	 7.02604.44.0	LS	500 mm	für OE-Nummer: A 009 542 59 18, A 009 542 60 18 for OE number: A 009 542 59 18, A 009 542 60 18 vor Katalysator in front of the catalyst
S 400 (222.165) 200-350 kW (272-476 PS) M 276.824	03.2014→05.2017	 7.02604.44.0	LS	500 mm	für OE-Nummer: A 009 542 59 18, A 009 542 60 18 for OE number: A 009 542 59 18, A 009 542 60 18 vor Katalysator in front of the catalyst
S 400 4-matic (222.067, 222.167) 200-350 kW (272-476 PS) M 276.824	11.2014→05.2017	 7.02604.44.0	LS	500 mm	für OE-Nummer: A 009 542 59 18, A 009 542 60 18 for OE number: A 009 542 59 18, A 009 542 60 18
S 400 Hybrid / h (222.057, 222.157) 225 kW (306 PS) M 276.960	05.2013→05.2017	 7.02604.44.0	LS	500 mm	vor Katalysator, rechts in front of the catalyst, Right für Fahrzeuge ohne Ladeluftkühler for vehicles without intercooler
S 400 Maybach 4-matic (222.967) 200-350 kW (272-476 PS) M 276.824	01.2015→05.2017	 7.02604.44.0	LS	500 mm	für OE-Nummer: A 009 542 59 18, A 009 542 60 18 for OE number: A 009 542 59 18, A 009 542 60 18 vor Katalysator in front of the catalyst
S 450 (222.066, 222.166) 200-350 kW (272-476 PS) M 276.824	02.2017→	 7.02604.44.0	LS	500 mm	für OE-Nummer: A 009 542 59 18, A 009 542 60 18 for OE number: A 009 542 59 18, A 009 542 60 18











M

					
S-CLASS (W222, V222, X222)					
80					
S 450 4-matic (222.064, 222.164, 222.964) 200-350 kW (272-476 PS) M 276.824	02.2017→		7.02604.44.0	LS	500 mm für OE-Nummer: A 009 542 59 18, A 009 542 60 18 für OE number: A 009 542 59 18, A 009 542 60 18
S 450 Maybach 4-matic (222.964) 200-350 kW (272-476 PS) M 276.824	09.2017→		7.02604.44.0	LS	500 mm für OE-Nummer: A 009 542 59 18, A 009 542 60 18 für OE number: A 009 542 59 18, A 009 542 60 18
S 500 (222.082, 222.182) 320-338 kW (435-460 PS) M 278.929	05.2013→05.2017		7.02604.44.0	LS	500 mm  M 278.929: vor Katalysator, links in front of the catalyst, Left Produktionsdatum bis: 16.01.2015 Production date to: 16.01.2015  M 278.929: für Getriebeautomatik 9 Gang für 9-speed automatic transmission vor Katalysator, links in front of the catalyst, Left für Rechtslenker für right-hand drive vehicles Produktionsdatum ab: 16.01.2015 Production date from: 16.01.2015  M 278.929: für Getriebeautomatik 9 Gang für 9-speed automatic transmission vor Katalysator, links in front of the catalyst, Left Heckantrieb Rear Wheel Drive für Linkslenker für left-hand drive vehicles Produktionsdatum ab: 16.01.2015 Production date from: 16.01.2015
S 500 4-matic (222.085, 222.185) 320-338 kW (435-460 PS) M 278.929	05.2013→05.2017		7.02604.44.0	LS	500 mm für OE-Nummer: A 009 542 60 18 für OE number: A 009 542 60 18 vor Katalysator in front of the catalyst
S 500 Hybrid / e (222.163) 200-350 kW (272-476 PS) M 276.824	07.2014→05.2017		7.02604.44.0	LS	500 mm für OE-Nummer: A 009 542 60 18, A 009 542 63 18 für OE number: A 009 542 60 18, A 009 542 63 18 vor Katalysator in front of the catalyst
S 500 L 4-matic (222.184) 310 kW (422 PS) M 278.910	02.2014→05.2017		7.02604.44.0	LS	500 mm für OE-Nummer: A 009 542 60 18 für OE number: A 009 542 60 18 vor Katalysator in front of the catalyst
S 500 Maybach (222.982) 320-338 kW (435-460 PS) M 278.929	12.2014→05.2017		7.02604.44.0	LS	500 mm für OE-Nummer: A 009 542 60 18, A 009 542 63 18 für OE number: A 009 542 60 18, A 009 542 63 18 vor Katalysator, links in front of the catalyst, Left
S 500 Maybach 4-matic (222.984) 310 kW (422 PS) M 278.910	09.2015→05.2017		7.02604.44.0	LS	500 mm  M 278.910: für OE-Nummer: A 009 542 60 18 für OE number: A 009 542 60 18 vor Katalysator, links in front of the catalyst, Left  M 278.910: nicht für Getriebeautomatik 9 Gang not for 9-speed automatic transmission vor Katalysator, rechts in front of the catalyst, Right
S 500 Maybach 4-matic (222.985) 320-338 kW (435-460 PS) M 278.929	04.2015→05.2017		7.02604.44.0	LS	500 mm für OE-Nummer: A 009 542 60 18 für OE number: A 009 542 60 18 vor Katalysator in front of the catalyst

M









S-CLASS (W222, V222, X222) 80

S 560 e (222.173) 200-350 kW (272-476 PS) M 276.824	10.2018→		7.02604.44.0	LS	500 mm	für OE-Nummer: A 009 542 60 18, A 009 542 63 18 for OE number: A 009 542 60 18, A 009 542 63 18 vor Katalysator in front of the catalyst
S 600 (222.176) 390 kW (530 PS) M 277.980	02.2014→		7.02604.44.0	LS	500 mm	Baumuster: 222.176 Type: 222.176 vor Katalysator, beidseitig in front of the catalyst, Left and right
S 600 Maybach (222.976) 390 kW (530 PS) M 277.980	12.2014→11.2018		7.02604.44.0	LS	500 mm	vor Katalysator, beidseitig in front of the catalyst, Left and right
S 600 Maybach (222.976) 390 kW (530 PS) M 277.980	12.2014→11.2018		7.04389.08.0	SLP	EL	
S 63 AMG (222.077) 430-435 kW (585-591 PS) M 157.985	01.2014→05.2017		7.02604.44.0	LS	500 mm	vor Katalysator, beidseitig in front of the catalyst, Left and right
S 63 AMG (222.077, 222.177) 430-435 kW (585-591 PS) M 157.985	05.2013→05.2017		7.02604.44.0	LS	500 mm	vor Katalysator, beidseitig in front of the catalyst, Left and right
S 63 AMG 4-matic (222.178) 430-435 kW (585-591 PS) M 157.985	05.2013→05.2017		7.02604.44.0	LS	500 mm	vor Katalysator, beidseitig in front of the catalyst, Left and right
S 65 AMG (222.179) 463 kW (630 PS) M 279.980	02.2014→		7.02604.44.0	LS	500 mm	vor Katalysator, beidseitig in front of the catalyst, Left and right
S 65 AMG (222.179) 463 kW (630 PS) M 279.980	02.2014→		7.04389.08.0	SLP	EL	
S 650 Maybach (222.980) 463 kW (630 PS) M 279.980	07.2017→		7.02604.44.0	LS	500 mm	vor Katalysator, beidseitig in front of the catalyst, Left and right
S 650 Maybach (222.980) 463 kW (630 PS) M 279.980	07.2017→		7.04389.08.0	SLP	EL	



















M

S-CLASS Convertible (A217) 81















AMG S 63 (217.477) 430-435 kW (585-591 PS) M 157.985	02.2016→10.2017		7.02604.44.0	LS	500 mm	vor Katalysator, beidseitig in front of the catalyst, Left and right
AMG S 63 4-matic (217.478) 430-435 kW (585-591 PS) M 157.985	12.2015→10.2017		7.02604.44.0	LS	500 mm	vor Katalysator, beidseitig in front of the catalyst, Left and right
AMG S 65 (217.479) 463 kW (630 PS) M 279.980	04.2016→05.2019		7.02604.44.0	LS	500 mm	vor Katalysator, beidseitig in front of the catalyst, Left and right
AMG S 65 (217.479) 463 kW (630 PS) M 279.980	04.2016→05.2019		7.04389.08.0	SLP	EL	
S 500 (217.482) 320-338 kW (435-460 PS) M 278.929	12.2015→10.2017		7.02604.44.0	LS	500 mm	 M 278.929: vor Katalysator, links in front of the catalyst, Left  M 278.929: für OE-Nummer: A 009 542 60 18 for OE number: A 009 542 60 18 vor Katalysator, rechts in front of the catalyst, Right

S-CLASS Coupe (C126) 82

560 SEC (126.045) 178-220 kW (242-300 PS) M 117.968	10.1985→06.1991		7.02604.03.0	LS	200 mm	
560 SEC (126.045) 178-220 kW (242-300 PS) M 117.968	10.1985→12.1987		7.02604.03.0	LS	200 mm	

						
S-CLASS Coupe (C126)						82
560 SEC (126.045) 178-220 kW (242-300 PS) M 117.968	10.1985→06.1991		7.02604.03.0	LS	200 mm	
560 SEC (126.045) 178-220 kW (242-300 PS) M 117.968	10.1985→12.1989		7.02604.03.0	LS	200 mm	
S-CLASS Coupe (C140)						83
500 SEC / CL 500 (140.070) 235-240 kW (320-326 PS) M 119.970, M 119.980	10.1992→12.1999		7.05270.00.0	LS	350 mm	
SEC/CL 420 (140.063) 205-214 kW (279-291 PS) M 119.971, M 119.981	10.1994→02.1999		7.05270.00.0	LS	350 mm	
SEC/CL 600 (140.076) 270-300 kW (394-408 PS) M 120.980, M 120.982	09.1992→02.1999		7.05270.15.0	LS	380 mm	
			7.05270.00.0	LS	350 mm	
S-CLASS Coupe (C215)						84
CL 500 (215.375) 215-225 kW (292-306 PS) M 113.960	03.1999→03.2006		7.22136.50.0	AGR	PN <input checked="" type="checkbox"/>	
			7.05270.12.0	LS	500 mm vor Katalysator, links in front of the catalyst, Left Produktionsdatum ab: 30.06.2000 Production date from: 30.06.2000	
			7.05270.15.0	LS	380 mm	
			7.04389.00.0	SLP	EL	
CL 55 AMG (215.373) 265 kW (360 PS) M 113.986	10.1999→03.2006		7.22136.50.0	AGR	PN <input checked="" type="checkbox"/>	
			7.05270.12.0	LS	500 mm vor Katalysator, beidseitig in front of the catalyst, Left and right Produktionsdatum ab: 30.06.2000 Production date from: 30.06.2000	
			7.04389.00.0	SLP	EL	
CL 55 AMG Kompressor (215.374) 349-368 kW (475-500 PS) M 113.991	06.2002→03.2006		7.05270.12.0	LS	500 mm vor Katalysator, beidseitig in front of the catalyst, Left and right	
			7.04389.06.0	SLP	EL  ch. A 024279→ Produktionsdatum ab: 30.09.2002 Production date from: 30.09.2002	
			7.04389.04.0	SLP	EL  →ch. A 032099 Produktionsdatum bis: 30.09.2002 Production date to: 30.09.2002	
CL 600 (215.376) 368 kW (500 PS) M 275.950	09.2002→03.2006		7.05270.12.0	LS	500 mm nach Katalysator Post-catalyst	
			7.04389.04.0	SLP	EL	
CL 600 (215.378) 270 kW (367 PS) M 137.970	03.1999→03.2006		7.05270.12.0	LS	500 mm vor Katalysator in front of the catalyst	
			7.04389.04.0	SLP	EL	
CL 65 AMG (215.379) 450 kW (612 PS) M 275.980	09.2003→03.2006		7.05270.12.0	LS	500 mm nach Katalysator Post-catalyst	
			7.04389.06.0	SLP	EL	

M

			 PIERBURG		
S-CLASS Coupe (C216)					
CL 500 (216.371) 271-285 kW (369-388 PS) M 273.961	06.2006→12.2013		7.05270.21.0	LS	600 mm
			7.05270.18.0	LS	500 mm
			7.04389.02.0	SLP	EL
CL 500 (216.373) 320 kW (435 PS) M 278.920	02.2011→12.2013		7.05270.21.0	LS	600 mm
			7.02604.44.0	LS	500 mm
			7.05270.18.0	LS	500 mm
vor Katalysator, beidseitig in front of the catalyst, Left and right					
CL 500 4-matic (216.386) 285 kW (388 PS) M 273.968	02.2008→12.2013		7.05270.21.0	LS	600 mm
			7.05270.18.0	LS	500 mm
			7.02604.99.0	LS	400 mm
			7.04389.02.0	SLP	EL
CL 500 4-matic (216.394) 320 kW (435 PS) M 278.920	02.2011→12.2013		7.05270.21.0	LS	600 mm
			7.02604.44.0	LS	500 mm
			7.05270.18.0	LS	500 mm
vor Katalysator, beidseitig in front of the catalyst, Left and right					
M CL 600 (216.376) 380 kW (517 PS) M 275.953	05.2006→12.2013		7.04389.06.0	SLP	EL
CL 63 AMG (216.374) 386-420 kW (525-571 PS) M 157.980	01.2010→12.2013		7.05270.22.0	LS	825 mm
			7.02604.44.0	LS	500 mm
			7.05270.18.0	LS	500 mm
vor Katalysator, beidseitig in front of the catalyst, Left and right					
CL 63 AMG (216.374) 386-420 kW (525-571 PS) M 157.980	02.2011→12.2013		7.05270.22.0	LS	825 mm
			7.02604.44.0	LS	500 mm
			7.05270.18.0	LS	500 mm
vor Katalysator, beidseitig in front of the catalyst, Left and right					
CL 63 AMG (216.377) 386 kW (525 PS) M 156.984	10.2006→12.2013		7.05270.22.0	LS	825 mm
			7.05270.18.0	LS	500 mm
			7.04389.05.0	SLP	EL
CL 65 AMG (216.379) 450-463 kW (612-630 PS) M 275.982	10.2006→12.2010		7.04389.06.0	SLP	EL
CL 65 AMG (216.379) 450-463 kW (612-630 PS) M 275.982	02.2011→12.2013		7.04389.04.0	SLP	EL
			7.04389.06.0	SLP	EL

S-CLASS Coupe (C217)					
86					
S 400 4-matic (217.364) 200-350 kW (272-476 PS) M 276.824	10.2015→		7.02604.44.0	LS	500 mm M 276.824: nicht für Getriebeautomatik 9 Gang not for 9-speed automatic transmission vor Katalysator, rechts in front of the catalyst, Right M 276.824: vor Katalysator, links in front of the catalyst, Left
S 450 4-matic (217.364) 200-350 kW (272-476 PS) M 276.824	10.2017→		7.02604.44.0	LS	500 mm M 276.824: nicht für Getriebeautomatik 9 Gang not for 9-speed automatic transmission vor Katalysator, rechts in front of the catalyst, Right M 276.824: vor Katalysator, links in front of the catalyst, Left
S 500 (217.382) 320-338 kW (435-460 PS) M 278.929	11.2014→10.2017		7.02604.44.0	LS	500 mm für OE-Nummer: A 009 542 60 18, A 009 542 63 18 for OE number: A 009 542 60 18, A 009 542 63 18
S 500 4-matic (217.384) 310 kW (422 PS) M 278.910	11.2014→10.2017		7.02604.44.0	LS	500 mm M 278.910: vor Katalysator, links in front of the catalyst, Left M 278.910: für Getriebeautomatik 9 Gang for 9-speed automatic transmission vor Katalysator, rechts in front of the catalyst, Right
S 500 4-matic (217.385) 320-338 kW (435-460 PS) M 278.929	04.2014→10.2017		7.02604.44.0	LS	500 mm M 278.929: nicht für Getriebeautomatik 9 Gang not for 9-speed automatic transmission vor Katalysator, rechts in front of the catalyst, Right M 278.929: vor Katalysator, links in front of the catalyst, Left
S 63 AMG (217.377) 430-435 kW (585-591 PS) M 157.985	07.2014→10.2017		7.02604.44.0	LS	500 mm vor Katalysator, beidseitig in front of the catalyst, Left and right
S 63 AMG 4-matic (217.378) 430-435 kW (585-591 PS) M 157.985	04.2014→10.2017		7.02604.44.0	LS	500 mm vor Katalysator, beidseitig in front of the catalyst, Left and right
S 65 AMG (217.379) 463 kW (630 PS) M 279.980	07.2014→05.2019		7.02604.44.0	LS	500 mm vor Katalysator, beidseitig in front of the catalyst, Left and right
			7.04389.08.0	SLP	EL
SL (R107)					
87					
300 SL (107.041) 132-138 kW (180-188 PS) M 103.982	09.1985→08.1989		7.02604.03.0	LS	200 mm
300 SL (107.041) 132-138 kW (180-188 PS) M 103.982	09.1985→08.1989		7.02604.03.0	LS	200 mm
420 SL (107.047) 150-160 kW (204-218 PS) M 116.964	01.1986→08.1989		7.02604.03.0	LS	200 mm
420 SL (107.047) 150-160 kW (204-218 PS) M 116.964	01.1986→08.1989		7.02604.03.0	LS	200 mm
SL (R129)					
88					
280 (129.058) 142-150 kW (193-204 PS) M 104.943	08.1993→10.2001		7.05270.00.0	LS	350 mm →ch. F125157
280 (129.059) 150 kW (204 PS) M 112.923	05.1998→10.2001		7.22136.50.0	AGR	PN

M























SL (R129) 88

			7.05270.03.0	LS	820 mm	links Left Regelsonde Regulating Probe
			7.04389.00.0	SLP	EL	
300 SL (129.060) 140 kW (190 PS) M 103.984	03.1989→08.1993		7.02604.03.0	LS	200 mm	
320 (129.063) 162-170 kW (220-231 PS) M 104.991	09.1993→10.2001		7.05270.00.0	LS	350 mm	 →ch. F125157
320 (129.064) 165 kW (224 PS) M 112.943	05.1998→10.2001		7.22136.50.0	AGR	PN	<input checked="" type="checkbox"/>
			7.05270.03.0	LS	820 mm	links Left Regelsonde Regulating Probe
			7.04389.00.0	SLP	EL	
500 (129.067) 235-240 kW (320-326 PS) M 119.972, M 119.982	09.1992→10.2001		7.05270.03.0	LS	820 mm	
500 (129.068) 225 kW (306 PS) M 113.961	05.1998→10.2001		7.22136.50.0	AGR	PN	<input checked="" type="checkbox"/>
			7.05270.03.0	LS	820 mm	
			7.04389.00.0	SLP	EL	
500 SL (129.066) 235-240 kW (320-326 PS) M 119.960, M 119.972	09.1989→08.1992		7.05270.03.0	LS	820 mm	
			7.05270.15.0	LS	380 mm	
			7.05270.00.0	LS	350 mm	
600 (129.076) 280-300 kW (381-408 PS) M 120.981, M 120.983	07.1992→10.2001		7.05270.15.0	LS	380 mm	
			7.05270.00.0	LS	350 mm	
600 SL (129.076) 280-300 kW (381-408 PS) M 120.981, M 120.983	02.1992→08.1994		7.05270.15.0	LS	380 mm	
			7.05270.00.0	LS	350 mm	





















M























SL (R230) 89

280 (230.454) 170 kW (231 PS) M 272.949	03.2008→01.2012		7.05270.17.0	LS	null mm	
			7.05270.21.0	LS	600 mm	
			7.04389.02.0	SLP	EL	
300 (230.454) 170 kW (231 PS) M 272.949	04.2009→01.2012		7.04389.02.0	SLP	EL	
350 (230.456) 200 kW (272 PS) M 272.966	03.2006→01.2012		7.05270.17.0	LS	null mm	links, rechts Left, Right Diagnosesonde Diagnostic Probe
			7.04389.02.0	SLP	EL	
350 (230.458) 232 kW (316 PS) M 272.968	04.2008→01.2012		7.04389.02.0	SLP	EL	
350 (230.467) 180 kW (245 PS) M 112.973	03.2003→01.2012		7.22136.50.0	AGR	PN	<input checked="" type="checkbox"/>

					
SL (R230)					89
			7.02604.27.0	LS	750 mm links, rechts Left, Right
			7.05270.12.0	LS	500 mm Diagnosesonde Diagnostic Probe
			7.04389.00.0	SLP	EL vor Katalysator, beidseitig in front of the catalyst, Left and right
500 215-225 kW (292-306 PS) M 113.963	09.2002→12.2005		7.22136.50.0	AGR	PN <input checked="" type="checkbox"/>
			7.04389.00.0	SLP	EL
500 (230.471) 285 kW (388 PS) M 273.965	03.2006→01.2012		7.05270.17.0	LS	null mm links, rechts Left, Right
			7.04389.02.0	SLP	EL Diagnosesonde Diagnostic Probe
500 (230.475) 215-225 kW (292-306 PS) M 113.963	10.2001→01.2012		7.22136.50.0	AGR	PN <input checked="" type="checkbox"/>
			7.02604.26.0	LS	500 mm links, rechts Left, Right
			7.05270.12.0	LS	500 mm vor Katalysator, beidseitig in front of the catalyst, Left and right
			7.04389.00.0	SLP	EL
55 AMG (230.472) 380 kW (517 PS) M 113.995	03.2006→01.2012		7.02604.26.0	LS	500 mm
			7.05270.12.0	LS	500 mm vor Katalysator, beidseitig in front of the catalyst, Left and right
			7.04389.04.0	SLP	EL für OE-Nummer: A 000 140 42 85 for OE number: A 000 140 42 85
			7.04389.06.0	SLP	EL für OE-Nummer: A 000 140 57 85 for OE number: A 000 140 57 85
55 AMG (230.474) 350-368 kW (476-500 PS) M 113.992	10.2001→06.2002		7.02604.26.0	LS	500 mm
			7.05270.12.0	LS	500 mm vor Katalysator, beidseitig in front of the catalyst, Left and right
			7.04389.05.0	SLP	EL für OE-Nummer: A 000 140 43 85 for OE number: A 000 140 43 85
			7.04389.06.0	SLP	EL
55 AMG Kompressor (230.474) 350-368 kW (476-500 PS) M 113.992	06.2002→01.2012		7.02604.26.0	LS	500 mm
			7.05270.12.0	LS	500 mm vor Katalysator, beidseitig in front of the catalyst, Left and right
			7.04389.05.0	SLP	EL für OE-Nummer: A 000 140 43 85 for OE number: A 000 140 43 85
			7.04389.06.0	SLP	EL
600 (230.476) 368 kW (500 PS) M 275.951	04.2003→01.2012		7.04389.04.0	SLP	EL
600 (230.477) 380 kW (517 PS) M 275.954	03.2006→01.2012		7.04389.04.0	SLP	EL
63 AMG (230.470) 386 kW (525 PS) M 156.981	03.2008→01.2012		7.05270.17.0	LS	null mm
			7.05270.22.0	LS	825 mm
			7.04389.06.0	SLP	EL

M









						
SL (R230)						89
65 AMG (230.479) 450 kW (612 PS) M 275.981	03.2004→01.2012		7.04389.06.0	SLP	EL	
65 AMG Black Series (230.479) 493 kW (670 PS) M 275.983	07.2008→01.2012		7.05270.12.0	LS	500 mm	vor Katalysator, beidseitig in front of the catalyst, Left and right
SL (R231)						90
350 (231.457) 225 kW (306 PS) M 276.954	02.2012→		7.05270.21.0	LS	600 mm	vor Katalysator, rechts in front of the catalyst, Right für Fahrzeuge mit Ladeluftkühler for vehicles with intercooler für Linkslenker for left-hand drive vehicles
400 (231.465) 245-270 kW (333-367 PS) M 276.825	04.2014→		7.05270.21.0	LS	600 mm	für OE-Nummer: A 009 542 56 18 for OE number: A 009 542 56 18
400 (231.466) 245-270 kW (333-367 PS) M 276.825	01.2016→		7.05270.21.0	LS	600 mm	für OE-Nummer: A 009 542 56 18 for OE number: A 009 542 56 18 vor Katalysator, beidseitig in front of the catalyst, Left and right
500 (231.473) 320-335 kW (435-455 PS) M 278.927	01.2012→		7.05270.21.0	LS	600 mm	für OE-Nummer: A 009 542 56 18 for OE number: A 009 542 56 18
500 (231.473) 320-335 kW (435-455 PS) M 278.927	04.2015→		7.05270.21.0	LS	600 mm	für OE-Nummer: A 009 542 56 18 for OE number: A 009 542 56 18
M			7.02604.44.0	LS	500 mm	nicht für Getriebeautomatik 9 Gang not for 9-speed automatic transmission vor Katalysator, beidseitig in front of the catalyst, Left and right für Linkslenker for left-hand drive vehicles
			7.02604.44.0	LS	500 mm	nicht für Getriebeautomatik 9 Gang not for 9-speed automatic transmission vor Katalysator, beidseitig in front of the catalyst, Left and right für Linkslenker for left-hand drive vehicles
63 AMG (231.474) 395-430 kW (537-585 PS) M 157.983	01.2012→		7.05270.21.0	LS	600 mm	für OE-Nummer: A 004 542 73 18 for OE number: A 004 542 73 18 vor Katalysator in front of the catalyst
			7.02604.44.0	LS	500 mm	für OE-Nummer: A 008 542 29 18, A 009 542 59 18 for OE number: A 008 542 29 18, A 009 542 59 18 vor Katalysator in front of the catalyst
			7.02604.44.0	LS	500 mm	für OE-Nummer: A 008 542 29 18, A 009 542 59 18 for OE number: A 008 542 29 18, A 009 542 59 18 vor Katalysator in front of the catalyst
63 AMG (231.474) 395-430 kW (537-585 PS) M 157.983	04.2014→		7.05270.21.0	LS	600 mm	für OE-Nummer: A 004 542 73 18 for OE number: A 004 542 73 18 vor Katalysator in front of the catalyst
63 AMG (231.474) 395-430 kW (537-585 PS) M 157.983	07.2018→		7.05270.21.0	LS	600 mm	für OE-Nummer: A 004 542 73 18 for OE number: A 004 542 73 18 vor Katalysator in front of the catalyst
65 AMG (231.479) 463 kW (630 PS) M 279.981	05.2012→		7.02604.44.0	LS	500 mm	vor Katalysator, beidseitig in front of the catalyst, Left and right
			7.04389.08.0	SLP	EL	
SLC (R172)						91
200 (172.434) 115-245 kW (156-333 PS) M 274.920	01.2016→		7.24809.85.0	AGR	EL	 Produktionsdatum bis: 29.09.2017 Production date to: 29.09.2017
250 d (172.404) 150 kW (204 PS) OM 651.980	01.2016→10.2017		7.08369.06.0	ATS	EL	

					
SLC (R172)					91
			7.08369.90.0	ATS	EL für OE-Nummer: A 000 905 65 04, A 001 905 07 00 for OE number: A 000 905 65 04, A 001 905 07 00 vor Katalysator in front of the catalyst
260 (172.435) 115-245 kW (156-333 PS) M 274.920	05.2018→		7.24809.85.0	AGR	EL  Produktionsdatum bis: 29.09.2017 Production date to: 29.09.2017
300 (172.438) 115-245 kW (156-333 PS) M 274.920	01.2016→		7.24809.85.0	AGR	EL  Produktionsdatum bis: 29.09.2017 Production date to: 29.09.2017
SLK (R170)					92
200 Kompressor (170.445) 132-141 kW (180-192 PS) M 111.943	10.1996→03.2000		7.05270.03.0	LS	820 mm  ch. 013521→ Regelsonde Regulating Probe
230 (170.449) 143-145 kW (194-197 PS) M 111.983	09.2000→04.2004		7.05270.12.0	LS	500 mm vor Katalysator in front of the catalyst für Linkslenker for left-hand drive vehicles USA USA Euro 4 Euro 4
230 Kompressor (170.447) 138-142 kW (188-193 PS) M 111.973	09.1996→03.2000		7.05270.03.0	LS	820 mm  ch. 041032→ Regelsonde Regulating Probe
230 Kompressor (170.449) 143-145 kW (194-197 PS) M 111.983	03.2000→04.2004		7.05270.12.0	LS	500 mm vor Katalysator in front of the catalyst für Linkslenker for left-hand drive vehicles USA USA Euro 4 Euro 4
32 AMG Kompressor (170.466) 260 kW (354 PS) M 112.960	03.2001→04.2004		7.05270.12.0	LS	500 mm  M 112.960: vor Katalysator, links in front of the catalyst, Left für Linkslenker for left-hand drive vehicles USA, Kanada USA, Canada  M 112.960: vor Katalysator, rechts in front of the catalyst, Right USA, Kanada USA, Canada
320 (170.465) 160 kW (218 PS) M 112.947	03.2000→04.2004		7.04389.05.0	SLP	EL
			7.22136.50.0	AGR	PN 
			7.05270.12.0	LS	500 mm  M 112.947: vor Katalysator, beidseitig in front of the catalyst, Left and right für Linkslenker for left-hand drive vehicles USA, Kanada USA, Canada  M 112.947: vor Katalysator, rechts in front of the catalyst, Right für Rechtslenker for right-hand drive vehicles USA, Kanada USA, Canada
			7.04389.00.0	SLP	EL



M



SLK (R171) **93**









200 Kompressor (171.442) 120 kW (163 PS) M 271.944	03.2004→02.2011		7.05271.23.0	LS	900 mm				
			7.05270.11.0	LS	750 mm	nach Katalysator Post-catalyst			
200 Kompressor (171.445) 135 kW (184 PS) M 271.954	01.2008→02.2011		7.05271.23.0	LS	900 mm				
			7.05270.11.0	LS	750 mm	nach Katalysator Post-catalyst			
280 (171.454) 170 kW (231 PS) M 272.942	01.2005→02.2011		7.05270.17.0	LS	null mm				
			7.05270.22.0	LS	825 mm				
			7.05270.21.0	LS	600 mm				
			7.04389.02.0	SLP	EL				
300 (171.454) 170 kW (231 PS) M 272.942	04.2009→02.2011		7.04389.02.0	SLP	EL				
			350 (171.456) 200 kW (272 PS) M 272.963	06.2004→02.2011		7.05270.17.0	LS	null mm	
						7.05270.22.0	LS	825 mm	
						7.05270.21.0	LS	600 mm	
350 (171.458) 224 kW (305 PS) M 272.969	01.2008→02.2011		7.05270.17.0	LS	null mm				
			7.05270.22.0	LS	825 mm				
			7.05270.21.0	LS	600 mm				
			7.04389.02.0	SLP	EL				
55 AMG (171.473) 260-294 kW (354-400 PS) M 113.989	06.2004→02.2011		7.22136.50.0	AGR	PN	<input checked="" type="checkbox"/>			
			7.02604.27.0	LS	750 mm				
			7.05270.11.0	LS	750 mm	vor Katalysator, beidseitig in front of the catalyst, Left and right			
			7.04389.06.0	SLP	EL				
55 AMG (171.473) 260-294 kW (354-400 PS) M 113.989	06.2006→02.2011		7.22136.50.0	AGR	PN	<input checked="" type="checkbox"/>			
			7.02604.27.0	LS	750 mm				
			7.05270.11.0	LS	750 mm	vor Katalysator, beidseitig in front of the catalyst, Left and right			
			7.04389.04.0	SLP	EL				

SLK (R172) **94**

200 (172.434) 115-245 kW (156-333 PS) M 274.920	04.2015→		7.24809.85.0	AGR	EL	<input checked="" type="checkbox"/>
200 (172.448) 135-150 kW (184-204 PS) M 271.860	02.2011→		7.04389.07.0	SLP	EL	









SLK (R172) 94

200 (172.448) 135-150 kW (184-204 PS) M 271.861	02.2011→		7.08369.76.0	ATS	EL	für OE-Nummer: A 000 905 52 02, A 000 905 89 04 for OE number: A 000 905 52 02, A 000 905 89 04 vor Katalysator in front of the catalyst
			7.04389.07.0	SLP	EL	
250 (172.447) 135-150 kW (184-204 PS) M 271.860	02.2011→		7.04389.07.0	SLP	EL	
			7.04389.07.0	SLP	EL	
250 (172.447) 135-150 kW (184-204 PS) M 271.861	02.2011→		7.08369.76.0	ATS	EL	für OE-Nummer: A 000 905 52 02, A 000 905 89 04 for OE number: A 000 905 52 02, A 000 905 89 04 vor Katalysator in front of the catalyst
			7.04389.07.0	SLP	EL	
250 CDI / d (172.403) 150 kW (204 PS) OM 651.980	01.2012→		7.08369.06.0	ATS	EL	
			7.08369.76.0	ATS	EL	für OE-Nummer: A 000 905 52 02, A 000 905 89 04 for OE number: A 000 905 52 02, A 000 905 89 04 vor Katalysator in front of the catalyst
			7.08369.90.0	ATS	EL	für OE-Nummer: A 000 905 65 04, A 001 905 07 00 for OE number: A 000 905 65 04, A 001 905 07 00 vor Katalysator in front of the catalyst
300 (172.438) 115-245 kW (156-333 PS) M 274.920	07.2015→		7.24809.85.0	AGR	EL	 Produktionsdatum bis: 29.09.2017 Production date to: 29.09.2017
350 (172.457) 225 kW (306 PS) M 276.956	02.2011→		7.08369.76.0	ATS	EL	für OE-Nummer: A 000 905 52 02, A 000 905 89 04 for OE number: A 000 905 52 02, A 000 905 89 04 vor Katalysator in front of the catalyst
			7.05270.21.0	LS	600 mm	für OE-Nummer: A 003 542 70 18, A 009 542 56 18 for OE number: A 003 542 70 18, A 009 542 56 18 vor Katalysator, rechts in front of the catalyst, Right
55 AMG (172.475) 310-314 kW (422-427 PS) M 152.980	06.2012→		7.08369.76.0	ATS	EL	für OE-Nummer: A 000 905 52 02, A 000 905 89 04 for OE number: A 000 905 52 02, A 000 905 89 04 vor Katalysator in front of the catalyst

M





SLR (R199) 95

5.4 (199.376) 420-478 kW (571-650 PS) M 155.980	04.2004→		7.02604.26.0	LS	500 mm	
			7.04389.05.0	SLP	EL	
5.4 722 Edition 420-478 kW (571-650 PS) M 155.980	10.2006→		7.02604.26.0	LS	500 mm	
			7.04389.05.0	SLP	EL	

						
SLR Roadster (R199)						96
5.4 420-478 kW (571-650 PS) M 155.980	10.2006→		7.02604.26.0	LS	500 mm	
			7.04389.05.0	SLP	EL	
5.4 420-478 kW (571-650 PS) M 155.980	04.2007→		7.02604.26.0	LS	500 mm	
			7.04389.05.0	SLP	EL	
SLS AMG (C197)						97
6.2 420-464 kW (571-631 PS) M 159.980	06.2013→		7.05270.22.0	LS	825 mm	
			7.04389.04.0	SLP	EL	
6.2 (197.377) 420-464 kW (571-631 PS) M 159.980	03.2010→		7.05270.22.0	LS	825 mm	
			7.04389.04.0	SLP	EL	
6.2 GT 420-464 kW (571-631 PS) M 159.980	06.2013→		7.05270.22.0	LS	825 mm	
			7.04389.04.0	SLP	EL	
SLS AMG Roadster (R197)						98
6.2 (197.477) 420-464 kW (571-631 PS) M 159.980	06.2011→		7.05270.22.0	LS	825 mm	
			7.04389.04.0	SLP	EL	
6.2 GT (197.478) 420-464 kW (571-631 PS) M 159.980	06.2013→		7.05270.22.0	LS	825 mm	
			7.04389.04.0	SLP	EL	
VANEO (414)						99
1.7 CDI (414.700) 55-67 kW (75-91 PS) OM 668.914	02.2002→07.2005		7.24809.49.0	AGR	PN 	
			7.24809.49.0	AGR	PN 	
X-CLASS (470)						100
X 220 d (470.210) 120 kW (163 PS) OM 699.300	09.2017→05.2020		7.11457.07.0*	DDS		
			↳ 7.11492.07.0	DDS		
X 220 d 4-matic (470.211) 120 kW (163 PS) OM 699.300	09.2017→05.2020		7.11457.07.0*	DDS		
			↳ 7.11492.07.0	DDS		
X 250 d (470.230) 140 kW (190 PS) OM 699.301	09.2017→05.2020		7.11457.07.0*	DDS		
			↳ 7.11492.07.0	DDS		
X 250 d 4-matic (470.231) 140 kW (190 PS) OM 699.301	09.2017→05.2020		7.11457.07.0*	DDS		
			↳ 7.11492.07.0	DDS		
CITAN Box Body/MPV (W415)						101
108 CDI (415.601, 415.603) 55-81 kW (75-110 PS) OM 607.951	11.2012→		7.03435.05.0	AGR	EL  Euro 5	
			7.05320.04.0	AGR	EL  Euro 6	
			7.03571.16.0	AK	EL  Euro 6	





CITAN Box Body/MPV (W415) 101

			↳ 7.03083.20.0 7.11190.08.0 7.11457.07.0* ↳ 7.11492.07.0	SRM-AK DDS DDS DDS	EL	für OE-Nummer: A 607 905 05 00 for OE number: A 607 905 05 00 Euro 6 Euro 6
108 CDI (415.603) 59-85 kW (80-116 PS) OM 608.915	05.2019→		7.11457.07.0* ↳ 7.11492.07.0	DDS DDS		
109 CDI (415.601, 415.603, 415.605) 55-81 kW (75-110 PS) OM 607.951	11.2012→		7.03435.05.0 7.05320.04.0 7.03571.16.0 ↳ 7.03083.20.0 7.11190.08.0 7.11457.07.0* ↳ 7.11492.07.0	AGR AGR AK SRM-AK DDS DDS	EL EL EL EL	○ Euro 5 Euro 5 ○ Euro 6 Euro 6 für OE-Nummer: A 607 905 05 00 for OE number: A 607 905 05 00 Euro 6 Euro 6
109 CDI (415.603, 415.605) 59-85 kW (80-116 PS) OM 608.915	05.2019→		7.11457.07.0* ↳ 7.11492.07.0	DDS DDS		
111 CDI (415.603, 415.605) 55-81 kW (75-110 PS) OM 607.951	06.2013→		7.03435.05.0 7.05320.04.0 7.03571.16.0 ↳ 7.03083.20.0 7.11190.08.0 7.11457.07.0* ↳ 7.11492.07.0	AGR AGR AK SRM-AK DDS DDS	EL EL EL EL	○ Euro 5 Euro 5 ○ Euro 6 Euro 6 für OE-Nummer: A 607 905 05 00 for OE number: A 607 905 05 00 Euro 6 Euro 6
111 CDI (415.603, 415.605) 59-85 kW (80-116 PS) OM 608.915	05.2019→		7.11457.07.0* ↳ 7.11492.07.0	DDS DDS		

M

CITAN Mixto (Double Cabin) (W415) 102

109 CDI 55-81 kW (75-110 PS) OM 607.951	11.2012→		7.03435.05.0 7.05320.04.0 7.03571.16.0 ↳ 7.03083.20.0 7.11190.08.0 7.11457.07.0* ↳ 7.11492.07.0	AGR AGR AK SRM-AK DDS DDS	EL EL EL EL	○ Euro 5 Euro 5 ○ Euro 6 Euro 6 für OE-Nummer: A 607 905 05 00 for OE number: A 607 905 05 00 Euro 6 Euro 6
111 CDI (415.601, 415.603, 415.605) 55-81 kW (75-110 PS) OM 607.951	06.2013→		7.03435.05.0	AGR	EL	○ Euro 5 Euro 5







CITAN Mixto (Double Cabin) (W415) 102

		7.05320.04.0	AGR	EL	 Euro 6 Euro 6
		7.03571.16.0	AK	EL	
		↳ 7.03083.20.0	SRM-AK	EL	
		7.11190.08.0	DDS		für OE-Nummer: A 607 905 05 00 for OE number: A 607 905 05 00
		7.11457.07.0*	DDS		Euro 6 Euro 6
		↳ 7.11492.07.0	DDS		

E-CLASS Platform/Chassis (VF210) 103









E 220 CDI (210.606) 75-105 kW (102-143 PS) OM 611.961	07.1999→12.2002	 7.05270.12.0	LS	500 mm	vor Katalysator, links in front of the catalyst, Left für Linkslenker for left-hand drive vehicles Produktionsdatum ab: 30.06.2000 Production date from: 30.06.2000
E 270 CDI (210.616) 120-125 kW (163-170 PS) OM 612.961	07.1999→12.2002	 7.05270.12.0	LS	500 mm	für OE-Nummer: A 001 540 51 17 for OE number: A 001 540 51 17
E 280 (210.663) 150 kW (204 PS) M 112.921	07.1999→11.2002	 7.05270.12.0	LS	500 mm	vor Katalysator, links in front of the catalyst, Left für Linkslenker for left-hand drive vehicles Produktionsdatum ab: 30.06.2000 Production date from: 30.06.2000
		7.04389.00.0	SLP	EL	

M E-CLASS Platform/Chassis (VF211) 104









E 220 CDI (211.606) 100-110 kW (136-150 PS) OM 646.961	10.2003→07.2006	 7.08369.80.0	ATS	EL	Abgaskrümmer Exhaust Manifold Euro 4 Euro 4 für Fahrzeuge mit Diesel-Partikel-Filter (DPF) for vehicles with diesel soot filter
		7.11020.35.0	ATS	EL	 → ch. B350084 nach Katalysator Post-catalyst für Linkslenker for left-hand drive vehicles für Fahrzeuge mit Diesel-Partikel-Filter (DPF) for vehicles with diesel soot filter Produktionsdatum ab: 30.04.2008 Production date from: 30.04.2008
		7.11190.01.0	DDS		für OE-Nummer: A 004 153 95 28, A 005 153 74 28, A 005 153 77 28, A 006 153 49 28 for OE number: A 004 153 95 28, A 005 153 74 28, A 005 153 77 28, A 006 153 49 28 Luftfiltergehäuse Air Filter Housing
7.05270.21.0	LS	600 mm	für OE-Nummer: A 004 542 73 18 for OE number: A 004 542 73 18 vor Katalysator in front of the catalyst		
E 220 CDI (211.608) 100-125 kW (136-170 PS) OM 646.821	04.2006→07.2009	 7.24809.48.0	AGR	ET	



E-CLASS Platform/Chassis (VF211) 104

			7.11020.35.0	ATS	EL	 ch. B350084→ nach Katalysator Post-catalyst für Linkslenker for left-hand drive vehicles für Fahrzeuge mit Diesel-Partikel-Filter (DPF) for vehicles with diesel soot filter Produktionsdatum ab: 30.04.2008 Production date from: 30.04.2008
			7.05270.21.0	LS	600 mm	für OE-Nummer: A 004 542 73 18 for OE number: A 004 542 73 18 vor Katalysator in front of the catalyst
E 270 CDI (211.616) 120-130 kW (163-177 PS) OM 647.961	03.2003→07.2009		7.24809.37.0	AGR	ET	
E 270 CDI (211.616) 120-130 kW (163-177 PS) OM 647.961	10.2003→07.2005		7.24809.37.0	AGR	ET	
E 280 CDI (211.620) 140-200 kW (190-272 PS) OM 642.920	08.2005→07.2009		7.24809.47.0	AGR	ET	 USA USA
			7.11190.01.0	DDS		Luftfiltergehäuse Air Filter Housing







MARCO POLO Camper (W447) 105

160 CDI (447.703) 65-84 kW (88-114 PS) OM 622.951	03.2015→		7.11457.07.0*	DDS		ab Euro 6 From Euro 6
			 7.11492.07.0	DDS		
180 CDI (447.703) 65-84 kW (88-114 PS) OM 622.951	03.2015→		7.11457.07.0*	DDS		ab Euro 6 From Euro 6
			 7.11492.07.0	DDS		
200 CDI (447.703, 447.813) 84-140 kW (114-190 PS) OM 651.950	03.2015→		7.08369.06.0	ATS	EL	
			7.08369.87.0	ATS	EL	nach Katalysator Post-catalyst ab Euro 5 From Euro 5 für Linkslenker for left-hand drive vehicles
			7.08369.97.0	ATS	EL	 OM 651.950: für OE-Nummer: A 000 905 52 05, A 008 153 41 28 for OE number: A 000 905 52 05, A 008 153 41 28 vor Katalysator in front of the catalyst  OM 651.950: für OE-Nummer: A 000 905 52 05, A 008 153 41 28 for OE number: A 000 905 52 05, A 008 153 41 28 vor Katalysator in front of the catalyst  OM 651.950: nach Katalysator Post-catalyst Euro 6b, Euro 6c Euro 6b, Euro 6c für Rechtslenker for right-hand drive vehicles
200 CDI 4-matic (447.703, 447.813) 84-140 kW (114-190 PS) OM 651.950	03.2015→		7.08369.06.0	ATS	EL	

M









MARCO POLO Camper (W447) **105**

			7.08369.87.0	ATS	EL	nach Katalysator Post-catalyst ab Euro 5 From Euro 5 für Linkslenker for left-hand drive vehicles
			7.08369.97.0	ATS	EL	 OM 651.950: vor Rußpartikelfilter before soot particulate filter Allrad permanent Permanent All-wheel Drive Euro 6b, Euro 6c Euro 6b, Euro 6c für Linkslenker for left-hand drive vehicles  OM 651.950: für OE-Nummer: A 000 905 52 05, A 008 153 41 28 for OE number: A 000 905 52 05, A 008 153 41 28 vor Katalysator in front of the catalyst  OM 651.950: nach Katalysator Post-catalyst Euro 6b, Euro 6c Euro 6b, Euro 6c für Rechtslenker for right-hand drive vehicles
220 CDI (447.703, 447.813) 84-140 kW (114-190 PS) OM 651.950	03.2015→		7.08369.06.0	ATS	EL	
			7.08369.87.0	ATS	EL	nach Katalysator Post-catalyst ab Euro 5 From Euro 5 für Linkslenker for left-hand drive vehicles
			7.08369.97.0	ATS	EL	 OM 651.950: für OE-Nummer: A 000 905 52 05, A 008 153 41 28 for OE number: A 000 905 52 05, A 008 153 41 28 vor Katalysator in front of the catalyst  OM 651.950: nach Katalysator Post-catalyst Euro 6b, Euro 6c Euro 6b, Euro 6c für Rechtslenker for right-hand drive vehicles
220 CDI 4-matic (447.703, 447.813) 84-140 kW (114-190 PS) OM 651.950	03.2015→		7.08369.06.0	ATS	EL	
			7.08369.87.0	ATS	EL	nach Katalysator Post-catalyst ab Euro 5 From Euro 5 für Linkslenker for left-hand drive vehicles

M





MARCO POLO Camper (W447) **105**

		7.08369.97.0	ATS	EL	 OM 651.950: vor Rußpartikelfilter before soot particulate filter Allrad permanent Permanent All-wheel Drive Euro 6b, Euro 6c Euro 6b, Euro 6c für Linkslenker for left-hand drive vehicles  OM 651.950: für OE-Nummer: A 000 905 52 05, A 008 153 41 28 for OE number: A 000 905 52 05, A 008 153 41 28 vor Katalysator in front of the catalyst  OM 651.950: nach Katalysator Post-catalyst Euro 6b, Euro 6c Euro 6b, Euro 6c für Rechtslenker for right-hand drive vehicles
250 CDI (447.703, 447.813) 84-140 kW (114-190 PS) OM 651.950	03.2015→	 7.08369.06.0	ATS	EL	
		7.08369.87.0	ATS	EL	nach Katalysator Post-catalyst ab Euro 5 From Euro 5 für Linkslenker for left-hand drive vehicles
		7.08369.97.0	ATS	EL	 OM 651.950: für OE-Nummer: A 000 905 52 05, A 008 153 41 28 for OE number: A 000 905 52 05, A 008 153 41 28 vor Katalysator in front of the catalyst  OM 651.950: nach Katalysator Post-catalyst Euro 6b, Euro 6c Euro 6b, Euro 6c für Rechtslenker for right-hand drive vehicles
250 CDI 4-matic (447.703, 447.813) 84-140 kW (114-190 PS) OM 651.950	03.2015→	 7.08369.06.0	ATS	EL	

M













MARCO POLO Camper (W447) 105

			7.08369.87.0	ATS	EL	nach Katalysator Post-catalyst ab Euro 5 From Euro 5 für Linkslenker for left-hand drive vehicles
			7.08369.97.0	ATS	EL	 OM 651.950: vor Rußpartikelfilter before soot particulate filter Allrad permanent Permanent All-wheel Drive Euro 6b, Euro 6c Euro 6b, Euro 6c für Linkslenker for left-hand drive vehicles  OM 651.950: für OE-Nummer: A 000 905 52 05, A 008 153 41 28 for OE number: A 000 905 52 05, A 008 153 41 28 vor Katalysator in front of the catalyst  OM 651.950: nach Katalysator Post-catalyst Euro 6b, Euro 6c Euro 6b, Euro 6c für Rechtslenker for right-hand drive vehicles

SPRINTER (901/902/903/904/905) 106

M	314 CDI 60-130 kW (82-177 PS) OM 647.981	04.2000→05.2006	 7.24809.65.0	AGR	ET	
	414 CDI 60-130 kW (82-177 PS) OM 647.981	04.2000→05.2006	 7.24809.65.0	AGR	ET	

SPRINTER 2-t Bus (B901, B902) 107







	208 CDI 60 kW (82 PS) OM 611.987	04.2000→05.2006	 7.24809.34.0	AGR	PN	
			7.24809.35.0	AGR	PN	 →50 030773 für OE-Nummer: 611 090 02 54 for OE number: 611 090 02 54
	211 CDI 80-95 kW (109-129 PS) OM 611.981	04.2000→05.2006	 7.24809.34.0	AGR	PN	
			7.24809.35.0	AGR	PN	 →50 030772 für OE-Nummer: 611 090 02 54 for OE number: 611 090 02 54
	213 CDI 80-95 kW (109-129 PS) OM 611.981	04.2000→05.2006	 7.24809.34.0	AGR	PN	
			7.24809.35.0	AGR	PN	 →50 030772 für OE-Nummer: 611 090 02 54 for OE number: 611 090 02 54
	216 CDI 110-115 kW (150-156 PS) OM 612.981	04.2000→05.2006	 7.24809.54.0	AGR	ET	

SPRINTER 2-t Platform/Chassis (B901, B902) 108













	208 CDI 60 kW (82 PS) OM 611.987	04.2000→05.2006	 7.24809.34.0	AGR	PN	
			7.24809.35.0	AGR	PN	 →50 030773 für OE-Nummer: 611 090 02 54 for OE number: 611 090 02 54
	211 CDI 80-95 kW (109-129 PS) OM 611.981	04.2000→05.2006	 7.24809.34.0	AGR	PN	



SPRINTER 2-t Platform/Chassis (B901, B902) 108







			7.24809.35.0	AGR	PN	 →50 030772 für OE-Nummer: 611 090 02 54 for OE number: 611 090 02 54
213 CDI 80-95 kW (109-129 PS) OM 611.981	04.2000→05.2006		7.24809.34.0	AGR	PN	
			7.24809.35.0	AGR	PN	 →50 030772 für OE-Nummer: 611 090 02 54 for OE number: 611 090 02 54
216 CDI 110-115 kW (150-156 PS) OM 612.981	04.2000→05.2006		7.24809.54.0	AGR	ET	

SPRINTER 2-t Van (B901, B902) 109

208 CDI 60 kW (82 PS) OM 611.987	04.2000→05.2006		7.24809.34.0	AGR	PN	
			7.24809.35.0	AGR	PN	 →50 030773 für OE-Nummer: 611 090 02 54 for OE number: 611 090 02 54
211 CDI 80-95 kW (109-129 PS) OM 611.981	04.2000→05.2006		7.24809.34.0	AGR	PN	
			7.24809.35.0	AGR	PN	 →50 030772 für OE-Nummer: 611 090 02 54 for OE number: 611 090 02 54
213 CDI 80-95 kW (109-129 PS) OM 611.981	04.2000→05.2006		7.24809.34.0	AGR	PN	
			7.24809.35.0	AGR	PN	 →50 030772 für OE-Nummer: 611 090 02 54 for OE number: 611 090 02 54
214 92-105 kW (125-143 PS) M 111.984	02.1995→05.2006		7.05270.03.0	LS	820 mm	Regelsonde Regulating Probe
			7.04389.05.0	SLP	EL	
216 CDI 110-115 kW (150-156 PS) OM 612.981	04.2000→05.2006		7.24809.54.0	AGR	ET	













M

SPRINTER 3,5-t Bus (B906) 110

310 CDI (906.731, 906.733, 906.735) 70-120 kW (95-163 PS) OM 651.955, OM 651.956	03.2009→12.2013		7.08369.06.0	ATS	EL	
			7.11020.16.0	ATS	EL	 OM 651.955, OM 651.956: vor Katalysator in front of the catalyst Euro 6  OM 651.955, OM 651.956: vor SCR-Katalysator before SCR catalytic converter Euro 6 Produktionsdatum bis: 24.01.2013 Production date to: 24.01.2013
311 CDI (906.731, 906.733, 906.735) 80 kW (109 PS) OM 646.985	06.2006→12.2009		7.24809.65.0	AGR	ET	
			7.08369.61.0	ATS	EL	
			7.08369.91.0	ATS	EL	vor Rußpartikelfilter before soot particulate filter Euro 3 Euro 3
311 CDI (906.731, 906.733, 906.735) 70-120 kW (95-163 PS) OM 651.955	05.2016→		7.08369.06.0	ATS	EL	













SPRINTER 3,5-t Bus (B906) 110

			7.11020.16.0	ATS	EL	für OE-Nummer: A 007 153 67 28 , A 000 905 39 05 for OE number: A 007 153 67 28 , A 000 905 39 05 vor Katalysator in front of the catalyst
311 CDI 4x4 (906.731, 906.733, 906.735) 80 kW (109 PS) OM 646.985	02.2008→12.2009		7.24809.65.0	AGR	ET	
			7.08369.30.0	ATS	EL	
			7.08369.61.0 7.08369.91.0	ATS ATS	EL EL	vor Rußpartikelfilter before soot particulate filter Euro 3 Euro 3
313 CDI (906.731, 906.733, 906.735) 70-120 kW (95-163 PS) OM 651.955	08.2011→05.2016		7.08369.06.0	ATS	EL	
			7.08369.61.0	ATS	EL	
			7.11020.16.0	ATS	EL	 OM 651.955: vor Katalysator in front of the catalyst Euro 6 Euro 6  OM 651.955: vor SCR-Katalysator before SCR catalytic converter Euro 6 Euro 6 Produktionsdatum bis: 24.01.2013 Production date to: 24.01.2013
313 CDI 4x4 (906.731, 906.733, 906.735) 70-120 kW (95-163 PS) OM 651.955	08.2011→05.2016		7.08369.06.0	ATS	EL	
			7.08369.61.0	ATS	EL	
			7.11020.16.0	ATS	EL	 OM 651.955: vor Katalysator in front of the catalyst Euro 6 Euro 6  OM 651.955: vor SCR-Katalysator before SCR catalytic converter Euro 6 Euro 6 Produktionsdatum bis: 24.01.2013 Production date to: 24.01.2013
314 CDI (906.731, 906.733, 906.735) 70-120 kW (95-163 PS) OM 651.955	05.2016→		7.08369.06.0	ATS	EL	
			7.11020.16.0	ATS	EL	für OE-Nummer: A 000 905 39 05, A 007 153 67 28 for OE number: A 000 905 39 05, A 007 153 67 28 vor Katalysator in front of the catalyst
314 CDI 4x4 (906.731, 906.733, 906.735) 70-120 kW (95-163 PS) OM 651.955	05.2016→		7.08369.06.0	ATS	EL	
			7.11020.16.0	ATS	EL	für OE-Nummer: A 000 905 39 05, A 007 153 67 28 for OE number: A 000 905 39 05, A 007 153 67 28 vor Katalysator in front of the catalyst
315 CDI (906.731, 906.733, 906.735) 95-110 kW (129-150 PS) OM 646.986	06.2006→12.2009		7.24809.65.0	AGR	ET	
			7.08369.30.0	ATS	EL	

M





















SPRINTER 3,5-t Bus (B906) 110

			7.08369.61.0 ATS EL 7.08369.91.0 ATS EL 7.11190.01.0 DDS		vor Rußpartikelfilter before soot particulate filter Euro 3 Euro 3 Baumuster: 906.735 Type: 906.735 Luftfiltergehäuse Air Filter Housing
315 CDI (906.731, 906.733, 906.735) 110 kW (150 PS) OM 646.989, OM 646.990	06.2006→12.2009	 7.08369.30.0 7.08369.61.0 7.08369.91.0	ATS EL ATS EL ATS EL		 OM 646.989, OM 646.990: vor Rußpartikelfilter before soot particulate filter Euro 3 Euro 3
315 CDI (906.733) 85-120 kW (116-163 PS) OM 651.957	06.2013→	 7.08369.06.0	ATS EL		
315 CDI 4x4 (906.731, 906.733, 906.735) 95-110 kW (129-150 PS) OM 646.986	02.2008→12.2009	 7.24809.65.0 7.08369.30.0 7.08369.61.0 7.08369.91.0 7.11190.01.0	AGR ET ATS EL ATS EL ATS EL DDS		 vor Rußpartikelfilter before soot particulate filter Euro 3 Euro 3 Baumuster: 906.735 Type: 906.735 Luftfiltergehäuse Air Filter Housing
315 CDI 4x4 (906.731, 906.733, 906.735) 110 kW (150 PS) OM 646.989, OM 646.990	02.2008→12.2009	 7.08369.30.0 7.08369.61.0 7.08369.91.0	ATS EL ATS EL ATS EL		 OM 646.989, OM 646.990: vor Rußpartikelfilter before soot particulate filter Euro 3 Euro 3
315 CDI 4x4 (906.735) 85-120 kW (116-163 PS) OM 651.957	06.2013→	 7.08369.06.0	ATS EL		
316 (906.733, 906.735) 115 kW (156 PS) M 271.951	09.2008→	 7.05271.23.0 7.05270.11.0	LS 900 mm LS 750 mm		nach Katalysator Post-catalyst Euro 6b Euro 6b
316 CDI (906.731, 906.733, 906.735) 70-120 kW (95-163 PS) OM 651.955, OM 651.957	08.2011→	 7.08369.06.0 7.08369.61.0	ATS EL ATS EL		

M











SPRINTER 3,5-t Bus (B906) 110

			7.11020.16.0	ATS	EL	 OM 651.955, OM 651.957: vor Katalysator in front of the catalyst Euro 6 Euro 6  OM 651.955, OM 651.957: vor SCR-Katalysator before SCR catalytic converter Euro 6 Euro 6 Produktionsdatum bis: 24.01.2013 Production date to: 24.01.2013	
316 CDI 4x4 (906.731, 906.733, 906.735) 70-120 kW (95-163 PS) OM 651.955, OM 651.957	08.2011→		7.08369.06.0	ATS	EL	 OM 651.955, OM 651.957: vor Katalysator in front of the catalyst Euro 6 Euro 6  OM 651.955, OM 651.957: vor SCR-Katalysator before SCR catalytic converter Euro 6 Euro 6 Produktionsdatum bis: 24.01.2013 Production date to: 24.01.2013	
			7.08369.61.0	ATS	EL		
			7.11020.16.0	ATS	EL		
318 CDI (906.731, 906.733, 906.735) 135-140 kW (184-190 PS) OM 642.896	02.2008→12.2009		7.08369.30.0	ATS	EL	 OM 651.955, OM 651.957: vor Katalysator in front of the catalyst Euro 6 Euro 6  OM 651.955, OM 651.957: vor SCR-Katalysator before SCR catalytic converter Euro 6 Euro 6 Produktionsdatum bis: 24.01.2013 Production date to: 24.01.2013	
			7.08369.61.0	ATS	EL		
			7.08369.91.0	ATS	EL		vor Rußpartikelfilter before soot particulate filter
			7.11020.28.0	ATS	EL		nach AGR-Kühler after EGR cooler
			7.11020.40.0	ATS	EL		Abgasturbolader Exhaust Turbocharger
318 CDI (906.731, 906.733, 906.735) 135-140 kW (184-190 PS) OM 642.986	02.2008→12.2009		7.08369.30.0	ATS	EL	 OM 651.955, OM 651.957: vor Katalysator in front of the catalyst Euro 6 Euro 6  OM 651.955, OM 651.957: vor SCR-Katalysator before SCR catalytic converter Euro 6 Euro 6 Produktionsdatum bis: 24.01.2013 Production date to: 24.01.2013	
			7.08369.61.0	ATS	EL		
			7.08369.91.0	ATS	EL		vor Rußpartikelfilter before soot particulate filter
			7.11190.01.0	DDS			Baumuster: 906.735 Type: 906.735
318 CDI (906.731, 906.733, 906.735) 135-140 kW (184-190 PS) OM 642.992	02.2008→12.2009		7.24809.60.0	AGR	ET		
			7.08369.30.0	ATS	EL	 OM 651.955, OM 651.957: vor Katalysator in front of the catalyst Euro 6 Euro 6  OM 651.955, OM 651.957: vor SCR-Katalysator before SCR catalytic converter Euro 6 Euro 6 Produktionsdatum bis: 24.01.2013 Production date to: 24.01.2013	
			7.08369.61.0	ATS	EL		
			7.08369.91.0	ATS	EL		vor Rußpartikelfilter before soot particulate filter
			7.11190.01.0	DDS			für OE-Nummer: A 006 153 49 28 for OE number: A 006 153 49 28
7.24809.60.0	AGR	ET					
318 CDI (906.731, 906.733, 906.735) 135 kW (184 PS) OM 642.993	02.2008→12.2009		7.08369.30.0	ATS	EL	 OM 651.955, OM 651.957: vor Katalysator in front of the catalyst Euro 6 Euro 6  OM 651.955, OM 651.957: vor SCR-Katalysator before SCR catalytic converter Euro 6 Euro 6 Produktionsdatum bis: 24.01.2013 Production date to: 24.01.2013	
			7.08369.61.0	ATS	EL		













SPRINTER 3,5-t Bus (B906) **110**

			7.08369.91.0	ATS	EL	vor Rußpartikelfilter before soot particulate filter
			7.11020.28.0	ATS	EL	für OE-Nummer: A 000 905 43 05 for OE number: A 000 905 43 05
			7.11190.01.0	DDS		Abgaskrümmer Exhaust Manifold
						für OE-Nummer: A 006 153 49 28 for OE number: A 006 153 49 28
318 CDI 4x4 (906.731, 906.733, 906.735) 135-140 kW (184-190 PS) OM 642.896	02.2008→12.2009		7.08369.30.0	ATS	EL	
			7.08369.61.0	ATS	EL	
			7.08369.91.0	ATS	EL	vor Rußpartikelfilter before soot particulate filter
			7.11020.28.0	ATS	EL	nach AGR-Kühler after EGR cooler
			7.11020.40.0	ATS	EL	Abgasturbolader Exhaust Turbocharger
318 CDI 4x4 (906.731, 906.733, 906.735) 135-140 kW (184-190 PS) OM 642.986	02.2008→12.2009		7.08369.30.0	ATS	EL	
			7.08369.61.0	ATS	EL	
			7.08369.91.0	ATS	EL	vor Rußpartikelfilter before soot particulate filter
			7.11190.01.0	DDS		Baumuster: 906.735 Type: 906.735 Luftfiltergehäuse Air Filter Housing
318 CDI 4x4 (906.731, 906.733, 906.735) 135-140 kW (184-190 PS) OM 642.992	02.2008→12.2009		7.24809.60.0	AGR	ET	
			7.08369.30.0	ATS	EL	
			7.08369.61.0	ATS	EL	
			7.08369.91.0	ATS	EL	vor Rußpartikelfilter before soot particulate filter
			7.11190.01.0	DDS		für OE-Nummer: A 006 153 49 28 for OE number: A 006 153 49 28
						Luftfiltergehäuse Air Filter Housing
318 CDI 4x4 (906.731, 906.733, 906.735) 135 kW (184 PS) OM 642.993	02.2008→12.2009		7.24809.60.0	AGR	ET	
			7.08369.30.0	ATS	EL	
			7.08369.61.0	ATS	EL	
			7.08369.91.0	ATS	EL	vor Rußpartikelfilter before soot particulate filter
			7.11020.28.0	ATS	EL	für OE-Nummer: A 000 905 43 05 for OE number: A 000 905 43 05
			7.11190.01.0	DDS		Abgaskrümmer Exhaust Manifold
						für OE-Nummer: A 006 153 49 28 for OE number: A 006 153 49 28
						Luftfiltergehäuse Air Filter Housing
319 CDI / BlueTEC (906.731, 906.733, 906.735) 135-155 kW (184-211 PS) OM 642.896, OM 642.898	03.2009→		7.11020.28.0	ATS	EL	 OM 642.896, OM 642.898: nach AGR-Kühler after EGR cooler



M











SPRINTER 3,5-t Bus (B906) 110

		7.11020.40.0	ATS	EL	 OM 642.896, OM 642.898: Abgasturbolader Exhaust Turbocharger	
319 CDI / BlueTEC (906.731, 906.733, 906.735) 135-140 kW (184-190 PS) OM 642.992	03.2009→	 7.24809.60.0	AGR	ET		
		7.11190.01.0	DDS			für OE-Nummer: A 006 153 49 28 for OE number: A 006 153 49 28 Luftfiltergehäuse Air Filter Housing
319 CDI / BlueTEC 4x4 (906.731, 906.733, 906.735) 135-155 kW (184-211 PS) OM 642.896, OM 642.898	03.2009→	 7.08369.30.0	ATS	EL		
		7.11020.28.0	ATS	EL		 OM 642.896, OM 642.898: nach AGR-Kühler after EGR cooler
		7.11020.40.0	ATS	EL		 OM 642.896, OM 642.898: Abgasturbolader Exhaust Turbocharger
319 CDI / BlueTEC 4x4 (906.731, 906.733, 906.735) 135-140 kW (184-190 PS) OM 642.986	03.2009→	 7.08369.30.0	ATS	EL		
319 CDI / BlueTEC 4x4 (906.731, 906.733, 906.735) 135-140 kW (184-190 PS) OM 642.992	03.2009→	 7.24809.60.0	AGR	ET		
		7.08369.30.0	ATS	EL		für OE-Nummer: A 006 153 49 28 for OE number: A 006 153 49 28
		7.11190.01.0	DDS			
324 (906.733, 906.735) 190 kW (258 PS) M 272.979	06.2006→12.2013	 7.08369.61.0	ATS	EL		
		7.05270.22.0	LS	825 mm		
		7.05270.21.0	LS	600 mm		
		7.04389.02.0	SLP	EL		

SPRINTER 3,5-t Platform/Chassis (B906) 111

309 CDI (906.131, 906.133, 906.135, 906.231, 906.233,...) 65 kW (88 PS) OM 646.984	06.2006→12.2009	 7.24809.65.0	AGR	ET	
		7.08369.30.0	ATS	EL	
		7.08369.61.0	ATS	EL	
		7.08369.91.0	ATS	EL	
310 CDI (906.131, 906.133, 906.135, 906.231, 906.233,...) 70-120 kW (95-163 PS) OM 651.955	03.2009→05.2016	 7.08369.06.0	ATS	EL	













SPRINTER 3,5-t Platform/Chassis (B906) 111

		7.11020.16.0	ATS	EL	 OM 651.955: vor Katalysator in front of the catalyst Euro 6 Euro 6  OM 651.955: vor SCR-Katalysator before SCR catalytic converter Euro 6 Euro 6 Produktionsdatum bis: 24.01.2013 Production date to: 24.01.2013
		7.11020.35.0	ATS	EL	für OE-Nummer: A 000 905 88 04, A 007 153 95 28 for OE number: A 000 905 88 04, A 007 153 95 28 Katalysator Catalytic Converter
310 CDI (906.131, 906.133, 906.135, 906.231, 906.233,... 70-95 kW (95-129 PS) OM 651.956	03.2009→05.2016	 7.08369.06.0	ATS	EL	
311 CDI (906.131, 906.133, 906.135, 906.231, 906.233,... 80 kW (109 PS) OM 646.985	06.2006→12.2009	 7.24809.65.0	AGR	ET	
		7.08369.30.0	ATS	EL	
		7.08369.61.0	ATS	EL	
		7.08369.91.0	ATS	EL	vor Rußpartikelfilter before soot particulate filter Euro 3 Euro 3
311 CDI (906.131, 906.133, 906.135, 906.231, 906.233,... 70-120 kW (95-163 PS) OM 651.955	05.2016→	 7.08369.06.0	ATS	EL	
		7.11020.16.0	ATS	EL	für OE-Nummer: A 000 905 39 05, A 007 153 67 28 for OE number: A 000 905 39 05, A 007 153 67 28 vor Katalysator in front of the catalyst
311 CDI 4x4 (906.131, 906.133, 906.135, 906.231, 906.233,... 80 kW (109 PS) OM 646.985	02.2008→12.2009	 7.24809.65.0	AGR	ET	
		7.08369.30.0	ATS	EL	
		7.08369.61.0	ATS	EL	
		7.08369.91.0	ATS	EL	vor Rußpartikelfilter before soot particulate filter Euro 3 Euro 3
313 CDI (906.131, 906.133, 906.135, 906.231, 906.233,... 70-120 kW (95-163 PS) OM 651.955, OM 651.956	06.2006→05.2016	 7.08369.06.0	ATS	EL	
		7.08369.61.0	ATS	EL	

M













SPRINTER 3,5-t Platform/Chassis (B906) 111

		7.11020.16.0	ATS	EL	 OM 651.955: vor Katalysator in front of the catalyst Euro 6 Euro 6  OM 651.955: vor SCR-Katalysator before SCR catalytic converter Produktionsdatum bis: 24.01.2013 Production date to: 24.01.2013  OM 651.956: vor Katalysator in front of the catalyst  OM 651.956: vor SCR-Katalysator before SCR catalytic converter Euro 6 Euro 6 Produktionsdatum bis: 16.08.2013 Production date to: 16.08.2013		
		7.11020.35.0	ATS	EL	 OM 651.955: für OE-Nummer: A 000 905 88 04, A 007 153 95 28 for OE number: A 000 905 88 04, A 007 153 95 28 Katalysator Catalytic Converter  OM 651.956: Katalysator Catalytic Converter		
M	313 CDI (906.131, 906.133, 906.135, 906.231, 906.233,... 95-110 kW (129-150 PS) OM 646.986	06.2006→05.2016		7.24809.65.0	AGR	ET	 vor Rußpartikelfilter before soot particulate filter Euro 3 Euro 3
				7.08369.30.0	ATS	EL	
				7.08369.61.0	ATS	EL	
			7.08369.91.0	ATS	EL		
	313 CDI 4x4 (906.131, 906.133, 906.135, 906.231, 906.233... 70-120 kW (95-163 PS) OM 651.955	06.2006→05.2016		7.08369.06.0	ATS	EL	 OM 651.955: vor Katalysator in front of the catalyst Euro 6 Euro 6  OM 651.955: vor SCR-Katalysator before SCR catalytic converter Euro 6 Euro 6 Produktionsdatum bis: 16.08.2013 Production date to: 16.08.2013
				7.08369.61.0	ATS	EL	
				7.11020.16.0	ATS	EL	
			7.11020.35.0	ATS	EL	für OE-Nummer: A 000 905 88 04, A 007 153 95 28 for OE number: A 000 905 88 04, A 007 153 95 28 Katalysator Catalytic Converter	
	314 CDI (906.131, 906.133, 906.135, 906.231, 906.233,... 70-120 kW (95-163 PS) OM 651.955	05.2016→		7.08369.06.0	ATS	EL	
				7.11020.16.0	ATS	EL	
							für OE-Nummer: A 000 905 39 05, A 007 153 67 28 for OE number: A 000 905 39 05, A 007 153 67 28 vor Katalysator in front of the catalyst











SPRINTER 3,5-t Platform/Chassis (B906) 111

314 CDI 4x4 (906.131, 906.133, 906.135, 906.231, 906.233... 70-120 kW (95-163 PS) OM 651.955	05.2016→		7.08369.06.0 ATS EL	
			7.11020.16.0 ATS EL	
315 CDI (906.131, 906.133, 906.135, 906.231, 906.233,... 95-110 kW (129-150 PS) OM 646.986	06.2006→12.2009		7.24809.65.0 AGR ET 	vor Rußpartikelfilter before soot particulate filter Euro 3 Euro 3
			7.08369.30.0 ATS EL	
			7.08369.61.0 ATS EL	
			7.08369.91.0 ATS EL	
315 CDI (906.131, 906.133, 906.135, 906.231, 906.233,... 110 kW (150 PS) OM 646.989, OM 646.990	06.2006→12.2009		7.08369.30.0 ATS EL	 OM 646.989, OM 646.990: vor Rußpartikelfilter before soot particulate filter Euro 3 Euro 3
			7.08369.61.0 ATS EL	
			7.08369.91.0 ATS EL	
315 CDI 4x4 (906.131, 906.133, 906.135, 906.231, 906.233... 95-110 kW (129-150 PS) OM 646.986	02.2008→12.2009		7.24809.65.0 AGR ET 	vor Rußpartikelfilter before soot particulate filter Euro 3 Euro 3
			7.08369.61.0 ATS EL	
			7.08369.91.0 ATS EL	
315 CDI 4x4 (906.131, 906.133, 906.135, 906.231, 906.233... 110 kW (150 PS) OM 646.989, OM 646.990	02.2008→12.2009		7.08369.61.0 ATS EL	 OM 646.989, OM 646.990: vor Rußpartikelfilter before soot particulate filter Euro 3 Euro 3
			7.08369.91.0 ATS EL	
316 (906.133, 906.135, 906.233, 906.235) 115 kW (156 PS) M 271.951	09.2008→		7.05271.23.0 LS 900 mm	für OE-Nummer: A 002 540 08 17 for OE number: A 002 540 08 17
			7.05270.11.0 LS 750 mm	
316 CDI (906.131, 906.133, 906.135, 906.231, 906.233,... 70-120 kW (95-163 PS) OM 651.955, OM 651.957	03.2009→		7.08369.06.0 ATS EL	
			7.08369.30.0 ATS EL	
			7.08369.61.0 ATS EL	

M













SPRINTER 3,5-t Platform/Chassis (B906) 111

			7.11020.16.0	ATS	EL	 OM 651.955, OM 651.957: vor Katalysator in front of the catalyst Euro 6 Euro 6  OM 651.955, OM 651.957: vor SCR-Katalysator before SCR catalytic converter Euro 6 Euro 6 Produktionsdatum bis: 24.01.2013 Production date to: 24.01.2013
			7.11020.35.0	ATS	EL	 OM 651.955, OM 651.957: für OE-Nummer: A 000 905 88 04, A 007 153 95 28 for OE number: A 000 905 88 04, A 007 153 95 28 Katalysator Catalytic Converter
316 CDI 4x4 (906.131, 906.133, 906.135, 906.231, 906.233... 70-120 kW (95-163 PS) OM 651.955, OM 651.957	03.2009→		7.08369.06.0	ATS	EL	
			7.08369.30.0	ATS	EL	
			7.08369.61.0	ATS	EL	
			7.11020.16.0	ATS	EL	 OM 651.955, OM 651.957: vor Katalysator in front of the catalyst Euro 6 Euro 6  OM 651.955, OM 651.957: vor SCR-Katalysator before SCR catalytic converter Euro 6 Euro 6 Produktionsdatum bis: 16.08.2013 Production date to: 16.08.2013
			7.11020.35.0	ATS	EL	 OM 651.955, OM 651.957: für OE-Nummer: A 000 905 88 04, A 007 153 95 28 for OE number: A 000 905 88 04, A 007 153 95 28 Katalysator Catalytic Converter
316 LGT (906.133, 906.135, 906.233, 906.235) 115 kW (156 PS) M 271.951	09.2008→		7.05270.11.0	LS	750 mm	nach Katalysator Post-catalyst Euro 6b Euro 6b
			7.05270.11.0	LS	750 mm	für OE-Nummer: A 002 540 08 17 for OE number: A 002 540 08 17
318 CDI (906.131, 906.133, 906.135, 906.231, 906.233,...) 135-140 kW (184-190 PS) OM 642.896	06.2006→12.2009		7.08369.61.0	ATS	EL	
			7.08369.91.0	ATS	EL	vor Rußpartikelfilter before soot particulate filter Euro 3 Euro 3
			7.11020.28.0	ATS	EL	nach AGR-Kühler after EGR cooler
			7.11020.40.0	ATS	EL	Abgasturbolader Exhaust Turbocharger

M















SPRINTER 3,5-t Platform/Chassis (B906) 111

318 CDI (906.131, 906.133, 906.135, 906.231, 906.233,... 135-140 kW (184-190 PS) OM 642.992	06.2006→12.2009		7.24809.60.0	AGR	ET		
			7.08369.30.0	ATS	EL		→07.2009 vor Katalysator in front of the catalyst
			7.08369.61.0	ATS	EL		
			7.08369.91.0	ATS	EL		vor Rußpartikelfilter before soot particulate filter Euro 3
			7.11190.01.0	DDS			Luftfiltergehäuse Air Filter Housing
318 CDI (906.131, 906.133, 906.135, 906.231, 906.233,... 135 kW (184 PS) OM 642.993	06.2006→12.2009		7.24809.60.0	AGR	ET		
			7.08369.61.0	ATS	EL		
			7.08369.91.0	ATS	EL		vor Rußpartikelfilter before soot particulate filter Euro 3
			7.11190.01.0	DDS			Luftfiltergehäuse Air Filter Housing
318 CDI 4x4 (906.131, 906.133, 906.135, 906.231, 906.233,... 135-140 kW (184-190 PS) OM 642.896	02.2008→12.2009		7.08369.30.0	ATS	EL		
			7.08369.61.0	ATS	EL		
			7.08369.91.0	ATS	EL		vor Rußpartikelfilter before soot particulate filter
			7.11020.28.0	ATS	EL		nach AGR-Kühler after EGR cooler
			7.11020.40.0	ATS	EL		Abgasturbolader Exhaust Turbocharger
318 CDI 4x4 (906.131, 906.133, 906.135, 906.231, 906.233... 135-140 kW (184-190 PS) OM 642.992	02.2008→12.2009		7.24809.60.0	AGR	ET		
			7.08369.30.0	ATS	EL		
			7.08369.61.0	ATS	EL		
			7.08369.91.0	ATS	EL		vor Rußpartikelfilter before soot particulate filter
			7.11190.01.0	DDS			Luftfiltergehäuse Air Filter Housing
318 CDI 4x4 (906.131, 906.133, 906.135, 906.231, 906.233... 135 kW (184 PS) OM 642.993	02.2008→12.2009		7.24809.60.0	AGR	ET		
			7.08369.30.0	ATS	EL		
			7.08369.61.0	ATS	EL		
			7.08369.91.0	ATS	EL		vor Rußpartikelfilter before soot particulate filter
			7.11020.28.0	ATS	EL		für OE-Nummer: A 000 905 43 05 for OE number: A 000 905 43 05
			7.11190.01.0	DDS			Abgaskrümmer Exhaust Manifold Luftfiltergehäuse Air Filter Housing

M









SPRINTER 3,5-t Platform/Chassis (B906) 111

319 CDI / BlueTEC (906.131, 906.133, 906.135, 906.231,... 135-155 kW (184-211 PS) OM 642.896, OM 642.898	03.2009→		7.08369.30.0	ATS	EL	
			7.11020.28.0	ATS	EL	 OM 642.896, OM 642.898: nach AGR-Kühler after EGR cooler
			7.11020.35.0	ATS	EL	 OM 642.896, OM 642.898: für OE-Nummer: A 000 905 88 04, A 007 153 95 28 for OE number: A 000 905 88 04, A 007 153 95 28 Katalysator Catalytic Converter
			7.11020.40.0	ATS	EL	 OM 642.896, OM 642.898: Abgasturbolader Exhaust Turbocharger
319 CDI / BlueTEC (906.131, 906.133, 906.135, 906.231,... 135-140 kW (184-190 PS) OM 642.992	03.2009→		7.24809.60.0	AGR	ET	
			7.08369.30.0	ATS	EL	
			7.11020.35.0	ATS	EL	für OE-Nummer: A 000 905 88 04, A 007 153 95 28 for OE number: A 000 905 88 04, A 007 153 95 28 Katalysator Catalytic Converter
			7.11190.01.0	DDS		Luftfiltergehäuse Air Filter Housing
319 CDI / BlueTEC 4x4 (906.131, 906.133, 906.135,... 135-155 kW (184-211 PS) OM 642.896, OM 642.898	05.2011→		7.11020.28.0	ATS	EL	 OM 642.896, OM 642.898: nach AGR-Kühler after EGR cooler
			7.11020.35.0	ATS	EL	 OM 642.896, OM 642.898: für OE-Nummer: A 000 905 88 04, A 007 153 95 28 for OE number: A 000 905 88 04, A 007 153 95 28 Katalysator Catalytic Converter
			7.11020.40.0	ATS	EL	 OM 642.896, OM 642.898: Abgasturbolader Exhaust Turbocharger
			7.24809.60.0	AGR	ET	
319 CDI / BlueTEC 4x4 (906.131, 906.133, 906.135,... 135-140 kW (184-190 PS) OM 642.992	05.2011→		7.11020.35.0	ATS	EL	für OE-Nummer: A 000 905 88 04, A 007 153 95 28 for OE number: A 000 905 88 04, A 007 153 95 28 Katalysator Catalytic Converter
			7.11190.01.0	DDS		Luftfiltergehäuse Air Filter Housing
			7.08369.61.0	ATS	EL	
			7.05270.22.0	LS	825 mm	
324 (906.133, 906.135, 906.233, 906.235, 906.132,... 190 kW (258 PS) M 272.979	06.2006→12.2013		7.05270.21.0	LS	600 mm	
			7.04389.02.0	SLP	EL	

M























SPRINTER 3,5-t Platform/Chassis (B907, B910) 112

311 CDI RWD (907.131, 907.133, 907.135, 907.231, 907.233... 84-120 kW (114-163 PS) OM 651.958	02.2018->		7.11020.16.0	ATS	EL	vor Katalysator in front of the catalyst
			7.11020.35.0	ATS	EL	Katalysator Catalytic Converter
314 CDI All-wheel Drive (907.133, 907.135, 907.233,... 84-120 kW (114-163 PS) OM 651.958	01.2019->		7.11020.16.0	ATS	EL	vor Katalysator in front of the catalyst
			7.11020.35.0	ATS	EL	Katalysator Catalytic Converter
314 CDI RWD (907.131, 907.133, 907.135, 907.231, 907.233... 84-120 kW (114-163 PS) OM 651.958	02.2018->		7.11020.16.0	ATS	EL	vor Katalysator in front of the catalyst
			7.11020.35.0	ATS	EL	Katalysator Catalytic Converter
316 CDI All-wheel Drive (907.133, 907.135, 907.233,... 84-120 kW (114-163 PS) OM 651.958	01.2019->		7.11020.16.0	ATS	EL	vor Katalysator in front of the catalyst
			7.11020.35.0	ATS	EL	Katalysator Catalytic Converter
316 CDI RWD (907.131, 907.133, 907.135, 907.231, 907.233... 84-120 kW (114-163 PS) OM 651.958	02.2018->		7.11020.16.0	ATS	EL	vor Katalysator in front of the catalyst
			7.11020.35.0	ATS	EL	Katalysator Catalytic Converter
319 CDI All-wheel Drive (907.133, 907.135, 907.233) 140 kW (190 PS) OM 642.899	01.2019->		7.11020.28.0	ATS	EL	nach AGR-Kühler after EGR cooler
			7.11020.35.0	ATS	EL	Katalysator Catalytic Converter
			7.11020.40.0	ATS	EL	vor Abgasturbolader in front of exhaust turbocharger
319 CDI RWD (907.133, 907.135, 907.233, 907.235) 140 kW (190 PS) OM 642.899	02.2018->		7.11020.28.0	ATS	EL	nach AGR-Kühler after EGR cooler
			7.11020.35.0	ATS	EL	Katalysator Catalytic Converter
			7.11020.40.0	ATS	EL	vor Abgasturbolader in front of exhaust turbocharger

M

SPRINTER 3,5-t Tourer Bus (B907) 113









311 CDI (907.731, 907.733, 907.735) 84-120 kW (114-163 PS) OM 651.958	02.2018->		7.11020.16.0	ATS	EL	vor Katalysator in front of the catalyst
			7.11020.35.0	ATS	EL	Katalysator Catalytic Converter
314 CDI (907.731, 907.733, 907.735) 84-120 kW (114-163 PS) OM 651.958	02.2018->		7.11020.16.0	ATS	EL	vor Katalysator in front of the catalyst
			7.11020.35.0	ATS	EL	Katalysator Catalytic Converter
314 CDI All-wheel Drive (907.733) 84-120 kW (114-163 PS) OM 651.958	01.2019->		7.11020.35.0	ATS	EL	Katalysator Catalytic Converter

					
SPRINTER 3,5-t Tourer Bus (B907)					113
316 CDI (907.731, 907.733, 907.735) 84-120 kW (114-163 PS) OM 651.958	02.2018→		7.11020.16.0	ATS	EL vor Katalysator in front of the catalyst
			7.11020.35.0	ATS	EL Katalysator Catalytic Converter
316 CDI All-wheel Drive (907.733) 84-120 kW (114-163 PS) OM 651.958	01.2019→		7.11020.35.0	ATS	EL Katalysator Catalytic Converter
319 CDI (907.733, 907.735) 140 kW (190 PS) OM 642.899	02.2018→		7.11020.28.0	ATS	EL nach AGR-Kühler after EGR cooler
			7.11020.35.0	ATS	EL Katalysator Catalytic Converter
			7.11020.40.0	ATS	EL vor Abgasturbolader in front of exhaust turbocharger
319 CDI All-wheel Drive (907.733) 140 kW (190 PS) OM 642.899	01.2019→		7.11020.28.0	ATS	EL nach AGR-Kühler after EGR cooler
			7.11020.35.0	ATS	EL Katalysator Catalytic Converter
			7.11020.40.0	ATS	EL vor Abgasturbolader in front of exhaust turbocharger
SPRINTER 3,5-t Van (B906)					114
309 CDI (906.631, 906.633, 906.635, 906.637) 65 kW (88 PS) OM 646.984	06.2006→12.2009		7.24809.65.0	AGR	ET 
			7.08369.30.0	ATS	EL
			7.08369.61.0	ATS	EL
			7.08369.91.0	ATS	EL vor Rußpartikelfilter before soot particulate filter Euro 3 Euro 3
310 CDI (906.631, 906.633, 906.635, 906.637) 70-120 kW (95-163 PS) OM 651.955	03.2009→		7.08369.06.0	ATS	EL
			7.11020.16.0	ATS	EL  OM 651.955: vor Katalysator in front of the catalyst Euro 6 Euro 6  OM 651.955: vor SCR-Katalysator before SCR catalytic converter Euro 6 Euro 6 Produktionsdatum bis: 24.01.2013 Production date to: 24.01.2013
			7.11020.35.0	ATS	EL für OE-Nummer: A 000 905 88 04, A 007 153 95 28 for OE number: A 000 905 88 04, A 007 153 95 28 Katalysator Catalytic Converter
310 CDI (906.631, 906.633, 906.635, 906.637) 70-95 kW (95-129 PS) OM 651.956	03.2009→		7.08369.06.0	ATS	EL
311 CDI (906.631, 906.633, 906.635, 906.637) 80 kW (109 PS) OM 646.985	06.2006→12.2009		7.24809.65.0	AGR	ET 
			7.08369.30.0	ATS	EL
			7.08369.61.0	ATS	EL

M









SPRINTER 3,5-t Van (B906) **114**

		7.08369.91.0	ATS	EL	vor Rußpartikelfilter before soot particulate filter Euro 3 Euro 3
311 CDI (906.631, 906.633, 906.635, 906.637) 70-120 kW (95-163 PS) OM 651.955	05.2016→	 7.08369.06.0	ATS	EL	
		7.11020.16.0	ATS	EL	für OE-Nummer: A 000 905 39 05, A 007 153 67 28 for OE number: A 000 905 39 05, A 007 153 67 28 vor Katalysator in front of the catalyst
311 CDI 4x4 (906.631, 906.633, 906.635, 906.637) 80 kW (109 PS) OM 646.985	02.2008→12.2009	 7.24809.65.0	AGR	ET	
		7.08369.30.0	ATS	EL	
		7.08369.61.0	ATS	EL	
		7.08369.91.0	ATS	EL	vor Rußpartikelfilter before soot particulate filter Euro 3 Euro 3
313 CDI (906.631, 906.633, 906.635, 906.637) 95-110 kW (129-150 PS) OM 646.986	06.2006→	 7.24809.65.0	AGR	ET	
		7.08369.30.0	ATS	EL	
		7.08369.61.0	ATS	EL	
		7.08369.91.0	ATS	EL	vor Rußpartikelfilter before soot particulate filter Euro 3 Euro 3
		7.11020.16.0	ATS	EL	vor Katalysator in front of the catalyst Euro 6 Euro 6
		7.11190.01.0	DDS		Baumuster: 906.633, 906.635 Type: 906.633, 906.635 Luftfiltergehäuse Air Filter Housing
313 CDI (906.631, 906.633, 906.635, 906.637) 70-120 kW (95-163 PS) OM 651.940, OM 651.955	05.2009→	 7.08369.06.0	ATS	EL	
		7.08369.61.0	ATS	EL	
		7.11020.16.0	ATS	EL	 OM 651.940, OM 651.955: vor Katalysator in front of the catalyst Euro 6 Euro 6  OM 651.940, OM 651.955: vor SCR-Katalysator before SCR catalytic converter Euro 6 Euro 6 Produktionsdatum bis: 24.01.2013 Production date to: 24.01.2013









M



SPRINTER 3,5-t Van (B906) 114

			7.11020.35.0	ATS	EL	 OM 651.940, OM 651.955: für OE-Nummer: A 000 905 88 04, A 007 153 95 28 for OE number: A 000 905 88 04, A 007 153 95 28 Katalysator Catalytic Converter
313 CDI 4x4 (906.631, 906.633, 906.635, 906.637) 70-120 kW (95-163 PS) OM 651.955	05.2009→		7.08369.06.0	ATS	EL	
			7.08369.61.0	ATS	EL	
			7.11020.16.0	ATS	EL	
			7.11020.35.0	ATS	EL	für OE-Nummer: A 000 905 88 04, A 007 153 95 28 for OE number: A 000 905 88 04, A 007 153 95 28 Katalysator Catalytic Converter
M 314 CDI (906.631, 906.633, 906.635, 906.637) 70-120 kW (95-163 PS) OM 651.955	05.2016→		7.08369.06.0	ATS	EL	
			7.11020.16.0	ATS	EL	
314 CDI 4x4 (906.631, 906.633, 906.635, 906.637) 70-120 kW (95-163 PS) OM 651.955	05.2016→		7.08369.06.0	ATS	EL	
			7.11020.16.0	ATS	EL	
315 CDI (906.631, 906.633, 906.635, 906.637) 95-110 kW (129-150 PS) OM 646.986	06.2006→12.2009		7.24809.65.0	AGR	ET	
			7.08369.30.0	ATS	EL	vor Rußpartikelfilter before soot particulate filter Euro 3 Euro 3 Baumuster: 906.633, 906.635 Type: 906.633, 906.635 Luftfiltergehäuse Air Filter Housing
			7.08369.61.0	ATS	EL	
			7.08369.91.0	ATS	EL	
			7.11190.01.0	DDS		





SPRINTER 3,5-t Van (B906) 114

315 CDI (906.631, 906.633, 906.635, 906.637) 110 kW (150 PS) OM 646.989	06.2006→12.2009	 7.08369.30.0	ATS	EL	vor Rußpartikelfilter before soot particulate filter Euro 3 Euro 3 für OE-Nummer: A 005 153 77 28, A 006 153 49 28, A 006 153 95 28, A 007 153 61 28, A 642 904 01 00 for OE number: A 005 153 77 28, A 006 153 49 28, A 006 153 95 28, A 007 153 61 28, A 642 904 01 00 Partikelfilter Particulate Filter für OE-Nummer: A 005 153 77 28, A 006 153 49 28, A 006 153 95 28, A 007 153 61 28, A 642 904 01 00 for OE number: A 005 153 77 28, A 006 153 49 28, A 006 153 95 28, A 007 153 61 28, A 642 904 01 00 Partikelfilter Particulate Filter
		7.08369.61.0	ATS	EL	
		7.08369.91.0	ATS	EL	
		7.11190.01.0	DDS		
315 CDI (906.631, 906.633, 906.635, 906.637) 110 kW (150 PS) OM 646.990	06.2006→12.2009	 7.08369.30.0	ATS	EL	vor Rußpartikelfilter before soot particulate filter Euro 3 Euro 3
		7.08369.61.0	ATS	EL	
		7.08369.91.0	ATS	EL	
315 CDI (906.633) 70-120 kW (95-163 PS) OM 651.955	12.2014→	 7.08369.06.0	ATS	EL	
315 CDI 4x4 (906.631, 906.633, 906.635, 906.637) 95-110 kW (129-150 PS) OM 646.986	02.2008→12.2009	 7.24809.65.0	AGR	ET	
		7.08369.30.0	ATS	EL	vor Rußpartikelfilter before soot particulate filter Euro 3 Euro 3 Baumuster: 906.633, 906.635 Type: 906.633, 906.635 Luftfiltergehäuse Air Filter Housing
		7.08369.61.0	ATS	EL	
		7.08369.91.0	ATS	EL	
7.11190.01.0	DDS				
315 CDI 4x4 (906.631, 906.633, 906.635, 906.637) 110 kW (150 PS) OM 646.989, OM 646.990	02.2008→12.2009	 7.08369.30.0	ATS	EL	 OM 646.989, OM 646.990: vor Rußpartikelfilter before soot particulate filter Euro 3 Euro 3
		7.08369.61.0	ATS	EL	
		7.08369.91.0	ATS	EL	
316 (906.635, 906.633) 115 kW (156 PS) M 271.951	09.2008→	 7.05271.23.0	LS	900 mm	

M











SPRINTER 3,5-t Van (B906) 114

316 CDI (906.631, 906.633, 906.635, 906.637) 70-120 kW (95-163 PS) OM 651.955, OM 651.957	03.2009→		7.08369.30.0 ATS EL	OM 651.955, OM 651.957: vor Katalysator in front of the catalyst Euro 6 Euro 6 OM 651.955, OM 651.957: vor SCR-Katalysator before SCR catalytic converter Euro 6 Euro 6 Produktionsdatum bis: 24.01.2013 Production date to: 24.01.2013 OM 651.955, OM 651.957: für OE-Nummer: A 000 905 88 04, A 007 153 95 28 for OE number: A 000 905 88 04, A 007 153 95 28 Katalysator Catalytic Converter
			7.08369.06.0 ATS EL	
			7.08369.61.0 ATS EL	
			7.11020.16.0 ATS EL	
316 CDI 4x4 (906.631, 906.633, 906.635, 906.637) 70-120 kW (95-163 PS) OM 651.955, OM 651.957	03.2009→		7.08369.06.0 ATS EL	OM 651.955, OM 651.957: vor Katalysator in front of the catalyst Euro 6 Euro 6 OM 651.955, OM 651.957: vor SCR-Katalysator before SCR catalytic converter Euro 6 Euro 6 Produktionsdatum bis: 24.01.2013 Production date to: 24.01.2013 OM 651.955, OM 651.957: für OE-Nummer: A 000 905 88 04, A 007 153 95 28 for OE number: A 000 905 88 04, A 007 153 95 28 Katalysator Catalytic Converter
			7.08369.61.0 ATS EL	
			7.11020.16.0 ATS EL	
			7.11020.35.0 ATS EL	
318 CDI (906.631, 906.633, 906.635, 906.637) 135-140 kW (184-190 PS) OM 642.896	06.2006→12.2009		7.08369.30.0 ATS EL	vor Rußpartikelfilter before soot particulate filter nach AGR-Kühler after EGR cooler Abgasturbolader Exhaust Turbocharger
			7.08369.61.0 ATS EL	
			7.08369.91.0 ATS EL	
			7.11020.28.0 ATS EL	
			7.11020.40.0 ATS EL	
318 CDI (906.631, 906.633, 906.635, 906.637) 135-140 kW (184-190 PS) OM 642.986	06.2006→12.2009		7.08369.30.0 ATS EL	
			7.08369.61.0 ATS EL	

M











SPRINTER 3,5-t Van (B906) **114**

		7.11190.01.0	DDS		Baumuster: 906.633, 906.635 Type: 906.633, 906.635 Luftfiltergehäuse Air Filter Housing	
318 CDI (906.631, 906.633, 906.635, 906.637) 135-140 kW (184-190 PS) OM 642.992	06.2006→12.2009	 7.24809.60.0	AGR	ET		
			7.08369.30.0	ATS	EL	
			7.08369.61.0	ATS	EL	
			7.08369.91.0	ATS	EL	vor Rußpartikelfilter before soot particulate filter
		7.11190.01.0	DDS		für OE-Nummer: A 006 153 49 28 for OE number: A 006 153 49 28 Luftfiltergehäuse Air Filter Housing	
318 CDI (906.631, 906.633, 906.635, 906.637) 135 kW (184 PS) OM 642.993	06.2006→12.2009	 7.24809.60.0	AGR	ET		
			7.08369.30.0	ATS	EL	
			7.08369.61.0	ATS	EL	
			7.08369.91.0	ATS	EL	vor Rußpartikelfilter before soot particulate filter
		7.11020.28.0	ATS	EL	für OE-Nummer: A 000 905 43 05 for OE number: A 000 905 43 05 Abgaskrümmer Exhaust Manifold	
		7.11190.01.0	DDS		für OE-Nummer: A 006 153 49 28 for OE number: A 006 153 49 28 Luftfiltergehäuse Air Filter Housing	
318 CDI 4x4 (906.631, 906.633, 906.635, 906.637) 135-140 kW (184-190 PS) OM 642.896	02.2008→12.2009	 7.08369.30.0	ATS	EL		
			7.08369.61.0	ATS	EL	
			7.08369.91.0	ATS	EL	vor Rußpartikelfilter before soot particulate filter
			7.11020.28.0	ATS	EL	nach AGR-Kühler after EGR cooler
		7.11020.40.0	ATS	EL	Abgasturbolader Exhaust Turbocharger	
318 CDI 4x4 (906.631, 906.633, 906.635, 906.637) 135-140 kW (184-190 PS) OM 642.986	02.2008→12.2009	 7.08369.30.0	ATS	EL		
			7.08369.61.0	ATS	EL	
			7.08369.91.0	ATS	EL	vor Rußpartikelfilter before soot particulate filter
			7.11190.01.0	DDS		Baumuster: 906.633, 906.635 Type: 906.633, 906.635 Luftfiltergehäuse Air Filter Housing
		7.11190.01.0	DDS		Baumuster: 906.633, 906.635 Type: 906.633, 906.635 Luftfiltergehäuse Air Filter Housing	
318 CDI 4x4 (906.631, 906.633, 906.635, 906.637) 135-140 kW (184-190 PS) OM 642.992	02.2008→12.2009	 7.24809.60.0	AGR	ET		
			7.08369.30.0	ATS	EL	

M









SPRINTER 3,5-t Van (B906) 114

			<p>7.08369.61.0 ATS EL</p> <p>7.08369.91.0 ATS EL</p> <p>7.11190.01.0 DDS</p>		<p>vor Rußpartikelfilter before soot particulate filter für OE-Nummer: A 006 153 49 28 for OE number: A 006 153 49 28 Luftfiltergehäuse Air Filter Housing</p>
<p>318 CDI 4x4 (906.631, 906.633, 906.635, 906.637) 135 kW (184 PS) OM 642.993</p>	<p>02.2008→12.2009</p>		<p>7.24809.60.0 AGR ET </p>		
			<p>7.08369.30.0 ATS EL</p> <p>7.08369.61.0 ATS EL</p> <p>7.08369.91.0 ATS EL</p>	<p>vor Rußpartikelfilter before soot particulate filter</p>	
			<p>7.11020.28.0 ATS EL</p>	<p>für OE-Nummer: A 000 905 43 05 for OE number: A 000 905 43 05 Abgaskrümmen Exhaust Manifold</p>	
			<p>7.11190.01.0 DDS</p>	<p>für OE-Nummer: A 006 153 49 28 for OE number: A 006 153 49 28 Luftfiltergehäuse Air Filter Housing</p>	
<p>319 CDI / BlueTEC (906.631, 906.633, 906.635, 906.637) 135-155 kW (184-211 PS) OM 642.896, OM 642.898</p>	<p>03.2009→</p>		<p>7.08369.30.0 ATS EL</p>		
			<p>7.11020.28.0 ATS EL </p>	<p>OM 642.896, OM 642.898: nach AGR-Kühler after EGR cooler</p>	
			<p>7.11020.35.0 ATS EL </p>	<p>OM 642.896, OM 642.898: für OE-Nummer: A 000 905 88 04, A 007 153 95 28 for OE number: A 000 905 88 04, A 007 153 95 28 Katalysator Catalytic Converter</p>	
			<p>7.11020.40.0 ATS EL </p>	<p>OM 642.896, OM 642.898: Abgasturbolader Exhaust Turbocharger</p>	
<p>319 CDI / BlueTEC (906.631, 906.633, 906.635, 906.637) 135-140 kW (184-190 PS) OM 642.986</p>	<p>03.2009→</p>		<p>7.08369.30.0 ATS EL</p>		
			<p>7.11020.35.0 ATS EL</p>	<p>für OE-Nummer: A 000 905 88 04, A 007 153 95 28 for OE number: A 000 905 88 04, A 007 153 95 28 Katalysator Catalytic Converter</p>	
<p>319 CDI / BlueTEC (906.631, 906.633, 906.635, 906.637) 135-140 kW (184-190 PS) OM 642.992</p>	<p>03.2009→</p>		<p>7.24809.60.0 AGR ET </p>		
			<p>7.08369.30.0 ATS EL</p> <p>7.11020.35.0 ATS EL</p>	<p>für OE-Nummer: A 000 905 88 04, A 007 153 95 28 for OE number: A 000 905 88 04, A 007 153 95 28 Katalysator Catalytic Converter</p>	
			<p>7.11190.01.0 DDS</p>	<p>für OE-Nummer: A 006 153 49 28 for OE number: A 006 153 49 28 Luftfiltergehäuse Air Filter Housing</p>	

M









SPRINTER 3,5-t Van (B906) 114

319 CDI / BlueTEC 4x4 (906.631, 906.633, 906.635,... 135-155 kW (184-211 PS) OM 642.896, OM 642.898	03.2009→		7.11020.28.0 ATS EL  OM 642.896, OM 642.898: nach AGR-Kühler after EGR cooler
			7.11020.35.0 ATS EL  OM 642.896, OM 642.898: für OE-Nummer: A 000 905 88 04, A 007 153 95 28 for OE number: A 000 905 88 04, A 007 153 95 28 Katalysator Catalytic Converter
			7.11020.40.0 ATS EL  OM 642.896, OM 642.898: Abgasturbolader Exhaust Turbocharger
319 CDI / BlueTEC 4x4 (906.631, 906.633, 906.635,... 135-140 kW (184-190 PS) OM 642.992	03.2009→		7.24809.60.0 AGR ET 
			7.11020.35.0 ATS EL für OE-Nummer: A 000 905 88 04, A 007 153 95 28 for OE number: A 000 905 88 04, A 007 153 95 28 Katalysator Catalytic Converter
			7.11190.01.0 DDS für OE-Nummer: A 006 153 49 28 for OE number: A 006 153 49 28 Luftfiltergehäuse Air Filter Housing
324 (906.633, 906.635, 906.637) 190 kW (258 PS) M 272.979	06.2006→12.2013		7.08369.61.0 ATS EL
			7.05270.22.0 LS 825 mm
			7.05270.21.0 LS 600 mm
			7.04389.02.0 SLP EL

M

SPRINTER 3,5-t Van (B907, B910) 115













311 CDI RWD (907.633, 907.635, 907.631, 907.637) 84-120 kW (114-163 PS) OM 651.958	02.2018→		7.11020.16.0 ATS EL vor Katalysator in front of the catalyst
			7.11020.35.0 ATS EL Katalysator Catalytic Converter
314 CDI All-wheel Drive (907.633, 907.635, 907.637) 84-120 kW (114-163 PS) OM 651.958	01.2019→		7.11020.35.0 ATS EL Katalysator Catalytic Converter
			7.11020.35.0 ATS EL Katalysator Catalytic Converter
314 CDI RWD (907.631, 907.633, 907.635, 907.637) 84-120 kW (114-163 PS) OM 651.958	02.2018→		7.11020.35.0 ATS EL Katalysator Catalytic Converter
			7.11020.35.0 ATS EL Katalysator Catalytic Converter
316 CDI All-wheel Drive (907.633, 907.635, 907.637) 84-120 kW (114-163 PS) OM 651.958	01.2019→		7.11020.35.0 ATS EL Katalysator Catalytic Converter
			7.11020.35.0 ATS EL Katalysator Catalytic Converter
316 CDI RWD (907.631, 907.633, 907.635, 907.637) 84-120 kW (114-163 PS) OM 651.958	02.2018→		7.11020.35.0 ATS EL Katalysator Catalytic Converter
			7.11020.35.0 ATS EL Katalysator Catalytic Converter
319 CDI All-wheel Drive (907.633, 907.635, 907.637) 140 kW (190 PS) OM 642.899	01.2019→		7.11020.28.0 ATS EL nach AGR-Kühler after EGR cooler
			7.11020.28.0 ATS EL nach AGR-Kühler after EGR cooler



SPRINTER 3,5-t Van (B907, B910) 115

			7.11020.35.0	ATS	EL	Katalysator Catalytic Converter
			7.11020.40.0	ATS	EL	vor Abgasturbolader in front of exhaust turbocharger
319 CDI RWD (907.633, 907.635, 907.637) 140 kW (190 PS) OM 642.899	02.2018→		7.11020.28.0	ATS	EL	nach AGR-Kühler after EGR cooler
			7.11020.35.0	ATS	EL	Katalysator Catalytic Converter
			7.11020.40.0	ATS	EL	vor Abgasturbolader in front of exhaust turbocharger













SPRINTER 3-t Bus (B903) 116

308 CDI 60 kW (82 PS) OM 611.987	04.2000→05.2006		7.24809.34.0	AGR	PN	
			7.24809.35.0	AGR	PN	 →50 030773 für OE-Nummer: 611 090 02 54 for OE number: 611 090 02 54
311 CDI 80-95 kW (109-129 PS) OM 611.981	04.2000→05.2006		7.24809.34.0	AGR	PN	
			7.24809.35.0	AGR	PN	 →50 030772 für OE-Nummer: 611 090 02 54 for OE number: 611 090 02 54
311 CDI 4x4 80-95 kW (109-129 PS) OM 611.981	08.2002→05.2006		7.24809.34.0	AGR	PN	
			7.24809.35.0	AGR	PN	 →50 030772 für OE-Nummer: 611 090 02 54 for OE number: 611 090 02 54
313 CDI 80-95 kW (109-129 PS) OM 611.981	04.2000→05.2006		7.24809.34.0	AGR	PN	
			7.24809.35.0	AGR	PN	 →50 030772 für OE-Nummer: 611 090 02 54 for OE number: 611 090 02 54
313 CDI 4x4 80-95 kW (109-129 PS) OM 611.981	08.2002→05.2006		7.24809.34.0	AGR	PN	
			7.24809.35.0	AGR	PN	 →50 030772 für OE-Nummer: 611 090 02 54 for OE number: 611 090 02 54
314 (903.071, 903.072, 903.073, 903.671, 903.672,... 92-105 kW (125-143 PS) M 111.984	02.1995→05.2006		7.05270.03.0	LS	820 mm	Regelsonde Regulating Probe
			7.04389.05.0	SLP	EL	
314 4x4 92-105 kW (125-143 PS) M 111.984	08.2002→05.2006		7.05270.03.0	LS	820 mm	Regelsonde Regulating Probe
			7.04389.05.0	SLP	EL	
316 CDI 110-115 kW (150-156 PS) OM 612.981	04.2000→05.2006		7.24809.54.0	AGR	ET	
316 CDI 4x4 110-115 kW (150-156 PS) OM 612.981	08.2002→05.2006		7.24809.54.0	AGR	ET	

M









SPRINTER 3-t Bus (B906) **117**

<p>210 CDI (906.711, 906.713) 70-120 kW (95-163 PS) OM 651.955</p>	<p>03.2009→12.2013</p>	 <p>7.08369.30.0 7.08369.06.0 7.11020.16.0</p>	<p>ATS ATS ATS</p>	<p>EL →10.2012 für Katalysator for catalytic converter EL EL  OM 651.955: vor Katalysator in front of the catalyst Euro 6 Euro 6  OM 651.955: vor SCR-Katalysator before SCR catalytic converter Euro 6 Euro 6 Produktionsdatum bis: 01.06.2013 Production date to: 01.06.2013</p>
<p>211 CDI (906.711, 906.713) 80 kW (109 PS) OM 646.985</p>	<p>06.2006→12.2009</p>	 <p>7.24809.65.0 7.08369.30.0 7.08369.61.0 7.08369.91.0</p>	<p>AGR ATS ATS ATS</p>	<p>ET  EL EL EL vor Rußpartikelfilter before soot particulate filter Euro 3 Euro 3</p>
<p>211 CDI (906.711, 906.713) 70-120 kW (95-163 PS) OM 651.955</p>	<p>04.2016→</p>	 <p>7.08369.06.0 7.11020.16.0</p>	<p>ATS ATS</p>	<p>EL EL vor Katalysator in front of the catalyst Euro 6, Euro 5b Euro 6, Euro 5b Produktionsdatum ab: 30.01.2016 Production date from: 30.01.2016</p>
<p>213 CDI (906.711, 906.713) 70-120 kW (95-163 PS) OM 651.955</p>	<p>06.2006→05.2016</p>	 <p>7.08369.06.0 7.08369.30.0 7.08369.61.0 7.11020.16.0 7.11020.35.0</p>	<p>ATS ATS ATS ATS ATS</p>	<p>EL EL EL EL  OM 651.955: vor Katalysator in front of the catalyst Euro 6 Euro 6  OM 651.955: vor SCR-Katalysator before SCR catalytic converter Euro 6 Euro 6 Produktionsdatum bis: 01.06.2013 Production date to: 01.06.2013 EL für OE-Nummer: A 000 905 88 04, A 007 153 95 28 for OE number: A 000 905 88 04, A 007 153 95 28 Katalysator Catalytic Converter</p>
<p>214 CDI (906.711, 906.713) 70-120 kW (95-163 PS) OM 651.955</p>	<p>04.2016→</p>	 <p>7.08369.06.0</p>	<p>ATS</p>	<p>EL</p>
<p>215 CDI (906.711, 906.713) 95-110 kW (129-150 PS) OM 646.986</p>	<p>06.2006→12.2009</p>	 <p>7.24809.65.0 7.08369.30.0 7.08369.61.0</p>	<p>AGR ATS ATS</p>	<p>ET  EL EL</p>

M















SPRINTER 3-t Bus (B906) 117

			7.08369.91.0	ATS	EL	vor Rußpartikelfilter before soot particulate filter Euro 3 Euro 3
215 CDI (906.711, 906.713) 110 kW (150 PS) OM 646.989, OM 646.990	06.2006→12.2009		7.08369.30.0	ATS	EL	
			7.08369.61.0	ATS	EL	
			7.08369.91.0	ATS	EL	 OM 646.989, OM 646.990: vor Rußpartikelfilter before soot particulate filter Euro 3 Euro 3
216 (906.713) 115 kW (156 PS) M 271.951	09.2008→		7.05271.23.0	LS	900 mm	
216 CDI (906.711, 906.713) 70-120 kW (95-163 PS) OM 651.955, OM 651.957	06.2006→		7.08369.06.0	ATS	EL	
			7.11020.16.0	ATS	EL	 OM 651.955, OM 651.957: vor Katalysator in front of the catalyst Euro 6 Euro 6  OM 651.955, OM 651.957: vor SCR-Katalysator before SCR catalytic converter Euro 6 Euro 6 Produktionsdatum bis: 01.06.2013 Production date to: 01.06.2013
224 (906.713) 190 kW (258 PS) M 272.979	06.2006→12.2013		7.08369.61.0	ATS	EL	
			7.05270.22.0	LS	825 mm	
			7.05270.21.0	LS	600 mm	
			7.04389.02.0	SLP	EL	









M

SPRINTER 3-t Platform/Chassis (B903) 118







308 CDI 60 kW (82 PS) OM 611.987	04.2000→05.2006		7.24809.34.0	AGR	PN	
			7.24809.35.0	AGR	PN	 →50 030773 für OE-Nummer: 611 090 02 54 for OE number: 611 090 02 54
311 CDI 80-95 kW (109-129 PS) OM 611.981	04.2000→05.2006		7.24809.34.0	AGR	PN	
			7.24809.35.0	AGR	PN	 →50 030772 für OE-Nummer: 611 090 02 54 for OE number: 611 090 02 54
311 CDI 4x4 80-95 kW (109-129 PS) OM 611.981	04.2000→05.2006		7.24809.34.0	AGR	PN	
			7.24809.35.0	AGR	PN	 →50 030772 für OE-Nummer: 611 090 02 54 for OE number: 611 090 02 54
313 CDI 80-95 kW (109-129 PS) OM 611.981	04.2000→05.2006		7.24809.34.0	AGR	PN	
			7.24809.35.0	AGR	PN	 →50 030772 für OE-Nummer: 611 090 02 54 for OE number: 611 090 02 54



SPRINTER 3-t Platform/Chassis (B903) 118

313 CDI 4x4 80-95 kW (109-129 PS) OM 611.981	04.2000→05.2006		7.24809.34.0	AGR	PN	
			7.24809.35.0	AGR	PN	 →50 030772 für OE-Nummer: 611 090 02 54 for OE number: 611 090 02 54
314 (903.011, 903.012, 903.013, 903.022, 903.611,...) 92-105 kW (125-143 PS) M 111.984	02.1995→05.2006		7.05270.03.0	LS	820 mm	Regelsonde Regulating Probe
			7.04389.05.0	SLP	EL	
314 4x4 92-105 kW (125-143 PS) M 111.984	08.2002→05.2006		7.05270.03.0	LS	820 mm	Regelsonde Regulating Probe
			7.04389.05.0	SLP	EL	
316 CDI 110-115 kW (150-156 PS) OM 612.981	04.2000→05.2006		7.24809.54.0	AGR	ET	
316 CDI 4x4 110-115 kW (150-156 PS) OM 612.981	08.2002→05.2006		7.24809.54.0	AGR	ET	









SPRINTER 3-t Platform/Chassis (B906) 119

209 CDI (906.111, 906.113, 906.211, 906.213) 65 kW (88 PS) OM 646.984	06.2006→12.2009		7.24809.65.0	AGR	ET	
			7.08369.30.0	ATS	EL	
			7.08369.61.0	ATS	EL	
			7.08369.91.0	ATS	EL	Baumuster: 906.211, 906.213 Type: 906.211, 906.213 vor Rußpartikelfilter before soot particulate filter Euro 3 Euro 3
210 CDI (906.111, 906.113, 906.211, 906.213) 70-120 kW (95-163 PS) OM 651.955	03.2009→05.2016		7.08369.06.0	ATS	EL	
			7.08369.30.0	ATS	EL	
			7.11020.16.0	ATS	EL	 OM 651.955: vor Katalysator in front of the catalyst Euro 6 Euro 6  OM 651.955: vor SCR-Katalysator before SCR catalytic converter Euro 6 Euro 6 Produktionsdatum bis: 16.08.2013 Production date to: 16.08.2013
			7.11020.35.0	ATS	EL	für OE-Nummer: A 000 905 88 04, A 007 153 95 28 for OE number: A 000 905 88 04, A 007 153 95 28 Katalysator Catalytic Converter
211 CDI (906.111, 906.113, 906.211, 906.213) 80 kW (109 PS) OM 646.985	06.2006→12.2009		7.24809.65.0	AGR	ET	
			7.08369.30.0	ATS	EL	
			7.08369.61.0	ATS	EL	

M







SPRINTER 3-t Platform/Chassis (B906) 119















			7.08369.91.0	ATS	EL	Baumuster: 906.211, 906.2013 Type: 906.211, 906.2013 vor Rußpartikelfilter before soot particulate filter Euro 3 Euro 3
211 CDI (906.111, 906.113, 906.211, 906.213) 70-120 kW (95-163 PS) OM 651.955	04.2016→		7.08369.06.0	ATS	EL	
			7.11020.16.0	ATS	EL	vor Katalysator in front of the catalyst Euro 6, Euro 5b Euro 6, Euro 5b Produktionsdatum ab: 30.01.2016 Production date from: 30.01.2016
213 CDI (906.111, 906.113, 906.211, 906.213) 95-110 kW (129-150 PS) OM 646.986	06.2006→12.2009		7.24809.65.0	AGR	ET	
			7.08369.30.0	ATS	EL	
			7.08369.61.0 7.08369.91.0	ATS ATS	EL EL	Baumuster: 906.211, 906.213 Type: 906.211, 906.213 vor Rußpartikelfilter before soot particulate filter Euro 3 Euro 3
M 213 CDI (906.111, 906.113, 906.211, 906.213) 70-120 kW (95-163 PS) OM 651.955, OM 651.957	03.2009→05.2016		7.08369.06.0	ATS	EL	
			7.08369.30.0	ATS	EL	
			7.08369.61.0	ATS	EL	
			7.11020.16.0	ATS	EL	 OM 651.955, OM 651.957: vor Katalysator in front of the catalyst Euro 6 Euro 6  OM 651.955, OM 651.957: vor SCR-Katalysator before SCR catalytic converter Euro 6 Euro 6 Produktionsdatum bis: 16.08.2013 Production date to: 16.08.2013
			7.11020.35.0	ATS	EL	 OM 651.955, OM 651.957: für OE-Nummer: A 000 905 88 04, A 007 153 95 28 for OE number: A 000 905 88 04, A 007 153 95 28 Katalysator Catalytic Converter
214 CDI (906.111, 906.113, 906.211, 906.213) 70-120 kW (95-163 PS) OM 651.955	04.2016→		7.08369.06.0	ATS	EL	
			7.11020.16.0	ATS	EL	vor Katalysator in front of the catalyst Euro 6, Euro 5b Euro 6, Euro 5b Produktionsdatum ab: 30.01.2016 Production date from: 30.01.2016































SPRINTER 3-t Platform/Chassis (B906) 119

<p>215 CDI (906.111, 906.113, 906.211, 906.213) 95-110 kW (129-150 PS) OM 646.986</p>	<p>06.2006→12.2009</p>	<p>7.24809.65.0 </p> <p>7.08369.30.0</p> <p>7.08369.61.0</p> <p>7.08369.91.0</p>	<p>AGR</p> <p>ET</p> <p>ATS</p> <p>ATS</p> <p>ATS</p>	<p>EL</p> <p>EL</p> <p>EL</p> <p>Baumuster: 906.211, 906.213 Type: 906.211, 906.213 vor Rußpartikelfilter before soot particulate filter Euro 3 Euro 3</p>
<p>215 CDI (906.111, 906.113, 906.211, 906.213) 110 kW (150 PS) OM 646.989, OM 646.990</p>	<p>06.2006→12.2009</p>	<p>7.08369.30.0 </p> <p>7.08369.61.0</p> <p>7.08369.91.0</p>	<p>ATS</p> <p>ATS</p> <p>ATS</p>	<p>EL</p> <p>EL</p> <p>EL</p> <p>OM 646.989, OM 646.990: Baumuster: 906.211, 906.213 Type: 906.211, 906.213 vor Rußpartikelfilter before soot particulate filter Euro 3 Euro 3</p>
<p>216 (906.113, 906.213) 115 kW (156 PS) M 271.951</p>	<p>09.2008→05.2016</p>	<p>7.05271.23.0 </p> <p>7.05270.11.0</p>	<p>LS</p> <p>LS</p>	<p>900 mm</p> <p>750 mm</p> <p>nach Katalysator Post-catalyst Euro 6b Euro 6b</p>
<p>216 CDI (906.111, 906.113, 906.211, 906.213) 85-120 kW (116-163 PS) OM 651.957</p>	<p>03.2009→</p>	<p>7.08369.06.0 </p> <p>7.08369.30.0</p> <p>7.11020.16.0</p> <p>7.11020.35.0</p>	<p>ATS</p> <p>ATS</p> <p>ATS</p> <p>ATS</p>	<p>EL</p> <p>EL</p> <p>EL</p> <p>EL</p> <p>OM 651.957: vor Katalysator in front of the catalyst Euro 6 Euro 6 OM 651.957: vor SCR-Katalysator before SCR catalytic converter Euro 6 Euro 6 Produktionsdatum bis: 16.03.2013 Production date to: 16.03.2013 für OE-Nummer: A 000 905 88 04, A 007 153 95 28 for OE number: A 000 905 88 04, A 007 153 95 28 Katalysator Catalytic Converter</p>
<p>218 CDI (906.111, 906.113, 906.211, 906.213) 135-140 kW (184-190 PS) OM 642.896</p>	<p>06.2006→12.2009</p>	<p>7.08369.30.0 </p> <p>7.08369.61.0</p> <p>7.08369.91.0</p> <p>7.11020.28.0</p> <p>7.11020.40.0</p>	<p>ATS</p> <p>ATS</p> <p>ATS</p> <p>ATS</p> <p>ATS</p>	<p>EL</p> <p>EL</p> <p>EL</p> <p>EL</p> <p>EL</p> <p>Baumuster: 906.211, 906.213 Type: 906.211, 906.213 vor Rußpartikelfilter before soot particulate filter nach AGR-Kühler after EGR cooler Abgasturbolader Exhaust Turbocharger</p>





















M

					
SPRINTER 3-t Platform/Chassis (B906)					
218 CDI (906.111, 906.113, 906.211, 906.213) 135-140 kW (184-190 PS) OM 642.992	06.2006→12.2009		7.24809.60.0	AGR	ET 
			7.08369.30.0	ATS	EL
			7.08369.61.0	ATS	EL
			7.08369.91.0	ATS	EL
Baumuster: 906.211, 906.213 Type: 906.211, 906.213 vor Rußpartikelfilter before soot particulate filter Luftfiltergehäuse Air Filter Housing					
218 CDI (906.111, 906.113, 906.211, 906.213) 135 kW (184 PS) OM 642.993	06.2006→12.2009		7.24809.60.0	AGR	ET 
			7.08369.30.0	ATS	EL
			7.08369.61.0	ATS	EL
			7.08369.91.0	ATS	EL
			7.11020.28.0	ATS	EL
Baumuster: 906.211, 906.213 Type: 906.211, 906.213 vor Rußpartikelfilter before soot particulate filter für OE-Nummer: A 000 905 43 05 for OE number: A 000 905 43 05 Abgaskrümmer Exhaust Manifold für OE-Nummer: A 006 153 49 28 for OE number: A 006 153 49 28 Luftfiltergehäuse Air Filter Housing für OE-Nummer: A 006 153 49 28 for OE number: A 006 153 49 28 Luftfiltergehäuse Air Filter Housing					
219 CDI / BlueTEC (906.111, 906.113, 906.211, 906.213) 135-140 kW (184-190 PS) OM 642.896	03.2009→05.2016		7.11020.28.0	ATS	EL nach AGR-Kühler after EGR cooler
			7.11020.35.0	ATS	EL für OE-Nummer: A 000 905 88 04, A 007 153 95 28 for OE number: A 000 905 88 04, A 007 153 95 28 Katalysator Catalytic Converter
			7.11020.40.0	ATS	EL Abgasturbolader Exhaust Turbocharger
219 CDI / BlueTEC (906.111, 906.113, 906.211, 906.213) 135-140 kW (184-190 PS) OM 642.992	03.2009→05.2016		7.24809.60.0	AGR	ET 
			7.11020.35.0	ATS	EL für OE-Nummer: A 000 905 88 04, A 007 153 95 28 for OE number: A 000 905 88 04, A 007 153 95 28 Katalysator Catalytic Converter
			7.11190.01.0	DDS	Luftfiltergehäuse Air Filter Housing
224 (906.113, 906.213) 190 kW (258 PS) M 272.979	06.2006→12.2013		7.08369.61.0	ATS	EL
			7.05270.22.0	LS	825 mm

M

					
SPRINTER 3-t Platform/Chassis (B906)					119
			7.05270.21.0	LS	600 mm
			7.04389.02.0	SLP	EL
SPRINTER 3-t Platform/Chassis (B910, B907)					120
211 CDI RWD (907.123, 907.221, 907.223) 84-120 kW (114-163 PS) OM 651.958	02.2018→		7.11020.16.0	ATS	EL vor Katalysator in front of the catalyst
214 CDI RWD (907.221, 907.223) 84-120 kW (114-163 PS) OM 651.958	02.2018→		7.11020.35.0	ATS	EL Katalysator Catalytic Converter
216 CDI RWD (907.221, 907.223) 84-120 kW (114-163 PS) OM 651.958	02.2018→		7.11020.35.0	ATS	EL Katalysator Catalytic Converter
SPRINTER 3-t Tourer Bus (B907)					121
211 CDI (907.721, 907.723) 84-120 kW (114-163 PS) OM 651.958	02.2018→		7.11020.16.0	ATS	EL
			7.11020.35.0	ATS	EL
214 CDI (907.721, 907.723) 84-120 kW (114-163 PS) OM 651.958	02.2018→		7.11020.35.0	ATS	EL
SPRINTER 3-t Van (B903)					122
308 CDI 60 kW (82 PS) OM 611.987	04.2000→05.2006		7.24809.34.0	AGR	PN 
			7.24809.35.0	AGR	PN  →50 030773 für OE-Nummer: 611 090 02 54 for OE number: 611 090 02 54
311 CDI 80-95 kW (109-129 PS) OM 611.981	04.2000→05.2006		7.24809.34.0	AGR	PN 
			7.24809.35.0	AGR	PN  →50 030772 für OE-Nummer: 611 090 02 54 for OE number: 611 090 02 54
311 CDI 4x4 80-95 kW (109-129 PS) OM 611.981	08.2002→05.2006		7.24809.34.0	AGR	PN 
			7.24809.35.0	AGR	PN  →50 030772 für OE-Nummer: 611 090 02 54 for OE number: 611 090 02 54
313 CDI (903.663, 903.662, 903.661) 80-95 kW (109-129 PS) OM 611.981	04.2000→05.2006		7.24809.34.0	AGR	PN 
			7.24809.35.0	AGR	PN  →50 030772 für OE-Nummer: 611 090 02 54 for OE number: 611 090 02 54
313 CDI 4x4 80-95 kW (109-129 PS) OM 611.981	08.2002→05.2006		7.24809.34.0	AGR	PN 
			7.24809.35.0	AGR	PN  →50 030772 für OE-Nummer: 611 090 02 54 for OE number: 611 090 02 54
314 92-105 kW (125-143 PS) M 111.984	02.1995→05.2006		7.05270.03.0	LS	820 mm Regelsonde Regulating Probe
			7.04389.05.0	SLP	EL
314 4x4 92-105 kW (125-143 PS) M 111.984	08.2002→05.2006		7.05270.03.0	LS	820 mm Regelsonde Regulating Probe







M

					
SPRINTER 3-t Van (B903)					122
			7.04389.05.0	SLP	EL
316 CDI 110-115 kW (150-156 PS) OM 612.981	04.2000→05.2006		7.24809.54.0	AGR	ET 
316 CDI 4x4 110-115 kW (150-156 PS) OM 612.981	02.2001→05.2006		7.24809.54.0	AGR	ET 
SPRINTER 3-t Van (B906)					123
209 CDI (906.611, 906.613) 65 kW (88 PS) OM 646.984	06.2006→12.2009		7.24809.65.0	AGR	ET 
			7.08369.30.0	ATS	EL
			7.08369.61.0	ATS	EL
			7.08369.91.0	ATS	EL vor Rußpartikelfilter before soot particulate filter Euro 3 Euro 3
210 CDI (906.611, 906.613) 70-120 kW (95-163 PS) OM 651.955	03.2009→		7.08369.06.0	ATS	EL
			7.11020.16.0	ATS	EL  OM 651.955: vor Katalysator in front of the catalyst Euro 6 Euro 6  OM 651.955: vor SCR-Katalysator before SCR catalytic converter Euro 6 Euro 6 Produktionsdatum bis: 24.01.2013 Production date to: 24.01.2013
			7.11020.35.0	ATS	EL für OE-Nummer: A 000 905 88 04, A 007 153 95 28 for OE number: A 000 905 88 04, A 007 153 95 28 Katalysator Catalytic Converter
211 CDI (906.611, 906.613) 80 kW (109 PS) OM 646.985	06.2006→12.2009		7.24809.65.0	AGR	ET 
			7.08369.30.0	ATS	EL
			7.08369.61.0	ATS	EL
			7.08369.91.0	ATS	EL vor Rußpartikelfilter before soot particulate filter Euro 3 Euro 3
211 CDI (906.611, 906.613) 70-120 kW (95-163 PS) OM 651.955	04.2016→		7.08369.06.0	ATS	EL
			7.08369.30.0	ATS	EL
			7.11020.16.0	ATS	EL für OE-Nummer: A 000 905 39 05, A 007 153 67 28 for OE number: A 000 905 39 05, A 007 153 67 28 vor Katalysator in front of the catalyst
213 CDI (906.611, 906.613) 95-110 kW (129-150 PS) OM 646.986	06.2006→12.2009		7.24809.65.0	AGR	ET 
			7.08369.30.0	ATS	EL
			7.08369.61.0	ATS	EL
			7.08369.91.0	ATS	EL vor Rußpartikelfilter before soot particulate filter Euro 3 Euro 3

M













SPRINTER 3-t Van (B906) **123**

213 CDI (906.611, 906.613) 70-120 kW (95-163 PS) OM 651.955, OM 651.957	06.2006→		7.08369.06.0	ATS	EL	OM 651.955, OM 651.957: vor Katalysator in front of the catalystr Euro 6 OM 651.955, OM 651.957: vor SCR-Katalysator before SCR catalytic converter Euro 6 Produktionsdatum bis: 24.01.2013 Production date to: 24.01.2013 OM 651.955, OM 651.957: für OE-Nummer: A 000 905 88 04, A 007 153 95 28 for OE number: A 000 905 88 04, A 007 153 95 28 Katalysator Catalytic Converter
			7.08369.61.0	ATS	EL	
			7.11020.16.0	ATS	EL	
214 CDI (906.611, 906.613) 70-120 kW (95-163 PS) OM 651.955	04.2016→		7.08369.06.0	ATS	EL	für OE-Nummer: A 000 905 39 05, A 007 153 67 28 for OE number: A 000 905 39 05, A 007 153 67 28 vor Katalysator in front of the catalystr
			7.11020.16.0	ATS	EL	
215 CDI (906.611, 906.613) 95-110 kW (129-150 PS) OM 646.986	06.2006→12.2009		7.24809.65.0	AGR	ET	vor Rußpartikelfilter before soot particulate filter Euro 3 Euro 3
			7.08369.30.0	ATS	EL	
			7.08369.61.0	ATS	EL	
			7.08369.91.0	ATS	EL	
215 CDI (906.611, 906.613) 110 kW (150 PS) OM 646.989, OM 646.990	06.2006→12.2009		7.08369.30.0	ATS	EL	OM 646.989, OM 646.990: vor Rußpartikelfilter before soot particulate filter Euro 3 Euro 3
			7.08369.61.0	ATS	EL	
			7.08369.91.0	ATS	EL	
216 (906.613) 115 kW (156 PS) M 271.951	09.2008→		7.05271.23.0	LS	900 mm	vor Katalysator in front of the catalystr Euro 6b Euro 6b
			7.05270.11.0	LS	750 mm	
216 CDI (906.611, 906.613) 70-120 kW (95-163 PS) OM 651.955, OM 651.957	03.2009→		7.08369.06.0	ATS	EL	

M





SPRINTER 3-t Van (B906) 123

			7.11020.16.0	ATS	EL	 OM 651.955, OM 651.957: vor Katalysator in front of the catalyst Euro 6 Euro 6  OM 651.955, OM 651.957: vor SCR-Katalysator before SCR catalytic converter Euro 6 Euro 6 Produktionsdatum bis: 24.01.2013 Production date to: 24.01.2013
			7.11020.35.0	ATS	EL	 OM 651.955: für OE-Nummer: A 000 905 88 04, A 007 153 95 28 for OE number: A 000 905 88 04, A 007 153 95 28  OM 651.957: für OE-Nummer: A 000 905 88 04, A 007 153 95 28 for OE number: A 000 905 88 04, A 007 153 95 28 Katalysator Catalytic Converter
218 CDI (906.611, 906.613) 135-140 kW (184-190 PS) OM 642.896	06.2006→12.2009		7.08369.30.0	ATS	EL	
			7.08369.61.0	ATS	EL	
			7.08369.91.0	ATS	EL	vor Rußpartikelfilter before soot particulate filter
			7.11020.28.0	ATS	EL	nach AGR-Kühler after EGR cooler
			7.11020.40.0	ATS	EL	Abgasturbolader Exhaust Turbocharger
218 CDI (906.611, 906.613) 135-140 kW (184-190 PS) OM 642.992	06.2006→12.2009		7.24809.60.0	AGR	ET	
			7.08369.30.0	ATS	EL	
			7.08369.61.0	ATS	EL	
			7.08369.91.0	ATS	EL	vor Rußpartikelfilter before soot particulate filter
			7.11190.01.0	DDS		Luftfiltergehäuse Air Filter Housing
219 CDI / BlueTEC (906.611, 906.613) 135-140 kW (184-190 PS) OM 642.896	03.2009→		7.08369.30.0	ATS	EL	
			7.11020.28.0	ATS	EL	nach AGR-Kühler after EGR cooler
			7.11020.35.0	ATS	EL	für OE-Nummer: A 000 905 88 04, A 007 153 95 28 for OE number: A 000 905 88 04, A 007 153 95 28 Katalysator Catalytic Converter
			7.11020.40.0	ATS	EL	Abgasturbolader Exhaust Turbocharger
219 CDI / BlueTEC (906.611, 906.613) 135-140 kW (184-190 PS) OM 642.992	03.2009→		7.24809.60.0	AGR	ET	
			7.08369.30.0	ATS	EL	

M











SPRINTER 3-t Van (B906) 123

			7.11020.35.0	ATS	EL	für OE-Nummer: A 000 905 88 04, A 007 153 95 28 for OE number: A 000 905 88 04, A 007 153 95 28 Katalysator Catalytic Converter
			7.11190.01.0	DDS		Luftfiltergehäuse Air Filter Housing
224 (906.613) 190 kW (258 PS) M 272.979	06.2006→		7.08369.61.0	ATS	EL	
			7.05270.22.0	LS	825 mm	
			7.05270.21.0	LS	600 mm	
			7.04389.02.0	SLP	EL	

SPRINTER 4,6-t Bus (B906) 124

415 CDI 85-120 kW (116-163 PS) OM 651.957	06.2006→		7.08369.06.0	ATS	EL	
---	----------	---	---------------------	-----	----	--













SPRINTER 4,6-t Platform/Chassis (B906) 125

411 CDI (906.153, 906.155, 906.253, 906.255) 80 kW (109 PS) OM 646.985	06.2009→12.2018		7.24809.65.0	AGR	ET	
411 CDI (906.153, 906.155, 906.253, 906.255) 70-120 kW (95-163 PS) OM 651.955	04.2016→		7.08369.06.0	ATS	EL	
			7.11020.16.0	ATS	EL	für OE-Nummer: A 000 905 39 05, A 007 153 67 28 for OE number: A 000 905 39 05, A 007 153 67 28 vor Katalysator in front of the catalyst
413 CDI 70-120 kW (95-163 PS) OM 651.955	03.2009→		7.08369.06.0	ATS	EL	
415 CDI (906.153, 906.155, 906.253, 906.255) 95-110 kW (129-150 PS) OM 646.986	06.2006→12.2009		7.24809.65.0	AGR	ET	
			7.08369.30.0	ATS	EL	
			7.08369.91.0	ATS	EL	vor Rußpartikelfilter before soot particulate filter Euro 3 Euro 3
415 CDI (906.153, 906.155, 906.253, 906.255) 110 kW (150 PS) OM 646.989, OM 646.990	06.2006→12.2009		7.08369.30.0	ATS	EL	
			7.08369.91.0	ATS	EL	 OM 646.989, OM 646.990: vor Rußpartikelfilter before soot particulate filter Euro 3 Euro 3
416 CDI (906.153, 906.155, 906.253, 906.255) 70-120 kW (95-163 PS) OM 651.955, OM 651.957	03.2009→		7.08369.06.0	ATS	EL	

M







SPRINTER 4,6-t Platform/Chassis (B906) 125

		7.11020.16.0	ATS	EL	 OM 651.955, OM 651.957: vor Katalysator in front of the catalyst Euro 6 Euro 6  OM 651.955, OM 651.957: vor SCR-Katalysator before SCR catalytic converter Euro 6 Euro 6 Produktionsdatum bis: 16.08.2013 Production date to: 16.08.2013
		7.11020.35.0	ATS	EL	 OM 651.955, OM 651.957: für OE-Nummer: A 000 905 88 04, A 007 153 95 28 for OE number: A 000 905 88 04, A 007 153 95 28 Katalysator Catalytic Converter
418 CDI (906.153, 906.155, 906.253, 906.255) 135-140 kW (184-190 PS) OM 642.896	06.2006→12.2009	 7.11020.28.0	ATS	EL	nach AGR-Kühler after EGR cooler
		7.11020.40.0	ATS	EL	Abgasturbolader Exhaust Turbocharger
		7.11190.01.0	DDS		für OE-Nummer: A 006 153 49 28 for OE number: A 006 153 49 28 Luftfiltergehäuse Air Filter Housing
418 CDI (906.153, 906.155, 906.253, 906.255) 135-140 kW (184-190 PS) OM 642.986	06.2006→12.2009	 7.11190.01.0	DDS		für OE-Nummer: A 006 153 49 28 for OE number: A 006 153 49 28 Luftfiltergehäuse Air Filter Housing
		 7.24809.60.0	AGR	ET	
418 CDI (906.153, 906.155, 906.253, 906.255) 135-140 kW (184-190 PS) OM 642.992	06.2006→12.2009	 7.11190.01.0	DDS		für OE-Nummer: A 006 153 49 28 for OE number: A 006 153 49 28 Luftfiltergehäuse Air Filter Housing
		 7.24809.60.0	AGR	ET	
418 CDI (906.153, 906.155, 906.253, 906.255) 135 kW (184 PS) OM 642.993	06.2006→12.2009	 7.11020.28.0	ATS	EL	für OE-Nummer: A 000 905 43 05 for OE number: A 000 905 43 05 Abgaskrümmer Exhaust Manifold
		7.11190.01.0	DDS		für OE-Nummer: A 006 153 49 28 for OE number: A 006 153 49 28 Luftfiltergehäuse Air Filter Housing
		 7.11020.28.0	ATS	EL	nach AGR-Kühler after EGR cooler
419 CDI (906.153, 906.155, 906.253, 906.255) 135-140 kW (184-190 PS) OM 642.896	03.2009→	 7.11020.35.0	ATS	EL	für OE-Nummer: A 000 905 88 04, A 007 153 95 28 for OE number: A 000 905 88 04, A 007 153 95 28 Katalysator Catalytic Converter
		7.11020.40.0	ATS	EL	Abgasturbolader Exhaust Turbocharger











SPRINTER 4,6-t Platform/Chassis (B906) 125

		7.11190.01.0	DDS		für OE-Nummer: A 006 153 49 28 for OE number: A 006 153 49 28 Luftfiltergehäuse Air Filter Housing
419 CDI (906.153, 906.155, 906.253, 906.255) 135-140 kW (184-190 PS) OM 642.986	03.2009→	 7.11190.01.0	DDS		für OE-Nummer: A 006 153 49 28 for OE number: A 006 153 49 28 Luftfiltergehäuse Air Filter Housing
419 CDI (906.153, 906.155, 906.253, 906.255) 135-140 kW (184-190 PS) OM 642.992	03.2009→	 7.24809.60.0	AGR	ET	
		7.11020.35.0	ATS	EL	für OE-Nummer: A 000 905 88 04, A 007 153 95 28 for OE number: A 000 905 88 04, A 007 153 95 28 Katalysator Catalytic Converter
		7.11190.01.0	DDS		für OE-Nummer: A 006 153 49 28 for OE number: A 006 153 49 28 Luftfiltergehäuse Air Filter Housing
419 CDI (906.153, 906.155, 906.253, 906.255) 140-155 kW (190-211 PS) OM 642.898	03.2009→	 7.11020.28.0	ATS	EL	nach AGR-Kühler after EGR cooler
		7.11020.35.0	ATS	EL	für OE-Nummer: A 000 905 88 04, A 007 153 95 28 for OE number: A 000 905 88 04, A 007 153 95 28 Katalysator Catalytic Converter
		7.11020.40.0	ATS	EL	Abgasturbolader Exhaust Turbocharger
424 (906.153, 906.155, 906.253, 906.255) 190 kW (258 PS) M 272.979	06.2006→12.2013	 7.04389.02.0	SLP	EL	













M

SPRINTER 4,6-t Van (B906) 126

411 CDI (906.653, 906.655, 906.657) 80 kW (109 PS) OM 646.985	06.2009→12.2018	 7.24809.65.0	AGR	ET	
413 CDI (906.653, 906.655, 906.657) 70-120 kW (95-163 PS) OM 651.955, OM 651.956	06.2006→05.2016	 7.08369.06.0	ATS	EL	
		7.11020.16.0	ATS	EL	 OM 651.955, OM 651.956: vor Katalysator in front of the catalyst Euro 6 Euro 6  OM 651.955, OM 651.956: vor SCR-Katalysator before SCR catalytic converter Euro 6 Euro 6 Produktionsdatum bis: 24.01.2013 Production date to: 24.01.2013
414 CDI 70-120 kW (95-163 PS) OM 651.955	05.2016→	 7.08369.06.0	ATS	EL	
414 CDI 4x4 70-120 kW (95-163 PS) OM 651.955	05.2016→	 7.08369.06.0	ATS	EL	
415 CDI 70-120 kW (95-163 PS) OM 651.955, OM 651.957	03.2012→	 7.08369.06.0	ATS	EL	







SPRINTER 4,6-t Van (B906) 126

415 CDI (906.653, 906.655, 906.657) 95-110 kW (129-150 PS) OM 646.986	06.2009→12.2009		7.24809.65.0	AGR	ET	
416 CDI (906.653, 906.655, 906.657) 70-120 kW (95-163 PS) OM 651.955, OM 651.957	03.2009→		7.08369.06.0	ATS	EL	
			7.11020.16.0	ATS	EL	
416 CDI 4x4 70-120 kW (95-163 PS) OM 651.955, OM 651.957	11.2013→		7.08369.06.0	ATS	EL	
418 CDI (906.653, 906.655, 906.657) 135-140 kW (184-190 PS) OM 642.896	06.2009→05.2016		7.11020.28.0	ATS	EL	nach AGR-Kühler after EGR cooler
			7.11020.40.0	ATS	EL	Abgasturbolader Exhaust Turbocharger
418 CDI (906.653, 906.655, 906.657) 135-140 kW (184-190 PS) OM 642.896	06.2009→05.2016		7.11190.01.0	DDS		Luftfiltergehäuse Air Filter Housing
			7.24809.60.0	AGR	ET	
418 CDI (906.653, 906.655, 906.657) 135-140 kW (184-190 PS) OM 642.992	06.2009→05.2016		7.11190.01.0	DDS		Luftfiltergehäuse Air Filter Housing
			7.11020.28.0	ATS	EL	nach AGR-Kühler after EGR cooler
419 CDI (906.653, 906.655, 906.657) 135-140 kW (184-190 PS) OM 642.896	03.2009→		7.11020.28.0	ATS	EL	nach AGR-Kühler after EGR cooler
			7.11020.40.0	ATS	EL	Abgasturbolader Exhaust Turbocharger
419 CDI (906.653, 906.655, 906.657) 135-140 kW (184-190 PS) OM 642.992	03.2009→		7.24809.60.0	AGR	ET	
			7.11190.01.0	DDS		Luftfiltergehäuse Air Filter Housing
424 (906.655, 906.657, 906.653) 190 kW (258 PS) M 272.979	06.2006→12.2013		7.04389.02.0	SLP	EL	







M

SPRINTER 4-t Bus (B904) 127













408 CDI 60 kW (82 PS) OM 611.987	04.2000→05.2006		7.24809.34.0	AGR	PN	
			7.24809.35.0	AGR	PN	 →50 030773 für OE-Nummer: 611 090 02 54 for OE number: 611 090 02 54
411 CDI 80-95 kW (109-129 PS) OM 611.981	04.2000→05.2006		7.24809.34.0	AGR	PN	



SPRINTER 4-t Bus (B904) 127

			7.24809.35.0	AGR	PN	 →50 030772 für OE-Nummer: 611 090 02 54 für OE number: 611 090 02 54
413 CDI 80-95 kW (109-129 PS) OM 611.981	04.2000→05.2006		7.24809.34.0	AGR	PN	
			7.24809.35.0	AGR	PN	 →50 030772 für OE-Nummer: 611 090 02 54 für OE number: 611 090 02 54
416 CDI 110-115 kW (150-156 PS) OM 612.981	04.2000→05.2006		7.24809.54.0	AGR	ET	

SPRINTER 4-t Platform/Chassis (B904) 128

408 CDI 60 kW (82 PS) OM 611.987	04.2000→05.2006		7.24809.34.0	AGR	PN	
			7.24809.35.0	AGR	PN	 →50 030773 für OE-Nummer: 611 090 02 54 für OE number: 611 090 02 54
411 CDI 80-95 kW (109-129 PS) OM 611.981	04.2000→05.2006		7.24809.34.0	AGR	PN	
			7.24809.35.0	AGR	PN	 →50 030772 für OE-Nummer: 611 090 02 54 für OE number: 611 090 02 54
411 CDI 4x4 80-95 kW (109-129 PS) OM 611.981	04.2000→05.2006		7.24809.34.0	AGR	PN	
			7.24809.35.0	AGR	PN	 →50 030772 für OE-Nummer: 611 090 02 54 für OE number: 611 090 02 54
413 CDI 80-95 kW (109-129 PS) OM 611.981	04.2000→05.2006		7.24809.34.0	AGR	PN	
			7.24809.35.0	AGR	PN	 →50 030772 für OE-Nummer: 611 090 02 54 für OE number: 611 090 02 54
413 CDI 4x4 80-95 kW (109-129 PS) OM 611.981	04.2000→05.2006		7.24809.34.0	AGR	PN	
			7.24809.35.0	AGR	PN	 →50 030772 für OE-Nummer: 611 090 02 54 für OE number: 611 090 02 54
414 (904.012, 904.013, 904.612, 904.613) 92-105 kW (125-143 PS) M 111.984	02.1995→05.2006		7.05270.03.0	LS	820 mm	Regelsonde Regulating Probe
			7.04389.05.0	SLP	EL	
416 CDI 110-115 kW (150-156 PS) OM 612.981	04.2000→05.2006		7.24809.54.0	AGR	ET	
416 CDI 4x4 110-115 kW (150-156 PS) OM 612.981	04.2000→05.2006		7.24809.54.0	AGR	ET	



SPRINTER 4-t Platform/Chassis (B907, B910) 129

411 CDI RWD (907.141, 907.143, 907.145, 907.241, 907.243... 84-120 kW (114-163 PS) OM 651.958	02.2018→		7.11020.16.0	ATS	EL	vor Katalysator in front of the catalyst
			7.11020.35.0	ATS	EL	Katalysator Catalytic Converter

M



SPRINTER 4-t Platform/Chassis (B907, B910) 129









414 CDI All-wheel Drive (907.143, 907.145, 907.243,... 84-120 kW (114-163 PS) OM 651.958	01.2019→		7.11020.35.0	ATS	EL	Katalysator Catalytic Converter
414 CDI RWD (907.143, 907.145, 907.243, 907.245, 907.141... 84-120 kW (114-163 PS) OM 651.958	02.2018→		7.11020.16.0	ATS	EL	vor Katalysator in front of the catalyst
			7.11020.35.0	ATS	EL	Katalysator Catalytic Converter
416 CDI All-wheel Drive (907.143, 907.145, 907.243,... 84-120 kW (114-163 PS) OM 651.958	01.2019→		7.11020.16.0	ATS	EL	vor Katalysator in front of the catalyst
			7.11020.35.0	ATS	EL	Katalysator Catalytic Converter
416 CDI RWD (907.143, 907.145, 907.243, 907.141, 907.241... 84-120 kW (114-163 PS) OM 651.958	02.2018→		7.11020.16.0	ATS	EL	vor Katalysator in front of the catalyst
			7.11020.35.0	ATS	EL	Katalysator Catalytic Converter
419 CDI All-wheel Drive (907.143, 907.145, 907.243,... 140 kW (190 PS) OM 642.899	01.2019→		7.11020.28.0	ATS	EL	nach AGR-Kühler after EGR cooler
			7.11020.35.0	ATS	EL	Katalysator Catalytic Converter
			7.11020.40.0	ATS	EL	vor Abgasturbolader in front of exhaust turbocharger
419 CDI RWD (907.143, 907.145, 907.243, 907.245) 140 kW (190 PS) OM 642.899	02.2018→		7.11020.28.0	ATS	EL	nach AGR-Kühler after EGR cooler
			7.11020.35.0	ATS	EL	Katalysator Catalytic Converter
			7.11020.40.0	ATS	EL	vor Abgasturbolader in front of exhaust turbocharger

M

SPRINTER 4-t Tourer Bus (B907) 130













416 CDI (907.843) 84-120 kW (114-163 PS) OM 651.958	09.2019→		7.11020.35.0	ATS	EL	Katalysator Catalytic Converter
--	----------	---	---------------------	-----	----	------------------------------------

SPRINTER 4-t Van (B904) 131

408 CDI 60 kW (82 PS) OM 611.987	04.2000→05.2006		7.24809.34.0	AGR	PN	
			7.24809.35.0	AGR	PN	 →50 030773 für OE-Nummer: 611 090 02 54 for OE number: 611 090 02 54
411 CDI 80-95 kW (109-129 PS) OM 611.981	04.2000→05.2006		7.24809.34.0	AGR	PN	
			7.24809.35.0	AGR	PN	 →50 030772 für OE-Nummer: 611 090 02 54 for OE number: 611 090 02 54
411 CDI 4x4 80-95 kW (109-129 PS) OM 611.981	04.2000→05.2006		7.24809.34.0	AGR	PN	
			7.24809.35.0	AGR	PN	 →50 030772 für OE-Nummer: 611 090 02 54 for OE number: 611 090 02 54





















SPRINTER 4-t Van (B904) 131

413 CDI 80-95 kW (109-129 PS) OM 611.981	04.2000→05.2006	 7.24809.34.0	AGR	PN	
		 7.24809.35.0	AGR	PN	 →50 030772 für OE-Nummer: 611 090 02 54 for OE number: 611 090 02 54
413 CDI 4x4 80-95 kW (109-129 PS) OM 611.981	04.2000→05.2006	 7.24809.34.0	AGR	PN	
		 7.24809.35.0	AGR	PN	 →50 030772 für OE-Nummer: 611 090 02 54 for OE number: 611 090 02 54
416 CDI 110-115 kW (150-156 PS) OM 612.981	04.2000→05.2006	 7.24809.54.0	AGR	ET	
416 CDI 4x4 110-115 kW (150-156 PS) OM 612.981	04.2000→05.2006	 7.24809.54.0	AGR	ET	

SPRINTER 4-t Van (B907, B910) 132

411 CDI (910.641, 910.643) 84-120 kW (114-163 PS) OM 651.958	02.2018→	 7.11020.16.0	ATS	EL	vor Katalysator in front of the catalyst
411 CDI RWD (907.643, 907.645) 84-120 kW (114-163 PS) OM 651.958	02.2018→	 7.11020.16.0	ATS	EL	vor Katalysator in front of the catalyst
		 7.11020.35.0	ATS	EL	Katalysator Catalytic Converter
414 CDI (910.643, 910.641) 84-120 kW (114-163 PS) OM 651.958	02.2018→	 7.11020.16.0	ATS	EL	vor Katalysator in front of the catalyst
414 CDI All-wheel Drive (907.643, 907.645, 907.647) 84-120 kW (114-163 PS) OM 651.958	01.2019→	 7.11020.16.0	ATS	EL	vor Katalysator in front of the catalyst
		 7.11020.35.0	ATS	EL	Katalysator Catalytic Converter
414 CDI RWD (907.643, 907.645, 907.647) 84-120 kW (114-163 PS) OM 651.958	02.2018→	 7.11020.16.0	ATS	EL	vor Katalysator in front of the catalyst
		 7.11020.35.0	ATS	EL	Katalysator Catalytic Converter
416 CDI All-wheel Drive (907.643, 907.645, 907.647) 84-120 kW (114-163 PS) OM 651.958	01.2019→	 7.11020.16.0	ATS	EL	vor Katalysator in front of the catalyst
		 7.11020.35.0	ATS	EL	Katalysator Catalytic Converter
416 CDI RWD (907.643, 907.645, 907.647) 84-120 kW (114-163 PS) OM 651.958	02.2018→	 7.11020.16.0	ATS	EL	vor Katalysator in front of the catalyst
		 7.11020.35.0	ATS	EL	Katalysator Catalytic Converter
419 CDI All-wheel Drive (907.643, 907.645, 907.647) 140 kW (190 PS) OM 642.899	01.2019→	 7.11020.28.0	ATS	EL	nach AGR-Kühler after EGR cooler
		 7.11020.35.0	ATS	EL	Katalysator Catalytic Converter
		 7.11020.40.0	ATS	EL	vor Abgasturbolader in front of exhaust turbocharger















M

			 PIERBURG		
SPRINTER 4-t Van (B907, B910)					132
419 CDI RWD (907.643, 907.645, 907.647) 140 kW (190 PS) OM 642.899	02.2018→		7.11020.28.0	ATS	EL nach AGR-Kühler after EGR cooler
			7.11020.35.0	ATS	EL Katalysator Catalytic Converter
			7.11020.40.0	ATS	EL vor Abgasturbolader in front of exhaust turbocharger
SPRINTER 5-t Bus (B906)					133
513 CDI (906.655, 906.657) 70-120 kW (95-163 PS) OM 651.955	03.2009→		7.08369.06.0	ATS	EL
515 CDI (906.755, 906.757) 85-120 kW (116-163 PS) OM 651.957	06.2006→		7.08369.06.0	ATS	EL
516 CDI (906.655, 906.657) 70-120 kW (95-163 PS) OM 651.955	03.2009→		7.08369.06.0	ATS	EL
SPRINTER 5-t Platform/Chassis (B905)					134
616 CDI (905.612, 905.613, 905.622, 905.623) 110-115 kW (150-156 PS) OM 612.981	04.2001→05.2006		7.24809.54.0	AGR	ET 
SPRINTER 5-t Platform/Chassis (B906)					135
509 CDI (906.153, 906.155, 906.253, 906.255) 65 kW (88 PS) OM 646.984	06.2006→12.2009		7.24809.65.0	AGR	ET 
			7.08369.30.0	ATS	EL
			7.08369.61.0	ATS	EL
			7.08369.91.0	ATS	EL vor Rußpartikelfilter before soot particulate filter Euro 3 Euro 3
510 CDI (906.153, 906.155, 906.253, 906.255) 70-120 kW (95-163 PS) OM 651.955	03.2009→		7.08369.06.0	ATS	EL
			7.11020.16.0	ATS	EL  OM 651.955: vor Katalysator in front of the catalyst Euro 6 Euro 6  OM 651.955: vor SCR-Katalysator before SCR catalytic converter Euro 6 Euro 6 Produktionsdatum bis: 16.08.2013 Production date to: 16.08.2013
			7.11020.35.0	ATS	EL für OE-Nummer: A 000 905 88 04, A 007 153 95 28 for OE number: A 000 905 88 04, A 007 153 95 28 Katalysator Catalytic Converter
511 CDI (906.153, 906.155, 906.253, 906.255) 80 kW (109 PS) OM 646.985	06.2006→12.2009		7.24809.65.0	AGR	ET 
			7.08369.30.0	ATS	EL
			7.08369.61.0	ATS	EL
			7.08369.91.0	ATS	EL vor Rußpartikelfilter before soot particulate filter Euro 3 Euro 3

M













SPRINTER 5-t Platform/Chassis (B906) 135

511 CDI (906.153, 906.155, 906.253, 906.255) 70-120 kW (95-163 PS) OM 651.955	05.2016→	 7.08369.06.0	ATS	EL	
					EL
511 CDI 4x4 (906.155, 906.253, 906.255) 80 kW (109 PS) OM 646.985	06.2006→12.2009	 7.24809.65.0	AGR	ET	
				EL	
				EL	vor Rußpartikelfilter before soot particulate filter Euro 3 Euro 3
513 CDI (906.155, 906.253, 906.255) 95-110 kW (129-150 PS) OM 646.986	06.2006→05.2016	 7.24809.65.0	AGR	ET	
				EL	
				EL	vor Rußpartikelfilter before soot particulate filter Euro 3 Euro 3
513 CDI (906.155, 906.253, 906.255) 70-120 kW (95-163 PS) OM 651.955, OM 651.957	06.2006→05.2016	 7.08369.06.0	ATS	EL	
				EL	 OM 651.955, OM 651.957: vor Katalysator in front of the catalyst Euro 6 Euro 6  OM 651.955, OM 651.957: vor SCR-Katalysator before SCR catalytic converter Euro 6 Euro 6 Produktionsdatum bis: 16.08.2013 Production date to: 16.08.2013
				EL	 OM 651.955, OM 651.957: für OE-Nummer: A 000 905 88 04, A 007 153 95 28 for OE number: A 000 905 88 04, A 007 153 95 28 Katalysator Catalytic Converter
513 CDI 4x4 (906.155, 906.253, 906.255) 70-120 kW (95-163 PS) OM 651.955, OM 651.957	05.2011→05.2016	 7.08369.06.0	ATS	EL	
				EL	 OM 651.955, OM 651.957: vor Katalysator in front of the catalyst Euro 6 Euro 6  OM 651.955, OM 651.957: vor SCR-Katalysator before SCR catalytic converter Euro 6 Euro 6 Produktionsdatum bis: 16.08.2013 Production date to: 16.08.2013
		 7.11020.16.0	ATS	EL	 OM 651.955, OM 651.957: vor Katalysator in front of the catalyst Euro 6 Euro 6  OM 651.955, OM 651.957: vor SCR-Katalysator before SCR catalytic converter Euro 6 Euro 6 Produktionsdatum bis: 16.08.2013 Production date to: 16.08.2013

M













SPRINTER 5-t Platform/Chassis (B906) 135

			7.11020.35.0	ATS	EL	 OM 651.955, OM 651.957: für OE-Nummer: A 000 905 88 04, A 007 153 95 28 for OE number: A 000 905 88 04, A 007 153 95 28 Katalysator Catalytic Converter
514 CDI (906.153, 906.155, 906.253, 906.255) 70-120 kW (95-163 PS) OM 651.955	05.2016→		7.08369.06.0	ATS	EL	
			7.11020.16.0	ATS	EL	für OE-Nummer: A 000 905 39 05, A 007 153 67 28 for OE number: A 000 905 39 05, A 007 153 67 28 vor Katalysator in front of the catalyst
514 CDI 4x4 (906.153, 906.155, 906.253, 906.255) 70-120 kW (95-163 PS) OM 651.955	05.2016→		7.08369.06.0	ATS	EL	
			7.11020.16.0	ATS	EL	für OE-Nummer: A 000 905 39 05, A 007 153 67 28 for OE number: A 000 905 39 05, A 007 153 67 28 vor Katalysator in front of the catalyst
515 CDI (906.153, 906.155, 906.253, 906.255) 95-110 kW (129-150 PS) OM 646.986, OM 646.989, OM 646.990	06.2006→12.2009		7.08369.30.0	ATS	EL	
			7.08369.61.0	ATS	EL	
			7.08369.91.0	ATS	EL	 OM 646.986, OM 646.989, OM 646.990: vor Rußpartikelfilter before soot particulate filter Euro 3 Euro 3
515 CDI 4x4 (906.153, 906.155, 906.253, 906.255) 95-110 kW (129-150 PS) OM 646.986	06.2006→12.2009		7.24809.65.0	AGR	ET	
			7.08369.61.0	ATS	EL	
			7.08369.91.0	ATS	EL	vor Rußpartikelfilter before soot particulate filter Euro 3 Euro 3
515 CDI 4x4 (906.153, 906.155, 906.253, 906.255) 110 kW (150 PS) OM 646.989, OM 646.990	06.2006→12.2009		7.08369.61.0	ATS	EL	
			7.08369.91.0	ATS	EL	 OM 646.989, OM 646.990: vor Rußpartikelfilter before soot particulate filter Euro 3 Euro 3
516 (906.153, 906.155, 906.253, 906.255) 115 kW (156 PS) M 271.951	09.2008→		7.05271.23.0	LS	900 mm	
			7.05270.11.0	LS	750 mm	nach Katalysator Post-catalyst Euro 6b Euro 6b

M











SPRINTER 5-t Platform/Chassis (B906) 135

516 CDI (906.153, 906.155, 906.253, 906.255) 70-120 kW (95-163 PS) OM 651.955, OM 651.957	03.2009→	 7.08369.06.0	ATS	EL	
		7.11020.16.0	ATS	EL	 OM 651.955, OM 651.957: vor Katalysator in front of the catalyst Euro 6 Euro 6  OM 651.955, OM 651.957: vor SCR-Katalysator before SCR catalytic converter Euro 6 Euro 6 Produktionsdatum bis: 16.08.2013 Production date to: 16.08.2013
		7.11020.35.0	ATS	EL	 OM 651.955, OM 651.957: für OE-Nummer: A 000 905 88 04, A 007 153 95 28 for OE number: A 000 905 88 04, A 007 153 95 28 Katalysator Catalytic Converter
516 CDI 4x4 (906.153, 906.155, 906.255) 70-120 kW (95-163 PS) OM 651.955, OM 651.957	05.2011→	 7.08369.06.0	ATS	EL	
		7.11020.16.0	ATS	EL	 OM 651.955, OM 651.957: vor Katalysator in front of the catalyst Euro 6 Euro 6  OM 651.955, OM 651.957: vor SCR-Katalysator before SCR catalytic converter Euro 6 Euro 6 Produktionsdatum bis: 24.01.2013 Production date to: 24.01.2013
		7.11020.35.0	ATS	EL	 OM 651.955, OM 651.957: für OE-Nummer: A 000 905 88 04, A 007 153 95 28 for OE number: A 000 905 88 04, A 007 153 95 28 Katalysator Catalytic Converter
516 NGT (906.153, 906.155, 906.253, 906.255) 115 kW (156 PS) M 271.951	09.2008→	 7.05270.11.0	LS	750 mm	nach Katalysator Post-catalyst Euro 6, Euro 6b Euro 6, Euro 6b
518 CDI (906.153, 906.155, 906.253, 906.255) 135-140 kW (184-190 PS) OM 642.896	06.2006→12.2009	 7.08369.30.0	ATS	EL	
		7.08369.61.0	ATS	EL	
		7.08369.91.0	ATS	EL	vor Rußpartikelfilter before soot particulate filter
		7.11020.28.0	ATS	EL	nach AGR-Kühler after EGR cooler
		7.11020.40.0	ATS	EL	Abgasturbolader Exhaust Turbocharger
7.11190.01.0	DDS		für OE-Nummer: A 006 153 49 28 for OE number: A 006 153 49 28 Luftfiltergehäuse Air Filter Housing		

M



SPRINTER 5-t Platform/Chassis (B906) 135







518 CDI (906.153, 906.155, 906.253, 906.255) 135-140 kW (184-190 PS) OM 642.986	06.2006→12.2009		7.08369.30.0	ATS	EL	vor Rußpartikelfilter before soot particulate filter für OE-Nummer: A 006 153 49 28 for OE number: A 006 153 49 28 Luftfiltergehäuse Air Filter Housing
			7.08369.61.0	ATS	EL	
			7.08369.91.0	ATS	EL	
			7.11190.01.0	DDS		
518 CDI (906.153, 906.155, 906.253, 906.255) 135-140 kW (184-190 PS) OM 642.992	06.2006→12.2009		7.24809.60.0	AGR	ET	 vor Rußpartikelfilter before soot particulate filter für OE-Nummer: A 006 153 49 28 for OE number: A 006 153 49 28 Luftfiltergehäuse Air Filter Housing
			7.08369.30.0	ATS	EL	
			7.08369.61.0	ATS	EL	
			7.08369.91.0	ATS	EL	
518 CDI (906.153, 906.155, 906.253, 906.255) 135 kW (184 PS) OM 642.993	06.2006→12.2009		7.24809.60.0	AGR	ET	 vor Rußpartikelfilter before soot particulate filter für OE-Nummer: A 000 905 43 05 for OE number: A 000 905 43 05 Abgaskrümmen Exhaust Manifold für OE-Nummer: A 006 153 49 28 for OE number: A 006 153 49 28 Luftfiltergehäuse Air Filter Housing
			7.08369.30.0	ATS	EL	
			7.08369.61.0	ATS	EL	
			7.08369.91.0	ATS	EL	
			7.11020.28.0	ATS	EL	
518 CDI 4x4 (906.153, 906.155, 906.253, 906.255) 135-140 kW (184-190 PS) OM 642.896	06.2006→12.2009		7.08369.61.0	ATS	EL	vor Rußpartikelfilter before soot particulate filter nach AGR-Kühler after EGR cooler Abgasturbolader Exhaust Turbocharger für OE-Nummer: A 006 153 49 28 for OE number: A 006 153 49 28
			7.08369.91.0	ATS	EL	
			7.11020.28.0	ATS	EL	
			7.11020.40.0	ATS	EL	
518 CDI 4x4 (906.153, 906.155, 906.253, 906.255) 135-140 kW (184-190 PS) OM 642.986	06.2006→12.2009		7.08369.61.0	ATS	EL	vor Rußpartikelfilter before soot particulate filter für OE-Nummer: A 006 153 49 28 for OE number: A 006 153 49 28
			7.08369.91.0	ATS	EL	
			7.11190.01.0	DDS		
518 CDI 4x4 (906.153, 906.155, 906.253, 906.255) 135-140 kW (184-190 PS) OM 642.992	06.2006→12.2009		7.24809.60.0	AGR	ET	

M



SPRINTER 5-t Platform/Chassis (B906)





135

			7.08369.61.0 ATS 7.08369.91.0 ATS 7.11190.01.0 DDS	EL EL EL	vor Rußpartikelfilter before soot particulate filter für OE-Nummer: A 006 153 49 28 for OE number: A 006 153 49 28
518 CDI 4x4 (906.153, 906.155, 906.253, 906.255) 135 kW (184 PS) OM 642.993	06.2006→12.2009		7.24809.60.0 AGR 7.08369.61.0 ATS 7.08369.91.0 ATS 7.11020.28.0 ATS 7.11190.01.0 DDS	ET EL EL EL EL DDS	 vor Rußpartikelfilter before soot particulate filter Euro 3 Euro 3 für OE-Nummer: A 000 905 43 05 for OE number: A 000 905 43 05 Abgaskrümmer Exhaust Manifold für OE-Nummer: A 006 153 49 28 for OE number: A 006 153 49 28
519 CDI / BlueTEC (906.153, 906.155, 906.253, 906.255) 135-140 kW (184-190 PS) OM 642.896	03.2009→		7.11020.28.0 ATS 7.11020.35.0 ATS 7.11020.40.0 ATS 7.11190.01.0 DDS	EL EL EL DDS	nach AGR-Kühler after EGR cooler für OE-Nummer: A 000 905 88 04, A 007 153 95 28 for OE number: A 000 905 88 04, A 007 153 95 28 Katalysator Catalytic Converter Abgasturbolader Exhaust Turbocharger für OE-Nummer: A 006 153 49 28 for OE number: A 006 153 49 28 Luftfiltergehäuse Air Filter Housing
519 CDI / BlueTEC (906.153, 906.155, 906.253, 906.255) 135-140 kW (184-190 PS) OM 642.986	03.2009→		7.11020.35.0 ATS	EL	für OE-Nummer: A 000 905 88 04, A 007 153 95 28 for OE number: A 000 905 88 04, A 007 153 95 28 Katalysator Catalytic Converter
519 CDI / BlueTEC (906.153, 906.155, 906.253, 906.255) 135-140 kW (184-190 PS) OM 642.992	03.2009→		7.24809.60.0 AGR 7.11020.35.0 ATS 7.11190.01.0 DDS	ET EL DDS	 für OE-Nummer: A 000 905 88 04, A 007 153 95 28 for OE number: A 000 905 88 04, A 007 153 95 28 Katalysator Catalytic Converter für OE-Nummer: A 006 153 49 28 for OE number: A 006 153 49 28 Luftfiltergehäuse Air Filter Housing
519 CDI / BlueTEC (906.153, 906.155, 906.253, 906.255) 140-155 kW (190-211 PS) OM 642.898	03.2009→		7.11020.28.0 ATS	EL	nach AGR-Kühler after EGR cooler

M



SPRINTER 5-t Platform/Chassis (B906) 135

			7.11020.35.0	ATS	EL	für OE-Nummer: A 000 905 88 04, A 007 153 95 28 for OE number: A 000 905 88 04, A 007 153 95 28 Katalysator Catalytic Converter
			7.11020.40.0	ATS	EL	Abgasturbolader Exhaust Turbocharger
519 CDI / BlueTEC 4x4 (906.153, 906.155, 906.253,... 135-140 kW (184-190 PS) OM 642.896	03.2009→		7.11020.28.0	ATS	EL	nach AGR-Kühler after EGR cooler
			7.11020.35.0	ATS	EL	für OE-Nummer: A 000 905 88 04, A 007 153 95 28 for OE number: A 000 905 88 04, A 007 153 95 28 Katalysator Catalytic Converter
			7.11020.40.0	ATS	EL	Abgasturbolader Exhaust Turbocharger
			7.11190.01.0	DDS	EL	für OE-Nummer: A 006 153 49 28 for OE number: A 006 153 49 28 Luftfiltergehäuse Air Filter Housing
519 CDI / BlueTEC 4x4 (906.153, 906.155, 906.253,... 135-140 kW (184-190 PS) OM 642.992	03.2009→		7.24809.60.0	AGR	ET	
			7.11020.35.0	ATS	EL	für OE-Nummer: A 000 905 88 04, A 007 153 95 28 for OE number: A 000 905 88 04, A 007 153 95 28 Katalysator Catalytic Converter
			7.11190.01.0	DDS	EL	für OE-Nummer: A 006 153 49 28 for OE number: A 006 153 49 28 Luftfiltergehäuse Air Filter Housing
519 CDI / BlueTEC 4x4 (906.153, 906.155, 906.253,... 140-155 kW (190-211 PS) OM 642.898	03.2009→		7.11020.28.0	ATS	EL	nach AGR-Kühler after EGR cooler
			7.11020.35.0	ATS	EL	für OE-Nummer: A 000 905 88 04, A 007 153 95 28 for OE number: A 000 905 88 04, A 007 153 95 28 Katalysator Catalytic Converter
			7.11020.40.0	ATS	EL	Abgasturbolader Exhaust Turbocharger
524 (906.153, 906.155, 906.253, 906.255) 190 kW (258 PS) M 272.979	06.2006→12.2013		7.08369.61.0	ATS	EL	
			7.05270.22.0	LS	825 mm	
			7.05270.21.0	LS	600 mm	
			7.04389.02.0	SLP	EL	

M



SPRINTER 5-t Platform/Chassis (B907) 136



511 CDI (907.153, 907.155, 907.253, 907.255) 84-120 kW (114-163 PS) OM 651.958	02.2018→		7.11020.16.0 ATS EL vor Katalysator in front of the catalyist
			7.11020.35.0 ATS EL Katalysator Catalytic Converter
514 CDI (907.153, 907.155, 907.253, 907.255) 84-120 kW (114-163 PS) OM 651.958	02.2018→		7.11020.16.0 ATS EL vor Katalysator in front of the catalyist
			7.11020.35.0 ATS EL Katalysator Catalytic Converter
516 CDI (907.153, 907.155, 907.253, 907.255) 84-120 kW (114-163 PS) OM 651.958	02.2018→		7.11020.16.0 ATS EL vor Katalysator in front of the catalyist
			7.11020.35.0 ATS EL Katalysator Catalytic Converter
516 CDI All-wheel Drive (907.153, 907.155, 907.253,...) 84-120 kW (114-163 PS) OM 651.958	01.2019→		7.11020.16.0 ATS EL vor Katalysator in front of the catalyist
			7.11020.35.0 ATS EL Katalysator Catalytic Converter
519 CDI (907.153, 907.155, 907.253, 907.255) 140 kW (190 PS) OM 642.899	02.2018→		7.11020.28.0 ATS EL nach AGR-Kühler after EGR cooler
			7.11020.35.0 ATS EL Katalysator Catalytic Converter
			7.11020.40.0 ATS EL vor Abgasturbolader in front of exhaust turbocharger
519 CDI All-wheel Drive (907.153, 907.155, 907.253,...) 140 kW (190 PS) OM 642.899	01.2019→		7.11020.28.0 ATS EL nach AGR-Kühler after EGR cooler
			7.11020.35.0 ATS EL Katalysator Catalytic Converter
			7.11020.40.0 ATS EL vor Abgasturbolader in front of exhaust turbocharger

M

SPRINTER 5-t Tourer Bus (B907) 137













516 CDI (907.855, 907.857) 84-120 kW (114-163 PS) OM 651.958	09.2019→		7.11020.16.0 ATS EL
			7.11020.35.0 ATS EL Katalysator Catalytic Converter

SPRINTER 5-t Van (B906) 138

509 CDI (906.653, 906.655, 906.657) 65 kW (88 PS) OM 646.984	06.2006→12.2009		7.24809.65.0 AGR ET 
			7.08369.30.0 ATS EL
			7.08369.61.0 ATS EL
			7.08369.91.0 ATS EL vor Rußpartikelfilter before soot particulate filter Euro 3 Euro 3
510 CDI (906.653, 906.655, 906.657) 70-120 kW (95-163 PS) OM 651.955	03.2009→05.2016		7.08369.06.0 ATS EL















SPRINTER 5-t Van (B906) 138

			7.11020.16.0	ATS	EL	 OM 651.955: vor Katalysator in front of the catalyst Euro 6 Euro 6  OM 651.955: vor SCR-Katalysator before SCR catalytic converter Euro 6 Euro 6 Produktionsdatum bis: 16.08.2013 Production date to: 16.08.2013
511 CDI (906.653, 906.655, 906.657) 80 kW (109 PS) OM 646.985	06.2006→12.2009		7.24809.65.0	AGR	ET	 vor Rußpartikelfilter before soot particulate filter Euro 3 Euro 3
			7.08369.30.0	ATS	EL	
			7.08369.61.0	ATS	EL	
			7.08369.91.0	ATS	EL	
511 CDI (906.653, 906.655, 906.657) 70-120 kW (95-163 PS) OM 651.955	05.2016→		7.08369.06.0	ATS	EL	für OE-Nummer: A 000 905 39 05, A 007 153 67 28 for OE number: A 000 905 39 05, A 007 153 67 28
			7.11020.16.0	ATS	EL	
511 CDI 4x4 (906.653, 906.655, 906.657) 80 kW (109 PS) OM 646.985	06.2006→12.2009		7.24809.65.0	AGR	ET	 vor Rußpartikelfilter before soot particulate filter Euro 3 Euro 3
			7.08369.61.0	ATS	EL	
			7.08369.91.0	ATS	EL	
513 CDI (906.653, 906.655, 906.657) 95-110 kW (129-150 PS) OM 646.986	06.2006→		7.24809.65.0	AGR	ET	 vor Rußpartikelfilter before soot particulate filter Euro 3 Euro 3
			7.08369.30.0	ATS	EL	
			7.08369.91.0	ATS	EL	
513 CDI (906.653, 906.655, 906.657) 70-120 kW (95-163 PS) OM 651.955, OM 651.957	06.2006→		7.08369.06.0	ATS	EL	 OM 651.955, OM 651.957: vor Katalysator in front of the catalyst Euro 6 Euro 6  OM 651.955, OM 651.957: vor SCR-Katalysator before SCR catalytic converter Euro 6 Euro 6 Produktionsdatum bis: 24.01.2013 Production date to: 24.01.2013
			7.11020.16.0	ATS	EL	
513 CDI 4x4 (906.653, 906.655, 906.657) 70-120 kW (95-163 PS) OM 651.955, OM 651.957	06.2006→		7.08369.06.0	ATS	EL	

M















SPRINTER 5-t Van (B906) 138

			7.11020.16.0	ATS	EL	 OM 651.955, OM 651.957: vor Katalysator in front of the catalyst Euro 6 Euro 6  OM 651.955, OM 651.957: vor SCR-Katalysator before SCR catalytic converter Euro 6 Euro 6 Produktionsdatum bis: 24.01.2013 Production date to: 24.01.2013
514 CDI (906.653, 906.655, 906.657) 70-120 kW (95-163 PS) OM 651.955	05.2016→		7.08369.06.0	ATS	EL	
			7.11020.16.0	ATS	EL	für OE-Nummer: A 000 905 39 05, A 007 153 67 28 for OE number: A 000 905 39 05, A 007 153 67 28 vor Katalysator in front of the catalyst
514 CDI 4x4 (906.653, 906.655, 906.657) 70-120 kW (95-163 PS) OM 651.955	05.2016→		7.08369.06.0	ATS	EL	
			7.11020.16.0	ATS	EL	für OE-Nummer: A 000 905 39 05, A 007 153 67 28 for OE number: A 000 905 39 05, A 007 153 67 28 vor Katalysator in front of the catalyst
515 CDI (906.653, 906.655, 906.657) 95-110 kW (129-150 PS) OM 646.986	06.2006→12.2009		7.24809.65.0	AGR	ET	
			7.08369.30.0	ATS	EL	
			7.08369.61.0	ATS	EL	
			7.08369.91.0	ATS	EL	vor Rußpartikelfilter before soot particulate filter Euro 3 Euro 3
515 CDI (906.653, 906.655, 906.657) 110 kW (150 PS) OM 646.989, OM 646.990	06.2006→12.2009		7.08369.30.0	ATS	EL	
			7.08369.61.0	ATS	EL	
			7.08369.91.0	ATS	EL	 OM 646.989, OM 646.990: vor Rußpartikelfilter before soot particulate filter Euro 3 Euro 3
515 CDI (906.655, 906.653, 906.957, 906.657) 70-120 kW (95-163 PS) OM 651.955	06.2011→		7.08369.06.0	ATS	EL	
515 CDI 4x4 (906.653, 906.655, 906.657) 95-110 kW (129-150 PS) OM 646.986	06.2006→12.2009		7.24809.65.0	AGR	ET	
			7.08369.61.0	ATS	EL	
			7.08369.91.0	ATS	EL	vor Rußpartikelfilter before soot particulate filter Euro 3 Euro 3
515 CDI 4x4 (906.653, 906.655, 906.657) 110 kW (150 PS) OM 646.989, OM 646.990	06.2006→12.2009		7.08369.61.0	ATS	EL	

M





SPRINTER 5-t Van (B906) **138**

			7.08369.91.0	ATS	EL	 OM 646.989, OM 646.990: vor Rußpartikelfilter before soot particulate filter Euro 3 Euro 3
516 CDI (906.653, 906.655, 906.657) 70-120 kW (95-163 PS) OM 651.955, OM 651.957	03.2009→		7.08369.06.0	ATS	EL	
			7.11020.16.0	ATS	EL	 OM 651.955, OM 651.957: vor Katalysator in front of the catalyst Euro 6 Euro 6  OM 651.955, OM 651.957: vor SCR-Katalysator before SCR catalytic converter Euro 6 Euro 6 Produktionsdatum bis: 24.01.2013 Production date to: 24.01.2013
516 CDI 4x4 (906.653, 906.655, 906.657) 70-120 kW (95-163 PS) OM 651.955, OM 651.957	06.2006→		7.08369.06.0	ATS	EL	
			7.11020.16.0	ATS	EL	 OM 651.955, OM 651.957: vor Katalysator in front of the catalyst Euro 6 Euro 6  OM 651.955, OM 651.957: vor SCR-Katalysator before SCR catalytic converter Euro 6 Euro 6 Produktionsdatum bis: 24.01.2013 Production date to: 24.01.2013
518 CDI (906.653, 906.655, 906.657) 135-140 kW (184-190 PS) OM 642.896	06.2006→12.2009		7.08369.30.0	ATS	EL	
			7.08369.61.0	ATS	EL	
			7.08369.91.0	ATS	EL	vor Rußpartikelfilter before soot particulate filter
			7.11020.28.0	ATS	EL	nach AGR-Kühler after EGR cooler
518 CDI (906.653, 906.655, 906.657) 135-140 kW (184-190 PS) OM 642.986	06.2006→12.2009		7.11020.40.0	ATS	EL	Abgasturbolader Exhaust Turbocharger
			7.08369.30.0	ATS	EL	
			7.08369.61.0	ATS	EL	
			7.08369.91.0	ATS	EL	vor Rußpartikelfilter before soot particulate filter
518 CDI (906.653, 906.655, 906.657) 135-140 kW (184-190 PS) OM 642.986	06.2006→12.2009		7.11190.01.0	DDS		Luftfiltergehäuse Air Filter Housing
518 CDI (906.653, 906.655, 906.657) 135-140 kW (184-190 PS) OM 642.992	06.2006→12.2009		7.24809.60.0	AGR	ET	
			7.08369.30.0	ATS	EL	
			7.08369.61.0	ATS	EL	
			7.08369.91.0	ATS	EL	vor Rußpartikelfilter before soot particulate filter
518 CDI (906.653, 906.655, 906.657) 135-140 kW (184-190 PS) OM 642.992	06.2006→12.2009		7.11190.01.0	DDS		Luftfiltergehäuse Air Filter Housing





















M























SPRINTER 5-t Van (B906) **138**

518 CDI (906.653, 906.655, 906.657) 135 kW (184 PS) OM 642.993	06.2006→12.2009		7.24809.60.0 AGR ET 	vor Rußpartikelfilter before soot particulate filter für OE-Nummer: A 000 905 43 05 for OE number: A 000 905 43 05 Abgaskrümmer Exhaust Manifold Luftfiltergehäuse Air Filter Housing
			7.08369.30.0 ATS EL	
			7.08369.61.0 ATS EL	
			7.08369.91.0 ATS EL	
			7.11020.28.0 ATS EL	
518 CDI 4x4 (906.653, 906.655, 906.657) 135-140 kW (184-190 PS) OM 642.896	06.2006→12.2009		7.08369.61.0 ATS EL	vor Rußpartikelfilter before soot particulate filter nach AGR-Kühler after EGR cooler Abgasturbolader Exhaust Turbocharger
			7.08369.91.0 ATS EL	
			7.11020.28.0 ATS EL	
			7.11020.40.0 ATS EL	
518 CDI 4x4 (906.653, 906.655, 906.657) 135-140 kW (184-190 PS) OM 642.986	06.2006→12.2009		7.08369.61.0 ATS EL	Luftfiltergehäuse Air Filter Housing
			7.11190.01.0 DDS	
518 CDI 4x4 (906.653, 906.655, 906.657) 135-140 kW (184-190 PS) OM 642.992	06.2006→12.2009		7.24809.60.0 AGR ET 	vor Rußpartikelfilter before soot particulate filter Luftfiltergehäuse Air Filter Housing
			7.08369.61.0 ATS EL	
			7.08369.91.0 ATS EL	
			7.11190.01.0 DDS	
518 CDI 4x4 (906.653, 906.655, 906.657) 135 kW (184 PS) OM 642.993	06.2006→12.2009		7.24809.60.0 AGR ET 	vor Rußpartikelfilter before soot particulate filter für OE-Nummer: A 000 905 43 05 for OE number: A 000 905 43 05 Abgaskrümmer Exhaust Manifold
			7.08369.61.0 ATS EL	
			7.08369.91.0 ATS EL	
			7.11020.28.0 ATS EL	
			7.11190.01.0 DDS	
519 CDI / BlueTEC (906.653, 906.655, 906.657) 135-155 kW (184-211 PS) OM 642.896, OM 642.898	03.2009→		7.11020.28.0 ATS EL 	OM 642.896, OM 642.898: nach AGR-Kühler after EGR cooler OM 642.896, OM 642.898: Abgasturbolader Exhaust Turbocharger
			7.11020.40.0 ATS EL 	
519 CDI / BlueTEC (906.653, 906.655, 906.657) 135-140 kW (184-190 PS) OM 642.992	03.2009→		7.24809.60.0 AGR ET 	
			7.11190.01.0 DDS	

M



















			 PIERBURG		
SPRINTER 5-t Van (B906)					138
519 CDI / BlueTEC 4x4 (906.653, 906.655, 906.657) 135-155 kW (184-211 PS) OM 642.896, OM 642.898	03.2009→		7.11020.28.0	ATS	EL  OM 642.896, OM 642.898: nach AGR-Kühler after EGR cooler
			7.11020.40.0	ATS	EL  OM 642.896, OM 642.898: Abgasturbolader Exhaust Turbocharger
519 CDI / BlueTEC 4x4 (906.653, 906.655, 906.657) 135-140 kW (184-190 PS) OM 642.992	03.2009→		7.24809.60.0	AGR	ET 
			7.11190.01.0	DDS	Luftfiltergehäuse Air Filter Housing
524 (906.653, 906.655, 906.657) 190 kW (258 PS) M 272.979	06.2006→12.2013		7.08369.61.0	ATS	EL
			7.05270.22.0	LS	825 mm
			7.05270.21.0	LS	600 mm
			7.04389.02.0	SLP	EL
SPRINTER 5-t Van (B907)					139
511 CDI (907.653, 907.655, 907.657) 84-120 kW (114-163 PS) OM 651.958	02.2018→		7.11020.16.0	ATS	EL vor Katalysator in front of the catalyst
			7.11020.35.0	ATS	EL Katalysator Catalytic Converter
514 CDI (907.653, 907.655, 907.657) 84-120 kW (114-163 PS) OM 651.958	02.2018→		7.11020.35.0	ATS	EL Katalysator Catalytic Converter
			7.11020.35.0	ATS	EL Katalysator Catalytic Converter
516 CDI (907.653, 907.655, 907.657) 84-120 kW (114-163 PS) OM 651.958	02.2018→		7.11020.35.0	ATS	EL Katalysator Catalytic Converter
			7.11020.35.0	ATS	EL Katalysator Catalytic Converter
516 CDI All-wheel Drive (907.653, 907.655, 907.657) 84-120 kW (114-163 PS) OM 651.958	01.2019→		7.11020.35.0	ATS	EL Katalysator Catalytic Converter
			7.11020.28.0	ATS	EL nach AGR-Kühler after EGR cooler
			7.11020.40.0	ATS	EL vor Abgasturbolader in front of exhaust turbocharger
519 CDI (907.653, 907.655, 907.657) 140 kW (190 PS) OM 642.899	02.2018→		7.11020.28.0	ATS	EL nach AGR-Kühler after EGR cooler
			7.11020.35.0	ATS	EL Katalysator Catalytic Converter
			7.11020.40.0	ATS	EL vor Abgasturbolader in front of exhaust turbocharger
519 CDI All-wheel Drive (907.653, 907.655, 907.657) 140 kW (190 PS) OM 642.899	01.2019→		7.11020.28.0	ATS	EL nach AGR-Kühler after EGR cooler
			7.11020.35.0	ATS	EL Katalysator Catalytic Converter
			7.11020.40.0	ATS	EL vor Abgasturbolader in front of exhaust turbocharger
SPRINTER CLASSIC 3,5-t Van (B909)					140
311 CDI (909.632, 909.633) 80-100 kW (109-136 PS) OM 646.701	09.2013→		7.24809.65.0	AGR	ET 
			7.08369.90.0	ATS	EL Euro 5 Euro 5

					
SPRINTER CLASSIC 3,5-t Van (B909)					140
			7.08369.91.0	ATS	EL vor Katalysator in front of the catalyst Euro 4 Euro 4 Produktionsdatum bis: 15.05.2015 Production date to: 15.05.2015
			7.11020.01.0	ATS	EL Euro 5 Euro 5
SPRINTER CLASSIC 4,6-t Bus (B909)					141
411 CDI (909.843) 80-100 kW (109-136 PS) OM 646.701	09.2013→		7.24809.65.0	AGR	ET 
			7.08369.90.0	ATS	EL Euro 5 Euro 5
			7.08369.91.0	ATS	EL vor Katalysator in front of the catalyst Euro 4 Euro 4 Produktionsdatum bis: 15.05.2015 Production date to: 15.05.2015
			7.11020.01.0	ATS	EL Euro 5 Euro 5
SPRINTER Dump Truck (B905)					142
616 CDI (905.612, 905.622, 905.623) 110-115 kW (150-156 PS) OM 612.981	04.2001→		7.24809.54.0	AGR	ET 
V-CLASS (638/2)					143
V 200 (638.214, 638.294) 95 kW (129 PS) M 111.950	02.1997→07.2003		7.04389.05.0	SLP	EL
V 200 CDI (638.294) 60-90 kW (82-122 PS) OM 611.980	03.1999→07.2003		7.24809.34.0	AGR	PN 
			7.24809.35.0	AGR	PN  →50 220599 für OE-Nummer: 611 090 02 54 for OE number: 611 090 02 54
V 220 CDI (638.294) 60-90 kW (82-122 PS) OM 611.980	03.1999→07.2003		7.24809.34.0	AGR	PN 
			7.24809.35.0	AGR	PN  →50 220599 für OE-Nummer: 611 090 02 54 for OE number: 611 090 02 54
V 280 (638.244, 638.294) 128 kW (174 PS) M 104.900	08.1997→07.2003		7.22090.11.0	ARV	PN 
			7.04389.00.0	SLP	EL
V-CLASS (W447)					144
V 200 CDI / d (447811, 447813, 447815) 84-140 kW (114-190 PS) OM 651.950	03.2014→		7.08369.06.0	ATS	EL
			7.08369.87.0	ATS	EL nach Katalysator Post-catalyst ab Euro 5 From Euro 5 für Linkslenker for left-hand drive vehicles

M











V-CLASS (W447) 144

			7.08369.97.0	ATS	EL	 OM 651.950: für OE-Nummer: A 000 905 52 05, A 008 153 41 28 for OE number: A 000 905 52 05, A 008 153 41 28 vor Katalysator in front of the catalyst  OM 651.950: nach Katalysator Post-catalyst Euro 6b, Euro 6c Euro 6b, Euro 6c für Rechtslenker for right-hand drive vehicles
V 200 CDI / d 4-matic 84-140 kW (114-190 PS) OM 651.950	04.2015→		7.08369.06.0	ATS	EL	
V 220 CDI / d (447811, 447813, 447815) 84-140 kW (114-190 PS) OM 651.950	03.2014→		7.08369.06.0	ATS	EL	
			7.08369.87.0	ATS	EL	nach Katalysator Post-catalyst ab Euro 5 From Euro 5 für Linkslenker for left-hand drive vehicles
			7.08369.97.0	ATS	EL	 OM 651.950: für OE-Nummer: A 000 905 52 05, A 008 153 41 28 for OE number: A 000 905 52 05, A 008 153 41 28 vor Katalysator in front of the catalyst  OM 651.950: nach Katalysator Post-catalyst Euro 6b, Euro 6c Euro 6b, Euro 6c für Rechtslenker for right-hand drive vehicles
V 220 CDI / d 4-matic 84-140 kW (114-190 PS) OM 651.950	03.2015→		7.08369.06.0	ATS	EL	
V 250 (447813, 447815) 115-245 kW (156-333 PS) M 274.920	03.2014→		7.24809.85.0	AGR	EL	 Produktionsdatum bis: 29.09.2017 Production date to: 29.09.2017
V 250 BlueTEC / d (447811, 447813, 447815) 84-140 kW (114-190 PS) OM 651.950	03.2014→		7.08369.06.0	ATS	EL	
			7.08369.87.0	ATS	EL	nach Katalysator Post-catalyst ab Euro 5 From Euro 5 für Linkslenker for left-hand drive vehicles
			7.08369.97.0	ATS	EL	 OM 651.950: für OE-Nummer: A 000 905 52 05, A 008 153 41 28 for OE number: A 000 905 52 05, A 008 153 41 28 vor Katalysator in front of the catalyst  OM 651.950: nach Katalysator Post-catalyst Euro 6b, Euro 6c Euro 6b, Euro 6c für Rechtslenker for right-hand drive vehicles
V 250 BlueTEC / d 4-matic 84-140 kW (114-190 PS) OM 651.950	12.2014→		7.08369.06.0	ATS	EL	

M















VIANO (W639) **145**

3,0 (639.711, 639.811) 140-160 kW (190-218 PS) M 112.951	09.2003→		7.22136.50.0	AGR	PN	☒
			7.05270.12.0	LS	500 mm	
			7.04389.00.0	SLP	EL	
3.2 (639.713, 639.813, 639.815) 140-160 kW (190-218 PS) M 112.951	09.2003→		7.22136.50.0	AGR	PN	☒
			7.05270.12.0	LS	500 mm	
			7.04389.00.0	SLP	EL	
3.5 (639.811, 639.813, 639.815) 190 kW (258 PS) M 272.978	09.2007→		7.05270.21.0	LS	600 mm	
			7.05270.18.0	LS	500 mm	
			7.04389.02.0	SLP	EL	
3.7 (639.811, 639.813, 639.815) 165-170 kW (224-231 PS) M 112.976	06.2004→07.2007		7.22136.50.0	AGR	PN	☒
			7.05270.12.0	LS	500 mm	
			7.04389.00.0	SLP	EL	
3.7 (639.815) 165-170 kW (224-231 PS) M 112.976	06.2004→		7.22136.50.0	AGR	PN	☒
			7.04389.00.0	SLP	EL	
CDI 2.0 (639.711, 639.713, 639.811, 639.813, 639.815) 80-110 kW (109-150 PS) OM 646.982	09.2003→		7.24809.37.0	AGR	ET	⊙
			7.08369.80.0	ATS	EL	Abgaskrümmer Exhaust Manifold
			7.08369.91.0	ATS	EL	vor Rußpartikelfilter before soot particulate filter
CDI 2.0 (639.711, 639.713, 639.811, 639.813, 639.815) 80-110 kW (109-150 PS) OM 646.982	08.2005→		7.24809.37.0	AGR	ET	⊙
			7.08369.80.0	ATS	EL	Abgaskrümmer Exhaust Manifold
			7.08369.91.0	ATS	EL	vor Rußpartikelfilter before soot particulate filter
			7.02604.99.0	LS	400 mm	
CDI 2.0 (639.811, 639.813, 639.815) 70-120 kW (95-163 PS) OM 651.940	07.2010→		7.08369.06.0	ATS	EL	
			7.08369.87.0	ATS	EL	vor Rußpartikelfilter before soot particulate filter
			7.02604.99.0	LS	400 mm	
CDI 2.0 4-matic (639.711, 639.713, 639.811, 639.813,...) 80-110 kW (109-150 PS) OM 646.982	03.2006→		7.24809.37.0	AGR	ET	⊙
			7.08369.80.0	ATS	EL	Abgaskrümmer Exhaust Manifold

M







VIANO (W639) 145

			7.08369.91.0	ATS	EL	Baumuster: 639.711, 639.713, 639.811, 639.813 Type: 639.711, 639.713, 639.811, 639.813 vor Rußpartikelfilter before soot particulate filter
CDI 2.0 4-matic (639.713) 80-110 kW (109-150 PS) OM 646.982	07.2005→		7.24809.37.0	AGR	ET	
			7.08369.80.0	ATS	EL	Abgaskrümmer Exhaust Manifold
CDI 2.0 4-matic (639.811, 639.813, 639.815) 70-120 kW (95-163 PS) OM 651.940	07.2010→		7.08369.06.0	ATS	EL	
			7.08369.87.0	ATS	EL	vor Rußpartikelfilter before soot particulate filter
			7.02604.99.0	LS	400 mm	
CDI 2.2 (639.711, 639.713, 639.811, 639.813, 639.815) 70-110 kW (95-150 PS) OM 646.980	09.2003→		7.24809.37.0	AGR	ET	 für OE-Nummer: A 646 140 08 60 for OE number: A 646 140 08 60 für SA Code: Z 522.673/03 for SA code: Z 522.673/03
			7.24809.59.0	AGR	ET	 für OE-Nummer: A 646 140 27 60 for OE number: A 646 140 27 60 für SA Code: Z 522.673/05, Z 522.673/06 for SA code: Z 522.673/05, Z 522.673/06
			7.08369.80.0	ATS	EL	Abgaskrümmer Exhaust Manifold
			7.08369.91.0	ATS	EL	vor Rußpartikelfilter before soot particulate filter
			7.02604.99.0	LS	400 mm	
CDI 2.2 (639.711, 639.713, 639.811, 639.813, 639.815) 80-110 kW (109-150 PS) OM 646.982	09.2003→		7.24809.37.0	AGR	ET	 für SA Code: Z 522.673/03 for SA code: Z 522.673/03
			7.08369.80.0	ATS	EL	Abgaskrümmer Exhaust Manifold
			7.08369.91.0	ATS	EL	vor Rußpartikelfilter before soot particulate filter
			7.02604.99.0	LS	400 mm	
CDI 2.2 (639.811, 639.813, 639.815) 70-120 kW (95-163 PS) OM 651.940	07.2010→		7.08369.06.0	ATS	EL	
			7.08369.87.0	ATS	EL	vor Rußpartikelfilter before soot particulate filter
			7.02604.99.0	LS	400 mm	
CDI 2.2 4-matic (639.711, 639.713, 639.811, 639.813,...) 80-110 kW (109-150 PS) OM 646.982	07.2005→		7.24809.37.0	AGR	ET	
			7.08369.80.0	ATS	EL	Abgaskrümmer Exhaust Manifold
			7.08369.91.0	ATS	EL	Baumuster: 639.711, 639.713, 639.811, 639.813 Type: 639.711, 639.713, 639.811, 639.813 vor Rußpartikelfilter before soot particulate filter
			7.02604.99.0	LS	400 mm	

M















VIANO (W639) 145

CDI 2.2 4-matic (639.811, 639.813, 639.815) 70-120 kW (95-163 PS) OM 651.940	07.2010→		7.08369.06.0 ATS EL	
			7.08369.87.0 ATS EL	vor Rußpartikelfilter before soot particulate filter
			7.02604.99.0 LS 400 mm	
CDI 3.0 (639.811, 639.813, 639.815) 150-165 kW (204-224 PS) OM 642.990	03.2006→		7.24809.60.0 AGR ET 	
			7.08369.91.0 ATS EL	vor Rußpartikelfilter before soot particulate filter
			7.08369.94.0 ATS EL	Katalysator Catalytic Converter für Fahrzeuge mit Diesel-Partikel-Filter (DPF) for vehicles with diesel soot filter
			7.11190.01.0 DDS 7.02604.99.0 LS 400 mm	Luftfiltergehäuse Air Filter Housing
CDI 3.0 (639.811, 639.813, 639.815) 165 kW (224 PS) OM 642.890	07.2010→		7.08369.87.0 ATS EL	vor Rußpartikelfilter before soot particulate filter
			7.11020.40.0 ATS EL	Abgasturbolader Exhaust Turbocharger
			7.05270.12.0 LS 500 mm	





M

VITO / MIXTO Van (W639) 146

109 CDI (639.601, 639.603, 639.605) 65-80 kW (88-109 PS) OM 646.983	09.2003→		7.24809.37.0 AGR ET 	
			7.08369.91.0 ATS EL	vor Rußpartikelfilter before soot particulate filter
109 CDI (639.601, 639.603, 639.605) 70-110 kW (95-150 PS) OM 646.980, OM 646.981	08.2006→		7.24809.37.0 AGR ET 	 OM 646.980, OM 646.981: für OE-Nummer: A 646 140 08 60 for OE number: A 646 140 08 60 für SA Code: Z 522.673/03 for SA code: Z 522.673/03
			7.24809.59.0 AGR ET 	 OM 646.980, OM 646.981: für OE-Nummer: A 646 140 27 60 for OE number: A 646 140 27 60 für SA Code: Z 522.673/05, Z 522.673/06 for SA code: Z 522.673/05, Z 522.673/06
			7.08369.80.0 ATS EL 	 OM 646.980, OM 646.981: Abgaskrümmer Exhaust Manifold
			7.08369.91.0 ATS EL 	 OM 646.980, OM 646.981: vor Rußpartikelfilter before soot particulate filter
			7.02604.99.0 LS 400 mm	
			7.08369.06.0 ATS EL	
110 CDI (639.601, 639.603, 639.605) 70-120 kW (95-163 PS) OM 651.940	09.2010→		7.08369.06.0 ATS EL	
			7.08369.87.0 ATS EL	vor Rußpartikelfilter before soot particulate filter
			7.02604.99.0 LS 400 mm	















VITO / MIXTO Van (W639) 146

111 CDI (639.601, 639.603) 70-110 kW (95-150 PS) OM 646.980	09.2007→		7.24809.37.0	AGR	ET 	für OE-Nummer: A 646 140 08 60 für OE number: A 646 140 08 60 für SA Code: Z 522.673/03 für SA code: Z 522.673/03
			7.24809.59.0	AGR	ET 	für OE-Nummer: A 646 140 27 60 für OE number: A 646 140 27 60 für SA Code: Z 522.673/05, Z 522.673/06 für SA code: Z 522.673/05, Z 522.673/06
			7.08369.80.0	ATS	EL	Abgaskrümmer Exhaust Manifold
			7.08369.91.0	ATS	EL	vor Rußpartikelfilter before soot particulate filter
			7.02604.99.0	LS	400 mm	
111 CDI (639.601, 639.603) 80-110 kW (109-150 PS) OM 646.982	09.2007→		7.24809.37.0	AGR	ET 	
			7.08369.80.0	ATS	EL	Abgaskrümmer Exhaust Manifold
			7.08369.91.0	ATS	EL	vor Rußpartikelfilter before soot particulate filter
			7.02604.99.0	LS	400 mm	
111 CDI (639.601, 639.603, 639.605) 80-110 kW (109-150 PS) OM 646.982	09.2003→		7.24809.37.0	AGR	ET 	
			7.08369.80.0	ATS	EL	Abgaskrümmer Exhaust Manifold
			7.08369.91.0	ATS	EL	vor Rußpartikelfilter before soot particulate filter
111 CDI 4x4 (639.601, 639.603, 639.605) 80-110 kW (109-150 PS) OM 646.982	09.2007→		7.24809.37.0	AGR	ET 	
			7.08369.80.0	ATS	EL	Abgaskrümmer Exhaust Manifold
			7.08369.91.0	ATS	EL	vor Rußpartikelfilter before soot particulate filter
113 CDI (639.601, 639.603, 639.605) 70-120 kW (95-163 PS) OM 651.940	09.2010→		7.08369.06.0	ATS	EL	
			7.08369.87.0	ATS	EL	vor Rußpartikelfilter before soot particulate filter
			7.02604.99.0	LS	400 mm	
113 CDI 4x4 (639.601, 639.603, 639.605) 70-120 kW (95-163 PS) OM 651.940	09.2010→		7.08369.06.0	ATS	EL	
			7.08369.87.0	ATS	EL	vor Rußpartikelfilter before soot particulate filter
			7.02604.99.0	LS	400 mm	
115 CDI (639.601, 639.603, 639.605) 70-110 kW (95-150 PS) OM 646.980	09.2003→		7.24809.37.0	AGR	ET 	für OE-Nummer: A 646 140 08 60 für OE number: A 646 140 08 60 für SA Code: Z 522.673/03 für SA code: Z 522.673/03
			7.24809.59.0	AGR	ET 	für OE-Nummer: A 646 140 27 60 für OE number: A 646 140 27 60 für SA Code: Z 522.673/05, Z 522.673/06 für SA code: Z 522.673/05, Z 522.673/06
			7.08369.80.0	ATS	EL	Abgaskrümmer Exhaust Manifold

M







VITO / MIXTO Van (W639) 146

			7.08369.91.0	ATS	EL	vor Rußpartikelfilter before soot particulate filter
115 CDI (639.601, 639.603, 639.605) 80-110 kW (109-150 PS) OM 646.982	09.2003→		7.24809.37.0	AGR	ET	
			7.08369.91.0	ATS	EL	vor Rußpartikelfilter before soot particulate filter
			7.02604.99.0	LS	400 mm	10.2003→07.2010 Motorcode: QM 646.982 Engine Code: QM 646.982 Produktionsdatum ab: 10.2003 Production date from: 10.2003 Produktionsdatum bis: 07.2010 Production date to: 07.2010
115 CDI (639.605, 639.601, 639.603) 70-120 kW (95-163 PS) OM 651.940	05.2012→02.2015		7.08369.06.0	ATS	EL	
115 CDI 4x4 (639.601, 639.603, 639.605) 80-110 kW (109-150 PS) OM 646.982	07.2006→		7.24809.37.0	AGR	ET	
			7.08369.80.0	ATS	EL	Abgaskrümmer Exhaust Manifold
			7.08369.91.0	ATS	EL	vor Rußpartikelfilter before soot particulate filter
			7.02604.99.0	LS	400 mm	
116 CDI (639.601, 639.603, 639.605) 70-120 kW (95-163 PS) OM 651.940	09.2010→		7.08369.06.0	ATS	EL	
			7.08369.87.0	ATS	EL	vor Rußpartikelfilter before soot particulate filter
			7.02604.99.0	LS	400 mm	
116 CDI 4x4 (639.601, 639.603, 639.605) 70-120 kW (95-163 PS) OM 651.940	09.2010→		7.08369.06.0	ATS	EL	
			7.08369.87.0	ATS	EL	vor Rußpartikelfilter before soot particulate filter
			7.02604.99.0	LS	400 mm	
119 (639.601, 639.603, 639.605) 140-160 kW (190-218 PS) M 112.951	09.2003→		7.22136.50.0	AGR	PN	
			7.05270.12.0	LS	500 mm	für OE-Nummer: A 001 540 95 17 for OE number: A 001 540 95 17
			7.04389.00.0	SLP	EL	
120 CDI (639.601, 639.603, 639.605) 150-165 kW (204-224 PS) OM 642.990	07.2006→		7.24809.60.0	AGR	ET	
			7.08369.91.0	ATS	EL	vor Rußpartikelfilter before soot particulate filter
			7.08369.94.0	ATS	EL	Katalysator Catalytic Converter für Fahrzeuge mit Diesel-Partikel-Filter (DPF) for vehicles with diesel soot filter
			7.11190.01.0	DDS		Luftfiltergehäuse Air Filter Housing
			7.02604.99.0	LS	400 mm	

M





VITO / MIXTO Van (W639) 146

122 (639.601, 639.603, 639.605) 140-160 kW (190-218 PS) M 112.951	09.2003→		7.22136.50.0	AGR	PN	☒
			7.05270.12.0	LS	500 mm	für OE-Nummer: A 001 540 95 17 für OE number: A 001 540 95 17
			7.04389.00.0	SLP	EL	
122 CDI (639.601, 639.603, 639.605) 165 kW (224 PS) OM 642.890	09.2010→		7.08369.87.0	ATS	EL	vor Rußpartikelfilter before soot particulate filter
			7.11020.40.0	ATS	EL	Abgasturbolader Exhaust Turbocharger
			7.05270.12.0	LS	500 mm	für OE-Nummer: A 001 540 95 17 für OE number: A 001 540 95 17
123 (639.601) 165-170 kW (224-231 PS) M 112.976	06.2004→07.2008		7.22136.50.0	AGR	PN	☒
			7.04389.00.0	SLP	EL	
123 (639.601, 639.603, 639.605) 165-170 kW (224-231 PS) M 112.976	06.2004→07.2008		7.04389.00.0	SLP	EL	
126 (639.601, 639.603, 639.605) 190 kW (258 PS) M 272.978	09.2007→		7.05270.21.0	LS	600 mm	
			7.04389.02.0	SLP	EL	

VITO Bus (W638) 147













M 112 CDI 2.2 (638.194) 60-90 kW (82-122 PS) OM 611.980	03.1999→07.2003		7.24809.34.0	AGR	PN	☐
			7.24809.35.0	AGR	PN	☐ →50 220599 für OE-Nummer: 611 090 02 54 für OE number: 611 090 02 54
113 2.0 (638.114, 638.194) 95 kW (129 PS) M 111.948	02.1996→07.2003		7.02604.04.0	LS	200 mm	
113 2.0 (638.114, 638.194) 95 kW (129 PS) M 111.950	02.1996→07.2003		7.02604.04.0	LS	200 mm	
			7.04389.05.0	SLP	EL	

VITO Bus (W639) 148

109 CDI (639.701) 65-80 kW (88-109 PS) OM 646.983	09.2003→		7.24809.37.0	AGR	ET	☐
			7.08369.91.0	ATS	EL	vor Rußpartikelfilter before soot particulate filter
109 CDI (639.701, 639.703) 70-110 kW (95-150 PS) OM 646.980	09.2006→		7.24809.37.0	AGR	ET	☐ für OE-Nummer: A 646 140 08 60 für OE number: A 646 140 08 60 für SA Code: Z 522.673/03 für SA code: Z 522.673/03
			7.24809.59.0	AGR	ET	☐ für OE-Nummer: A 646 140 27 60 für OE number: A 646 140 27 60 für SA Code: Z 522.673/05, Z 522.673/06 für SA code: Z 522.673/05, Z 522.673/06
			7.08369.80.0	ATS	EL	Abgaskrümmer Exhaust Manifold
			7.08369.91.0	ATS	EL	vor Rußpartikelfilter before soot particulate filter
			7.02604.99.0	LS	400 mm	









VITO Bus (W639) **148**

109 CDI 4x4 (639.701) 70 kW (95 PS) OM 646.981	09.2007→08.2014		7.24809.37.0	AGR	ET	 für OE-Nummer: A 646 140 08 60 for OE number: A 646 140 08 60 für SA Code: Z 522.673/03 for SA code: Z 522.673/03
			7.24809.59.0	AGR	ET	 für OE-Nummer: A 646 140 27 60 for OE number: A 646 140 27 60 für SA Code: Z 522.673/05, Z 522.673/06 for SA code: Z 522.673/05, Z 522.673/06
			7.08369.80.0	ATS	EL	Abgaskrümmer Exhaust Manifold
			7.08369.91.0	ATS	EL	vor Rußpartikelfilter before soot particulate filter
			7.02604.99.0	LS	400 mm	
110 CDI (639.701, 639.703, 639.705) 70-120 kW (95-163 PS) OM 651.940	09.2010→08.2014		7.08369.06.0	ATS	EL	
			7.08369.87.0	ATS	EL	vor Rußpartikelfilter before soot particulate filter
			7.02604.99.0	LS	400 mm	
111 CDI (639.701, 639.703, 639.705) 80-110 kW (109-150 PS) OM 646.982	09.2003→		7.24809.37.0	AGR	ET	
			7.08369.80.0	ATS	EL	Abgaskrümmer Exhaust Manifold
			7.08369.91.0	ATS	EL	vor Rußpartikelfilter before soot particulate filter
111 CDI (639.701, 639.703, 639.705) 70-110 kW (95-150 PS) OM 646.980	09.2007→		7.24809.37.0	AGR	ET	 für OE-Nummer: A 646 140 08 60 for OE number: A 646 140 08 60 für SA Code: Z 522.673/03 for SA code: Z 522.673/03
			7.24809.59.0	AGR	ET	 für OE-Nummer: A 646 140 27 60 for OE number: A 646 140 27 60 für SA Code: Z 522.673/05, Z 522.673/06 for SA code: Z 522.673/05, Z 522.673/06
			7.08369.80.0	ATS	EL	Abgaskrümmer Exhaust Manifold
			7.08369.91.0	ATS	EL	vor Rußpartikelfilter before soot particulate filter
			7.02604.99.0	LS	400 mm	
111 CDI 4x4 (639.701, 639.703, 639.705) 80-110 kW (109-150 PS) OM 646.982	09.2007→08.2014		7.24809.37.0	AGR	ET	
			7.08369.80.0	ATS	EL	Abgaskrümmer Exhaust Manifold
			7.08369.91.0	ATS	EL	vor Rußpartikelfilter before soot particulate filter
113 CDI (639.701, 639.703, 639.705) 70-120 kW (95-163 PS) OM 651.940	09.2010→		7.08369.06.0	ATS	EL	
			7.08369.87.0	ATS	EL	vor Rußpartikelfilter before soot particulate filter
			7.02604.99.0	LS	400 mm	
113 CDI 4x4 (639.701, 639.703, 639.705) 70-120 kW (95-163 PS) OM 651.940	09.2010→08.2014		7.08369.06.0	ATS	EL	
			7.08369.87.0	ATS	EL	vor Rußpartikelfilter before soot particulate filter

M







VITO Bus (W639) 148

		7.02604.99.0	LS	400 mm	
115 CDI (639.701, 639.703, 639.705) 70-110 kW (95-150 PS) OM 646.980	09.2003→	 7.24809.37.0	AGR	ET	⊗ für OE-Nummer: A 646 140 08 60 for OE number: A 646 140 08 60 für SA Code: Z 522.673/03 for SA code: Z 522.673/03
		7.24809.59.0	AGR	ET	⊗ für OE-Nummer: A 646 140 27 60 for OE number: A 646 140 27 60 für SA Code: Z 522.673/05, Z 522.673/06 for SA code: Z 522.673/05, Z 522.673/06
		7.08369.80.0	ATS	EL	Abgaskrümmer Exhaust Manifold
		7.08369.91.0	ATS	EL	vor Rußpartikelfilter before soot particulate filter
		7.02604.99.0	LS	400 mm	
115 CDI (639.701, 639.703, 639.705) 80-110 kW (109-150 PS) OM 646.982	09.2003→	 7.24809.37.0	AGR	ET	⊗
		7.08369.80.0	ATS	EL	Abgaskrümmer Exhaust Manifold
		7.08369.91.0	ATS	EL	vor Rußpartikelfilter before soot particulate filter
115 CDI 4x4 (639.701, 639.705) 80-110 kW (109-150 PS) OM 646.982	09.2007→08.2014	 7.24809.37.0	AGR	ET	⊗
		7.08369.80.0	ATS	EL	Abgaskrümmer Exhaust Manifold
		7.08369.91.0	ATS	EL	vor Rußpartikelfilter before soot particulate filter
116 CDI (639.701, 639.703, 639.705) 70-120 kW (95-163 PS) OM 651.940	09.2010→	 7.08369.06.0	ATS	EL	
		7.08369.87.0	ATS	EL	nach Katalysator Post-catalyst
		7.02604.99.0	LS	400 mm	
116 CDI 4x4 (639.701, 639.703, 639.705) 70-120 kW (95-163 PS) OM 651.940	09.2010→08.2014	 7.08369.06.0	ATS	EL	
		7.08369.87.0	ATS	EL	vor Rußpartikelfilter before soot particulate filter
		7.02604.99.0	LS	400 mm	
119 (639.701, 639.703, 639.705) 140-160 kW (190-218 PS) M 112.951	09.2003→	 7.22136.50.0	AGR	PN	⊗
		7.05270.12.0	LS	500 mm	für OE-Nummer: A 001 540 95 17 for OE number: A 001 540 95 17
		7.04389.00.0	SLP	EL	
120 CDI (639.701, 639.703, 639.705) 150-165 kW (204-224 PS) OM 642.990	07.2006→	 7.24809.60.0	AGR	ET	⊗
		7.08369.91.0	ATS	EL	vor Rußpartikelfilter before soot particulate filter

M





VITO Bus (W639) 148

			7.08369.94.0	ATS	EL	Katalysator Catalytic Converter für Fahrzeuge mit Diesel-Partikel-Filter (DPF) for vehicles with diesel soot filter
			7.11190.01.0	DDS		Luftfiltergehäuse Air Filter Housing
			7.02604.99.0	LS	400 mm	
122 (639.701, 639.703, 639.705) 140-160 kW (190-218 PS) M 112.951	09.2003→		7.22136.50.0	AGR	PN	☒
			7.05270.12.0	LS	500 mm	für OE-Nummer: A 001 540 95 17 for OE number: A 001 540 95 17
			7.04389.00.0	SLP	EL	
122 CDI (639.701, 639.703, 639.705) 165 kW (224 PS) OM 642.890	09.2010→		7.08369.87.0	ATS	EL	vor Rußpartikelfilter before soot particulate filter
			7.11020.40.0	ATS	EL	Abgasturbolader Exhaust Turbocharger
			7.05270.12.0	LS	500 mm	für OE-Nummer: A 001 540 95 17 for OE number: A 001 540 95 17
123 (639.701) 165-170 kW (224-231 PS) M 112.976	06.2004→07.2008		7.22136.50.0	AGR	PN	☒
			7.04389.00.0	SLP	EL	
123 (639.701, 639.703, 639.705) 165-170 kW (224-231 PS) M 112.976	06.2004→07.2008		7.22136.50.0	AGR	PN	☒
			7.05270.12.0	LS	500 mm	für OE-Nummer: A 001 540 95 17 for OE number: A 001 540 95 17
			7.04389.00.0	SLP	EL	
126 (639.701, 639.703, 639.705) 190 kW (258 PS) M 272.978	09.2007→		7.05270.21.0	LS	600 mm	
			7.04389.02.0	SLP	EL	











M

VITO Mixto (Double Cabin) (W447) 149

109 CDI (447.701, 447.703, 447.705) 65-84 kW (88-114 PS) OM 622.951	10.2014→		7.24809.90.0	AGR	EL	☐
			7.08369.61.0	ATS	EL	
			7.11457.07.0*	DDS		ab Euro 6 From Euro 6
			↳ 7.11492.07.0	DDS		
111 CDI (447.701, 447.703, 447.705) 65-84 kW (88-114 PS) OM 622.951	10.2014→		7.24809.90.0	AGR	EL	☐
			7.08369.61.0	ATS	EL	
			7.11457.07.0*	DDS		ab Euro 6 From Euro 6
			↳ 7.11492.07.0	DDS		
114 CDI (447.701, 447.703, 447.705) 84-140 kW (114-190 PS) OM 651.950	10.2014→		7.08369.06.0	ATS	EL	
			7.08369.61.0	ATS	EL	
			7.08369.87.0	ATS	EL	nach Katalysator Post-catalyst ab Euro 5 From Euro 5 für Linkslenker for left-hand drive vehicles









VITO Mixto (Double Cabin) (W447) 149

		7.08369.97.0	ATS	EL	 OM 651.950: für OE-Nummer: A 000 905 52 05, A 008 153 41 28 for OE number: A 000 905 52 05, A 008 153 41 28 vor Katalysator in front of the catalyst  OM 651.950: nach Katalysator Post-catalyst Euro 6b, Euro 6c Euro 6b, Euro 6c für Rechtslenker for right-hand drive vehicles
114 CDI 4-matic (447.701, 447.703, 447.705) 84-140 kW (114-190 PS) OM 651.950	07.2015→	 7.08369.06.0	ATS	EL	
		7.08369.87.0	ATS	EL	nach Katalysator Post-catalyst ab Euro 5 From Euro 5 für Linkslenker for left-hand drive vehicles
		7.08369.97.0	ATS	EL	 OM 651.950: vor Rußpartikelfilter before soot particulate filter Allrad permanent Permanent All-wheel Drive Euro 6b, Euro 6c Euro 6b, Euro 6c für Linkslenker for left-hand drive vehicles  OM 651.950: für OE-Nummer: A 000 905 52 05, A 008 153 41 28 for OE number: A 000 905 52 05, A 008 153 41 28 vor Katalysator in front of the catalyst  OM 651.950: nach Katalysator Post-catalyst Euro 6b, Euro 6c Euro 6b, Euro 6c für Rechtslenker for right-hand drive vehicles
116 CDI (447.701, 447.703, 447.705) 84-140 kW (114-190 PS) OM 651.950	10.2014→	 7.08369.06.0	ATS	EL	
		7.08369.61.0	ATS	EL	
		7.08369.87.0	ATS	EL	nach Katalysator Post-catalyst ab Euro 5 From Euro 5 für Linkslenker for left-hand drive vehicles
		7.08369.97.0	ATS	EL	 OM 651.950: für OE-Nummer: A 000 905 52 05, A 008 153 41 28 for OE number: A 000 905 52 05, A 008 153 41 28 vor Katalysator in front of the catalyst  OM 651.950: nach Katalysator Post-catalyst Euro 6b, Euro 6c Euro 6b, Euro 6c für Rechtslenker for right-hand drive vehicles
116 CDI 4-matic (447.701, 447.703, 447.705) 84-140 kW (114-190 PS) OM 651.950	07.2015→	 7.08369.06.0	ATS	EL	

M





VITO Mixto (Double Cabin) (W447) 149

			7.08369.87.0	ATS	EL	nach Katalysator Post-catalyst ab Euro 5 From Euro 5 für Linkslenker for left-hand drive vehicles
			7.08369.97.0	ATS	EL	 OM 651.950: vor Rußpartikelfilter before soot particulate filter Allrad permanent Permanent All-wheel Drive Euro 6b, Euro 6c Euro 6b, Euro 6c für Linkslenker for left-hand drive vehicles  OM 651.950: für OE-Nummer: A 000 905 52 05, A 008 153 41 28 for OE number: A 000 905 52 05, A 008 153 41 28 vor Katalysator in front of the catalyst  OM 651.950: nach Katalysator Post-catalyst Euro 6b, Euro 6c Euro 6b, Euro 6c für Rechtslenker for right-hand drive vehicles
119 BlueTEC (447.701, 447.703, 447.705) 84-140 kW (114-190 PS) OM 651.950	10.2014→		7.08369.06.0	ATS	EL	
			7.08369.61.0	ATS	EL	
			7.08369.87.0	ATS	EL	nach Katalysator Post-catalyst ab Euro 5 From Euro 5 für Linkslenker for left-hand drive vehicles
			7.08369.97.0	ATS	EL	 OM 651.950: für OE-Nummer: A 000 905 52 05, A 008 153 41 28 for OE number: A 000 905 52 05, A 008 153 41 28 vor Katalysator in front of the catalyst  OM 651.950: nach Katalysator Post-catalyst Euro 6b, Euro 6c Euro 6b, Euro 6c für Rechtslenker for right-hand drive vehicles
119 BlueTEC 4-matic (447.701, 447.703, 447.705) 84-140 kW (114-190 PS) OM 651.950	12.2014→		7.08369.06.0	ATS	EL	
			7.08369.61.0	ATS	EL	

M





VITO Mixto (Double Cabin) (W447) 149

		7.08369.87.0	ATS	EL	nach Katalysator Post-catalyst ab Euro 5 From Euro 5 für Linkslenker for left-hand drive vehicles
		7.08369.97.0	ATS	EL	 OM 651.950: vor Rußpartikelfilter before soot particulate filter Allrad permanent Permanent All-wheel Drive Euro 6b, Euro 6c Euro 6b, Euro 6c für Linkslenker for left-hand drive vehicles  OM 651.950: für OE-Nummer: A 000 905 52 05, A 008 153 41 28 for OE number: A 000 905 52 05, A 008 153 41 28 vor Katalysator in front of the catalyst  OM 651.950: nach Katalysator Post-catalyst Euro 6b, Euro 6c Euro 6b, Euro 6c für Rechtslenker for right-hand drive vehicles









VITO Tourer (W447) 150

M











109 CDI / 109 BlueTEC (447.701, 447.703, 447.705) 65-84 kW (88-114 PS) OM 622.951	10.2014→	7.24809.90.0	AGR	EL	
		7.08369.61.0	ATS	EL	ab Euro 6 From Euro 6
		7.11457.07.0*	DDS		
		↳ 7.11492.07.0	DDS		
111 CDI / 111 BlueTEC (447.701, 447.703, 447.705) 65-84 kW (88-114 PS) OM 622.951	10.2014→	7.24809.90.0	AGR	EL	
		7.08369.61.0	ATS	EL	ab Euro 6 From Euro 6
		7.11457.07.0*	DDS		
		↳ 7.11492.07.0	DDS		
114 CDI / 114 BlueTEC (447.701, 447.703, 447.705) 84-140 kW (114-190 PS) OM 651.950	10.2014→	7.08369.06.0	ATS	EL	
		7.08369.61.0	ATS	EL	nach Katalysator Post-catalyst ab Euro 5 From Euro 5 für Linkslenker for left-hand drive vehicles
		7.08369.87.0	ATS	EL	



VITO Tourer (W447) **150**





		7.08369.97.0	ATS	EL	 OM 651.950: für OE-Nummer: A 000 905 52 05, A 008 153 41 28 for OE number: A 000 905 52 05, A 008 153 41 28 vor Katalysator in front of the catalyst  OM 651.950: nach Katalysator Post-catalyst Euro 6b, Euro 6c Euro 6b, Euro 6c für Rechtslenker for right-hand drive vehicles	
114 CDI / 114 BlueTEC 4-matic (447.701, 447.703,... 84-140 kW (114-190 PS) OM 651.950	07.2015->		7.08369.06.0	ATS	EL	
			7.08369.61.0	ATS	EL	nach Katalysator Post-catalyst ab Euro 5 From Euro 5 für Linkslenker for left-hand drive vehicles
		7.08369.87.0	ATS	EL	nach Katalysator Post-catalyst ab Euro 5 From Euro 5 für Linkslenker for left-hand drive vehicles	
		7.08369.97.0	ATS	EL	 OM 651.950: vor Rußpartikelfilter before soot particulate filter Allrad permanent Permanent All-wheel Drive Euro 6b, Euro 6c Euro 6b, Euro 6c für Linkslenker for left-hand drive vehicles  OM 651.950: für OE-Nummer: A 000 905 52 05, A 008 153 41 28 for OE number: A 000 905 52 05, A 008 153 41 28 vor Katalysator in front of the catalyst  OM 651.950: nach Katalysator Post-catalyst Euro 6b, Euro 6c Euro 6b, Euro 6c für Rechtslenker for right-hand drive vehicles	
116 CDI / 116 BlueTEC (447.701, 447.703, 447.705) 84-140 kW (114-190 PS) OM 651.950	10.2014->		7.08369.06.0	ATS	EL	
			7.08369.61.0	ATS	EL	nach Katalysator Post-catalyst ab Euro 5 From Euro 5 für Linkslenker for left-hand drive vehicles
		7.08369.87.0	ATS	EL	nach Katalysator Post-catalyst ab Euro 5 From Euro 5 für Linkslenker for left-hand drive vehicles	
		7.08369.97.0	ATS	EL	 OM 651.950: für OE-Nummer: A 000 905 52 05, A 008 153 41 28 for OE number: A 000 905 52 05, A 008 153 41 28 vor Katalysator in front of the catalyst  OM 651.950: nach Katalysator Post-catalyst Euro 6b, Euro 6c Euro 6b, Euro 6c für Rechtslenker for right-hand drive vehicles	

M





					
VITO Tourer (W447)					150
116 CDI / 116 BlueTEC 4-matic (447.701, 447.703,... 84-140 kW (114-190 PS) OM 651.950	07.2015→		7.08369.06.0	ATS	EL
			7.08369.61.0	ATS	EL
			7.08369.87.0	ATS	EL
			7.08369.97.0	ATS	EL
nach Katalysator Post-catalyst ab Euro 5 From Euro 5 für Linkslenker for left-hand drive vehicles 🌀 OM 651.950: vor Rußpartikelfilter before soot particulate filter Allrad permanent Permanent All-wheel Drive Euro 6b, Euro 6c Euro 6b, Euro 6c für Linkslenker for left-hand drive vehicles 🌀 OM 651.950: für OE-Nummer: A 000 905 52 05, A 008 153 41 28 for OE number: A 000 905 52 05, A 008 153 41 28 🌀 OM 651.950: nach Katalysator Post-catalyst Euro 6b, Euro 6c Euro 6b, Euro 6c für Rechtslenker for right-hand drive vehicles					
M 116 CDI 4-matic (447.701, 447.703, 447.705) 84-235 kW (114-320 PS) OM 654.920	03.2019→		7.11020.35.0	ATS	EL
			Katalysator Catalytic Converter		
119 CDI / 119 BlueTEC (447.701, 447.703, 447.705) 84-140 kW (114-190 PS) OM 651.950	10.2014→		7.08369.06.0	ATS	EL
			7.08369.61.0	ATS	EL
			7.08369.87.0	ATS	EL
			7.08369.97.0	ATS	EL
nach Katalysator Post-catalyst ab Euro 5 From Euro 5 für Linkslenker for left-hand drive vehicles 🌀 OM 651.950: für OE-Nummer: A 000 905 52 05, A 008 153 41 28 for OE number: A 000 905 52 05, A 008 153 41 28 vor Katalysator in front of the catalyst 🌀 OM 651.950: nach Katalysator Post-catalyst Euro 6b, Euro 6c Euro 6b, Euro 6c für Rechtslenker for right-hand drive vehicles					
119 CDI / 119 BlueTEC 4-matic (447.701, 447.703,... 84-140 kW (114-190 PS) OM 651.950	12.2014→		7.08369.06.0	ATS	EL
			7.08369.61.0	ATS	EL



VITO Tourer (W447) 150

		7.08369.87.0	ATS	EL	nach Katalysator Post-catalyst ab Euro 5 From Euro 5 für Linkslenker for left-hand drive vehicles
		7.08369.97.0	ATS	EL	 OM 651.950: vor Rußpartikelfilter before soot particulate filter Allrad permanent Permanent All-wheel Drive Euro 6b, Euro 6c Euro 6b, Euro 6c für Linkslenker for left-hand drive vehicles  OM 651.950: für OE-Nummer: A 000 905 52 05, A 008 153 41 28 for OE number: A 000 905 52 05, A 008 153 41 28 vor Katalysator in front of the catalyst  OM 651.950: nach Katalysator Post-catalyst Euro 6b, Euro 6c Euro 6b, Euro 6c für Rechtslenker for right-hand drive vehicles
119 Flex (447.703) 115-245 kW (156-333 PS) M 274.920	11.2015→	 7.24809.85.0	AGR	EL	 Produktionsdatum bis: 29.09.2017 Production date to: 29.09.2017









VITO Van (W447) 151

109 CDI (447.601, 447.603, 447.605) 65-84 kW (88-114 PS) OM 622.951	10.2014→	 7.24809.90.0	AGR	EL	
		7.08369.61.0	ATS	EL	ab Euro 6 From Euro 6
		7.11457.07.0*	DDS		
111 CDI (447.601, 447.603, 447.605) 65-84 kW (88-114 PS) OM 622.951	10.2014→	 7.24809.90.0	AGR	EL	
		7.08369.61.0	ATS	EL	ab Euro 6 From Euro 6
		7.11457.07.0*	DDS		
114 CDI (447.601, 447.603, 447.605) 84-140 kW (114-190 PS) OM 651.950	10.2014→	 7.08369.06.0	ATS	EL	
		7.08369.61.0	ATS	EL	nach Katalysator Post-catalyst ab Euro 5 From Euro 5 für Linkslenker for left-hand drive vehicles
		7.08369.87.0	ATS	EL	

M











VITO Van (W447) **151**

		7.08369.97.0	ATS	EL	 OM 651.950: für OE-Nummer: A 000 905 52 05, A 008 153 41 28 for OE number: A 000 905 52 05, A 008 153 41 28 vor Katalysator in front of the catalyst  OM 651.950: nach Katalysator Post-catalyst Euro 6b, Euro 6c Euro 6b, Euro 6c für Rechtslenker for right-hand drive vehicles
114 CDI 4x4 (447.601, 447.603, 447.605) 84-140 kW (114-190 PS) OM 651.950	07.2015→	 7.08369.06.0	ATS	EL	
		7.08369.61.0	ATS	EL	für OE-Nummer: A 001 905 06 00 for OE number: A 001 905 06 00 vor Katalysator in front of the catalyst
		7.08369.87.0	ATS	EL	nach Katalysator Post-catalyst ab Euro 5 From Euro 5 für Linkslenker for left-hand drive vehicles
		7.08369.97.0	ATS	EL	 OM 651.950: vor Rußpartikelfilter before soot particulate filter Allrad permanent Permanent All-wheel Drive Euro 6b, Euro 6c Euro 6b, Euro 6c  OM 651.950: für OE-Nummer: A 000 905 52 05, A 008 153 41 28 for OE number: A 000 905 52 05, A 008 153 41 28 vor Katalysator in front of the catalyst  OM 651.950: nach Katalysator Post-catalyst Euro 6b, Euro 6c Euro 6b, Euro 6c für Rechtslenker for right-hand drive vehicles
116 CDI (447.601, 447.603, 447.605) 84-140 kW (114-190 PS) OM 651.950	10.2014→	 7.08369.06.0	ATS	EL	
		7.08369.61.0	ATS	EL	für OE-Nummer: A 001 905 06 00 for OE number: A 001 905 06 00 vor Katalysator in front of the catalyst
		7.08369.87.0	ATS	EL	nach Katalysator Post-catalyst ab Euro 5 From Euro 5 für Linkslenker for left-hand drive vehicles
		7.08369.97.0	ATS	EL	 OM 651.950: für OE-Nummer: A 000 905 52 05, A 008 153 41 28 for OE number: A 000 905 52 05, A 008 153 41 28 vor Katalysator in front of the catalyst  OM 651.950: nach Katalysator Post-catalyst Euro 6b, Euro 6c Euro 6b, Euro 6c für Rechtslenker for right-hand drive vehicles

























M







































VITO Van (W447) **151**

116 CDI 4x4 (447.601, 447.603, 447.605) 84-140 kW (114-190 PS) OM 651.950	07.2015->		7.08369.06.0	ATS	EL	
			7.08369.61.0	ATS	EL	für OE-Nummer: A 001 905 06 00 for OE number: A 001 905 06 00 vor Katalysator in front of the catalyst
			7.08369.87.0	ATS	EL	nach Katalysator Post-catalyst ab Euro 5 From Euro 5 für Linkslenker for left-hand drive vehicles
			7.08369.97.0	ATS	EL	 OM 651.950: vor Rußpartikelfilter before soot particulate filter Allrad permanent Permanent All-wheel Drive Euro 6b, Euro 6c Euro 6b, Euro 6c  OM 651.950: für OE-Nummer: A 000 905 52 05, A 008 153 41 28 for OE number: A 000 905 52 05, A 008 153 41 28 vor Katalysator in front of the catalyst  OM 651.950: nach Katalysator Post-catalyst Euro 6b, Euro 6c Euro 6b, Euro 6c für Rechtslenker for right-hand drive vehicles
119 CDI / BlueTEC (447.601, 447.603, 447.605) 84-140 kW (114-190 PS) OM 651.950	10.2014->		7.08369.06.0	ATS	EL	
			7.08369.61.0	ATS	EL	für OE-Nummer: A 001 905 06 00 for OE number: A 001 905 06 00 vor Katalysator in front of the catalyst
			7.08369.87.0	ATS	EL	nach Katalysator Post-catalyst ab Euro 5 From Euro 5 für Linkslenker for left-hand drive vehicles
			7.08369.97.0	ATS	EL	 OM 651.950: für OE-Nummer: A 000 905 52 05, A 008 153 41 28 for OE number: A 000 905 52 05, A 008 153 41 28 vor Katalysator in front of the catalyst  OM 651.950: nach Katalysator Post-catalyst Euro 6b, Euro 6c Euro 6b, Euro 6c für Rechtslenker for right-hand drive vehicles
119 CDI / BlueTEC 4x4 (447.601, 447.603, 447.605) 84-140 kW (114-190 PS) OM 651.950	07.2015->		7.08369.06.0	ATS	EL	
			7.08369.61.0	ATS	EL	

M

					
VITO Van (W447)					151
			7.08369.87.0	ATS	EL nach Katalysator Post-catalyst ab Euro 5 From Euro 5 für Linkslenker for left-hand drive vehicles
			7.08369.97.0	ATS	EL  OM 651.950: vor Rußpartikelfilter before soot particulate filter Allrad permanent Permanent All-wheel Drive Euro 6b, Euro 6c Euro 6b, Euro 6c  OM 651.950: für OE-Nummer: A 000 905 52 05, A 008 153 41 28 for OE number: A 000 905 52 05, A 008 153 41 28 vor Katalysator in front of the catalyst  OM 651.950: nach Katalysator Post-catalyst Euro 6b, Euro 6c Euro 6b, Euro 6c für Rechtslenker for right-hand drive vehicles
VITO Van (W638)					152
M	112 CDI 2.2 (638.094) 60-90 kW (82-122 PS) OM 611.980	03.1999→07.2003	 7.24809.34.0	AGR	PN 
			7.24809.35.0	AGR	PN  →50 220599 für OE-Nummer: 611 090 02 54 for OE number: 611 090 02 54
	113 2.0 (638.014, 638.094) 95 kW (129 PS) M 111.948	03.1997→07.2003	 7.02604.04.0	LS	200 mm
113 2.0 (638.014, 638.094) 95 kW (129 PS) M 111.950	03.1997→07.2003	 7.02604.04.0	LS	200 mm	
		7.04389.05.0	SLP	EL	
X-CLASS Platform/Chassis (470)					153
X 220 d (470.210) 120 kW (163 PS) OM 699.300	09.2017→	 7.11457.07.0*	DDS		
		↳ 7.11492.07.0	DDS		
X 250 d 4-matic (470.231) 140 kW (190 PS) OM 699.301	09.2017→	 7.11457.07.0*	DDS		
		↳ 7.11492.07.0	DDS		
11T-SERIES					154
1119 142 kW (193 PS) OM 924.929		 7.24809.66.0	AGR	ET 	
13T-SERIES					155
1319 142 kW (193 PS) OM 924.929	12.1985→	 7.24809.66.0	AGR	ET 	
14T-SERIES					156
1423 172 kW (230 PS) OM 902.920, OM 906.966		 7.24809.66.0	AGR	ET   ch. *0408738→	
15T-SERIES					157
1519 142 kW (193 PS) OM 924.925	06.1971→	 7.24809.66.0	AGR	ET 	



					
16T-SERIES					158
1623 172-194 kW (230-264 PS) OM 902.920, OM 906.999	01.1964→		7.24809.66.0	AGR	ET  ch. *0408738→
1626 172-194 kW (234-264 PS) OM 906.999, OM 926.950	04.1972→12.1985		7.24809.66.0	AGR	ET  ch. *0408738→
17T-SERIES					159
1730 224 kW (305 PS) OM 926.942			7.24809.66.0	AGR	ET  ch. *0408738→
ACTROS III					160
1848 BlueTec	09.2008→		7.01268.03.0	AGR	PN Rückschlagventil/non-return valve
1851 BlueTec	09.2008→		7.01268.03.0	AGR	PN Rückschlagventil/non-return valve
2048 BlueTec	09.2008→		7.01268.03.0	AGR	PN Rückschlagventil/non-return valve
2051 BlueTec	09.2008→		7.01268.03.0	AGR	PN Rückschlagventil/non-return valve
2548 BlueTec	09.2008→		7.01268.03.0	AGR	PN Rückschlagventil/non-return valve
2551 BlueTec	09.2008→		7.01268.03.0	AGR	PN Rückschlagventil/non-return valve
2648 BlueTec	09.2008→		7.01268.03.0	AGR	PN Rückschlagventil/non-return valve
2651 BlueTec	09.2008→		7.01268.03.0	AGR	PN Rückschlagventil/non-return valve
3348 BlueTec	09.2008→		7.01268.03.0	AGR	PN Rückschlagventil/non-return valve
3351 BlueTec	09.2008→		7.01268.03.0	AGR	PN Rückschlagventil/non-return valve
ACTROS MP4 / MP5					161
1842 L 310-375 kW (422-510 PS) OM 471.900, OM 471.909	07.2011→		7.01268.03.0	AGR	PN Rückschlagventil/non-return valve
1842 LS 310-375 kW (422-510 PS) OM 471.900, OM 471.909	07.2011→		7.01268.03.0	AGR	PN Rückschlagventil/non-return valve
1845 L 310-375 kW (422-510 PS) OM 471.900, OM 471.909	07.2011→		7.01268.03.0	AGR	PN Rückschlagventil/non-return valve
1845 LS 310-375 kW (422-510 PS) OM 471.900, OM 471.909	07.2011→		7.01268.03.0	AGR	PN Rückschlagventil/non-return valve
1848 L 310-375 kW (422-510 PS) OM 471.900	07.2011→		7.01268.03.0	AGR	PN Rückschlagventil/non-return valve
1848 LS 310-375 kW (422-510 PS) OM 471.900	07.2011→		7.01268.03.0	AGR	PN Rückschlagventil/non-return valve
1851 L 310-375 kW (422-510 PS) OM 471.900, OM 471.909	07.2011→		7.01268.03.0	AGR	PN Rückschlagventil/non-return valve
1851 LS 310-375 kW (422-510 PS) OM 471.900, OM 471.909	07.2011→		7.01268.03.0	AGR	PN Rückschlagventil/non-return valve
2042 L 310-375 kW (422-510 PS) OM 471.900, OM 471.909	07.2011→		7.01268.03.0	AGR	PN Rückschlagventil/non-return valve
2042 LS 310-375 kW (422-510 PS) OM 471.900, OM 471.909	07.2011→		7.01268.03.0	AGR	PN Rückschlagventil/non-return valve
2045 L 310-375 kW (422-510 PS) OM 471.900, OM 471.909	07.2011→		7.01268.03.0	AGR	PN Rückschlagventil/non-return valve
2045 LS 310-375 kW (422-510 PS) OM 471.900, OM 471.909	07.2011→		7.01268.03.0	AGR	PN Rückschlagventil/non-return valve
2048 L 310-375 kW (422-510 PS) OM 471.900	07.2011→		7.01268.03.0	AGR	PN Rückschlagventil/non-return valve
2048 LS 310-375 kW (422-510 PS) OM 471.900	07.2011→		7.01268.03.0	AGR	PN Rückschlagventil/non-return valve

M



ACTROS MP4 / MP5

161

2645 LS 310-375 kW (422-510 PS) OM 471.900, OM 471.909	07.2011→		7.01268.03.0	AGR	PN	Rückschlagventil/non-return valve
2645 LS 310-375 kW (422-510 PS) OM 471.900, OM 471.909	07.2011→		7.01268.03.0	AGR	PN	Rückschlagventil/non-return valve
2646 LS 310-375 kW (422-510 PS) OM 471.900, OM 471.909	01.2012→		7.01268.03.0	AGR	PN	Rückschlagventil/non-return valve
2648 L 310-375 kW (422-510 PS) OM 471.900	07.2011→		7.01268.03.0	AGR	PN	Rückschlagventil/non-return valve
2648 L 310-375 kW (422-510 PS) OM 471.900	07.2011→		7.01268.03.0	AGR	PN	Rückschlagventil/non-return valve
2648 LS 310-375 kW (422-510 PS) OM 471.900	07.2011→		7.01268.03.0	AGR	PN	Rückschlagventil/non-return valve
2648 LS 310-375 kW (422-510 PS) OM 471.900	07.2011→		7.01268.03.0	AGR	PN	Rückschlagventil/non-return valve
2651 L 310-375 kW (422-510 PS) OM 471.900, OM 471.909	07.2011→		7.01268.03.0	AGR	PN	Rückschlagventil/non-return valve
2651 L 310-375 kW (422-510 PS) OM 471.900	07.2011→		7.01268.03.0	AGR	PN	Rückschlagventil/non-return valve
2651 LS 310-375 kW (422-510 PS) OM 471.900, OM 471.909	07.2011→		7.01268.03.0	AGR	PN	Rückschlagventil/non-return valve
2651 LS 310-375 kW (422-510 PS) OM 471.900, OM 471.909	07.2011→		7.01268.03.0	AGR	PN	Rückschlagventil/non-return valve
3342 L 310-375 kW (422-510 PS) OM 471.900, OM 471.909	07.2011→		7.01268.03.0	AGR	PN	Rückschlagventil/non-return valve
3342 LS 310-375 kW (422-510 PS) OM 471.900, OM 471.909	07.2011→		7.01268.03.0	AGR	PN	Rückschlagventil/non-return valve
3345 L 310-375 kW (422-510 PS) OM 471.900, OM 471.909	07.2011→		7.01268.03.0	AGR	PN	Rückschlagventil/non-return valve
3345 LS 310-375 kW (422-510 PS) OM 471.900, OM 471.909	07.2011→		7.01268.03.0	AGR	PN	Rückschlagventil/non-return valve
3348 L 310-375 kW (422-510 PS) OM 471.900	07.2011→		7.01268.03.0	AGR	PN	Rückschlagventil/non-return valve
3348 LS 310-375 kW (422-510 PS) OM 471.900	07.2011→		7.01268.03.0	AGR	PN	Rückschlagventil/non-return valve
3351 L 310-375 kW (422-510 PS) OM 471.900, OM 471.909	07.2011→		7.01268.03.0	AGR	PN	Rückschlagventil/non-return valve
3351 LS 310-375 kW (422-510 PS) OM 471.900, OM 471.909	07.2011→		7.01268.03.0	AGR	PN	Rückschlagventil/non-return valve

M

ANTOS

162

1842 L 310-375 kW (422-510 PS) OM 471.900	07.2012→		7.01268.03.0	AGR	PN	Rückschlagventil/non-return valve
1842 LS 310-375 kW (422-510 PS) OM 471.900	07.2012→		7.01268.03.0	AGR	PN	Rückschlagventil/non-return valve
1845 L 310-375 kW (422-510 PS) OM 471.900	07.2012→		7.01268.03.0	AGR	PN	Rückschlagventil/non-return valve
1845 LS 310-375 kW (422-510 PS) OM 471.900	07.2012→		7.01268.03.0	AGR	PN	Rückschlagventil/non-return valve
1848 L 310-375 kW (422-510 PS) OM 471.900	07.2012→		7.01268.03.0	AGR	PN	Rückschlagventil/non-return valve
1848 LS 310-375 kW (422-510 PS) OM 471.900	07.2012→		7.01268.03.0	AGR	PN	Rückschlagventil/non-return valve
1851 L 310-375 kW (422-510 PS) OM 471.900	07.2012→		7.01268.03.0	AGR	PN	Rückschlagventil/non-return valve
2042 L 310-375 kW (422-510 PS) OM 471.900	07.2012→		7.01268.03.0	AGR	PN	Rückschlagventil/non-return valve
2042 LS 310-375 kW (422-510 PS) OM 471.900	07.2012→		7.01268.03.0	AGR	PN	Rückschlagventil/non-return valve



ANTOS **162**

2045 L 310-375 kW (422-510 PS) OM 471.900	07.2012→		7.01268.03.0	AGR	PN	Rückschlagventil/non-return valve
2045 LS 310-375 kW (422-510 PS) OM 471.900	07.2012→		7.01268.03.0	AGR	PN	Rückschlagventil/non-return valve
2048 L 310-375 kW (422-510 PS) OM 471.900	07.2012→		7.01268.03.0	AGR	PN	Rückschlagventil/non-return valve
2048 LS 310-375 kW (422-510 PS) OM 471.900	07.2012→		7.01268.03.0	AGR	PN	Rückschlagventil/non-return valve
2051 L 310-375 kW (422-510 PS) OM 471.900	07.2012→		7.01268.03.0	AGR	PN	Rückschlagventil/non-return valve
2051 LS 310-375 kW (422-510 PS) OM 471.900	07.2012→		7.01268.03.0	AGR	PN	Rückschlagventil/non-return valve
2442 LS 310-375 kW (422-510 PS) OM 471.900	07.2012→		7.01268.03.0	AGR	PN	Rückschlagventil/non-return valve
2445 LS 310-375 kW (422-510 PS) OM 471.900	07.2012→		7.01268.03.0	AGR	PN	Rückschlagventil/non-return valve
2448 LS 310-375 kW (422-510 PS) OM 471.900	07.2012→		7.01268.03.0	AGR	PN	Rückschlagventil/non-return valve
2451 LS 310-375 kW (422-510 PS) OM 471.900	07.2012→		7.01268.03.0	AGR	PN	Rückschlagventil/non-return valve
2542 L 310-375 kW (422-510 PS) OM 471.900	07.2012→		7.01268.03.0	AGR	PN	Rückschlagventil/non-return valve
2542 LS 310-375 kW (422-510 PS) OM 471.900	07.2012→		7.01268.03.0	AGR	PN	Rückschlagventil/non-return valve
2542 LS 310-375 kW (422-510 PS) OM 471.900	07.2012→		7.01268.03.0	AGR	PN	Rückschlagventil/non-return valve
2545 L 310-375 kW (422-510 PS) OM 471.900	07.2012→		7.01268.03.0	AGR	PN	Rückschlagventil/non-return valve
2545 LS 310-375 kW (422-510 PS) OM 471.900, OM 471.909	07.2012→		7.01268.03.0	AGR	PN	Rückschlagventil/non-return valve
2545 LS 310-375 kW (422-510 PS) OM 471.900	07.2012→		7.01268.03.0	AGR	PN	Rückschlagventil/non-return valve
2548 L 310-375 kW (422-510 PS) OM 471.900	07.2012→		7.01268.03.0	AGR	PN	Rückschlagventil/non-return valve
2548 LS 310-375 kW (422-510 PS) OM 471.900, OM 471.909	07.2012→		7.01268.03.0	AGR	PN	Rückschlagventil/non-return valve
2548 LS 310-375 kW (422-510 PS) OM 471.900	07.2012→		7.01268.03.0	AGR	PN	Rückschlagventil/non-return valve
2551 L 310-375 kW (422-510 PS) OM 471.900	07.2012→		7.01268.03.0	AGR	PN	Rückschlagventil/non-return valve
2551 LS 310-375 kW (422-510 PS) OM 471.909	07.2012→		7.01268.03.0	AGR	PN	Rückschlagventil/non-return valve
2551 LS 310-375 kW (422-510 PS) OM 471.900	07.2012→		7.01268.03.0	AGR	PN	Rückschlagventil/non-return valve
2642 L 310-375 kW (422-510 PS) OM 471.900	07.2012→		7.01268.03.0	AGR	PN	Rückschlagventil/non-return valve
2642 L 310-375 kW (422-510 PS) OM 471.900	07.2012→		7.01268.03.0	AGR	PN	Rückschlagventil/non-return valve
2642 LS 310-375 kW (422-510 PS) OM 471.900	07.2012→		7.01268.03.0	AGR	PN	Rückschlagventil/non-return valve
2642 LS 310-375 kW (422-510 PS) OM 471.900	07.2012→		7.01268.03.0	AGR	PN	Rückschlagventil/non-return valve
2645 L 310-375 kW (422-510 PS) OM 471.900	07.2012→		7.01268.03.0	AGR	PN	Rückschlagventil/non-return valve
2645 L 310-375 kW (422-510 PS) OM 471.900	07.2012→		7.01268.03.0	AGR	PN	Rückschlagventil/non-return valve
2645 LS 310-375 kW (422-510 PS) OM 471.900	07.2012→		7.01268.03.0	AGR	PN	Rückschlagventil/non-return valve

M



ANTOS







162

2645 LS 310-375 kW (422-510 PS) OM 471.900	07.2012→		7.01268.03.0	AGR	PN	Rückschlagventil/non-return valve
2648 L 310-375 kW (422-510 PS) OM 471.900	07.2012→		7.01268.03.0	AGR	PN	Rückschlagventil/non-return valve
2648 L 310-375 kW (422-510 PS) OM 471.900	07.2012→		7.01268.03.0	AGR	PN	Rückschlagventil/non-return valve
2648 L 310-375 kW (422-510 PS) OM 471.900	07.2012→		7.01268.03.0	AGR	PN	Rückschlagventil/non-return valve
2648 LS 310-375 kW (422-510 PS) OM 471.900	07.2012→		7.01268.03.0	AGR	PN	Rückschlagventil/non-return valve
2648 LS 310-375 kW (422-510 PS) OM 471.900	07.2012→		7.01268.03.0	AGR	PN	Rückschlagventil/non-return valve
2651 L 310-375 kW (422-510 PS) OM 471.900	07.2012→		7.01268.03.0	AGR	PN	Rückschlagventil/non-return valve
2651 L 310-375 kW (422-510 PS) OM 471.900	07.2012→		7.01268.03.0	AGR	PN	Rückschlagventil/non-return valve
2651 LS 310-375 kW (422-510 PS) OM 471.900	07.2012→		7.01268.03.0	AGR	PN	Rückschlagventil/non-return valve
2651 LS 310-375 kW (422-510 PS) OM 471.900	07.2012→		7.01268.03.0	AGR	PN	Rückschlagventil/non-return valve
3336 LS 240-375 kW (326-510 PS) OM 470.906	07.2012→		7.01268.03.0	AGR	PN	Rückschlagventil/non-return valve
3342 L 310-375 kW (422-510 PS) OM 471.900	07.2012→		7.01268.03.0	AGR	PN	Rückschlagventil/non-return valve
3342 LS 310-375 kW (422-510 PS) OM 471.900	07.2012→		7.01268.03.0	AGR	PN	Rückschlagventil/non-return valve
3345 L 310-375 kW (422-510 PS) OM 471.900	07.2012→		7.01268.03.0	AGR	PN	Rückschlagventil/non-return valve
3345 LS 310-375 kW (422-510 PS) OM 471.900	07.2012→		7.01268.03.0	AGR	PN	Rückschlagventil/non-return valve
3348 L 310-375 kW (422-510 PS) OM 471.900	07.2012→		7.01268.03.0	AGR	PN	Rückschlagventil/non-return valve
3348 LS 310-375 kW (422-510 PS) OM 471.900	07.2012→		7.01268.03.0	AGR	PN	Rückschlagventil/non-return valve
3351 L 310-375 kW (422-510 PS) OM 471.900	07.2012→		7.01268.03.0	AGR	PN	Rückschlagventil/non-return valve
3351 LS 310-375 kW (422-510 PS) OM 471.900	07.2012→		7.01268.03.0	AGR	PN	Rückschlagventil/non-return valve

M

AROCS

163

1842 310-375 kW (422-510 PS) OM 471.900	01.2013→		7.01268.03.0	AGR	PN	Rückschlagventil/non-return valve
1842 A 310-375 kW (422-510 PS) OM 471.900	01.2013→		7.01268.03.0	AGR	PN	Rückschlagventil/non-return valve
1842 AK 310-375 kW (422-510 PS) OM 471.900	01.2013→		7.01268.03.0	AGR	PN	Rückschlagventil/non-return valve
1842 AS 310-375 kW (422-510 PS) OM 471.900	01.2013→		7.01268.03.0	AGR	PN	Rückschlagventil/non-return valve
1842 K 310-375 kW (422-510 PS) OM 471.900	01.2013→		7.01268.03.0	AGR	PN	Rückschlagventil/non-return valve
1842 LS 310-375 kW (422-510 PS) OM 471.900	01.2013→		7.01268.03.0	AGR	PN	Rückschlagventil/non-return valve
1845 310-375 kW (422-510 PS) OM 471.900, OM 471.906	01.2013→		7.01268.03.0	AGR	PN	Rückschlagventil/non-return valve
1845 A 310-390 kW (422-530 PS) OM 471.906, OM 471.926	01.2013→		7.01268.03.0	AGR	PN	Rückschlagventil/non-return valve
1845 AK 310-390 kW (422-530 PS) OM 471.906, OM 471.926	01.2013→		7.01268.03.0	AGR	PN	Rückschlagventil/non-return valve



AROCS 163



1845 AS 310-390 kW (422-530 PS) OM 471.906, OM 471.926	01.2013→		7.01268.03.0	AGR	PN	Rückschlagventil/non-return valve
1845 K 310-375 kW (422-510 PS) OM 471.900, OM 471.906	01.2013→		7.01268.03.0	AGR	PN	Rückschlagventil/non-return valve
1845 LS 310-375 kW (422-510 PS) OM 471.900, OM 471.906	01.2013→		7.01268.03.0	AGR	PN	Rückschlagventil/non-return valve
1848 310-375 kW (422-510 PS) OM 471.900, OM 471.906	01.2013→		7.01268.03.0	AGR	PN	Rückschlagventil/non-return valve
1848 A 310-375 kW (422-510 PS) OM 471.906	01.2013→		7.01268.03.0	AGR	PN	Rückschlagventil/non-return valve
1848 AK 310-375 kW (422-510 PS) OM 471.906	01.2013→		7.01268.03.0	AGR	PN	Rückschlagventil/non-return valve
1848 AS 310-375 kW (422-510 PS) OM 471.906	01.2013→		7.01268.03.0	AGR	PN	Rückschlagventil/non-return valve
1848 K 310-375 kW (422-510 PS) OM 471.900, OM 471.906	01.2013→		7.01268.03.0	AGR	PN	Rückschlagventil/non-return valve
1848 LS 310-375 kW (422-510 PS) OM 471.900, OM 471.906	01.2013→		7.01268.03.0	AGR	PN	Rückschlagventil/non-return valve
1851 310-375 kW (422-510 PS) OM 471.909	01.2013→		7.01268.03.0	AGR	PN	Rückschlagventil/non-return valve
1851 A 310-375 kW (422-510 PS) OM 471.909	01.2013→		7.01268.03.0	AGR	PN	Rückschlagventil/non-return valve
1851 AK 310-375 kW (422-510 PS) OM 471.909	01.2013→		7.01268.03.0	AGR	PN	Rückschlagventil/non-return valve
1851 AS 310-375 kW (422-510 PS) OM 471.909	01.2013→		7.01268.03.0	AGR	PN	Rückschlagventil/non-return valve
1851 K 310-375 kW (422-510 PS) OM 471.909	01.2013→		7.01268.03.0	AGR	PN	Rückschlagventil/non-return valve
1851 LS 310-375 kW (422-510 PS) OM 471.909	01.2013→		7.01268.03.0	AGR	PN	Rückschlagventil/non-return valve
2042 310-375 kW (422-510 PS) OM 471.900	01.2013→		7.01268.03.0	AGR	PN	Rückschlagventil/non-return valve
2042 A 310-375 kW (422-510 PS) OM 471.900	01.2013→		7.01268.03.0	AGR	PN	Rückschlagventil/non-return valve
2042 AK 310-375 kW (422-510 PS) OM 471.900	01.2013→		7.01268.03.0	AGR	PN	Rückschlagventil/non-return valve
2042 AS 310-375 kW (422-510 PS) OM 471.900	01.2013→		7.01268.03.0	AGR	PN	Rückschlagventil/non-return valve
2042 K 310-375 kW (422-510 PS) OM 471.900	01.2013→		7.01268.03.0	AGR	PN	Rückschlagventil/non-return valve
2042 S, 2042 LS 310-375 kW (422-510 PS) OM 471.900	01.2013→		7.01268.03.0	AGR	PN	Rückschlagventil/non-return valve
2045 310-375 kW (422-510 PS) OM 471.900, OM 471.906	01.2013→		7.01268.03.0	AGR	PN	Rückschlagventil/non-return valve
2045 A 310-390 kW (422-530 PS) OM 471.906, OM 471.926	01.2013→		7.01268.03.0	AGR	PN	Rückschlagventil/non-return valve
2045 AK 310-390 kW (422-530 PS) OM 471.906, OM 471.926	01.2013→		7.01268.03.0	AGR	PN	Rückschlagventil/non-return valve
2045 AS 310-390 kW (422-530 PS) OM 471.906, OM 471.926	01.2013→		7.01268.03.0	AGR	PN	Rückschlagventil/non-return valve
2045 K 310-375 kW (422-510 PS) OM 471.900, OM 471.906	01.2013→		7.01268.03.0	AGR	PN	Rückschlagventil/non-return valve
2045 S, 2045 LS 310-375 kW (422-510 PS) OM 471.900, OM 471.906	01.2013→		7.01268.03.0	AGR	PN	Rückschlagventil/non-return valve
2048 310-390 kW (422-530 PS) OM 471.900, OM 471.926	01.2013→		7.01268.03.0	AGR	PN	Rückschlagventil/non-return valve

M



AROCS

163

2048 A 310-390 kW (422-530 PS) OM 471.906, OM 471.926	01.2013→		7.01268.03.0	AGR	PN	Rückschlagventil/non-return valve
2048 AK 310-390 kW (422-530 PS) OM 471.906, OM 471.926	01.2013→		7.01268.03.0	AGR	PN	Rückschlagventil/non-return valve
2048 AS 310-390 kW (422-530 PS) OM 471.906, OM 471.926	01.2013→		7.01268.03.0	AGR	PN	Rückschlagventil/non-return valve
2048 K 310-375 kW (422-510 PS) OM 471.900, OM 471.906	01.2013→		7.01268.03.0	AGR	PN	Rückschlagventil/non-return valve
2048 S, 2048 LS 310-390 kW (422-530 PS) OM 471.900, OM 471.926	01.2013→		7.01268.03.0	AGR	PN	Rückschlagventil/non-return valve
2051 310-375 kW (422-510 PS) OM 471.909	01.2013→		7.01268.03.0	AGR	PN	Rückschlagventil/non-return valve
2051 A 310-375 kW (422-510 PS) OM 471.909	01.2013→		7.01268.03.0	AGR	PN	Rückschlagventil/non-return valve
2051 AK 310-375 kW (422-510 PS) OM 471.909	01.2013→		7.01268.03.0	AGR	PN	Rückschlagventil/non-return valve
2051 AS 310-375 kW (422-510 PS) OM 471.909	01.2013→		7.01268.03.0	AGR	PN	Rückschlagventil/non-return valve
2051 K 310-375 kW (422-510 PS) OM 471.909	01.2013→		7.01268.03.0	AGR	PN	Rückschlagventil/non-return valve
2051 S, 2051 LS 310-375 kW (422-510 PS) OM 471.909	01.2013→		7.01268.03.0	AGR	PN	Rückschlagventil/non-return valve
2542 L 310-375 kW (422-510 PS) OM 471.900	01.2013→		7.01268.03.0	AGR	PN	Rückschlagventil/non-return valve
2542 LS 310-375 kW (422-510 PS) OM 471.900	01.2013→		7.01268.03.0	AGR	PN	Rückschlagventil/non-return valve
2542 LS 310-375 kW (422-510 PS) OM 471.900	01.2013→		7.01268.03.0	AGR	PN	Rückschlagventil/non-return valve
2545 L 310-375 kW (422-510 PS) OM 471.900, OM 471.906	01.2013→		7.01268.03.0	AGR	PN	Rückschlagventil/non-return valve
2545 LS 310-375 kW (422-510 PS) OM 471.900, OM 471.906	01.2013→		7.01268.03.0	AGR	PN	Rückschlagventil/non-return valve
2545 LS 310-375 kW (422-510 PS) OM 471.900	01.2013→		7.01268.03.0	AGR	PN	Rückschlagventil/non-return valve
2548 L 310-375 kW (422-510 PS) OM 471.900, OM 471.906	01.2013→		7.01268.03.0	AGR	PN	Rückschlagventil/non-return valve
2548 LS 310-390 kW (422-530 PS) OM 471.900, OM 471.926	01.2013→		7.01268.03.0	AGR	PN	Rückschlagventil/non-return valve
2548 LS 310-390 kW (422-530 PS) OM 471.900, OM 471.926	01.2013→		7.01268.03.0	AGR	PN	Rückschlagventil/non-return valve
2551 L 310-375 kW (422-510 PS) OM 471.909	01.2013→		7.01268.03.0	AGR	PN	Rückschlagventil/non-return valve
2551 L 310-375 kW (422-510 PS) OM 471.909	01.2013→		7.01268.03.0	AGR	PN	Rückschlagventil/non-return valve
2551 LS 310-375 kW (422-510 PS) OM 471.909	01.2013→		7.01268.03.0	AGR	PN	Rückschlagventil/non-return valve
2551 LS 310-375 kW (422-510 PS) OM 471.909	01.2013→		7.01268.03.0	AGR	PN	Rückschlagventil/non-return valve
2551 LS 310-375 kW (422-510 PS) OM 471.909	01.2013→		7.01268.03.0	AGR	PN	Rückschlagventil/non-return valve
2642 K, 2642 LK 310-375 kW (422-510 PS) OM 471.900	01.2013→		7.01268.03.0	AGR	PN	Rückschlagventil/non-return valve
2642 L 310-375 kW (422-510 PS) OM 471.900	01.2013→		7.01268.03.0	AGR	PN	Rückschlagventil/non-return valve
2642 LS 310-375 kW (422-510 PS) OM 471.900	01.2013→		7.01268.03.0	AGR	PN	Rückschlagventil/non-return valve

M







AROCS 163

2642 S, 2642 LS 310-375 kW (422-510 PS) OM 471.900	01.2013→		7.01268.03.0	AGR	PN	Rückschlagventil/non-return valve
2642, 2642 L 310-375 kW (422-510 PS) OM 471.900	01.2013→		7.01268.03.0	AGR	PN	Rückschlagventil/non-return valve
2645 K, 2645 LK 310-375 kW (422-510 PS) OM 471.900	01.2013→		7.01268.03.0	AGR	PN	Rückschlagventil/non-return valve
2645 L 310-375 kW (422-510 PS) OM 471.900	01.2013→		7.01268.03.0	AGR	PN	Rückschlagventil/non-return valve
2645 LS 310-375 kW (422-510 PS) OM 471.900	01.2013→		7.01268.03.0	AGR	PN	Rückschlagventil/non-return valve
2645 S, 2645 LS 310-375 kW (422-510 PS) OM 471.900, OM 471.906	01.2013→		7.01268.03.0	AGR	PN	Rückschlagventil/non-return valve
2645, 2645 L 310-375 kW (422-510 PS) OM 471.900, OM 471.906	01.2013→		7.01268.03.0	AGR	PN	Rückschlagventil/non-return valve
2648 K, 2648 LK 310-390 kW (422-530 PS) OM 471.900, OM 471.926	01.2013→		7.01268.03.0	AGR	PN	Rückschlagventil/non-return valve
2648 L 310-390 kW (422-530 PS) OM 471.900, OM 471.926	01.2013→		7.01268.03.0	AGR	PN	Rückschlagventil/non-return valve
2648 LS 310-375 kW (422-510 PS) OM 471.900	01.2013→		7.01268.03.0	AGR	PN	Rückschlagventil/non-return valve
M 2648 LS 310-390 kW (422-530 PS) OM 471.900, OM 471.926	01.2013→		7.01268.03.0	AGR	PN	Rückschlagventil/non-return valve
2648 S, 2648 LS 310-390 kW (422-530 PS) OM 471.900, OM 471.926	01.2013→		7.01268.03.0	AGR	PN	Rückschlagventil/non-return valve
2648, 2648 L 310-390 kW (422-530 PS) OM 471.900, OM 471.926	01.2013→		7.01268.03.0	AGR	PN	Rückschlagventil/non-return valve
2651 K, 2651 LK 310-375 kW (422-510 PS) OM 471.909	01.2013→		7.01268.03.0	AGR	PN	Rückschlagventil/non-return valve
2651 L 310-375 kW (422-510 PS) OM 471.909	01.2013→		7.01268.03.0	AGR	PN	Rückschlagventil/non-return valve
2651 LS 310-375 kW (422-510 PS) OM 471.909	01.2013→		7.01268.03.0	AGR	PN	Rückschlagventil/non-return valve
2651 S, 2651 LS 310-375 kW (422-510 PS) OM 471.909	01.2013→		7.01268.03.0	AGR	PN	Rückschlagventil/non-return valve
2651, 2651 L 310-375 kW (422-510 PS) OM 471.909	01.2013→		7.01268.03.0	AGR	PN	Rückschlagventil/non-return valve
3242 K, 3242 LK 310-375 kW (422-510 PS) OM 471.900	01.2013→		7.01268.03.0	AGR	PN	Rückschlagventil/non-return valve
3242 L 310-375 kW (422-510 PS) OM 471.900	01.2013→		7.01268.03.0	AGR	PN	Rückschlagventil/non-return valve
3242 LK 310-375 kW (422-510 PS) OM 471.900	01.2013→		7.01268.03.0	AGR	PN	Rückschlagventil/non-return valve
3242, 3242 L 310-375 kW (422-510 PS) OM 471.900	01.2013→		7.01268.03.0	AGR	PN	Rückschlagventil/non-return valve
3245 K, 3245 LK 310-375 kW (422-510 PS) OM 471.900	01.2013→		7.01268.03.0	AGR	PN	Rückschlagventil/non-return valve



AROCS

163

3245 L 310-375 kW (422-510 PS) OM 471.900	01.2013→		7.01268.03.0	AGR	PN	Rückschlagventil/non-return valve
3245 LK 310-375 kW (422-510 PS) OM 471.900	01.2013→		7.01268.03.0	AGR	PN	Rückschlagventil/non-return valve
3245, 3245 L 310-375 kW (422-510 PS) OM 471.900	01.2013→		7.01268.03.0	AGR	PN	Rückschlagventil/non-return valve
3248 K, 3248 LK 310-390 kW (422-530 PS) OM 471.900, OM 471.926	01.2013→		7.01268.03.0	AGR	PN	Rückschlagventil/non-return valve
3248 L 310-390 kW (422-530 PS) OM 471.900, OM 471.926	01.2013→		7.01268.03.0	AGR	PN	Rückschlagventil/non-return valve
3248 LK 310-390 kW (422-530 PS) OM 471.900, OM 471.926	01.2013→		7.01268.03.0	AGR	PN	Rückschlagventil/non-return valve
3248, 3248 L 310-390 kW (422-530 PS) OM 471.900, OM 471.926	01.2013→		7.01268.03.0	AGR	PN	Rückschlagventil/non-return valve
3251 K, 3251 LK 310-375 kW (422-510 PS) OM 471.909	01.2013→		7.01268.03.0	AGR	PN	Rückschlagventil/non-return valve
3251 L 310-375 kW (422-510 PS) OM 471.909	01.2013→		7.01268.03.0	AGR	PN	Rückschlagventil/non-return valve
3251 LK 310-375 kW (422-510 PS) OM 471.909	01.2013→		7.01268.03.0	AGR	PN	Rückschlagventil/non-return valve
3251, 3251 L 310-375 kW (422-510 PS) OM 471.909	01.2013→		7.01268.03.0	AGR	PN	Rückschlagventil/non-return valve
3342 A 310-375 kW (422-510 PS) OM 471.900	01.2013→		7.01268.03.0	AGR	PN	Rückschlagventil/non-return valve
3342 AK 310-375 kW (422-510 PS) OM 471.900	01.2013→		7.01268.03.0	AGR	PN	Rückschlagventil/non-return valve
3342 AS 310-375 kW (422-510 PS) OM 471.900	01.2013→		7.01268.03.0	AGR	PN	Rückschlagventil/non-return valve
3342 K, 3342 LK 310-375 kW (422-510 PS) OM 471.900	01.2013→		7.01268.03.0	AGR	PN	Rückschlagventil/non-return valve
3342 S, 3342 LS 310-375 kW (422-510 PS) OM 471.900	01.2013→		7.01268.03.0	AGR	PN	Rückschlagventil/non-return valve
3342, 3342 L 310-375 kW (422-510 PS) OM 471.900	01.2013→		7.01268.03.0	AGR	PN	Rückschlagventil/non-return valve
3345 A 310-390 kW (422-530 PS) OM 471.906, OM 471.926	01.2013→		7.01268.03.0	AGR	PN	Rückschlagventil/non-return valve
3345 AK 310-390 kW (422-530 PS) OM 471.906, OM 471.926	01.2013→		7.01268.03.0	AGR	PN	Rückschlagventil/non-return valve
3345 AS 310-390 kW (422-530 PS) OM 471.906, OM 471.926	01.2013→		7.01268.03.0	AGR	PN	Rückschlagventil/non-return valve
3345, 3345 L 310-375 kW (422-510 PS) OM 471.900	01.2013→		7.01268.03.0	AGR	PN	Rückschlagventil/non-return valve
3345K, 3345 LK 310-375 kW (422-510 PS) OM 471.900	01.2013→		7.01268.03.0	AGR	PN	Rückschlagventil/non-return valve
3345S, 3345 LS 310-375 kW (422-510 PS) OM 471.900	01.2013→		7.01268.03.0	AGR	PN	Rückschlagventil/non-return valve
3348 A 310-390 kW (422-530 PS) OM 471.906, OM 471.926	01.2013→		7.01268.03.0	AGR	PN	Rückschlagventil/non-return valve

M



AROCS 163







3348 AK 310-375 kW (422-510 PS) OM 471.906	01.2013→		7.01268.03.0	AGR	PN	Rückschlagventil/non-return valve
3348 AS 310-375 kW (422-510 PS) OM 471.906	01.2013→		7.01268.03.0	AGR	PN	Rückschlagventil/non-return valve
3348 K, 3348 LK 310-375 kW (422-510 PS) OM 471.900	01.2013→		7.01268.03.0	AGR	PN	Rückschlagventil/non-return valve
3348 S, 3348 LS 310-375 kW (422-510 PS) OM 471.900	01.2013→		7.01268.03.0	AGR	PN	Rückschlagventil/non-return valve
3348, 3348 L 310-375 kW (422-510 PS) OM 471.900	01.2013→		7.01268.03.0	AGR	PN	Rückschlagventil/non-return valve
3351 A 310-375 kW (422-510 PS) OM 471.909	01.2013→		7.01268.03.0	AGR	PN	Rückschlagventil/non-return valve
3351 AK 310-375 kW (422-510 PS) OM 471.909	01.2013→		7.01268.03.0	AGR	PN	Rückschlagventil/non-return valve
3351 AS 310-375 kW (422-510 PS) OM 471.909	01.2013→		7.01268.03.0	AGR	PN	Rückschlagventil/non-return valve
3351 K, 3351 LK 310-375 kW (422-510 PS) OM 471.909	01.2013→		7.01268.03.0	AGR	PN	Rückschlagventil/non-return valve
3351 S, 3351 LS 310-375 kW (422-510 PS) OM 471.909	01.2013→		7.01268.03.0	AGR	PN	Rückschlagventil/non-return valve
M 3351, 3351 L 310-375 kW (422-510 PS) OM 471.909	01.2013→		7.01268.03.0	AGR	PN	Rückschlagventil/non-return valve
4142 310-375 kW (422-510 PS) OM 471.900	01.2013→		7.01268.03.0	AGR	PN	Rückschlagventil/non-return valve
4142 AK 310-375 kW (422-510 PS) OM 471.906	01.2013→		7.01268.03.0	AGR	PN	Rückschlagventil/non-return valve
4142 AK 310-375 kW (422-510 PS) OM 471.906	01.2013→		7.01268.03.0	AGR	PN	Rückschlagventil/non-return valve
4142 K 310-375 kW (422-510 PS) OM 471.900	01.2013→		7.01268.03.0	AGR	PN	Rückschlagventil/non-return valve
4145 310-375 kW (422-510 PS) OM 471.900	01.2013→		7.01268.03.0	AGR	PN	Rückschlagventil/non-return valve
4145 AK 310-375 kW (422-510 PS) OM 471.906	01.2013→		7.01268.03.0	AGR	PN	Rückschlagventil/non-return valve
4145 AK 310-375 kW (422-510 PS) OM 471.906	01.2013→		7.01268.03.0	AGR	PN	Rückschlagventil/non-return valve
4145 K 310-375 kW (422-510 PS) OM 471.900	01.2013→		7.01268.03.0	AGR	PN	Rückschlagventil/non-return valve
4148 AK 310-375 kW (422-510 PS) OM 471.906	01.2013→		7.01268.03.0	AGR	PN	Rückschlagventil/non-return valve
4148 AK 310-375 kW (422-510 PS) OM 471.906	01.2013→		7.01268.03.0	AGR	PN	Rückschlagventil/non-return valve
4151 310-375 kW (422-510 PS) OM 471.909	01.2013→		7.01268.03.0	AGR	PN	Rückschlagventil/non-return valve
4151 AK 310-375 kW (422-510 PS) OM 471.906	01.2013→		7.01268.03.0	AGR	PN	Rückschlagventil/non-return valve
4151 AK 310-375 kW (422-510 PS) OM 471.906	01.2013→		7.01268.03.0	AGR	PN	Rückschlagventil/non-return valve
4151 K 310-375 kW (422-510 PS) OM 471.909	01.2013→		7.01268.03.0	AGR	PN	Rückschlagventil/non-return valve
4845 K 310-375 kW (422-510 PS) OM 471.900	01.2018→		7.01268.03.0	AGR	PN	Rückschlagventil/non-return valve

						
ACTROS MP2 / MP3						164
3232 B 230-350 kW (313-476 PS) OM 501 LA, OM 541.970, OM 541.996	04.2003→12.2008		7.01268.03.0	AGR	PN	Rückschlagventil/non-return valve
AROCS						165
2642 B, 2642 LB 310-375 kW (422-510 PS) OM 471.900	01.2013→		7.01268.03.0	AGR	PN	Rückschlagventil/non-return valve
2645 B, 2645 LB 310-375 kW (422-510 PS) OM 471.900	01.2013→		7.01268.03.0	AGR	PN	Rückschlagventil/non-return valve
2648 B, 2648 LB 310-390 kW (422-530 PS) OM 471.900, OM 471.926	01.2013→		7.01268.03.0	AGR	PN	Rückschlagventil/non-return valve
2651 B, 2651 LB 310-375 kW (422-510 PS) OM 471.909	01.2013→		7.01268.03.0	AGR	PN	Rückschlagventil/non-return valve
3242 B, 3242 LB 310-375 kW (422-510 PS) OM 471.900	01.2013→		7.01268.03.0	AGR	PN	Rückschlagventil/non-return valve
3242 LB 310-375 kW (422-510 PS) OM 471.900	01.2013→		7.01268.03.0	AGR	PN	Rückschlagventil/non-return valve
3245 B, 3245 LB 310-390 kW (422-530 PS) OM 471.900, OM 471.926	01.2013→		7.01268.03.0	AGR	PN	Rückschlagventil/non-return valve
3245 LB 310-375 kW (422-510 PS) OM 471.900	01.2013→		7.01268.03.0	AGR	PN	Rückschlagventil/non-return valve
3248 B, 3248 LB 310-390 kW (422-530 PS) OM 471.900, OM 471.926	01.2013→		7.01268.03.0	AGR	PN	Rückschlagventil/non-return valve
3248 LB 310-390 kW (422-530 PS) OM 471.906, OM 471.926	01.2013→		7.01268.03.0	AGR	PN	Rückschlagventil/non-return valve
3251 B, 3251 LB 310-375 kW (422-510 PS) OM 471.909	01.2013→		7.01268.03.0	AGR	PN	Rückschlagventil/non-return valve
3251 LB 310-375 kW (422-510 PS) OM 471.909	01.2013→		7.01268.03.0	AGR	PN	Rückschlagventil/non-return valve
3342 B, 3342 LB 310-375 kW (422-510 PS) OM 471.900	01.2013→		7.01268.03.0	AGR	PN	Rückschlagventil/non-return valve
3345B, 3345 LB 310-375 kW (422-510 PS) OM 471.900	01.2013→		7.01268.03.0	AGR	PN	Rückschlagventil/non-return valve
3348 B, 3348 LB 310-375 kW (422-510 PS) OM 471.900	01.2013→		7.01268.03.0	AGR	PN	Rückschlagventil/non-return valve
3351 B, 3351 LB 310-375 kW (422-510 PS) OM 471.909	01.2013→		7.01268.03.0	AGR	PN	Rückschlagventil/non-return valve
4142 B 310-375 kW (422-510 PS) OM 471.900	01.2013→		7.01268.03.0	AGR	PN	Rückschlagventil/non-return valve
4145 B 310-375 kW (422-510 PS) OM 471.900	01.2013→		7.01268.03.0	AGR	PN	Rückschlagventil/non-return valve
4148 B 310-375 kW (422-510 PS) OM 471.900	01.2013→		7.01268.03.0	AGR	PN	Rückschlagventil/non-return valve
4151 B 310-375 kW (422-510 PS) OM 471.909	01.2013→		7.01268.03.0	AGR	PN	Rückschlagventil/non-return valve

























M



ENGINE **166**

<p>ENGINE OM 646.992</p>		<p> 7.24809.59.0</p>	<p>AGR ET </p>	
<p>ENGINE 115-240 kW (156-326 PS) OM 900.910, OM 900.920, OM 900.921, OM 902.910, OM 902.911, OM 902.912, OM 902.919, OM 902.922, OM 924.917, OM 926.916, OM 926.920, OM 926.927, OM 926.928, OM 926.942, OM 926.950</p>		<p>7.24809.66.0 </p>	<p>AGR ET </p>	<p> OM 900.910, OM 900.920, OM 900.921, OM 902.910, OM 902.911, OM 902.912, OM 902.919, OM 902.922, OM 924.917, OM 926.916, OM 926.920, OM 926.927, OM 926.928, OM 926.942, OM 926.950:  ch. *0408738→</p>

M

							
C-CLASS (W204)							1
C 180 (204.049) 115-137 kW (156-186 PS) M 271.820	08.2013→12.2014		7.04389.07.0	SLP	EL		
C 180 CGI (204.049) 115-137 kW (156-186 PS) M 271.820	11.2012→12.2014		7.04389.07.0	SLP	EL		
C 200 CGI (204.048) 135-150 kW (184-204 PS) M 271.860	07.2010→12.2012		7.04389.07.0	SLP	EL		
C 200 Kompressor (204.041) 135 kW (184 PS) M 271.950	03.2008→12.2009		7.05270.11.0	LS	750 mm	nach Katalysator Post-catalyst	
C 230 (204.052) 150 kW (204 PS) M 272.921	05.2008→10.2009		7.04389.02.0	SLP	EL		
C 260 (204.047) 135-150 kW (184-204 PS) M 271.860	08.2013→12.2014		7.04389.07.0	SLP	EL		
C 260 (204.052) 150 kW (204 PS) M 272.921	01.2009→12.2010		7.04389.02.0	SLP	EL		
C 260 CGI (204.047) 135-150 kW (184-204 PS) M 271.860	10.2009→12.2014		7.04389.07.0	SLP	EL		
C 280 (204.054) 170-180 kW (231-245 PS) M 272.947	03.2008→01.2009		7.04389.02.0	SLP	EL		
C 300 (204.054) 170-180 kW (231-245 PS) M 272.947	07.2011→12.2014		7.04389.02.0	SLP	EL		
E-CLASS (W211)							2
2.5 E 230 (211.052) 150 kW (204 PS) M 272.922	11.2005→12.2009		7.04389.02.0	SLP	EL		
3.0 E 280 (211.054) 170 kW (231 PS) M 272.943	11.2005→12.2009		7.04389.02.0	SLP	EL		
3.5 E 350 (211.056) 200 kW (272 PS) M 272.964	11.2005→12.2009		7.04389.02.0	SLP	EL		
E-CLASS (W212)							3
E 180 L (212.133) 115-205 kW (156-279 PS) M 274.920	11.2014→		7.02604.44.0	LS	500 mm	vor Katalysator in front of the catalyst	
E 200 L (212.134) 115-205 kW (156-279 PS) M 274.920	06.2014→		7.02604.44.0	LS	500 mm	vor Katalysator in front of the catalyst	
E 260 L (212.136) 115-205 kW (156-279 PS) M 274.920	06.2014→		7.02604.44.0	LS	500 mm	vor Katalysator in front of the catalyst	
E 300 L (212.154) 170-180 kW (231-245 PS) M 272.952	12.2010→12.2014		7.04389.02.0	SLP	EL		
E 320 L 4-matic (212.168) 200-245 kW (272-333 PS) M 276.820	06.2014→		7.02604.44.0	LS	500 mm	vor Katalysator, beidseitig in front of the catalyst, Left and right	
E 400 L 4-matic (212.167) 200-245 kW (272-333 PS) M 276.820	06.2014→		7.02604.44.0	LS	500 mm	vor Katalysator, beidseitig in front of the catalyst, Left and right	

M

					
---	---	---	---	--	---













E-CLASS (W213)	4
-----------------------	----------

E 320 L 4-matic (213.163) 200 kW (272 PS) M 276.823	11.2016→		7.02604.44.0	LS	500 mm	vor Katalysator, links in front of the catalyst, Left
---	----------	---	---------------------	----	--------	---























GLK-CLASS (X204)	5
-------------------------	----------



































300 4-matic (204.981) 170-180 kW (231-245 PS) M 272.948	04.2012→12.2015		7.05270.21.0	LS	600 mm	
			7.05270.18.0	LS	500 mm	
			7.04389.02.0	SLP	EL	

M

						
VIANO						1
2.5 V6 140 kW (190 PS) M 272.924	01.2010→12.2012	 7.04389.02.0	SLP	EL		
3.0 3.0 V6 165 kW (224 PS) M 272.939	04.2013→03.2016	 7.04389.02.0	SLP	EL		
SPRINTER (B906)						2
2.1 311 CDI 110 kW (150 PS) OM 651.955	11.2011→	 7.08369.06.0	ATS	EL		
VITO (V639)						3
115 CDI 2.2 110 kW (150 PS) OM 646.980	01.2010→12.2011	 7.24809.37.0	AGR	ET	<input type="radio"/> für OE-Nummer: A 646 140 08 60 für OE number: A 646 140 08 60 für SA Code: Z 522.673/03 für SA code: Z 522.673/03	
		7.24809.59.0	AGR	ET	<input type="radio"/> für OE-Nummer: A 646 140 27 60 für OE number: A 646 140 27 60 für SA Code: Z 522.673/05, Z 522.673/06 für SA code: Z 522.673/05, Z 522.673/06	
119 2.5 140 kW (190 PS) M 272.924	01.2010→03.2016	 7.04389.02.0	SLP	EL		
122 3.0 165 kW (224 PS) M 272.939	05.2013→03.2016	 7.04389.02.0	SLP	EL		
2.1 70-120 kW (95-163 PS) OM 651.940	08.2013→03.2016	 7.08369.06.0	ATS	EL		

M























					
MG TF 1					
120 86-100 kW (117-136 PS) 18 K4F	03.2002→12.2009		7.05271.75.0	LS	540 mm
135 86-100 kW (117-136 PS) 18 K4F	03.2002→12.2009		7.05271.75.0	LS	540 mm
160 107-118 kW (146-160 PS) 18 K4K	03.2002→12.2009		7.05271.75.0	LS	540 mm
MG ZR 2					
120 86-100 kW (117-136 PS) 18 K4F	06.2001→04.2005		7.05271.75.0	LS	540 mm
MG ZS 3					
120 86-100 kW (117-136 PS) 18 K4F	07.2001→04.2005		7.05271.75.0	LS	540 mm
180 118-140 kW (160-190 PS) 25 K4F	07.2001→04.2005		7.05271.72.0	LS	650 mm
MG ZS Hatchback 4					
120 86-100 kW (117-136 PS) 18 K4F	07.2001→10.2005		7.05271.75.0	LS	540 mm
180 118-140 kW (160-190 PS) 25 K4F	07.2001→10.2005		7.05271.72.0	LS	650 mm
MG ZT 5					
160 118-140 kW (160-190 PS) 25 K4F	06.2001→07.2005		7.05271.72.0	LS	650 mm
190 118-140 kW (160-190 PS) 25 K4F	06.2001→07.2005		7.05271.72.0	LS	650 mm
M MG ZT- T 6					
160 118-140 kW (160-190 PS) 25 K4F	10.2001→07.2005		7.05271.72.0	LS	650 mm
190 118-140 kW (160-190 PS) 25 K4F	10.2001→07.2005		7.05271.72.0	LS	650 mm
MGF (RD) 7					
1.8 i VVC 107-118 kW (146-160 PS) 18 K4K	10.2001→03.2002		7.05271.75.0	LS	540 mm
1.6 79-86 kW (107-117 PS) 16 K4F	02.2000→03.2002		7.05271.75.0	LS	540 mm
1.8 i 16V 86-100 kW (117-136 PS) 18 K4F	03.1995→03.2002		7.05271.75.0	LS	540 mm
1.8 i VVC 107-118 kW (146-160 PS) 18 K4K	08.1995→03.2002		7.05271.75.0	LS	540 mm
MIDGET 8					
1.1 41 kW (56 PS) 10CG	01.1964→12.1966		7.02604.01.0	LS	200 mm

						
MINI (F55)						1
Cooper D 70-85 kW (95-116 PS) B37 C15 A	10.2013→		7.04493.17.0	AGR	EL 	
			7.07417.39.0	AGR	EL  Produktionsdatum ab: 01.03.2019 Production date from: 01.03.2019	
Cooper SD 100-140 kW (136-190 PS) B47 C20 A	09.2013→		7.04493.17.0	AGR	EL 	
Cooper SD 100-140 kW (136-190 PS) B47 C20 A, B47 C20 B	09.2013→10.2017		7.04493.17.0	AGR	EL 	
One D 70-85 kW (95-116 PS) B37 C15 A	02.2014→		7.04493.17.0	AGR	EL 	
			7.07417.39.0	AGR	EL  Produktionsdatum ab: 01.03.2019 Production date from: 01.03.2019	
MINI (F56)						2
Cooper D 70-85 kW (95-116 PS) B37 C15 A	12.2013→		7.04493.17.0	AGR	EL 	
			7.07417.39.0	AGR	EL  Produktionsdatum ab: 01.03.2019 Production date from: 01.03.2019	
Cooper SD 100-140 kW (136-190 PS) B47 C20 A, B47 C20 B	06.2014→10.2017		7.04493.17.0	AGR	EL 	
Cooper SD 100-140 kW (136-190 PS) B47 C20 A, B47 C20 B	06.2014→10.2017		7.04493.17.0	AGR	EL 	
One D 70-85 kW (95-116 PS) B37 C15 A	03.2014→		7.04493.17.0	AGR	EL 	
			7.07417.39.0	AGR	EL  Produktionsdatum ab: 01.03.2019 Production date from: 01.03.2019	
MINI (R50, R53)						3
Cooper 66-85 kW (90-116 PS) W10 B16 A	06.2001→09.2006		7.05271.72.0	LS	650 mm	
Cooper S 120-160 kW (163-218 PS) W11 B16 A	03.2002→09.2006		7.05271.72.0	LS	650 mm	
Cooper S 120-160 kW (163-218 PS) W11 B16 A	07.2004→09.2006		7.05271.72.0	LS	650 mm	
John Cooper Works 120-160 kW (163-218 PS) W11 B16 A	03.2006→09.2006		7.05271.74.0	LS	450 mm	
One 66-85 kW (90-116 PS) W10 B16 A	06.2001→09.2006		7.05271.72.0	LS	650 mm	
Works 120-160 kW (163-218 PS) W11 B16 A	11.2003→09.2006		7.05271.72.0	LS	650 mm	
MINI (R56)						4
Cooper 55-90 kW (75-122 PS) N12 B16 A, N16 B16 A	09.2006→11.2013		7.05271.74.0	LS	450 mm	
Cooper 55-90 kW (75-122 PS) N12 B16 A, N16 B16 A	10.2006→02.2012		7.05271.72.0	LS	650 mm	
			7.05271.74.0	LS	450 mm	
Cooper 55-90 kW (75-122 PS) N12 B16 A, N16 B16 A	09.2009→11.2013		7.05271.74.0	LS	450 mm	

M



MINI (R56) **4**

Cooper D 66-80 kW (90-109 PS) 9HZ (DV6TED4)	11.2006→09.2010	 7.24809.39.0	AGR	EL	
		 7.11492.01.0	DDS		ohne Zubehör without accessories
Cooper D 80 kW (109 PS) W16 D16 (9HZ)	11.2006→09.2010	 7.11492.01.0	DDS		ohne Zubehör without accessories
Cooper D 66-82 kW (90-112 PS) N47 C16 A	06.2010→11.2013	 7.03051.04.0	AGR	PN	mit Potentiometer with potentiometer 
Cooper D 82-105 kW (112-143 PS) N47 C20 A	02.2011→11.2013	 7.03051.04.0	AGR	PN	mit Potentiometer with potentiometer 
Cooper S 120-141 kW (163-192 PS) N14 B16 A, N14 B16 AB	10.2006→02.2010	 7.02604.41.0	LS	700 mm	 Korea (Republik)
		 7.05271.72.0	LS	650 mm	 Korea (Republic)
		 7.05271.74.0	LS	450 mm	
Cooper S 90-160 kW (122-218 PS) N18 B16 A	03.2010→11.2013	 7.05271.74.0	LS	450 mm	
Cooper S 90-160 kW (122-218 PS) N18 B16 A	03.2010→11.2013	 7.05271.74.0	LS	450 mm	
Cooper S John Cooper Works 90-160 kW (122-218 PS) N18 B16 A	01.2012→11.2013	 7.05271.74.0	LS	450 mm	
Cooper SD 82-105 kW (112-143 PS) N47 C20 A	02.2011→11.2013	 7.03051.04.0	AGR	PN	mit Potentiometer with potentiometer 
		 7.03051.04.0	AGR	PN	mit Potentiometer with potentiometer 
John Cooper Works 141-160 kW (192-218 PS) N14 B16 C	11.2007→11.2013	 7.02604.41.0	LS	700 mm	
		 7.05271.74.0	LS	450 mm	
John Cooper Works 155-160 kW (211-218 PS) N18 B16 C	11.2007→11.2013	 7.05271.74.0	LS	450 mm	
		 7.02604.41.0	LS	700 mm	
John Cooper Works GP 141-160 kW (192-218 PS) N14 B16 C	09.2012→11.2013	 7.02604.41.0	LS	700 mm	
		 7.05271.74.0	LS	450 mm	
John Cooper Works GP 155-160 kW (211-218 PS) N18 B16 C	09.2012→11.2013	 7.05271.74.0	LS	450 mm	
One 55-70 kW (75-95 PS) N12 B14 A	11.2006→03.2010	 7.05271.74.0	LS	450 mm	
One 55-70 kW (75-95 PS) N12 B14 A	03.2009→03.2010	 7.05271.74.0	LS	450 mm	
One 55-90 kW (75-122 PS) N16 B16 A	03.2010→11.2013	 7.05271.74.0	LS	450 mm	
One 55-90 kW (75-122 PS) N16 B16 A	03.2010→11.2013	 7.05271.74.0	LS	450 mm	
One D 66-80 kW (90-109 PS) 9HZ (DV6TED4)	06.2009→07.2010	 7.24809.39.0	AGR	EL	











M

MINI (R56)						4
			7.11492.01.0	DDS	ohne Zubehör without accessories	
One D 66-82 kW (90-112 PS) N47 C16 A	07.2010→11.2013		7.03051.04.0	AGR	PN mit Potentiometer with potentiometer 	
MINI CLUBMAN (F54)						5
Cooper D 100-140 kW (136-190 PS) B47 C20 A, B47 C20 B	12.2014→		7.04493.17.0	AGR	EL	
Cooper D 100-140 kW (136-190 PS) B47 C20 A, B47 C20 B	12.2014→02.2018		7.04493.17.0	AGR	EL	
Cooper SD 100-140 kW (136-190 PS) B47 C20 A, B47 C20 B	02.2015→		7.04493.17.0	AGR	EL	
Cooper SD 100-140 kW (136-190 PS) B47 C20 A, B47 C20 B	02.2015→02.2018		7.04493.17.0	AGR	EL	
Cooper SD ALL4 100-140 kW (136-190 PS) B47 C20 A, B47 C20 B	04.2015→		7.04493.17.0	AGR	EL	
Cooper SD ALL4 100-140 kW (136-190 PS) B47 C20 A, B47 C20 B	04.2015→02.2018		7.04493.17.0	AGR	EL	
One D 70-85 kW (95-116 PS) B37 C15 A	02.2015→		7.04493.17.0	AGR	EL	
			7.07417.39.0	AGR	EL Produktionsdatum ab: 01.03.2019 Production date from: 01.03.2019	
MINI CLUBMAN (R55)						6
Cooper 55-90 kW (75-122 PS) N12 B16 A, N16 B16 A	10.2007→12.2013		7.05271.74.0	LS	450 mm	
Cooper 55-90 kW (75-122 PS) N16 B16 A	03.2010→06.2014		7.05271.74.0	LS	450 mm	
Cooper 55-90 kW (75-122 PS) N16 B16 A	03.2010→06.2014		7.05271.74.0	LS	450 mm	
Cooper D 66-80 kW (90-109 PS) 9HZ (DV6TED4)	10.2007→02.2010		7.24809.39.0	AGR	EL	
			7.11492.01.0	DDS	ohne Zubehör without accessories	
Cooper D 66-82 kW (90-112 PS) N47 C16 A	03.2010→06.2014		7.03051.04.0	AGR	PN mit Potentiometer with potentiometer 	
Cooper D 82-105 kW (112-143 PS) N47 C20 A	02.2011→06.2014		7.03051.04.0	AGR	PN mit Potentiometer with potentiometer 	
Cooper S 120-141 kW (163-192 PS) N14 B16 A, N14 B16 AB	08.2007→07.2010		7.02604.41.0	LS	700 mm N14 B16 A: USA N14 B16 AB: Europa Europe	
			7.05271.74.0	LS	450 mm	
Cooper S 120-141 kW (163-192 PS) N14 B16 A, N14 B16 AB	10.2007→06.2014		7.02604.41.0	LS	700 mm N14 B16 A: USA N14 B16 AB: Europa Europe	
Cooper S 90-160 kW (122-218 PS) N18 B16 A	03.2010→06.2014		7.05271.74.0	LS	450 mm	
Cooper S 90-160 kW (122-218 PS) N18 B16 A	03.2010→06.2014		7.05271.74.0	LS	450 mm	

M























MINI CLUBMAN (R55) 6





Cooper SD 82-105 kW (112-143 PS) N47 C20 A	02.2011→06.2014	 7.03051.04.0	AGR	PN	mit Potentiometer with potentiometer 
Cooper SD 82-105 kW (112-143 PS) N47 C20 A	02.2011→06.2014	 7.03051.04.0	AGR	PN	mit Potentiometer with potentiometer 
John Cooper Works 141-160 kW (192-218 PS) N14 B16 C	11.2007→06.2014	 7.02604.41.0	LS	700 mm	
		 7.05271.74.0	LS	450 mm	
John Cooper Works 155-160 kW (211-218 PS) N18 B16 C	11.2007→06.2014	 7.05271.74.0	LS	450 mm	
One 55-90 kW (75-122 PS) N16 B16 A	03.2010→06.2014	 7.05271.74.0	LS	450 mm	
One D 66-82 kW (90-112 PS) N47 C16 A	03.2010→06.2014	 7.03051.04.0	AGR	PN	mit Potentiometer with potentiometer 

MINI COUNTRYMAN (F60) 7

M









Cooper D 100-140 kW (136-190 PS) B47 C20 A	10.2016→	 7.04493.17.0	AGR	EL	
Cooper D 100-140 kW (136-190 PS) B47 C20 A	10.2016→	 7.04493.17.0	AGR	EL	
Cooper D ALL4 100-140 kW (136-190 PS) B47 C20 A	10.2016→	 7.04493.17.0	AGR	EL	
Cooper D ALL4 100-140 kW (136-190 PS) B47 C20 A	10.2016→	 7.04493.17.0	AGR	EL	
Cooper SD 100-140 kW (136-190 PS) B47 C20 A	10.2016→	 7.04493.17.0	AGR	EL	
Cooper SD 100-140 kW (136-190 PS) B47 C20 A	10.2016→	 7.04493.17.0	AGR	EL	
Cooper SD ALL4 100-140 kW (136-190 PS) B47 C20 A	10.2016→	 7.04493.17.0	AGR	EL	
Cooper SD ALL4 100-140 kW (136-190 PS) B47 C20 A	10.2016→	 7.04493.17.0	AGR	EL	
One D 70-85 kW (95-116 PS) B37 C15 A	07.2017→	 7.04493.17.0	AGR	EL	
		 7.07417.39.0	AGR	EL	 Produktionsdatum ab: 01.03.2019 Production date from: 01.03.2019

MINI COUNTRYMAN (R60) 8

Cooper 55-90 kW (75-122 PS) N16 B16 A	08.2010→10.2016	 7.05271.74.0	LS	450 mm	
Cooper D 66-82 kW (90-112 PS) N47 C16 A	08.2010→10.2016	 7.03051.04.0	AGR	PN	mit Potentiometer with potentiometer 
		 7.04493.17.0	AGR	EL	 07.2014→ Euro 5 Euro 5



MINI COUNTRYMAN (R60) 8

			7.11190.12.0	DDS		ohne Zubehör without accessories Euro 5 Euro 5
Cooper D 82-105 kW (112-143 PS) N47 C20 A	03.2011→10.2016		7.03051.04.0	AGR	PN	mit Potentiometer with potentiometer ⊗
			7.04493.17.0	AGR	EL	⊗ 07.2014→ Euro 5 Euro 5
			7.11190.12.0	DDS		ohne Zubehör without accessories Euro 5 Euro 5
Cooper D ALL4 66-82 kW (90-112 PS) N47 C16 A	08.2010→10.2016		7.03051.04.0	AGR	PN	mit Potentiometer with potentiometer ⊗
			7.04493.17.0	AGR	EL	⊗ 07.2014→ Euro 5 Euro 5
			7.11190.12.0	DDS		ohne Zubehör without accessories Euro 5 Euro 5
Cooper D ALL4 82-105 kW (112-143 PS) N47 C20 A	03.2011→10.2016		7.03051.04.0	AGR	PN	mit Potentiometer with potentiometer ⊗
			7.04493.17.0	AGR	EL	⊗ 07.2014→ Euro 5 Euro 5
			7.11190.12.0	DDS		ohne Zubehör without accessories Euro 5 Euro 5
Cooper S 90-160 kW (122-218 PS) N18 B16 A	08.2010→10.2016		7.05271.74.0	LS	450 mm	
Cooper S 90-160 kW (122-218 PS) N18 B16 A	08.2010→10.2016		7.05271.74.0	LS	450 mm	
Cooper S ALL4 90-160 kW (122-218 PS) N18 B16 A	08.2010→10.2016		7.05271.74.0	LS	450 mm	
Cooper S ALL4 90-160 kW (122-218 PS) N18 B16 A	08.2010→10.2016		7.05271.74.0	LS	450 mm	
Cooper SD 82-105 kW (112-143 PS) N47 C20 A	03.2011→10.2016		7.03051.04.0	AGR	PN	mit Potentiometer with potentiometer ⊗
			7.04493.17.0	AGR	EL	⊗ 07.2014→ Euro 5 Euro 5
			7.11190.12.0	DDS		ohne Zubehör without accessories Euro 5 Euro 5
Cooper SD 82-105 kW (112-143 PS) N47 C20 A	03.2011→10.2016		7.03051.04.0	AGR	PN	mit Potentiometer with potentiometer ⊗
			7.04493.17.0	AGR	EL	⊗ 07.2014→ Euro 5 Euro 5

M



MINI COUNTRYMAN (R60)						8	
Cooper SD ALL4 82-105 kW (112-143 PS) N47 C20 A	03.2011→10.2016		7.03051.04.0	AGR	PN	mit Potentiometer with potentiometer ○	
			7.04493.17.0	AGR	EL		○ 07.2014→ Euro 5 Euro 5
Cooper SD ALL4 82-105 kW (112-143 PS) N47 C20 A	03.2011→10.2016		7.03051.04.0	AGR	PN	mit Potentiometer with potentiometer ○	
			7.04493.17.0	AGR	EL		○ 07.2014→ Euro 5 Euro 5
			7.11190.12.0	DDS			ohne Zubehör without accessories Euro 5 Euro 5
John Cooper Works ALL4 155-160 kW (211-218 PS) N18 B16 C	11.2012→10.2016		7.05271.74.0	LS	450 mm		
One 55-90 kW (75-122 PS) N16 B16 A	08.2010→10.2016		7.05271.74.0	LS	450 mm		
One D 66-82 kW (90-112 PS) N47 C16 A	08.2010→10.2016		7.03051.04.0	AGR	PN	mit Potentiometer with potentiometer ○	
			7.04493.17.0	AGR	EL		○ 07.2014→ Euro 5 Euro 5
			7.11190.12.0	DDS			ohne Zubehör without accessories Euro 5 Euro 5

M







MINI Convertible (F57)						9
Cooper D 70-85 kW (95-116 PS) B37 C15 A	12.2014→		7.04493.17.0	AGR	EL	○
			7.07417.39.0	AGR	EL	○ Produktionsdatum ab: 01.03.2019 Production date from: 01.03.2019
Cooper SD 100-140 kW (136-190 PS) B47 C20 A, B47 C20 B	05.2015→		7.04493.17.0	AGR	EL	○
Cooper SD 100-140 kW (136-190 PS) B47 C20 A, B47 C20 B	05.2015→02.2018		7.04493.17.0	AGR	EL	○

MINI Convertible (R52)						10
Cooper 66-85 kW (90-116 PS) W10 B16 A	04.2004→07.2008		7.05271.72.0	LS	650 mm	
Cooper S 120-160 kW (163-218 PS) W11 B16 A	07.2004→11.2007		7.05271.72.0	LS	650 mm	
John Cooper Works 120-160 kW (163-218 PS) W11 B16 A	07.2004→11.2007		7.05271.72.0	LS	650 mm	
One 66-85 kW (90-116 PS) W10 B16 A	07.2004→11.2007		7.05271.72.0	LS	650 mm	



MINI Convertible (R57)





11

Cooper 55-90 kW (75-122 PS) N12 B16 A, N16 B16 A	12.2008→06.2015		7.05271.74.0	LS	450 mm	
Cooper 85-90 kW (116-122 PS) N12 B16 A	12.2008→07.2010		7.05271.74.0	LS	450 mm	
Cooper 55-90 kW (75-122 PS) N16 B16 A	03.2010→06.2015		7.05271.74.0	LS	450 mm	
Cooper D 66-82 kW (90-112 PS) N47 C16 A	05.2009→11.2013		7.03051.04.0	AGR	PN	mit Potentiometer with potentiometer 
Cooper D 82-105 kW (112-143 PS) N47 C20 A	02.2011→05.2015		7.03051.04.0	AGR	PN	mit Potentiometer with potentiometer 
Cooper S 120-141 kW (163-192 PS) N14 B16 A	10.2007→06.2015		7.02604.41.0	LS	700 mm	
Cooper S 120-141 kW (163-192 PS) N14 B16 A	11.2007→12.2008		7.02604.41.0	LS	700 mm	
Cooper S 120-141 kW (163-192 PS) N14 B16 A, N14 B16 AB	04.2008→07.2010		7.02604.41.0	LS	700 mm	
			7.05271.74.0	LS	450 mm	
Cooper S 120-141 kW (163-192 PS) N14 B16 A, N14 B16 AB	04.2008→07.2010		7.02604.41.0	LS	700 mm	
Cooper S 90-160 kW (122-218 PS) N18 B16 A	02.2010→06.2015		7.05271.74.0	LS	450 mm	
Cooper S 90-160 kW (122-218 PS) N18 B16 A	02.2010→06.2015		7.05271.74.0	LS	450 mm	
Cooper SD 82-105 kW (112-143 PS) N47 C20 A	06.2009→05.2015		7.03051.04.0	AGR	PN	mit Potentiometer with potentiometer 
Cooper SD 82-105 kW (112-143 PS) N47 C20 A	01.2011→05.2015		7.03051.04.0	AGR	PN	mit Potentiometer with potentiometer 
John Cooper Works 141-160 kW (192-218 PS) N14 B16 C	08.2008→05.2015		7.02604.41.0	LS	700 mm	
			7.05271.74.0	LS	450 mm	
John Cooper Works 155-160 kW (211-218 PS) N18 B16 C	08.2008→05.2015		7.05271.74.0	LS	450 mm	
One 55-90 kW (75-122 PS) N16 B16 A	09.2009→06.2015		7.05271.74.0	LS	450 mm	

M







MINI Coupe (R58)

12















Cooper 55-90 kW (75-122 PS) N16 B16 A	12.2010→04.2015		7.05271.74.0	LS	450 mm	
Cooper 55-90 kW (75-122 PS) N16 B16 A	12.2010→04.2015		7.05271.74.0	LS	450 mm	
Cooper S 90-160 kW (122-218 PS) N14 B16 A, N18 B16 A	12.2010→04.2015		7.05271.74.0	LS	450 mm	
Cooper S 90-160 kW (122-218 PS) N18 B16 A	12.2010→04.2015		7.05271.74.0	LS	450 mm	
Cooper S JCW 90-160 kW (122-218 PS) N18 B16 A	12.2010→04.2015		7.05271.74.0	LS	450 mm	



MINI Coupe (R58) 12

Cooper SD 82-105 kW (112-143 PS) N47 C20 A	12.2010→05.2015	 7.03051.04.0	AGR	PN	mit Potentiometer with potentiometer 
Cooper SD 82-105 kW (112-143 PS) N47 C20 A	12.2010→05.2015	 7.03051.04.0	AGR	PN	mit Potentiometer with potentiometer 
John Cooper Works 141-160 kW (192-218 PS) N14 B16 C	12.2010→05.2015	 7.02604.41.0	LS	700 mm	
		7.05271.74.0	LS	450 mm	
John Cooper Works 155-160 kW (211-218 PS) N18 B16 C	12.2010→05.2015	 7.05271.74.0	LS	450 mm	

MINI PACEMAN (R61) 13











Cooper 55-90 kW (75-122 PS) N16 B16 A	04.2012→09.2016	 7.05271.74.0	LS	450 mm	
Cooper D 66-82 kW (90-112 PS) N47 C16 A	04.2012→09.2016	 7.03051.04.0	AGR	PN	mit Potentiometer with potentiometer 
		7.04493.17.0	AGR	EL	 07.2014→ Euro 5 Euro 5
		7.11190.12.0	DDS		ohne Zubehör without accessories Euro 5 Euro 5
Cooper D 82-105 kW (112-143 PS) N47 C20 A	07.2012→09.2016	 7.03051.04.0	AGR	PN	mit Potentiometer with potentiometer 
		7.04493.17.0	AGR	EL	 07.2014→ Euro 5 Euro 5
		7.11190.12.0	DDS		ohne Zubehör without accessories
Cooper D ALL4 82-105 kW (112-143 PS) N47 C20 A	03.2012→09.2016	 7.03051.04.0	AGR	PN	mit Potentiometer with potentiometer 
		7.04493.17.0	AGR	EL	 07.2014→ Euro 5 Euro 5
		7.11190.12.0	DDS		ohne Zubehör without accessories Euro 5 Euro 5
Cooper D ALL4 66-82 kW (90-112 PS) N47 C16 A	04.2012→09.2016	 7.03051.04.0	AGR	PN	mit Potentiometer with potentiometer 
		7.04493.17.0	AGR	EL	 07.2014→ Euro 5 Euro 5
		7.11190.12.0	DDS		ohne Zubehör without accessories Euro 5 Euro 5
Cooper S 90-160 kW (122-218 PS) N18 B16 A	11.2012→10.2016	 7.05271.74.0	LS	450 mm	

M



MINI PACEMAN (R61)











13

Cooper SD 82-105 kW (112-143 PS) N47 C20 A	03.2012→09.2016		7.03051.04.0	AGR	PN	mit Potentiometer with potentiometer 
			7.04493.17.0	AGR	EL	 07.2014→ Euro 5 Euro 5
			7.11190.12.0	DDS		ohne Zubehör without accessories Euro 5 Euro 5
Cooper SD ALL4 82-105 kW (112-143 PS) N47 C20 A	04.2012→09.2016		7.03051.04.0	AGR	PN	mit Potentiometer with potentiometer 
			7.04493.17.0	AGR	EL	 07.2014→ Euro 5 Euro 5
			7.11190.12.0	DDS		ohne Zubehör without accessories Euro 5 Euro 5
Cooper SD ALL4 82-105 kW (112-143 PS) N47 C20 A	04.2012→09.2016		7.03051.04.0	AGR	PN	mit Potentiometer with potentiometer 
			7.04493.17.0	AGR	EL	 07.2014→ Euro 5 Euro 5
John Cooper Works 155-160 kW (211-218 PS) N18 B16 C	03.2013→10.2016		7.05271.74.0	LS	450 mm	

M



MINI Roadster (R59)

14

Cooper 55-90 kW (75-122 PS) N16 B16 A	11.2011→04.2015		7.05271.74.0	LS	450 mm	
Cooper 55-90 kW (75-122 PS) N16 B16 A	11.2011→04.2015		7.05271.74.0	LS	450 mm	
Cooper S 90-160 kW (122-218 PS) N18 B16 A	11.2011→04.2015		7.05271.74.0	LS	450 mm	
Cooper S 90-160 kW (122-218 PS) N18 B16 A	11.2011→04.2015		7.05271.74.0	LS	450 mm	
Cooper S JCW 90-160 kW (122-218 PS) N18 B16 A	11.2011→04.2015		7.05271.74.0	LS	450 mm	
Cooper SD 82-105 kW (112-143 PS) N47 C20 A	11.2011→04.2015		7.03051.04.0	AGR	PN	mit Potentiometer with potentiometer 
Cooper SD 82-105 kW (112-143 PS) N47 C20 A	11.2011→04.2015		7.03051.04.0	AGR	PN	mit Potentiometer with potentiometer 
John Cooper Works 141-160 kW (192-218 PS) N14 B16 C	11.2011→06.2012		7.02604.41.0	LS	700 mm	
			7.05271.74.0	LS	450 mm	
John Cooper Works 155-160 kW (211-218 PS) N18 B16 C	07.2012→04.2015		7.05271.74.0	LS	450 mm	



























MINI CLUBVAN (R55)

15

























Cooper D 82-105 kW (112-143 PS) N47 C20 A	12.2012→06.2014		7.03051.04.0	AGR	PN	mit Potentiometer with potentiometer 
---	-----------------	---	---------------------	-----	----	--



M

						
ASX (GA_W_)						1
1.6 DI-D 84 kW (114 PS) 9HD	07.2015→		7.02209.11.0	AGR	EL 	
			7.02156.35.0	AGR-K	EL ohne Sensor without sensor →06.2018 mit AGR-Ventil with EGR valve	
			7.02156.34.0	AGR-K	EL ohne Sensor without sensor →06.2018 ohne AGR-Ventil without EGR valve	
1.6 DI-D 4WD 84 kW (114 PS) 9HD	07.2015→		7.02209.11.0	AGR	EL 	
			7.02156.35.0	AGR-K	EL ohne Sensor without sensor →06.2018 mit AGR-Ventil with EGR valve	
			7.02156.34.0	AGR-K	EL ohne Sensor without sensor →06.2018 ohne AGR-Ventil without EGR valve	
CARISMA (DA_)						2
1.6 (DA1A) 66-88 kW (90-120 PS) 4G92 (SOHC 16V)	09.2000→06.2006		7.05271.63.0	LS	500 mm	
1.9 DI-D 85 kW (116 PS) F9Q2	09.2000→06.2006		7.22818.57.0	AGR	EL 	
1.9 DI-D (DA5A) 75 kW (102 PS) F9Q1	09.2000→06.2006		7.22818.57.0	AGR	EL 	
CARISMA Saloon (DA_)						3
1.9 DI-D 85 kW (116 PS) F9Q2	09.2000→06.2006		7.22818.57.0	AGR	EL 	
1.9 DI-D (DA5A) 75 kW (102 PS) F9Q1	09.2000→06.2006		7.22818.57.0	AGR	EL 	
COLT II (C1_A)						4
1.3 EL, GL (C11A) 44-57 kW (60-78 PS) G13B	06.1986→04.1988		7.02604.01.0	LS	200 mm	
1.5 GLX (C12A) 51-64 kW (70-87 PS) G15B	09.1985→04.1988		7.02604.01.0	LS	200 mm	
COLT III (C5_A)						5
1.3 (C51A) 44-55 kW (60-75 PS) 4G13 (8V)	07.1988→12.1990		7.02604.01.0	LS	200 mm	
1.8 GTi 16V Cat (C58A) 99-100 kW (135-136 PS) 4G67	06.1990→05.1992		7.02604.01.0	LS	200 mm	
COLT IV (CA_A)						6
1.6 4WD (CC4A) 66-88 kW (90-120 PS) 4G92 (SOHC 16V)	08.1993→08.1995		7.02604.01.0	LS	200 mm	
1.6 GLXi 16V (CA4A) 66-88 kW (90-120 PS) 4G92 (SOHC 16V)	10.1992→02.1995		7.02604.01.0	LS	200 mm	
1.8 GTi 16V (CA5A) 82-189 kW (112-156 PS) 4G93 (DOHC 16V)	04.1992→04.1996		7.02604.01.0	LS	200 mm	

M

			 PIERBURG			
COLT V (CJ_, CP_)						7
1300 (CJ1A) 60-65 kW (82-88 PS) 4G13 (16V)	06.2000→09.2003		7.05271.63.0	LS	500 mm	
1300 GL, GLX (CJ1A) 44-58 kW (60-79 PS) 4G13 (12V)	05.1996→06.2000		7.05271.63.0	LS	500 mm	
1600 66-88 kW (90-120 PS) 4G92 (SOHC 16V)	09.2000→09.2003		7.02604.01.0	LS	200 mm	
1600 GLX (CJ4A) 66-88 kW (90-120 PS) 4G92 (SOHC 16V)	05.1996→09.2000		7.02604.01.0	LS	200 mm	
COLT VI (Z3_A, Z2_A)						8
1.5 DI-D 50-70 kW (58-95 PS) OM 639.939	08.2004→06.2012		7.00306.36.0	AGR	PN 	
			7.02604.99.0	LS	400 mm	
1.5 DI-D 50-70 kW (58-95 PS) OM 639.939	08.2004→06.2012		7.00306.36.0	AGR	PN 	
			7.02604.99.0	LS	400 mm	
GALANT						9
1.8 60-100 kW (81-136 PS) 4G37, 4G51, G51B, G62B	05.1976→10.1992		7.02604.01.0	LS	200 mm	
GALANT VI (E3_A)						10
1.8 (E32A) 62-71 kW (86-97 PS) 4G37	11.1988→10.1992		7.02604.01.0	LS	200 mm	
GALANT VI Saloon (E3_A)						11
1.8 (E32A) 62-71 kW (86-97 PS) 4G37	11.1987→10.1992		7.02604.01.0	LS	200 mm	
GALANT VII (E5_A, E7_A, E8_A)						12
1.8 (E52A) 81-115 kW (110-156 PS) 4G93 (SOHC 16V)	02.1994→08.1996		7.02604.01.0	LS	200 mm	
GALANT VII Saloon (E5_A, E7_A, E8_A)						13
1.8 (E52A) 81-115 kW (110-156 PS) 4G93 (SOHC 16V)	02.1994→08.1996		7.02604.01.0	LS	200 mm	
GALANT VIII (EA_)						14
2.5 V6 24V (EA5A) 118-151 kW (160-205 PS) 6A13	09.1996→09.2000		7.05271.63.0	LS	500 mm	
2.5 V6 24V (EA5A) 118-151 kW (160-205 PS) 6A13	09.2000→10.2004		7.05271.63.0	LS	500 mm	
GALANT VIII Estate (EA_)						15
2.5 V6 24V (EA5W) 118-151 kW (160-205 PS) 6A13	09.1996→09.2000		7.05271.63.0	LS	500 mm	
2.5 V6 24V (EA5W) 118-151 kW (160-205 PS) 6A13	09.2000→10.2003		7.05271.63.0	LS	500 mm	
GRANDIS (NA_W)						16
2.0 DI-D (NA8W) 100-103 kW (136-140 PS) BSY	09.2005→03.2010		7.24809.16.0	AGR	PN 	
2.0 DI-D (NA8W) 103 kW (140 PS) BWC	02.2007→03.2010		7.24809.16.0	AGR	PN 	

						
L200 (K3_T, K2_T, K1_T, K0_T)						17
2.6 4WD (K33T) 76-114 kW (103-155 PS) G54B	11.1989→12.1991		7.02604.01.0	LS	200 mm	
L200 (K7_T, K6_T)						18
2.4 4WD (K75T) 84-117 kW (114-159 PS) 4G64 (16V)	06.1996→12.2007		7.05271.63.0	LS	500 mm	
LANCER III (C1_A, C6_A)						19
1.5 GLX (C12AS) 51-64 kW (70-87 PS) G15B	06.1985→04.1988		7.02604.01.0	LS	200 mm	
LANCER III Station Wagon (C1_V, C3_V)						20
1.5 (C12V) 51-64 kW (70-87 PS) G15B	09.1985→11.1988		7.02604.01.0	LS	200 mm	
1.8 4WD (C37V) 61-66 kW (83-90 PS) G37B	01.1987→08.1989		7.02604.01.0	LS	200 mm	
LANCER VI (CJ_, CP_)						21
1.3 12V (CK1A) 44-58 kW (60-79 PS) 4G13 (12V)	12.1995→08.2003		7.05271.63.0	LS	500 mm	
LANCER VIII (CY_A, CZ_A)						22
2.0 DI-D 103 kW (140 PS) BKD, BWC	01.2008→		7.24809.16.0	AGR	PN 	
LANCER VIII Sportback (CX_A)						23
2.0 DI-D 103 kW (140 PS) BKD, BWC	06.2008→		7.24809.16.0	AGR	PN 	
OUTLANDER I (CU_W)						24
2.0 (CU2W) 85-142 kW (116-193 PS) 4G63 (DOHC 16V)	05.2003→10.2006		7.05271.63.0	LS	500 mm	
2.0 4WD (CU2W) 85-142 kW (116-193 PS) 4G63 (DOHC 16V)	05.2003→10.2006		7.05271.63.0	LS	500 mm	
2.0 Turbo-R 4WD 101-336 kW (241-456 PS) 4G63 Turbo	01.2002→10.2006		7.05271.63.0	LS	500 mm	
OUTLANDER II (CW_W)						25
2.0 DI-D 100-103 kW (136-140 PS) BSY	02.2007→11.2012		7.24809.16.0	AGR	PN 	
2.2 DI-D 4WD 115 kW (156 PS) 4HK, 4HN	08.2007→11.2012		7.00578.12.0	AGR	EL 	
PAJERO PININ I (H6_W, H7_W)						26
2.0 GDI (H67W, H77W) 85-107 kW (116-146 PS) 4G94 (GDI)	10.2000→06.2007		7.05271.63.0	LS	500 mm	
SAPPORO III (E16A)						27
2.4 (E16A) 75-97 kW (102-132 PS) 4G64 (8V)	06.1987→08.1990		7.02604.01.0	LS	200 mm	
SPACE STAR MPV (DG_A)						28
1.9 DI-D 85 kW (116 PS) F9Q2	10.2002→12.2004		7.22818.57.0	AGR	EL 	
1.9 DI-D (DG4A) 75 kW (102 PS) F9Q1	02.2001→12.2004		7.22818.57.0	AGR	EL 	

M

			 PIERBURG		
L 300 / DELICA II Bus (LO3_P/G, LO_2P) 29					
2.0 4WD (L037G) 63-101 kW (86-137 PS) 4G63 (SOHC 8V)	11.1986→02.1987		7.02604.01.0	LS	200 mm
L 300 III Bus (P0_W, P1_W, P2_W, P3_W) 30					
2.0 (P03W) 78-101 kW (106-137 PS) 4G63 (SOHC 16V)	06.1994→05.2003		7.02604.01.0	LS	200 mm
2.0 (P03W, P13W) 62-81 kW (84-110 PS) G63B	11.1986→12.1988		7.02604.01.0	LS	200 mm
2.0 (P03W, P13W) 63-101 kW (86-137 PS) 4G63 (SOHC 8V)	11.1986→05.2004		7.02604.01.0	LS	200 mm
2.0 (P03W, P13W) 62-81 kW (84-110 PS) G63B	11.1986→07.1988		7.02604.01.0	LS	200 mm
2.0 4WD (P23W, P03W, P13W) 63-101 kW (86-137 PS) 4G63 (SOHC 8V)	11.1986→05.2004		7.02604.01.0	LS	200 mm
2.0 4WD (P23W, P03W, P13W) 63-101 kW (86-137 PS) 4G63 (SOHC 8V)	12.1986→05.2004		7.02604.01.0	LS	200 mm
2.4 (P04W, P14W) 75-97 kW (102-132 PS) 4G64 (8V)	11.1990→05.2004		7.02604.01.0	LS	200 mm
M 2.4 4WD (P24W) 75-97 kW (102-132 PS) 4G64 (8V)	08.1986→05.2004		7.02604.01.0	LS	200 mm
2.4 4WD (P24W) 80-82 kW (109-112 PS) G64B	11.1986→02.1990		7.02604.01.0	LS	200 mm
L 300 III Van (P0_V, P1_V, P_2V) 31					
2.0 (P03V, P13V) 62-81 kW (84-110 PS) G63B	11.1986→12.1988		7.02604.01.0	LS	200 mm
2.0 (P23W, P23V) 62-81 kW (84-110 PS) G63B	11.1986→07.1988		7.02604.01.0	LS	200 mm
2.0 4WD (P23W, P23V) 63-101 kW (86-137 PS) 4G63 (SOHC 8V)	08.1988→05.1994		7.02604.01.0	LS	200 mm
2.4 (P24V, P24W) 75-97 kW (102-132 PS) 4G64 (8V), G64B	11.1986→08.1997		7.02604.01.0	LS	200 mm
2.4 4WD (P24V, P24W) 75-97 kW (102-132 PS) 4G64 (8V), G64B	11.1986→08.1997		7.02604.01.0	LS	200 mm
Canter (FB7, FB8, FE7, FE8) VII 32					
6C18 129 kW (175 PS) 4P10-T6	08.2005→		7.02321.17.0	AK	EL 06.2011→03.2016
Canter (FE5, FE6) VI 33					
413 96 kW (131 PS) 4P10-T2	01.2012→		7.02321.17.0	AK	EL →03.2016
515, 516 110 kW (150 PS) 4P10-T4	01.2012→		7.02321.17.0	AK	EL →03.2016
615, 616 110 kW (150 PS) 4P10-T4	01.2012→		7.02321.17.0	AK	EL →03.2016



Canter (FE5, FE6) VI **33**

6C18 4X4 110 kW (150 PS) 4P10-T4	01.2012→	 7.02321.17.0	AK	EL	→03.2016
715 110 kW (150 PS) 4P10-T4	01.2012→	 7.02321.17.0	AK	EL	→03.2016
815, 816 110 kW (150 PS) 4P10-T4	01.2012→	 7.02321.17.0	AK	EL	→03.2016
916, 918 129 kW (175 PS) 4P10-T6	01.2012→	 7.02321.17.0	AK	EL	→03.2016





FUSO CANTER **34**

6C18 129 kW (175 PS) 4P10-T6	12.2011→	 7.02321.17.0	AK	EL	
916, 918 129 kW (175 PS) 4P10-T6	01.2012→	 7.02321.17.0	AK	EL	

M

						
Airliner						1
N 9112 176 kW (239 PS) D 0836 LOH 52	01.1992→		7.01268.03.0	AGR	PN	Rückschlagventil/non-return valve
Centroliner						2
N 4411 206 kW (280 PS) D 0836 LOH 02	10.1998→		7.01268.03.0	AGR	PN	Rückschlagventil/non-return valve
N 4416 162 kW (220 PS) D 0826 LOH 17, D 0826 LUH 12, D 0836 LOH 03	10.1998→		7.01268.03.0	AGR	PN	Rückschlagventil/non-return valve
N 4516 228 kW (310 PS) D 2066 LUH 22	10.1998→		7.01268.03.0	AGR	PN	Rückschlagventil/non-return valve
N 4516 206 kW (280 PS) D 2066 LUH 46	10.1998→		7.01268.03.0	AGR	PN	Rückschlagventil/non-return valve
N 4516 235 kW (320 PS) D 2066 LUH 47	10.1998→		7.01268.03.0	AGR	PN	Rückschlagventil/non-return valve
N 4516 265 kW (360 PS) D 2066 LUH 33	10.1998→		7.01268.03.0	AGR	PN	Rückschlagventil/non-return valve
N 4516 199 kW (271 PS) D 2066 LUH 21	08.2006→		7.01268.03.0	AGR	PN	Rückschlagventil/non-return valve
N 4522 235 kW (320 PS) D 2066 LUH 47	10.1998→		7.01268.03.0	AGR	PN	Rückschlagventil/non-return valve
N 4522 265 kW (360 PS) D 2066 LUH 33	10.1998→		7.01268.03.0	AGR	PN	Rückschlagventil/non-return valve
N 4522 257 kW (350 PS) D 2066 LUH 23	05.2006→		7.01268.03.0	AGR	PN	Rückschlagventil/non-return valve
N 4522 228 kW (310 PS) D 2066 LUH 22	08.2006→		7.01268.03.0	AGR	PN	Rückschlagventil/non-return valve
Cityliner						3
N 1216 HD 294 kW (400 PS) D 2066 LOH 03	09.2006→		7.01268.03.0	AGR	PN	Rückschlagventil/non-return valve
N 1216 HDC 324 kW (440 PS) D 2066 LOH 04	09.2006→		7.01268.03.0	AGR	PN	Rückschlagventil/non-return valve
Euroliner						4
N 3316 K, N 3316 Ü 265 kW (360 PS) D 2866 LUH 25	05.2004→		7.01268.03.0	AGR	PN	Rückschlagventil/non-return valve
N 3316 KL, N 3316 ÜL 265 kW (360 PS) D 2866 LUH 25	04.1999→04.2002		7.01268.03.0	AGR	PN	Rückschlagventil/non-return valve
N 3316 KL, N 3316 ÜL 301-302 kW (409-411 PS) D 2866 LUH 30	05.2004→		7.01268.03.0	AGR	PN	Rückschlagventil/non-return valve
N 3316 Ü, N 3316 K 301-302 kW (409-411 PS) D 2866 LUH 30	10.1998→03.2002		7.01268.03.0	AGR	PN	Rückschlagventil/non-return valve
N 3318/3 Ü 301-302 kW (409-411 PS) D 2866 LUH 30	07.1997→04.2002		7.01268.03.0	AGR	PN	Rückschlagventil/non-return valve
Tourliner						5
N 2216 SHD 294 kW (400 PS) D 2066 LOH 03	06.2006→		7.01268.03.0	AGR	PN	Rückschlagventil/non-return valve
N 2216 SHD 324 kW (440 PS) D 2066 LOH 04	06.2006→		7.01268.03.0	AGR	PN	Rückschlagventil/non-return valve
N 2216 SHDL 324 kW (440 PS) D 2066 LOH 04	06.2006→		7.01268.03.0	AGR	PN	Rückschlagventil/non-return valve

Trendliner
6



N 3516 Ü 265 kW (360 PS) D 2866 LUH 29	09.2004->	 7.01268.03.0	AGR	PN	Rückschlagventil/non-return valve
N 3516 Ü 228 kW (310 PS) D 2866 LUH 24, D 2866 LUH 28, D 2866 LUH 35, D 2866 LUH 51	09.2004->	 7.01268.03.0	AGR	PN	Rückschlagventil/non-return valve
N 3516 Ü 301-302 kW (409-411 PS) D 2866 LUH 30, D 2866 LUH 37	09.2004->	 7.01268.03.0	AGR	PN	Rückschlagventil/non-return valve
N 3516/3 ÜL 301-302 kW (409-411 PS) D 2866 LUH 30, D 2866 LUH 37	09.2004->	 7.01268.03.0	AGR	PN	Rückschlagventil/non-return valve

N





























ENGINE

1

<p>ENGINE 67-72 kW (91-98 PS) F5BFL413A B007, F5BFL413A B009, F5BFL413A C001, F5BFL413E B002, F5GFL413A B006, F5GFL413A B007, F5GFL413A B013, F5GFL413A B019, F5GFL413A B021</p>		<p>7.05243.04.0</p>	<p>AGR-M EL</p>	
<p>ENGINE 52-55 kW (71-74 PS) F5HFL463A F001, F5HFL463A F012</p>		<p>7.03693.12.0</p>	<p>AGR-M EL</p>	





N

							
100NX (B13)							1
1.6 64-79 kW (87-107 PS) GA16DS	03.1990→10.1994		7.02604.01.0	LS	200 mm		
1.6 SR 60-88 kW (82-120 PS) GA16DE	09.1993→10.1994		7.02604.01.0	LS	200 mm		
350 Z Coupe (Z33)							2
3.5 170-224 kW (231-305 PS) VQ35DE	09.2002→12.2008		7.05270.80.0	LS	650 mm		
3.5 170-224 kW (231-305 PS) VQ35DE	10.2003→12.2006		7.05270.80.0	LS	650 mm		
3.5 170-224 kW (231-305 PS) VQ35DE	11.2004→01.2007		7.05270.80.0	LS	650 mm		
3.5 225-232 kW (306-316 PS) VQ35HR	09.2005→12.2008		7.05270.80.0	LS	650 mm		
350Z Roadster (Z33)							3
3.5 170-224 kW (231-305 PS) VQ35DE	11.2004→01.2007		7.05270.80.0	LS	650 mm		
3.5 170-224 kW (231-305 PS) VQ35DE	03.2005→12.2007		7.05270.80.0	LS	650 mm		
3.5 225-232 kW (306-316 PS) VQ35HR	09.2005→12.2009		7.05270.80.0	LS	650 mm		
ALMERA I (N15)							4
1.4 55-64 kW (75-87 PS) GA14DE	09.1995→07.2000		7.02604.03.0	LS	200 mm		
1.4 GX,LX 55-64 kW (75-87 PS) GA14DE	09.1995→07.2000		7.02604.03.0	LS	200 mm		
1.6 60-88 kW (82-120 PS) GA16DE	07.1995→03.2000		7.02604.03.0	LS	200 mm		
1.6 60-88 kW (82-120 PS) GA16DE	09.1995→07.2000		7.02604.03.0	LS	200 mm		
1.6 SLX 60-88 kW (82-120 PS) GA16DE	09.1995→07.2000		7.02604.03.0	LS	200 mm		
ALMERA I Hatchback (N15)							5
1.4 55-64 kW (75-87 PS) GA14DE	09.1995→03.2000		7.02604.03.0	LS	200 mm		
1.4 S,GX,LX 55-64 kW (75-87 PS) GA14DE	09.1995→03.2000		7.02604.03.0	LS	200 mm		
1.6 60-88 kW (82-120 PS) GA16DE	09.1995→03.2000		7.02604.03.0	LS	200 mm		
1.6 SR,SLX 60-88 kW (82-120 PS) GA16DE	09.1995→03.2000		7.02604.03.0	LS	200 mm		
ALMERA II (N16)							6
1.5 66-80 kW (90-109 PS) QG15DE	07.2000→11.2006		7.05271.37.0	LS	470 mm	02.2003→04.2006 Regelsonde Regulating Probe vor Katalysator in front of the catalyst	
			7.05271.69.0	LS	350 mm		
1.5 66-80 kW (90-109 PS) QG15DE	03.2001→		7.05271.37.0	LS	470 mm	02.2003→04.2006 Regelsonde Regulating Probe vor Katalysator in front of the catalyst	
1.5 66-80 kW (90-109 PS) QG15DE	10.2002→09.2006		7.05271.37.0	LS	470 mm	02.2003→04.2006 Regelsonde Regulating Probe vor Katalysator in front of the catalyst	







N























ALMERA II (N16) **6**

			7.05271.69.0	LS	350 mm	
1.6 75-88 kW (102-120 PS) QG16DE	06.2000→12.2009		7.02604.03.0	LS	200 mm	
1.6 60-88 kW (82-120 PS) GA16DE, QG16DE	07.2000→02.2003		7.02604.03.0	LS	200 mm	
1.8 78-94 kW (106-128 PS) QG18DE	07.2000→11.2002		7.05271.37.0	LS	470 mm	Regelsonde Regulating Probe vor Katalysator in front of the catalyst
			7.05271.69.0	LS	350 mm	
1.8 78-94 kW (106-128 PS) QG18DE	01.2002→		7.05271.37.0	LS	470 mm	02.2003→04.2006 Regelsonde Regulating Probe vor Katalysator in front of the catalyst
1.8 78-94 kW (106-128 PS) QG18DE	10.2002→09.2006		7.05271.37.0	LS	470 mm	02.2003→04.2006 Regelsonde Regulating Probe vor Katalysator in front of the catalyst
			7.05271.69.0	LS	350 mm	

ALMERA II Hatchback (N16) **7**

1.5 66-80 kW (90-109 PS) QG15DE	03.2000→11.2006		7.05271.37.0	LS	470 mm	02.2003→04.2006 Regelsonde Regulating Probe vor Katalysator in front of the catalyst
			7.05271.69.0	LS	350 mm	
1.5 66-80 kW (90-109 PS) QG15DE	10.2002→09.2006		7.05271.37.0	LS	470 mm	02.2003→04.2006 Regelsonde Regulating Probe vor Katalysator in front of the catalyst
			7.05271.69.0	LS	350 mm	
1.5 XL 66-80 kW (90-109 PS) QG15DE	03.2001→		7.05271.37.0	LS	470 mm	02.2003→04.2006 Regelsonde Regulating Probe vor Katalysator in front of the catalyst
1.8 78-94 kW (106-128 PS) QG18DE	01.2000→11.2002		7.05271.37.0	LS	470 mm	Regelsonde Regulating Probe vor Katalysator in front of the catalyst
			7.05271.69.0	LS	350 mm	
1.8 78-94 kW (106-128 PS) QG18DE	08.2002→		7.05271.37.0	LS	470 mm	02.2003→04.2006 Regelsonde Regulating Probe vor Katalysator in front of the catalyst
1.8 78-94 kW (106-128 PS) QG18DE	10.2002→09.2006		7.05271.37.0	LS	470 mm	02.2003→04.2006 Regelsonde Regulating Probe vor Katalysator in front of the catalyst
			7.05271.69.0	LS	350 mm	





N

						
ALMERA TINO (V10) 8						
1.8 78-94 kW (106-128 PS) QG18DE	08.2000→02.2006		7.05271.37.0	LS	470 mm	02.2003→11.2005 Regelsonde Regulating Probe vor Katalysator in front of the catalyst
			7.05271.69.0	LS	350 mm	
1.8 78-94 kW (106-128 PS) QG18DE	12.2002→02.2006		7.05271.37.0	LS	470 mm	02.2003→11.2005 Regelsonde Regulating Probe vor Katalysator in front of the catalyst
			7.05271.69.0	LS	350 mm	
BLUEBIRD (T72 , T12, U12) 9						
1.8 i 16V (RLT72) 92-99 kW (125-129 PS) CA18D	02.1989→12.1990		7.02604.01.0	LS	200 mm	
BLUEBIRD Hatchback (T72, T12) 10						
1.8 i 16V (FRLT72) 92-99 kW (125-129 PS) CA18D	02.1989→12.1990		7.02604.01.0	LS	200 mm	
JUKE (F15) 11						
1.5 dCi 81 kW (110 PS) K9K 410, K9K 896	06.2010→		7.00368.16.0	AGR	EL	 K9K 410, K9K 896: →05.2014  K9K 410, K9K 896: für OE-Nummer: 20827-00Q0G, 22770-00Q0C for OE number: 20827-00Q0G, 22770-00Q0C
			7.11190.08.0	DDS		
1.5 dCi 81 kW (110 PS) K9K 636	06.2010→		7.03435.05.0	AGR	EL	 Euro 5 Euro 5 für OE-Nummer: 20827-00Q0G, 22770-00Q0C for OE number: 20827-00Q0G, 22770-00Q0C
			7.11190.08.0	DDS		
1.5 dCi 81 kW (110 PS) K9K 646	06.2010→		7.05320.04.0	AGR	EL	 05.2015→ Euro 6 Euro 6 Euro 6 Euro 6 Produktionsdatum ab: 01.05.2015 Production date from: 01.05.2015
			7.11457.07.0*	DDS		
			↳7.11492.07.0	DDS		
MICRA C+C III (K12) 12						
1.4 16V 65-72 kW (88-98 PS) CR14DE	08.2005→		7.05270.55.0	LS	470 mm	Diagnosesonde Diagnostic Probe nach Katalysator Post-catalyst
			7.05271.37.0	LS	470 mm	
			7.05271.67.0	LS	300 mm	
1.6 160 SR 64-103 kW (87-140 PS) HR16DE	08.2005→		7.05271.67.0	LS	300 mm	
MICRA I (K10) 13						
1.2 40-44 kW (54-60 PS) MA12S	07.1986→07.1992		7.02604.01.0	LS	200 mm	
1.2 40-44 kW (54-60 PS) MA12S	07.1986→07.1992		7.02604.01.0	LS	200 mm	













N



























MICRA II (K11) **14**

1.0 i 16V 40-48 kW (54-65 PS) CG10DE	08.1992→07.2000		7.05271.37.0	LS	470 mm	Regelsonde Regulating Probe vor Katalysator in front of the catalyst
			7.02604.03.0	LS	200 mm	
1.0 i 16V 40-48 kW (54-65 PS) CG10DE	07.2000→02.2003		7.05271.37.0	LS	470 mm	Regelsonde Regulating Probe vor Katalysator in front of the catalyst
			7.05271.69.0	LS	350 mm	
			7.02604.03.0	LS	200 mm	
1.3 i 16V 54-55 kW (73-75 PS) CG13DE	08.1992→09.2000		7.02604.03.0	LS	200 mm	
1.4 i 16V 60-74 kW (82-101 PS) CGA3DE	09.2000→02.2003		7.05271.69.0	LS	350 mm	

MICRA III (K12) **15**

1.0 16V 40-48 kW (54-65 PS) CG10DE	01.2003→06.2010		7.05270.55.0	LS	470 mm	Regelsonde Regulating Probe vor Katalysator in front of the catalyst
			7.05271.37.0	LS	470 mm	
			7.02604.03.0	LS	200 mm	
1.2 16V 48-66 kW (65-90 PS) CG12DE	01.2003→06.2010		7.05270.55.0	LS	470 mm	10.2004→
1.2 16V 48-81 kW (65-110 PS) CR12DE	01.2003→06.2010		7.05270.55.0	LS	470 mm	10.2004→
			7.05271.37.0	LS	470 mm	Diagnosesonde Diagnostic Probe nach Katalysator Post-catalyst
			7.05271.67.0	LS	300 mm	
						 CR12DE: 06.2005→ Diagnosesonde Diagnostic Probe  CR12DE: 06.2005→ Regelsonde Regulating Probe
1.2 16V 48-66 kW (65-90 PS) CG12DE	01.2003→06.2010		7.05270.55.0	LS	470 mm	10.2004→
1.2 16V 48-81 kW (65-110 PS) CR12DE	01.2003→06.2010		7.05270.55.0	LS	470 mm	10.2004→
			7.05271.37.0	LS	470 mm	Diagnosesonde Diagnostic Probe nach Katalysator Post-catalyst
			7.05271.67.0	LS	300 mm	
						 CR12DE: 06.2005→ Diagnosesonde Diagnostic Probe  CR12DE: 06.2005→ Regelsonde Regulating Probe
1.4 16V 65-72 kW (88-98 PS) CR14DE	01.2003→06.2010		7.05270.55.0	LS	470 mm	Diagnosesonde Diagnostic Probe nach Katalysator Post-catalyst
			7.05271.37.0	LS	470 mm	
1.5 dCi 47-48 kW (64-65 PS) K9K 704	01.2003→06.2010		7.22818.58.0	AGR	EL	



N

						
MICRA III (K12)						15
1.5 dCi 60 kW (82 PS) K9K 722	09.2003→06.2010	 7.22818.58.0	AGR	EL		
1.5 dCi 62-66 kW (84-90 PS) K9K 276	06.2005→06.2010	 7.00368.15.0	AGR	EL		
160 SR 64-103 kW (87-140 PS) HR16DE	05.2005→06.2010	 7.05271.67.0	LS	300 mm		
MICRA V (K14)						16
1.5 DCI 63-66 kW (86-90 PS) K9K 628	12.2016→	 7.05320.04.0	AGR	EL		
		7.11457.07.0*	DDS		→05.2019 Euro 6 Euro 6	
		↳7.11492.07.0	DDS		Produktionsdatum bis: 31.05.2019 Production date to: 31.05.2019	
MURANO I (Z50)						17
3.5 4x4 170-224 kW (231-305 PS) VQ35DE	08.2003→09.2008	 7.05270.80.0	LS	650 mm		
		7.05271.69.0	LS	350 mm		
MURANO II (Z51)						18
3.5 170-224 kW (231-305 PS) VQ35DE	11.2007→09.2014	 7.05270.80.0	LS	650 mm		
3.5 4x4 170-224 kW (231-305 PS) VQ35DE	11.2007→09.2014	 7.05270.80.0	LS	650 mm		
3.5 4x4 170-224 kW (231-305 PS) VQ35DE	10.2008→09.2014	 7.05270.80.0	LS	650 mm		
3.5 4x4 170-224 kW (231-305 PS) VQ35DE	12.2010→09.2014	 7.05270.80.0	LS	650 mm		
NOTE (E11, NE11)						19
1.4 65-72 kW (88-98 PS) CR14DE	03.2006→06.2012	 7.05271.37.0	LS	470 mm	Diagnosesonde Diagnostic Probe nach Katalysator Post-catalyst	
		7.05271.67.0	LS	300 mm		
1.5 dCi 62-66 kW (84-90 PS) K9K 276	03.2006→06.2012	 7.00368.15.0	AGR	EL		
1.5 dCi 62-66 kW (84-90 PS) K9K 276	09.2010→06.2012	 7.00368.15.0	AGR	EL		
1.6 64-103 kW (87-140 PS) HR16DE	03.2006→06.2012	 7.05271.67.0	LS	300 mm		
NOTE (E12)						20
1.5 dCi 63-66 kW (86-90 PS) K9K 608	06.2013→	 7.03435.05.0	AGR	EL		
		7.11457.07.0*	DDS		Euro 5 Euro 5 Euro 6 Euro 6	
		↳7.11492.07.0	DDS		Produktionsdatum ab: 01.06.2015 Production date from: 01.06.2015	
1.5 dCi 66 kW (90 PS) K9K 892	06.2013→	 7.00368.16.0	AGR	EL		
		7.11457.07.0*	DDS		Euro 6 Euro 6	
		↳7.11492.07.0	DDS		Produktionsdatum ab: 01.06.2015 Production date from: 01.06.2015	





N



NP300 NAVARA (D40) 21



3.0 dCi 4WD 170-175 kW (231-238 PS) V9X	02.2010→		7.02014.07.0	AGR	EL	
--	----------	---	---------------------	-----	----	---

NP300 NAVARA Pickup (D23) 22

2.3 dCi 116-120 kW (158-163 PS) YS23DDT	01.2015→		7.11190.08.0	DDS	Produktionsdatum ab: 01.07.2016 Production date from: 01.07.2016
			7.11457.07.0*	DDS	
			↳ 7.11492.07.0	DDS	
2.3 dCi 140 kW (190 PS) YS23DDTT	10.2015→		7.11190.08.0	DDS	Produktionsdatum ab: 01.07.2016 Production date from: 01.07.2016
			7.11457.07.0*	DDS	
			↳ 7.11492.07.0	DDS	
2.3 dCi (D231) 116-120 kW (158-163 PS) YS23DDT	01.2015→		7.11190.08.0	DDS	Produktionsdatum ab: 01.07.2016 Production date from: 01.07.2016
			7.11457.07.0*	DDS	
			↳ 7.11492.07.0	DDS	
2.3 dCi 4x4 116-120 kW (158-163 PS) YS23DDT	01.2015→		7.11190.08.0	DDS	Produktionsdatum ab: 01.07.2016 Production date from: 01.07.2016
			7.11457.07.0*	DDS	
			↳ 7.11492.07.0	DDS	
2.3 dCi 4x4 116-120 kW (158-163 PS) YS23DDT	01.2019→		7.11190.08.0	DDS	
			7.11457.07.0*	DDS	
			↳ 7.11492.07.0	DDS	
2.3 dCi 4x4 (D231) 116-120 kW (158-163 PS) YS23DDT	01.2015→		7.11190.08.0	DDS	Produktionsdatum ab: 01.07.2016 Production date from: 01.07.2016
			7.11457.07.0*	DDS	
			↳ 7.11492.07.0	DDS	
2.3 dCi 4x4 (D231) 140 kW (190 PS) YS23DDTT	10.2015→		7.11190.08.0	DDS	Produktionsdatum ab: 01.07.2016 Production date from: 01.07.2016
			7.11457.07.0*	DDS	
			↳ 7.11492.07.0	DDS	





























N

PATHFINDER III (R51) 23































3.0 dCi 170-175 kW (231-238 PS) V9X	08.2010→		7.02014.07.0	AGR	EL	
4.0 4WD 194-217 kW (264-295 PS) VQ40DE	09.2005→		7.05270.80.0	LS	650 mm	

PRIMERA (P10) 24































1.6 64-79 kW (87-107 PS) GA16DS	06.1990→05.1993		7.02604.01.0	LS	200 mm	
1.6 64-79 kW (87-107 PS) GA16DS	06.1990→01.1996		7.02604.01.0	LS	200 mm	
1.6 60-88 kW (82-120 PS) GA16DE	06.1993→01.1996		7.02604.01.0	LS	200 mm	
2.0 92-121 kW (125-165 PS) SR20DE	06.1990→04.1993		7.02604.03.0	LS	200 mm	

						
PRIMERA (P10)						24
2.0 16V 85 kW (116 PS) SR20DI	06.1990→01.1996		7.02604.03.0	LS	200 mm	
2.0 16V 4x4 85 kW (116 PS) SR20DI	04.1991→06.1996		7.02604.03.0	LS	200 mm	
2.0 4x4 92-121 kW (125-165 PS) SR20DE	03.1991→04.1993		7.02604.03.0	LS	200 mm	
2.0 GT 92-121 kW (125-165 PS) SR20DE	06.1990→01.1996		7.02604.03.0	LS	200 mm	
2.0 GT 4x4 92-121 kW (125-165 PS) SR20DE	03.1991→04.1993		7.02604.03.0	LS	200 mm	
2.0 i 92-121 kW (125-165 PS) SR20DE	01.1995→06.1996		7.02604.03.0	LS	200 mm	
PRIMERA (P11)						25
1.6 16V 60-88 kW (82-120 PS) GA16DE	09.1996→10.2000		7.02604.01.0	LS	200 mm	
1.6 16V 60-88 kW (82-120 PS) GA16DE	09.1996→12.2001		7.02604.01.0	LS	200 mm	
2.0 139-150 kW (189-204 PS) SR20VE	06.1996→05.1999		7.02604.03.0	LS	200 mm	
2.0 16V 92-121 kW (125-165 PS) SR20DE	09.1996→12.2001		7.02604.03.0	LS	200 mm	
2.0 16V 85 kW (115 PS) SR20De	09.1996→12.2001		7.02604.03.0	LS	200 mm	
2.0 16V 92-121 kW (125-165 PS) SR20DE	09.1996→12.2001		7.02604.03.0	LS	200 mm	
2.0 16V 92-121 kW (125-165 PS) SR20DE	08.1999→12.2001		7.02604.03.0	LS	200 mm	
PRIMERA (P12)						26
1.6 75-88 kW (102-120 PS) QG16DE	01.2002→04.2006		7.05271.37.0	LS	470 mm	03.2002→ Regelsonde Regulating Probe vor Katalysator in front of the catalyst
			7.05271.69.0	LS	350 mm	
1.6 75-88 kW (102-120 PS) QG16DE	03.2002→08.2008		7.05271.69.0	LS	350 mm	
			7.02604.01.0	LS	200 mm	
1.8 78-94 kW (106-128 PS) QG18DE	03.2002→10.2008		7.05271.69.0	LS	350 mm	
1.9 dCi 74-88 kW (101-120 PS) F9Q	08.2002→10.2007		7.22818.62.0	AGR	EL	
1.9 dCi 74-88 kW (101-120 PS) F9Q	04.2003→10.2007		7.22818.62.0	AGR	EL	
2.0 96-110 kW (131-150 PS) QR20DE	03.2002→10.2008		7.05270.55.0	LS	470 mm	
			7.05271.69.0	LS	350 mm	
			7.02604.03.0	LS	200 mm	
PRIMERA Estate (WP12)						27
1.6 Visia 75-88 kW (102-120 PS) QG16DE	01.2002→04.2006		7.05271.37.0	LS	470 mm	03.2002→ Regelsonde Regulating Probe vor Katalysator in front of the catalyst
			7.05271.69.0	LS	350 mm	

N













			 PIERBURG		
PRIMERA Estate (WP12)					27
1.8 78-94 kW (106-128 PS) QG18DE	03.2002→05.2007		7.05271.69.0	LS	350 mm
1.9 dCi 74-88 kW (101-120 PS) F9Q	08.2002→10.2007		7.22818.62.0	AGR	EL 
1.9 dCi 74-88 kW (101-120 PS) F9Q	04.2003→		7.22818.62.0	AGR	EL 
2.0 96-110 kW (131-150 PS) QR20DE	03.2002→		7.05270.55.0	LS	470 mm
			7.05271.69.0	LS	350 mm
			7.02604.03.0	LS	200 mm
PRIMERA Hatchback (P10)					28
1.6 64-79 kW (87-107 PS) GA16DS	06.1990→05.1993		7.02604.01.0	LS	200 mm
1.6 64-79 kW (87-107 PS) GA16DS	06.1990→06.1993		7.02604.01.0	LS	200 mm
1.6 60-88 kW (82-120 PS) GA16DE	06.1993→01.1996		7.02604.01.0	LS	200 mm
2.0 92-121 kW (125-165 PS) SR20DE	06.1990→01.1996		7.02604.03.0	LS	200 mm
2.0 92-121 kW (125-165 PS) SR20DE	06.1990→04.1993		7.02604.03.0	LS	200 mm
2.0 92-121 kW (125-165 PS) SR20DE	09.1990→01.1996		7.02604.03.0	LS	200 mm
2.0 16V 85 kW (116 PS) SR20DI	06.1990→01.1996		7.02604.03.0	LS	200 mm
2.0 16V 4x4 85 kW (116 PS) SR20DI	04.1991→06.1996		7.02604.03.0	LS	200 mm
2.0 i 92-121 kW (125-165 PS) SR20DE	01.1995→06.1996		7.02604.03.0	LS	200 mm
PRIMERA Hatchback (P11)					29
1.6 16V 60-88 kW (82-120 PS) GA16DE	09.1996→07.2002		7.02604.01.0	LS	200 mm
1.6 16V 60-88 kW (82-120 PS) GA16DE	09.1996→07.2002		7.02604.01.0	LS	200 mm
1.6 16V 75-88 kW (102-120 PS) QG16DE	09.2000→07.2002		7.05271.37.0	LS	470 mm 03.2002→ Regelsonde Regulating Probe vor Katalysator in front of the catalyst
2.0 16V 92-121 kW (125-165 PS) SR20DE	09.1996→07.2002		7.02604.03.0	LS	200 mm
2.0 16V 85 kW (115 PS) SR20De	09.1996→07.2002		7.02604.03.0	LS	200 mm
2.0 16V 92-121 kW (125-165 PS) SR20DE	09.1996→07.2002		7.02604.03.0	LS	200 mm
2.0 16V 92-121 kW (125-165 PS) SR20DE	08.1999→07.2002		7.02604.03.0	LS	200 mm
PRIMERA Hatchback (P12)					30
1.6 75-88 kW (102-120 PS) QG16DE	07.2002→08.2008		7.05271.69.0	LS	350 mm
			7.02604.01.0	LS	200 mm
1.6 75-88 kW (102-120 PS) QG16DE	07.2002→04.2006		7.05271.37.0	LS	470 mm Regelsonde Regulating Probe vor Katalysator in front of the catalyst

N

					
PRIMERA Hatchback (P12)					30
			7.05271.69.0	LS	350 mm
1.8 78-94 kW (106-128 PS) QG18DE	07.2002→10.2008		7.05271.69.0	LS	350 mm
1.9 dCi 74-88 kW (101-120 PS) F9Q	08.2002→10.2007		7.22818.62.0	AGR	EL 
1.9 dCi 74-88 kW (101-120 PS) F9Q	04.2003→10.2007		7.22818.62.0	AGR	EL 
2.0 96-110 kW (131-150 PS) QR20DE	07.2002→10.2008		7.05270.55.0	LS	470 mm
			7.05271.69.0	LS	350 mm
			7.02604.03.0	LS	200 mm
PRIMERA Traveller (W10)					31
1.6 i 64-79 kW (87-107 PS) GA16DS	07.1990→05.1993		7.02604.01.0	LS	200 mm
1.6 i 60-88 kW (82-120 PS) GA16DE	02.1991→03.1998		7.02604.01.0	LS	200 mm
2.0 92-121 kW (125-165 PS) SR20DE	07.1994→01.1998		7.02604.03.0	LS	200 mm
2.0 i 85 kW (116 PS) SR20DI	07.1990→03.1998		7.02604.03.0	LS	200 mm
PRIMERA Traveller (WP11)					32
1.6 16V 60-88 kW (82-120 PS) GA16DE	04.1998→12.2001		7.02604.01.0	LS	200 mm
1.6 16V 60-88 kW (82-120 PS) GA16DE	04.1998→12.2001		7.02604.01.0	LS	200 mm
2.0 16V 85 kW (115 PS) SR20De	06.1996→12.2001		7.02604.03.0	LS	200 mm
2.0 16V 139-150 kW (189-204 PS) SR20VE	06.1996→05.1999		7.02604.03.0	LS	200 mm
2.0 16V 92-121 kW (125-165 PS) SR20DE	04.1998→12.2001		7.02604.03.0	LS	200 mm
2.0 16V 92-121 kW (125-165 PS) SR20DE	08.1999→12.2001		7.02604.03.0	LS	200 mm
PULSAR Hatchback (C13)					33
1.5 dCi 48-81 kW (65-110 PS) K9K	10.2014→		7.11190.08.0	DDS	Euro 5
			7.11457.07.0*	DDS	Euro 5
			↳7.11492.07.0	DDS	Euro 6
					Produktionsdatum ab: 01.05.2015 Production date from: 01.05.2015
QASHQAI / QASHQAI +2 I (J10, NJ10, JJ10E)					34
1.5 dCi 76-78 kW (103-106 PS) K9K 282, K9K 292	02.2007→12.2013		7.00368.15.0	AGR	EL
1.5 dCi 76-78 kW (103-106 PS) K9K 282, K9K 292	07.2008→12.2013		7.00368.15.0	AGR	EL
1.5 dCi 81 kW (110 PS) K9K 430	01.2010→12.2013		7.00368.16.0	AGR	EL 
1.6 64-103 kW (87-140 PS) HR16DE	02.2007→12.2013		7.05271.67.0	LS	300 mm
1.6 64-103 kW (87-140 PS) HR16DE	11.2010→12.2013		7.05271.67.0	LS	300 mm
1.6 dCi 70-107 kW (95-146 PS) R9M	10.2011→12.2013		7.24809.90.0	AGR	EL 
			7.03571.16.0	AK	EL



QASHQAI / QASHQAI +2 I (J10, NJ10, JJ10E) 34

			↳ 7.03083.20.0 7.11190.08.0 7.02604.99.0	SRM-AK DDS LS	EL 400 mm	
1.6 dCi All-wheel Drive 70-107 kW (95-146 PS) R9M	10.2011→12.2013		7.24809.90.0 7.03571.16.0 ↳ 7.03083.20.0 7.11190.08.0 7.02604.99.0	AGR AK SRM-AK DDS LS	EL EL EL 400 mm	
2.0 dCi 110-130 kW (150-177 PS) M9R	02.2007→12.2013		7.10334.05.0 7.10334.03.0 7.11190.08.0 7.02604.44.0	AGR AGR DDS LS	EL EL 500 mm	 04.2007→05.2010 für OE-Nummer: 14956-00Q0F, 14956-00Q0J, 14956-00Q1A for OE number: 14956-00Q0F, 14956-00Q0J, 14956-00Q1A  08.2008→ für OE-Nummer: 14956-00Q0F, 14956-00Q0J, 14956-00Q1A for OE number: 14956-00Q0F, 14956-00Q0J, 14956-00Q1A für OE-Nummer: 22771-JG70A for OE number: 22771-JG70A  M9R: Ausstattungsvariante: Qashqai +2 Equipment Variant: Qashqai +2 vor Katalysator in front of the catalyst  M9R: vor Katalysator in front of the catalyst nicht für Ausstattungsvariante: Qashqai +2 not for equipment variant: Qashqai +2
2.0 dCi All-wheel Drive 110-130 kW (150-177 PS) M9R	02.2007→12.2013		7.10334.05.0 7.10334.03.0 7.11190.08.0 7.02604.44.0	AGR AGR DDS LS	EL EL 500 mm	 04.2007→05.2010 für OE-Nummer: 14956-00Q0F, 14956-00Q0J, 14956-00Q1A for OE number: 14956-00Q0F, 14956-00Q0J, 14956-00Q1A  08.2008→ für OE-Nummer: 14710-00Q0Y, 14956-00Q1E, 14956-00Q1J for OE number: 14710-00Q0Y, 14956-00Q1E, 14956-00Q1J für OE-Nummer: 22771-JG70A for OE number: 22771-JG70A  M9R: 08.2008→06.2012 Ausstattungsvariante: Qashqai +2 Equipment Variant: Qashqai +2 vor Katalysator in front of the catalyst  M9R: 04.2007→ vor Katalysator in front of the catalyst nicht für Ausstattungsvariante: Qashqai +2 not for equipment variant: Qashqai +2

QASHQAI II SUV (J11, J11_) 35

1.5 dCi 81 kW (110 PS) K9K 636	11.2013→		7.03435.05.0 7.03571.16.0	AGR AK	EL EL	 Euro 5 Euro 5 →04.2017
--	----------	---	--	---------------	--------------	---



QASHQAI II SUV (J11, J11_) 35

1.5 dCi 81 kW (110 PS) K9K 646	11.2013→	↳7.03083.20.0	SRM-AK	EL	 05.2015→09.2019 Euro 6 Euro 6 →04.2017 Euro 6 Euro 6 Produktionsdatum ab: 01.05.2015 Production date from: 01.05.2015
		7.05320.04.0	AGR	EL	
		7.03571.16.0	AK	EL	
		↳7.03083.20.0	SRM-AK	EL	
1.5 dCi 59-85 kW (80-116 PS) K9K 872	06.2018→	7.11457.07.0*	DDS	EL	Euro 6 Euro 6 Produktionsdatum ab: 01.05.2015 Production date from: 01.05.2015
		↳7.11492.07.0	DDS		
		7.11457.07.0*	DDS		
1.6 dCi 70-107 kW (95-146 PS) R9M	11.2013→	↳7.24809.90.0	AGR	EL	 →07.2017 →06.2017 Automatikgetriebe Automatic Transmission Euro 6 Euro 6 Produktionsdatum ab: 01.05.2015 Production date from: 01.05.2015
		7.03571.16.0	AK	EL	
		↳7.03083.20.0	SRM-AK	EL	
		7.11457.07.0*	DDS		
1.6 dCi ALL MODE 4x4-i 70-107 kW (95-146 PS) R9M	11.2013→	↳7.11492.07.0	DDS	EL	 →07.2017 Euro 6 Euro 6 Produktionsdatum ab: 01.05.2015 Production date from: 01.05.2015
		7.11457.07.0*	DDS		
		↳7.11492.07.0	DDS		
1.7 dCi 110 kW (150 PS) R9N 401	01.2019→	7.11457.07.0*	DDS		
		↳7.11492.07.0	DDS		
1.7 dCi ALL MODE 4x4-i 110 kW (150 PS) R9N 401	01.2019→	7.11457.07.0*	DDS		
		↳7.11492.07.0	DDS		











N

SERENA (C23) 36

1.6 60-88 kW (82-120 PS) GA16DE	02.1993→09.2001		7.02604.03.0	LS	200 mm
1.6 60-88 kW (82-120 PS) GA16DE	09.1994→08.2000		7.02604.01.0	LS	200 mm
2.0 92-121 kW (125-165 PS) SR20DE	11.1992→09.2001		7.02604.03.0	LS	200 mm

SERENA (C24) 37

























2.0 SGX 92-121 kW (125-165 PS) SR20DE	09.2000→09.2005		7.02604.03.0	LS	200 mm
2.0 SGX 4x4 92-121 kW (125-165 PS) SR20DE	09.2000→09.2005		7.02604.03.0	LS	200 mm

						
SERENA (C25)						38
2.0 95-108 kW (129-147 PS) MR20DE	04.2005→11.2010		7.02604.03.0	LS	200 mm	
2.0 4x4 95-108 kW (129-147 PS) MR20DE	04.2005→11.2010		7.02604.03.0	LS	200 mm	
SUNNY II (N13, B12)						39
1.4 LX 55-60 kW (75-82 PS) GA14S	10.1988→08.1991		7.02604.01.0	LS	200 mm	
1.6 60-88 kW (82-120 PS) GA16DE	02.1987→10.1988		7.02604.01.0	LS	200 mm	
SUNNY II Hatchback (N13)						40
1.4 LX 55-60 kW (75-82 PS) GA14S	01.1989→08.1991		7.02604.01.0	LS	200 mm	
1.6 60-88 kW (82-120 PS) GA16DE	02.1987→10.1988		7.02604.01.0	LS	200 mm	
SUNNY III (N14)						41
1.4 55-63 kW (75-86 PS) GA14DS	10.1990→06.1995		7.02604.01.0	LS	200 mm	
1.4 i 55-64 kW (75-87 PS) GA14DE, GA14DS	10.1990→05.1995		7.02604.01.0	LS	200 mm	
1.4 i 16V 55-64 kW (75-87 PS) GA14DE	10.1990→06.1995		7.02604.01.0	LS	200 mm	
1.6 60-88 kW (82-120 PS) GA16DE	08.1990→10.1994		7.02604.01.0	LS	200 mm	
1.6 i 16V 60-88 kW (82-120 PS) GA16DE	10.1992→05.1995		7.02604.01.0	LS	200 mm	
1.6 i 16V 4WD 64-79 kW (87-107 PS) GA16DS	10.1990→05.1995		7.02604.01.0	LS	200 mm	
SUNNY III Hatchback (N14)						42
1.4 55-63 kW (75-86 PS) GA14DS	10.1990→06.1995		7.02604.01.0	LS	200 mm	
1.4 i 55-64 kW (75-87 PS) GA14DE, GA14DS	10.1990→05.1995		7.02604.01.0	LS	200 mm	
1.4 i 16V 55-64 kW (75-87 PS) GA14DE	10.1990→05.1995		7.02604.01.0	LS	200 mm	
1.6 i 60-88 kW (82-120 PS) GA16DE, GA16DEL, GA16DS	10.1990→05.1995		7.02604.01.0	LS	200 mm	
1.6 i 16V 60-88 kW (82-120 PS) GA16DE	10.1992→05.1995		7.02604.01.0	LS	200 mm	
1.6 i 16V 4x4 60-88 kW (82-120 PS) GA16DE	10.1992→05.1995		7.02604.01.0	LS	200 mm	
SUNNY III Liftback (N14)						43
1.4 i 55-64 kW (75-87 PS) GA14DE, GA14DS	10.1990→05.1995		7.02604.01.0	LS	200 mm	
1.4 i 16V 55-64 kW (75-87 PS) GA14DE	10.1990→06.1995		7.02604.01.0	LS	200 mm	
1.6 i 60-88 kW (82-120 PS) GA16DE, GA16DEL, GA16DS	10.1990→05.1995		7.02604.01.0	LS	200 mm	
1.6 i 16V 60-88 kW (82-120 PS) GA16DE	10.1992→05.1995		7.02604.01.0	LS	200 mm	
SUNNY III Traveller (Y10)						44
1.6 60-88 kW (82-120 PS) GA16DE	07.1995→03.2000		7.02604.01.0	LS	200 mm	

N

						
SUNNY III Traveller (Y10)						44
1.6 16V 4x4 64-79 kW (87-107 PS) GA16DS	11.1990→05.1995		7.02604.01.0	LS	200 mm	
1.6 i 16V 4x4 60-88 kW (82-120 PS) GA16DE	10.1992→03.2000		7.02604.01.0	LS	200 mm	
TERRA (JD23TT, JD23F)						45
2.3 TDCI 140 kW (190 PS) YS23DDTT	08.2018→		7.11457.07.0*	DDS		
			↳7.11492.07.0	DDS		
2.3 TDCI 4WD 140 kW (190 PS) YS23DDTT	08.2018→		7.11457.07.0*	DDS		
			↳7.11492.07.0	DDS		
TERRANO I (WD21)						46
2.4 i 4WD 72-100 kW (98-124 PS) Z24i	10.1987→02.1993		7.02604.01.0	LS	200 mm	
TERRANO II (R20)						47
2.4 4WD 79-105 kW (107-143 PS) KA24E	05.1996→01.2002		7.02604.01.0	LS	200 mm	
2.4 4WD 79-105 kW (107-143 PS) KA24E	05.1996→09.2007		7.02604.01.0	LS	200 mm	
2.4 i 12V 4WD 79-105 kW (107-143 PS) KA24E	02.1993→12.1997		7.02604.01.0	LS	200 mm	
TIIDA Hatchback (C11)						48
1.5 dCi 76-78 kW (103-106 PS) K9K 278	09.2007→12.2011		7.00368.15.0	AGR	EL	
1.6 64-103 kW (87-140 PS) HR16DE	09.2007→12.2011		7.05271.67.0	LS	300 mm	
TIIDA Saloon (SC11)						49
1.5 dCi 76-78 kW (103-106 PS) K9K 278	01.2007→12.2012		7.00368.15.0	AGR	EL	
1.5 dCi 76-78 kW (103-106 PS) K9K 278	09.2007→12.2012		7.00368.15.0	AGR	EL	
1.6 (C11L) 64-103 kW (87-140 PS) HR16DE	09.2007→12.2012		7.05271.67.0	LS	300 mm	
X-TRAIL (T30)						50
2.0 96-110 kW (131-150 PS) QR20DE	07.2001→01.2013		7.05270.55.0	LS	470 mm	
			7.05271.69.0	LS	350 mm	
2.0 96-110 kW (131-150 PS) QR20DE	09.2001→01.2013		7.05270.55.0	LS	470 mm	
2.0 4x4 96-110 kW (131-150 PS) QR20DE	07.2001→01.2013		7.05270.55.0	LS	470 mm	
			7.05271.69.0	LS	350 mm	
2.0 4x4 96-110 kW (131-150 PS) QR20DE	09.2001→01.2013		7.05270.55.0	LS	470 mm	
2.2 Di 4x4 84-110 kW (114-150 PS) YD22DDTi, YD22ETI	07.2001→10.2005		7.05271.69.0	LS	350 mm	
2.2 dCi 84-110 kW (114-150 PS) YD22DDTi, YD22ETI	12.2003→01.2013		7.05271.69.0	LS	350 mm	
2.2 dCi 4x4 84-110 kW (114-150 PS) YD22DDTi, YD22ETI	06.2001→12.2008		7.05271.69.0	LS	350 mm	
2.5 4x4 104-149 kW (141-203 PS) QR25DE	09.2002→01.2013		7.05270.55.0	LS	470 mm	

N

					
X-TRAIL (T30)					50
			7.05271.69.0	LS	350 mm
2.5 4x4 104-149 kW (141-203 PS) QR25DE	11.2002→01.2013		7.05270.55.0	LS	470 mm
X-TRAIL (T31)					51
2.0 dCi 110-130 kW (150-177 PS) M9R	06.2007→11.2013		7.10334.05.0	AGR	EL  →05.2010 für OE-Nummer: 14956-00Q0F, 14956-00Q0J, 14956-00Q1A for OE number: 14956-00Q0F, 14956-00Q0J, 14956-00Q1A
			7.10334.03.0	AGR	EL  für OE-Nummer: 14710-00Q0Y, 14956-00Q1E, 14956-00Q1J for OE number: 14710-00Q0Y, 14956-00Q1E, 14956-00Q1J
			7.11190.08.0 7.02604.44.0	DDS LS	500 mm →09.2012 vor Katalysator in front of the catalyst
2.0 dCi 4x4 127-130 kW (173-177 PS) M9R 760	06.2007→11.2013		7.10334.03.0	AGR	EL  für OE-Nummer: 14710-00Q0Y, 14956-00Q1E, 14956-00Q1J for OE number: 14710-00Q0Y, 14956-00Q1E, 14956-00Q1J
			7.10334.05.0	AGR	EL   →ch. 05.2010 für OE-Nummer: 14956-00Q0F, 14956-00Q0J, 14956-00Q1A for OE number: 14956-00Q0F, 14956-00Q0J, 14956-00Q1A
			7.11190.08.0	DDS	
2.0 dCi 4x4 110-130 kW (150-177 PS) M9R	06.2007→11.2013		7.10334.03.0	AGR	EL  für OE-Nummer: 14710-00Q0Y, 14956-00Q1E, 14956-00Q1J for OE number: 14710-00Q0Y, 14956-00Q1E, 14956-00Q1J
			7.10334.05.0	AGR	EL   →ch. 02.2010 für OE-Nummer: 14956-00Q0F, 14956-00Q0J, 14956-00Q1A for OE number: 14956-00Q0F, 14956-00Q0J, 14956-00Q1A
			7.11190.08.0 7.02604.44.0	DDS LS	500 mm →09.2012 vor Katalysator in front of the catalyst
2.0 dCi 4x4 127-130 kW (173-177 PS) M9R 760	10.2009→11.2013		7.10334.03.0	AGR	EL  für OE-Nummer: 14710-00Q0Y, 14956-00Q1E, 14956-00Q1J for OE number: 14710-00Q0Y, 14956-00Q1E, 14956-00Q1J
			7.10334.05.0	AGR	EL  für OE-Nummer: 14956-00Q0F, 14956-00Q0J, 14956-00Q1A for OE number: 14956-00Q0F, 14956-00Q0J, 14956-00Q1A
2.5 4x4 104-149 kW (141-203 PS) QR25DE	06.2007→11.2013		7.05271.69.0	LS	350 mm
X-TRAIL (T32_)					52
1.6 dCi (T32) 70-107 kW (95-146 PS) R9M	04.2014→		7.24809.90.0	AGR	EL  →08.2018
			7.11190.08.0	DDS	für OE-Nummer: 20827-00Q0G for OE number: 20827-00Q0G

N

X-TRAIL (T32_)
52



			7.11457.07.0*	DDS		ab Euro 6 From Euro 6 Produktionsdatum ab: 01.05.2015 Production date from: 01.05.2015
			↳7.11492.07.0	DDS		
1.6 dCi ALL MODE 4x4-i (NT32) 70-107 kW (95-146 PS) R9M	04.2014→		7.24809.90.0	AGR	EL	⊙ →08.2018
			7.11190.08.0	DDS		für OE-Nummer: 20827-00Q0G for OE number: 20827-00Q0G
			7.11457.07.0*	DDS		ab Euro 6 From Euro 6 Produktionsdatum ab: 01.05.2015 Production date from: 01.05.2015
			↳7.11492.07.0	DDS		
1.7 dCi 96-120 kW (131-163 PS) R9N	04.2019→		7.11457.07.0*	DDS		
			↳7.11492.07.0	DDS		
1.7 dCi 96-120 kW (131-163 PS) R9N	04.2019→		7.11457.07.0*	DDS		
			↳7.11492.07.0	DDS		
1.7 dCi 96-120 kW (131-163 PS) R9N	04.2019→		7.11457.07.0*	DDS		
			↳7.11492.07.0	DDS		
1.7 dCi ALL MODE 4x4-i 96-120 kW (131-163 PS) R9N	04.2019→		7.11457.07.0*	DDS		
			↳7.11492.07.0	DDS		
1.7 dCi ALL MODE 4x4-i 96-120 kW (131-163 PS) R9N	04.2019→		7.11457.07.0*	DDS		
			↳7.11492.07.0	DDS		
1.7 dCi ALL MODE 4x4-i 96-120 kW (131-163 PS) R9N	04.2019→		7.11457.07.0*	DDS		
			↳7.11492.07.0	DDS		
2.0 dCi (T32) 110-130 kW (150-177 PS) M9R	10.2016→		7.10334.03.0	AGR	EL	⊙ 11.2016→11.2018
2.0 dCi ALL MODE 4x4-i (NT32) 110-130 kW (150-177 PS) M9R	10.2016→		7.10334.03.0	AGR	EL	⊙ 11.2016→11.2018

N
INTERSTAR Bus (X70)
53







dCi 90 66 kW (90 PS) G9T 722	07.2002→08.2006		7.22818.59.0	AGR	EL	⊙ Durchmesser Ventilteller/diameter valve head 30 mm
			7.22818.63.0	AGR	EL	⊙ Durchmesser Ventilteller/diameter valve head 16 mm
dCi 100 73-84 kW (99-114 PS) G9U 720	11.2003→03.2006		7.22818.59.0	AGR	EL	⊙ Durchmesser Ventilteller/diameter valve head 30 mm
dCi 100 74-88 kW (101-120 PS) G9U 650	04.2006→03.2011		7.11190.08.0	DDS		für OE-Nummer: 20827-00Q0B for OE number: 20827-00Q0B
dCi 115 73-84 kW (99-114 PS) G9U 750	07.2002→08.2006		7.22818.59.0	AGR	EL	⊙ Durchmesser Ventilteller/diameter valve head 30 mm
dCi 120 74-88 kW (101-120 PS) G9U 650	09.2006→03.2011		7.11190.08.0	DDS		für OE-Nummer: 20827-00Q0B for OE number: 20827-00Q0B

















INTERSTAR Bus (X70) 53

dCi 150 88-107 kW (120-146 PS) G9U 632	09.2006→03.2011		7.11190.08.0	DDS		für OE-Nummer: 20827-00Q0B for OE number: 20827-00Q0B
dCi 80 60 kW (82 PS) F9Q 772, F9Q 774	04.2002→08.2006		7.22818.57.0	AGR	EL	













INTERSTAR Platform/Chassis 54

dCi 100 73-84 kW (99-114 PS) G9U 720	02.2004→		7.22818.59.0	AGR	EL	 Durchmesser Ventilteller/diameter valve head 30 mm
dCi 115 73-84 kW (99-114 PS) G9U 720, G9U 750	08.2003→		7.22818.59.0	AGR	EL	 Durchmesser Ventilteller/diameter valve head 30 mm
dCi 120 74-88 kW (101-120 PS) G9U 650	08.2006→		7.11190.08.0	DDS		für OE-Nummer: 20827-00Q0B for OE number: 20827-00Q0B
dCi 150 88-107 kW (120-146 PS) G9U 632	08.2006→		7.11190.08.0	DDS		für OE-Nummer: 20827-00Q0B for OE number: 20827-00Q0B





















INTERSTAR Van (X70) 55

dCi 90 66 kW (90 PS) G9T 722	07.2002→		7.22818.59.0	AGR	EL	 Durchmesser Ventilteller/diameter valve head 30 mm
			7.22818.63.0	AGR	EL	 Durchmesser Ventilteller/diameter valve head 16 mm
dCi 100 73-84 kW (99-114 PS) G9U 720	11.2003→03.2006		7.22818.59.0	AGR	EL	 Durchmesser Ventilteller/diameter valve head 30 mm
dCi 100 73-84 kW (99-114 PS) G9U 720	04.2006→		7.22818.59.0	AGR	EL	 Durchmesser Ventilteller/diameter valve head 30 mm
			7.11190.08.0	DDS		für OE-Nummer: 20827-00Q0B for OE number: 20827-00Q0B
dCi 100 73-84 kW (99-115 PS) G9U 754	04.2006→		7.11190.08.0	DDS		für OE-Nummer: 20827-00Q0B for OE number: 20827-00Q0B
dCi 115 73-84 kW (99-114 PS) G9U 720, G9U 750	04.2002→		7.22818.59.0	AGR	EL	 Durchmesser Ventilteller/diameter valve head 30 mm
dCi 120 74-88 kW (101-120 PS) G9U 650	09.2006→		7.11190.08.0	DDS		für OE-Nummer: 20827-00Q0B for OE number: 20827-00Q0B
dCi 150 88-107 kW (120-146 PS) G9U 632	09.2006→		7.11190.08.0	DDS		für OE-Nummer: 20827-00Q0B for OE number: 20827-00Q0B
dCi 80 60 kW (82 PS) F9Q 772, F9Q 774	04.2002→08.2006		7.22818.57.0	AGR	EL	

KUBISTAR Van (X76) 56



1.2 44 kW (60 PS) D7F 764	08.2003→		7.05270.54.0	LS	450 mm	nach Katalysator Post-catalyst
1.2 16V 55 kW (75 PS) D4F 712	04.2006→		7.05270.54.0	LS	450 mm	vor Katalysator, nach Katalysator in front of the catalyst, Post-catalyst Produktionsdatum bis: 06.2006 Production date to: 06.2006
1.5 dCi 47-48 kW (64-65 PS) K9K 704	08.2003→		7.22818.58.0	AGR	EL	
1.5 dCi 60 kW (82 PS) K9K 722	08.2003→10.2009		7.22818.58.0	AGR	EL	
1.5 dCi 42-45 kW (57-61 PS) K9K 714	08.2003→10.2009		7.00368.15.0	AGR	EL	
1.5 dCi 42-45 kW (57-61 PS) K9K 710	08.2005→10.2009		7.22818.58.0	AGR	EL	
1.5 dCi 42-45 kW (57-61 PS) K9K 714	08.2005→10.2009		7.00368.15.0	AGR	EL	
1.5 dCi 70 47-50 kW (64-68 PS) K9K 700	09.2005→10.2009		7.22818.58.0	AGR	EL	

N

						
KUBISTAR Van (X76)						56
1.5 dCi 70 50-51 kW (68-69 PS) K9K 716	09.2005→10.2009		7.00368.15.0	AGR	EL	
dCi 85 50-66 kW (68-90 PS) K9K 276, K9K 718	04.2006→10.2009		7.00368.15.0	AGR	EL	
NAVARA Platform/Chassis (D23)						57
2.3 dCi 116-120 kW (158-163 PS) YS23DDT	01.2015→		7.11457.07.0*	DDS	Produktionsdatum ab: 01.07.2016 Production date from: 01.07.2016	
			↳7.11492.07.0	DDS		
2.3 dCi 4x4 116-120 kW (158-163 PS) YS23DDT	01.2015→		7.11457.07.0*	DDS	Produktionsdatum ab: 01.07.2016 Production date from: 01.07.2016	
			↳7.11492.07.0	DDS		
NP300 NAVARA Platform/Chassis (D40)						58
3.0 dCi 170-175 kW (231-238 PS) V9X	03.2010→		7.02014.07.0	AGR	EL 	
NV200 / EVALIA Bus						59
1.5 dCi 110 (M20, M20M) 81 kW (110 PS) K9K 636	04.2011→		7.03435.05.0	AGR	EL  Euro 5 Euro 5	
			7.11190.08.0	DDS	10.2013→ Euro 5 Euro 5 🇪🇸 Spanien 🇪🇸 Spain	
1.5 dCi 110 (M20, M20M) 81 kW (110 PS) K9K 646	04.2011→		7.05320.04.0	AGR	EL  07.2015→ Euro 6 Euro 6	
			7.11190.08.0	DDS	10.2013→ Euro 5 Euro 5 🇪🇸 Spanien 🇪🇸 Spain	
			7.11457.07.0*	DDS	Euro 6 Euro 6 Produktionsdatum ab: 01.07.2015 Production date from: 01.07.2015	
			↳7.11492.07.0	DDS		
1.5 dCi 85 (M20, M20M, M20K, M20KK) 63 kW (86 PS) K9K 400	07.2010→		7.00368.16.0	AGR	EL  10.2010→10.2013	
			7.11190.08.0	DDS	10.2013→ Euro 5 Euro 5 🇪🇸 Spanien 🇪🇸 Spain	
1.5 dCi 85 (M20, M20M, M20K, M20KK) 63-66 kW (86-90 PS) K9K 608	07.2010→		7.03435.05.0	AGR	EL  Euro 5 Euro 5	
			7.11190.08.0	DDS	10.2013→ Euro 5 Euro 5 🇪🇸 Spanien 🇪🇸 Spain	
1.5 dCi 85 (M20, M20M, M20K, M20KK) 63-66 kW (86-90 PS) K9K 628	07.2010→		7.05320.04.0	AGR	EL  07.2015→ Euro 6 Euro 6	



























NV200 / EVALIA Bus **59**

			7.11190.08.0	DDS		10.2013→ Euro 5 Euro 5 ** Spanien ** Spain
			7.11457.07.0*	DDS		Euro 6 Euro 6 Produktionsdatum ab: 01.07.2015 Production date from: 01.07.2015
			↳ 7.11492.07.0	DDS		
1.5 dCi 90 (M20, M20M) 66 kW (90 PS) K9K 892	04.2011→		7.00368.16.0	AGR	EL	 →10.2013
1.6 16V (M20, M20M) 64-103 kW (87-140 PS) HR16DE	07.2010→		7.05271.67.0	LS	300 mm	

NV200 Van **60**

1.5 dCi 110 (M20, M20M) 81 kW (110 PS) K9K 636	04.2011→		7.03435.05.0	AGR	EL	 Euro 5 Euro 5
			7.11190.08.0	DDS		Euro 5 Euro 5 ** Spanien ** Spain
1.5 dCi 110 (M20, M20M) 81 kW (110 PS) K9K 646	04.2011→		7.05320.04.0	AGR	EL	 07.2015→ Euro 6 Euro 6
			7.11190.08.0	DDS		Euro 5 Euro 5 ** Spanien ** Spain
			7.11457.07.0*	DDS		Euro 6 Euro 6 Produktionsdatum ab: 01.07.2015 Production date from: 01.07.2015
			↳ 7.11492.07.0	DDS		
1.5 dCi 85 (M20, M20M) 63 kW (86 PS) K9K 400	02.2010→		7.00368.16.0	AGR	EL	 10.2010→10.2013
			7.11190.08.0	DDS		10.2013→ Euro 5 Euro 5 ** Spanien ** Spain
1.5 dCi 85 (M20, M20M) 63-66 kW (86-90 PS) K9K 608	02.2010→		7.03435.05.0	AGR	EL	 Euro 5 Euro 5
			7.11190.08.0	DDS		10.2013→ Euro 5 Euro 5 ** Spanien ** Spain
1.5 dCi 85 (M20, M20M) 63-66 kW (86-90 PS) K9K 628	02.2010→		7.05320.04.0	AGR	EL	 07.2015→ Euro 6 Euro 6
			7.11190.08.0	DDS		Euro 6 Euro 6 Produktionsdatum ab: 01.07.2015 Production date from: 01.07.2015
			7.11457.07.0*	DDS		Euro 6 Euro 6 Produktionsdatum ab: 01.07.2015 Production date from: 01.07.2015
			↳ 7.11492.07.0	DDS		









N

						
NV200 Van						60
1.5 dCi 90 (M20, M20M) 66 kW (90 PS) K9K 892	04.2011→		7.00368.16.0	AGR	EL  →10.2013	
1.6 16V (M20, M20M) 64-103 kW (87-140 PS) HR16DE	02.2010→		7.05271.67.0	LS	300 mm	
NV250 Bus (X61)						61
dCi 115 59-85 kW (80-116 PS) K9K 872	07.2019→		7.11457.07.0* ↳ 7.11492.07.0	DDS		
dCi 80 59-85 kW (80-116 PS) K9K 872	07.2019→		7.11457.07.0* ↳ 7.11492.07.0	DDS		
dCi 95 59-85 kW (80-116 PS) K9K 872	07.2019→		7.11457.07.0* ↳ 7.11492.07.0	DDS		
NV250 Van (X61)						62
dCi 115 59-85 kW (80-116 PS) K9K 872	07.2019→		7.11457.07.0* ↳ 7.11492.07.0	DDS		
dCi 80 59-85 kW (80-116 PS) K9K 872	07.2019→		7.11457.07.0* ↳ 7.11492.07.0	DDS		
dCi 95 59-85 kW (80-116 PS) K9K 872	07.2019→		7.11457.07.0* ↳ 7.11492.07.0	DDS		
NV300 Kombi (X82)						63
1.6 dCi 125 92-118 kW (125-160 PS) R9M 452	09.2016→		7.24809.90.0 7.11457.07.0* ↳ 7.11492.07.0	AGR DDS DDS	EL 	
1.6 dCi 145 92-118 kW (125-160 PS) R9M 452	09.2016→		7.24809.90.0 7.11457.07.0* ↳ 7.11492.07.0	AGR DDS DDS	EL  →08.2018	
1.6 dci 120 70-89 kW (95-121 PS) R9M 413	09.2016→		7.11457.07.0* ↳ 7.11492.07.0	DDS DDS		
1.6 dci 95 70-89 kW (95-121 PS) R9M 413	09.2016→		7.24809.90.0 7.11457.07.0* ↳ 7.11492.07.0	AGR DDS DDS	EL  →06.2019	
NV300 Platform/Chassis (X82)						64
1.6 dci 125 92-118 kW (125-160 PS) R9M 452	09.2016→		7.11457.07.0* ↳ 7.11492.07.0	DDS DDS		
1.6 dci 145 92-118 kW (125-160 PS) R9M 452	09.2016→		7.11457.07.0* ↳ 7.11492.07.0	DDS DDS		



















N



NV300 Van (X82) 65



















1.6 dci 120 70-89 kW (95-121 PS) R9M 413	09.2016→	 7.24809.90.0	AGR	EL 	→06.2019
		7.11457.07.0* ↳ 7.11492.07.0	DDS DDS		
1.6 dci 125 92-118 kW (125-160 PS) R9M 452	09.2016→	 7.24809.90.0	AGR	EL 	→06.2019
		7.11457.07.0* ↳ 7.11492.07.0	DDS DDS		
1.6 dci 145 92-118 kW (125-160 PS) R9M 452	09.2016→	 7.24809.90.0	AGR	EL 	→06.2019
		7.11457.07.0* ↳ 7.11492.07.0	DDS DDS		
1.6 dci 95 70-89 kW (95-121 PS) R9M 413	09.2016→	 7.24809.90.0	AGR	EL 	→06.2019
		7.11457.07.0* ↳ 7.11492.07.0	DDS DDS		
1.6 dci 95 70-89 kW (95-121 PS) R9M 415	07.2019→	 7.11457.07.0*	DDS		
		↳ 7.11492.07.0	DDS		

NV400 Bus (X62, X62B) 66

dCi 100 74-92 kW (101-125 PS) M9T 670, M9T 672, M9T 676	11.2011→06.2014	 7.10334.03.0	AGR	EL 	 M9T 670, M9T 672, M9T 676: für OE-Nummer: 14710-00Q0Y, 14956-00Q1E, 14956-00Q1J for OE number: 14710-00Q0Y, 14956-00Q1E, 14956-00Q1J
dCi 110 74-92 kW (100-125 PS) M9T 870	06.2014→09.2016	 7.10334.03.0	AGR	EL 	 für OE-Nummer: 14710-00Q0Y, 14956-00Q1E, 14956-00Q1J for OE number: 14710-00Q0Y, 14956-00Q1E, 14956-00Q1J
dCi 125 74-92 kW (101-125 PS) M9T 670, M9T 672, M9T 676	11.2011→09.2016	 7.10334.03.0	AGR	EL 	 M9T 670, M9T 672, M9T 676: für OE-Nummer: 14710-00Q0Y, 14956-00Q1E, 14956-00Q1J for OE number: 14710-00Q0Y, 14956-00Q1E, 14956-00Q1J
dCi 135 100-120 kW (136-163 PS) M9T 702	06.2014→09.2016	 7.11190.08.0	DDS		
dCi 145 92-107 kW (125-146 PS) M9T 678, M9T 680	11.2011→02.2014	 7.10334.03.0	AGR	EL 	 M9T 678, M9T 680: für OE-Nummer: 14710-00Q0Y, 14956-00Q1E, 14956-00Q1J for OE number: 14710-00Q0Y, 14956-00Q1E, 14956-00Q1J
dCi 145 107-125 kW (145-170 PS) M9T 706, M9T 708	11.2011→02.2014	 7.11492.07.0	DDS		ohne Zubehör without accessories
dCi 150 110 kW (150 PS) M9T 880	02.2014→09.2016	 7.10334.03.0	AGR	EL 	 für OE-Nummer: 14710-00Q0Y, 14956-00Q1E, 14956-00Q1J for OE number: 14710-00Q0Y, 14956-00Q1E, 14956-00Q1J
dCi 160 100-120 kW (136-163 PS) M9T 702	06.2014→09.2016	 7.11190.08.0	DDS		
dCi 170 107-125 kW (145-170 PS) M9T 706	07.2015→	 7.11492.07.0	DDS		ohne Zubehör without accessories





























NV400 Platform/Chassis (X62, X62B) 67

dCi 100 74-92 kW (101-125 PS) M9T 670, M9T 672, M9T 676	11.2011→06.2014	 7.10334.03.0	AGR	EL	 M9T 670, M9T 672, M9T 676: für OE-Nummer: 14710-00Q0Y, 14956-00Q1E, 14956-00Q1J for OE number: 14710-00Q0Y, 14956-00Q1E, 14956-00Q1J
dCi 110 74-92 kW (100-125 PS) M9T 870	06.2014→06.2016	 7.10334.03.0	AGR	EL	
dCi 110 81-96 kW (110-131 PS) M9T 704	06.2014→06.2016	 7.10334.03.0 7.11492.07.0	AGR DDS	EL	 ohne Zubehör without accessories
dCi 125 74-92 kW (101-125 PS) M9T 670, M9T 672, M9T 676	11.2011→06.2016	 7.10334.03.0	AGR	EL	 M9T 670, M9T 672, M9T 676: für OE-Nummer: 14710-00Q0Y, 14956-00Q1E, 14956-00Q1J for OE number: 14710-00Q0Y, 14956-00Q1E, 14956-00Q1J
dCi 125 RWD 66-110 kW (90-150 PS) M9T 686, M9T 690, M9T 692, M9T 696, M9T 698, M9T 870, M9T 896	11.2011→06.2016	 7.10334.03.0	AGR	EL	
dCi 130 81-96 kW (110-131 PS) M9T 704	06.2016→	 7.11492.07.0	DDS		ohne Zubehör without accessories
dCi 135 100-120 kW (136-163 PS) M9T 702	06.2014→06.2016	 7.11190.08.0	DDS		Frontantrieb Front Wheel Drive
dCi 135 RWD 92-107 kW (125-146 PS) M9T 696, M9T 698	06.2014→06.2016	 7.10334.03.0	AGR	EL	 M9T 696, M9T 698: für OE-Nummer: 14710-00Q0Y, 14956-00Q1E, 14956-00Q1J for OE number: 14710-00Q0Y, 14956-00Q1E, 14956-00Q1J
dCi 145 92-107 kW (125-146 PS) M9T 678, M9T 680	11.2011→06.2016	 7.10334.03.0	AGR	EL	 M9T 678, M9T 680: für OE-Nummer: 14710-00Q0Y, 14956-00Q1E, 14956-00Q1J for OE number: 14710-00Q0Y, 14956-00Q1E, 14956-00Q1J
dCi 145 107-125 kW (145-170 PS) M9T 706	11.2011→06.2016	 7.11492.07.0	DDS		ohne Zubehör without accessories
dCi 145 RWD 92-107 kW (125-146 PS) M9T 694, M9T 696, M9T 698	11.2011→06.2016	 7.10334.03.0	AGR	EL	 M9T 694, M9T 696, M9T 698: für OE-Nummer: 14710-00Q0Y, 14956-00Q1E, 14956-00Q1J for OE number: 14710-00Q0Y, 14956-00Q1E, 14956-00Q1J
dCi 150 110 kW (150 PS) M9T 880	08.2014→06.2016	 7.10334.03.0	AGR	EL	 für OE-Nummer: 14710-00Q0Y, 14956-00Q1E, 14956-00Q1J for OE number: 14710-00Q0Y, 14956-00Q1E, 14956-00Q1J
dCi 150 RWD 110 kW (150 PS) M9T 880	08.2014→06.2016	 7.10334.03.0	AGR	EL	 für OE-Nummer: 14710-00Q0Y, 14956-00Q1E, 14956-00Q1J for OE number: 14710-00Q0Y, 14956-00Q1E, 14956-00Q1J
dCi 165 RWD 100-120 kW (136-163 PS) M9T 700	06.2014→	 7.11190.08.0	DDS		Frontantrieb Front Wheel Drive
dCi 170 107-125 kW (145-170 PS) M9T 706	06.2016→	 7.11492.07.0	DDS		ohne Zubehör without accessories





N











































































NV400 Van (X62, X62B) 68































dCi 100 74-92 kW (101-125 PS) M9T 670, M9T 672, M9T 676	11.2011→05.2014	 7.10334.03.0	AGR	EL 	 M9T 670, M9T 672, M9T 676: für OE-Nummer: 14710-00Q0Y, 14956-00Q1E, 14956-00Q1J for OE number: 14710-00Q0Y, 14956-00Q1E, 14956-00Q1J
dCi 110 74-92 kW (100-125 PS) M9T 870	06.2014→	 7.10334.03.0	AGR	EL 	für OE-Nummer: 14710-00Q0Y, 14956-00Q1E, 14956-00Q1J for OE number: 14710-00Q0Y, 14956-00Q1E, 14956-00Q1J
dCi 110 81-96 kW (110-131 PS) M9T 704	06.2014→	 7.11492.07.0	DDS		ohne Zubehör without accessories
dCi 125 74-92 kW (101-125 PS) M9T 670, M9T 672, M9T 676	11.2011→09.2016	 7.10334.03.0	AGR	EL 	 M9T 670, M9T 672, M9T 676: für OE-Nummer: 14710-00Q0Y, 14956-00Q1E, 14956-00Q1J for OE number: 14710-00Q0Y, 14956-00Q1E, 14956-00Q1J
dCi 125 RWD 66-110 kW (90-150 PS) M9T 686, M9T 690, M9T 692, M9T 696, M9T 698, M9T 870, M9T 896	11.2011→09.2016	 7.10334.03.0	AGR	EL 	
dCi 130 81-96 kW (110-131 PS) M9T 704	09.2016→	 7.11492.07.0	DDS		ohne Zubehör without accessories
dCi 135 100-120 kW (136-163 PS) M9T 702	06.2014→09.2016	 7.11190.08.0	DDS		
dCi 145 92-107 kW (125-146 PS) M9T 678, M9T 680	11.2011→02.2014	 7.10334.03.0	AGR	EL 	 M9T 678, M9T 680: für OE-Nummer: 14710-00Q0Y, 14956-00Q1E, 14956-00Q1J for OE number: 14710-00Q0Y, 14956-00Q1E, 14956-00Q1J
dCi 145 107-125 kW (145-170 PS) M9T 706	11.2011→02.2014	 7.11492.07.0	DDS		ohne Zubehör without accessories
dCi 145 RWD 92-107 kW (125-146 PS) M9T 694, M9T 696, M9T 698	11.2011→02.2014	 7.10334.03.0	AGR	EL 	 M9T 694, M9T 696, M9T 698: für OE-Nummer: 14710-00Q0Y, 14956-00Q1E, 14956-00Q1J for OE number: 14710-00Q0Y, 14956-00Q1E, 14956-00Q1J
dCi 150 110 kW (150 PS) M9T 880	02.2014→09.2016	 7.10334.03.0	AGR	EL 	für OE-Nummer: 14710-00Q0Y, 14956-00Q1E, 14956-00Q1J for OE number: 14710-00Q0Y, 14956-00Q1E, 14956-00Q1J
dCi 150 RWD 110 kW (150 PS) M9T 880	02.2014→09.2016	 7.10334.03.0	AGR	EL 	für OE-Nummer: 14710-00Q0Y, 14956-00Q1E, 14956-00Q1J for OE number: 14710-00Q0Y, 14956-00Q1E, 14956-00Q1J
dCi 165 100-120 kW (136-163 PS) M9T 702	06.2014→09.2016	 7.11190.08.0	DDS		Frontantrieb Front Wheel Drive
dCi 170 107-125 kW (145-170 PS) M9T 706	09.2016→	 7.11492.07.0	DDS		ohne Zubehör without accessories

PRIMASTAR Bus (X83) 69

dCi 100 74 kW (101 PS) F9Q 760	03.2001→	 7.22818.57.0	AGR	EL 	
dCi 120 66-84 kW (90-114 PS) M9R 692, M9R 786	09.2006→	 7.10334.03.0	AGR	EL 	10.2012→
dCi 120 66-84 kW (90-114 PS) M9R 780	09.2006→	 7.10334.05.0	AGR	EL 	



















					
PRIMASTAR Bus (X83)					69
dCi 140 99 kW (135 PS) G9U 730	07.2003→		7.22818.59.0	AGR	EL  Durchmesser Ventilteller/diameter valve head 30 mm
dCi 80 60 kW (82 PS) F9Q 762	03.2001→		7.22818.57.0	AGR	EL 
dCi 90 66-84 kW (90-114 PS) M9R 692, M9R 782, M9R 786	09.2006→		7.10334.03.0	AGR	EL   M9R 782, M9R 786: 10.2012→
PRIMASTAR Platform/Chassis (X83)					70
1.9 dCi 100 74 kW (101 PS) F9Q 760	07.2002→08.2006		7.22818.57.0	AGR	EL 
PRIMASTAR Van (X83)					71
1.9 dCi 100 74 kW (101 PS) F9Q 760	09.2002→		7.22818.57.0	AGR	EL 
1.9 dCi 80 60 kW (82 PS) F9Q 762	09.2002→		7.22818.57.0	AGR	EL 
2.0 dCi 115 66-84 kW (90-114 PS) M9R 630, M9R 692, M9R 786	09.2006→		7.10334.03.0	AGR	EL  10.2012→
2.0 dCi 115 66-84 kW (90-114 PS) M9R 780	09.2006→		7.10334.05.0	AGR	EL 
2.0 dCi 90 66-84 kW (90-114 PS) M9R 692, M9R 782, M9R 786	09.2006→		7.10334.03.0	AGR	EL   M9R 782, M9R 786: 10.2012→
2.5 dCi 140 99 kW (135 PS) G9U 730	07.2003→		7.22818.59.0	AGR	EL  Durchmesser Ventilteller/diameter valve head 30 mm
QASHQAI II VAN (J11_)					72
1.5 dCi 81 kW (110 PS) K9K 646	05.2015→		7.11457.07.0*	DDS	Euro 6 Euro 6 Produktionsdatum ab: 01.05.2015 Production date from: 01.05.2015
			↳7.11492.07.0	DDS	
1.5 dCi 59-85 kW (80-116 PS) K9K 872	06.2018→		7.11457.07.0*	DDS	Euro 6 Euro 6 Produktionsdatum ab: 01.05.2015 Production date from: 01.05.2015
			↳7.11492.07.0	DDS	
SUNNY III Estate Van (Y10)					73
1.6 L 60-88 kW (82-120 PS) GA16DE	11.1992→04.1996		7.02604.01.0	LS	200 mm
1.6 i 16V 60-88 kW (82-120 PS) GA16DE	10.1992→03.2000		7.02604.01.0	LS	200 mm
VANETTE Bus (C22)					74
2.4 i (SLC22) 72-100 kW (98-124 PS) Z24i	10.1986→12.1995		7.02604.01.0	LS	200 mm
2.4 i (SLC22) 72-100 kW (98-124 PS) Z24i	10.1986→12.1995		7.02604.01.0	LS	200 mm
X-TRAIL VAN (T32)					75
dCi 70-107 kW (95-146 PS) R9M	04.2014→		7.11457.07.0*	DDS	ab Euro 6 From Euro 6 Produktionsdatum ab: 01.05.2015 Production date from: 01.05.2015
			↳7.11492.07.0	DDS	
dCi 4x4 70-107 kW (95-146 PS) R9M	04.2014→		7.11457.07.0*	DDS	ab Euro 6 From Euro 6 Produktionsdatum ab: 01.05.2015 Production date from: 01.05.2015
			↳7.11492.07.0	DDS	



























			 PIERBURG			
ADAM (M13)						1
1.0 66-77 kW (90-105 PS) D 10 XFL	07.2014→11.2018		7.11190.08.0	DDS		
1.0 85 kW (115 PS) D 10 XFT	07.2014→11.2018		7.11190.08.0	DDS		
AGILA (A) (H00)						2
1.0 (F68) 44 kW (60 PS) Z 10 XEP	08.2003→12.2007		7.22875.16.0	AGR	EL   ch. 5G000001→	
			7.22875.13.0	AGR	EL   →ch. 4G999999	
			7.02604.07.0	LS	570  →ch. 5G999999 mm vor Katalysator in front of the catalyst	
			7.05271.81.0	LS	210 mm vor Katalysator in front of the catalyst	
1.0 12V (F68) 43 kW (58 PS) Z 10 XE	09.2000→12.2007		7.22875.13.0	AGR	EL 	
			7.02604.07.0	LS	570 vor Katalysator mm in front of the catalyst	
			7.05271.81.0	LS	210  →ch. 4G999999 mm vor Katalysator in front of the catalyst	
1.2 16V (F68) 55 kW (75 PS) Z 12 XE	09.2000→12.2007		7.22875.13.0	AGR	EL 	
			7.05271.68.0	LS	750 mm	
			7.02604.08.0	LS	350 Diagnosesonde mm Diagnostic Probe	
			7.05271.81.0	LS	210  →ch. 4G999999 mm vor Katalysator in front of the catalyst	
1.2 16V Twinport (F68) 55-59 kW (75-80 PS) Z 12 XEP	07.2004→12.2007		7.22875.16.0	AGR	EL   ch. 5G000001→	
			7.22875.13.0	AGR	EL   →ch. 4G999999	
			7.05271.68.0	LS	750  →ch. 5G999999 mm vorne Front	
			7.05271.81.0	LS	210 vor Katalysator mm in front of the catalyst	
1.3 CDTI (F68) 51-59 kW (70-80 PS) Z 13 DT	08.2003→12.2007		7.00020.24.0	AGR	EL 	
AGILA (B) (H08)						3
1.3 CDTI (F68) 55 kW (75 PS) D13A	04.2008→04.2010		7.00020.50.0	AGR	EL 	
			7.11190.04.0	DDS		
1.3 CDTI (F68) 55 kW (75 PS) Z 13 DTJ	04.2008→04.2010		7.00020.24.0	AGR	EL 	
AGILA A						4
1.0i Twinport 12V 44 kW (60 PS) Z 10 XEP	09.2003→09.2007		7.22875.16.0	AGR	EL 	
			7.02604.08.0	LS	350 mm	
ANTARA A (L07)						5
2.0 CDTI 110 kW (150 PS) Z 20 DMH	08.2006→12.2011		7.08369.54.0	ATS	EL	
			7.08369.70.0	ATS	EL	
2.0 CDTI 93-110 kW (126-150 PS) Z 20 S	03.2007→12.2011		7.08369.70.0	ATS	EL	

						
ANTARA A (L07)						5
2.0 CDTi 93 kW (126 PS) Z 20 DM	09.2008→12.2011		7.08369.54.0	ATS	EL	
			7.08369.70.0	ATS	EL	
2.0 CDTi 125 kW (170 PS) B 20 DTH	01.2016→		7.24809.87.0	AGR	EL	
2.0 CDTi 4x4 110 kW (150 PS) Z 20 DMH	07.2006→12.2011		7.08369.54.0	ATS	EL	
			7.08369.70.0	ATS	EL	
2.2 CDTi 120-122 kW (163-166 PS) A 22 DM	12.2010→12.2015		7.11020.49.0	ATS	EL	
2.2 CDTi 120-122 kW (163-166 PS) A 22 DM	07.2014→		7.11020.49.0	ATS	EL	
2.2 CDTi 4x4 120-122 kW (163-166 PS) A 22 DM	12.2010→12.2015		7.11020.49.0	ATS	EL	
2.4 103 kW (140 PS) Z 24 XE	09.2008→12.2011		7.09002.13.0	AGR	ET	
2.4 4x4 103 kW (140 PS) Z 24 XE	08.2006→12.2011		7.09002.13.0	AGR	ET	
2.4 LPG 103 kW (140 PS) Z 24 XE	10.2008→		7.09002.13.0	AGR	ET	
2.4 LPG 4x4 103 kW (140 PS) Z 24 XE	08.2006→12.2010		7.09002.13.0	AGR	ET	
3.2 V6 167 kW (227 PS) Z 32 SEE	07.2006→12.2011		7.05271.81.0	LS	210 mm	Fahrgestellnummer bis: 80999999, 93999999, 9B999999 Vehicle Identification Number to: 80999999, 93999999, 9B999999 nach Katalysator Post-catalyst
ASCONA C (J82)						6
1.6 i (F11, M11, F68, M68) 55-65 kW (75-88 PS) E 16 NZ	09.1987→08.1988		7.02604.15.0	LS	360 mm	vor Katalysator in front of the catalyst
1.6 i Cat (F11, M11, F68, M68) 55-60 kW (75-82 PS) C 16 LZ, C 16 NZ	09.1986→08.1988		7.02604.15.0	LS	360 mm	 C 16 LZ, C 16 NZ: Katalysator Catalytic Converter
2.0 i (F11, M11, F68, M68) 85-95 kW (115-129 PS) 20 NE	09.1986→08.1988		7.02604.03.0	LS	200 mm	
2.0 i (F11, M11, F68, M68) 74 kW (100 PS) C 20 NEF	01.1988→08.1988		7.02604.03.0	LS	200 mm	
2.0 i Cat (F11, M11, F68, M68) 85 kW (116 PS) C 20 NE	09.1986→08.1988		7.02604.03.0	LS	200 mm	
2.0 i GT (F11, M11, F68, M68) 95 kW (129 PS) 20 SEH	03.1987→08.1988		7.02604.03.0	LS	200 mm	
ASCONA C Hatchback (J82)						7
2.0 i (F68, M68) 85-95 kW (115-129 PS) 20 NE	09.1986→08.1988		7.02604.03.0	LS	200 mm	
2.0 i Cat (F68, M68) 85 kW (116 PS) C 20 NE	09.1986→08.1988		7.02604.03.0	LS	200 mm	
2.0 i GT (F68, M68) 95 kW (129 PS) 20 SEH	03.1987→08.1988		7.02604.03.0	LS	200 mm	



ASTRA F (T92) **8**

1.4 Si (F19, M19) 54-60 kW (73-82 PS) C 14 SE	03.1992→09.1998		7.02604.15.0	LS	360 mm	
1.4 i (F19, M19) 40-44 kW (54-60 PS) C 14 NZ, X 14 NZ	09.1991→09.1998		7.02604.15.0	LS	360 mm	
1.4 i 16V (F19, M19) 63-69 kW (86-94 PS) X 14 XE	02.1996→09.1998		7.22296.02.0	ARV	PN	
			7.02604.15.0	LS	360 mm	
1.6 (F19, M19) 55 kW (75 PS) 16 NZR	09.1995→09.1998		7.02604.15.0	LS	360 mm	
1.6 Si (F19, M19) 74 kW (101 PS) C 16 SE	05.1992→12.1994		7.02604.15.0	LS	360 mm	
			7.02604.01.0	LS	200 mm	
1.6 i (F19, M19) 55-60 kW (75-82 PS) C 16 NZ, X 16 SZR	03.1992→09.1998		7.02604.15.0	LS	360 mm	
1.6 i (F19, M19) 52 kW (71 PS) X 16 SZ	05.1993→07.1996		7.02604.15.0	LS	360 mm	
1.6 i 16V (F19, M19) 74 kW (101 PS) X 16 XEL	08.1994→09.1998		7.22296.02.0	ARV	PN	
			7.02604.15.0	LS	360 mm	Fahrgestellnummer ab: S2531219, S3, S4, S5223657, S6, S8, SA, SB, SE, SP, SS Vehicle Identification Number from: S2531219, S3, S4, S5223657, S6, S8, SA, SB, SE, SP, SS Japan Japan
1.8 i (F19, M19) 66 kW (90 PS) C 18 NZ	03.1992→09.1998		7.02604.15.0	LS	360 mm	
1.8 i 16V (F19, M19) 92 kW (125 PS) C 18 XE	06.1993→10.1994		7.05270.32.0	LS	825 mm	 →ch. T2500014
			7.05270.33.0	LS	705 mm	 ch. T2500015→
1.8 i 16V (F19, M19) 85 kW (115 PS) C 18 SEL	11.1994→09.1998		7.05270.33.0	LS	705 mm	
1.8 i 16V (F19, M19) 85 kW (116 PS) C 18 XEL	11.1994→02.1996		7.05270.32.0	LS	825 mm	
1.8 i 16V (F19, M19) 82-85 kW (112-116 PS) 18 SE	09.1995→09.1996		7.02604.01.0	LS	200 mm	
1.8 i 16V (F19, M19) 85 kW (116 PS) X 18 XE	03.1996→01.1998		7.22296.02.0	ARV	PN	
			7.05270.33.0	LS	705 mm	 ch. T2500015→
2.0 i (F19, M19) 85 kW (116 PS) C 20 NE	03.1992→09.1998		7.02604.03.0	LS	200 mm	
2.0 i 16V (F19, M19) 100 kW (136 PS) X 20 XEV	02.1995→09.1998		7.22296.02.0	ARV	PN	
			7.05270.32.0	LS	825 mm	 →ch. T8100001
			7.05270.33.0	LS	705 mm	 ch. T2500015→























						
ASTRA F CLASSIC Estate (T92)						9
1.4 i (F35, M35) 44 kW (60 PS) X 14 NZ	01.1998→01.2005		7.02604.15.0	LS	360 mm	
1.6 i (F35, M35) 55 kW (75 PS) X 16 SZR	01.1998→01.2005		7.02604.15.0	LS	360 mm	
1.6 i 16V (F35, M35) 74 kW (101 PS) X 16 XEL	01.1998→01.2005		7.22296.02.0	ARV	PN	
			7.02604.15.0	LS	360 mm	Fahrgestellnummer ab: S2531219, S3, S4, S5223657, S6, S8, SA, SB, SE, SP, SS Vehicle Identification Number from: S2531219, S3, S4, S5223657, S6, S8, SA, SB, SE, SP, SS Japan Japan
ASTRA F CLASSIC Hatchback (T92)						10
1.4 i (M08, M68, F08, F68) 44 kW (60 PS) X 14 NZ	01.1998→08.2002		7.02604.15.0	LS	360 mm	
1.6 i (F08, M08, F68, M68) 55 kW (75 PS) X 16 SZR	01.1998→08.2002		7.02604.15.0	LS	360 mm	
1.6 i 16V (F08, M08, F68, M68) 74 kW (101 PS) X 16 XEL	01.1998→08.2002		7.22296.02.0	ARV	PN	
			7.02604.15.0	LS	360 mm	Fahrgestellnummer ab: S2531219, S3, S4, S5223757, S6, S8, SA, SB, SE, SP, SS Vehicle Identification Number from: S2531219, S3, S4, S5223757, S6, S8, SA, SB, SE, SP, SS Japan Japan
ASTRA F CLASSIC Saloon (T92)						11
1.4 i (F19, M19) 44 kW (60 PS) X 14 NZ	01.1998→08.2002		7.02604.15.0	LS	360 mm	
1.6 i (F19, M19) 55 kW (75 PS) X 16 SZR	01.1998→08.2002		7.02604.15.0	LS	360 mm	
1.6 i 16V (F19, M19) 74 kW (101 PS) X 16 XEL	01.1998→08.2002		7.22296.02.0	ARV	PN	
			7.02604.15.0	LS	360 mm	Fahrgestellnummer ab: S2531219, S3, S4, S5223657, S6, S8, SA, SB, SE, SP, SS Vehicle Identification Number from: S2531219, S3, S4, S5223657, S6, S8, SA, SB, SE, SP, SS
ASTRA F Convertible (T92)						12
1.4 Si 54-60 kW (73-82 PS) C 14 SE	05.1993→03.2001		7.02604.15.0	LS	360 mm	
1.4 i 16V 63-69 kW (86-94 PS) X 14 XE	01.1996→03.2001		7.22296.02.0	ARV	PN	
			7.02604.15.0	LS	360 mm	
1.6 i 52 kW (71 PS) X 16 SZ	03.1993→08.1996		7.02604.15.0	LS	360 mm	
1.6 i 55 kW (75 PS) X 16 SZR	01.1996→03.2001		7.02604.15.0	LS	360 mm	
1.8 i 16V 85 kW (116 PS) C 18 XEL	11.1994→02.1996		7.05270.32.0	LS	825 mm	
1.8 i 16V 85 kW (116 PS) X 18 XE	03.1996→03.2001		7.22296.02.0	ARV	PN	



























ASTRA F Convertible (T92) **12**





















		 PIERBURG	7.05270.33.0	LS	705 mm	 ch. T2500015→
2.0 i 85 kW (116 PS) C 20 NE	03.1993→10.1994		7.02604.03.0	LS	200 mm	

ASTRA F Estate (T92) **13**

1.4 Si (F35, M35) 54-60 kW (73-82 PS) C 14 SE	03.1992→01.1998		7.02604.15.0	LS	360 mm	
1.4 i (F35, M35) 40-44 kW (54-60 PS) C 14 NZ	09.1991→01.1998		7.02604.15.0	LS	360 mm	
1.4 i 16V (F35, M35) 63-69 kW (86-94 PS) X 14 XE	02.1996→01.1998		7.22296.02.0	ARV	PN	
			7.02604.15.0	LS	360 mm	
1.6 (F35, M35) 55 kW (75 PS) 16 NZR	09.1995→01.1998		7.02604.15.0	LS	360 mm	
1.6 Si (F35, M35) 74 kW (101 PS) C 16 SE	03.1992→12.1994		7.02604.15.0	LS	360 mm	
1.6 i (F35, M35) 55-60 kW (75-82 PS) C 16 NZ, X 16 SZR	09.1991→01.1998		7.02604.15.0	LS	360 mm	
1.6 i (F35, M35) 52 kW (71 PS) X 16 SZ	05.1993→07.1996		7.02604.15.0	LS	360 mm	
1.6 i 16V (F35, M35) 74 kW (101 PS) X 16 XEL	08.1994→01.1998		7.22296.02.0	ARV	PN	
			7.02604.15.0	LS	360 mm	Fahrgestellnummer ab: S2531219, S3, S4, S5223657, S6, S8, SA, SB, SE, SP, SS Vehicle Identification Number from: S2531219, S3, S4, S5223657, S6, S8, SA, SB, SE, SP, SS Japan Japan
1.8 i (F35, M35) 66 kW (90 PS) C 18 NZ	09.1991→01.1998		7.02604.15.0	LS	360 mm	
1.8 i 16V (F35, M35) 92 kW (125 PS) C 18 XE	06.1993→01.1998		7.05270.32.0	LS	825 mm	 →ch. T2500014
			7.05270.33.0	LS	705 mm	 ch. T2500015→
1.8 i 16V (F35, M35) 85 kW (116 PS) C 18 XEL	07.1994→02.1996		7.05270.32.0	LS	825 mm	
1.8 i 16V (F35, M35) 85 kW (116 PS) X 18 XE	03.1996→01.1998		7.22296.02.0	ARV	PN	
			7.05270.33.0	LS	705 mm	 ch. T2500015→
2.0 i (F35, M35) 85 kW (116 PS) C 20 NE	09.1991→07.1994		7.02604.03.0	LS	200 mm	
2.0 i 16V (F35, M35) 100 kW (136 PS) X 20 XEV	02.1995→01.1998		7.22296.02.0	ARV	PN	
			7.05270.32.0	LS	825 mm	 →ch. T8100001
			7.05270.33.0	LS	705 mm	 ch. T2500015→

O





























					
ASTRA F Hatchback (T92)					
1.4 Si (F08, M08, F68, M68) 54-60 kW (73-82 PS) C 14 SE	03.1992→01.1998		7.02604.15.0	LS	360 mm
1.4 i (F08, M08, F68, M68) 40-44 kW (54-60 PS) C 14 NZ	09.1991→01.1998		7.02604.15.0	LS	360 mm
1.4 i 16V (F08, M08, F68, M68) 63-69 kW (86-94 PS) X 14 XE	09.1996→02.1998		7.22296.02.0	ARV	PN 
			7.02604.15.0	LS	360 mm
1.6 (F08, M08, F68, M68) 55 kW (75 PS) 16 NZR	09.1995→01.1998		7.02604.15.0	LS	360 mm
1.6 Si (F08, M08, F68, M68) 74 kW (101 PS) C 16 SE	03.1992→12.1994		7.02604.15.0	LS	360 mm
1.6 i (F08, M08, F68, M68) 55-60 kW (75-82 PS) C 16 NZ, X 16 SZR	09.1991→01.1998		7.02604.15.0	LS	360 mm
1.6 i (F08, M08, F68, M68) 52 kW (71 PS) X 16 SZ	05.1993→07.1996		7.02604.15.0	LS	360 mm
1.6 i 16V (F08, M08, F68, M68) 74 kW (101 PS) X 16 XEL	08.1994→01.1998		7.22296.02.0	ARV	PN 
			7.02604.15.0	LS	360 mm Fahrgestellnummer ab: S2531219, S3, S4, S5223657, S6, S8, SA, SB, SE, SP, SS Vehicle Identification Number from: S2531219, S3, S4, S5223657, S6, S8, SA, SB, SE, SP, SS Japan Japan
1.8 i (F08, M08, F68, M68) 66 kW (90 PS) C 18 NZ	09.1991→01.1998		7.02604.15.0	LS	360 mm
1.8 i 16V (F08, M08, F68, M68) 92 kW (125 PS) C 18 XE	06.1993→08.1994		7.05270.32.0	LS	825 mm  →ch. T2500014
			7.05270.33.0	LS	705 mm  ch. T2500015→
1.8 i 16V (F08, M08, F68, M68) 85 kW (116 PS) C 18 XEL	09.1994→02.1996		7.05270.32.0	LS	825 mm
1.8 i 16V (F08, M08, F68, M68) 85 kW (116 PS) X 18 XE	03.1996→01.1998		7.22296.02.0	ARV	PN 
			7.05270.33.0	LS	705 mm  ch. T2500015→
2.0 i (F08, M08, F68, M68) 85 kW (116 PS) C 20 NE	09.1991→01.1998		7.02604.03.0	LS	200 mm
2.0 i 16V (F08, M08, F68, M68) 100 kW (136 PS) X 20 XEV	02.1995→01.1998		7.22296.02.0	ARV	PN 
			7.05270.32.0	LS	825 mm  →ch. T8100001
			7.05270.33.0	LS	705 mm  ch. T2500015→

			 PIERBURG			
ASTRA G CLASSIC (T98)						15
1.4 16V (F08, F48) 66 kW (90 PS) Z 14 XE	05.2004→07.2009		7.24809.10.0	AGR	EL   →ch. 42999999	
1.6 (F08, F48) 74-77 kW (101-105 PS) Z 16 XEP	03.2006→06.2008		7.24809.10.0	AGR	EL 	
1.6 16V (F08, F48) 74-76 kW (101-103 PS) Z 16 XE	05.2004→02.2006		7.24809.10.0	AGR	EL 	
ASTRA G CLASSIC Caravan (F35)						16
1.4 (F35) 66 kW (90 PS) Z 14 XEP	10.2007→07.2009		7.22875.16.0	AGR	EL 	
			7.02604.07.0	LS	570 mm vor Katalysator in front of the catalyst	
			7.05271.81.0	LS	210 mm	
1.4 16V 66 kW (90 PS) Z 14 XE	07.2004→09.2007		7.24809.10.0	AGR	EL 	
1.6 74-76 kW (101-103 PS) Z 16 XE	06.2004→02.2006		7.24809.10.0	AGR	EL 	
			7.05271.76.0	LS	630 mm	
1.6 74-77 kW (101-105 PS) Z 16 XEP	02.2006→07.2009		7.28384.13.0	AGR	EL 	
			7.04879.00.0	AGR-TH	 Öffnungstemperatur/opening temperature 105C	
			7.02604.05.0	LS	550 mm	
ASTRA G CLASSIC Saloon (T98)						17
1.4 16V (F69) 66 kW (90 PS) Z 14 XE	05.2004→07.2009		7.24809.10.0	AGR	EL 	
			7.05271.76.0	LS	630 mm	
1.6 16V (F69) 74-76 kW (101-103 PS) Z 16 XE	03.2004→01.2008		7.24809.10.0	AGR	EL 	
			7.05271.76.0	LS	630 mm	
ASTRA G Convertible (T98)						18
1.6 (F67) 74-77 kW (101-105 PS) Z 16 XEP	01.2003→10.2005		7.28384.13.0	AGR	EL 	
			7.04879.00.0	AGR-TH	 Öffnungstemperatur/opening temperature 105C	
			7.02604.05.0	LS	550 mm vor Katalysator in front of the catalyst	
1.6 16V (F67) 74-76 kW (101-103 PS) Z 16 XE	03.2001→10.2005		7.24809.10.0	AGR	EL   →ch. 42999999	
			7.05270.25.0	LS	800 mm  →ch. 12999999 Diagnosesonde Diagnostic Probe	
			7.05270.26.0	LS	300 mm  ch. 28000001→ Diagnosesonde Diagnostic Probe	
1.8 16V (F67) 90-92 kW (122-125 PS) Z 18 XE	03.2001→10.2005		7.05271.55.0	LS	800 mm	

ASTRA G Convertible (T98)						18
2.0 16V Turbo (F67) 140-162 kW (190-220 PS) Z 20 LET	11.2002→10.2005		7.02604.07.0	LS	570 mm vor Katalysator in front of the catalyst	
2.2 16V (F67) 108 kW (147 PS) Z 22 SE	03.2001→10.2005		7.22630.28.0	AGR	EL →11292859	
			7.05270.29.0	LS	630 mm	
			7.05270.30.0	LS	1275 mm	
2.2 DTI (F67) 86-92 kW (117-125 PS) Y 22 DTR	09.2002→10.2005		7.24809.29.0	AGR	ET	
ASTRA G Coupe (T98)						19
1.6 16V (F07) 74-76 kW (101-103 PS) Z 16 XE	03.2000→05.2005		7.24809.10.0	AGR	EL →ch. 42999999	
			7.05270.25.0	LS	800 mm →ch. 12999999 Diagnosesonde Diagnostic Probe	
			7.05271.76.0	LS	630 mm	
			7.05270.26.0	LS	300 mm ch. 28000001→ Diagnosesonde Diagnostic Probe	
1.6 16V (F07) 74-77 kW (101-105 PS) Z 16 XEP	03.2000→05.2005		7.28384.13.0	AGR	EL	
			7.04879.00.0	AGR-TH	Öffnungstemperatur/opening temperature 105C	
			7.02604.05.0	LS	550 mm vor Katalysator in front of the catalyst	
1.8 16V (F07) 85 kW (115 PS) X 18 XE1	03.2000→10.2000		7.24809.10.0	AGR	EL	
			7.05270.32.0	LS	825 mm	
1.8 16V (F07) 90-92 kW (122-125 PS) Z 18 XE	09.2000→05.2005		7.05271.55.0	LS	800 mm	
2.0 16V Turbo (F07) 140-162 kW (190-220 PS) Z 20 LET	11.2002→05.2005		7.02604.07.0	LS	570 mm vor Katalysator in front of the catalyst	
2.2 16V (F07) 108 kW (147 PS) Z 22 SE	09.2000→05.2005		7.22630.28.0	AGR	EL →11292859	
			7.05270.29.0	LS	630 mm	
			7.05270.30.0	LS	1275 mm	
2.2 DTI (F07) 86-92 kW (117-125 PS) Y 22 DTR	09.2002→05.2005		7.24809.29.0	AGR	ET	
ASTRA G Estate (T98)						20
1.2 16V (F35) 48 kW (65 PS) X 12 XE	02.1998→09.2000		7.22414.07.0	AGR	EL	
			7.05271.76.0	LS	630 mm	
			7.02604.08.0	LS	350 mm	
1.2 16V (F35) 55 kW (75 PS) Z 12 XE	09.2000→07.2004		7.22875.13.0	AGR	EL →ch. 22999999	



ASTRA G Estate (T98) **20**

			7.02604.07.0	LS	570 mm	vor Katalysator in front of the catalyst
			7.02604.08.0	LS	350 mm	
1.4 16V (F35) 63-69 kW (86-94 PS) X 14 XE	06.1998→09.2000		7.05270.26.0	LS	300 mm	
1.4 16V (F35) 66 kW (90 PS) Z 14 XE	09.2000→07.2004		7.24809.10.0	AGR	EL	 →ch. 42999999
			7.05270.25.0	LS	800 mm	 →ch. 12999999 Diagnosesonde Diagnostic Probe
			7.05271.76.0	LS	630 mm	
			7.05270.26.0	LS	300 mm	
1.4 LPG (F35) 66 kW (90 PS) Z 14 XE	03.1998→07.2004		7.24809.10.0	AGR	EL	 →ch. 42999999
1.6 (F35) 55 kW (75 PS) X 16 SZR	02.1998→09.2000		7.24809.10.0	AGR	EL	
			7.02604.15.0	LS	360 mm	
1.6 (F35) 62-69 kW (84-94 PS) Z 16 SE	09.2000→07.2004		7.24809.10.0	AGR	EL	
			7.05270.26.0	LS	300 mm	 ch. 22000001→ Diagnosesonde Diagnostic Probe
1.6 (F35) 74-77 kW (101-105 PS) Z 16 XEP	12.2002→05.2004		7.28384.13.0	AGR	EL	
			7.04879.00.0	AGR-TH		 Öffnungstemperatur/opening temperature 105C
			7.02604.05.0	LS	550 mm	vor Katalysator in front of the catalyst
1.6 16V (F35) 74 kW (101 PS) X 16 XEL	02.1998→08.2000		7.05270.26.0	LS	300 mm	 ch. 28000001→ Diagnosesonde Diagnostic Probe
1.6 16V (F35) 74-76 kW (101-103 PS) Z 16 XE	08.2000→07.2004		7.24809.10.0	AGR	EL	 →ch. 42999999
			7.05270.25.0	LS	800 mm	 →ch. 12999999 Diagnosesonde Diagnostic Probe
			7.05271.76.0	LS	630 mm	
			7.05270.26.0	LS	300 mm	 ch. 28000001→ Diagnosesonde Diagnostic Probe
1.6 CNG (F35) 69-74 kW (94-101 PS) Z 16 YNG	03.2003→07.2004		7.24809.10.0	AGR	EL	  →ch. 48030275
			7.05270.25.0	LS	800 mm	
			7.05270.26.0	LS	300 mm	
1.6 LPG (F35) 74-76 kW (101-103 PS) Z 16 XE	03.1998→07.2004		7.24809.10.0	AGR	EL	  →ch. 42999999
			7.05271.76.0	LS	630 mm	
1.6 LPG (F35) 74-77 kW (101-105 PS) Z 16 XEP	06.2002→07.2004		7.04879.00.0	AGR-TH		 Öffnungstemperatur/opening temperature 105C

ASTRA G Estate (T98) **20**































			7.02604.05.0	LS	550 mm	für OE-Nummer: 8 55 510, 93174519 for OE number: 8 55 510, 93174519
1.7 DTI 16V (F35) 55 kW (75 PS) Y 17 DT	02.2000→07.2004		7.22772.12.0	AGR	PN	
1.8 16V (F35) 85 kW (115 PS) X 18 XE1	02.1998→09.2000		7.24809.10.0	AGR	EL	
			7.05270.32.0	LS	825 mm	
1.8 16V (F35) 90-92 kW (122-125 PS) Z 18 XE	09.2000→07.2004		7.05271.55.0	LS	800 mm	
2.0 16V (F35) 100 kW (136 PS) X 20 XEV	02.1998→07.2004		7.05270.33.0	LS	705 mm	
2.0 DI (F35) 60-63 kW (82-86 PS) X 20 DTL	02.1998→09.2000		7.24809.24.0*	AGR	PN	mit Saugrohr with suction pipe
			↪ 7.24809.27.0	AGR	PN	für Hersteller-Abgasnorm: NC8 for manufacturer exhaust norm: NC8
			7.24809.25.0*	AGR	PN	mit Saugrohr with suction pipe
			↪ 7.24809.28.0	AGR	PN	96 EEC, D3 96 EEC, D3
2.0 DI (F35) 60-63 kW (82-86 PS) Y 20 DTL	09.2000→07.2004		7.24809.25.0*	AGR	PN	mit Saugrohr with suction pipe
			↪ 7.24809.28.0	AGR	PN	
2.0 DTI 16V (F35) 74 kW (101 PS) Y 20 DTH	08.1999→07.2004		7.24809.25.0*	AGR	PN	mit Saugrohr with suction pipe
			↪ 7.24809.28.0	AGR	PN	→ch. 22999999
			↪ 7.24809.29.0	AGR	ET	
2.2 16V (F35) 108 kW (147 PS) Z 22 SE	03.2001→07.2004		7.22630.28.0	AGR	EL	
			7.05270.29.0	LS	630 mm	→11292859
			7.05270.30.0	LS	1275 mm	
2.2 DTI (F35) 86-92 kW (117-125 PS) Y 22 DTR	09.2002→07.2004		7.24809.29.0	AGR	ET	
2.2 DTI (F35) 86-92 kW (117-125 PS) Y 22 DTR	09.2002→07.2004		7.24809.29.0	AGR	ET	

ASTRA G Hatchback (T98) **21**

1.2 16V (F08, F48) 48 kW (65 PS) X 12 XE	02.1998→09.2000		7.22414.07.0	AGR	EL	
			7.05271.76.0	LS	630 mm	
			7.02604.08.0	LS	350 mm	
1.2 16V (F08, F48) 55 kW (75 PS) Z 12 XE	09.2000→01.2005		7.22875.13.0	AGR	EL	
			7.02604.07.0	LS	570 mm	vor Katalysator in front of the catalyst
			7.02604.08.0	LS	350 mm	
			7.05271.81.0	LS	210 mm	vor Katalysator in front of the catalyst





































ASTRA G Hatchback (T98) 21

1.4 (F08, F48) 66 kW (90 PS) Z 14 XEP	09.2007→12.2009		7.22875.16.0	AGR	EL	
			7.05271.81.0	LS	210 mm	 Z 14 XEP: nach Katalysator Post-catalyst  Z 14 XEP: vor Katalysator in front of the catalyst
1.4 16V (F08, F48) 63-69 kW (86-94 PS) X 14 XE	02.1998→09.2000		7.05270.26.0	LS	300 mm	 ch. 28000001→ Diagnosesonde Diagnostic Probe
1.4 16V (F08, F48) 66 kW (90 PS) Z 14 XE	09.2000→01.2005		7.24809.10.0	AGR	EL	 →ch. 42999999
			7.05270.25.0	LS	800 mm	 →ch. 12999999 Diagnosesonde Diagnostic Probe
			7.05271.76.0	LS	630 mm	
			7.05270.26.0	LS	300 mm	 ch. 28000001→ Diagnosesonde Diagnostic Probe
1.4 LPG (F08, F48) 66 kW (90 PS) Z 14 XE	02.1998→01.2005		7.24809.10.0	AGR	EL	 →ch. 42999999
			7.05271.76.0	LS	630 mm	
1.6 (F08, F48) 55 kW (75 PS) X 16 SZR	02.1998→09.2000		7.24809.10.0	AGR	EL	
			7.02604.15.0	LS	360 mm	
1.6 (F08, F48) 62-69 kW (84-94 PS) Z 16 SE	09.2000→01.2005		7.24809.10.0	AGR	EL	
			7.05270.26.0	LS	300 mm	 ch. 22000001→ Diagnosesonde Diagnostic Probe
O 1.6 (F08, F48) 74-77 kW (101-105 PS) Z 16 XEP	11.2002→01.2005		7.28384.13.0	AGR	EL	
			7.04879.00.0	AGR-TH		 Öffnungstemperatur/opening temperature 105C
			7.02604.05.0	LS	550 mm	vor Katalysator in front of the catalyst
1.6 16V (F08, F48) 74 kW (101 PS) X 16 XEL	02.1998→08.2000		7.05270.26.0	LS	300 mm	 ch. 28000001→ Diagnosesonde Diagnostic Probe
1.6 16V (F08, F48) 74-76 kW (101-103 PS) Z 16 XE	08.2000→01.2005		7.24809.10.0	AGR	EL	 →ch. 42999999
			7.05270.25.0	LS	800 mm	 →ch. 12999999 Diagnosesonde Diagnostic Probe
			7.05270.26.0	LS	300 mm	 ch. 28000001→ Diagnosesonde Diagnostic Probe
1.6 LPG (F08, F48) 74-76 kW (101-103 PS) Z 16 XE	03.1998→01.2005		7.24809.10.0	AGR	EL	 →ch. 42999999
			7.05271.76.0	LS	630 mm	
1.6 LPG (F08, F48) 74-77 kW (101-105 PS) Z 16 XEP	11.2002→06.2007		7.04879.00.0	AGR-TH		 Öffnungstemperatur/opening temperature 105C
			7.02604.05.0	LS	550 mm	für OE-Nummer: 8 55 510, 93174519 for OE number: 8 55 510, 93174519

ASTRA G Hatchback (T98)					
21					
1.7 DTI 16V (F08, F48) 55 kW (75 PS) Y 17 DT	02.2000→01.2005		7.22772.12.0	AGR	PN
1.8 16V (F08, F48) 85 kW (115 PS) X 18 XE1	02.1998→09.2000		7.24809.10.0	AGR	EL
			7.05270.32.0	LS	825 mm
1.8 16V (F08, F48) 90-92 kW (122-125 PS) Z 18 XE	09.2000→01.2005		7.05271.55.0	LS	800 mm
2.0 16V (F08, F48) 100 kW (136 PS) X 20 XEV	02.1998→01.2005		7.05270.33.0	LS	705 mm
2.0 16V OPC (F08, F48) 118 kW (160 PS) X 20 XER	11.1999→09.2002		7.05270.32.0	LS	825 mm
2.0 DI (F08, F48) 60-63 kW (82-86 PS) X 20 DTL	02.1998→09.2000		7.24809.24.0*	AGR	PN mit Saugrohr with suction pipe für Hersteller-Abgasnorm: NC8 for manufacturer exhaust norm: NC8
			↳ 7.24809.27.0	AGR	PN mit Saugrohr with suction pipe
			7.24809.25.0*	AGR	PN 96 EEC, D3 96 EEC, D3
			↳ 7.24809.28.0	AGR	PN
2.0 DI (F08, F48) 60-63 kW (82-86 PS) Y 20 DTL	09.2000→01.2005		7.24809.25.0*	AGR	PN mit Saugrohr with suction pipe
			↳ 7.24809.28.0	AGR	PN
2.0 DTI 16V (F08, F48) 74 kW (101 PS) Y 20 DTH	08.1999→01.2005		7.24809.25.0*	AGR	PN mit Saugrohr with suction pipe →ch. 22999999
			↳ 7.24809.28.0	AGR	PN
			7.24809.29.0	AGR	ET
2.2 16V (F08, F48) 108 kW (147 PS) Z 22 SE	06.2000→01.2005		7.22630.28.0	AGR	EL →11292859
			7.05270.29.0	LS	630 mm
			7.05270.30.0	LS	1275 mm
2.2 DTI (F08, F48) 86-92 kW (117-125 PS) Y 22 DTR	09.2002→01.2005		7.24809.29.0	AGR	ET
2.2 DTI (F08, F48) 86-92 kW (117-125 PS) Y 22 DTR	09.2002→01.2005		7.24809.29.0	AGR	ET
ASTRA G Saloon (T98)					
22					
1.2 16V (F69) 48 kW (65 PS) X 12 XE	09.1998→09.2000		7.22414.07.0	AGR	EL
			7.05271.76.0	LS	630 mm
			7.02604.08.0	LS	350 mm
1.2 16V (F69) 55 kW (75 PS) Z 12 XE	09.2000→01.2005		7.22875.13.0	AGR	EL →ch. 22999999
			7.02604.07.0	LS	570 mm vor Katalysator in front of the catalyst





























ASTRA G Saloon (T98) **22**

			7.02604.08.0	LS	350 mm	
			7.05271.81.0	LS	210 mm	vor Katalysator in front of the catalyst
1.4 (F69) 66 kW (90 PS) Z 14 XEP	09.2007→12.2009		7.22875.16.0	AGR	EL	
			7.05271.81.0	LS	210 mm	 Z 14 XEP: nach Katalysator Post-catalyst  Z 14 XEP: vor Katalysator in front of the catalyst
1.4 16V (F69) 63-69 kW (86-94 PS) X 14 XE	09.1998→09.2000		7.05270.26.0	LS	300 mm	 ch. 28000001→ Diagnosesonde Diagnostic Probe
1.4 16V (F69) 66 kW (90 PS) Z 14 XE	09.2000→01.2005		7.24809.10.0	AGR	EL	  →ch. 42999999
			7.05270.25.0	LS	800 mm	 →ch. 12999999 Diagnosesonde Diagnostic Probe
			7.05271.76.0	LS	630 mm	
			7.05270.26.0	LS	300 mm	 ch. 28000001→ Diagnosesonde Diagnostic Probe
1.4 LPG (F69) 66 kW (90 PS) Z 14 XE	03.1998→01.2005		7.24809.10.0	AGR	EL	  →ch. 42999999
			7.05271.76.0	LS	630 mm	
1.6 (F69) 55 kW (75 PS) X 16 SZR	09.1998→09.2000		7.24809.10.0	AGR	EL	
1.6 (F69) 62-69 kW (84-94 PS) Z 16 SE	09.2000→01.2005		7.24809.10.0	AGR	EL	
			7.05270.26.0	LS	300 mm	 ch. 22000001→ Diagnosesonde Diagnostic Probe
1.6 (F69) 74-77 kW (101-105 PS) Z 16 XEP	12.2002→12.2009		7.28384.13.0	AGR	EL	
			7.02604.05.0	LS	550 mm	vor Katalysator in front of the catalyst
1.6 16V (F69) 74 kW (101 PS) X 16 XEL	09.1998→08.2000		7.05270.26.0	LS	300 mm	 ch. 28000001→ Diagnosesonde Diagnostic Probe
1.6 16V (F69) 74-76 kW (101-103 PS) Z 16 XE	08.2000→01.2005		7.24809.10.0	AGR	EL	  →ch. 42999999
			7.05270.25.0	LS	800 mm	 →ch. 12999999 Diagnosesonde Diagnostic Probe
			7.05271.76.0	LS	630 mm	
			7.05270.26.0	LS	300 mm	 ch. 28000001→ Diagnosesonde Diagnostic Probe
1.6 LPG (F69) 74-76 kW (101-103 PS) Z 16 XE	06.2002→01.2005		7.24809.10.0	AGR	EL	  →ch. 42999999
			7.05271.76.0	LS	630 mm	
1.7 DTI 16V (F69) 55 kW (75 PS) Y 17 DT	02.2000→01.2005		7.22772.12.0	AGR	PN	
1.8 16V (F69) 85 kW (115 PS) X 18 XE1	09.1998→09.2000		7.24809.10.0	AGR	EL	
			7.05270.32.0	LS	825 mm	

ASTRA G Saloon (T98)					22	
1.8 16V (F69) 90-92 kW (122-125 PS) Z 18 XE	06.2000→01.2005	 7.05271.55.0	LS	800 mm		
2.0 16V (F69) 100 kW (136 PS) X 20 XEV	09.1998→01.2005	 7.05270.33.0	LS	705 mm		
2.0 DI (F69) 60-63 kW (82-86 PS) X 20 DTL	09.1998→09.2000	 7.24809.24.0*	AGR	PN	mit Saugrohr with suction pipe für Hersteller-Abgasnorm: NC8 for manufacturer exhaust norm: NC8	
			↳ 7.24809.27.0	AGR	PN	mit Saugrohr with suction pipe 96 EEC, D3 96 EEC, D3
			7.24809.25.0*	AGR	PN	
2.0 DI (F69) 60-63 kW (82-86 PS) Y 20 DTL	09.2000→01.2005	 7.24809.25.0*	AGR	PN	mit Saugrohr with suction pipe 	
2.0 DTI 16V (F69) 74 kW (101 PS) Y 20 DTH	08.1999→01.2005	 7.24809.25.0*	AGR	PN	mit Saugrohr with suction pipe →ch. 22999999	
			↳ 7.24809.28.0	AGR		PN
2.2 16V (F69) 108 kW (147 PS) Z 22 SE	03.2001→01.2005	 7.22630.28.0	AGR	EL	 →11292859	
			7.05270.29.0	LS		630 mm
			7.05270.30.0	LS		1275 mm
2.2 DTI (F69) 86-92 kW (117-125 PS) Y 22 DTR	09.2002→01.2005	 7.24809.29.0	AGR	ET		
2.2 DTI (F69) 86-92 kW (117-125 PS) Y 22 DTR	09.2002→01.2005	 7.24809.29.0	AGR	ET		
ASTRA H (A04)					23	
1.2 (L48) 55-59 kW (75-80 PS) Z 12 XEP	08.2005→10.2010		AGR	EL	 ch. 5200001→ →12.2005 vor Katalysator in front of the catalyst Z 12 XEP: nach Katalysator Post-catalyst Z 12 XEP: Fahrgestellnummer ab: 62, 65, 68, 6G Vehicle Identification Number from: 62, 65, 68, 6G vor Katalysator in front of the catalyst	
			7.22875.13.0	AGR		EL
			7.02604.07.0	LS		570 mm
			7.02604.08.0	LS		350 mm
1.3 CDTI (L48) 66-74 kW (90-101 PS) Z 13 DTH	08.2005→10.2010		7.00020.25.0	AGR	EL	
			7.08369.15.0	ATS	EL	
			7.11190.04.0	DDS		



ASTRA H (A04) **23**







1.4 (L48) 66 kW (90 PS) Z 14 XEP	03.2004→10.2010		7.22875.16.0	AGR	EL	
			7.22875.13.0	AGR	EL	
			7.02604.07.0	LS	570 mm	→12.2005 vor Katalysator in front of the catalyst
			7.02604.08.0	LS	350 mm	Regelsonde, Diagnosesonde Regulating Probe, Diagnostic Probe
1.4 (L48) 55-59 kW (75-80 PS) Z 14 XEL	04.2004→10.2004		7.22875.16.0	AGR	EL	
			7.22875.13.0	AGR	EL	
			7.02604.07.0	LS	570 mm	vor Katalysator in front of the catalyst
			7.05271.81.0	LS	210 mm	 Z 14 XEL: nach Katalysator Post-catalyst  Z 14 XEL: Fahrgestellnummer ab: 62, 65, 68, 6G Vehicle Identification Number from: 62, 65, 68, 6G vor Katalysator in front of the catalyst
1.4 (L48) 55-59 kW (75-80 PS) Z 14 XEL	04.2004→10.2004		7.22875.16.0	AGR	EL	
			7.22875.13.0	AGR	EL	
			7.02604.07.0	LS	570 mm	vor Katalysator in front of the catalyst
			7.05271.81.0	LS	210 mm	 Z 14 XEL: nach Katalysator Post-catalyst  Z 14 XEL: Fahrgestellnummer ab: 62, 65, 68, 6G Vehicle Identification Number from: 62, 65, 68, 6G vor Katalysator in front of the catalyst
1.4 LPG (L48) 66 kW (90 PS) Z 14 XEP	08.2009→10.2010		7.22875.16.0	AGR	EL	
			7.22875.13.0	AGR	EL	
			7.02604.07.0	LS	570 mm	→ch. 42999999 für OE-Nummer: 93177169 for OE number: 93177169
1.6 (L48) 74-77 kW (101-105 PS) Z 16 XEP	03.2004→10.2010		7.28384.13.0	AGR	EL	
			7.04879.00.0	AGR-TH		
			7.02604.05.0	LS	550 mm	Öffnungstemperatur/opening temperature 105C  →20HH5427 vor Katalysator in front of the catalyst
1.6 (L48) 77 kW (105 PS) Z 16 XE1	03.2004→10.2010		7.04879.00.0	AGR-TH		
			7.02604.05.0	LS	550 mm	Öffnungstemperatur/opening temperature 105C  →20HH5427 vor Katalysator in front of the catalyst
1.6 (L48) 85 kW (116 PS) Z 16 XER	12.2006→05.2014		7.04879.00.0	AGR-TH		
1.6 Turbo (L48) 132 kW (180 PS) Z 16 LET	02.2007→10.2010		7.02604.08.0	LS	350 mm	Regelsonde Regulating Probe

ASTRA H (A04)					23
			7.05271.81.0	LS	210 mm vor Katalysator in front of the catalyst
1.7 CDTI (L48) 81 kW (110 PS) A 17 DTJ	02.2007→05.2014		7.10334.08.0	AGR	EL
			7.08369.49.0	ATS	EL
			7.08369.75.0	ATS	EL
			7.11190.04.0	DDS	
1.7 CDTI (L48) 81 kW (110 PS) Z 17 DTJ	02.2007→05.2014		7.10334.08.0	AGR	EL
			7.08369.49.0	ATS	EL
			7.08369.74.0	ATS	EL
			7.11190.04.0	DDS	
1.7 CDTI (L48) 92 kW (125 PS) A 17 DTR	02.2007→05.2014		7.10334.08.0	AGR	EL
			7.08369.49.0	ATS	EL
			7.08369.75.0	ATS	EL
			7.11190.04.0	DDS	
1.7 CDTI (L48) 92 kW (125 PS) Z 17 DTR	02.2007→05.2014		7.10334.08.0	AGR	EL
			7.08369.49.0	ATS	EL
			7.08369.74.0	ATS	EL
			7.11190.04.0	DDS	
1.8 (L48) 90-92 kW (122-125 PS) Z 18 XE	01.2004→10.2010		7.05271.55.0	LS	800 mm
1.8 (L48) 101-103 kW (137-140 PS) A 18 XER, Z 18 XER	01.2006→10.2010		7.04879.00.0	AGR-TH	 Öffnungstemperatur/opening temperature 105C
			7.05271.62.0	LS	500 mm
1.9 CDTI (L48) 88 kW (120 PS) Z 19 DT	06.2004→10.2010		7.22946.38.0	AGR	EL
			7.08369.05.0	ATS	EL
			7.08369.32.0	ATS	EL
			7.11190.03.0	DDS	
			7.11190.04.0	DDS	ohne Zubehör without accessories Fahrgestellnummer bis: 62167207, 65165230, 68124718 Vehicle Identification Number to: 62167207, 65165230, 68124718 Fahrgestellnummer ab: 62167207, 65165231, 68124719, 8B000001 Vehicle Identification Number from: 62167207, 65165231, 68124719, 8B000001
7.02604.99.0	LS	400 mm			
1.9 CDTI (L48) 110 kW (150 PS) Z 19 DTH	09.2004→10.2010		7.00063.10.0	AGR	EL
			7.08369.05.0	ATS	EL
			7.08369.32.0	ATS	EL
			7.11190.03.0	DDS	
			7.11190.04.0	DDS	ohne Zubehör without accessories Fahrgestellnummer bis: 62167207, 65165230, 68124718 Vehicle Identification Number to: 62167207, 65165230, 68124718 Fahrgestellnummer ab: 62167207, 65165231, 68124719, 8B000001 Vehicle Identification Number from: 62167207, 65165231, 68124719, 8B000001















ASTRA H (A04) **23**

			7.02604.99.0	LS	400 mm	
1.9 CDTI (L48) 74 kW (101 PS) Z 19 DTL	09.2005→10.2010		7.22946.38.0	AGR	EL	ohne Zubehör without accessories Fahrgestellnummer bis: 62167207, 65165230, 68124718 Vehicle Identification Number to: 62167207, 65165230, 68124718 Fahrgestellnummer ab: 62167207, 65165231, 68124719, 8B000001 Vehicle Identification Number from: 62167207, 65165231, 68124719, 8B000001
			7.08369.05.0	ATS	EL	
			7.08369.32.0	ATS	EL	
			7.11190.03.0	DDS		
			7.11190.04.0	DDS		
			7.02604.99.0	LS	400 mm	
1.9 CDTI 16V (L48) 88 kW (120 PS) Z 19 DTJ	04.2004→10.2010		7.00063.10.0	AGR	EL	ohne Zubehör without accessories Fahrgestellnummer bis: 62167207, 65165230, 68124718 Vehicle Identification Number to: 62167207, 65165230, 68124718
			7.08369.05.0	ATS	EL	
			7.08369.32.0	ATS	EL	
			7.11190.03.0	DDS		
			7.02604.99.0	LS	400 mm	
2.0 Turbo (L48) 125 kW (170 PS) Z 20 LEL	03.2004→10.2010		7.02604.07.0	LS	570 mm	vor Katalysator in front of the catalyst
2.0 Turbo (L48) 147 kW (200 PS) Z 20 LER	09.2004→10.2010		7.02604.07.0	LS	570 mm	vor Katalysator in front of the catalyst
2.0 Turbo (L48) 177 kW (240 PS) Z 20 LEH	03.2005→10.2010		7.02604.07.0	LS	570 mm	vor Katalysator in front of the catalyst

ASTRA H CLASSIC Estate (A04) **24**

1.4 (L35) 66 kW (90 PS) Z 14 XEP	01.2009→		7.22875.16.0	AGR	EL	 ch. 52000001→  →ch. 42999999  Z 14 XEP: nach Katalysator Post-catalyst  Z 14 XEP: Fahrgestellnummer ab: 62, 65, 68, 6G Vehicle Identification Number from: 62, 65, 68, 6G vor Katalysator in front of the catalyst
			7.22875.13.0	AGR	EL	
			7.05271.81.0	LS	210 mm	
1.7 CDTI (L35) 92 kW (125 PS) A 17 DTR	01.2009→		7.10334.08.0	AGR	EL	
			7.11190.04.0	DDS		
1.7 CDTi (L35) 81 kW (110 PS) Z 17 DTJ	01.2009→		7.10334.08.0	AGR	EL	
			7.11190.04.0	DDS		

ASTRA H CLASSIC Hatchback (A04) **25**



























1.3 CDTI (L48) 66-74 kW (90-101 PS) Z 13 DTH	01.2009→		7.00020.25.0	AGR	EL	
			7.08369.15.0	ATS	EL	
			7.11190.04.0	DDS		

















ASTRA H CLASSIC Hatchback (A04)					
25					
1.4 (L48) 66 kW (90 PS) Z 14 XEP	01.2009→		7.22875.16.0	AGR	EL ch. 52000001→
			7.22875.13.0	AGR	EL →ch. 42999999
			7.05271.81.0	LS	210 mm Z 14 XEP: nach Katalysator Post-catalyst Z 14 XEP: Fahrgestellnummer ab: 62, 65, 68, 6G Vehicle Identification Number from: 62, 65, 68, 6G vor Katalysator in front of the catalyst
1.7 CDTI (L48) 92 kW (125 PS) A 17 DTR	01.2009→		7.10334.08.0	AGR	EL
			7.11190.04.0	DDS	
1.7 CDTI (L48) 81 kW (110 PS) A 17 DTJ, Z 17 DTJ	01.2009→		7.10334.08.0	AGR	EL
			7.11190.04.0	DDS	
ASTRA H CLASSIC Saloon (A04)					
26					
1.7 CDTI (L69) 92 kW (125 PS) A 17 DTR	01.2009→		7.10334.08.0	AGR	EL
			7.11190.04.0	DDS	
1.7 CDTi (L69) 81 kW (110 PS) Z 17 DTJ	01.2009→		7.10334.08.0	AGR	EL
			7.11190.04.0	DDS	
ASTRA H Estate (A04)					
27					
1.3 CDTI (L35) 66-74 kW (90-101 PS) Z 13 DTH	08.2005→10.2010		7.00020.25.0	AGR	EL
			7.08369.15.0	ATS	EL
			7.11190.04.0	DDS	
1.4 (L35) 55-59 kW (75-80 PS) Z 14 XEL	08.2004→10.2010		7.22875.16.0	AGR	EL
			7.22875.13.0	AGR	EL
			7.02604.07.0	LS	570 mm →12.2005 vor Katalysator in front of the catalyst
7.05271.81.0	LS	210 mm Z 14 XEL: nach Katalysator Post-catalyst Z 14 XEL: Fahrgestellnummer ab: 62, 65, 68, 6G Vehicle Identification Number from: 62, 65, 68, 6G vor Katalysator in front of the catalyst			
			7.22875.16.0	AGR	EL
			7.22875.13.0	AGR	EL
7.02604.07.0	LS	570 mm →12.2005 vor Katalysator in front of the catalyst			
7.02604.08.0	LS	350 mm Regelsonde, Diagnosesonde Regulating Probe, Diagnostic Probe			
7.05271.81.0	LS	210 mm Z 14 XEP: nach Katalysator Post-catalyst Z 14 XEP: Fahrgestellnummer ab: 62, 65, 68, 6G Vehicle Identification Number from: 62, 65, 68, 6G vor Katalysator in front of the catalyst			

O

























ASTRA H Estate (A04) **27**

















1.4 LPG (L35) 66 kW (90 PS) Z 14 XEP	08.2009→10.2010		7.22875.16.0	AGR	EL	
			7.22875.13.0	AGR	EL	 →ch. 42999999
1.6 (L35) 74-77 kW (101-105 PS) Z 16 XEP	08.2004→10.2010		7.28384.13.0	AGR	EL	
			7.04879.00.0	AGR-TH		 Öffnungstemperatur/opening temperature 105C
			7.02604.05.0	LS	550 mm	 →20HH5427
1.6 (L35) 77 kW (105 PS) Z 16 XE1	08.2004→10.2010		7.04879.00.0	AGR-TH		 Öffnungstemperatur/opening temperature 105C
			7.02604.05.0	LS	550 mm	vor Katalysator in front of the catalyst
1.6 (L35) 84-85 kW (114-116 PS) A 16 XER, Z 16 XER	12.2006→05.2014		7.04879.00.0	AGR-TH		 Öffnungstemperatur/opening temperature 105C
1.6 LPG (L35) 85 kW (116 PS) Z 16 XER	08.2009→10.2010		7.04879.00.0	AGR-TH		 Öffnungstemperatur/opening temperature 105C
1.6 Turbo (L35) 132 kW (180 PS) Z 16 LET	02.2007→10.2010		7.02604.08.0	LS	350 mm	Regelsonde Regulating Probe
			7.05271.81.0	LS	210 mm	vor Katalysator in front of the catalyst
1.7 CDTI (L35) 81 kW (110 PS) A 17 DTJ	02.2007→05.2014		7.10334.08.0	AGR	EL	
			7.08369.49.0	ATS	EL	
			7.11190.04.0	DDS		
1.7 CDTI (L35) 81 kW (110 PS) Z 17 DTJ	02.2007→05.2014		7.10334.08.0	AGR	EL	
			7.08369.49.0	ATS	EL	
			7.08369.74.0	ATS	EL	
			7.11190.04.0	DDS		
1.7 CDTI (L35) 92 kW (125 PS) A 17 DTR	02.2007→05.2014		7.10334.08.0	AGR	EL	
			7.08369.49.0	ATS	EL	
			7.11190.04.0	DDS		
1.7 CDTI (L35) 92 kW (125 PS) Z 17 DTR	02.2007→05.2014		7.10334.08.0	AGR	EL	
			7.08369.49.0	ATS	EL	
			7.08369.74.0	ATS	EL	
			7.11190.04.0	DDS		
1.8 (L35) 90-92 kW (122-125 PS) Z 18 XE	08.2004→10.2010		7.05271.55.0	LS	800 mm	
1.8 (L35) 101-103 kW (137-140 PS) A 18 XER, Z 18 XER	08.2005→05.2014		7.04879.00.0	AGR-TH		 Öffnungstemperatur/opening temperature 105C
			7.05271.62.0	LS	500 mm	
1.9 CDTI (L35) 110 kW (150 PS) Z 19 DTH	09.2004→10.2010		7.00063.10.0	AGR	EL	
			7.08369.05.0	ATS	EL	
			7.08369.32.0	ATS	EL	
			7.11190.03.0	DDS		ohne Zubehör without accessories Fahrgestellnummer bis: 62167207, 65165230, 68124718 Vehicle Identification Number to: 62167207, 65165230, 68124718

					
ASTRA H Estate (A04)					27
			7.11190.04.0	DDS	Fahrgestellnummer ab: 62167207, 65165231, 68124719, 8B000001 Vehicle Identification Number from: 62167207, 65165231, 68124719, 8B000001
			7.02604.99.0	LS	400 mm
1.9 CDTI (L35) 88 kW (120 PS) Z 19 DT	09.2005→10.2010		7.22946.38.0	AGR	EL 
			7.08369.05.0	ATS	EL
			7.08369.32.0	ATS	EL
			7.11190.03.0	DDS	ohne Zubehör without accessories Fahrgestellnummer bis: 62167207, 65165230, 68124718 Vehicle Identification Number to: 62167207, 65165230, 68124718
			7.11190.04.0	DDS	Fahrgestellnummer ab: 62167207, 65165231, 68124719, 8B000001 Vehicle Identification Number from: 62167207, 65165231, 68124719, 8B000001
			7.02604.99.0	LS	400 mm
1.9 CDTI (L35) 74 kW (101 PS) Z 19 DTL	09.2005→10.2010		7.22946.38.0	AGR	EL 
			7.08369.05.0	ATS	EL
			7.08369.32.0	ATS	EL
			7.11190.03.0	DDS	ohne Zubehör without accessories Fahrgestellnummer bis: 62167207, 65165230, 68124718 Vehicle Identification Number to: 62167207, 65165230, 68124718
			7.11190.04.0	DDS	Fahrgestellnummer ab: 62167207, 65165231, 68124719, 8B000001 Vehicle Identification Number from: 62167207, 65165231, 68124719, 8B000001
			7.02604.99.0	LS	400 mm
1.9 CDTI 16V (L35) 88 kW (120 PS) Z 19 DTJ	08.2004→10.2010		7.00063.10.0	AGR	EL 
			7.08369.05.0	ATS	EL
			7.08369.32.0	ATS	EL
			7.11190.03.0	DDS	ohne Zubehör without accessories Fahrgestellnummer bis: 62167207, 65165230, 68124718 Vehicle Identification Number to: 62167207, 65165230, 68124718
			7.02604.99.0	LS	400 mm
2.0 Turbo (L35) 125 kW (170 PS) Z 20 LEL	08.2004→10.2010		7.02604.07.0	LS	570 mm vor Katalysator in front of the catalyst
2.0 Turbo (L35) 147 kW (200 PS) Z 20 LER	09.2004→10.2010		7.02604.07.0	LS	570 mm vor Katalysator in front of the catalyst
ASTRA H GTC (A04)					28
1.3 CDTI (L08) 66-74 kW (90-101 PS) Z 13 DTH	04.2005→10.2010		7.00020.25.0	AGR	EL 
			7.08369.15.0	ATS	EL
			7.11190.04.0	DDS	





ASTRA H GTC (A04) **28**

1.4 (L08) 55-59 kW (75-80 PS) Z 14 XEL	03.2005→10.2010		7.22875.16.0	AGR	EL	
			7.22875.13.0	AGR	EL	
			7.02604.07.0	LS	570 mm	→12.2005 vor Katalysator in front of the catalyst
1.4 (L08) 66 kW (90 PS) Z 14 XEP	03.2005→10.2010		7.22875.16.0	AGR	EL	
			7.22875.13.0	AGR	EL	
			7.02604.07.0	LS	570 mm	→12.2005 vor Katalysator in front of the catalyst
1.6 (L08) 74-77 kW (101-105 PS) Z 16 XEP	03.2005→10.2010		7.22875.13.0	AGR	EL	
			7.02604.08.0	LS	350 mm	Regelsonde, Diagnosesonde Regulating Probe, Diagnostic Probe
			7.05271.81.0	LS	210 mm	 Z 14 XEP: nach Katalysator Post-catalyst  Z 14 XEP: Fahrgestellnummer ab: 62, 65, 68, 6G Vehicle Identification Number from: 62, 65, 68, 6G vor Katalysator in front of the catalyst
1.6 (L08) 77 kW (105 PS) Z 16 XE1	03.2005→10.2010		7.28384.13.0	AGR	EL	
			7.04879.00.0	AGR-TH		 Öffnungstemperatur/opening temperature 105C
			7.02604.05.0	LS	550 mm	 →20HH5427 vor Katalysator in front of the catalyst
1.6 (L08) 85 kW (116 PS) Z 16 XER	12.2006→10.2010		7.04879.00.0	AGR-TH		 Öffnungstemperatur/opening temperature 105C
			7.02604.05.0	LS	550 mm	 →20HH5427 vor Katalysator in front of the catalyst
1.6 Turbo (L08) 132 kW (180 PS) Z 16 LET	02.2007→10.2010		7.02604.08.0	LS	350 mm	Regelsonde Regulating Probe
			7.05271.81.0	LS	210 mm	vor Katalysator in front of the catalyst
1.7 CDTI (L08) 81 kW (110 PS) A 17 DTJ	02.2007→10.2010		7.10334.08.0	AGR	EL	
			7.08369.49.0	ATS	EL	
			7.08369.75.0	ATS	EL	
			7.11190.04.0	DDS		
1.7 CDTI (L08) 81 kW (110 PS) Z 17 DTJ	02.2007→10.2010		7.08369.49.0	ATS	EL	
1.7 CDTI (L08) 92 kW (125 PS) A 17 DTR	02.2007→10.2010		7.10334.08.0	AGR	EL	
			7.08369.49.0	ATS	EL	
			7.08369.75.0	ATS	EL	
			7.11190.04.0	DDS		



















					
ASTRA H GTC (A04)					
1.7 CDTI (L08) 92 kW (125 PS) Z 17 DTR	02.2007→10.2010		7.08369.49.0	ATS	EL
1.8 (L08) 90-92 kW (122-125 PS) Z 18 XE	03.2005→10.2010		7.05271.55.0	LS	800 mm
1.8 (L08) 101-103 kW (137-140 PS) Z 18 XER	01.2006→10.2010		7.04879.00.0 7.05271.62.0	AGR-TH LS	 Öffnungstemperatur/opening temperature 105C Diagnosesonde Diagnostic Probe nach Katalysator Post-catalyst
1.9 CDTI (L08) 88 kW (120 PS) Z 19 DT	09.2005→10.2010		7.22946.38.0 7.08369.05.0 7.08369.32.0 7.11190.03.0 7.11190.04.0	AGR ATS ATS DDS DDS	EL  EL EL ohne Zubehör without accessories Fahrgestellnummer bis: 62167207, 65165230, 68124718 Vehicle Identification Number to: 62167207, 65165230, 68124718 Fahrgestellnummer ab: 62167207, 65165231, 68124719, 8B000001 Vehicle Identification Number from: 62167207, 65165231, 68124719, 8B000001
1.9 CDTI (L08) 74 kW (101 PS) Z 19 DTL	01.2006→10.2010		7.22946.38.0 7.08369.05.0 7.08369.32.0 7.11190.03.0 7.11190.04.0 7.02604.99.0	AGR ATS ATS DDS DDS LS	EL  EL EL ohne Zubehör without accessories Fahrgestellnummer bis: 62167207, 65165230, 68124718 Vehicle Identification Number to: 62167207, 65165230, 68124718 Fahrgestellnummer ab: 62167207, 65165231, 68124719, 8B000001 Vehicle Identification Number from: 62167207, 65165231, 68124719, 8B000001 400 mm
1.9 CDTi (L08) 110 kW (150 PS) Z 19 DTH	03.2005→10.2010		7.00063.10.0 7.08369.05.0 7.08369.32.0 7.11190.03.0 7.11190.04.0 7.02604.99.0	AGR ATS ATS DDS DDS LS	EL  EL EL ohne Zubehör without accessories Fahrgestellnummer bis: 62167207, 65165230, 68124718 Vehicle Identification Number to: 62167207, 65165230, 68124718 Fahrgestellnummer ab: 62167207, 65165231, 68124719, 8B000001 Vehicle Identification Number from: 62167207, 65165231, 68124719, 8B000001 400 mm
1.9 CDTi 16V (L08) 88 kW (120 PS) Z 19 DTJ	03.2005→10.2010		7.08369.05.0 7.08369.32.0	ATS ATS	EL EL









ASTRA H GTC (A04) **28**

			7.11190.03.0	DDS		ohne Zubehör without accessories Fahrgestellnummer bis: 62167207, 65165230, 68124718 Vehicle Identification Number to: 62167207, 65165230, 68124718
			7.02604.99.0	LS	400 mm	
2.0 Turbo (L08) 147 kW (200 PS) Z 20 LER	03.2005→10.2010		7.02604.07.0	LS	570 mm	vor Katalysator in front of the catalyst
2.0 Turbo (L08) 125 kW (170 PS) Z 20 LEL	03.2005→10.2010		7.02604.07.0	LS	570 mm	vor Katalysator in front of the catalyst
2.0 Turbo (L08) 177 kW (240 PS) Z 20 LEH	08.2005→10.2010		7.02604.07.0	LS	570 mm	vor Katalysator in front of the catalyst

ASTRA H Saloon (A04) **29**

1.3 CDTi (L69) 66-74 kW (90-101 PS) Z 13 DTH	02.2007→10.2010		7.00020.25.0	AGR	EL	
			7.08369.15.0	ATS	EL	
			7.11190.04.0	DDS		
1.4 (L69) 66 kW (90 PS) Z 14 XEP	02.2007→06.2010		7.22875.16.0	AGR	EL	
			7.22875.13.0	AGR	EL	
			7.05271.81.0	LS	210 mm	 →ch. 42999999  Z 14 XEP: nach Katalysator Post-catalyst  Z 14 XEP: Fahrgestellnummer ab: 62, 65, 68, 6G Vehicle Identification Number from: 62, 65, 68, 6G nach Katalysator Post-catalyst
1.6 (L69) 85 kW (116 PS) Z 16 XER	02.2007→05.2014		7.04879.00.0	AGR-TH		 Öffnungstemperatur/opening temperature 105C
			7.04879.00.0	AGR-TH		 Öffnungstemperatur/opening temperature 105C
1.6 (L69) 74-77 kW (101-105 PS) Z 16 XEP	02.2007→06.2010		7.04879.00.0	AGR-TH		 Öffnungstemperatur/opening temperature 105C
			7.02604.05.0	LS	550 mm	 →20HH5427 vor Katalysator in front of the catalyst
1.7 CDTi (L69) 81 kW (110 PS) Z 17 DTJ	02.2007→05.2014		7.10334.08.0	AGR	EL	
			7.08369.49.0	ATS	EL	
			7.08369.74.0	ATS	EL	
			7.11190.04.0	DDS		
1.8 (L69) 101-103 kW (137-140 PS) A 18 XER, Z 18 XER	02.2007→09.2012		7.04879.00.0	AGR-TH		 Öffnungstemperatur/opening temperature 105C















































ASTRA H TwinTop (A04) **30**

1.4 (L67) 66 kW (90 PS) Z 14 XEP	10.2005→10.2010		7.22875.16.0	AGR	EL	
			7.22875.13.0	AGR	EL	
1.6 (L67) 74-77 kW (101-105 PS) Z 16 XEP	09.2005→10.2010		7.28384.13.0	AGR	EL	
			7.04879.00.0	AGR-TH		 Öffnungstemperatur/opening temperature 105C
			7.02604.05.0	LS	550 mm	 →20HH5427 vor Katalysator in front of the catalyst

ASTRA H TwinTop (A04)					
30					
1.6 (L67) 77 kW (105 PS) Z 16 XE1	09.2005→10.2010		7.04879.00.0 7.02604.05.0	AGR-TH LS	550 mm Öffnungstemperatur/opening temperature 105C →20HH5427 vor Katalysator in front of the catalyst
1.6 (L67) 85 kW (116 PS) Z 16 XER	12.2006→10.2010		7.04879.00.0	AGR-TH	Öffnungstemperatur/opening temperature 105C
1.6 Turbo (L67) 132 kW (180 PS) Z 16 LET	02.2007→10.2010		7.02604.08.0 7.05271.81.0	LS LS	350 mm 210 mm Regelsonde Regulating Probe vor Katalysator in front of the catalyst
1.8 (L67) 90-92 kW (122-125 PS) Z 18 XE	09.2005→10.2010		7.05271.55.0	LS	800 mm
1.8 (L67) 101-103 kW (137-140 PS) A 18 XER, Z 18 XER	09.2005→10.2010		7.04879.00.0 7.05271.62.0	AGR-TH LS	500 mm Öffnungstemperatur/opening temperature 105C
1.9 CDTi (L67) 110 kW (150 PS) Z 19 DTH	09.2005→10.2010		7.00063.10.0 7.08369.05.0 7.08369.32.0 7.11190.04.0 7.02604.99.0	AGR ATS ATS DDS LS	EL EL EL 400 mm
2.0 Turbo (L67) 125 kW (170 PS) Z 20 LEL	09.2005→10.2010		7.02604.07.0	LS	570 mm vor Katalysator in front of the catalyst
2.0 Turbo (L67) 147 kW (200 PS) Z 20 LER	09.2005→10.2010		7.02604.07.0	LS	570 mm vor Katalysator in front of the catalyst
ASTRA J (P10)					
31					
1.3 CDTi (68) 70 kW (95 PS) A 13 DTE	12.2009→10.2015		7.01599.10.0 7.03622.11.0 7.03622.10.0 7.03622.09.0 7.03622.06.0 7.08369.46.0 7.11190.04.0 7.02604.44.0	AGR AGR-K AGR-K AGR-K AGR-K ATS DDS LS	EL EL EL EL →ch. BG999999 EL 500 mm für OE-Nummer: 55564978 for OE number: 55564978
1.6 (68) 84-85 kW (114-116 PS) A 16 XER, B 16 XER	12.2009→10.2015		7.02604.07.0	LS	570 mm A 16 XER, B 16 XER: vor Katalysator in front of the catalyst
1.6 CDTi (68) 81-100 kW (110-136 PS) B 16 DTH	11.2013→10.2015		7.24809.81.0	AGR	EL





























ASTRA J (P10) **31**

			7.11020.42.0	ATS	EL	 B 16 DTH:  ch. F0000001→ch. F0999999 für RPO Nummer: WM3 for RPO number: WM3  B 16 DTH:  ch. F1000001→ch. F1999999 für RPO Nummer: WM3 for RPO number: WM3  B 16 DTH:  ch. F3000001→ch. F3999999 für RPO Nummer: WM3 for RPO number: WM3  B 16 DTH:  ch. F8000001→ch. F8999999 für RPO Nummer: WM3 for RPO number: WM3  B 16 DTH:  ch. FG000001→ch. FG999999 für RPO Nummer: WM3 for RPO number: WM3  B 16 DTH:  ch. G0000001→  B 16 DTH:  ch. G1000001→  B 16 DTH:  ch. G8000001→  B 16 DTH:  ch. GG000001→
1.6 CDTi (68) 81 kW (110 PS) B 16 DTL	02.2014→10.2015		7.11020.27.0 7.24809.81.0 7.11020.42.0	ATS AGR ATS	EL EL EL	  B 16 DTL:  ch. F0000001→ch. F0999999 für RPO Nummer: WM3 for RPO number: WM3  B 16 DTL:  ch. F1000001→ch. F1999999 für RPO Nummer: WM3 for RPO number: WM3  B 16 DTL:  ch. F3000001→ch. F3999999 für RPO Nummer: WM3 for RPO number: WM3  B 16 DTL:  ch. F8000001→ch. F8999999 für RPO Nummer: WM3 for RPO number: WM3  B 16 DTL:  ch. FG000001→ch. FG999999 für RPO Nummer: WM3 for RPO number: WM3  B 16 DTL:  ch. G0000001→  B 16 DTL:  ch. G1000001→  B 16 DTL:  ch. G8000001→  B 16 DTL:  ch. GG000001→
1.6 Turbo (68) 132 kW (180 PS) A 16 LET	12.2009→10.2015		7.05271.81.0	ATS LS	EL 210 mm	vor Katalysator in front of the catalyst
1.6 Turbo 4x4 (68) 132 kW (180 PS) A 16 LET	12.2009→10.2015		7.05271.81.0	ATS LS	EL 210 mm	vor Katalysator in front of the catalyst
1.7 CDTi (68) 81 kW (110 PS) A 17 DTC, A 17 DTE	09.2009→10.2015		7.10334.08.0 7.11020.38.0 7.11190.04.0	AGR ATS DDS	EL EL EL	
1.7 CDTi (68) 81 kW (110 PS) A 17 DTJ	09.2009→10.2015		7.10334.08.0	AGR	EL	
1.7 CDTi (68) 92 kW (125 PS) A 17 DTR	12.2009→10.2015		7.10334.08.0	AGR	EL	

O





















ASTRA J (P10)						31
1.7 CDTI (68) 96 kW (131 PS) A 17 DTF, A 17 DTS	07.2011→10.2015		7.10334.08.0	AGR	EL	
			7.11020.38.0	ATS	EL	
			7.11190.04.0	DDS		
2.0 BiTurbo CDTI (68) 140-143 kW (190-195 PS) A 20 DTR	09.2012→10.2015		7.24809.78.0	AGR	ET	
			7.11190.04.0	DDS		
2.0 CDTI 96-121 kW (131-165 PS) A 20 DTH	10.2014→10.2015		7.24809.78.0	AGR	ET	
			7.08369.17.0	ATS	EL	
			7.11190.04.0	DDS		
2.0 CDTI (68) 96-121 kW (131-165 PS) A 20 DTH	09.2009→10.2015		7.24809.78.0	AGR	ET	
			7.08369.17.0	ATS	EL	
			7.11190.04.0	DDS		
			7.02604.44.0	LS	500 mm	
2.0 CDTI (68) 96-121 kW (131-165 PS) A 20 DTH	06.2011→10.2015		7.24809.78.0	AGR	ET	
			7.08369.17.0	ATS	EL	
			7.11190.04.0	DDS		
			7.02604.44.0	LS	500 mm	

ASTRA J GTC						32
1.6 CDTI (08) 81 kW (110 PS) B 16 DTL	07.2014→		7.24809.81.0	AGR	EL	
1.6 CDTI (08) 81-100 kW (110-136 PS) B 16 DTH	07.2014→		7.24809.81.0	AGR	EL	
1.7 CDTI (08) 81 kW (110 PS) A 17 DTC, A 17 DTE	10.2011→10.2015		7.10334.08.0	AGR	EL	
			7.11190.04.0	DDS		
1.7 CDTI (08) 81 kW (110 PS) A 17 DTJ	10.2011→10.2015		7.10334.08.0	AGR	EL	
1.7 CDTI (08) 96 kW (131 PS) A 17 DTF, A 17 DTS	10.2011→10.2015		7.10334.08.0	AGR	EL	
			7.11190.04.0	DDS		
1.8 (08) 101-103 kW (137-140 PS) A 18 XER	10.2011→10.2015		7.02604.07.0	LS	570 mm	vor Katalysator in front of the catalyst
2.0 BiTurbo CDTI (08) 140-143 kW (190-195 PS) A 20 DTR	10.2012→10.2015		7.24809.78.0	AGR	ET	
			7.11190.04.0	DDS		
2.0 CDTI (08) 96-121 kW (131-165 PS) A 20 DTH	10.2011→10.2015		7.24809.78.0	AGR	ET	
			7.08369.17.0	ATS	EL	
			7.11190.04.0	DDS		
			7.02604.44.0	LS	500 mm	
2.0 CDTI (08) 96-121 kW (131-165 PS) A 20 DTH	04.2015→10.2015		7.24809.78.0	AGR	ET	
			7.08369.17.0	ATS	EL	
			7.11190.04.0	DDS		



ASTRA J Saloon **33**

1.3 CDTi (69) 70 kW (95 PS) A 13 DTE	06.2012→10.2015		7.01599.10.0	AGR	EL	
			7.03622.11.0	AGR-K	EL	
			7.03622.10.0	AGR-K	EL	
			7.03622.09.0	AGR-K		
			7.03622.06.0	AGR-K		
			7.08369.46.0	ATS	EL	 →ch. BG999999
			7.11190.04.0	DDS		
			7.02604.44.0	LS	500 mm	für OE-Nummer: 55564978 for OE number: 55564978
1.6 (69) 84-85 kW (114-116 PS) A 16 XER, B 16 XER	06.2012→		7.02604.07.0	LS	570 mm	 A 16 XER, B 16 XER: vor Katalysator in front of the catalyst
1.6 CDTi (69) 81-100 kW (110-136 PS) B 16 DTH	01.2014→		7.24809.81.0	AGR	EL	
1.6 CDTi (69) 81 kW (110 PS) B 16 DTL	04.2014→		7.24809.81.0	AGR	EL	
1.7 CDTi (69) 81 kW (110 PS) A 17 DTC, A 17 DTE	06.2012→10.2015		7.10334.08.0	AGR	EL	
7.11190.04.0			DDS			
1.7 CDTi (69) 81 kW (110 PS) A 17 DTJ	06.2012→10.2015		7.10334.08.0	AGR	EL	
1.7 CDTi (69) 96 kW (131 PS) A 17 DTF, A 17 DTS	06.2012→10.2015		7.10334.08.0	AGR	EL	
7.11190.04.0			DDS			

ASTRA J Sports Tourer (P10) **34**

1.3 CDTi (35) 70 kW (95 PS) A 13 DTE	10.2010→10.2014		7.01599.10.0	AGR	EL	
			7.03622.11.0	AGR-K	EL	
			7.03622.10.0	AGR-K	EL	
			7.03622.09.0	AGR-K		
			7.03622.06.0	AGR-K		
			7.11190.04.0	DDS		 →ch. BG999999
1.6 (35) 84-85 kW (114-116 PS) A 16 XER, B 16 XER	10.2010→10.2015		7.02604.07.0	LS	570 mm	 A 16 XER, B 16 XER: vor Katalysator in front of the catalyst
1.6 CDTi (35) 81-100 kW (110-136 PS) B 16 DTH	11.2013→10.2015		7.24809.81.0	AGR	EL	

O











ASTRA J Sports Tourer (P10) **34**

			7.11020.42.0	ATS	EL	B 16 DTH: ch. F0000001→ch. F0999999 für RPO Nummer: WM3 for RPO number: WM3 B 16 DTH: ch. F1000001→ch. F1999999 für RPO Nummer: WM3 for RPO number: WM3 B 16 DTH: ch. F3000001→ch. F3999999 für RPO Nummer: WM3 for RPO number: WM3 B 16 DTH: ch. F8000001→ch. F8999999 für RPO Nummer: WM3 for RPO number: WM3 B 16 DTH: ch. FG000001→ch. FG999999 für RPO Nummer: WM3 for RPO number: WM3 B 16 DTH: ch. G0000001→ B 16 DTH: ch. G1000001→ B 16 DTH: ch. G8000001→ B 16 DTH: ch. GG000001→
			7.11020.27.0	ATS	EL	
1.6 CDTi (35) 81 kW (110 PS) B 16 DTL	02.2014→10.2015		7.24809.81.0	AGR	EL	
			7.11020.42.0	ATS	EL	B 16 DTL: ch. F0000001→ch. F0999999 für RPO Nummer: WM3 for RPO number: WM3 B 16 DTL: ch. F1000001→ch. F1999999 für RPO Nummer: WM3 for RPO number: WM3 B 16 DTL: ch. F3000001→ch. F3999999 für RPO Nummer: WM3 for RPO number: WM3 B 16 DTL: ch. F8000001→ch. F8999999 für RPO Nummer: WM3 for RPO number: WM3 B 16 DTL: ch. FG000001→ch. FG999999 für RPO Nummer: WM3 for RPO number: WM3 B 16 DTL: ch. G0000001→ B 16 DTL: ch. G1000001→ B 16 DTL: ch. G8000001→ B 16 DTL: ch. GG000001→
			7.11020.27.0	ATS	EL	
1.6 Turbo (35) 132 kW (180 PS) A 16 LET	10.2010→10.2015		7.05271.81.0	LS	210 mm	vor Katalysator in front of the catalyst
1.7 CDTi (35) 81 kW (110 PS) A 17 DTC, A 17 DTE	10.2010→10.2015		7.10334.08.0	AGR	EL	
			7.11020.38.0	ATS	EL	
			7.11190.04.0	DDS		
1.7 CDTi (35) 81 kW (110 PS) A 17 DTJ	10.2010→10.2015		7.10334.08.0	AGR	EL	
1.7 CDTi (35) 92 kW (125 PS) A 17 DTR	10.2010→10.2015		7.10334.08.0	AGR	EL	
1.7 CDTi (35) 74 kW (101 PS) A 17 DTL	10.2010→10.2015		7.10334.08.0	AGR	EL	
1.7 CDTi (35) 74 kW (101 PS) A 17 DTN	10.2010→10.2015		7.10334.08.0	AGR	EL	



















ASTRA J Sports Tourer (P10) **34**

			7.11020.38.0	ATS	EL	
			7.11190.04.0	DDS		
1.7 CDTI (35) 96 kW (131 PS) A 17 DTF, A 17 DTS	10.2010→10.2015		7.10334.08.0	AGR	EL	
			7.11020.38.0	ATS	EL	
			7.11190.04.0	DDS		
2.0 BiTurbo CDTI (35) 140-143 kW (190-195 PS) A 20 DTR	09.2012→10.2015		7.24809.78.0	AGR	ET	
			7.11190.04.0	DDS		
2.0 CDTI (35) 96-121 kW (131-165 PS) A 20 DTH	10.2010→10.2015		7.24809.78.0	AGR	ET	
			7.08369.17.0	ATS	EL	
			7.11190.04.0	DDS		
			7.02604.44.0	LS	500 mm	vor Katalysator in front of the catalyst
2.0 CDTI (35) 96-121 kW (131-165 PS) A 20 DTH	08.2011→10.2015		7.24809.78.0	AGR	ET	
			7.08369.17.0	ATS	EL	
			7.11190.04.0	DDS		
			7.02604.44.0	LS	500 mm	vor Katalysator in front of the catalyst
2.0 CDTI (35) 96-121 kW (131-165 PS) A 20 DTH	01.2014→10.2015		7.08369.17.0	ATS	EL	











ASTRA K (B16) **35**

1.0 Turbo (68) 66-77 kW (90-105 PS) B 10 XFL, D 10 XFL	06.2015→		7.11190.08.0	DDS		 B 10 XFL, D 10 XFL: Euro 6d-Temp Euro 6d-Temp
1.0 Turbo (68) 66-77 kW (90-105 PS) D 10 XFL	06.2018→		7.11190.08.0	DDS		Euro 6d-Temp Euro 6d-Temp
1.4 Turbo (68) 88-92 kW (120-125 PS) B 14 XFL	06.2015→		7.11190.08.0	DDS		Euro 6d-Temp Euro 6d-Temp
1.4 Turbo (68) 103-112 kW (140-152 PS) B 14 XFT	06.2015→		7.11190.08.0	DDS		Euro 6d-Temp Euro 6d-Temp
1.4 Turbo (68) 103-112 kW (140-152 PS) B 14 XFT	07.2017→		7.11190.08.0	DDS		Euro 6d-Temp Euro 6d-Temp
1.6 BiTurbo 110 kW (150 PS) D 16 DTR	08.2018→		7.24809.81.0	AGR	EL	
1.6 CDTi (68) 70-81 kW (95-110 PS) B 16 DTE, B 16 DTU	06.2015→		7.24809.81.0	AGR	EL	
			7.11020.27.0	ATS	EL	
			7.11020.42.0	ATS	EL	
1.6 CDTi (68) 81 kW (110 PS) D 16 DTI	06.2015→		7.24809.81.0	AGR	EL	
			7.11020.42.0	ATS	EL	
1.6 CDTi (68) 81-100 kW (110-136 PS) B 16 DTH	06.2015→		7.24809.81.0	AGR	EL	
			7.11020.27.0	ATS	EL	
			7.11020.42.0	ATS	EL	





ASTRA K (B16)						35
1.6 CDTi (68) 99-100 kW (135-136 PS) D 16 DTH	06.2015→		7.24809.81.0	AGR	EL	○
			7.11020.42.0	ATS	EL	
1.6 CDTi (68) 70-81 kW (95-110 PS) B 16 DTE	06.2015→		7.24809.81.0	AGR	EL	○
			7.11020.27.0	ATS	EL	
			7.11020.42.0	ATS	EL	
1.6 CDTi (68) 118 kW (160 PS) B 16 DTR	11.2015→		7.24809.81.0	AGR	EL	○
ASTRA K Sports Tourer (B16)						36
1.0 Turbo (35) 66-77 kW (90-105 PS) B 10 XFL, D 10 XFL	11.2015→		7.11190.08.0	DDS		B 10 XFL, D 10 XFL: Euro 6d-Temp Euro 6d-Temp
1.0 Turbo (35) 66-77 kW (90-105 PS) D 10 XFL	06.2018→		7.11190.08.0	DDS		Euro 6d-Temp Euro 6d-Temp
1.4 Turbo (35) 88-92 kW (120-125 PS) B 14 XFL	11.2015→		7.11190.08.0	DDS		Euro 6d-Temp Euro 6d-Temp
1.4 Turbo (35) 103-112 kW (140-152 PS) B 14 XFT	11.2015→		7.11190.08.0	DDS		Euro 6d-Temp Euro 6d-Temp
1.6 BiTurbo 110 kW (150 PS) D 16 DTR	08.2018→		7.24809.81.0	AGR	EL	○
1.6 CDTi (35) 70-81 kW (95-110 PS) B 16 DTE	11.2015→		7.24809.81.0	AGR	EL	○
			7.11020.27.0	ATS	EL	
			7.11020.42.0	ATS	EL	
1.6 CDTi (35) 70-81 kW (95-110 PS) B 16 DTE	11.2015→		7.24809.81.0	AGR	EL	○
			7.11020.27.0	ATS	EL	
1.6 CDTi (35) 81 kW (110 PS) B 16 DTU	11.2015→		7.24809.81.0	AGR	EL	○
			7.11020.27.0	ATS	EL	
			7.11020.42.0	ATS	EL	
1.6 CDTi (35) 81 kW (110 PS) D 16 DTI	11.2015→		7.24809.81.0	AGR	EL	○
			7.11020.42.0	ATS	EL	
1.6 CDTi (35) 81-100 kW (110-136 PS) B 16 DTH	11.2015→		7.24809.81.0	AGR	EL	○
			7.11020.27.0	ATS	EL	
			7.11020.42.0	ATS	EL	
1.6 CDTi (35) 118 kW (160 PS) B 16 DTR	11.2015→		7.24809.81.0	AGR	EL	○
CALIBRA A (C89)						37
2.0 i (M07) 85 kW (116 PS) C 20 NE	08.1989→12.1996		7.02604.03.0	LS	200 mm	
2.0 i 16V (M07) 100 kW (136 PS) X 20 XEV	02.1994→07.1997		7.22296.02.0	ARV	PN	○ Fahrgestellnummer ab: T1000001 Vehicle Identification Number from: T1000001
			7.05270.32.0	LS	825 mm	→ch. T9004511





CALIBRA A (C89) **37**

			7.05270.33.0	LS	705 mm	 ch. T9004512→
2.0 i 16V 4x4 (M07) 100 kW (136 PS) X 20 XEV	02.1994→07.1997		7.22296.02.0	ARV	PN	 Fahrgestellnummer ab: T1000001 Vehicle Identification Number from: T1000001
			7.05270.32.0	LS	825 mm	 →ch. T9004511
			7.05270.33.0	LS	705 mm	 ch. T9004512→
2.0 i 4x4 (M07) 85 kW (116 PS) C 20 NE	06.1990→07.1997		7.02604.03.0	LS	200 mm	
2.0 i Turbo 4x4 (M07) 150 kW (204 PS) C 20 LET	08.1991→07.1997		7.02604.03.0	LS	200 mm	
2.5 i V6 (M07) 125 kW (170 PS) C 25 XE	04.1993→08.1995		7.02604.03.0	LS	200 mm	
2.5 i V6 (M07) 125-144 kW (170-196 PS) X 25 XE	08.1995→07.1997		7.22296.02.0	ARV	PN	
			7.02604.03.0	LS	200 mm	

CASCADA (W13) **38**





























2.0 CDTI (67) 96-121 kW (131-165 PS) A 20 DTH	04.2013→06.2015		7.24809.78.0	AGR	ET	
			7.08369.17.0	ATS	EL	
			7.11190.04.0	DDS		
			7.02604.44.0	LS	500 mm	vor Katalysator in front of the catalyst
2.0 CDTI (67) 140-143 kW (190-195 PS) A 20 DTR	04.2013→06.2015		7.24809.78.0	AGR	ET	
			7.11190.04.0	DDS		
2.0 CDTI (67) 125 kW (170 PS) B 20 DTH	07.2015→04.2018		7.24809.87.0	AGR	EL	

COMBO E Tour / Life (X19) **39**

1.5 56 kW (76 PS) D 15 DTL (DV5RE)	06.2018→		7.07794.23.0	AGR	EL	mit Dichtring with O-ring
1.5 75 kW (102 PS) D 15 DT (DV5RD)	06.2018→		7.07794.23.0	AGR	EL	mit Dichtring with O-ring
1.5 88-96 kW (120-131 PS) D 15 DTH (DV5RC)	06.2018→		7.07794.23.0	AGR	EL	mit Dichtring with O-ring
1.6 68 kW (92 PS) A 16 DT (DV6D)	09.2019→		7.11492.01.0	DDS		ohne Zubehör without accessories



COMBO Tour **40**

1.3 CDTI 16V 51-59 kW (70-80 PS) Y 13 DT, Z 13 DT	06.2004→01.2011		7.00020.24.0	AGR	EL	
1.3 CDTI 16V 55 kW (75 PS) Z 13 DTJ	10.2005→12.2011		7.00020.24.0	AGR	EL	
			7.08369.15.0	ATS	EL	
1.4 66 kW (90 PS) Z 14 XEP	10.2004→12.2011		7.22875.13.0	AGR	EL	  →ch. 43999999
			7.22875.16.0	AGR	EL	
1.6 62-69 kW (84-94 PS) Z 16 SE	10.2001→09.2006		7.24809.10.0	AGR	EL	  →ch. 46999999
			7.24809.10.0	AGR	EL	  →ch. 46999999

						
COMBO Tour						40
1.7 DI 16V 48 kW (65 PS) Y 17 DTL	10.2001→06.2004		7.22772.11.0	AGR	PN	mit Potentiometer with potentiometer  ch. 00782974→
			7.22772.12.0	AGR	PN	 →ch. 00782973
1.7 DTI 16V 55 kW (75 PS) Y 17 DT	10.2001→06.2004		7.22772.11.0	AGR	PN	mit Potentiometer with potentiometer  ch. 00782974→
			7.22772.12.0	AGR	PN	 →ch. 00782973
COMBO Tour (X12)						41
1.3 CDTI (C26, D26, E26, C05) 55-70 kW (75-95 PS) A 13 FD	02.2012→		7.04589.06.0	AGR	EL	 03.2016→ Euro 6 Euro 6
			7.03622.10.0	AGR-K	EL	 Euro 5 Euro 5 mit AGR-Ventil with EGR valve
			7.11190.03.0	DDS		ohne Zubehör without accessories
1.3 CDTI (C26, D26, E26, C05) 55-70 kW (75-95 PS) A 13 FD	03.2015→		7.03622.10.0	AGR-K	EL	 Euro 5 Euro 5 mit AGR-Ventil with EGR valve
			7.11190.03.0	DDS		ohne Zubehör without accessories
1.3 CDTI (C26, D26, E26, C05) 55-70 kW (75-95 PS) A 13 FD	03.2015→		7.03622.10.0	AGR-K	EL	 Euro 5 Euro 5 mit AGR-Ventil with EGR valve
			7.11190.03.0	DDS		ohne Zubehör without accessories
1.3 CDTI (C26, D26, E26, C05) 55-70 kW (75-95 PS) A 13 FD	03.2016→		7.04589.06.0	AGR	EL	 Euro 6 Euro 6
			7.03622.10.0	AGR-K	EL	 Euro 5 Euro 5 mit AGR-Ventil with EGR valve
			7.11190.03.0	DDS		ohne Zubehör without accessories
1.6 CDTI (C26, D26, E26, C05) 66-88 kW (90-120 PS) A 16 FDL	02.2012→		7.24809.77.0	AGR	ET	
			7.11020.41.0	ATS	EL	ohne Zubehör without accessories
			7.11190.03.0	DDS		
1.6 CDTI (C26, D26, E26, C05) 74-77 kW (101-105 PS) A 16 FDH	02.2012→		7.24809.77.0	AGR	ET	
			7.11020.41.0	ATS	EL	ohne Zubehör without accessories
			7.11190.03.0	DDS		
1.6 CDTI (C26, D26, E26, C05) 66-88 kW (90-120 PS) A 16 FDL	03.2015→		7.24809.77.0	AGR	ET	
			7.11020.41.0	ATS	EL	











































COMBO Tour (X12) 41

			7.11190.03.0	DDS		ohne Zubehör without accessories
1.6 CDTI (C26, D26, E26, C05) 66-88 kW (90-120 PS) A 16 FDL	03.2015→		7.24809.77.0	AGR	ET	<input checked="" type="checkbox"/>
			7.11020.41.0	ATS	EL	
			7.11190.03.0	DDS		ohne Zubehör without accessories
2.0 CDTI (C26, D26, E26, C05) 99 kW (135 PS) A 20 FD	02.2012→		7.24809.77.0	AGR	ET	<input checked="" type="checkbox"/>
			7.11020.41.0	ATS	EL	
			7.11190.03.0	DDS		ohne Zubehör without accessories

































CORSA A Hatchback (S83) 42

1.2 (F08, M08, F68, M68) 40-44 kW (54-60 PS) 12 S	09.1982→08.1990		7.02604.01.0	LS	200 mm	
1.2 (F08, M08, F68, M68) 33 kW (45 PS) 12 NC, E 12 GV	01.1985→08.1990		7.02604.01.0	LS	200 mm	
1.2 N (F08, M08, F68, M68) 37-38 kW (50-52 PS) 12 NV	01.1990→03.1993		7.02604.01.0	LS	200 mm	
1.2 S (F08, M08, F68, M68) 40-43 kW (55-58 PS) 12 ST	09.1982→02.1990		7.02604.01.0	LS	200 mm	
1.2 i (F08, M08, F68, M68) 33 kW (45 PS) C 12 NZ	09.1989→03.1993		7.02604.15.0	LS	360 mm	→12.1992
1.3 (F08, M08, F68, M68) 44 kW (60 PS) 13 NB	09.1985→10.1989		7.02604.01.0	LS	200 mm	
1.3 S (F08, M08, F68, M68) 51 kW (70 PS) 13 SB	09.1982→10.1989		7.02604.01.0	LS	200 mm	
1.3 i (F08, M08, F68, M68) 44 kW (60 PS) C 13 N	09.1986→09.1990		7.02604.15.0	LS	360 mm	
1.4 S (F08, M08, F68, M68) 53-55 kW (72-75 PS) 14 NV	01.1990→03.1993		7.02604.01.0	LS	200 mm	
1.4 Si (F08, M08, F68, M68) 54-60 kW (73-82 PS) C 14 SE	09.1991→03.1993		7.02604.15.0	LS	360 mm	→12.1992
1.4 i (F08, M08, F68, M68) 40-44 kW (54-60 PS) C 14 NZ	01.1985→03.1993		7.02604.15.0	LS	360 mm	
1.4 i (F08, M08, F68, M68) 40-44 kW (54-60 PS) C 14 NZ	01.1990→03.1993		7.02604.15.0	LS	360 mm	→12.1992
1.6 GSI (F08, M08, F68, M68) 55-60 kW (75-82 PS) C 16 NZ	09.1988→08.1990		7.02604.15.0	LS	360 mm	
1.6 GSI (F08, M08, M68, F68) 55-60 kW (75-82 PS) C 16 NZ	09.1988→09.1992		7.02604.15.0	LS	360 mm	
1.6 GSI Cat (F08, M08, F68, M68) 74 kW (101 PS) C 16 SE	02.1992→03.1993		7.02604.15.0	LS	360 mm	→12.1992



































						
CORSA A TR (S83)						43
1.2 N (F11, M11, F19, M19) 33 kW (45 PS) 12 NC, E 12 GV	01.1985→10.1987		7.02604.01.0	LS	200 mm	
1.2 S (F11, M11, F19, M19) 40-44 kW (54-60 PS) 12 S	09.1982→10.1987		7.02604.01.0	LS	200 mm	
1.2 S (F11, M11, M19, F19) 40-43 kW (55-58 PS) 12 ST	09.1982→03.1993		7.02604.01.0	LS	200 mm	
1.2 i (F11, M11, F19, M19) 33 kW (45 PS) C 12 NZ	09.1989→03.1993		7.02604.01.0	LS	200 mm	
1.3 (F11, F19, M11, M19) 44 kW (60 PS) 13 NB, C 13 N	09.1985→10.1987		7.02604.01.0	LS	200 mm	
1.3 S (F11, M11, F19, M19) 51 kW (70 PS) 13 SB	09.1982→10.1987		7.02604.01.0	LS	200 mm	
1.4 S (F11, M11, F19, M19) 53-55 kW (72-75 PS) 14 NV	09.1989→03.1993		7.02604.01.0	LS	200 mm	
1.4 i (F11, M11, F19, M19) 40-44 kW (54-60 PS) C 14 NZ	10.1989→03.1993		7.02604.01.0	LS	200 mm	
CORSA B (S93)						44
1.0 i 12V (F08, F68, M68) 40 kW (54 PS) X 10 XE	11.1996→09.2000		7.22414.04.0	AGR	EL 	
			7.05271.76.0	LS	630 mm	
1.2 i (F08, F68, M68) 33 kW (45 PS) C 12 NZ, X 12 SZ	03.1993→09.2000		7.02604.15.0	LS	360 mm	
1.2 i (F08, F68, M68) 33 kW (45 PS) 12 NZ	03.1993→09.2000		7.02604.01.0	LS	200 mm	
1.2 i 16V (F08, F68, M68) 48 kW (65 PS) X 12 XE	03.1998→09.2000		7.22414.08.0	AGR	EL 	
			7.05271.76.0	LS	630 mm	
1.4 (F08, F68, M68) 54-60 kW (73-82 PS) C 14 SE	04.1993→08.1994		7.02604.15.0	LS	360 mm	
1.4 Si (F08, F68, M68) 54-60 kW (73-82 PS) C 14 SE	03.1993→09.2000		7.02604.15.0	LS	360 mm	
1.4 i (F08, F68, M68) 40-44 kW (54-60 PS) C 14 NZ, X 14 SZ	03.1993→09.2000		7.02604.15.0	LS	360 mm	
1.4 i (F08, F68, M68) 40-44 kW (54-60 PS) C 14 NZ, X 14 SZ	03.1993→09.2000		7.02604.15.0	LS	360 mm	
1.4 i 16V (F08, F68, M68) 63-69 kW (86-94 PS) X 14 XE	09.1994→09.2000		7.22296.02.0	ARV	PN 	
			7.02604.15.0	LS	360 mm	
					 X 14 XE:  ch. S4269628→ch. T4124375  X 14 XE:  ch. S6011905→ch. T6060013	

			 PIERBURG			
CORSA B (S93)						44
1.4 i 16V (F08, F68, M68) 63 kW (86 PS) C 14 SEL	08.1997→09.2000		7.02604.01.0	LS	200 mm	
1.6 GSI 16V (F08, F68, M68) 80 kW (109 PS) C 16 XE	03.1993→09.2000		7.02604.15.0	LS	360 mm	 C 16 XE: → ch. S4269628→ch. T4124375  C 16 XE: → ch. S6011905→ch. T6060013
1.6 i 16V (F08, F68, M68) 78 kW (106 PS) X 16 XE	09.1994→09.2000		7.22296.02.0	ARV	PN	
			7.02604.15.0	LS	360 mm	 X 16 XE: → ch. S4269628→ch. T4124375  X 16 XE: → ch. S6011905→ch. T6060013
1.6 i 16V (F08, F68, M68) 74 kW (101 PS) C 16 SEL	08.1997→09.2000		7.02604.01.0	LS	200 mm	
CORSA B Estate (S93)						45
1.2 i 16V (F35) 48 kW (65 PS) X 12 XE	04.1998→07.2000		7.05271.76.0	LS	630 mm	
1.4 i 16V (F35) 63-69 kW (86-94 PS) X 14 XE	01.1999→12.2002		7.22296.02.0	ARV	PN	
			7.02604.01.0	LS	200 mm	
CORSA C (X01)						46
1.0 (F08, F68) 43 kW (58 PS) Z 10 XE	09.2000→06.2003		7.22875.13.0	AGR	EL	
			7.02604.08.0	LS	350 mm	Diagnosesonde Diagnostic Probe
			7.05271.81.0	LS	210 mm	vor Katalysator in front of the catalyst
1.0 (F08, F68) 44 kW (60 PS) Z 10 XEP	06.2003→12.2009		7.22875.16.0	AGR	EL	 → ch. 53000001→
			7.22875.13.0	AGR	EL	 → ch. 43999999
			7.02604.08.0	LS	350 mm	Regelsonde Regulating Probe
			7.05271.81.0	LS	210 mm	vor Katalysator in front of the catalyst
1.2 (F08, F68) 55 kW (75 PS) Z 12 XE	09.2000→12.2009		7.22875.13.0	AGR	EL	 → ch. 24999999
			7.02604.07.0	LS	570 mm	vor Katalysator in front of the catalyst
			7.05271.81.0	LS	210 mm	vor Katalysator in front of the catalyst
1.2 Twinport (F08, F68) 55-59 kW (75-80 PS) Z 12 XEP	07.2004→12.2009		7.22875.16.0	AGR	EL	 → ch. 53000001→
			7.22875.13.0	AGR	EL	 → ch. 43999999
			7.02604.07.0	LS	570 mm	→12.2005 vor Katalysator in front of the catalyst
			7.05271.81.0	LS	210 mm	 Z 12 XEP: Fahrgestellnummer bis: 13025250, 14177496, 16079019 Vehicle Identification Number to: 13025250, 14177496, 16079019 vor Katalysator in front of the catalyst  Z 12 XEP: nach Katalysator Post-catalyst

CORSA C (X01)						46
1.3 CDTI (F08, F68) 51-59 kW (70-80 PS) Z 13 DT	06.2003→12.2009		7.00020.24.0	AGR	EL	
1.4 (F08, F68) 66 kW (90 PS) Z 14 XE	09.2000→12.2009		7.24809.10.0	AGR	EL →ch. 43999999	
			7.05270.25.0	LS	800 mm →ch. 13999999 Regelsonde, Diagnosesonde Regulating Probe, Diagnostic Probe	
			7.05271.76.0	LS	630 mm	
			7.05270.26.0	LS	300 mm ch. 23000001→ Regelsonde Regulating Probe	
1.4 Twinport (F08, F68) 66 kW (90 PS) Z 14 XEP	06.2003→12.2009		7.22875.16.0	AGR	EL ch. 53000001→	
			7.22875.13.0	AGR	EL →ch. 43999999	
			7.02604.07.0	LS	570 mm →12.2005 vor Katalysator in front of the catalyst	
			7.02604.08.0	LS	350 mm Diagnosesonde Diagnostic Probe	
			7.05271.81.0	LS	210 mm vor Katalysator in front of the catalyst	
1.6 (F08, F68) 62-69 kW (84-94 PS) Z 16 SE	09.2000→12.2009		7.24809.10.0	AGR	EL Z 16 SE: →ch. 46999999 Z 16 SE: →ch. 43999999 Z 16 SE: →ch. 44999999	
			7.05270.26.0	LS	300 mm	
1.7 DI (F08, F68) 48 kW (65 PS) Y 17 DTL	09.2000→12.2009		7.22772.12.0	AGR	PN	
1.7 DTI (F08, F68) 55 kW (75 PS) Y 17 DT	09.2000→12.2009		7.22772.12.0	AGR	PN	
1.8 (F08, F68) 90-92 kW (122-125 PS) Z 18 XE	09.2000→12.2009		7.24809.10.0	AGR	EL →ch. 43999999	
			7.05271.55.0	LS	800 mm	
CORSA C Saloon (X01)						47
1.6 62-69 kW (84-94 PS) Z 16 SE	01.2003→12.2007		7.24809.10.0	AGR	EL →ch. 46999999	
CORSA CLASSIC Saloon						48
1.4 66 kW (90 PS) Z 14 XEP	07.2000→12.2003		7.22875.16.0	AGR	EL	
			7.22875.13.0	AGR	EL →ch. 43999999	
1.4 66 kW (90 PS) Z 14 XE	07.2000→05.2001		7.24809.10.0	AGR	EL →ch. 43999999	
CORSA D (S07)						49
1.0 (L08, L68) 44 kW (60 PS) Z 10 XEP	07.2006→12.2010		7.22875.16.0	AGR	EL	
			7.02604.08.0	LS	350 mm Regelsonde Regulating Probe	
			7.05271.81.0	LS	210 mm vor Katalysator in front of the catalyst	
1.0 (L08, L68) 44-48 kW (60-65 PS) A 10 XEP	12.2009→08.2014		7.22875.16.0	AGR	EL	
			7.05271.81.0	LS	210 mm vor Katalysator, nach Katalysator in front of the catalyst, Post-catalyst	

			 PIERBURG		
CORSA D (S07)					
1.2 (L08, L68) 55-59 kW (75-80 PS) Z 12 XEP	07.2006→08.2014		7.22875.16.0	AGR	EL 
			7.02604.08.0	LS	350 mm
			7.05271.81.0	LS	210 mm
Diagnosesonde Diagnostic Probe vor Katalysator, nach Katalysator in front of the catalyst, Post-catalyst					
1.2 LPG (L08, L68) 55-59 kW (75-80 PS) Z 12 XEP	08.2006→08.2014		7.22875.16.0	AGR	EL 
			7.02604.08.0	LS	350 mm
Diagnosesonde Diagnostic Probe					
1.2 LPG (L08, L68) 55-59 kW (75-80 PS) Z 12 XEP	09.2009→12.2011		7.22875.16.0	AGR	EL 
1.3 CDTI (L08, L68) 55 kW (75 PS) A 13 DTC	07.2006→08.2014		7.01599.10.0	AGR	EL 
			7.03622.10.0	AGR-K	EL 
			7.03622.09.0	AGR-K	
			7.03622.06.0	AGR-K	
mit AGR-Ventil with EGR valve					
A 13 DTC:  ch. C6000001→ ohne AGR-Ventil without EGR valve					
A 13 DTC:  ch. C4000001→ ohne AGR-Ventil without EGR valve					
1.3 CDTI (L08, L68) 55 kW (75 PS) Z 13 DTJ	07.2006→08.2014		7.00020.24.0	AGR	EL 
			7.08369.67.0	ATS	EL
			7.11190.04.0	DDS	
1.3 CDTI (L08, L68) 66-74 kW (90-101 PS) Z 13 DTH	07.2006→06.2011		7.00020.25.0	AGR	EL 
			7.03622.10.0	AGR-K	EL 
			7.08369.67.0	ATS	EL
			7.11190.04.0	DDS	
1.3 CDTI (L08, L68) 70 kW (95 PS) A 13 DTE, A 13 DTR, Z 13 DTE	06.2009→08.2014		7.01599.10.0	AGR	EL 
			7.03622.10.0	AGR-K	EL 
			7.03622.09.0	AGR-K	
			7.03622.06.0	AGR-K	
			7.08369.46.0	ATS	EL
			7.11190.04.0	DDS	
			7.02604.44.0	LS	500 mm
A 13 DTE, A 13 DTR, Z 13 DTE: für OE-Nummer: 55564978 for OE number: 55564978					
1.4 (L08, L68) 66 kW (90 PS) Z 14 XEP	07.2006→08.2014		7.22875.16.0	AGR	EL 
			7.02604.08.0	LS	350 mm
			7.05271.81.0	LS	210 mm
Diagnosesonde Diagnostic Probe vor Katalysator, nach Katalysator in front of the catalyst, Post-catalyst					
1.4 LPG (L08, L68) 66 kW (90 PS) Z 14 XEP	08.2006→12.2011		7.22875.16.0	AGR	EL 
			7.02604.08.0	LS	350 mm
Diagnosesonde Diagnostic Probe					

CORSA D (S07)						49
1.6 Turbo (L08, L68) 141-152 kW (192-207 PS) A 16 LER, B 16 LER	11.2006→08.2014		7.05271.81.0	LS	210 mm A 16 LER, B 16 LER: vor Katalysator in front of the catalyst	
1.6 Turbo (L08, L68) 141 kW (192 PS) Z 16 LER	11.2006→08.2014		7.02604.08.0	LS	350 mm Regelsonde Regulating Probe	
			7.05271.81.0	LS	210 mm vor Katalysator in front of the catalyst	
1.6 Turbo (L08, L68) 110 kW (150 PS) A 16 LEL, Z 16 LEL	05.2007→08.2014		7.05271.81.0	LS	210 mm A 16 LEL, Z 16 LEL: vor Katalysator in front of the catalyst	
1.6 Turbo (L08, L68) 150-155 kW (204-211 PS) A 16 LES	06.2011→08.2014		7.05271.81.0	LS	210 mm vor Katalysator in front of the catalyst	
1.7 CDTi (L08, L68) 92 kW (125 PS) Z 17 DTR	08.2006→12.2011		7.10334.08.0	AGR	EL	
			7.08369.49.0	ATS	EL	
			7.11190.04.0	DDS		
1.7 CDTi (L08, L68) 96 kW (131 PS) A 17 DTS	12.2009→08.2014		7.10334.08.0	AGR	EL	
			7.11190.04.0	DDS		
CORSA E (X15)						50
1.0 (08, 68) 66-77 kW (90-105 PS) D 10 XFL, F 10 XFL	09.2014→		7.11190.08.0	DDS		
1.3 CDTi (08, 68) 55 kW (75 PS) B 13 DTC, B 13 DTN	09.2014→		7.05031.06.0	AGR-M	EL	
				AGR-M	EL	
1.6 Turbo (08, 68) 152-155 kW (207-211 PS) B 16 LES	03.2015→		7.05271.81.0	LS	210 mm vor Katalysator in front of the catalyst 2019 2019	
CORSA F						51
1.5 (68) 75 kW (102 PS) D 15 DT (DV5RD)	07.2019→		7.07794.23.0	AGR	EL mit Dichtring with O-ring	
CORSA Utility Pickup						52
1.4 66 kW (90 PS) Z 14 XE	07.2000→12.2003		7.24809.10.0	AGR	EL →ch. 43999999	
	01.2003→12.2010		7.24809.10.0	AGR	EL →ch. 43999999	
1.7 DTi 55 kW (75 PS) Y 17 DT	08.2001→06.2004		7.22772.12.0	AGR	PN	
	01.2003→12.2010		7.22772.12.0	AGR	PN	
1.7 Di 48 kW (65 PS) Y 17 DTL	11.2001→06.2004		7.22772.12.0	AGR	PN	
CROSSLAND X / CROSSLAND (P17, P2Q0)						53
1.5 Turbo D (75) 75 kW (102 PS) D 15 DT (DV5RD)	06.2018→		7.07794.23.0	AGR	EL mit Dichtring with O-ring	
1.5 Turbo D (75) 88-96 kW (120-131 PS) D 15 DTH (DV5RC)	08.2018→		7.07794.23.0	AGR	EL mit Dichtring with O-ring	
				DDS		
1.6 Turbo D (75) 73 kW (99 PS) B 16 DT (DV6FD)	03.2017→		7.11492.01.0	DDS	ohne Zubehör without accessories	
1.6 Turbo D (75) 68 kW (92 PS) B 16 DT (DV6DTED)	07.2019→		7.11492.01.0	DDS	ohne Zubehör without accessories	

			 PIERBURG		
FRONTERA A Sport (U92) 54					
2.0 i (52SUD2, 55SUD2) 85 kW (115-116 PS) C 20 NE, X 20 SE	03.1992→10.1998		7.02604.03.0	LS	200 mm
FRONTERA B (U99) 55					
2.2 DTI (6B_66, 6B_76) 81-88 kW (110-120 PS) Y 22 DTH	09.2002→07.2004		7.24809.27.0	AGR	PN  Fahrgestellnummer bis: 2V599999 Vehicle Identification Number to: 2V599999 für OE-Nummer: 8 49 104, 9117505 for OE number: 8 49 104, 9117505
			7.24809.29.0	AGR	ET 
2.2 DTI (6B_ZC, 6B_VF, 6B_66, 6B_76) 81-88 kW (110-120 PS) X 22 DTH, Y 22 DTH	10.1998→12.2003		7.24809.27.0	AGR	PN  X 22 DTH, Y 22 DTH: Fahrgestellnummer bis: 2V599999 Vehicle Identification Number to: 2V599999 für OE-Nummer: 8 49 104, 9117505 for OE number: 8 49 104, 9117505
			7.24809.29.0	AGR	ET 
3.2 i (6B1VF, 6B1_6) 130-151 kW (177-205 PS) 6VD1 (DOHC), Y 32 NE	10.1998→07.2004		7.05271.52.0	LS	350 mm
GRANDLAND X (A18) 56					
1.5 Turbo D (75) 88-96 kW (120-131 PS) D 15 DTH (DV5RC)	04.2018→		7.07794.23.0	AGR	EL mit Dichtring with O-ring
1.5 Turbo D (75) 75 kW (102 PS) D 15 DT (DV5RD)	06.2018→		7.07794.23.0	AGR	EL mit Dichtring with O-ring
INSIGNIA A (G09) 57					
1.6 (68) 84-85 kW (114-116 PS) A 16 XER	07.2008→03.2017		7.04879.00.0	AGR-TH	 Öffnungstemperatur/opening temperature 105C  →ch. 91999999
			7.02604.07.0	LS	570 mm vor Katalysator in front of the catalyst
1.6 CDTi (68) 88 kW (120 PS) B 16 DTJ	07.2015→03.2017		7.24809.81.0	AGR	EL 
			7.11020.27.0	ATS	EL
1.6 CDTi (68) 81-100 kW (110-136 PS) B 16 DTH	07.2015→03.2017		7.24809.81.0	AGR	EL 
			7.11020.27.0	ATS	EL
1.6 Turbo (68) 132 kW (180 PS) A 16 LET	07.2008→03.2017		7.05271.81.0	LS	210 mm vor Katalysator in front of the catalyst
1.8 (68) 101-103 kW (137-140 PS) A 18 XER, B 18 XER	07.2008→03.2017		7.04879.00.0	AGR-TH	 Öffnungstemperatur/opening temperature 105C
			7.02604.07.0	LS	570 mm  A 18 XER, B 18 XER: vor Katalysator in front of the catalyst
2.0 Biturbo CDTi (68) 140-143 kW (190-195 PS) A 20 DTR	07.2008→12.2011		7.24809.78.0	AGR	ET 
2.0 Biturbo CDTi (68) 140-143 kW (190-195 PS) A 20 DTR	01.2012→03.2017		7.24809.78.0	AGR	ET 
2.0 Biturbo CDTi 4x4 (68) 140-143 kW (190-195 PS) A 20 DTR	05.2009→12.2011		7.24809.78.0	AGR	ET 
2.0 Biturbo CDTi 4x4 (68) 140-143 kW (190-195 PS) A 20 DTR	01.2012→03.2017		7.24809.78.0	AGR	ET 

INSIGNIA A (G09)
57















2.0 CDTi (68) 81 kW (110 PS) A 20 DTC, A 20 DTL	07.2008→03.2017		7.24809.78.0 AGR ET	A 20 DTC, A 20 DTL: vor Katalysator in front of the catalyst
			7.08369.17.0 ATS EL	
			7.02604.44.0 LS 500 mm	
2.0 CDTi (68) 96 kW (131 PS) A 20 DT, A 20 DTJ	07.2008→03.2017		7.24809.78.0 AGR ET	A 20 DT, A 20 DTJ: vor Katalysator in front of the catalyst
			7.08369.17.0 ATS EL	
			7.02604.44.0 LS 500 mm	
2.0 CDTi (68) 96-121 kW (131-165 PS) A 20 DTH	07.2008→03.2017		7.24809.78.0 AGR ET	vor Katalysator in front of the catalyst
			7.08369.17.0 ATS EL	
			7.02604.44.0 LS 500 mm	
2.0 CDTi (68) 88-103 kW (120-140 PS) A 20 DTE	03.2012→03.2017		7.24809.78.0 AGR ET	vor Katalysator in front of the catalyst
			7.08369.17.0 ATS EL	
			7.02604.44.0 LS 500 mm	
2.0 CDTi (68) 88-103 kW (120-140 PS) A 20 DTE	06.2013→03.2017		7.24809.78.0 AGR ET	vor Katalysator in front of the catalyst
			7.08369.17.0 ATS EL	
			7.02604.44.0 LS 500 mm	
2.0 CDTi (68) 96-121 kW (131-165 PS) A 20 DTH	07.2013→03.2017		7.24809.78.0 AGR ET	vor Katalysator in front of the catalyst
			7.08369.17.0 ATS EL	
			7.02604.44.0 LS 500 mm	
2.0 CDTi (68) 125 kW (170 PS) B 20 DTH	11.2014→03.2017		7.24809.87.0 AGR EL	
2.0 CDTi 4x4 (68) 96-121 kW (131-165 PS) A 20 DTH	06.2010→03.2017		7.24809.78.0 AGR ET	vor Katalysator in front of the catalyst
			7.08369.17.0 ATS EL	
			7.02604.44.0 LS 500 mm	
2.0 CDTi 4x4 (68) 96-121 kW (131-165 PS) A 20 DTH	07.2013→03.2017		7.24809.78.0 AGR ET	vor Katalysator in front of the catalyst
			7.08369.17.0 ATS EL	
			7.02604.44.0 LS 500 mm	
2.0 CDTi 4x4 (68) 125 kW (170 PS) B 20 DTH	11.2014→03.2017		7.24809.87.0 AGR EL	
2.0 Turbo (68) 162-184 kW (220-250 PS) A 20 NHT	07.2008→03.2017		7.02604.99.0 LS 400 mm	
			7.02604.99.0 LS 400 mm	
2.0 Turbo 4x4 (68) 162-184 kW (220-250 PS) A 20 NHT	07.2008→03.2017		7.02604.99.0 LS 400 mm	
			7.02604.99.0 LS 400 mm	

O
INSIGNIA A Country Tourer (G09)
58















1.6 CDTi (47) 88 kW (120 PS) B 16 DTJ	07.2015→03.2017		7.24809.81.0 AGR EL	
			7.11020.27.0 ATS EL	

















INSIGNIA A Country Tourer (G09) 58

1.6 CDTi (47) 81-100 kW (110-136 PS) B 16 DTH	07.2015→03.2017		7.24809.81.0	AGR	EL	
			7.11020.27.0	ATS	EL	
2.0 CDTi (47) 96 kW (131 PS) A 20 DT, A 20 DTJ	07.2008→03.2017		7.24809.78.0	AGR	ET	 A 20 DT, A 20 DTJ: vor Katalysator in front of the catalyst
			7.08369.17.0	ATS	EL	
			7.02604.44.0	LS	500 mm	
2.0 CDTi (47) 88-103 kW (120-140 PS) A 20 DTE	03.2012→03.2017		7.24809.78.0	AGR	ET	
			7.08369.17.0	ATS	EL	
2.0 CDTi (47) 96-121 kW (131-165 PS) A 20 DTH	07.2014→03.2017		7.24809.78.0	AGR	ET	 vor Katalysator in front of the catalyst
			7.08369.17.0	ATS	EL	
			7.02604.44.0	LS	500 mm	
2.0 CDTi (47) 125 kW (170 PS) B 20 DTH	11.2014→03.2017		7.24809.87.0	AGR	EL	
2.0 CDTi 4x4 (47) 96-121 kW (131-165 PS) A 20 DTH	09.2013→03.2017		7.24809.78.0	AGR	ET	 vor Katalysator in front of the catalyst
			7.08369.17.0	ATS	EL	
			7.02604.44.0	LS	500 mm	
2.0 CDTi 4x4 (47) 140-143 kW (190-195 PS) A 20 DTR	09.2013→03.2017		7.24809.78.0	AGR	ET	
2.0 CDTi 4x4 (47) 125 kW (170 PS) B 20 DTH	11.2014→03.2017		7.24809.87.0	AGR	EL	

INSIGNIA A Saloon (G09) 59

1.6 (69) 84-85 kW (114-116 PS) A 16 XER	07.2008→03.2017		7.04879.00.0	AGR-TH		 Öffnungstemperatur/opening temperature 105C  →ch. 91999999 vor Katalysator in front of the catalyst
			7.02604.07.0	LS	570 mm	
1.6 CDTi (69) 88 kW (120 PS) B 16 DTJ	07.2015→03.2017		7.24809.81.0	AGR	EL	
			7.11020.27.0	ATS	EL	
1.6 CDTi (69) 81-100 kW (110-136 PS) B 16 DTH	07.2015→03.2017		7.24809.81.0	AGR	EL	
			7.11020.27.0	ATS	EL	
1.6 Turbo (69) 132 kW (180 PS) A 16 LET	07.2008→03.2017		7.05271.81.0	LS	210 mm	vor Katalysator in front of the catalyst
1.8 (69) 101-103 kW (137-140 PS) A 18 XER, B 18 XER	07.2008→03.2017		7.04879.00.0	AGR-TH		 Öffnungstemperatur/opening temperature 105C A 18 XER, B 18 XER: vor Katalysator in front of the catalyst
			7.02604.07.0	LS	570 mm	
2.0 Biturbo CDTi (69) 140-143 kW (190-195 PS) A 20 DTR	07.2008→12.2011		7.24809.78.0	AGR	ET	
2.0 Biturbo CDTi (69) 140-143 kW (190-195 PS) A 20 DTR	01.2012→03.2017		7.24809.78.0	AGR	ET	





























 				
INSIGNIA A Saloon (G09)				
2.0 Biturbo CDTI 4x4 (69) 140-143 kW (190-195 PS) A 20 DTR	07.2008→12.2011	 7.24809.78.0	AGR	ET 
2.0 Biturbo CDTI 4x4 (69) 140-143 kW (190-195 PS) A 20 DTR	01.2012→03.2017	 7.24809.78.0	AGR	ET 
2.0 CDTI (69) 81 kW (110 PS) A 20 DTC, A 20 DTL	07.2008→03.2017	 7.24809.78.0 7.08369.17.0 7.02604.44.0	AGR ATS LS	ET EL 500 mm  A 20 DTC, A 20 DTL: vor Katalysator in front of the catalyst
2.0 CDTI (69) 96 kW (131 PS) A 20 DT, A 20 DTJ	07.2008→03.2017	 7.24809.78.0 7.08369.17.0 7.02604.44.0	AGR ATS LS	ET EL 500 mm  A 20 DT, A 20 DTJ: vor Katalysator in front of the catalyst
2.0 CDTI (69) 96-121 kW (131-165 PS) A 20 DTH	07.2008→03.2017	 7.24809.78.0 7.08369.17.0 7.02604.44.0	AGR ATS LS	ET EL 500 mm vor Katalysator in front of the catalyst
2.0 CDTI (69) 88-103 kW (120-140 PS) A 20 DTE	03.2012→03.2017	 7.24809.78.0 7.08369.17.0 7.02604.44.0	AGR ATS LS	ET EL 500 mm vor Katalysator in front of the catalyst
2.0 CDTI (69) 88-103 kW (120-140 PS) A 20 DTE	06.2013→03.2017	 7.24809.78.0 7.08369.17.0 7.02604.44.0	AGR ATS LS	ET EL 500 mm vor Katalysator in front of the catalyst
2.0 CDTI (69) 96-121 kW (131-165 PS) A 20 DTH	07.2013→03.2017	 7.24809.78.0 7.08369.17.0 7.02604.44.0	AGR ATS LS	ET EL 500 mm vor Katalysator in front of the catalyst
2.0 CDTI (69) 125 kW (170 PS) B 20 DTH	11.2014→03.2017	 7.24809.87.0	AGR	EL
2.0 CDTI 4x4 (69) 96-121 kW (131-165 PS) A 20 DTH	06.2010→03.2017	 7.24809.78.0 7.08369.17.0 7.02604.44.0	AGR ATS LS	ET EL 500 mm vor Katalysator in front of the catalyst
2.0 CDTI 4x4 (69) 96-121 kW (131-165 PS) A 20 DTH	07.2013→03.2017	 7.24809.78.0 7.08369.17.0 7.02604.44.0	AGR ATS LS	ET EL 500 mm vor Katalysator in front of the catalyst
2.0 CDTI 4x4 (69) 125 kW (170 PS) B 20 DTH	11.2014→03.2017	 7.24809.87.0	AGR	EL



INSIGNIA A Saloon (G09) **59**

2.0 Turbo (69) 162-184 kW (220-250 PS) A 20 NHT	07.2008→03.2017		7.02604.99.0	LS	400 mm	
2.0 Turbo 4x4 (69) 162-184 kW (220-250 PS) A 20 NHT	07.2008→03.2017		7.02604.99.0	LS	400 mm	

INSIGNIA A Sports Tourer (G09) **60**

1.6 (35) 84-85 kW (114-116 PS) A 16 XER	07.2008→06.2012		7.04879.00.0	AGR-TH		 Öffnungstemperatur/opening temperature 105C  →ch. 91999999
			7.02604.07.0	LS	570 mm	vor Katalysator in front of the catalyst
1.6 CDTi (35) 88 kW (120 PS) B 16 DTJ	07.2015→01.2017		7.24809.81.0	AGR	EL	
			7.11020.27.0	ATS	EL	
1.6 CDTi (35) 81-100 kW (110-136 PS) B 16 DTH	07.2015→12.2016		7.24809.81.0	AGR	EL	
			7.11020.27.0	ATS	EL	
1.6 Turbo (35) 132 kW (180 PS) A 16 LET	01.2009→06.2013		7.05271.81.0	LS	210 mm	vor Katalysator in front of the catalyst
1.8 (35) 101-103 kW (137-140 PS) A 18 XER	07.2008→06.2013		7.04879.00.0	AGR-TH		 Öffnungstemperatur/opening temperature 105C  →ch. 91999999
			7.02604.07.0	LS	570 mm	vor Katalysator in front of the catalyst
1.8 (35) 103 kW (140 PS) B 18 XER	07.2008→06.2013		7.02604.07.0	LS	570 mm	vor Katalysator in front of the catalyst
2.0 Biturbo CDTi (35) 140-143 kW (190-195 PS) A 20 DTR	07.2008→03.2017		7.24809.78.0	AGR	ET	
2.0 Biturbo CDTi (35) 140-143 kW (190-195 PS) A 20 DTR	01.2012→06.2015		7.24809.78.0	AGR	ET	
2.0 Biturbo CDTi 4x4 (35) 140-143 kW (190-195 PS) A 20 DTR	07.2008→03.2017		7.24809.78.0	AGR	ET	
2.0 Biturbo CDTi 4x4 (35) 140-143 kW (190-195 PS) A 20 DTR	01.2012→06.2015		7.24809.78.0	AGR	ET	
2.0 CDTi (35) 81 kW (110 PS) A 20 DTC	07.2008→06.2013		7.24809.78.0	AGR	ET	
			7.02604.44.0	LS	500 mm	vor Katalysator in front of the catalyst
2.0 CDTi (35) 81 kW (110 PS) A 20 DTL	07.2008→06.2013		7.24809.78.0	AGR	ET	
			7.08369.17.0	ATS	EL	
			7.02604.44.0	LS	500 mm	vor Katalysator in front of the catalyst
2.0 CDTi (35) 96 kW (131 PS) A 20 DT, A 20 DTJ	07.2008→06.2015		7.24809.78.0	AGR	ET	
			7.08369.17.0	ATS	EL	
			7.02604.44.0	LS	500 mm	 A 20 DT, A 20 DTJ: vor Katalysator in front of the catalyst
2.0 CDTi (35) 96-121 kW (131-165 PS) A 20 DTH	07.2008→06.2015		7.24809.78.0	AGR	ET	
			7.08369.17.0	ATS	EL	

INSIGNIA A Sports Tourer (G09)
60

































2.0 CDTi (35) 88-103 kW (120-140 PS) A 20 DTE	03.2012→06.2015		7.24809.78.0	AGR	ET	vor Katalysator in front of the catalyst
			7.08369.17.0	ATS	EL	
			7.02604.44.0	LS	500 mm	
2.0 CDTi (35) 96-121 kW (131-165 PS) A 20 DTH	07.2013→06.2015		7.24809.78.0	AGR	ET	vor Katalysator in front of the catalyst
			7.08369.17.0	ATS	EL	
			7.02604.44.0	LS	500 mm	
2.0 CDTi (35) 88-103 kW (120-140 PS) A 20 DTE	07.2013→06.2015		7.24809.78.0	AGR	ET	vor Katalysator in front of the catalyst
			7.08369.17.0	ATS	EL	
			7.02604.44.0	LS	500 mm	
2.0 CDTi (35) 125 kW (170 PS) B 20 DTH	11.2014→12.2016		7.24809.87.0	AGR	EL	
2.0 CDTi 4x4 (35) 96-121 kW (131-165 PS) A 20 DTH	06.2010→06.2015		7.24809.78.0	AGR	ET	vor Katalysator in front of the catalyst
			7.08369.17.0	ATS	EL	
			7.02604.44.0	LS	500 mm	
2.0 CDTi 4x4 (35) 96-121 kW (131-165 PS) A 20 DTH	07.2013→06.2015		7.24809.78.0	AGR	ET	vor Katalysator in front of the catalyst
			7.08369.17.0	ATS	EL	
			7.02604.44.0	LS	500 mm	
2.0 CDTi 4x4 (35) 125 kW (170 PS) B 20 DTH	11.2014→12.2016		7.24809.87.0	AGR	EL	
2.0 Turbo (35) 162-206 kW (220-280 PS) A 20 NFT, A 20 NHT	07.2008→06.2013		7.02604.99.0	LS	400 mm	
2.0 Turbo 4x4 (35) 162-184 kW (220-250 PS) A 20 NHT	07.2008→06.2011		7.02604.99.0	LS	400 mm	



























INSIGNIA B Country Tourer (Z18)
61







































2.0 CDTi (47) 125 kW (170 PS) D 20 DTH	06.2017→		7.24809.87.0	AGR	EL	
2.0 CDTi 4x4 (47) 125 kW (170 PS) D 20 DTH	06.2017→		7.24809.87.0	AGR	EL	
2.0 CDTi 4x4 (47) 154 kW (210 PS) D 20 DTR	01.2018→		7.24809.87.0	AGR	EL	

INSIGNIA B Grand Sport (Z18)
62

1.6 CDTi (68) 70-81 kW (95-110 PS) B 16 DTE, D 16 DTE, D 16 DTN	03.2017→		7.24809.81.0	AGR	EL	
1.6 CDTi (68) 81-100 kW (110-136 PS) B 16 DTH, D 16 DTH	03.2017→		7.24809.81.0	AGR	EL	
2.0 CDTi (68) 125 kW (170 PS) D 20 DTH	03.2017→		7.24809.87.0	AGR	EL	

			 PIERBURG			
INSIGNIA B Grand Sport (Z18)						62
2.0 CDTi 4x4 (68) 154 kW (210 PS) D 20 DTR	03.2017→		7.24809.87.0	AGR	EL	
2.0 CDTi 4x4 (68) 125 kW (170 PS) D 20 DTH	03.2017→		7.24809.87.0	AGR	EL	
INSIGNIA B Sports Tourer (Z18)						63
1.6 CDTi (35) 70-81 kW (95-110 PS) B 16 DTE, D 16 DTE, D 16 DTN	03.2017→		7.24809.81.0	AGR	EL 	
1.6 CDTi (35) 81-100 kW (110-136 PS) B 16 DTH, D 16 DTH	03.2017→		7.24809.81.0	AGR	EL 	
2.0 CDTi (35) 125 kW (170 PS) D 20 DTH	03.2017→		7.24809.87.0	AGR	EL	
2.0 CDTi 4x4 (35) 154 kW (210 PS) D 20 DTR	03.2017→		7.24809.87.0	AGR	EL	
2.0 CDTi 4x4 (35) 125 kW (170 PS) D 20 DTH	03.2017→		7.24809.87.0	AGR	EL	
KADETT E (T85)						64
1.3 i Cat (C19, D19) 44 kW (60 PS) C 13 N	09.1985→08.1991		7.02604.15.0	LS	360 mm	
1.4 i (C19, D19) 40-44 kW (54-60 PS) C 14 NZ	01.1990→08.1991		7.02604.15.0	LS	360 mm für Fahrzeuge mit Katalysator for vehicles with catalytic converter	
1.6 i Cat (C19, D19) 55-60 kW (75-82 PS) C 16 LZ, C 16 NZ	09.1986→08.1991		7.02604.15.0	LS	 C 16 LZ, C 16 NZ: für Fahrzeuge mit Katalysator for vehicles with catalytic converter	
1.8 (C19, D19) 82-85 kW (112-115 PS) 18 E	09.1987→08.1990		7.02604.03.0	LS	200 mm	
1.8 i (C19, D19) 82-85 kW (112-116 PS) 18 E, 18 SE	09.1984→08.1986		7.02604.03.0	LS	200 mm	
1.8 i (C19, D19) 74 kW (100 PS) C 18 NE	10.1985→08.1986		7.02604.03.0	LS	200 mm	
1.8 i (C19, D19) 63-66 kW (86-90 PS) 18 SV, C 18 NT	08.1989→05.1992		7.02604.03.0	LS	200 mm	
1.8 i (C19, D19) 66 kW (90 PS) C 18 NZ	08.1989→05.1992		7.02604.15.0 7.02604.03.0	LS LS	360 mm für Fahrzeuge mit Katalysator for vehicles with catalytic converter 200 mm	
2.0 i (C19, D19) 85-95 kW (115-129 PS) 20 NE, 20 SE	09.1987→05.1992		7.02604.03.0	LS	200 mm	
2.0 i Cat (C19, D19) 85 kW (116 PS) C 20 NE	03.1987→05.1992		7.02604.03.0	LS	200 mm	
KADETT E Convertible (T85)						65
1.4 i 40-44 kW (54-60 PS) C 14 NZ	01.1990→08.1991		7.02604.15.0	LS	360 mm für Fahrzeuge mit Katalysator for vehicles with catalytic converter	
1.6 i Cat 55-60 kW (75-82 PS) C 16 LZ, C 16 NZ	10.1987→02.1993		7.02604.15.0	LS	 C 16 LZ, C 16 NZ: für Fahrzeuge mit Katalysator for vehicles with catalytic converter	
2.0 GSi 115 kW (156 PS) 20 XE	09.1990→05.1992		7.02604.03.0	LS	200 mm	
2.0 i 85-95 kW (115-129 PS) 20 NE, 20 SER	10.1986→02.1993		7.02604.03.0	LS	200 mm	
2.0 i Cat 85 kW (116 PS) 20 SER, C 20 NE	10.1986→02.1993		7.02604.03.0	LS	200 mm	

					
KADETT E Estate (T85)					
66					
1.3 i Cat (C15, C35, D15, D35) 44 kW (60 PS) C 13 N	09.1985→08.1991		7.02604.15.0	LS	360 mm
1.4 i (C15, C35, D15, D35) 40-44 kW (54-60 PS) C 14 NZ	01.1990→08.1991		7.02604.15.0	LS	360 mm für Fahrzeuge mit Katalysator for vehicles with catalytic converter
1.6 i Cat (C15, C35, D15, D35) 55-60 kW (75-82 PS) C 16 LZ, C 16 NZ	09.1986→08.1991		7.02604.15.0	LS	360 mm  C 16 LZ, C 16 NZ: für Fahrzeuge mit Katalysator for vehicles with catalytic converter
1.8 E (C15, C35, D15, D35) 74 kW (100 PS) C 18 NE	10.1985→08.1986		7.02604.03.0	LS	200 mm
1.8 i (C15, C35, D15, D35) 82-85 kW (112-116 PS) 18 E, 18 SE	09.1984→08.1986		7.02604.03.0	LS	200 mm
1.8 i (C15, C35, D15, D35) 66 kW (90 PS) C 18 NT	06.1985→08.1991		7.02604.03.0	LS	200 mm
1.8 i (C15, C35, D15, D35) 66 kW (90 PS) C 18 NZ	06.1985→08.1991		7.02604.15.0	LS	360 mm für Fahrzeuge mit Katalysator for vehicles with catalytic converter
			7.02604.03.0	LS	200 mm
2.0 i (C15, C35, D15, D35) 85-95 kW (115-129 PS) 20 NE	09.1987→08.1991		7.02604.03.0	LS	200 mm
2.0 i Cat (C15, C35, D15, D35) 85 kW (116 PS) C 20 NE	09.1987→08.1991		7.02604.03.0	LS	200 mm
KADETT E Hatchback (T85)					
67					
1.3 i Cat (C08, C48, D08, D48) 44 kW (60 PS) C 13 N	09.1985→08.1991		7.02604.15.0	LS	360 mm
1.4 i (C08, C48, D08, D48) 40-44 kW (54-60 PS) C 14 NZ	01.1990→08.1991		7.02604.15.0	LS	360 mm für Fahrzeuge mit Katalysator for vehicles with catalytic converter
1.6 i Cat (C08, C48, D08, D48) 55-60 kW (75-82 PS) C 16 LZ, C 16 NZ	09.1986→08.1991		7.02604.15.0	LS	360 mm  C 16 LZ, C 16 NZ: für Fahrzeuge mit Katalysator for vehicles with catalytic converter
1.8 E (C08, C48, D08, D48) 74 kW (100 PS) C 18 NE	10.1985→08.1986		7.02604.03.0	LS	200 mm
1.8 GSI (C08, C48, D08, D48) 82-85 kW (112-115 PS) 18 E	09.1984→08.1986		7.02604.03.0	LS	200 mm
1.8 i (C08, C48, D08, D48) 66 kW (90 PS) C 18 NZ	06.1985→08.1991		7.02604.15.0	LS	360 mm für Fahrzeuge mit Katalysator for vehicles with catalytic converter
2.0 GSI (C08, C48, D08, D48) 85-95 kW (115-129 PS) 20 NE	09.1986→08.1991		7.02604.03.0	LS	200 mm
2.0 GSI (C08, C48, D08, D48) 95 kW (129 PS) 20 SEH	09.1986→08.1991		7.02604.03.0	LS	200 mm
2.0 GSI 16V (C08, C48, D08, D48) 115 kW (156 PS) 20 XE	12.1987→08.1991		7.02604.03.0	LS	200 mm
2.0 GSI Cat (C08, C48, D08, D48) 85 kW (116 PS) C 20 NE	09.1986→08.1991		7.02604.03.0	LS	200 mm

			 PIERBURG		
MERIVA A MPV (X03)					
1.3 CDTI (E75) 55 kW (75 PS) Z 13 DTJ	09.2003→05.2010		7.00020.24.0	AGR	EL 
			7.08369.15.0	ATS	EL
			7.11190.04.0	DDS	
1.3 CDTI (E75) 51-59 kW (70-80 PS) Y 13 DT, Z 13 DT	04.2005→05.2010		7.00020.24.0	AGR	EL 
1.4 16V Twinport (E75) 66 kW (90 PS) Z 14 XEP	07.2004→05.2010		7.22875.16.0	AGR	EL   ch. 54000001→
			7.22875.13.0	AGR	EL   →ch. 44999999
			7.02604.07.0	LS	570 mm  →ch. 54999999 vor Katalysator in front of the catalyst
			7.05271.81.0	LS	210 mm  Z 14 XEP: nach Katalysator Post-catalyst  Z 14 XEP:  ch. 64→ vor Katalysator in front of the catalyst
1.4 16V Twinport LPG (E75) 66 kW (90 PS) Z 14 XEP	07.2004→05.2010		7.22875.16.0	AGR	EL 
			7.22875.13.0	AGR	EL   →ch. 44999999
			7.02604.07.0	LS	570 mm  →ch. 54999999 für OE-Nummer: 93177169 for OE number: 93177169
1.6 (E75) 62-69 kW (84-94 PS) Z 16 SE	05.2003→05.2010		7.24809.10.0	AGR	EL 
			7.05270.26.0	LS	300 mm  →ch. 44999999 Regelsonde, Diagnosesonde Regulating Probe, Diagnostic Probe
1.6 (E75) 74-77 kW (101-105 PS) Z 16 XEP	01.2006→05.2010		7.28384.13.0	AGR	EL 
			7.04879.00.0	AGR-TH	 Öffnungstemperatur/opening temperature 105C
			7.02604.05.0	LS	550 mm  →20HH5427 vor Katalysator in front of the catalyst
1.6 16V (E75) 74-76 kW (101-103 PS) Z 16 XE	05.2003→01.2006		7.24809.10.0	AGR	EL   →ch. 44999999
			7.05271.76.0	LS	630 mm
			7.05270.26.0	LS	300 mm Diagnosesonde Diagnostic Probe
1.6 Turbo (E75) 132 kW (180 PS) Z 16 LET	09.2005→05.2010		7.02604.08.0	LS	350 mm
			7.05271.81.0	LS	210 mm vor Katalysator in front of the catalyst
1.7 CDTI (E75) 74 kW (101 PS) Z 17 DT	09.2003→05.2010		7.10334.08.0	AGR	EL 
			7.08369.49.0	ATS	EL vor Katalysator in front of the catalyst
			7.11190.04.0	DDS	
1.7 CDTI (E75) 92 kW (125 PS) Z 17 DTR	09.2006→05.2010		7.08369.49.0	ATS	EL vor Katalysator in front of the catalyst
			7.11190.04.0	DDS	



















O

MERIVA A MPV (X03)					68
1.8 (E75) 90-92 kW (122-125 PS) Z 18 XE	05.2003→05.2010		7.24809.10.0	AGR	EL
			7.05271.55.0	LS	800 mm →ch. 44999999
MERIVA B MPV (S10)					69
1.3 CDTI (75) 55 kW (75 PS) A 13 DTC	06.2010→10.2013		7.01599.10.0	AGR	EL
			7.03622.11.0	AGR-K	EL ch. C4000001→ch. C4999999 mit AGR-Ventil with EGR valve
			7.03622.10.0	AGR-K	EL
			7.03622.09.0	AGR-K	EL
			7.03622.06.0	AGR-K	EL
			7.08369.46.0	ATS	EL
			7.11190.04.0	DDS	
7.02604.44.0	LS	500 mm vor Katalysator in front of the catalyst			
1.3 CDTI (75) 70 kW (95 PS) A 13 DTE	06.2010→11.2014		7.01599.10.0	AGR	EL
			7.03622.11.0	AGR-K	EL ch. C4000001→ch. C4999999 mit AGR-Ventil with EGR valve
			7.03622.10.0	AGR-K	EL
			7.03622.09.0	AGR-K	EL
			7.03622.06.0	AGR-K	EL
			7.08369.46.0	ATS	EL
			7.11190.04.0	DDS	
7.02604.44.0	LS	500 mm			
1.6 CDTI (75) 70 kW (95 PS) B 16 DTC	01.2014→01.2017		7.24809.81.0	AGR	EL
			7.11020.27.0	ATS	EL
1.6 CDTI (75) 70-81 kW (95-110 PS) B 16 DTE, B 16 DTL	03.2014→03.2017		7.24809.81.0	AGR	EL
			7.11020.27.0	ATS	EL
1.6 CDTI (75) 81 kW (110 PS) B 16 DTN	03.2014→03.2017		7.24809.81.0	AGR	EL
			7.11020.42.0	ATS	EL B 16 DTN: ch. F4000001→ch. F4999999 für RPO Nummer: WM3 for RPO number: WM3 B 16 DTN: ch. G4000001→
			7.11020.27.0	ATS	EL
1.6 CDTi (75) 81-100 kW (110-136 PS) B 16 DTH	08.2013→01.2017		7.24809.81.0	AGR	EL
			7.11020.27.0	ATS	EL
1.7 CDTI (75) 74 kW (101 PS) A 17 DT	06.2010→01.2017		7.10334.08.0	AGR	EL
			7.11190.04.0	DDS	
1.7 CDTI (75) 81 kW (110 PS) A 17 DTC, A 17 DTI	06.2010→06.2015		7.10334.08.0	AGR	EL
			7.11190.04.0	DDS	
1.7 CDTI (75) 96 kW (131 PS) A 17 DTS	06.2010→10.2013		7.10334.08.0	AGR	EL
			7.11190.04.0	DDS	



























0





























MOKKA / MOKKA X (J13) **70**

1.6 (_76) 84-85 kW (114-116 PS) A 16 XER, B 16 XER, D 16 XER	06.2012→		7.02604.07.0	LS	570 mm	 A 16 XER, B 16 XER, D 16 XER: vor Katalysator in front of the catalyst
1.6 CDTI (_76) 81-100 kW (110-136 PS) A 16 DTH, B 16 DTH, D 16 DTH	01.2015→		7.24809.81.0	AGR	EL	
			7.11020.27.0	ATS	EL	 A 16 DTH, B 16 DTH, D 16 DTH: Fahrgestellnummer bis: H4999999, HB999999 Vehicle Identification Number to: H4999999, HB999999
			7.11020.42.0	ATS	EL	 A 16 DTH, B 16 DTH, D 16 DTH: Fahrgestellnummer ab: F4000001, FB000001 Vehicle Identification Number from: F4000001, FB000001
1.6 CDTI (_76) 81 kW (110 PS) B 16 DTN, B 16 DTU	06.2015→		7.24809.81.0	AGR	EL	
			7.11020.27.0	ATS	EL	 B 16 DTN, B 16 DTU: Fahrgestellnummer bis: H4999999, HB999999 Vehicle Identification Number to: H4999999, HB999999
			7.11020.42.0	ATS	EL	 B 16 DTN, B 16 DTU: Fahrgestellnummer ab: F4000001, FB000001 Vehicle Identification Number from: F4000001, FB000001
1.6 CDTI 4x4 (_76) 81-100 kW (110-136 PS) B 16 DTH, D 16 DTH	01.2015→		7.24809.81.0	AGR	EL	
			7.11020.27.0	ATS	EL	 B 16 DTH: Fahrgestellnummer ab: H4999999, HB999999 Vehicle Identification Number from: H4999999, HB999999
			7.11020.42.0	ATS	EL	 D 16 DTH: Fahrgestellnummer bis: H4999999, HB999999 Vehicle Identification Number to: H4999999, HB999999  B 16 DTH, D 16 DTH: Fahrgestellnummer ab: F4000001, FB000001 Vehicle Identification Number from: F4000001, FB000001
1.6 CDTI 4x4 (_76) 81 kW (110 PS) D 16 DTN	03.2018→		7.24809.81.0	AGR	EL	
			7.11020.27.0	ATS	EL	Fahrgestellnummer bis: H4999999, HB999999 Vehicle Identification Number to: H4999999, HB999999
			7.11020.42.0	ATS	EL	Fahrgestellnummer ab: F4000001, FB000001, J4000001, JB000001 Vehicle Identification Number from: F4000001, FB000001, J4000001, JB000001
1.7 CDTI (_76) 96 kW (131 PS) A 17 DTS	06.2012→		7.11020.38.0	ATS	EL	
			7.11190.04.0	DDS		
1.7 CDTI 4x4 (_76) 96 kW (131 PS) A 17 DTS	06.2012→		7.11020.38.0	ATS	EL	
			7.11190.04.0	DDS		

O

						
MOKKA / MOKKA X (J13)						70
1.8 (_76) 101-103 kW (137-140 PS) A 18 XER	01.2013→		7.02604.07.0	LS	570 mm	vor Katalysator in front of the catalyst
1.8 4x4 (_76) 101-103 kW (137-140 PS) A 18 XER	01.2013→		7.02604.07.0	LS	570 mm	vor Katalysator in front of the catalyst
MONTEREY B (M98)						71
3.5 V6 24V (UBS26D, UBS26G) 158 kW (215 PS) 6 VE1	07.1998→08.1999		7.05271.52.0	LS	350 mm	
OMEGA A (V87)						72
2.0 (F19, M19, N19) 85-90 kW (115-122 PS) 20 SE	09.1986→03.1994		7.02604.03.0	LS	200 mm	
2.0 (F19, M19, N19) 74 kW (100 PS) C 20 NEF	09.1990→03.1994		7.02604.03.0	LS	200 mm	
2.0 (F19, M19, N19) 73-74 kW (99-100 PS) C 20 NEJ	09.1990→03.1994		7.02604.03.0	LS	200 mm	
2.0 i (F19, M19, N19) 85 kW (116 PS) C 20 NE	09.1986→03.1994		7.02604.03.0	LS	200 mm	
2.4 i (F19, M19, N19) 92 kW (125 PS) C 24 NE	09.1988→03.1994		7.02604.03.0	LS	200 mm	
3.0 (3000) (F19, M19, N19) 115 kW (156 PS) C 30 LE	03.1987→12.1987		7.02604.03.0	LS	200 mm	
3.0 (3000) (F19, M19, N19) 130 kW (177 PS) 30 NE	03.1987→09.1990		7.02604.03.0	LS	200 mm	
3.0 (3000) Cat (F19, M19, N19) 130 kW (177 PS) C 30 NE	03.1988→03.1994		7.02604.03.0	LS	200 mm	
3.0 24V (3000) (F19, M19, N19) 147 kW (200 PS) C 30 SEJ	09.1989→03.1994		7.02604.03.0	LS	200 mm	
3.0 24V (3000) (F19, M19, N19) 150 kW (204 PS) C 30 SE	09.1989→03.1994		7.02604.03.0	LS	200 mm	
OMEGA A Estate (V87)						73
2.0 (F35, M35) 85-90 kW (115-122 PS) 20 SE	09.1986→03.1994		7.02604.03.0	LS	200 mm	
2.0 (F35, M35) 85 kW (116 PS) C 20 NE	09.1987→04.1994		7.02604.03.0	LS	200 mm	
2.0 (F35, M35) 74 kW (100 PS) C 20 NEF	09.1990→03.1994		7.02604.03.0	LS	200 mm	
2.0 i (F35, M35) 85 kW (116 PS) C 20 NE	09.1986→04.1994		7.02604.03.0	LS	200 mm	
2.0 i (F35, M35) 73-74 kW (99-100 PS) C 20 NEJ	09.1990→03.1994		7.02604.03.0	LS	200 mm	
2.4 i (F35, M35) 92 kW (125 PS) C 24 NE	09.1988→03.1994		7.02604.03.0	LS	200 mm	
3.0 (F35, M35) 115 kW (156 PS) C 30 LE	03.1987→03.1994		7.02604.03.0	LS	200 mm	









			 PIERBURG			
OMEGA A Estate (V87)						73
3.0 (F35, M35) 130 kW (177 PS) 30 NE	03.1987→09.1990		7.02604.03.0	LS	200 mm	
3.0 24V (F35, M35) 147 kW (200 PS) C 30 SEJ	09.1989→03.1994		7.02604.03.0	LS	200 mm	
3.0 24V Omega 3000 (F35, M35) 150 kW (204 PS) C 30 SE	09.1988→04.1994		7.02604.03.0	LS	200 mm	
3.0 Cat (F35, M35) 130 kW (177 PS) C 30 NE	03.1987→03.1994		7.02604.03.0	LS	200 mm	
OMEGA B (V94)						74
2.0 (F69, M69, P69) 85 kW (115 PS) X 20 SE	03.1994→09.1999		7.02604.03.0	LS	200 mm	
2.0 (F69, M69, P69) 85-90 kW (115-122 PS) 20 SE	03.1994→12.2000		7.02604.03.0	LS	200 mm	
2.0 16V (F69, M69, P69) 100 kW (136 PS) X 20 XEV	03.1994→09.1999		7.05270.34.0	LS	340 mm	
2.0 DTI 16V (F69, M69, P69) 74 kW (101 PS) X 20 DTH	09.1997→09.2000		7.24809.24.0*	AGR	PN mit Saugrohr with suction pipe  für Hersteller-Abgasnorm: NC8 for manufacturer exhaust norm: NC8	
			↳ 7.24809.27.0	AGR	PN	
			7.24809.25.0*	AGR	PN mit Saugrohr with suction pipe  96 EEC, D3 96 EEC, D3	
			↳ 7.24809.28.0	AGR	PN	
2.2 16V (F69, M69, P69) 106 kW (144 PS) Y 22 XE, Z 22 XE	09.1999→07.2003		7.05271.62.0	LS	500 mm	
2.2 DTI 16V (F69, M69, P69) 81-88 kW (110-120 PS) Y 22 DTH	09.2000→07.2003		7.24809.24.0*	AGR	PN mit Saugrohr with suction pipe  für Hersteller-Abgasnorm: NC8 for manufacturer exhaust norm: NC8	
			↳ 7.24809.27.0	AGR	PN	
			7.24809.25.0*	AGR	PN mit Saugrohr with suction pipe 	
			↳ 7.24809.28.0	AGR	PN	
2.2 DTI 16V (F69, M69, P69) 81-88 kW (110-120 PS) Y 22 DTH	09.2000→07.2003		7.24809.24.0*	AGR	PN mit Saugrohr with suction pipe  für Hersteller-Abgasnorm: NC8 for manufacturer exhaust norm: NC8	
			↳ 7.24809.27.0	AGR	PN	
			7.24809.25.0*	AGR	PN mit Saugrohr with suction pipe 	
			↳ 7.24809.28.0	AGR	PN	
2.5 TD (F69, M69, P69) 96 kW (131 PS) U 25 DT, U 25 TD, X 25 DT, X 25 TD	04.1994→07.2003		7.21920.62.0	AGR	PN mit Rohrstützen with pipe socket 	
2.5 V6 (F69, M69, P69) 125-144 kW (170-196 PS) X 25 XE	03.1994→09.2000		7.02604.03.0	LS	200 mm	

O

OMEGA B (V94)						74
2.6 V6 (F69, M69, P69) 125-132 kW (170-180 PS) Y 26 SE	09.2000→07.2003		7.05271.68.0	LS	750 mm	Automatikgetriebe Automatic Transmission vorne Front
			7.02604.07.0	LS	570 mm	nach Katalysator Post-catalyst
			7.02604.08.0	LS	350 mm	
			7.05271.81.0	LS	210 mm	Y 26 SE: →ch. 21059096 nach Katalysator Post-catalyst Y 26 SE: vor Katalysator in front of the catalyst
3.0 V6 (F69, M69, P69) 148-155 kW (201-211 PS) X 30 XE	04.1994→02.2001		7.02604.03.0	LS	200 mm	
3.2 V6 (F69, M69, P69) 160 kW (218 PS) Y 32 SE	02.2001→07.2003		7.05271.68.0	LS	750 mm	Automatikgetriebe Automatic Transmission vorne Front
			7.02604.07.0	LS	570 mm	nach Katalysator Post-catalyst
			7.05271.81.0	LS	210 mm	für Schaltgetriebe for manual transmission vor Katalysator in front of the catalyst
OMEGA B Estate (V94)						75
2.0 (F35, M35, P35) 85 kW (115 PS) X 20 SE	03.1994→09.1999		7.02604.03.0	LS	200 mm	
2.0 16V (F35, M35, P35) 100 kW (136 PS) X 20 XEV	03.1994→09.1999		7.05270.34.0	LS	340 mm	
2.0 DTI 16V (F35, M35, P35) 74 kW (101 PS) X 20 DTH	09.1997→09.2000		7.24809.24.0*	AGR	PN	mit Saugrohr with suction pipe für Hersteller-Abgasnorm: NC8 for manufacturer exhaust norm: NC8
			↳7.24809.27.0	AGR	PN	
			7.24809.25.0*	AGR	PN	mit Saugrohr with suction pipe 96 EEC, D3 96 EEC, D3
			↳7.24809.28.0	AGR	PN	
2.2 16V (F35, M35, P35) 106 kW (144 PS) Y 22 XE, Z 22 XE	09.1999→07.2003		7.05271.55.0	LS	800 mm	
			7.05271.62.0	LS	500 mm	
2.2 DTI 16V (F35, M35, P35) 81-88 kW (110-120 PS) Y 22 DTH	09.2000→07.2003		7.24809.24.0*	AGR	PN	mit Saugrohr with suction pipe für Hersteller-Abgasnorm: NC8 for manufacturer exhaust norm: NC8
			↳7.24809.27.0	AGR	PN	
			7.24809.25.0*	AGR	PN	mit Saugrohr with suction pipe
2.2 DTI 16V (F35, M35, P35) 81-88 kW (110-120 PS) Y 22 DTH	09.2000→07.2003		7.24809.24.0*	AGR	PN	mit Saugrohr with suction pipe für Hersteller-Abgasnorm: NC8 for manufacturer exhaust norm: NC8









OMEGA B Estate (V94) **75**

			↳ 7.24809.27.0 7.24809.25.0*	AGR AGR	PN PN	mit Saugrohr with suction pipe 
			↳ 7.24809.28.0	AGR	PN	
2.5 TD (F35, M35, P35) 96 kW (131 PS) U 25 DT, U 25 TD, X 25 DT, X 25 TD	04.1994→07.2001		7.21920.62.0	AGR	PN	mit Rohrstützen with pipe socket 
2.5 V6 (F35, M35, P35) 125-144 kW (170-196 PS) X 25 XE	03.1994→09.2000		7.02604.03.0	LS	200 mm	
2.6 V6 (F35, M35, P35) 125-132 kW (170-180 PS) Y 26 SE	09.2000→07.2003		7.05271.68.0	LS	750 mm	Automatikgetriebe Automatic Transmission vorne Front Menge: 2 Quantity: 2
			7.02604.07.0	LS	570 mm	nach Katalysator Post-catalyst
			7.02604.08.0	LS	350 mm	
			7.05271.81.0	LS	210 mm	 Y 26 SE: →ch. 21059096 nach Katalysator Post-catalyst  Y 26 SE: vor Katalysator in front of the catalyst
3.0 V6 (F35, M35, P35) 148-155 kW (201-211 PS) X 30 XE	04.1994→02.2001		7.02604.03.0	LS	200 mm	
3.2 V6 (F35, M35, P35) 160 kW (218 PS) Y 32 SE	02.2001→07.2003		7.05271.68.0	LS	750 mm	Automatikgetriebe Automatic Transmission vorne Front
			7.02604.07.0	LS	570 mm	nach Katalysator Post-catalyst
			7.05271.81.0	LS	210 mm	für Schaltgetriebe for manual transmission vor Katalysator in front of the catalyst

SENATOR B (V88) **76**

3.0 24V (P19) 150 kW (204 PS) C 30 SE	09.1989→09.1993		7.02604.03.0	LS	200 mm	
---	-----------------	---	---------------------	----	--------	--

SIGNUM Hatchback (Z03) **77**































1.8 (F48) 90-92 kW (122-125 PS) Z 18 XE	05.2003→07.2005		7.05271.55.0	LS	800 mm	
1.8 (F48) 101-103 kW (137-140 PS) Z 18 XER	09.2005→12.2008		7.04879.00.0	AGR-TH		 Öffnungstemperatur/opening temperature 105C
			7.05271.62.0	LS	500 mm	
1.9 CDTI (F48) 88 kW (120 PS) Z 19 DT	04.2004→02.2008		7.22946.38.0	AGR	EL	
			7.08369.05.0	ATS	EL	
			7.08369.38.0	ATS	EL	Fahrgestellnummer ab: 51065674 Vehicle Identification Number from: 51065674 nach Rußpartikelfilter after soot particulate filter
			7.11190.04.0	DDS		 ch. 71021892→
			7.11190.03.0	DDS		ohne Zubehör without accessories  →ch. 71021891

SIGNUM Hatchback (Z03) 77

			7.02604.99.0	LS	400 mm	
1.9 CDTI (F48) 110 kW (150 PS) Z 19 DTH	04.2004→02.2008		7.00063.10.0	AGR	EL	 Fahrgestellnummer ab: 51065674 Vehicle Identification Number from: 51065674 nach Rußpartikelfilter after soot particulate filter ch. 71021892→ ohne Zubehör without accessories →ch. 71021891
			7.08369.05.0	ATS	EL	
			7.08369.38.0	ATS	EL	
			7.11190.04.0	DDS		
			7.11190.03.0	DDS		
			7.02604.99.0	LS	400 mm	
1.9 CDTI (F48) 74 kW (101 PS) Z 19 DTL	08.2005→02.2008		7.22946.38.0	AGR	EL	 Fahrgestellnummer ab: 51065674 Vehicle Identification Number from: 51065674 nach Rußpartikelfilter after soot particulate filter ch. 71021892→ ohne Zubehör without accessories →ch. 71021891
			7.08369.05.0	ATS	EL	
			7.08369.38.0	ATS	EL	
			7.11190.04.0	DDS		
			7.11190.03.0	DDS		
			7.02604.99.0	LS	400 mm	
2.0 DTI (F48) 74 kW (101 PS) Y 20 DTH	05.2003→04.2004		7.24809.29.0	AGR	ET	
2.0 Turbo (F48) 129 kW (175 PS) Z 20 NET	05.2003→12.2008		7.05270.27.0	LS	400 mm	→ch. 41039263
			7.05270.37.0	LS	1640 mm	
2.2 DTI (F48) 86-92 kW (117-125 PS) Y 22 DTR	05.2003→04.2004		7.24809.29.0	AGR	ET	
2.8 V6 Turbo (F48) 169 kW (230 PS) Z 28 NEL	09.2005→12.2008		7.02604.08.0	LS	350 mm	Diagnosesonde Diagnostic Probe
3.0 V6 CDTI (F48) 135 kW (184 PS) Z 30 DT	09.2005→12.2008		7.11190.04.0	DDS		
3.2 V6 (F48) 155 kW (211 PS) Z 32 SE	05.2003→07.2005		7.02604.08.0	LS	350 mm	
			7.05271.81.0	LS	210 mm	vor Katalysator, nach Katalysator in front of the catalyst, Post-catalyst

SINTRA (APV) 78











2.2 DTI 85 kW (116 PS) X 22 DTH	07.1997→04.1999		7.24809.27.0	AGR	PN	 für OE-Nummer: 8 49 104, 9117505 for OE number: 8 49 104, 9117505
2.2 i 16V (OUN16, Y94) 100-104 kW (136-141 PS) X 22 XE	11.1996→04.1999		7.22296.02.0	ARV	PN	
			7.02604.03.0	LS	200 mm	
3.0 i 24V (OUN16, Y94) 148-155 kW (201-211 PS) X 30 XE	11.1996→04.1999		7.22296.02.0	ARV	PN	
			7.02604.03.0	LS	200 mm	





















			 PIERBURG		
SPEEDSTER (E01)					79
2.0 Turbo (R97) 140-162 kW (190-220 PS) Z 20 LET	08.2002→08.2006		7.02604.07.0	LS	570 mm vor Katalysator in front of the catalyst
2.2 (R97) 108 kW (147 PS) Z 22 SE	06.2000→08.2005		7.05270.29.0	LS	630 mm
			7.05270.30.0	LS	1275 mm
TIGRA (S93)					80
1.4 16V (F07) 63-69 kW (86-94 PS) X 14 XE	07.1994→12.2000		7.22296.02.0	ARV	PN 
			7.02604.15.0	LS	360 mm
1.4 16V (F07) 63-69 kW (86-94 PS) X 14 XE	08.1997→12.2000		7.22296.02.0	ARV	PN 
			7.02604.15.0	LS	360 mm
1.6 16V (F07) 78 kW (106 PS) X 16 XE	07.1994→08.1998		7.22296.02.0	ARV	PN 
			7.02604.15.0	LS	360 mm
1.6 16V (F07) 74 kW (101 PS) C 16 SEL	08.1997→08.1998		7.02604.01.0	LS	200 mm
TIGRA TwinTop (X04)					81
1.3 CDTI (R97) 51-59 kW (70-80 PS) Z 13 DT	06.2004→12.2010		7.00020.24.0	AGR	EL 
1.4 (R97) 66 kW (90 PS) Z 14 XEP	06.2004→12.2010		7.22875.16.0	AGR	EL   ch. 5E000001→
			7.22875.13.0	AGR	EL 
			7.02604.07.0	LS	570 mm  →ch. 5E999999 vor Katalysator in front of the catalyst
			7.02604.08.0	LS	350 mm
1.8 (R97) 90-92 kW (122-125 PS) Z 18 XE	06.2004→12.2010		7.05271.81.0	LS	210 mm nach Katalysator Post-catalyst
			7.24809.10.0	AGR	EL 
			7.05271.55.0	LS	800 mm
VECTRA A (J89)					82
1.6 (F19, M19) 60 kW (82 PS) 16 SV	09.1988→05.1993		7.02604.01.0	LS	200 mm
1.6 i (F19, M19) 55-60 kW (75-82 PS) C 16 NZ, C 16 NZ2	09.1988→11.1995		7.02604.15.0	LS	360 mm Fahrgestellnummer bis: R1999999, R5999999, R7999999, R8, RV Vehicle Identification Number to: R1999999, R5999999, R7999999, R8, RV
			7.02604.15.0	LS	360 mm Fahrgestellnummer bis: R1999999, R5999999, R7999999, R8, RV Vehicle Identification Number to: R1999999, R5999999, R7999999, R8, RV
1.6 i (F19, M19) 52 kW (71 PS) X 16 SZ	09.1993→11.1995		7.02604.15.0	LS	360 mm
1.6 i (F19, M19) 51-55 kW (69-75 PS) 16 LZ2, C 16 LZ2	09.1993→11.1995		7.02604.15.0	LS	360 mm
1.8 i Cat (F19, M19) 66 kW (90 PS) C 18 NZ	03.1990→11.1995		7.02604.15.0	LS	360 mm
2.0 (F19, M19) 74 kW (100 PS) C 20 NEF	09.1988→12.1988		7.02604.03.0	LS	200 mm

VECTRA A (J89)
82

2.0 i (F19, M19) 85-95 kW (115-129 PS) 20 NE	09.1988→10.1990		7.02604.03.0	LS	200 mm	
2.0 i (F19, M19) 95 kW (129 PS) 20 SEH	09.1988→09.1992		7.02604.03.0	LS	200 mm	
2.0 i 16V (F19, M19) 100 kW (136 PS) X 20 XEV	08.1992→08.1995		7.05270.32.0	LS	825 mm	
2.0 i 16V 4x4 (F19, M19) 100 kW (136 PS) X 20 XEV	06.1994→11.1995		7.05270.32.0	LS	825 mm	
2.0 i 4x4 (F19, M19) 85-95 kW (115-129 PS) 20 NE	01.1989→10.1990		7.02604.03.0	LS	200 mm	
2.0 i 4x4 (F19, M19) 95 kW (129 PS) 20 SEH	08.1989→07.1992		7.02604.03.0	LS	200 mm	
2.0 i Cat (F19, M19) 85 kW (116 PS) C 20 NE	09.1988→11.1995		7.02604.03.0	LS	200 mm	
2.0 i Cat 4x4 (F19, M19) 85 kW (116 PS) C 20 NE	01.1989→11.1995		7.02604.03.0	LS	200 mm	
2.0 i Turbo 4x4 (F19, M19) 150 kW (204 PS) C 20 LET	06.1994→11.1995		7.02604.03.0	LS	200 mm	
2.5 CD 4x4 (F19, M19) 125 kW (170 PS) C 25 XE	08.1992→08.1995		7.02604.03.0	LS	200 mm	
2.5 V6 (F19, M19) 125 kW (170 PS) C 25 XE	02.1993→11.1995		7.02604.03.0	LS	200 mm	

VECTRA A Hatchback (J89)
83
O





















1.6 S 60 kW (82 PS) 16 SV	09.1988→05.1993		7.02604.01.0	LS	200 mm	
1.6 i (F68, M68) 52 kW (71 PS) X 16 SZ	09.1993→11.1995		7.02604.15.0	LS	360 mm	Fahrgestellnummer bis: R1999999, R5999999, R7999999, R8, RV Vehicle Identification Number to: R1999999, R5999999, R7999999, R8, RV
1.6 i Cat (F68, M68) 55-60 kW (75-82 PS) C 16 NZ, C 16 NZ2	09.1988→11.1995		7.02604.15.0	LS	360 mm	Fahrgestellnummer bis: R1999999, R5999999, R7999999, R8, RV Vehicle Identification Number to: R1999999, R5999999, R7999999, R8, RV
1.8 i Cat (F68, M68) 66 kW (90 PS) C 18 NZ	03.1990→11.1995		7.02604.15.0	LS	360 mm	
2.0 (F68, M68) 74 kW (100 PS) C 20 NEF	04.1988→12.1988		7.02604.03.0	LS	200 mm	
2.0 i (F68, M68) 85-95 kW (115-129 PS) 20 NE	09.1988→10.1990		7.02604.03.0	LS	200 mm	
2.0 i 16V (F68, M68) 100 kW (136 PS) X 20 XEV	08.1992→08.1995		7.05270.32.0	LS	825 mm	
2.0 i Cat (F68, M68) 85 kW (116 PS) C 20 NE	09.1988→11.1995		7.02604.03.0	LS	200 mm	
2.0 i GT (F68, M68) 95 kW (129 PS) 20 SEH	09.1988→11.1995		7.02604.03.0	LS	200 mm	
2.5 V6 (F68, M68) 125 kW (170 PS) C 25 XE	02.1993→11.1995		7.02604.03.0	LS	200 mm	

			 PIERBURG		
VECTRA B (J96)					
1.6 i (F19) 55 kW (75 PS) X 16 SZR	10.1995→04.2002		7.02604.15.0	LS	360 mm  →ch. W5276825
1.6 i (F19) 55 kW (75 PS) 16 LZ2	10.1995→04.2002		7.02604.15.0	LS	360 mm
1.6 i 16V (F19) 74 kW (101 PS) X 16 XEL	10.1995→03.1999		7.22296.02.0	ARV	PN ○ Fahrgestellnummer bis: W5276825 Vehicle Identification Number to: W5276825
			7.02604.15.0	LS	360 mm  ch. T1000001→ch. W1285446
1.6 i 16V (F19) 74-76 kW (101-103 PS) Y 16 XE, Z 16 XE	03.1999→04.2002		7.24809.10.0	AGR	EL ○
			7.05270.25.0	LS	800 mm  Y 16 XE, Z 16 XE: Regelsonde, Diagnosesonde Regulating Probe, Diagnostic Probe
1.8 i 16V (F19) 85 kW (116 PS) X 18 XE	10.1995→09.2000		7.22296.02.0	ARV	PN ○
			7.05270.33.0	LS	705 mm
1.8 i 16V (F19) 85 kW (115 PS) X 18 XE1	03.1999→09.2000		7.24809.10.0	AGR	EL ○
			7.05270.32.0	LS	825 mm
1.8 i 16V (F19) 90-92 kW (122-125 PS) Z 18 XE	09.2000→04.2002		7.05271.55.0	LS	800 mm
2.0 DI 16V (F19) 60-63 kW (82-86 PS) X 20 DTL	11.1996→04.2002		7.24809.25.0*	AGR	PN mit Saugrohr with suction pipe ○ 96 EEC, D3 96 EEC, D3
			↳ 7.24809.28.0	AGR	PN
			7.24809.27.0	AGR	PN ○ für OE-Nummer: 8 49 067, 8 49 104, 90500935, 9117505 for OE number: 8 49 067, 8 49 104, 90500935, 9117505 für Hersteller-Abgasnorm: NC8 for manufacturer exhaust norm: NC8
2.0 DTI 16V (F19) 74 kW (101 PS) X 20 DTH	06.1997→09.2000		7.24809.24.0*	AGR	PN mit Saugrohr with suction pipe ○ für Hersteller-Abgasnorm: NC8 for manufacturer exhaust norm: NC8
			↳ 7.24809.27.0	AGR	PN
			7.24809.25.0*	AGR	PN mit Saugrohr with suction pipe ○ 96 EEC, D3 96 EEC, D3
			↳ 7.24809.28.0	AGR	PN
2.0 DTI 16V (F19) 74 kW (101 PS) Y 20 DTH	09.2000→04.2002		7.24809.25.0*	AGR	PN mit Saugrohr with suction pipe ○
			↳ 7.24809.28.0	AGR	PN
2.0 i 16V (F19) 85-100 kW (116-136 PS) C 20 SEL	09.1995→06.2000		7.05270.33.0	LS	705 mm
2.0 i 16V (F19) 100 kW (136 PS) X 20 XEV	09.1995→06.2000		7.22296.02.0	ARV	PN ○
			7.05270.33.0	LS	705 mm





VECTRA B (J96)						84
2.2 DTI 16V (F19) 86-92 kW (117-125 PS) Y 22 DTR	09.2000→04.2002		7.24809.25.0*	AGR	PN	mit Saugrohr with suction pipe
			↳7.24809.28.0	AGR	PN	
2.2 DTI 16V (F19) 86-92 kW (117-125 PS) Y 22 DTR	09.2000→04.2002		7.24809.25.0*	AGR	PN	mit Saugrohr with suction pipe
			↳7.24809.28.0	AGR	PN	
2.2 i 16V (F19) 108 kW (147 PS) Z 22 SE	09.2000→04.2002		7.22630.28.0	AGR	EL	
			7.05270.29.0	LS	630 mm	
			7.05270.30.0	LS	1275 mm	
2.5 i V6 (F19) 125-144 kW (170-196 PS) X 25 XE	10.1995→09.2000		7.22296.02.0	ARV	PN	
2.6 i V6 (F19) 125-132 kW (170-180 PS) Y 26 SE	09.2000→04.2002		7.05271.68.0	LS	750 mm	hinten Rear für Fahrzeuge mit Katalysator for vehicles with catalytic converter
i 500 2.5 (F19) 125-144 kW (170-196 PS) X 25 XE	05.1998→09.2000		7.22296.02.0	ARV	PN	
VECTRA B Estate (J96)						85
1.6 i (F35) 55 kW (75 PS) X 16 SZR	11.1996→06.2000		7.02604.15.0	LS	360 mm	→ch. W5276825
			7.02604.15.0	LS	360 mm	
1.6 i (F35) 55 kW (75 PS) 16 LZ2	11.1996→06.2000		7.22296.02.0	ARV	PN	 Fahrgestellnummer bis: W5276825 Vehicle Identification Number to: W5276825
			7.02604.15.0	LS	360 mm	ch. T1000001→ch. W1285446
1.6 i 16V (F35) 74 kW (101 PS) X 16 XEL	11.1996→03.1999		7.22296.02.0	ARV	PN	
			7.02604.15.0	LS	360 mm	
1.6 i 16V (F35) 74-76 kW (101-103 PS) Y 16 XE, Z 16 XE	03.1999→07.2002		7.24809.10.0	AGR	EL	
			7.05270.25.0	LS	800 mm	Y 16 XE, Z 16 XE: Regelsonde, Diagnosesonde Regulating Probe, Diagnostic Probe
1.8 i 16V (F35) 85 kW (116 PS) X 18 XE	11.1996→09.2000		7.22296.02.0	ARV	PN	
			7.05270.33.0	LS	705 mm	
1.8 i 16V (F35) 85 kW (115 PS) X 18 XE1	03.1999→09.2000		7.24809.10.0	AGR	EL	
			7.05270.32.0	LS	825 mm	
1.8 i 16V (F35) 90-92 kW (122-125 PS) Z 18 XE	09.2000→07.2003		7.05271.55.0	LS	800 mm	
2.0 DI 16V (F35) 60-63 kW (82-86 PS) X 20 DTL	11.1996→06.2000		7.24809.25.0*	AGR	PN	mit Saugrohr with suction pipe
			↳7.24809.28.0	AGR	PN	96 EEC, D3 96 EEC, D3



VECTRA B Estate (J96) 85

			7.24809.27.0	AGR	PN	 für OE-Nummer: 8 49 067, 8 49 104, 90500935, 9117505 for OE number: 8 49 067, 8 49 104, 90500935, 9117505 für Hersteller-Abgasnorm: NC8 for manufacturer exhaust norm: NC8
2.0 DTI 16V (F35) 74 kW (101 PS) X 20 DTH	06.1997→07.2003		7.24809.24.0*	AGR	PN	mit Saugrohr with suction pipe  für Hersteller-Abgasnorm: NC8 for manufacturer exhaust norm: NC8
			↳ 7.24809.27.0	AGR	PN	
			7.24809.25.0*	AGR	PN	mit Saugrohr with suction pipe  96 EEC, D3 96 EEC, D3
2.0 DTI 16V (F35) 74 kW (101 PS) Y 20 DTH	06.1997→07.2003		7.24809.25.0*	AGR	PN	mit Saugrohr with suction pipe 
			↳ 7.24809.28.0	AGR	PN	
2.0 i 16V (F35) 85-100 kW (116-136 PS) C 20 SEL	11.1996→06.2000		7.05270.33.0	LS	705 mm	
2.0 i 16V (F35) 100 kW (136 PS) X 20 XEV	11.1996→06.2000		7.22296.02.0	ARV	PN	
			7.05270.33.0	LS	705 mm	
2.2 DTI 16V (F35) 86-92 kW (117-125 PS) Y 22 DTR	09.2000→04.2002		7.24809.25.0*	AGR	PN	mit Saugrohr with suction pipe 
			↳ 7.24809.28.0	AGR	PN	
2.2 DTI 16V (F35) 86-92 kW (117-125 PS) Y 22 DTR	09.2000→07.2003		7.24809.25.0*	AGR	PN	mit Saugrohr with suction pipe 
			↳ 7.24809.28.0	AGR	PN	
2.2 i 16V (F35) 108 kW (147 PS) Z 22 SE	09.2000→07.2003		7.22630.28.0	AGR	EL	
			7.05270.29.0	LS	630 mm	
			7.05270.30.0	LS	1275 mm	
2.5 i V6 (F35) 125-144 kW (170-196 PS) X 25 XE	11.1996→09.2000		7.22296.02.0	ARV	PN	
2.6 i V6 (F35) 125-132 kW (170-180 PS) Y 26 SE	09.2000→07.2003		7.05271.68.0	LS	750 mm	hinten Rear für Fahrzeuge mit Katalysator for vehicles with catalytic converter
i 500 2.5 (F35) 125-144 kW (170-196 PS) X 25 XE	05.1998→09.2000		7.22296.02.0	ARV	PN	







VECTRA B Hatchback (J96) 86

1.6 i (F68) 55 kW (75 PS) X 16 SZR	10.1995→07.2003		7.02604.15.0	LS	360 mm	 →ch. W5276825
			7.02604.15.0	LS	360 mm	
1.6 i (F68) 55 kW (75 PS) 16 LZ2	10.1995→07.2003		7.02604.15.0	LS	360 mm	
1.6 i 16V (F68) 74 kW (101 PS) X 16 XEL	10.1995→03.1999		7.22296.02.0	ARV	PN	 Fahrgestellnummer bis: W5276825 Vehicle Identification Number to: W5276825

















VECTRA B Hatchback (J96)					86
			7.02604.15.0	LS	360 mm ch. T1000001→ch. W1285446
1.6 i 16V (F68) 74-76 kW (101-103 PS) Y 16 XE, Z 16 XE	03.1999→07.2002		7.24809.10.0	AGR	EL
			7.05270.25.0	LS	800 mm Y 16 XE, Z 16 XE: Regelsonde, Diagnosesonde Regulating Probe, Diagnostic Probe
1.8 FlexFuel (F68) 85 kW (116 PS) X 18 XE	01.1999→09.2000		7.22296.02.0	ARV	PN
1.8 i 16V (F68) 85 kW (116 PS) X 18 XE	10.1995→09.2000		7.22296.02.0	ARV	PN
1.8 i 16V (F68) 85 kW (115 PS) X 18 XE1	03.1999→09.2000		7.24809.10.0	AGR	EL
			7.05270.32.0	LS	825 mm
1.8 i 16V (F68) 90-92 kW (122-125 PS) Z 18 XE	09.2000→07.2003		7.05271.55.0	LS	800 mm
2.0 DI 16V (F68) 60-63 kW (82-86 PS) X 20 DTL	11.1996→06.2000		7.24809.25.0*	AGR	PN mit Saugrohr with suction pipe 96 EEC, D3 96 EEC, D3
			↳ 7.24809.28.0	AGR	PN
			7.24809.27.0	AGR	PN für OE-Nummer: 8 49 067, 8 49 104, 90500935, 9117505 for OE number: 8 49 067, 8 49 104, 90500935, 9117505 für Hersteller-Abgasnorm: NC8 for manufacturer exhaust norm: NC8
2.0 DTI 16V (F68) 74 kW (101 PS) X 20 DTH	06.1997→09.2000		7.24809.24.0*	AGR	PN mit Saugrohr with suction pipe für Hersteller-Abgasnorm: NC8 for manufacturer exhaust norm: NC8
			↳ 7.24809.27.0	AGR	PN
			7.24809.25.0*	AGR	PN mit Saugrohr with suction pipe 96 EEC, D3 96 EEC, D3
			↳ 7.24809.28.0	AGR	PN
2.0 DTI 16V (F68) 74 kW (101 PS) Y 20 DTH	09.2000→07.2003		7.24809.25.0*	AGR	PN mit Saugrohr with suction pipe
2.0 i 16V (F68) 85-100 kW (116-136 PS) C 20 SEL	09.1995→06.2000		7.05270.33.0	LS	705 mm
			7.22296.02.0	ARV	PN
2.0 i 16V (F68) 100 kW (136 PS) X 20 XEV	09.1995→06.2000		7.22296.02.0	ARV	PN
			7.05270.33.0	LS	705 mm
2.2 DTI 16V (F68) 86-92 kW (117-125 PS) Y 22 DTR	09.2000→04.2002		7.24809.28.0	AGR	PN für OE-Nummer: 849124, 849156, 9192805, 93170138 for OE number: 849124, 849156, 9192805, 93170138
2.2 DTI 16V (F68) 86-92 kW (117-125 PS) Y 22 DTR	09.2000→07.2003		7.24809.25.0*	AGR	PN mit Saugrohr with suction pipe
			↳ 7.24809.28.0	AGR	PN

























VECTRA B Hatchback (J96) 86

2.2 i 16V (F68) 108 kW (147 PS) Z 22 SE	09.2000→07.2003	 7.22630.28.0	AGR	EL	
		7.05270.29.0	LS	630 mm	
		7.05270.30.0	LS	1275 mm	
2.5 (F68) 125-144 kW (170-196 PS) X 25 XE	10.1999→06.2000	 7.22296.02.0	ARV	PN	
2.5 i V6 (F68) 125-144 kW (170-196 PS) X 25 XE	10.1995→09.2000	 7.22296.02.0	ARV	PN	
2.6 i V6 (F68) 125-132 kW (170-180 PS) Y 26 SE	09.2000→07.2003	 7.05271.68.0	LS	750 mm	hinten Rear für Fahrzeuge mit Katalysator for vehicles with catalytic converter

VECTRA C (Z02) 87

1.6 (F69) 74-77 kW (101-105 PS) Z 16 XEP	08.2005→08.2008	 7.28384.13.0	AGR	EL	
		7.04879.00.0	AGR-TH	 Öffnungstemperatur/opening temperature 105C	
		7.02604.05.0	LS	550 mm  →20HH5427 vor Katalysator in front of the catalyst	
1.6 16V (F69) 74-76 kW (101-103 PS) Z 16 XE	07.2004→10.2005	 7.24809.10.0	AGR	EL	  →ch. 20CR2605
		7.05271.76.0	LS	630 mm	
		7.05270.26.0	LS	300 mm	Diagnosesonde Diagnostic Probe
1.8 (F69) 79-85 kW (107-116 PS) Z 18 XEL	04.2002→07.2008	 7.24809.10.0	AGR	EL	  →ch. 20AN8144
		7.05271.55.0	LS	800 mm	
1.8 (F69) 101-103 kW (137-140 PS) Z 18 XER	08.2005→08.2008	 7.04879.00.0	AGR-TH		 Öffnungstemperatur/opening temperature 105C
		7.05271.62.0	LS	500 mm	
1.8 16V 90-92 kW (122-125 PS) Z 18 XE	04.2002→09.2008	 7.24809.10.0	AGR	EL	  →ch. 20AN8144
		7.05271.55.0	LS	800 mm	
1.9 CDTI (F69) 88 kW (120 PS) Z 19 DT	04.2004→01.2009	 7.22946.38.0	AGR	EL	
		7.08369.05.0	ATS	EL	
		7.08369.38.0	ATS	EL	Fahrgestellnummer ab: 51065674, 58 Vehicle Identification Number from: 51065674, 58 nach Rußpartikelfilter after soot particulate filter
		7.11190.03.0	DDS		ohne Zubehör without accessories Fahrgestellnummer bis: 48999999, 71021891 Vehicle Identification Number to: 48999999, 71021891
		7.11190.04.0	DDS		Fahrgestellnummer ab: 71021892, 78 Vehicle Identification Number from: 71021892, 78
7.02604.99.0	LS	400 mm			

















					
VECTRA C (Z02)					
1.9 CDTI (F69) 110 kW (150 PS) Z 19 DTH		04.2004→08.2008	7.00063.10.0	AGR	EL 
		7.08369.05.0	ATS	EL	
		7.08369.38.0	ATS	EL	Fahrgestellnummer ab: 51065674, 58 Vehicle Identification Number from: 51065674, 58 nach Rußpartikelfilter after soot particulate filter
		7.11190.03.0	DDS		ohne Zubehör without accessories Fahrgestellnummer bis: 48999999, 71021891 Vehicle Identification Number to: 48999999, 71021891
		7.11190.04.0	DDS		Fahrgestellnummer ab: 71021892, 78 Vehicle Identification Number from: 71021892, 78
			7.02604.99.0	LS	400 mm
1.9 CDTI (F69) 74 kW (101 PS) Z 19 DTL		10.2005→08.2008	7.22946.38.0	AGR	EL 
		7.08369.05.0	ATS	EL	
		7.08369.38.0	ATS	EL	Fahrgestellnummer ab: 51065674, 58 Vehicle Identification Number from: 51065674, 58 nach Rußpartikelfilter after soot particulate filter
		7.11190.03.0	DDS		ohne Zubehör without accessories Fahrgestellnummer bis: 48999999, 71021891 Vehicle Identification Number to: 48999999, 71021891
		7.11190.04.0	DDS		Fahrgestellnummer ab: 71021892, 78 Vehicle Identification Number from: 71021892, 78
			7.02604.99.0	LS	400 mm
2.0 16V Turbo (F69) 129 kW (175 PS) Z 20 NET		03.2003→08.2008	7.05270.27.0	LS	400 mm  →ch. 41039263
			7.05270.37.0	LS	1640 mm
2.0 DTI 16V (F69) 74 kW (101 PS) Y 20 DTH		04.2002→08.2006	7.24809.29.0	AGR	ET 
2.2 16V (F69) 108 kW (147 PS) Z 22 SE		04.2002→12.2008	7.22630.28.0	AGR	EL  →11293531
2.2 DTI 16V (F69) 86-92 kW (117-125 PS) Y 22 DTR		04.2002→07.2004	7.24809.29.0	AGR	ET 
2.2 DTI 16V (F69) 86-92 kW (117-125 PS) Y 22 DTR		04.2002→12.2004	7.24809.29.0	AGR	ET 
2.8 V6 Turbo (F69) 169 kW (230 PS) Z 28 NEL		08.2005→10.2006	7.02604.08.0	LS	350 mm
2.8 V6 Turbo (F69) 184-206 kW (250-280 PS) Z 28 NET		08.2005→09.2006	7.02604.08.0	LS	350 mm
2.8 V6 Turbo (F69) 184-206 kW (250-280 PS) Z 28 NET		08.2005→08.2008	7.02604.08.0	LS	350 mm



VECTRA C (Z02) 87

2.8 V6 Turbo OPC (F69) 184-206 kW (250-280 PS) Z 28 NET	09.2006→08.2008		7.02604.08.0	LS	350 mm	
3.0 CDTi (F69) 135 kW (184 PS) Z 30 DT	08.2005→08.2008		7.11190.04.0	DDS		
3.2 V6 (F69) 155 kW (211 PS) Z 32 SE	08.2002→07.2006		7.02604.08.0	LS	350 mm	
			7.05271.81.0	LS	210 mm	vor Katalysator, nach Katalysator in front of the catalyst, Post-catalyst

VECTRA C Estate (Z02) 88

1.6 (F35) 74-77 kW (101-105 PS) Z 16 XEP	12.2005→08.2008		7.28384.13.0	AGR	EL	
			7.04879.00.0	AGR-TH		
			7.02604.05.0	LS	550 mm	Öffnungstemperatur/opening temperature 105C  →20HH5427 vor Katalysator in front of the catalyst
1.6 16V (F35) 74-76 kW (101-103 PS) Z 16 XE	06.2004→09.2005		7.24809.10.0	AGR	EL	  →ch. 20CR2605
			7.05271.76.0	LS	630 mm	
			7.05270.26.0	LS	300 mm	Diagnosesonde Diagnostic Probe
1.8 (F35) 90-92 kW (122-125 PS) Z 18 XE	10.2003→09.2006		7.24809.10.0	AGR	EL	  →ch. 20AN8144
			7.05271.55.0	LS	800 mm	
1.8 (F35) 101-103 kW (137-140 PS) Z 18 XER	08.2005→08.2008		7.04879.00.0	AGR-TH		
			7.05271.62.0	LS	500 mm	Öffnungstemperatur/opening temperature 105C
1.9 CDTi (F35) 88 kW (120 PS) Z 19 DT	04.2004→01.2009		7.22946.38.0	AGR	EL	
			7.08369.05.0	ATS	EL	
			7.08369.38.0	ATS	EL	Fahrgestellnummer ab: 51065674, 58 Vehicle Identification Number from: 51065674, 58 nach Rußpartikelfilter after soot particulate filter
			7.11190.03.0	DDS		ohne Zubehör without accessories Fahrgestellnummer bis: 48999999, 71021891 Vehicle Identification Number to: 48999999, 71021891
			7.11190.04.0	DDS		Fahrgestellnummer ab: 71021892, 78 Vehicle Identification Number from: 71021892, 78
			7.02604.99.0	LS	400 mm	
1.9 CDTi (F35) 110 kW (150 PS) Z 19 DTH	04.2004→08.2008		7.00063.10.0	AGR	EL	
			7.08369.05.0	ATS	EL	
			7.08369.38.0	ATS	EL	Fahrgestellnummer ab: 51065674, 58 Vehicle Identification Number from: 51065674, 58 nach Rußpartikelfilter after soot particulate filter

VECTRA C Estate (Z02)
88

















			7.11190.03.0	DDS		ohne Zubehör without accessories Fahrgestellnummer bis: 48999999, 71021891 Vehicle Identification Number to: 48999999, 71021891
			7.11190.04.0	DDS		Fahrgestellnummer ab: 71021892, 78 Vehicle Identification Number from: 71021892, 78
			7.02604.99.0	LS	400 mm	
1.9 CDTI (F35) 74 kW (101 PS) Z 19 DTL	06.2005→08.2008		7.22946.38.0	AGR	EL	
			7.08369.05.0	ATS	EL	
			7.08369.38.0	ATS	EL	Fahrgestellnummer ab: 51065674, 58 Vehicle Identification Number from: 51065674, 58 nach Rußpartikelfilter after soot particulate filter
			7.11190.03.0	DDS		ohne Zubehör without accessories Fahrgestellnummer bis: 48999999, 71021891 Vehicle Identification Number to: 48999999, 71021891
			7.11190.04.0	DDS		Fahrgestellnummer ab: 71021892, 78 Vehicle Identification Number from: 71021892, 78
			7.02604.99.0	LS	400 mm	
2.0 DTI (F35) 74 kW (101 PS) Y 20 DTH	10.2003→08.2005		7.24809.29.0	AGR	ET	
2.0 Turbo (F35) 129 kW (175 PS) Z 20 NET	10.2003→08.2008		7.05270.27.0	LS	400 mm	→ch. 41039263
			7.05270.37.0	LS	1640 mm	
2.2 DTI (F35) 86-92 kW (117-125 PS) Y 22 DTR	10.2003→12.2005		7.24809.29.0	AGR	ET	
2.8 V6 Turbo (F35) 169 kW (230 PS) Z 28 NEL	08.2005→10.2008		7.02604.08.0	LS	350 mm	
2.8 V6 Turbo (F35) 184-206 kW (250-280 PS) Z 28 NET	08.2005→09.2008		7.02604.08.0	LS	350 mm	
2.8 V6 Turbo (F35) 184-206 kW (250-280 PS) Z 28 NET	08.2005→08.2008		7.02604.08.0	LS	350 mm	
2.8 V6 Turbo (F35) 184-206 kW (250-280 PS) Z 28 NET	07.2006→08.2008		7.02604.08.0	LS	350 mm	
3.0 V6 CDTI (F35) 135 kW (184 PS) Z 30 DT	08.2005→08.2008		7.11190.04.0	DDS		
3.2 V6 (F35) 155 kW (211 PS) Z 32 SE	10.2003→07.2005		7.02604.08.0	LS	350 mm	
			7.05271.81.0	LS	210 mm	vor Katalysator, nach Katalysator in front of the catalyst, Post-catalyst

VECTRA C GTS (Z02)
89

1.6 (F68) 74-76 kW (101-103 PS) Z 16 XE	08.2005→08.2008		7.24809.10.0	AGR	EL	→ch. 20CR2605
			7.05271.76.0	LS	630 mm	



VECTRA C GTS (Z02) **89**

			7.05270.26.0	LS	300 mm	Diagnosesonde Diagnostic Probe
1.6 (F68) 74-77 kW (101-105 PS) Z 16 XEP	01.2006→08.2008		7.28384.13.0	AGR	EL	
			7.04879.00.0	AGR-TH		
			7.02604.05.0	LS	550 mm	 →20HH5427 vor Katalysator in front of the catalyst
1.8 (F68) 101-103 kW (137-140 PS) Z 18 XER	08.2005→08.2008		7.04879.00.0	AGR-TH		
			7.05271.62.0	LS	500 mm	Öffnungstemperatur/opening temperature 105C
1.8 16V (F68) 90-92 kW (122-125 PS) Z 18 XE	08.2002→09.2008		7.24809.10.0	AGR	EL	 →ch. 20AN8144
			7.05271.55.0	LS	800 mm	
1.8 16V (F68) 79-85 kW (107-116 PS) Z 18 XEL	08.2002→12.2006		7.24809.10.0	AGR	EL	 →ch. 20AN8144
1.9 CDTI (F68) 88 kW (120 PS) Z 19 DT	04.2004→01.2009		7.22946.38.0	AGR	EL	
			7.08369.05.0	ATS	EL	
			7.08369.38.0	ATS	EL	Fahrgestellnummer ab: 51065674, 58 Vehicle Identification Number from: 51065674, 58 nach Rußpartikelfilter after soot particulate filter
			7.11190.03.0	DDS		ohne Zubehör without accessories Fahrgestellnummer bis: 48999999, 71021891 Vehicle Identification Number to: 48999999, 71021891
			7.11190.04.0	DDS		Fahrgestellnummer ab: 71021892, 78 Vehicle Identification Number from: 71021892, 78
1.9 CDTI (F68) 110 kW (150 PS) Z 19 DTH	04.2004→08.2008		7.00063.10.0	AGR	EL	
			7.08369.05.0	ATS	EL	
			7.08369.38.0	ATS	EL	Fahrgestellnummer ab: 51065674, 58 Vehicle Identification Number from: 51065674, 58 nach Rußpartikelfilter after soot particulate filter
			7.11190.03.0	DDS		ohne Zubehör without accessories Fahrgestellnummer bis: 48999999, 71021891 Vehicle Identification Number to: 48999999, 71021891
			7.11190.04.0	DDS		Fahrgestellnummer ab: 71021892, 78 Vehicle Identification Number from: 71021892, 78
1.9 CDTI (F68) 74 kW (101 PS) Z 19 DTL	06.2005→08.2008		7.22946.38.0	AGR	EL	
			7.08369.05.0	ATS	EL	

VECTRA C GTS (Z02)
89

			7.08369.38.0	ATS	EL	Fahrgestellnummer ab: 51065674, 58 Vehicle Identification Number from: 51065674, 58 nach Rußpartikelfilter after soot particulate filter
			7.11190.03.0	DDS		ohne Zubehör without accessories
			7.11190.04.0	DDS		Fahrgestellnummer bis: 48999999, 71021891 Vehicle Identification Number to: 48999999, 71021891
			7.02604.99.0	LS	400 mm	Fahrgestellnummer ab: 71021892, 78 Vehicle Identification Number from: 71021892, 78
2.0 16V Turbo (F68) 129 kW (175 PS) Z 20 NET	03.2003→08.2008		7.05270.27.0	LS	400 mm	→ch. 41039263
			7.05270.37.0	LS	1640 mm	
2.0 DTI 16V (F68) 74 kW (101 PS) Y 20 DTH	08.2002→08.2005		7.24809.29.0	AGR	ET	
2.2 16V (F68) 108 kW (147 PS) Z 22 SE	08.2002→08.2008		7.22630.28.0	AGR	EL	→11293531
2.2 DTI 16V (F68) 86-92 kW (117-125 PS) Y 22 DTR	08.2002→07.2006		7.24809.29.0	AGR	ET	
2.2 DTI 16V (F68) 86-92 kW (117-125 PS) Y 22 DTR	08.2002→06.2008		7.24809.29.0	AGR	ET	
2.8 V6 Turbo (F68) 169 kW (230 PS) Z 28 NEL	08.2005→08.2008		7.02604.08.0	LS	350 mm	
2.8 V6 Turbo (F68) 184-206 kW (250-280 PS) Z 28 NET	08.2005→09.2008		7.02604.08.0	LS	350 mm	
2.8 V6 Turbo (F68) 184-206 kW (250-280 PS) Z 28 NET	08.2005→08.2008		7.02604.08.0	LS	350 mm	
2.8 V6 Turbo (F68) 184-206 kW (250-280 PS) Z 28 NET	08.2006→08.2008		7.02604.08.0	LS	350 mm	
3.0 CDTi (F68) 135 kW (184 PS) Z 30 DT	08.2005→08.2008		7.11190.04.0	DDS		
3.2 V6 (F68) 155 kW (211 PS) Z 32 SE	08.2002→07.2006		7.02604.08.0	LS	350 mm	
			7.05271.81.0	LS	210 mm	vor Katalysator, nach Katalysator in front of the catalyst, Post-catalyst









ZAFIRA / ZAFIRA FAMILY B (A05)
90

1.6 (M75) 74-77 kW (101-105 PS) Z 16 XE1, Z 16 XEP	07.2005→09.2012		7.28384.13.0	AGR	EL	
			7.04879.00.0	AGR-TH		 Öffnungstemperatur/opening temperature 105C
			7.02604.05.0	LS	550 mm	Z 16 XE1, Z 16 XEP: →20HH5427 vor Katalysator in front of the catalyst
1.6 (M75) 84-85 kW (114-116 PS) A 16 XER, Z 16 XER	01.2008→04.2015		7.04879.00.0	AGR-TH		 Öffnungstemperatur/opening temperature 105C



ZAFIRA / ZAFIRA FAMILY B (A05)

90

			7.05271.62.0	LS	500 mm	
1.6 FlexFuel (M75) 85 kW (116 PS) Z 16 XER	08.2008→12.2012		7.04879.00.0	AGR-TH		⊗ Öffnungstemperatur/opening temperature 105C
1.7 CDTI (M75) 81 kW (110 PS) A 17 DTJ	01.2008→04.2015		7.10334.08.0	AGR	EL	⊗
			7.08369.49.0	ATS	EL	
			7.08369.75.0	ATS	EL	
1.7 CDTI (M75) 81 kW (110 PS) Z 17 DTJ	01.2008→04.2015		7.10334.08.0	AGR	EL	⊗
			7.08369.49.0	ATS	EL	
			7.08369.74.0	ATS	EL	
1.7 CDTI (M75) 92 kW (125 PS) A 17 DTR	01.2008→04.2015		7.10334.08.0	AGR	EL	⊗
			7.08369.49.0	ATS	EL	
			7.08369.75.0	ATS	EL	
1.8 (M75) 101-103 kW (137-140 PS) A 18 XER, Z 18 XER	07.2005→04.2015		7.04879.00.0	AGR-TH		⊗ Öffnungstemperatur/opening temperature 105C
			7.05271.62.0	LS	500 mm	
1.8 (M75) 85-88 kW (116-120 PS) A 18 XEL	06.2013→04.2015		7.04879.00.0	AGR-TH		⊗ Öffnungstemperatur/opening temperature 105C
1.9 CDTI (M75) 110 kW (150 PS) Z 19 DTH	07.2005→04.2015		7.00063.10.0	AGR	EL	⊗
			7.08369.05.0	ATS	EL	
			7.08369.32.0	ATS	EL	
			7.11190.03.0	DDS		ohne Zubehör without accessories Fahrgestellnummer bis: 62167884, 6G119243 Vehicle Identification Number to: 62167884, 6G119243
			7.11190.04.0	DDS		Fahrgestellnummer ab: 62127885, 6G119244 Vehicle Identification Number from: 62127885, 6G119244
			7.02604.99.0	LS	400 mm	
1.9 CDTI (M75) 74 kW (101 PS) Z 19 DTL	07.2005→12.2010		7.22946.38.0	AGR	EL	⊗
			7.08369.05.0	ATS	EL	
			7.08369.32.0	ATS	EL	
			7.11190.03.0	DDS		ohne Zubehör without accessories Fahrgestellnummer bis: 62167884, 6G119243 Vehicle Identification Number to: 62167884, 6G119243
			7.11190.04.0	DDS		für OE-Nummer: 62127885, 6G119244 for OE number: 62127885, 6G119244
			7.02604.99.0	LS	400 mm	
1.9 CDTI (M75) 88 kW (120 PS) Z 19 DT	07.2005→04.2015		7.22946.38.0	AGR	EL	⊗
			7.08369.05.0	ATS	EL	
			7.08369.32.0	ATS	EL	

O

ZAFIRA / ZAFIRA FAMILY B (A05)
90

			7.11190.03.0	DDS		ohne Zubehör without accessories Fahrgestellnummer bis: 62167884, 6G119243 Vehicle Identification Number to: 62167884, 6G119243
			7.11190.04.0	DDS		Fahrgestellnummer ab: 62127885, 6G119244 Vehicle Identification Number from: 62127885, 6G119244
			7.02604.99.0	LS	400 mm	
2.0 (M75) 147 kW (200 PS) Z 20 LER	07.2005→12.2010		7.02604.07.0	LS	570 mm	vor Katalysator in front of the catalyst
2.0 (M75) 177 kW (240 PS) Z 20 LEH	01.2006→12.2010		7.02604.07.0	LS	570 mm	vor Katalysator in front of the catalyst
2.2 (M75) 110-114 kW (150-155 PS) Z 22 YH	07.2005→12.2012		7.02604.08.0	LS	350 mm	









ZAFIRA A MPV (T98)
91

1.6 (F75) 74-76 kW (101-103 PS) Z 16 XE	10.2003→06.2005		7.24809.10.0	AGR	EL	→ch. 42999999
1.6 16V (F75) 74-76 kW (101-103 PS) Z 16 XE	09.2000→06.2005		7.24809.10.0	AGR	EL	→ch. 42999999
			7.05270.25.0	LS	800 mm	→ch. 12999999 Diagnosesonde Diagnostic Probe
			7.05271.76.0	LS	630 mm	
			7.05270.26.0	LS	300 mm	ch. 28000001→ Regelsonde Regulating Probe
1.6 CNG (F75) 69-74 kW (94-101 PS) Z 16 YNG	09.2001→06.2005		7.24809.10.0	AGR	EL	→ch. 42009015
			7.05270.25.0	LS	800 mm	
			7.05271.76.0	LS	630 mm	
			7.05270.26.0	LS	300 mm	ch. 22000001→ Regelsonde Regulating Probe
1.6 LPG (F75) 74-76 kW (101-103 PS) Z 16 XE	04.1999→06.2005		7.24809.10.0	AGR	EL	→ch. 42999999
			7.05271.76.0	LS	630 mm	
1.6 LPG (F75) 74-77 kW (101-105 PS) Z 16 XEP	10.2003→06.2005		7.04879.00.0	AGR-TH		 Öffnungstemperatur/opening temperature 105C
			7.02604.05.0	LS	550 mm	für OE-Nummer: 8 55 510, 93174519 for OE number: 8 55 510, 93174519
1.8 16V (F75) 85 kW (115 PS) X 18 XE1	04.1999→09.2000		7.24809.10.0	AGR	EL	
			7.05270.32.0	LS	825 mm	
1.8 16V (F75) 90-92 kW (122-125 PS) Z 18 XE	09.2000→06.2005		7.05271.55.0	LS	800 mm	















O



ZAFIRA A MPV (T98) **91**

2.0 DI 16V (F75) 60-63 kW (82-86 PS) X 20 DTL	10.1999→06.2005	7.24809.24.0*	AGR	PN	mit Saugrohr with suction pipe  für Hersteller-Abgasnorm: NC8 for manufacturer exhaust norm: NC8
		↳ 7.24809.27.0	AGR	PN	
		7.24809.25.0*	AGR	PN	mit Saugrohr with suction pipe  96 EEC, D3 96 EEC, D3
		↳ 7.24809.28.0	AGR	PN	
2.0 DTI 16V (F75) 74 kW (101 PS) Y 20 DTH	09.2000→06.2005	7.24809.25.0*	AGR	PN	mit Saugrohr with suction pipe   →ch. 22999999
		↳ 7.24809.28.0	AGR	PN	
		7.24809.29.0	AGR	ET	
2.2 16V (F75) 108 kW (147 PS) Z 22 SE	09.2000→06.2005	7.22630.28.0	AGR	EL	 →11292859
		7.05270.29.0	LS	630 mm	
		7.05270.30.0	LS	1275 mm	
2.2 DTI 16V (F75) 86-92 kW (117-125 PS) Y 22 DTR	01.2002→06.2005	7.24809.29.0	AGR	ET	
2.2 DTI 16V (F75) 86-92 kW (117-125 PS) Y 22 DTR	01.2002→06.2005	7.24809.29.0	AGR	ET	

ZAFIRA TOURER C (P12) **92**

1.6 CDTI (75) 81-100 kW (110-136 PS) B 16 DTH	02.2013→	7.24809.81.0	AGR	EL	
		7.11020.42.0	ATS	EL	 B 16 DTH: für RPO Nummer: WM3 for RPO number: WM3  B 16 DTH:  ch. F2000001→ch. F2999999 für RPO Nummer: WM3 for RPO number: WM3  B 16 DTH:  ch. G1000001→
		7.11020.27.0	ATS	EL	Fahrgestellnummer ab: E2000001, F1000001 Vehicle Identification Number from: E2000001, F1000001
1.6 CDTI (75) 88 kW (120 PS) B 16 DTJ, D 16 DTJ	07.2014→	7.24809.81.0	AGR	EL	
		7.11020.42.0	ATS	EL	 B 16 DTJ, D 16 DTJ:  ch. F1000001→ch. F1999999 für RPO Nummer: WM3 for RPO number: WM3  B 16 DTJ, D 16 DTJ:  ch. F2000001→ch. F2999999 für RPO Nummer: WM3 for RPO number: WM3  B 16 DTJ, D 16 DTJ:  ch. G1000001→
		7.11020.27.0	ATS	EL	 B 16 DTJ, D 16 DTJ: Fahrgestellnummer ab: E2000001, F1000001 Vehicle Identification Number from: E2000001, F1000001

ZAFIRA TOURER C (P12)
92

























1.6 CDTi (75) 81-100 kW (110-136 PS) B 16 DTH, D 16 DTH	11.2016→		7.24809.81.0 AGR EL
			7.11020.27.0 ATS EL B 16 DTH, D 16 DTH: Fahrgestellnummer ab: E2000001, F1000001 Vehicle Identification Number from: E2000001, F1000001
1.8 (75) 101-103 kW (137-140 PS) A 18 XER	10.2011→		7.02604.07.0 LS 570 mm vor Katalysator in front of the catalyst
1.8 (75) 85-88 kW (116-120 PS) A 18 XEL	10.2011→		7.02604.07.0 LS 570 mm vor Katalysator in front of the catalyst
2.0 BiTurbo CDTi (75) 140-143 kW (190-195 PS) A 20 DTR	01.2013→		7.24809.78.0 AGR ET
2.0 CDTi (75) 96-121 kW (131-165 PS) A 20 DTH	10.2011→		7.11190.04.0 DDS
			7.24809.78.0 AGR ET
			7.08369.17.0 ATS EL
			7.11190.04.0 DDS 7.02604.44.0 LS 500 mm vor Katalysator in front of the catalyst
2.0 CDTi (75) 96 kW (131 PS) A 20 DT, Y 20 DTJ, Z 20 DTJ	10.2011→		7.24809.78.0 AGR ET
			7.08369.17.0 ATS EL
			7.11190.04.0 DDS
			7.02604.44.0 LS 500 mm A 20 DT, Y 20 DTJ, Z 20 DTJ: vor Katalysator in front of the catalyst
2.0 CDTi (75) 81 kW (110 PS) A 20 DTL	10.2011→		7.24809.78.0 AGR ET
			7.08369.17.0 ATS EL
			7.11190.04.0 DDS
			7.02604.44.0 LS 500 mm vor Katalysator in front of the catalyst
2.0 CDTi (75) 125 kW (170 PS) B 20 DTH, D 20 DTH	01.2015→		7.24809.87.0 AGR EL
2.0 CDTi (75) 96 kW (131 PS) B 20 DTJ, D 20 DTJ	06.2016→		7.24809.87.0 AGR EL

ASTRA F Estate Van (T92)
93







1.4 i (F70) 40-44 kW (54-60 PS) C 14 NZ	10.1991→01.1999		7.02604.15.0 LS 360 mm
1.6 i (F70) 55-60 kW (75-82 PS) C 16 NZ	10.1991→04.1993		7.02604.15.0 LS 360 mm
1.6 i (F70) 74 kW (101 PS) C 16 SE	03.1992→12.1994		7.02604.15.0 LS 360 mm
1.6 i (F70) 52 kW (71 PS) X 16 SZ	02.1993→07.1996		7.02604.15.0 LS 360 mm
1.6 i 16V (F70) 74 kW (101 PS) X 16 XEL	08.1994→03.1998		7.22296.02.0 ARV PN
			7.02604.15.0 LS 360 mm ch. S2531219→
1.8 i (F70) 66 kW (90 PS) C 18 NZ	06.1993→08.1994		7.02604.15.0 LS 360 mm























ASTRA G Estate Van (F70) 94

1.2 (F70) 48 kW (65 PS) X 12 XE	09.1998→08.2000		7.22414.07.0	AGR	EL	
			7.05271.76.0	LS	630 mm	
1.4 (F70) 66 kW (90 PS) Z 14 XE	09.1998→04.2005		7.24809.10.0	AGR	EL	  →ch. 42999999
			7.05271.76.0	LS	630 mm	
1.6 (F70) 74-76 kW (101-103 PS) Z 16 XE	09.1998→01.2004		7.24809.10.0	AGR	EL	  →ch. 42999999
			7.05271.76.0	LS	630 mm	
1.6 (F70) 55 kW (75 PS) X 16 SZR	01.1999→09.2000		7.24809.10.0	AGR	EL	
			7.02604.15.0	LS	360 mm	
1.6 (F70) 62-69 kW (84-94 PS) Z 16 SE	09.2000→04.2005		7.24809.10.0	AGR	EL	
			7.05270.26.0	LS	300 mm	 ch. 22000001→ Diagnosesonde Diagnostic Probe
1.6 (F70) 74-77 kW (101-105 PS) Z 16 XEP	02.2004→11.2004		7.28384.13.0	AGR	EL	
			7.04879.00.0	AGR-TH		 Öffnungstemperatur/opening temperature 105C
			7.02604.05.0	LS	550 mm	für OE-Nummer: 8 55 510, 93174519 for OE number: 8 55 510, 93174519
1.7 DTI 16V (F70) 55 kW (75 PS) Y 17 DT	02.2000→04.2005		7.22772.12.0	AGR	PN	
2.0 DI (F70) 60-63 kW (82-86 PS) X 20 DTL	01.1999→04.2005		7.24809.24.0*	AGR	PN	mit Saugrohr with suction pipe  für Hersteller-Abgasnorm: NC8 for manufacturer exhaust norm: NC8
			↳ 7.24809.27.0	AGR	PN	
			7.24809.25.0*	AGR	PN	mit Saugrohr with suction pipe  96 EEC, D3 96 EEC, D3
			↳ 7.24809.28.0	AGR	PN	
2.0 DTI (F70) 74 kW (101 PS) Y 20 DTH	09.2000→04.2005		7.24809.28.0	AGR	PN	 Fahrgestellnummer bis: 22999999, 25999999, 28999999, 2H999999 Vehicle Identification Number to: 22999999, 25999999, 28999999, 2H999999 für OE-Nummer: 849124, 849156, 9192805, 93170138 for OE number: 849124, 849156, 9192805, 93170138
			7.24809.29.0	AGR	ET	

ASTRA H Estate Van (L70) 95



1.3 CDTI (L70) 66-74 kW (90-101 PS) Z 13 DTH	08.2005→10.2010		7.00020.25.0	AGR	EL	
			7.08369.15.0	ATS	EL	
			7.11190.04.0	DDS		
1.4 EcoTec (L70) 66 kW (90 PS) Z 14 XEP	12.2004→12.2012		7.22875.16.0	AGR	EL	
			7.22875.13.0	AGR	EL	  →ch. 42999999

					
ASTRA H Estate Van (L70)					95
			7.02604.07.0	LS	570 mm →12.2005 vor Katalysator in front of the catalyst
1.6 EcoTec (L70) 74-77 kW (101-105 PS) Z 16 XEP	02.2004→11.2004		7.28384.13.0	AGR	EL 
			7.04879.00.0	AGR-TH	 Öffnungstemperatur/opening temperature 105C
			7.02604.05.0	LS	550 mm  →20HH5427 vor Katalysator in front of the catalyst
1.6 EcoTec (L70) 85 kW (116 PS) Z 16 XER	10.2006→12.2010		7.04879.00.0	AGR-TH	 Öffnungstemperatur/opening temperature 105C
1.7 CDTI (L70) 81 kW (110 PS) A 17 DTJ	02.2007→10.2010		7.08369.49.0	ATS	EL
			7.08369.75.0	ATS	EL
			7.11190.04.0	DDS	
1.7 CDTI (L70) 81 kW (110 PS) Z 17 DTJ	02.2007→10.2010		7.08369.49.0	ATS	EL
			7.08369.74.0	ATS	EL
			7.11190.04.0	DDS	
1.7 CDTI (L70) 92 kW (125 PS) A 17 DTR	02.2007→10.2010		7.08369.49.0	ATS	EL
			7.08369.75.0	ATS	EL
			7.11190.04.0	DDS	
1.7 CDTI (L70) 92 kW (125 PS) Z 17 DTR	02.2007→10.2010		7.08369.49.0	ATS	EL
			7.08369.74.0	ATS	EL
			7.11190.04.0	DDS	
1.9 CDTI (L70) 110 kW (150 PS) Z 19 DTH	09.2004→10.2010		7.00063.10.0	AGR	EL 
			7.08369.05.0	ATS	EL
			7.08369.32.0	ATS	EL
			7.11190.03.0	DDS	
			7.11190.04.0	DDS	ohne Zubehör without accessories Fahrgestellnummer bis: 62167207, 65165230, 68124718 Vehicle Identification Number to: 62167207, 65165230, 68124718 für OE-Nummer: 62167207, 65165231, 68124719, 8B000001 for OE number: 62167207, 65165231, 68124719, 8B000001
7.02604.99.0	LS	400 mm			
1.9 CDTI (L70) 74 kW (101 PS) Z 19 DTL	08.2005→12.2012		7.22946.38.0	AGR	EL 
			7.08369.05.0	ATS	EL
			7.08369.32.0	ATS	EL
			7.11190.03.0	DDS	
			7.11190.04.0	DDS	ohne Zubehör without accessories Fahrgestellnummer bis: 62167207, 65165230, 68124718 Vehicle Identification Number to: 62167207, 65165230, 68124718 Fahrgestellnummer ab: 62167207, 65165231, 68124719, 8B000001 Vehicle Identification Number from: 62167207, 65165231, 68124719, 8B000001

O



ASTRA H Estate Van (L70) 95

1.9 CDTi (L70) 88 kW (120 PS) Z 19 DT	09.2005→10.2010		7.22946.38.0	AGR	EL	<input type="checkbox"/> ohne Zubehör without accessories Fahrgestellnummer bis: 62167207, 65165230, 68124718 Vehicle Identification Number to: 62167207, 65165230, 68124718 Fahrgestellnummer ab: 62167207, 65165231, 68124719, 8B000001 Vehicle Identification Number from: 62167207, 65165231, 68124719, 8B000001
			7.08369.05.0	ATS	EL	
			7.08369.32.0	ATS	EL	
			7.11190.03.0	DDS		
			7.11190.04.0	DDS		
7.02604.99.0	LS	400 mm				
1.9 CDTi 16V (L70) 88 kW (120 PS) Z 19 DTJ	08.2004→10.2010		7.00063.10.0	AGR	EL	<input type="checkbox"/> ohne Zubehör without accessories Fahrgestellnummer bis: 62167207, 65165230, 68124718 Vehicle Identification Number to: 62167207, 65165230, 68124718
			7.08369.05.0	ATS	EL	
			7.08369.32.0	ATS	EL	
			7.11190.03.0	DDS		
			7.02604.99.0	LS	400 mm	

ASTRA J Estate Van (P10) 96

1.3 CDTi (35) 70 kW (95 PS) A 13 DTE	10.2012→10.2015		7.03622.11.0	AGR-K	EL	<input type="checkbox"/> <input type="checkbox"/> <input type="checkbox"/> <input type="checkbox"/> <input type="checkbox"/> →ch. BG999999 für OE-Nummer: 55564978 for OE number: 55564978
			7.03622.10.0	AGR-K	EL	
			7.03622.09.0	AGR-K		
			7.03622.06.0	AGR-K		
			7.11190.04.0	DDS		
			7.02604.44.0	LS	500 mm	

1.6 CDTi (35) 81 kW (110 PS) B 16 DTL	01.2014→10.2015		7.24809.81.0	AGR	EL	<input type="checkbox"/>
---	-----------------	---	---------------------	-----	----	--------------------------

ASTRA J Estate Van (P10) 96

			7.11020.42.0	ATS	EL	B 16 DTL: ch. F0000001→ch. F0999999 für RPO Nummer: WM3 for RPO number: WM3 B 16 DTL: ch. F1000001→ch. F1999999 für RPO Nummer: WM3 for RPO number: WM3 B 16 DTL: ch. F3000001→ch. F3999999 für RPO Nummer: WM3 for RPO number: WM3 B 16 DTL: ch. F8000001→ch. F8999999 für RPO Nummer: WM3 for RPO number: WM3 B 16 DTL: ch. FG000001→ch. FG999999 für RPO Nummer: WM3 for RPO number: WM3 B 16 DTL: Fahrgestellnummer ab: G0000001, G1000001, G8000001, GG000001 Vehicle Identification Number from: G0000001, G1000001, G8000001, GG000001
			7.11020.27.0	ATS	EL	
1.7 CDTi (35) 96 kW (131 PS) A 17 DTF, A 17 DTS	10.2012→10.2015		7.11020.38.0	ATS	EL	
			7.11190.04.0	DDS		
2.0 CDTi (35) 96-121 kW (131-165 PS) A 20 DTH	10.2012→10.2015		7.24809.78.0	AGR	ET	
			7.08369.17.0	ATS	EL	
			7.11190.04.0	DDS		
			7.02604.44.0	LS	500 mm	vor Katalysator in front of the catalyst

ASTRA J Hatchback Van (P10) 97

1.3 CDTi (68) 70 kW (95 PS) A 13 DTE	05.2013→10.2015		7.03622.11.0	AGR-K	EL	
			7.03622.10.0	AGR-K	EL	
			7.03622.09.0	AGR-K		
			7.03622.06.0	AGR-K		
			7.11190.04.0	DDS		→ch. BG999999
			7.02604.44.0	LS	500 mm	für OE-Nummer: 55564978 for OE number: 55564978
1.6 CDTi (68) 81 kW (110 PS) B 16 DTL	01.2014→10.2015		7.24809.81.0	AGR	EL	



ASTRA J Hatchback Van (P10) 97

			7.11020.42.0	ATS	EL	B 16 DTL: ch. F0000001→ch. F0999999 für RPO Nummer: WM3 for RPO number: WM3 B 16 DTL: ch. F1000001→ch. F1999999 für RPO Nummer: WM3 for RPO number: WM3 B 16 DTL: ch. F3000001→ch. F3999999 für RPO Nummer: WM3 for RPO number: WM3 B 16 DTL: ch. F8000001→ch. F8999999 für RPO Nummer: WM3 for RPO number: WM3 B 16 DTL: ch. FG000001→ch. FG999999 für RPO Nummer: WM3 for RPO number: WM3 B 16 DTL: ch. G0000001→ B 16 DTL: ch. G1000001→ B 16 DTL: ch. G8000001→ B 16 DTL: ch. GG000001→
1.7 CDTi (68) 81 kW (110 PS) A 17 DTC, A 17 DTE	05.2013→10.2015		7.11020.27.0 7.11020.38.0 7.11190.04.0	ATS ATS DDS	EL EL	

ASTRA K Hatchback Van 98

1.6 CDTi 99-100 kW (135-136 PS) D 16 DTH	04.2018→		7.24809.81.0	AGR	EL	
--	----------	--	---------------------	-----	----	--

COMBO Box Body/MPV 99

1.3 CDTi 16V 51-59 kW (70-80 PS) Z 13 DT	08.2005→		7.00020.24.0	AGR	EL	
1.3 CDTi 16V 55 kW (75 PS) Z 13 DTJ	10.2005→12.2012		7.00020.24.0 7.08369.15.0	AGR ATS	EL EL	
1.4 16V 66 kW (90 PS) Z 14 XEP	08.2005→		7.22875.13.0 7.22875.16.0	AGR AGR	EL EL	→ch. 43999999
1.6 62-69 kW (84-94 PS) Z 16 SE	10.2001→		7.24809.10.0	AGR	EL	→ch. 46999999
1.7 DI 16V 48 kW (65 PS) Y 17 DTL	10.2001→		7.22772.11.0 7.22772.12.0	AGR AGR	PN PN	mit Potentiometer with potentiometer ch. 00782974→ →ch. 00782973
1.7 DTi 16V 55 kW (75 PS) Y 17 DT	10.2001→		7.22772.11.0 7.22772.12.0	AGR AGR	PN PN	mit Potentiometer with potentiometer ch. 00782974→ →ch. 00782973

COMBO Box Body/MPV (71_) 100



































1.2 33 kW (45 PS) C 12 NZ, X 12 SZ	07.1994→10.2001		7.02604.01.0	LS	200 mm	
1.4 40-44 kW (54-60 PS) C 14 NZ, X 14 SZ	07.1994→10.2001		7.02604.01.0	LS	200 mm	
1.4 16V 63-69 kW (86-94 PS) X 14 XE	08.1999→10.2001		7.22296.02.0	ARV	PN	

COMBO Box Body/MPV (X12) 101

1.3 CDTI (B05) 55-70 kW (75-95 PS) A 13 FD	02.2012→		7.04589.06.0	AGR	EL	<input type="radio"/>	03.2016→ Euro 6 Euro 6
			7.03622.10.0	AGR-K	EL	<input type="radio"/>	Euro 5 Euro 5 mit AGR-Ventil with EGR valve
			7.11190.03.0	DDS			ohne Zubehör without accessories
1.3 CDTI (B05) 55-70 kW (75-95 PS) A 13 FD	02.2012→		7.03622.10.0	AGR-K	EL	<input type="radio"/>	Euro 5 Euro 5 mit AGR-Ventil with EGR valve
			7.11190.03.0	DDS			ohne Zubehör without accessories
1.3 CDTI (B05) 55-70 kW (75-95 PS) A 13 FD	03.2016→		7.04589.06.0	AGR	EL	<input type="radio"/>	Euro 6 Euro 6
			7.03622.10.0	AGR-K	EL	<input type="radio"/>	Euro 5 Euro 5 mit AGR-Ventil with EGR valve
			7.11190.03.0	DDS			ohne Zubehör without accessories
1.6 CDTI (B05) 66-88 kW (90-120 PS) A 16 FDL	02.2012→		7.24809.77.0	AGR	ET	<input checked="" type="checkbox"/>	
			7.11020.41.0	ATS	EL		ohne Zubehör without accessories
			7.11190.03.0	DDS			
1.6 CDTI (B05) 74-77 kW (101-105 PS) A 16 FDH	02.2012→		7.24809.77.0	AGR	ET	<input checked="" type="checkbox"/>	
			7.11020.41.0	ATS	EL		ohne Zubehör without accessories
			7.11190.03.0	DDS			
1.6 CDTI (B05) 66-88 kW (90-120 PS) A 16 FDL	02.2012→		7.24809.77.0	AGR	ET	<input checked="" type="checkbox"/>	
			7.11020.41.0	ATS	EL		ohne Zubehör without accessories
			7.11190.03.0	DDS			
1.6 CDTI (B05) 66-88 kW (90-120 PS) A 16 FDL	04.2015→		7.24809.77.0	AGR	ET	<input checked="" type="checkbox"/>	
			7.11020.41.0	ATS	EL		ohne Zubehör without accessories
			7.11190.03.0	DDS			
2.0 CDTI (B05) 99 kW (135 PS) A 20 FD	02.2012→		7.24809.77.0	AGR	ET	<input checked="" type="checkbox"/>	
			7.11020.41.0	ATS	EL		ohne Zubehör without accessories
			7.11190.03.0	DDS			

COMBO Box Body/MPV (X19) 102

1.5 D 56 kW (76 PS) D 15 DTL (DV5RE)	08.2018→		7.07794.23.0	AGR	EL		mit Dichtring with O-ring
---	----------	--	--------------	-----	----	--	------------------------------















			 PIERBURG			
COMBO Box Body/MPV (X19)						102
1.5 D 75 kW (102 PS) D 15 DT (DV5RD)	08.2018→		7.07794.23.0	AGR	EL	mit Dichtring with O-ring
1.5 D 88-96 kW (120-131 PS) D 15 DTH (DV5RC)	08.2018→		7.07794.23.0	AGR	EL	mit Dichtring with O-ring
CORSA A Hatchback Van (S83)						103
1.2 (F08, W5L) 33 kW (45 PS) 12 NC, E 12 GV	02.1986→04.1989		7.02604.01.0	LS	200 mm	
1.2 (F08, W5L) 40-43 kW (55-58 PS) 12 ST	02.1986→04.1989		7.02604.01.0	LS	200 mm	
1.2 (F08, W5L) 40-44 kW (54-60 PS) 12 S	02.1986→07.1990		7.02604.01.0	LS	200 mm	
1.2 (F08, W5L) 33 kW (45 PS) C 12 NZ	08.1990→07.1994		7.02604.15.0	LS	360 mm	
1.3 (F08, W5L) 44 kW (60 PS) 13 NB	02.1986→04.1989		7.02604.01.0	LS	200 mm	
1.3 (F08, W5L) 51 kW (70 PS) 13 SB	02.1986→04.1989		7.02604.01.0	LS	200 mm	
CORSA B Hatchback Van (S93)						104
1.2 (F08, W5L) 33 kW (45 PS) C 12 NZ	08.1994→12.2001		7.02604.15.0	LS	360 mm	
1.4 i (F08, W5L) 40-44 kW (54-60 PS) C 14 NZ, X 14 SZ	08.1999→09.2000		7.02604.15.0	LS	360 mm	
CORSA C Hatchback Van (X01)						105
1.2 (F08, W5L) 55-59 kW (75-80 PS) Z 12 XEP	07.2005→06.2006		7.22875.16.0	AGR	EL	 ch. 53000001→
			7.22875.13.0	AGR	EL	 →ch. 43999999
			7.02604.07.0	LS	570 mm	→12.2005 vor Katalysator in front of the catalyst
1.2 16V (F08, W5L) 55 kW (75 PS) Z 12 XE	09.2000→07.2003		7.22875.13.0	AGR	EL	 →ch. 24999999
1.3 CDTI 16V (F08, W5L) 51-59 kW (70-80 PS) Z 13 DT	07.2005→06.2006		7.00020.24.0	AGR	EL	
1.4 (W5L, F08) 66 kW (90 PS) Z 14 XEP	08.2003→06.2012		7.22875.16.0	AGR	EL	 ch. 53000001→
			7.22875.13.0	AGR	EL	 →ch. 43999999
			7.02604.07.0	LS	570 mm	→12.2005 vor Katalysator in front of the catalyst
			7.02604.08.0	LS	350 mm	Diagnosesonde Diagnostic Probe
1.7 DI 16V (F08, W5L) 48 kW (65 PS) Y 17 DTL	09.2000→07.2003		7.22772.12.0	AGR	PN	
1.7 DTI 16V (F08, W5L) 55 kW (75 PS) Y 17 DT	09.2000→07.2003		7.22772.12.0	AGR	PN	
CORSA D Hatchback Van (S07)						106
1.0 (L08) 44-48 kW (60-65 PS) A 10 XEP	08.2006→08.2014		7.22875.16.0	AGR	EL	
1.0 (L08) 44-48 kW (60-65 PS) A 10 XEP	01.2010→08.2014		7.22875.16.0	AGR	EL	

CORSA D Hatchback Van (S07)						106
1.2 (L08) 55-59 kW (75-80 PS) Z 12 XEP	08.2006→08.2014		7.22875.16.0	AGR	EL	
			7.02604.08.0	LS	350 mm Diagnosesonde Diagnostic Probe	
1.3 CDTi (L08) 55 kW (75 PS) A 13 DTC	07.2006→08.2014		7.01599.10.0	AGR	EL	
			7.03622.10.0	AGR-K	EL mit AGR-Ventil with EGR valve	
			7.03622.09.0	AGR-K	 A 13 DTC: ch. C4000001→ ohne AGR-Ventil without EGR valve	
			7.03622.06.0	AGR-K	 A 13 DTC: ch. C6000001→ ohne AGR-Ventil without EGR valve	
			7.08369.46.0 7.11190.04.0	ATS DDS	EL	
1.3 CDTi (L08) 55 kW (75 PS) Z 13 DTJ	07.2006→08.2014		7.00020.24.0	AGR	EL	
			7.08369.67.0 7.11190.04.0	ATS DDS	EL	
			7.00020.25.0	AGR	EL	
1.3 CDTi (L08) 66-74 kW (90-101 PS) Z 13 DTH	07.2006→06.2010		7.00020.25.0	AGR	EL	
			7.03622.10.0 7.08369.67.0 7.11190.04.0	AGR-K ATS DDS	EL EL	
			7.01599.10.0	AGR	EL	
			7.03622.10.0 7.03622.09.0 7.03622.06.0 7.08369.46.0 7.11190.04.0 7.02604.44.0	AGR-K AGR-K AGR-K ATS DDS LS	EL EL EL EL EL 500 mm A 13 DTE, A 13 DTR, Z 13 DTE: für OE-Nummer: 55564978 for OE number: 55564978	
1.7 CDTi (L08) 96 kW (131 PS) A 17 DTS	07.2012→08.2014		7.11190.04.0	DDS		
CORSA E Hatchback Van (X15)						107
1.3 CDTi (08) 70 kW (95 PS) B 13 DTE, B 13 DTR	09.2014→		7.05031.06.0	AGR-M	EL	
			7.05031.06.0	AGR-M	EL	
1.3 CDTi (08) 55 kW (75 PS) B 13 DTC, B 13 DTN	01.2015→		7.05031.06.0	AGR-M	EL	
			7.05031.06.0	AGR-M	EL	
INSIGNIA B Sports Tourer Combi Van (Z18)						108
CDTi ECOTEC 81-100 kW (110-136 PS) B 16 DTH, D 16 DTH	03.2017→		7.24809.81.0	AGR	EL	
			7.11020.42.0	ATS	EL	
KADETT E Combo (T85)						109
1.4 i (C25, D25) 40-44 kW (54-60 PS) C 14 NZ	08.1991→07.1994		7.02604.15.0	LS	360 mm	
			7.02604.15.0	LS	360 mm für Fahrzeuge mit Katalysator for vehicles with catalytic converter	
1.6 i (C25, D25) 55-60 kW (75-82 PS) C 16 NZ	08.1991→07.1994		7.02604.15.0	LS	360 mm für Fahrzeuge mit Katalysator for vehicles with catalytic converter	













KADETT E Estate Van (T85) 110

1.4 i (C70, D70) 40-44 kW (54-60 PS) C 14 NZ	01.1990→08.1991		7.02604.15.0	LS	360 mm	für Fahrzeuge mit Katalysator for vehicles with catalytic converter
---	-----------------	---	---------------------	----	--------	--















MOVANO B Bus (X62) 111

2.3 CDTI FWD (JV) 74-92 kW (101-125 PS) M9T 670, M9T 672, M9T 676	12.2010→		7.10334.03.0	AGR	EL	
2.3 CDTI FWD (JV) 74-107 kW (101-146 PS) M9T 670, M9T 672, M9T 676, M9T 680	12.2010→		7.10334.03.0	AGR	EL	
2.3 CDTI FWD (JV) 92-107 kW (125-146 PS) M9T 678, M9T 680	12.2010→		7.10334.03.0	AGR	EL	
2.3 CDTI FWD (JV) 107-125 kW (145-170 PS) M9T 706, M9T 708	12.2010→		7.11492.07.0	DDS		ohne Zubehör without accessories
2.3 CDTI FWD (JV) 107-110 kW (145-150 PS) M9T 880	01.2013→		7.10334.03.0	AGR	EL	
2.3 CDTI FWD (JV) 100-120 kW (136-163 PS) M9T 702	05.2014→		7.11190.08.0	DDS		
2.3 CDTI FWD (JV) 100-120 kW (136-163 PS) M9T 702	05.2014→		7.11190.08.0	DDS		
2.3 CDTI FWD (JV) 107-120 kW (145-163 PS) M9T 708	05.2014→		7.11492.07.0	DDS		ohne Zubehör without accessories
2.3 CDTI FWD (JV) 81-92 kW (110-125 PS) M9T 870	05.2014→		7.10334.03.0	AGR	EL	
2.3 CDTI FWD (JV) 107-125 kW (145-170 PS) M9T 706	07.2015→		7.11492.07.0	DDS		ohne Zubehör without accessories















MOVANO B Platform/Chassis (X62) 112

2.3 CDTI FWD (EV, HV, UV) 74-92 kW (101-125 PS) M9T 670, M9T 672, M9T 676	05.2010→		7.10334.03.0	AGR	EL	
2.3 CDTI FWD (EV, HV, UV) 74-107 kW (101-146 PS) M9T 670, M9T 672, M9T 676, M9T 680, M9T 876	05.2010→		7.10334.03.0	AGR	EL	
2.3 CDTI FWD (EV, HV, UV) 92-107 kW (125-146 PS) M9T 678, M9T 680	05.2010→		7.10334.03.0	AGR	EL	
2.3 CDTI FWD (EV, HV, UV) 107-125 kW (145-170 PS) M9T 706, M9T 708	05.2010→		7.11492.07.0	DDS		ohne Zubehör without accessories
2.3 CDTI FWD (EV, HV, UV) 107-110 kW (145-150 PS) M9T 880	01.2013→		7.10334.03.0	AGR	EL	
2.3 CDTI FWD (EV, HV, UV) 100-120 kW (136-163 PS) M9T 702	05.2014→		7.11190.08.0	DDS		
2.3 CDTI FWD (EV, HV, UV) 100-120 kW (136-163 PS) M9T 702	05.2014→		7.11190.08.0	DDS		









































MOVANO B Platform/Chassis (X62)
112





























2.3 CDTI FWD (EV, HV, UV) 81-92 kW (110-125 PS) M9T 870	05.2014→		7.10334.03.0	AGR	EL	
2.3 CDTI FWD (EV, HV, UV) 107-125 kW (145-170 PS) M9T 706	11.2016→		7.11492.07.0	DDS		ohne Zubehör without accessories
2.3 CDTI FWD (EV, HV, UV) 96 kW (131 PS) M9T 704	11.2016→		7.11492.07.0	DDS		ohne Zubehör without accessories
2.3 CDTI RWD (EV, HV, UV) 74-92 kW (101-125 PS) M9T 690, M9T 692	05.2010→		7.10334.03.0	AGR	EL	
2.3 CDTI RWD (EV, HV, UV) 74-110 kW (101-150 PS) M9T 692, M9T 696, M9T 698, M9T 876	05.2010→		7.10334.03.0	AGR	EL	
2.3 CDTI RWD (EV, HV, UV) 92-110 kW (125-150 PS) M9T 694, M9T 696, M9T 698	05.2010→		7.10334.03.0	AGR	EL	
2.3 CDTI RWD (EV, HV, UV) 92-110 kW (125-150 PS) M9T 694, M9T 696, M9T 698	01.2013→		7.10334.03.0	AGR	EL	
2.3 CDTI RWD (EV, HV, UV) 100-120 kW (136-163 PS) M9T 700	05.2014→		7.11190.08.0	DDS		
2.3 CDTI RWD (EV, HV, UV) 100-120 kW (136-163 PS) M9T 700	05.2014→		7.11190.08.0	DDS		

MOVANO B Van (X62)
113

2.3 CDTI FWD (FV) 74-92 kW (101-125 PS) M9T 670, M9T 672, M9T 676	05.2010→		7.10334.03.0	AGR	EL	
2.3 CDTI FWD (FV) 74-92 kW (101-125 PS) M9T 670, M9T 672, M9T 676	05.2010→		7.10334.03.0	AGR	EL	
2.3 CDTI FWD (FV) 92-107 kW (125-146 PS) M9T 678, M9T 680	05.2010→		7.10334.03.0	AGR	EL	
2.3 CDTI FWD (FV) 107-125 kW (145-170 PS) M9T 706, M9T 708	05.2010→		7.11492.07.0	DDS		ohne Zubehör without accessories
2.3 CDTI FWD (FV) 81-92 kW (110-125 PS) M9T 870	02.2012→		7.10334.03.0	AGR	EL	
2.3 CDTI FWD (FV) 107-110 kW (145-150 PS) M9T 880	01.2013→		7.10334.03.0	AGR	EL	
2.3 CDTI FWD (FV) 100-120 kW (136-163 PS) M9T 702	05.2014→		7.11190.08.0	DDS		
2.3 CDTI FWD (FV) 100-120 kW (136-163 PS) M9T 702	05.2014→		7.11190.08.0	DDS		
2.3 CDTI FWD (FV) 107-125 kW (145-170 PS) M9T 706	11.2016→		7.11492.07.0	DDS		ohne Zubehör without accessories
2.3 CDTI FWD (FV) 96 kW (131 PS) M9T 704	11.2016→		7.11492.07.0	DDS		ohne Zubehör without accessories





















O

					
MOVANO B Van (X62)					113
2.3 CDTI RWD (FV) 74-92 kW (101-125 PS) M9T 690, M9T 692	05.2010→		7.10334.03.0	AGR	EL 
2.3 CDTI RWD (FV) 74-110 kW (101-150 PS) M9T 686, M9T 690, M9T 696	05.2010→		7.10334.03.0	AGR	EL 
2.3 CDTI RWD (FV) 92-110 kW (125-150 PS) M9T 694, M9T 696, M9T 698	05.2010→		7.10334.03.0	AGR	EL 
2.3 CDTI RWD (FV) 92-110 kW (125-150 PS) M9T 694, M9T 696, M9T 698	01.2013→		7.10334.03.0	AGR	EL 
2.3 CDTI RWD (FV) 100-120 kW (136-163 PS) M9T 700	05.2014→		7.11190.08.0	DDS	
2.3 CDTI RWD (FV) 96-120 kW (131-163 PS) M9T 700, M9T 710	05.2014→		7.11190.08.0	DDS	
MOVANO Bus (X70)					114
1.9 DTI (JD) 60 kW (82 PS) F9Q 772, F9Q 774	10.2001→		7.22818.57.0	AGR	EL  für Fahrzeuge ohne Klimaanlage for vehicles without air conditioning
2.2 DTI (JD) 66 kW (90 PS) G9T 720, G9T 722, G9T 750	09.2000→		7.22818.59.0	AGR	EL  Durchmesser Ventilteller/diameter valve head 30 mm
2.5 CDTI (JD) 74-107 kW (101-146 PS) G9U 632, G9U 650	08.2006→		7.02604.44.0	LS	500 mm  G9U 632, G9U 650: vor Katalysator in front of the catalyst
2.5 CDTI (JD) 74-107 kW (101-146 PS) G9U 632, G9U 650	08.2006→		7.02604.44.0	LS	500 mm  G9U 632, G9U 650: vor Katalysator in front of the catalyst
2.5 DTI (JD) 84-85 kW (114-116 PS) G9U 720, G9U 750	10.2001→		7.22818.59.0	AGR	EL  Durchmesser Ventilteller/diameter valve head 30 mm
MOVANO Platform/Chassis (X70)					115
2.2 DTI (ED, HD, UD0, UD4) 66 kW (90 PS) G9T 720, G9T 722, G9T 750	09.2000→		7.22818.59.0	AGR	EL  Durchmesser Ventilteller/diameter valve head 30 mm
2.5 CDTI (ED, HD, UD0, UD4) 74-107 kW (101-146 PS) G9U 632, G9U 650	08.2006→		7.02604.44.0	LS	500 mm  G9U 632, G9U 650: vor Katalysator in front of the catalyst
2.5 CDTI (ED, HD, UD0, UD4) 74-107 kW (101-146 PS) G9U 632, G9U 650	08.2006→		7.02604.44.0	LS	500 mm  G9U 632, G9U 650: vor Katalysator in front of the catalyst
2.5 DTI (ED, HD, UD0, UD4) 84-85 kW (114-116 PS) G9U 720, G9U 750	10.2001→		7.22818.59.0	AGR	EL  Durchmesser Ventilteller/diameter valve head 30 mm
MOVANO Van (X70)					116
1.9 DTI (FD) 60 kW (82 PS) F9Q 772, F9Q 774	10.2001→		7.22818.57.0	AGR	EL  für Fahrzeuge ohne Klimaanlage for vehicles without air conditioning
2.2 DTI (FD) 66 kW (90 PS) G9T 720, G9T 722, G9T 750	09.2000→		7.22818.59.0	AGR	EL  Durchmesser Ventilteller/diameter valve head 30 mm
2.5 CDTI (FD) 74-107 kW (101-146 PS) G9U 632, G9U 650	10.2003→		7.02604.44.0	LS	500 mm  G9U 632, G9U 650: Abgaskrümmer Exhaust Manifold







					
MOVANO Van (X70)					116
2.5 CDTI (FD) 74-107 kW (101-146 PS) G9U 632, G9U 650	10.2003→		7.02604.44.0	LS	500 mm G9U 632, G9U 650: vor Katalysator in front of the catalyst
2.5 DTI (FD) 84-85 kW (114-116 PS) G9U 720	10.2001→		7.22818.59.0	AGR	EL Durchmesser Ventilteller/diameter valve head 30 mm
VIVARO A Bus (X83)					117
1.9 DI (F7, J7, A07) 59-60 kW (80-82 PS) F9Q 762	08.2001→		7.22818.57.0	AGR	EL 
1.9 DTI (F7, J7, A07) 74 kW (101 PS) F9Q 760	08.2001→		7.22818.57.0	AGR	EL 
2.0 16V (F7, J7, A07) 88 kW (120 PS) F4R 720	08.2001→		7.02604.10.0	LS	560 mm vor Katalysator, nach Katalysator in front of the catalyst, Post-catalyst
2.0 CDTI (F7, J7, A07) 66-84 kW (90-114 PS) M9R 780, M9R 782, M9R 786	08.2006→		7.10334.03.0	AGR	EL  M9R 780, M9R 782: Produktionsdatum ab: 12.04.2010 Production date from: 12.04.2010 M9R 786: Produktionsdatum ab: 19.10.2010 Production date from: 19.10.2010
			7.10334.05.0	AGR	EL  M9R 780, M9R 782:  C015660→ Produktionsdatum bis: 12.04.2010 Production date to: 12.04.2010 M9R 786: Produktionsdatum bis: 19.10.2010 Production date to: 19.10.2010
2.0 CDTI (F7, J7, A07) 66-84 kW (90-114 PS) M9R 630, M9R 692	08.2006→		7.10334.03.0	AGR	EL  Produktionsdatum ab: 01.06.2010 Production date from: 01.06.2010
2.0 CDTI (F7, J7, A07) 66-84 kW (90-114 PS) M9R 780, M9R 784, M9R 786, M9R 788	08.2006→		7.10334.03.0	AGR	EL  M9R 780, M9R 784: Produktionsdatum ab: 12.04.2010 Production date from: 12.04.2010 M9R 786, M9R 788: Produktionsdatum ab: 19.10.2010 Production date from: 19.10.2010
			7.10334.05.0	AGR	EL  M9R 780, M9R 784:  C015660→ Produktionsdatum bis: 12.04.2010 Production date to: 12.04.2010 M9R 786, M9R 788: Produktionsdatum bis: 19.10.2010 Production date to: 19.10.2010
2.5 CDTI (F7, J7, A07) 84-107 kW (114-146 PS) G9U 630	08.2006→		7.02604.44.0	LS	500 mm vor Katalysator in front of the catalyst
2.5 CDTI (F7, J7, A07) 84-107 kW (114-146 PS) G9U 630	08.2006→		7.02604.44.0	LS	500 mm vor Katalysator in front of the catalyst
2.5 DTI (F7, J7, A07) 99 kW (135 PS) G9U 730	05.2003→		7.22818.59.0	AGR	EL  Durchmesser Ventilteller/diameter valve head 30 mm
			7.22818.63.0	AGR	EL  Durchmesser Ventilteller/diameter valve head 16 mm



VIVARO A Platform/Chassis (X83) 118

1.9 DTI 74 kW (101 PS) F9Q 760	08.2006→		7.22818.57.0	AGR	EL	
1.9 Di 59-60 kW (80-82 PS) F9Q 762	08.2001→		7.22818.57.0	AGR	EL	
2.0 16V 88 kW (120 PS) F4R 720	08.2003→		7.02604.10.0	LS	560 mm	vor Katalysator, nach Katalysator in front of the catalyst, Post-catalyst
2.0 CDTI 66-84 kW (90-114 PS) M9R 630	01.2006→		7.10334.03.0	AGR	EL	
2.0 CDTI 66-84 kW (90-114 PS) M9R 780, M9R 782, M9R 786	01.2006→		7.10334.03.0	AGR	EL	 M9R 780, M9R 782: Produktionsdatum ab: 12.04.2010 Production date from: 12.04.2010 M9R 786: Produktionsdatum ab: 19.10.2010 Production date from: 19.10.2010
			7.10334.05.0	AGR	EL	 M9R 780, M9R 782:  C015660→ Produktionsdatum bis: 12.04.2010 Production date to: 12.04.2010 M9R 786: Produktionsdatum bis: 19.10.2010 Production date to: 19.10.2010
2.0 CDTI 66-84 kW (90-114 PS) M9R 630	08.2006→		7.10334.03.0	AGR	EL	
2.0 CDTI 66-84 kW (90-114 PS) M9R 780	08.2006→		7.10334.03.0	AGR	EL	 Produktionsdatum ab: 12.04.2010 Production date from: 12.04.2010
			7.10334.05.0	AGR	EL	 C015660→ Produktionsdatum bis: 12.04.2010 Production date to: 12.04.2010
2.5 CDTI 84-107 kW (114-146 PS) G9U 630	08.2006→		7.02604.44.0	LS	500 mm	vor Katalysator in front of the catalyst
2.5 CDTI 84-107 kW (114-146 PS) G9U 630	08.2006→		7.02604.44.0	LS	500 mm	vor Katalysator in front of the catalyst
2.5 DTi 99 kW (135 PS) G9U 730	08.2003→		7.22818.59.0	AGR	EL	 Durchmesser Ventilteller/diameter valve head 30 mm
			7.22818.63.0	AGR	EL	 Durchmesser Ventilteller/diameter valve head 16 mm

VIVARO A Van (X83) 119

1.9 DI (F7) 59-60 kW (80-82 PS) F9Q 762	08.2001→		7.22818.57.0	AGR	EL	
1.9 DTI (F7) 74 kW (101 PS) F9Q 760	08.2001→		7.22818.57.0	AGR	EL	
2.0 16V (F7) 88 kW (120 PS) F4R 720	08.2001→		7.02604.10.0	LS	560 mm	vor Katalysator, nach Katalysator in front of the catalyst, Post-catalyst
2.0 CDTI (F7) 66-84 kW (90-114 PS) M9R 630	08.2006→		7.10334.03.0	AGR	EL	
2.0 CDTI (F7) 66-84 kW (90-114 PS) M9R 780, M9R 782, M9R 786	08.2006→		7.10334.03.0	AGR	EL	 M9R 780, M9R 782: Produktionsdatum ab: 12.04.2010 Production date from: 12.04.2010 M9R 786: Produktionsdatum ab: 19.10.2010 Production date from: 19.10.2010

VIVARO A Van (X83)
119





		7.10334.05.0	AGR	EL	<ul style="list-style-type: none"> M9R 780, M9R 782: C015660→ Produktionsdatum bis: 12.04.2010 Production date to: 12.04.2010 M9R 786: Produktionsdatum bis: 19.10.2010 Production date to: 19.10.2010
2.0 CDTI (F7) 66-84 kW (90-114 PS) M9R 630, M9R 692	08.2006→	7.10334.03.0	AGR	EL	<ul style="list-style-type: none"> Produktionsdatum ab: 01.06.2010 Production date from: 01.06.2010
2.0 CDTI (F7) 66-84 kW (90-114 PS) M9R 780, M9R 784, M9R 786, M9R 788	08.2006→	7.10334.03.0	AGR	EL	<ul style="list-style-type: none"> M9R 780, M9R 784: Produktionsdatum ab: 12.04.2010 Production date from: 12.04.2010 M9R 786, M9R 788: Produktionsdatum ab: 19.10.2010 Production date from: 19.10.2010
		7.10334.05.0	AGR	EL	<ul style="list-style-type: none"> M9R 780, M9R 784: C015660→ Produktionsdatum bis: 12.04.2010 Production date to: 12.04.2010 M9R 786, M9R 786, M9R 788, M9R 788: Produktionsdatum bis: 19.10.2010 Production date to: 19.10.2010
2.5 CDTI (F7) 84-107 kW (114-146 PS) G9U 630	08.2006→	7.02604.44.0	LS	500 mm	vor Katalysator in front of the catalyst
2.5 CDTI (F7) 84-107 kW (114-146 PS) G9U 630	08.2006→	7.02604.44.0	LS	500 mm	vor Katalysator in front of the catalyst
2.5 DTI (F7) 99 kW (135 PS) G9U 730	05.2003→	7.22818.59.0	AGR	EL	Durchmesser Ventilteller/diameter valve head 30 mm
		7.22818.63.0	AGR	EL	Durchmesser Ventilteller/diameter valve head 16 mm

VIVARO B Bus (X82)
120





1.6 CDTI (06) 66-85 kW (90-116 PS) R9M 408	06.2014→	7.24809.90.0	AGR	EL	→06.2015
		7.11190.08.0	DDS		
1.6 CDTI (06) 85-107 kW (116-145 PS) R9M 450	06.2014→	7.11190.08.0	DDS		
1.6 CDTI (06) 66-85 kW (90-116 PS) R9M 408	06.2014→	7.24809.90.0	AGR	EL	→06.2015
		7.11190.08.0	DDS		
1.6 CDTI (06) 85-107 kW (116-145 PS) R9M 450	06.2014→	7.24809.90.0	AGR	EL	→01.2019
		7.11190.08.0	DDS		
1.6 CDTI (06) 85-107 kW (116-145 PS) R9M 450	06.2014→	7.24809.90.0	AGR	EL	→01.2019
		7.11190.08.0	DDS		
1.6 CDTI (06) 70-89 kW (95-121 PS) R9M 413, R9M 415	04.2015→	7.11457.07.0*	DDS		R9M 413, R9M 415: ab Euro 6 From Euro 6
		7.11492.07.0	DDS		













VIVARO B Bus (X82) **120**

1.6 CDTI (06) 92-107 kW (125-146 PS) R9M 452	04.2015→		7.24809.90.0	AGR	EL	 →01.2019
			7.11457.07.0*	DDS		ab Euro 6 From Euro 6
			↳7.11492.07.0	DDS		
1.6 CDTI (06) 92-107 kW (125-146 PS) R9M 452	04.2015→		7.24809.90.0	AGR	EL	 →01.2019
			7.11457.07.0*	DDS		ab Euro 6 From Euro 6
			↳7.11492.07.0	DDS		
1.6 CDTI (06) 70-89 kW (95-121 PS) R9M 415	01.2019→		7.11457.07.0*	DDS		ab Euro 6 From Euro 6
			↳7.11492.07.0	DDS		

VIVARO B Platform/Chassis (X82) **121**

1.6 CDTI (03) 66-107 kW (90-145 PS) R9M 408, R9M 450	06.2014→		7.11190.08.0	DDS		
1.6 CDTI (03) 85-107 kW (116-145 PS) R9M 450	08.2015→		7.11190.08.0	DDS		
1.6 CDTI (03) 85-107 kW (116-145 PS) R9M 450	08.2015→		7.11190.08.0	DDS		
1.6 CDTI (03) 92-107 kW (125-146 PS) R9M 452	11.2016→		7.11457.07.0*	DDS		ab Euro 6 From Euro 6
			↳7.11492.07.0	DDS		
1.6 CDTI (03) 92-107 kW (125-146 PS) R9M 452	11.2016→		7.11457.07.0*	DDS		ab Euro 6 From Euro 6
			↳7.11492.07.0	DDS		









VIVARO B Van (X82) **122**

1.6 CDTI (05) 85-107 kW (116-145 PS) R9M 450	06.2014→		7.24809.90.0	AGR	EL	 →01.2019
			7.11190.08.0	DDS		
1.6 CDTI (05) 66-85 kW (90-116 PS) R9M 408	06.2014→		7.24809.90.0	AGR	EL	 →03.2016
			7.11190.08.0	DDS		
1.6 CDTI (05) 66-107 kW (90-145 PS) R9M 408, R9M 450	06.2014→		7.24809.90.0	AGR	EL	 R9M 408, R9M 450: →03.2016
			7.11190.08.0	DDS		
1.6 CDTI (05) 85-107 kW (116-145 PS) R9M 450	06.2014→		7.24809.90.0	AGR	EL	 →01.2019
			7.11190.08.0	DDS		
1.6 CDTI (05) 92-107 kW (125-146 PS) R9M 452	03.2016→		7.24809.90.0	AGR	EL	 →01.2019
			7.11457.07.0*	DDS		ab Euro 6 From Euro 6
			↳7.11492.07.0	DDS		

VIVARO B Van (X82)						122
1.6 CDTI (05) 92-107 kW (125-146 PS) R9M 452	03.2016→		7.24809.90.0	AGR	EL →01.2019	
			7.11457.07.0*	DDS	ab Euro 6 From Euro 6	
			↳7.11492.07.0	DDS		
1.6 CDTI (05) 70-89 kW (95-121 PS) R9M 413, R9M 415	03.2016→		7.11457.07.0*	DDS	R9M 413, R9M 415: ab Euro 6 From Euro 6	
			↳7.11492.07.0	DDS		
1.6 CDTI (05) 70-89 kW (95-121 PS) R9M 413, R9M 415	08.2016→		7.11457.07.0*	DDS	R9M 413, R9M 415: ab Euro 6 From Euro 6	
			↳7.11492.07.0	DDS		
VIVARO C Bus (K0)						123
1.5 75 kW (102 PS) D 15 DT (DV5RUCD)	03.2019→		7.07794.23.0	AGR	EL mit Dichtring with O-ring	
1.5 88 kW (120 PS) D 15 DTH (DV5RUC)	03.2019→		7.07794.23.0	AGR	EL mit Dichtring with O-ring	
2.0 90 kW (122 PS) D 20 DTL (DW10FE)	03.2019→		7.11492.01.0	DDS	ohne Zubehör without accessories Organisationsnummer ab: 15432LT, 15432U9 RPO number from: 15432LT, 15432U9	
2.0 110 kW (150 PS) D 20 DTH (DW10FD)	03.2019→		7.11492.01.0	DDS	ohne Zubehör without accessories Organisationsnummer ab: 15432LT, 15432U9 RPO number from: 15432LT, 15432U9	
VIVARO C Platform Cabin (K0)						124
2.0 110 kW (150 PS) D 20 DTH (DW10FD)	03.2019→		7.11492.01.0	DDS	ohne Zubehör without accessories Organisationsnummer ab: 15432LT, 15432U9 RPO number from: 15432LT, 15432U9	
2.0 90 kW (122 PS) D 20 DTL (DW10FE)	03.2019→		7.11492.01.0	DDS	ohne Zubehör without accessories Organisationsnummer ab: 15432LT, 15432U9 RPO number from: 15432LT, 15432U9	
VIVARO C Van (K0)						125
1.5 75 kW (102 PS) D 15 DT (DV5RUCD)	03.2019→		7.07794.23.0	AGR	EL mit Dichtring with O-ring	
1.5 88 kW (120 PS) D 15 DTH (DV5RUC)	03.2019→		7.07794.23.0	AGR	EL mit Dichtring with O-ring	
2.0 90 kW (122 PS) D 20 DTL (DW10FE)	03.2019→		7.11492.01.0	DDS	ohne Zubehör without accessories Organisationsnummer ab: 15432LT, 15432U9 RPO number from: 15432LT, 15432U9	
2.0 110 kW (150 PS) D 20 DTH (DW10FD)	03.2019→		7.11492.01.0	DDS	ohne Zubehör without accessories Organisationsnummer ab: 15432LT, 15432U9 RPO number from: 15432LT, 15432U9	
ZAFIRA B Box Body/MPV (A05)						126
1.7 CDTI VAN (M75) 81 kW (110 PS) A 17 DTJ	01.2008→04.2015		7.08369.75.0	ATS	EL	
			7.11190.04.0	DDS		





ZAFIRA B Box Body/MPV (A05) **126**

1.7 CDTI VAN (M75) 81 kW (110 PS) Z 17 DTJ	01.2008→04.2015		7.08369.74.0	ATS	EL	
			7.11190.04.0	DDS		
1.7 CDTI VAN (M75) 92 kW (125 PS) A 17 DTR	01.2008→04.2015		7.08369.75.0	ATS	EL	
			7.11190.04.0	DDS		
1.8 VAN (M75) 101-103 kW (137-140 PS) A 18 XER, Z 18 XER	07.2005→04.2015		7.04879.00.0	AGR-TH		 Öffnungstemperatur/opening temperature 105C
1.9 CDTI VAN (M75) 110 kW (150 PS) Z 19 DTH	07.2005→04.2015		7.08369.05.0	ATS	EL	ohne Zubehör without accessories Fahrgestellnummer bis: 62167884, 6G119243 Vehicle Identification Number to: 62167884, 6G119243 Fahrgestellnummer ab: 62127885, 6G119244 Vehicle Identification Number from: 62127885, 6G119244
			7.08369.32.0	ATS	EL	
			7.11190.03.0	DDS		
1.9 CDTI VAN (M75) 88 kW (120 PS) Z 19 DT	07.2005→04.2015		7.22946.38.0	AGR	EL	 ohne Zubehör without accessories Fahrgestellnummer bis: 62167884, 6G119243 Vehicle Identification Number to: 62167884, 6G119243 Fahrgestellnummer ab: 62127885, 6G119244 Vehicle Identification Number from: 62127885, 6G119244
			7.08369.05.0	ATS	EL	
			7.08369.32.0	ATS	EL	
			7.11190.03.0	DDS		
2.0 VAN (M75) 147 kW (200 PS) Z 20 LER	07.2005→12.2010		7.02604.07.0	LS	570 mm	vor Katalysator in front of the catalyst



ZAFIRA LIFE Bus (K0) **127**

1.5 75 kW (102 PS) D 15 DT (DV5RUCD)	03.2019→		7.07794.23.0	AGR	EL	mit Dichtring with O-ring
---	----------	---	--------------	-----	----	------------------------------

ZAFIRA TOURER C VAN (P12) **128**

2.0 CDTi (75) 96 kW (131 PS) A 20 DT, Y 20 DTJ, Z 20 DTJ	01.2012→		7.08369.17.0	ATS	EL	
2.0 CDTi (75) 81 kW (110 PS) A 20 DTL	01.2013→		7.08369.17.0	ATS	EL	
2.0 CDTi (75) 96-121 kW (131-165 PS) A 20 DTH	01.2013→		7.08369.17.0	ATS	EL	







			 PIERBURG		
---	---	---	---	--	---

ENGINE					1
ENGINE 62-129 kW (82-174 PS) 1204E-E44TA, 1204E-E44TTA		7.04209.06.0	AK	EL  1204E-E44TA, 1204E-E44TTA: für OE-Nummer: 4683932 for OE number: 4683932	
		7.04210.06.0	AK	EL  1204E-E44TA, 1204E-E44TTA: für OE-Nummer: 4683934 for OE number: 4683934	























1007 (KM_) 1























1.4 16V 65 kW (88 PS) KFU (ET3J4)	10.2005→	 7.02604.11.0	LS	null mm	
1.4 HDi 50-52 kW (68-70 PS) 8HX (DV4TD), 8HZ (DV4TD)	04.2005→	 7.24809.06.0	AGR	PN	mit Rohrstutzen with pipe socket
		7.24809.76.0	AGR	EL	 8HX (DV4TD), 8HZ (DV4TD): Euro 3  8HX (DV4TD), 8HZ (DV4TD): Euro 4 (D4) Euro 4 (D4)
1.6 HDi 80-84 kW (109-114 PS) 9HZ (DV6TED4)	06.2007→	 7.24809.39.0	AGR	EL	 Euro 4 (D4) Euro 4 (D4) ohne Zubehör without accessories Organisationsnummer ab: 11074 RPO number from: 11074
		7.11492.01.0	DDS		





























106 I (1A, 1C) 2

1.0 32-33 kW (44-45 PS) CDY (TU9M), TU9	09.1991→04.1996	 7.02604.04.0	LS	200 mm	
1.0 37 kW (50 PS) CDZ (TU9M)	09.1991→04.1996	 7.02604.04.0	LS	200 mm	
1.1 44 kW (60 PS) HDZ (TU1M)	09.1991→04.1996	 7.05270.39.0	LS	400 mm	06.1995→ Euro 2 Euro 2
1.3 72-74 kW (98-101 PS) TU2J2	10.1993→04.1996	 7.05270.39.0	LS	400 mm	
		7.02604.04.0	LS	200 mm	
1.4 47-51 kW (64-69 PS) K5A (TU3)	08.1991→03.1996	 7.02604.04.0	LS	200 mm	
1.4 55-58 kW (75-79 PS) KDX (TU3MC)	09.1991→04.1996	 7.05270.39.0	LS	400 mm	06.1995→ Euro 2 Euro 2
1.4 69 kW (94 PS) KFZ (TU3J2/Z)	09.1991→04.1996	 7.05270.39.0	LS	400 mm	06.1995→ Euro 2 Euro 2
1.6 65-66 kW (88-90 PS) NFZ (TU5JP)	06.1993→04.1996	 7.02604.04.0	LS	200 mm	
1.6 74-76 kW (101-104 PS) NFY (TU5J2)	01.1994→04.1996	 7.02604.04.0	LS	200 mm	
1.1 40 kW (54 PS) H1B (TU1)	09.1991→04.1996	 7.02604.04.0	LS	200 mm	

106 II (1A_, 1C_) 3











1.0 i 32-33 kW (44-45 PS) CDY (TU9M)	05.1996→10.1999	 7.05270.39.0	LS	400 mm	
1.0 i 37 kW (50 PS) CDZ (TU9M)	01.1997→03.2001	 7.05270.39.0	LS	400 mm	
1.4 i 47-60 kW (64-82 PS) KFW (TU3JP), KFX (TU3JP)	05.1996→07.2004	 7.05270.36.0	LS	540 mm	 KFW (TU3JP), KFX (TU3JP): Euro 3 Euro 3
		7.05270.39.0	LS	400 mm	 KFW (TU3JP), KFX (TU3JP): Euro 2 Euro 2
1.6 S16 87-88 kW (118-120 PS) NFX (TU5J4)	05.1996→07.2004	 7.05270.36.0	LS	540 mm	15-04 15-04
1.6 S16 87-88 kW (118-120 PS) NFX (TU5J4)	04.1998→09.2001	 7.05270.36.0	LS	540 mm	15-04 15-04
1.6 i 65-66 kW (88-90 PS) NFZ (TU5JP)	05.1996→10.1999	 7.05270.39.0	LS	400 mm	
		7.02604.04.0	LS	200 mm	

						
106 II (1A_, 1C_)						3
1.6 i 74-76 kW (101-104 PS) NFW (TU5J2), NFY (TU5J2)	05.1996→01.2001		7.05270.39.0	LS	400 mm	
			7.02604.04.0	LS	200 mm	
107 (PM_, PN_)						4
1.0 50-53 kW (68-72 PS) CFA (384F), CFB (1KR)	06.2005→05.2014		7.05271.51.0	LS	300 mm	
			7.24809.76.0	AGR	EL 	
1.4 HDi 40 kW (54 PS) 8HT (DV4TD)	06.2005→05.2014		7.24809.76.0	AGR	EL 	
2008 I (CU_)						5
1.4 HDi 50 kW (68 PS) 8HR (DV4C)	06.2013→		7.02209.11.0	AGR	EL 	
			7.02156.35.0	AGR-K	EL ohne Sensor without sensor mit AGR-Ventil with EGR valve	
			7.02156.34.0	AGR-K	EL ohne Sensor without sensor ohne AGR-Ventil without EGR valve	
			7.11492.01.0	DDS	EL ohne Zubehör without accessories Organisationsnummer ab: 1310088 RPO number from: 1310088	
1.5 BlueHDI 100 75 kW (102 PS) YHY (DV5RD)	05.2018→		7.07794.23.0	AGR	EL mit Dichtring with O-ring	
1.5 BlueHDI 120 88 kW (120 PS) YHX (DV5RC)	05.2018→		7.07794.23.0	AGR	EL mit Dichtring with O-ring	
1.6 HDi 66-69 kW (90-94 PS) 9HP (DV6DTED)	03.2013→		7.02209.11.0	AGR	EL 	
			7.02156.35.0	AGR-K	EL ohne Sensor without sensor  ch. 1323488→ mit AGR-Ventil with EGR valve	
			7.02156.34.0	AGR-K	EL ohne Sensor without sensor ohne AGR-Ventil without EGR valve	
			7.11492.01.0	DDS	EL ohne Zubehör without accessories Organisationsnummer ab: 1310088 RPO number from: 1310088	
7.02604.99.0	03.2013→		7.02604.99.0	LS	400 mm	
			7.02156.35.0	AGR-K	EL ohne Sensor without sensor mit AGR-Ventil with EGR valve	
			7.02156.34.0	AGR-K	EL ohne Sensor without sensor ohne AGR-Ventil without EGR valve	
1.6 HDi 84-85 kW (114-116 PS) 9HD (DV6C)	03.2013→		7.02156.35.0	AGR-K	EL ohne Sensor without sensor mit AGR-Ventil with EGR valve	
			7.02156.34.0	AGR-K	EL ohne Sensor without sensor ohne AGR-Ventil without EGR valve	
			7.11492.01.0	DDS	EL ohne Zubehör without accessories Organisationsnummer ab: 1310088 RPO number from: 1310088	
1.6 VTi 85-90 kW (116-122 PS) 5FS (EP6C)	03.2013→		7.05271.74.0	LS	450 mm	
2008 II (UD_, US_, UY_, UK_)						6
1.5 BlueHDI 130 96 kW (131 PS) YHZ (DV5RC)	08.2019→		7.07794.23.0	AGR	EL mit Dichtring with O-ring	











						
205 I (741A/C)						7
1.9 GTI 94-96 kW (128-131 PS) D6B (XU9JA)	10.1986→10.1987		7.02604.04.0	LS	200 mm	
1.9 GTI 72-77 kW (98-105 PS) DFZ (XU9J1)	03.1987→10.1987		7.02604.04.0	LS	200 mm	
205 I Convertible (741B, 20D)						8
1.9 72-77 kW (98-105 PS) DFZ (XU9J1)	05.1986→07.1987		7.02604.04.0	LS	200 mm	
1.9 CTI 72-77 kW (98-105 PS) DFZ (XU9J1)	10.1987→12.1994		7.02604.04.0	LS	200 mm	
1.9 CTi 72-77 kW (98-105 PS) DFZ (XU9J1)	08.1987→07.1990		7.02604.04.0	LS	200 mm	
205 II (20A/C)						9
1.9 88-93 kW (120-126 PS) DKZ (XU9JAZ)	08.1990→05.1997		7.02604.04.0	LS	200 mm	
1.9 72-77 kW (98-105 PS) DFZ (XU9J1)	08.1992→05.1997		7.02604.04.0	LS	200 mm	
1.9 GTI 94-96 kW (128-131 PS) D6B (XU9JA)	10.1987→09.1998		7.02604.04.0	LS	200 mm	
1.9 GTI 75 kW (102 PS) D2A (XU92C)	10.1987→05.1989		7.02604.04.0	LS	200 mm	
1.9 GTI 88-93 kW (120-126 PS) DKZ (XU9JAZ)	10.1987→10.1994		7.02604.04.0	LS	200 mm	
1.9 GTI 94-96 kW (128-131 PS) D6B (XU9JA)	08.1990→07.1992		7.02604.04.0	LS	200 mm	
1.9 GTI Cat 72-77 kW (98-105 PS) DFZ (XU9J1)	10.1987→07.1994		7.02604.04.0	LS	200 mm	
206 CC (2D)						10
1.6 HDi 110 80-84 kW (109-114 PS) 9HZ (DV6TED4)	04.2005→02.2007		7.24809.39.0	AGR	EL 	
			7.11492.01.0	DDS	ohne Zubehör without accessories Organisationsnummer ab: 10920 RPO number from: 10920	
206 Hatchback (2A/C)						11
1.0 52-57 kW (71-77 PS) D4D	06.2001→12.2005		7.05270.54.0	LS	450 mm vor Katalysator in front of the catalyst	
1.1 40 kW (54 PS) HFY (TU1JP)	08.1998→07.2000		7.05270.39.0	LS	400 mm	
1.1 i 44 kW (60 PS) HFX (TU1JP), HFZ (TU1JP)	09.1998→02.2007		7.05270.36.0	LS	540 mm	
			7.05270.39.0	LS	400 mm	
1.4 16V 65 kW (88 PS) KFU (ET3J4)	10.2003→02.2008		7.02604.11.0	LS	null mm	
			7.02604.12.0	LS	400 mm	
1.4 HDi 50-51 kW (68-69 PS) 8HX (DV4TD)	09.2002→02.2007		7.24809.06.0	AGR	PN mit Rohrstützen with pipe socket  Euro 3 Euro 3	
			7.24809.76.0	AGR	EL  Euro 4 (D4) Euro 4 (D4)	
1.4 HDi eco 70 50-52 kW (68-70 PS) 8HX (DV4TD), 8HZ (DV4TD)	09.2001→04.2009		7.24809.06.0	AGR	PN mit Rohrstützen with pipe socket  8HX (DV4TD), 8HZ (DV4TD): Euro 3 Euro 3	

























206 Hatchback (2A/C) 11

			7.24809.76.0	AGR	EL	 8HX (DV4TD), 8HZ (DV4TD): Euro 4 (D4) Euro 4 (D4)
1.4 i 47-60 kW (64-82 PS) KFW (TU3JP)	09.1998→12.2012		7.05270.36.0	LS	540 mm	Organisationsnummer ab: 10556 RPO number from: 10556 Euro 3 Euro 3
			7.05270.39.0	LS	400 mm	
			7.05270.37.0	LS	1640 mm	
1.4 i 49-60 kW (67-82 PS) KFW (TU3A), KFX (TU3JP)	09.1998→12.2012		7.05270.39.0	LS	400 mm	
			7.05270.37.0	LS	1640 mm	
1.6 HDi 110 80-84 kW (109-114 PS) 9HY (DV6TED4), 9HZ (DV6TED4)	05.2004→02.2007		7.24809.39.0	AGR	EL	 9HY (DV6TED4), 9HZ (DV6TED4): Euro 4 (D4) Euro 4 (D4) ohne Zubehör without accessories  9HY (DV6TED4), 9HZ (DV6TED4): Organisationsnummer ab: 10920 RPO number from: 10920
			7.11492.01.0	DDS		
2.0 HDi 90 66 kW (90 PS) RHY (DW10TD)	12.1999→09.2009		7.22843.06.0	AGR	PN	
2.0 RC 130-132 kW (177-180 PS) RFK (EW10J4S)	07.2003→12.2007		7.05270.37.0	LS	1640 mm	
2.0 S16 100-105 kW (136-143 PS) RFN (EW10J4)	06.1999→12.2007		7.05270.37.0	LS	1640 mm	

206 SW (2E/K) 12

1.1 44 kW (60 PS) HFX (TU1JP)	07.2002→02.2007		7.05270.39.0	LS	400 mm	
1.4 47-60 kW (64-82 PS) KFW (TU3JP)	07.2002→02.2007		7.05270.36.0	LS	540 mm	Organisationsnummer ab: 10556 RPO number from: 10556 Euro 3 Euro 3
			7.05270.39.0	LS	400 mm	
			7.05270.37.0	LS	1640 mm	
1.4 54-60 kW (73-82 PS) KFV (TU3A)	07.2002→02.2007		7.05270.39.0	LS	400 mm	
			7.05270.37.0	LS	1640 mm	
1.4 16V 65 kW (88 PS) KFU (ET3J4)	10.2003→		7.02604.11.0	LS	null mm	
			7.02604.12.0	LS	400 mm	
1.4 Flex 47-60 kW (64-82 PS) KFW (TU3JP)	01.2006→07.2008		7.05270.36.0	LS	540 mm	Euro 3 Euro 3
1.4 HDi 50-51 kW (68-69 PS) 8HX (DV4TD)	07.2002→02.2007		7.24809.06.0	AGR	PN	mit Rohrstützen with pipe socket  Euro 3 Euro 3
			7.24809.76.0	AGR	EL	 Euro 4 (D4) Euro 4 (D4)
1.6 HDi 110 80-84 kW (109-114 PS) 9HZ (DV6TED4)	05.2004→		7.24809.39.0	AGR	EL	 Euro 4 (D4) Euro 4 (D4)

















P

			 PIERBURG		
206 SW (2E/K)					12
			7.11492.01.0	DDS	ohne Zubehör without accessories Organisationsnummer ab: 10920 RPO number from: 10920
2.0 HDi 66 kW (90 PS) RHY (DW10TD)	07.2002→02.2007		7.22843.06.0	AGR	PN 
206 Saloon					13
1.4 47-60 kW (64-82 PS) KFW (TU3JP)	03.2007→		7.05270.36.0	LS	540 mm Euro 3
			7.05270.39.0	LS	400 mm Euro 3
			7.05270.37.0	LS	1640 mm
1.4 54-60 kW (73-82 PS) KfV (TU3A)	03.2007→		7.05270.39.0	LS	400 mm
			7.05270.37.0	LS	1640 mm
1.4 HDi eco 70 50-52 kW (68-70 PS) 8HZ (DV4TD)	09.2008→		7.24809.76.0	AGR	EL  Euro 4 (D4) Euro 4 (D4)
206+ (2L_, 2M_)					14
1.4 HDi eco 70 50 kW (68 PS) 8HR (DV4C)	01.2009→06.2013		7.02209.11.0	AGR	EL 
			7.02156.24.0	AGR-K	EL mit Sensor with sensor  →10.2012
			7.02156.35.0	AGR-K	EL ohne Sensor without sensor 11.2012→
			7.02156.33.0	AGR-K	mit Sensor with sensor →10.2012
			7.02156.34.0	AGR-K	ohne AGR-Ventil without EGR valve ohne Sensor without sensor 11.2012→
			7.11492.01.0	DDS	ohne AGR-Ventil without EGR valve ohne Zubehör without accessories
1.4 HDi eco 70 50-52 kW (68-70 PS) 8HZ (DV4TD)	01.2009→06.2013		7.24809.76.0	AGR	EL 
207 (WA_, WC_)					15
1.4 54-60 kW (73-82 PS) KfV (TU3A)	02.2006→10.2013		7.05271.74.0	LS	450 mm
1.4 16V 65 kW (88 PS) KFU (ET3J4)	02.2006→10.2013		7.02604.11.0	LS	null mm
1.4 16V 70 kW (95 PS) 8FS (EP3), EP3, EP3C	06.2007→10.2013		7.02604.11.0	LS	null mm
			7.05271.74.0	LS	450 mm
1.4 HDi 50 kW (68 PS) 8HR (DV4C)	02.2006→12.2015		7.02209.11.0	AGR	EL 
			7.02156.24.0	AGR-K	EL mit Sensor with sensor  →10.2012

P





207 (WA_, WC_) 15

			7.02156.35.0	AGR-K	EL	ohne Sensor without sensor 12.2012→ mit AGR-Ventil with EGR valve
			7.02156.33.0	AGR-K		mit Sensor with sensor →10.2012 ohne AGR-Ventil without EGR valve
			7.02156.34.0	AGR-K		ohne Sensor without sensor 12.2012→ ohne AGR-Ventil without EGR valve
			7.11492.01.0	DDS		ohne Sensor without sensor 12.2012→ ohne AGR-Ventil without EGR valve ohne Zubehör without accessories
1.4 HDi 50-52 kW (68-70 PS) 8HZ (DV4TD)	02.2006→12.2015		7.24809.76.0	AGR	EL	
1.4 HDi 50-52 kW (68-70 PS) 8HZ (DV4TD)	02.2011→12.2015		7.24809.76.0	AGR	EL	
1.6 16V 78-90 kW (106-122 PS) NFU (TU5JP4)	02.2006→10.2013		7.05271.74.0	LS	450 mm	
1.6 16V RC 127 kW (173 PS) 5FY (EP6DTS)	02.2007→12.2012		7.02604.41.0	LS	700 mm	vor Katalysator in front of the catalyst
			7.05271.74.0	LS	450 mm	
1.6 16V Turbo 110 kW (150 PS) 5FX (EP6DT)	02.2006→10.2013		7.02604.41.0	LS	700 mm	Organisationsnummer bis: 11556 81, 11563 82 RPO number to: 11556 81, 11563 82 vor Katalysator in front of the catalyst
			7.05271.74.0	LS	450 mm	
1.6 16V Turbo 115 kW (156 PS) 5FR (EP6DT)	10.2009→12.2012		7.02604.41.0	LS	700 mm	
			7.05271.74.0	LS	450 mm	
1.6 16V VTi 81-90 kW (110-122 PS) 5FS (EP6C), 5FW (EP6), EP6	02.2007→12.2012		7.05271.74.0	LS	450 mm	
1.6 HDi 66-68 kW (90-92 PS) 9HX (DV6ATED4)	02.2006→10.2013		7.24809.39.0	AGR	EL	 Euro 4 (D4) Euro 4 (D4)
1.6 HDi 80-84 kW (109-114 PS) 9HY (DV6TED4), 9HZ (DV6TED4)	02.2006→10.2013		7.24809.39.0	AGR	EL	 9HY (DV6TED4), 9HZ (DV6TED4): Euro 4 (D4) Euro 4 (D4)
			7.11492.01.0	DDS		ohne Zubehör without accessories 9HY (DV6TED4), 9HZ (DV6TED4): für OE-Nummer: 1618 Z9 for OE number: 1618 Z9
			7.05271.74.0	LS	450 mm	
1.6 HDi 66-69 kW (90-94 PS) 9HP (DV6DTEd)	11.2009→12.2012		7.02209.11.0	AGR	EL	
			7.02156.24.0	AGR-K	EL	mit Sensor with sensor  →11.2012
			7.02156.33.0	AGR-K		mit Sensor with sensor →11.2012 ohne AGR-Ventil without EGR valve









P



207 (WA_, WC_) 15





















			7.11492.01.0	DDS		ohne Zubehör without accessories
			7.02604.99.0	LS	400 mm	
1.6 HDi 110 82-85 kW (112-116 PS) 9HR (DV6C)	08.2009→12.2012		7.02209.11.0	AGR	EL	
			7.02156.24.0	AGR-K	EL	mit Sensor with sensor  →11.2012
			7.02156.33.0	AGR-K		mit Sensor with sensor →11.2012 ohne AGR-Ventil without EGR valve
			7.11492.01.0	DDS		ohne Zubehör without accessories

207 CC (WD_) 16

1.6 16V 81-90 kW (110-122 PS) 5FS (EP6C), 5FW (EP6), EP6	02.2007→10.2013		7.05271.74.0	LS	450 mm	
			7.02604.41.0	LS	700 mm	Organisationsnummer bis: 11556 81, 11563 82 RPO number to: 11556 81, 11563 82 vor Katalysator in front of the catalyst
1.6 16V Turbo 110 kW (150 PS) 5FX (EP6DT)	02.2007→12.2012		7.05271.74.0	LS	450 mm	
1.6 16V Turbo 115 kW (156 PS) 5FR (EP6DT), 5FV (EP6CDT)	10.2009→12.2013		7.05271.74.0	LS	450 mm	
1.6 HDi 80-84 kW (109-114 PS) 9HZ (DV6TED4)	02.2007→01.2015		7.24809.39.0	AGR	EL	
			7.11492.01.0	DDS		ohne Zubehör without accessories für OE-Nummer: 1618 Z9 for OE number: 1618 Z9
1.6 HDi 82-85 kW (112-116 PS) 9HR (DV6C)	08.2009→10.2013		7.02209.11.0	AGR	EL	
			7.02156.24.0	AGR-K	EL	mit Sensor with sensor  →11.2012
			7.02156.35.0	AGR-K	EL	ohne Sensor without sensor 01.2013→ mit AGR-Ventil with EGR valve
			7.02156.33.0	AGR-K		mit Sensor with sensor →11.2012 ohne AGR-Ventil without EGR valve
			7.02156.34.0	AGR-K		ohne Sensor without sensor 01.2013→ ohne AGR-Ventil without EGR valve
7.11492.01.0	DDS		ohne Zubehör without accessories			

207 SW (WK_) 17













1.4 16V 70 kW (95 PS) 8FS (EP3), EP3, EP3C	06.2007→10.2013		7.02604.11.0	LS	null mm	
			7.05271.74.0	LS	450 mm	

					
207 SW (WK_)					
1.6 16V 81-90 kW (110-122 PS) 5FS (EP6C), 5FW (EP6), EP6	06.2007→10.2013		7.05271.74.0	LS	450 mm
1.6 16V RC 127 kW (173 PS) 5FY (EP6DTS)	02.2007→12.2012		7.02604.41.0	LS	700 mm
			7.05271.74.0	LS	450 mm
1.6 16V Turbo 110 kW (150 PS) 5FX (EP6DT)	02.2007→12.2012		7.02604.41.0	LS	700 mm
1.6 HDi 66 kW (90 PS) 9HV (DV6TED4B), 9HV (DV6TED4BU)	06.2007→12.2012		7.24809.39.0	AGR	EL 
1.6 HDi 80-84 kW (109-114 PS) 9HZ (DV6TED4)	06.2007→12.2012		7.24809.39.0	AGR	EL 
			7.11492.01.0	DDS	 Euro 4 (D4) Euro 4 (D4) ohne Zubehör without accessories für OE-Nummer: 1618 Z9 for OE number: 1618 Z9
1.6 HDi 82-85 kW (112-116 PS) 9HR (DV6C)	08.2009→10.2013		7.02209.11.0	AGR	EL 
			7.02156.24.0	AGR-K	EL mit Sensor with sensor  →11.2012
			7.02156.35.0	AGR-K	EL ohne Sensor without sensor 01.2013→ mit AGR-Ventil with EGR valve
			7.02156.33.0	AGR-K	EL mit Sensor with sensor →11.2012 ohne AGR-Ventil without EGR valve
			7.02156.34.0	AGR-K	EL ohne Sensor without sensor 01.2013→ ohne AGR-Ventil without EGR valve
			7.11492.01.0	DDS	EL ohne Zubehör without accessories
1.6 HDi 66-69 kW (90-94 PS) 9HP (DV6DTED)	11.2009→12.2012		7.02209.11.0	AGR	EL 
			7.02156.24.0	AGR-K	EL mit Sensor with sensor  →11.2012
			7.02156.33.0	AGR-K	EL mit Sensor with sensor →11.2012 ohne AGR-Ventil without EGR valve
			7.11492.01.0	DDS	EL ohne Zubehör without accessories
			7.02604.99.0	LS	400 mm













208 I (CA_, CC_) 18

















1.4 HDi 50 kW (68 PS) 8HP (DV4C)	03.2012→		7.02209.11.0	AGR	EL	
			7.02156.24.0	AGR-K	EL	mit Sensor with sensor
			7.02156.35.0	AGR-K	EL	 8HP (DV4C): →10.2012  8HP (DV4C): →10.2012 ohne Sensor without sensor 12.2012→ mit AGR-Ventil with EGR valve
			7.02156.33.0	AGR-K		mit Sensor with sensor
			7.02156.34.0	AGR-K		ohne Sensor without sensor 12.2012→ ohne AGR-Ventil without EGR valve
			7.11492.01.0	DDS		ohne Zubehör without accessories
1.4 HDi 50 kW (68 PS) 8HR (DV4C)	03.2012→		7.02209.11.0	AGR	EL	
			7.02156.35.0	AGR-K	EL	ohne Sensor without sensor 12.2012→ mit AGR-Ventil with EGR valve
			7.02156.33.0	AGR-K		mit Sensor with sensor
			7.02156.34.0	AGR-K		ohne Sensor without sensor 12.2012→ ohne AGR-Ventil without EGR valve
		7.11492.01.0	DDS		ohne Zubehör without accessories	
P 1.4 VTi 70 kW (95 PS) 8FS (EP3), EP3C	03.2012→		7.05271.74.0	LS	450 mm	
1.5 BlueHDi 100 75 kW (102 PS) YHY (DV5RD)	05.2018→		7.07794.23.0	AGR	EL	mit Dichtring with O-ring
1.6 115 kW (156 PS) 5FV (EP6CDT)	03.2012→		7.05271.74.0	LS	450 mm	
1.6 85-90 kW (116-122 PS) 5FS (EP6C)	03.2012→		7.05271.74.0	LS	450 mm	
1.6 HDi 84-85 kW (114-116 PS) 9HD (DV6C)	03.2012→		7.02156.35.0	AGR-K	EL	ohne Sensor without sensor 01.2013→ mit AGR-Ventil with EGR valve
			7.02156.33.0	AGR-K		mit Sensor with sensor →11.2012 ohne AGR-Ventil without EGR valve
			7.02156.34.0	AGR-K		ohne Sensor without sensor 01.2013→ ohne AGR-Ventil without EGR valve
			7.11492.01.0	DDS		ohne Zubehör without accessories
1.6 HDi 66-69 kW (90-94 PS) 9HP (DV6DTE)	03.2012→		7.02209.11.0	AGR	EL	

























208 I (CA_, CC_) 18

			<p>7.02156.24.0 AGR-K EL mit Sensor with sensor  →11.2012</p> <p>7.02156.35.0 AGR-K EL ohne Sensor without sensor 01.2013→ mit AGR-Ventil with EGR valve</p> <p>7.02156.33.0 AGR-K mit Sensor with sensor →11.2012 ohne AGR-Ventil without EGR valve</p> <p>7.02156.34.0 AGR-K ohne Sensor without sensor 01.2013→ ohne AGR-Ventil without EGR valve</p> <p>7.11492.01.0 DDS ohne Zubehör without accessories</p> <p>7.02604.99.0 LS 400 mm</p>
<p>1.6 HDi 68 kW (92 PS) 9HJ (DV6DTEDM)</p>	<p>03.2012→</p>		<p>7.02209.11.0 AGR EL </p>
			<p>7.02156.35.0 AGR-K EL ohne Sensor without sensor 01.2013→ mit AGR-Ventil with EGR valve</p>
			<p>7.03647.10.0 AGR-K EL </p>
			<p>7.02156.33.0 AGR-K mit Sensor with sensor →11.2012 ohne AGR-Ventil without EGR valve</p>
			<p>7.02156.34.0 AGR-K ohne Sensor without sensor 01.2013→ ohne AGR-Ventil without EGR valve</p>
<p>1.6 HDi 66-69 kW (90-94 PS) 9HP (DV6DTEED)</p>	<p>09.2016→</p>		<p>7.02209.11.0 AGR EL </p>
			<p>7.02156.35.0 AGR-K EL ohne Sensor without sensor mit AGR-Ventil with EGR valve</p>
			<p>7.02156.34.0 AGR-K ohne Sensor without sensor ohne AGR-Ventil without EGR valve</p>
			<p>7.11492.01.0 DDS ohne Zubehör without accessories</p>
<p>1.6 HDi / BlueHDi 75 55 kW (75 PS) 9HK (DV6ETEDM)</p>	<p>01.2013→</p>		<p>7.02209.11.0 AGR EL </p>
			<p>7.03647.10.0 AGR-K EL </p> <p>ohne Sensor without sensor</p>





						
208 I (CA_, CC_) 18						
1.6 e-HDi 82-85 kW (112-116 PS) 9HR (DV6C)	07.2015→		7.02156.35.0	AGR-K	EL	ohne Sensor without sensor mit AGR-Ventil with EGR valve ohne Sensor without sensor ohne AGR-Ventil without EGR valve
			7.02156.34.0	AGR-K		
208 II (UB_, UP_, UW_, UJ_) 19						
1.5 BlueHDI 130 96 kW (131 PS) YHZ (DV5RC)	09.2019→		7.07794.23.0	AGR	EL	mit Dichtring with O-ring
3008 MPV (0U_) 20						
1.6 HDi 80-84 kW (109-114 PS) 9HZ (DV6TED4)	06.2009→08.2016		7.24809.39.0	AGR	EL	Euro 4 (D4) Euro 4 (D4) ohne Zubehör without accessories
			7.11492.01.0	DDS		
1.6 HDi 82-85 kW (112-116 PS) 9HR (DV6C)	12.2009→08.2016		7.02209.11.0	AGR	EL	mit Sensor with sensor  →11.2012 ohne Sensor without sensor 01.2013→ mit AGR-Ventil with EGR valve mit Sensor with sensor →11.2012 ohne AGR-Ventil without EGR valve ohne Sensor without sensor 01.2013→ ohne AGR-Ventil without EGR valve ohne Zubehör without accessories
			7.02156.24.0	AGR-K	EL	
			7.02156.35.0	AGR-K	EL	
			7.02156.33.0	AGR-K		
			7.02156.34.0	AGR-K		
1.6 HDi 84 kW (114 PS) 9HD (DV6CTED)	03.2013→08.2016		7.02209.11.0	AGR	EL	
			7.02156.35.0	AGR-K	EL	
			7.02156.34.0	AGR-K		
1.6 HDi 115 / BlueHDI 115 82-85 kW (112-116 PS) 9HC (DV6C)	02.2013→08.2016		7.02156.35.0	AGR-K	EL	ohne Sensor without sensor mit AGR-Ventil with EGR valve ohne Sensor without sensor ohne AGR-Ventil without EGR valve ohne Zubehör without accessories
			7.02156.34.0	AGR-K		
			7.11492.01.0	DDS		
1.6 THP 110 kW (150 PS) 5FE (EP6CDTM), 5FE (EP6CDTMD), 5FX (EP6DT)	06.2009→08.2016		7.05271.74.0	LS	450 mm	
1.6 THP 115 kW (156 PS) 5FV (EP6CDT)	06.2009→08.2016		7.05271.74.0	LS	450 mm	

P

					
3008 MPV (0U_)					20
1.6 VTi 81-90 kW (110-122 PS) 5FS (EP6C), 5FW (EP6), EP6	06.2009→08.2016		7.05271.74.0	LS	450 mm
2.0 HDi 120 kW (163 PS) RHH (DW10CTED4)	06.2009→08.2016		7.24809.94.0	AGR-K	EL 
			7.11492.01.0	DDS	Organisationsnummer ab: 12775 RPO number from: 12775 ohne Zubehör without accessories
			7.02604.99.0	LS	400 mm
2.0 HDi 100 kW (136 PS) RHD (DW10CB)	09.2011→08.2016		7.24809.94.0	AGR-K	EL 
			7.11492.01.0	DDS	ohne Zubehör without accessories
			7.02604.99.0	LS	400 mm
2.0 HDi 150 / BlueHDi 150 100-110 kW (136-150 PS) RHE (DW10CTED4)	06.2009→08.2016		7.24809.94.0	AGR-K	EL 
			7.11492.01.0	DDS	Organisationsnummer ab: 12775 RPO number from: 12775 ohne Zubehör without accessories
			7.02604.99.0	LS	400 mm Motorcode: RHE (DW10CTED4) Engine Code: RHE (DW10CTED4) Produktionsdatum ab: 06.2009 Production date from: 06.2009 Produktionsdatum bis: 08.2016 Production date to: 08.2016
2.0 HDi 150 / BlueHDi 150 110 kW (150 PS) AHX (DW10FD)	06.2009→08.2016		7.11492.01.0	DDS	ohne Zubehör without accessories
2.0 HDi Hybrid4 120-147 kW (163-200 PS) RHC (DW10CTED4)	02.2011→08.2016		7.11492.01.0	DDS	ohne Zubehör without accessories
			7.02604.99.0	LS	400 mm
2.0 HDi Hybrid4 (0URHCA) 120-147 kW (163-200 PS) RHC (DW10CTED4)	02.2011→08.2016		7.11492.01.0	DDS	ohne Zubehör without accessories
3008 SUV (MC_, MR_, MJ_, M4_)					21
1.5 BlueHDi 130 96 kW (131 PS) YHZ (DV5RC)	02.2018→		7.07794.23.0	AGR	EL mit Dichtring with O-ring
2.0 BlueHDi 136 100 kW (136 PS) AHV (DW10FD)	11.2016→		7.11492.01.0	DDS	ohne Zubehör without accessories
2.0 BlueHDi 150 110 kW (150 PS) AHX (DW10FD)	05.2016→		7.11492.01.0	DDS	ohne Zubehör without accessories
301					22
1.5 BlueHDi 100 75 kW (102 PS) YHY (DV5RD)	05.2018→		7.07794.23.0	AGR	EL mit Dichtring with O-ring
1.6 HDi 90 66-69 kW (90-94 PS) 9HF (DV6DTEd)	11.2012→		7.02209.11.0	AGR	EL 
			7.02156.24.0	AGR-K	EL mit Sensor with sensor  →11.2012
			7.02156.35.0	AGR-K	EL ohne Sensor without sensor 01.2013→ mit AGR-Ventil with EGR valve











301 **22**

			7.02156.33.0	AGR-K		mit Sensor with sensor →11.2012 ohne AGR-Ventil without EGR valve	
			7.02156.34.0	AGR-K		ohne Sensor without sensor 01.2013→ ohne AGR-Ventil without EGR valve	
			7.11492.01.0	DDS		ohne Zubehör without accessories	
			7.02604.99.0	LS	400 mm		
1.6 HDI 90 68 kW (92 PS) 9HJ (DV6DTEDM)	11.2012→		7.02209.11.0	AGR	EL		
			7.02156.35.0	AGR-K	EL	ohne Sensor without sensor 01.2013→ mit AGR-Ventil with EGR valve	
			7.03647.10.0	AGR-K	EL		ohne Sensor without sensor
			7.02156.33.0	AGR-K		mit Sensor with sensor →11.2012 ohne AGR-Ventil without EGR valve	
			7.02156.34.0	AGR-K		ohne Sensor without sensor 01.2013→ ohne AGR-Ventil without EGR valve	
			7.02604.99.0	LS	400 mm		

306 (7B, N3, N5) **23**



P

1.4 SL 55-58 kW (75-79 PS) KDX (TU3MC)	06.1994→05.2001		7.02604.04.0	LS	200 mm	
1.4 SL 49-55 kW (67-75 PS) KFX (TU3JP)	02.1997→05.2001		7.05270.39.0	LS	400 mm	Euro 2
			7.02604.04.0	LS	200 mm	Euro 2
1.4 SL 47-60 kW (64-82 PS) KFW (TU3JP)	10.2000→05.2001		7.05270.36.0	LS	540 mm	Euro 3, Technische Schadstoffverringierung K
			7.05270.39.0	LS	400 mm	Euro 2
			7.02604.04.0	LS	200 mm	Euro 2
1.6 SR 65-66 kW (88-90 PS) NFZ (TU5JP)	06.1994→10.2000		7.05270.39.0	LS	400 mm	
			7.02604.04.0	LS	200 mm	
1.8 74-77 kW (101-105 PS) LFZ (XU7JP)	06.1994→05.2001		7.05270.36.0	LS	540 mm	Euro 3
			7.02604.04.0	LS	200 mm	Euro 3
1.8 76-86 kW (103-117 PS) LFY (XU7JP4)	09.1997→12.2002		7.05270.36.0	LS	540 mm	15-04
						15-04
1.8 16V 76-86 kW (103-117 PS) LFY (XU7JP4)	03.1997→05.2001		7.05270.36.0	LS	540 mm	15-04
			7.05270.37.0	LS	1640 mm	15-04

						
306 (7B, N3, N5)						23
1.8 16V 76-86 kW (103-117 PS) LFY (XU7JP4)	03.1997→07.2001		7.05270.36.0	LS	540 mm	15-04 15-04
1.8 16V 76-86 kW (103-117 PS) LFY (XU7JP4)	10.1999→10.2003		7.05270.36.0	LS	540 mm	15-04 15-04
1.8 ST 74-77 kW (101-105 PS) LFZ (XU7JP)	06.1994→05.2001		7.02604.04.0	LS	200 mm	
2.0 HDI 90 66 kW (90 PS) RHY (DW10TD)	06.1999→12.2001		7.22843.06.0	AGR	PN	
2.0 ST 89-96 kW (121-131 PS) RFX (XU10J2)	07.1994→05.2001		7.02604.04.0	LS	200 mm	
306 Break (7E, N3, N5)						24
1.4 49-55 kW (67-75 PS) KFX (TU3JP)	03.1997→04.2002		7.05270.39.0	LS	400 mm	Euro 2
			7.02604.04.0	LS	200 mm	Euro 2
1.4 47-60 kW (64-82 PS) KFW (TU3JP)	10.2000→04.2002		7.05270.36.0	LS	540 mm	Euro 3, Technische Schadstoffverringerng K
			7.05270.39.0	LS	400 mm	Euro 3, Technical pollution reduction K
			7.02604.04.0	LS	200 mm	Euro 2 Euro 2
1.6 65-66 kW (88-90 PS) NFZ (TU5JP)	03.1997→10.2000		7.05270.39.0	LS	400 mm	
			7.02604.04.0	LS	200 mm	
1.6 72 kW (98 PS) NFT (TU5JP)	10.2000→04.2002		7.05270.39.0	LS	400 mm	
			7.02604.04.0	LS	200 mm	
1.8 74-77 kW (101-105 PS) LFZ (XU7JP)	03.1997→04.2002		7.02604.04.0	LS	200 mm	
1.8 16V 76-86 kW (103-117 PS) LFY (XU7JP4)	03.1997→04.2002		7.05270.36.0	LS	540 mm	15-04 15-04
			7.05270.37.0	LS	1640 mm	
1.8 16V 76-86 kW (103-117 PS) LFY (XU7JP4)	03.1997→07.2001		7.05270.36.0	LS	540 mm	15-04 15-04
2.0 HDI 90 66 kW (90 PS) RHY (DW10TD)	06.1999→04.2002		7.22843.06.0	AGR	PN	
306 Convertible (7D, N3, N5)						25
1.6 65-66 kW (88-90 PS) NFZ (TU5JP)	04.1996→10.2000		7.05270.39.0	LS	400 mm	
			7.02604.04.0	LS	200 mm	
1.6 72 kW (98 PS) NFT (TU5JP)	10.2000→04.2002		7.05270.39.0	LS	400 mm	
			7.02604.04.0	LS	200 mm	
1.8 74 kW (101 PS) L6A (XU7JP)	03.1994→04.2002		7.02604.04.0	LS	200 mm	
1.8 74-77 kW (101-105 PS) LFZ (XU7JP)	03.1994→04.2002		7.05270.36.0	LS	540 mm	Euro 3
			7.02604.04.0	LS	200 mm	Euro 3
1.8 16V 76-86 kW (103-117 PS) LFY (XU7JP4)	05.1997→04.2002		7.05270.36.0	LS	540 mm	15-04 15-04







306 Convertible (7D, N3, N5) 25





























			7.05270.37.0	LS	1640 mm	
2.0 89-96 kW (121-131 PS) RFX (XU10J2)	03.1994→04.2002		7.02604.04.0	LS	200 mm	

306 Hatchback (7A, 7C, N3, N5) 26

1.4 55-58 kW (75-79 PS) KDX (TU3MC)	04.1993→07.2001		7.02604.04.0	LS	200 mm	
1.4 49-55 kW (67-75 PS) KFX (TU3JP)	02.1997→07.2001		7.05270.39.0	LS	400 mm	Euro 2
			7.02604.04.0	LS	200 mm	Euro 2
1.4 47-60 kW (64-82 PS) KFW (TU3JP)	10.2000→07.2001		7.05270.36.0	LS	540 mm	Euro 3, Technische Schadstoffverringerng K
			7.05270.39.0	LS	400 mm	Euro 2
			7.02604.04.0	LS	200 mm	Euro 2
1.6 65-66 kW (88-90 PS) NFZ (TU5JP)	05.1993→10.2000		7.05270.39.0	LS	400 mm	
			7.02604.04.0	LS	200 mm	
1.6 65-66 kW (88-90 PS) NFZ (TU5JP)	07.2000→05.2001		7.05270.39.0	LS	400 mm	
			7.02604.04.0	LS	200 mm	
1.6 72 kW (98 PS) NFT (TU5JP)	10.2000→05.2001		7.05270.39.0	LS	400 mm	
			7.02604.04.0	LS	200 mm	
1.8 74-77 kW (101-105 PS) LFZ (XU7JP)	05.1993→05.2001		7.05270.36.0	LS	540 mm	Euro 3
			7.02604.04.0	LS	200 mm	Euro 3
1.8 16V 76-86 kW (103-117 PS) LFY (XU7JP4)	03.1997→05.2001		7.05270.36.0	LS	540 mm	15-04
			7.05270.37.0	LS	1640 mm	15-04
1.8 16V 76-86 kW (103-117 PS) LFY (XU7JP4)	03.1997→10.2003		7.05270.36.0	LS	540 mm	15-04
1.8 16V 76-86 kW (103-117 PS) LFY (XU7JP4)	07.1997→10.2000		7.05270.36.0	LS	540 mm	15-04
1.8 16V 76-86 kW (103-117 PS) LFY (XU7JP4)	10.1999→10.2003		7.05270.36.0	LS	540 mm	15-04
2.0 HDi 90 66 kW (90 PS) RHY (DW10TD)	06.1999→12.2002		7.22843.06.0	AGR	PN	
2.0 XSi 89-96 kW (121-131 PS) RFX (XU10J2)	05.1993→05.2001		7.02604.04.0	LS	200 mm	



307 (3A/C) 27

1.4 47-60 kW (64-82 PS) KFW (TU3JP)	08.2000→09.2003		7.05270.36.0	LS	540 mm	Euro 3, Technische Schadstoffverringerng K
1.4 16V 65 kW (88 PS) KFU (ET3J4)	11.2003→07.2007		7.02604.11.0	LS	null mm	
			7.02604.12.0	LS	400 mm	
1.4 HDi 50-52 kW (68-70 PS) 8HX (DV4TD), 8HZ (DV4TD)	10.2001→06.2005		7.24809.06.0	AGR	PN	mit Rohrstutzen with pipe socket   8HX (DV4TD), 8HZ (DV4TD): Euro 3 Euro 3





						
307 (3A/C)						27
1.6 16V 78-90 kW (106-122 PS) NFU (TU5JP4)	08.2000→11.2007		7.05270.37.0	LS	1640 mm	
1.6 BioFlex 78-90 kW (106-122 PS) NFU (TU5JP4)	09.2007→04.2009		7.05270.37.0	LS	1640 mm	
1.6 HDi 66-68 kW (90-92 PS) 9HX (DV6ATED4)	04.2005→03.2009		7.24809.39.0	AGR	EL	 Euro 4 (D4) Euro 4 (D4)
1.6 HDi 110 80-84 kW (109-114 PS) 9HY (DV6TED4), 9HZ (DV6TED4)	02.2004→03.2009		7.24809.39.0	AGR	EL	 9HY (DV6TED4), 9HZ (DV6TED4): Euro 4 (D4) Euro 4 (D4)
			7.11492.01.0	DDS		ohne Zubehör without accessories  9HY (DV6TED4), 9HZ (DV6TED4): Organisationsnummer ab: 10948 RPO number from: 10948
2.0 16V 130-132 kW (177-180 PS) RFK (EW10J4S)	06.2005→11.2007		7.05270.37.0	LS	1640 mm	
2.0 HDi 110 79 kW (107 PS) RHS (DW10ATED)	08.2000→03.2007		7.22843.06.0	AGR	PN	
			7.22843.07.0	AGR	PN	
2.0 HDi 135 100-103 kW (136-140 PS) RHR (DW10BTED4)	10.2003→11.2007		7.24809.68.0	AGR	EL	
			7.09730.00.0	AGR-K		
			7.11492.01.0	DDS		ohne Zubehör without accessories Organisationsnummer ab: 10948 RPO number from: 10948
2.0 HDi 90 66 kW (90 PS) RHY (DW10TD)	08.2000→03.2007		7.22843.06.0	AGR	PN	
307 Break (3E)						28
1.4 47-60 kW (64-82 PS) KFW (TU3JP)	04.2002→09.2003		7.05270.36.0	LS	540 mm	Euro 3, Technische Schadstoffverringierung K
						Euro 3, Technical pollution reduction K
1.4 16V 65 kW (88 PS) KFU (ET3J4)	11.2003→07.2007		7.02604.11.0	LS	null mm	
			7.02604.12.0	LS	400 mm	
1.4 HDi 50-52 kW (68-70 PS) 8HZ (DV4TD)	03.2002→06.2005		7.24809.06.0	AGR	PN	mit Rohrstützen with pipe socket  Euro 3 Euro 3
1.6 16V 78-90 kW (106-122 PS) NFU (TU5JP4)	03.2002→04.2008		7.05270.37.0	LS	1640 mm	
1.6 BioFlex 78-90 kW (106-122 PS) NFU (TU5JP4)	09.2007→04.2008		7.05270.37.0	LS	1640 mm	
1.6 HDi 66-68 kW (90-92 PS) 9HV (DV6TED4B), 9HV (DV6TED4BU), 9HX (DV6ATED4), 9HX (DV6AUTED4)	04.2005→04.2008		7.24809.39.0	AGR	EL	
1.6 HDi 110 80-84 kW (109-114 PS) 9HY (DV6TED4), 9HZ (DV6TED4)	02.2004→04.2008		7.24809.39.0	AGR	EL	 9HY (DV6TED4), 9HZ (DV6TED4): Euro 4 (D4) Euro 4 (D4)
			7.11492.01.0	DDS		ohne Zubehör without accessories  9HY (DV6TED4), 9HZ (DV6TED4): Organisationsnummer ab: 10948 RPO number from: 10948
2.0 16V 130-132 kW (177-180 PS) RFK (EW10J4S)	06.2005→04.2008		7.05270.37.0	LS	1640 mm	











307 Break (3E) 28

2.0 HDi 110 79 kW (107 PS) RHS (DW10ATED)	03.2002→12.2009		7.22843.06.0	AGR	PN	<input type="checkbox"/>
			7.22843.07.0	AGR	PN	<input type="checkbox"/>
2.0 HDi 90 66 kW (90 PS) RHY (DW10TD)	03.2002→04.2008		7.22843.06.0	AGR	PN	<input type="checkbox"/>
2.0 HDi 135 100-103 kW (136-140 PS) RHR (DW10BTED4)	02.2004→04.2008		7.24809.68.0	AGR	EL	<input type="checkbox"/>
			7.09730.00.0	AGR-K		
			7.11492.01.0	DDS		ohne Zubehör without accessories Organisationsnummer ab: 11074 RPO number from: 11074























307 CC (3B) 29

2.0 16V 100-105 kW (136-143 PS) RFN (EW10J4)	10.2003→06.2005		7.02604.13.0	LS	1170 mm	
2.0 16V 130-132 kW (177-180 PS) RFK (EW10J4S)	10.2003→04.2009		7.02604.13.0	LS	1170 mm	
2.0 16V 103-111 kW (140-151 PS) RFJ (EW10A)	12.2004→04.2009		7.02604.13.0	LS	1170 mm	
2.0 HDi 135 100-103 kW (136-140 PS) RHR (DW10BTED4)	06.2005→04.2009		7.24809.68.0	AGR	EL	<input type="checkbox"/>
			7.09730.00.0	AGR-K		
			7.11492.01.0	DDS		ohne Zubehör without accessories Organisationsnummer ab: 11074 RPO number from: 11074

307 SW (3H) 30









1.4 47-60 kW (64-82 PS) KFW (TU3JP)	04.2002→09.2003		7.05270.36.0	LS	540 mm	Euro 3, Technische Schadstoffverringerng K Euro 3, Technical pollution reduction K
1.4 16V 65 kW (88 PS) KFU (ET3J4)	11.2003→07.2007		7.02604.11.0	LS	null mm	
			7.02604.12.0	LS	400 mm	
1.6 16V 78-90 kW (106-122 PS) NFU (TU5JP4)	03.2002→04.2008		7.05270.37.0	LS	1640 mm	
1.6 BioFlex 78-90 kW (106-122 PS) NFU (TU5JP4)	09.2007→04.2008		7.05270.37.0	LS	1640 mm	
1.6 HDi 110 80-84 kW (109-114 PS) 9HY (DV6TED4), 9HZ (DV6TED4)	11.2003→12.2007		7.24809.39.0	AGR	EL	<input type="checkbox"/>
			7.11492.01.0	DDS		<input checked="" type="checkbox"/> 9HY (DV6TED4), 9HZ (DV6TED4): Euro 4 (D4) Euro 4 (D4) ohne Zubehör without accessories <input checked="" type="checkbox"/> 9HY (DV6TED4), 9HZ (DV6TED4): Organisationsnummer ab: 10948 RPO number from: 10948
1.6 HDi 90 66-68 kW (90-92 PS) 9HX (DV6ATED4)	04.2005→04.2008		7.24809.39.0	AGR	EL	<input type="checkbox"/> Euro 4 (D4) Euro 4 (D4)
2.0 HDi 110 79 kW (107 PS) RHS (DW10ATED)	03.2002→12.2009		7.22843.06.0	AGR	PN	<input type="checkbox"/>
			7.22843.07.0	AGR	PN	<input type="checkbox"/>
2.0 HDi 90 66 kW (90 PS) RHY (DW10TD)	03.2002→04.2008		7.22843.06.0	AGR	PN	<input type="checkbox"/>
2.0 HDi 135 100-103 kW (136-140 PS) RHR (DW10BTED4)	02.2004→04.2008		7.24809.68.0	AGR	EL	<input type="checkbox"/>

P













					
307 SW (3H)					30
			7.09730.00.0 7.11492.01.0	AGR-K DDS	ohne Zubehör without accessories Organisationsnummer ab: 11074 RPO number from: 11074
307 Saloon					31
2.0 HDi 79-80 kW (107-109 PS) RHZ (DW10ATED)	09.2006→03.2012		7.22843.06.0	AGR PN	
			7.22843.07.0	AGR PN	
2.0 HDi 66 kW (90 PS) RHY (DW10TD)	09.2006→10.2010		7.22843.06.0	AGR PN	
308 CC (4B_)					32
1.6 16V 110 kW (150 PS) 5FX (EP6DT)	06.2009→12.2014		7.02604.41.0	LS 700 mm	nicht für Schaltgetriebe not for manual transmission vor Katalysator in front of the catalyst
			7.05271.74.0	LS 450 mm	
1.6 16V 81-88 kW (110-120 PS) EP6	06.2009→12.2014		7.05271.74.0	LS 450 mm	
1.6 16V 115 kW (156 PS) 5FV (EP6CDT)	06.2009→12.2014		7.05271.74.0	LS 450 mm	
1.6 16V 103 kW (140 PS) 5FT (EP6DT)	06.2009→12.2014		7.02604.41.0	LS 700 mm	nicht für Schaltgetriebe not for manual transmission vor Katalysator in front of the catalyst
			7.05271.74.0	LS 450 mm	
1.6 HDi 80-84 kW (109-114 PS) 9HZ (DV6TED4)	02.2009→05.2012		7.24809.39.0	AGR EL	
			7.11492.01.0	DDS	ohne Zubehör without accessories
1.6 HDi 82-85 kW (112-116 PS) 9HR (DV6C)	06.2009→12.2014		7.02209.11.0	AGR EL	
			7.02156.24.0	AGR-K EL	mit Sensor with sensor  →11.2012
			7.02156.35.0	AGR-K EL	ohne Sensor without sensor 01.2013→ mit AGR-Ventil with EGR valve
			7.02156.33.0	AGR-K	mit Sensor with sensor →11.2012 ohne AGR-Ventil without EGR valve
			7.02156.34.0	AGR-K	ohne Sensor without sensor 01.2013→ ohne AGR-Ventil without EGR valve
			7.11492.01.0	DDS	ohne Zubehör without accessories
1.6 HDi 84-85 kW (114-116 PS) 9HD (DV6C)	03.2013→12.2014		7.02209.11.0	AGR EL	
			7.02156.35.0	AGR-K EL	ohne Sensor without sensor mit AGR-Ventil with EGR valve



308 CC (4B_) **32**







			7.02156.34.0	AGR-K		ohne Sensor without sensor ohne AGR-Ventil without EGR valve ohne Zubehör without accessories
			7.11492.01.0	DDS		
1.6 THP 147-150 kW (200-204 PS) EP6CDTX	10.2010→12.2014		7.05271.74.0	LS	450 mm	
2.0 HDi 103 kW (140 PS) RHF (DW10BTED4)	04.2009→12.2012		7.24809.68.0	AGR	EL	
			7.24809.94.0	AGR-K	EL	 Organisationsnummer ab: 12775 RPO number from: 12775
			7.09730.00.0	AGR-K		
			7.11492.01.0	DDS		ohne Zubehör without accessories
2.0 HDi 100-103 kW (136-140 PS) RHR (DW10BTED4)	04.2009→12.2014		7.24809.68.0	AGR	EL	
			7.24809.94.0	AGR-K	EL	 Organisationsnummer ab: 12775 RPO number from: 12775
			7.09730.00.0	AGR-K		
			7.11492.01.0	DDS		ohne Zubehör without accessories
2.0 HDi 120 kW (163 PS) RHH (DW10CTED4)	06.2009→12.2014		7.24809.94.0	AGR-K	EL	 Organisationsnummer ab: 12775 RPO number from: 12775
			7.11492.01.0	DDS		ohne Zubehör without accessories
			7.02604.99.0	LS	400 mm	

308 I (4A_, 4C_) **33**

1.4 16V 70 kW (95 PS) 8FS (EP3), EP3	09.2007→10.2014		7.05271.74.0	LS	450 mm	
1.4 16V 72 kW (98 PS) 8FR (EP3)	12.2009→10.2014		7.05271.74.0	LS	450 mm	
1.6 16V 81-88 kW (110-120 PS) 5FW (EP6), EP6	09.2007→10.2014		7.05271.74.0	LS	450 mm	
1.6 16V 110 kW (150 PS) 5FX (EP6DT)	09.2007→10.2014		7.02604.41.0	LS	700 mm	nicht für Schaltgetriebe not for manual transmission vor Katalysator in front of the catalyst
			7.05271.74.0	LS	450 mm	
1.6 16V 103 kW (140 PS) 5FT (EP6DT)	09.2007→10.2014		7.05271.74.0	LS	450 mm	
1.6 16V 127 kW (173 PS) 5FY (EP6DTS)	03.2008→10.2014		7.02604.41.0	LS	700 mm	vor Katalysator in front of the catalyst
			7.05271.74.0	LS	450 mm	
1.6 HDi 66-68 kW (90-92 PS) 9HV (DV6TED4B), 9HV (DV6TED4BU), 9HX (DV6ATED4)	09.2007→10.2014		7.24809.39.0	AGR	EL	
1.6 HDi 80-84 kW (109-114 PS) 9HZ (DV6TED4)	09.2007→10.2014		7.24809.39.0	AGR	EL	 Euro 4 (D4) Euro 4 (D4)
			7.11492.01.0	DDS		ohne Zubehör without accessories
1.6 HDi 66-69 kW (90-94 PS) 9HP (DV6DTED)	11.2009→10.2014		7.02209.11.0	AGR	EL	



















308 I (4A_, 4C_) 33

			7.02156.24.0	AGR-K	EL	mit Sensor with sensor 
			7.02156.35.0	AGR-K	EL	ohne Sensor without sensor →11.2012
			7.02156.33.0	AGR-K		01.2013→ mit AGR-Ventil with EGR valve
			7.02156.34.0	AGR-K		mit Sensor with sensor →11.2012
			7.11492.01.0	DDS		ohne AGR-Ventil without EGR valve
			7.02604.99.0	LS	400 mm	ohne Sensor without sensor 01.2013→ ohne AGR-Ventil without EGR valve
			7.11492.01.0	DDS		ohne Zubehör without accessories
1.6 HDi 68 kW (92 PS) 9HJ (DV6DTEDM)	11.2009→10.2014		7.02209.11.0	AGR	EL	
			7.02156.35.0	AGR-K	EL	ohne Sensor without sensor 01.2013→ mit AGR-Ventil with EGR valve
			7.03647.10.0	AGR-K	EL	
			7.02156.33.0	AGR-K		mit Sensor with sensor →11.2012
			7.02156.34.0	AGR-K		ohne AGR-Ventil without EGR valve
			7.02604.99.0	LS	400 mm	ohne Sensor without sensor 01.2013→ ohne AGR-Ventil without EGR valve
1.6 HDi 82-85 kW (112-116 PS) 9HR (DV6C)	12.2009→10.2014		7.02209.11.0	AGR	EL	
			7.02156.24.0	AGR-K	EL	mit Sensor with sensor 
			7.02156.35.0	AGR-K	EL	ohne Sensor without sensor 01.2013→ mit AGR-Ventil with EGR valve
			7.02156.33.0	AGR-K		mit Sensor with sensor →11.2012
			7.02156.34.0	AGR-K		ohne AGR-Ventil without EGR valve
			7.02156.34.0	AGR-K		ohne Sensor without sensor 01.2013→ ohne AGR-Ventil without EGR valve











308 I (4A_, 4C_) 33









			7.11492.01.0	DDS		ohne Zubehör without accessories
1.6 HDi 82-84 kW (114 PS) 9HG (DV6C M)	03.2013→10.2014		7.02156.35.0	AGR-K	EL	ohne Sensor without sensor mit AGR-Ventil with EGR valve
			7.03647.10.0	AGR-K	EL	 ohne Sensor without sensor
			7.02156.34.0	AGR-K		ohne Sensor without sensor ohne AGR-Ventil without EGR valve
1.6 HDi 84-85 kW (114-116 PS) 9HD (DV6C)	03.2013→10.2014		7.02209.11.0	AGR	EL	
			7.02156.35.0	AGR-K	EL	ohne Sensor without sensor mit AGR-Ventil with EGR valve
			7.02156.34.0	AGR-K		ohne Sensor without sensor ohne AGR-Ventil without EGR valve
			7.11492.01.0	DDS		ohne Zubehör without accessories
1.6 THP 16V 115 kW (156 PS) 5FV (EP6CDT)	10.2009→10.2014		7.05271.74.0	LS	450 mm	
2.0 HDi 100-103 kW (136-140 PS) RHR (DW10BTED4)	09.2007→10.2014		7.24809.68.0	AGR	EL	
			7.24809.94.0	AGR-K	EL	 Organisationsnummer ab: 12775 RPO number from: 12775
			7.09730.00.0	AGR-K		Organisationsnummer bis: 1168289 RPO number to: 1168289
			7.11492.01.0	DDS		ohne Zubehör without accessories
2.0 HDi 100-103 kW (136-140 PS) RHR (DW10CB)	09.2007→10.2014		7.24809.94.0	AGR-K	EL	
			7.11492.01.0	DDS		ohne Zubehör without accessories
2.0 HDi 100-103 kW (136-140 PS) RHR (DW10BTED4)	07.2010→12.2012		7.24809.68.0	AGR	EL	
			7.24809.94.0	AGR-K	EL	 Organisationsnummer ab: 12775 RPO number from: 12775
			7.09730.00.0	AGR-K		
			7.11492.01.0	DDS		ohne Zubehör without accessories
2.0 HDi 100-110 kW (136-150 PS) RHE (DW10CTED4)	10.2011→10.2014		7.24809.94.0	AGR-K	EL	 Organisationsnummer ab: 12775 RPO number from: 12775
			7.11492.01.0	DDS		ohne Zubehör without accessories
			7.02604.99.0	LS	400 mm	
2.0 HDi 120 kW (163 PS) RHH (DW10CTED4)	04.2012→10.2014		7.24809.94.0	AGR-K	EL	 Organisationsnummer ab: 12775 RPO number from: 12775
			7.11492.01.0	DDS		ohne Zubehör without accessories
			7.02604.99.0	LS	400 mm	



308 II (LB_, LP_, LW_, LH_, L3_) 34











1.6 HDi 66-69 kW (90-94 PS) 9HP (DV6DTEd)	09.2013→		7.02209.11.0	AGR	EL	 ohne Sensor without sensor mit AGR-Ventil with EGR valve ohne Sensor without sensor ohne AGR-Ventil without EGR valve ohne Zubehör without accessories
			7.02156.35.0	AGR-K	EL	
			7.02156.34.0	AGR-K		
			7.11492.01.0	DDS		
			7.02604.99.0	LS	400 mm	
1.6 HDi / BlueHDi 115 82-85 kW (112-116 PS) 9HC (DV6C)	09.2013→		7.02209.11.0	AGR	EL	 ohne Sensor without sensor mit AGR-Ventil with EGR valve ohne Sensor without sensor ohne AGR-Ventil without EGR valve ohne Zubehör without accessories
			7.02156.35.0	AGR-K	EL	
			7.02156.34.0	AGR-K		
			7.11492.01.0	DDS		
2.0 BlueHDi 150 110 kW (150 PS) AHX (DW10FD)	11.2013→		7.11492.01.0	DDS		ohne Zubehör without accessories für OE-Nummer: 1618 Z9 for OE number: 1618 Z9
2.0 GT BlueHDi 180 130-133 kW (177-181 PS) EHZ (DW10FC)	06.2017→		7.11492.01.0	DDS		ohne Zubehör without accessories für OE-Nummer: 1618 Z9 for OE number: 1618 Z9

308 SW I (4E_, 4H_) 35

1.4 16V 70 kW (95 PS) 8FS (EP3)	09.2007→10.2014		7.05271.74.0	LS	450 mm	
			7.05271.74.0	LS	450 mm	
1.6 16V 81-88 kW (110-120 PS) 5FW (EP6), EP6	09.2007→10.2014		7.05271.74.0	LS	450 mm	
			7.05271.74.0	LS	450 mm	
1.6 16V 110 kW (150 PS) 5FX (EP6DT)	09.2007→10.2014		7.02604.41.0	LS	700 mm	nicht für Schaltgetriebe not for manual transmission vor Katalysator in front of the catalyst
			7.05271.74.0	LS	450 mm	
1.6 16V 103 kW (140 PS) 5FT (EP6DT)	09.2007→10.2014		7.02604.41.0	LS	700 mm	nicht für Schaltgetriebe not for manual transmission vor Katalysator in front of the catalyst
			7.05271.74.0	LS	450 mm	
1.6 16V 127 kW (173 PS) 5FY (EP6DTS)	03.2008→10.2014		7.02604.41.0	LS	700 mm	vor Katalysator in front of the catalyst
			7.05271.74.0	LS	450 mm	
1.6 HDi 66-68 kW (90-92 PS) 9HX (DV6ATED4)	09.2007→10.2014		7.24809.39.0	AGR	EL	 Euro 4 (D4) Euro 4 (D4)
			7.24809.39.0	AGR	EL	
1.6 HDi 80-84 kW (109-114 PS) 9HZ (DV6TED4)	09.2007→10.2014		7.24809.39.0	AGR	EL	 Euro 4 (D4) Euro 4 (D4)









308 SW I (4E_, 4H_) 35

			7.11492.01.0	DDS		ohne Zubehör without accessories
1.6 HDi 66-69 kW (90-94 PS) 9HP (DV6DTEd)	11.2009→10.2014		7.02209.11.0	AGR	EL	
			7.02156.24.0	AGR-K	EL	mit Sensor with sensor  →11.2012
			7.02156.35.0	AGR-K	EL	ohne Sensor without sensor 01.2013→ mit AGR-Ventil with EGR valve
			7.02156.33.0	AGR-K		mit Sensor with sensor →11.2012 ohne AGR-Ventil without EGR valve
			7.02156.34.0	AGR-K		ohne Sensor without sensor 01.2013→ ohne AGR-Ventil without EGR valve
			7.11492.01.0	DDS		ohne Zubehör without accessories
			7.02604.99.0	LS	400 mm	
1.6 HDi 82-85 kW (112-116 PS) 9HR (DV6C)	12.2009→10.2014		7.02209.11.0	AGR	EL	
			7.02156.24.0	AGR-K	EL	mit Sensor with sensor  →11.2012
			7.02156.35.0	AGR-K	EL	ohne Sensor without sensor 01.2013→ mit AGR-Ventil with EGR valve
			7.02156.33.0	AGR-K		mit Sensor with sensor →11.2012 ohne AGR-Ventil without EGR valve
			7.02156.34.0	AGR-K		ohne Sensor without sensor 01.2013→ ohne AGR-Ventil without EGR valve
			7.11492.01.0	DDS		ohne Zubehör without accessories
1.6 HDi 84-85 kW (114-116 PS) 9HD (DV6C)	03.2013→10.2014		7.02209.11.0	AGR	EL	
			7.02156.35.0	AGR-K	EL	ohne Sensor without sensor mit AGR-Ventil with EGR valve
			7.02156.34.0	AGR-K		ohne Sensor without sensor
			7.11492.01.0	DDS		ohne Zubehör without accessories
1.6 THP 16V 115 kW (156 PS) 5FV (EP6CDT)	10.2009→10.2014		7.05271.74.0	LS	450 mm	
2.0 HDi 100-103 kW (136-140 PS) RHR (DW10BTED4)	09.2007→12.2012		7.24809.68.0	AGR	EL	
			7.09730.00.0	AGR-K		





P



308 SW I (4E_, 4H_) 35

			7.11492.01.0	DDS		ohne Zubehör without accessories
2.0 HDi 100-103 kW (136-140 PS) RHR (DW10BTED4)	09.2007→10.2014		7.24809.68.0	AGR	EL	
			7.09730.00.0	AGR-K		
			7.11492.01.0	DDS		ohne Zubehör without accessories
2.0 HDi 120 kW (163 PS) RHH (DW10CTED4)	06.2009→10.2014		7.24809.94.0	AGR-K	EL	
			7.11492.01.0	DDS		Organisationsnummer ab: 12775 RPO number from: 12775
			7.02604.99.0	LS	400 mm	ohne Zubehör without accessories
2.0 HDi 100-110 kW (136-150 PS) RHE (DW10CTED4)	04.2011→10.2014		7.24809.94.0	AGR-K	EL	
			7.11492.01.0	DDS		Organisationsnummer ab: 12775 RPO number from: 12775
			7.02604.99.0	LS	400 mm	ohne Zubehör without accessories

308 SW II (LC_, LJ_, LR_, LX_, L4_) 36

1.6 HDi / BlueHDi 115 82-85 kW (112-116 PS) 9HC (DV6C)	03.2014→		7.02209.11.0	AGR	EL	
			7.02156.35.0	AGR-K	EL	ohne Sensor without sensor
			7.02156.34.0	AGR-K		mit AGR-Ventil with EGR valve
			7.11492.01.0	DDS		ohne Sensor without sensor ohne AGR-Ventil without EGR valve ohne Zubehör without accessories
1.6 HDi 92 66-69 kW (90-94 PS) 9HP (DV6DTE)	03.2014→		7.02156.35.0	AGR-K	EL	
			7.02156.34.0	AGR-K		ohne Sensor without sensor
			7.11492.01.0	DDS		mit AGR-Ventil with EGR valve
			7.02604.99.0	LS	400 mm	ohne Sensor without sensor ohne AGR-Ventil without EGR valve ohne Zubehör without accessories
2.0 GT BlueHDi 180 130-133 kW (177-181 PS) EHZ (DW10FC)	06.2017→		7.11492.01.0	DDS		ohne Zubehör without accessories für OE-Nummer: 1618 Z9 for OE number: 1618 Z9





P



4007 (VU_, VV_) 37

2.2 HDi 115 kW (156 PS) 4HK (DW12ME5), 4HN (DW12MTED4)	02.2007→03.2013		7.00578.12.0 AGR EL 	ohne Zubehör without accessories  4HK (DW12ME5): Schaltgetriebe 6 Gang, Getriebeautomatik 6 Gang 6-Speed Manual Transmission, 6-Speed Automatic Transmission Allrad All-wheel Drive  4HN (DW12MTED4): Schaltgetriebe 6 Gang, für Getriebeautomatik 6 Gang 6-Speed Manual Transmission, for 6-speed automatic transmission Organisationsnummer ab: 11533 RPO number from: 11533 Allrad All-wheel Drive
			7.11492.01.0 DDS	

4008 38

1.6 HDi 84-85 kW (114-116 PS) 9HD (DV6C)	05.2012→		7.02209.11.0 AGR EL 	ohne Sensor without sensor 05.2013→ mit AGR-Ventil with EGR valve mit Sensor with sensor →04.2013 ohne AGR-Ventil without EGR valve ohne Sensor without sensor 05.2013→ ohne AGR-Ventil without EGR valve ohne Zubehör without accessories
			7.02156.35.0 AGR-K EL	
			7.02156.33.0 AGR-K	
			7.02156.34.0 AGR-K	
			7.11492.01.0 DDS	
1.6 HDi AWC 84-85 kW (114-116 PS) 9HD (DV6C)	05.2012→		7.02209.11.0 AGR EL 	mit Sensor with sensor  →04.2013 ohne Sensor without sensor 05.2013→ mit AGR-Ventil with EGR valve mit Sensor with sensor →04.2013 ohne AGR-Ventil without EGR valve ohne Sensor without sensor 05.2013→ ohne AGR-Ventil without EGR valve ohne Zubehör without accessories
			7.02156.24.0 AGR-K EL	
			7.02156.35.0 AGR-K EL	
			7.02156.33.0 AGR-K	
			7.02156.34.0 AGR-K	
7.11492.01.0 DDS				





P





4008 38

1.6 HDi AWC 82-85 kW (112-116 PS) 9HC (DV6C)	05.2012→		7.02156.35.0	AGR-K	EL	ohne Sensor without sensor 05.2013→ mit AGR-Ventil with EGR valve
			7.02156.33.0	AGR-K		mit Sensor with sensor →04.2013 ohne AGR-Ventil without EGR valve
			7.02156.34.0	AGR-K		ohne Sensor without sensor 05.2013→ ohne AGR-Ventil without EGR valve
			7.11492.01.0	DDS		ohne Sensor without sensor 05.2013→ ohne AGR-Ventil without EGR valve ohne Zubehör without accessories











405 II (4B) 39

1.8 74-77 kW (101-105 PS) LFZ (XU7JP)	08.1992→10.1995		7.02604.04.0	LS	200 mm	
1.8 74-77 kW (101-105 PS) LFZ (XU7JP)	08.1996→11.1999		7.02604.04.0	LS	200 mm	
2.0 16V 110-116 kW (150-155 PS) RFT (XU10J4)	06.1994→10.1995		7.02604.04.0	LS	200 mm	
2.0 MI-16 110-112 kW (150-152 PS) RFY (XU10J4Z)	08.1992→10.1995		7.02604.04.0	LS	200 mm	
2.0 T 16 X4 144 kW (196 PS) RGZ (XU10J4TE/Z)	08.1992→10.1995		7.02604.04.0	LS	200 mm	

405 II Break (4E) 40

1.8 74-77 kW (101-105 PS) LFZ (XU7JP)	08.1992→10.1996		7.02604.04.0	LS	200 mm	
2.0 4x4 144 kW (196 PS) RGZ (XU10J4TE/Z)	08.1992→12.1995		7.02604.04.0	LS	200 mm	







406 (8B) 41

1.6 65-68 kW (88-92 PS) BFZ (XU5JP)	11.1995→05.2004		7.05270.39.0	LS	400 mm	Organisationsnummer ab: 07084 RPO number from: 07084
1.8 66 kW (90 PS) LFX (XU7JB)	05.1997→05.2004		7.05270.39.0	LS	400 mm	
1.8 16V 76-86 kW (103-117 PS) LFY (XU7JP4)	11.1995→10.2000		7.05270.39.0	LS	400 mm	Benzin/Gas Petrol/Gas Euro 2 Euro 2
			7.05270.37.0	LS	1640 mm	Euro 3 Euro 3
1.8 16V 85 kW (116 PS) 6FZ (EW7J4)	10.2000→05.2004		7.05270.38.0	LS	1240 mm	Euro 3 Euro 3 Diagnosesonde Diagnostic Probe
2.0 16V 97-100 kW (132-136 PS) RFV (XU10J4R)	11.1995→05.2004		7.02604.04.0	LS	200 mm	
			7.05270.38.0	LS	1240 mm	Regelsonde Regulating Probe
2.0 16V 99 kW (135 PS) RFR (EW10J4)	01.1999→08.2000		7.02604.04.0	LS	200 mm	
2.0 16V 100-105 kW (136-143 PS) RFN (EW10J4)	08.2000→06.2004		7.02604.04.0	LS	200 mm	
2.0 16V HPi 103 kW (140 PS) RLZ (EW10D)	05.2001→05.2004		7.05270.38.0	LS	1240 mm	
2.0 HDI 110 79-80 kW (107-109 PS) RHZ (DW10ATED)	06.1998→08.2001		7.22843.06.0	AGR	PN	













P





























406 (8B) **41**

			7.22843.07.0	AGR	PN	○
			7.09730.01.0	AGR-K		
2.0 HDi 90 66 kW (90 PS) RHY (DW10TD)	02.1999→05.2004		7.22843.06.0	AGR	PN	○
2.0 HDi 110 79-80 kW (107-109 PS) RHS (DW10ATED), RHZ (DW10ATED)	08.2001→05.2004		7.22843.06.0	AGR	PN	○
			7.22843.07.0	AGR	PN	○
			7.09730.01.0	AGR-K		
2.2 116 kW (158 PS) 3FZ (EW12J4)	07.2000→05.2004		7.05270.37.0	LS	1640 mm	
2.2 HDi 98 kW (133 PS) 4HX (DW12TED4)	03.2000→05.2004		7.22888.02.0	AGR	PN	○
3.0 24V 140-150 kW (190-204 PS) XFZ (ES9J4)	03.1997→05.2004		7.05270.36.0	LS	540 mm	15-04 15-04
3.0 24V 140-150 kW (190-204 PS) XFZ (ES9J4)	01.1998→06.1999		7.05270.36.0	LS	540 mm	15-04 15-04

406 Break (8E/F) **42**

1.8 66 kW (90 PS) LFX (XU7JB)	05.1997→10.2004		7.05270.39.0	LS	400 mm	
1.8 16V 76-86 kW (103-117 PS) LFY (XU7JP4)	10.1996→10.2000		7.05270.39.0	LS	400 mm	Benzin/Gas Petrol/Gas Euro 2 Euro 2
			7.05270.37.0	LS	1640 mm	Euro 3 Euro 3
1.8 16V 85 kW (116 PS) 6FZ (EW7J4)	10.2000→10.2004		7.05270.38.0	LS	1240 mm	Euro 3 Euro 3 Diagnosesonde Diagnostic Probe
2.0 16V 97-100 kW (132-136 PS) RFV (XU10J4R)	10.1996→10.2004		7.02604.04.0	LS	200 mm	
			7.05270.38.0	LS	1240 mm	Regelsonde Regulating Probe
2.0 16V 99 kW (135 PS) RFR (EW10J4)	01.1999→10.2000		7.02604.04.0	LS	200 mm	
2.0 16V 100-105 kW (136-143 PS) RFN (EW10J4)	10.2000→10.2004		7.02604.04.0	LS	200 mm	
2.0 16V HPI 103 kW (140 PS) RLZ (EW10D)	05.2001→10.2004		7.05270.38.0	LS	1240 mm	
2.0 HDi 110 79-80 kW (107-109 PS) RHZ (DW10ATED)	02.1999→04.2004		7.22843.06.0	AGR	PN	○
			7.22843.07.0	AGR	PN	○
			7.09730.01.0	AGR-K		
2.0 HDi 90 66 kW (90 PS) RHY (DW10TD)	02.1999→10.2004		7.22843.06.0	AGR	PN	○
2.0 HDi 110 79-80 kW (107-109 PS) RHS (DW10ATED), RHZ (DW10ATED)	08.2001→10.2004		7.22843.06.0	AGR	PN	○
			7.22843.07.0	AGR	PN	○
			7.09730.01.0	AGR-K		
2.2 116 kW (158 PS) 3FZ (EW12J4)	07.2000→10.2004		7.05270.37.0	LS	1640 mm	
2.2 HDi 98 kW (133 PS) 4HX (DW12TED4)	03.2000→10.2004		7.22888.02.0	AGR	PN	○
3.0 24V 140-150 kW (190-204 PS) XFZ (ES9J4)	03.1997→10.2004		7.05270.36.0	LS	540 mm	15-04 15-04

P

						
406 Coupe (8C)						
43						
2.0 16V 97-100 kW (132-136 PS) RFV (XU10J4R)	03.1997→12.2004		7.02604.04.0	LS	200 mm	Regelsonde Regulating Probe
			7.05270.38.0	LS	1240 mm	
2.0 16V 99 kW (135 PS) RFR (EW10J4)	01.1999→10.2000		7.02604.04.0	LS	200 mm	
2.0 16V 97-100 kW (132-136 PS) RFV (XU10J4R)	04.1999→09.2004		7.02604.04.0	LS	200 mm	Regelsonde Regulating Probe
			7.05270.38.0	LS	1240 mm	
2.0 16V 97-100 kW (132-136 PS) RFV (XU10J4R)	10.2000→12.2004		7.02604.04.0	LS	200 mm	Regelsonde Regulating Probe
			7.05270.38.0	LS	1240 mm	
2.0 16V 100-105 kW (136-143 PS) RFN (EW10J4)	10.2000→12.2004		7.02604.04.0	LS	200 mm	
2.2 116 kW (158 PS) 3FZ (EW12J4)	03.2002→12.2004		7.05270.37.0	LS	1640 mm	
2.2 HDi 98 kW (133 PS) 4HX (DW12TED4)	03.2000→12.2004		7.22888.02.0	AGR	PN	
3.0 24V 140-150 kW (190-204 PS) XFZ (ES9J4)	05.1997→06.1999		7.05270.36.0	LS	540 mm	15-04
						15-04
3.0 V6 24V 140-150 kW (190-204 PS) XFZ (ES9J4)	03.1997→12.2004		7.05270.36.0	LS	540 mm	15-04
						15-04
407 (6D_)						
44						
1.6 HDi 110 80-84 kW (109-114 PS) 9HZ (DV6TED4)	05.2004→12.2010		7.24809.39.0	AGR	EL	
			7.11492.01.0	DDS		Euro 4 (D4) Euro 4 (D4) ohne Zubehör without accessories Organisationsnummer ab: 11284 RPO number from: 11284
1.8 85 kW (116 PS) 6FZ (EW7J4)	03.2004→07.2005		7.05270.38.0	LS	1240 mm	Regelsonde Regulating Probe
2.0 HDi 93 kW (126 PS) RHL (DW10BTED4)	11.2004→10.2007		7.24809.68.0	AGR	EL	
			7.11492.01.0	DDS		ohne Zubehör without accessories Organisationsnummer ab: 10948 RPO number from: 10948
2.0 HDi 100-103 kW (136-140 PS) RHR (DW10BTED4)	06.2009→12.2010		7.24809.68.0	AGR	EL	
			7.09730.00.0	AGR-K		ohne Zubehör without accessories Organisationsnummer ab: 10948 RPO number from: 10948
			7.11492.01.0	DDS		
2.0 HDi 120 kW (163 PS) RHH (DW10CTED4)	06.2009→12.2010		7.24809.94.0	AGR-K	EL	
			7.11492.01.0	DDS		Organisationsnummer ab: 12775 RPO number from: 12775
			7.02604.99.0	LS	400 mm	ohne Zubehör without accessories
2.0 HDi 135 100-103 kW (136-140 PS) RHR (DW10BTED4)	05.2004→10.2010		7.24809.68.0	AGR	EL	
			7.09730.00.0	AGR-K		









P



407 (6D_) **44**

			7.11492.01.0	DDS		ohne Zubehör without accessories Organisationsnummer ab: 10948 RPO number from: 10948
2.2 HDi 120 kW (163 PS) 4HP (DW12BTED4)	03.2006→12.2010		7.11492.01.0	DDS		ohne Zubehör without accessories Organisationsnummer ab: 11284 RPO number from: 11284
2.2 HDi 170 125 kW (170 PS) 4HT (DW12BTED4)	03.2006→12.2010		7.00578.12.0	AGR	EL 	für Fahrzeuge mit Diesel-Partikel-Filter (DPF) for vehicles with diesel soot filter
			7.11492.01.0	DDS		ohne Zubehör without accessories Organisationsnummer ab: 11284 RPO number from: 11284
2.7 HDi 150 kW (204 PS) UHZ (DT17TED4)	10.2005→12.2010		7.24809.96.0	AGR	EL 	→06.2009
			7.11237.01.0	AGR	EL 	07.2008→07.2009
			7.11492.01.0	DDS		ohne Zubehör without accessories Organisationsnummer ab: 11284 RPO number from: 11284

407 Coupe (6C_) **45**

2.0 HDi 100-103 kW (136-140 PS) RHR (DW10BTED4)	10.2005→		7.24809.68.0	AGR	EL 	
			7.09730.00.0	AGR-K		
			7.11492.01.0	DDS		ohne Zubehör without accessories Organisationsnummer ab: 10948 RPO number from: 10948
2.0 HDi 120 kW (163 PS) RHH (DW10CTED4)	06.2009→		7.24809.94.0	AGR-K	EL 	Organisationsnummer ab: 12775 RPO number from: 12775
			7.11492.01.0	DDS		ohne Zubehör without accessories
			7.02604.99.0	LS	400 mm	
2.7 HDi 150 kW (204 PS) UHZ (DT17TED4)	10.2005→		7.24809.96.0	AGR	EL 	→06.2009
			7.11237.01.0	AGR	EL 	02.2006→07.2009
			7.11492.01.0	DDS		ohne Zubehör without accessories Organisationsnummer ab: 11284 RPO number from: 11284
3.0 HDi 177 kW (241 PS) DT20C	06.2009→		7.11492.01.0	DDS		ohne Zubehör without accessories

407 SW (6E_) **46**

1.6 HDi 110 80-84 kW (109-114 PS) 9HZ (DV6TED4)	05.2004→12.2010		7.24809.39.0	AGR	EL 	Euro 4 (D4) Euro 4 (D4)
			7.11492.01.0	DDS		ohne Zubehör without accessories Organisationsnummer ab: 11284 RPO number from: 11284
1.8 85 kW (116 PS) 6FZ (EW7J4)	05.2004→07.2005		7.05270.38.0	LS	1240 mm	Regelsonde Regulating Probe
2.0 HDi 93 kW (126 PS) RHL (DW10BTED4)	11.2004→10.2007		7.24809.68.0	AGR	EL 	
			7.09730.00.0	AGR-K		



407 SW (6E_) 46

			7.11492.01.0	DDS		ohne Zubehör without accessories Organisationsnummer ab: 10948 RPO number from: 10948
2.0 HDi 100-103 kW (136-140 PS) RHR (DW10BTED4)	08.2008→12.2010		7.09730.00.0	AGR-K		
			7.11492.01.0	DDS		ohne Zubehör without accessories Organisationsnummer ab: 10948 RPO number from: 10948
2.0 HDi 120 kW (163 PS) RHH (DW10CTED4)	06.2009→12.2010		7.24809.94.0	AGR-K	EL	Organisationsnummer ab: 12775 RPO number from: 12775
			7.11492.01.0	DDS		ohne Zubehör without accessories
			7.02604.99.0	LS	400 mm	
2.0 HDi 135 100-103 kW (136-140 PS) RHR (DW10BTED4)	07.2004→12.2010		7.09730.00.0	AGR-K		
			7.11492.01.0	DDS		ohne Zubehör without accessories Organisationsnummer ab: 10948 RPO number from: 10948
2.2 HDi 120 kW (163 PS) 4HP (DW12BTED4)	06.2008→12.2010		7.11492.01.0	DDS		ohne Zubehör without accessories Organisationsnummer ab: 11284 RPO number from: 11284
2.2 HDi 170 125 kW (170 PS) 4HT (DW12BTED4)	03.2006→12.2010		7.00578.12.0	AGR	EL	für Fahrzeuge mit Diesel-Partikel-Filter (DPF) for vehicles with diesel soot filter
			7.11492.01.0	DDS		ohne Zubehör without accessories Organisationsnummer ab: 11284 RPO number from: 11284
2.7 HDi 150 kW (204 PS) UHZ (DT17TED4)	10.2005→12.2010		7.24809.96.0	AGR	EL	→06.2009
			7.11237.01.0	AGR	EL	07.2008→07.2009
			7.11492.01.0	DDS		ohne Zubehör without accessories Organisationsnummer ab: 11284 RPO number from: 11284













P























5008 (0U_, 0E_) 47

1.6 16V 81-90 kW (110-122 PS) 5FS (EP6C), 5FW (EP6), EP6	09.2009→03.2017		7.05271.74.0	LS	450 mm	
1.6 16V 115 kW (156 PS) 5FV (EP6CDT)	09.2009→03.2017		7.05271.74.0	LS	450 mm	
1.6 HDi 80-84 kW (109-114 PS) 9HZ (DV6TED4)	09.2009→03.2017		7.24809.39.0	AGR	EL	Euro 4 (D4) Euro 4 (D4)
			7.11492.01.0	DDS		ohne Zubehör without accessories
1.6 HDi 82-85 kW (112-116 PS) 9HR (DV6C)	08.2010→03.2017		7.02209.11.0	AGR	EL	
			7.02156.24.0	AGR-K	EL	mit Sensor with sensor →11.2012
			7.02156.35.0	AGR-K	EL	ohne Sensor without sensor 01.2013→ mit AGR-Ventil with EGR valve

















5008 (0U_, 0E_) 47

			7.02156.33.0	AGR-K		mit Sensor with sensor →11.2012
			7.02156.34.0	AGR-K		ohne AGR-Ventil without EGR valve
			7.11492.01.0	DDS		ohne Sensor without sensor 01.2013→ ohne AGR-Ventil without EGR valve ohne Zubehör without accessories
1.6 HDi 84-85 kW (114-116 PS) 9HD (DV6C)	03.2013→03.2017		7.02209.11.0	AGR	EL	
			7.02156.24.0	AGR-K	EL	mit Sensor with sensor  →04.2013
			7.02156.35.0	AGR-K	EL	ohne Sensor without sensor mit AGR-Ventil with EGR valve
			7.02156.34.0	AGR-K		ohne Sensor without sensor ohne AGR-Ventil without EGR valve
			7.11492.01.0	DDS		ohne Zubehör without accessories
2.0 HDi 120 kW (163 PS) RHH (DW10CTED4)	09.2009→03.2017		7.24809.94.0	AGR-K	EL	 Organisationsnummer ab: 12775 RPO number from: 12775
			7.11492.01.0	DDS		ohne Zubehör without accessories
			7.02604.99.0	LS	400 mm	
2.0 HDi 136 / BlueHDi 136 100 kW (136 PS) AHV (DW10FD)	02.2012→03.2017		7.11492.01.0	DDS		ohne Zubehör without accessories
2.0 HDi 136 / BlueHDi 136 100 kW (136 PS) RHD (DW10CB)	02.2012→03.2017		7.24809.94.0	AGR-K	EL	
			7.11492.01.0	DDS		ohne Zubehör without accessories
2.0 HDi 136 / BlueHDi 136 100 kW (136 PS) RHD (DW10CTED4)	02.2012→03.2017		7.24809.94.0	AGR-K	EL	 Organisationsnummer ab: 12775 RPO number from: 12775
			7.11492.01.0	DDS		ohne Zubehör without accessories
			7.02604.99.0	LS	400 mm	Motorcode: RHD (DW10CTED4) Engine Code: RHD (DW10CTED4) Produktionsdatum ab: 02.2012 Production date from: 02.2012 Produktionsdatum bis: 03.2017 Production date to: 03.2017
2.0 HDi 150 / BlueHDi 150 100-110 kW (136-150 PS) RHE (DW10CTED4)	06.2009→03.2017		7.24809.94.0	AGR-K	EL	 Organisationsnummer ab: 12775 RPO number from: 12775
			7.11492.01.0	DDS		ohne Zubehör without accessories
2.0 HDi 150 / BlueHDi 150 110 kW (150 PS) AHX (DW10FD)	06.2009→03.2017		7.11492.01.0	DDS		ohne Zubehör without accessories

























						
5008 II (MC_, MJ_, MR_, M4_)						48
1.5 BlueHDi 130 96 kW (131 PS) YHZ (DV5RC)	02.2018→		7.07794.23.0	AGR	EL mit Dichtring with O-ring	
2.0 BlueHDi 136 100 kW (136 PS) AHS (DW10FD), AHV (DW10FD)	12.2016→		7.11492.01.0	DDS	ohne Zubehör without accessories	
2.0 BlueHDi 150 110 kW (150 PS) AHX (DW10FD)	12.2016→		7.11492.01.0	DDS	ohne Zubehör without accessories	
505 (551A)						49
2.2 85 kW (115 PS) 851 (ZDJ)	05.1981→10.1984		7.02604.03.0	LS	200 mm	
2.2 84 kW (114 PS) 851X (ZDJL)	03.1986→12.1993		7.02604.03.0	LS	200 mm	
2.2 GTI 90 kW (122 PS) 851B (ZDJL)	08.1983→12.1993		7.02604.03.0	LS	200 mm	
2.2 GTI 85-96 kW (116-131 PS) ZDJK	08.1983→12.1993		7.02604.03.0	LS	200 mm	
505 Break (551D)						50
2.2 84 kW (114 PS) 851X (ZDJL)	01.1986→12.1993		7.02604.03.0	LS	200 mm	
2.2 GTI 90 kW (122 PS) 851B (ZDJL)	09.1985→12.1986		7.02604.03.0	LS	200 mm	
508 I (8D_)						51
1.6 HDi 82-85 kW (112-116 PS) 9HL (DV6C)	11.2010→12.2018		7.02209.11.0	AGR	EL 	
			7.02156.35.0	AGR-K	EL ohne Sensor without sensor 01.2013→ mit AGR-Ventil with EGR valve	
			7.02156.33.0	AGR-K	mit Sensor with sensor	
			7.02156.34.0	AGR-K	ohne Sensor without sensor 01.2013→ ohne AGR-Ventil without EGR valve	
			7.11492.01.0	DDS	ohne Zubehör without accessories	
1.6 HDi 82-85 kW (112-116 PS) 9HR (DV6C)	11.2010→12.2018		7.02209.11.0	AGR	EL 	
			7.02156.24.0	AGR-K	EL mit Sensor with sensor  →11.2012	
			7.02156.35.0	AGR-K	EL ohne Sensor without sensor 01.2013→ mit AGR-Ventil with EGR valve	
			7.02156.33.0	AGR-K	mit Sensor with sensor	
			7.02156.34.0	AGR-K	ohne Sensor without sensor 01.2013→ ohne AGR-Ventil without EGR valve	
			7.11492.01.0	DDS	ohne Zubehör without accessories	
1.6 HDi 84 kW (114 PS) 9HD (DV6CTED)	02.2012→12.2018		7.02209.11.0	AGR	EL 	



























508 I (8D_) **51**

































			7.02156.35.0	AGR-K	EL	ohne Sensor without sensor 01.2013→ mit AGR-Ventil with EGR valve
			7.02156.33.0	AGR-K		mit Sensor with sensor →11.2012 ohne AGR-Ventil without EGR valve
			7.02156.34.0	AGR-K		ohne Sensor without sensor 01.2013→ ohne AGR-Ventil without EGR valve
1.6 THP 115 kW (156 PS) 5FV (EP6CDT)	11.2010→12.2018		7.05271.74.0	LS	450 mm	
1.6 VTi 85-90 kW (116-122 PS) 5FS (EP6C)	11.2010→12.2018		7.05271.74.0	LS	450 mm	
2.0 BlueHDi 150 110 kW (150 PS) AHX (DW10FD)	04.2014→12.2018		7.11492.01.0	DDS		ohne Zubehör without accessories
2.0 BlueHDi 180 132-133 kW (179-181 PS) AHW (DW10FC)	04.2014→12.2018		7.11492.01.0	DDS		ohne Zubehör without accessories
2.0 HDi 103 kW (140 PS) RHA (DW10CTED4)	11.2010→12.2018		7.24809.94.0	AGR-K	EL	 Organisationsnummer ab: 12775 RPO number from: 12775
			7.11492.01.0	DDS		ohne Zubehör without accessories
2.0 HDi 103 kW (140 PS) RHF (DW10BTED4)	11.2010→12.2018		7.24809.68.0	AGR	EL	
			7.11492.01.0	DDS		ohne Zubehör without accessories
2.0 HDi 120 kW (163 PS) RHH (DW10CTED4)	11.2010→12.2018		7.24809.94.0	AGR-K	EL	 Organisationsnummer ab: 12775 RPO number from: 12775
			7.11492.01.0	DDS		ohne Zubehör without accessories
			7.02604.99.0	LS	400 mm	
2.0 HDi 100-103 kW (136-140 PS) RHR (DW10BTED4)	11.2010→12.2018		7.24809.68.0	AGR	EL	
			7.11492.01.0	DDS		ohne Zubehör without accessories
			7.02604.99.0	LS	400 mm	
2.0 HDi Hybrid4 AWC 120-147 kW (163-200 PS) RHC (DW10CTED4)	11.2010→12.2018		7.11492.01.0	DDS		ohne Zubehör without accessories
			7.02604.99.0	LS	400 mm	
2.0 HDi Hybrid4 AWC 120-147 kW (163-200 PS) RHC (DW10CTED4)	11.2010→12.2018		7.11492.01.0	DDS		ohne Zubehör without accessories
			7.02604.99.0	LS	400 mm	
2.2 HDi 147-150 kW (200-204 PS) 4HL (DW12C)	11.2010→12.2018		7.11492.01.0	DDS		ohne Zubehör without accessories
			7.02604.99.0	LS	400 mm	

P

					
508 II (FB_, FH_, F3_)					52
1.5 BlueHDI 130 (FBYHZJ, FBYHZR) 96 kW (131 PS) YHZ (DV5RC)	10.2018→		7.07794.23.0	AGR	EL mit Dichtring with O-ring
508 SW I (8E_)					53
1.6 HDi 82-85 kW (112-116 PS) 9HL (DV6C), 9HR (DV6C)	11.2010→12.2018		7.02209.11.0	AGR	EL 
			7.02156.24.0	AGR-K	EL mit Sensor with sensor 
			7.02156.35.0	AGR-K	EL ohne Sensor without sensor  9HL (DV6C), 9HR (DV6C): →11.2012
			7.02156.33.0	AGR-K	EL mit AGR-Ventil with EGR valve mit Sensor with sensor
			7.02156.34.0	AGR-K	EL ohne Sensor without sensor  9HL (DV6C), 9HR (DV6C): 01.2013→
1.6 HDi 82-85 kW (112-116 PS) 9HL (DV6C), 9HR (DV6C)	02.2012→12.2018		7.02156.35.0	AGR-K	EL ohne Sensor without sensor  9HL (DV6C), 9HR (DV6C): 01.2013→
			7.02156.33.0	AGR-K	EL mit AGR-Ventil with EGR valve mit Sensor with sensor
			7.02156.34.0	AGR-K	EL ohne Sensor without sensor  9HL (DV6C), 9HR (DV6C): 01.2013→
			7.11492.01.0	DDS	EL ohne AGR-Ventil without EGR valve ohne Zubehör without accessories
1.6 THP 115 kW (156 PS) 5FV (EP6CDT)	11.2010→12.2018		7.05271.74.0	LS	450 mm
1.6 VTi 85-90 kW (116-122 PS) 5FS (EP6C)	11.2010→12.2018		7.05271.74.0	LS	450 mm
2.0 BlueHDi 150 110 kW (150 PS) AHX (DW10FD)	04.2014→12.2018		7.11492.01.0	DDS	ohne Zubehör without accessories
2.0 BlueHDi 180 132-133 kW (179-181 PS) AHW (DW10FC)	04.2014→12.2018		7.11492.01.0	DDS	ohne Zubehör without accessories
2.0 HDi 103 kW (140 PS) RHA (DW10CTED4)	11.2010→12.2018		7.24809.94.0	AGR-K	EL  Organisationsnummer ab: 12775 RPO number from: 12775
			7.11492.01.0	DDS	EL ohne Zubehör without accessories
2.0 HDi 103 kW (140 PS) RHF (DW10BTED4)	11.2010→12.2018		7.24809.68.0	AGR	EL 
			7.11492.01.0	DDS	EL ohne Zubehör without accessories
2.0 HDi 120 kW (163 PS) RHH (DW10CTED4)	11.2010→12.2018		7.24809.94.0	AGR-K	EL  Organisationsnummer ab: 12775 RPO number from: 12775
			7.11492.01.0	DDS	EL ohne Zubehör without accessories
			7.02604.99.0	LS	400 mm





P

			 PIERBURG			
508 SW I (8E_)						53
2.0 HDi 100-103 kW (136-140 PS) RHR (DW10BTED4)	11.2010→12.2018		7.24809.68.0	AGR	EL	○ ohne Zubehör without accessories
			7.11492.01.0	DDS		
			7.02604.99.0	LS	400 mm	
2.0 HDi 180 RXH	10.2014→12.2018		7.02604.99.0	LS	400 mm	
2.0 HDi RXH Hybrid4 120-147 kW (163-200 PS) RHC (DW10CTED4)	11.2010→12.2018		7.11492.01.0	DDS		ohne Zubehör without accessories
			7.02604.99.0	LS	400 mm	
2.2 HDi 147-150 kW (200-204 PS) 4HL (DW12C)	11.2010→12.2018		7.11492.01.0	DDS		ohne Zubehör without accessories
			7.02604.99.0	LS	400 mm	
508 SW II (FC_, FJ_, F4_)						54
1.5 BlueHDi 130 96 kW (131 PS) YHZ (DV5RC)	09.2018→		7.07794.23.0	AGR	EL	mit Dichtring with O-ring
605 (6B)						55
2.0 89-90 kW (121-123 PS) RFZ (XU10J2Z)	06.1989→09.1999		7.02604.04.0	LS	200 mm	
2.0 84 kW (114 PS) R5A (XU102C)	06.1989→09.1999		7.02604.04.0	LS	200 mm	
2.0 79 kW (107 PS) XU10MZ	02.1990→09.1999		7.02604.04.0	LS	200 mm	
2.0 16V 97-100 kW (132-136 PS) RFV (XU10J4R)	07.1994→09.1999		7.02604.04.0	LS	200 mm	
2.0 Turbo 108 kW (147 PS) RGX (XU10J2TE)	07.1991→09.1999		7.02604.04.0	LS	200 mm	
2.0 Turbo 104 kW (141 PS) RGY (XU10J2TE)	07.1992→09.1999		7.02604.04.0	LS	200 mm	
3.0 V6 140-150 kW (190-204 PS) XFZ (ES9J4)	04.1997→09.1999		7.05270.36.0	LS	540 mm	15-04 15-04
607 (9D, 9U)						56
2.0 100-105 kW (136-143 PS) RFN (EW10J4)	02.2000→08.2005		7.05270.37.0	LS	1640 mm	
2.0 HDi 79-80 kW (107-109 PS) RHZ (DW10ATED)	05.2000→09.2005		7.22843.06.0	AGR	PN	○
			7.22843.07.0	AGR	PN	○
			7.09730.01.0	AGR-K		
2.0 HDi 100-103 kW (136-140 PS) RHR (DW10BTED4)	09.2005→07.2011		7.24809.68.0	AGR	EL	○
			7.09730.00.0	AGR-K		
			7.11492.01.0	DDS		ohne Zubehör without accessories Organisationsnummer ab: 11347 RPO number from: 11347
2.0 HDi 79 kW (107 PS) RHS (DW10ATED)	03.2001→09.2004		7.22843.06.0	AGR	PN	○
			7.22843.07.0	AGR	PN	○
			7.09730.01.0	AGR-K		
2.2 16V 116 kW (158 PS) 3FZ (EW12J4)	02.2000→08.2005		7.05270.37.0	LS	1640 mm	Euro3/Euro4 Euro3/Euro4
2.2 HDi 98 kW (133 PS) 4HX (DW12TED4)	02.2000→02.2006		7.22888.02.0	AGR	PN	○

					
607 (9D, 9U)					56
2.2 HDi 125 kW (170 PS) 4HT (DW12BTED4)	05.2006→06.2010		7.00578.12.0	AGR	EL 
			7.11492.01.0	DDS	für Fahrzeuge mit Diesel-Partikel-Filter (DPF) for vehicles with diesel soot filter ohne Zubehör without accessories Organisationsnummer ab: 11347 RPO number from: 11347
2.7 HDi 24V 150 kW (204 PS) DT17TED4	12.2004→07.2011		7.11237.01.0	AGR	EL 
			7.24809.96.0	AGR	EL 
			7.11492.01.0	DDS	→09.2010 ohne Zubehör without accessories Organisationsnummer ab: 11347 RPO number from: 11347
806 (221)					57
2.0 89-90 kW (121-123 PS) RFU (XU10J2)	06.1994→08.2002		7.02604.04.0	LS	200 mm
2.0 16V 97-100 kW (132-136 PS) RFV (XU10J4R)	05.1998→09.2000		7.05270.37.0	LS	1640 mm
2.0 16V 100-105 kW (136-143 PS) RFN (EW10J4)	09.2000→08.2002		7.05270.37.0	LS	1640 mm
2.0 HDI 79-80 kW (107-109 PS) RHZ (DW10ATED)	08.1999→08.2002		7.22843.06.0	AGR	PN 
2.0 HDI 16V 79-80 kW (107-109 PS) RHW (DW10ATED4)	08.1999→08.2002		7.28069.03.0	AGR	PN 
807 (EB_)					58
2.0 HDI 100-103 kW (136-140 PS) RHR (DW10BTED4)	06.2006→		7.24809.68.0	AGR	EL 
			7.09730.00.0	AGR-K	ohne Zubehör without accessories Organisationsnummer ab: 11207 RPO number from: 11207
			7.11492.01.0	DDS	
2.0 HDI 100-103 kW (136-140 PS) RHR (DW10CB)	06.2006→		7.24809.94.0	AGR-K	EL 
			7.11492.01.0	DDS	Organisationsnummer ab: 12853 RPO number from: 12853 ohne Zubehör without accessories
2.0 HDi 79-80 kW (107-109 PS) RHM (DW10ATED4), RHT (DW10ATED4)	06.2002→05.2006		7.28069.04.0	AGR	PN 
2.0 HDi 79-80 kW (107-109 PS) RHW (DW10ATED4)	06.2002→05.2006		7.28069.03.0	AGR	PN 
					für Fahrzeuge ohne Diesel-Partikel-Filter (DPF) for vehicles without diesel soot filter
2.0 HDi 79-80 kW (107-109 PS) RHW (DW10ATED4)	04.2004→		7.28069.03.0	AGR	PN 
			7.28069.04.0	AGR	für Fahrzeuge ohne Diesel-Partikel-Filter (DPF) for vehicles without diesel soot filter
2.0 HDi 79-88 kW (107-120 PS) RHK (DW10UTED4)	02.2006→		7.24809.68.0	AGR	EL 
					für Fahrzeuge mit Diesel-Partikel-Filter (DPF) for vehicles with diesel soot filter
2.0 HDi 120 kW (163 PS) RHH (DW10CTED4)	06.2009→		7.24809.94.0	AGR-K	EL 
					Organisationsnummer ab: 12853 RPO number from: 12853











807 (EB_) **58**

















			7.11492.01.0	DDS		ohne Zubehör without accessories
2.2 HDi 94 kW (128 PS) 4HW (DW12BTED4)	06.2002→		7.28069.04.0	AGR	PN	<input type="radio"/>
			7.11492.01.0	DDS		ohne Zubehör without accessories
2.2 HDi 94-100 kW (128-136 PS) 4HW (DW12TED4)	04.2004→05.2006		7.28069.04.0	AGR	PN	<input type="radio"/>
2.2 HDi 125 kW (170 PS) 4HT (DW12BTED4)	06.2006→		7.00578.12.0	AGR	EL	<input type="radio"/>
			7.11492.01.0	DDS		für Fahrzeuge mit Diesel-Partikel-Filter (DPF) for vehicles with diesel soot filter ohne Zubehör without accessories
2.2 HDi 120 kW (163 PS) 4HR (DW12BTED4)	06.2006→		7.11492.01.0	DDS		ohne Zubehör without accessories

BIPPER TEPEE **59**

1.3 HDi 75 55 kW (75 PS) FHZ (F13DTE5)	10.2010→		7.01599.10.0	AGR	EL	<input type="radio"/>
			7.03622.06.0	AGR-K		<input type="radio"/>
			7.11190.03.0	DDS		ohne Zubehör without accessories
1.3 HDi 80 59-70 kW (80-95 PS) FHY (F13DTE6)	12.2015→		7.01599.10.0	AGR	EL	<input type="radio"/>
			7.11190.03.0	DDS		ohne Zubehör without accessories für OE-Nummer: 16 105 313 80, 1618 SV for OE number: 16 105 313 80, 1618 SV
1.4 HDi 50 kW (68 PS) 8HS (DV4TED)	04.2008→		7.24809.76.0	AGR	EL	<input type="radio"/>

PARTNER MPV (5_, G_) **60**

1.1 44 kW (60 PS) HDZ (TU1M)	06.1996→10.2002		7.05270.39.0	LS	400 mm	Euro 2 Euro 2
1.4 47-60 kW (64-82 PS) KFW (TU3JP)	06.1996→12.2015		7.05270.36.0	LS	540 mm	Euro3/Euro4, Technische Schadstoffverringerng K Euro3/Euro4, Technical pollution reduction K
			7.05270.39.0	LS	400 mm	
1.4 49-60 kW (67-82 PS) KFW (TU3A), KFX (TU3JP)	06.1996→12.2015		7.05270.39.0	LS	400 mm	
1.4 47-60 kW (64-82 PS) KFW (TU3JP)	11.2002→10.2006		7.05270.36.0	LS	540 mm	Euro3/Euro4, Technische Schadstoffverringerng K Euro3/Euro4, Technical pollution reduction K
1.6 HDi 92 68 kW (92 PS) 9HJ (DV6DTEDM)	11.2009→12.2010		7.03647.10.0	AGR-K	EL	<input type="radio"/>
1.6 HDi 90 66-68 kW (90-92 PS) 9HX (DV6ATED4)	08.2005→12.2015		7.24809.39.0	AGR	EL	<input type="radio"/>
						Euro 4 (D4) Euro 4 (D4)
2.0 HDi 66 kW (90 PS) RHY (DW10TD)	02.2000→07.2008		7.22843.06.0	AGR	PN	<input type="radio"/>
			7.09730.01.0	AGR-K		
2.0 HDi 4x4 66 kW (90 PS) RHY (DW10TD)	04.2004→08.2005		7.22843.06.0	AGR	PN	<input type="radio"/>
			7.09730.01.0	AGR-K		











					
PARTNER ORIGIN MPV (G_)					61
1.4 47-60 kW (64-82 PS) KFW (TU3JP)	07.2008→12.2013		7.05270.36.0	LS	540 mm Euro3/Euro4, Technische Schadstoffverringerng K Euro3/Euro4, Technical pollution reduction K
PARTNER TEPEE					62
1.6 HDi 80-84 kW (109-114 PS) 9HZ (DV6TED4)	04.2008→		7.24809.39.0	AGR	EL 
			7.11492.01.0	DDS	ohne Zubehör without accessories Organisationsnummer ab: 11211FL, 11211FV RPO number from: 11211FL, 11211FV
1.6 HDi 82-85 kW (112-116 PS) 9HL (DV6C)	08.2010→		7.02209.11.0	AGR	EL 
			7.02156.24.0	AGR-K	EL mit Sensor with sensor 
			7.02156.35.0	AGR-K	EL ohne Sensor without sensor 01.2013→ mit AGR-Ventil with EGR valve
			7.02156.33.0	AGR-K	EL mit Sensor with sensor →11.2012 ohne AGR-Ventil without EGR valve
			7.02156.34.0	AGR-K	EL ohne Sensor without sensor 01.2013→ ohne AGR-Ventil without EGR valve
			7.11492.01.0	DDS	ohne Zubehör without accessories Organisationsnummer ab: 11211FL, 11211FV RPO number from: 11211FL, 11211FV
1.6 HDi 82-85 kW (112-116 PS) 9HL (DV6C)	03.2013→		7.02209.11.0	AGR	EL 
			7.02156.35.0	AGR-K	EL ohne Sensor without sensor mit AGR-Ventil with EGR valve
			7.02156.34.0	AGR-K	EL ohne Sensor without sensor ohne AGR-Ventil without EGR valve
			7.11492.01.0	DDS	ohne Zubehör without accessories Organisationsnummer ab: 11211FL, 11211FV RPO number from: 11211FL, 11211FV
1.6 HDi 66-69 kW (90-94 PS) 9HF (DV6DTED)	03.2013→		7.02209.11.0	AGR	EL 
			7.02156.35.0	AGR-K	EL ohne Sensor without sensor mit AGR-Ventil with EGR valve
			7.02156.34.0	AGR-K	EL ohne Sensor without sensor ohne AGR-Ventil without EGR valve

P







PARTNER TEPEE

62





			7.11492.01.0	DDS		ohne Zubehör without accessories Organisationsnummer ab: 11211FL, 11211FV RPO number from: 11211FL, 11211FV
1.6 HDi / BlueHDi 75 55 kW (75 PS) 9HK (DV6ETEDM)	06.2008→12.2018		7.02209.11.0	AGR	EL	
			7.02156.35.0	AGR-K	EL	ohne Sensor without sensor 01.2013→ mit AGR-Ventil with EGR valve
			7.03647.10.0	AGR-K	EL	
			7.02156.33.0	AGR-K		ohne Sensor without sensor mit Sensor with sensor →11.2012
			7.02156.34.0	AGR-K		ohne Sensor without sensor 01.2013→ ohne AGR-Ventil without EGR valve
1.6 HDi / BlueHDi 75 55 kW (75 PS) 9HN (DV6ETED)	06.2008→12.2018		7.02209.11.0	AGR	EL	
			7.02156.35.0	AGR-K	EL	ohne Sensor without sensor 01.2013→ mit AGR-Ventil with EGR valve
			7.02156.33.0	AGR-K		mit Sensor with sensor →11.2012
			7.02156.34.0	AGR-K		ohne Sensor without sensor 01.2013→ ohne AGR-Ventil without EGR valve
			7.11492.01.0	DDS		ohne Zubehör without accessories Organisationsnummer ab: 11211FL, 11211FV RPO number from: 11211FL, 11211FV
1.6 HDi 16V 66 kW (90 PS) 9HV (DV6TED4B), 9HV (DV6TED4BU)	04.2008→		7.24809.39.0	AGR	EL	
			7.02604.99.0	LS	400 mm	
1.6 HDi 90 66-69 kW (90-94 PS) 9HP (DV6DTED)	04.2010→		7.02209.11.0	AGR	EL	
			7.02156.24.0	AGR-K	EL	mit Sensor with sensor  →11.2012
			7.02156.35.0	AGR-K	EL	ohne Sensor without sensor 01.2013→
			7.02156.33.0	AGR-K		mit Sensor with sensor →11.2012 ohne AGR-Ventil without EGR valve

P





PARTNER TEPEE
62

			7.02156.34.0	AGR-K		ohne Sensor without sensor 01.2013→ ohne AGR-Ventil without EGR valve
			7.11492.01.0	DDS		ohne Zubehör without accessories Organisationsnummer ab: 11211FL, 11211FV RPO number from: 11211FL, 11211FV
			7.05270.21.0	LS	600 mm	vor Katalysator in front of the catalyzt
			7.02604.99.0	LS	400 mm	
1.6 HDi 90 68 kW (92 PS) 9HJ (DV6DTEDM)	04.2010→		7.02209.11.0	AGR	EL	
			7.02156.35.0	AGR-K	EL	ohne Sensor without sensor 01.2013→
			7.03647.10.0	AGR-K	EL	
			7.02156.33.0	AGR-K		ohne Sensor without sensor mit Sensor with sensor →11.2012 ohne AGR-Ventil without EGR valve
			7.02156.34.0	AGR-K		ohne Sensor without sensor 01.2013→ ohne AGR-Ventil without EGR valve
			7.02604.99.0	LS	400 mm	
1.6 VTi 72 kW (98 PS) 5FK (EP6CB)	08.2010→		7.05271.74.0	LS	450 mm	

RCZ
63

1.6 16V 115 kW (156 PS) 5FV (EP6CDT)	03.2010→12.2015		7.05271.74.0	LS	450 mm	
1.6 16V 147-150 kW (200-204 PS) EP6CDTX	06.2010→12.2015		7.05271.74.0	LS	450 mm	
2.0 HDi 120 kW (163 PS) RHH (DW10CTED4)	03.2010→12.2015		7.24809.94.0	AGR-K	EL	
			7.11492.01.0	DDS		Organisationsnummer ab: 12775 RPO number from: 12775 ohne Zubehör without accessories
			7.02604.99.0	LS	400 mm	

RIFTER
64



1.5 BlueHDi 100 75 kW (102 PS) YHY (DV5RD)	09.2018→		7.07794.23.0	AGR	EL	mit Dichtring with O-ring
1.5 BlueHDi 130 96 kW (131 PS) YHZ (DV5RC)	09.2018→		7.07794.23.0	AGR	EL	mit Dichtring with O-ring
1.5 BlueHDi 75 (ECYHW) 55 kW (75 PS) YHW (DV5RE)	09.2018→		7.07794.23.0	AGR	EL	mit Dichtring with O-ring
1.6 HDi 75 / BlueHDi 75 55 kW (75 PS) 9HN (DV6ETED)	09.2018→		7.02156.35.0	AGR-K	EL	ohne Sensor without sensor mit AGR-Ventil with EGR valve
			7.02156.34.0	AGR-K		ohne Sensor without sensor ohne AGR-Ventil without EGR valve









RIFTER **64**

			7.11492.01.0	DDS		ohne Zubehör without accessories
1.6 HDi 90 66-69 kW (90-94 PS) 9HP (DV6DTE)	09.2018→		7.02156.35.0	AGR-K	EL	ohne Sensor without sensor mit AGR-Ventil with EGR valve
			7.02156.34.0	AGR-K		ohne Sensor without sensor
1.6 HDi 92 66-69 kW (90-94 PS) 9HP (DV6DTE)	09.2018→		7.02156.35.0	AGR-K	EL	ohne Sensor without sensor mit AGR-Ventil with EGR valve
			7.02156.34.0	AGR-K		ohne Sensor without sensor
			7.11492.01.0	DDS		ohne Zubehör without accessories

206 Van **65**

1.1 44 kW (60 PS) HFZ (TU1JP)	09.2002→02.2007		7.05270.36.0	LS	540 mm	Organisationsnummer ab: 10556 RPO number from: 10556 Euro 3 Euro 3
1.4 HDi 50-52 kW (68-70 PS) 8HX (DV4TD), 8HZ (DV4TD)	09.2001→03.2009		7.24809.06.0	AGR	PN	mit Rohrstützen with pipe socket  8HX (DV4TD), 8HZ (DV4TD): Euro 3 Euro 3
			7.24809.76.0	AGR	EL	 8HX (DV4TD), 8HZ (DV4TD): Euro 4 (D4) Euro 4 (D4)

207 Hatchback Van (WA_, WC_) **66**

1.4 HDi 50 kW (68 PS) 8HR (DV4C)	04.2007→		7.02156.35.0	AGR-K	EL	ohne Sensor without sensor 12.2012→ mit AGR-Ventil with EGR valve
			7.02156.33.0	AGR-K		mit Sensor with sensor →10.2012
			7.02156.34.0	AGR-K		ohne AGR-Ventil without EGR valve ohne Sensor without sensor 12.2012→ ohne AGR-Ventil without EGR valve
1.4 HDi 50-52 kW (68-70 PS) 8HZ (DV4TD)	04.2007→		7.24809.76.0	AGR	EL	
			7.02156.24.0	AGR-K	EL	mit Sensor with sensor  →10.2012
1.6 HDi 80-84 kW (109-114 PS) 9HZ (DV6TED4)	04.2006→12.2012		7.11492.01.0	DDS		ohne Zubehör without accessories für OE-Nummer: 1618 Z9 for OE number: 1618 Z9
1.6 HDi 66-68 kW (90-92 PS) 9HX (DV6ATED4)	04.2007→10.2012		7.24809.39.0	AGR	EL	 Euro 4 (D4) Euro 4 (D4)
1.6 HDi 66-69 kW (90-94 PS) 9HP (DV6DTE)	11.2009→03.2013		7.02209.11.0	AGR	EL	
			7.02156.24.0	AGR-K	EL	mit Sensor with sensor  →11.2012

P









207 Hatchback Van (WA_, WC_) 66

		7.02156.35.0	AGR-K	EL	ohne Sensor without sensor 01.2013→ mit AGR-Ventil with EGR valve
		7.02156.33.0	AGR-K		mit Sensor with sensor →11.2012 ohne AGR-Ventil without EGR valve
		7.02156.34.0	AGR-K		ohne Sensor without sensor 01.2013→ ohne AGR-Ventil without EGR valve
		7.11492.01.0	DDS		ohne Zubehör without accessories



207 SW Estate Van (WK_) 67

1.6 HDi 80-84 kW (109-114 PS) 9HZ (DV6TED4)	08.2007→12.2012	 7.11492.01.0	DDS		ohne Zubehör without accessories für OE-Nummer: 1618 Z9 for OE number: 1618 Z9
---	-----------------	---	-----	--	---























208 Hatchback Van (CR_) 68

1.4 HDi 68 (CR8HR0) 50 kW (68 PS) 8HR (DV4C)	10.2012→	 7.02209.11.0	AGR	EL	
		7.02156.24.0	AGR-K	EL	mit Sensor with sensor  →10.2012
		7.02156.35.0	AGR-K	EL	ohne Sensor without sensor 12.2012→ mit AGR-Ventil with EGR valve
		7.02156.34.0	AGR-K		ohne Sensor without sensor 12.2012→ ohne AGR-Ventil without EGR valve
		7.11492.01.0	DDS		ohne Zubehör without accessories
1.5 BlueHDi 100 75 kW (102 PS) YHY (DV5RD)	05.2018→	 7.07794.23.0	AGR	EL	mit Dichtring with O-ring
1.6 HDi 92 66-69 kW (90-94 PS) 9HP (DV6DTE)	03.2014→	 7.02209.11.0	AGR	EL	
		7.02156.35.0	AGR-K	EL	ohne Sensor without sensor mit AGR-Ventil with EGR valve
		7.02156.34.0	AGR-K		ohne Sensor without sensor ohne AGR-Ventil without EGR valve
		7.11492.01.0	DDS		ohne Zubehör without accessories

































306 Estate Van (N_, 7_) 69

1.4 47-60 kW (64-82 PS) KFW (TU3JP)	03.1996→07.2001	 7.05270.36.0	LS	540 mm	Euro 3, Technische Schadstoffverringernung K Euro 3, Technical pollution reduction K
2.0 HDi 66 kW (90 PS) RHY (DW10TD)	08.1998→06.2000	 7.22843.06.0	AGR	PN	



































P

			 PIERBURG		
307 SW Estate Van (3E_, 3H_) 70					
1.4 HDi 50-52 kW (68-70 PS) 8HZ (DV4TD)	04.2002→06.2005		7.24809.06.0	AGR	PN mit Rohrstutzen with pipe socket Euro 3 Euro 3
2.0 HDi 100-103 kW (136-140 PS) RHR (DW10BTED4)	04.2004→11.2007		7.24809.68.0 7.11492.01.0	AGR DDS	EL  ohne Zubehör without accessories Organisationsnummer ab: 11074 RPO number from: 11074
308 Hatchback Van (LB_) 71					
1.6 e-HDi 115 (LB9HCG) 82-85 kW (112-116 PS) 9HC (DV6C)	03.2015→		7.02209.11.0 7.02156.35.0 7.02156.34.0 7.11492.01.0	AGR AGR-K AGR-K DDS	EL  EL ohne Sensor without sensor mit AGR-Ventil with EGR valve ohne Sensor without sensor ohne AGR-Ventil without EGR valve ohne Zubehör without accessories
308 SW I Estate Van (4E_) 72					
1.6 HDi 80-84 kW (109-114 PS) 9HZ (DV6TED4)	01.2008→12.2012		7.11492.01.0	DDS	ohne Zubehör without accessories
2.0 HDi 100-103 kW (136-140 PS) RHR (DW10BTED4)	01.2008→12.2011		7.24809.68.0 7.11492.01.0	AGR DDS	EL  ohne Zubehör without accessories
4007 Van (VU_, VV_) 73					
HDi 155 (VU4HNNH, VV4HK8) 115 kW (156 PS) 4HK (DW12ME5), 4HN (DW12MTED4)	02.2007→03.2013		7.00578.12.0	AGR	EL 
407 SW Estate Van (6E_) 74					
1.6 HDi 80-84 kW (109-114 PS) 9HZ (DV6TED4)	08.2004→12.2010		7.11492.01.0	DDS	ohne Zubehör without accessories Organisationsnummer ab: 11284 RPO number from: 11284
2.0 HDi 100-103 kW (136-140 PS) RHR (DW10BTED4)	06.2009→12.2010		7.24809.68.0 7.11492.01.0	AGR DDS	EL  ohne Zubehör without accessories Organisationsnummer ab: 10948 RPO number from: 10948
2.0 HDi 120 kW (163 PS) RHH (DW10CTED4)	06.2009→12.2010		7.11492.01.0	DDS	ohne Zubehör without accessories
508 SW Estate Van (8E_) 75					
1.6 HDi 82-85 kW (112-116 PS) 9HL (DV6C)	03.2013→12.2018		7.02209.11.0 7.02156.35.0	AGR AGR-K	EL  EL ohne Sensor without sensor mit AGR-Ventil with EGR valve



































P

					
508 SW Estate Van (8E_)					75
			7.02156.34.0	AGR-K	ohne Sensor without sensor ohne AGR-Ventil without EGR valve
2.0 HDi 103 kW (140 PS) RHF (DW10BTED4)	03.2013→12.2018		7.24809.68.0	AGR	EL 
BIPPER (AA_)					76
1.3 HDi 75 55 kW (75 PS) FHZ (F13DTE5)	10.2010→		7.01599.10.0	AGR	EL 
			7.03622.06.0	AGR-K	
			7.11190.03.0	DDS	ohne Zubehör without accessories
1.3 HDi 80 / BlueHDi 80 59-70 kW (80-95 PS) FHY (F13DTE6)	12.2015→		7.01599.10.0	AGR	EL 
			7.11190.03.0	DDS	ohne Zubehör without accessories für OE-Nummer: 16 105 313 80, 1618 SV for OE number: 16 105 313 80, 1618 SV
1.4 HDi 50 kW (68 PS) 8HS (DV4TED)	02.2008→		7.24809.76.0	AGR	EL 
BOXER Bus					77
2.0 BlueHDi 110 80-81 kW (109-110 PS) AHM (DW10FUE)	07.2015→09.2019		7.11492.01.0	DDS	ohne Zubehör without accessories
2.0 BlueHDi 130 96 kW (130 PS) AHN (DW10FUD)	07.2015→09.2019		7.11492.01.0	DDS	ohne Zubehör without accessories
2.0 BlueHDi 160 120 kW (163 PS) AHP (DW10FUC)	07.2015→09.2019		7.11492.01.0	DDS	ohne Zubehör without accessories
2.2 HDi 100 74 kW (101 PS) 4HV (P22DTE)	04.2006→		7.24809.70.0	AGR	EL 
2.2 HDi 110 81 kW (110 PS) 4HG (P22DTE)	03.2011→		7.03784.34.0	AGR	EL 
2.2 HDi 120 88 kW (120 PS) 4HU (P22DTE)	04.2006→		7.24809.70.0	AGR	EL 
2.2 HDi 130 96 kW (130 PS) 4HH (P22DTE)	03.2011→		7.03784.34.0	AGR	EL 
2.2 HDi 150 110 kW (150 PS) 4HJ (P22DTE)	03.2011→		7.03784.34.0	AGR	EL 
3.0 HDi 145 107 kW (146 PS) F1CE3481N (F30DTE)	04.2010→		7.02604.99.0	LS	400 mm
3.0 HDi 160 115-130 kW (156-177 PS) F1CE0481D (F30DT)	04.2006→		7.24809.51.0	AGR	PN 
			7.08369.98.0	ATS	EL Partikelfilter Particulate Filter
			7.08369.99.0	ATS	EL
			7.11190.03.0	DDS	ohne Zubehör without accessories  ch. 12421976→ Euro 5 Euro 5
			7.02604.99.0	LS	400 mm
3.0 HDi 175 130 kW (177 PS) F1CE3481E (F30DTE)	03.2011→		7.02604.99.0	LS	400 mm

P







			 PIERBURG			
BOXER Bus (230P)						78
2.0 i 80 kW (109 PS) RFW (XU10J2)	03.1994→04.2002		7.02604.04.0	LS	200 mm	
2.0 i 4x4 80 kW (109 PS) RFW (XU10J2)	08.1996→04.2002		7.02604.04.0	LS	200 mm	
2.8 D 64 kW (87 PS) 8140.63 (F28D)	01.1999→02.2002		7.24809.53.0	AGR	PN 	
BOXER Bus (244, Z_)						79
2.0 HDi 62 kW (84 PS) RHV (DW10TD)	04.2002→		7.11237.04.0	AGR	PN →06.2006	
2.2 HDi 74 kW (101 PS) 4HY (DW12UTED)	04.2002→		7.11237.04.0	AGR	PN →06.2006	
BOXER Platform/Chassis						80
2.0 BlueHDi 110 80-81 kW (109-110 PS) AHM (DW10FUE)	07.2015→09.2019		7.11492.01.0	DDS	ohne Zubehör without accessories	
2.0 BlueHDi 130 96 kW (130 PS) AHN (DW10FUD)	07.2015→09.2019		7.11492.01.0	DDS	ohne Zubehör without accessories	
2.0 BlueHDi 160 120 kW (163 PS) AHP (DW10FUC)	07.2015→09.2019		7.11492.01.0	DDS	ohne Zubehör without accessories	
2.2 HDi 100 74 kW (101 PS) 4HV (P22DTE)	04.2006→		7.24809.70.0	AGR	EL 	
2.2 HDi 110 81 kW (110 PS) 4HG (P22DTE)	03.2011→		7.03784.34.0	AGR	EL 	
2.2 HDi 120 88 kW (120 PS) 4HU (P22DTE)	04.2006→		7.24809.70.0	AGR	EL 	
2.2 HDi 130 96 kW (130 PS) 4HH (P22DTE)	03.2011→		7.03784.34.0	AGR	EL 	
2.2 HDi 150 110 kW (150 PS) 4HJ (P22DTE)	03.2011→		7.03784.34.0	AGR	EL 	
3.0 HDi 115-130 kW (156-177 PS) F1CE0481D (F30DT)	04.2006→		7.08369.98.0 7.08369.99.0 7.11190.03.0	ATS ATS DDS	EL Partikelfilter Particulate Filter EL ohne Zubehör without accessories  ch. 12421976→ Euro 5 Euro 5	
3.0 HDi 145 107 kW (146 PS) F1CE3481N (F30DTE)	04.2010→		7.02604.99.0	LS	400 mm	
3.0 HDi 160 115-130 kW (156-177 PS) F1CE0481D (F30DT)	04.2006→		7.24809.51.0 7.08369.98.0 7.08369.99.0 7.11190.03.0 7.02604.99.0	AGR ATS ATS DDS LS	PN  EL EL ohne Zubehör without accessories  ch. 12421976→ Euro 5 Euro 5 400 mm	
3.0 HDi 175 130 kW (177 PS) F1CE3481E (F30DTE)	03.2011→		7.02604.99.0	LS	400 mm	
BOXER Platform/Chassis (244)						81
2.0 HDi 62 kW (84 PS) RHV (DW10TD)	04.2002→		7.11237.04.0	AGR	PN →06.2006	
2.2 HDi 74 kW (101 PS) 4HY (DW12UTED)	04.2002→		7.11237.04.0	AGR	PN →06.2006	

P



						
BOXER Platform/Chassis (ZCT_)						82
2.0 i 80 kW (109 PS) RFW (XU10J2)	06.1994→04.2002		7.02604.04.0	LS	200 mm	
2.8 D 64 kW (87 PS) 8140.63 (F28D)	01.1999→02.2002		7.24809.53.0	AGR	PN	
BOXER Van						83
2.0 BlueHDi 110 80-81 kW (109-110 PS) AHM (DW10FUE)	07.2015→09.2019		7.11492.01.0	DDS		ohne Zubehör without accessories
2.0 BlueHDi 130 96 kW (130 PS) AHN (DW10FUD)	07.2015→09.2019		7.11492.01.0	DDS		ohne Zubehör without accessories
2.0 BlueHDi 160 120 kW (163 PS) AHP (DW10FUC)	07.2015→09.2019		7.11492.01.0	DDS		ohne Zubehör without accessories
2.2 HDi 100 74 kW (101 PS) 4HV (P22DTE)	04.2006→		7.24809.70.0	AGR	EL	
2.2 HDi 110 81 kW (110 PS) 4HG (P22DTE)	03.2011→		7.03784.34.0	AGR	EL	
2.2 HDi 120 88 kW (120 PS) 4HU (P22DTE)	04.2006→		7.24809.70.0	AGR	EL	
2.2 HDi 130 96 kW (130 PS) 4HH (P22DTE)	03.2011→		7.03784.34.0	AGR	EL	
2.2 HDi 150 110 kW (150 PS) 4HJ (P22DTE)	03.2011→		7.03784.34.0	AGR	EL	
3.0 HDi 115-130 kW (156-177 PS) F1CE0481D (F30DT)	07.2006→		7.08369.98.0	ATS	EL	Partikelfilter Particulate Filter
			7.08369.99.0	ATS	EL	
			7.11190.03.0	DDS		
			7.02604.99.0	LS	400 mm	ohne Zubehör without accessories  ch. 12421976→ Euro 5 Euro 5
3.0 HDi 145 107 kW (146 PS) F1CE3481N (F30DTE)	04.2010→		7.02604.99.0	LS	400 mm	
3.0 HDi 160 115-130 kW (156-177 PS) F1CE0481D (F30DT)	04.2006→		7.24809.51.0	AGR	PN	
			7.08369.98.0	ATS	EL	nach Rußpartikelfilter after soot particulate filter
			7.08369.99.0	ATS	EL	
			7.11190.03.0	DDS		ohne Zubehör without accessories  ch. 12421976→ Euro 5 Euro 5
			7.02604.99.0	LS	400 mm	
3.0 HDi 175 130 kW (177 PS) F1CE3481E (F30DTE)	03.2011→		7.02604.99.0	LS	400 mm	
BOXER Van (230L)						84
2.0 i 80 kW (109 PS) RFW (XU10J2)	06.1994→04.2002		7.02604.04.0	LS	200 mm	
2.8 D 64 kW (87 PS) 8140.63 (F28D)	01.1999→02.2002		7.24809.53.0	AGR	PN	
BOXER Van (244)						85
2.0 HDi 62 kW (84 PS) RHV (DW10TD)	04.2002→		7.11237.04.0	AGR	PN	→06.2006
2.2 HDi 74 kW (101 PS) 4HY (DW12UTED)	04.2002→		7.11237.04.0	AGR	PN	→06.2006











EXPERT (224_) **86**

1.6 58 kW (79 PS) 222A2 (1580 SPI)	02.1996→09.2000		7.02604.04.0	LS	200 mm	
2.0 HDi 79-80 kW (107-109 PS) RHZ (DW10ATED), RHZ (DW10BTED+)	07.2000→12.2006		7.22843.06.0	AGR	PN	
2.0 HDi 80 kW (109 PS) RHZ (DW10BTED)	07.2000→12.2006		7.22843.06.0	AGR	PN	
2.0 HDi 69 kW (94 PS) RHX (DW10BTED)	10.2000→10.2006		7.09730.01.0	AGR-K		
			7.22843.06.0	AGR	PN	
			7.09730.01.0	AGR-K		

EXPERT Bus (V_) **87**







2.0 BlueHDi 150 110 kW (150 PS) AHX (DW10FD)	04.2016→		7.11492.01.0	DDS		ohne Zubehör without accessories Organisationsnummer ab: 14299U9 RPO number from: 14299U9
2.0 BlueHDi 180 130 kW (178 PS) AHH (DW10FC)	04.2016→		7.11492.01.0	DDS		ohne Zubehör without accessories Organisationsnummer ab: 14299U9 RPO number from: 14299U9

EXPERT Platform/Chassis **88**







1.6 HDi 90 16V 66 kW (90 PS) 9HU (DV6UTED4)	01.2007→		7.24809.39.0	AGR	EL	 Euro 4 (D4) Euro 4 (D4)
1.6 HDi 90 8V 66 kW (90 PS) 9HH (DV6DUM)	01.2007→		7.02209.11.0	AGR	EL	
			7.02156.35.0	AGR-K	EL	ohne Sensor without sensor 01.2016→ mit AGR-Ventil with EGR valve
			7.03647.10.0	AGR-K	EL	
			7.02156.34.0	AGR-K		ohne Sensor without sensor 01.2016→ ohne AGR-Ventil without EGR valve
			7.11492.01.0	DDS		ohne Zubehör without accessories Organisationsnummer ab: 14299U9 RPO number from: 14299U9
1.6 HDi 90 8V 66 kW (90 PS) 9HM (DV6UC)	01.2007→		7.02209.11.0	AGR	EL	
			7.02156.24.0	AGR-K	EL	mit Sensor with sensor  →11.2012
			7.02156.35.0	AGR-K	EL	ohne Sensor without sensor 01.2013→ mit AGR-Ventil with EGR valve
			7.02156.33.0	AGR-K		mit Sensor with sensor →11.2012
			7.02156.34.0	AGR-K		ohne Sensor without sensor 01.2013→ ohne AGR-Ventil without EGR valve

P



EXPERT Platform/Chassis
88

			7.11492.01.0	DDS		ohne Zubehör without accessories für OE-Nummer: 1618 Z9 for OE number: 1618 Z9
			7.05270.21.0	LS	600 mm	für OE-Nummer: 1618AS for OE number: 1618AS vor Katalysator in front of the catalyst
2.0 HDi 120 79-88 kW (107-120 PS) RHK (DW10UTED4)	01.2007→		7.24809.68.0	AGR	EL	
			7.11492.01.0	DDS		ohne Zubehör without accessories
2.0 HDi 130 94 kW (128 PS) AHZ (DW10CD)	03.2011→		7.11492.01.0	DDS		ohne Zubehör without accessories
			7.05270.21.0	LS	600 mm	vor Katalysator in front of the catalyst für Fahrzeuge mit Diesel-Partikel-Filter (DPF) for vehicles with diesel soot filter
2.0 HDi 140 100-103 kW (136-140 PS) RHR (DW10BTED4)	01.2007→		7.24809.68.0	AGR	EL	
			7.09730.00.0	AGR-K		
			7.11492.01.0	DDS		ohne Zubehör without accessories Organisationsnummer ab: 11319 RPO number from: 11319
2.0 HDi 165 120 kW (163 PS) RHH (DW10CTED4)	09.2009→		7.11492.01.0	DDS		ohne Zubehör without accessories
			7.05270.21.0	LS	600 mm	vor Katalysator in front of the catalyst für Fahrzeuge mit Diesel-Partikel-Filter (DPF) for vehicles with diesel soot filter





EXPERT Platform/Chassis (223)
89

1.6 58 kW (79 PS) 222A2 (1580 SPI)	02.1996→09.2000		7.02604.04.0	LS	200 mm	
2.0 HDI	10.2000→10.2006		7.28069.03.0	AGR	PN	
2.0 HDi 69 kW (94 PS) RHX (DW10BTED)	10.2000→10.2006		7.22843.06.0	AGR	PN	
			7.09730.01.0	AGR-K		
2.0 HDi 79-80 kW (107-109 PS) RHW (DW10ATED4)	10.2000→10.2006		7.28069.03.0	AGR	PN	 für Fahrzeuge ohne Diesel-Partikel-Filter (DPF) for vehicles without diesel soot filter

EXPERT Platform/Chassis (V_)
90













2.0 BlueHDi 150 110 kW (150 PS) AHX (DW10FD)	09.2016→		7.11492.01.0	DDS		ohne Zubehör without accessories Organisationsnummer ab: 14299U9 RPO number from: 14299U9
--	----------	---	---------------------	-----	--	--

EXPERT TEPEE (VF3X_)
91

1.6 HDi 90 16V 66 kW (90 PS) 9HU (DV6UTED4)	01.2007→03.2016		7.24809.39.0	AGR	EL	
1.6 HDi 90 8V 66 kW (90 PS) 9HH (DV6DUM)	01.2007→03.2016		7.02209.11.0	AGR	EL	
			7.02156.35.0	AGR-K	EL	ohne Sensor without sensor 01.2016→ mit AGR-Ventil with EGR valve



EXPERT TEPEE (VF3X_) 91



			7.03647.10.0	AGR-K	EL	 ohne Sensor without sensor
			7.02156.34.0	AGR-K		ohne Sensor without sensor
			7.11492.01.0	DDS		01.2016→ ohne AGR-Ventil without EGR valve
			7.11492.01.0	DDS		ohne Zubehör without accessories Organisationsnummer ab: 14299U9 RPO number from: 14299U9
1.6 HDi 90 8V 66 kW (90 PS) 9HM (DV6UC)	01.2007→03.2016		7.02209.11.0	AGR	EL	
			7.02156.24.0	AGR-K	EL	mit Sensor with sensor
			7.02156.35.0	AGR-K	EL	 →11.2012
			7.02156.33.0	AGR-K		ohne Sensor without sensor 01.2013→ mit AGR-Ventil with EGR valve
			7.02156.33.0	AGR-K		mit Sensor with sensor →11.2012
			7.02156.34.0	AGR-K		ohne AGR-Ventil without EGR valve
			7.11492.01.0	DDS		ohne Sensor without sensor 01.2013→ ohne AGR-Ventil without EGR valve
			7.05270.21.0	LS	600 mm	ohne Zubehör without accessories für OE-Nummer: 1618 Z9 for OE number: 1618 Z9 für OE-Nummer: 1618 AS for OE number: 1618 AS vor Katalysator in front of the catalyst
2.0 HDi 100 72 kW (98 PS) AHY (DW10CE)	03.2011→03.2016		7.24809.94.0	AGR-K	EL	 Organisationsnummer ab: 12853 RPO number from: 12853
			7.11492.01.0	DDS		ohne Zubehör without accessories
			7.05270.21.0	LS	600 mm	vor Katalysator in front of the catalyst für Fahrzeuge mit Diesel-Partikel-Filter (DPF) for vehicles with diesel soot filter
2.0 HDi 120 79-88 kW (107-120 PS) RHK (DW10UTED4)	01.2007→03.2016		7.24809.68.0	AGR	EL	
			7.11492.01.0	DDS		ohne Zubehör without accessories
2.0 HDi 120 4x4 79-88 kW (107-120 PS) RHK (DW10UTED4)	01.2007→03.2016		7.24809.68.0	AGR	EL	
			7.11492.01.0	DDS		ohne Zubehör without accessories
2.0 HDi 130 94 kW (128 PS) AHZ (DW10CD)	03.2011→		7.24809.94.0	AGR-K	EL	 Organisationsnummer ab: 12853 RPO number from: 12853
			7.11492.01.0	DDS		ohne Zubehör without accessories

P







EXPERT TEPEE (VF3X_)

91

			7.05270.21.0	LS	600 mm	vor Katalysator in front of the catalyst für Fahrzeuge mit Diesel-Partikel-Filter (DPF) for vehicles with diesel soot filter
2.0 HDi 130 4x4 94 kW (128 PS) AHZ (DW10CD)	03.2011→03.2016		7.24809.94.0	AGR-K	EL	⊙ Organisationsnummer ab: 12853 RPO number from: 12853
			7.11492.01.0	DDS		ohne Zubehör without accessories
			7.05270.21.0	LS	600 mm	vor Katalysator in front of the catalyst für Fahrzeuge mit Diesel-Partikel-Filter (DPF) for vehicles with diesel soot filter
2.0 HDi 140 100-103 kW (136-140 PS) RHR (DW10BTED4)	01.2007→		7.24809.68.0	AGR	EL	⊙
			7.09730.00.0	AGR-K		ohne Zubehör without accessories Organisationsnummer ab: 11319 RPO number from: 11319
			7.11492.01.0	DDS		
2.0 HDi 165 120 kW (163 PS) RHH (DW10CTED4)	09.2009→		7.24809.94.0	AGR-K	EL	⊙ Organisationsnummer ab: 12853 RPO number from: 12853
			7.11492.01.0	DDS		ohne Zubehör without accessories
			7.05270.21.0	LS	600 mm	vor Katalysator in front of the catalyst für Fahrzeuge mit Diesel-Partikel-Filter (DPF) for vehicles with diesel soot filter

EXPERT Van (222)



92

1.6 58 kW (79 PS) 222A2 (1580 SPI)	02.1996→09.2000		7.02604.04.0	LS	200 mm	
2.0 HDI 69 kW (94 PS) RHX (DW10BTED)	07.2000→12.2006		7.22843.06.0	AGR	PN	⊙
			7.09730.01.0	AGR-K		
2.0 HDI 79-80 kW (107-109 PS) RHZ (DW10ATED), RHZ (DW10BTED+)	07.2000→12.2006		7.22843.06.0	AGR	PN	⊙
2.0 HDI 80 kW (109 PS) RHZ (DW10BTED)	07.2000→12.2006		7.22843.06.0	AGR	PN	⊙
			7.09730.01.0	AGR-K		
2.0 HDI 79-80 kW (107-109 PS) RHW (DW10ATED4)	07.2000→12.2006		7.28069.03.0	AGR	PN	⊙ für Fahrzeuge ohne Diesel-Partikel-Filter (DPF) for vehicles without diesel soot filter

P











EXPERT Van (VF3A_, VF3U_, VF3X_)















93

1.6 HDi 90 16V 66 kW (90 PS) 9HU (DV6UTED4)	01.2007→		7.24809.39.0	AGR	EL	⊙ Euro 4 (D4) Euro 4 (D4)
1.6 HDi 90 8V 66 kW (90 PS) 9HH (DV6DUM)	01.2007→		7.02209.11.0	AGR	EL	⊙
			7.02156.35.0	AGR-K	EL	ohne Sensor without sensor 01.2016→ mit AGR-Ventil with EGR valve
			7.03647.10.0	AGR-K	EL	⊙ ohne Sensor without sensor











EXPERT Van (VF3A_, VF3U_, VF3X_) 93

			7.02156.34.0	AGR-K		ohne Sensor without sensor 01.2016→ ohne AGR-Ventil without EGR valve
			7.11492.01.0	DDS		ohne Zubehör without accessories Organisationsnummer ab: 14299U9 RPO number from: 14299U9
1.6 HDi 90 8V 66 kW (90 PS) 9HM (DV6UC)	01.2007→		7.02209.11.0	AGR	EL	
			7.02156.24.0	AGR-K	EL	mit Sensor with sensor  →11.2012
			7.02156.35.0	AGR-K	EL	ohne Sensor without sensor 01.2013→ mit AGR-Ventil with EGR valve
			7.02156.33.0	AGR-K		mit Sensor with sensor →11.2012 ohne AGR-Ventil without EGR valve
			7.02156.34.0	AGR-K		ohne Sensor without sensor 01.2013→ ohne AGR-Ventil without EGR valve
			7.11492.01.0	DDS		ohne Zubehör without accessories für OE-Nummer: 1618 Z9 for OE number: 1618 Z9
			7.05270.21.0	LS	600 mm	für OE-Nummer: 1618 AS for OE number: 1618 AS vor Katalysator in front of the catalyst
P 2.0 HDi 120 79-88 kW (107-120 PS) RHK (DW10UTED4)	01.2007→		7.24809.68.0	AGR	EL	
			7.11492.01.0	DDS		ohne Zubehör without accessories
2.0 HDi 120 4x4 79-88 kW (107-120 PS) RHK (DW10UTED4)	01.2010→		7.24809.68.0	AGR	EL	
			7.11492.01.0	DDS		ohne Zubehör without accessories
2.0 HDi 130 94 kW (128 PS) AHZ (DW10CD)	03.2011→		7.11492.01.0	DDS		ohne Zubehör without accessories
			7.05270.21.0	LS	600 mm	vor Katalysator in front of the catalyst für Fahrzeuge mit Diesel-Partikel-Filter (DPF) for vehicles with diesel soot filter
2.0 HDi 130 4x4 94 kW (128 PS) AHZ (DW10CD)	01.2012→03.2016		7.11492.01.0	DDS		ohne Zubehör without accessories
			7.05270.21.0	LS	600 mm	vor Katalysator in front of the catalyst für Fahrzeuge mit Diesel-Partikel-Filter (DPF) for vehicles with diesel soot filter
2.0 HDi 140 100-103 kW (136-140 PS) RHR (DW10BTED4)	01.2007→		7.24809.68.0	AGR	EL	
			7.09730.00.0	AGR-K		

					
EXPERT Van (VF3A_, VF3U_, VF3X_)					93
			7.11492.01.0	DDS	ohne Zubehör without accessories Organisationsnummer ab: 11319 RPO number from: 11319
2.0 HDi 165 120 kW (163 PS) RHH (DW10CTED4)	09.2009→		7.11492.01.0	DDS	ohne Zubehör without accessories
			7.05270.21.0	LS	600 mm vor Katalysator in front of the catalyst für Fahrzeuge mit Diesel-Partikel-Filter (DPF) for vehicles with diesel soot filter
EXPERT Van (V_)					94
2.0 BlueHDi 150 110 kW (150 PS) AHX (DW10FD)	04.2016→		7.11492.01.0	DDS	ohne Zubehör without accessories Organisationsnummer ab: 14299U9 RPO number from: 14299U9
2.0 BlueHDi 180 130 kW (178 PS) AHH (DW10FC)	04.2016→		7.11492.01.0	DDS	ohne Zubehör without accessories Organisationsnummer ab: 14299U9 RPO number from: 14299U9
PARTNER Box Body/MPV					95
1.6 72 kW (98 PS) 5FK (EP6CB)	11.2010→		7.05271.74.0	LS	450 mm
1.6 HDi 55 kW (75 PS) 9HT (DV6BTED4), 9HT (DV6BUTED4), 9HW (DV6BTED4)	04.2008→		7.24809.39.0	AGR	EL 
			7.02604.99.0	LS	400 mm
1.6 HDi 82-85 kW (112-116 PS) 9HL (DV6C)	08.2010→		7.02156.35.0	AGR-K	EL ohne Sensor without sensor 01.2013→ mit AGR-Ventil with EGR valve
			7.02156.33.0	AGR-K	mit Sensor with sensor →11.2012 ohne AGR-Ventil without EGR valve
			7.02156.34.0	AGR-K	ohne Sensor without sensor 01.2013→ ohne AGR-Ventil without EGR valve
			7.11492.01.0	DDS	ohne Zubehör without accessories Organisationsnummer ab: 11211FL, 11211FV RPO number from: 11211FL, 11211FV
1.6 HDi 66-69 kW (90-94 PS) 9HF (DV6DTED)	12.2011→		7.02209.11.0	AGR	EL 
			7.02156.35.0	AGR-K	EL ohne Sensor without sensor 01.2013→ mit AGR-Ventil with EGR valve
			7.02156.33.0	AGR-K	mit Sensor with sensor →11.2012 ohne AGR-Ventil without EGR valve
			7.02156.34.0	AGR-K	ohne Sensor without sensor 01.2013→ ohne AGR-Ventil without EGR valve



PARTNER Box Body/MPV **95**













			7.11492.01.0	DDS		ohne Zubehör without accessories Organisationsnummer ab: 11211FL, 11211FV RPO number from: 11211FL, 11211FV
1.6 HDi 82-85 kW (112-116 PS) 9HL (DV6C)	03.2013→		7.02209.11.0	AGR	EL	
			7.02156.35.0	AGR-K	EL	ohne Sensor without sensor mit AGR-Ventil with EGR valve
			7.02156.34.0	AGR-K		ohne Sensor without sensor ohne AGR-Ventil without EGR valve
			7.11492.01.0	DDS		ohne Zubehör without accessories Organisationsnummer ab: 11211FL, 11211FV RPO number from: 11211FL, 11211FV
1.6 HDi / BlueHDi 75 55 kW (75 PS) 9HK (DV6ETEDM)	07.2011→		7.02209.11.0	AGR	EL	
			7.02156.35.0	AGR-K	EL	ohne Sensor without sensor 01.2013→ mit AGR-Ventil with EGR valve
			7.03647.10.0	AGR-K	EL	
			7.02156.33.0	AGR-K		ohne Sensor without sensor mit Sensor with sensor →11.2012 ohne AGR-Ventil without EGR valve
			7.02156.34.0	AGR-K		ohne Sensor without sensor 01.2013→ ohne AGR-Ventil without EGR valve
1.6 HDi / BlueHDi 75 55 kW (75 PS) 9HN (DV6ETED)	07.2011→		7.02209.11.0	AGR	EL	
			7.02156.24.0	AGR-K	EL	mit Sensor with sensor  →11.2012
			7.02156.35.0	AGR-K	EL	ohne Sensor without sensor 01.2013→ mit AGR-Ventil with EGR valve
			7.02156.33.0	AGR-K		mit Sensor with sensor →11.2012 ohne AGR-Ventil without EGR valve
			7.02156.34.0	AGR-K		ohne Sensor without sensor 01.2013→ ohne AGR-Ventil without EGR valve

P



PARTNER Box Body/MPV



95

			7.11492.01.0	DDS		ohne Zubehör without accessories Organisationsnummer ab: 11211FL, 11211FV RPO number from: 11211FL, 11211FV
			7.02604.99.0	LS	400 mm	→03.2015 Motorcode: 9HN (DV6ETED) Engine Code: 9HN (DV6ETED) Produktionsdatum ab: 07.2011 Production date from: 07.2011 Produktionsdatum bis: 03.2015 Production date to: 03.2015
1.6 HDi 16V 66 kW (90 PS) 9HS (DV6TED4BU)	04.2008→		7.24809.39.0	AGR	EL	
			7.11492.01.0	DDS		ohne Zubehör without accessories Organisationsnummer ab: 11211FL, 11211FV RPO number from: 11211FL, 11211FV
			7.02604.99.0	LS	400 mm	
1.6 HDi 16V 66 kW (90 PS) 9HX (DV6AUTED4)	04.2008→		7.24809.39.0	AGR	EL	
			7.02604.99.0	LS	400 mm	
1.6 HDi 16V 66-68 kW (90-92 PS) 9HX (DV6ATED4)	04.2010→		7.24809.39.0	AGR	EL	
1.6 HDi 16V 4x4 66 kW (90 PS) 9HS (DV6TED4BU)	04.2012→		7.11492.01.0	DDS		ohne Zubehör without accessories Organisationsnummer ab: 11211FL, 11211FV RPO number from: 11211FL, 11211FV
1.6 HDi 16V 4x4 66-68 kW (90-92 PS) 9HX (DV6ATED4)	04.2012→		7.24809.39.0	AGR	EL	 Euro 4 (D4) Euro 4 (D4)
1.6 HDi 90 66-69 kW (90-94 PS) 9HP (DV6DTED)	04.2010→		7.02209.11.0	AGR	EL	
			7.02156.24.0	AGR-K	EL	mit Sensor with sensor  →11.2012
			7.02156.35.0	AGR-K	EL	ohne Sensor without sensor 01.2013→ mit AGR-Ventil with EGR valve
			7.02156.33.0	AGR-K		mit Sensor with sensor →11.2012 ohne AGR-Ventil without EGR valve
			7.02156.34.0	AGR-K		ohne Sensor without sensor 01.2013→ ohne AGR-Ventil without EGR valve
			7.11492.01.0	DDS		ohne Zubehör without accessories Organisationsnummer ab: 11211FL, 11211FV RPO number from: 11211FL, 11211FV
			7.05270.21.0	LS	600 mm	vor Katalysator in front of the catalyst
			7.02604.99.0	LS	400 mm	



















P

































































PARTNER Box Body/MPV **95**

1.6 HDi 90 68 kW (92 PS) 9HJ (DV6DTEDM)	04.2010→	 7.02209.11.0	AGR	EL	
		7.02156.35.0	AGR-K	EL	ohne Sensor without sensor 01.2013→ mit AGR-Ventil with EGR valve
		7.03647.10.0	AGR-K	EL	
		7.02156.33.0	AGR-K		ohne Sensor without sensor mit Sensor with sensor →11.2012 ohne AGR-Ventil without EGR valve
		7.02156.34.0	AGR-K		ohne Sensor without sensor 01.2013→ ohne AGR-Ventil without EGR valve
		7.02604.99.0	LS	400 mm	





























PARTNER Box Body/MPV (5_, G_) **96**

1.1 44 kW (60 PS) HDZ (TU1M)	06.1996→09.2005	 7.05270.39.0	LS	400 mm	Euro 2 Euro 2
1.4 49-55 kW (67-75 PS) KFX (TU3JP)	06.1996→12.2015	 7.05270.36.0	LS	540 mm	Euro3/Euro4, Technische Schadstoffverringerng K Euro3/Euro4, Technical pollution reduction K
		7.05270.39.0	LS	400 mm	
1.4 51-60 kW (70-82 PS) KFW (TU3A), TU32	06.1996→12.2015	 7.05270.39.0	LS	400 mm	
1.4 BiFuel 47-60 kW (64-82 PS) KFW (TU3JP)	04.2003→10.2006	 7.05270.36.0	LS	540 mm	Euro3/Euro4, Technische Schadstoffverringerng K Euro3/Euro4, Technical pollution reduction K
1.6 HDi 92 66-69 kW (90-94 PS) 9HP (DV6DTEd)	11.2009→12.2010	 7.11492.01.0	DDS		ohne Zubehör without accessories Organisationsnummer ab: 11211FL, 11211FV RPO number from: 11211FL, 11211FV
		 7.03647.10.0	AGR-K	EL	
1.6 HDi 92 68 kW (92 PS) 9HJ (DV6DTEdM)	11.2009→12.2010	 7.02209.11.0	AGR	EL	
1.6 HDi 75 55 kW (75 PS) 9HK (DV6ETEDM)	08.2005→07.2008	 7.03647.10.0	AGR-K	EL	
		 7.24809.39.0	AGR	EL	
1.6 HDi 90 66-68 kW (90-92 PS) 9HX (DV6ATED4)	08.2005→12.2015	 7.22843.06.0	AGR	PN	
2.0 HDi 66 kW (90 PS) RHY (DW10TD)	04.2000→07.2008	7.09730.01.0	AGR-K		
		 7.22843.06.0	AGR	PN	
2.0 HDi 4x4 66 kW (90 PS) RHY (DW10TD)	04.2004→08.2005	7.09730.01.0	AGR-K		
		 7.09730.01.0	AGR-K		



































						
PARTNER Box Body/MPV (K9)						97
1.5 BlueHDI 130 96 kW (131 PS) YHZ (DV5RC)	09.2018→		7.07794.23.0	AGR	EL	mit Dichtring with O-ring
1.5 BlueHdi 100 75 kW (102 PS) YHY (DV5RD)	07.2019→		7.07794.23.0	AGR	EL	mit Dichtring with O-ring
1.6 HDi 92 66-69 kW (90-94 PS) 9HP (DV6DTED)	09.2018→		7.02156.35.0	AGR-K	EL	ohne Sensor without sensor mit AGR-Ventil with EGR valve
			7.02156.34.0	AGR-K		ohne Sensor without sensor ohne AGR-Ventil without EGR valve
PARTNER ORIGIN Box Body/MPV (G_)						98
1.4 47-60 kW (64-82 PS) KFW (TU3JP)	08.2008→12.2015		7.05270.36.0	LS	540 mm	Euro3/Euro4, Technische Schadstoffverringernung K Euro3/Euro4, Technical pollution reduction K
PARTNER Platform/Chassis						99
1.6 HDi 55 kW (75 PS) 9HT (DV6BTED4)	01.2009→		7.24809.39.0	AGR	EL	
1.6 HDi 66-69 kW (90-94 PS) 9HF (DV6DTED)	03.2013→		7.02209.11.0	AGR	EL	
			7.02156.35.0	AGR-K	EL	ohne Sensor without sensor mit AGR-Ventil with EGR valve
			7.02156.34.0	AGR-K		ohne Sensor without sensor ohne AGR-Ventil without EGR valve
1.6 HDi 16V 66-68 kW (90-92 PS) 9HX (DV6ATED4)	01.2009→		7.11492.01.0	DDS		ohne Zubehör without accessories Organisationsnummer ab: 11211FL, 11211FV RPO number from: 11211FL, 11211FV
			7.11492.01.0	DDS		ohne Zubehör without accessories Organisationsnummer ab: 11211FL, 11211FV RPO number from: 11211FL, 11211FV
1.6 HDi 16V 66-68 kW (90-92 PS) 9HS (DV6TED4BU)	01.2009→		7.11492.01.0	DDS		ohne Zubehör without accessories Organisationsnummer ab: 11211FL, 11211FV RPO number from: 11211FL, 11211FV
1.6 HDi 16V 66-68 kW (90-92 PS) 9HX (DV6ATED4)	01.2009→		7.24809.39.0	AGR	EL	 Euro 4 (D4) Euro 4 (D4)
TRAVELLER Bus (V_)						100
1.6 BlueHdi 115 85 kW (116 PS) BHX (DV6FCU)	04.2016→		7.02209.11.0	AGR	EL	
2.0 BlueHdi 150 110 kW (150 PS) AHX (DW10FD)	04.2016→		7.11492.01.0	DDS		ohne Zubehör without accessories für OE-Nummer: 1618 Z9 for OE number: 1618 Z9
			7.11492.01.0	DDS		ohne Zubehör without accessories für OE-Nummer: 1618 Z9 for OE number: 1618 Z9
2.0 BlueHdi 180 130 kW (178 PS) AHH (DW10FC)	04.2016→		7.11492.01.0	DDS		ohne Zubehör without accessories für OE-Nummer: 1618 Z9 for OE number: 1618 Z9















			 PIERBURG			
911						1
3.2 160 kW (218 PS) 930.25	08.1986→08.1989		7.02604.03.0	LS	200 mm	
3.2 SC Carrera 170 kW (231 PS) 930.20, 930.26	08.1983→08.1989		7.02604.03.0	LS	200 mm	
3.2 SC Carrera 152 kW (207 PS) 930.21	02.1984→06.1987		7.02604.03.0	LS	200 mm	
911 (964)						2
3.3 Turbo 235 kW (320 PS) M 30.69	08.1990→09.1993		7.02604.03.0	LS	200 mm	
3.6 Carrera 4 184 kW (250 PS) M 64.01	12.1988→09.1993		7.02604.03.0	LS	200 mm	
3.6 Carrera RS 191 kW (260 PS) M 64.03	06.1991→09.1993		7.02604.03.0	LS	200 mm	
3.6 Turbo 265 kW (360 PS) M 64.50	01.1993→09.1993		7.02604.03.0	LS	200 mm	
911 (991)						3
3.8 GT2 RS 515 kW (700 PS) MDH.NA	07.2017→		7.00018.52.0	SLV	PN	
3.8 GT3 350-354 kW (475-481 PS) MA1.75	08.2013→		7.22938.06.0	ARV	PN	
3.8 Turbo 368-395 kW (500-537 PS) MA1.70	02.2013→		7.00018.52.0	SLV	PN	
3.8 Turbo 397 kW (540 PS) MDA.BA	01.2016→		7.00018.52.0	SLV	PN	
3.8 Turbo S 427-446 kW (580-607 PS) MDB.CA	01.2016→		7.00018.52.0	SLV	PN	
3.8 Turbo S 427-446 kW (580-607 PS) MDB.CA	08.2017→		7.00018.52.0	SLV	PN	
4.0 GT3 368 kW (500 PS) MDG.GA	05.2017→		7.22938.06.0	ARV	PN	
4.0 GT3 RS 383 kW (520 PS) MDG.GB	05.2018→		7.22938.06.0	ARV	PN	
4.0 GT3 RS / R 368-373 kW (500-507 PS) MA1.76, MDG.GA	04.2015→		7.22938.06.0	ARV	PN	
911 (996)						4
3.4 Carrera 221 kW (301 PS) M 96.01, M 96.04	09.1997→09.2001		7.22938.06.0	ARV	PN	
3.4 Carrera 221-235 kW (301-320 PS) M 96.02	05.2001→08.2005		7.22938.06.0	ARV	PN	
3.4 Carrera 4 221 kW (301 PS) M 96.01, M 96.04	09.1997→09.2001		7.22938.06.0	ARV	PN	
3.4 Carrera 4 221-235 kW (301-320 PS) M 96.02	05.2001→08.2005		7.22938.06.0	ARV	PN	
3.6 Carrera 235-254 kW (320-345 PS) M 96.03	10.2001→08.2005		7.22938.06.0	ARV	PN	
3.6 Carrera 4 235-254 kW (320-345 PS) M 96.03	10.2001→08.2005		7.22938.06.0	ARV	PN	
3.6 Carrera 4S 235-254 kW (320-345 PS) M 96.03	02.2003→08.2005		7.22938.06.0	ARV	PN	







P



























						
911 (996)						4
3.6 Carrera S 235-254 kW (320-345 PS) M 96.03	02.2003→08.2005		7.22938.06.0	ARV	PN 	
3.6 GT3 280-283 kW (381-385 PS) M 96.79	03.2003→08.2005		7.22938.06.0	ARV	PN 	
911 (997)						5
3.6 Carrera 235-242 kW (320-329 PS) M 96.05	07.2004→12.2008		7.02604.07.0	LS	570 mm vor Katalysator, beidseitig in front of the catalyst, Left and right 2006	
			7.00018.50.0	SLV	PN	
3.6 Carrera 235-242 kW (320-329 PS) M 96.05	08.2004→07.2005		7.00018.50.0	SLV	PN	
3.6 Carrera 4 235-242 kW (320-329 PS) M 96.05	07.2004→12.2008		7.02604.07.0	LS	570 mm vor Katalysator, beidseitig in front of the catalyst, Left and right 2006	
			7.00018.50.0	SLV	PN	
3.6 Carrera 4 235-242 kW (320-329 PS) M 96.05	09.2005→12.2008		7.02604.07.0	LS	570 mm vor Katalysator, beidseitig in front of the catalyst, Left and right 2006	
			7.00018.50.0	SLV	PN	
3.6 GT 2 390 kW (530 PS) M 97.70S	09.2007→12.2012		7.00018.52.0	SLV	PN	
3.6 GT2 RS 353-462 kW (480-628 PS) M 97.70	05.2010→12.2012		7.00018.52.0	SLV	PN	
3.6 GT3 305 kW (415 PS) M 97.76	03.2006→12.2009		7.05271.68.0	LS	750 mm	
			7.00018.51.0	SLV	PN	
3.6 Turbo 353-462 kW (480-628 PS) M 97.70	03.2006→12.2009		7.00018.52.0	SLV	PN	
3.8 Carrera 4S 261-264 kW (355-359 PS) M 97.01	07.2004→12.2008		7.02604.07.0	LS	570 mm vor Katalysator, beidseitig in front of the catalyst, Left and right 2006	
			7.00018.50.0	SLV	PN	
3.8 Carrera 4S 280 kW (381 PS) M 97.01S	08.2005→12.2008		7.00018.50.0	SLV	PN	
3.8 Carrera 4S 261-264 kW (355-359 PS) M 97.01	09.2005→12.2008		7.02604.07.0	LS	570 mm vor Katalysator, beidseitig in front of the catalyst, Left and right 2006	
			7.00018.50.0	SLV	PN	
3.8 Carrera S 261-264 kW (355-359 PS) M 97.01	07.2004→12.2008		7.02604.07.0	LS	570 mm vor Katalysator, beidseitig in front of the catalyst, Left and right 2006	
			7.00018.50.0	SLV	PN	
3.8 Carrera S 280 kW (381 PS) M 97.01S	08.2005→12.2008		7.00018.50.0	SLV	PN	
3.8 GT3 320 kW (435 PS) M 97.77	05.2009→12.2011		7.22938.06.0	ARV	PN 	
3.8 GT3 RS 331 kW (450 PS) M 97.77R	08.2009→12.2011		7.22938.06.0	ARV	PN 	
3.8 Turbo 368-395 kW (500-537 PS) MA1.70	09.2009→12.2012		7.00018.52.0	SLV	PN	

P

			 PIERBURG			
911 (997)						5
3.8 Turbo 368-395 kW (500-537 PS) MA1.70	09.2010→12.2011		7.00018.52.0	SLV	PN	
3.8 Turbo S 368-395 kW (500-537 PS) MA1.70	02.2010→12.2012		7.00018.52.0	SLV	PN	
3.8 Turbo S 368-395 kW (500-537 PS) MA1.70	09.2010→12.2011		7.00018.52.0	SLV	PN	
4.0 GT3 RS 368 kW (500 PS) M 97.74	07.2011→12.2012		7.22938.06.0	ARV	PN	
911 Convertible						6
3.2 Carrera Speedster 160 kW (218 PS) 930.25	08.1986→08.1989		7.02604.03.0	LS	200 mm	
3.2 Carrera Speedster 170 kW (231 PS) 930.20	08.1986→08.1989		7.02604.03.0	LS	200 mm	
3.2 SC Carrera 170 kW (231 PS) 930.20	08.1983→08.1984		7.02604.03.0	LS	200 mm	
3.2 SC Carrera 152 kW (207 PS) 930.21	10.1984→08.1989		7.02604.03.0	LS	200 mm	
911 Convertible (964)						7
3.6 Carrera 4 184 kW (250 PS) M 64.01	05.1989→05.1994		7.02604.03.0	LS	200 mm	
911 Convertible (991)						8
3.8 Turbo 397 kW (540 PS) MDA.BA	01.2016→		7.00018.52.0	SLV	PN	
3.8 Turbo S 427-446 kW (580-607 PS) MDB.CA	01.2016→		7.00018.52.0	SLV	PN	
911 Convertible (996)						9
3.4 Carrera 221 kW (301 PS) M 96.01, M 96.04	02.1998→09.2001		7.22938.06.0	ARV	PN	
3.4 Carrera 221-235 kW (301-320 PS) M 96.02	05.2001→08.2005		7.22938.06.0	ARV	PN	
3.4 Carrera 4 221-235 kW (301-320 PS) M 96.02, M 96.04	02.1998→09.2001		7.22938.06.0	ARV	PN	  M 96.02, M 96.04: Baujahr ab: 01.2000 Construction year from: 01.2000
3.4 Carrera 4 221-235 kW (301-320 PS) M 96.02	05.2001→08.2005		7.22938.06.0	ARV	PN	
3.6 Carrera 235-254 kW (320-345 PS) M 96.03	10.2001→08.2005		7.22938.06.0	ARV	PN	
3.6 Carrera 4 235-254 kW (320-345 PS) M 96.03	10.2001→08.2005		7.22938.06.0	ARV	PN	
3.6 Carrera 4S 235-254 kW (320-345 PS) M 96.03	06.2002→08.2005		7.22938.06.0	ARV	PN	
3.6 Carrera S 235-254 kW (320-345 PS) M 96.03	06.2002→08.2005		7.22938.06.0	ARV	PN	

















						
911 Convertible (997)						10
3.6 Carrera 235-242 kW (320-329 PS) M 96.05	04.2005→12.2008		7.02604.07.0	LS	570 mm	vor Katalysator, beidseitig in front of the catalyst, Left and right 2006 2006
			7.00018.50.0	SLV	PN	
3.6 Carrera 235-242 kW (320-329 PS) M 96.05	04.2005→07.2005		7.00018.50.0	SLV	PN	
3.6 Carrera 4 235-242 kW (320-329 PS) M 96.05	04.2005→12.2008		7.02604.07.0	LS	570 mm	vor Katalysator, beidseitig in front of the catalyst, Left and right 2006 2006
			7.00018.50.0	SLV	PN	
3.6 Turbo 353-462 kW (480-628 PS) M 97.70	09.2007→12.2009		7.00018.52.0	SLV	PN	
3.8 Carrera 4S 261-264 kW (355-359 PS) M 97.01	04.2005→12.2008		7.02604.07.0	LS	570 mm	vor Katalysator, beidseitig in front of the catalyst, Left and right 2006 2006
			7.00018.50.0	SLV	PN	
3.8 Carrera 4S 261-264 kW (355-359 PS) M 97.01	04.2005→12.2010		7.02604.07.0	LS	570 mm	vor Katalysator, beidseitig in front of the catalyst, Left and right 2006 2006
			7.00018.50.0	SLV	PN	
3.8 Carrera 4S 280 kW (381 PS) M 97.01S	08.2005→12.2008		7.00018.50.0	SLV	PN	
3.8 Carrera S 261-264 kW (355-359 PS) M 97.01	04.2005→12.2008		7.02604.07.0	LS	570 mm	vor Katalysator, beidseitig in front of the catalyst, Left and right 2006 2006
			7.00018.50.0	SLV	PN	
3.8 Carrera S 280 kW (381 PS) M 97.01S	08.2005→12.2008		7.00018.50.0	SLV	PN	
3.8 Turbo 368-395 kW (500-537 PS) MA1.70	09.2009→12.2012		7.00018.52.0	SLV	PN	
3.8 Turbo S 368-395 kW (500-537 PS) MA1.70	02.2010→12.2012		7.00018.52.0	SLV	PN	
3.8 Turbo S 368-395 kW (500-537 PS) MA1.70	09.2010→12.2011		7.00018.52.0	SLV	PN	
911 Targa (996)						11
3.6 235-254 kW (320-345 PS) M 96.03	12.2001→08.2005		7.22938.06.0	ARV	PN	
911 Targa (997)						12
3.6 Carrera 4 235-242 kW (320-329 PS) M 96.05	07.2006→12.2008		7.02604.07.0	LS	570 mm	vor Katalysator, beidseitig in front of the catalyst, Left and right 2006 2006
			7.00018.50.0	SLV	PN	
3.8 Carrera 4S 261-264 kW (355-359 PS) M 97.01	07.2006→12.2008		7.02604.07.0	LS	570 mm	vor Katalysator, beidseitig in front of the catalyst, Left and right
			7.00018.50.0	SLV	PN	
3.8 Carrera 4S 280 kW (381 PS) M 97.01S	11.2006→12.2008		7.00018.50.0	SLV	PN	

			 PIERBURG			
924						13
2.5 S 110 kW (150 PS) M 44.07, M 44.08	09.1985→07.1987		7.02604.03.0	LS	200 mm	
2.5 S 118 kW (160 PS) M 44.09, M 44.10	08.1987→07.1988		7.02604.03.0	LS	200 mm	
928						14
5.0 S,S4 221-235 kW (300-320 PS) M 28.41, M 28.42	08.1986→07.1991		7.02604.03.0	LS	200 mm	
5.0 S4 Cat 221-235 kW (300-320 PS) M 28.41, M 28.42	08.1986→07.1991		7.02604.03.0	LS	200 mm	
5.4 GTS 250-257 kW (340-350 PS) M 28.49, M 28.50	08.1991→11.1995		7.02604.03.0	LS	200 mm	
944						15
2.5 S 135-140 kW (184-190 PS) M 44.40	08.1986→07.1988		7.02604.03.0	LS	200 mm	
2.5 Turbo 162 kW (220 PS) M 44.50, M 44.51	08.1985→07.1988		7.02604.03.0	LS	200 mm	
2.5 Turbo 184 kW (250 PS) M 44.52	09.1987→07.1991		7.02604.03.0	LS	200 mm	
2.7 121 kW (165 PS) M 44.11, M 44.12	11.1988→08.1989		7.02604.03.0	LS	200 mm	
3.0 S2 155 kW (211 PS) M 44.41	12.1988→07.1991		7.02604.03.0	LS	200 mm	
944 Convertible						16
3.0 S2 155 kW (211 PS) M 44.41	12.1988→07.1991		7.02604.03.0	LS	200 mm	
968						17
3.0 176 kW (239 PS) M 44.43, M 44.44	06.1991→11.1995		7.02604.03.0	LS	200 mm	
968 Convertible						18
3.0 176 kW (239 PS) M 44.43, M 44.44	06.1991→11.1995		7.02604.03.0	LS	200 mm	
BOXSTER (986)						19
2.7 155-162 kW (218-220 PS) M 96.22	08.1999→07.2002		7.22938.06.0	ARV	PN 	
2.7 168 kW (228 PS) M 96.23	07.2002→12.2004		7.22938.06.0	ARV	PN 	
S 3.2 185 kW (252 PS) M 96.21	08.1999→07.2002		7.22938.06.0	ARV	PN 	
S 3.2 191-196 kW (260-267 PS) M 96.24	07.2002→12.2004		7.22938.06.0	ARV	PN 	
S 3.2 191-196 kW (260-267 PS) M 96.24	01.2004→12.2004		7.22938.06.0	ARV	PN 	
BOXSTER (987)						20
2.7 155-176 kW (211-239 PS) M 96.25	11.2004→12.2005		7.00018.50.0	SLV	PN	
2.7 155-176 kW (211-239 PS) M 96.25	11.2004→12.2006		7.05271.68.0	LS	750 mm	
			7.00018.50.0	SLV	PN	
2.7 179-180 kW (143-245 PS) M 97.20	07.2006→12.2009		7.05271.68.0	LS	750 mm	
			7.00018.50.0	SLV	PN	
2.9 155-195 kW (211-265 PS) MA1.20	02.2009→03.2012		7.00018.50.0	SLV	PN	

					
BOXSTER (987)					20
2.9 155-195 kW (211-265 PS) MA1.20	06.2009→03.2012		7.00018.50.0	SLV	PN
S 3.2 191-206 kW (260-280 PS) M 96.26	11.2004→12.2006		7.05271.68.0	LS	750 mm
			7.00018.50.0	SLV	PN
S 3.4 217 kW (295 PS) M 97.21	07.2006→12.2009		7.05271.68.0	LS	750 mm
			7.00018.50.0	SLV	PN
S 3.4 223 kW (303 PS) M 97.22	08.2008→12.2009		7.00018.50.0	SLV	PN
BOXSTER Spyder (987)					21
3.4 RS 60 223 kW (303 PS) M 97.22	09.2007→12.2008		7.00018.50.0	SLV	PN
CARRERA GT (980)					22
5.7 450 kW (612 PS) M 80.01	07.2003→12.2006		7.22938.06.0	ARV	PN 
CAYENNE (92A)					23
3.0 Diesel 176 kW (239 PS) M 05.9E	06.2010→		7.02132.07.0	AGR	EL 
			7.01106.38.0	AGR-K	EL
			7.08369.45.0	ATS	EL nach AGR-Kühler after EGR cooler
			7.11190.02.0	DDS	Euro 5 Euro 5
3.0 Diesel 176-245 kW (239-333 PS) MCN.RB	06.2010→		7.08369.73.0	ATS	EL Abgasturbolader Exhaust Turbocharger 2014 2014
			7.11190.02.0	DDS	Euro 5 Euro 5
3.0 Diesel 155 kW (211 PS) MCR.CB	06.2010→		7.08369.73.0	ATS	EL Abgasturbolader Exhaust Turbocharger 2014 2014
			7.11190.02.0	DDS	Euro 5 Euro 5
3.0 Diesel 155 kW (211 PS) MCV.VC	06.2010→		7.08369.73.0	ATS	EL Abgasturbolader Exhaust Turbocharger 2014 2014
			7.11492.03.0	DDS	ohne Zubehör without accessories
3.0 Diesel 180 kW (245 PS) MCR.C	06.2011→		7.11190.02.0	DDS	Euro 5 Euro 5
3.0 Diesel 180 kW (245 PS) MCR.CA	06.2011→		7.08369.73.0	ATS	EL Abgasturbolader Exhaust Turbocharger
			7.11190.02.0	DDS	Euro 5 Euro 5
3.0 Diesel 184 kW (250 PS) MCV.VB	08.2014→		7.11492.03.0	DDS	ohne Zubehör without accessories
3.0 Diesel 193 kW (262 PS) MCV.VA	10.2014→		7.11492.03.0	DDS	ohne Zubehör without accessories
3.0 S 245 kW (333 PS) M 06.EC, MCJ.T	04.2011→		7.22286.52.0	ARV	PN   M 06.EC, MCJ.T: rechts Right
			7.22286.53.0	ARV	PN   M 06.EC, MCJ.T: links Left





CAYENNE (92A) **23**

3.0 S E-Hybrid 245-248 kW (333-337 PS) M 06.EC, MCG.E, MCG.EA, MCG.FA	06.2010→	 7.22286.52.0	ARV	PN	 M 06.EC, MCG.E, MCG.EA, MCG.FA: rechts Right
		 7.22286.53.0	ARV	PN	 M 06.EC, MCG.E, MCG.EA, MCG.FA: links Left
3.0 S E-Hybrid 245-248 kW (333-337 PS) M 06.EC, MCG.E, MCG.EA, MCG.FA	10.2014→	 7.22286.52.0	ARV	PN	 M 06.EC, MCG.E, MCG.EA, MCG.FA: rechts Right
		 7.22286.53.0	ARV	PN	 M 06.EC, MCG.E, MCG.EA, MCG.FA: links Left
3.6 GTS 324-328 kW (440-446 PS) MCX.ZA	02.2015→	 7.00018.50.0	SLV	PN	
3.6 S 309-313 kW (420-426 PS) MCU.RA	10.2014→	 7.00018.50.0	SLV	PN	
4.2 S Diesel 281 kW (382 PS) MCU.DB	10.2012→	 7.00789.10.0	AGR	EL	
4.2 S Diesel 283 kW (385 PS) MCU.DC	10.2014→	 7.00789.10.0	AGR	EL	
4.8 GTS 294-309 kW (400-420 PS) M 48.02	06.2012→	 7.00018.55.0	SLV	PN	mit Dichtring with O-ring rechts Right für PR-Nummer: 7MG, 7MJ, 7MM for PR number: 7MG, 7MJ, 7MM
		 7.00018.56.0	SLV	PN	mit Dichtring with O-ring links Left für PR-Nummer: 7MG, 7MJ, 7MM for PR number: 7MG, 7MJ, 7MM
4.8 S 294-309 kW (400-420 PS) M 48.02	06.2010→	 7.00018.55.0	SLV	PN	mit Dichtring with O-ring rechts Right für PR-Nummer: 7MG, 7MJ, 7MM for PR number: 7MG, 7MJ, 7MM
		 7.00018.56.0	SLV	PN	mit Dichtring with O-ring links Left für PR-Nummer: 7MG, 7MJ, 7MM for PR number: 7MG, 7MJ, 7MM
4.8 Turbo 368-410 kW (500-550 PS) M 48.52	06.2010→	 7.00018.55.0	SLV	PN	mit Dichtring with O-ring rechts Right für PR-Nummer: 7MG, 7MJ, 7MM for PR number: 7MG, 7MJ, 7MM
		 7.00018.56.0	SLV	PN	mit Dichtring with O-ring links Left für PR-Nummer: 7MG, 7MJ, 7MM for PR number: 7MG, 7MJ, 7MM
4.8 Turbo 368-410 kW (500-550 PS) M 48.52	06.2010→	 7.00018.55.0	SLV	PN	mit Dichtring with O-ring rechts Right für PR-Nummer: 7MG, 7MJ, 7MM for PR number: 7MG, 7MJ, 7MM

P











CAYENNE (92A) 23

			7.00018.56.0	SLV	PN	mit Dichtring with O-ring links Left für PR-Nummer: 7MG, 7MJ, 7MM for PR number: 7MG, 7MJ, 7MM
4.8 Turbo 382 kW (520 PS) MCF.TB	10.2014→		7.00018.55.0	SLV	PN	mit Dichtring with O-ring rechts Right für PR-Nummer: 7MG, 7MJ, 7MM for PR number: 7MG, 7MJ, 7MM
			7.00018.56.0	SLV	PN	mit Dichtring with O-ring links Left für PR-Nummer: 7MG, 7MJ, 7MM for PR number: 7MG, 7MJ, 7MM
4.8 Turbo S 368-410 kW (500-550 PS) M 48.52	10.2012→		7.00018.55.0	SLV	PN	mit Dichtring with O-ring rechts Right für PR-Nummer: 7MG, 7MJ, 7MM for PR number: 7MG, 7MJ, 7MM
			7.00018.56.0	SLV	PN	mit Dichtring with O-ring links Left für PR-Nummer: 7MG, 7MJ, 7MM for PR number: 7MG, 7MJ, 7MM
4.8 Turbo S 419 kW (570 PS) MCY.XA	01.2015→		7.00018.55.0	SLV	PN	mit Dichtring with O-ring rechts Right für PR-Nummer: 7MG, 7MJ, 7MM for PR number: 7MG, 7MJ, 7MM
			7.00018.56.0	SLV	PN	mit Dichtring with O-ring links Left für PR-Nummer: 7MG, 7MJ, 7MM for PR number: 7MG, 7MJ, 7MM

P

CAYENNE (9PA) 24

3.0 TDI 176 kW (239 PS) M 05.9D	02.2009→09.2010		7.01782.07.0	AGR	EL	
3.2 177-184 kW (241-250 PS) M02.2Y	08.2003→09.2007		7.22738.08.0	SLP	EL	
3.2 177-184 kW (241-250 PS) M02.2Y	10.2003→09.2007		7.22738.08.0	SLP	EL	
S 4.5 250 kW (340 PS) M 48.00	09.2002→09.2007		7.00018.51.0	SLV	PN	
Turbo 4.5 331 kW (450 PS) M 48.50	09.2002→09.2007		7.05271.77.0	LS	800 mm	vor Katalysator, beidseitig in front of the catalyst, Left and right 2006
			7.00018.50.0	SLV	PN	
Turbo S 4.5 368 kW (500 PS) M 48.50S	01.2004→09.2007		7.00018.50.0	SLV	PN	
Turbo S 4.5 383 kW (521 PS) M 48.50T	03.2006→09.2007		7.00018.50.0	SLV	PN	

CAYMAN (987) 25





2.7 179-180 kW (143-245 PS) M 97.20	07.2006→12.2009		7.05271.68.0	LS	750 mm	
			7.00018.50.0	SLV	PN	

















CAYMAN (987) **25**

2.9 155-195 kW (211-265 PS) MA1.20	02.2009→12.2012		7.00018.50.0	SLV	PN	
2.9 155-195 kW (211-265 PS) MA1.20	02.2009→06.2013		7.00018.50.0	SLV	PN	
S 3,4 Sport 223 kW (303 PS) M 97.22	08.2008→12.2012		7.00018.50.0	SLV	PN	
S 3.4 217 kW (295 PS) M 97.21	11.2005→12.2009		7.05271.68.0	LS	750 mm	
			7.00018.50.0	SLV	PN	

MACAN (95B) **26**

3.0 GTS 265 kW (360 PS) MDC.NA	10.2015→09.2018		7.00018.52.0	SLV	PN	
3.0 S 250 kW (340 PS) MCT.MA	02.2014→09.2018		7.00018.52.0	SLV	PN	
3.0 S Diesel 180 kW (245 PS) MCD.UD	02.2014→09.2018		7.08369.73.0	ATS	EL	Abgasturbolader Exhaust Turbocharger
			7.11020.25.0	ATS	EL	vor Katalysator in front of the catalyst für PR-Nummer: 7HI for PR number: 7HI
			7.11190.02.0	DDS		für PR-Nummer: 7HI for PR number: 7HI
3.6 Turbo 294 kW (400 PS) MCT.LA	02.2014→09.2018		7.00018.52.0	SLV	PN	
3.6 Turbo 324 kW (441 PS) MDH.KA	09.2016→		7.00018.52.0	SLV	PN	

PANAMERA (970) **27**

3.0 4S 309 kW (420 PS) MCW.DA	07.2013→10.2016		7.00018.50.0	SLV	PN	
3.0 4S 235 kW (320 PS) MCW.F, MCW.FA	10.2013→10.2016		7.00018.50.0	SLV	PN	
3.0 D 184 kW (250 PS) MCR.CC	08.2011→07.2013		7.08369.73.0	ATS	EL	Abgasturbolader Exhaust Turbocharger
			7.11190.02.0	DDS		für PR-Nummer: 165 for PR number: 165
3.0 D 155 kW (211 PS) MCR.CB	08.2011→07.2013		7.08369.73.0	ATS	EL	Abgasturbolader Exhaust Turbocharger
			7.11190.02.0	DDS		für PR-Nummer: 165 for PR number: 165
3.0 D 221 kW (300 PS) MCW.JA	07.2013→10.2016		7.11190.02.0	DDS		für PR-Nummer: 165 for PR number: 165
3.0 S 309 kW (420 PS) MCW.DA	07.2013→10.2016		7.00018.50.0	SLV	PN	
3.0 S 235 kW (320 PS) MCW.F, MCW.FA	10.2013→10.2016		7.00018.50.0	SLV	PN	
3.0 S E-Hybrid 245-248 kW (333-337 PS) MCG.EA, MCG.FA	03.2011→07.2013		7.22286.52.0	ARV	PN	 MCG.EA, MCG.FA: rechts Right
			7.22286.53.0	ARV	PN	 MCG.EA, MCG.FA: links Left
3.0 S E-Hybrid 245-248 kW (333-337 PS) MCG.EA, MCG.FA	03.2011→07.2013		7.22286.52.0	ARV	PN	 MCG.EA, MCG.FA: rechts Right
			7.22286.53.0	ARV	PN	 MCG.EA, MCG.FA: links Left
3.0 S E-Hybrid 245-248 kW (333-337 PS) MCG.FA	01.2012→10.2016		7.22286.52.0	ARV	PN	 rechts Right

P



PANAMERA (970) **27**

		7.22286.53.0	ARV	PN	 links Left
3.0 S E-Hybrid 245-248 kW (333-337 PS) MCG.EA, MCG.FA	07.2013→10.2016	 7.22286.52.0	ARV	PN	  MCG.EA, MCG.FA: rechts Right
		7.22286.53.0	ARV	PN	  MCG.EA, MCG.FA: links Left
4.8 4S 294-328 kW (400-446 PS) M 48.40	09.2009→07.2013	 7.00018.55.0	SLV	PN	mit Dichtring with O-ring rechts Right für PR-Nummer: 165, 7MM for PR number: 165, 7MM
		7.00018.56.0	SLV	PN	mit Dichtring with O-ring links Left für PR-Nummer: 165, 7MM for PR number: 165, 7MM
4.8 GTS 294-328 kW (400-446 PS) M 48.40	01.2012→12.2015	 7.00018.55.0	SLV	PN	mit Dichtring with O-ring rechts Right für PR-Nummer: 165, 7MM for PR number: 165, 7MM
		7.00018.56.0	SLV	PN	mit Dichtring with O-ring links Left für PR-Nummer: 165, 7MM for PR number: 165, 7MM
4.8 GTS 324 kW (440 PS) MCX.PA, MCX.RA	07.2013→10.2016	 7.00018.55.0	SLV	PN	mit Dichtring with O-ring  MCX.PA, MCX.RA: rechts Right für PR-Nummer: 165, 7MM for PR number: 165, 7MM
		7.00018.56.0	SLV	PN	mit Dichtring with O-ring  MCX.PA, MCX.RA: links Left für PR-Nummer: 165, 7MM for PR number: 165, 7MM
4.8 S 294-302 kW (400-411 PS) M 48.20	09.2009→07.2013	 7.00018.55.0	SLV	PN	mit Dichtring with O-ring rechts Right für PR-Nummer: 165, 7MM for PR number: 165, 7MM
		7.00018.56.0	SLV	PN	mit Dichtring with O-ring links Left für PR-Nummer: 165, 7MM for PR number: 165, 7MM
4.8 Turbo 382 kW (520 PS) MCW.BA	07.2013→10.2016	 7.00018.55.0	SLV	PN	mit Dichtring with O-ring rechts Right für PR-Nummer: 165, 7MM for PR number: 165, 7MM



























































PANAMERA (970)

27

























		7.00018.56.0	SLV	PN	mit Dichtring with O-ring links Left für PR-Nummer: 165, 7MM for PR number: 165, 7MM
4.8 Turbo S 419 kW (570 PS) MCW.CA	07.2013→10.2016	7.00018.55.0	SLV	PN	mit Dichtring with O-ring rechts Right für PR-Nummer: 165, 7MM for PR number: 165, 7MM
		 7.00018.56.0	SLV	PN	mit Dichtring with O-ring links Left für PR-Nummer: 165, 7MM for PR number: 165, 7MM

						
1500 Crew Cab Pickup (DS)						1
3.0 TD 176-179 kW (239-243 PS) EXF	09.2013→		7.24809.80.0	AGR	ET <input checked="" type="checkbox"/>	
3.0 TD 4WD 176-179 kW (239-243 PS) EXF	09.2013→		7.24809.80.0	AGR	ET <input checked="" type="checkbox"/>	
3.7 151-160 kW (205-218 PS) EKG	09.2010→12.2015		7.00992.36.0	AGR	EL <input type="checkbox"/> mit Befestigungsmaterial with fastening material	
3.7 4WD 151-160 kW (205-218 PS) EKG	09.2010→12.2015		7.00992.36.0	AGR	EL <input type="checkbox"/> mit Befestigungsmaterial with fastening material	
4.7 FLEX 231 kW (314 PS) EVE	09.2010→		7.02769.05.0	AGR	EL <input type="checkbox"/> mit Befestigungsmaterial with fastening material	
4.7 FLEX 4WD 231 kW (314 PS) EVE	09.2010→		7.02769.05.0	AGR	EL <input type="checkbox"/> mit Befestigungsmaterial with fastening material	
1500 Extended Cab Pickup (DS)						2
3.0 TD 176-179 kW (239-243 PS) EXF	09.2013→		7.24809.80.0	AGR	ET <input checked="" type="checkbox"/>	
3.0 TD 4WD 176-179 kW (239-243 PS) EXF	09.2013→		7.24809.80.0	AGR	ET <input checked="" type="checkbox"/>	
3.7 151-160 kW (205-218 PS) EKG	09.2010→12.2012		7.00992.36.0	AGR	EL <input type="checkbox"/> mit Befestigungsmaterial with fastening material	
3.7 4WD 151-160 kW (205-218 PS) EKG	09.2010→12.2013		7.00992.36.0	AGR	EL <input type="checkbox"/> mit Befestigungsmaterial with fastening material	
4.7 FLEX 231 kW (314 PS) EVE	09.2010→		7.02769.05.0	AGR	EL <input type="checkbox"/> mit Befestigungsmaterial with fastening material	
4.7 FLEX 4WD 231 kW (314 PS) EVE	09.2010→		7.02769.05.0	AGR	EL <input type="checkbox"/> mit Befestigungsmaterial with fastening material	
1500 Standard Cab Pickup (DS)						3
3.0 TD 176-179 kW (239-243 PS) EXF	09.2013→		7.24809.80.0	AGR	ET <input checked="" type="checkbox"/>	
3.0 TD 4WD 176-179 kW (239-243 PS) EXF	09.2013→		7.24809.80.0	AGR	ET <input checked="" type="checkbox"/>	
3.7 151-160 kW (205-218 PS) EKG	09.2009→12.2015		7.00992.36.0	AGR	EL <input type="checkbox"/> mit Befestigungsmaterial with fastening material	
3.7 4WD 151-160 kW (205-218 PS) EKG	09.2009→12.2014		7.00992.36.0	AGR	EL <input type="checkbox"/> mit Befestigungsmaterial with fastening material	
4.7 231 kW (314 PS) EVE	09.2009→		7.02769.05.0	AGR	EL <input type="checkbox"/> mit Befestigungsmaterial with fastening material	
4.7 FLEX 231 kW (314 PS) EVE	09.2010→		7.02769.05.0	AGR	EL <input type="checkbox"/> mit Befestigungsmaterial with fastening material	
4.7 FLEX 4WD 231 kW (314 PS) EVE	09.2010→		7.02769.05.0	AGR	EL <input type="checkbox"/> mit Befestigungsmaterial with fastening material	
2500						4
6.4 HEMI 306 kW (416 PS) ESA	12.2019→		7.04739.09.0	AGR	EL <input type="checkbox"/>	
6.4 HEMI 4x4 306 kW (416 PS) ESA	12.2019→		7.04739.09.0	AGR	EL <input type="checkbox"/>	

R

			 PIERBURG			
2500 Crew Cab Pickup (DJ)						5
6.4 306 kW (416 PS) ESA	09.2013→		7.04739.09.0	AGR	EL <input type="checkbox"/>	
6.4 4WD 306 kW (416 PS) ESA	09.2013→		7.04739.09.0	AGR	EL <input type="checkbox"/>	
2500 Extended Crew Cab Pickup (DJ)						6
6.4 306 kW (416 PS) ESA	09.2013→		7.04739.09.0	AGR	EL <input type="checkbox"/>	
6.4 4WD 306 kW (416 PS) ESA	09.2013→		7.04739.09.0	AGR	EL <input type="checkbox"/>	
2500 Standard Cab Pickup (DJ)						7
6.4 306 kW (416 PS) ESA	09.2013→		7.04739.09.0	AGR	EL <input type="checkbox"/>	
6.4 4WD 306 kW (416 PS) ESA	09.2013→		7.04739.09.0	AGR	EL <input type="checkbox"/>	
3500 Crew Cab Pickup (D2)						8
6.4 276 kW (375 PS) ESB	09.2013→		7.04739.09.0	AGR	EL <input type="checkbox"/>	
6.4 306 kW (416 PS) ESA	09.2013→		7.04739.09.0	AGR	EL <input type="checkbox"/>	
6.4 4WD 276 kW (375 PS) ESB	09.2013→		7.04739.09.0	AGR	EL <input type="checkbox"/>	
6.4 4WD 306 kW (416 PS) ESA	09.2013→		7.04739.09.0	AGR	EL <input type="checkbox"/>	
3500 Extended Crew Cab Pickup (D2)						9
6.4 276 kW (375 PS) ESB	09.2013→		7.04739.09.0	AGR	EL <input type="checkbox"/>	
6.4 306 kW (416 PS) ESA	09.2013→		7.04739.09.0	AGR	EL <input type="checkbox"/>	
6.4 4WD 276 kW (375 PS) ESB	09.2013→		7.04739.09.0	AGR	EL <input type="checkbox"/>	
6.4 4WD 306 kW (416 PS) ESA	09.2013→		7.04739.09.0	AGR	EL <input type="checkbox"/>	
3500 Standard Cab Pickup (D2)						10
6.4 276 kW (375 PS) ESB	09.2013→		7.04739.09.0	AGR	EL <input type="checkbox"/>	
6.4 306 kW (416 PS) ESA	09.2013→		7.04739.09.0	AGR	EL <input type="checkbox"/>	
6.4 4WD 276 kW (375 PS) ESB	09.2013→		7.04739.09.0	AGR	EL <input type="checkbox"/>	
6.4 4WD 306 kW (416 PS) ESA	09.2013→		7.04739.09.0	AGR	EL <input type="checkbox"/>	
DAKOTA						11
3.7 151-160 kW (205-218 PS) EKG	09.2010→12.2011		7.00992.36.0	AGR	EL <input type="checkbox"/> mit Befestigungsmaterial with fastening material	
3.7 4WD 151-160 kW (205-218 PS) EKG	09.2010→12.2011		7.00992.36.0	AGR	EL <input type="checkbox"/> mit Befestigungsmaterial with fastening material	
3500 Platform/Chassis (D2)						12
6.4 276 kW (375 PS) ESB	09.2013→		7.04739.09.0	AGR	EL <input type="checkbox"/>	
6.4 306 kW (416 PS) ESA	09.2013→		7.04739.09.0	AGR	EL <input type="checkbox"/>	





























R

						
3500 Platform/Chassis (D2)						12
6.4 4WD 276 kW (375 PS) ESB	09.2013->		7.04739.09.0	AGR	EL 	
6.4 4WD 306 kW (416 PS) ESA	09.2013->		7.04739.09.0	AGR	EL 	
4500 Platform/Chassis (DC)						13
6.4 306 kW (416 PS) ESA	09.2013->		7.04739.09.0	AGR	EL 	
6.4 4WD 306 kW (416 PS) ESA	09.2013->		7.04739.09.0	AGR	EL 	
5500 Cab & Chassis (DC)						14
6.4 306 kW (416 PS) ESA	09.2013->		7.04739.09.0	AGR	EL 	
6.4 4WD 306 kW (416 PS) ESA	09.2013->		7.04739.09.0	AGR	EL 	
PROMASTER 1500 Van (VF1)						15
3.0 D 130 kW (177 PS) EXG	09.2013->		7.11190.03.0	DDS	ohne Zubehör without accessories 2015 2015	
PROMASTER 2500 Cab & Chassis						16
3.0 D 130 kW (177 PS) EXG	08.2016->		7.11190.03.0	DDS	ohne Zubehör without accessories 2015 2015	
PROMASTER 2500 Standard Cargo Van (VF2)						17
3.0 D 130 kW (177 PS) EXG	09.2013->		7.11190.03.0	DDS	ohne Zubehör without accessories 2015 2015	
PROMASTER 3500 Cab & Chassis (VF3)						18
3.0 D 130 kW (177 PS) EXG	09.2013->		7.11190.03.0	DDS	ohne Zubehör without accessories 2015 2015	
PROMASTER 3500 Cutaway Van (VF3)						19
3.0 D 130 kW (177 PS) EXG	09.2013->		7.11190.03.0	DDS	ohne Zubehör without accessories 2015 2015	
PROMASTER 3500 Extended Cargo Van						20
3.0 D 130 kW (177 PS) EXG	08.2016->		7.11190.03.0	DDS	ohne Zubehör without accessories 2015 2015	

R

			 PIERBURG			
11 (B/C37_)						1
1.7 (B/C37D) 64-66 kW (87-90 PS) F2N 742	06.1987→12.1988		7.05270.51.0	LS	375 mm	
1.7 (B/C37E) 69 kW (94 PS) F3N 708	06.1987→12.1988		7.05270.51.0	LS	375 mm	12.1988→
18 (134_)						2
2.1 Diesel 49-53 kW (67-72 PS) J8S 711	11.1981→07.1986		7.02604.01.0	LS	200 mm	
2.1 Diesel (1344) 49-53 kW (67-72 PS) 852 710, J8S 711	11.1981→07.1986		7.02604.01.0	LS	200 mm	
18 Variable (135_)						3
2.1 Diesel 49-53 kW (67-72 PS) J8S 711	05.1979→07.1986		7.02604.01.0	LS	200 mm	
2.1 Diesel (1354) 49-53 kW (67-72 PS) 852 710, J8S 711	11.1981→07.1986		7.02604.01.0	LS	200 mm	
19 I (B/C53_)						4
1.7 (B/C53C) 66-70 kW (90-95 PS) F3N 742	03.1989→04.1992		7.05270.51.0	LS	375 mm	
1.8 16V (B/C53D) 99-101 kW (135-137 PS) F7P 704	06.1991→04.1992		7.05270.51.0	LS	375 mm	
			7.02604.03.0	LS	200 mm	
19 I Cabriolet (D53_)						5
1.7 55-56 kW (75-76 PS) F2N 724	07.1991→04.1992		7.02604.01.0	LS	200 mm	
1.7 66-70 kW (90-95 PS) F3N 742	07.1991→04.1992		7.05270.51.0	LS	375 mm	
1.8 16V (D53D) 99-103 kW (135-140 PS) F7P 700, F7P 704	07.1991→04.1992		7.05270.51.0	LS	375 mm	
			7.02604.03.0	LS	200 mm	
19 I Chamade (L53_)						6
1.7 (L533) 65-69 kW (88-94 PS) F2N 720, F2N 721	09.1988→12.1992		7.02604.01.0	LS	200 mm	
1.7 (L53C) 66-70 kW (90-95 PS) F3N 742	10.1989→04.1992		7.05270.51.0	LS	375 mm	
1.8 16V (L53D) 99-101 kW (135-137 PS) F7P 704	06.1991→04.1992		7.05270.51.0	LS	375 mm	
			7.02604.03.0	LS	200 mm	
19 II (B/C53_)						7
1.4 (B/C535) 55 kW (75 PS) E7J 742	09.1994→12.1995		7.05270.51.0	LS	375 mm	
1.7 (B/C53C) 66 kW (90 PS) F3N 743	04.1992→12.1995		7.05270.51.0	LS	375 mm	05.1992→
1.8 (5/353A) 65-79 kW (88-107 PS) F3P 706	09.1992→12.1995		7.05270.51.0	LS	375 mm	09.1993→
1.8 (5/353F, B/C538) 67-79 kW (91-107 PS) F3P 682, F3P 765	05.1994→12.1995		7.05270.51.0	LS	375 mm	
1.8 (B/C538) 79-83 kW (107-110 PS) F3P 700	04.1992→05.1994		7.05270.51.0	LS	375 mm	

R

						
19 II (B/C53_)						7
1.8 (B/C53Y) 65-79 kW (88-107 PS) F3P 706, F3P 707	04.1992→12.1995		7.05270.51.0	LS	375 mm	09.1993→
1.8 16V (B/C53D) 99-101 kW (135-137 PS) F7P 704	04.1992→12.1995		7.05270.51.0	LS	375 mm	
			7.02604.03.0	LS	200 mm	
19 II Cabriolet (D53_, 853_)						8
1.7 (D53C) 66-70 kW (90-95 PS) F3N 742, F3N 743	04.1992→09.1993		7.05270.51.0	LS	375 mm	05.1992→
1.8 (853A) 65-79 kW (88-107 PS) F3P 706	09.1993→06.1996		7.05270.51.0	LS	375 mm	
1.8 (D53V, 853F, D53C) 67-79 kW (91-107 PS) F3P 682, F3P 765	07.1994→06.1996		7.05270.51.0	LS	375 mm	
1.8 (D53Y) 65-79 kW (88-107 PS) F3P 704, F3P 705, F3P 706, F3P 707	04.1992→06.1996		7.05270.51.0	LS	375 mm	09.1993→
1.8 16V (D53D) 99-101 kW (135-137 PS) F7P 704	04.1992→06.1996		7.05270.51.0	LS	375 mm	
			7.02604.03.0	LS	200 mm	
19 II Chamade (L53_)						9
1.4 43-44 kW (58-60 PS) C3J 710	05.1992→09.1994		7.05270.51.0	LS	375 mm	07.1993→
1.4 (L535) 55 kW (75 PS) E7J 742	09.1994→12.1995		7.05270.51.0	LS	375 mm	
1.7 (L533) 65-69 kW (88-94 PS) F2N 720, F2N 721	01.1993→08.1995		7.02604.01.0	LS	200 mm	
1.7 (L53C) 66-70 kW (90-95 PS) F3N 742, F3N 743	04.1992→12.1995		7.05270.51.0	LS	375 mm	05.1992→
1.8 65-83 kW (88-110 PS) F3P 700, F3P 706	05.1992→11.1995		7.05270.51.0	LS	375 mm	09.1993→
1.8 67-79 kW (91-107 PS) F3P 765	04.1994→09.1994		7.05270.51.0	LS	375 mm	
1.8 (453A/F) 65-79 kW (88-107 PS) F3P 706	09.1992→12.1995		7.05270.51.0	LS	375 mm	09.1993→
1.8 (L538) 79-83 kW (107-110 PS) F3P 700	04.1992→05.1994		7.05270.51.0	LS	375 mm	
1.8 (L53V, L538) 79 kW (107 PS) F3P 682	05.1994→12.1995		7.05270.51.0	LS	375 mm	
1.8 (L53Y) 65-79 kW (88-107 PS) F3P 704, F3P 705, F3P 706, F3P 707	04.1992→12.1995		7.05270.51.0	LS	375 mm	09.1993→
1.8 16V (L53D) 99-101 kW (135-137 PS) F7P 704	04.1992→12.1995		7.05270.51.0	LS	375 mm	
			7.02604.03.0	LS	200 mm	
21 (B48_)						10
1.7 65 kW (88 PS) F2N 711, F2N 754	07.1989→05.1993		7.05270.51.0	LS	375 mm	
1.7 (B48E) 66-70 kW (90-95 PS) F3N 722, F3N 723	09.1989→12.1993		7.05270.51.0	LS	375 mm	 F3N 722, F3N 723: →04.1993
2.0 TXi 99-100 kW (134-136 PS) J7R 740	07.1989→05.1993		7.05270.51.0	LS	375 mm	

					
21 (B48_)					10
2.1 Turbo-D (B486, B488, B48V) 65 kW (88 PS) J8S 714, J8S 786, J8S 788	09.1989→06.1994		7.02604.03.0	LS	200 mm
2.2 (B48K) 79-88 kW (107-110 PS) J7T 754, J7T 755	09.1989→06.1994		7.05270.51.0	LS	375 mm
2.2 4x4 (B48K) 79-88 kW (107-110 PS) J7T 754, J7T 755	07.1990→12.1993		7.05270.51.0	LS	375 mm
21 Estate (K48_)					11
1.7 (K/S481) 55 kW (75 PS) F2N 712	06.1986→12.1987		7.05270.51.0	LS	375 mm
1.7 (K/S482) 65 kW (88 PS) F2N 710	10.1986→12.1988		7.05270.51.0	LS	375 mm
1.7 (K48E) 66-70 kW (90-95 PS) F3N 722, F3N 723	06.1986→12.1989		7.05270.51.0	LS	375 mm
1.7 (K48E) 66-70 kW (90-95 PS) F3N 722, F3N 723	10.1989→12.1993		7.05270.51.0	LS	 F3N 722, F3N 723: →04.1993
1.7 (K48M) 54 kW (73 PS) F2N 750	07.1986→12.1989		7.05270.51.0	LS	375 mm
1.7 (K48N) 64 kW (87 PS) F2N 752	06.1987→04.1989		7.05270.51.0	LS	375 mm
2.1 Turbo-D (K48A, K48W, K487, K488) 65 kW (88 PS) J8S 714, J8S 786, J8S 788	10.1986→11.1993		7.02604.03.0	LS	200 mm
2.2 (K48K) 79-88 kW (107-110 PS) J7T 754, J7T 755	08.1986→11.1993		7.05270.51.0	LS	375 mm
2.2 4x4 (K48K) 79-88 kW (107-110 PS) J7T 754, J7T 755	08.1986→12.1993		7.05270.51.0	LS	375 mm
21 Saloon (L48_)					12
1.7 (L481) 55 kW (75 PS) F2N 712	03.1986→12.1987		7.05270.51.0	LS	375 mm
1.7 (L482) 65 kW (88 PS) F2N 710	06.1986→03.1992		7.05270.51.0	LS	375 mm
1.7 (L48E) 66-70 kW (90-95 PS) F3N 722, F3N 723	06.1986→12.1993		7.05270.51.0	LS	 F3N 722, F3N 723: →04.1993
1.7 (L48E) 66-70 kW (90-95 PS) F3N 722, F3N 723	09.1989→12.1993		7.05270.51.0	LS	 F3N 722, F3N 723: →04.1993
1.7 (L48N) 64 kW (87 PS) F2N 752	06.1987→04.1989		7.05270.51.0	LS	375 mm
2.0 Turbo (L48L) 119 kW (162 PS) J7R 756	02.1990→10.1992		7.05270.51.0	LS	375 mm
2.0 Turbo 4x4 (L48L) 119 kW (162 PS) J7R 756	02.1990→10.1992		7.05270.51.0	LS	375 mm
2.1 Turbo-D (L48A, L48W, L487, L488) 65 kW (88 PS) J8S 714, J8S 786, J8S 788	03.1986→06.1994		7.02604.03.0	LS	200 mm
2.2 (L48K) 79-88 kW (107-110 PS) J7T 754, J7T 755	08.1986→12.1993		7.05270.51.0	LS	375 mm
2.2 4x4 (L48K) 79-88 kW (107-110 PS) J7T 754, J7T 755	07.1990→12.1993		7.05270.51.0	LS	375 mm



R

25 (B29_)					13
2.0 12V (B294) 99-100 kW (135-136 PS) J7R 726	06.1989→12.1992		7.05270.51.0	LS	375 mm
2.5 V6 Turbo (B29G) 151 kW (205 PS) Z7U 700	01.1990→12.1992		7.05270.51.0	LS	375 mm
2.8 V6 (B293) 115 kW (156 PS) Z7W 700	06.1987→02.1990		7.02604.01.0	LS	200 mm
2.8 V6 Injection (B29A) 100 kW (136 PS) Z7W 702	06.1986→02.1988		7.02604.01.0	LS	200 mm
2.8 V6 Injection (B29F) 110-112 kW (150-153 PS) Z7W 706, Z7W 707, Z7W 709	06.1987→12.1992		7.02604.01.0	LS	200 mm
ALASKAN					14
2.3 dCi 163 4x4 (U3MB) 120-140 kW (163-190 PS) M9T 260	09.2017→		7.11457.07.0*	DDS	
			↳7.11492.07.0	DDS	
2.3 dCi 190 4x4 (U3MD) 120-140 kW (163-190 PS) M9T 260	09.2017→		7.11457.07.0*	DDS	
			↳7.11492.07.0	DDS	
AVANTIME (DE0_)					15
2.2 dCi (DE01) 110 kW (150 PS) G9T 712	05.2002→05.2003		7.22818.59.0	AGR	EL Durchmesser Ventilteller/diameter valve head 30 mm
			7.22818.63.0	AGR	EL Durchmesser Ventilteller/diameter valve head 16 mm
CAPTUR I (J5_, H5_)					16
1.5 dCi (J5MW) 60-66 kW (82-90 PS) K9K 830	06.2013→		7.03571.16.0	AK	EL
			↳7.03083.20.0	SRM-AK	EL
1.5 dCi 110 70-81 kW (95-110 PS) K9K 646	01.2015→		7.05320.04.0	AGR	EL
			7.03571.16.0	AK	EL
			↳7.03083.20.0	SRM-AK	EL
			7.11457.07.0*	DDS	
			↳7.11492.07.0	DDS	
1.5 dCi 110 80-81 kW (109-110 PS) K9K 856	01.2015→		7.00368.16.0	AGR	EL
1.5 dCi 90 55-66 kW (75-90 PS) K9K 608, K9K 609	06.2013→		7.03435.05.0	AGR	EL
			7.03571.16.0	AK	EL
			↳7.03083.20.0	SRM-AK	EL
			7.11190.08.0	DDS	
1.5 dCi 90 55-66 kW (75-90 PS) K9K 628, K9K 629	06.2013→		7.05320.04.0	AGR	EL
			7.03571.16.0	AK	EL
			↳7.03083.20.0	SRM-AK	EL
			7.11457.07.0*	DDS	
			↳7.11492.07.0	DDS	
1.5 dCi 90 60-62 kW (82-84 PS) K9K 838	06.2013→		7.03571.16.0	AK	EL

R







































CAPTUR II **17**

Blue dCi 115 (HFAD) 59-85 kW (80-116 PS) K9K 872, K9K 873	01.2020→		7.11457.07.0*	DDS	
			↳ 7.11492.07.0	DDS	
Blue dCi 95 (HFAF) 59-85 kW (80-116 PS) K9K 872	01.2020→		7.11457.07.0*	DDS	
			↳ 7.11492.07.0	DDS	

CLIO I (B/C57_, 5/357_) **18**

1.1 35-36 kW (48-49 PS) C1E 700	01.1991→09.1998		7.02604.03.0	LS	200 mm
1.1 35-36 kW (48-49 PS) C1E 700	04.1992→08.1992		7.02604.03.0	LS	200 mm
1.2 (B/C/S577) 40 kW (54 PS) C3G 720	01.1996→12.1996		7.05270.45.0	LS	375 mm
1.2 (B/C/S57A, B/C57S, 5/357F, 5/357J, 5/357L, 5/357R) 43-44 kW (58-60 PS) E7F 700	05.1990→09.1998		7.05270.51.0	LS	375 mm
1.2 (B/C57R) 40-43 kW (54-58 PS) E7F 706	01.1991→06.1996		7.05270.51.0	LS	375 mm
1.4 (B/C57T, B/C57Y) 58 kW (79 PS) E7J 718, E7J 719	01.1991→09.1998		7.05270.51.0	LS	375 mm
1.4 (B57J, C57J, B57P) 55 kW (75 PS) E7J 757	01.1991→09.1998		7.05270.51.0	LS	375 mm
1.8 66 kW (90 PS) F3P 755	08.1990→04.1996		7.05270.51.0	LS	375 mm
1.8 65-70 kW (88-95 PS) F3P 710	01.1991→09.1998		7.05270.51.0	LS	375 mm
1.8 (B/C578) 66 kW (90 PS) F3P 754, F3P 755	08.1994→09.1998		7.05270.51.0	LS	375 mm →12.1996
1.8 (B/C57C, B/C57U) 65-70 kW (88-95 PS) F3P 710, F3P 714	01.1991→09.1998		7.05270.51.0	LS	375 mm
1.8 16V (C57D) 99 kW (135 PS) F7P 722			7.05270.51.0	LS	375 mm
			7.02604.03.0	LS	200 mm
1.8 Rsi (B/C579) 66-80 kW (90-109 PS) F3P 712	01.1993→08.1995		7.05270.51.0	LS	375 mm
1.8 Rsi (B/C57H) 79-80 kW (107-109 PS) F3P 758	08.1995→09.1998		7.05270.51.0	LS	375 mm
1.9 D 47-48 kW (64-65 PS) F8Q 632	05.1996→02.1998		7.22818.57.0	AGR	EL 
Williams (B/C57M) 108-110 kW (147-150 PS) F7R 700			7.05270.51.0	LS	375 mm
			7.02604.03.0	LS	200 mm

















R

					
CLIO II (BB_, CB_) 19					
1.2 (BB0A, BB0F, BB10, BB1K, BB28, BB2D, BB2H, CB0A,...) 43 kW (58 PS) D7F 720	09.1998→02.2010		7.05270.48.0	LS	420 mm
1.2 (BB0A, BB0F, BB10, BB1K, BB28, BB2D, BB2H, CB0A,...) 43 kW (58 PS) D7F 726, D7F 746	09.1998→02.2010		7.02604.10.0	LS	560 mm  D7F 726: vor Katalysator in front of the catalyst  D7F 746: Baumuster: BB0F, BB10, CB0F, CB10 Type: BB0F, BB10, CB0F, CB10 vor Katalysator in front of the catalyst
1.2 16V (BB05, BB0W, BB11, BB27, BB2T, BB2U, BB2V, CB05,...) 50-55 kW (68-75 PS) D4F 706, D4F 712, D4F 722, D4F 728	06.2001→08.2016		7.05270.54.0	LS	450 mm  D4F 706, D4F 712: vor Katalysator, nach Katalysator in front of the catalyst, Post-catalyst Produktionsdatum bis: 28.06.2006 Production date to: 28.06.2006  D4F 722: vor Katalysator in front of the catalyst Produktionsdatum bis: 28.06.2006 Production date to: 28.06.2006  D4F 722: nach Katalysator Post-catalyst  D4F 728: vor Katalysator in front of the catalyst  D4F 728: nach Katalysator Post-catalyst Produktionsdatum bis: 28.06.2006 Production date to: 28.06.2006
1.2 LPG (BB0A, CB0A) 43-44 kW (58-60 PS) D7F 722	03.1999→05.2001		7.05270.48.0	LS	420 mm
1.4 (B/CB0C, B/CB0S) 55-72 kW (75-98 PS) E7J 634, K7J 700	09.1998→05.2005		7.05270.56.0	LS	275 mm  E7J 634, K7J 700: Regelsonde Regulating Probe
1.4 (B/CB0C, B/CB0S) 55 kW (75 PS) E7J 780	09.1998→05.2005		7.05270.49.0	LS	285 mm
1.4 16V (B/CB0L) 70-72 kW (95-98 PS) K4J 712, K4J 713	10.1999→09.2004		7.02604.10.0	LS	560 mm  K4J 712, K4J 713: vor Katalysator in front of the catalyst
1.4 16V (B/CB0P, BB13) 70-72 kW (95-98 PS) K4J 710, K4J 711, K4J 712, K4J 713	02.2000→07.2008		7.02604.10.0	LS	560 mm  K4J 710, K4J 711, K4J 712, K4J 713: vor Katalysator in front of the catalyst
1.5 dCi 42-48 kW (57-65 PS) K9K 704	06.2001→12.2006		7.22818.58.0	AGR	EL 
1.5 dCi 74 kW (100 PS) K9K 712	10.2003→04.2005		7.22818.58.0	AGR	EL 
1.5 dCi (B/C2J) 45-50 kW (61-68 PS) K9K 700	08.2004→12.2012		7.22818.58.0	AGR	EL 
1.5 dCi (B/C2J) 47-50 kW (64-68 PS) K9K 714	08.2004→12.2012		7.00368.15.0	AGR	EL
1.5 dCi (B/CB03) 45-60 kW (61-82 PS) K9K 702	06.2001→10.2003		7.22818.58.0	AGR	EL 
1.5 dCi (B/CB07) 42-50 kW (57-68 PS) K9K 700, K9K 704	06.2001→07.2009		7.22818.58.0	AGR	EL 
1.5 dCi (B/CB08) 45-60 kW (61-82 PS) K9K 702	06.2001→04.2005		7.22818.58.0	AGR	EL 



R

































CLIO II (BB_, CB_) 19

1.5 dCi (B/CB3M) 47 kW (64 PS) K9K 740	06.2005→12.2010		7.00368.15.0	AGR	EL	
1.5 dCi (BB3N, CB3N) 60-62 kW (82-84 PS) K9K 718	02.2007→06.2009		7.00368.15.0	AGR	EL	
1.6 (B/CB0D) 66 kW (90 PS) K7M 744, K7M 745	09.1998→05.2005		7.05270.49.0	LS	285 mm	
1.6 16V (BB01, BB0H, BB0T, BB14, BB1D, BB1R, BB2KL, BB3G... 55-86 kW (75-117 PS) K4M 708, K4M 740, K4M 742, K4M 743, K4M 744, K4M 745	09.1998→04.2005		7.02604.10.0	LS	560 mm	 K4M 708: Baumuster: BB0H, CB14, CB1D Type: BB0H, CB14, CB1D vor Katalysator in front of the catalyst  K4M 740: vor Katalysator in front of the catalyst Produktionsdatum ab: 29.11.2002 Production date from: 29.11.2002  K4M 742, K4M 743: Baumuster: BB1R, BB2K Type: BB1R, BB2K vor Katalysator in front of the catalyst  K4M 744: Baumuster: BB14, BB1D Type: BB14, BB1D vor Katalysator in front of the catalyst  K4M 745: Baumuster: BB14, BB1D, CB14, CB1D Type: BB14, BB1D, CB14, CB1D vor Katalysator in front of the catalyst
1.6 16V (BB01, BB0H, BB0T, BB14, BB1D, BB1R, BB2KL, BB3G... 79-86 kW (107-117 PS) K4M 748	09.1998→04.2005		7.02604.10.0	LS	560 mm	Baumuster: BB0H, BB0T, CB0H, CB0L, CB0T Type: BB0H, BB0T, CB0H, CB0L, CB0T vor Katalysator in front of the catalyst
			7.05270.54.0	LS	450 mm	Baumuster: BB0T, CB0T Type: BB0T, CB0T nach Katalysator Post-catalyst
1.9 D (B/CB0J) 47-48 kW (64-65 PS) F8Q 632	02.2000→05.2001		7.22818.57.0	AGR	EL	
2.0 16V 124-126 kW (169-172 PS) F4R 730, F4R 736	06.2001→05.2005		7.02604.10.0	LS	560 mm	 F4R 730: Baumuster: CB0M Type: CB0M vor Katalysator in front of the catalyst  F4R 736: Baumuster: CB_ Type: CB_ vor Katalysator in front of the catalyst
2.0 16V Sport 124-132 kW (168-180 PS) F4R 738	01.2004→04.2005		7.02604.10.0	LS	560 mm	Baumuster: CB_ Type: CB_ vor Katalysator in front of the catalyst
2.0 16V Sport (CB0M) 124-126 kW (169-172 PS) F4R 730	02.2000→06.2009		7.02604.10.0	LS	560 mm	nach Katalysator Post-catalyst

















CLIO III (BR0/1, CR0/1) 20

1.2 (BR01, BR03, BR0E, CR0E) 43-58 kW (58-79 PS) D4F 764	10.2005→12.2012		7.05270.54.0	LS	450 mm	vor Katalysator, nach Katalysator in front of the catalyst, Post-catalyst nicht für Baumuster: CR0E not for code: CR0E Produktionsdatum bis: 28.06.2006 Production date to: 28.06.2006
1.2 16V 43-58 kW (58-79 PS) D4F 764	06.2005→12.2014		7.05270.54.0	LS	450 mm	für OE-Nummer: 82 00 485 076 for OE number: 82 00 485 076

					
CLIO III (BR0/1, CR0/1)					
1.2 16V (BR02, BR0J, BR11, CR02, CR0J, CR11) 48-55 kW (65-75 PS) D4F 740	06.2005→12.2014		7.05270.54.0	LS	450 mm vor Katalysator, nach Katalysator in front of the catalyst, Post-catalyst Produktionsdatum bis: 28.06.2006 Production date to: 28.06.2006
1.2 16V (BR0R, BR1D, BR1L, CR0R) 48-55 kW (65-75 PS) D4F 740	06.2005→12.2012		7.05270.54.0	LS	450 mm vor Katalysator, nach Katalysator in front of the catalyst, Post-catalyst Produktionsdatum bis: 28.06.2006 Production date to: 28.06.2006
1.4 16V 72 kW (98 PS) K4J 780	06.2005→12.2012		7.02604.10.0	LS	560 mm für OE-Nummer: 77 00 107 433, 82 00 551 743 for OE number: 77 00 107 433, 82 00 551 743 vor Katalysator, nach Katalysator in front of the catalyst, Post-catalyst
1.5 dCi 47-50 kW (64-68 PS) K9K 752	05.2005→07.2010		7.22818.58.0	AGR	EL 
1.5 dCi 47-50 kW (64-68 PS) K9K 752	06.2005→12.2012		7.22818.58.0	AGR	EL 
1.5 dCi 57-65 kW (78-88 PS) K9K 750	11.2007→12.2012		7.22818.58.0	AGR	EL 
1.5 dCi 55-65 kW (75-88 PS) K9K 770	08.2010→12.2014		7.00368.16.0	AGR	EL 
1.5 dCi 55-65 kW (75-88 PS) K9K 770	08.2010→12.2014		7.00368.16.0	AGR	EL 
1.5 dCi (BR0H, CR0H, CR1S, BR1S) 78 kW (106 PS) K9K 764	06.2005→12.2014		7.00368.15.0	AGR	EL
1.5 dCi (BR0H, CR0H, CR1S, BR1S) 78 kW (106 PS) K9K 774	06.2005→12.2014		7.00368.16.0	AGR	EL 
1.5 dCi (BR17, CR17) 63-65 kW (86-88 PS) K9K 766	06.2005→12.2012		7.00368.15.0	AGR	EL
1.5 dCi (C/BR0G, C/BR1G) 47-50 kW (64-68 PS) K9K 714, K9K 768	06.2005→12.2012		7.00368.15.0	AGR	EL
1.6 16V (BR05, BR0B, BR0Y, BR15, BR1J, BR1M, BR1Y, CR0B,...) 82 kW (112 PS) K4M 800, K4M 801	06.2005→12.2014		7.02604.10.0	LS	560 mm  K4M 800, K4M 801: für OE-Nummer: 77 00 107 433, 82 00 551 743 for OE number: 77 00 107 433, 82 00 551 743 vor Katalysator, nach Katalysator in front of the catalyst, Post-catalyst
1.6 16V (BR09, BR0T, CR09, CR0T) 65 kW (88 PS) K4M 804	06.2005→10.2007		7.02604.10.0	LS	560 mm für OE-Nummer: 77 00 107 433, 82 00 551 743 for OE number: 77 00 107 433, 82 00 551 743 vor Katalysator, nach Katalysator in front of the catalyst, Post-catalyst
2.0 16V Sport 145-148 kW (197-201 PS) F4R 832	09.2008→12.2014		7.02604.10.0	LS	560 mm für OE-Nummer: 77 00 107 433 for OE number: 77 00 107 433 vor Katalysator in front of the catalyst
2.0 16V Sport (CR0N, CR1P) 145-148 kW (197-201 PS) F4R 830, F4R 832	02.2006→12.2012		7.02604.10.0	LS	560 mm  F4R 830, F4R 832: für OE-Nummer: 77 00 107 433 for OE number: 77 00 107 433 vor Katalysator in front of the catalyst











CLIO III Grandtour (KR0/1_) **21**

1.2 16V (KR02, KR0J) 48-55 kW (65-75 PS) D4F 740	02.2008→12.2012		7.05270.54.0	LS	450 mm	für OE-Nummer: 82 00 052 063 for OE number: 82 00 052 063
1.4 16V 72 kW (98 PS) K4J 780	11.2007→12.2012		7.02604.10.0	LS	560 mm	für OE-Nummer: 77 00 107 433, 82 00 551 743 for OE number: 77 00 107 433, 82 00 551 743 vor Katalysator, nach Katalysator in front of the catalyst, Post-catalyst
1.5 dCi 47-50 kW (64-68 PS) K9K 752	11.2007→12.2012		7.22818.58.0	AGR	EL	
1.5 dCi 55-65 kW (75-88 PS) K9K 770	08.2010→12.2012		7.00368.16.0	AGR	EL	
1.5 dCi 55-65 kW (75-88 PS) K9K 770	08.2010→12.2012		7.00368.16.0	AGR	EL	
1.5 dCi 63-76 kW (86-103 PS) K9K 772	08.2010→12.2012		7.00368.15.0	AGR	EL	
1.5 dCi (KR0F) 63-65 kW (86-88 PS) K9K 766	11.2007→12.2012		7.00368.15.0	AGR	EL	
1.5 dCi (KR0G) 47-50 kW (64-68 PS) K9K 714, K9K 768	11.2007→12.2012		7.00368.15.0	AGR	EL	
1.5 dCi (KR0H, KR1S) 78 kW (106 PS) K9K 764	02.2008→12.2012		7.00368.15.0	AGR	EL	
1.5 dCi (KR0H, KR1S) 78 kW (106 PS) K9K 774	02.2008→12.2012		7.00368.16.0	AGR	EL	
1.6 16V (KR0B) 82 kW (112 PS) K4M 800, K4M 801	11.2007→12.2012		7.02604.10.0	LS	560 mm	 K4M 800: für OE-Nummer: 77 00 107 433, 82 00 551 743 for OE number: 77 00 107 433, 82 00 551 743 vor Katalysator, nach Katalysator in front of the catalyst, Post-catalyst  K4M 801: für OE-Nummer: 77 00 107 433, 82 00 551 743 for OE number: 77 00 107 433, 82 00 551 743



CLIO IV (BH_) **22**

R







1.2 16V 48-55 kW (65-75 PS) D4F 740	11.2012→		7.05270.54.0	LS	450 mm	für OE-Nummer: 82 00 052 063 for OE number: 82 00 052 063 nach Katalysator Post-catalyst
1.2 16V (BHA1, BHAK, BHMGM, BHMK) 48-55 kW (65-75 PS) D4F 740	06.2015→		7.05270.54.0	LS	450 mm	für OE-Nummer: 82 00 052 063 for OE number: 82 00 052 063 nach Katalysator Post-catalyst
1.5 dCi 110 70-81 kW (95-110 PS) K9K 646	06.2016→		7.05320.04.0	AGR	EL	
			7.03571.16.0	AK	EL	
			↳ 7.03083.20.0	SRM-AK	EL	
			7.11457.07.0*	DDS		
			↳ 7.11492.07.0	DDS		
1.5 dCi 75 55-66 kW (75-90 PS) K9K 612	11.2012→		7.00368.16.0	AGR	EL	
			7.03571.16.0	AK	EL	
			↳ 7.03083.20.0	SRM-AK	EL	
1.5 dCi 75 55-66 kW (75-90 PS) K9K 628	11.2012→		7.05320.04.0	AGR	EL	
			7.03571.16.0	AK	EL	



CLIO IV (BH_) 22

		↳ 7.03083.20.0 7.11457.07.0* ↳ 7.11492.07.0	SRM-AK DDS DDS	EL	
1.5 dCi 90 55-66 kW (75-90 PS) K9K 608	11.2012→	 7.03435.05.0 7.03571.16.0 ↳ 7.03083.20.0 7.11190.08.0	AGR AK SRM-AK DDS	EL EL EL	⊙ Baumuster: BHAL Type: BHAL
1.5 dCi 90 55-66 kW (75-90 PS) K9K 628	11.2012→	 7.05320.04.0 7.03571.16.0 ↳ 7.03083.20.0 7.11457.07.0* ↳ 7.11492.07.0	AGR AK SRM-AK DDS DDS	EL EL EL	⊙
1.5 dCi 90 66 kW (90 PS) K9K 638	11.2012→	 7.03571.16.0 7.11457.07.0* ↳ 7.11492.07.0	AK DDS DDS	EL	



CLIO IV Grandtour (KH_) 23

1.2 16V 48-55 kW (65-75 PS) D4F 740	01.2013→	 7.05270.54.0	LS	450 mm	für OE-Nummer: 82 00 052 063 for OE number: 82 00 052 063 nach Katalysator Post-catalyst
1.5 dCi 110 70-81 kW (95-110 PS) K9K 646	06.2016→	 7.05320.04.0 7.03571.16.0 ↳ 7.03083.20.0 7.11457.07.0* ↳ 7.11492.07.0	AGR AK SRM-AK DDS DDS	EL EL EL	⊙
1.5 dCi 75 55-66 kW (75-90 PS) K9K 612	01.2013→	 7.00368.16.0 7.03571.16.0 ↳ 7.03083.20.0	AGR AK SRM-AK	EL EL EL	⊙
1.5 dCi 75 55-66 kW (75-90 PS) K9K 628	01.2013→	 7.05320.04.0 7.03571.16.0 ↳ 7.03083.20.0 7.11457.07.0* ↳ 7.11492.07.0	AGR AK SRM-AK DDS DDS	EL EL EL	⊙
1.5 dCi 90 (KHN3, KHN4) 55-66 kW (75-90 PS) K9K 608	01.2013→	 7.03435.05.0 7.03571.16.0 ↳ 7.03083.20.0 7.11190.08.0	AGR AK SRM-AK DDS	EL EL EL	⊙ Baumuster: KAHL Type: KAHL
1.5 dCi 90 (KHN3, KHN4) 55-66 kW (75-90 PS) K9K 628, K9K 629	01.2013→	 7.05320.04.0 7.03571.16.0 ↳ 7.03083.20.0 7.11457.07.0* ↳ 7.11492.07.0	AGR AK SRM-AK DDS DDS	EL EL EL	⊙



R











CLIO V (B7_) **24**

1.5 Blue dCi 115 (B7AD) 59-85 kW (80-116 PS) K9K 854, K9K 862, K9K 872	06.2019→		7.11457.07.0*	DDS	
			↳ 7.11492.07.0	DDS	
1.5 Blue dCi 85 (B7AG) 59-85 kW (80-116 PS) K9K 854, K9K 872	06.2019→		7.11457.07.0*	DDS	
			↳ 7.11492.07.0	DDS	



DUSTER (HM_) **25**

































1.5 dCi 110 (HMAB) 66-81 kW (90-110 PS) K9K 656	07.2019→		7.05320.04.0	AGR	EL <input type="checkbox"/>
			7.11457.07.0*	DDS	
			↳ 7.11492.07.0	DDS	
1.5 dCi 110 4x4 (HMAB) 80 kW (109 PS) K9K 658	07.2019→		7.05320.04.0	AGR	EL <input type="checkbox"/>
			7.11457.07.0*	DDS	
			↳ 7.11492.07.0	DDS	
1.5 dCi 90 (HMAA) 66-81 kW (90-110 PS) K9K 656	07.2019→		7.11457.07.0*	DDS	
			↳ 7.11492.07.0	DDS	

DUSTER (HS_) **26**

1.5 dCi 63 kW (86 PS) K9K 796	02.2012→		7.00368.15.0	AGR	EL
1.5 dCi 81 kW (110 PS) K9K 896	02.2012→		7.00368.16.0	AGR	EL <input type="checkbox"/>
1.5 dCi (HSAE, HSAD, HSAF, HSJ7, HSMC, HSMD) 80-81 kW (109-110 PS) K9K 856, K9K 858, K9K 898	09.2013→01.2018		7.00368.16.0	AGR	EL <input type="checkbox"/>
1.5 dCi 4x4 66 kW (90 PS) K9K 884	06.2011→		7.00368.16.0	AGR	EL <input type="checkbox"/>
1.5 dCi 4x4 (HSMC) 81 kW (110 PS) K9K 896	09.2014→		7.00368.16.0	AGR	EL <input type="checkbox"/>
1.5 dCi 4x4 (HSMD) 80-81 kW (109-110 PS) K9K 856, K9K 858	09.2013→01.2018		7.00368.16.0	AGR	EL <input type="checkbox"/>
1.6 16V 75-85 kW (102-116 PS) K4M 690	01.2011→		7.05270.54.0	LS	450 mm für OE-Nummer: 60 01 549 007, 82 00 052 063 for OE number: 60 01 549 007, 82 00 052 063 vor Katalysator in front of the catalyst
1.6 16V 4x4 75-85 kW (102-116 PS) K4M 690	06.2011→05.2015		7.05270.54.0	LS	450 mm für OE-Nummer: 60 01 549 007, 82 00 052 063 for OE number: 60 01 549 007, 82 00 052 063 vor Katalysator in front of the catalyst















SPACE I (J11_) **27**

2.2 (J117) 79-81 kW (107-110 PS) J7T 770	07.1986→12.1990		7.02604.01.0	LS	200 mm
2.2 Quadra (J117) 79-81 kW (107-110 PS) J7T 770	01.1988→12.1990		7.02604.01.0	LS	200 mm





						
ESPACE II (J/S63_)						28
2.0 (J636) 76 kW (103 PS) J7R 768	01.1991→10.1996		7.05270.51.0	LS	375 mm	
2.2 (J/S637, J63G) 79-81 kW (107-110 PS) J7T 772, J7T 773, J7T 776	01.1991→10.1996		7.05270.51.0	LS	375 mm	
2.2 4x4 (J/S637, J63G) 79-81 kW (107-110 PS) J7T 772, J7T 773	03.1991→12.1996		7.05270.51.0	LS	375 mm	
2.8 V6 (J638, J63J) 110 kW (150 PS) Z7W 712, Z7W 713, Z7W 717	01.1991→10.1996		7.05270.51.0	LS	375 mm	
ESPACE III (JE0_)						29
2.0 16V (JE0N, JE0L, JE02) 103 kW (140 PS) F4R 700, F4R 701	10.1998→10.2002		7.02604.10.0	LS	560 mm  F4R 700, F4R 701: vor Katalysator in front of the catalyst	
2.2 dCi (JE0K) 85-95 kW (115-130 PS) G9T 710	10.2000→10.2002		7.22818.59.0	AGR	EL  Durchmesser Ventilteller/diameter valve head 30 mm	
			7.22818.63.0	AGR	EL  Durchmesser Ventilteller/diameter valve head 16 mm	
2.2 dCi (JE0S) 85-95 kW (115-130 PS) G9T 710	07.2000→10.2002		7.22818.59.0	AGR	EL  Durchmesser Ventilteller/diameter valve head 30 mm	
			7.22818.63.0	AGR	EL  Durchmesser Ventilteller/diameter valve head 16 mm	
ESPACE IV (JK0/1_)						30
1.9 dCi (JK0U) 85-88 kW (115-120 PS) F9Q 820	04.2003→02.2005		7.22818.57.0	AGR	EL 	
1.9 dCi (JK0U, JK0G) 85-88 kW (115-120 PS) F9Q 820	11.2002→		7.22818.57.0	AGR	EL 	
2.0 (JK09) 100 kW (136 PS) F4R 792	11.2002→01.2015		7.02604.10.0	LS	560 mm vor Katalysator in front of the catalyst	
2.0 (JK0K) 98-100 kW (133-136 PS) F4R 790	11.2002→12.2015		7.02604.10.0	LS	560 mm vor Katalysator in front of the catalyst	
2.0 dCi (JK01, JK02, JK1J, JK1K, JK1H) 96-110 kW (131-150 PS) M9R 740	01.2006→		7.10334.05.0	AGR	EL 	
			7.10334.03.0	AGR	EL 	
2.0 dCi (JK01, JK02, JK1J, JK1K, JK1H) 96-127 kW (131-173 PS) M9R 814, M9R 815, M9R 858	01.2006→		7.02604.41.0	LS	700 mm  M9R 814, M9R 815, M9R 858: 10.2011→ für OE-Nummer: 22 6A 471 42R for OE number: 22 6A 471 42R vor Katalysator in front of the catalyst	
			7.02604.44.0	LS	500 mm  M9R 814, M9R 815, M9R 858: für OE-Nummer: 22 69 3JG 70A for OE number: 22 69 3JG 70A vor Katalysator in front of the catalyst	
2.0 dCi (JK02, JK03) 96-127 kW (131-173 PS) M9R 740, M9R 760	01.2006→		7.10334.05.0	AGR	EL 	
			7.02604.41.0	LS	700 mm	







































ESPACE IV (JK0/1_) 30

2.0 dCi (JK02, JK03) 96-127 kW (131-173 PS) M9R 750, M9R 761, M9R 762, M9R 763	01.2006→		7.02604.41.0	LS	700 mm	
2.0 dCi (JK03, JK04, JK1C, JK1G, JK1J, JK1K) 96-127 kW (131-173 PS) M9R 760	01.2006→		7.10334.05.0	AGR	EL	
2.0 dCi (JK03, JK04, JK1C, JK1G, JK1J, JK1K) 110-127 kW (150-173 PS) M9R 815	01.2006→		7.10334.03.0	AGR	EL	
			7.02604.41.0	LS	700 mm	10.2011→ für OE-Nummer: 22 6A 471 42R for OE number: 22 6A 471 42R vor Katalysator in front of the catalyst
			7.02604.44.0	LS	500 mm	für OE-Nummer: 22 69 3JG 70A for OE number: 22 69 3JG 70A vor Katalysator in front of the catalyst
2.0 dCi (JK03, JK04, JK1C, JK1G, JK1J, JK1K) 127 kW (173 PS) M9R 812	01.2006→		7.10334.05.0	AGR	EL	
			7.02604.41.0	LS	700 mm	10.2011→ Ausstattungsvariante: 1K1C, 1K1G Equipment Variant: 1K1C, 1K1G vor Katalysator in front of the catalyst
2.0 dCi (JK03, JK04, JK1C, JK1G, JK1J, JK1K) 127 kW (173 PS) M9R 859	01.2006→		7.10334.03.0	AGR	EL	
			7.02604.41.0	LS	700 mm	10.2011→ vor Katalysator in front of the catalyst
2.2 dCi (JK07) 102 kW (139 PS) G9T 645	02.2006→		7.02604.44.0	LS	500 mm	vor Katalysator in front of the catalyst
2.2 dCi (JK0H) 110 kW (150 PS) G9T 742, G9T 743	11.2002→08.2006		7.22818.59.0	AGR	EL	
			7.22818.63.0	AGR	EL	
3.5 V6 (JK00, JK0F, JK0P, JK0S, JK0W) 170-177 kW (231-241 PS) V4Y 711, V4Y 715	11.2002→		7.05270.55.0	LS	470 mm	 V4Y 711, V4Y 715: links, rechts Left, Right









ESPACE V (JR_) 31

1.6 dCi 130 96 kW (130 PS) R9M 409	06.2015→		7.24809.90.0	AGR	EL	
			7.03571.16.0	AK	EL	→08.2018
			↳ 7.03083.20.0	SRM-AK	EL	
			7.11457.07.0*	DDS		
			↳ 7.11492.07.0	DDS		
1.6 dCi 160 92-120 kW (125-163 PS) R9M 452	06.2015→		7.24809.90.0	AGR	EL	



						
FLUENCE (L3_)						32
1.5 dCi 70 kW (95 PS) K9K 826	07.2014→		7.00368.16.0	AGR	EL 	
1.5 dCi (L30A) 60-66 kW (82-90 PS) K9K 830	02.2010→		7.00368.15.0	AGR	EL	
1.5 dCi (L30B) 78 kW (106 PS) K9K 832	02.2010→		7.00368.15.0	AGR	EL	
1.5 dCi (L30D, L30L, L306, L33F, L33L, L33M, L33V, L33W) 66-81 kW (90-110 PS) K9K 656, K9K 657	02.2010→		7.05320.04.0	AGR	EL 	
			7.11457.07.0* ↳ 7.11492.07.0	DDS DDS		
1.5 dCi (L30D, L30L, L306, L33F, L33L, L33M, L33V, L33W) 78-81 kW (106-110 PS) K9K 836, K9K 837	02.2010→		7.00368.16.0	AGR	EL 	
1.5 dCi (L30S) 66 kW (90 PS) K9K 834	02.2010→		7.00368.16.0	AGR	EL 	
1.6 dCi 96 kW (130 PS) R9M 402	07.2014→		7.03571.16.0	AK	EL	
			↳ 7.03083.20.0 7.11190.08.0	SRM-AK DDS	EL	
			7.02604.99.0	LS	400 mm Baumuster: L339 Type: L339	
GRAND SCÉNIC II (JM0/1_)						33
1.5 dCi 74-78 kW (103-106 PS) K9K 734	06.2006→11.2008		7.00368.15.0	AGR	EL	
1.5 dCi (JM02, JM13) 74-78 kW (101-106 PS) K9K 728	04.2004→11.2008		7.22818.58.0	AGR	EL 	
1.5 dCi (JM1E) 78 kW (106 PS) K9K 732	05.2005→01.2009		7.00368.15.0	AGR	EL	
1.9 dCi 85-88 kW (116-120 PS) F9Q 812	05.2005→01.2009		7.00075.07.0	AGR	EL 	
			7.00837.01.0	AGR-K	 ohne AGR-Ventil without EGR valve	
1.9 dCi (JM0G, JM12, JM1G, JM2C) 85-88 kW (116-120 PS) F9Q 812	04.2004→05.2006		7.00075.07.0	AGR	EL 	
			7.00837.01.0	AGR-K	 ohne AGR-Ventil without EGR valve	
2.0 99-103 kW (135-140 PS) F4R 770, F4R 771	04.2004→06.2009		7.02604.10.0	LS	560 mm  F4R 770, F4R 771: für OE-Nummer: 77 00 107 433, 82 00 551 743 for OE number: 77 00 107 433, 82 00 551 743 vor Katalysator, nach Katalysator in front of the catalyst, Post-catalyst	
2.0 dCi (JM1K) 110 kW (150 PS) M9R 700, M9R 721	09.2005→11.2008		7.10334.05.0	AGR	EL 	
GRAND SCÉNIC III (JZ0/1_)						34
1.5 dCi 78 kW (106 PS) K9K 832	02.2009→		7.00368.15.0	AGR	EL	
1.5 dCi 78-81 kW (106-110 PS) K9K 836, K9K 837	04.2009→		7.00368.16.0	AGR	EL 	
1.5 dCi 81 kW (110 PS) K9K 636	04.2009→		7.03435.05.0	AGR	EL 	



























GRAND SCÉNIC III (JZ0/1_) **34**

			7.03571.16.0 ↳ 7.03083.20.0	AK SRM-AK	EL EL	
1.5 dCi 60-66 kW (82-90 PS) K9K 830	04.2009→		7.00368.15.0	AGR	EL	
1.5 dCi 70-81 kW (95-110 PS) K9K 846	11.2010→		7.00368.16.0	AGR	EL	⊗
1.6 dCi (JZ00, JZ12) 96 kW (130 PS) R9M 402	04.2011→		7.24809.90.0	AGR	EL	⊗ →09.2016
			7.03571.16.0 ↳ 7.03083.20.0 7.11190.08.0	AK SRM-AK DDS	EL EL	für OE-Nummer: 22 77 014 54R, 22 77 021 84R, 82 00 469 905 for OE number: 22 77 014 54R, 22 77 021 84R, 82 00 469 905
			7.02604.99.0	LS	400 mm	Motorcode: R9M 402 Engine Code: R9M 402 Produktionsdatum ab: 04.2011 Production date from: 04.2011
1.6 dCi (JZ00, JZ12) 96 kW (130 PS) R9M 404	04.2011→		7.24809.90.0	AGR	EL	⊗ →09.2016
			7.03571.16.0 ↳ 7.03083.20.0 7.11190.08.0	AK SRM-AK DDS	EL EL	für OE-Nummer: 22 77 014 54R, 22 77 021 84R, 82 00 469 905 for OE number: 22 77 014 54R, 22 77 021 84R, 82 00 469 905
1.6 dCi (JZ00, JZ12) 96 kW (130 PS) R9M 414	04.2011→		7.03571.16.0 ↳ 7.03083.20.0	AK SRM-AK	EL EL	
			7.11457.07.0* ↳ 7.11492.07.0	DDS DDS		
1.9 dCi 96 kW (131 PS) F9Q 870, F9Q 872	02.2009→		7.11237.05.0	AGR-K	EL	⊗ F9Q 870, F9Q 872: →02.2012
2.0 dCi (JZ0L) 118-120 kW (160-163 PS) M9R 610	04.2009→		7.10334.03.0	AGR	EL	⊗
			7.02604.99.0	LS	400 mm	
2.0 dCi (JZ0Y) 110 kW (150 PS) M9R 615	02.2009→		7.10334.03.0	AGR	EL	⊗
			7.02604.99.0	LS	400 mm	

GRAND SCÉNIC IV (R9_) **35**































1.5 dCi 110 67-81 kW (91-110 PS) K9K 646, K9K 647	09.2016→		7.05320.04.0	AGR	EL	⊗
			7.03571.16.0 ↳ 7.03083.20.0 7.11457.07.0*	AK SRM-AK DDS	EL EL	
			↳ 7.11492.07.0	DDS		
1.5 dCi 110 Hybrid Assist (R9AE) 70-81 kW (95-110 PS) K9K 500, K9K 502	04.2017→		7.05320.04.0	AGR	EL	⊗
1.7 Blue dCi 120 (R9A7, R9A8) 88-110 kW (120-150 PS) R9N 401	08.2018→		7.11457.07.0*	DDS		
			↳ 7.11492.07.0	DDS		

					
GRAND SCÉNIC IV (R9_)					35
1.7 Blue dCi 150 (R9A7, R9A8) 88-110 kW (120-150 PS) R9N 401	08.2018→		7.11457.07.0* ↳7.11492.07.0	DDS DDS	
KADJAR (HA_, HL_)					36
1.5 BLUE dCi 115 59-85 kW (80-116 PS) K9K 872, K9K 873	08.2018→		7.11457.07.0* ↳7.11492.07.0	DDS DDS	
1.5 dCi 110 (HLA3) 67-81 kW (91-110 PS) K9K 646, K9K 647, K9K 649	06.2015→		7.05320.04.0 7.03571.16.0 ↳7.03083.20.0 7.11457.07.0* ↳7.11492.07.0	AGR AK SRM-AK DDS DDS	EL  EL  K9K 646, K9K 647, K9K 649: →03.2017 EL
1.5 dCi 110 (HLA3) 81 kW (110 PS) K9K 648	06.2015→		7.11457.07.0* ↳7.11492.07.0 7.03083.20.0	DDS DDS SRM-AK	EL →03.2017
1.6 dCi 130 96 kW (130 PS) R9M 414	06.2015→		7.24809.90.0 7.03571.16.0 ↳7.03083.20.0 7.11190.08.0 7.11457.07.0* ↳7.11492.07.0	AGR AK SRM-AK DDS DDS DDS	EL  →08.2018 EL →03.2017 EL
1.6 dCi 130 4x4 96 kW (130 PS) R9M 414	06.2015→		7.24809.90.0 7.03571.16.0 ↳7.03083.20.0 7.11190.08.0 7.11457.07.0* ↳7.11492.07.0	AGR AK SRM-AK DDS DDS DDS	EL  →03.2019 EL →03.2017 EL
1.7 Blue dCi 150 (HLA7) 88-110 kW (120-150 PS) R9N 401	08.2018→		7.11457.07.0* ↳7.11492.07.0	DDS DDS	
1.7 Blue dCi 150 4WD (HLA7) 88-110 kW (120-150 PS) R9N 401	08.2018→		7.11457.07.0* ↳7.11492.07.0	DDS DDS	
KANGOO (KC0/1_)					37
1.0 44-50 kW (60-68 PS) D4D 700, D4D 720	01.2002→01.2007		7.05270.54.0	LS	450 mm  D4D 700, D4D 720: vor Katalysator, nach Katalysator in front of the catalyst, Post-catalyst Produktionsdatum bis: 28.06.2006 Production date to: 28.06.2006
1.2 (KC0A, KC0K, KC0F, KC01) 43-44 kW (58-60 PS) D7F 720, D7F 722	08.1997→		7.05270.48.0	LS	420 mm
1.2 (KC0A, KC0K, KC0F, KC01) 43-44 kW (58-60 PS) D7F 726, D7F 744	08.1997→		7.02604.10.0	LS	560 mm  D7F 726: Baumuster: KC01, KC0F Type: KC01, KC0F vor Katalysator in front of the catalyst  D7F 744: Baumuster: KC0F Type: KC0F vor Katalysator in front of the catalyst



R



KANGOO (KC0/1_) **37**

1.2 16V (KC05, KC06, KC03, KC0T, KC0W, KC1D) 50-55 kW (68-75 PS) D4F 712, D4F 730	06.2001→		7.05270.54.0	LS	450 mm	 D4F 712, D4F 730: vor Katalysator, nach Katalysator in front of the catalyst, Post-catalyst Produktionsdatum bis: 28.06.2006 Production date to: 28.06.2006
1.4 (KC0C, KC0H, KC0B, KC0M) 55-72 kW (75-98 PS) E7J 634, E7J 635, K7J 700, K7J 701	08.1997→		7.05270.56.0	LS	275 mm	 E7J 634, E7J 635: Regelsonde Regulating Probe  K7J 700, K7J 701: 03.2003→ Regelsonde Regulating Probe
			7.02604.03.0	LS	200 mm	
1.4 (KC0C, KC0H, KC0B, KC0M) 55 kW (75 PS) E7J 780	03.1998→		7.05270.49.0	LS	285 mm	→02.2003
			7.02604.03.0	LS	200 mm	
1.5 dCi 42-48 kW (57-65 PS) K9K 704	07.2003→		7.22818.58.0	AGR	EL	
1.5 dCi 45-60 kW (61-82 PS) K9K 700, K9K 702	04.2005→06.2010		7.22818.58.0	AGR	EL	
1.5 dCi 47-50 kW (64-68 PS) K9K 714	06.2005→		7.00368.15.0	AGR	EL	
1.5 dCi 60-62 kW (82-84 PS) K9K 718	06.2005→		7.00368.15.0	AGR	EL	
1.5 dCi (KC07) 42-50 kW (57-68 PS) K9K 700, K9K 704	12.2001→		7.22818.58.0	AGR	EL	
1.5 dCi (KC08, KC09) 45-60 kW (61-82 PS) K9K 702, K9K 710	07.2002→		7.22818.58.0	AGR	EL	
1.6 16V 70-81 kW (95-109 PS) K4M 730, K4M 750, K4M 752	06.2001→		7.02604.10.0	LS	560 mm	 K4M 730: vor Katalysator, nach Katalysator in front of the catalyst, Post-catalyst Produktionsdatum ab: 12.05.2002 Production date from: 12.05.2002  K4M 750, K4M 752: vor Katalysator, nach Katalysator in front of the catalyst, Post-catalyst
1.6 16V 4x4 (KC0P, KC0S, KC0L) 70 kW (95 PS) K4M 752, K4M 753	10.2001→		7.02604.10.0	LS	560 mm	 K4M 752: vor Katalysator, nach Katalysator in front of the catalyst, Post-catalyst  K4M 753: Baumuster: KC0S Type: KC0S vor Katalysator, nach Katalysator in front of the catalyst, Post-catalyst
1.9 RXd 47-48 kW (64-65 PS) F8Q 632	09.1999→06.2001		7.22818.57.0	AGR	EL	
1.9 dCi 4x4 59-62 kW (80-84 PS) F9Q 790	10.2003→		7.22818.57.0	AGR	EL	
1.9 dCi 4x4 (KC0V) 59-62 kW (80-84 PS) F9Q 782, F9Q 790	10.2001→		7.22818.57.0	AGR	EL	
D 65 1.9 (KC0E, KC02, KC0J, KC0N) 47-48 kW (64-65 PS) F8Q 632	08.1997→06.2001		7.22818.57.0	AGR	EL	













KANGOO / GRAND KANGOO (KW0/1_) **38**

1.5 dCi 105 (KW0F) 76 kW (103 PS) K9K 806	02.2008→		7.00368.15.0	AGR	EL	
1.5 dCi 110 (KW06, KW12) 67-81 kW (91-110 PS) K9K 646, K9K 647, K9K 648	03.2013→		7.05320.04.0	AGR	EL	

R



KANGOO / GRAND KANGOO (KW0/1_) **38**

			7.03571.16.0 AK EL →07.2013 ↳7.03083.20.0 SRM-AK EL 7.11457.07.0* DDS ↳7.11492.07.0 DDS		
1.5 dCi 110 (KW06, KW12) 81 kW (110 PS) K9K 636	03.2013→		7.03435.05.0 AGR EL 7.03571.16.0 AK EL ↳7.03083.20.0 SRM-AK EL		
1.5 dCi 115 (KW17) 59-85 kW (80-116 PS) K9K 872	03.2019→		7.11457.07.0* DDS ↳7.11492.07.0 DDS		
1.5 dCi 70 (KW0V, KW0A) 50-63 kW (75-86 PS) K9K 800	02.2008→		7.00368.15.0 AGR EL		
1.5 dCi 75 (KW07, KW10, KW04) 55-66 kW (75-90 PS) K9K 608	11.2012→		7.03435.05.0 AGR EL 7.03571.16.0 AK EL ↳7.03083.20.0 SRM-AK EL		
1.5 dCi 75 (KW07, KW10, KW04) 55-66 kW (75-90 PS) K9K 628	11.2012→		7.05320.04.0 AGR EL 7.03571.16.0 AK EL ↳7.03083.20.0 SRM-AK EL 7.11457.07.0* DDS ↳7.11492.07.0 DDS		
1.5 dCi 75 (KW07, KW10, KW04) 55-66 kW (75-90 PS) K9K 808	11.2012→		7.00368.16.0 AGR EL		
1.5 dCi 80 (KW15) 59-85 kW (80-116 PS) K9K 872	03.2019→		7.11457.07.0* DDS ↳7.11492.07.0 DDS		
1.5 dCi 85 (KW0K, KW0L, KW0B) 50-63 kW (68-86 PS) K9K 802	02.2008→		7.00368.15.0 AGR EL		
1.5 dCi 90 (KW05, KW08, KW0G, KW11) 55-66 kW (75-90 PS) K9K 608	06.2008→		7.03435.05.0 AGR EL 7.03571.16.0 AK EL ↳7.03083.20.0 SRM-AK EL		
1.5 dCi 90 (KW05, KW08, KW0G, KW11) 55-66 kW (75-90 PS) K9K 628	06.2008→		7.05320.04.0 AGR EL 7.03571.16.0 AK EL ↳7.03083.20.0 SRM-AK EL 7.11457.07.0* DDS ↳7.11492.07.0 DDS		
1.5 dCi 90 (KW05, KW08, KW0G, KW11) 55-66 kW (75-90 PS) K9K 808	06.2008→		7.00368.16.0 AGR EL		
1.5 dCi 90 (KW18) 67-81 kW (91-110 PS) K9K 647	08.2017→		7.05320.04.0 AGR EL 7.03571.16.0 AK EL ↳7.03083.20.0 SRM-AK EL		





R















KANGOO / GRAND KANGOO (KW0/1_) 38

			7.11457.07.0*	DDS	
			↳ 7.11492.07.0	DDS	
1.5 dCi 95 (KW16) 59-85 kW (80-116 PS) K9K 872	03.2019→		7.11457.07.0*	DDS	
			↳ 7.11492.07.0	DDS	

KANGOO BE BOP (KW0/1_) 39

1.5 dCi 47-50 kW (64-68 PS) K9K 714	11.2013→		7.00368.15.0	AGR	EL
1.5 dCi (KW0F) 76 kW (103 PS) K9K 806	02.2009→12.2012		7.00368.15.0	AGR	EL
1.5 dCi (KW0G) 55-66 kW (75-90 PS) K9K 808	06.2009→12.2012		7.00368.16.0	AGR	EL 
1.5 dCi 75 50-63 kW (68-86 PS) K9K 802	09.2010→		7.00368.15.0	AGR	EL

























KOLEOS I (HY_) 40

2.0 dCi 110-127 kW (150-173 PS) M9R 865	07.2013→		7.10334.03.0	AGR	EL 	
			7.02604.41.0	LS	700 mm vor Katalysator in front of the catalyst	
2.0 dCi (HY0K) 110-127 kW (150-173 PS) M9R 855, M9R 856, M9R 862, M9R 865	09.2008→		7.10334.03.0	AGR	EL 	
			7.02604.41.0	LS	700 mm  M9R 855, M9R 856, M9R 862, M9R 865, M9R 865: vor Katalysator in front of the catalyst	
2.0 dCi (HY0K) 110 kW (150 PS) M9R 866	09.2008→		7.10334.03.0	AGR	EL 	
2.0 dCi 4x4 127-130 kW (173-177 PS) M9R 830	09.2008→03.2013		7.10334.03.0	AGR	EL  für OE-Nummer: 14 71 003 85R, 14 71 055 43R, 82 00 796 674 for OE number: 14 71 003 85R, 14 71 055 43R, 82 00 796 674	
			7.10334.05.0	AGR	EL  für OE-Nummer: 82 00 327 004, 82 00 691 292, 82 00 693 739, 82 00 797 706 for OE number: 82 00 327 004, 82 00 691 292, 82 00 693 739, 82 00 797 706	
			7.11190.08.0	DDS		für OE-Nummer: 22 77 014 54R for OE number: 22 77 014 54R
			7.02604.41.0	LS	700 mm	für OE-Nummer: 22 6A 471 42R for OE number: 22 6A 471 42R vor Katalysator in front of the catalyst
			7.02604.44.0	LS	500 mm	für OE-Nummer: 22 69 3JG 70A for OE number: 22 69 3JG 70A vor Katalysator in front of the catalyst
2.0 dCi 4x4 (HY0B) 127-130 kW (173-177 PS) M9R 830	09.2008→		7.10334.03.0	AGR	EL  für OE-Nummer: 14 71 003 85R, 14 71 055 43R, 82 00 796 674 for OE number: 14 71 003 85R, 14 71 055 43R, 82 00 796 674	
			7.10334.05.0	AGR	EL  für OE-Nummer: 82 00 327 004, 82 00 691 292, 82 00 693 739, 82 00 797 706 for OE number: 82 00 327 004, 82 00 691 292, 82 00 693 739, 82 00 797 706	
			7.11190.08.0	DDS		für OE-Nummer: 22 77 014 54R for OE number: 22 77 014 54R

R







KOLEOS I (HY_) 40

		7.02604.41.0	LS	700 mm	für OE-Nummer: 22 6A 471 42R for OE number: 22 6A 471 42R vor Katalysator in front of the catalyst
		7.02604.44.0	LS	500 mm	für OE-Nummer: 22 69 3JG 70A for OE number: 22 69 3JG 70A vor Katalysator in front of the catalyst
2.0 dCi 4x4 (HY0K) 110 kW (150 PS) M9R 832	09.2008→		7.10334.03.0	AGR	EL  für OE-Nummer: 14 71 003 85R, 147105543R, 82 00 796 674 for OE number: 14 71 003 85R, 147105543R, 82 00 796 674
			7.10334.05.0	AGR	EL  für OE-Nummer: 82 00 327 004, 82 00 691 292, 82 00 693 739, 82 00 797 706 for OE number: 82 00 327 004, 82 00 691 292, 82 00 693 739, 82 00 797 706
			7.11190.08.0	DDS	für OE-Nummer: 22 77 014 54R for OE number: 22 77 014 54R
			7.02604.41.0	LS	700 mm vor Katalysator in front of the catalyst
2.0 dCi 4x4 (HY0K) 110 kW (150 PS) M9R 833, M9R 836	09.2008→		7.10334.03.0	AGR	EL   M9R 833, M9R 836: für OE-Nummer: 14 71 003 85R, 14 71 055 43R, 82 00 796 674 for OE number: 14 71 003 85R, 14 71 055 43R, 82 00 796 674
			7.10334.05.0	AGR	EL   M9R 833, M9R 836: für OE-Nummer: 82 00 327 004, 82 00 691 292, 82 00 693 739, 82 00 797 706 for OE number: 82 00 327 004, 82 00 691 292, 82 00 693 739, 82 00 797 706
			7.11190.08.0	DDS	 M9R 833, M9R 836: für OE-Nummer: 22 77 014 54R for OE number: 22 77 014 54R
			7.10334.03.0	AGR	EL 
2.0 dCi 4x4 (HY0K) 110 kW (150 PS) M9R 834	09.2008→		7.10334.03.0	AGR	EL 
			7.10334.05.0	AGR	EL   M9R 835, M9R 838: für OE-Nummer: 14 71 003 85R, 14 71 055 43R, 82 00 796 674 for OE number: 14 71 003 85R, 14 71 055 43R, 82 00 796 674
			7.10334.05.0	AGR	EL   M9R 835, M9R 838: für OE-Nummer: 82 00 327 004, 82 00 691 292, 82 00 693 739, 82 00 797 706 for OE number: 82 00 327 004, 82 00 691 292, 82 00 693 739, 82 00 797 706
			7.11190.08.0	DDS	 M9R 835, M9R 838: für OE-Nummer: 22 77 014 54R for OE number: 22 77 014 54R
2.0 dCi 4x4 (HY0K) 110 kW (150 PS) M9R 835, M9R 838	09.2008→		7.02604.44.0	LS	500 mm  M9R 835, M9R 838: für OE-Nummer: 22 69 3JG 70A for OE number: 22 69 3JG 70A vor Katalysator in front of the catalyst
			7.10334.03.0	AGR	EL 
			7.11190.08.0	DDS	 M9R 835, M9R 838: für OE-Nummer: 22 77 014 54R for OE number: 22 77 014 54R
2.0 dCi 4x4 (HY0K) 110-127 kW (150-173 PS) M9R 855, M9R 856, M9R 862, M9R 865, M9R 866	09.2008→		7.10334.03.0	AGR	EL 
			7.02604.41.0	LS	700 mm  M9R 855, M9R 856, M9R 862, M9R 865, M9R 866: vor Katalysator in front of the catalyst





R



KOLEOS II (HC_) **41**

1.6 dCi 130 96 kW (130 PS) R9M 409, R9M 414	08.2016→	 7.24809.90.0	AGR	EL	 R9M 409, R9M 414: →07.2018
		7.11457.07.0*	DDS		
		↳ 7.11492.07.0	DDS		
1.7 BLUE dCi 150 (HCA7) 88-110 kW (120-150 PS) R9N 401	06.2019→	 7.11457.07.0*	DDS		
		↳ 7.11492.07.0	DDS		
2.0 dCi 175 4WD 130 kW (177 PS) M9R 868	08.2016→	 7.10334.03.0	AGR	EL	





















LAGUNA Coupe (DT0/1) **42**

1.5 dCi 70-81 kW (95-110 PS) K9K 846	03.2012→12.2015	 7.00368.16.0	AGR	EL	
2.0 dCi (DT01, DT08, DT09, DT0K, DT12, DT1C, DT1D, DT1M,...) 96-110 kW (131-150 PS) M9R 802, M9R 805, M9R 808	09.2008→12.2015	 7.10334.03.0	AGR	EL	 M9R 802, M9R 805, M9R 808: für OE-Nummer: 14 71 003 85R, 14 71 055 43R, 82 00 796 674 for OE number: 14 71 003 85R, 14 71 055 43R, 82 00 796 674
		7.10334.05.0	AGR	EL	 M9R 802, M9R 805, M9R 808: für OE-Nummer: 82 00 327 004, 82 00 691 292, 82 00 693 739, 82 00 797 706 for OE number: 82 00 327 004, 82 00 691 292, 82 00 693 739, 82 00 797 706
2.0 dCi (DT01, DT08, DT09, DT0K, DT12, DT1C, DT1D, DT1M,...) 96-110 kW (131-150 PS) M9R 814	09.2008→12.2015	 7.02604.41.0	LS	700 mm	10.2011→ für OE-Nummer: 22 6A 471 42R for OE number: 22 6A 471 42R vor Katalysator in front of the catalyst
		7.02604.44.0	LS	500 mm	für OE-Nummer: 22 69 3JG 70A for OE number: 22 69 3JG 70A vor Katalysator in front of the catalyst
2.0 dCi (DT01, DT08, DT09, DT0K, DT12, DT1C, DT1D, DT1M,...) 96-127 kW (131-173 PS) M9R 854	09.2008→12.2015	 7.10334.03.0	AGR	EL	
		7.02604.41.0	LS	700 mm	10.2011→ vor Katalysator in front of the catalyst
2.0 dCi (DT01, DT08, DT09, DT0K, DT12, DT1C, DT1D, DT1M,...) 96-127 kW (131-173 PS) M9R 858	09.2008→12.2015	 7.10334.03.0	AGR	EL	
		7.02604.41.0	LS	700 mm	10.2011→ für OE-Nummer: 22 6A 471 42R for OE number: 22 6A 471 42R vor Katalysator in front of the catalyst
		7.02604.44.0	LS	500 mm	für OE-Nummer: 22 69 3JG 70A for OE number: 22 69 3JG 70A vor Katalysator in front of the catalyst
2.0 dCi (DT01, DT08, DT09, DT0K, DT12, DT1C, DT1D, DT1M,...) 110 kW (150 PS) M9R 748, M9R 754, M9R 845	09.2008→12.2015	 7.10334.03.0	AGR	EL	
2.0 dCi (DT0M, DT0N, DT0S, DT19, DT1F) 96-127 kW (131-173 PS) M9R 854, M9R 857	09.2008→12.2015	 7.10334.03.0	AGR	EL	



R



LAGUNA Coupe (DT0/1) 42















		7.02604.41.0	LS	700 mm	 M9R 854, M9R 857: 10.2011→ vor Katalysator in front of the catalyst
2.0 dCi (DT0M, DT0N, DT0S, DT19, DT1F) 110-127 kW (150-173 PS) M9R 815	09.2008→12.2015	 7.10334.03.0	AGR	EL	
		7.02604.41.0	LS	700 mm	10.2011→ für OE-Nummer: 22 6A 471 42R for OE number: 22 6A 471 42R vor Katalysator in front of the catalyst
		7.02604.44.0	LS	500 mm	für OE-Nummer: 22 69 3JG 70A for OE number: 22 69 3JG 70A vor Katalysator in front of the catalyst
2.0 dCi (DT0M, DT0N, DT0S, DT19, DT1F) 110-127 kW (150-173 PS) M9R 849	09.2008→12.2015	 7.10334.03.0	AGR	EL	
2.0 dCi (DT0M, DT0N, DT0S, DT19, DT1F) 127 kW (173 PS) M9R 800	09.2008→12.2015	 7.10334.05.0	AGR	EL	
2.0 dCi (DT0M, DT0N, DT0S, DT19, DT1F) 127 kW (173 PS) M9R 806, M9R 809	09.2008→12.2015	 7.10334.03.0	AGR	EL	 M9R 806, M9R 809: für OE-Nummer: 14 71 003 85R, 14 71 055 43R, 82 00 796 674 for OE number: 14 71 003 85R, 14 71 055 43R, 82 00 796 674
		7.10334.05.0	AGR	EL	 M9R 806, M9R 809: für OE-Nummer: 82 00 327 004, 82 00 691 292, 82 00 693 739, 82 00 797 706 for OE number: 82 00 327 004, 82 00 691 292, 82 00 693 739, 82 00 797 706
2.0 dCi GT (DT11, DT1E, DT1N) 127-132 kW (173-180 PS) M9R 816	09.2008→12.2015	 7.10334.03.0	AGR	EL	 für OE-Nummer: 14 71 003 85R, 14 71 055 43R, 82 00 796 674 for OE number: 14 71 003 85R, 14 71 055 43R, 82 00 796 674
		7.10334.05.0	AGR	EL	 für OE-Nummer: 82 00 327 004, 82 00 691 292, 82 00 693 739, 82 00 797 706 for OE number: 82 00 327 004, 82 00 691 292, 82 00 693 739, 82 00 797 706
2.0 dCi GT (DT11, DT1E, DT1N) 131 kW (178 PS) M9R 820, M9R 828	09.2008→12.2015	 7.10334.03.0	AGR	EL	
		7.02604.41.0	LS	700 mm	 M9R 820, M9R 828: 10.2011→ vor Katalysator in front of the catalyst
3.0 dCi 173-195 kW (235-265 PS) V9X 891	01.2012→12.2015	 7.00999.08.0	AGR	EL	
3.0 dCi (DT03) 173-195 kW (235-265 PS) V9X 791, V9X 891	09.2008→12.2015	 7.00999.08.0	AGR	EL	

LAGUNA I (B56_, 556_) 43

1.6 16V (B568, B561) 79 kW (107 PS) K4M 720	11.1997→03.2001	 7.02604.10.0	LS	560 mm	vor Katalysator in front of the catalyst
1.8 66-70 kW (90-95 PS) F3P 676, F3P 678	06.1995→06.1998	 7.02604.03.0	LS	200 mm	
1.8 69 kW (94 PS) F3P 674	06.1995→02.2001	 7.02604.03.0	LS	200 mm	











































LAGUNA I (B56_, 556_) 43

1.8 (B56A/B) 66-69 kW (90-94 PS) F3P 720	11.1993→03.2001		7.02604.03.0	LS	200 mm	
1.8 (B56A/B) 66-69 kW (90-94 PS) F3P 724	11.1993→03.2001		7.05270.47.0	LS	325 mm	→01.1996
			7.02604.03.0	LS	200 mm	
1.8 (B56S/T/0) 66 kW (90 PS) F3P 670	08.1995→03.2001		7.02604.03.0	LS	200 mm	
1.8 (B56S/T/0) 66-70 kW (90-95 PS) F3P 678	08.1995→03.2001		7.05270.47.0	LS	325 mm	
			7.02604.03.0	LS	200 mm	
1.8 (B56Z) 66-69 kW (90-94 PS) F3P 720	08.1995→03.2001		7.02604.03.0	LS	200 mm	
1.8 (B56Z) 66-69 kW (90-94 PS) F3P 724	08.1995→03.2001		7.05270.47.0	LS	325 mm	→01.1996
			7.02604.03.0	LS	200 mm	
1.8 16V (B563, B564) 88 kW (120 PS) F4P 760	04.1998→03.2001		7.02604.10.0	LS	560 mm	vor Katalysator in front of the catalyst
1.9 dCi (B56W) 79 kW (107 PS) F9Q 718	09.1999→03.2001		7.22818.57.0	AGR	EL	
2.0 83-84 kW (113-114 PS) F3R 722	06.1995→02.2001		7.05270.47.0	LS	325 mm	
2.0 (556A) 103 kW (140 PS) F4R 780	09.1999→02.2001		7.02604.10.0	LS	560 mm	vor Katalysator in front of the catalyst
2.0 (B56C/H/N) 83-84 kW (113-114 PS) F3R 722, F3R 723	12.1993→03.2001		7.05270.47.0	LS	325 mm	
2.0 16V (556A/B) 103 kW (140 PS) F4R 780	09.1999→03.2001		7.02604.10.0	LS	560 mm	vor Katalysator in front of the catalyst
3.0 (B56E/R, B565) 123 kW (167 PS) Z7X 760, Z7X 765	11.1993→03.2001		7.05270.51.0	LS	375 mm	 Z7X 760, Z7X 765: →12.1996

LAGUNA I Grandtour (K56_) 44

R

























1.6 16V (K568) 79 kW (107 PS) K4M 720	11.1997→03.2001		7.02604.10.0	LS	560 mm	vor Katalysator in front of the catalyst
1.8 (K56S/T/0) 66-70 kW (90-95 PS) F3P 678	09.1995→03.2001		7.05270.47.0	LS	325 mm	→04.1998
1.8 (K56Z) 66-69 kW (90-94 PS) F3P 724	09.1995→03.2001		7.05270.47.0	LS	325 mm	→04.1998
1.9 dCi (K56W) 79 kW (107 PS) F9Q 718	09.1999→03.2001		7.22818.57.0	AGR	EL	
2.0 (K56C/H) 83-84 kW (113-114 PS) F3R 722, F3R 723	09.1995→03.2001		7.05270.47.0	LS	325 mm	
2.0 16V (A56A/B) 103 kW (140 PS) F4R 780	09.1999→03.2001		7.02604.10.0	LS	560 mm	vor Katalysator in front of the catalyst
3.0 (K56R, K565) 123 kW (167 PS) Z7X 765	02.1996→03.2001		7.05270.51.0	LS	375 mm	→12.1996

					
LAGUNA II (BG0/1_)					
45					
1.6 16V (BG0A, BG0L) 76-79 kW (103-107 PS) K4M 710, K4M 714	03.2001→05.2005		7.02604.10.0	LS	560 mm  K4M 710: vor Katalysator in front of the catalyst  K4M 714: Baumuster: BG0L Type: BG0L vor Katalysator in front of the catalyst
1.6 16V (BG1G, BG1H) 82 kW (112 PS) K4M 716	02.2005→08.2007		7.02604.10.0	LS	560 mm für OE-Nummer: 77 00 107 433, 82 00 551 743 for OE number: 77 00 107 433, 82 00 551 743 vor Katalysator in front of the catalyst
1.8 16V (BG04, BG0B, BG0C, BG0V) 85-89 kW (116-121 PS) F4P 770, F4P 774	03.2001→05.2005		7.02604.10.0	LS	560 mm  F4P 770: Baumuster: BG0B, BG0C, BG0V Type: BG0B, BG0C, BG0V vor Katalysator in front of the catalyst  F4P 774: vor Katalysator in front of the catalyst
1.8 16V (BG06, BG0J, BG0M) 85-89 kW (116-121 PS) F4P 771, F4P 774, F4P 775	03.2001→12.2007		7.02604.10.0	LS	560 mm  F4P 771: Baumuster: BG06 Type: BG06 vor Katalysator in front of the catalyst  F4P 774: Baumuster: BG0M Type: BG0M vor Katalysator in front of the catalyst  F4P 775: für OE-Nummer: BG0J for OE number: BG0J vor Katalysator in front of the catalyst
1.8 16V (BG0B, BG0C, BG0J, BG0M, BG0V) 85-89 kW (116-121 PS) F4P 770, F4P 772	03.2001→05.2005		7.02604.10.0	LS	560 mm  F4P 770: Baumuster: BG0B, BG0C Type: BG0B, BG0C vor Katalysator in front of the catalyst  F4P 772: Baumuster: BG0M Type: BG0M vor Katalysator in front of the catalyst
1.8 16V (BG0B, BG0M) 85-89 kW (116-121 PS) F4P 770	03.2001→09.2007		7.02604.10.0	LS	560 mm Baumuster: BG0B Type: BG0B vor Katalysator in front of the catalyst
1.9 dCi (BG0E) 74-77 kW (101-105 PS) F9Q 752	06.2001→05.2005		7.22818.57.0	AGR	EL 
1.9 dCi 74-79 kW (101-107 PS) F9Q 718, F9Q 754	03.2001→09.2007		7.22818.57.0	AGR	EL 
1.9 dCi 85-92 kW (115-125 PS) F9Q 750	09.2005→12.2007		7.22818.57.0	AGR	EL 
1.9 dCi (BG05) 66-68 kW (90-92 PS) F9Q 664	03.2004→05.2005		7.00075.07.0	AGR	EL 
			7.00837.01.0	AGR-K	 ohne AGR-Ventil without EGR valve
1.9 dCi (BG08, BG0G) 81-92 kW (110-125 PS) F9Q 670, F9Q 674, F9Q 750	03.2001→09.2007		7.22818.57.0	AGR	EL 
1.9 dCi (BG08, BG0G) 88 kW (120 PS) F9Q 650	03.2001→09.2007		7.00075.07.0	AGR	EL 
			7.00837.01.0	AGR-K	 ohne AGR-Ventil without EGR valve

R









LAGUNA II (BG0/1_) **45**

1.9 dCi (BG0R) 74-79 kW (101-107 PS) F9Q 754	10.2001→05.2005	 7.22818.57.0	AGR	EL	
1.9 dCi (BG12) 85-92 kW (115-125 PS) F9Q 750	09.2005→12.2007	 7.22818.57.0	AGR	EL	
1.9 dCi (BG1A, BG1V) 81-96 kW (110-130 PS) F9Q 758, F9Q 759	05.2005→08.2007	 7.10334.06.0	AGR	EL	
1.9 dCi (BG1A, BG1W) 81-88 kW (110-120 PS) F9Q 674	01.2005→08.2007	 7.22818.57.0	AGR	EL	
1.9 dCi (BG1A, BG1W) 81-96 kW (110-130 PS) F9Q 758	01.2005→08.2007	 7.10334.06.0	AGR	EL	
2.0 16V (BG00, BG0K, BG0P, BG0W) 95-99 kW (129-135 PS) F4R 712, F4R 713, F4R 714, F4R 715	08.2002→12.2007	 7.02604.10.0	LS	560 mm	 F4R 712, F4R 713: Baumuster: BG00, BG0K Type: BG00, BG0K vor Katalysator in front of the catalyst  F4R 714: vor Katalysator in front of the catalyst Produktionsdatum bis: 20.11.2006 Production date to: 20.11.2006  F4R 715: vor Katalysator in front of the catalyst
2.0 dCi (BG14, BG1S) 96-127 kW (131-173 PS) M9R 760	01.2006→08.2007	 7.10334.05.0	AGR	EL	
2.0 dCi (BG1T) 96-110 kW (131-150 PS) M9R 740	08.2005→08.2006	 7.10334.05.0	AGR	EL	
2.2 dCi 102-110 kW (139-150 PS) G9T 706, G9T 707	05.2005→08.2007	 7.22818.59.0	AGR	EL	 Durchmesser Ventilteller/diameter valve head 30 mm
				EL	 Durchmesser Ventilteller/diameter valve head 16 mm
2.2 dCi (BG0F) 83-110 kW (113-150 PS) G9T 702	10.2001→08.2006	 7.22818.59.0	AGR	EL	 Durchmesser Ventilteller/diameter valve head 30 mm
				EL	 Durchmesser Ventilteller/diameter valve head 16 mm

R

LAGUNA II Grandtour (KG0/1_) **46**

1.6 16V 82 kW (112 PS) K4M 716	02.2005→08.2007	 7.02604.10.0	LS	560 mm	für OE-Nummer: 77 00 107 433, 82 00 551 743 for OE number: 77 00 107 433, 82 00 551 743 vor Katalysator in front of the catalyst
1.6 16V (KG0A, KG0L) 76-79 kW (103-107 PS) K4M 710, K4M 714	03.2001→12.2007	 7.02604.10.0	LS	560 mm	 K4M 710: vor Katalysator in front of the catalyst  K4M 714: Baumuster: KG0L Type: KG0L vor Katalysator in front of the catalyst
1.8 16V 85-89 kW (116-121 PS) F4P 770, F4P 774	03.2001→05.2005	 7.02604.10.0	LS	560 mm	 F4P 770: Baumuster: 77 00 107 433 Type: 77 00 107 433 vor Katalysator in front of the catalyst  F4P 774: vor Katalysator in front of the catalyst



LAGUNA II Grandtour (KG0/1_)





46

1.8 16V 85-89 kW (116-121 PS) F4P 770	03.2001→05.2005	 7.02604.10.0	LS	560 mm	Baumuster: KG0V Type: KG0V vor Katalysator in front of the catalyst
1.8 16V (KG0B, KG0M) 85-89 kW (116-121 PS) F4P 770	03.2001→05.2005	 7.02604.10.0	LS	560 mm	Baumuster: KG0B Type: KG0B vor Katalysator in front of the catalyst
1.8 16V (KG0J) 85-89 kW (116-121 PS) F4P 770, F4P 771, F4P 774, F4P 775	03.2001→05.2005	 7.02604.10.0	LS	560 mm	 F4P 770, F4P 771, F4P 774, F4P 775: vor Katalysator in front of the catalyst
1.9 dCi (KG0E) 74-77 kW (101-105 PS) F9Q 752	06.2001→05.2005	 7.22818.57.0	AGR	EL	
1.9 dCi 74-79 kW (101-107 PS) F9Q 754	03.2001→12.2007	 7.22818.57.0	AGR	EL	
1.9 dCi 66-68 kW (90-92 PS) F9Q 664	08.2003→09.2007	 7.00075.07.0 7.00837.01.0	AGR AGR-K	EL	  ohne AGR-Ventil without EGR valve
1.9 dCi 85-92 kW (115-125 PS) F9Q 750	09.2005→12.2007	 7.22818.57.0	AGR	EL	
1.9 dCi (KG05) 66-68 kW (90-92 PS) F9Q 664	03.2004→05.2005	 7.00075.07.0 7.00837.01.0	AGR AGR-K	EL	  ohne AGR-Ventil without EGR valve
1.9 dCi (KG0E, KG0R) 74-77 kW (101-105 PS) F9Q 752	10.2001→05.2005	 7.22818.57.0	AGR	EL	
1.9 dCi (KG0G) 81-92 kW (110-125 PS) F9Q 670, F9Q 674, F9Q 750	03.2001→09.2007	 7.22818.57.0	AGR	EL	
1.9 dCi (KG1A, KG1W) 81-88 kW (110-120 PS) F9Q 674	01.2005→12.2007	 7.22818.57.0	AGR	EL	
1.9 dCi (KG1V) 81-96 kW (110-130 PS) F9Q 758, F9Q 759	05.2005→12.2007	 7.10334.06.0	AGR	EL	
2.0 16V (KG00, KG0K, KG0W, KG0P) 95-99 kW (129-135 PS) F4R 712, F4R 713, F4R 714, F4R 715	08.2002→12.2007	 7.02604.10.0	LS	560 mm	 F4R 712, F4R 713: Baumuster: KG00 Type: KG00 vor Katalysator in front of the catalyst  F4R 714: vor Katalysator in front of the catalyst Produktionsdatum bis: 20.11.2006 Production date to: 20.11.2006  F4R 715: vor Katalysator in front of the catalyst
2.0 dCi (KG1S) 96-127 kW (131-173 PS) M9R 760	01.2006→12.2007	 7.10334.05.0	AGR	EL	
2.0 dCi (KG1T) 96-110 kW (131-150 PS) M9R 740	08.2005→08.2006	 7.10334.05.0	AGR	EL	
2.2 dCi 102-110 kW (139-150 PS) G9T 706, G9T 707	05.2005→12.2007	 7.22818.59.0	AGR	EL	 Durchmesser Ventilteller/diameter valve head 30 mm

















R



LAGUNA II Grandtour (KG0/1_) **46**

		7.22818.63.0	AGR	EL	 Durchmesser Ventilteller/diameter valve head 16 mm
2.2 dCi (KG0F) 83-110 kW (113-150 PS) G9T 702	10.2001→08.2006	 7.22818.59.0	AGR	EL	 Durchmesser Ventilteller/diameter valve head 30 mm
		7.22818.63.0	AGR	EL	 Durchmesser Ventilteller/diameter valve head 16 mm





























LAGUNA III (BT0/1) **47**

1.5 dCi (BT00, BT0A, BT0T, BT1J) 76-81 kW (103-110 PS) K9K 780	10.2007→12.2015	 7.00368.15.0	AGR	EL	
1.5 dCi (BT00, BT0A, BT0T, BT1J) 81 kW (110 PS) K9K 782	10.2007→12.2015	 7.00368.16.0	AGR	EL	
1.6 16V (BT04, BT0D, BT0U) 81 kW (110 PS) K4M 824	10.2007→12.2015	 7.02604.10.0	LS	560 mm	vor Katalysator in front of the catalyst
2.0 dCi (BT01, BT08, BT09, BT0E, BT0K, BT12, BT1C, BT1D,...) 96-110 kW (131-150 PS) M9R 742, M9R 748, M9R 754, M9R 845	10.2007→12.2015	 7.10334.03.0	AGR	EL	
2.0 dCi (BT01, BT08, BT09, BT0E, BT0K, BT12, BT1C, BT1D,...) 96-110 kW (131-150 PS) M9R 802, M9R 805, M9R 808	10.2007→12.2015	 7.10334.03.0	AGR	EL	 M9R 802, M9R 805, M9R 808: für OE-Nummer: 14 71 003 85R, 14 71 055 43R, 82 00 796 674 for OE number: 14 71 003 85R, 14 71 055 43R, 82 00 796 674
		7.10334.05.0	AGR	EL	 M9R 802, M9R 805, M9R 808: für OE-Nummer: 82 00 327 004, 82 00 691 292, 82 00 693 739, 82 00 797 706 for OE number: 82 00 327 004, 82 00 691 292, 82 00 693 739, 82 00 797 706
2.0 dCi (BT01, BT08, BT09, BT0E, BT0K, BT12, BT1C, BT1D,...) 96-127 kW (131-173 PS) M9R 814, M9R 858	10.2007→12.2015	 7.10334.03.0	AGR	EL	
		7.02604.41.0	LS	700 mm	 M9R 814, M9R 858: 10.2011→ für OE-Nummer: 22 6A 471 42R for OE number: 22 6A 471 42R vor Katalysator in front of the catalyst
		7.02604.44.0	LS	500 mm	 M9R 814, M9R 858: für OE-Nummer: 22 69 3JG 70A for OE number: 22 69 3JG 70A vor Katalysator in front of the catalyst
2.0 dCi (BT01, BT08, BT09, BT0E, BT0K, BT12, BT1C, BT1D,...) 96-127 kW (131-173 PS) M9R 854	10.2007→12.2015	 7.10334.03.0	AGR	EL	
		7.02604.41.0	LS	700 mm	10.2011→ vor Katalysator in front of the catalyst
2.0 dCi (BT07, BT0J, BT14, BT1A, BT1S) 96-110 kW (131-150 PS) M9R 742	10.2007→12.2015	 7.10334.03.0	AGR	EL	

R











LAGUNA III (BT0/1) 47

2.0 dCi (BT07, BT0J, BT14, BT1A, BT1S) 96-110 kW (131-150 PS) M9R 802	10.2007→12.2015	 7.10334.03.0	AGR	EL	 für OE-Nummer: 14 71 003 85R, 14 71 055 43R, 82 00 796 674 for OE number: 14 71 003 85R, 14 71 055 43R, 82 00 796 674
		 7.10334.05.0	AGR	EL	 für OE-Nummer: 82 00 327 004, 82 00 691 292, 82 00 693 739, 82 00 797 706 for OE number: 82 00 327 004, 82 00 691 292, 82 00 693 739, 82 00 797 706
2.0 dCi (BT07, BT0J, BT14, BT1A, BT1S) 96-127 kW (131-173 PS) M9R 814, M9R 858	10.2007→12.2015	 7.10334.03.0	AGR	EL	
		 7.02604.41.0	LS	700 mm	 M9R 814, M9R 858: 10.2011→ für OE-Nummer: 22 6A 471 42R for OE number: 22 6A 471 42R vor Katalysator in front of the catalyst
		 7.02604.44.0	LS	500 mm	 M9R 814, M9R 858: für OE-Nummer: 22 69 3JG 70A for OE number: 22 69 3JG 70A vor Katalysator in front of the catalyst
2.0 dCi (BT07, BT0J, BT14, BT1A, BT1S) 96-127 kW (131-173 PS) M9R 854	10.2007→12.2015	 7.10334.03.0	AGR	EL	
		 7.02604.41.0	LS	700 mm	10.2011→ vor Katalysator in front of the catalyst
2.0 dCi (BT0M, BT0N, BT0S, BT19, BT1F) 96-127 kW (131-173 PS) M9R 854, M9R 857	01.2008→12.2015	 7.10334.03.0	AGR	EL	
		 7.02604.41.0	LS	700 mm	 M9R 854, M9R 857: 10.2011→ vor Katalysator in front of the catalyst
2.0 dCi (BT0M, BT0N, BT0S, BT19, BT1F) 96-127 kW (131-173 PS) M9R 858	01.2008→12.2015	 7.10334.03.0	AGR	EL	
		 7.02604.41.0	LS	700 mm	10.2011→ für OE-Nummer: 22 6A 471 42R for OE number: 22 6A 471 42R vor Katalysator in front of the catalyst
		 7.02604.44.0	LS	500 mm	 für OE-Nummer: 22 69 3JG 70A for OE number: 22 69 3JG 70A vor Katalysator in front of the catalyst
2.0 dCi (BT0M, BT0N, BT0S, BT19, BT1F) 110-127 kW (150-173 PS) M9R 815	01.2008→12.2015	 7.10334.03.0	AGR	EL	
		 7.02604.44.0	LS	500 mm	für OE-Nummer: 22 69 3JG 70A for OE number: 22 69 3JG 70A vor Katalysator in front of the catalyst
2.0 dCi (BT0M, BT0N, BT0S, BT19, BT1F) 127 kW (173 PS) M9R 800	01.2008→12.2015	 7.10334.05.0	AGR	EL	
2.0 dCi (BT0M, BT0N, BT0S, BT19, BT1F) 127 kW (173 PS) M9R 806, M9R 809	01.2008→12.2015	 7.10334.03.0	AGR	EL	 M9R 806, M9R 809: für OE-Nummer: 14 71 003 85R, 14 71 055 43R, 82 00 796 674 for OE number: 14 71 003 85R, 14 71 055 43R, 82 00 796 674













R





























LAGUNA III (BT0/1) **47**

			7.10334.05.0	AGR	EL	 M9R 806, M9R 809: für OE-Nummer: 82 00 327 004, 82 00 691 292, 82 00 693 739, 82 00 797 706 for OE number: 82 00 327 004, 82 00 691 292, 82 00 693 739, 82 00 797 706
2.0 dCi GT (BT11, BT1E, BT1N) 127-132 kW (173-180 PS) M9R 816	03.2008→12.2015		7.10334.03.0	AGR	EL	 für OE-Nummer: 14 71 003 85R, 14 71 055 43R, 82 00 796 674 for OE number: 14 71 003 85R, 14 71 055 43R, 82 00 796 674
			7.10334.05.0	AGR	EL	 für OE-Nummer: 82 00 327 004, 82 00 691 292, 82 00 693 739, 82 00 797 706 for OE number: 82 00 327 004, 82 00 691 292, 82 00 693 739, 82 00 797 706
2.0 dCi GT (BT11, BT1E, BT1N) 131 kW (178 PS) M9R 820, M9R 828	03.2008→12.2015		7.10334.03.0	AGR	EL	
			7.02604.41.0	LS	700 mm	 M9R 820, M9R 828: 10.2011→ vor Katalysator in front of the catalyst
3.0 dCi (BT03, BT13) 173-195 kW (235-265 PS) V9X 791, V9X 891	09.2008→12.2015		7.00999.08.0	AGR	EL	

LAGUNA III Grandtour (KT0/1) **48**













R	1.5 dCi (KT0A) 76-81 kW (103-110 PS) K9K 780	10.2007→12.2015		7.00368.15.0	AGR	EL	
	1.5 dCi (KT0A) 81 kW (110 PS) K9K 782	10.2007→12.2015		7.00368.16.0	AGR	EL	
	1.6 16V (KT0D) 81 kW (110 PS) K4M 824	10.2007→12.2015		7.02604.10.0	LS	560 mm	vor Katalysator in front of the catalyst
	2.0 dCi (KT01, KT08, KT09, KT0K, KT12, KT1D, KT1W) 96-110 kW (131-150 PS) M9R 742, M9R 845	10.2007→12.2015		7.10334.03.0	AGR	EL	
	2.0 dCi (KT01, KT08, KT09, KT0K, KT12, KT1D, KT1W) 96-110 kW (131-150 PS) M9R 802, M9R 805, M9R 808	10.2007→12.2015		7.10334.03.0	AGR	EL	 M9R 802, M9R 805, M9R 808: für OE-Nummer: 14 71 003 85R, 14 71 055 43R, 82 00 796 674 for OE number: 14 71 003 85R, 14 71 055 43R, 82 00 796 674
				7.10334.05.0	AGR	EL	 M9R 802, M9R 805, M9R 808: für OE-Nummer: 82 00 327 004, 82 00 691 292, 82 00 693 739, 82 00 797 706 for OE number: 82 00 327 004, 82 00 691 292, 82 00 693 739, 82 00 797 706
	2.0 dCi (KT01, KT08, KT09, KT0K, KT12, KT1D, KT1W) 96-127 kW (131-173 PS) M9R 814, M9R 858	10.2007→12.2015		7.10334.03.0	AGR	EL	
7.02604.41.0				LS	700 mm	 M9R 814, M9R 858: 10.2011→ für OE-Nummer: 22 6A 471 42R for OE number: 22 6A 471 42R vor Katalysator in front of the catalyst	
7.02604.44.0				LS	500 mm	 M9R 814, M9R 858: für OE-Nummer: 22 69 3JG 70A for OE number: 22 69 3JG 70A vor Katalysator in front of the catalyst	

					
LAGUNA III Grandtour (KT0/1)					
2.0 dCi (KT01, KT08, KT09, KT0K, KT12, KT1D, KT1W) 96-127 kW (131-173 PS) M9R 854	10.2007→12.2015		7.10334.03.0	AGR	EL 
			7.02604.41.0	LS	700 mm 10.2011→ vor Katalysator in front of the catalyst
2.0 dCi (KT07, KT0J, KT14, KT1A, KT1S) 96-110 kW (131-150 PS) M9R 742	10.2007→12.2015		7.10334.03.0	AGR	EL 
2.0 dCi (KT07, KT0J, KT14, KT1A, KT1S) 96-110 kW (131-150 PS) M9R 802	10.2007→12.2015		7.10334.03.0	AGR	EL  für OE-Nummer: 14 71 003 85R, 14 71 055 43R, 82 00 796 674 for OE number: 14 71 003 85R, 14 71 055 43R, 82 00 796 674
			7.10334.05.0	AGR	EL  für OE-Nummer: 82 00 327 004, 82 00 691 292, 82 00 693 739, 82 00 797 706 for OE number: 82 00 327 004, 82 00 691 292, 82 00 693 739, 82 00 797 706
2.0 dCi (KT07, KT0J, KT14, KT1A, KT1S) 96-127 kW (131-173 PS) M9R 814, M9R 858	10.2007→12.2015		7.10334.03.0	AGR	EL 
			7.02604.41.0	LS	700 mm  M9R 814, M9R 858: 10.2011→ für OE-Nummer: 22 6A 471 42R for OE number: 22 6A 471 42R vor Katalysator in front of the catalyst
			7.02604.44.0	LS	500 mm  M9R 814, M9R 858: für OE-Nummer: 22 69 3JG 70A for OE number: 22 69 3JG 70A vor Katalysator in front of the catalyst
2.0 dCi (KT07, KT0J, KT14, KT1A, KT1S) 96-127 kW (131-173 PS) M9R 854	10.2007→12.2015		7.10334.03.0	AGR	EL 
			7.02604.41.0	LS	700 mm 10.2011→ vor Katalysator in front of the catalyst
2.0 dCi (KT0M, KT0N, KT0S, KT19, KT1F) 96-127 kW (131-173 PS) M9R 854, M9R 857, M9R 858	01.2008→12.2015		7.10334.03.0	AGR	EL 
			7.02604.41.0	LS	700 mm  M9R 854, M9R 857: 10.2011→ vor Katalysator in front of the catalyst  M9R 858: 10.2011→ für OE-Nummer: 22 6A 471 42R for OE number: 22 6A 471 42R vor Katalysator in front of the catalyst
2.0 dCi (KT0M, KT0N, KT0S, KT19, KT1F) 110-127 kW (150-173 PS) M9R 815	01.2008→12.2015		7.10334.03.0	AGR	EL 
			7.02604.41.0	LS	700 mm 10.2011→ für OE-Nummer: 22 6A 471 42R for OE number: 22 6A 471 42R vor Katalysator in front of the catalyst
			7.02604.44.0	LS	500 mm für OE-Nummer: 22 69 3JG 70A for OE number: 22 69 3JG 70A vor Katalysator in front of the catalyst
2.0 dCi (KT0M, KT0N, KT0S, KT19, KT1F) 110-127 kW (150-173 PS) M9R 849	01.2008→12.2015		7.10334.03.0	AGR	EL 















R





























LAGUNA III Grandtour (KT0/1) **48**

2.0 dCi (KT0M, KT0N, KT0S, KT19, KT1F) 127 kW (173 PS) M9R 800	01.2008→12.2015		7.10334.05.0	AGR	EL	
2.0 dCi (KT0M, KT0N, KT0S, KT19, KT1F) 127 kW (173 PS) M9R 806, M9R 809	01.2008→12.2015		7.10334.03.0	AGR	EL	 M9R 806, M9R 809: für OE-Nummer: 14 71 003 85R, 14 71 055 43R, 82 00 796 674 for OE number: 14 71 003 85R, 14 71 055 43R, 82 00 796 674
			7.10334.05.0	AGR	EL	 M9R 806, M9R 809: für OE-Nummer: 82 00 327 004, 82 00 691 292, 82 00 693 739, 82 00 797 706 for OE number: 82 00 327 004, 82 00 691 292, 82 00 693 739, 82 00 797 706
2.0 dCi GT (KT11, KT1E, KT1N) 127-132 kW (173-180 PS) M9R 816	03.2008→12.2015		7.10334.03.0	AGR	EL	 für OE-Nummer: 14 71 003 85R, 14 71 055 43R, 82 00 796 674 for OE number: 14 71 003 85R, 14 71 055 43R, 82 00 796 674
			7.10334.05.0	AGR	EL	 für OE-Nummer: 82 00 327 004, 82 00 691 292, 82 00 693 739, 82 00 797 706 for OE number: 82 00 327 004, 82 00 691 292, 82 00 693 739, 82 00 797 706
2.0 dCi GT (KT11, KT1E, KT1N) 131 kW (178 PS) M9R 820, M9R 828	03.2008→12.2015		7.10334.03.0	AGR	EL	
			7.02604.41.0	LS	700 mm	 M9R 820, M9R 828: 10.2011→ vor Katalysator in front of the catalyst
3.0 dCi (KT03, KT13) 173-195 kW (235-265 PS) V9X 791, V9X 891	09.2008→12.2015		7.00999.08.0	AGR	EL	

LATITUDE (L70_) **49**

1.5 dCi (L70R, L731) 81 kW (110 PS) K9K 782	07.2010→		7.00368.16.0	AGR	EL	
2.0 dCi 130 96 kW (131 PS) M9R 756	12.2013→		7.10334.03.0	AGR	EL	
			7.02604.41.0	LS	700 mm	vor Katalysator in front of the catalyst
2.0 dCi 150 (L70H) 110 kW (150 PS) M9R 824	02.2011→		7.10334.03.0	AGR	EL	
2.0 dCi 150 (L70H) 110 kW (150 PS) M9R 846	02.2011→		7.10334.03.0	AGR	EL	
			7.02604.41.0	LS	700 mm	10.2011→ vor Katalysator in front of the catalyst
2.0 dCi 175 (L70Y) 127 kW (173 PS) M9R 817	05.2011→		7.10334.03.0	AGR	EL	
2.0 dCi 175 (L70Y) 127 kW (173 PS) M9R 844	05.2011→		7.10334.03.0	AGR	EL	
			7.02604.41.0	LS	700 mm	vor Katalysator in front of the catalyst
3.0 dCi 240 (L70G) 173-195 kW (235-265 PS) V9X 891	02.2011→		7.00999.08.0	AGR	EL	



R

						
LODGY (JS_)						50
1.5 dCi 60-66 kW (82-90 PS) K9K 830	01.2015→		7.00368.15.0	AGR	EL	
1.5 dCi 70-81 kW (95-110 PS) K9K 846	04.2015→12.2019		7.00368.16.0	AGR	EL	
LOGAN I (LS_)						51
1.4 55 kW (75 PS) K7J 710	09.2004→		7.05270.54.0	LS	450 mm	für OE-Nummer: 82 00 052 063 for OE number: 82 00 052 063 vor Katalysator in front of the catalyst Produktionsdatum bis: 05.12.2006 Production date to: 05.12.2006
1.5 dCi 50 kW (68 PS) K9K 792	04.2007→		7.00368.15.0	AGR	EL	
1.5 dCi 63 kW (86 PS) K9K 796	02.2008→06.2015		7.00368.15.0	AGR	EL	
1.5 dCi 45-50 kW (61-68 PS) K9K 700, K9K 790, K9K 794	06.2011→		7.22818.58.0	AGR	EL	
1.6 64-76 kW (87-103 PS) K7M 710	09.2004→		7.05270.54.0	LS	450 mm	vor Katalysator in front of the catalyst Produktionsdatum bis: 05.12.2006 Production date to: 05.12.2006
1.6 75-85 kW (102-116 PS) K4M 690	04.2007→		7.05270.54.0	LS	450 mm	für OE-Nummer: 60 01 549 007, 82 00 052 063 for OE number: 60 01 549 007, 82 00 052 063 vor Katalysator in front of the catalyst
1.6 (LS0L, LS09, LS0V, LS0P, LS18, LS1S, LS1V, LS1Y,...) 75-85 kW (102-116 PS) K4M 690	04.2007→10.2013		7.05270.54.0	LS	450 mm	für OE-Nummer: 60 01 549 007, 82 00 052 063 for OE number: 60 01 549 007, 82 00 052 063 vor Katalysator in front of the catalyst
LOGAN I Estate (KS_)						52
1.5 dCi 50 kW (68 PS) K9K 792	04.2007→		7.00368.15.0	AGR	EL	
1.5 dCi 63 kW (86 PS) K9K 796	02.2008→06.2015		7.00368.15.0	AGR	EL	
1.6 (KS0L, KS0M, KS0P, KS1S) 75-85 kW (102-116 PS) K4M 690	04.2007→		7.05270.54.0	LS	450 mm	für OE-Nummer: 60 01 549 007, 82 00 052 063 for OE number: 60 01 549 007, 82 00 052 063 vor Katalysator in front of the catalyst
LOGAN II Estate (K8_)						53
1.5 dCi 60-62 kW (82-84 PS) K9K 838	12.2013→		7.00368.15.0	AGR	EL	
LOGAN/STEPWAY II (L8_)						54
1.5 dCi 60-62 kW (82-84 PS) K9K 838	12.2013→		7.00368.15.0	AGR	EL	
MEGANE CC (EZ0/1_)						55
1.5 dCi (EZ09, EZ1G, EZ0D) 81 kW (110 PS) K9K 837	06.2010→		7.00368.16.0	AGR	EL	
1.6 dCi (EZ00) 96 kW (130 PS) R9M 402	04.2011→		7.24809.90.0 7.03571.16.0 ↳ 7.03083.20.0 7.02604.99.0	AGR AK SRM-AK LS	EL EL EL 400 mm	 03.2014→07.2015





















R



































MEGANE CC (EZ0/1_) **55**

1.9 dCi (EZ0J, EZ1S) 96 kW (131 PS) F9Q 870	06.2010→		7.11237.05.0	AGR-K	EL	→02.2012
2.0 dCi (EZ0L) 118-120 kW (160-163 PS) M9R 610	06.2010→		7.10334.03.0	AGR	EL	
			7.02604.99.0	LS	400 mm	

MEGANE I (BA0/1_) **56**

1.4 16V (BA0D, BA1H, BA0W, BA10) 70 kW (95 PS) K4J 714, K4J 750	03.1999→08.2003		7.02604.10.0	LS	560 mm	 K4J 714: vor Katalysator in front of the catalyst nicht für Baumuster: BA10 not for code: BA10  K4J 750: vor Katalysator in front of the catalyst
1.4 e (BA0E, BA0V) 55 kW (75 PS) E7J 626	01.1996→08.2003		7.05270.56.0	LS	275 mm	→10.2000 Regelsonde Regulating Probe
1.4 e (BA0E, BA0V) 55 kW (75 PS) E7J 764	01.1996→08.2003		7.05270.51.0	LS	375 mm	
1.6 16V (BA04, BA0B, BA11, BA1J, BA16, BA19, BA1K, BA1V,...) 69-85 kW (94-116 PS) K4M 700, K4M 701, K4M 706, K4M 708, K4M 709	03.1999→08.2002		7.02604.10.0	LS	560 mm	 K4M 700, K4M 701: Baumuster: BA04, BA0B, BA11 Type: BA04, BA0B, BA11 vor Katalysator in front of the catalyst  K4M 706: vor Katalysator in front of the catalyst  K4M 706: nach Katalysator Post-catalyst Produktionsdatum ab: 04.03.2002 Production date from: 04.03.2002  K4M 708: Baumuster: BA0B, BA11, BA1J Type: BA0B, BA11, BA1J vor Katalysator in front of the catalyst  K4M 709: Baumuster: BA0B, BA1J Type: BA0B, BA1J vor Katalysator in front of the catalyst
1.6 e (BA0F, BA0S) 66 kW (90 PS) K7M 702, K7M 703, K7M 790	01.1996→03.1999		7.05270.51.0	LS	375 mm	
			7.02604.03.0	LS	200 mm	
1.6 i (BA0L) 55 kW (75 PS) K7M 720	01.1996→03.1999		7.05270.51.0	LS	375 mm	
			7.02604.03.0	LS	200 mm	
1.8 16V (BA06, BA12, BA1A, BA1M, BA1R) 85 kW (115 PS) F4P 720, F4P 722	01.2001→08.2003		7.02604.10.0	LS	560 mm	 F4P 720: vor Katalysator in front of the catalyst nicht für Baumuster: BA06, BA1M not for code: BA06, BA1M  F4P 722: Baumuster: BA1M Type: BA1M vor Katalysator in front of the catalyst
1.9 D Eco (BA0A, BA0U, BA0R) 47 kW (64 PS) F8Q 622	01.1996→08.2003		7.22818.57.0	AGR	EL	
1.9 DCi 59-79 kW (80-107 PS) F9Q 732, F9Q 738	03.1999→08.2003		7.22818.57.0	AGR	EL	













R

					
MEGANE I (BA0/1_)					56
1.9 dCi (BA05, BA1F) 74-77 kW (101-105 PS) F9Q 732, F9Q 733	02.2001→08.2003		7.22818.57.0	AGR	EL 
1.9 dTi (BA1U) 59 kW (80 PS) F9Q 744	02.2001→08.2003		7.22818.57.0	AGR	EL 
MEGANE I Cabriolet (EA0/1_)					57
1.4 16V (EA0D, EA1H, EA0W, EA10) 70 kW (95 PS) K4J 714, K4J 750	03.1999→08.2003		7.02604.10.0	LS	560 mm  K4J 714: vor Katalysator in front of the catalyst nicht für Baumuster: EA0W not for code: EA0W  K4J 750: vor Katalysator in front of the catalyst
1.6 16V (EA04, EA0B, EA11, EA1J) 75-85 kW (102-116 PS) K4M 700, K4M 701, K4M 708, K4M 709	03.1999→07.2003		7.02604.10.0	LS	560 mm  K4M 700: nicht für Baumuster: EA1J not for code: EA1J  K4M 701: vor Katalysator in front of the catalyst nicht für Baumuster: EA1J not for code: EA1J  K4M 708: vor Katalysator in front of the catalyst  K4M 709: Baumuster: EA0B, EA1J Type: EA0B, EA1J vor Katalysator in front of the catalyst
1.6 e (EA0F) 66 kW (90 PS) K7M 702, K7M 703	10.1996→03.1999		7.05270.51.0	LS	375 mm
			7.02604.03.0	LS	200 mm
2.0 16V 102-103 kW (139-140 PS) F4R 746	01.2002→08.2003		7.02604.10.0	LS	560 mm vor Katalysator in front of the catalyst
MEGANE I Classic (LA0/1_)					58
1.4 (LA0E, LA0V) 55 kW (75 PS) E7J 626	09.1996→08.2003		7.05270.56.0	LS	275 mm 03.1999→10.2000 Regelsonde Regulating Probe
1.4 (LA0E, LA0V) 55 kW (75 PS) E7J 764	09.1996→08.2003		7.05270.51.0	LS	375 mm
1.4 16V (LA0D, LA1H, IA0W, LA10) 70 kW (95 PS) K4J 714, K4J 750	03.1999→08.2003		7.02604.10.0	LS	560 mm  K4J 714: vor Katalysator in front of the catalyst nicht für Baumuster: LA0W not for code: LA0W  K4J 750: vor Katalysator in front of the catalyst
1.6 16V (LA00, LA04, LA0B, LA11, LA16, LA19, LA1J, LA1K,...) 69-85 kW (94-116 PS) K4M 700, K4M 701, K4M 706, K4M 708, K4M 709	03.1999→07.2003		7.02604.10.0	LS	560 mm  K4M 700, K4M 701: Baumuster: LA04, LA0B, LA11 Type: LA04, LA0B, LA11 vor Katalysator in front of the catalyst  K4M 706: vor Katalysator in front of the catalyst  K4M 706: für OE-Nummer: 04.03.2002 for OE number: 04.03.2002 nach Katalysator Post-catalyst  K4M 708: Baumuster: LA0B, LA11, LA1J Type: LA0B, LA11, LA1J vor Katalysator in front of the catalyst  K4M 709: Baumuster: LA0B, LA1J Type: LA0B, LA1J vor Katalysator in front of the catalyst
1.6 e (LA0F, LA0S) 66 kW (90 PS) K7M 702, K7M 703, K7M 790	09.1996→03.1999		7.05270.51.0	LS	375 mm













R







MEGANE I Classic (LA0/1_) 58

			7.02604.03.0	LS	200 mm	
1.6 i (LA0L) 55 kW (75 PS) K7M 720	09.1996→03.1999		7.05270.51.0	LS	375 mm	
1.8 16V (LA06, LA12, LA1A, LA1M, LA1R) 85 kW (115 PS) F4P 720, F4P 722	01.2001→08.2003		7.02604.10.0	LS	560 mm	 F4P 720: vor Katalysator in front of the catalyst nicht für Baumuster: LA06, LA1M not for code: LA06, LA1M  F4P 722: Baumuster: LA1M Type: LA1M vor Katalysator in front of the catalyst
1.9 D (LA0A, LA0U, LA0R) 47 kW (64 PS) F8Q 622	09.1996→08.2003		7.22818.57.0	AGR	EL	
1.9 dCi (LA05) 74-77 kW (101-105 PS) F9Q 732, F9Q 733	03.1999→07.2003		7.22818.57.0	AGR	EL	
1.9 dCi (LA05, LA1F) 59-79 kW (80-107 PS) F9Q 732, F9Q 733, F9Q 738	02.2001→08.2003		7.22818.57.0	AGR	EL	
1.9 dTi (LA1U) 59 kW (80 PS) F9Q 744	02.2001→08.2003		7.22818.57.0	AGR	EL	

































MEGANE I Coach (DA0/1_) 59

1.4 16V (DA0D, DA1H, DA0W, DA10) 70 kW (95 PS) K4J 714, K4J 750	03.1999→07.2003		7.02604.10.0	LS	560 mm	 K4J 714: vor Katalysator in front of the catalyst nicht für Baumuster: DA0W not for code: DA0W  K4J 750: vor Katalysator in front of the catalyst nicht für Baumuster: DA1H not for code: DA1H
1.6 16V (DA0B, DA04, DA11) 75-85 kW (102-116 PS) K4M 700, K4M 701, K4M 708, K4M 709	03.1999→07.2003		7.02604.10.0	LS	560 mm	 K4M 700, K4M 701: vor Katalysator in front of the catalyst  K4M 708: vor Katalysator in front of the catalyst nicht für Baumuster: DA04 not for code: DA04  K4M 709: Baumuster: DA0B Type: DA0B vor Katalysator in front of the catalyst
1.6 e (DA0F) 66 kW (90 PS) K7M 702, K7M 703	03.1996→03.1999		7.05270.51.0	LS	375 mm	
			7.02604.03.0	LS	200 mm	
1.9 DCi 74-77 kW (101-105 PS) F9Q 732, F9Q 733	03.1999→09.2000		7.22818.57.0	AGR	EL	
1.9 dCi (DA05, DA1F) 74-77 kW (101-105 PS) F9Q 732, F9Q 733	02.2001→08.2003		7.22818.57.0	AGR	EL	
2.0 16V 102-103 kW (139-140 PS) F4R 746	01.2002→08.2003		7.02604.10.0	LS	560 mm	vor Katalysator in front of the catalyst

MEGANE I Grandtour (KA0/1_) 60

1.4 16V (KA0D, KA1H, KA0W, KA10) 70 kW (95 PS) K4J 714, K4J 750	03.1999→08.2003		7.02604.10.0	LS	560 mm	 K4J 714: vor Katalysator in front of the catalyst nicht für Baumuster: KA0W not for code: KA0W  K4J 750: vor Katalysator in front of the catalyst nicht für Baumuster: KA1H not for code: KA1H
1.4 e (KA0V) 55 kW (75 PS) E7J 626	03.1999→08.2003		7.05270.56.0	LS	275 mm	















R

					
MEGANE I Grandtour (KA0/1_)					60
1.6 16V (KA0B, KA04, KA11) 75-85 kW (102-116 PS) K4M 700, K4M 701, K4M 708, K4M 709	03.1999→08.2003		7.02604.10.0	LS	560 mm  K4M 700, K4M 701, K4M 709: vor Katalysator in front of the catalyst  K4M 708: Baumuster: KA0B Type: KA0B vor Katalysator in front of the catalyst
1.6 e (KA0F) 66 kW (90 PS) K7M 702	03.1999→08.2003		7.05270.51.0	LS	375 mm →10.2000
1.8 16V (KA0S, KA12, KA1A, KA1M, KA1R) 85 kW (115 PS) F4P 720, F4P 722	01.2001→08.2003		7.02604.10.0	LS	560 mm  F4P 720: vor Katalysator in front of the catalyst nicht für Baumuster: KA0S, KA1M not for code: KA0S, KA1M  F4P 722: Baumuster: KA12, KA1M Type: KA12, KA1M vor Katalysator in front of the catalyst
1.9 D (KA0J, KA0R) 47 kW (64 PS) F8Q 622	04.1999→08.2003		7.22818.57.0	AGR	EL 
1.9 dCi 74-77 kW (101-105 PS) F9Q 732	03.1999→09.2000		7.22818.57.0	AGR	EL 
1.9 dCi (KA05, KA1F) 59-79 kW (80-107 PS) F9Q 732, F9Q 733, F9Q 738	02.2001→08.2003		7.22818.57.0	AGR	EL 
1.9 dTi (KA1U) 59 kW (80 PS) F9Q 744	02.2001→08.2003		7.22818.57.0	AGR	EL 
MEGANE II (BM0/1_, CM0/1_)					61
1.4 16V 60 kW (82 PS) K4J 732	10.2003→02.2008		7.02604.10.0	LS	560 mm vor Katalysator, nach Katalysator in front of the catalyst, Post-catalyst
1.4 16V (BM0B, CM0B) 72 kW (98 PS) K4J 730, K4J 740	11.2002→02.2008		7.02604.10.0	LS	560 mm  K4J 730: vor Katalysator, nach Katalysator in front of the catalyst, Post-catalyst  K4J 740: für OE-Nummer: 77 00 107 433, 82 00 551 743 for OE number: 77 00 107 433, 82 00 551 743 vor Katalysator, nach Katalysator in front of the catalyst, Post-catalyst
1.5 dCi (BM02, BM13, BM2A, CM02, CM13) 74-78 kW (101-106 PS) K9K 728, K9K 729	10.2003→02.2008		7.22818.58.0	AGR	EL 
1.5 dCi (BM0F, BM0T, BM2B, CM0F, CM0T) 60-63 kW (82-86 PS) K9K 722	09.2002→02.2008		7.22818.58.0	AGR	EL 
1.5 dCi (BM16, CM16) 74-78 kW (103-106 PS) K9K 734	01.2007→03.2009		7.00368.15.0	AGR	EL
1.5 dCi (BM1E, CM1E) 78 kW (106 PS) K9K 732	05.2005→06.2008		7.00368.15.0	AGR	EL
1.5 dCi (BM1F, CM1F) 63 kW (86 PS) K9K 724	05.2005→02.2008		7.00368.15.0	AGR	EL
1.6 77 kW (105 PS) K4M 788	06.2005→02.2008		7.02604.10.0	LS	560 mm für OE-Nummer: 77 00 107 433, 82 00 551 743 for OE number: 77 00 107 433, 82 00 551 743 vor Katalysator, nach Katalysator in front of the catalyst, Post-catalyst









R



MEGANE II (BM0/1_, CM0/1_) 61

1.6 16V 81-83 kW (110-113 PS) K4M 760, K4M 812, K4M 813	01.2006→06.2008	 7.02604.10.0	LS	560 mm	 K4M 760: Baumuster: BM0J, BM1B, CM0J, CM1B Type: BM0J, BM1B, CM0J, CM1B vor Katalysator, nach Katalysator in front of the catalyst, Post-catalyst  K4M 812, K4M 813: für OE-Nummer: 77 00 107 433, 82 00 551 743 for OE number: 77 00 107 433, 82 00 551 743 vor Katalysator, nach Katalysator in front of the catalyst, Post-catalyst
1.6 Flex-Fuel 77 kW (105 PS) K4M 788	01.2007→02.2008	 7.02604.10.0	LS	560 mm	für OE-Nummer: 77 00 107 433, 82 00 551 743 for OE number: 77 00 107 433, 82 00 551 743 vor Katalysator, nach Katalysator in front of the catalyst, Post-catalyst
1.9 dCi 66-75 kW (90-102 PS) F9Q 808	11.2002→12.2005	 7.00075.07.0 7.00837.01.0	AGR AGR-K	EL	  ohne AGR-Ventil without EGR valve
1.9 dCi 66-75 kW (90-102 PS) F9Q 808	03.2004→08.2006	 7.00075.07.0 7.00837.01.0	AGR AGR-K	EL	  ohne AGR-Ventil without EGR valve
1.9 dCi (BM0G, CM0G) 88 kW (120 PS) F9Q 800	11.2002→02.2008	 7.22818.62.0	AGR	EL	
2.0 16V (BM0U, CM0U) 99-103 kW (135-140 PS) F4R 770	11.2002→02.2008	 7.02604.10.0	LS	560 mm	für OE-Nummer: 82 00 551 743 for OE number: 82 00 551 743 vor Katalysator, nach Katalysator in front of the catalyst, Post-catalyst
2.0 dCi (BM1K, CM1K) 110 kW (150 PS) M9R 700	09.2005→02.2008	 7.10334.05.0	AGR	EL	

MEGANE II Coupé-Cabriolet (EM0/1_) 62





1.5 dCi (EM16) 74-78 kW (103-106 PS) K9K 734	01.2007→06.2009	 7.00368.15.0	AGR	EL	
1.5 dCi (EM1E) 78 kW (106 PS) K9K 732	03.2006→01.2009	 7.00368.15.0	AGR	EL	
1.6 81-83 kW (110-113 PS) K4M 760, K4M 761	09.2003→03.2009	 7.02604.10.0	LS	560 mm	 K4M 760, K4M 761: Baumuster: EM0J, EM1B Type: EM0J, EM1B vor Katalysator, nach Katalysator in front of the catalyst, Post-catalyst
1.6 16V 81-83 kW (110-113 PS) K4M 760, K4M 812, K4M 813	01.2006→06.2008	 7.02604.10.0	LS	560 mm	 K4M 760: Baumuster: EM0J, EM1B Type: EM0J, EM1B vor Katalysator, nach Katalysator in front of the catalyst, Post-catalyst  K4M 812, K4M 813: für OE-Nummer: 77 00 107 433, 82 00 551 743 for OE number: 77 00 107 433, 82 00 551 743 vor Katalysator, nach Katalysator in front of the catalyst, Post-catalyst
1.9 dCi 88 kW (120 PS) F9Q 800	09.2003→03.2009	 7.22818.62.0	AGR	EL	

R





















MEGANE II Coupé-Cabriolet (EM0/1_)

62

2.0 99-103 kW (135-140 PS) F4R 770, F4R 771	09.2003→12.2009	 7.02604.10.0	LS	560 mm	 F4R 770, F4R 771: für OE-Nummer: 77 00 107 433, 82 00 551 743 for OE number: 77 00 107 433, 82 00 551 743 vor Katalysator, nach Katalysator in front of the catalyst, Post-catalyst
2.0 99-103 kW (135-140 PS) F4R 770	09.2003→02.2007	 7.02604.10.0	LS	560 mm	für OE-Nummer: 77 00 107 433 for OE number: 77 00 107 433 vor Katalysator, nach Katalysator in front of the catalyst, Post-catalyst
2.0 dCi 110 kW (150 PS) M9R 700	09.2005→03.2009	 7.10334.05.0	AGR	EL	

MEGANE II Estate (KM0/1_)





63

1.4 72 kW (98 PS) K4J 730, K4J 740	08.2003→07.2009	 7.02604.10.0	LS	560 mm	 K4J 730: vor Katalysator, nach Katalysator in front of the catalyst, Post-catalyst  K4J 740: für OE-Nummer: 77 00 107 433, 82 00 551 743 for OE number: 77 00 107 433, 82 00 551 743 vor Katalysator, nach Katalysator in front of the catalyst, Post-catalyst
1.5 dCi (KM02, KM13) 74-78 kW (101-106 PS) K9K 728, K9K 729	02.2004→03.2006	 7.22818.58.0	AGR	EL	
1.5 dCi (KM0F, KM0T, KM2B) 60-63 kW (82-86 PS) K9K 722	08.2003→05.2006	 7.22818.58.0	AGR	EL	
1.5 dCi (KM16) 74-78 kW (103-106 PS) K9K 734	01.2007→07.2009	 7.00368.15.0	AGR	EL	
1.5 dCi (KM16, KM1E) 78 kW (106 PS) K9K 732	05.2005→06.2008	 7.00368.15.0	AGR	EL	
1.5 dCi (KM1F) 63 kW (86 PS) K9K 724	05.2005→07.2009	 7.00368.15.0	AGR	EL	
1.6 81-83 kW (110-113 PS) K4M 760, K4M 761	08.2003→07.2009	 7.02604.10.0	LS	560 mm	 K4M 760, K4M 761: Baumuster: KM1B Type: KM1B vor Katalysator, nach Katalysator in front of the catalyst, Post-catalyst
1.6 16V 82 kW (112 PS) K4M 812, K4M 813	01.2006→08.2009	 7.02604.10.0	LS	560 mm	 K4M 812, K4M 813: für OE-Nummer: 77 00 107 433, 82 00 551 743 for OE number: 77 00 107 433, 82 00 551 743 vor Katalysator, nach Katalysator in front of the catalyst, Post-catalyst
1.9 dCi 66-75 kW (90-102 PS) F9Q 808	03.2004→02.2007	 7.00075.07.0	AGR	EL	
		7.00837.01.0	AGR-K		 ohne AGR-Ventil without EGR valve
1.9 dCi 66-75 kW (90-102 PS) F9Q 808	04.2004→12.2005	 7.00075.07.0	AGR	EL	
		7.00837.01.0	AGR-K		 ohne AGR-Ventil without EGR valve
1.9 dCi (KMRG, KM1G, KM0G, KM2C) 88 kW (120 PS) F9Q 800	08.2003→07.2009	 7.22818.62.0	AGR	EL	





























R

































MEGANE II Estate (KM0/1_) 63

2.0 99-103 kW (135-140 PS) F4R 770, F4R 771	08.2003→07.2009	 7.02604.10.0	LS	560 mm	 F4R 770, F4R 771: für OE-Nummer: 77 00 107 433, 82 00 551 743 for OE number: 77 00 107 433, 82 00 551 743 vor Katalysator, nach Katalysator in front of the catalyst, Post-catalyst
2.0 99-103 kW (135-140 PS) F4R 771	12.2006→01.2011	 7.02604.10.0	LS	560 mm	für OE-Nummer: 77 00 107 433 for OE number: 77 00 107 433 vor Katalysator, nach Katalysator in front of the catalyst, Post-catalyst
2.0 dCi 110 kW (150 PS) M9R 700	09.2005→07.2009	 7.10334.05.0	AGR	EL	

MEGANE II Saloon (LM0/1_) 64

























1.4 60 kW (82 PS) K4J 732	09.2003→	 7.02604.10.0	LS	560 mm	vor Katalysator, nach Katalysator in front of the catalyst, Post-catalyst
1.4 72 kW (98 PS) K4J 730, K4J 740	09.2003→	 7.02604.10.0	LS	560 mm	 K4J 730: vor Katalysator, nach Katalysator in front of the catalyst, Post-catalyst  K4J 740: für OE-Nummer: 77 00 107 433, 82 00 551 743 for OE number: 77 00 107 433, 82 00 551 743 vor Katalysator, nach Katalysator in front of the catalyst, Post-catalyst
1.5 dCi (LM02, LM13, LM2A) 74-78 kW (101-106 PS) K9K 728, K9K 729	02.2004→12.2010	 7.22818.58.0	AGR	EL	
1.5 dCi (LM0F, LM0T, LM2B) 60-63 kW (82-86 PS) K9K 722	08.2003→12.2010	 7.22818.58.0	AGR	EL	
1.5 dCi (LM16) 74-78 kW (103-106 PS) K9K 734	10.2003→12.2010	 7.00368.15.0	AGR	EL	
1.5 dCi (LM1E) 78 kW (106 PS) K9K 732	05.2005→12.2010	 7.00368.15.0	AGR	EL	
1.5 dCi (LM1F) 63 kW (86 PS) K9K 724	05.2005→12.2010	 7.00368.15.0	AGR	EL	
1.6 81-83 kW (110-113 PS) K4M 760, K4M 761	09.2003→	 7.02604.10.0	LS	560 mm	 K4M 760, K4M 761: Baumuster: LM0J, LM1B Type: LM0J, LM1B vor Katalysator, nach Katalysator in front of the catalyst, Post-catalyst
1.6 16V (LM1R, LM0C) 82 kW (112 PS) K4M 812, K4M 813	01.2006→	 7.02604.10.0	LS	560 mm	 K4M 812, K4M 813: für OE-Nummer: 77 00 107 433, 82 00 551 743 for OE number: 77 00 107 433, 82 00 551 743 vor Katalysator, nach Katalysator in front of the catalyst, Post-catalyst
		 7.00075.07.0	AGR	EL	
1.9 dCi 66-75 kW (90-102 PS) F9Q 808	09.2003→12.2005	 7.00075.07.0	AGR	EL	
		 7.00837.01.0	AGR-K		 ohne AGR-Ventil without EGR valve
1.9 dCi 66-75 kW (90-102 PS) F9Q 808	03.2004→	 7.00075.07.0	AGR	EL	
		 7.00837.01.0	AGR-K		 ohne AGR-Ventil without EGR valve
1.9 dCi (LM0G, LM1G, LM2C) 88 kW (120 PS) F9Q 800	09.2003→	 7.22818.62.0	AGR	EL	
1.9 dCi (LM14, LM1D) 81-97 kW (110-132 PS) F9Q 804, F9Q 816	05.2005→	 7.10334.06.0	AGR	EL	

R

						
MEGANE II Saloon (LM0/1_)						64
2.0 99-103 kW (135-140 PS) F4R 770, F4R 771	09.2003→		7.02604.10.0	LS	560 mm	 F4R 770, F4R 771: für OE-Nummer: 77 00 107 433, 82 00 551 743 for OE number: 77 00 107 433, 82 00 551 743 vor Katalysator, nach Katalysator in front of the catalyst, Post-catalyst
2.0 99-103 kW (135-140 PS) F4R 770	04.2006→11.2010		7.02604.10.0	LS	560 mm	für OE-Nummer: 77 00 107 433 for OE number: 77 00 107 433 vor Katalysator, nach Katalysator in front of the catalyst, Post-catalyst
2.0 dCi 110 kW (150 PS) M9R 700	09.2005→		7.10334.05.0	AGR	EL	
MEGANE III Coupe (DZ0/1_)						65
1.5 dCi 70-81 kW (95-110 PS) K9K 846	07.2014→		7.00368.16.0	AGR	EL	
1.5 dCi (DZ09, DZ0D, DZ1F, DZ1G) 70-81 kW (95-110 PS) K9K 836, K9K 837, K9K 846	02.2009→08.2015		7.00368.16.0	AGR	EL	
1.5 dCi (DZ09, DZ0D, DZ1F, DZ1G) 81 kW (110 PS) K9K 636	02.2009→08.2015		7.03435.05.0	AGR	EL	
			7.03571.16.0 ↳ 7.03083.20.0	AK SRM-AK	EL EL	
1.5 dCi (DZ0A) 60-66 kW (82-90 PS) K9K 830	11.2008→08.2015		7.00368.15.0	AGR	EL	
1.5 dCi (DZ0B) 78 kW (106 PS) K9K 832	02.2009→		7.00368.15.0	AGR	EL	
1.5 dCi (DZ0C, DZ1A) 66 kW (90 PS) K9K 834	11.2008→08.2015		7.00368.16.0	AGR	EL	
1.6 dCi (DZ00) 96 kW (130 PS) R9M 402	04.2011→08.2015		7.24809.90.0 7.03571.16.0 ↳ 7.03083.20.0 7.11190.08.0 7.02604.99.0	AGR AK SRM-AK DDS LS	EL EL EL 400 mm	 04.2012→ für OE-Nummer: 22 77 014 54R, 22 77 021 84R for OE number: 22 77 014 54R, 22 77 021 84R
1.9 dCi (DZ0N, DZ0J, DZ1J, DZ1K) 96 kW (131 PS) F9Q 870, F9Q 872	11.2008→08.2015		7.11237.05.0	AGR-K	EL	 F9Q 870, F9Q 872: →02.2012
2.0 dCi 118-120 kW (160-163 PS) M9R 610	07.2012→		7.10334.03.0 7.02604.99.0	AGR LS	EL 400 mm	
2.0 dCi (DZ0L) 118-120 kW (160-163 PS) M9R 610	04.2009→08.2015		7.10334.03.0 7.02604.99.0	AGR LS	EL 400 mm	
2.0 dCi (DZ0Y) 110 kW (150 PS) M9R 615	04.2009→		7.10334.03.0 7.02604.99.0	AGR LS	EL 400 mm	















MEGANE III Grandtour (KZ0/1) **66**

1.5 dCi 60-66 kW (82-90 PS) K9K 830	03.2009→		7.00368.15.0	AGR	EL	
1.5 dCi 70-81 kW (95-110 PS) K9K 846	11.2013→		7.00368.16.0	AGR	EL	
1.5 dCi (KZ09, KZ0D, KZ1G) 70-81 kW (95-110 PS) K9K 836, K9K 837, K9K 846	02.2009→		7.00368.16.0	AGR	EL	
1.5 dCi (KZ09, KZ0D, KZ1G) 81 kW (110 PS) K9K 636	02.2009→		7.03435.05.0	AGR	EL	
			7.03571.16.0	AK	EL	
			↳ 7.03083.20.0	SRM-AK	EL	
1.5 dCi (KZ0C, KZ1A) 66 kW (90 PS) K9K 834	05.2009→		7.00368.16.0	AGR	EL	
1.5 dCi (KZ1M, KZ1W) 70-81 kW (95-110 PS) K9K 836, K9K 846	02.2009→		7.00368.16.0	AGR	EL	
1.5 dCi (KZ1M, KZ1W) 78 kW (106 PS) K9K 832	02.2009→		7.00368.15.0	AGR	EL	
1.6 dCi (KZ00, KZ12, KZ13) 96 kW (130 PS) R9M 402, R9M 404	04.2011→		7.24809.90.0	AGR	EL	 R9M 402, R9M 404: 04.2012→07.2016
			7.03571.16.0	AK	EL	
			↳ 7.03083.20.0	SRM-AK	EL	
			7.11190.08.0	DDS		 R9M 402, R9M 404: für OE-Nummer: 22 77 014 54R, 22 77 021 84R for OE number: 22 77 014 54R, 22 77 021 84R
			7.02604.99.0	LS	400 mm	
1.6 dCi (KZ00, KZ12, KZ13) 96 kW (130 PS) R9M 414	04.2011→		7.03571.16.0	AK	EL	
			↳ 7.03083.20.0	SRM-AK	EL	
			7.11457.07.0*	DDS		
			↳ 7.11492.07.0	DDS		
			7.02604.99.0	LS	400 mm	
1.9 dCi (KZ0J, KZ0N, KZ1S) 96 kW (131 PS) F9Q 870, F9Q 872	05.2009→		7.11237.05.0	AGR-K	EL	 F9Q 870, F9Q 872: →02.2012
2.0 dCi 118-120 kW (160-163 PS) M9R 610	07.2012→		7.10334.03.0	AGR	EL	
			7.02604.99.0	LS	400 mm	
2.0 dCi (KZ0L) 118-120 kW (160-163 PS) M9R 610	04.2009→		7.10334.03.0	AGR	EL	
			7.02604.99.0	LS	400 mm	
2.0 dCi (KZ0Y) 110 kW (150 PS) M9R 615	10.2010→		7.10334.03.0	AGR	EL	
			7.02604.99.0	LS	400 mm	

R



MEGANE III Hatchback (BZ0/1_, B3_) 67





1.5 dCi 60-66 kW (82-90 PS) K9K 830	11.2008→		7.00368.15.0	AGR	EL	
1.5 dCi 78 kW (106 PS) K9K 832	02.2009→		7.00368.15.0	AGR	EL	
1.5 dCi (BZ09, BZ0D, BZ1W, BZ29) 70-81 kW (95-110 PS) K9K 836, K9K 837, K9K 846	02.2009→		7.00368.16.0	AGR	EL	⊙
1.5 dCi (BZ09, BZ0D, BZ1W, BZ29) 81 kW (110 PS) K9K 636	02.2009→		7.03435.05.0	AGR	EL	⊙
			7.03571.16.0 ↳ 7.03083.20.0	AK SRM-AK	EL EL	
1.5 dCi (BZ0C) 66 kW (90 PS) K9K 834	11.2008→08.2015		7.00368.16.0	AGR	EL	⊙
1.5 dCi (BZ1G, BZ1W, BZ0R) 70-81 kW (95-110 PS) K9K 846	11.2013→08.2015		7.00368.16.0	AGR	EL	⊙
1.6 dCi (BZ00, BZ12) 96 kW (130 PS) R9M 402	04.2011→08.2015		7.24809.90.0	AGR	EL	⊙ 04.2012→
			7.03571.16.0 ↳ 7.03083.20.0 7.11190.08.0	AK SRM-AK DDS	EL EL	für OE-Nummer: 22 77 014 54R, 22 77 021 84R for OE number: 22 77 014 54R, 22 77 021 84R
			7.02604.99.0	LS	400 mm	
1.6 dCi (BZ00, BZ12) 96 kW (130 PS) R9M 404	04.2011→08.2015		7.03571.16.0	AK	EL	
			↳ 7.03083.20.0 7.11190.08.0	SRM-AK DDS	EL	für OE-Nummer: 22 77 014 54R, 22 77 021 84R for OE number: 22 77 014 54R, 22 77 021 84R
			7.02604.99.0	LS	400 mm	
1.9 dCi (BZ0N, BZ0J) 96 kW (131 PS) F9Q 870, F9Q 872	11.2008→		7.11237.05.0	AGR-K	EL	⊙ F9Q 870, F9Q 872: →02.2012
2.0 dCi 118-120 kW (160-163 PS) M9R 610	07.2012→		7.10334.03.0	AGR	EL	⊙
			7.02604.99.0	LS	400 mm	
2.0 dCi (BZ0L) 118-120 kW (160-163 PS) M9R 610	04.2009→08.2015		7.10334.03.0	AGR	EL	⊙
			7.02604.99.0	LS	400 mm	
2.0 dCi (BZ0Y) 110 kW (150 PS) M9R 615	10.2010→		7.10334.03.0	AGR	EL	⊙
			7.02604.99.0	LS	400 mm	

MEGANE IV GRAND COUPE 68













1.5 Blue dCi 115 (LVA6) 59-85 kW (80-116 PS) K9K 872, K9K 873	02.2019→		7.11457.07.0*	DDS		
			↳ 7.11492.07.0	DDS		



MEGANE IV GRAND COUPE **68**

1.5 Blue dCi 95 (LVA2) 59-85 kW (80-116 PS) K9K 872	02.2019→		7.11457.07.0*	DDS	
			↳ 7.11492.07.0	DDS	
1.5 dCi 110 66-81 kW (90-110 PS) K9K 656, K9K 657, K9K 674, K9K 675, K9K 676, K9K 677	10.2016→		7.11457.07.0*	DDS	
			↳ 7.11492.07.0	DDS	
1.5 dCi 90 (LVA1) 66-81 kW (90-110 PS) K9K 656	10.2016→		7.05320.04.0	AGR	EL 
			7.03571.16.0	AK	EL
			↳ 7.03083.20.0	SRM-AK	EL
			7.11457.07.0*	DDS	
			↳ 7.11492.07.0	DDS	

MEGANE IV Grandtour (K9A/M/N_) **69**

1.5 Blue dCi 115 (K9A6) 59-85 kW (80-116 PS) K9K 872, K9K 873	08.2018→		7.11457.07.0*	DDS	
			↳ 7.11492.07.0	DDS	
1.5 Blue dCi 95 (K9A2) 59-85 kW (80-116 PS) K9K 872	08.2018→		7.11457.07.0*	DDS	
			↳ 7.11492.07.0	DDS	
1.5 dCi 110 66-81 kW (90-110 PS) K9K 656, K9K 657	04.2016→		7.05320.04.0	AGR	EL 
			7.03571.16.0	AK	EL
			↳ 7.03083.20.0	SRM-AK	EL
			7.11457.07.0*	DDS	
			↳ 7.11492.07.0	DDS	
1.5 dCi 90 66-81 kW (90-110 PS) K9K 656	04.2016→		7.05320.04.0	AGR	EL 
			7.03571.16.0	AK	EL
			↳ 7.03083.20.0	SRM-AK	EL
			7.11457.07.0*	DDS	
			↳ 7.11492.07.0	DDS	
1.6 dCi 130 96 kW (130 PS) R9M 409	04.2016→		7.24809.90.0	AGR	EL  11.2016→  →170823
			7.03571.16.0	AK	EL
			↳ 7.03083.20.0	SRM-AK	EL
			7.11457.07.0*	DDS	
			↳ 7.11492.07.0	DDS	
1.6 dCi 165 92-120 kW (125-163 PS) R9M 452	04.2016→		7.24809.90.0	AGR	EL  11.2016→  →170823
			↳ 7.11492.07.0	DDS	
1.8 Blue dCi 150 (K9A7) 88-110 kW (120-150 PS) R9N 401	02.2019→		7.11457.07.0*	DDS	
			↳ 7.11492.07.0	DDS	

MEGANE IV Hatchback (B9A/M/N_) **70**

1.5 Blue dCi 115 (B9A6) 59-85 kW (80-116 PS) K9K 872, K9K 873	08.2018→		7.11457.07.0*	DDS	
			↳ 7.11492.07.0	DDS	



MEGANE IV Hatchback (B9A/M/N_) 70

1.5 Blue dCi 95 (B9A2) 59-85 kW (80-116 PS) K9K 872	08.2018→		7.11457.07.0* ↳ 7.11492.07.0	DDS DDS		
1.5 dCi 110 (B9A3) 66-81 kW (90-110 PS) K9K 646, K9K 648, K9K 656, K9K 657	11.2015→		7.05320.04.0 7.03571.16.0 ↳ 7.03083.20.0 7.11457.07.0* ↳ 7.11492.07.0	AGR AK SRM-AK DDS DDS	EL EL EL	
1.5 dCi 90 (B9A1) 66-81 kW (90-110 PS) K9K 656	11.2015→		7.05320.04.0 7.03571.16.0 ↳ 7.03083.20.0 7.11457.07.0* ↳ 7.11492.07.0	AGR AK SRM-AK DDS DDS	EL EL EL	
1.6 dCi 130 (B9A4) 96 kW (130 PS) R9M 409	11.2015→		7.24809.90.0 7.03571.16.0 ↳ 7.03083.20.0 7.11457.07.0* ↳ 7.11492.07.0	AGR AK SRM-AK DDS DDS	EL EL EL	 11.2016→ →170823
1.6 dCi 165 92-120 kW (125-163 PS) R9M 452	11.2015→		7.24809.90.0	AGR	EL	 11.2016→ →170823
1.8 Blue dCi 150 (B9A7) 88-110 kW (120-150 PS) R9N 401	02.2019→		7.11457.07.0* ↳ 7.11492.07.0	DDS DDS		

MEGANE Scenic (JA0/1_) 71

1.6 16V (JA0B, JA04, JA11) 75-85 kW (102-116 PS) K4M 700, K4M 701, K4M 704, K4M 708	04.1998→10.1999		7.02604.10.0	LS	560 mm	K4M 700: vor Katalysator in front of the catalyst nicht für Baumuster: JA11 not for code: JA11 K4M 701: vor Katalysator in front of the catalyst K4M 704: Baumuster: JA04 Type: JA04 vor Katalysator in front of the catalyst K4M 708: Baumuster: JA0B Type: JA0B vor Katalysator in front of the catalyst
--	-----------------	--	---------------------	----	--------	---























R

MODUS / GRAND MODUS (F/JP0_) 72

1.2 (FP0C, FP0K, FP0P) 48-55 kW (65-75 PS) D4F 740	05.2005→		7.05270.54.0	LS	450 mm	vor Katalysator, nach Katalysator in front of the catalyst, Post-catalyst nicht für Baumuster: FP0C not for code: FP0C Produktionsdatum bis: 28.06.2006 Production date to: 28.06.2006
1.2 (JP0C, JP0K, FP0C, FP0K, FP0P, JP0P, JP0T) 48-55 kW (65-75 PS) D4F 740	12.2004→		7.05270.54.0	LS	450 mm	vor Katalysator, nach Katalysator in front of the catalyst, Post-catalyst nicht für Baumuster: FP0C, JP0P not for code: FP0C, JP0P Produktionsdatum bis: 28.06.2006 Production date to: 28.06.2006





















MODUS / GRAND MODUS (F/JP0_) **72**

1.2 (JP0S) 43-58 kW (58-79 PS) D4F 764	12.2004→		7.05270.54.0	LS	450 mm	vor Katalysator, nach Katalysator in front of the catalyst, Post-catalyst Produktionsdatum bis: 28.06.2006 Production date to: 28.06.2006
1.2 16V Hi-Flex 48-55 kW (65-75 PS) D4F 740	10.2008→		7.05270.54.0	LS	450 mm	für OE-Nummer: 82 00 052 063 for OE number: 82 00 052 063
1.4 (JP01, JP0J) 72 kW (98 PS) K4J 770, K4J 780	12.2004→		7.02604.10.0	LS	560 mm	 K4J 770, K4J 780: für OE-Nummer: 77 00 107 433, 82 00 551 743 for OE number: 77 00 107 433, 82 00 551 743 vor Katalysator, nach Katalysator in front of the catalyst, Post-catalyst
1.5 dCi (FP0D, JP0D) 57-65 kW (78-88 PS) K9K 750	09.2004→		7.22818.58.0	AGR	EL	
1.5 dCi (FP0E, JP0E) 47-50 kW (64-68 PS) K9K 752	12.2004→		7.22818.58.0	AGR	EL	
1.5 dCi (FP0E, JP0E) 48-50 kW (65-68 PS) K9K 768	12.2004→		7.00368.15.0	AGR	EL	
1.5 dCi (FP0F, JP0F) 50-65 kW (68-88 PS) K9K 760, K9K 766	12.2004→		7.00368.15.0	AGR	EL	
1.5 dCi (FP0G, JP0G) 48-50 kW (65-68 PS) K9K 768	12.2004→		7.00368.15.0	AGR	EL	
1.5 dCi (JP02) 63-76 kW (86-103 PS) K9K 772	05.2007→		7.00368.15.0	AGR	EL	
1.5 dCi (JP0G, JP0H) 78 kW (106 PS) K9K 764	05.2005→		7.00368.15.0	AGR	EL	
1.5 dCi 75 55-65 kW (75-88 PS) K9K 770	10.2010→		7.00368.16.0	AGR	EL	
1.5 dCi 90 55-65 kW (75-88 PS) K9K 770	10.2010→		7.00368.16.0	AGR	EL	
1.5 dCi 90 57-65 kW (78-88 PS) K9K 750	10.2010→		7.22818.58.0	AGR	EL	
1.6 (JP03, JP0B, JP0U, JP0Y, JP1G) 82 kW (112 PS) K4M 790, K4M 791, K4M 800, K4M 801	12.2004→		7.02604.10.0	LS	560 mm	 K4M 790, K4M 791, K4M 800, K4M 801: für OE-Nummer: 77 00 107 433, 82 00 551 743 for OE number: 77 00 107 433, 82 00 551 743 vor Katalysator, nach Katalysator in front of the catalyst, Post-catalyst
1.6 (JP0L, JP0V) 65 kW (88 PS) K4M 794	12.2004→		7.02604.10.0	LS	560 mm	für OE-Nummer: 77 00 107 433, 82 00 551 743 for OE number: 77 00 107 433, 82 00 551 743 vor Katalysator, nach Katalysator in front of the catalyst, Post-catalyst

SAFRANE I (B54_) **73**





























2.0 (B540) 77 kW (105 PS) J7R 732, J7R 733	11.1992→07.1996		7.05270.47.0	LS	325 mm	
2.0 12V (B542, B54E) 97-99 kW (132-135 PS) J7R 734, J7R 735	04.1992→07.1996		7.05270.47.0	LS	325 mm	
2.2 (B541) 79-81 kW (107-110 PS) J7T 762	04.1992→07.1996		7.05270.47.0	LS	325 mm	

						
SAFRANE I (B54_)						73
			7.02604.03.0	LS	200 mm	
2.2 (B543) 101 kW (137 PS) J7T 760, J7T 761	04.1992→07.1996		7.05270.47.0	LS	325 mm	
3.0 123-125 kW (167-170 PS) Z7X 723	02.1993→06.1996		7.05270.47.0	LS	325 mm	
			7.02604.03.0	LS	200 mm	
3.0 Biturbo 4x4 (B545) 193 kW (262 PS) Z7X 726	02.1993→07.1996		7.05270.47.0	LS	325 mm	
			7.02604.03.0	LS	200 mm	
3.0 V6 (B54B, B544) 123-125 kW (167-170 PS) Z7X 721	12.1992→07.1996		7.02604.03.0	LS	200 mm	
3.0 V6 (B54B, B544) 123-125 kW (167-170 PS) Z7X 722, Z7X 723, Z7X 753	12.1992→07.1996		7.05270.47.0	LS	325 mm	
			7.02604.03.0	LS	200 mm	
3.0 V6 4x4 (B54B, B544) 123-125 kW (167-170 PS) Z7X 721	12.1992→07.1996		7.02604.03.0	LS	200 mm	
3.0 V6 4x4 (B54B, B544) 123-125 kW (167-170 PS) Z7X 722, Z7X 723	12.1992→07.1996		7.05270.47.0	LS	325 mm	
			7.02604.03.0	LS	200 mm	
SAFRANE II (B54_)						74
3.0 V6 (B54M) 123-125 kW (170 PS) Z7X 755	07.1996→12.2000		7.02604.03.0	LS	200 mm	
SANDERO/STEPWAY I (BS_)						75
1.5 dCi 45-50 kW (61-68 PS) K9K 700	02.2008→11.2011		7.22818.58.0	AGR	EL 	
1.5 dCi 47 kW (64 PS) K9K 740	02.2008→11.2011		7.00368.15.0	AGR	EL	
SANDERO/STEPWAY II (B8_)						76
1.5 dCi 60-66 kW (82-90 PS) K9K 830	12.2013→		7.00368.15.0	AGR	EL	
SCALA (LJM_)						77
1.5 dCi 63-65 kW (86-88 PS) K9K 766	09.2012→10.2017		7.00368.15.0	AGR	EL	

R



SCÉNIC I MPV (JA0/1_, FA0_) 78

<p>1.4 16V (JA0D, JA1H, Ja0W, JA10) 70 kW (95 PS) K4J 714, K4J 750</p>	<p>09.1999→08.2003</p>	<p>7.02604.10.0</p> 	<p>LS</p>	<p>560 mm</p>	<p> K4J 714: vor Katalysator in front of the catalyst nicht für Baumuster: JA0W not for code: JA0W  K4J 750: vor Katalysator in front of the catalyst</p>
<p>1.6 (JA00, JA16, JA15, JA19, JA1V, JA2B, JA2C, JA0B) 69-85 kW (94-116 PS) K4M 700, K4M 706, K4M 707</p>	<p>09.1999→09.2003</p>	<p>7.02604.10.0</p> 	<p>LS</p>	<p>560 mm</p>	<p> K4M 700: Baumuster: JA0B Type: JA0B vor Katalysator in front of the catalyst  K4M 706: vor Katalysator in front of the catalyst Produktionsdatum ab: 04.03.2002 Production date from: 04.03.2002  K4M 706: nach Katalysator Post-catalyst  K4M 707: Baumuster: JA00, JA16 Type: JA00, JA16 vor Katalysator in front of the catalyst</p>
<p>1.8 16V (JA12, JA1R, JA1M, JA1A) 85 kW (115 PS) F4P 720, F4P 722</p>	<p>01.2001→08.2003</p>	<p>7.02604.10.0</p> 	<p>LS</p>	<p>560 mm</p>	<p> F4P 720: vor Katalysator in front of the catalyst nicht für Baumuster: JA1M not for code: JA1M  F4P 722: Baumuster: JA1M Type: JA1M vor Katalysator in front of the catalyst</p>
<p>1.9 dCi (JA05, JA1F) 74-77 kW (101-105 PS) F9Q 732, F9Q 733</p>	<p>09.1999→08.2003</p>	<p>7.22818.57.0</p> 	<p>AGR</p>	<p>EL</p>	<p></p>
<p>1.9 dCi RX4 75 kW (102 PS) F9Q 740</p>	<p>11.2000→08.2003</p>	<p>7.22818.57.0</p> 	<p>AGR</p>	<p>EL</p>	<p></p>
<p>1.9 dCi RX4 74-79 kW (101-107 PS) F9Q 732, F9Q 748, F9Q 796</p>	<p>12.2002→08.2003</p>	<p>7.22818.57.0</p> 	<p>AGR</p>	<p>EL</p>	<p></p>
<p>1.9 dTi (JA1U) 59 kW (80 PS) F9Q 744</p>	<p>02.2001→08.2003</p>	<p>7.22818.57.0</p> 	<p>AGR</p>	<p>EL</p>	<p></p>
<p>2.0 16V 99-103 kW (135-140 PS) F4R 740, F4R 741, F4R 744, F4R 747</p>	<p>09.1999→08.2003</p>	<p>7.02604.10.0</p> 	<p>LS</p>	<p>560 mm</p>	<p> F4R 740, F4R 741: für OE-Nummer: 77 00 107 433 for OE number: 77 00 107 433 vor Katalysator in front of the catalyst  F4R 744, F4R 747: Baumuster: JA_ Type: JA_ vor Katalysator in front of the catalyst</p>
<p>2.0 16V (JA1B, JA1D) 99-103 kW (135-140 PS) F4R 740, F4R 746</p>	<p>07.2000→08.2003</p>	<p>7.02604.10.0</p> 	<p>LS</p>	<p>560 mm</p>	<p> F4R 740: für OE-Nummer: 77 00 107 433 for OE number: 77 00 107 433 vor Katalysator in front of the catalyst  F4R 746: vor Katalysator in front of the catalyst nicht für Baumuster: JA1B not for code: JA1B</p>
<p>2.0 16V RX4 99-103 kW (135-140 PS) F4R 744, F4R 746</p>	<p>06.2000→08.2003</p>	<p>7.02604.10.0</p> 	<p>LS</p>	<p>560 mm</p>	<p> F4R 744: Baumuster: JA_ Type: JA_  F4R 746: Baumuster: JA_ Type: JA_ vor Katalysator in front of the catalyst</p>



















R



SCÉNIC II (JM0/1_) 79











1.4 (JM0B, JM0H, JM1A) 72 kW (98 PS) K4J 730, K4J 740	06.2003→11.2008	 7.02604.10.0	LS	560 mm	 K4J 730: vor Katalysator, nach Katalysator in front of the catalyst, Post-catalyst  K4J 740: für OE-Nummer: 77 00 107 433, 82 00 551 743 for OE number: 77 00 107 433, 82 00 551 743 vor Katalysator, nach Katalysator in front of the catalyst, Post-catalyst
1.5 dCi (JM02, JM13) 74-78 kW (101-106 PS) K9K 728, K9K 729	11.2003→08.2005	 7.22818.58.0	AGR	EL	
1.5 dCi (JM0F) 60-63 kW (82-86 PS) K9K 722	06.2003→05.2006	 7.22818.58.0	AGR	EL	
1.5 dCi (JM16) 74-78 kW (103-106 PS) K9K 734	01.2007→11.2008	 7.00368.15.0	AGR	EL	
1.5 dCi (JM1E, JM16) 74-78 kW (103-106 PS) K9K 732, K9K 734	05.2005→11.2008	 7.00368.15.0	AGR	EL	
1.5 dCi (JM1F) 63 kW (86 PS) K9K 724	05.2005→11.2008	 7.00368.15.0	AGR	EL	
1.6 (JM0C, JM0J, JM1B) 81-83 kW (110-113 PS) K4M 761, K4M 782	06.2003→10.2006	 7.02604.10.0	LS	560 mm	 K4M 761: vor Katalysator, nach Katalysator in front of the catalyst, Post-catalyst  K4M 782: vor Katalysator in front of the catalyst
1.6 16V (JM1R) 81-85 kW (110-116 PS) K4M 766, K4M 812, K4M 813	10.2005→11.2008	 7.02604.10.0	LS	560 mm	 K4M 766, K4M 812, K4M 813: für OE-Nummer: 77 00 107 433, 82 00 551 743 for OE number: 77 00 107 433, 82 00 551 743 vor Katalysator, nach Katalysator in front of the catalyst, Post-catalyst
1.9 D 85-88 kW (116-120 PS) F9Q 812	06.2006→11.2008	 7.00075.07.0	AGR	EL	
		 7.00837.01.0	AGR-K		 ohne AGR-Ventil without EGR valve
1.9 dCi (JM0G, JM12, JM1G, JM2C) 85-88 kW (116-120 PS) F9Q 812	06.2003→05.2006	 7.00075.07.0	AGR	EL	
		 7.00837.01.0	AGR-K		 ohne AGR-Ventil without EGR valve
1.9 dCi (JM14) 81-97 kW (110-132 PS) F9Q 804	05.2005→11.2008	 7.10334.06.0	AGR	EL	
1.9 dCi (JM15) 81-97 kW (110-132 PS) F9Q 804	05.2005→11.2008	 7.10334.06.0	AGR	EL	
2.0 (JM05, JM0U, JM1N, JM1U, JM2V) 99-103 kW (135-140 PS) F4R 770, F4R 771	06.2003→06.2009	 7.02604.10.0	LS	560 mm	 F4R 770: für OE-Nummer: 77 00 107 433, 82 00 551 743 for OE number: 77 00 107 433, 82 00 551 743 vor Katalysator, nach Katalysator in front of the catalyst, Post-catalyst  F4R 771: für OE-Nummer: 82 00 551 743 for OE number: 82 00 551 743 vor Katalysator, nach Katalysator in front of the catalyst, Post-catalyst
2.0 dCi (JM1K) 110 kW (150 PS) M9R 700, M9R 721	09.2005→11.2008	 7.10334.05.0	AGR	EL	

R

					
SCÉNIC III (JZ0/1_)					80
1.5 dCi 78 kW (106 PS) K9K 832	02.2009→		7.00368.15.0	AGR	EL
1.5 dCi 60-66 kW (82-90 PS) K9K 830	04.2009→		7.00368.15.0	AGR	EL
1.5 dCi 66-81 kW (90-110 PS) K9K 656, K9K 657	04.2009→		7.05320.04.0 7.03571.16.0 ↳ 7.03083.20.0 7.11457.07.0* ↳ 7.11492.07.0	AGR AK SRM-AK DDS DDS	EL EL EL EL
1.5 dCi 78-81 kW (106-110 PS) K9K 836, K9K 837	04.2009→		7.00368.16.0	AGR	EL
1.5 dCi 81 kW (110 PS) K9K 636	04.2009→		7.03435.05.0 7.03571.16.0 ↳ 7.03083.20.0	AGR AK SRM-AK	EL EL EL
1.5 dCi (JZ02, JZ0R) 70-81 kW (95-110 PS) K9K 846	11.2010→		7.00368.16.0	AGR	EL
1.6 dCi (JZ00, JZ12) 96 kW (130 PS) R9M 402	04.2011→		7.24809.90.0 7.03571.16.0 ↳ 7.03083.20.0 7.11190.08.0 7.02604.99.0	AGR AK SRM-AK DDS LS	EL EL EL 400 mm
					○ →09.2016 für OE-Nummer: 22 77 014 54R, 22 77 021 84R, 82 00 469 905 for OE number: 22 77 014 54R, 22 77 021 84R, 82 00 469 905 Motorcode: R9M 402 Engine Code: R9M 402 Produktionsdatum ab: 04.2011 Production date from: 04.2011
1.6 dCi (JZ00, JZ12) 96 kW (130 PS) R9M 404	04.2011→		7.24809.90.0 7.03571.16.0 ↳ 7.03083.20.0 7.11190.08.0	AGR AK SRM-AK DDS	EL EL EL
					○ →09.2016 für OE-Nummer: 22 77 014 54R, 22 77 021 84R, 82 00 469 905 for OE number: 22 77 014 54R, 22 77 021 84R, 82 00 469 905
1.6 dCi (JZ00, JZ12) 96 kW (130 PS) R9M 414	04.2011→		7.03571.16.0 ↳ 7.03083.20.0 7.11457.07.0* ↳ 7.11492.07.0	AK SRM-AK DDS DDS	EL EL EL EL
1.9 dCi (JZ0J, JZ1J, JZ1K, JZ1S) 96 kW (131 PS) F9Q 870, F9Q 872	02.2009→		7.11237.05.0	AGR-K	EL
					⊗ F9Q 870, F9Q 872: →02.2012
2.0 dCi (JZ0L) 118-120 kW (160-163 PS) M9R 610	04.2009→		7.10334.03.0 7.02604.99.0	AGR LS	EL 400 mm
2.0 dCi (JZ0Y, JZ26) 110 kW (150 PS) M9R 615	02.2009→		7.10334.03.0 7.02604.99.0	AGR LS	EL 400 mm









SCÉNIC IV (J9_) 81

1.5 dCi 110 67-81 kW (91-110 PS) K9K 646, K9K 647	09.2016→		7.05320.04.0	AGR	EL	
			7.03571.16.0	AK	EL	
			↳ 7.03083.20.0	SRM-AK	EL	
			7.11457.07.0*	DDS		
			↳ 7.11492.07.0	DDS		
1.5 dCi 110 Hybrid Assist (J9AE) 70-81 kW (95-110 PS) K9K 500, K9K 502	04.2017→		7.05320.04.0	AGR	EL	
1.5 dCi 95 70-81 kW (95-110 PS) K9K 646	09.2016→		7.05320.04.0	AGR	EL	
			7.03571.16.0	AK	EL	
			↳ 7.03083.20.0	SRM-AK	EL	
			7.11457.07.0*	DDS		
			↳ 7.11492.07.0	DDS		
1.5 dCi 95 70-81 kW (95-110 PS) K9K 846	09.2016→		7.00368.16.0	AGR	EL	
1.6 dCi 130 96 kW (130 PS) R9M 409	09.2016→		7.03571.16.0	AK	EL	
			↳ 7.03083.20.0	SRM-AK	EL	
			7.11457.07.0*	DDS		
			↳ 7.11492.07.0	DDS		
1.7 Blue dCi 120 (J9A7, J9A8) 88-110 kW (120-150 PS) R9N 401	08.2018→		7.11457.07.0*	DDS		
			↳ 7.11492.07.0	DDS		
1.7 Blue dCi 150 (J9A7, J9A8) 88-110 kW (120-150 PS) R9N 401	08.2018→		7.11457.07.0*	DDS		
			↳ 7.11492.07.0	DDS		

SUPER 5 (B/C40_) 82

1.7 (B/C40K, B/C40G) 64-66 kW (87-90 PS) F2N 740, F2N 742	06.1987→03.1995		7.02604.01.0	LS	200 mm	
--	-----------------	---	---------------------	----	--------	--









TALISMAN (LP_) 83

1.5 dCi 110 67-81 kW (91-110 PS) K9K 646, K9K 647	11.2015→		7.05320.04.0	AGR	EL	
			7.03571.16.0	AK	EL	
			↳ 7.03083.20.0	SRM-AK	EL	
			7.11457.07.0*	DDS		
			↳ 7.11492.07.0	DDS		
1.6 dCi 130 96 kW (130 PS) R9M 409	11.2015→		7.24809.90.0	AGR	EL	 →08.2018
			7.03571.16.0	AK	EL	
			↳ 7.03083.20.0	SRM-AK	EL	
			7.11457.07.0*	DDS		
			↳ 7.11492.07.0	DDS		
1.7 Blue dCi 120 (LPA7) 88-110 kW (120-150 PS) R9N 401	09.2018→		7.11457.07.0*	DDS		
			↳ 7.11492.07.0	DDS		
1.7 Blue dCi 150 (LPA8) 88-110 kW (120-150 PS) R9N 401	09.2018→		7.11457.07.0*	DDS		
			↳ 7.11492.07.0	DDS		

















R



































TALISMAN Grandtour (KP_) 84

1.5 dCi 110 67-81 kW (91-110 PS) K9K 646, K9K 647, K9K 648, K9K 649	03.2016→	 7.05320.04.0	AGR	EL	
		7.03571.16.0 ↳ 7.03083.20.0 7.11457.07.0* ↳ 7.11492.07.0	AK SRM-AK DDS DDS	EL EL	
1.6 dCi 130 96 kW (130 PS) R9M 409	03.2016→	 7.24809.90.0	AGR	EL	 →08.2018
		7.03571.16.0 ↳ 7.03083.20.0 7.11457.07.0* ↳ 7.11492.07.0	AK SRM-AK DDS DDS	EL EL	
1.6 dCi 160 92-120 kW (125-163 PS) R9M 452, R9M 453	03.2016→	 7.24809.90.0	AGR	EL	
1.7 Blue dCi 120 (KPA7) 88-110 kW (120-150 PS) R9N 401	09.2018→	 7.11457.07.0*	DDS		
		↳ 7.11492.07.0	DDS		
1.7 Blue dCi 150 (KPA8) 88-110 kW (120-150 PS) R9N 401	09.2018→	 7.11457.07.0*	DDS		
		↳ 7.11492.07.0	DDS		

THALIA I (LB_) 85

1.2 16V 50-55 kW (68-75 PS) D4F 706, D4F 712, D4F 728	04.2002→	 7.05270.54.0	LS	450 mm	 D4F 706: vor Katalysator, nach Katalysator in front of the catalyst, Post-catalyst Produktionsdatum bis: 28.06.2006 Production date to: 28.06.2006  D4F 712: für OE-Nummer: 82 00 052 063 for OE number: 82 00 052 063  D4F 728: nach Katalysator Post-catalyst Produktionsdatum bis: 28.06.2006 Production date to: 28.06.2006  D4F 728: vor Katalysator in front of the catalyst
1.4 55-72 kW (75-98 PS) K7J 700	08.2000→	 7.05270.56.0	LS	275 mm	
1.4 16V 70-72 kW (95-98 PS) K4J 712	08.2000→	 7.02604.10.0	LS	560 mm	vor Katalysator in front of the catalyst
1.5 dCi 48-60 kW (65-82 PS) K9K 706	06.2001→02.2009	 7.22818.58.0	AGR	EL	
1.5 dCi 45-50 kW (61-68 PS) K9K 700	04.2002→	 7.22818.58.0	AGR	EL	
1.5 dCi 45-50 kW (61-68 PS) K9K 700	02.2003→	 7.22818.58.0	AGR	EL	
1.5 dCi 47-50 kW (64-68 PS) K9K 714	02.2003→	 7.00368.15.0	AGR	EL	
1.5 dCi 48-60 kW (65-82 PS) K9K 706	04.2004→11.2009	 7.22818.58.0	AGR	EL	
1.5 dCi 47 kW (64 PS) K9K 740	06.2005→	 7.00368.15.0	AGR	EL	















R

					
THALIA II (LU_)					
86					
1.2 16V (LU2V) 54-55 kW (73-75 PS) D4F 728	09.2008→06.2014		7.05270.54.0	LS	450 mm  D4F 728: nach Katalysator Post-catalyst Produktionsdatum bis: 28.06.2006 Production date to: 28.06.2006  D4F 728: vor Katalysator in front of the catalyst
1.4 70-72 kW (95-98 PS) K4J 712	01.2009→12.2011		7.02604.10.0	LS	560 mm vor Katalysator in front of the catalyst
1.5 dCi 60-62 kW (82-84 PS) K9K 718	09.2008→		7.00368.15.0	AGR	EL
1.5 dCi 47 kW (64 PS) K9K 740	09.2008→		7.00368.15.0	AGR	EL
1.5 dCi 45-50 kW (61-68 PS) K9K 700	01.2009→		7.22818.58.0	AGR	EL 
1.5 dCi 66 kW (90 PS) K9K 834	01.2009→		7.00368.16.0	AGR	EL 
THALIA III (L8_)					
87					
1.5 dCi 55-66 kW (75-90 PS) K9K 612	12.2013→		7.00368.16.0	AGR	EL 
1.5 dCi 55-66 kW (75-90 PS) K9K 612	07.2014→06.2014		7.00368.16.0	AGR	EL 
1.5 dCi (L8AJ) 55-66 kW (75-90 PS) K9K 612	12.2013→		7.00368.16.0	AGR	EL 
TWINGO I (C06_)					
88					
1.0 50 kW (68 PS) D4D 712	03.2001→05.2007		7.05270.54.0	LS	450 mm vor Katalysator in front of the catalyst Produktionsdatum bis: 28.06.2006 Production date to: 28.06.2006
1.2 43-44 kW (58-60 PS) D7F 702, D7F 703, D7F 704	09.1998→08.2000		7.02604.10.0	LS	560 mm  D7F 702: Baumuster: C06G Type: C06G vor Katalysator, nach Katalysator in front of the catalyst, Post-catalyst  D7F 703: Baumuster: C066, C068 Type: C066, C068 vor Katalysator in front of the catalyst  D7F 704: Baumuster: S068 Type: S068 vor Katalysator in front of the catalyst
			7.02604.03.0	LS	200 mm
1.2 (C063, C064) 40 kW (55 PS) C3G 700	03.1993→10.1996		7.05270.45.0	LS	375 mm
			7.02604.03.0	LS	200 mm
1.2 (C063, C064) 40 kW (55 PS) C3G 702	10.1994→10.1996		7.05270.47.0	LS	325 mm
			7.02604.03.0	LS	200 mm
1.2 (C066, C068) 40-44 kW (54-60 PS) D7F 700, D7F 701	05.1996→06.2007		7.05270.54.0	LS	450 mm  D7F 700: vor Katalysator in front of the catalyst nicht für Baumuster: C068 not for code: C068 Produktionsdatum ab: 10.12.1999 Production date from: 10.12.1999  D7F 701: Baumuster: C066 Type: C066 vor Katalysator in front of the catalyst Produktionsdatum ab: 10.12.1999 Production date from: 10.12.1999

R







TWINGO I (C06_) **88**

			7.05270.48.0	LS	420 mm	 D7F 700, D7F 701: →12.1999
			7.02604.03.0	LS	200 mm	
1.2 (C066, C068) 43-44 kW (58-60 PS) D7F 702, D7F 703, D7F 704	05.1996→06.2007		7.02604.10.0	LS	560 mm	 D7F 702: Baumuster: C068 Type: C068 vor Katalysator, nach Katalysator in front of the catalyst, Post-catalyst
			7.02604.03.0	LS	200 mm	 D7F 703: vor Katalysator in front of the catalyst
			7.02604.03.0	LS	200 mm	 D7F 704: Baumuster: C068 Type: C068 vor Katalysator in front of the catalyst
1.2 (C067) 40-44 kW (54-60 PS) D7F 700, D7F 701	05.1996→03.2007		7.05270.54.0	LS	450 mm	 D7F 700, D7F 701: vor Katalysator in front of the catalyst Produktionsdatum ab: 10.12.1999 Production date from: 10.12.1999
			7.05270.48.0	LS	420 mm	 D7F 700, D7F 701: →12.1999
			7.02604.03.0	LS	200 mm	
1.2 16V (C060) 44 kW (60 PS) D4F 708	08.2004→06.2007		7.05270.54.0	LS	450 mm	 D4F 708: vor Katalysator in front of the catalyst
						 D4F 708: nach Katalysator Post-catalyst Produktionsdatum bis: 28.06.2006 Production date to: 28.06.2006
1.2 16V (C06C, C06D, C06K) 55 kW (75 PS) D4F 702	01.2001→06.2007		7.05270.54.0	LS	450 mm	 D4F 702: vor Katalysator in front of the catalyst
						 D4F 702: nach Katalysator Post-catalyst Produktionsdatum bis: 28.06.2006 Production date to: 28.06.2006
1.2 LPG 43-44 kW (58-60 PS) D7F 708	10.2003→06.2007		7.02604.10.0	LS	560 mm	Baumuster: C06G Type: C06G vor Katalysator, nach Katalysator in front of the catalyst, Post-catalyst









TWINGO II (CN0_) **89**

R

1.5 dCi (CN0E) 47 kW (64 PS) K9K 740	03.2007→09.2014		7.00368.15.0	AGR	EL	
1.5 dCi (CN0U) 60-62 kW (82-84 PS) K9K 718	04.2008→09.2014		7.00368.15.0	AGR	EL	
1.5 dCi 75 55-63 kW (75-86 PS) K9K 820	10.2010→		7.00368.16.0	AGR	EL	
1.5 dCi 90 55-63 kW (75-86 PS) K9K 820	10.2010→		7.00368.16.0	AGR	EL	







VEL SATIS (BJ0_) **90**

2.0 dCi (BJ03) 96-127 kW (131-173 PS) M9R 760	08.2005→		7.10334.05.0	AGR	EL	
2.0 dCi (BJ03, BJ0B) 96-127 kW (131-173 PS) M9R 760	01.2006→		7.10334.05.0	AGR	EL	
2.2 dCi (BJ0E, BJ0F) 83-110 kW (113-150 PS) G9T 702, G9T 703	06.2002→08.2009		7.22818.59.0	AGR	EL	 Durchmesser Ventilteller/diameter valve head 30 mm
			7.22818.63.0	AGR	EL	 Durchmesser Ventilteller/diameter valve head 16 mm



						
VEL SATIS (BJ0_)						90
2.2 dCi (BJ0E, BJ0F, BJ0G, BJ0H) 83-110 kW (113-150 PS) G9T 702	09.2004→		7.22818.59.0	AGR	EL 	Durchmesser Ventilteller/diameter valve head 30 mm
			7.22818.63.0	AGR	EL 	Durchmesser Ventilteller/diameter valve head 16 mm
2.2 dCi (BJ0H) 83-110 kW (113-150 PS) G9T 702	04.2004→		7.22818.59.0	AGR	EL 	Durchmesser Ventilteller/diameter valve head 30 mm
			7.22818.63.0	AGR	EL 	Durchmesser Ventilteller/diameter valve head 16 mm
2.2 dCi (BJ0M) 83-110 kW (113-150 PS) G9T 702	12.2004→		7.22818.59.0	AGR	EL 	Durchmesser Ventilteller/diameter valve head 30 mm
			7.22818.63.0	AGR	EL 	Durchmesser Ventilteller/diameter valve head 16 mm
3.5 V6 (BJ0R, BJ0V, BJ0U) 177 kW (241 PS) V4Y 701, V4Y 711	06.2002→		7.05270.55.0	LS	470 mm	 V4Y 701, V4Y 711: links, rechts Left, Right
18 Estate Van						91
2.1 Diesel 49-53 kW (67-72 PS) 852 710, J8S 711	11.1981→07.1986		7.02604.01.0	LS	200 mm	
21 Estate Van (S48_)						92
1.7 65 kW (88 PS) F2N 710	06.1986→03.1992		7.05270.51.0	LS	375 mm	
CLIO I Hatchback Van (S57_)						93
1.1 35-36 kW (48-49 PS) C1E 700	01.1991→09.1998		7.02604.03.0	LS	200 mm	
1.2 40-43 kW (54-58 PS) E7F 706	01.1991→09.1998		7.05270.51.0	LS	375 mm	
1.2 40 kW (54 PS) C3G 720	01.1996→12.1996		7.05270.45.0	LS	375 mm	
CLIO II Hatchback Van (SB0/1/2_)						94
1.2 (SB0A, SB0F, SB10) 43-44 kW (58-60 PS) D7F 722	03.1999→10.2003		7.05270.48.0	LS	420 mm	
1.2 (SB0A, SB0F, SB1K, SB2D) 43 kW (58 PS) D7F 720	09.1998→		7.05270.48.0	LS	420 mm	
1.2 (SB0A, SB0F, SB1K, SB2D) 43 kW (58 PS) D7F 726	09.1998→		7.02604.10.0	LS	560 mm	Baumuster: SB2D Type: SB2D vor Katalysator in front of the catalyst
1.5 dCi 45-60 kW (61-82 PS) K9K 702	06.2001→10.2004		7.22818.58.0	AGR	EL 	
1.5 dCi 45-60 kW (61-82 PS) K9K 702, K9K 710	11.2003→		7.22818.58.0	AGR	EL 	
1.5 dCi 45-60 kW (61-82 PS) K9K 716	11.2003→		7.00368.15.0	AGR	EL	
1.5 dCi 47-50 kW (64-68 PS) K9K 714	04.2004→		7.00368.15.0	AGR	EL	
1.5 dCi (SB07) 42-50 kW (57-68 PS) K9K 700, K9K 704	06.2001→		7.22818.58.0	AGR	EL 	
1.9 D (SB0J) 47-48 kW (64-65 PS) F8Q 632	02.2000→05.2001		7.22818.57.0	AGR	EL 	







CLIO III Hatchback Van (SB_, SR_) 95

1.2 (SR0J) 48-55 kW (65-75 PS) D4F 740	11.2005→12.2014		7.05270.54.0	LS	450 mm	Baumuster: SR23 Type: SR23 vor Katalysator, nach Katalysator in front of the catalyst, Post-catalyst Produktionsdatum bis: 28.06.2006 Production date to: 28.06.2006
1.5 dCi 63-65 kW (86-88 PS) K9K 766	06.2005→07.2010		7.00368.15.0	AGR	EL	
1.5 dCi 48-50 kW (65-68 PS) K9K 768	10.2005→07.2010		7.00368.15.0	AGR	EL	
1.5 dCi 78 kW (106 PS) K9K 764	10.2005→10.2007		7.00368.15.0	AGR	EL	
1.5 dCi (SR1H) 55-65 kW (75-88 PS) K9K 770	08.2010→12.2014		7.00368.16.0	AGR	EL	

CLIO IV Grandtour (KH_) 96



1.5 dCi 75 55-66 kW (75-90 PS) K9K 612	01.2014→		7.03571.16.0	AK	EL	
			↳ 7.03083.20.0	SRM-AK	EL	
1.5 dCi 90 55-66 kW (75-90 PS) K9K 608	01.2014→		7.03571.16.0	AK	EL	
			↳ 7.03083.20.0	SRM-AK	EL	

CLIO IV Hatchback Van (BH_) 97

1.5 dCi 75 55-66 kW (75-90 PS) K9K 612	01.2014→		7.00368.16.0	AGR	EL	
			7.03571.16.0	AK	EL	
			↳ 7.03083.20.0	SRM-AK	EL	
1.5 dCi 90 (BH AJ) 55-66 kW (75-90 PS) K9K 608	01.2014→		7.03435.05.0	AGR	EL	
			7.03571.16.0	AK	EL	
			↳ 7.03083.20.0	SRM-AK	EL	
1.5 dCi 90 (BH AJ) 55-66 kW (75-90 PS) K9K 628, K9K 629	01.2014→		7.03571.16.0	AK	EL	
			↳ 7.03083.20.0	SRM-AK	EL	
			7.11457.07.0*	DDS	EL	
			↳ 7.11492.07.0	DDS	EL	

































R

DOKKER 98

1.5 dCi 55-66 kW (75-90 PS) K9K 612	12.2013→		7.00368.16.0	AGR	EL	
---	----------	---	---------------------	-----	----	---

KANGOO Express (FC0/1_) 99

1.0 44-50 kW (60-68 PS) D4D 700	01.2002→01.2007		7.05270.54.0	LS	450 mm	vor Katalysator, nach Katalysator in front of the catalyst, Post-catalyst Produktionsdatum bis: 28.06.2006 Production date to: 28.06.2006
1.2 (FC01, FC0A, FC0F) 43-44 kW (58-60 PS) D7F 720, D7F 722	08.1997→		7.05270.48.0	LS	420 mm	
1.2 (FC01, FC0A, FC0F) 43-44 kW (58-60 PS) D7F 726, D7F 744	08.1997→		7.02604.10.0	LS	560 mm	 D7F 726: vor Katalysator in front of the catalyst nicht für Baumuster: FC0A not for code: FC0A  D7F 744: Baumuster: FC0F Type: FC0F vor Katalysator in front of the catalyst

					
KANGOO Express (FC0/1_)					
1.2 (FC1A) 43 kW (58 PS) D7F 764, D7F 766	07.1998→07.2001		7.02604.10.0	LS	560 mm D7F 764, D7F 766: vor Katalysator, nach Katalysator in front of the catalyst, Post-catalyst
1.2 16V (FC05, FC0W, FC1D, FC1P, FC1K, FC0T) 50-55 kW (68-75 PS) D4F 712, D4F 730	10.2001→		7.05270.54.0	LS	450 mm D4F 712, D4F 730: vor Katalysator, nach Katalysator in front of the catalyst, Post-catalyst Produktionsdatum bis: 28.06.2006 Production date to: 28.06.2006
1.4 (FC0C, FC0B, FC0H, FC0M) 55 kW (75 PS) E7J 634, E7J 635, K7J 701	08.1997→06.2008		7.05270.56.0	LS	275 mm E7J 634, E7J 635: Regelsonde Regulating Probe K7J 701: 03.2003→ Regelsonde Regulating Probe
1.4 (FC0C, FC0B, FC0H, FC0M) 55-72 kW (75-98 PS) K7J 700	08.1997→06.2008		7.02604.03.0	LS	200 mm
1.4 (FC0C, FC0B, FC0H, FC0M) 55 kW (75 PS) E7J 780	03.1998→06.2008		7.05270.49.0	LS	285 mm →02.2003
			7.02604.03.0	LS	200 mm
1.5 dCi 45-60 kW (61-82 PS) K9K 716	10.2005→		7.00368.15.0	AGR	EL
1.5 dCi (FC07, FC1R) 42-60 kW (57-82 PS) K9K 700, K9K 702, K9K 704	12.2001→		7.22818.58.0	AGR	EL 
1.5 dCi (FC08, FC09) 45-60 kW (61-82 PS) K9K 702, K9K 710	04.2003→		7.22818.58.0	AGR	EL 
1.5 dCi (FC1E) 47-50 kW (64-68 PS) K9K 714	06.2005→		7.00368.15.0	AGR	EL
1.5 dCi (FC1G) 60-62 kW (82-84 PS) K9K 718	06.2005→		7.00368.15.0	AGR	EL
1.5 dCi (FC1R) 42-48 kW (57-65 PS) K9K 704	12.2002→		7.22818.58.0	AGR	EL 
1.6 16V 70 kW (95 PS) K4M 752	10.2001→		7.02604.10.0	LS	560 mm vor Katalysator, nach Katalysator in front of the catalyst, Post-catalyst
1.6 16V 4x4 (FC0L, FC0P, FC0S) 70 kW (95 PS) K4M 750, K4M 752, K4M 753	10.2001→		7.02604.10.0	LS	K4M 750, K4M 752, K4M 753: vor Katalysator, nach Katalysator in front of the catalyst, Post-catalyst
1.9 D (FC0J) 47-48 kW (64-65 PS) F8Q 632	09.1999→06.2003		7.22818.57.0	AGR	EL 
1.9 dCi (FC0V) 59-62 kW (80-84 PS) F9Q 782, F9Q 790	07.2003→		7.22818.57.0	AGR	EL 
1.9 dCi 4x4 (FC0V) 59-62 kW (80-84 PS) F9Q 782, F9Q 790	10.2001→		7.22818.57.0	AGR	EL 
1.9 dCi 4x4 (FC0V) 59-62 kW (80-84 PS) F9Q 790	07.2003→		7.22818.57.0	AGR	EL 
D 65 1.9 (FC0E, FC02, FC0J, FC0N) 47-48 kW (64-65 PS) F8Q 632	08.1997→		7.22818.57.0	AGR	EL 



























R





































KANGOO Express (FW0/1_) 100

























1.5 dCi 45-50 kW (61-68 PS) K9K 700	05.2008→01.2014		7.22818.58.0	AGR	EL	
1.5 dCi 105 (FW0F) 76 kW (103 PS) K9K 806	02.2008→		7.00368.15.0	AGR	EL	
1.5 dCi 110 (FW06, FW12) 67-81 kW (91-110 PS) K9K 647	09.2013→		7.05320.04.0	AGR	EL	
			7.03571.16.0	AK	EL	
			↳ 7.03083.20.0	SRM-AK	EL	
			7.11457.07.0*	DDS		
			↳ 7.11492.07.0	DDS		
1.5 dCi 110 (FW06, FW12) 70-81 kW (95-110 PS) K9K 646	09.2013→		7.05320.04.0	AGR	EL	
			7.11457.07.0*	DDS		
			↳ 7.11492.07.0	DDS		
1.5 dCi 110 (FW06, FW12) 81 kW (110 PS) K9K 636	09.2013→		7.03435.05.0	AGR	EL	
			7.03571.16.0	AK	EL	
			↳ 7.03083.20.0	SRM-AK	EL	
1.5 dCi 110 (FW06, FW12) 81 kW (110 PS) K9K 648	09.2013→		7.05320.04.0	AGR	EL	
			7.11457.07.0*	DDS		
			↳ 7.11492.07.0	DDS		
			7.03083.20.0	SRM-AK	EL	
1.5 dCi 110 (FW0C, FW0H) 80-81 kW (109-110 PS) K9K 816	09.2010→		7.00368.16.0	AGR	EL	
1.5 dCi 115 (FW17) 59-85 kW (80-116 PS) K9K 872	10.2019→		7.11457.07.0*	DDS		
			↳ 7.11492.07.0	DDS		
1.5 dCi 70 (FW0A, KW0V) 50-63 kW (75-86 PS) K9K 800	02.2008→		7.00368.15.0	AGR	EL	
1.5 dCi 75 (FW07, FW10, FW04) 55-66 kW (75-90 PS) K9K 608	09.2010→		7.03435.05.0	AGR	EL	
			7.03571.16.0	AK	EL	
			↳ 7.03083.20.0	SRM-AK	EL	
1.5 dCi 75 (FW07, FW10, FW04) 55-66 kW (75-90 PS) K9K 628	09.2010→		7.05320.04.0	AGR	EL	
			7.03571.16.0	AK	EL	
			↳ 7.03083.20.0	SRM-AK	EL	
			7.11457.07.0*	DDS		
			↳ 7.11492.07.0	DDS		
1.5 dCi 75 (FW07, FW10, FW04) 55-66 kW (75-90 PS) K9K 808	09.2010→		7.00368.16.0	AGR	EL	
1.5 dCi 80 (FW15) 59-85 kW (80-116 PS) K9K 872	10.2019→		7.11457.07.0*	DDS		
			↳ 7.11492.07.0	DDS		

R

						
KANGOO Express (FW0/1_)						100
1.5 dCi 85 (FW0K, FW0L, FW0B) 50-63 kW (68-86 PS) K9K 802	02.2008→		7.00368.15.0	AGR	EL	
1.5 dCi 90 (FW0G, FW05, FW08, FW11) 55-66 kW (75-90 PS) K9K 608	06.2009→		7.03435.05.0	AGR	EL	
			7.03571.16.0 ↳ 7.03083.20.0	AK SRM-AK	EL EL	
1.5 dCi 90 (FW0G, FW05, FW08, FW11) 55-66 kW (75-90 PS) K9K 628	06.2009→		7.05320.04.0	AGR	EL	
			7.03571.16.0 ↳ 7.03083.20.0	AK SRM-AK	EL EL	
			7.11457.07.0* ↳ 7.11492.07.0	DDS DDS		
1.5 dCi 90 (FW0G, FW05, FW08, FW11) 55-66 kW (75-90 PS) K9K 808	06.2009→		7.00368.16.0	AGR	EL	
1.5 dCi 90 (FW18) 67-81 kW (91-110 PS) K9K 647	08.2017→		7.05320.04.0	AGR	EL	
			7.03571.16.0 ↳ 7.03083.20.0	AK SRM-AK	EL EL	
			7.11457.07.0* ↳ 7.11492.07.0	DDS DDS		
1.5 dCi 95 (FW16) 59-85 kW (80-116 PS) K9K 872	10.2019→		7.11457.07.0* ↳ 7.11492.07.0	DDS DDS		
LOGAN EXPRESS (US_)						101
1.5 dCi 50 kW (68 PS) K9K 792	04.2007→		7.00368.15.0	AGR	EL	
1.6 64-76 kW (87-103 PS) K7M 710	04.2007→		7.05270.54.0	LS	450 mm	für OE-Nummer: 82 00 052 063 for OE number: 82 00 052 063 vor Katalysator in front of the catalyst
MASTER I Bus (T_)						102
30 2,2 67-71 kW (91-97 PS) J7T 782, J7T 788	08.1980→07.1998		7.02604.01.0	LS	200 mm	
MASTER I Platform/Chassis (P_)						103
2.2 67-71 kW (91-97 PS) J7T 788	08.1993→02.1998		7.02604.01.0	LS	200 mm	
MASTER I Van (T_)						104
30 2,2 67-71 kW (91-97 PS) J7T 782, J7T 788	08.1980→07.1998		7.02604.01.0	LS	200 mm	
MASTER II Bus (JD)						105
1.9 dCi 80 60 kW (82 PS) F9Q 772, F9Q 774	11.2001→		7.22818.57.0	AGR	EL	
2.2 dCi 90 66 kW (90 PS) G9T 720, G9T 722, G9T 750	09.2000→		7.22818.59.0	AGR	EL	
			7.22818.63.0	AGR	EL	
2.5 dCi 74-88 kW (101-120 PS) G9U 650	08.2006→		7.02604.44.0	LS	500 mm	vor Katalysator in front of the catalyst

R

						
MASTER II Bus (JD)						105
2.5 dCi 88-107 kW (120-146 PS) G9U 632	08.2006→		7.02604.44.0	LS	500 mm	vor Katalysator in front of the catalyst
2.5 dCi 120 84 kW (115 PS) G9U 720, G9U 750	10.2001→		7.22818.59.0	AGR	EL	 Durchmesser Ventilteller/diameter valve head 30 mm
MASTER II Platform/Chassis (ED/HD/UD)						106
2.2 dCi 90 66 kW (90 PS) G9T 720, G9T 722, G9T 750	09.2000→		7.22818.59.0	AGR	EL	 Durchmesser Ventilteller/diameter valve head 30 mm
			7.22818.63.0	AGR	EL	 Durchmesser Ventilteller/diameter valve head 16 mm
2.5 dCi 74-88 kW (101-120 PS) G9U 650	08.2006→		7.02604.44.0	LS	500 mm	vor Katalysator in front of the catalyst
2.5 dCi 74-88 kW (101-120 PS) G9U 650	08.2006→		7.02604.44.0	LS	500 mm	vor Katalysator in front of the catalyst
2.5 dCi 88-107 kW (120-146 PS) G9U 632	08.2006→		7.02604.44.0	LS	500 mm	vor Katalysator in front of the catalyst
2.5 dCi 120 84 kW (115 PS) G9U 720, G9U 750	10.2001→		7.22818.59.0	AGR	EL	 Durchmesser Ventilteller/diameter valve head 30 mm
MASTER II Van (FD)						107
1.9 dCi 80 60 kW (82 PS) F9Q 772, F9Q 774	11.2001→		7.22818.57.0	AGR	EL	
2.2 dCi 90 66 kW (90 PS) G9T 720, G9T 722, G9T 750	09.2000→		7.22818.59.0	AGR	EL	 Durchmesser Ventilteller/diameter valve head 30 mm
			7.22818.63.0	AGR	EL	 Durchmesser Ventilteller/diameter valve head 16 mm
2.5 dCi 74-88 kW (101-120 PS) G9U 650	08.2006→01.2010		7.02604.44.0	LS	500 mm	vor Katalysator in front of the catalyst
2.5 dCi 74-88 kW (101-120 PS) G9U 650	08.2006→		7.02604.44.0	LS	500 mm	vor Katalysator in front of the catalyst
2.5 dCi 88-107 kW (120-146 PS) G9U 632	08.2006→		7.02604.44.0	LS	500 mm	vor Katalysator in front of the catalyst
2.5 dCi 120 84 kW (115 PS) G9U 720, G9U 750	10.2001→		7.22818.59.0	AGR	EL	 Durchmesser Ventilteller/diameter valve head 30 mm
MASTER III Bus (JV)						108
2.3 dCi 100 FWD (JV0A, JV0B, JV0G, JV0H) 74-92 kW (100-125 PS) M9T 670, M9T 672, M9T 676, M9T 870	02.2011→		7.10334.03.0	AGR	EL	
			7.02604.99.0	LS	400 mm	
2.3 dCi 110 FWD (JV0R, JV0W) 74-92 kW (100-125 PS) M9T 870	09.2014→		7.10334.03.0	AGR	EL	
2.3 dCi 110 FWD (JV0R, JV0W) 81-96 kW (110-131 PS) M9T 704	09.2014→		7.11492.07.0	DDS		ohne Zubehör without accessories
2.3 dCi 125 FWD (JV0C, JV0D, JV0H, JV0G, JV0J) 74-92 kW (100-125 PS) M9T 670, M9T 672, M9T 676, M9T 870	02.2011→		7.10334.03.0	AGR	EL	
			7.02604.99.0	LS	400 mm	

















					
MASTER III Bus (JV)					
108					
2.3 dCi 125 FWD (JV0C, JV0D, JV0H, JV0G, JV0J) 92-110 kW (125-150 PS) M9T 680, M9T 880	02.2011→		7.02604.99.0	LS	400 mm
2.3 dCi 145 FWD (JV0F, JV0S, JV0T) 92-107 kW (125-145 PS) M9T 680	02.2011→		7.10334.03.0	AGR	EL 
			7.02604.99.0	LS	400 mm
2.3 dCi 145 FWD (JV0F, JV0S, JV0T) 107-125 kW (145-170 PS) M9T 706, M9T 708	02.2011→		7.11492.07.0	DDS	ohne Zubehör without accessories
			7.02604.99.0	LS	400 mm
2.3 dCi 150 FWD (JV0F, JV03) 92-110 kW (125-150 PS) M9T 880	10.2012→		7.10334.03.0	AGR	EL 
			7.02604.99.0	LS	400 mm
2.3 dCi 150 FWD (JV0F, JV03) 100-132 kW (136-179 PS) M9T 716	03.2020→		7.02604.99.0	LS	400 mm
2.3 dCi 165 FWD (JV0P, JV0U) 107-120 kW (145-163 PS) M9T 708	07.2014→		7.11492.07.0	DDS	ohne Zubehör without accessories
2.3 dCi 170 FWD (JV0L) 107-125 kW (145-170 PS) M9T 706	07.2015→		7.11492.07.0	DDS	ohne Zubehör without accessories
MASTER III Platform/Chassis (EV, HV, UV)					
109					
2.3 dCi 100 FWD (EV0A, EV0B, HV0A, HV0B, UV0A, UV0B,...) 74-92 kW (100-125 PS) M9T 670, M9T 672, M9T 676, M9T 870	02.2010→		7.10334.03.0	AGR	EL 
			7.02604.99.0	LS	400 mm
2.3 dCi 100 FWD (EV0A, EV0B, HV0A, HV0B, UV0A, UV0B,...) 74-92 kW (100-125 PS) M9T 876	02.2010→		7.02604.99.0	LS	400 mm
2.3 dCi 100 RWD (HV0B, UV0B) 74-92 kW (101-125 PS) M9T 690	02.2010→		7.10334.03.0	AGR	EL 
			7.02604.99.0	LS	400 mm
2.3 dCi 110 FWD (EV0R, EV0W, HV0R, HV0W, UV0R, UV0W) 74-92 kW (100-125 PS) M9T 870	09.2014→		7.10334.03.0	AGR	EL 
2.3 dCi 110 FWD (EV0R, EV0W, HV0R, HV0W, UV0R, UV0W) 81-96 kW (110-131 PS) M9T 704	09.2014→		7.11492.07.0	DDS	ohne Zubehör without accessories
2.3 dCi 125 FWD (EV0C, EV0D, EV0J, HV0C, HV0D, HV0H,...) 74-92 kW (100-125 PS) M9T 670, M9T 672, M9T 676, M9T 870	02.2010→		7.10334.03.0	AGR	EL 
			7.02604.99.0	LS	400 mm

R



MASTER III Platform/Chassis (EV, HV, UV)

109

<p>2.3 dCi 125 FWD (EV0C, EV0D, EV0J, HV0C, HV0D, HV0H,... 74-110 kW (100-150 PS) M9T 680, M9T 872, M9T 876, M9T 880</p>	<p>02.2010→</p>	<p>7.02604.99.0</p> 	<p>LS 400 mm</p>	
<p>2.3 dCi 125 RWD (HV0C, HV0D, UV0C, UV0D, UV0H, UV0J,... 74-110 kW (100-150 PS) M9T 686, M9T 690, M9T 692, M9T 698, M9T 890</p>	<p>02.2010→</p>	<p>7.10334.03.0</p> 	<p>AGR EL</p>	<p> für OE-Nummer: 14 71 003 85R, 14 71 055 43R, 82 00 796 674 for OE number: 14 71 003 85R, 14 71 055 43R, 82 00 796 674</p>
<p>2.3 dCi 125 RWD (HV0C, HV0D, UV0C, UV0D, UV0H, UV0J,... 92-110 kW (125-150 PS) M9T 696, M9T 882, M9T 896, M9T 898</p>	<p>02.2010→</p>	<p>7.02604.99.0</p> 	<p>LS 400 mm</p>	
<p>2.3 dCi 130 FWD (EV0Y, HV0Y, UV0M, UV0Y) 81-96 kW (110-131 PS) M9T 704</p>	<p>03.2012→</p>	<p>7.11492.07.0</p> 	<p>DDS</p>	<p>ohne Zubehör without accessories</p>
<p>2.3 dCi 145 FWD (EV0E, EV0F, HV0E, HV0F, UV0E, UV0F,... 92-107 kW (125-146 PS) M9T 678, M9T 680</p>	<p>02.2010→</p>	<p>7.10334.03.0</p> 	<p>AGR EL</p>	<p></p>
<p>2.3 dCi 145 FWD (EV0E, EV0F, HV0E, HV0F, UV0E, UV0F,... 107-125 kW (145-170 PS) M9T 706</p>	<p>02.2010→</p>	<p>7.11492.07.0</p> 	<p>DDS</p>	<p>ohne Zubehör without accessories</p>
<p>2.3 dCi 145 FWD (EV0E, EV0F, HV0E, HV0F, UV0E, UV0F,... 107-120 kW (145-163 PS) M9T 708</p>	<p>02.2010→</p>	<p>7.02604.99.0</p> 	<p>LS 400 mm</p>	
<p>2.3 dCi 145 RWD (UV0F, UV0E, HV0E, HV0F, HV0T, HV10,... 92-110 kW (125-150 PS) M9T 694, M9T 696, M9T 698</p>	<p>02.2010→</p>	<p>7.10334.03.0</p> 	<p>AGR EL</p>	<p></p>
<p>2.3 dCi 145 RWD (UV0F, UV0E, HV0E, HV0F, HV0T, HV10,... 96-120 kW (131-163 PS) M9T 710</p>	<p>02.2010→</p>	<p>7.02604.99.0</p> 	<p>LS 400 mm</p>	
<p>2.3 dCi 150 FWD (EV0F, HV0F, UV0F, EV03, HV03, UV03) 92-110 kW (125-150 PS) M9T 880</p>	<p>03.2013→</p>	<p>7.10334.03.0</p> 	<p>AGR EL</p>	<p></p>
<p>2.3 dCi 150 FWD (EV0F, HV0F, UV0F, EV03, HV03, UV03) 92-110 kW (125-150 PS) M9T 880</p>	<p>03.2013→</p>	<p>7.02604.99.0</p> 	<p>LS 400 mm</p>	<p>Motorcode: M9T880 Engine Code: M9T880 Produktionsdatum ab: 03.2013 Production date from: 03.2013</p>
<p>2.3 dCi 150 RWD (HV0F, UV0F) 92-110 kW (125-150 PS) M9T 898</p>	<p>03.2013→</p>	<p>7.10334.03.0</p> 	<p>AGR EL</p>	<p></p>

R



















MASTER III Platform/Chassis (EV, HV, UV)

109

		7.02604.99.0	LS	400 mm	Motorcode: M9T898 Engine Code: M9T898 Produktionsdatum ab: 03.2013 Production date from: 03.2013
2.3 dCi 170 FWD (EV0L, HV0L, UV0L) 107-125 kW (145-170 PS) M9T 706	06.2016→	 7.11492.07.0	DDS		ohne Zubehör without accessories

MASTER III Van (FV)











110

2.3 dCi 100 FWD (FV0A, FV0B, FV0G, FV0K, FV0H) 74-92 kW (100-125 PS) M9T 670, M9T 672, M9T 676, M9T 870	02.2010→	 7.10334.03.0	AGR	EL	
		7.02604.99.0	LS	400 mm	
2.3 dCi 100 FWD (FV0A, FV0B, FV0G, FV0K, FV0H) 74-92 kW (100-125 PS) M9T 876	02.2010→	 7.02604.99.0	LS	400 mm	
2.3 dCi 100 RWD (FV0B) 74-92 kW (100-125 PS) M9T 690, M9T 890	02.2010→	 7.10334.03.0	AGR	EL	
		7.02604.99.0	LS	400 mm	
2.3 dCi 110 FWD (FV0R, FV0W) 74-92 kW (100-125 PS) M9T 870	09.2014→	 7.10334.03.0	AGR	EL	
2.3 dCi 110 FWD (FV0R, FV0W) 81-96 kW (110-131 PS) M9T 704	09.2014→	 7.11492.07.0	DDS		ohne Zubehör without accessories
2.3 dCi 125 FWD (FV0C, FV0D, FV0G, FV0H, FV0J, FV0K) 74-92 kW (100-125 PS) M9T 670, M9T 672, M9T 676, M9T 870	02.2010→	 7.10334.03.0	AGR	EL	
		7.02604.99.0	LS	400 mm	
2.3 dCi 125 FWD (FV0C, FV0D, FV0G, FV0H, FV0J, FV0K) 74-110 kW (100-150 PS) M9T 680, M9T 872, M9T 876, M9T 880, M9T 882	02.2010→	 7.02604.99.0	LS	400 mm	
2.3 dCi 125 RWD (FV0C, FV0D, FV0H, FV0J, FV0A, FV0K) 74-110 kW (100-150 PS) M9T 686, M9T 690, M9T 692, M9T 696, M9T 698, M9T 890, M9T 896	02.2010→	 7.10334.03.0	AGR	EL	
		7.02604.99.0	LS	400 mm	
2.3 dCi 125 RWD (FV0C, FV0D, FV0H, FV0J, FV0A, FV0K) 92-110 kW (125-150 PS) M9T 898	02.2010→	 7.02604.99.0	LS	400 mm	
2.3 dCi 130 FWD (FV0M, FV0Y) 81-120 kW (110-163 PS) M9T 704, M9T 710	06.2016→	 7.11492.07.0	DDS		ohne Zubehör without accessories
2.3 dCi 145 FWD (FV0E, FV0F, FV0H, FV02, FV0M, FV0S,...) 92-107 kW (125-146 PS) M9T 678, M9T 680	02.2010→	 7.10334.03.0	AGR	EL	



R









MASTER III Van (FV) 110

			7.02604.99.0	LS	400 mm	
2.3 dCi 145 FWD (FV0E, FV0F, FV0H, FV02, FV0M, FV0S,...) 107-125 kW (145-170 PS) M9T 706, M9T 708	02.2010→		7.11492.07.0	DDS		ohne Zubehör without accessories
			7.02604.99.0	LS	400 mm	
2.3 dCi 145 RWD (FV0E, FV0F, FV0T, FV10, FV12) 92-120 kW (125-163 PS) M9T 696, M9T 710	02.2010→		7.02604.99.0	LS	400 mm	
			7.10334.03.0	AGR	EL	
2.3 dCi 145 RWD (FV0E, FV0F, FV0T, FV10, FV12) 92-110 kW (125-150 PS) M9T 694, M9T 698	02.2010→		7.02604.99.0	LS	400 mm	
			7.10334.03.0	AGR	EL	
2.3 dCi 150 FWD (FV0F, FV03) 92-110 kW (125-150 PS) M9T 880	03.2013→		7.02604.99.0	LS	400 mm	
			7.10334.03.0	AGR	EL	
2.3 dCi 150 FWD (FV0F, FV03) 100-132 kW (136-179 PS) M9T 716	07.2019→		7.02604.99.0	LS	400 mm	
			7.10334.03.0	AGR	EL	
2.3 dCi 150 RWD (FV0F) 92-110 kW (125-150 PS) M9T 898	03.2013→		7.02604.99.0	LS	400 mm	Motorcode: M9T898 Engine Code: M9T898 Produktionsdatum ab: 03.2013 Production date from: 03.2013
			7.11492.07.0	DDS		ohne Zubehör without accessories
2.3 dCi 165 FWD (FV0P, FV0U, FV11, FV12) 107-120 kW (145-163 PS) M9T 708	07.2014→		7.11492.07.0	DDS		ohne Zubehör without accessories
2.3 dCi 170 FWD (FV0L) 107-125 kW (145-170 PS) M9T 706	07.2015→		7.11492.07.0	DDS		ohne Zubehör without accessories

R MEGANE I Hatchback Van (SA0/1_) 111

1.9 (SA0U, SA0R, SA0A) 47 kW (64 PS) F8Q 622	08.1995→09.2000		7.22818.57.0	AGR	EL	
---	-----------------	---	---------------------	-----	----	---

MEGANE II Estate Van (KM_) 112

1.5 dCi (KM02) 74-78 kW (101-106 PS) K9K 728	08.2003→07.2009		7.22818.58.0	AGR	EL	
1.5 dCi (KM0F) 60-63 kW (82-86 PS) K9K 722	08.2003→07.2009		7.22818.58.0	AGR	EL	
1.5 dCi (KM1E) 78 kW (106 PS) K9K 732	08.2003→07.2009		7.00368.15.0	AGR	EL	
1.5 dCi (KM1F) 63 kW (86 PS) K9K 724	05.2005→07.2009		7.00368.15.0	AGR	EL	











MEGANE II Hatchback Van (KM0/2_) 113

1.5 dCi 63 kW (86 PS) K9K 724	04.2005→02.2008		7.00368.15.0	AGR	EL	
---	-----------------	---	---------------------	-----	----	--

















					
MEGANE III Combi Van (KZ0/1) 114					
1.5 dCi 78-81 kW (106-110 PS) K9K 836, K9K 837	01.2009→08.2015		7.00368.16.0	AGR	EL 
1.5 dCi (KZ1A) 66 kW (90 PS) K9K 834	03.2010→08.2015		7.00368.16.0	AGR	EL 
MEGANE III Hatchback Van (BZ_) 115					
1.5 dCi (BZ0C, BZ1A) 66 kW (90 PS) K9K 834	11.2008→08.2015		7.00368.16.0	AGR	EL 
1.5 dCi (BZ0D, BZ1G, BZ1F, BZ1M, BZ1W, BZ0R, BZ10) 70-81 kW (95-110 PS) K9K 836, K9K 846	02.2009→08.2015		7.00368.16.0	AGR	EL 
Megane I Kombi van (KA_) 116					
1.4 (KA0D) 70 kW (95 PS) K4J 714, K4J 750	04.2001→07.2003		7.02604.10.0	LS	560 mm  K4J 714, K4J 750: vor Katalysator in front of the catalyst
1.8 (KA1M) 85 kW (115 PS) F4P 722	04.2001→07.2003		7.02604.10.0	LS	560 mm vor Katalysator in front of the catalyst
RAPID Box Body/MPV (F40_, G40_) 117					
1.2 40 kW (54 PS) C1G 726	09.1991→08.1993		7.02604.01.0	LS	200 mm
1.2 (F406, G40A) 40 kW (55 PS) C3G 710	09.1991→03.1998		7.05270.45.0	LS	375 mm 07.1993→
1.4 54-59 kW (73-80 PS) E7J 724	09.1991→08.1993		7.05270.51.0	LS	375 mm
1.4 (F402) 39-44 kW (53-60 PS) C1J 768, C1J 780	07.1985→08.1991		7.02604.01.0	LS	200 mm
1.4 (F40M) 44 kW (60 PS) C2J 784	03.1986→08.1991		7.02604.01.0	LS	200 mm
1.4 (F40U, F40V) 43-59 kW (58-80 PS) E7J 720, E7J 724	09.1991→09.1995		7.05270.51.0	LS	375 mm
1.4 (F40Y, F40A, F40V) 43-59 kW (58-80 PS) E7J 720	09.1991→08.1997		7.05270.51.0	LS	375 mm
TRAFIC Bus (TXW) 118					
2.2 59-74 kW (101 PS) J7T 600	06.1994→10.1997		7.05270.47.0	LS	325 mm
2.2 4x4 59-74 kW (101 PS) J7T 600	06.1994→10.1997		7.05270.47.0	LS	325 mm
TRAFIC II Bus (JL) 119					
1.9 dCi 100 (JL0C) 60-75 kW (82-102 PS) F9Q 760	03.2001→		7.22818.57.0	AGR	EL 
1.9 dCi 60 kW (82 PS) F9Q 762	04.2001→07.2003		7.22818.57.0	AGR	EL 
1.9 dCi 60-75 kW (82-102 PS) F9Q 760	01.2012→12.2018		7.22818.57.0	AGR	EL 
2.0 (JL0A) 88 kW (120 PS) F4R 720	03.2001→		7.02604.10.0	LS	560 mm vor Katalysator, nach Katalysator in front of the catalyst, Post-catalyst
2.0 16V 86 kW (117 PS) F4R 820	08.2006→		7.02604.10.0	LS	560 mm für OE-Nummer: 77 00 107 433 for OE number: 77 00 107 433 vor Katalysator, nach Katalysator in front of the catalyst, Post-catalyst
2.0 dCi 115 66-84 kW (90-114 PS) M9R 780	08.2006→		7.10334.03.0	AGR	EL  für OE-Nummer: 14 71 003 85R, 14 71 055 43R, 82 00 796 674 for OE number: 14 71 003 85R, 14 71 055 43R, 82 00 796 674





































TRAFIC II Bus (JL) 119

			7.10334.05.0	AGR	EL	 für OE-Nummer: 82 00 327 004, 82 00 691 292, 82 00 693 739, 82 00 797 706 for OE number: 82 00 327 004, 82 00 691 292, 82 00 693 739, 82 00 797 706
2.0 dCi 115 66-84 kW (90-114 PS) M9R 692, M9R 782, M9R 786	08.2006→		7.10334.03.0	AGR	EL	
2.0 dCi 90 66-84 kW (90-114 PS) M9R 630, M9R 782	08.2006→		7.10334.03.0	AGR	EL	
2.5 dCi 115 84-107 kW (114-146 PS) G9U 630	02.2008→		7.02604.44.0	LS	500 mm	vor Katalysator in front of the catalyst
2.5 dCi 135 (JL0D) 99 kW (135 PS) G9U 730	05.2003→		7.22818.59.0	AGR	EL	 Durchmesser Ventilteller/diameter valve head 30 mm
2.5 dCi 145 (JL0J) 84-107 kW (114-146 PS) G9U 630	08.2006→		7.02604.44.0	LS	500 mm	vor Katalysator in front of the catalyst

TRAFIC II Platform/Chassis (EL) 120

1.9 dCi 60 kW (82 PS) F9Q 762	09.2001→07.2003		7.22818.57.0	AGR	EL	
1.9 dCi 100 (EL0C) 60-75 kW (82-102 PS) F9Q 760	03.2001→		7.22818.57.0	AGR	EL	
1.9 dCi 80 (EL0B) 60 kW (82 PS) F9Q 762	03.2001→		7.22818.57.0	AGR	EL	
2.0 (EL0A) 88 kW (120 PS) F4R 720	03.2001→		7.02604.10.0	LS	560 mm	vor Katalysator, nach Katalysator in front of the catalyst, Post-catalyst
2.0 16V 86 kW (117 PS) F4R 820	08.2006→		7.02604.10.0	LS	560 mm	für OE-Nummer: 77 00 107 433 for OE number: 77 00 107 433 vor Katalysator, nach Katalysator in front of the catalyst, Post-catalyst
2.0 dCi 115 (EL0H) 66-84 kW (90-114 PS) M9R 780	08.2006→		7.10334.03.0	AGR	EL	 für OE-Nummer: 14 71 003 85R, 14 71 055 43R, 82 00 796 674 for OE number: 14 71 003 85R, 14 71 055 43R, 82 00 796 674
			7.10334.05.0	AGR	EL	 für OE-Nummer: 82 00 327 004, 82 00 691 292, 82 00 693 739, 82 00 797 706 for OE number: 82 00 327 004, 82 00 691 292, 82 00 693 739, 82 00 797 706
2.0 dCi 115 (EL0H) 66-84 kW (90-114 PS) M9R 692, M9R 782, M9R 786	08.2006→		7.10334.03.0	AGR	EL	
2.0 dCi 90 (EL0H) 66-84 kW (90-114 PS) M9R 780	08.2006→		7.10334.03.0	AGR	EL	 für OE-Nummer: 14 71 003 85R, 14 71 055 43R, 82 00 796 674 for OE number: 14 71 003 85R, 14 71 055 43R, 82 00 796 674
			7.10334.05.0	AGR	EL	 für OE-Nummer: 82 00 327 004, 82 00 691 292, 82 00 693 739, 82 00 797 706 for OE number: 82 00 327 004, 82 00 691 292, 82 00 693 739, 82 00 797 706
2.0 dCi 90 (EL0H) 66-84 kW (90-114 PS) M9R 782	08.2006→		7.10334.03.0	AGR	EL	
2.5 dCi 84-107 kW (114-146 PS) G9U 630	08.2007→		7.02604.44.0	LS	500 mm	vor Katalysator in front of the catalyst















R

					
TRAFIC II Platform/Chassis (EL)					120
2.5 dCi 135 (EL0D) 99 kW (135 PS) G9U 730	03.2001→		7.22818.59.0	AGR	EL  Durchmesser Ventilteller/diameter valve head 30 mm
2.5 dCi 145 (EL0J) 84-107 kW (114-146 PS) G9U 630	08.2006→		7.02604.44.0	LS	500 mm vor Katalysator in front of the catalyst
TRAFIC II Van (FL)					121
1.9 dCi 60-75 kW (82-102 PS) F9Q 760	03.2001→		7.22818.57.0	AGR	EL 
1.9 dCi 60 kW (82 PS) F9Q 762	04.2001→07.2003		7.22818.57.0	AGR	EL 
1.9 dCi 100 (FL0C) 60-75 kW (82-102 PS) F9Q 760	03.2001→		7.22818.57.0	AGR	EL 
1.9 dCi 80 (FL0B) 60-75 kW (82-102 PS) F9Q 760, F9Q 762	03.2001→		7.22818.57.0	AGR	EL 
2.0 (FL0A) 88 kW (120 PS) F4R 720	03.2001→		7.02604.10.0	LS	560 mm vor Katalysator, nach Katalysator in front of the catalyst, Post-catalyst
2.0 16V 86 kW (117 PS) F4R 820	08.2006→		7.02604.10.0	LS	560 mm für OE-Nummer: 77 00 107 433 for OE number: 77 00 107 433 vor Katalysator, nach Katalysator in front of the catalyst, Post-catalyst
2.0 dCi 115 (FL01, FL0U) 66-84 kW (90-114 PS) M9R 780	08.2006→		7.10334.03.0	AGR	EL  für OE-Nummer: 14 71 003 85R, 14 71 055 43R, 82 00 796 674 for OE number: 14 71 003 85R, 14 71 055 43R, 82 00 796 674
			7.10334.05.0	AGR	EL  für OE-Nummer: 82 00 327 004, 82 00 691 292, 82 00 693 739, 82 00 797 706 for OE number: 82 00 327 004, 82 00 691 292, 82 00 693 739, 82 00 797 706
2.0 dCi 115 (FL01, FL0U) 66-84 kW (90-114 PS) M9R 782, M9R 786	08.2006→		7.10334.03.0	AGR	EL 
2.0 dCi 115 (FL01, FL0U) 84 kW (114 PS) M9R 692	08.2006→		7.10334.03.0	AGR	EL 
			7.02604.44.0	LS	500 mm vor Katalysator in front of the catalyst
2.0 dCi 90 (FL0H) 66-84 kW (90-114 PS) M9R 630, M9R 782	08.2006→		7.10334.03.0	AGR	EL 
2.0 dCi 90 (FL0H) 66-84 kW (90-114 PS) M9R 780	08.2006→		7.10334.03.0	AGR	EL  für OE-Nummer: 14 71 003 85R, 14 71 055 43R, 82 00 796 674 for OE number: 14 71 003 85R, 14 71 055 43R, 82 00 796 674
			7.10334.05.0	AGR	EL  für OE-Nummer: 82 00 327 004, 82 00 691 292, 82 00 693 739, 82 00 797 706 for OE number: 82 00 327 004, 82 00 691 292, 82 00 693 739, 82 00 797 706
2.5 dCi 84-107 kW (114-146 PS) G9U 630	08.2007→		7.02604.44.0	LS	500 mm vor Katalysator in front of the catalyst
2.5 dCi 135 (FL0D) 99 kW (135 PS) G9U 730	05.2003→		7.22818.59.0	AGR	EL  Durchmesser Ventilteller/diameter valve head 30 mm
2.5 dCi 145 (FL0J) 84-107 kW (114-146 PS) G9U 630	08.2006→		7.02604.44.0	LS	500 mm vor Katalysator in front of the catalyst

R







TRAFIC III Bus (JG_) 122

1.6 dCi 115 (JGMD) 66-85 kW (90-116 PS) R9M 408	05.2014→	 7.24809.90.0	AGR	EL	 →07.2015
1.6 dCi 120 (JGMB) 88-107 kW (120-145 PS) R9M 450	05.2014→	 7.24809.90.0 7.11190.08.0 7.02604.99.0	AGR DDS LS	EL	 →07.2015 400 mm Motorcode: R9m 450 Engine Code: R9m 450 Produktionsdatum ab: 05.2014 Production date from: 05.2014
1.6 dCi 120 (JGMS) 70-89 kW (95-121 PS) R9M 415	01.2019→	 7.11457.07.0* ↳ 7.11492.07.0	DDS DDS		ab Euro 6 From Euro 6
1.6 dCi 125 (JGMH) 92-120 kW (125-163 PS) R9M 452	07.2015→	 7.24809.90.0 7.11457.07.0* ↳ 7.11492.07.0	AGR DDS DDS	EL	 →07.2018 ab Euro 6 From Euro 6
1.6 dCi 140 (JGMA) 88-107 kW (120-145 PS) R9M 450	05.2014→	 7.24809.90.0 7.11190.08.0 7.02604.99.0	AGR DDS LS	EL	 →07.2015 400 mm
1.6 dCi 145 (JGMG) 92-120 kW (125-163 PS) R9M 452	07.2015→	 7.24809.90.0 7.11457.07.0* ↳ 7.11492.07.0	AGR DDS DDS	EL	 →07.2018 ab Euro 6 From Euro 6
1.6 dCi 90 (JGME) 66-85 kW (90-116 PS) R9M 408	05.2014→	 7.24809.90.0 7.11190.08.0	AGR DDS	EL	 →07.2015
1.6 dCi 95 (JGMR, JGMJ) 70-89 kW (95-121 PS) R9M 413, R9M 415	07.2015→	 7.11457.07.0* ↳ 7.11492.07.0	DDS DDS		 R9M 413, R9M 415: ab Euro 6 From Euro 6

R

TRAFIC III Platform/Chassis (EG_) 123

1.6 dCi 120 (EGMB) 88-107 kW (120-145 PS) R9M 450	06.2014→	 7.24809.90.0	AGR	EL	 →07.2015
1.6 dCi 125 (EGMH) 92-120 kW (125-163 PS) R9M 452	07.2015→	 7.11457.07.0* ↳ 7.11492.07.0	DDS DDS		ab Euro 6 From Euro 6
1.6 dCi 145 (EGMG) 92-120 kW (125-163 PS) R9M 452	07.2015→	 7.11457.07.0* ↳ 7.11492.07.0	DDS DDS		ab Euro 6 From Euro 6



TRAFIC III Van (FG_) 124

1.6 dCi 115 (FGMD) 66-85 kW (90-116 PS) R9M 408	05.2014→		7.24809.90.0	AGR	EL		→07.2015
1.6 dCi 120 (FGMB) 88-107 kW (120-145 PS) R9M 450	05.2014→		7.24809.90.0 7.11190.08.0 7.02604.99.0	AGR DDS LS	EL		→07.2015 400 mm Motorcode: R9M 450 Engine Code: R9M 450 Produktionsdatum ab: 05.2014 Production date from: 05.2014
1.6 dCi 120 (FGMK) 70-89 kW (95-121 PS) R9M 413	07.2015→		7.11457.07.0* ↳7.11492.07.0	DDS			ab Euro 6 From Euro 6
1.6 dCi 125 (FGMH) 92-120 kW (125-163 PS) R9M 452	07.2015→		7.11457.07.0* ↳7.11492.07.0	DDS			ab Euro 6 From Euro 6
1.6 dCi 140 (FGMA) 88-107 kW (120-145 PS) R9M 450	05.2014→		7.24809.90.0 7.11190.08.0 7.02604.99.0	AGR DDS LS	EL		→07.2015 400 mm
1.6 dCi 145 (FGMG) 92-120 kW (125-163 PS) R9M 452	07.2015→		7.11457.07.0* ↳7.11492.07.0	DDS			ab Euro 6 From Euro 6
1.6 dCi 90 (FGME) 66-85 kW (90-116 PS) R9M 408	05.2014→		7.24809.90.0	AGR	EL		→07.2015
1.6 dCi 95 (FGMJ, FGMR) 70-89 kW (95-121 PS) R9M 413, R9M 415	07.2015→		7.11457.07.0* ↳7.11492.07.0	DDS			R9M 413, R9M 415: ab Euro 6 From Euro 6

TRAFIC Platform/Chassis (PXX) 125

2.2 59-74 kW (101 PS) J7T 600	09.1994→04.1998		7.05270.47.0	LS	325 mm	
2.2 4x4 59-74 kW (101 PS) J7T 600	09.1994→04.1998		7.05270.47.0	LS	325 mm	

TRAFIC Van (TXX) 126

2.2 59-74 kW (101 PS) J7T 600	06.1994→10.1997		7.05270.47.0	LS	325 mm	
2.2 4x4 59-74 kW (101 PS) J7T 600	06.1994→10.1997		7.05270.47.0	LS	325 mm	





TWINGO I Hatchback Van (S06_) 127





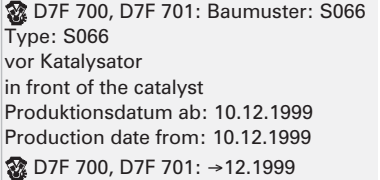

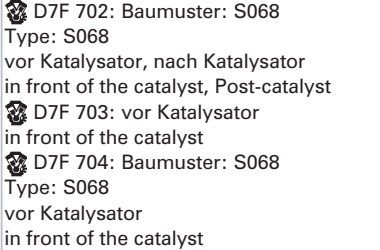





1.2 55 kW (75 PS) D4F 702	01.2001→06.2012		7.05270.54.0	LS	450 mm	D4F 702: vor Katalysator in front of the catalyst D4F 702: nach Katalysator Post-catalyst Produktionsdatum bis: 28.06.2006 Production date to: 28.06.2006
1.2 (S063, S064) 40 kW (55 PS) C3G 700	03.1993→05.1996		7.05270.45.0 7.02604.03.0	LS	375 mm 200 mm	
1.2 (S063, S064) 40 kW (55 PS) C3G 702	10.1994→05.1996		7.05270.47.0	LS	325 mm	























































TWINGO I Hatchback Van (S06_)

127

		7.02604.03.0	LS	200 mm		
1.2 (S066, S068) 40-44 kW (54-60 PS) D7F 700, D7F 701	05.1996→08.2004	7.05270.54.0	LS	450 mm		
			7.05270.48.0	LS		420 mm
		7.02604.03.0	LS	200 mm		
1.2 (S066, S068) 43-44 kW (58-60 PS) D7F 702, D7F 703, D7F 704	05.1996→08.2004	7.02604.10.0	LS	560 mm		
			7.02604.03.0	LS		200 mm
1.2 (S066, S068) 43 kW (58 PS) D7F 706	05.1996→08.2004		7.02604.03.0	LS	200 mm	

						
PHANTOM VII (RR1) 1						
V12 338 kW (460 PS) N73 B68 A	01.2003→07.2017		7.02604.41.0	LS	700 mm	vor Katalysator in front of the catalyst Produktionsdatum ab: 01.09.2006 Production date from: 01.09.2006
			7.28238.57.0	SLV	PN	
PHANTOM VII Coupe (RR3) 2						
6.75 V12 338 kW (460 PS) N73 B68 A	06.2008→07.2017		7.02604.41.0	LS	700 mm	vor Katalysator in front of the catalyst Produktionsdatum ab: 01.09.2006 Production date from: 01.09.2006
			7.28238.57.0	SLV	PN	
PHANTOM VII Drophead Coupe (RR2) 3						
6.75 V12 338 kW (460 PS) N73 B68 A	06.2007→07.2017		7.02604.41.0	LS	700 mm	vor Katalysator in front of the catalyst Produktionsdatum ab: 01.09.2006 Production date from: 01.09.2006
			7.28238.57.0	SLV	PN	









						
200 Coupe (XW) 1						
220 Turbo 132-147 kW (180-200 PS) 20 T4G	10.1992→06.1999		7.02604.04.0	LS	200 mm	
200 II Convertible (XW) 2						
214 1.4 66-70 kW (90-95 PS) 14 K4C	04.1990→09.1992		7.02604.04.0	LS	200 mm	
214 1.4 66-70 kW (90-95 PS) 14 K4C, 14 K4D	01.1992→11.1999		7.02604.04.0	LS	200 mm	
214 1.4i 16V 76 kW (103 PS) 14 K4F	01.1993→11.1999		7.02604.04.0	LS	200 mm	
200 II Hatchback (RF) 3						
211 44 kW (60 PS) 11 K2D	01.1998→03.2000		7.05271.75.0	LS	540 mm	
214 Si 76 kW (103 PS) 14 K4F	11.1995→03.2000		7.05271.75.0	LS	540 mm	
			7.02604.04.0	LS	200 mm	
214 i 55 kW (75 PS) 14 K2F	11.1995→03.2000		7.05271.75.0	LS	540 mm	
			7.02604.04.0	LS	200 mm	
216 Si 80-86 kW (109-117 PS) 16 K4F	11.1995→06.1999		7.05271.75.0	LS	540 mm	
200 II Hatchback (XW) 4						
214 55 kW (75 PS) 14 K2A, 14 K2D	09.1993→12.1995		7.02604.04.0	LS	200 mm	
214 GSi/Si 66-70 kW (90-95 PS) 14 K4C	01.1990→10.1995		7.02604.04.0	LS	200 mm	
214 GSi/Si 76 kW (103 PS) 14 K4F	12.1992→10.1995		7.02604.04.0	LS	200 mm	
214 Si/Gsi 66-70 kW (90-95 PS) 14 K4C, 14 K4D	10.1989→10.1995		7.02604.04.0	LS	200 mm	
220 Turbo 132-147 kW (180-200 PS) 20 T4G	01.1993→12.1995		7.02604.04.0	LS	200 mm	
25 I Hatchback (RF) 5						
R	1.1 16V 55 kW (75 PS) 11 K4F	01.2004→05.2005		7.05271.75.0	LS	540 mm
	1.4 16V 62 kW (84 PS) 14 K4M	10.1999→05.2005		7.05271.75.0	LS	540 mm
	1.4 16V 76 kW (103 PS) 14 K4F	10.1999→05.2005		7.05271.75.0	LS	540 mm
	1.6 16V 80-86 kW (109-117 PS) 16 K4F	10.1999→05.2005		7.05271.75.0	LS	540 mm
	1.8 16V 85-88 kW (116-120 PS) 18 K4F	10.1999→05.2005		7.05271.75.0	LS	540 mm
	1.8 16V 107-110 kW (146-150 PS) 18 K4K	02.2000→05.2005		7.05271.75.0	LS	540 mm
	400 II (RT) 6					
	414 Si 76 kW (103 PS) 14 K4F	05.1995→03.2000		7.05271.75.0	LS	540 mm
416 Si 80-86 kW (109-117 PS) 16 K4F	05.1995→03.2000		7.05271.75.0	LS	540 mm	
400 II (XW) 7						
420 Turbo 132-147 kW (180-200 PS) 20 T4G	01.1993→04.1995		7.02604.04.0	LS	200 mm	

						
400 II Hatchback (RT)						8
414 Si 76 kW (103 PS) 14 K4F	05.1995→03.2005		7.05271.75.0	LS	540 mm	
45 I Hatchback (RT)						9
1.4 76 kW (103 PS) 14 K4F	02.2000→05.2005		7.05271.75.0	LS	540 mm	
1.6 80-86 kW (109-117 PS) 16 K4F	02.2000→05.2005		7.05271.75.0	LS	540 mm	
1.8 85-88 kW (116-120 PS) 18 K4F	02.2000→05.2005		7.05271.75.0	LS	540 mm	
2.0 V6 110 kW (150 PS) 20 K4F	02.2000→05.2005		7.05271.72.0	LS	650 mm	
45 I Saloon (RT)						10
1.4 76 kW (103 PS) 14 K4F	02.2000→05.2005		7.05271.75.0	LS	540 mm	
1.6 80-86 kW (109-117 PS) 16 K4F	02.2000→05.2005		7.05271.75.0	LS	540 mm	
1.8 85-88 kW (116-120 PS) 18 K4F	02.2000→05.2005		7.05271.75.0	LS	540 mm	
2.0 V6 110 kW (150 PS) 20 K4F	02.2000→05.2005		7.05271.72.0	LS	650 mm	
75 (RJ)						11
1.8 88 kW (120 PS) K 1.8	02.1999→05.2005		7.05271.72.0	LS	650 mm	
1.8 Turbo 110 kW (150 PS) 18 K4G	05.2003→05.2005		7.05271.72.0	LS	650 mm	
2.0 V6 110 kW (150 PS) 20 K4F	02.1999→05.2005		7.05271.72.0	LS	650 mm	
2.5 V6 129 kW (175 PS) KV 6	02.1999→10.2001		7.05271.72.0	LS	650 mm	
2.5 V6 129-130 kW (175-177 PS) 25 K4F	10.2001→05.2005		7.05271.72.0	LS	650 mm	
75 I Tourer (RJ)						12
1.8 88 kW (120 PS) K 1.8	08.2001→05.2005		7.05271.72.0	LS	650 mm	
1.8 Turbo 110 kW (150 PS) 18 K4G	05.2003→05.2005		7.05271.72.0	LS	650 mm	
2.0 V6 110 kW (150 PS) 20 K4F	08.2001→05.2005		7.05271.72.0	LS	650 mm	
2.5 V6 129 kW (175 PS) KV 6	08.2001→05.2005		7.05271.72.0	LS	650 mm	
800 (XS)						13
820 74 kW (101 PS) 20HC	10.1988→10.1991		7.02604.01.0	LS	200 mm	
820e 88 kW (120 PS) 20 HS	10.1986→10.1991		7.02604.01.0	LS	200 mm	

















R



9-3 (YS3D) **1**





















2.0 Turbo 110-141 kW (150-192 PS) B205E	02.1998→09.2002	 7.05270.67.0	LS	770 mm	Regelsonde Regulating Probe
2.0 Turbo 110-141 kW (150-192 PS) B205E	03.1999→09.2002	 7.05270.67.0	LS	770 mm	Regelsonde Regulating Probe
2.0 Turbo 151 kW (205 PS) B205R	10.1999→09.2002	 7.05270.67.0	LS	770 mm	Regelsonde Regulating Probe
2.2 TiD 85-92 kW (115-125 PS) D223L, X 22 DTH	02.1998→11.2000	 7.24809.29.0	AGR	ET	
2.2 TiD 85-92 kW (115-125 PS) D223L	11.2000→09.2002	 7.24809.29.0	AGR	ET	
2.3 152-224 kW (207-305 PS) B235R	09.1999→01.2002	 7.05270.67.0	LS	770 mm	
2.3 Turbo 152-224 kW (207-305 PS) B235R	10.1998→09.2002	 7.05270.67.0	LS	770 mm	

9-3 (YS3F, E79, D79, D75) **2**

1.8t 110 kW (150 PS) B207E	09.2002→02.2015	 7.02604.11.0	LS	null mm	vorne Front 2011
		7.22936.08.0	SLV	PN	
1.8t BioPower 110 kW (150 PS) B207E	01.2007→02.2015	 7.02604.11.0	LS	null mm	vorne Front 2011
1.8t BioPower 129-143 kW (175-194 PS) B207L	05.2009→02.2015	 7.02604.11.0	LS	null mm	vorne Front 2011
1.8 i 90 kW (122 PS) Z 18 XE	01.2004→02.2015	 7.05271.55.0	LS	800 mm	
1.9 TTiD 96-132 kW (130-180 PS) A 19 DTR	12.2007→02.2015	 7.24809.77.0	AGR	ET	
		7.02604.99.0	LS	400 mm	
1.9 TTiD 96-132 kW (130-180 PS) A 19 DTR	12.2007→02.2015	 7.24809.77.0	AGR	ET	
		7.02604.99.0	LS	400 mm	
1.9 TTiD 96-132 kW (130-180 PS) A 19 DTR	12.2007→02.2015	 7.24809.77.0	AGR	ET	
		7.08369.05.0	ATS	EL	
		7.24809.77.0	AGR	ET	
1.9 TTiD 129-132 kW (175-180 PS) Z 19 DTR	12.2007→02.2015	 7.24809.77.0	AGR	ET	
		7.08369.05.0	ATS	EL	
		7.02604.99.0	LS	400 mm	02.2008→02.2011 Motorcode: Z19DTR Engine Code: Z19DTR Produktionsdatum ab: 02.2008 Production date from: 02.2008 Produktionsdatum bis: 02.2011 Production date to: 02.2011
1.9 TiD 88 kW (120 PS) Z 19 DT	09.2004→02.2015	 7.22946.38.0	AGR	EL	
		7.08369.05.0	ATS	EL	01.2005→12.2007

S











9-3 (YS3F, E79, D79, D75)
2

			7.11190.03.0	DDS		ohne Zubehör without accessories Fahrgestellnummer bis: 71019398, 76004481 Vehicle Identification Number to: 71019398, 76004481 2005 2005 2010 2010
			7.02604.99.0	LS	400 mm	
1.9 TiD 110 kW (150 PS) Z 19 DTH	09.2004→02.2015		7.00063.10.0	AGR	EL	→01.2007
			7.08369.05.0	ATS	EL	
			7.11190.03.0	DDS		ohne Zubehör without accessories Fahrgestellnummer bis: 71019398, 76004481 Vehicle Identification Number to: 71019398, 76004481 2005 2005 2010 2010
			7.02604.99.0	LS	400 mm	
2.0 145-185 kW (197-252 PS) B207R	09.2002→12.2006		7.22936.08.0	SLV	PN	
2.0 T16 145-185 kW (197-252 PS) B207R	05.2009→02.2015		7.22936.08.0	SLV	PN	
2.0 Turbo Performance 145-185 kW (197-252 PS) B207R	04.2004→02.2015		7.22936.08.0	SLV	PN	
2.0 Turbo XWD 145-185 kW (197-252 PS) B207R	01.2008→02.2015		7.02604.11.0	LS	null mm	vorne Front 2011 2011
			7.22936.08.0	SLV	PN	
2.0 t 145-185 kW (197-252 PS) B207R	09.2002→02.2015		7.02604.11.0	LS	null mm	vorne Front 2011 2011
			7.22936.08.0	SLV	PN	
2.0 t 129-143 kW (175-194 PS) B207L	09.2002→02.2015		7.02604.11.0	LS	null mm	vorne Front 2011 2011
			7.22936.08.0	SLV	PN	
2.0 t 145-185 kW (197-252 PS) B207R	05.2009→02.2015		7.22936.08.0	SLV	PN	
2.0 t BioPower 145-185 kW (197-252 PS) B207R	09.2002→02.2015		7.02604.11.0	LS	null mm	vorne Front 2011 2011
			7.22936.08.0	SLV	PN	
2.0 t BioPower 129-143 kW (175-194 PS) B207L	01.2007→02.2015		7.02604.11.0	LS	null mm	vorne Front 2011 2011
2.0 t BioPower 145-185 kW (197-252 PS) B207R	06.2007→02.2015		7.22936.08.0	SLV	PN	





S







9-3 (YS3F, E79, D79, D75) 2

2.0 t BioPower XWD 145-185 kW (197-252 PS) B207R	01.2008→02.2015		7.02604.11.0	LS	null mm	vorne Front 2011 2011
			7.22936.08.0	SLV	PN	
2.0 t XWD 120 kW (163 PS) B207G	01.2007→02.2015		7.02604.11.0	LS	null mm	vorne Front 2011 2011
2.0 t XWD 145-185 kW (197-252 PS) B207R	05.2009→02.2015		7.22936.08.0	SLV	PN	
2.2 TiD 85-92 kW (115-125 PS) D223L	09.2002→02.2015		7.24809.29.0	AGR	ET	 →01.2004
2.8 Turbo V6 169-203 kW (230-276 PS) B284L	12.2007→02.2015		7.02604.08.0	LS	350 mm	Diagnosesonde Diagnostic Probe
2.8 Turbo V6 169-203 kW (230-276 PS) B284L	04.2008→02.2015		7.02604.08.0	LS	350 mm	Diagnosesonde Diagnostic Probe

9-3 Cabriolet (YS3D) 3

2.0 Turbo 110-141 kW (150-192 PS) B205E	02.1998→08.2003		7.05270.67.0	LS	770 mm	Regelsonde Regulating Probe
2.0 Turbo 151 kW (205 PS) B205R	10.1999→08.2003		7.05270.67.0	LS	770 mm	Regelsonde Regulating Probe
2.0 Turbo 110-141 kW (150-192 PS) B205E	01.2001→08.2003		7.05270.67.0	LS	770 mm	Regelsonde Regulating Probe
2.3 152-224 kW (207-305 PS) B235R	09.1999→01.2002		7.05270.67.0	LS	770 mm	
2.3 Turbo 152-224 kW (207-305 PS) B235R	10.1999→08.2003		7.05270.67.0	LS	770 mm	

9-3 Convertible (YS3F) 4

1.9 TTiD 96-132 kW (130-180 PS) A 19 DTR	12.2007→02.2015		7.24809.77.0	AGR	ET	<input checked="" type="checkbox"/>
1.9 TTiD 96-132 kW (130-180 PS) A 19 DTR	12.2007→02.2015		7.24809.77.0	AGR	ET	<input checked="" type="checkbox"/>
			7.02604.99.0	LS	400 mm	
1.9 TTiD 96-132 kW (130-180 PS) A 19 DTR	12.2007→02.2015		7.24809.77.0	AGR	ET	<input checked="" type="checkbox"/>
			7.08369.05.0	ATS	EL	
1.9 TTiD 129-132 kW (175-180 PS) Z 19 DTR	12.2007→02.2015		7.24809.77.0	AGR	ET	<input checked="" type="checkbox"/>
			7.08369.05.0	ATS	EL	
			7.02604.99.0	LS	400 mm	02.2008→02.2011 Motorcode: Z19DTR Engine Code: Z19DTR Produktionsdatum ab: 02.2008 Production date from: 02.2008 Produktionsdatum bis: 02.2011 Production date to: 02.2011
1.9 TiD 88 kW (120 PS) Z 19 DT	09.2004→02.2015		7.22946.38.0	AGR	EL	<input checked="" type="checkbox"/> 01.2005→12.2007
			7.08369.05.0	ATS	EL	
			7.11190.03.0	DDS		ohne Zubehör without accessories















S

9-3 Convertible (YS3F)					
4					
1.9 TiD 110 kW (150 PS) Z 19 DTH	01.2006→02.2015		7.00063.10.0	AGR	EL
			7.08369.05.0	ATS	EL
			7.11190.03.0	DDS	
			7.02604.99.0	LS	400 mm
ohne Zubehör without accessories Fahrgestellnummer bis: 71019398, 76004481 Vehicle Identification Number to: 71019398, 76004481 2005 2005 2010 2010					
2.0 Turbo Performance 145-185 kW (197-252 PS) B207R	04.2004→02.2015		7.22936.08.0	SLV	PN
2.0 t 129-143 kW (175-194 PS) B207L	08.2003→02.2015		7.22936.08.0	SLV	PN
2.0 t 145-185 kW (197-252 PS) B207R	08.2003→02.2015		7.22936.08.0	SLV	PN
2.8 Turbo V6 169-203 kW (230-276 PS) B284L	12.2007→02.2015		7.02604.08.0	LS	350 mm Diagnosesonde Diagnostic Probe
9-3 Estate (E50)					
5					
1.8 i 90 kW (122 PS) Z 18 XE	03.2005→02.2015		7.05271.55.0	LS	800 mm
1.9 TTiD 96-132 kW (130-180 PS) A 19 DTR	12.2007→02.2015		7.24809.77.0	AGR	ET
			7.02604.99.0	LS	400 mm
1.9 TTiD 96-132 kW (130-180 PS) A 19 DTR	12.2007→02.2015		7.24809.77.0	AGR	ET
			7.02604.99.0	LS	400 mm
1.9 TTiD 129-132 kW (175-180 PS) Z 19 DTR	12.2007→02.2015		7.24809.77.0	AGR	ET
			7.02604.99.0	LS	400 mm
1.9 TiD 88 kW (120 PS) Z 19 DT	03.2005→02.2015		7.22946.38.0	AGR	EL
			7.08369.05.0	ATS	EL
			7.11190.03.0	DDS	
			7.02604.99.0	LS	400 mm
ohne Zubehör without accessories Fahrgestellnummer bis: 71019398, 76004481 Vehicle Identification Number to: 71019398, 76004481 2005 2005 2010 2010 →09.2010 Motorcode: Z19DT Engine Code: Z19DT Produktionsdatum ab: 03.2005 Production date from: 03.2005 Produktionsdatum bis: 09.2010 Production date to: 09.2010					
1.9 TiD 110 kW (150 PS) Z 19 DTH	03.2005→02.2015		7.00063.10.0	AGR	EL
			7.08369.05.0	ATS	EL
→01.2007					







S







9-3 Estate (E50) **5**



























			7.11190.03.0	DDS		ohne Zubehör without accessories Fahrgestellnummer bis: 71019398, 76004481 Vehicle Identification Number to: 71019398, 76004481 2005 2005 2010 2010
			7.02604.99.0	LS	400 mm	
2.0 t 129-143 kW (175-194 PS) B207L	03.2005→02.2015		7.22936.08.0	SLV	PN	
2.0 t 145-185 kW (197-252 PS) B207R	03.2005→02.2015		7.22936.08.0	SLV	PN	
2.0 t 145-185 kW (197-252 PS) B207R	05.2009→02.2015		7.22936.08.0	SLV	PN	
2.0 t Bio Power XWD 145-185 kW (197-252 PS) B207R	06.2008→02.2015		7.22936.08.0	SLV	PN	
2.0 t BioPower 145-185 kW (197-252 PS) B207R	06.2007→02.2015		7.22936.08.0	SLV	PN	
2.0 t XWD 145-185 kW (197-252 PS) B207R	06.2008→02.2015		7.22936.08.0	SLV	PN	
2.0 t XWD 145-185 kW (197-252 PS) B207R	05.2009→02.2015		7.22936.08.0	SLV	PN	
2.8 Turbo V6 169-203 kW (230-276 PS) B284L	12.2007→02.2015		7.02604.08.0	LS	350 mm	Diagnosesonde Diagnostic Probe

9-3X (YS3) **6**

S	1.9 TTiD AWD 96-132 kW (130-180 PS) A 19 DTR, Z 19 DTR	02.2009→12.2012		7.24809.77.0	AGR	ET	<input checked="" type="checkbox"/>
			7.08369.05.0	ATS	EL		
			7.02604.99.0	LS	400 mm		
2.0 AWD 145-185 kW (197-252 PS) B207R	09.2009→12.2012		7.22936.08.0	SLV	PN		
2.0 t BioPower XWD 145-185 kW (197-252 PS) B207R	02.2009→12.2012		7.22936.08.0	SLV	PN		
2.0 t XWD 145-185 kW (197-252 PS) B207R	02.2009→02.2015		7.22936.08.0	SLV	PN		









9-5 (YS3E) **7**

1.9 TiD 110 kW (150 PS) Z 19 DTH	01.2006→12.2009		7.00063.10.0	AGR	EL	
2.0 t 110-141 kW (150-192 PS) B205E	09.1997→12.2009		7.05270.67.0	LS	770 mm	
2.0 t 136 kW (185 PS) B205L	07.2000→12.2009		7.05270.67.0	LS	770 mm	
2.2 TiD 85-92 kW (115-125 PS) D223L	03.2002→12.2009		7.24809.29.0	AGR	ET	 →01.2005
2.3 Turbo 152-224 kW (207-305 PS) B235R	10.1999→09.2001		7.05270.67.0	LS	770 mm	







						
9-5 (YS3E)						7
2.3 Turbo 152-224 kW (207-305 PS) B235R	09.2001→12.2009		7.05270.67.0	LS	770 mm	
2.3 Turbo 149-184 kW (203-250 PS) B235L	07.2003→12.2009		7.05270.67.0	LS	770 mm	
2.3 Turbo 152-224 kW (207-305 PS) B235R	11.2005→12.2009		7.05270.67.0	LS	770 mm	
2.3 Turbo 152-224 kW (207-305 PS) B235R	04.2008→12.2009		7.05270.67.0	LS	770 mm	
2.3 t 125-136 kW (170-185 PS) B235E	09.1997→12.2009		7.05270.67.0	LS	770 mm	
2.3 t 125-136 kW (170-185 PS) B235E	01.2001→12.2009		7.05270.67.0	LS	770 mm	
3.0 147-149 kW (200-203 PS) B308E	09.1998→12.2003		7.22936.08.0	SLV	PN ⊙ Baujahr ab: 01.2002 Construction year from: 01.2002	
3.0 V6t 147-149 kW (200-203 PS) B308E	01.1998→12.2009		7.05270.67.0	LS	770 mm	
			7.05270.37.0	LS	1640 mm	
			7.22936.08.0	SLV	PN ⊙ Baujahr ab: 01.2002 Construction year from: 01.2002 Baujahr bis: 08.2003 Construction year to: 08.2003	
9-5 (YS3G)						8
1.6 Turbo 132 kW (180 PS) A 16 LET	05.2010→01.2012		7.05271.81.0	LS	210 mm vor Katalysator in front of the catalyst	
2.0 TTiD 140 kW (190 PS) A 20 DTR	05.2010→01.2012		7.24809.78.0	AGR	ET ⊙	
2.0 TTiD XWD 140 kW (190 PS) A 20 DTR	05.2010→01.2012		7.24809.78.0	AGR	ET ⊙	
2.0 TiD 118 kW (160 PS) A 20 DTH	05.2010→01.2012		7.24809.78.0	AGR	ET ⊙	
2.0 Turbo 162 kW (220 PS) A 20 NHT	05.2010→01.2012		7.02604.99.0	LS	400 mm	
2.0 Turbo XWD 162 kW (220 PS) A 20 NHT	05.2010→01.2012		7.02604.99.0	LS	400 mm	
9-5 Estate (YS3E)						9
1.9 TiD 110 kW (150 PS) Z 19 DTH	01.2006→12.2009		7.00063.10.0	AGR	EL ⊙	
2.0 t 110-141 kW (150-192 PS) B205E	10.1998→12.2009		7.05270.67.0	LS	770 mm	
2.0 t 110-141 kW (150-192 PS) B205E	10.1998→07.2000		7.05270.67.0	LS	770 mm	
2.0 t 136 kW (185 PS) B205L	07.2000→07.2001		7.05270.67.0	LS	770 mm	
2.2 TiD 85-92 kW (115-125 PS) D223L	03.2002→12.2009		7.24809.29.0	AGR	ET ⊙ →01.2005	
2.3 Turbo 152-224 kW (207-305 PS) B235R	10.1999→09.2001		7.05270.67.0	LS	770 mm	
2.3 Turbo 152-224 kW (207-305 PS) B235R	09.2001→12.2009		7.05270.67.0	LS	770 mm	



9-5 Estate (YS3E) 9







2.3 Turbo 149-184 kW (203-250 PS) B235L	07.2003→12.2009		7.05270.67.0	LS	770 mm	
2.3 Turbo 152-224 kW (207-305 PS) B235R	01.2006→12.2009		7.05270.67.0	LS	770 mm	
2.3 t 125-136 kW (170-185 PS) B235E	10.1998→12.2009		7.05270.67.0	LS	770 mm	
2.3 t 125-136 kW (170-185 PS) B235E	01.2001→12.2009		7.05270.67.0	LS	770 mm	
3.0 147-149 kW (200-203 PS) B308E	10.1998→12.2003		7.22936.08.0	SLV	PN	 Baujahr ab: 01.2002 Construction year from: 01.2002
3.0 V6t 147-149 kW (200-203 PS) B308E	10.1998→12.2009		7.05270.67.0	LS	770 mm	 Baujahr ab: 01.2002 Construction year from: 01.2002 Baujahr bis: 08.2003 Construction year to: 08.2003
			7.05270.37.0	LS	1640 mm	
			7.22936.08.0	SLV	PN	

900 I (AC4, AM4) 10

2.0 S Turbo-16 104-110 kW (141-150 PS) B202S	01.1992→12.1993		7.02604.03.0	LS	200 mm	
2.0 S Turbo-16 104-110 kW (141-150 PS) B202S	01.1992→12.1993		7.02604.03.0	LS	200 mm	
2.0 Turbo-16 118-132 kW (160-180 PS) B202XL	01.1986→12.1993		7.02604.03.0	LS	200 mm	
2.0 Turbo-16 S 118-132 kW (160-180 PS) B202XL	01.1984→12.1988		7.02604.03.0	LS	200 mm	
2.0 Turbo-16 S Cat 118-132 kW (160-180 PS) B202XL	01.1989→12.1993		7.02604.03.0	LS	200 mm	
2.1 -16 100-107 kW (136-145 PS) B212I	01.1992→12.1993		7.02604.03.0	LS	200 mm	

900 I Combi Coupe 11

S

2.0 -16 104-110 kW (141-150 PS) B202S	05.1991→10.1993		7.02604.03.0	LS	200 mm	
2.0 S Turbo-16 104-110 kW (141-150 PS) B202S	09.1991→07.1993		7.02604.03.0	LS	200 mm	
2.0 Turbo-16 118-132 kW (160-180 PS) B202XL	01.1986→12.1993		7.02604.03.0	LS	200 mm	
2.0 Turbo-16 129-150 kW (175-204 PS) B202L	01.1993→06.1994		7.02604.03.0	LS	200 mm	
2.0 Turbo-16 S 118-132 kW (160-180 PS) B202XL	02.1984→12.1988		7.02604.03.0	LS	200 mm	
2.0 Turbo-16 S Cat 118-132 kW (160-180 PS) B202XL	01.1989→12.1993		7.02604.03.0	LS	200 mm	
2.1 -16 100-107 kW (136-145 PS) B212I	01.1992→07.1993		7.02604.03.0	LS	200 mm	

						
900 I Convertible						12
2.0 104-110 kW (141-150 PS) B202S	05.1991→10.1993		7.02604.03.0	LS	200 mm	
2.0 S Turbo-16 104-110 kW (141-150 PS) B202S	09.1991→06.1994		7.02604.03.0	LS	200 mm	
2.0 Turbo-16 118-132 kW (160-180 PS) B202XL	11.1986→12.1993		7.02604.03.0	LS	200 mm	
2.0 Turbo-16 S 118-132 kW (160-180 PS) B202XL	11.1986→06.1994		7.02604.03.0	LS	200 mm	
2.1 -16 100-107 kW (136-145 PS) B212I	01.1992→12.1993		7.02604.03.0	LS	200 mm	
900 II						13
2.0 -16 Turbo 136-147 kW (185-200 PS) B204L	07.1993→02.1998		7.02604.03.0	LS	200 mm	
900 II Convertible						14
2.0 -16 Turbo 136-147 kW (185-200 PS) B204L	12.1993→02.1998		7.02604.03.0	LS	200 mm	
900 II Coupe						15
2.0 -16 Turbo 136-147 kW (185-200 PS) B204L	12.1993→02.1998		7.02604.03.0	LS	200 mm	
9000						16
2.0 -16 93-99 kW (126-135 PS) B202I	01.1989→01.1993		7.02604.03.0	LS	200 mm	
2.0 -16 CD 93-99 kW (126-135 PS) B202I, B204I	09.1993→12.1998		7.02604.03.0	LS	200 mm	
2.0 -16 Turbo 118-132 kW (160-180 PS) B202XL	04.1985→12.1991		7.02604.03.0	LS	200 mm	
2.0 -16 Turbo 118-132 kW (160-180 PS) B202XL	05.1988→08.1993		7.02604.03.0	LS	200 mm	
2.0 -16 Turbo CD 118-132 kW (160-180 PS) B202XL	09.1988→08.1993		7.02604.03.0	LS	200 mm	
2.0 -16 Turbo CD 104-113 kW (141-154 PS) B202S, B204E	09.1992→12.1998		7.02604.03.0	LS	200 mm	S
2.0 -16 Turbo CD 129-150 kW (175-204 PS) B202L	09.1993→12.1998		7.02604.03.0	LS	200 mm	
2.3 107-112 kW (146-152 PS) B234I	01.1991→01.1992		7.02604.03.0	LS	200 mm	
2.3 162-168 kW (220-228 PS) B234R	01.1993→10.1998		7.02604.03.0	LS	200 mm	
2.3 -16 CD 107-112 kW (146-152 PS) B234I	01.1991→12.1998		7.02604.03.0	LS	200 mm	
2.3 -16 CD Turbo 143-149 kW (195-203 PS) B234L	07.1990→12.1998		7.02604.03.0	LS	200 mm	
2.3 -16 CDE 107-112 kW (146-152 PS) B234I	09.1993→12.1998		7.02604.03.0	LS	200 mm	



9000 **16**

2.3 -16 CDE Eco-Power 125 kW (170 PS) B234E	01.1994→12.1998		7.02604.03.0	LS	200 mm
2.3 -16 Turbo 143-149 kW (195-203 PS) B234L	01.1991→12.1998		7.02604.03.0	LS	200 mm
3.0 -24 V6 CD/CDE 155 kW (211 PS) B308I	01.1995→12.1998		7.02604.03.0	LS	200 mm

9000 Hatchback **17**

2.0 -16 92-96 kW (125-130 PS) B202XI	01.1986→12.1988		7.02604.03.0	LS	200 mm
2.0 -16 92-96 kW (125-130 PS) B202XI	01.1986→08.1988		7.02604.03.0	LS	200 mm
2.0 -16 CS 93-99 kW (126-135 PS) B202I	01.1989→12.1998		7.02604.03.0	LS	200 mm
2.0 -16 CS 96 kW (131 PS) B204I	09.1993→12.1998		7.02604.03.0	LS	200 mm
2.0 -16 ND Turbo 104-113 kW (141-154 PS) B202S, B204E, B204S	09.1993→12.1998		7.02604.03.0	LS	200 mm
2.0 -16 Turbo 118-150 kW (160-204 PS) B202L, B202XL	09.1984→12.1991		7.02604.03.0	LS	200 mm
2.0 -16 Turbo 118-132 kW (160-180 PS) B202XL	01.1986→08.1993		7.02604.03.0	LS	200 mm
2.0 -16 Turbo 118-132 kW (160-180 PS) B202XL	05.1988→08.1993		7.02604.03.0	LS	200 mm
2.0 -16 Turbo 127 kW (172 PS) B202	06.1989→12.1992		7.02604.03.0	LS	200 mm
2.0 -16 Turbo CS 129-150 kW (175-204 PS) B202L	09.1993→12.1998		7.02604.03.0	LS	200 mm
2.3 107-112 kW (146-152 PS) B234I	01.1991→12.1993		7.02604.03.0	LS	200 mm
2.3 -16 Aero CS 162-168 kW (220-228 PS) B234R	02.1993→12.1998		7.02604.03.0	LS	200 mm
2.3 -16 Aero CS 162-168 kW (220-228 PS) B234R	02.1993→12.1998		7.02604.03.0	LS	200 mm
2.3 -16 CS 107-112 kW (146-152 PS) B234I	01.1991→12.1998		7.02604.03.0	LS	200 mm
2.3 -16 CSE 107-112 kW (146-152 PS) B234I	09.1993→12.1998		7.02604.03.0	LS	200 mm
2.3 -16 CSE Eco Power 125 kW (170 PS) B234E	01.1994→12.1998		7.02604.03.0	LS	200 mm
2.3 -16 Turbo 143-149 kW (195-203 PS) B234L	01.1991→12.1998		7.02604.03.0	LS	200 mm

S

9000 Hatchback
17

2.3 -16 Turbo CSE 143-149 kW (195-203 PS) B234L	09.1993→12.1998	 7.02604.03.0	LS 200 mm	
3.0 -24 V6 CS/CSE 155 kW (211 PS) B308I	01.1995→12.1998	 7.02604.03.0	LS 200 mm	



































QM3 **1**

1.5 dCi 66 kW (90 PS) K9K 609	12.2013→		7.03571.16.0	AK	EL
			↳ 7.03083.20.0	SRM-AK	EL

QM6 **2**

1.7 dCi	11.2019→		7.11457.07.0*	DDS	
			↳ 7.11492.07.0	DDS	

S

 				
ALHAMBRA (710, 711)				
1.4 TSI 110 kW (150 PS) CZDA, DJKA	05.2015→	 7.03635.37.0	SLP	EL
2.0 TDI 103 kW (140 PS) CFFB	06.2010→	 7.09720.00.0	AGR-K	EL 
		7.11492.00.0	DDS	ohne Zubehör without accessories
2.0 TDI 125 kW (170 PS) CFGB	06.2010→02.2013	 7.09720.00.0	AGR-K	EL 
		7.11492.00.0	DDS	ohne Zubehör without accessories
2.0 TDI 100 kW (136 PS) CFFA	06.2010→05.2011	 7.09720.00.0	AGR-K	EL 
		7.11492.00.0	DDS	ohne Zubehör without accessories
2.0 TDI 85 kW (116 PS) CFFE	05.2011→	 7.09720.00.0	AGR-K	EL 
		7.11492.00.0	DDS	ohne Zubehör without accessories
2.0 TDI 85 kW (115 PS) CUVA	05.2011→	 7.10334.02.0	AGR	EL 
		7.11492.03.0	DDS	ohne Zubehör without accessories
		7.07696.00.0	SRM-AK	EL
2.0 TDI 85 kW (115 PS) DFLD	05.2011→	 7.07696.00.0	SRM-AK	EL
2.0 TDI 85 kW (115 PS) DLTC	05.2011→	 7.11492.03.0	DDS	ohne Zubehör without accessories
		2.0 TDI 130 kW (177 PS) CFGC	11.2012→	 7.09720.00.0
7.11492.00.0	DDS			ohne Zubehör without accessories
2.0 TDI 130 kW (177 PS) DLUB	11.2012→	 7.10334.02.0	AGR	EL 
		7.08369.81.0	ATS	EL
		7.11492.03.0	DDS	ohne Zubehör without accessories
2.0 TDI 110 kW (150 PS) CUVC, DFLA, DLTA	05.2015→	 7.10334.02.0	AGR	EL 
		7.11492.03.0	DDS	ohne Zubehör without accessories
		7.07696.00.0	SRM-AK	EL
2.0 TDI 135 kW (184 PS) CUWA, DFMA	05.2015→	 7.10334.02.0	AGR	EL 
		7.11492.03.0	DDS	ohne Zubehör without accessories
		7.07696.00.0	SRM-AK	EL
2.0 TDI 4Drive 103 kW (140 PS) CFFB	05.2011→	 7.09720.00.0	AGR-K	EL 
		7.11492.00.0	DDS	ohne Zubehör without accessories
2.0 TDI 4Drive 110 kW (150 PS) CUVC, DFLA	05.2015→	 7.10334.02.0	AGR	EL 
		7.11492.03.0	DDS	ohne Zubehör without accessories
		7.07696.00.0	SRM-AK	EL
2.0 TDI 4Drive 135 kW (184 PS) DFMA	05.2016→	 7.10334.02.0	AGR	EL 
		7.11492.03.0	DDS	ohne Zubehör without accessories
		7.07696.00.0	SRM-AK	EL













1
S



ALHAMBRA (710, 711) **1**



2.0 TDi 4Drive 130 kW (177 PS) DLUB	11.2018→		7.10334.02.0	AGR	EL	○ ohne Zubehör without accessories
			7.08369.81.0	ATS	EL	
			7.11492.03.0	DDS		

ALHAMBRA (7V8, 7V9) **2**

1.8 T 20V 110 kW (150 PS) AJH	10.1997→03.2010		7.22286.41.0	ARV	PN	○ Regelsonde Regulating Probe
			7.05271.03.0	LS	730 mm	
1.8 T 20V 110 kW (150 PS) AWC	08.2000→03.2010		7.28070.03.0	AGR	EL	○ 01.2001→ vor Katalysator in front of the catalyst
			7.05271.23.0	LS	900 mm	
			7.05271.77.0	LS	800 mm	
			7.22738.08.0	SLP	EL	
1.9 TDI 85 kW (115 PS) AUY, BVK	06.2000→03.2010		7.22778.79.0	SLV	PN	○
			7.24809.20.0	AGR	PN	
1.9 TDI 66 kW (90 PS) ANU	08.2000→03.2010		7.24809.19.0	AGR	PN	○
1.9 TDI 96-112 kW (130-152 PS) ASZ	11.2002→11.2008		7.24809.20.0	AGR	PN	○
1.9 TDI 110 kW (150 PS) BTB	05.2005→05.2007		7.24809.20.0	AGR	PN	○
1.9 TDI 4motion 85 kW (115 PS) AUY, BVK	06.2000→03.2010		7.24809.20.0	AGR	PN	○
2.0 TDI 103 kW (140 PS) BRT	11.2005→03.2010		7.08369.43.0	ATS	EL	vor Turbolader before turbocharger ohne Zubehör without accessories  ch. 7M-7-500 001→  →ch. 7M-6-520 000
			7.11492.02.0	DDS		
			7.11190.02.0	DDS		
2.0 i 85 kW (115 PS) ATM	08.2000→03.2010		7.22574.12.0	AGR	EL	○ 800 mm vor Katalysator in front of the catalyst
			7.05271.77.0	LS	EL	
			7.22738.08.0	SLP	PN	
			7.22778.80.0	SLV	PN	
2.8 V6 150 kW (204 PS) AYL	06.2000→03.2010		7.22286.55.0	ARV	PN	○ 925 mm Diagnosesonde Diagnostic Probe
			7.05270.89.0	LS	EL	
			7.22738.08.0	SLP		
2.8 V6 4motion 150 kW (204 PS) AYL	06.2000→03.2010		7.22286.55.0	ARV	PN	○ 925 mm Diagnosesonde Diagnostic Probe
			7.05270.89.0	LS	EL	
			7.22738.08.0	SLP		

S

ALTEA (5P1) **3**



















1.4 16V 63 kW (85-86 PS) BXW, CGGB	05.2006→		7.05271.18.0	LS	525 mm	
			7.05271.18.0	LS	525 mm	
1.4 TSI 92 kW (125 PS) CAXC	11.2007→		7.05271.18.0	LS	525 mm	
			7.22738.08.0	SLP	EL	
1.6 75 kW (102 PS) BSE, CCSA	03.2004→		7.22778.96.0	SLV	PN	○
			7.22738.08.0	SLP	EL	

ALTEA (5P1)					
1.6 75 kW (102 PS) BSF	03.2004→		7.05271.18.0	LS	525 mm
1.6 75 kW (102 PS) BGU	06.2004→		7.22574.12.0	AGR	EL
			7.05271.18.0	LS	525 mm
			7.22738.08.0	SLP	EL
			7.22778.96.0	SLV	PN
1.6 LPG 75 kW (102 PS) CHGA	09.2009→		7.05271.18.0	LS	525 mm
			7.22738.08.0	SLP	EL
			7.22778.96.0	SLV	PN
1.6 Multifuel 75 kW (102 PS) CMXA	11.2010→05.2011		7.22738.08.0	SLP	EL
			7.22778.96.0	SLV	PN
1.6 TDI 77 kW (105 PS) CAYC	10.2009→		7.09720.00.0	AGR-K	EL
			7.08369.01.0	ATS	EL
			7.08369.04.0	ATS	EL
			7.11492.00.0	DDS	ohne Zubehör without accessories
1.6 TDI 66 kW (90 PS) CAYB	11.2010→		7.09720.00.0	AGR-K	EL
			7.08369.01.0	ATS	EL
			7.08369.04.0	ATS	EL
			7.11492.00.0	DDS	ohne Zubehör without accessories
1.8 TFSI 118 kW (160 PS) BYT, BZB	01.2007→		7.05271.19.0	LS	975 mm BYT, BZB: →ch. 5P-8-070 000 Regelsonde Regulating Probe
			7.05271.11.0	LS	800 mm BYT, BZB: ch. 5P-8-070 001→ Regelsonde Regulating Probe
1.8 TFSI 118 kW (160 PS) CDAA	01.2007→		7.05271.15.0	LS	525 mm
1.9 TDI 77 kW (105 PS) BLS	04.2004→		7.00678.04.0*	AGR-M	EL mit Rohrstützen with pipe socket
			7.00907.03.0	AGR	EL
			7.00678.06.0	AGR-M	EL
			7.08369.00.0	ATS	EL
			7.08369.02.0	ATS	EL
			7.08369.03.0	ATS	EL
			7.11190.02.0	DDS	2006 2006
7.11492.02.0	DDS	ohne Zubehör without accessories 2007 2007			
1.9 TDI 77 kW (105 PS) BKC, BXE	04.2004→		7.24809.16.0	AGR	PN
1.9 TDI 77 kW (105 PS) BJB	06.2004→		7.24809.32.0	AGR	PN
1.9 TDI 66 kW (90 PS) BXF	08.2009→		7.24809.16.0	AGR	PN
2.0 FSI 110 kW (150 PS) BLR, BVY	05.2004→03.2009		7.10334.09.0	AGR	EL
			7.05271.29.0	LS	900 mm BLR, BVY: rechts Right



S



ALTEA (5P1) **3**

			7.05271.16.0	LS	1300 mm	 BLR, BVY: hinten, links, rechts Rear, Left, Right Diagnosesonde Diagnostic Probe
2.0 FSI 110 kW (150 PS) BLY, BVZ	05.2004→03.2009		7.10334.09.0	AGR	EL	 →02.2006
			7.05271.16.0	LS	1300 mm	 BLY, BVZ: hinten Rear Diagnosesonde Diagnostic Probe
2.0 TDI 100 kW (136 PS) AZV	03.2004→05.2009		7.24809.16.0	AGR	PN	
2.0 TDI 103 kW (140 PS) BMM	11.2005→		7.00678.04.0*	AGR-M	EL	mit Rohrstützen with pipe socket
			↳ 7.00907.03.0	AGR	EL	
			7.00678.06.0	AGR-M	EL	
			7.08369.00.0	ATS	EL	
			7.08369.02.0	ATS	EL	
			7.08369.03.0	ATS	EL	
			7.11190.02.0	DDS	EL	2006 2006
7.11492.02.0	DDS		ohne Zubehör without accessories 2007 2007			
2.0 TDI 125 kW (170 PS) BMN	03.2006→		7.10334.00.0	AGR	EL	
			7.08369.00.0	ATS	EL	
			7.08369.02.0	ATS	EL	
			7.08369.03.0	ATS	EL	
			7.11190.02.0	DDS	EL	2006 2006
7.11492.02.0	DDS		ohne Zubehör without accessories 2007 2007			
2.0 TDI 125 kW (170 PS) CEGA	03.2006→		7.10334.00.0	AGR	EL	
			7.08369.00.0	ATS	EL	
			7.08369.01.0	ATS	EL	
			7.08369.04.0	ATS	EL	
			7.11492.00.0	DDS		ohne Zubehör without accessories
2.0 TDI 16V 103 kW (140 PS) CFHC	03.2004→		7.09720.00.0	AGR-K	EL	
			7.11190.09.0	DDS		
2.0 TDI 16V 103 kW (140 PS) BKD	06.2004→		7.24809.16.0	AGR	PN	
2.0 TDI 16V 4WD 103 kW (140 PS) CFHC	10.2010→		7.09720.00.0	AGR-K	EL	
			7.11190.09.0	DDS		
2.0 TFSI 147 kW (200 PS) BWA	04.2006→05.2009		7.05271.15.0	LS	525 mm	













ALTEA XL (5P5, 5P8) **4**

1.4 16V 63 kW (85-86 PS) BXW, CGGB	10.2006→		7.05271.18.0	LS	525 mm	
1.4 TSI 92 kW (125 PS) CAXC	11.2007→		7.05271.18.0	LS	525 mm	
1.6 75 kW (102 PS) BGU	10.2006→		7.05271.18.0	LS	525 mm	

ALTEA XL (5P5, 5P8)					4	
1.6 75 kW (102 PS) BSE, CCSA	10.2006→		7.22778.96.0	SLV	PN	
			7.05271.18.0	LS	525 mm	
			7.22738.08.0	SLP	EL	
1.6 75 kW (102 PS) BSF	10.2006→		7.22778.96.0	SLV	PN	
			7.05271.18.0	LS	525 mm	
1.6 LPG 75 kW (102 PS) CHGA	09.2009→		7.05271.18.0	LS	525 mm	
			7.22738.08.0	SLP	EL	
			7.22778.96.0	SLV	PN	
1.6 Multifuel 75 kW (102 PS) BSE, CMXA	10.2006→11.2010		7.05271.18.0	LS	525 mm	
			7.22778.96.0	SLV	PN	
1.6 Multifuel 75 kW (102 PS) BSF	10.2006→11.2010		7.05271.18.0	LS	525 mm	
1.6 Multifuel 75 kW (102 PS) CCSA	10.2006→11.2010		7.05271.18.0	LS	525 mm	
			7.22738.08.0	SLP	EL	
			7.22778.96.0	SLV	PN	
1.6 TDI 77 kW (105 PS) CAYC	10.2009→		7.09720.00.0	AGR-K	EL	ohne Zubehör without accessories
			7.08369.01.0	ATS	EL	
			7.08369.04.0	ATS	EL	
			7.11492.00.0	DDS		
1.6 TDI 66 kW (90 PS) CAYB	11.2010→		7.09720.00.0	AGR-K	EL	ohne Zubehör without accessories
			7.08369.01.0	ATS	EL	
			7.08369.04.0	ATS	EL	
			7.11492.00.0	DDS		
1.8 TFSI 118 kW (160 PS) BYT, BZB	01.2007→		7.05271.19.0	LS	975 mm	BYT, BZB: →ch. 5P-8-070 000 Regelsonde Regulating Probe
			7.05271.11.0	LS	800 mm	
1.8 TFSI 118 kW (160 PS) CDA A	01.2007→		7.05271.15.0	LS	525 mm	
1.9 TDI 77 kW (105 PS) BKC, BXE	10.2006→12.2010		7.24809.16.0	AGR	PN	
1.9 TDI 77 kW (105 PS) BLS	10.2006→12.2010		7.00678.04.0*	AGR-M	EL	mit Rohrstützen with pipe socket
			↪7.00907.03.0	AGR	EL	
			7.00678.06.0	AGR-M	EL	
			7.08369.00.0	ATS	EL	
			7.08369.02.0	ATS	EL	
			7.08369.03.0	ATS	EL	
			7.11190.02.0	DDS		
7.11492.02.0	DDS					
2006 2006						
ohne Zubehör without accessories						
2007 2007						
1.9 TDI 66 kW (90 PS) BXF	08.2009→12.2010		7.24809.16.0	AGR	PN	
1.9 TDI 4x4 77 kW (105 PS) BLS	06.2009→12.2010		7.00907.03.0	AGR	EL	

























ALTEA XL (5P5, 5P8) 4











			7.00678.06.0 7.08369.00.0 7.08369.02.0 7.08369.03.0 7.11492.02.0	AGR-M ATS ATS ATS DDS	EL EL EL EL EL	ohne Zubehör without accessories
2.0 FSI 110 kW (150 PS) BVY	10.2006→03.2009		7.10334.09.0 7.05271.29.0 7.05271.16.0	AGR LS LS	EL 900 mm 1300 mm	rechts Right hinten, links, rechts Rear, Left, Right Diagnosesonde Diagnostic Probe
2.0 FSI 110 kW (150 PS) BVZ	10.2006→03.2009		7.10334.09.0 7.05271.16.0	AGR LS	EL 1300 mm	hinten Rear Diagnosesonde Diagnostic Probe
2.0 TDI 103 kW (140 PS) BMM	10.2006→		7.00678.04.0* ↳ 7.00907.03.0 7.00678.06.0 7.08369.00.0 7.08369.02.0 7.08369.03.0 7.11190.02.0 7.11492.02.0	AGR-M AGR AGR-M ATS ATS ATS DDS DDS	EL EL EL EL EL EL	mit Rohrstutzen with pipe socket 2006 2006 ohne Zubehör without accessories 2007 2007
2.0 TDI 100 kW (136 PS) AZV	11.2006→03.2009		7.24809.16.0	AGR	PN	
2.0 TDI 125 kW (170 PS) BMN	06.2007→05.2009		7.10334.00.0 7.08369.00.0 7.08369.02.0 7.08369.03.0 7.11190.02.0 7.11492.02.0	AGR ATS ATS ATS DDS DDS	EL EL EL EL	2006 2006 ohne Zubehör without accessories 2007 2007
2.0 TDI 125 kW (170 PS) CEGA	06.2007→05.2009		7.10334.00.0 7.08369.00.0 7.08369.01.0 7.08369.04.0 7.11492.00.0	AGR ATS ATS ATS DDS	EL EL EL EL	ohne Zubehör without accessories
2.0 TDI 16V 103 kW (140 PS) BKD	10.2006→		7.24809.16.0	AGR	PN	
2.0 TDI 16V 103 kW (140 PS) CFHC	10.2006→		7.09720.00.0 7.11190.09.0	AGR-K DDS	EL EL	
2.0 TDI 16V 4x4 103 kW (140 PS) CFHC	10.2010→		7.09720.00.0	AGR-K	EL	

S

ALTEA XL (5P5, 5P8) **4**

2.0 TDI 4x4 125 kW (170 PS) BMN	06.2007→05.2009	 7.11190.09.0	DDS		
		 7.10334.00.0	AGR	EL	ohne Zubehör without accessories
		 7.08369.00.0	ATS	EL	
		 7.08369.02.0	ATS	EL	
		 7.08369.03.0	ATS	EL	
 7.11492.02.0	DDS				
2.0 TDI 4x4 125 kW (170 PS) CEGA	06.2007→05.2009	 7.10334.00.0	AGR	EL	ohne Zubehör without accessories
		 7.08369.00.0	ATS	EL	
		 7.08369.01.0	ATS	EL	
		 7.08369.04.0	ATS	EL	
2.0 TDI 4x4 125 kW (170 PS) CFJA	06.2007→05.2009	 7.09720.00.0	AGR-K	EL	ohne Zubehör without accessories
		 7.11190.09.0	DDS		
2.0 TDI 4x4 103 kW (140 PS) BMM	06.2007→	 7.00678.04.0*	AGR-M	EL	mit Rohrstützen with pipe socket
		 7.00907.03.0	AGR	EL	
		 7.00678.06.0	AGR-M	EL	
		 7.08369.00.0	ATS	EL	
		 7.08369.02.0	ATS	EL	
		 7.08369.03.0	ATS	EL	
2.0 TFSI 147 kW (200 PS) BWA	10.2006→05.2009	 7.05271.15.0	LS	525 mm	
		 7.05271.15.0	LS	525 mm	
2.0 TFSI 4x4 147 kW (200 PS) BWA	06.2007→05.2009	 7.05271.15.0	LS	525 mm	
2.0 TFSI 4x4 155 kW (211 PS) CCZB	05.2009→	 7.05271.15.0	LS	525 mm	

ARONA (KJ7) **5**





























1.6 TDI 85 kW (115 PS) DGTA	07.2017→	 7.11020.17.0	ATS	EL	vor Katalysator in front of the catalyst
		 7.11020.22.0	ATS	EL	
		 7.11020.23.0	ATS	EL	
		 7.11492.05.0	DDS		
1.6 TDI 70 kW (95 PS) DGTD	11.2017→	 7.07696.00.0	SRM-AK	EL	ohne Zubehör without accessories
		 7.11020.17.0	ATS	EL	
		 7.11020.22.0	ATS	EL	
		 7.11020.23.0	ATS	EL	
		 7.11492.05.0	DDS		
 7.07696.00.0	SRM-AK	EL			

AROSA (6H1) **6**









1.0 37 kW (50 PS) AER	05.1997→01.1999	 7.05271.04.0	LS	505 mm	
1.0 37 kW (50 PS) AHT	10.1998→01.2001	 7.05271.03.0	LS	730 mm	Regelsonde Regulating Probe
1.0 37 kW (50 PS) ALD	01.1999→06.2004	 7.05270.99.0	LS	940 mm	Regelsonde Regulating Probe
1.0 37 kW (50 PS) ANV	01.1999→06.2004	 7.05271.77.0	LS	800 mm	vor Katalysator in front of the catalyst











AROSA (6H1) **6**

			 PIERBURG		
			7.05271.14.0	LS	1700 mm  →ch. 6H-3-009 600
1.0 37 kW (50 PS) AUC	03.2000→06.2004		7.05270.99.0	LS	940 mm  ch. 6H-3-009 601→ Diagnosesonde Diagnostic Probe
			7.05271.77.0	LS	800 mm vor Katalysator in front of the catalyst
			7.05271.14.0	LS	1700 mm  →ch. 6H-3-009 600
1.4 44 kW (60 PS) AEX, AKV, APQ	05.1997→06.2004		7.05271.03.0	LS	730 mm  AEX, AKV, APQ: Regelsonde Regulating Probe
1.4 44 kW (60 PS) AKK	01.1999→06.2004		7.05270.99.0	LS	940 mm Regelsonde Regulating Probe
1.4 44 kW (60 PS) ANW	01.1999→06.2004		7.05271.77.0	LS	800 mm vor Katalysator in front of the catalyst
			7.05271.14.0	LS	1700 mm  →ch. 6H-3-009 600
1.4 44 kW (60 PS) AUD	03.2000→06.2004		7.05270.99.0	LS	940 mm Diagnosesonde Diagnostic Probe
			7.05271.77.0	LS	800 mm vor Katalysator in front of the catalyst
1.4 16V 74 kW (101 PS) AFK	01.2000→06.2004		7.05271.03.0	LS	730 mm Regelsonde Regulating Probe
1.4 16V 74 kW (100 PS) AQQ, AUB	01.2000→06.2004		7.28248.17.0	AGR	EL   AQQ, AUB:  ch. 6H-2-000 001→
			7.22785.17.0	AGR	EL   AQQ, AUB:  →ch. 6H-1-018 000
			7.05271.06.0	LS	1720 mm
1.4 TDI 55 kW (75 PS) AMF	01.2000→06.2004		7.22477.10.0	AGR	PN  für Linkslenker for left-hand drive vehicles
			7.24809.17.0	AGR	PN  für Linkslenker for left-hand drive vehicles
			7.24809.57.0	AGR	PN  für Rechtslenker for right-hand drive vehicles
1.7 SDI 44 kW (60 PS) AKU	08.1997→06.2004		7.22477.10.0	AGR	PN 

ATECA (KH7, KHP) **7**

S	1.6 TDI 85 kW (115 PS) DDYA, DGTE	04.2016→07.2018		7.10334.02.0	AGR	EL 
				7.08369.95.0	ATS	EL  DDYA, DGTE: für Fahrzeuge ohne Aktivkohlebehälter for vehicles without charcoal canister
				7.11020.17.0	ATS	EL  DDYA, DGTE: vor Katalysator in front of the catalyst
				7.11020.22.0	ATS	EL  DDYA, DGTE: für PR-Nummer: 1E9 for PR number: 1E9
				7.11020.23.0	ATS	EL  DDYA, DGTE: für PR-Nummer: 1E9 for PR number: 1E9
				7.11492.05.0	DDS	ohne Zubehör without accessories  DDYA, DGTE: für OE-Nummer: 04L 906 051 AB, 04L 906 051 F, 04L 906 051 G, 04L 906 051 L for OE number: 04L 906 051 AB, 04L 906 051 F, 04L 906 051 G, 04L 906 051 L
			7.07696.00.0	SRM-AK	EL	
2.0 TDI 110 kW (150 PS) DFFA	04.2016→		7.10334.02.0	AGR	EL 	

ATECA (KH7, KHP) **7**

			7.08369.81.0	ATS	EL	für OE-Nummer: 04L 906 088 DQ, 04L 906 088 HT for OE number: 04L 906 088 DQ, 04L 906 088 HT
			7.11020.26.0	ATS	EL	für OE-Nummer: 04L 919 529 D for OE number: 04L 919 529 D
			7.11492.05.0	DDS		ohne Zubehör without accessories
			7.07696.00.0	SRM-AK	EL	für OE-Nummer: 04L 906 051 AB, 04L 906 051 F, 04L 906 051 G, 04L 906 051 L for OE number: 04L 906 051 AB, 04L 906 051 F, 04L 906 051 G, 04L 906 051 L
2.0 TDI 81 kW (110 PS) CRVA	10.2016→		7.10334.02.0	AGR	EL	
			7.08369.81.0	ATS	EL	für OE-Nummer: 04L 906 088 DQ, 04L 906 088 HT for OE number: 04L 906 088 DQ, 04L 906 088 HT
			7.11492.05.0	DDS		ohne Zubehör without accessories
						für OE-Nummer: 04L 906 051 AB, 04L 906 051 F, 04L 906 051 G, 04L 906 051 L for OE number: 04L 906 051 AB, 04L 906 051 F, 04L 906 051 G, 04L 906 051 L
2.0 TDI 105 kW (143 PS) CRVC	10.2016→		7.10334.02.0	AGR	EL	
			7.08369.81.0	ATS	EL	 ch. 124179→ für OE-Nummer: 04L 906 088 DQ, 04L 906 088 HT for OE number: 04L 906 088 DQ, 04L 906 088 HT
			7.11492.05.0	DDS		ohne Zubehör without accessories
						für OE-Nummer: 04L 906 051 AB, 04L 906 051 F, 04L 906 051 G, 04L 906 051 L for OE number: 04L 906 051 AB, 04L 906 051 F, 04L 906 051 G, 04L 906 051 L
2.0 TDI 4Drive 110 kW (150 PS) DFFA	04.2016→		7.10334.02.0	AGR	EL	
			7.03608.16.0	AK	EL	
			↳ 7.07696.00.0	SRM-AK	EL	
			7.08369.81.0	ATS	EL	für OE-Nummer: 04L 906 088 DQ, 04L 906 088 HT for OE number: 04L 906 088 DQ, 04L 906 088 HT
			7.11020.26.0	ATS	EL	für OE-Nummer: 04L 919 529 D for OE number: 04L 919 529 D
			7.11492.05.0	DDS		ohne Zubehör without accessories
2.0 TDI 4Drive 140 kW (190 PS) DFHA	06.2016→		7.10334.02.0	AGR	EL	
			7.03608.16.0	AK	EL	
			↳ 7.07696.00.0	SRM-AK	EL	
			7.08369.81.0	ATS	EL	für OE-Nummer: 04L 906 088 DQ, 04L 906 088 HT for OE number: 04L 906 088 DQ, 04L 906 088 HT

S



ATECA (KH7, KHP) **7**

		7.11020.26.0	ATS	EL	für OE-Nummer: 04L 919 529 D for OE number: 04L 919 529 D ohne Zubehör without accessories für OE-Nummer: 04L 906 051 AB, 04L 906 051 F, 04L 906 051 G, 04L 906 051 L for OE number: 04L 906 051 AB, 04L 906 051 F, 04L 906 051 G, 04L 906 051 L
		7.11492.05.0	DDS		

CORDOBA (6K1, 6K2) **8**















1.0 i 37 kW (50 PS) ANV, AUC	09.1996→10.2002	 7.05271.77.0	LS	800 mm	 ANV, AUC:  ch. 6K-X-400 000→ch. 6K-X-499 999 vor Katalysator in front of the catalyst
1.0 i 37 kW (50 PS) AER	05.1997→10.2002	 7.05270.88.0	LS	740 mm	 ch. 6K-V-165 001→ch. 6K-X-127 000
			LS	730 mm	 ch. 6K-X-127 001→ Regelsonde Regulating Probe
1.4 40 kW (54 PS) ANX	12.1997→04.1999	 7.05270.88.0	LS	740 mm	 ch. 6K-V-165 001→ch. 6K-X-127 000
			LS	730 mm	 ch. 6K-X-127 001→ Regelsonde Regulating Probe
1.4 16V 55 kW (75 PS) APE, AUA	05.2000→10.2002	 7.28248.17.0	AGR	EL	
1.4 i 44 kW (60 PS) ABD	06.1994→12.1995	 7.05270.86.0	LS	625 mm	 →ch. 6K-ZR155 000
1.4 i 44 kW (60 PS) ANW, AUD	06.1994→10.2002	 7.05271.77.0	LS	800 mm	 ANW, AUD:  ch. 6K-X-400 000→ch. 6K-X-499 999 vor Katalysator in front of the catalyst
			LS	740 mm	 AEX, AKV, APQ:  ch. 6K-V-165 001→ch. 6K-X-127 000
1.4 i 44 kW (60 PS) AEX, AKV, APQ	12.1995→10.2002	 7.05271.03.0	LS	730 mm	 AEX, AKV, APQ:  ch. 6K-X-127 001→ Regelsonde Regulating Probe
			AGR	EL	 AQQ:  045 001→  AUB:  030 351→
1.4 i 16V 74 kW (100 PS) AQQ, AUB	09.1996→10.2002	 7.28248.17.0	AGR	EL	
1.6 i 55 kW (75 PS) ABU	02.1993→07.1994	 7.05270.86.0	LS	625 mm	 →ch. 6K-ZR155 000
			AGR	EL	 APF, AUR: 01.1999→
1.6 i 74 kW (100-101 PS) APF, AUR	07.1996→10.2002	 7.22574.12.0	AGR	EL	
			ARV	PN	 APF, AUR:  ch. 6K-X-400 000→ch. 6K-X-499 999
			LS	800 mm	 APF, AUR:  ch. 6K-X-400 000→ch. 6K-X-499 999 vor Katalysator in front of the catalyst
1.8 T 20V Cupra 115-132 kW (156-179 PS) AQX, AYP	07.2000→10.2002	 7.22738.08.0	SLP	EL	
			ARV	PN	
1.8 i 66 kW (90 PS) ABS, ACC, ADZ	02.1993→09.2002	 7.21851.31.0	SLP	EL	
			LS	200 mm	
		7.02604.04.0			

S















CORDOBA (6K1, 6K2)					
8					
1.8 i 16V 95 kW (129 PS) ADL	10.1993→08.1996	7.05270.86.0	LS	625 mm	
1.9 SDI 50 kW (68 PS) AGP, AQM	06.1999→10.2002	7.22477.10.0	AGR	PN	
1.9 TDI 66 kW (90 PS) AGR, ALH	08.1996→10.2002	7.24809.17.0	AGR	PN	AGR, ALH: ch. 6K-X-400 000→ch. 6K-X-499 99
1.9 TDI 81 kW (110 PS) ASV	03.1997→10.2002	7.24809.17.0	AGR	PN	ch. 6K-X-400 000→ch. 6K-X-499 99
2.0 i 85 kW (115 PS) 2E	02.1993→06.1996	7.05270.86.0	LS	625 mm	
CORDOBA (6L2)					
9					
1.2 47 kW (64 PS) AZQ	10.2002→06.2006	7.22785.16.0	AGR	EL	
		7.05271.23.0	LS	900 mm	
1.2 47 kW (64 PS) BME	10.2002→06.2006	7.22785.16.0	AGR	EL	→ch. 6L-6-104 000
		7.05271.20.0	LS	500 mm	
1.2 12V 51 kW (70 PS) BXV	05.2006→11.2009	7.22785.16.0	AGR	EL	→ch. 6L-6-104 000
		7.05271.20.0	LS	500 mm	
1.4 16V 55 kW (75 PS) BBY, BKY	09.2002→12.2007	7.28248.17.0	AGR	EL	
		7.05271.05.0	LS	700 mm	BBY: vor Katalysator in front of the catalyst BKY: nach Katalysator Post-catalyst
1.4 16V 74 kW (100 PS) BBZ	10.2002→11.2009	7.28248.17.0	AGR	EL	
		7.05271.05.0	LS	700 mm	vor Katalysator in front of the catalyst
1.4 16V 63 kW (86 PS) BXW	05.2006→11.2009	7.05271.05.0	LS	700 mm	nach Katalysator Post-catalyst
1.4 TDI 55 kW (75 PS) AMF	10.2002→12.2005	7.24809.17.0	AGR	PN	
1.4 TDI 51 kW (70 PS) BNM	05.2005→11.2009	7.24809.31.0	AGR	PN	
1.4 TDI 59 kW (80 PS) BMS	06.2005→11.2009	7.00678.04.0*	AGR-M	EL	mit Rohrstützen with pipe socket
		↪ 7.00907.03.0	AGR	EL	
		7.00678.06.0	AGR-M	EL	
		7.08369.53.0	ATS	EL	vor Rußpartikelfilter before soot particulate filter
		7.08369.86.0	ATS	EL	für Rechtslenker for right-hand drive vehicles
		7.11020.02.0	ATS	EL	nach Rußpartikelfilter after soot particulate filter für Linkslenker for left-hand drive vehicles
		7.11020.03.0	ATS	EL	für Rechtslenker for right-hand drive vehicles
		7.11020.07.0	ATS	EL	für Linkslenker for left-hand drive vehicles
		7.11492.02.0	DDS		ohne Zubehör without accessories
1.4 TDI 59 kW (80 PS) BNV	06.2005→11.2009	7.24809.31.0	AGR	PN	



























CORDOBA (6L2) **9**























1.6 74-75 kW (101-102 PS) BAH	04.2003→11.2009		7.05270.91.0	LS	350 mm	Regelsonde Regulating Probe
1.6 16V 77 kW (105 PS) BTS	11.2006→11.2009		7.05271.18.0	LS	525 mm	
1.9 SDI 47 kW (64 PS) ASY	09.2002→11.2009		7.22477.10.0	AGR	PN	
1.9 TDI 74 kW (100 PS) ATD	09.2002→11.2009		7.24809.30.0	AGR	PN	
1.9 TDI 74 kW (100 PS) AXR	09.2002→11.2009		7.24809.16.0	AGR	PN	
1.9 TDI 74 kW (101 PS) BMT	09.2002→11.2009		7.00678.04.0* ↳ 7.00907.03.0 7.00678.06.0 7.08369.53.0 7.08369.86.0 7.11020.02.0 7.11020.03.0 7.11020.07.0 7.11492.02.0	AGR-M AGR AGR-M ATS ATS ATS ATS ATS DDS	EL EL EL EL EL EL EL EL EL	mit Rohrstützen with pipe socket vor Rußpartikelfilter before soot particulate filter für Rechtslenker for right-hand drive vehicles nach Rußpartikelfilter after soot particulate filter für Linkslenker for left-hand drive vehicles für Rechtslenker for right-hand drive vehicles für Linkslenker for left-hand drive vehicles ohne Zubehör without accessories
1.9 TDI 96-112 kW (130-152 PS) ASZ	10.2002→11.2009		7.24809.55.0	AGR	PN	
1.9 TDI 96 kW (131 PS) BLT	10.2002→11.2009		7.24809.16.0	AGR	PN	
2.0 85 kW (115 PS) AZL	09.2002→11.2009		7.05271.77.0 7.22738.08.0 7.22778.80.0	LS SLP SLV	800 mm EL PN	vor Katalysator in front of the catalyst 

CORDOBA Vario (6K5) **10**

1.4 16V 55 kW (75 PS) APE, AUA	06.1999→12.2002		7.28248.17.0	AGR	EL	
1.4 i 44 kW (60 PS) AEX, AKV, APQ	09.1996→12.2002		7.05270.88.0 7.05271.03.0	LS LS	740 mm 730 mm	 AEX, AKV, APQ:  ch. 6K-V-165 001→ch. 6K-X-127 000  AEX, AKV, APQ:  ch. 6K-X-127 001→ Regelsonde Regulating Probe
1.6 i 74 kW (100-101 PS) APF, AUR	09.1996→12.2002		7.22574.12.0 7.22286.41.0 7.05271.77.0 7.22738.08.0	AGR ARV LS SLP	EL PN 800 mm EL	 APF, AUR: 01.1999→  APF, AUR, AUR:  ch. 6K-X-400 000→ch. 6K-X-499 999  APF, AUR:  ch. 6K-X-400 000→ch. 6K-X-499 999 vor Katalysator in front of the catalyst
1.8 i 66 kW (90 PS) ACC	07.1996→06.1999		7.02604.04.0	LS	200 mm	

					
CORDOBA Vario (6K5)					10
1.9 SDI 50 kW (68 PS) AGP, AQM	06.1999→12.2002		7.22477.10.0	AGR	PN 
1.9 TDI 66 kW (90 PS) AGR, ALH	08.1996→12.2002		7.24809.17.0	AGR	PN  AGR, ALH:  ch. 6K-X-400 000→ch. 6K-X-499 99
1.9 TDI 81 kW (110 PS) ASV	07.1997→12.2002		7.24809.17.0	AGR	PN   ch. 6K-X-400 000→ch. 6K-X-499 99
EXEO (3R2)					11
1.6 75 kW (102 PS) ALZ	03.2009→09.2010		7.22785.20.0	AGR	EL 
			7.05271.01.0	LS	950 mm
			7.22738.08.0	SLP	EL
			7.22778.99.0	SLV	PN 
1.8 T 110 kW (150 PS) CFMA	12.2008→05.2010		7.22560.43.0	ARV	PN 
			7.05271.24.0	LS	1500 mm
			7.22738.08.0	SLP	EL
2.0 TDI 105 kW (143 PS) CAGA	12.2008→05.2013		7.10334.00.0	AGR	EL 
			7.08369.08.0	ATS	EL
			7.08369.14.0	ATS	EL
			7.08369.86.0	ATS	EL
			7.11190.02.0	DDS	für PR-Nummer: G0K for PR number: G0K Produktionsdatum ab: 13.12.2010 Production date from: 13.12.2010 Produktionsdatum bis: 07.11.2011 Production date to: 07.11.2011
			7.11190.09.0	DDS	für PR-Nummer: G0Z for PR number: G0Z Produktionsdatum ab: 13.12.2010 Production date from: 13.12.2010 Produktionsdatum bis: 07.11.2011 Production date to: 07.11.2011
2.0 TDI 105 kW (143 PS) CJCA	12.2008→05.2013		7.09720.03.0	AGR-K	EL 
			7.11190.02.0	DDS	Produktionsdatum bis: 13.12.2010 Production date to: 13.12.2010
			7.11190.09.0	DDS	Produktionsdatum ab: 07.11.2011 Production date from: 07.11.2011
2.0 TDI 88 kW (120 PS) CAGC	12.2008→05.2013		7.10334.00.0	AGR	EL 
			7.08369.08.0	ATS	EL
			7.08369.14.0	ATS	EL
			7.08369.86.0	ATS	EL
			7.11190.02.0	DDS	für PR-Nummer: G0Z for PR number: G0Z für PR-Nummer: G0K for PR number: G0K Produktionsdatum ab: 13.12.2010 Production date from: 13.12.2010 Produktionsdatum bis: 07.11.2011 Production date to: 07.11.2011
			7.11190.09.0	DDS	für PR-Nummer: G0Z for PR number: G0Z Produktionsdatum ab: 13.12.2010 Production date from: 13.12.2010 Produktionsdatum bis: 07.11.2011 Production date to: 07.11.2011

S

			 PIERBURG		
EXEO (3R2)					
2.0 TDI 88 kW (120 PS) CJCC	12.2008→05.2013		7.09720.03.0	AGR-K	EL 
			7.11190.02.0	DDS	Produktionsdatum bis: 13.12.2010 Production date to: 13.12.2010 Produktionsdatum ab: 07.11.2011 Production date from: 07.11.2011
			7.11190.09.0	DDS	
2.0 TDI 125 kW (170 PS) CAHA	02.2009→05.2013		7.10334.00.0	AGR	EL 
			7.08369.08.0	ATS	EL
			7.08369.14.0	ATS	EL
			7.08369.86.0	ATS	EL
			7.11190.02.0	DDS	für PR-Nummer: G0K for PR number: G0K Produktionsdatum ab: 13.12.2010 Production date from: 13.12.2010 Produktionsdatum bis: 07.11.2011 Production date to: 07.11.2011 für PR-Nummer: G0K for PR number: G0K Produktionsdatum ab: 13.12.2010 Production date from: 13.12.2010 Produktionsdatum bis: 07.11.2011 Production date to: 07.11.2011
7.11190.09.0	DDS				
2.0 TDI 125 kW (170 PS) CGLB	02.2009→05.2013		7.09720.03.0	AGR-K	EL 
			7.11190.02.0	DDS	Produktionsdatum bis: 13.12.2010 Production date to: 13.12.2010 Produktionsdatum ab: 07.11.2011 Production date from: 07.11.2011
			7.11190.09.0	DDS	
2.0 TFSI 147 kW (200 PS) BWE	03.2009→05.2013		7.05271.11.0	LS	800 mm Diagnosesonde Diagnostic Probe
EXEO ST (3R5)					
1.6 75 kW (102 PS) ALZ	06.2009→09.2010		7.22785.20.0	AGR	EL 
			7.05271.01.0	LS	950 mm
			7.22738.08.0	SLP	EL
			7.22778.99.0	SLV	PN 
1.8 T 110 kW (150 PS) CFMA	06.2009→05.2010		7.22560.43.0	ARV	PN 
			7.05271.24.0	LS	1500 mm
			7.22738.08.0	SLP	EL
2.0 TDI 105 kW (143 PS) CAGA	05.2009→05.2013		7.10334.00.0	AGR	EL 
			7.08369.08.0	ATS	EL
			7.08369.14.0	ATS	EL
			7.08369.86.0	ATS	EL
			7.11190.02.0	DDS	für PR-Nummer: G0K for PR number: G0K Produktionsdatum ab: 13.12.2010 Production date from: 13.12.2010 Produktionsdatum bis: 07.11.2011 Production date to: 07.11.2011 für PR-Nummer: G0Z for PR number: G0Z Produktionsdatum ab: 13.12.2010 Production date from: 13.12.2010 Produktionsdatum bis: 07.11.2011 Production date to: 07.11.2011
7.11190.09.0	DDS				
2.0 TDI 105 kW (143 PS) CJCA	05.2009→05.2013		7.09720.03.0	AGR-K	EL 

















































11

12

S

EXEO ST (3R5)					12
			7.11190.02.0	DDS	Produktionsdatum bis: 13.12.2010 Production date to: 13.12.2010
			7.11190.09.0	DDS	Produktionsdatum ab: 07.11.2011 Production date from: 07.11.2011
2.0 TDI 125 kW (170 PS) CAHA	05.2009→05.2013		7.10334.00.0	AGR	EL
			7.08369.08.0	ATS	EL
			7.08369.14.0	ATS	EL
			7.08369.86.0	ATS	EL
			7.11190.02.0	DDS	für PR-Nummer: G0K for PR number: G0K Produktionsdatum ab: 13.12.2010 Production date from: 13.12.2010 Produktionsdatum bis: 07.11.2011 Production date to: 07.11.2011
			7.11190.09.0	DDS	für PR-Nummer: G0K for PR number: G0K Produktionsdatum ab: 13.12.2010 Production date from: 13.12.2010 Produktionsdatum bis: 07.11.2011 Production date to: 07.11.2011
2.0 TDI 125 kW (170 PS) CGLB	05.2009→05.2013		7.09720.03.0	AGR-K	EL
			7.11190.02.0	DDS	Produktionsdatum bis: 13.12.2010 Production date to: 13.12.2010
			7.11190.09.0	DDS	Produktionsdatum ab: 07.11.2011 Production date from: 07.11.2011
2.0 TDI 88 kW (120 PS) CAGC	07.2009→05.2013		7.10334.00.0	AGR	EL
			7.08369.08.0	ATS	EL
			7.08369.14.0	ATS	EL
			7.08369.86.0	ATS	EL
			7.11190.02.0	DDS	für PR-Nummer: G0Z for PR number: G0Z für PR-Nummer: G0K for PR number: G0K Produktionsdatum ab: 13.12.2010 Production date from: 13.12.2010 Produktionsdatum bis: 07.11.2011 Production date to: 07.11.2011
			7.11190.09.0	DDS	für PR-Nummer: G0Z for PR number: G0Z Produktionsdatum ab: 13.12.2010 Production date from: 13.12.2010 Produktionsdatum bis: 07.11.2011 Production date to: 07.11.2011
2.0 TDI 88 kW (120 PS) CJCC	07.2009→05.2013		7.09720.03.0	AGR-K	EL
			7.11190.02.0	DDS	Produktionsdatum bis: 13.12.2010 Production date to: 13.12.2010
			7.11190.09.0	DDS	Produktionsdatum ab: 07.11.2011 Production date from: 07.11.2011
2.0 TFSI 147 kW (200 PS) BWE	06.2009→05.2013		7.05271.11.0	LS	800 mm Diagnosesonde Diagnostic Probe
IBIZA II (6K1)					13
1.0 33 kW (45 PS) AAU	03.1993→09.1996		7.05270.86.0	LS	625 mm
1.0 i 37 kW (50 PS) AER	09.1996→02.2002		7.05270.88.0	LS	740 mm ch. 6K-V-165 001→ch. 6K-X-127 000
			7.05271.03.0	LS	730 mm ch. 6K-X-127 001→ Regelsonde Regulating Probe

S

					
IBIZA II (6K1)					
13					
1.0 i 37 kW (50 PS) ANV, AUC	09.1996→02.2002		7.05271.77.0	LS	800 mm  ANV: vor Katalysator in front of the catalyst  AUC:  ch. 6K-X-400 000→ch. 6K-X-499 99 vor Katalysator in front of the catalyst
1.3 i 40 kW (54 PS) AAV	03.1993→08.1999		7.05270.86.0	LS	625 mm  →ch. 6K-ZR155 000
1.4 40 kW (54 PS) ANX	12.1997→04.1999		7.05270.88.0	LS	740 mm  ch. 6K-V-165 001→ch. 6K-X-127 000
			7.05271.03.0	LS	730 mm  ch. 6K-X-127 001→ Regelsonde Regulating Probe
1.4 16V 55 kW (75 PS) APE, AUA	05.2000→02.2002		7.28248.17.0	AGR	EL 
1.4 i 44 kW (60 PS) ABD	09.1993→12.1995		7.05270.86.0	LS	625 mm  →ch. 6K-ZR155 000
1.4 i 44 kW (60 PS) ANW, AUD	09.1993→02.2002		7.05271.77.0	LS	800 mm  ANW, AUD:  ch. 6K-X-400 000→ch. 6K-X-499 99 vor Katalysator in front of the catalyst
1.4 i 44 kW (60 PS) AEX, AKV, APQ	12.1995→02.2002		7.05270.88.0	LS	740 mm  AEX, AKV, APQ:  ch. 6K-V-165 001→ch. 6K-X-127 000
			7.05271.03.0	LS	730 mm  AEX, AKV, APQ:  ch. 6K-X-127 001→ Regelsonde Regulating Probe
1.4 i 16V 74 kW (100 PS) AQQ, AUB	06.1997→02.2002		7.28248.17.0	AGR	EL   AQQ:  045 001→  AUB:  030 351→
1.6 i 55 kW (75 PS) ABU	03.1993→07.1994		7.05270.86.0	LS	625 mm  →ch. 6K-ZR155 000
1.6 i 74 kW (100-101 PS) APF, AUR	04.1996→02.2002		7.22574.12.0	AGR	EL  APF, AUR: 01.1999→
			7.22286.41.0	ARV	PN  APF, AUR:  ch. 6K-X-400 000→ch. 6K-X-499 99
			7.05271.77.0	LS	800 mm  APF, AUR:  ch. 6K-X-400 000→ch. 6K-X-499 99 vor Katalysator in front of the catalyst
			7.22738.08.0	SLP	EL
1.8 T 20V Cupra 115-132 kW (156-179 PS) AQX, AYP	07.2000→02.2002		7.22769.73.0	ARV	PN 
1.8 T 20V Cupra R 115-132 kW (156-179 PS) AYP	07.2000→02.2002		7.21851.31.0	SLP	EL
			7.22769.73.0	ARV	PN  ch. 6K-X-400 000→ch. 6K-X-499 99
			7.21851.31.0	SLP	EL  ch. 6K-X-400 000→ch. 6K-X-499 99
1.8 i 16V 95 kW (129 PS) ADL	11.1993→08.1996		7.05270.86.0	LS	625 mm
1.9 SDI 50 kW (68 PS) AGP, AQM	08.1999→02.2002		7.22477.10.0	AGR	PN 































S

































IBIZA II (6K1)					13
1.9 TDI 66 kW (90 PS) AGR, ALH	08.1996→02.2002	 7.24809.17.0	AGR	PN	 AGR, ALH: ch. 6K-X-400 000→ch. 6K-X-499 99
2.0 i 85 kW (115 PS) 2E	03.1993→08.1999	 7.05270.86.0	LS	625 mm	
IBIZA III (6L1)					14
1.2 47 kW (64 PS) AZQ	02.2002→06.2006	 7.22785.16.0 7.05271.23.0	AGR LS	EL 900 mm	 ch. 6L-2-000 001→
1.2 47 kW (64 PS) BME	02.2002→06.2006	 7.22785.16.0 7.05271.20.0	AGR LS	EL 500 mm	 →ch. 6L-6-104 000
1.2 44 kW (60 PS) BBM	06.2007→05.2008	 7.05271.05.0	LS	700 mm	vor Katalysator in front of the catalyst
1.2 12V 51 kW (70 PS) BXV	05.2006→11.2009	 7.22785.16.0 7.05271.20.0	AGR LS	EL 500 mm	 →ch. 6L-6-104 000
1.4 16V 74 kW (100 PS) AUB	02.2002→11.2009	 7.22785.17.0 7.28248.17.0 7.05271.05.0	AGR AGR LS	EL EL 700 mm	 →AQQ 045 000 →AUB 030 350 030 351→ ch. 6L-2-000 001→ nach Katalysator Post-catalyst
1.4 16V 74 kW (100 PS) BBZ	02.2002→11.2009	 7.28248.17.0 7.05271.05.0	AGR LS	EL 700 mm	 ch. 6L-2-000 001→ ch. 6L-2-000 001→ nach Katalysator Post-catalyst
1.4 16V 55 kW (75 PS) BBY, BKY	02.2002→12.2007	 7.28248.17.0 7.05271.05.0	AGR LS	EL 700 mm	 BBY, BKY: ch. 6L-2-000 001→ BKY: ch. 6L-2-000 001→ nach Katalysator Post-catalyst
1.4 16V 63 kW (86 PS) BXW	05.2006→11.2009	 7.05271.05.0	LS	700 mm	nach Katalysator Post-catalyst
1.4 TDI 55 kW (75 PS) AMF	05.2002→12.2005	 7.24809.17.0	AGR	PN	 ch. 6L-2-000 001→
1.4 TDI 51 kW (70 PS) BNM	05.2005→11.2009	 7.24809.31.0	AGR	PN	
1.4 TDI 59 kW (80 PS) BMS	06.2005→11.2009	 7.00678.04.0* ↳7.00907.03.0 7.00678.06.0 7.08369.53.0 7.08369.86.0 7.11020.02.0 7.11020.03.0 7.11020.07.0	AGR-M AGR AGR-M ATS ATS ATS ATS ATS	EL EL EL EL EL EL EL	mit Rohrstützen with pipe socket vor Rußpartikelfilter before soot particulate filter für Rechtslenker for right-hand drive vehicles nach Rußpartikelfilter after soot particulate filter für Linkslenker for left-hand drive vehicles für Rechtslenker for right-hand drive vehicles für Linkslenker for left-hand drive vehicles

S





















IBIZA III (6L1) **14**

			7.11492.02.0	DDS		ohne Zubehör without accessories
1.4 TDI 59 kW (80 PS) BNV	06.2005→11.2009		7.24809.31.0	AGR	PN	
1.6 74-75 kW (101-102 PS) BAH	02.2003→11.2009		7.05270.91.0	LS	350 mm	Regelsonde Regulating Probe
1.6 16V 77 kW (105 PS) BTS	11.2006→11.2009		7.05271.18.0	LS	525 mm	
1.8 T Cupra R 132 kW (180 PS) BBU	01.2004→02.2008		7.22286.54.0	ARV	PN	 ch. 6L-2-000 001→
			7.05271.24.0	LS	1500 mm	 ch. 6L-2-000 001→ vor Katalysator in front of the catalyst
			7.22738.20.0	SLP	EL	Fahrgestellnummer ab: 6L-2-000 001 Vehicle Identification Number from: 6L-2-000 001
1.8 T Cupra R 132 kW (180 PS) BLZ	01.2004→02.2008		7.22286.54.0	ARV	PN	 ch. 6L-2-000 001→
			7.05271.24.0	LS	1500 mm	 →ch. 6L-2-000 001 vor Katalysator in front of the catalyst
1.8 T FR 110 kW (150 PS) BJX, BKV	12.2003→05.2008		7.22286.54.0	ARV	PN	 BJK, BKV:  ch. 6L-2-000 001→
			7.05271.24.0	LS	1500 mm	 BJK, BKV:  ch. 6L-2-000 001→ vor Katalysator in front of the catalyst
			7.22738.20.0	SLP	EL	 BJK, BKV: Fahrgestellnummer ab: 6L-2-000 001 Vehicle Identification Number from: 6L-2-000 001
1.9 SDI 47 kW (64 PS) ASY	02.2002→12.2005		7.22477.10.0	AGR	PN	 ch. 6L-2-000 001→
1.9 TDI 74 kW (100 PS) ATD	02.2002→11.2009		7.24809.30.0	AGR	PN	 ch. 6L-2-000 001→
1.9 TDI 74 kW (100 PS) AXR	02.2002→11.2009		7.24809.16.0	AGR	PN	
1.9 TDI 74 kW (101 PS) BMT	02.2002→11.2009		7.00678.04.0*	AGR-M	EL	mit Rohrstützen with pipe socket
			↳ 7.00907.03.0	AGR	EL	
			7.00678.06.0	AGR-M	EL	
			7.08369.53.0	ATS	EL	vor Rußpartikelfilter before soot particulate filter
			7.08369.86.0	ATS	EL	für Rechtslenker for right-hand drive vehicles
			7.11020.02.0	ATS	EL	nach Rußpartikelfilter after soot particulate filter
			7.11020.03.0	ATS	EL	für Linkslenker for left-hand drive vehicles
			7.11020.07.0	ATS	EL	für Rechtslenker for right-hand drive vehicles
7.11492.02.0	DDS	EL	für Linkslenker for left-hand drive vehicles ohne Zubehör without accessories			
1.9 TDI 96-112 kW (130-152 PS) ASZ	02.2002→11.2009		7.24809.55.0	AGR	PN	
1.9 TDI 96 kW (131 PS) BLT	02.2002→11.2009		7.24809.16.0	AGR	PN	
1.9 TDI Cupra R 118 kW (160 PS) BPX, BUK	03.2004→02.2008		7.24809.26.0	AGR	PN	 ch. 6L-2-000 001→

					
IBIZA III (6L1)					
14					
2.0 85 kW (115 PS) AZL	04.2002→11.2009		7.05271.77.0	LS	800 mm  ch. 6L-2-000 001→ vor Katalysator in front of the catalyst
			7.22738.08.0	SLP	EL  ch. 6L-2-000 001→
			7.22778.80.0	SLV	PN  Fahrgestellnummer ab: 6L-2-000 001 Vehicle Identification Number from: 6L-2-000 001
IBIZA IV (6J5, 6P1)					
15					
1.2 TDI 55 kW (75 PS) CFWA	06.2010→03.2012		7.09720.02.0	AGR-K	EL   ch. 6J-9-000 001→
			7.08369.50.0	ATS	EL
			7.08369.83.0	ATS	EL  ch. 6J-9-000 001→
			7.08369.11.0	ATS	EL Fahrgestellnummer ab: 6J-9-000 001 Vehicle Identification Number from: 6J-9-000 001 für Rechtslenker for right-hand drive vehicles
			7.08369.37.0	ATS	EL Fahrgestellnummer ab: 6J-9-000 001 Vehicle Identification Number from: 6J-9-000 001 nach Rußpartikelfilter after soot particulate filter
1.4 63 kW (85-86 PS) BXW, CGGB	03.2008→05.2015		7.05271.05.0	LS	700 mm  BXW:  ch. 6J-9-000 001→  CGGB: nach Katalysator Post-catalyst
			7.05271.05.0	LS	700 mm  ch. 6J-9-000 001→ nach Katalysator Post-catalyst
1.4 LPG 63 kW (86 PS) BXW	03.2008→05.2011		7.00678.06.0	AGR-M	EL  ch. 6J-9-000 001→
			7.00678.04.0*	AGR-M	EL mit Rohrstützen with pipe socket
			7.00907.03.0	AGR	EL
			7.08369.86.0	ATS	EL  ch. 6J-9-000 001→ für Rechtslenker for right-hand drive vehicles
			7.11020.02.0	ATS	EL  ch. 6J-9-000 001→ nach Rußpartikelfilter after soot particulate filter für Linkslenker for left-hand drive vehicles
			7.11020.03.0	ATS	EL  ch. 6J-9-000 001→ für Rechtslenker for right-hand drive vehicles
			7.11020.07.0	ATS	EL  ch. 6J-9-000 001→ für Linkslenker for left-hand drive vehicles
			7.08369.53.0	ATS	EL vor Rußpartikelfilter before soot particulate filter
			7.11492.02.0	DDS	ohne Zubehör without accessories
1.4 TDI 55 kW (75 PS) CUSA	05.2015→06.2017		7.07696.00.0	SRM-AK	EL
1.4 TDI 66 kW (90 PS) CUSB	05.2015→06.2017		7.07696.00.0	SRM-AK	EL
1.4 TDI 77 kW (105 PS) CUTA	05.2015→06.2017		7.07696.00.0	SRM-AK	EL
1.4 TDI 77 kW (105 PS) CYZA	05.2015→06.2017		7.09720.00.0	AGR-K	EL 
1.6 TDI 66 kW (90 PS) CAYB	05.2009→05.2015		7.09720.01.0	AGR-K	EL   ch. 6J-9-000 001→

























































IBIZA IV (6J5, 6P1) 15

			<p>7.08369.26.0 ATS EL  ch. 6J-9-000 001→</p> <p>7.08369.09.0 ATS EL Fahrgestellnummer ab: 6J-9-000 001 Vehicle Identification Number from: 6J-9-000 001 für Linkslenker for left-hand drive vehicles</p> <p>7.08369.11.0 ATS EL Fahrgestellnummer ab: 6J-9-000 001 Vehicle Identification Number from: 6J-9-000 001 für Rechtslenker for right-hand drive vehicles</p> <p>7.11190.09.0 DDS  ch. 6J-9-000 001→</p>
1.6 TDI 77 kW (105 PS) CAYC	05.2009→05.2015		<p>7.09720.01.0 AGR-K EL  ch. 6J-9-000 001→</p> <p>7.08369.26.0 ATS EL  ch. 6J-9-000 001→</p> <p>7.08369.09.0 ATS EL Fahrgestellnummer ab: 6J-9-000 001 Vehicle Identification Number from: 6J-9-000 001 für Linkslenker for left-hand drive vehicles</p> <p>7.08369.11.0 ATS EL Fahrgestellnummer ab: 6J-9-000 001 Vehicle Identification Number from: 6J-9-000 001 für Rechtslenker for right-hand drive vehicles</p> <p>7.11190.09.0 DDS  ch. 6J-9-000 001→</p>
1.6 TDI 77 kW (105 PS) CLNA	05.2009→05.2015		<p>7.09720.01.0 AGR-K EL  ch. 6J-9-000 001→</p>
1.6 TDI 55 kW (75 PS) CAYA	05.2009→06.2010		<p>7.08369.09.0 ATS EL Fahrgestellnummer ab: 6J-9-000 001 Vehicle Identification Number from: 6J-9-000 001 für Linkslenker for left-hand drive vehicles</p> <p>7.08369.11.0 ATS EL Fahrgestellnummer ab: 6J-9-000 001 Vehicle Identification Number from: 6J-9-000 001 für Rechtslenker for right-hand drive vehicles</p>
1.9 TDI 77 kW (105 PS) BLS	03.2008→06.2010		<p>7.00678.04.0* AGR-M EL mit Rohrstützen with pipe socket  ch. 6J-9-000 001→</p> <p>↳ 7.00907.03.0 AGR EL</p> <p>7.00678.06.0 AGR-M EL  ch. 6J-9-000 001→</p> <p>7.11020.02.0 ATS EL  BLS: für OE-Nummer: 045 906 088 D for OE number: 045 906 088 D vor Abgasturbolader in front of exhaust turbocharger  BLS:  ch. 6J-9-000 001→ nach Rußpartikelfilter after soot particulate filter</p> <p>7.08369.00.0 ATS EL Fahrgestellnummer ab: 6J-9-000 001 Vehicle Identification Number from: 6J-9-000 001 für OE-Nummer: 03L 906 088 BS for OE number: 03L 906 088 BS</p> <p>7.08369.53.0 ATS EL vor Rußpartikelfilter before soot particulate filter</p> <p>7.11492.02.0 DDS ohne Zubehör without accessories  ch. 6J-9-000 001→</p>
1.9 TDI 66 kW (90 PS) BXJ	07.2008→06.2010		<p>7.00678.04.0* AGR-M EL mit Rohrstützen with pipe socket  ch. 6J-9-000 001→</p> <p>↳ 7.00907.03.0 AGR EL</p> <p>7.00678.06.0 AGR-M EL  ch. 6J-9-000 001→</p>

IBIZA IV (6J5, 6P1)					15
			7.11020.02.0	ATS	EL BXJ: für OE-Nummer: 045 906 088 D for OE number: 045 906 088 D vor Abgasturbolader in front of exhaust turbocharger
			7.08369.00.0	ATS	EL BXJ: ch. 6J-9-000 001→ nach Rußpartikelfilter after soot particulate filter
			7.11492.02.0	DDS	EL Fahrgestellnummer ab: 6J-9-000 001 Vehicle Identification Number from: 6J-9-000 001 für OE-Nummer: 03L 906 088 BS for OE number: 03L 906 088 BS ohne Zubehör without accessories ch. 6J-9-000 001→
2.0 85-86 kW (115-117 PS) CEKA	10.2008→05.2015		7.05270.98.0	LS	700 mm nach Katalysator Post-catalyst
2.0 TDI 105 kW (143 PS) CFHD	01.2010→05.2015		7.09720.01.0	AGR-K	EL 01.2012→
			7.11190.09.0	DDS	ch. 6J-9-000 001→
IBIZA IV SC (6J1, 6P5)					16
1.2 TDI 55 kW (75 PS) CFWA	05.2010→05.2015		7.09720.02.0	AGR-K	EL ch. 6J-9-000 001→
			7.08369.50.0	ATS	EL ch. 6J-9-000 001→
			7.08369.83.0	ATS	EL ch. 6J-9-000 001→
			7.08369.11.0	ATS	EL Fahrgestellnummer ab: 6J-9-000 001 Vehicle Identification Number from: 6J-9-000 001 für Rechtslenker for right-hand drive vehicles
			7.08369.37.0	ATS	EL Fahrgestellnummer ab: 6J-9-000 001 Vehicle Identification Number from: 6J-9-000 001 nach Rußpartikelfilter after soot particulate filter
			7.11190.09.0	DDS	ch. 6J-9-000 001→
1.4 63 kW (85-86 PS) BXW, CGGB	07.2008→05.2015		7.05271.05.0	LS	700 mm BXW: ch. 6J-9-000 001→ nach Katalysator Post-catalyst CGGB: nach Katalysator Post-catalyst
1.4 TDI 59 kW (80 PS) BMS	07.2008→06.2010		7.00678.06.0	AGR-M	EL ch. 6J-9-000 001→
			7.00678.04.0*	AGR-M	EL mit Rohrstützen with pipe socket
			↳ 7.00907.03.0	AGR	EL
			7.08369.86.0	ATS	EL ch. 6J-9-000 001→ für Rechtslenker for right-hand drive vehicles
			7.11020.02.0	ATS	EL ch. 6J-9-000 001→ nach Rußpartikelfilter after soot particulate filter für Linkslenker for left-hand drive vehicles
			7.11020.03.0	ATS	EL ch. 6J-9-000 001→ für Rechtslenker for right-hand drive vehicles
			7.11020.07.0	ATS	EL ch. 6J-9-000 001→ für Linkslenker for left-hand drive vehicles
			7.08369.53.0	ATS	EL vor Rußpartikelfilter before soot particulate filter ohne Zubehör without accessories
			7.11492.02.0	DDS	







S

					
IBIZA IV SC (6J1, 6P5)					
1.4 TDI 55 kW (75 PS) CUSA	05.2015→12.2016		7.07696.00.0	SRM-AK	EL
1.4 TDI 66 kW (90 PS) CUSB	05.2015→12.2016		7.07696.00.0	SRM-AK	EL
1.4 TDI 77 kW (105 PS) CUTA	05.2015→12.2016		7.07696.00.0	SRM-AK	EL
1.6 TDI 66 kW (90 PS) CAYB	05.2009→05.2015		7.09720.01.0	AGR-K	EL 
			7.08369.26.0	ATS	EL  ch. 6J-9-000 001→
			7.08369.09.0	ATS	EL  ch. 6J-9-000 001→ Fahrgestellnummer ab: 6J-9-000 001 Vehicle Identification Number from: 6J-9-000 001 für Linkslenker for left-hand drive vehicles
			7.08369.11.0	ATS	EL Fahrgestellnummer ab: 6J-9-000 001 Vehicle Identification Number from: 6J-9-000 001 für Rechtslenker for right-hand drive vehicles
1.6 TDI 77 kW (105 PS) CAYC	05.2009→05.2015		7.09720.01.0	AGR-K	EL 
			7.08369.26.0	ATS	EL  ch. 6J-9-000 001→
			7.08369.09.0	ATS	EL Fahrgestellnummer ab: 6J-9-000 001 Vehicle Identification Number from: 6J-9-000 001 für Linkslenker for left-hand drive vehicles
			7.08369.11.0	ATS	EL Fahrgestellnummer ab: 6J-9-000 001 Vehicle Identification Number from: 6J-9-000 001 für Rechtslenker for right-hand drive vehicles
1.6 TDI 55 kW (75 PS) CAYA	05.2010→06.2010		7.08369.09.0	ATS	EL Fahrgestellnummer ab: 6J-9-000 001 Vehicle Identification Number from: 6J-9-000 001 für Linkslenker for left-hand drive vehicles
			7.08369.11.0	ATS	EL Fahrgestellnummer ab: 6J-9-000 001 Vehicle Identification Number from: 6J-9-000 001 für Rechtslenker for right-hand drive vehicles
			7.11190.09.0	DDS	 ch. 6J-9-000 001→
S 1.9 TDI 66 kW (90 PS) BXJ	06.2008→06.2010		7.00678.04.0*	AGR-M	EL mit Rohrstützen with pipe socket  ch. 6J-9-000 001→
			7.00907.03.0	AGR	EL
			7.00678.06.0	AGR-M	EL  ch. 6J-9-000 001→
			7.11020.02.0	ATS	EL  BXJ: für OE-Nummer: 045 906 088 D for OE number: 045 906 088 D vor Abgasturbolader in front of exhaust turbocharger  BXJ:  ch. 6J-9-000 001→ nach Rußpartikelfilter after soot particulate filter
			7.08369.00.0	ATS	EL Fahrgestellnummer ab: 6J-9-000 001 Vehicle Identification Number from: 6J-9-000 001 für OE-Nummer: 03L 906 088 BS for OE number: 03L 906 088 BS
			7.11492.02.0	DDS	ohne Zubehör without accessories  ch. 6J-9-000 001→

						
IBIZA IV SC (6J1, 6P5)						16
1.9 TDI 77 kW (105 PS) BLS	07.2008→06.2010		7.00678.04.0*	AGR-M	EL	mit Rohrstützen with pipe socket  ch. 6J-9-000 001→
			↳ 7.00907.03.0	AGR	EL	
			7.00678.06.0	AGR-M	EL	 ch. 6J-9-000 001→
			7.11020.02.0	ATS	EL	 BLS: für OE-Nummer: 045 906 088 D for OE number: 045 906 088 D vor Abgasturbolader in front of exhaust turbocharger  BLS:  ch. 6J-9-000 001→ nach Rußpartikelfilter after soot particulate filter
			7.08369.00.0	ATS	EL	Fahrgestellnummer ab: 6J-9-000 001 Vehicle Identification Number from: 6J-9-000 001
			7.08369.53.0	ATS	EL	für OE-Nummer: 03L 906 088 BS for OE number: 03L 906 088 BS
			7.11492.02.0	DDS	EL	vor Rußpartikelfilter before soot particulate filter ohne Zubehör without accessories  ch. 6J-9-000 001→
2.0 85-86 kW (115-117 PS) CEKA	10.2008→05.2015		7.05270.98.0	LS	700 mm	nach Katalysator Post-catalyst
2.0 TDI 105 kW (143 PS) CFHD	01.2010→05.2015		7.09720.01.0	AGR-K	EL	 01.2012→
			7.11190.09.0	DDS	EL	 ch. 6J-9-000 001→
IBIZA IV ST (6J8, 6P8)						17
1.2 TDI 55 kW (75 PS) CFWA	04.2010→05.2015		7.09720.02.0	AGR-K	EL	  ch. 6J-9-000 001→
			7.08369.50.0	ATS	EL	
			7.08369.83.0	ATS	EL	 ch. 6J-9-000 001→
			7.08369.11.0	ATS	EL	Fahrgestellnummer ab: 6J-9-000 001 Vehicle Identification Number from: 6J-9-000 001 für Rechtslenker for right-hand drive vehicles
			7.08369.37.0	ATS	EL	Fahrgestellnummer ab: 6J-9-000 001 Vehicle Identification Number from: 6J-9-000 001 nach Rußpartikelfilter after soot particulate filter
			7.11190.09.0	DDS	EL	 ch. 6J-9-000 001→
1.4 63 kW (85 PS) CGGB	03.2010→05.2015		7.05271.05.0	LS	700 mm	nach Katalysator Post-catalyst
1.4 TDI 55 kW (75 PS) CUSA	05.2015→07.2016		7.07696.00.0	SRM-AK	EL	
1.4 TDI 66 kW (90 PS) CUSB	05.2015→07.2016		7.07696.00.0	SRM-AK	EL	
1.4 TDI 77 kW (105 PS) CUTA	05.2015→07.2016		7.07696.00.0	SRM-AK	EL	
1.6 TDI 66 kW (90 PS) CAYB	03.2010→05.2015		7.09720.01.0	AGR-K	EL	  ch. 6J-9-000 001→
			7.08369.26.0	ATS	EL	 ch. 6J-9-000 001→
			7.08369.09.0	ATS	EL	Fahrgestellnummer ab: 6J-9-000 001 Vehicle Identification Number from: 6J-9-000 001 für Linkslenker for left-hand drive vehicles





IBIZA IV ST (6J8, 6P8) 17

			7.08369.11.0	ATS	EL	Fahrgestellnummer ab: 6J-9-000 001 Vehicle Identification Number from: 6J-9-000 001 für Rechtslenker for right-hand drive vehicles
			7.11190.09.0	DDS		
1.6 TDI 77 kW (105 PS) CAYC	03.2010→05.2015		7.09720.01.0	AGR-K	EL	 ch. 6J-9-000 001→
			7.08369.26.0	ATS	EL	 ch. 6J-9-000 001→
			7.08369.09.0	ATS	EL	Fahrgestellnummer ab: 6J-9-000 001 Vehicle Identification Number from: 6J-9-000 001 für Linkslenker for left-hand drive vehicles
			7.08369.11.0	ATS	EL	Fahrgestellnummer ab: 6J-9-000 001 Vehicle Identification Number from: 6J-9-000 001 für Rechtslenker for right-hand drive vehicles
			7.11190.09.0	DDS		 ch. 6J-9-000 001→
1.6 TDI 77 kW (105 PS) CLNA	03.2010→05.2015		7.09720.01.0	AGR-K	EL	 ch. 6J-9-000 001→





IBIZA V (6J_) 18

1.2 SRE 12V 51 kW (70 PS) BZG	03.2008→05.2011		7.05271.20.0	LS	500 mm	
---	-----------------	---	---------------------	----	--------	--

IBIZA V (KJ1) 19

1.6 TDI 70 kW (95 PS) DGTD	09.2017→		7.11020.17.0	ATS	EL	vor Katalysator in front of the catalyst
			7.11020.22.0	ATS	EL	
			7.11020.23.0	ATS	EL	
			7.11492.05.0	DDS		ohne Zubehör without accessories
			7.07696.00.0	SRM-AK	EL	
1.6 TDI 59 kW (80 PS) DGTC	11.2017→		7.11020.17.0	ATS	EL	vor Katalysator in front of the catalyst
			7.11020.22.0	ATS	EL	
			7.11020.23.0	ATS	EL	
			7.11492.05.0	DDS		ohne Zubehör without accessories
			7.07696.00.0	SRM-AK	EL	
1.6 TDI 85 kW (115 PS) DGTA	12.2017→		7.11020.17.0	ATS	EL	vor Katalysator in front of the catalyst
			7.11020.22.0	ATS	EL	
			7.11020.23.0	ATS	EL	
			7.11492.05.0	DDS		ohne Zubehör without accessories
			7.07696.00.0	SRM-AK	EL	

LEON (1M1) 20





















1.4 16V 55 kW (75 PS) AHW	11.1999→06.2006		7.05271.03.0	LS	730 mm	Regelsonde Regulating Probe
1.4 16V 55 kW (75 PS) APE	11.1999→05.2000		7.22785.17.0	AGR	EL	
			7.05271.24.0	LS	1500 mm	vor Katalysator in front of the catalyst
1.4 16V 55 kW (75 PS) BCA	11.1999→06.2006		7.28248.17.0	AGR	EL	
			7.05271.24.0	LS	1500 mm	vor Katalysator in front of the catalyst

LEON (1M1)					
20					
1.4 16V 55 kW (75 PS) AXP	06.2000→06.2006		7.22785.17.0 AGR EL		
			7.28248.17.0 AGR EL		
			7.05271.24.0 LS 1500 mm vor Katalysator in front of the catalyst		
1.6 74-76 kW (101-103 PS) AEH, AKL	11.1999→06.2006		7.05271.21.0 LS 1250 mm AEH, AKL: Regelsonde Regulating Probe		
1.6 75 kW (102 PS) BFQ	10.2005→06.2006		7.22574.12.0 AGR EL		
			7.05271.24.0 LS 1500 mm vor Katalysator in front of the catalyst		
			7.22738.08.0 SLP EL		
			7.22778.96.0 SLV PN		
1.6 16 V 77 kW (105 PS) AUS	09.2000→06.2006		7.22785.17.0 AGR EL		
1.6 16 V 77 kW (105 PS) AZD	09.2000→06.2006		7.22785.17.0 AGR EL →04.2001		
			7.28248.17.0 AGR EL 05.2001→		
1.6 16 V 77 kW (105 PS) BCB	09.2000→06.2006		7.28248.17.0 AGR EL		
1.8 20V 92 kW (125 PS) AGN	11.1999→06.2006		7.05271.03.0 LS 730 mm		
1.8 20V 92 kW (125 PS) APG	11.1999→06.2006		7.22785.18.0 AGR EL		
			7.22286.26.0 ARV PN		
			7.05271.23.0 LS 900 mm		
			7.22738.08.0 SLP EL		
1.8 20V T 132 kW (180 PS) APP	11.1999→06.2006		7.22769.73.0 ARV PN		
			7.21851.31.0 SLP EL		
1.8 20V T 132 kW (180 PS) AUQ	03.2000→06.2006		7.22769.73.0 ARV PN		
			7.05271.23.0 LS 900 mm		
			7.05271.24.0 LS 1500 mm vor Katalysator in front of the catalyst		
			7.21851.31.0 SLP EL		
1.8 20V T 4 132 kW (180 PS) AJQ	11.1999→06.2006		7.05270.89.0 LS 925 mm Regelsonde Regulating Probe		
1.8 20V T 4 132 kW (180 PS) ARY	03.2000→06.2006		7.22769.73.0 ARV PN		
			7.05270.99.0 LS 940 mm Diagnosesonde Diagnostic Probe		
			7.05271.24.0 LS 1500 mm vor Katalysator in front of the catalyst		
			7.21851.31.0 SLP EL		
1.8 T Cupra R 154 kW (209 PS) AMK	02.2002→06.2006		7.05271.77.0 LS 800 mm vor Katalysator in front of the catalyst		
1.8 T Cupra R 165 kW (225 PS) BAM	07.2003→06.2006		7.05271.77.0 LS 800 mm vor Katalysator in front of the catalyst		
1.9 SDI 50 kW (68 PS) AQM	11.1999→06.2006		7.22477.10.0 AGR PN		
1.9 TDI 66 kW (90 PS) AGR, ALH	11.1999→06.2006		7.24809.17.0 AGR PN		
1.9 TDI 81 kW (110 PS) AHF, ASV	11.1999→06.2006		7.24809.17.0 AGR PN		
1.9 TDI 110 kW (150 PS) ARL	09.2000→06.2006		7.24809.26.0 AGR PN		

















S



LEON (1M1) **20**

1.9 TDI 96-112 kW (130-152 PS) ASZ	05.2003→06.2006		7.24809.26.0	AGR	PN	
1.9 TDI 74 kW (100 PS) AXR	10.2005→06.2006		7.24809.16.0	AGR	PN	
1.9 TDI Syncro 110 kW (150 PS) ARL	05.2002→06.2006		7.24809.26.0	AGR	PN	
2.8 150 kW (204 PS) BDE	05.2002→06.2004		7.22286.55.0	ARV	PN	
			7.05270.98.0	LS	700 mm	nach Katalysator, rechts Post-catalyst, Right
			7.05270.91.0	LS	350 mm	
			7.05271.00.0	LS	1525 mm	
2.8 Cupra 4 150 kW (204 PS) AUE	02.2001→06.2006		7.22286.55.0	ARV	PN	
			7.05270.98.0	LS	700 mm	nach Katalysator, rechts Post-catalyst, Right
			7.05270.91.0	LS	350 mm	
			7.05271.00.0	LS	1525 mm	
2.8 Cupra 4 150 kW (204 PS) BDE	02.2001→06.2006		7.22286.55.0	ARV	PN	
			7.05270.98.0	LS	700 mm	nach Katalysator, rechts Post-catalyst, Right
			7.05270.91.0	LS	350 mm	
			7.05271.00.0	LS	1525 mm	
2.8 Cupra 4 150 kW (204 PS) BDE	02.2001→06.2006		7.22286.55.0	ARV	PN	
			7.05270.98.0	LS	700 mm	nach Katalysator, rechts Post-catalyst, Right
			7.05270.91.0	LS	350 mm	
			7.05271.00.0	LS	1525 mm	
2.8 Cupra 4 150 kW (204 PS) BDE	02.2001→06.2006		7.22286.55.0	ARV	PN	
			7.05270.98.0	LS	700 mm	nach Katalysator, rechts Post-catalyst, Right
			7.05270.91.0	LS	350 mm	
			7.05271.00.0	LS	1525 mm	
2.8 Cupra 4 150 kW (204 PS) BDE	02.2001→06.2006		7.22286.55.0	ARV	PN	
			7.05270.98.0	LS	700 mm	nach Katalysator, rechts Post-catalyst, Right
			7.05270.91.0	LS	350 mm	
			7.05271.00.0	LS	1525 mm	
2.8 Cupra 4 150 kW (204 PS) BDE	02.2001→06.2006		7.22286.55.0	ARV	PN	
			7.05270.98.0	LS	700 mm	nach Katalysator, rechts Post-catalyst, Right
			7.05270.91.0	LS	350 mm	
			7.05271.00.0	LS	1525 mm	

LEON (1P1) **21**

1.4 16V 63 kW (85-86 PS) BXW, CGGB	06.2006→12.2012		7.05271.18.0	LS	525 mm	
1.4 TSI 92 kW (125 PS) CAXC	11.2007→12.2012		7.05271.18.0	LS	525 mm	
1.6 75 kW (102 PS) BSE, CCSA	07.2005→12.2012		7.05271.18.0	LS	525 mm	
			7.22738.08.0	SLP	EL	 BSE, CCSA:  ch. 1P-6-000 001→
			7.22778.96.0	SLV	PN	 BSE, CCSA:  ch. 1P-6-000 001→
1.6 75 kW (102 PS) BSF	07.2005→12.2012		7.05271.18.0	LS	525 mm	
1.6 LPG 75 kW (102 PS) CHGA	12.2009→12.2012		7.05271.18.0	LS	525 mm	
			7.22738.08.0	SLP	EL	 ch. 1P-6-000 001→
			7.22778.96.0	SLV	PN	  ch. 1P-6-000 001→
1.6 MultiFuel 75 kW (102 PS) BSE, CMXA	07.2005→08.2013		7.05271.18.0	LS	525 mm	
			7.22738.08.0	SLP	EL	 ch. 1P-6-000 001→
			7.22778.96.0	SLV	PN	  ch. 1P-6-000 001→
1.6 MultiFuel 75 kW (102 PS) CCSA	07.2005→08.2013		7.05271.18.0	LS	525 mm	





















S

LEON (1P1)					21
			7.22778.96.0	SLV	PN ch. 1P-6-000 001→
1.6 TDI 77 kW (105 PS) CAYC	02.2010→12.2012		7.09720.00.0	AGR-K	EL
			7.08369.01.0	ATS	EL Fahrgestellnummer ab: 1P-6-000 001 Vehicle Identification Number from: 1P-6-000 001
			7.08369.04.0	ATS	EL
			7.11492.00.0	DDS	ohne Zubehör without accessories
1.6 TDI 66 kW (90 PS) CAYB	11.2010→12.2012		7.09720.00.0	AGR-K	EL
			7.08369.04.0	ATS	EL ch. 1P-6-000 001→
			7.08369.01.0	ATS	EL
			7.11492.00.0	DDS	ohne Zubehör without accessories
1.8 TSI 118 kW (160 PS) BZB	06.2007→12.2012		7.05271.19.0	LS	975 mm →ch. 1P-8-108 000 Regelsonde Regulating Probe
			7.05271.11.0	LS	800 mm ch. 1P-8-108 001→ Regelsonde Regulating Probe
1.9 TDI 77 kW (105 PS) BKC, BXE	07.2005→12.2010		7.24809.16.0	AGR	PN
1.9 TDI 77 kW (105 PS) BLS	07.2005→12.2010		7.00678.06.0	AGR-M	EL ch. 1P-6-000 001→
			7.08369.00.0	ATS	EL Fahrgestellnummer ab: 1P-6-000 001 Vehicle Identification Number from: 1P-6-000 001
			7.08369.02.0	ATS	EL Fahrgestellnummer ab: 1P-6-000 001 Vehicle Identification Number from: 1P-6-000 001
			7.08369.03.0	ATS	EL Fahrgestellnummer ab: 1P-6-000 001 Vehicle Identification Number from: 1P-6-000 001
			7.11492.02.0	DDS	ohne Zubehör without accessories
7.11190.02.0	DDS	ch. 1P-7-021 001→ →ch. 1P-7-021 000			
1.9 TDI 66 kW (90 PS) BXF	06.2007→12.2010		7.24809.16.0	AGR	PN
2.0 FSI 110 kW (150 PS) BLR, BVY	07.2005→05.2010		7.10334.09.0	AGR	EL BLR, BVY: ch. 1P-6-000 001→
			7.05271.29.0	LS	900 mm BLR, BVY: rechts Right
			7.05271.16.0	LS	1300 mm BLR, BVY: hinten, links, rechts Rear, Left, Right Diagnosesonde Diagnostic Probe
2.0 FSI 110 kW (150 PS) BLY, BVZ	07.2005→05.2010		7.10334.09.0	AGR	EL BLY, BVZ: ch. 1P-6-000 001→
			7.05271.16.0	LS	1300 mm BLY, BVZ: hinten Rear Diagnosesonde Diagnostic Probe
2.0 TDI 100 kW (136 PS) AZV	07.2005→05.2010		7.24809.16.0	AGR	PN
			7.00678.04.0*	AGR-M	EL mit Rohrstützen with pipe socket
			↳ 7.00907.03.0	AGR	EL
2.0 TDI 103 kW (140 PS) BMM	10.2005→10.2010		7.00678.04.0*	AGR-M	EL mit Rohrstützen with pipe socket
			↳ 7.00907.03.0	AGR	EL

S



LEON (1P1) **21**

			7.00678.06.0	AGR-M	EL	 ch. 1P-6-000 001→
			7.08369.00.0	ATS	EL	Fahrgestellnummer ab: 1P-6-000 001 Vehicle Identification Number from: 1P-6-000 001
			7.08369.02.0	ATS	EL	Fahrgestellnummer ab: 1P-6-000 001 Vehicle Identification Number from: 1P-6-000 001
			7.08369.03.0	ATS	EL	Fahrgestellnummer ab: 1P-6-000 001 Vehicle Identification Number from: 1P-6-000 001
			7.11492.02.0	DDS		ohne Zubehör without accessories  ch. 1P-7-021 001→
			7.11190.02.0	DDS		 →ch. 1P-7-021 000
2.0 TDI 125 kW (170 PS) BMN	05.2006→12.2012		7.10334.00.0	AGR	EL	 ch. 1P-6-000 001→
			7.08369.00.0	ATS	EL	Fahrgestellnummer ab: 1P-6-000 001 Vehicle Identification Number from: 1P-6-000 001
			7.08369.02.0	ATS	EL	Fahrgestellnummer ab: 1P-6-000 001 Vehicle Identification Number from: 1P-6-000 001
			7.08369.03.0	ATS	EL	Fahrgestellnummer ab: 1P-6-000 001 Vehicle Identification Number from: 1P-6-000 001
			7.11492.02.0	DDS		ohne Zubehör without accessories  ch. 1P-7-021 001→
			7.11190.02.0	DDS		 →ch. 1P-7-021 000
2.0 TDI 125 kW (170 PS) CEGA	05.2006→12.2012		7.10334.00.0	AGR	EL	 ch. 1P-6-000 001→
			7.08369.00.0	ATS	EL	Fahrgestellnummer ab: 1P-6-000 001 Vehicle Identification Number from: 1P-6-000 001
			7.08369.01.0	ATS	EL	Fahrgestellnummer ab: 1P-6-000 001 Vehicle Identification Number from: 1P-6-000 001
			7.08369.04.0	ATS	EL	Fahrgestellnummer ab: 1P-6-000 001 Vehicle Identification Number from: 1P-6-000 001
			7.11492.00.0	DDS		ohne Zubehör without accessories
2.0 TDI 125 kW (170 PS) CFJA	05.2006→12.2012		7.09720.00.0	AGR-K	EL	
			7.11190.09.0	DDS		
2.0 TDI 16V 103 kW (140 PS) BKD	07.2005→12.2012		7.24809.16.0	AGR	PN	
2.0 TDI 16V 103 kW (140 PS) CFHC	07.2005→12.2012		7.09720.00.0	AGR-K	EL	
			7.11190.09.0	DDS		
2.0 TDI 16V 103 kW (140 PS) CLCB	07.2005→12.2012		7.09720.00.0	AGR-K	EL	
2.0 TFSI 147 kW (200 PS) BWA	05.2005→03.2009		7.05271.15.0	LS	525 mm	
2.0 TFSI 136 kW (185 PS) BWA1	09.2005→05.2006		7.05271.15.0	LS	525 mm	
2.0 TFSI 177 kW (240 PS) BWJ, CDLD	11.2006→05.2011		7.05271.15.0	LS	525 mm	
2.0 TFSI 155 kW (211 PS) CCZB	06.2009→12.2012		7.05271.15.0	LS	525 mm	



















S

LEON (5F1)					22
1.5 TGi 96 kW (131 PS) DHFA	10.2018→		7.03635.37.0	SLP	EL
1.5 TSI 96 kW (130-131 PS) DACA, DPBA	09.2018→		7.03635.37.0	SLP	EL
1.5 TSI 110 kW (150 PS) DADA, DPCA	09.2018→		7.03635.37.0	SLP	EL
1.6 TDI 77 kW (105 PS) CLHA	11.2012→		7.10334.02.0	AGR	EL
			7.03608.16.0	AK	EL ch. 5F-D-000 001→
			7.08369.82.0	ATS	EL ch. 5F-D-000 001→ Euro 5 Euro 5
			7.11020.18.0	ATS	EL ch. 5F-D-000 001→ vor Katalysator in front of the catalyst
			7.08369.79.0	ATS	EL ch. 5F-D-000 001 →
			7.11492.03.0	DDS	ohne Zubehör without accessories für OE-Nummer: 03L 906 051 B, 03L 906 051 D, 03N 906 051 B for OE number: 03L 906 051 B, 03L 906 051 D, 03N 906 051 B
1.6 TDI 66 kW (90 PS) CLHB	11.2012→		7.03608.16.0	AK	EL ch. 5F-D-000 001→
			7.11020.18.0	ATS	EL ch. 5F-D-000 001→ vor Katalysator in front of the catalyst
			7.08369.79.0	ATS	EL ch. 5F-D-000 001 →
			7.11492.03.0	DDS	ohne Zubehör without accessories für OE-Nummer: 03L 906 051 B, 03L 906 051 D, 03N 906 051 B for OE number: 03L 906 051 B, 03L 906 051 D, 03N 906 051 B
1.6 TDI 66 kW (90 PS) CXXA	11.2012→		7.10334.02.0	AGR	EL
			7.03608.16.0	AK	EL ch. 5F-D-000 001→
			7.08369.95.0	ATS	EL ch. 5F-D-000 001→
			7.11020.18.0	ATS	EL ch. 5F-D-000 001→ für OE-Nummer: 04L 906 088 K for OE number: 04L 906 088 K vor Katalysator in front of the catalyst
			7.11020.17.0	ATS	EL für OE-Nummer: 04L 906 088 BD for OE number: 04L 906 088 BD vor Katalysator in front of the catalyst
			7.11492.03.0	DDS	ohne Zubehör without accessories für OE-Nummer: 03L 906 051 B, 03L 906 051 D, 03N 906 051 B for OE number: 03L 906 051 B, 03L 906 051 D, 03N 906 051 B
1.6 TDI 66 kW (90 PS) DDYB	11.2012→		7.10334.02.0	AGR	EL
			7.08369.95.0	ATS	EL Euro 6 Euro 6

S













LEON (5F1) **22**

			7.11492.05.0	DDS		ohne Zubehör without accessories für OE-Nummer: 04L 906 051 AB, 04L 906 051 F, 04L 906 051 L for OE number: 04L 906 051 AB, 04L 906 051 F, 04L 906 051 L
1.6 TDI 81 kW (110 PS) CRKB	09.2013→		7.03608.16.0	AK	EL	 ch. 5F-D-000 001→
			7.08369.79.0	ATS	EL	 ch. 5F-D-000 001→
			7.08369.82.0	ATS	EL	 ch. 5F-D-000 001→
			7.11020.18.0	ATS	EL	 ch. 5F-D-000 001→ vor Katalysator in front of the catalyst
			7.11492.03.0	DDS		ohne Zubehör without accessories für OE-Nummer: 03L 906 051 B, 03L 906 051 D, 03N 906 051 B for OE number: 03L 906 051 B, 03L 906 051 D, 03N 906 051 B
1.6 TDI 81 kW (110 PS) CXXB	09.2013→		7.03608.16.0	AK	EL	 ch. 5F-D-000 001→
			7.08369.79.0	ATS	EL	 ch. 5F-D-000 001→
			7.08369.95.0	ATS	EL	 ch. 5F-D-000 001→
			7.11020.17.0	ATS	EL	 ch. 5F-D-000 001→ für OE-Nummer: 04L 906 088 BD for OE number: 04L 906 088 BD vor Katalysator in front of the catalyst
			7.11020.18.0	ATS	EL	 ch. 5F-D-000 001 → für OE-Nummer: 04L 906 088 K for OE number: 04L 906 088 K vor Katalysator in front of the catalyst
7.11492.03.0	DDS		ohne Zubehör without accessories für OE-Nummer: 03L 906 051 B, 03L 906 051 D, 03N 906 051 B for OE number: 03L 906 051 B, 03L 906 051 D, 03N 906 051 B			
1.6 TDI 81 kW (110 PS) DBKA	09.2013→		7.03608.16.0	AK	EL	 ch. 5F-D-000 001→
			7.08369.95.0	ATS	EL	 ch. 5F-D-000 001→
			7.11020.17.0	ATS	EL	für OE-Nummer: 04L 906 088 BD for OE number: 04L 906 088 BD vor Katalysator in front of the catalyst
7.11492.03.0	DDS		ohne Zubehör without accessories für OE-Nummer: 03L 906 051 B, 03L 906 051 D, 03N 906 051 B for OE number: 03L 906 051 B, 03L 906 051 D, 03N 906 051 B			
1.6 TDI 85 kW (115 PS) DDYA	11.2016→		7.08369.95.0	ATS	EL	 ch. 5F-D-000 001→ Euro 6b Euro 6b
			7.11020.17.0	ATS	EL	 ch. 5F-D-000 001→ für OE-Nummer: 04L 906 088 BD for OE number: 04L 906 088 BD vor Katalysator in front of the catalyst
			7.11020.18.0	ATS	EL	 ch. 5F-D-000 001→ für OE-Nummer: 04L 906 088 K for OE number: 04L 906 088 K vor Katalysator in front of the catalyst



					
LEON (5F1)					22
			7.11020.22.0 ATS 7.11020.23.0 ATS 7.11492.03.0 DDS 7.11492.05.0 DDS	EL EL EL EL	Euro 6c, Euro 6d-Temp Euro 6c, Euro 6d-Temp Euro 6c, Euro 6d-Temp Euro 6c, Euro 6d-Temp ohne Zubehör without accessories für OE-Nummer: 03L 906 051 B, 03L 906 051 D, 03N 906 051 B for OE number: 03L 906 051 B, 03L 906 051 D, 03N 906 051 B ohne Zubehör without accessories für OE-Nummer: 04L 906 051 AB, 04L 906 051 F, 04L 906 051 L for OE number: 04L 906 051 AB, 04L 906 051 F, 04L 906 051 L
1.6 TDI 85 kW (115 PS) DGTE	11.2016→		7.10334.02.0 AGR 7.08369.95.0 ATS 7.11020.17.0 ATS 7.11020.22.0 ATS 7.11020.23.0 ATS 7.11492.05.0 DDS	EL EL EL EL EL EL	 Euro 6, Euro 6b Euro 6, Euro 6b vor Katalysator in front of the catalyst Euro 6d-Temp Euro 6d-Temp Euro 6c, Euro 6d-Temp Euro 6c, Euro 6d-Temp Euro 6c, Euro 6d-Temp Euro 6c, Euro 6d-Temp ohne Zubehör without accessories für OE-Nummer: 04L 906 051 AB, 04L 906 051 F, 04L 906 051 L for OE number: 04L 906 051 AB, 04L 906 051 F, 04L 906 051 L
2.0 TDI 135 kW (184 PS) CUNA	09.2012→		7.03608.16.0 AK 7.08369.81.0 ATS 7.11492.03.0 DDS 7.11492.05.0 DDS	EL EL EL EL	 ch. 5F-D-000 001→  ch. 5F-D-000 001→ ohne Zubehör without accessories für OE-Nummer: 03L 906 051 B, 03L 906 051 D, 03N 906 051 B for OE number: 03L 906 051 B, 03L 906 051 D, 03N 906 051 B ohne Zubehör without accessories für OE-Nummer: 04L 906 051 AB, 04L 906 051 F, 04L 906 051 L for OE number: 04L 906 051 AB, 04L 906 051 F, 04L 906 051 L
2.0 TDI 135 kW (184 PS) CUPA	09.2012→		7.03608.16.0 AK 7.08369.81.0 ATS 7.11492.03.0 DDS	EL EL EL	 ch. 5F-D-000 001→  ch. 5F-D-000 001→ ohne Zubehör without accessories für OE-Nummer: 03L 906 051 B, 03L 906 051 D, 03N 906 051 B for OE number: 03L 906 051 B, 03L 906 051 D, 03N 906 051 B
2.0 TDI 135 kW (184 PS) DJGA	09.2012→		7.10334.02.0 AGR	EL	
2.0 TDI 110 kW (150 PS) CKFC	10.2012→		7.03608.16.0 AK 7.08369.81.0 ATS	EL EL	 ch. 5F-D-000 001→  ch. 5F-D-000 001→









LEON (5F1) **22**

























			7.11492.03.0	DDS		ohne Zubehör without accessories für OE-Nummer: 03L 906 051 B, 03L 906 051 D, 03N 906 051 B for OE number: 03L 906 051 B, 03L 906 051 D, 03N 906 051 B
2.0 TDI 110 kW (150 PS) CRMB	10.2012→		7.03608.16.0	AK	EL	 ch. 5F-D-000 001→
			7.08369.81.0	ATS	EL	 ch. 5F-D-000 001→
			7.11492.03.0	DDS		ohne Zubehör without accessories für OE-Nummer: 03L 906 051 B, 03L 906 051 D, 03N 906 051 B for OE number: 03L 906 051 B, 03L 906 051 D, 03N 906 051 B
			7.11492.05.0	DDS		ohne Zubehör without accessories für OE-Nummer: 04L 906 051 AB, 04L 906 051 F, 04L 906 051 L for OE number: 04L 906 051 AB, 04L 906 051 F, 04L 906 051 L
2.0 TDI 110 kW (150 PS) DFFA	10.2012→		7.10334.02.0	AGR	EL	
			7.08369.81.0	ATS	EL	für OE-Nummer: 04L 906 088 DQ, 04L 906 088 HT for OE number: 04L 906 088 DQ, 04L 906 088 HT
			7.11492.05.0	DDS		ohne Zubehör without accessories für OE-Nummer: 04L 906 051 AB, 04L 906 051 F, 04L 906 051 L for OE number: 04L 906 051 AB, 04L 906 051 F, 04L 906 051 L
			7.07696.00.0	SRM-AK	EL	
2.0 TDI 105 kW (143 PS) CRVC	05.2013→		7.10334.02.0	AGR	EL	
			7.03608.16.0	AK	EL	 ch. 5F-D-000 001→
			7.11492.05.0	DDS		ohne Zubehör without accessories für OE-Nummer: 04L 906 051 AB, 04L 906 051 F, 04L 906 051 L for OE number: 04L 906 051 AB, 04L 906 051 F, 04L 906 051 L
2.0 TDI 81 kW (110 PS) CRLD, CRVA	05.2013→		7.03608.16.0	AK	EL	 CRLD, CRVA:  ch. 5F-D-000 001→

S LEON (KL1) **23**

2.0 TDI 85 kW (116 PS) DSUD	11.2019→		7.11492.05.0	DDS		ohne Zubehör without accessories  ch. KL-L-000 001→
---------------------------------------	----------	---	---------------------	-----	--	--

LEON SC (5F5) **24**













1.6 TDI 66 kW (90 PS) CLHB	02.2013→08.2018		7.03608.16.0	AK	EL	 ch. 5F-D-000 001→
			7.08369.79.0	ATS	EL	 ch. 5F-D-000 001→
			7.11020.18.0	ATS	EL	 ch. 5F-D-000 001→ vor Katalysator in front of the catalyst
			7.11492.03.0	DDS		ohne Zubehör without accessories für OE-Nummer: 03L 906 051 B, 03L 906 051 D, 03N 906 051 B for OE number: 03L 906 051 B, 03L 906 051 D, 03N 906 051 B
1.6 TDI 66 kW (90 PS) CXXA	02.2013→08.2018		7.08369.95.0	ATS	EL	 ch. 5F-D-000 001→

					
LEON SC (5F5)					
			7.11020.17.0	ATS	EL  ch. 5F-D-000 001→ für OE-Nummer: 04L 906 088 BD für OE number: 04L 906 088 BD vor Katalysator in front of the catalyst
			7.11020.18.0	ATS	EL  ch. 5F-D-000 001→ für OE-Nummer: 04L 906 088 K für OE number: 04L 906 088 K vor Katalysator in front of the catalyst
			7.11492.03.0	DDS	ohne Zubehör without accessories für OE-Nummer: 03L 906 051 B, 03L 906 051 D, 03N 906 051 B für OE number: 03L 906 051 B, 03L 906 051 D, 03N 906 051 B
1.6 TDI 66 kW (90 PS) DDYB	02.2013→08.2018		7.08369.95.0	ATS	EL Euro 6 Euro 6
			7.11492.05.0	DDS	ohne Zubehör without accessories für OE-Nummer: 04L 906 051 AB, 04L 906 051 F, 04L 906 051 L für OE number: 04L 906 051 AB, 04L 906 051 F, 04L 906 051 L
1.6 TDI 77 kW (105 PS) CLHA	02.2013→08.2018		7.10334.02.0	AGR	EL  ch. 5F-D-000 001→
			7.03608.16.0	AK	EL  ch. 5F-D-000 001→
			7.08369.79.0	ATS	EL  ch. 5F-D-000 001→
			7.08369.82.0	ATS	EL  ch. 5F-D-000 001→ Euro 5 Euro 5
			7.11020.18.0	ATS	EL  ch. 5F-D-000 001→ vor Katalysator in front of the catalyst
			7.11492.03.0	DDS	ohne Zubehör without accessories für OE-Nummer: 03L 906 051 B, 03L 906 051 D, 03N 906 051 B für OE number: 03L 906 051 B, 03L 906 051 D, 03N 906 051 B
			7.11492.05.0	DDS	ohne Zubehör without accessories für OE-Nummer: 04L 906 051 AB, 04L 906 051 F, 04L 906 051 L für OE number: 04L 906 051 AB, 04L 906 051 F, 04L 906 051 L
1.6 TDI 81 kW (110 PS) CRKB	09.2013→11.2016		7.10334.02.0	AGR	EL  ch. 5F-D-000 001→
			7.08369.79.0	ATS	EL  ch. 5F-D-000 001→
			7.08369.82.0	ATS	EL  ch. 5F-D-000 001→
			7.11020.18.0	ATS	EL  ch. 5F-D-000 001→ vor Katalysator in front of the catalyst
			7.11492.03.0	DDS	ohne Zubehör without accessories für OE-Nummer: 03L 906 051 B, 03L 906 051 D, 03N 906 051 B für OE number: 03L 906 051 B, 03L 906 051 D, 03N 906 051 B
1.6 TDI 81 kW (110 PS) CXXB	09.2013→11.2016		7.11020.18.0	ATS	EL  ch. 04L 906 088 K→ für OE-Nummer: 04L 906 088 K für OE number: 04L 906 088 K vor Katalysator in front of the catalyst
			7.08369.79.0	ATS	EL  ch. 5F-D-000 001→
			7.08369.95.0	ATS	EL  ch. 5F-D-000 001→























24
S



LEON SC (5F5) **24**



















			7.11020.17.0	ATS	EL	 ch. 5F-D-000 001→ für OE-Nummer: 04L 906 088 BD for OE number: 04L 906 088 BD vor Katalysator in front of the catalyst
			7.11492.03.0	DDS		ohne Zubehör without accessories für OE-Nummer: 03L 906 051 B, 03L 906 051 D, 03N 906 051 B for OE number: 03L 906 051 B, 03L 906 051 D, 03N 906 051 B
1.6 TDI 85 kW (115 PS) DDYA	11.2016→08.2018		7.10334.02.0	AGR	EL	
			7.08369.95.0	ATS	EL	 ch. 5F-D-000 001→ Euro 6b Euro 6b
			7.11020.17.0	ATS	EL	 ch. 5F-D-000 001→ für OE-Nummer: 04L 906 088 BD for OE number: 04L 906 088 BD vor Katalysator in front of the catalyst
			7.11020.18.0	ATS	EL	 ch. 5F-D-000 001→ für OE-Nummer: 04L 906 088 K for OE number: 04L 906 088 K vor Katalysator in front of the catalyst
			7.11020.22.0	ATS	EL	Euro 6c, Euro 6d-Temp Euro 6c, Euro 6d-Temp
			7.11020.23.0	ATS	EL	Euro 6c, Euro 6d-Temp Euro 6c, Euro 6d-Temp
			7.11492.03.0	DDS		ohne Zubehör without accessories für OE-Nummer: 03L 906 051 B, 03L 906 051 D, 03N 906 051 B for OE number: 03L 906 051 B, 03L 906 051 D, 03N 906 051 B
			7.11492.05.0	DDS		ohne Zubehör without accessories für OE-Nummer: 04L 906 051 AB, 04L 906 051 F, 04L 906 051 L for OE number: 04L 906 051 AB, 04L 906 051 F, 04L 906 051 L
2.0 TDI 110 kW (150 PS) CKFC	02.2013→		7.10334.02.0	AGR	EL	
			7.03608.16.0	AK	EL	 ch. 5F-D-000 001→
			7.08369.81.0	ATS	EL	 ch. 5F-D-000 001→
			7.11492.03.0	DDS		ohne Zubehör without accessories für OE-Nummer: 03L 906 051 B, 03L 906 051 D, 03N 906 051 B for OE number: 03L 906 051 B, 03L 906 051 D, 03N 906 051 B
2.0 TDI 110 kW (150 PS) CRMB	02.2013→		7.10334.02.0	AGR	EL	
			7.08369.81.0	ATS	EL	 ch. 5F-D-000 001→
			7.11492.03.0	DDS		ohne Zubehör without accessories für OE-Nummer: 03L 906 051 B, 03L 906 051 D, 03N 906 051 B for OE number: 03L 906 051 B, 03L 906 051 D, 03N 906 051 B















S

 				
LEON SC (5F5)				24
		7.11492.05.0	DDS	ohne Zubehör without accessories für OE-Nummer: 04L 906 051 AB, 04L 906 051 F, 04L 906 051 L for OE number: 04L 906 051 AB, 04L 906 051 F, 04L 906 051 L
2.0 TDI 135 kW (184 PS) CUNA	03.2013→		7.10334.02.0 AGR EL  ch. 5F-D-000 001→	
			7.03608.16.0 AK EL	
			7.08369.81.0 ATS EL  ch. 5F-D-000 001→	
			7.11492.03.0 DDS 7.11492.05.0 DDS ohne Zubehör without accessories für OE-Nummer: 03L 906 051 B, 03L 906 051 D, 03N 906 051 B for OE number: 03L 906 051 B, 03L 906 051 D, 03N 906 051 B ohne Zubehör without accessories für OE-Nummer: 04L 906 051 AB, 04L 906 051 F, 04L 906 051 L for OE number: 04L 906 051 AB, 04L 906 051 F, 04L 906 051 L	
2.0 TDI 135 kW (184 PS) CUPA	03.2013→		7.10334.02.0 AGR EL  ch. 5F-D-000 001→	
			7.03608.16.0 AK EL	
			7.08369.81.0 ATS EL  ch. 5F-D-000 001→	
			7.11492.03.0 DDS ohne Zubehör without accessories für OE-Nummer: 03L 906 051 B, 03L 906 051 D, 03N 906 051 B for OE number: 03L 906 051 B, 03L 906 051 D, 03N 906 051 B	
2.0 TDI 105 kW (143 PS) CRVC	05.2013→		7.10334.02.0 AGR EL 	
			7.03608.16.0 AK EL	
			7.11492.05.0 DDS ohne Zubehör without accessories für OE-Nummer: 04L 906 051 AB, 04L 906 051 F, 04L 906 051 L for OE number: 04L 906 051 AB, 04L 906 051 F, 04L 906 051 L	
LEON ST (5F8)				25
1.6 TDI 81 kW (110 PS) CRKB	09.2013→		7.08369.82.0 ATS EL  ch. 5F-D-000 001→	
			7.11020.18.0 ATS EL  ch. 5F-D-000 001→ vor Katalysator in front of the catalyst	
			7.08369.79.0 ATS EL  ch. 5F-D-000 001→	
			7.11492.03.0 DDS ohne Zubehör without accessories für OE-Nummer: 03L 906 051 B, 03L 906 051 D, 03N 906 051 B for OE number: 03L 906 051 B, 03L 906 051 D, 03N 906 051 B	
1.6 TDI 81 kW (110 PS) CXXB	09.2013→		7.08369.79.0 ATS EL  ch. 5F-D-000 001→	
			7.08369.95.0 ATS EL  ch. 5F-D-000 001→	
			7.11020.17.0 ATS EL  ch. 5F-D-000 001→ für OE-Nummer: 04L 906 088 BD for OE number: 04L 906 088 BD vor Katalysator in front of the catalyst	



LEON ST (5F8) **25**













			7.11020.18.0	ATS	EL	 ch. 5F-D-000 001→ für OE-Nummer: 04L 906 088 K for OE number: 04L 906 088 K vor Katalysator in front of the catalyst
			7.11492.03.0	DDS		ohne Zubehör without accessories für OE-Nummer: 03L 906 051 B, 03L 906 051 D, 03N 906 051 B for OE number: 03L 906 051 B, 03L 906 051 D, 03N 906 051 B
1.6 TDI 81 kW (110 PS) DBKA	09.2013→		7.08369.95.0	ATS	EL	 ch. 5F-D-000 001→
			7.11020.17.0	ATS	EL	 ch. 5F-D-000 001→ für OE-Nummer: 04L 906 088 BD for OE number: 04L 906 088 BD vor Katalysator in front of the catalyst
			7.11020.18.0	ATS	EL	 ch. 5F-D-000 001→ für OE-Nummer: 04L 906 088 K for OE number: 04L 906 088 K vor Katalysator in front of the catalyst
			7.11492.03.0	DDS		ohne Zubehör without accessories für OE-Nummer: 03L 906 051 B, 03L 906 051 D, 03N 906 051 B for OE number: 03L 906 051 B, 03L 906 051 D, 03N 906 051 B
1.6 TDI 77 kW (105 PS) CLHA	10.2013→		7.10334.02.0	AGR	EL	
			7.03608.16.0	AK	EL	 ch. 5F-D-000 001→
			7.08369.82.0	ATS	EL	 ch. 5F-D-000 001→ Euro 5 Euro 5
			7.11020.18.0	ATS	EL	 ch. 5F-D-000 001→ vor Katalysator in front of the catalyst
			7.08369.79.0	ATS	EL	 ch. 5F-D-000 001→
			7.11492.03.0	DDS		ohne Zubehör without accessories für OE-Nummer: 03L 906 051 B, 03L 906 051 D, 03N 906 051 B for OE number: 03L 906 051 B, 03L 906 051 D, 03N 906 051 B
1.6 TDI 66 kW (90 PS) CLHB	11.2013→		7.11492.05.0	DDS		ohne Zubehör without accessories für OE-Nummer: 04L 906 051 AB, 04L 906 051 F, 04L 906 051 L for OE number: 04L 906 051 AB, 04L 906 051 F, 04L 906 051 L
			7.03608.16.0	AK	EL	 ch. 5F-D-000 001→
			7.08369.79.0	ATS	EL	 ch. 5F-D-000 001→
			7.11020.18.0	ATS	EL	 ch. 5F-D-000 001→ vor Katalysator in front of the catalyst
1.6 TDI 66 kW (90 PS) CXXA	11.2013→		7.11492.03.0	DDS		ohne Zubehör without accessories für OE-Nummer: 03L 906 051 B, 03L 906 051 D, 03N 906 051 B for OE number: 03L 906 051 B, 03L 906 051 D, 03N 906 051 B
			7.10334.02.0	AGR	EL	
			7.08369.95.0	ATS	EL	 ch. 5F-D-000 001→

					
LEON ST (5F8)					25
			7.11020.17.0	ATS	EL  ch. 5F-D-000 001→ für OE-Nummer: 04L 906 088 BD for OE number: 04L 906 088 BD
			7.11020.18.0	ATS	EL  ch. 5F-D-000 001→ für OE-Nummer: 04L 906 088 K for OE number: 04L 906 088 K vor Katalysator in front of the catalyst
			7.11492.03.0	DDS	ohne Zubehör without accessories für OE-Nummer: 03L 906 051 B, 03L 906 051 D, 03N 906 051 B for OE number: 03L 906 051 B, 03L 906 051 D, 03N 906 051 B
1.6 TDI 66 kW (90 PS) DDYB	11.2013→		7.10334.02.0	AGR	EL 
			7.08369.95.0	ATS	EL Euro 6 Euro 6
			7.11492.05.0	DDS	ohne Zubehör without accessories für OE-Nummer: 04L 906 051 AB, 04L 906 051 F, 04L 906 051 L for OE number: 04L 906 051 AB, 04L 906 051 F, 04L 906 051 L
1.6 TDI 85 kW (115 PS) DDYA	11.2016→		7.08369.95.0	ATS	EL  ch. 5F-D-000 001→ Euro 6b Euro 6b
			7.11020.17.0	ATS	EL  ch. 5F-D-000 001→ für OE-Nummer: 04L 906 088 BD for OE number: 04L 906 088 BD
			7.11020.18.0	ATS	EL  ch. 5F-D-000 001→ für OE-Nummer: 04L 906 088 K for OE number: 04L 906 088 K vor Katalysator in front of the catalyst
			7.11020.22.0	ATS	EL Euro 6c, Euro 6d-Temp Euro 6c, Euro 6d-Temp
			7.11020.23.0	ATS	EL Euro 6c, Euro 6d-Temp Euro 6c, Euro 6d-Temp
			7.11492.03.0	DDS	ohne Zubehör without accessories für OE-Nummer: 03L 906 051 B, 03L 906 051 D, 03N 906 051 B for OE number: 03L 906 051 B, 03L 906 051 D, 03N 906 051 B
			7.11492.05.0	DDS	ohne Zubehör without accessories für OE-Nummer: 04L 906 051 AB, 04L 906 051 F, 04L 906 051 L for OE number: 04L 906 051 AB, 04L 906 051 F, 04L 906 051 L
1.6 TDI 85 kW (115 PS) DGTE	11.2016→		7.08369.95.0	ATS	EL Euro 6, Euro 6b Euro 6, Euro 6b
			7.11020.17.0	ATS	EL vor Katalysator in front of the catalyst Euro 6d-Temp Euro 6d-Temp
			7.11020.22.0	ATS	EL Euro 6c, Euro 6d-Temp Euro 6c, Euro 6d-Temp
			7.11020.23.0	ATS	EL Euro 6c, Euro 6d-Temp Euro 6c, Euro 6d-Temp
			7.11492.05.0	DDS	ohne Zubehör without accessories für OE-Nummer: 04L 906 051 AB, 04L 906 051 F, 04L 906 051 L for OE number: 04L 906 051 AB, 04L 906 051 F, 04L 906 051 L

S



LEON ST (5F8) **25**

1.6 TDI 4Drive 77 kW (105 PS) CLHA	04.2014→		7.03608.16.0	AK	EL  ch. 5F-D-000 001→
			7.08369.82.0	ATS	EL  ch. 5F-D-000 001→ Euro 5 Euro 5
			7.11020.18.0	ATS	EL  ch. 5F-D-000 001→ vor Katalysator in front of the catalyst
			7.08369.79.0 7.11492.03.0	ATS DDS	EL  ch. 5F-D-000 001 → ohne Zubehör without accessories für OE-Nummer: 03L 906 051 B, 03L 906 051 D, 03N 906 051 B for OE number: 03L 906 051 B, 03L 906 051 D, 03N 906 051 B
			7.11492.05.0	DDS	ohne Zubehör without accessories für OE-Nummer: 04L 906 051 AB, 04L 906 051 F, 04L 906 051 L for OE number: 04L 906 051 AB, 04L 906 051 F, 04L 906 051 L
1.6 TDI 4Drive 81 kW (110 PS) CXXB	11.2014→		7.08369.79.0	ATS	EL  ch. 5F-D-000 001→
			7.08369.95.0	ATS	EL  ch. 5F-D-000 001→
			7.11020.17.0	ATS	EL  ch. 5F-D-000 001→ für OE-Nummer: 04L 906 088 BD for OE number: 04L 906 088 BD vor Katalysator in front of the catalyst
			7.11020.18.0	ATS	EL  ch. 5F-D-000 001→ für OE-Nummer: 04L 906 088 K for OE number: 04L 906 088 K vor Katalysator in front of the catalyst
1.6 TDI 4Drive 85 kW (115 PS) DGTE	07.2018→		7.08369.95.0	ATS	EL Euro 6, Euro 6b Euro 6, Euro 6b
			7.11020.17.0	ATS	EL vor Katalysator in front of the catalyst Euro 6d-Temp Euro 6d-Temp
			7.11020.22.0	ATS	EL Euro 6c, Euro 6d-Temp Euro 6c, Euro 6d-Temp
			7.11020.23.0	ATS	EL Euro 6c, Euro 6d-Temp Euro 6c, Euro 6d-Temp
2.0 TDI 135 kW (184 PS) CUNA	08.2013→		7.03608.16.0	AK	EL
			7.08369.81.0 7.11492.03.0	ATS DDS	EL  ch. 5F-D-000 001→ ohne Zubehör without accessories für OE-Nummer: 03L 906 051 B, 03L 906 051 D, 03N 906 051 B for OE number: 03L 906 051 B, 03L 906 051 D, 03N 906 051 B
			7.11492.05.0	DDS	ohne Zubehör without accessories für OE-Nummer: 04L 906 051 AB, 04L 906 051 F, 04L 906 051 L for OE number: 04L 906 051 AB, 04L 906 051 F, 04L 906 051 L

LEON ST (5F8)					
25					
2.0 TDI 135 kW (184 PS) CUPA	08.2013→		7.03608.16.0	AK	EL
			7.08369.81.0	ATS	EL
			7.11492.03.0	DDS	EL ch. 5F-D-000 001→ ohne Zubehör without accessories für OE-Nummer: 03L 906 051 B, 03L 906 051 D, 03N 906 051 B for OE number: 03L 906 051 B, 03L 906 051 D, 03N 906 051 B
2.0 TDI 135 kW (184 PS) DJGA	08.2013→		7.10334.02.0	AGR	EL
2.0 TDI 110 kW (150 PS) CKFC	10.2013→		7.03608.16.0	AK	EL ch. 5F-D-000 001→
			7.08369.81.0	ATS	EL ch. 5F-D-000 001→
			7.11492.03.0	DDS	EL ohne Zubehör without accessories für OE-Nummer: 03L 906 051 B, 03L 906 051 D, 03N 906 051 B for OE number: 03L 906 051 B, 03L 906 051 D, 03N 906 051 B
2.0 TDI 110 kW (150 PS) CRBC	10.2013→		7.10334.02.0	AGR	EL ch. 5F-D-000 001→
			7.11492.03.0	DDS	EL ohne Zubehör without accessories für OE-Nummer: 03L 906 051 B, 03L 906 051 D, 03N 906 051 B for OE number: 03L 906 051 B, 03L 906 051 D, 03N 906 051 B
2.0 TDI 110 kW (150 PS) CRLB	10.2013→		7.10334.02.0	AGR	EL
			7.03608.16.0	AK	EL CRLB: ch. 5F-D-000 001→
			7.08369.81.0	ATS	EL CRLB: ch. 5F-D-000 001→
			7.11492.03.0	DDS	EL ch. 5F-D-000 001→
			7.11492.05.0	DDS	EL ohne Zubehör without accessories für OE-Nummer: 03L 906 051 D, 03L 906 051 B, 03N 906 051 B for OE number: 03L 906 051 D, 03L 906 051 B, 03N 906 051 B ohne Zubehör without accessories für OE-Nummer: 04L 906 051 AB, 04L 906 051 F, 04L 906 051 L for OE number: 04L 906 051 AB, 04L 906 051 F, 04L 906 051 L
2.0 TDI 110 kW (150 PS) CRMB	10.2013→		7.08369.81.0	ATS	EL ch. 5F-D-000 001→
			7.11492.03.0	DDS	EL ohne Zubehör without accessories für OE-Nummer: 03L 906 051 B, 03L 906 051 D, 03N 906 051 B for OE number: 03L 906 051 B, 03L 906 051 D, 03N 906 051 B
			7.11492.05.0	DDS	EL ohne Zubehör without accessories für OE-Nummer: 04L 906 051 AB, 04L 906 051 F, 04L 906 051 L for OE number: 04L 906 051 AB, 04L 906 051 F, 04L 906 051 L
2.0 TDI 110 kW (150 PS) DFFA, DFGA	10.2013→		7.08369.81.0	ATS	EL DFFA, DFGA: für OE-Nummer: 04L 906 088 DQ, 04L 906 088 HT for OE number: 04L 906 088 DQ, 04L 906 088 HT



LEON ST (5F8)

25

			7.11492.05.0	DDS		ohne Zubehör without accessories  DFFA, DFGA: für OE-Nummer: 04L 906 051 AB, 04L 906 051 F, 04L 906 051 L for OE number: 04L 906 051 AB, 04L 906 051 F, 04L 906 051 L
			7.07696.00.0	SRM-AK	EL	
2.0 TDI 105 kW (143 PS) CRVC	10.2013→		7.03608.16.0	AK	EL	
			7.11492.05.0	DDS		ohne Zubehör without accessories für OE-Nummer: 04L 906 051 AB, 04L 906 051 F, 04L 906 051 L for OE number: 04L 906 051 AB, 04L 906 051 F, 04L 906 051 L
2.0 TDI 81 kW (110 PS) CRVA	11.2013→		7.03608.16.0	AK	EL	
2.0 TDI 4Drive 110 kW (150 PS) CRBC	04.2014→		7.11492.03.0	DDS		ohne Zubehör without accessories für OE-Nummer: 03L 906 051 B, 03L 906 051 D, 03N 906 051 B for OE number: 03L 906 051 B, 03L 906 051 D, 03N 906 051 B
2.0 TDI 4Drive 110 kW (150 PS) CRLB	04.2014→		7.03608.16.0	AK	EL	
			7.08369.81.0	ATS	EL	 ch. 5F-D-000 001→
			7.11492.03.0	DDS		ohne Zubehör without accessories für OE-Nummer: 03L 906 051 B, 03L 906 051 D, 03N 906 051 B for OE number: 03L 906 051 B, 03L 906 051 D, 03N 906 051 B
			7.11492.05.0	DDS		ohne Zubehör without accessories für OE-Nummer: 04L 906 051 AB, 04L 906 051 F, 04L 906 051 L for OE number: 04L 906 051 AB, 04L 906 051 F, 04L 906 051 L
2.0 TDI 4Drive 110 kW (150 PS) CRMB	04.2014→		7.08369.81.0	ATS	EL	 ch. 5F-D-000 001→
			7.11492.03.0	DDS		ohne Zubehör without accessories für OE-Nummer: 03L 906 051 B, 03L 906 051 D, 03N 906 051 B for OE number: 03L 906 051 B, 03L 906 051 D, 03N 906 051 B
			7.11492.05.0	DDS		ohne Zubehör without accessories für OE-Nummer: 04L 906 051 AB, 04L 906 051 F, 04L 906 051 L for OE number: 04L 906 051 AB, 04L 906 051 F, 04L 906 051 L
2.0 TDI 4Drive 110 kW (150 PS) DCYA	04.2014→		7.08369.81.0	ATS	EL	für OE-Nummer: 04L 906 088 DQ, 04L 906 088 HT for OE number: 04L 906 088 DQ, 04L 906 088 HT
			7.11492.05.0	DDS		ohne Zubehör without accessories für OE-Nummer: 04L 906 051 AB, 04L 906 051 F, 04L 906 051 L for OE number: 04L 906 051 AB, 04L 906 051 F, 04L 906 051 L
2.0 TDI 4Drive 110 kW (150 PS) DFGA	04.2014→		7.08369.81.0	ATS	EL	für OE-Nummer: 04L 906 088 DQ, 04L 906 088 HT for OE number: 04L 906 088 DQ, 04L 906 088 HT































S

LEON ST (5F8)					25
			7.11492.05.0	DDS	ohne Zubehör without accessories für OE-Nummer: 04L 906 051 AB, 04L 906 051 F, 04L 906 051 L for OE number: 04L 906 051 AB, 04L 906 051 F, 04L 906 051 L
			7.07696.00.0	SRM-AK	EL
2.0 TDI 4Drive 135 kW (184 PS) CUNA	11.2014→		7.03608.16.0	AK	EL
			7.08369.81.0	ATS	EL ch. 5F-D-000 001→
			7.11492.03.0	DDS	ohne Zubehör without accessories für OE-Nummer: 03L 906 051 B, 03L 906 051 D, 03N 906 051 B for OE number: 03L 906 051 B, 03L 906 051 D, 03N 906 051 B
			7.11492.05.0	DDS	ohne Zubehör without accessories für OE-Nummer: 04L 906 051 AB, 04L 906 051 F, 04L 906 051 L for OE number: 04L 906 051 AB, 04L 906 051 F, 04L 906 051 L
TARRACO (KN2)					26
2.0 TDI 110 kW (150 PS) DFGA	09.2018→		7.08369.81.0	ATS	EL
			7.07696.00.0	SRM-AK	EL
2.0 TDI 4Drive 110 kW (150 PS) DFGA	09.2018→		7.08369.81.0	ATS	EL
			7.07696.00.0	SRM-AK	EL
2.0 TDI 4Drive 140 kW (190 PS) DFHA	09.2018→		7.10334.02.0	AGR	EL
			7.11020.26.0	ATS	EL
			7.07696.00.0	SRM-AK	EL
TOLEDO I (1L2)					27
2.0 i 85 kW (115 PS) 2E	05.1991→06.1996		7.05270.86.0	LS	625 mm ch. 1L-ZD320 001→ch. 1L-ZR020 000
			7.02604.03.0	LS	200 mm
2.0 i 85 kW (115 PS) AGG	03.1996→03.1999		7.02604.03.0	LS	200 mm
2.0 i 16V 110 kW (150 PS) ABF	11.1993→03.1999		7.05270.86.0	LS	625 mm
			7.02604.04.0	LS	200 mm
TOLEDO II (1M2)					28
1.4 16V 55 kW (75 PS) AHW	01.2000→05.2002		7.05271.03.0	LS	730 mm Regelsonde Regulating Probe
1.4 16V 55 kW (75 PS) AXP	01.2000→05.2002		7.22785.17.0	AGR	EL ch. 1M-X-000 001→ch. 1M-x-025 000
			7.28248.17.0	AGR	EL
			7.05271.24.0	LS	1500 mm vor Katalysator in front of the catalyst
1.4 16V 55 kW (75 PS) BCA	01.2000→05.2002		7.28248.17.0	AGR	EL
			7.05271.24.0	LS	1500 mm vor Katalysator in front of the catalyst
1.6 74-76 kW (101-103 PS) AEH, AKL	10.1998→07.2004		7.05271.21.0	LS	1250 mm AEH, AKL: Regelsonde Regulating Probe

S



TOLEDO II (1M2) **28**

1.6 16V 77 kW (105 PS) AUS	06.2000→05.2006	 7.22785.17.0	AGR	EL	 ch. 1M-X-000 001→ch. 1M-X-025 000
1.6 16V 77 kW (105 PS) AZD	06.2000→05.2006	 7.22785.17.0	AGR	EL	 →04.2001,  ch. 1M-X-000 001→ch. 1M-X-025 000
		7.28248.17.0	AGR	EL	 05.2001→
1.6 16V 77 kW (105 PS) BCB	06.2000→05.2006	 7.28248.17.0	AGR	EL	
1.8 20V 92 kW (125 PS) AGN	10.1998→07.2004	 7.05271.03.0	LS	730 mm	
1.8 20V 92 kW (125 PS) APG	05.1999→07.2004	 7.22785.18.0	AGR	EL	
		7.22286.26.0	ARV	PN	 ch. 1M-X-000 001→ch. 1M-X-025 000
		7.05271.23.0	LS	900 mm	
		7.22738.08.0	SLP	EL	 ch. 1M-X-000 001→ch. 1M-X-025 000
1.8 20VT 132 kW (180 PS) APP, ARY	09.2000→07.2004	 7.22769.73.0	ARV	PN	
		7.05271.23.0	LS	900 mm	
		7.21851.31.0	SLP	EL	
1.8 20VT 132 kW (180 PS) AUQ	09.2000→07.2004	 7.22769.73.0	ARV	PN	
		7.05271.23.0	LS	900 mm	
		7.05271.24.0	LS	1500 mm	für OE-Nummer: 021 906 262 B for OE number: 021 906 262 B vor Katalysator in front of the catalyst
		7.21851.31.0	SLP	EL	
1.9 TDI 81 kW (110 PS) AHF, ASV	10.1998→07.2004	 7.24809.17.0	AGR	PN	
1.9 TDI 66 kW (90 PS) AGR, ALH	03.1999→07.2004	 7.24809.17.0	AGR	PN	
1.9 TDI 110 kW (150 PS) ARL	10.2000→07.2004	 7.24809.26.0	AGR	PN	
S 1.9 TDI 96-112 kW (130-152 PS) ASZ	05.2003→05.2006	 7.24809.26.0	AGR	PN	
1.9 TDI 74 kW (100 PS) AXR	08.2005→05.2006	 7.24809.16.0	AGR	PN	
1.9 TDI 4Drive 110 kW (150 PS) ARL	10.2000→10.2005	 7.24809.26.0	AGR	PN	
2.3 V5 110 kW (150 PS) AGZ	10.1998→11.2000	 7.22286.55.0	ARV	PN	 Fahrgestellnummer ab: 1M-X-000 001 Vehicle Identification Number from: 1M-X-000 001 Fahrgestellnummer bis: 1M-X-025 000 Vehicle Identification Number to: 1M-X-025 000
		7.05271.03.0	LS	730 mm	

TOLEDO II (1M2)
28

2.3 V5 20V 125 kW (170 PS) AQN	09.2000→11.2003		7.22286.55.0	ARV	PN	<p>Fahrgestellnummer ab: 1M-X-000 001 Vehicle Identification Number from: 1M-X-000 001 Fahrgestellnummer bis: 1M-X-025 000 Vehicle Identification Number to: 1M-X-025 000</p>
			7.05270.89.0	LS	925 mm	
			7.05271.23.0	LS	900 mm	
			7.22738.08.0	SLP	EL	
2.8 150 kW (204 PS) AUE	10.2000→07.2001		7.22286.55.0	ARV	PN	<p>Fahrgestellnummer ab: 1M-X-000 001 Vehicle Identification Number from: 1M-X-000 001 Fahrgestellnummer bis: 1M-X-025 000 Vehicle Identification Number to: 1M-X-025 000</p> <p>nach Katalysator, rechts Post-catalyst, Right</p> <p>für OE-Nummer: 022 906 262 H, 022 906 262 J for OE number: 022 906 262 H, 022 906 262 J vor Katalysator in front of the catalyst</p>
			7.05270.98.0	LS	700 mm	
			7.05271.24.0	LS	1500 mm	
			7.22738.08.0	SLP	EL	























TOLEDO III (5P2)
29

1.4 16V 63 kW (86 PS) BXW	05.2006→05.2009		7.05271.18.0	LS	525 mm	
1.4 TSI 92 kW (125 PS) CAXC	11.2007→05.2009		7.05271.18.0	LS	525 mm	
1.6 75 kW (102 PS) BGU	10.2004→05.2009		7.22574.12.0	AGR	EL	
			7.05271.18.0	LS	525 mm	
			7.02604.01.0	LS	200 mm	
			7.22738.08.0	SLP	EL	
1.6 75 kW (102 PS) BSE, CCSA	10.2004→05.2009		7.05271.18.0	LS	525 mm	
			7.02604.01.0	LS	200 mm	
			7.22738.08.0	SLP	EL	
			7.22778.96.0	SLV	PN	
1.6 75 kW (102 PS) BSF	10.2004→05.2009		7.05271.18.0	LS	525 mm	
			7.02604.01.0	LS	200 mm	
1.8 TFSI 118 kW (160 PS) BZB	01.2007→05.2009		7.05271.19.0	LS	975 mm	→ ch. 5P-8-070 000 Regelsonde Regulating Probe ch. 5P-8-070 001 → Regelsonde Regulating Probe
			7.05271.11.0	LS	800 mm	
1.9 TDI 77 kW (105 PS) BJB	10.2004→05.2009		7.24809.32.0	AGR	PN	
1.9 TDI 77 kW (105 PS) BKC, BXE	10.2004→05.2009		7.24809.16.0	AGR	PN	
1.9 TDI 77 kW (105 PS) BLS	10.2004→05.2009		7.00678.04.0*	AGR-M	EL	mit Rohrstützen with pipe socket



S



TOLEDO III (5P2) **29**

			↳ 7.00907.03.0 7.00678.06.0 7.08369.00.0 7.08369.02.0 7.08369.03.0 7.11492.02.0 7.11190.02.0	AGR AGR-M ATS ATS ATS DDS DDS	EL EL EL EL EL EL	ohne Zubehör without accessories  ch. 5P-7-014 001→  →ch. 5P-7-014 000
2.0 FSI 110 kW (150 PS) BLR, BVY	10.2004→05.2009		7.10334.09.0 7.05271.29.0 7.05271.16.0	AGR LS LS	EL 900 mm 1300 mm	  BLR, BVY: rechts Right  BLR, BVY: hinten, links, rechts Rear, Left, Right Diagnosesonde Diagnostic Probe
2.0 FSI 110 kW (150 PS) BLY, BVZ	10.2004→05.2009		7.10334.09.0 7.05271.16.0	AGR LS	EL 1300 mm	  BLY, BVZ: hinten Rear Diagnosesonde Diagnostic Probe
2.0 TDI 100 kW (136 PS) AZV	09.2004→05.2009		7.24809.16.0	AGR	PN	
2.0 TDI 103 kW (140 PS) BMM	11.2005→05.2009		7.00678.04.0* ↳ 7.00907.03.0 7.00678.06.0 7.08369.00.0 7.08369.02.0 7.08369.03.0 7.11492.02.0 7.11190.02.0	AGR-M AGR AGR-M ATS ATS ATS DDS DDS	EL EL EL EL EL EL	mit Rohrstützen with pipe socket ohne Zubehör without accessories  ch. 5P-7-014 001→  →ch. 5P-7-014 000
2.0 TDI 125 kW (170 PS) BMN	01.2006→05.2009		7.10334.00.0 7.08369.00.0 7.08369.02.0 7.08369.03.0 7.11492.02.0 7.11190.02.0	AGR ATS ATS ATS DDS DDS	EL EL EL EL EL	ohne Zubehör without accessories  ch. 5P-7-014 001→  →ch. 5P-7-014 000
2.0 TDI 125 kW (170 PS) CEGA	01.2006→05.2009		7.10334.00.0	AGR	EL	
2.0 TDI 16V 103 kW (140 PS) BKD	04.2004→05.2009		7.24809.16.0	AGR	PN	
2.0 TFSI 147 kW (200 PS) BWA	11.2005→05.2009		7.05271.15.0	LS	525 mm	

TOLEDO IV (KG3) **30**

1.6 TDI 77 kW (105 PS) CAYC	07.2012→06.2015		7.09720.01.0 7.08369.09.0 7.08369.11.0 7.08369.26.0 7.11190.09.0	AGR-K ATS ATS ATS DDS	EL EL EL EL	 für Linkslenker for left-hand drive vehicles für Rechtslenker for right-hand drive vehicles
---------------------------------------	-----------------	---	---	---------------------------------------	--------------------------	---



















TOLEDO IV (KG3)					30
1.6 TDI 77 kW (105 PS) CLNA	07.2012→06.2015		7.09720.01.0	AGR-K	EL
			7.08369.09.0	ATS	EL für Linkslenker for left-hand drive vehicles
			7.11190.09.0	DDS	
1.6 TDI 66 kW (90 PS) CAYB	06.2013→06.2015		7.09720.01.0	AGR-K	EL
			7.08369.09.0	ATS	EL für Linkslenker for left-hand drive vehicles
			7.08369.11.0	ATS	EL für Rechtslenker for right-hand drive vehicles
			7.08369.26.0	ATS	EL
			7.11190.09.0	DDS	
ALHAMBRA VAN (7V8, 7V9)					31
2.0 85 kW (115 PS) ATM	06.2000→03.2010		7.22778.80.0	SLV	PN
IBIZA IV Hatchback Van (6J1)					32
1.2 TDI 55 kW (75 PS) CFWA	05.2010→05.2015		7.08369.11.0	ATS	EL Fahrgestellnummer ab: 6J-9-000 001 Vehicle Identification Number from: 6J-9-000 001 für Rechtslenker for right-hand drive vehicles
			7.08369.37.0	ATS	EL Fahrgestellnummer ab: 6J-9-000 001 Vehicle Identification Number from: 6J-9-000 001 nach Rußpartikelfilter after soot particulate filter
1.6 TDI 66 kW (90 PS) CAYB	05.2009→05.2015		7.09720.01.0	AGR-K	EL
			7.08369.26.0	ATS	EL ch. 6J-9-000 001→
			7.08369.09.0	ATS	EL ch. 6J-9-000 001→
			7.08369.11.0	ATS	EL Fahrgestellnummer ab: 6J-9-000 001 Vehicle Identification Number from: 6J-9-000 001 für Linkslenker for left-hand drive vehicles
			7.11190.09.0	DDS	EL Fahrgestellnummer ab: 6J-9-000 001 Vehicle Identification Number from: 6J-9-000 001 für Rechtslenker for right-hand drive vehicles ch. 6J-9-000 001→
INCA (6K9)					33
1.4 16V 55 kW (75 PS) AUA	04.2000→06.2003		7.28248.17.0	AGR	EL
			7.22785.17.0	AGR	EL
1.4 i 44 kW (60 PS) AEX, AKV, APQ	05.1997→06.2003		7.05270.88.0	LS	740 mm AEX, AKV, APQ: ch. 9K-V-015 501→ch. 9K-X-010 000
			7.05271.03.0	LS	730 mm AEX, AKV, APQ: ch. 9K-X-010 001→ Regelsonde Regulating Probe
1.4 i 44 kW (60 PS) AUD	09.2000→06.2003		7.05271.01.0	LS	950 mm ch. 9K-1-010 201→ch. 9K-3-001 200 Diagnosesonde Diagnostic Probe
			7.05271.77.0	LS	800 mm vor Katalysator in front of the catalyst
			7.05271.02.0	LS	500 mm ch. 9K-3-001 201→ Regelsonde Regulating Probe



INCA (6K9) 33















		7.05271.00.0	LS	1525 mm	 →ch. 9K-1-010 200
1.9 SDI 47 kW (64 PS) AYQ	09.2000→06.2003	 7.22477.10.0	AGR	PN	

LEON Hatchback Van (5F1) 34

1.6 TDI 77 kW (105 PS) CLHA	09.2012→10.2016	 7.03608.16.0	AK	EL	 ch. 5F-D-000 001→
		7.08369.79.0	ATS	EL	 ch. 5F-D-000 001→
		7.08369.82.0	ATS	EL	 ch. 5F-D-000 001→ Euro 5
		7.11020.18.0	ATS	EL	 ch. 5F-D-000 001→ vor Katalysator in front of the catalyst
		7.11492.03.0	DDS		ohne Zubehör without accessories für OE-Nummer: 03L 906 051 B, 03L 906 051 D, 03N 906 051 B for OE number: 03L 906 051 B, 03L 906 051 D, 03N 906 051 B
1.6 TDI 66 kW (90 PS) CLHB	11.2012→10.2016	 7.03608.16.0	AK	EL	 ch. 5F-D-000 001→
		7.08369.79.0	ATS	EL	 ch. 5F-D-000 001→
		7.11020.18.0	ATS	EL	 ch. 5F-D-000 001→ vor Katalysator in front of the catalyst
		7.11492.03.0	DDS		ohne Zubehör without accessories für OE-Nummer: 03L 906 051 B, 03L 906 051 D, 03N 906 051 B for OE number: 03L 906 051 B, 03L 906 051 D, 03N 906 051 B
1.6 TDI 81 kW (110 PS) CRKB	09.2013→10.2016	 7.08369.79.0	ATS	EL	 ch. 5F-D-000 001→
		7.08369.82.0	ATS	EL	 ch. 5F-D-000 001→
		7.11020.18.0	ATS	EL	 ch. 5F-D-000 001→ vor Katalysator in front of the catalyst
		7.11492.03.0	DDS		ohne Zubehör without accessories für OE-Nummer: 03L 906 051 B, 03L 906 051 D, 03N 906 051 B for OE number: 03L 906 051 B, 03L 906 051 D, 03N 906 051 B
1.6 TDI 81 kW (110 PS) CXXB	09.2013→10.2016	 7.08369.79.0	ATS	EL	 ch. 5F-D-000 001→
		7.08369.95.0	ATS	EL	 ch. 5F-D-000 001→
		7.11020.18.0	ATS	EL	 ch. 5F-D-000 001→ vor Katalysator in front of the catalyst
		7.11492.03.0	DDS		ohne Zubehör without accessories für OE-Nummer: 03L 906 051 B, 03L 906 051 D, 03N 906 051 B for OE number: 03L 906 051 B, 03L 906 051 D, 03N 906 051 B
1.6 TDI 81 kW (110 PS) DBKA	09.2013→10.2016	 7.08369.95.0	ATS	EL	 ch. 5F-D-000 001→

S





LEON Hatchback Van (5F1) **34**

			7.11020.18.0	ATS	EL	 ch. 5F-D-000 001→ vor Katalysator in front of the catalyst
			7.11492.03.0	DDS		ohne Zubehör without accessories für OE-Nummer: 03L 906 051 B, 03L 906 051 D, 03N 906 051 B for OE number: 03L 906 051 B, 03L 906 051 D, 03N 906 051 B
1.6 TDI 85 kW (115 PS) DDYA	11.2016→		7.08369.95.0	ATS	EL	 ch. 5F-D-000 001→ Euro 6b Euro 6b
			7.11020.22.0	ATS	EL	Euro 6c, Euro 6d-Temp Euro 6c, Euro 6d-Temp
			7.11020.23.0	ATS	EL	Euro 6c, Euro 6d-Temp Euro 6c, Euro 6d-Temp
			7.11492.03.0	DDS		ohne Zubehör without accessories für OE-Nummer: 03L 906 051 B, 03L 906 051 D, 03N 906 051 B for OE number: 03L 906 051 B, 03L 906 051 D, 03N 906 051 B
			7.11492.05.0	DDS		ohne Zubehör without accessories für OE-Nummer: 04L 906 051 AB, 04L 906 051 F, 04L 906 051 L for OE number: 04L 906 051 AB, 04L 906 051 F, 04L 906 051 L
2.0 TDI 110 kW (150 PS) CKFC	10.2012→		7.03608.16.0	AK	EL	 ch. 5F-D-000 001→
			7.08369.81.0	ATS	EL	 ch. 5F-D-000 001→
			7.11492.03.0	DDS		ohne Zubehör without accessories für OE-Nummer: 03L 906 051 B, 03L 906 051 D, 03N 906 051 B for OE number: 03L 906 051 B, 03L 906 051 D, 03N 906 051 B
2.0 TDI 110 kW (150 PS) CRMB	10.2012→		7.08369.81.0	ATS	EL	 ch. 5F-D-000 001→
			7.11492.03.0	DDS		ohne Zubehör without accessories für OE-Nummer: 03L 906 051 B, 03L 906 051 D, 03N 906 051 B for OE number: 03L 906 051 B, 03L 906 051 D, 03N 906 051 B
			7.11492.05.0	DDS		ohne Zubehör without accessories für OE-Nummer: 04L 906 051 AB, 04L 906 051 F, 04L 906 051 L for OE number: 04L 906 051 AB, 04L 906 051 F, 04L 906 051 L
2.0 TDI 135 kW (184 PS) CUNA	02.2013→		7.10334.02.0	AGR	EL	 CUNA:  ch. 5F-D-000 001→  CUNA:  ch. 5F-D-000 001→
			7.08369.81.0	ATS	EL	 ch. 5F-D-000 001→
			7.11492.03.0	DDS		ohne Zubehör without accessories für OE-Nummer: 03L 906 051 B, 03L 906 051 D, 03N 906 051 B for OE number: 03L 906 051 B, 03L 906 051 D, 03N 906 051 B
			7.11492.05.0	DDS		ohne Zubehör without accessories für OE-Nummer: 04L 906 051 AB, 04L 906 051 F, 04L 906 051 L for OE number: 04L 906 051 AB, 04L 906 051 F, 04L 906 051 L



















S























LEON Hatchback Van (5F1) **34**

2.0 TDI 135 kW (184 PS) CUPA	02.2013→		7.10334.02.0	AGR	EL  ch. 5F-D-000 001→
			7.08369.81.0	ATS	EL  ch. 5F-D-000 001→
			7.11492.03.0	DDS	ohne Zubehör without accessories für OE-Nummer: 03L 906 051 B, 03L 906 051 D, 03N 906 051 B for OE number: 03L 906 051 B, 03L 906 051 D, 03N 906 051 B

LEON ST Estate Van (5F8) **35**

1.6 TDI 81 kW (110 PS) CRKB	09.2013→		7.10334.02.0	AGR	EL  ch. 5F-D-000 001→			
			7.08369.79.0	ATS	EL  ch. 5F-D-000 001→			
			7.08369.82.0	ATS	EL  ch. 5F-D-000 001→			
			7.11020.18.0	ATS	EL  ch. 5F-D-000 001→ vor Katalysator in front of the catalyst			
			7.11492.03.0	DDS	ohne Zubehör without accessories für OE-Nummer: 03L 906 051 B, 03L 906 051 D, 03N 906 051 B for OE number: 03L 906 051 B, 03L 906 051 D, 03N 906 051 B			
			1.6 TDI 81 kW (110 PS) CXXB	09.2013→		7.10334.02.0	AGR	EL  ch. 5F-D-000 001→
						7.08369.79.0	ATS	EL  ch. 5F-D-000 001→
7.08369.95.0	ATS	EL  ch. 5F-D-000 001→						
			7.11020.17.0	ATS	EL  ch. 5F-D-000 001→ für OE-Nummer: 04L 906 088 BD for OE number: 04L 906 088 BD			
			7.11020.18.0	ATS	EL für OE-Nummer: 04L 906 088 K for OE number: 04L 906 088 K vor Katalysator in front of the catalyst			
			7.11492.03.0	DDS	ohne Zubehör without accessories für OE-Nummer: 03L 906 051 B, 03L 906 051 D, 03N 906 051 B for OE number: 03L 906 051 B, 03L 906 051 D, 03N 906 051 B			
			1.6 TDI 81 kW (110 PS) DBKA	09.2013→		7.10334.02.0	AGR	EL  ch. 5F-D-000 001→
7.08369.95.0	ATS	EL  ch. 5F-D-000 001→						
7.11020.17.0	ATS	EL  ch. 5F-D-000 001→ für OE-Nummer: 04L 906 088 BD for OE number: 04L 906 088 BD vor Katalysator in front of the catalyst						
			7.11020.18.0	ATS	EL  ch. 5F-D-000 001→ für OE-Nummer: 04L 906 088 K for OE number: 04L 906 088 K vor Katalysator in front of the catalyst			
			7.11492.03.0	DDS	ohne Zubehör without accessories für OE-Nummer: 03L 906 051 B, 03L 906 051 D, 03N 906 051 B for OE number: 03L 906 051 B, 03L 906 051 D, 03N 906 051 B			
			1.6 TDI 85 kW (115 PS) DDYA	11.2016→		7.08369.95.0	ATS	EL  ch. 5F-D-000 001→ Euro 6b Euro 6b
7.11020.17.0	ATS	EL  ch. 5F-D-000 001→ für OE-Nummer: 04L 906 088 BD for OE number: 04L 906 088 BD						







S

					
LEON ST Estate Van (5F8)					35
			<p>7.11020.18.0 ATS EL  ch. 5F-D-000 001→ für OE-Nummer: 04L 906 088 K for OE number: 04L 906 088 K vor Katalysator in front of the catalyst</p> <p>7.11020.22.0 ATS EL Euro 6c, Euro 6d-Temp</p> <p>7.11020.23.0 ATS EL Euro 6c, Euro 6d-Temp</p> <p>7.11492.03.0 DDS ohne Zubehör without accessories für OE-Nummer: 03L 906 051 B, 03L 906 051 D, 03N 906 051 B for OE number: 03L 906 051 B, 03L 906 051 D, 03N 906 051 B</p> <p>7.11492.05.0 DDS ohne Zubehör without accessories für OE-Nummer: 04L 906 051 AB, 04L 906 051 F, 04L 906 051 L for OE number: 04L 906 051 AB, 04L 906 051 F, 04L 906 051 L</p>		
2.0 TDI 110 kW (150 PS) CKFC	04.2013→		<p>7.10334.02.0 AGR EL  ch. 5F-D-000 001→</p> <p>7.03608.16.0 AK EL  ch. 5F-D-000 001→</p> <p>7.08369.81.0 ATS EL  ch. 5F-D-000 001→</p> <p>7.11492.03.0 DDS ohne Zubehör without accessories für OE-Nummer: 03L 906 051 B, 03L 906 051 D, 03N 906 051 B for OE number: 03L 906 051 B, 03L 906 051 D, 03N 906 051 B</p>		
2.0 TDI 110 kW (150 PS) CRBC	04.2013→		7.11492.03.0 DDS ohne Zubehör without accessories für OE-Nummer: 03L 906 051 B, 03L 906 051 D, 03N 906 051 B for OE number: 03L 906 051 B, 03L 906 051 D, 03N 906 051 B		
2.0 TDI 110 kW (150 PS) CRLB, CRMB	04.2013→		<p>7.10334.02.0 AGR EL  ch. 5F-D-000 001→</p> <p>7.08369.81.0 ATS EL  CRLB, CRMB:  ch. 5F-D-000 001→</p> <p>7.11492.03.0 DDS ohne Zubehör without accessories  CRLB, CRMB: für OE-Nummer: 03L 906 051 B, 03L 906 051 D, 03N 906 051 B for OE number: 03L 906 051 B, 03L 906 051 D, 03N 906 051 B</p> <p>7.11492.05.0 DDS ohne Zubehör without accessories  CRLB, CRMB: für OE-Nummer: 04L 906 051 AB, 04L 906 051 F, 04L 906 051 L for OE number: 04L 906 051 AB, 04L 906 051 F, 04L 906 051 L</p>		
2.0 TDI 135 kW (184 PS) CUNA	08.2013→		<p>7.08369.81.0 ATS EL  ch. 5F-D-000 001→</p> <p>7.11492.03.0 DDS ohne Zubehör without accessories für OE-Nummer: 03L 906 051 B, 03L 906 051 D, 03N 906 051 B for OE number: 03L 906 051 B, 03L 906 051 D, 03N 906 051 B</p> <p>7.11492.05.0 DDS ohne Zubehör without accessories für OE-Nummer: 04L 906 051 AB, 04L 906 051 F, 04L 906 051 L for OE number: 04L 906 051 AB, 04L 906 051 F, 04L 906 051 L</p>		

S



LEON ST Estate Van (5F8) **35**

2.0 TDI 135 kW (184 PS) CUPA	08.2013→		7.08369.81.0	ATS	EL	 ch. 5F-D-000 001→ ohne Zubehör without accessories für OE-Nummer: 03L 906 051 B, 03L 906 051 D, 03N 906 051 B for OE number: 03L 906 051 B, 03L 906 051 D, 03N 906 051 B
			7.11492.03.0	DDS		
2.0 TDI 4Drive 110 kW (150 PS) CRBC	09.2014→		7.11492.03.0	DDS		ohne Zubehör without accessories für OE-Nummer: 03L 906 051 B, 03L 906 051 D, 03N 906 051 B for OE number: 03L 906 051 B, 03L 906 051 D, 03N 906 051 B
2.0 TDI 4Drive 110 kW (150 PS) CRLB	09.2014→		7.08369.81.0	ATS	EL	 ch. 5F-D-000 001→ ohne Zubehör without accessories für OE-Nummer: 03L 906 051 B, 03L 906 051 D, 03N 906 051 B for OE number: 03L 906 051 B, 03L 906 051 D, 03N 906 051 B
			7.11492.03.0	DDS		
2.0 TDI 4Drive 135 kW (184 PS) CUNA	10.2014→		7.08369.81.0	ATS	EL	 ch. 5F-D-000 001→ ohne Zubehör without accessories für OE-Nummer: 03L 906 051 B, 03L 906 051 D, 03N 906 051 B for OE number: 03L 906 051 B, 03L 906 051 D, 03N 906 051 B
			7.11492.03.0	DDS		
			7.11492.05.0	DDS		











































S

FABIA I (6Y2)					
1.0 37 kW (50 PS) ARV	12.1999→08.2002		7.05271.02.0	LS	500 mm Regelsonde Regulating Probe
1.2 40 kW (54 PS) AWY, BMD	07.2001→04.2007		7.05271.05.0	LS	700 mm AWY: →ch. 6Y-4-095 989 vor Katalysator in front of the catalyst BMD: ch. 6Y-4-095 990→ vor Katalysator in front of the catalyst
1.2 47 kW (64 PS) AZQ, BME	01.2003→03.2008		7.22785.16.0	AGR	EL AZQ, BME: →ch. 6Y-64562 417
1.4 50 kW (68 PS) AME	08.1999→05.2003		7.05271.02.0	LS	500 mm Regelsonde Regulating Probe
1.4 44 kW (60 PS) AZE	08.2000→08.2002		7.05271.02.0	LS	500 mm Regelsonde Regulating Probe
1.4 59 kW (80 PS) BUD	02.2006→10.2006		7.05271.05.0	LS	700 mm nach Katalysator Post-catalyst
1.4 16V 74 kW (100 PS) AUB, BBZ	12.1999→03.2008		7.28248.17.0	AGR	EL AUB, BBZ: ch. 6Y-23305 001→
			7.22785.17.0	AGR	EL AUB, BBZ: →ch. 6Y-13305 000
			7.05271.05.0	LS	700 mm AUB, BBZ: nach Katalysator Post-catalyst
1.4 16V 55 kW (75 PS) AUA, BBY	12.1999→03.2008		7.22785.17.0	AGR	EL AUA, BBY: →05.2001
			7.28248.17.0	AGR	EL AUA, BBY: ch. 6Y-23286 344→
			7.05271.05.0	LS	700 mm AUA, BBY: nach Katalysator Post-catalyst
1.4 16V 55 kW (75 PS) BKY	12.1999→03.2008		7.28248.17.0	AGR	EL →ch. 6Y-54391 600
			7.05271.05.0	LS	700 mm nach Katalysator Post-catalyst
1.4 TDI 55 kW (75 PS) AMF	04.2003→03.2008		7.24809.17.0	AGR	PN
1.4 TDI 51 kW (70 PS) BNM	10.2005→03.2008		7.24809.31.0	AGR	PN
1.4 TDI 59 kW (80 PS) BNV	10.2005→03.2008		7.24809.31.0	AGR	PN
1.9 SDI 47 kW (64 PS) ASY	12.1999→03.2008		7.22477.10.0	AGR	PN ch. 6Y-2-386 001→
1.9 TDI 74 kW (100 PS) ATD	01.2000→03.2008		7.24809.30.0	AGR	PN
1.9 TDI 74 kW (100 PS) AXR	01.2000→03.2008		7.24809.16.0	AGR	PN
1.9 TDI RS 96 kW (130 PS) ASZ	06.2003→03.2008		7.24809.55.0	AGR	PN ch. 6Y-23473 987→
1.9 TDI RS 96 kW (130 PS) BLT	06.2003→03.2008		7.24809.16.0	AGR	PN
2.0 85 kW (116 PS) AZL	12.1999→03.2008		7.05271.77.0	LS	800 mm vor Katalysator in front of the catalyst
			7.22738.08.0	SLP	EL
			7.22778.80.0	SLV	PN







1
S



FABIA I Combi (6Y5) **2**

1.0 37 kW (50 PS) ARV	11.2000→08.2002		7.05271.02.0	LS	500 mm	Regelsonde Regulating Probe
1.2 40 kW (54 PS) AWY, BMD	07.2001→12.2007		7.05271.05.0	LS	700 mm	 AWY:  →ch. 6Y-4-095 989 vor Katalysator in front of the catalyst  BMD:  ch. 6Y-4-095 990→ vor Katalysator in front of the catalyst
1.2 47 kW (64 PS) AZQ, BME	01.2003→12.2007		7.22785.16.0	AGR	EL	 AZQ, BME:  →ch. 6Y-64562 417
			7.05271.20.0	LS	500 mm	
1.4 50 kW (68 PS) AME	04.2000→05.2003		7.05271.02.0	LS	500 mm	Regelsonde Regulating Probe
1.4 44 kW (60 PS) AZE	04.2000→03.2003		7.05271.02.0	LS	500 mm	Regelsonde Regulating Probe
1.4 16V 74 kW (100 PS) AUB, BBZ	04.2000→12.2007		7.28248.17.0	AGR	EL	 AUB, BBZ:  ch. 6Y-23305 001→
			7.22785.17.0	AGR	EL	 AUB, BBZ:  →ch. 6Y-13305 000
			7.05271.05.0	LS	700 mm	 AUB, BBZ: nach Katalysator Post-catalyst
1.4 16V 55 kW (75 PS) AUA, BBY	05.2000→12.2007		7.28248.17.0	AGR	EL	 AUA, BBY:  ch. 6Y-23286 344→
			7.22785.17.0	AGR	EL	 AUA, BBY:  →ch. 6Y-23286 343
			7.05271.05.0	LS	700 mm	 AUA, BBY: nach Katalysator Post-catalyst
1.4 16V 55 kW (75 PS) BKY	05.2000→12.2007		7.28248.17.0	AGR	EL	  →ch. 6Y-54391 600
			7.05271.05.0	LS	700 mm	nach Katalysator Post-catalyst
1.4 16V 59 kW (80 PS) BUD	04.2006→12.2007		7.05271.05.0	LS	700 mm	nach Katalysator Post-catalyst
1.4 TDI 55 kW (75 PS) AMF	04.2003→12.2007		7.24809.17.0	AGR	PN	
1.4 TDI 51 kW (70 PS) BNM	10.2005→12.2007		7.24809.31.0	AGR	PN	
1.4 TDI 59 kW (80 PS) BNV	10.2005→12.2007		7.24809.31.0	AGR	PN	
1.9 SDI 47 kW (64 PS) ASY	04.2000→12.2007		7.22477.10.0	AGR	PN	  ch. 6Y-2-386 001→
1.9 TDI 74 kW (100 PS) ATD	04.2000→12.2007		7.24809.30.0	AGR	PN	
1.9 TDI 74 kW (100 PS) AXR	04.2000→12.2007		7.24809.16.0	AGR	PN	
2.0 85 kW (116 PS) AZL	04.2000→12.2007		7.05271.77.0	LS	800 mm	vor Katalysator in front of the catalyst
			7.22738.08.0	SLP	EL	
			7.22778.80.0	SLV	PN	





















FABIA I Saloon (6Y3) **3**

1.0 37 kW (50 PS) ARV	11.2000→08.2002		7.05271.02.0	LS	500 mm	Regelsonde Regulating Probe
1.2 40 kW (54 PS) AWY, BMD	07.2001→12.2007		7.05271.05.0	LS	700 mm	 AWY:  ch. 6Y-4-095 989→ vor Katalysator in front of the catalyst  BMD:  ch. 6Y-4-095 990→ vor Katalysator in front of the catalyst

FABIA I Saloon (6Y3)					
3					
1.2 47 kW (64 PS) AZQ, BME	01.2003→12.2007	 7.22785.16.0 7.05271.20.0	AGR LS	EL 500 mm	 AZQ, BME: →ch. 6Y-64562 417
1.4 44 kW (60 PS) AZE	04.2000→08.2002	 7.05271.02.0	LS	500 mm	Regelsonde Regulating Probe
1.4 50 kW (68 PS) AME	07.2001→05.2003	 7.05271.02.0	LS	500 mm	Regelsonde Regulating Probe
1.4 16V 55 kW (75 PS) AUA, BBY	10.1999→12.2007	 7.28248.17.0 7.22785.17.0 7.05271.05.0	AGR AGR LS	EL EL 700 mm	 AUA, BBY: →ch. 6Y-23286 344→ AUA, BBY: →ch. 6Y-23286 343 AUA, BBY: nach Katalysator Post-catalyst
1.4 16V 55 kW (75 PS) BKY	10.1999→12.2007	 7.28248.17.0 7.05271.05.0	AGR LS	EL 700 mm	 →ch. 6Y-54391 600 nach Katalysator Post-catalyst
1.4 16V 74 kW (100 PS) AUB, BBZ	12.1999→12.2007	 7.28248.17.0 7.22785.17.0 7.05271.05.0	AGR AGR LS	EL EL 700 mm	 AUB, BBZ: →ch. 6Y-23305 001→ AUB, BBZ: →ch. 6Y-13305 000 AUB, BBZ: nach Katalysator Post-catalyst
1.4 16V 59 kW (80 PS) BUD	04.2006→12.2007	 7.05271.05.0	LS	700 mm	nach Katalysator Post-catalyst
1.4 TDI 55 kW (75 PS) AMF	04.2003→12.2007	 7.24809.17.0	AGR	PN	
1.4 TDI 51 kW (70 PS) BNM	10.2005→12.2007	 7.24809.31.0	AGR	PN	
1.4 TDI 59 kW (80 PS) BNV	10.2005→12.2007	 7.24809.31.0	AGR	PN	
1.9 SDI 47 kW (64 PS) ASY	11.1999→12.2007	 7.22477.10.0	AGR	PN	 →ch. 6Y-2-386 001→
1.9 TDI 74 kW (100 PS) ATD	01.2000→12.2007	 7.24809.30.0	AGR	PN	
1.9 TDI 74 kW (100 PS) AXR	01.2000→12.2007	 7.24809.16.0	AGR	PN	
2.0 85 kW (116 PS) AZL	12.1999→12.2007	 7.05271.77.0 7.22738.08.0 7.22778.80.0	LS SLP SLV	800 mm EL PN	vor Katalysator in front of the catalyst
FABIA II (542)					
4					
1.2 44 kW (60 PS) BBM, CHFA	12.2006→12.2014	 7.05271.05.0	LS	700 mm	 BBM: Fahrgestellnummer ab: 5J-8A509 005, 5J-93176 789, 5J-9B508 221, 5J-9K510 312, 5J-9S501 321 Vehicle Identification Number from: 5J-8A509 005, 5J-93176 789, 5J-9B508 221, 5J-9K510 312, 5J-9S501 321 vor Katalysator in front of the catalyst CHFA: Fahrgestellnummer ab: 5J-8A509 004, 5J-93176 788, 5J-9B508 220, 5J-9K510 311, 5J-9S501 320 Vehicle Identification Number from: 5J-8A509 004, 5J-93176 788, 5J-9B508 220, 5J-9K510 311, 5J-9S501 320 vor Katalysator in front of the catalyst
1.2 TDI 55 kW (75 PS) CFWA	05.2010→12.2014	 7.09720.02.0	AGR-K	EL	









FABIA II (542) **4**













			7.08369.50.0	ATS	EL	
			7.08369.11.0	ATS	EL	für Rechtslenker for right-hand drive vehicles
			7.08369.37.0	ATS	EL	für Linkslenker for left-hand drive vehicles nach Rußpartikelfilter after soot particulate filter Produktionsdatum ab: 31.05.2010 Production date from: 31.05.2010
			7.08369.83.0	ATS	EL	
			7.11190.09.0	DDS		
1.4 63 kW (85-86 PS) BXW, CGGB	01.2007→12.2014		7.05271.05.0	LS	700 mm	 BXW:  ch. 5J-7-000 001→ nach Katalysator Post-catalyst  CGGB: nach Katalysator Post-catalyst
1.4 TDI 59 kW (80 PS) BMS	01.2007→03.2010		7.00907.03.0	AGR	EL	 ch. 5J-7-000 001→
			7.00678.06.0	AGR-M	EL	 ch. 5J-7-000 001→
			7.08369.86.0	ATS	EL	 ch. 5J-7-000 001→ für Rechtslenker for right-hand drive vehicles
			7.11020.03.0	ATS	EL	 ch. 5J-7-000 001→
			7.08369.53.0	ATS	EL	vor Rußpartikelfilter before soot particulate filter
			7.11020.07.0	ATS	EL	für Linkslenker for left-hand drive vehicles
			7.11492.00.0	DDS		ohne Zubehör without accessories für OE-Nummer: 076 906 051 B for OE number: 076 906 051 B
			7.11492.02.0	DDS		ohne Zubehör without accessories für OE-Nummer: 076 906 051 A for OE number: 076 906 051 A
1.4 TDI 59 kW (80 PS) BNV	01.2007→03.2010		7.24809.31.0	AGR	PN	
1.4 TDI 51 kW (70 PS) BNM	02.2007→03.2010		7.24809.31.0	AGR	PN	
1.6 77 kW (105 PS) BTS, CFNA, CLSA	04.2007→12.2014		7.05271.18.0	LS	525 mm	
1.6 TDI 66 kW (90 PS) CAYB	03.2010→12.2014		7.09720.01.0	AGR-K	EL	
			7.08369.09.0	ATS	EL	für Linkslenker for left-hand drive vehicles
			7.08369.11.0	ATS	EL	für Rechtslenker for right-hand drive vehicles
			7.08369.26.0	ATS	EL	
			7.11190.09.0	DDS		
1.6 TDI 77 kW (105 PS) CAYC	03.2010→12.2014		7.09720.01.0	AGR-K	EL	
			7.08369.09.0	ATS	EL	für Linkslenker for left-hand drive vehicles
			7.08369.11.0	ATS	EL	für Rechtslenker for right-hand drive vehicles
			7.08369.26.0	ATS	EL	
			7.11190.09.0	DDS		
1.6 TDI 55 kW (75 PS) CAYA	04.2010→12.2014		7.09720.01.0	AGR-K	EL	
			7.08369.09.0	ATS	EL	für Linkslenker for left-hand drive vehicles
			7.08369.11.0	ATS	EL	für Rechtslenker for right-hand drive vehicles

S





























FABIA II (542) 4

		7.08369.26.0	ATS	EL	
		7.11190.09.0	DDS		
1.9 TDI 77 kW (105 PS) BLS	04.2007→03.2010	 7.00907.03.0	AGR	EL	 ch. 5J-7-000 001→
		7.00678.06.0	AGR-M	EL	 ch. 5J-7-000 001→
		7.11020.02.0	ATS	EL	 ch. 5J-7-000 001→ nach Rußpartikelfilter after soot particulate filter
		7.08369.00.0	ATS	EL	Fahrgestellnummer ab: 5J-7-000 001 Vehicle Identification Number from: 5J-7-000 001
		7.08369.53.0	ATS	EL	vor Rußpartikelfilter before soot particulate filter
		7.11190.02.0	DDS		für OE-Nummer: 059 906 051 A, 07Z 906 051 B for OE number: 059 906 051 A, 07Z 906 051 B
		7.11492.00.0	DDS		ohne Zubehör without accessories für OE-Nummer: 076 906 051 B for OE number: 076 906 051 B
		7.11492.02.0	DDS		ohne Zubehör without accessories für OE-Nummer: 076 906 051 A for OE number: 076 906 051 A
1.9 TDI 77 kW (105 PS) BSW	04.2007→03.2010	 7.24809.16.0	AGR	PN	

FABIA II Combi (545) 5





















1.2 44 kW (60 PS) BBM, CHFA	10.2007→11.2014	 7.05271.05.0	LS	700 mm	 BBM, CHFA: ch. 5J-7-000 001→ Fahrgestellnummer bis: 5J-8A509 004, 5J-93176 788, 5J-9B508 220, 5J-9K510 311, 5J-9S501 320 Vehicle Identification Number to: 5J-8A509 004, 5J-93176 788, 5J-9B508 220, 5J-9K510 311, 5J-9S501 320 vor Katalysator in front of the catalyst
1.2 LPG 44 kW (60 PS) CHFA	03.2009→11.2011	 7.05271.05.0	LS	700 mm	vor Katalysator in front of the catalyst
1.2 TDI 55 kW (75 PS) CFWA	05.2010→12.2014	 7.09720.02.0	AGR-K	EL	
		7.08369.50.0	ATS	EL	
		7.08369.11.0	ATS	EL	für Rechtslenker for right-hand drive vehicles
		7.08369.37.0	ATS	EL	für Linkslenker for left-hand drive vehicles nach Rußpartikelfilter after soot particulate filter Produktionsdatum ab: 31.05.2010 Production date from: 31.05.2010
		7.08369.83.0	ATS	EL	
		7.11190.09.0	DDS		
1.4 63 kW (85-86 PS) BXW, CGGB	10.2007→12.2014	 7.05271.05.0	LS	700 mm	 BXW:  ch. 5J-7-000 001→ nach Katalysator Post-catalyst
					 CGGB: nach Katalysator Post-catalyst
1.4 LPG 63 kW (85-86 PS) BXW, CGGB	10.2007→11.2014	 7.05271.05.0	LS	700 mm	 BXW:  ch. 5J-7-000 001→ nach Katalysator Post-catalyst
					 CGGB: nach Katalysator Post-catalyst

S

			 PIERBURG		
FABIA II Combi (545)					
1.4 TDI 51 kW (70 PS) BNM	10.2007→03.2010		7.24809.31.0	AGR	PN 
1.4 TDI 59 kW (80 PS) BMS	10.2007→03.2010		7.00907.03.0 7.00678.06.0 7.08369.86.0 7.11020.03.0 7.08369.53.0 7.11020.07.0 7.11492.00.0 7.11492.02.0	AGR AGR-M ATS ATS ATS ATS DDS DDS	EL  ch. 5J-7-000 001→ EL  ch. 5J-7-000 001→ EL  ch. 5J-7-000 001→ für Rechtslenker for right-hand drive vehicles EL  ch. 5J-7-000 001→ EL vor Rußpartikelfilter before soot particulate filter EL für Linkslenker for left-hand drive vehicles ohne Zubehör without accessories für OE-Nummer: 076 906 051 B for OE number: 076 906 051 B ohne Zubehör without accessories für OE-Nummer: 076 906 051 A for OE number: 076 906 051 A
1.4 TDI 59 kW (80 PS) BNV	10.2007→03.2010		7.24809.31.0	AGR	PN 
1.6 77 kW (105 PS) BTS, CFNA	10.2007→12.2014		7.05271.18.0	LS	525 mm
1.6 TDI 66 kW (90 PS) CAYB	03.2010→12.2014		7.09720.01.0 7.08369.09.0 7.08369.11.0 7.08369.26.0 7.11190.09.0	AGR-K ATS ATS ATS DDS	EL  EL für Linkslenker for left-hand drive vehicles EL für Rechtslenker for right-hand drive vehicles EL
1.6 TDI 77 kW (105 PS) CAYC	03.2010→12.2014		7.09720.01.0 7.08369.09.0 7.08369.11.0 7.08369.26.0 7.11190.09.0	AGR-K ATS ATS ATS DDS	EL  EL für Linkslenker for left-hand drive vehicles EL für Rechtslenker for right-hand drive vehicles EL
1.6 TDI 55 kW (75 PS) CAYA	04.2010→12.2014		7.09720.01.0 7.08369.09.0 7.08369.11.0 7.08369.26.0 7.11190.09.0	AGR-K ATS ATS ATS DDS	EL  EL für Linkslenker for left-hand drive vehicles EL für Rechtslenker for right-hand drive vehicles EL
1.9 TDI 77 kW (105 PS) BLS	10.2007→03.2010		7.00907.03.0 7.00678.06.0 7.08369.00.0 7.11020.02.0 7.08369.53.0	AGR AGR-M ATS ATS ATS	EL  ch. 5J-7-000 001→ EL  ch. 5J-7-000 001→ EL  ch. 5J-7-000 001→ Fahrgestellnummer ab: 5J-7-000 001 Vehicle Identification Number from: 5J-7-000 001 EL  ch. 5J-7-000 001→ nach Rußpartikelfilter after soot particulate filter EL vor Rußpartikelfilter before soot particulate filter















5

S

					
FABIA II Combi (545)					5
			7.11190.02.0	DDS	für OE-Nummer: 059 906 051 A, 07Z 906 051 B for OE number: 059 906 051 A, 07Z 906 051 B ohne Zubehör without accessories für OE-Nummer: 076 906 051 B for OE number: 076 906 051 B ohne Zubehör without accessories für OE-Nummer: 076 906 051 A for OE number: 076 906 051 A
			7.11492.00.0	DDS	
			7.11492.02.0	DDS	
1.9 TDI 77 kW (105 PS) BSW	10.2007→03.2010		7.24809.16.0	AGR	PN 
FABIA SCOUT					6
1.6i 16V 77 kW (105 PS) BTS	05.2009→03.2010		7.05271.18.0	LS	525 mm
FAVORIT (781)					7
1.3 136 (781) 45 kW (61 PS) 136 L	10.1990→09.1994		7.05270.86.0	LS	625 mm
FELICIA I (6U1)					8
1.3 43 kW (58 PS) 135L, AMJ	10.1994→03.1998		7.05270.86.0	LS	625 mm
1.6 LX 55 kW (75 PS) AEE	08.1995→03.1998		7.05270.86.0	LS	625 mm
FELICIA I Estate (6U5)					9
1.3 43 kW (58 PS) 135L, AMJ	08.1995→03.1998		7.05270.86.0	LS	625 mm
1.6 GLX 55 kW (75 PS) AEE	08.1995→03.1998		7.05270.86.0	LS	625 mm
FELICIA I Pickup (6UF, 6U7)					10
1.6 55 kW (75 PS) AEE	06.1997→04.2002		7.05270.86.0	LS	625 mm
FELICIA II (6U1)					11
1.3 43 kW (58 PS) AMJ	01.1998→06.2001		7.05270.86.0	LS	625 mm
1.6 55 kW (75 PS) AEE	01.1998→06.2001		7.05270.86.0	LS	625 mm
FELICIA II Estate (6U5)					12
1.6 55 kW (75 PS) AEE	01.1998→06.2001		7.05270.86.0	LS	625 mm
KAMIQ (NW4)					13
1.6 TDI 85 kW (115 PS) DGTA	07.2019→		7.10334.02.0	AGR	EL 
			7.11020.17.0	ATS	EL Euro 6 Euro 6 für Vorkatalysator for pre-catalyst
			7.11020.23.0	ATS	EL Euro 6d-Temp Euro 6d-Temp
			7.11492.05.0	DDS	ohne Zubehör without accessories Euro 6d-Temp Euro 6d-Temp



KAMIQ (NW4)						13
1.6 TDI 70 kW (95 PS) DGTD	09.2019→		7.07696.00.0	SRM-AK	EL	ohne Zubehör without accessories Euro 6d-Temp Euro 6d-Temp
			7.11492.05.0	DDS		

KAROQ (NU7)						14
1.6 TDI 85 kW (115 PS) DDYA, DGTE	07.2017→		7.10334.02.0	AGR	EL	  DDYA, DGTE: für OE-Nummer: 04L 906 088 B for OE number: 04L 906 088 B  DDYA, DGTE: Euro 5 Euro 5  DDYA, DGTE: für PR-Nummer: 1E0, 7MM for PR number: 1E0, 7MM  DDYA, DGTE: Euro 6d-Temp Euro 6d-Temp für Vorkatalysator for pre-catalyst  DDYA, DGTE: für Hersteller-Abgasnorm: Euro 5 plus for manufacturer exhaust norm: Euro 5 plus für Vorkatalysator for pre-catalyst  DDYA, DGTE: für OE-Nummer: 04L 906 088 BF for OE number: 04L 906 088 BF  DDYA, DGTE: Euro 6b, Euro 6c Euro 6b, Euro 6c für PR-Nummer: 1E9 for PR number: 1E9  DDYA, DGTE: Euro 6d-Temp Euro 6d-Temp ohne Zubehör without accessories  DDYA, DGTE: für OE-Nummer: 04L 906 051 AB, 04L 906 051 F, 04L 906 051 G, 04L 906 051 L for OE number: 04L 906 051 AB, 04L 906 051 F, 04L 906 051 G, 04L 906 051 L
			7.08369.79.0	ATS	EL	
			7.08369.82.0	ATS	EL	
			7.08369.95.0	ATS	EL	
			7.11020.17.0	ATS	EL	
			7.11020.18.0	ATS	EL	
			7.11020.22.0	ATS	EL	
			7.11020.23.0	ATS	EL	
			7.11492.05.0	DDS		
2.0 TDI 110 kW (150 PS) DFFA	07.2017→		7.10334.02.0	AGR	EL	 Euro 6 Euro 6 ohne Zubehör without accessories für OE-Nummer: 04L 906 051 AB, 04L 906 051 F, 04L 906 051 G, 04L 906 051 L for OE number: 04L 906 051 AB, 04L 906 051 F, 04L 906 051 G, 04L 906 051 L
			7.03608.16.0	AK	EL	
			↳ 7.07696.00.0	SRM-AK	EL	
			7.08369.81.0	ATS	EL	
			7.11492.05.0	DDS		
2.0 TDI 4x4 110 kW (150 PS) DFFA	07.2017→		7.10334.02.0	AGR	EL	 Euro 6 Euro 6
			7.03608.16.0	AK	EL	
			↳ 7.07696.00.0	SRM-AK	EL	
			7.08369.81.0	ATS	EL	

S

KAROQ (NU7) 14

			7.11492.05.0	DDS		ohne Zubehör without accessories für OE-Nummer: 04L 906 051 AB, 04L 906 051 F, 04L 906 051 G, 04L 906 051 L for OE number: 04L 906 051 AB, 04L 906 051 F, 04L 906 051 G, 04L 906 051 L
2.0 TDI 4x4 140 kW (190 PS) DFHA	07.2017→		7.08369.81.0	ATS	EL	Euro 6 Euro 6
			7.11492.05.0	DDS		ohne Zubehör without accessories für OE-Nummer: 04L 906 051 AB, 04L 906 051 F, 04L 906 051 G, 04L 906 051 L for OE number: 04L 906 051 AB, 04L 906 051 F, 04L 906 051 G, 04L 906 051 L
2.0 TDI 4x4 105 kW (143 PS) CRVC	07.2018→		7.07696.00.0	SRM-AK	EL	
			7.10334.02.0	AGR	EL	
			7.08369.81.0 7.11492.05.0	ATS DDS	EL	ch. NE-D-000 001→ ohne Zubehör without accessories für OE-Nummer: 04L 906 051 AB, 04L 906 051 F, 04L 906 051 G, 04L 906 051 L for OE number: 04L 906 051 AB, 04L 906 051 F, 04L 906 051 G, 04L 906 051 L



KODIAQ (NS7, NV7) 15

2.0 RS Bi-TDI 4x4 176 kW (240 PS) CUAA	11.2018→		7.07696.00.0	SRM-AK	EL	
2.0 TDI 110 kW (150 PS) DBGA, DBGC	10.2016→		7.10334.02.0	AGR	EL	DBGA, DBGC: ch. 5F-D-000 001→
			7.08369.81.0 7.11492.03.0	ATS DDS	EL	ohne Zubehör without accessories
			7.10334.02.0 7.08369.81.0 7.11492.05.0	AGR ATS DDS	EL	ch. 5F-D-000 001→ ohne Zubehör without accessories für OE-Nummer: 04L 906 051 AB, 04L 906 051 F, 04L 906 051 L for OE number: 04L 906 051 AB, 04L 906 051 F, 04L 906 051 L
2.0 TDI 85 kW (115 PS) DFGC	02.2019→		7.07696.00.0	SRM-AK	EL	
2.0 TDI 4x4 110 kW (150 PS) DBGA	10.2016→		7.08369.81.0	ATS	EL	
			7.11492.03.0	DDS		ohne Zubehör without accessories
2.0 TDI 4x4 110 kW (150 PS) DBGC	10.2016→		7.10334.02.0	AGR	EL	ch. 5F-D-000 001→
			7.08369.81.0 7.11492.03.0	ATS DDS	EL	ohne Zubehör without accessories
			7.08369.81.0 7.11492.05.0	ATS DDS	EL	ohne Zubehör without accessories für OE-Nummer: 04L 906 051 AB, 04L 906 051 F, 04L 906 051 G, 04L 906 051 L for OE number: 04L 906 051 AB, 04L 906 051 F, 04L 906 051 G, 04L 906 051 L



























S











































KODIAQ (NS7, NV7) **15**



















2.0 TDI 4x4 140 kW (190 PS) DFHA	10.2016→		7.11020.26.0	ATS	EL	ohne Zubehör without accessories  DFHA: für PR-Nummer: 1E0 for PR number: 1E0  DFHA: für PR-Nummer: 1E9 for PR number: 1E9 Produktionsdatum ab: 29.08.2018 Production date from: 29.08.2018
			7.11492.05.0	DDS		

OCTAVIA I (1U2) **16**

1.4 44 kW (60 PS) AMD	04.1999→03.2001		7.05271.02.0	LS	500 mm	
1.4 16V 55 kW (75 PS) AXP, BCA	09.2000→12.2010		7.22785.17.0	AGR	EL	 AXP, BCA: →04.2001,  →ch. 1U-2-530 144
			7.28248.17.0	AGR	EL	 AXP, BCA:  ch. 1U-2-530 145→
			7.05270.99.0	LS	940 mm	
			7.05271.24.0	LS	1500 mm	 AXP, BCA: vor Katalysator in front of the catalyst
1.6 55 kW (75 PS) AEE	09.1996→09.2004		7.05271.03.0	LS	730 mm	 →ch. 1U-X-197 894 Regelsonde Regulating Probe
			7.05271.04.0	LS	505 mm	 ch. 1U-X-197 895→
1.6 74 kW (101 PS) AEH	02.1997→12.2007		7.05271.03.0	LS	730 mm	 →ch. 1U-V-007 000 Regelsonde Regulating Probe
			7.05271.04.0	LS	505 mm	 ch. 1U-V-007 001→ch. 1U-W-134 200
			7.05271.21.0	LS	1250 mm	 ch. 1U-X-134 201→ Regelsonde Regulating Probe
1.6 74 kW (101 PS) AKL	02.1997→12.2007		7.05271.04.0	LS	505 mm	 ch. 1U-V-007 001→ch. 1U-W-134 200
			7.05271.21.0	LS	1250 mm	 ch. 1U-X-134 201→ Regelsonde Regulating Probe
1.6 75 kW (102 PS) AVU, BFQ	11.2000→12.2010		7.22574.12.0	AGR	EL	
			7.05271.24.0	LS	1500 mm	 AVU, BFQ: vor Katalysator in front of the catalyst
			7.22738.08.0	SLP	EL	
1.8 92 kW (125 PS) AGN	09.1996→07.2000		7.22778.96.0	SLV	PN	
			7.22769.73.0	ARV	PN	
			7.05271.03.0	LS	730 mm	
1.8 T 110 kW (150 PS) AGU	08.1997→12.2010		7.21851.31.0	SLP	EL	
			7.22769.73.0	ARV	PN	
			7.05271.03.0	LS	730 mm	Regelsonde Regulating Probe
1.8 T 110 kW (150 PS) ARX	08.1997→12.2010		7.21851.31.0	SLP	EL	
			7.22769.73.0	ARV	PN	
			7.05270.99.0	LS	940 mm	Diagnosesonde Diagnostic Probe
			7.05271.24.0	LS	1500 mm	vor Katalysator in front of the catalyst
			7.21851.31.0	SLP	EL	

S

					
OCTAVIA I (1U2)					
1.8 T 110 kW (150 PS) ARZ	08.1997→12.2010		7.22769.73.0	ARV	PN 
			7.21851.31.0	SLP	EL
1.8 T 110 kW (150 PS) AUM	08.1997→12.2010		7.22769.73.0	ARV	PN 
			7.05271.24.0	LS	1500 mm vor Katalysator in front of the catalyst
			7.21851.31.0	SLP	EL
1.8 T 4x4 110 kW (150 PS) ARX	05.2001→05.2006		7.22769.73.0	ARV	PN 
			7.05270.99.0	LS	940 mm Diagnosesonde Diagnostic Probe
			7.05271.24.0	LS	1500 mm vor Katalysator in front of the catalyst
			7.21851.31.0	SLP	EL
1.9 SDI 50 kW (68 PS) AGP, AQM	06.1997→12.2003		7.22477.10.0	AGR	PN   AGP, AQM:  ch. 1U-2-578 323→
1.9 TDI 66 kW (90 PS) AGR, ALH	09.1996→03.2010		7.24809.17.0	AGR	PN   AGR: →03.2003,  ch. 1U-V-020 000→  ALH: →03.2003
			7.24809.30.0	AGR	PN   AGR, ALH: 03.2003→
1.9 TDI 81 kW (110 PS) AHF, ASV	08.1997→01.2006		7.24809.17.0	AGR	PN   AHF, ASV: →03.2003
			7.24809.30.0	AGR	PN   AHF, ASV: 03.2003→
1.9 TDI 96 kW (130 PS) ASZ	01.2003→09.2004		7.24809.26.0	AGR	PN 
1.9 TDI 74 kW (100 PS) AXR	10.2005→12.2010		7.24809.16.0	AGR	PN 
2.0 85 kW (116 PS) APK	04.1999→05.2007		7.05271.02.0	LS	500 mm Diagnosesonde Diagnostic Probe
2.0 85 kW (116 PS) AQY	04.1999→05.2007		7.22286.26.0	ARV	PN   →ch. 1U-Y-433 000
			7.05271.02.0	LS	500 mm Diagnosesonde Diagnostic Probe
			7.22738.08.0	SLP	EL
			7.22778.80.0	SLV	PN  Fahrge­st­ell­num­mer ab: 1U-Y-433 001, 1U-Y8308 001 Vehicle Identification Number from: 1U-Y-433 001, 1U-Y8308 001
2.0 85 kW (116 PS) AZH	04.1999→05.2007		7.05271.24.0	LS	1500 mm vor Katalysator in front of the catalyst
			7.22738.08.0	SLP	EL
			7.22778.80.0	SLV	PN  Fahrge­st­ell­num­mer ab: 1U-Y-433 001, 1U-Y8308 001 Vehicle Identification Number from: 1U-Y-433 001, 1U-Y8308 001
2.0 85 kW (116 PS) AZJ	04.1999→05.2007		7.05270.98.0	LS	700 mm nach Katalysator Post-catalyst
			7.05271.14.0	LS	1700 mm
			7.05271.24.0	LS	1500 mm vor Katalysator in front of the catalyst
			7.22738.08.0	SLP	EL
			7.22778.80.0	SLV	PN 





			 PIERBURG		
OCTAVIA I (1U2)					16
RS 1.8 T 132 kW (180 PS) AUQ	05.2001→01.2006		7.22769.73.0	ARV	PN 
			7.21851.31.0	SLP	EL
OCTAVIA I Combi (1U5)					17
1.4 16V 55 kW (75 PS) AXP, BCA	08.2000→12.2010		7.22785.17.0	AGR	EL   AXP, BCA: →04.2001,  →ch. 1U-2-530 144
			7.28248.17.0	AGR	EL   AXP, BCA:  ch. 1U-2-530 145→
			7.05270.99.0	LS	940 mm
			7.05271.24.0	LS	1500 mm  AXP, BCA: vor Katalysator in front of the catalyst
1.6 74 kW (101 PS) AEH	07.1998→12.2007		7.05271.03.0	LS	730 mm  →ch. 1U-V-007 000 Regelsonde Regulating Probe
			7.05271.04.0	LS	505 mm  ch. 1U-V-007 001→ch. 1U-W-134 200
			7.05271.21.0	LS	1250 mm  ch. 1U-X-134 201→ Regelsonde Regulating Probe
1.6 74 kW (101 PS) AKL	07.1998→12.2007		7.05271.04.0	LS	505 mm  ch. 1U-V-007 001→ch. 1U-W-134 200
			7.05271.21.0	LS	1250 mm  ch. 1U-X-134 201→ Regelsonde Regulating Probe
1.6 55 kW (75 PS) AEE	07.1998→09.2004		7.05271.03.0	LS	730 mm  →ch. 1U-X-197 894 Regelsonde Regulating Probe
			7.05271.04.0	LS	505 mm  ch. 1U-X-197 895→
1.6 75 kW (102 PS) AVU, BFQ	09.2000→12.2010		7.22574.12.0	AGR	EL 
			7.05271.24.0	LS	1500 mm
			7.22738.08.0	SLP	EL
			7.22778.96.0	SLV	PN 
1.8 20V 92 kW (125 PS) AGN	07.1998→07.2000		7.22769.73.0	ARV	PN 
			7.05271.03.0	LS	730 mm
			7.21851.31.0	SLP	EL
S 1.8 T 110 kW (150 PS) AGU	07.1998→12.2010		7.22769.73.0	ARV	PN 
			7.05271.03.0	LS	730 mm Regelsonde Regulating Probe
			7.21851.31.0	SLP	EL
1.8 T 110 kW (150 PS) ARX	07.1998→12.2010		7.22769.73.0	ARV	PN 
			7.05270.99.0	LS	940 mm Diagnosesonde Diagnostic Probe
			7.05271.24.0	LS	1500 mm vor Katalysator in front of the catalyst
			7.21851.31.0	SLP	EL
1.8 T 110 kW (150 PS) ARZ	07.1998→12.2010		7.22769.73.0	ARV	PN 
			7.21851.31.0	SLP	EL
1.8 T 110 kW (150 PS) AUM	07.1998→12.2010		7.22769.73.0	ARV	PN 
			7.05271.24.0	LS	1500 mm vor Katalysator in front of the catalyst

OCTAVIA I Combi (1U5)					
17					
1.8 T 4x4 110 kW (150 PS) ARX	05.2001→05.2006	7.21851.31.0	SLP	EL	
		7.22769.73.0	ARV	PN	
		7.05270.99.0	LS	940 mm	Diagnosesonde Diagnostic Probe
		7.05271.24.0	LS	1500 mm	vor Katalysator in front of the catalyst
1.9 SDI 50 kW (68 PS) AGP, AQM	07.1998→12.2003	7.22477.10.0	AGR	PN	AGP, AQM: ch. 1U-2-578 323→
		7.24809.17.0	AGR	PN	AGR: →03.2003, ch. 1U-V-020 000→ ALH: →03.2003
1.9 TDI 66 kW (90 PS) AGR, ALH	07.1998→03.2010	7.24809.30.0	AGR	PN	AGR, ALH: 03.2003→
		7.24809.17.0	AGR	PN	AHF, ASV: →03.2003
1.9 TDI 81 kW (110 PS) AHF, ASV	07.1998→01.2006	7.24809.30.0	AGR	PN	AHF, ASV: 03.2003→
		7.24809.16.0	AGR	PN	
1.9 TDI 74 kW (100 PS) AXR	08.2000→12.2010	7.24809.26.0	AGR	PN	
1.9 TDI 96 kW (130 PS) ASZ	01.2003→09.2004	7.24809.17.0	AGR	PN	
1.9 TDI 4x4 66 kW (90 PS) AGR	11.1999→02.2006	7.24809.30.0	AGR	PN	→03.2003, ch. 1U-V-020 000→
		7.24809.17.0	AGR	PN	03.2003→
1.9 TDI 4x4 74 kW (100 PS) ATD	09.2000→01.2006	7.24809.30.0	AGR	PN	→03.2003
		7.24809.17.0	AGR	PN	03.2003→
2.0 85 kW (116 PS) APK	04.1999→05.2007	7.05271.02.0	LS	500 mm	Diagnosesonde Diagnostic Probe
2.0 85 kW (116 PS) AQY	04.1999→05.2007	7.22286.26.0	ARV	PN	→ch. 1U-Y-433 000
		7.05271.02.0	LS	500 mm	Diagnosesonde Diagnostic Probe
		7.22738.08.0	SLP	EL	
		7.22778.80.0	SLV	PN	
2.0 85 kW (116 PS) AZH	04.1999→05.2007	7.05271.24.0	LS	1500 mm	vor Katalysator in front of the catalyst
		7.22738.08.0	SLP	EL	
2.0 85 kW (116 PS) AZJ	04.1999→05.2007	7.05271.14.0	LS	1700 mm	
		7.05271.24.0	LS	1500 mm	vor Katalysator in front of the catalyst
		7.22738.08.0	SLP	EL	
		7.22778.80.0	SLV	PN	



































S



OCTAVIA I Combi (1U5) **17**

2.0 4x4 85 kW (116 PS) AZH	08.2000→09.2004	 7.05271.24.0	LS	1500 mm	vor Katalysator in front of the catalyst
		7.22738.08.0	SLP	EL	
		7.22778.80.0	SLV	PN	 Fahrgestellnummer ab: 1U-Y-433 001, 1U-Y8308 001 Vehicle Identification Number from: 1U-Y-433 001, 1U-Y8308 001
2.0 4x4 85 kW (116 PS) AZJ	08.2000→09.2004	 7.05271.14.0	LS	1700 mm	vor Katalysator in front of the catalyst
		7.05271.24.0	LS	1500 mm	
		7.22738.08.0	SLP	EL	
		7.22778.80.0	SLV	PN	
RS 1.8 T 132 kW (180 PS) AUQ	08.2002→01.2006	 7.22769.73.0	ARV	PN	
		7.21851.31.0	SLP	EL	

OCTAVIA II (1Z3) **18**

1.4 55 kW (75 PS) BCA	05.2004→05.2006	 7.28248.17.0	AGR	EL	  BCA:  →ch. 1Z-52121 646  BCA:  →ch. 1Z-58052 421
		7.05271.24.0	LS	1500 mm	vor Katalysator in front of the catalyst
1.6 75 kW (102 PS) BGU	06.2004→06.2013	 7.22574.12.0	AGR	EL	 →12.2008
		7.22738.08.0	SLP	EL	 ch. 1Z-4-000 001→
		7.22778.96.0	SLV	PN	  ch. 1Z-4-000 001→
1.6 75 kW (102 PS) BSE, CMXA	06.2004→06.2013	 7.22738.08.0	SLP	EL	  BSE:  ch. 1Z-4-000 001→  CMXA:  ch. 1Z-9-000 001→
		7.22778.96.0	SLV	PN	  BSE:  ch. 1Z-4-000 001→  CMXA:  ch. 1Z-9-000 001→
1.6 75 kW (102 PS) CCSA	06.2004→06.2013	 7.05271.18.0	LS	525 mm	
		7.22738.08.0	SLP	EL	 ch. 1Z-4-000 001→
		7.22778.96.0	SLV	PN	  ch. 1Z-4-000 001→
1.6 FSI 85 kW (115 PS) BLF	02.2004→10.2008	 7.10334.04.0	AGR	EL	  ch. 1Z-4-000 001→
		7.05271.30.0	LS	400 mm	
1.6 LPG 75 kW (102 PS) BSE	08.2009→11.2012	 7.05271.18.0	LS	525 mm	
		7.22778.96.0	SLV	PN	  ch. 1Z-9-000 001→
1.6 LPG 75 kW (102 PS) CHGA	08.2009→11.2012	 7.05271.18.0	LS	525 mm	
		7.22738.08.0	SLP	EL	 ch. 1Z-9-000 001→
		7.22778.96.0	SLV	PN	  ch. 1Z-9-000 001→
1.6 MultiFuel 75 kW (102 PS) CCSA	01.2008→06.2013	 7.05271.18.0	LS	525 mm	
		7.22738.08.0	SLP	EL	 ch. 1Z-4-000 001→
		7.22778.96.0	SLV	PN	  ch. 1Z-4-000 001→
1.6 MultiFuel 75 kW (102 PS) CMXA	01.2008→06.2013	 7.22738.08.0	SLP	EL	 ch. 1Z-9-000 001→
		7.22778.96.0	SLV	PN	  ch. 1Z-9-000 001→





















S

OCTAVIA II (1Z3)					
1.6 TDI 77 kW (105 PS) CAYC	06.2009→04.2013		7.09720.00.0	AGR-K	EL
			7.08369.01.0	ATS	EL Fahrgestellnummer ab: 1Z-9-000 001 Vehicle Identification Number from: 1Z-9-000 001
			7.08369.04.0	ATS	EL Fahrgestellnummer ab: 1Z-9-000 001 Vehicle Identification Number from: 1Z-9-000 001
			7.11492.00.0	DDS	ohne Zubehör without accessories ch. 1Z-9-000 001→
1.8 TSI 118 kW (160 PS) BZB	06.2007→04.2013		7.05271.19.0	LS	975 mm vorne Front Diagnosesonde Diagnostic Probe
			7.05271.11.0	LS	800 mm 04.2008→ Regelsonde Regulating Probe
1.9 TDI 77 kW (105 PS) BJB	06.2004→12.2010		7.24809.32.0	AGR	PN
1.9 TDI 77 kW (105 PS) BKC, BXE	06.2004→12.2010		7.24809.16.0	AGR	PN
1.9 TDI 77 kW (105 PS) BLS	06.2004→12.2010		7.00907.03.0	AGR	EL BLS: →12.2008, ch. 1Z-4-000 001→ BLS: 01.2009→, ch. 1Z-9-000 001→
			7.00678.06.0	AGR-M	EL ch. 1Z-4-000 001→
			7.08369.00.0	ATS	EL Fahrgestellnummer ab: 1Z-4-000 001 Vehicle Identification Number from: 1Z-4-000 001
			7.08369.02.0	ATS	EL Fahrgestellnummer ab: 1Z-4-000 001 Vehicle Identification Number from: 1Z-4-000 001
			7.08369.03.0	ATS	EL Fahrgestellnummer ab: 1Z-4-000 001 Vehicle Identification Number from: 1Z-4-000 001
			7.11190.02.0	DDS	ch. 1Z-4-000 001→ Produktionsdatum bis: 30.06.2006 Production date to: 30.06.2006
			7.11492.02.0	DDS	ohne Zubehör without accessories ch. 1Z-4-000 001→ Produktionsdatum ab: 01.07.2006 Production date from: 01.07.2006
2.0 FSI 110 kW (150 PS) BLR, BVY	11.2004→10.2008		7.10334.09.0	AGR	EL BLR, BVY: ch. 1Z-4-000 001→
			7.05271.29.0	LS	900 mm BLR, BVY: rechts Right
			7.05271.16.0	LS	1300 mm BLR: hinten, links, rechts Rear, Left, Right Diagnosesonde Diagnostic Probe BVY: hinten, links Rear, Left Diagnosesonde Diagnostic Probe
2.0 FSI 110 kW (150 PS) BLY, BVZ	11.2004→10.2008		7.05271.16.0	LS	1300 mm BLY: hinten, links, rechts Rear, Left, Right Diagnosesonde Diagnostic Probe BVZ: hinten, links Rear, Left Diagnosesonde Diagnostic Probe







18
S

































OCTAVIA II (1Z3) **18**

2.0 TDI 100 kW (136 PS) AZV	02.2004→05.2010		7.24809.16.0	AGR	PN		
			7.00678.04.0*	AGR-M	EL		mit Rohrstopfen with pipe socket
			↳ 7.00907.03.0	AGR	EL		
2.0 TDI 103 kW (140 PS) BMM	11.2005→05.2010		7.00678.04.0*	AGR-M	EL	mit Rohrstopfen with pipe socket	
			↳ 7.00907.03.0	AGR	EL		
			7.00678.06.0	AGR-M	EL		
			7.08369.00.0	ATS	EL	Fahrgestellnummer ab: 1Z-4-000 001 Vehicle Identification Number from: 1Z-4-000 001	
			7.08369.02.0	ATS	EL	Fahrgestellnummer ab: 1Z-4-000 001 Vehicle Identification Number from: 1Z-4-000 001	
			7.08369.03.0	ATS	EL	Fahrgestellnummer ab: 1Z-4-000 001 Vehicle Identification Number from: 1Z-4-000 001	
			7.11190.02.0	DDS	EL	 ch. 1Z-4-000 001→ Produktionsdatum bis: 30.06.2006 Production date to: 30.06.2006	
7.11492.02.0	DDS	EL	ohne Zubehör without accessories  ch. 1Z-4-000 001→ Produktionsdatum ab: 01.07.2006 Production date from: 01.07.2006				
2.0 TDI 81 kW (110 PS) CFHF, CLCA	03.2010→06.2013		7.09720.00.0	AGR-K	EL		
			7.00678.04.0*	AGR-M	EL	mit Rohrstopfen with pipe socket	
			↳ 7.00907.03.0	AGR	EL		
2.0 TDI 16V 103 kW (140 PS) BKD	02.2004→04.2013		7.09720.00.0	AGR-K	EL		
			7.11190.09.0	DDS	EL	 ch. 1Z-9-000 001→	
2.0 TDI 16V 103 kW (140 PS) CFHC	02.2004→04.2013		7.11190.09.0	DDS	EL	 ch. 1Z-9-000 001→	
2.0 TDI 16V 103 kW (140 PS) CLCB	02.2004→04.2013		7.09720.00.0	AGR-K	EL	 ch. 1Z-9-000 001→	
2.0 TDI RS 125 kW (170 PS) BMN	04.2006→02.2013		7.10334.00.0	AGR	EL	 ch. 1Z-4-000 001→	
			7.08369.00.0	ATS	EL	Fahrgestellnummer ab: 1Z-4-000 001 Vehicle Identification Number from: 1Z-4-000 001	
			7.08369.02.0	ATS	EL	Fahrgestellnummer ab: 1Z-4-000 001 Vehicle Identification Number from: 1Z-4-000 001	
			7.08369.03.0	ATS	EL	Fahrgestellnummer ab: 1Z-4-000 001 Vehicle Identification Number from: 1Z-4-000 001	
			7.11190.02.0	DDS	EL	 ch. 1Z-4-000 001→ Produktionsdatum bis: 30.06.2006 Production date to: 30.06.2006	
7.11492.02.0	DDS	EL	ohne Zubehör without accessories  ch. 1Z-4-000 001→ Produktionsdatum ab: 01.07.2006 Production date from: 01.07.2006				
2.0 TDI RS 125 kW (170 PS) CEGA	04.2006→02.2013		7.10334.00.0	AGR	EL	 ch. 1Z-4-000 001→	

OCTAVIA II (1Z3) 18

			7.08369.00.0	ATS	EL	Fahrgestellnummer ab: 1Z-4-000 001 Vehicle Identification Number from: 1Z-4-000 001
			7.08369.01.0	ATS	EL	Fahrgestellnummer ab: 1Z-9-000 001 Vehicle Identification Number from: 1Z-9-000 001
			7.08369.04.0	ATS	EL	Fahrgestellnummer ab: 1P-6-000 001 Vehicle Identification Number from: 1P-6-000 001
			7.11492.00.0	DDS		ohne Zubehör without accessories  ch. 1Z-9-000 001→ Euro 5
			7.11492.02.0	DDS		ohne Zubehör without accessories  ch. 1Z-9-000 001→ Euro 4



























OCTAVIA II Combi (1Z5) 19

1.4 55 kW (75 PS) BCA	05.2004→05.2006		7.05271.24.0	LS	1500 mm	vor Katalysator in front of the catalyst
1.6 75 kW (102 PS) BGU	09.2004→06.2013		7.22574.12.0	AGR	EL	 →12.2008
			7.22738.08.0	SLP	EL	 ch. 1Z-4-000 001→
			7.22778.96.0	SLV	PN	 ch. 1Z-4-000 001→
1.6 75 kW (102 PS) BSE, CMXA	09.2004→06.2013		7.22738.08.0	SLP	EL	 BSE:  ch. 1Z-4-000 001→  CMXA:  ch. 1Z-9-000 001→
			7.22778.96.0	SLV	PN	 BSE:  ch. 1Z-4-000 001→  CMXA:  ch. 1Z-9-000 001→
1.6 75 kW (102 PS) CCSA	09.2004→06.2013		7.05271.18.0	LS	525 mm	
			7.22738.08.0	SLP	EL	 ch. 1Z-4-000 001→
			7.22778.96.0	SLV	PN	 ch. 1Z-4-000 001→
1.6 FSI 85 kW (115 PS) BLF	02.2004→10.2008		7.10334.04.0	AGR	EL	 ch. 1Z-4-000 001→
			7.05271.30.0	LS	400 mm	
1.6 LPG 75 kW (102 PS) CHGA	08.2009→11.2012		7.05271.18.0	LS	525 mm	
			7.22738.08.0	SLP	EL	 ch. 1Z-9-000 001→
			7.22778.96.0	SLV	PN	 ch. 1Z-9-000 001→
1.6 MultiFuel 75 kW (102 PS) CCSA	01.2008→06.2013		7.05271.18.0	LS	525 mm	
			7.22738.08.0	SLP	EL	 ch. 1Z-4-000 001→
			7.22778.96.0	SLV	PN	 ch. 1Z-4-000 001→
1.6 MultiFuel 75 kW (102 PS) CMXA	01.2008→06.2013		7.22738.08.0	SLP	EL	 ch. 1Z-9-000 001→
			7.22778.96.0	SLV	PN	 ch. 1Z-9-000 001→
1.6 TDI 77 kW (105 PS) CAYC	06.2009→04.2013		7.09720.00.0	AGR-K	EL	
			7.08369.01.0	ATS	EL	Fahrgestellnummer ab: 1Z-9-000 001 Vehicle Identification Number from: 1Z-9-000 001
			7.08369.04.0	ATS	EL	Fahrgestellnummer ab: 1Z-9-000 001 Vehicle Identification Number from: 1Z-9-000 001

S



OCTAVIA II Combi (1Z5) **19**

			7.11492.00.0	DDS		ohne Zubehör without accessories  ch. 1Z-9-000 001→
1.6 TDI 4x4 77 kW (105 PS) CAYC	06.2009→02.2013		7.09720.00.0	AGR-K	EL	
			7.08369.01.0	ATS	EL	Fahrgestellnummer ab: 1Z-9-000 001 Vehicle Identification Number from: 1Z-9-000 001
			7.08369.04.0	ATS	EL	Fahrgestellnummer ab: 1Z-9-000 001 Vehicle Identification Number from: 1Z-9-000 001
			7.11492.00.0	DDS		ohne Zubehör without accessories  ch. 1Z-9-000 001→
1.8 TSI 118 kW (160 PS) BZB	06.2007→04.2013		7.05271.19.0	LS	975 mm	vorne Front Diagnosesonde Diagnostic Probe
			7.05271.11.0	LS	800 mm	04.2008→ Regelsonde Regulating Probe
1.9 TDI 77 kW (105 PS) BJB	09.2004→12.2010		7.24809.32.0	AGR	PN	
1.9 TDI 77 kW (105 PS) BKC, BXE	09.2004→12.2010		7.24809.16.0	AGR	PN	
1.9 TDI 77 kW (105 PS) BLS	09.2004→12.2010		7.00907.03.0	AGR	EL	 BLS: 01.2009→,  ch. 1Z-9-000 001→ BLS: →12.2008,  ch. 1Z-4-000 001→
			7.00678.06.0	AGR-M	EL	 BLS:  ch. 1Z-4-000 001→ BLS:  ch. 1Z-9-000 001→
			7.08369.00.0	ATS	EL	Fahrgestellnummer ab: 1Z-4-000 001 Vehicle Identification Number from: 1Z-4-000 001
			7.08369.02.0	ATS	EL	Fahrgestellnummer ab: 1Z-4-000 001 Vehicle Identification Number from: 1Z-4-000 001
			7.08369.03.0	ATS	EL	Fahrgestellnummer ab: 1Z-4-000 001 Vehicle Identification Number from: 1Z-4-000 001
			7.11190.02.0	DDS		 ch. 1Z-4-000 001→ Produktionsdatum bis: 30.06.2006 Production date to: 30.06.2006
			7.11492.02.0	DDS		ohne Zubehör without accessories  ch. 1Z-4-000 001→ Produktionsdatum ab: 01.07.2006 Production date from: 01.07.2006
1.9 TDI 4x4 77 kW (105 PS) BKC, BXE	11.2004→12.2010		7.24809.16.0	AGR	PN	
1.9 TDI 4x4 77 kW (105 PS) BLS	11.2004→12.2010		7.00907.03.0	AGR	EL	 01.2009→,  ch. 1Z-9-000 001→
			7.00678.06.0	AGR-M	EL	 BLS:  ch. 1Z-4-000 001→ BLS:  ch. 1Z-9-000 001→
			7.08369.00.0	ATS	EL	Fahrgestellnummer ab: 1Z-4-000 001 Vehicle Identification Number from: 1Z-4-000 001
			7.08369.02.0	ATS	EL	Fahrgestellnummer ab: 1Z-4-000 001 Vehicle Identification Number from: 1Z-4-000 001
			7.08369.03.0	ATS	EL	Fahrgestellnummer ab: 1Z-4-000 001 Vehicle Identification Number from: 1Z-4-000 001

























S

OCTAVIA II Combi (1Z5)					19
			7.11190.02.0	DDS	ch. 1Z-4-000 001→ Produktionsdatum bis: 30.06.2006 Production date to: 30.06.2006
			7.11492.02.0	DDS	ohne Zubehör without accessories ch. 1Z-4-000 001→ Produktionsdatum ab: 01.07.2006 Production date from: 01.07.2006
2.0 FSI 110 kW (150 PS) BLR, BVY	11.2004→10.2008		7.10334.09.0	AGR	EL
			7.05271.29.0	LS	900 mm BLR, BVY: rechts Right
			7.05271.16.0	LS	1300 mm BLR: hinten, links, rechts Rear, Left, Right Diagnosesonde Diagnostic Probe BVY: hinten, links Rear, Left Diagnosesonde Diagnostic Probe
2.0 FSI 110 kW (150 PS) BLY, BVZ	11.2004→10.2008		7.05271.16.0	LS	1300 mm BLY: hinten, links, rechts Rear, Left, Right Diagnosesonde Diagnostic Probe BVZ: hinten, links Rear, Left Diagnosesonde Diagnostic Probe
2.0 FSI 4x4 110 kW (150 PS) BLX, BVX	11.2004→04.2009		7.10334.09.0	AGR	EL
			7.05271.29.0	LS	900 mm BLX, BVX: rechts Right
			7.05271.16.0	LS	1300 mm BLX, BVX: rechts Right Diagnosesonde Diagnostic Probe
2.0 TDI 103 kW (140 PS) BMM	11.2005→05.2010		7.00678.04.0*	AGR-M	EL mit Rohrstützen with pipe socket
			7.00907.03.0	AGR	EL
			7.00678.06.0	AGR-M	EL BMM: ch. 1Z-4-000 001→ BMM: ch. 1Z-9-000 001→
			7.08369.00.0	ATS	EL Fahrgestellnummer ab: 1Z-4-000 001 Vehicle Identification Number from: 1Z-4-000 001
			7.08369.02.0	ATS	EL Fahrgestellnummer ab: 1Z-4-000 001 Vehicle Identification Number from: 1Z-4-000 001
			7.08369.03.0	ATS	EL Fahrgestellnummer ab: 1Z-4-000 001 Vehicle Identification Number from: 1Z-4-000 001
			7.11190.02.0	DDS	ch. 1Z-4-000 001→ Produktionsdatum bis: 30.06.2006 Production date to: 30.06.2006
			7.11492.02.0	DDS	ohne Zubehör without accessories ch. 1Z-4-000 001→ Produktionsdatum ab: 01.07.2006 Production date from: 01.07.2006
2.0 TDI 81 kW (110 PS) CFHF, CLCA	03.2010→06.2013		7.09720.00.0	AGR-K	EL
			7.00678.04.0*	AGR-M	EL mit Rohrstützen with pipe socket
			7.00907.03.0	AGR	EL
			7.11190.09.0	DDS	CFHF, CLCA: ch. 1Z-9-000 001→

S



OCTAVIA II Combi (1Z5) **19**

2.0 TDI 16V 103 kW (140 PS) BKD	02.2004→05.2013	 7.24809.16.0	AGR	PN	
2.0 TDI 16V 103 kW (140 PS) CFHC	02.2004→05.2013	 7.09720.00.0	AGR-K	EL	 ch. 1Z-9-000 001→
		 7.11190.09.0	DDS		 ch. 1Z-9-000 001→
2.0 TDI 16V 103 kW (140 PS) CLCB	02.2004→05.2013	 7.09720.00.0	AGR-K	EL	 ch. 1Z-9-000 001→
		 7.24809.16.0	AGR	PN	
2.0 TDI 16V 4x4 103 kW (140 PS) BKD, CLCB	05.2010→02.2013	 7.09720.00.0	AGR-K	EL	
2.0 TDI 4x4 103 kW (140 PS) BMM	07.2006→05.2010	 7.00678.04.0*	AGR-M	EL	mit Rohrstützen with pipe socket
		↳ 7.00907.03.0	AGR	EL	
		7.00678.06.0	AGR-M	EL	
		7.08369.00.0	ATS	EL	Fahrgestellnummer ab: 1Z-4-000 001 Vehicle Identification Number from: 1Z-4-000 001
		7.08369.02.0	ATS	EL	Fahrgestellnummer ab: 1Z-4-000 001 Vehicle Identification Number from: 1Z-4-000 001
		7.08369.03.0	ATS	EL	Fahrgestellnummer ab: 1Z-4-000 001 Vehicle Identification Number from: 1Z-4-000 001
		7.11190.02.0	DDS		 ch. 1Z-4-000 001→ Produktionsdatum bis: 30.06.2006 Production date to: 30.06.2006
		7.11492.02.0	DDS		ohne Zubehör without accessories  ch. 1Z-4-000 001→
2.0 TDI 4x4 81 kW (110 PS) CFHF	05.2011→02.2013	 7.09720.00.0	AGR-K	EL	
		7.00678.04.0*	AGR-M	EL	mit Rohrstützen with pipe socket
		↳ 7.00907.03.0	AGR	EL	
		7.11190.09.0	DDS		 ch. 1Z-9-000 001→
2.0 TDI RS 125 kW (170 PS) BMN	04.2006→02.2013	 7.10334.00.0	AGR	EL	 ch. 1Z-4-000 001→
		7.08369.00.0	ATS	EL	Fahrgestellnummer ab: 1Z-4-000 001 Vehicle Identification Number from: 1Z-4-000 001
		7.08369.02.0	ATS	EL	Fahrgestellnummer ab: 1Z-4-000 001 Vehicle Identification Number from: 1Z-4-000 001
		7.08369.03.0	ATS	EL	Fahrgestellnummer ab: 1Z-4-000 001 Vehicle Identification Number from: 1Z-4-000 001
		7.11190.02.0	DDS		 ch. 1Z-4-000 001→ Produktionsdatum bis: 30.06.2006 Production date to: 30.06.2006
		7.11492.02.0	DDS		ohne Zubehör without accessories  ch. 1Z-4-000 001→ Produktionsdatum ab: 01.07.2006 Production date from: 01.07.2006
2.0 TDI RS 125 kW (170 PS) CEGA	04.2006→02.2013	 7.10334.00.0	AGR	EL	 ch. 1Z-4-000 001→
		7.08369.00.0	ATS	EL	Fahrgestellnummer ab: 1Z-4-000 001 Vehicle Identification Number from: 1Z-4-000 001

OCTAVIA II Combi (1Z5) 19

		7.08369.01.0	ATS	EL	Fahrgestellnummer ab: 1Z-9-000 001 Vehicle Identification Number from: 1Z-9-000 001
		7.08369.04.0	ATS	EL	Fahrgestellnummer ab: 1Z-4-000 001 Vehicle Identification Number from: 1Z-4-000 001
		7.11492.00.0	DDS		ohne Zubehör without accessories Euro 5 Euro 5

















OCTAVIA III (5E3, NL3, NR3) 20

1.6 TDI 77 kW (105 PS) CLHA	11.2012→	7.10334.02.0	AGR	EL	ch. 5E-D-000 001→
		7.03608.16.0	AK	EL	ch. NE-D-000 001→
		7.08369.79.0	ATS	EL	ch. NE-D-000 001→
		7.08369.82.0	ATS	EL	ch. NE-D-000 001→
		7.11020.18.0	ATS	EL	ch. NE-D-000 001→ vor Katalysator in front of the catalyst
		7.11492.03.0	DDS		ohne Zubehör without accessories für OE-Nummer: 03L 906 051 B, 03L 906 051 D, 03N 906 051 B for OE number: 03L 906 051 B, 03L 906 051 D, 03N 906 051 B
1.6 TDI 66 kW (90 PS) CLHB	11.2012→	7.10334.02.0	AGR	EL	ch. 5E-D-000 001→
		7.03608.16.0	AK	EL	ch. NE-D-000 001→
		7.08369.79.0	ATS	EL	ch. NE-D-000 001→
		7.08369.82.0	ATS	EL	ch. NE-D-000 001→
		7.11020.18.0	ATS	EL	ch. NE-D-000 001→ vor Katalysator in front of the catalyst
		7.11492.03.0	DDS		ohne Zubehör without accessories für OE-Nummer: 03L 906 051 B, 03L 906 051 D, 03N 906 051 B for OE number: 03L 906 051 B, 03L 906 051 D, 03N 906 051 B
1.6 TDI 66 kW (90 PS) CRKA	11.2012→	7.08369.82.0	ATS	EL	ch. NE-D-000 001→
		7.11020.18.0	ATS	EL	ch. NE-D-000 001→ vor Katalysator in front of the catalyst Produktionsdatum bis: 25.05.2015 Production date to: 25.05.2015
		7.11492.05.0	DDS		ohne Zubehör without accessories ch. NE-D-000 001→ für PR-Nummer: 1E0, 7MM, FM0 for PR number: 1E0, 7MM, FM0 Produktionsdatum ab: 07.11.2016 Production date from: 07.11.2016
1.6 TDI 66 kW (90 PS) CXXA	11.2012→	7.10334.02.0	AGR	EL	ch. 5E-D-000 001→
		7.03608.16.0	AK	EL	→03.2016, ch. NE-D-000 001→
		7.07696.00.0	SRM-AK	EL	
		7.08369.95.0	ATS	EL	ch. NE-D-000 001→

S















OCTAVIA III (5E3, NL3, NR3) 20

			7.11020.17.0	ATS	EL	 ch. NE-D-000 001→ vor Katalysator in front of the catalyst Produktionsdatum ab: 25.05.2015 Production date from: 25.05.2015
			7.11492.03.0	DDS		ohne Zubehör without accessories für OE-Nummer: 03L 906 051 B, 03L 906 051 D, 03N 906 051 B for OE number: 03L 906 051 B, 03L 906 051 D, 03N 906 051 B
			7.11492.05.0	DDS		ohne Zubehör without accessories für PR-Nummer: 1E0, 7MM, FM0 for PR number: 1E0, 7MM, FM0 Produktionsdatum ab: 07.11.2016 Production date from: 07.11.2016
1.6 TDI 66 kW (90 PS) DDYB	11.2012→		7.10334.02.0	AGR	EL	
			7.08369.79.0	ATS	EL	
			7.08369.95.0	ATS	EL	für OE-Nummer: 04L 906 088 DA for OE number: 04L 906 088 DA
			7.11020.17.0	ATS	EL	vor Katalysator in front of the catalyst
			7.11020.23.0	ATS	EL	für OE-Nummer: 04L 906 088 DH for OE number: 04L 906 088 DH
			7.11492.05.0	DDS		ohne Zubehör without accessories für PR-Nummer: 1E0, 7MM, FM0 for PR number: 1E0, 7MM, FM0 Produktionsdatum ab: 07.11.2016 Production date from: 07.11.2016
1.6 TDI 81 kW (110 PS) CRKB	05.2013→		7.10334.02.0	AGR	EL	
			7.03608.16.0	AK	EL	 ch. NE-D-000 001→
			7.08369.79.0	ATS	EL	 ch. NE-D-000 001→
			7.08369.82.0	ATS	EL	 ch. NE-D-000 001→
			7.11020.18.0	ATS	EL	 ch. NE-D-000 001→ vor Katalysator in front of the catalyst
			7.11492.03.0	DDS		ohne Zubehör without accessories für OE-Nummer: 03L 906 051 B, 03L 906 051 D, 03N 906 051 B for OE number: 03L 906 051 B, 03L 906 051 D, 03N 906 051 B
1.6 TDI 81 kW (110 PS) CXXB	05.2013→		7.10334.02.0	AGR	EL	
			7.03608.16.0	AK	EL	→03.2016,  ch. NE-D-000 001→
			↳7.07696.00.0	SRM-AK	EL	
			7.08369.95.0	ATS	EL	 ch. NE-D-000 001→
			7.11020.17.0	ATS	EL	vor Katalysator in front of the catalyst Produktionsdatum ab: 25.05.2015 Production date from: 25.05.2015
			7.11492.03.0	DDS		ohne Zubehör without accessories für OE-Nummer: 03L 906 051 B, 03L 906 051 D, 03N 906 051 B for OE number: 03L 906 051 B, 03L 906 051 D, 03N 906 051 B
1.6 TDI 81 kW (110 PS) DBKA	05.2013→		7.10334.02.0	AGR	EL	
			7.03608.16.0	AK	EL	→03.2016,  ch. NE-D-000 001→

S































OCTAVIA III (5E3, NL3, NR3) 20

		↳ 7.07696.00.0 7.08369.95.0 7.11020.17.0	SRM-AK ATS ATS	EL EL EL	 ch. NE-D-000 001→  ch. NE-D-000 001→ vor Katalysator in front of the catalyst Produktionsdatum ab: 25.05.2015 Production date from: 25.05.2015 ohne Zubehör without accessories für PR-Nummer: 1E0 for PR number: 1E0
1.6 TDI 85 kW (115 PS) DDYA	02.2017→	 7.10334.02.0 7.08369.79.0 7.08369.95.0 7.11020.17.0 7.11020.23.0 7.11492.05.0	AGR ATS ATS ATS ATS DDS	EL EL EL EL EL	 für OE-Nummer: 04L 906 088 DA for OE number: 04L 906 088 DA vor Katalysator in front of the catalyst für OE-Nummer: 04L 906 088 DH for OE number: 04L 906 088 DH ohne Zubehör without accessories für OE-Nummer: 04L 906 051 AB, 04L 906 051 F, 04L 906 051 L for OE number: 04L 906 051 AB, 04L 906 051 F, 04L 906 051 L
1.6 TDI 85 kW (115 PS) DGTE	02.2017→	 7.11020.22.0 7.11020.23.0	ATS ATS	EL EL	für OE-Nummer: 04L 906 088 BF for OE number: 04L 906 088 BF Euro 6c, Euro 6d-Temp Euro 6c, Euro 6d-Temp Euro 6c, Euro 6d-Temp Euro 6c, Euro 6d-Temp
1.6 TDI 4x4 77 kW (105 PS) CLHA	09.2014→	 7.03608.16.0 7.08369.79.0 7.08369.82.0 7.11020.18.0 7.11492.03.0	AK ATS ATS ATS DDS	EL EL EL EL	 ch. NE-D-000 001→  ch. NE-D-000 001→  ch. NE-D-000 001→ vor Katalysator in front of the catalyst ohne Zubehör without accessories für OE-Nummer: 03L 906 051 B, 03L 906 051 D, 03N 906 051 B for OE number: 03L 906 051 B, 03L 906 051 D, 03N 906 051 B
1.6 TDI 4x4 81 kW (110 PS) CRKB	05.2015→	 7.03608.16.0 7.08369.82.0 7.11020.18.0 7.11020.22.0 7.11492.03.0	AK ATS ATS ATS DDS	EL EL EL EL	 ch. NE-D-000 001→  ch. NE-D-000 001→ vor Katalysator in front of the catalyst für OE-Nummer: 04L 906 088 BF for OE number: 04L 906 088 BF Euro 6c, Euro 6d-Temp Euro 6c, Euro 6d-Temp ohne Zubehör without accessories für OE-Nummer: 03L 906 051 B, 03L 906 051 D, 03N 906 051 B for OE number: 03L 906 051 B, 03L 906 051 D, 03N 906 051 B
1.6 TDI 4x4 81 kW (110 PS) CXXB	05.2015→	 7.03608.16.0	AK	EL	→03.2016



















S



OCTAVIA III (5E3, NL3, NR3) 20

		↳ 7.07696.00.0 7.08369.95.0 7.11020.17.0	SRM-AK ATS ATS	EL EL EL	 ch. NE-D-000 001→  ch. NE-D-000 001→ vor Katalysator in front of the catalyst Produktionsdatum ab: 15.05.2015 Production date from: 15.05.2015 ohne Zubehör without accessories für OE-Nummer: 03L 906 051 B, 03L 906 051 D, 03N 906 051 B for OE number: 03L 906 051 B, 03L 906 051 D, 03N 906 051 B
1.6 TDI 4x4 85 kW (115 PS) DGTE	02.2017→	 7.11020.22.0 7.11020.23.0 7.11492.05.0	ATS ATS DDS	EL EL	für OE-Nummer: 04L 906 088 BF for OE number: 04L 906 088 BF Euro 6c, Euro 6d-Temp Euro 6c, Euro 6d-Temp Euro 6c, Euro 6d-Temp ohne Zubehör without accessories für OE-Nummer: 04L 906 051 AB, 04L 906 051 F, 04L 906 051 L for OE number: 04L 906 051 AB, 04L 906 051 L
2.0 TDI 110 kW (150 PS) CKFC, CRMB, CYKA	11.2012→	 7.10334.02.0 7.03608.16.0 7.08369.81.0 7.11492.03.0	AGR AK ATS DDS	EL EL EL	 CKFC, CRMB, CYKA:  ch. 5E-D-000 001→  CKFC, CRMB, CYKA:  ch. NE-D-000 001→  CKFC, CRMB:  ch. NE-D-000 001→  CYKA: für PR-Nummer: 7MJ for PR number: 7MJ ohne Zubehör without accessories  CKFC, CRMB, CYKA: für OE-Nummer: 03L 906 051 B, 03L 906 051 D, 03N 906 051 B for OE number: 03L 906 051 B, 03L 906 051 D, 03N 906 051 B
2.0 TDI 110 kW (150 PS) DCYA	11.2012→	 7.03608.16.0 7.08369.81.0	AK ATS	EL EL	 ch. NE-D-000 001→
2.0 TDI 110 kW (150 PS) DFFA	11.2012→	 7.08369.81.0 7.07696.00.0	ATS SRM-AK	EL EL	Produktionsdatum ab: 01.05.2018 Production date from: 01.05.2018
2.0 TDI 105 kW (143 PS) CKFB	11.2012→	 7.10334.02.0 7.08369.81.0	AGR ATS	EL EL	 ch. 5E-D-000 001→  ch. NE-D-000 001→
2.0 TDI 105 kW (143 PS) CRVC	11.2012→	 7.10334.02.0 7.03608.16.0 7.08369.81.0	AGR AK ATS	EL EL EL	 ch. 5E-D-000 001→  ch. NE-D-000 001→  ch. NE-D-000 001→
2.0 TDI / TDI RS 4x4 135 kW (184 PS) CUNA, CUPA	05.2013→	 7.10334.02.0 7.03608.16.0 7.08369.81.0	AGR AK ATS	EL EL EL	 CUNA, CUPA:  ch. 5E-D-000 001→  CUNA, CUPA:  ch. NE-D-000 001→  CUNA, CUPA:  ch. NE-D-000 001→







S

					
OCTAVIA III (5E3, NL3, NR3)					20
			7.11492.03.0	DDS	ohne Zubehör without accessories  CUNA, CUPA: für OE-Nummer: 03L 906 051 B, 03L 906 051 D, 03N 906 051 B for OE number: 03L 906 051 B, 03L 906 051 D, 03N 906 051 B
2.0 TDI / TDI RS 4x4 135 kW (184 PS) DJGA	05.2013→		7.07696.00.0	SRM-AK	EL
2.0 TDI 4x4 110 kW (150 PS) CKFC	09.2014→		7.10334.02.0	AGR	EL  ch. 5E-D-000 001→
			7.03608.16.0	AK	EL
			7.08369.81.0	ATS	EL  ch. NE-D-000 001→
			7.11492.05.0	DDS	ohne Zubehör without accessories  ch. NE-D-000 001→ für Getriebeautomatik 7 Gang for 7-speed automatic transmission für Hersteller-Abgasnorm: Euro 6 plus for manufacturer exhaust norm: Euro 6 plus Produktionsdatum ab: 07.11.2016 Production date from: 07.11.2016
			7.11492.03.0	DDS	ohne Zubehör without accessories für OE-Nummer: 03L 906 051 B, 03L 906 051 D, 03N 906 051 B for OE number: 03L 906 051 B, 03L 906 051 D, 03N 906 051 B
2.0 TDI 4x4 110 kW (150 PS) CRMB	09.2014→		7.03608.16.0	AK	EL
			7.08369.81.0	ATS	EL  ch. NE-D-000 001→
			7.11492.05.0	DDS	ohne Zubehör without accessories  ch. NE-D-000 001→ für Getriebeautomatik 7 Gang for 7-speed automatic transmission für Hersteller-Abgasnorm: Euro 6 plus for manufacturer exhaust norm: Euro 6 plus Produktionsdatum ab: 07.11.2016 Production date from: 07.11.2016
			7.11492.03.0	DDS	ohne Zubehör without accessories für OE-Nummer: 03L 906 051 B, 03L 906 051 D, 03N 906 051 B for OE number: 03L 906 051 B, 03L 906 051 D, 03N 906 051 B
2.0 TDI 4x4 110 kW (150 PS) DCYA	09.2014→		7.03608.16.0	AK	EL
			7.08369.81.0	ATS	EL
			7.11492.05.0	DDS	ohne Zubehör without accessories für Getriebeautomatik 7 Gang for 7-speed automatic transmission für Hersteller-Abgasnorm: Euro 6 plus for manufacturer exhaust norm: Euro 6 plus für PR-Nummer: 1E0 for PR number: 1E0
2.0 TDI 4x4 110 kW (150 PS) DFFA	01.2017→		7.10334.02.0	AGR	EL 
			7.08369.81.0	ATS	EL Produktionsdatum ab: 01.05.2018 Production date from: 01.05.2018















S



OCTAVIA III (5E3, NL3, NR3) 20

			7.11492.05.0	DDS		ohne Zubehör without accessories für Getriebeautomatik 7 Gang for 7-speed automatic transmission für Hersteller-Abgasnorm: Euro 6 plus for manufacturer exhaust norm: Euro 6 plus für PR-Nummer: 1E0 for PR number: 1E0
2.0 TDI RS 135 kW (184 PS) CUNA, CUPA	05.2013→		7.03608.16.0	AK	EL	 CUNA, CUPA:  ch. NE-D-000 001→
			7.08369.81.0	ATS	EL	 CUNA, CUPA:  ch. NE-D-000 001→
			7.11492.03.0	DDS		ohne Zubehör without accessories  CUNA, CUPA: für OE-Nummer: 03L 906 051 B, 03L 906 051 D, 03N 906 051 B for OE number: 03L 906 051 B, 03L 906 051 D, 03N 906 051 B
2.0 TDI RS 135 kW (184 PS) DJGA	05.2013→		7.07696.00.0	SRM-AK	EL	

OCTAVIA III Combi (5E5, 5E6) 21

1.6 TDI 77 kW (105 PS) CLHA	11.2012→		7.10334.02.0	AGR	EL	 ch. 5E-D-000 001→
			7.03608.16.0	AK	EL	 ch. NE-D-000 001→
			7.08369.79.0	ATS	EL	 ch. NE-D-000 001→
			7.11020.18.0	ATS	EL	 ch. NE-D-000 001→ vor Katalysator in front of the catalyst
			7.11492.03.0	DDS		ohne Zubehör without accessories für OE-Nummer: 03L 906 051 B, 03L 906 051 D, 03N 906 051 B for OE number: 03L 906 051 B, 03L 906 051 D, 03N 906 051 B
1.6 TDI 66 kW (90 PS) CLHB	11.2012→		7.10334.02.0	AGR	EL	 ch. 5E-D-000 001→
			7.03608.16.0	AK	EL	 ch. NE-D-000 001→
			7.08369.79.0	ATS	EL	 ch. NE-D-000 001→
			7.08369.82.0	ATS	EL	 ch. NE-D-000 001→
			7.11020.18.0	ATS	EL	 ch. NE-D-000 001→ vor Katalysator in front of the catalyst
			7.11492.05.0	DDS		ohne Zubehör without accessories  ch. NE-D-000 001→ für PR-Nummer: 1E0, 7MM, FM0 for PR number: 1E0, 7MM, FM0 Produktionsdatum ab: 07.11.2016 Production date from: 07.11.2016
			7.11492.03.0	DDS		ohne Zubehör without accessories für OE-Nummer: 03L 906 051 B, 03L 906 051 D, 03N 906 051 B for OE number: 03L 906 051 B, 03L 906 051 D, 03N 906 051 B
1.6 TDI 66 kW (90 PS) CRKA	11.2012→		7.08369.82.0	ATS	EL	 ch. NE-D-000 001→
			7.11020.18.0	ATS	EL	 ch. NE-D-000 001→ vor Katalysator in front of the catalyst Produktionsdatum bis: 25.05.2015 Production date to: 25.05.2015

S

















OCTAVIA III Combi (5E5, 5E6) 21

			7.11492.05.0	DDS		ohne Zubehör without accessories ch. NE-D-000 001→ für PR-Nummer: 1E0, 7MM, FM0 for PR number: 1E0, 7MM, FM0 Produktionsdatum ab: 07.11.2016 Production date from: 07.11.2016
1.6 TDI 66 kW (90 PS) CXXA	11.2012→		7.10334.02.0	AGR	EL	ch. 59078→
			7.03608.16.0	AK	EL	→06.2016, ch. NE-D-000 001→
			↳7.07696.00.0	SRM-AK	EL	
			7.08369.95.0	ATS	EL	ch. NE-D-000 001→
			7.11020.17.0	ATS	EL	ch. NE-D-000 001→ vor Katalysator in front of the catalyst Produktionsdatum ab: 25.05.2015 Production date from: 25.05.2015
			7.11492.05.0	DDS		ohne Zubehör without accessories ch. NE-D-000 001→ für PR-Nummer: 1E0, 7MM, FM0 for PR number: 1E0, 7MM, FM0 Produktionsdatum ab: 07.11.2016 Production date from: 07.11.2016
			7.11492.03.0	DDS		ohne Zubehör without accessories für OE-Nummer: 03L 906 051 B, 03L 906 051 D, 03N 906 051 B for OE number: 03L 906 051 B, 03L 906 051 D, 03N 906 051 B
1.6 TDI 66 kW (90 PS) DDYB	11.2012→		7.10334.02.0	AGR	EL	
			7.08369.79.0	ATS	EL	
			7.08369.95.0	ATS	EL	für OE-Nummer: 04L 906 088 DA for OE number: 04L 906 088 DA
			7.11020.17.0	ATS	EL	vor Katalysator in front of the catalyst
			7.11020.23.0	ATS	EL	für OE-Nummer: 04L 906 088 DH for OE number: 04L 906 088 DH
			7.11492.05.0	DDS		ohne Zubehör without accessories für PR-Nummer: 1E0, 7MM, FM0 for PR number: 1E0, 7MM, FM0 Produktionsdatum ab: 07.11.2016 Production date from: 07.11.2016
1.6 TDI 81 kW (110 PS) CRKB	05.2013→		7.03608.16.0	AK	EL	ch. NE-D-000 001→
			7.08369.79.0	ATS	EL	ch. NE-D-000 001→
			7.08369.82.0	ATS	EL	ch. NE-D-000 001→
			7.11020.18.0	ATS	EL	ch. NE-D-000 001→ vor Katalysator in front of the catalyst
			7.11492.03.0	DDS		ohne Zubehör without accessories für OE-Nummer: 03L 906 051 B, 03L 906 051 D, 03N 906 051 B for OE number: 03L 906 051 B, 03L 906 051 D, 03N 906 051 B
1.6 TDI 81 kW (110 PS) CXXB	05.2013→		7.10334.02.0	AGR	EL	ch. 5E-D-000 001→
			7.03608.16.0	AK	EL	→03.2016, ch. NE-D-000 001→
			↳7.07696.00.0	SRM-AK	EL	











S



OCTAVIA III Combi (5E5, 5E6) 21

			7.11020.17.0	ATS	EL	 ch. NE-D-000 001→ vor Katalysator in front of the catalyst Produktionsdatum ab: 25.05.2015 Production date from: 25.05.2015
			7.11492.03.0	DDS		ohne Zubehör without accessories für OE-Nummer: 03L 906 051 B, 03L 906 051 D, 03N 906 051 B for OE number: 03L 906 051 B, 03L 906 051 D, 03N 906 051 B
1.6 TDI 81 kW (110 PS) DBKA	05.2013→		7.10334.02.0	AGR	EL	 ch. 5E-D-000 001→
			7.03608.16.0	AK	EL	→03.2016,  ch. NE-D-000 001→
			↳7.07696.00.0	SRM-AK	EL	
			7.08369.95.0	ATS	EL	 ch. NE-D-000 001→
			7.11020.17.0	ATS	EL	 ch. NE-D-000 001→ vor Katalysator in front of the catalyst Produktionsdatum ab: 25.05.2015 Production date from: 25.05.2015
			7.08369.79.0	ATS	EL	ohne Zubehör without accessories für PR-Nummer: 1E0 for PR number: 1E0
			7.11492.03.0	DDS		
1.6 TDI 85 kW (115 PS) DDYA	02.2017→		7.10334.02.0	AGR	EL	
			7.08369.79.0	ATS	EL	
			7.08369.95.0	ATS	EL	für OE-Nummer: 04L 906 088 DA for OE number: 04L 906 088 DA
			7.11020.17.0	ATS	EL	vor Katalysator in front of the catalyst
			7.11020.23.0	ATS	EL	für OE-Nummer: 04L 906 088 DH for OE number: 04L 906 088 DH
			7.11492.05.0	DDS		ohne Zubehör without accessories für OE-Nummer: 04L 906 051 AB, 04L 906 051 F, 04L 906 051 L for OE number: 04L 906 051 AB, 04L 906 051 F, 04L 906 051 L
1.6 TDI 85 kW (115 PS) DGTA	02.2017→		7.11492.05.0	DDS		ohne Zubehör without accessories für OE-Nummer: 04L 906 051 AB, 04L 906 051 F, 04L 906 051 L for OE number: 04L 906 051 AB, 04L 906 051 F, 04L 906 051 L
1.6 TDI 85 kW (115 PS) DGTE	02.2017→		7.11020.22.0	ATS	EL	für OE-Nummer: 04L 906 088 BF for OE number: 04L 906 088 BF Euro 6c, Euro 6d-Temp
			7.11020.23.0	ATS	EL	Euro 6c, Euro 6d-Temp Euro 6c, Euro 6d-Temp
1.6 TDI 4x4 77 kW (105 PS) CLHA	11.2012→		7.03608.16.0	AK	EL	 ch. NE-D-000 001→
			7.08369.79.0	ATS	EL	 ch. NE-D-000 001→
			7.08369.82.0	ATS	EL	 ch. NE-D-000 001→
			7.11020.18.0	ATS	EL	 ch. NE-D-000 001→ vor Katalysator in front of the catalyst



































OCTAVIA III Combi (5E5, 5E6) 21













			7.11492.03.0	DDS		ohne Zubehör without accessories für OE-Nummer: 03L 906 051 B, 03L 906 051 D, 03N 906 051 B for OE number: 03L 906 051 B, 03L 906 051 D, 03N 906 051 B
1.6 TDI 4x4 81 kW (110 PS) CRKB	05.2015→		7.03608.16.0	AK	EL	
			7.08369.82.0	ATS	EL	 ch. NE-D-000 001→
			7.08369.95.0	ATS	EL	 ch. NE-D-000 001→
			7.11020.18.0	ATS	EL	 ch. NE-D-000 001→ vor Katalysator in front of the catalyst
			7.11020.22.0	ATS	EL	für OE-Nummer: 04L 906 088 BF for OE number: 04L 906 088 BF Euro 6c, Euro 6d-Temp Euro 6c, Euro 6d-Temp
			7.11492.03.0	DDS		ohne Zubehör without accessories für OE-Nummer: 03L 906 051 B, 03L 906 051 D, 03N 906 051 B for OE number: 03L 906 051 B, 03L 906 051 D, 03N 906 051 B
1.6 TDI 4x4 81 kW (110 PS) CXXB	05.2015→		7.03608.16.0	AK	EL	→03.2016
			↳ 7.07696.00.0	SRM-AK	EL	
			7.08369.95.0	ATS	EL	 ch. NE-D-000 001→
			7.11020.17.0	ATS	EL	 ch. NE-D-000 001→ vor Katalysator in front of the catalyst Produktionsdatum ab: 25.05.2015 Production date from: 25.05.2015
			7.11492.03.0	DDS		ohne Zubehör without accessories für OE-Nummer: 03L 906 051 B, 03L 906 051 D, 03N 906 051 B for OE number: 03L 906 051 B, 03L 906 051 D, 03N 906 051 B
1.6 TDI 4x4 81 kW (110 PS) DBKA	05.2015→		7.03608.16.0	AK	EL	→03.2016
			↳ 7.07696.00.0	SRM-AK	EL	
			7.11020.17.0	ATS	EL	 ch. NE-D-000 001→ vor Katalysator in front of the catalyst Produktionsdatum ab: 25.05.2015 Production date from: 25.05.2015
			7.11020.22.0	ATS	EL	für OE-Nummer: 04L 906 088 BF for OE number: 04L 906 088 BF Euro 6c, Euro 6d-Temp Euro 6c, Euro 6d-Temp
			7.11492.03.0	DDS		ohne Zubehör without accessories für OE-Nummer: 03L 906 051 B, 03L 906 051 D, 03N 906 051 B for OE number: 03L 906 051 B, 03L 906 051 D, 03N 906 051 B
1.6 TDI 4x4 85 kW (115 PS) DGTE	02.2017→		7.11020.22.0	ATS	EL	für OE-Nummer: 04L 906 088 BF for OE number: 04L 906 088 BF Euro 6c, Euro 6d-Temp Euro 6c, Euro 6d-Temp
			7.11020.23.0	ATS	EL	Euro 6c, Euro 6d-Temp Euro 6c, Euro 6d-Temp













OCTAVIA III Combi (5E5, 5E6) 21





			7.11492.05.0	DDS		ohne Zubehör without accessories für OE-Nummer: 04L 906 051 AB, 04L 906 051 F, 04L 906 051 L for OE number: 04L 906 051 AB, 04L 906 051 F, 04L 906 051 L
2.0 TDI 110 kW (150 PS) CKFC	11.2012→		7.03608.16.0	AK	EL	 ch. NE-D-000 001→
			7.11492.03.0	DDS		ohne Zubehör without accessories für OE-Nummer: 03L 906 051 B, 03L 906 051 D, 03N 906 051 B for OE number: 03L 906 051 B, 03L 906 051 D, 03N 906 051 B
2.0 TDI 110 kW (150 PS) CRMB, CYKA	11.2012→		7.10334.02.0	AGR	EL	 CRMB, CYKA:  ch. 5E-D-000 001→
			7.03608.16.0	AK	EL	 CRMB, CYKA:  ch. NE-D-000 001→
			7.11492.03.0	DDS		ohne Zubehör without accessories  CRMB, CYKA: für OE-Nummer: 03L 906 051 B, 03L 906 051 D, 03N 906 051 B for OE number: 03L 906 051 B, 03L 906 051 D, 03N 906 051 B
2.0 TDI 110 kW (150 PS) DCYA	11.2012→		7.03608.16.0	AK	EL	 ch. NE-D-000 001→
2.0 TDI 110 kW (150 PS) DFFA	11.2012→		7.10334.02.0	AGR	EL	
			7.07696.00.0	SRM-AK	EL	
2.0 TDI 105 kW (143 PS) CKFB	11.2012→		7.10334.02.0	AGR	EL	 ch. 5E-D-000 001→
			7.08369.81.0	ATS	EL	 ch. NE-D-000 001→
2.0 TDI 105 kW (143 PS) CRVC	11.2012→		7.10334.02.0	AGR	EL	 ch. 5E-D-000 001→
			7.03608.16.0	AK	EL	 ch. NE-D-000 001→
			7.08369.81.0	ATS	EL	 ch. NE-D-000 001→
2.0 TDI / TDI RS 4x4 135 kW (184 PS) CUNA, CUPA	09.2014→		7.10334.02.0	AGR	EL	 CUNA, CUPA:  ch. 5E-D-000 001→
			7.03608.16.0	AK	EL	 CUNA, CUPA:  ch. NE-D-000 001→
			7.08369.81.0	ATS	EL	 CUNA, CUPA:  ch. NE-D-000 001→
			7.11492.03.0	DDS		ohne Zubehör without accessories  CUNA, CUPA: für OE-Nummer: 03L 906 051 B, 03L 906 051 D, 03N 906 051 B for OE number: 03L 906 051 B, 03L 906 051 D, 03N 906 051 B
2.0 TDI / TDI RS 4x4 135 kW (184 PS) DJGA	09.2014→		7.07696.00.0	SRM-AK	EL	
2.0 TDI 4x4 110 kW (150 PS) CKFC, CRMB	11.2012→		7.03608.16.0	AK	EL	 CKFC, CRMB:  ch. NE-D-000 001→
			7.08369.81.0	ATS	EL	 CKFC, CRMB:  ch. NE-D-000 001→



					
OCTAVIA III Combi (5E5, 5E6)					21
			7.11492.05.0	DDS	ohne Zubehör without accessories  CKFC, CRMB:  ch. NE-D-000 001→ für Getriebeautomatik 7 Gang for 7-speed automatic transmission für Hersteller-Abgasnorm: Euro 6 plus for manufacturer exhaust norm: Euro 6 plus Produktionsdatum ab: 07.11.2016 Production date from: 07.11.2016
			7.11492.03.0	DDS	ohne Zubehör without accessories  CKFC, CRMB: für OE-Nummer: 03L 906 051 B, 03L 906 051 D, 03N 906 051 B for OE number: 03L 906 051 B, 03L 906 051 D, 03N 906 051 B
2.0 TDI 4x4 110 kW (150 PS) DCYA	11.2012→		7.03608.16.0	AK	EL  ch. NE-D-000 001→
			7.08369.81.0	ATS	EL
			7.11492.05.0	DDS	ohne Zubehör without accessories für Getriebeautomatik 7 Gang for 7-speed automatic transmission für Hersteller-Abgasnorm: Euro 6 plus for manufacturer exhaust norm: Euro 6 plus für PR-Nummer: 1E0 for PR number: 1E0
2.0 TDI 4x4 110 kW (150 PS) DFFA	11.2012→		7.08369.81.0	ATS	EL Produktionsdatum ab: 01.05.2018 Production date from: 01.05.2018
			7.11492.05.0	DDS	ohne Zubehör without accessories für Getriebeautomatik 7 Gang for 7-speed automatic transmission für Hersteller-Abgasnorm: Euro 6 plus for manufacturer exhaust norm: Euro 6 plus für PR-Nummer: 1E0 for PR number: 1E0
			7.07696.00.0	SRM-AK	EL
2.0 TDI RS 135 kW (184 PS) CUNA, CUPA	05.2013→		7.03608.16.0	AK	EL  CUNA, CUPA:  ch. NE-D-000 001→
			7.08369.81.0	ATS	EL  CUNA, CUPA:  ch. NE-D-000 001→
			7.11492.03.0	DDS	ohne Zubehör without accessories  CUNA, CUPA: für OE-Nummer: 03L 906 051 B, 03L 906 051 D, 03N 906 051 B for OE number: 03L 906 051 B, 03L 906 051 D, 03N 906 051 B
2.0 TDI RS 135 kW (184 PS) DJGA	05.2013→		7.07696.00.0	SRM-AK	EL
OCTAVIA IV (NX3)					22
2.0 TDI 85 kW (116 PS) DSUD	03.2020→		7.11492.05.0	DDS	ohne Zubehör without accessories  ch. NX-L-000 001→
OCTAVIA IV Combi (NX5)					23
2.0 TDI 85 kW (116 PS) DSUD	11.2019→		7.11492.05.0	DDS	ohne Zubehör without accessories  ch. NX-L-000 001→



RAPID (NA2)						24
1.5 TDI 77 kW (105 PS) CWXB	01.2014→08.2016		7.09720.00.0	AGR-K	EL	<input type="checkbox"/>
1.5 TDI 81 kW (110 PS) CWXC	09.2016→10.2019		7.09720.00.0	AGR-K	EL	<input type="checkbox"/>
1.6 TDI 77 kW (105 PS) CLNA	10.2011→12.2013		7.09720.00.0	AGR-K	EL	<input type="checkbox"/>
			7.09720.01.0	AGR-K	EL	<input type="checkbox"/>
für PR-Nummer: T1S for PR number: T1S						
für PR-Nummer: TF3 for PR number: TF3						

















RAPID (NH3)						25
1.4 TSI 90 kW (122 PS) CAXA	07.2012→06.2015		7.05271.15.0	LS	525 mm	
1.6 TDI 77 kW (105 PS) CAYC	07.2012→12.2019		7.09720.01.0	AGR-K	EL	<input type="checkbox"/>
			7.08369.09.0	ATS	EL	für Linkslenker for left-hand drive vehicles
			7.08369.11.0	ATS	EL	
			7.08369.26.0	ATS	EL	
1.6 TDI 77 kW (105 PS) CLNA	07.2012→12.2019		7.11190.09.0	DDS		
			7.09720.00.0	AGR-K	EL	<input type="checkbox"/>
			7.09720.01.0	AGR-K	EL	<input type="checkbox"/>
1.6 TDI 66 kW (90 PS) CAYB	08.2013→05.2015		7.09720.01.0	AGR-K	EL	<input type="checkbox"/>
			7.08369.09.0	ATS	EL	für Linkslenker for left-hand drive vehicles
			7.08369.11.0	ATS	EL	für Rechtslenker for right-hand drive vehicles
			7.08369.26.0	ATS	EL	
1.6 TDI 66 kW (90 PS) CAYB	08.2013→05.2015		7.11190.09.0	DDS		
			7.11190.09.0	DDS		

RAPID Spaceback (NH1)						26
1.4 TSI 90 kW (122 PS) CAXA	07.2012→06.2015		7.05271.15.0	LS	525 mm	
1.6 TDI 77 kW (105 PS) CAYC	07.2012→12.2019		7.09720.01.0	AGR-K	EL	<input type="checkbox"/>
			7.08369.09.0	ATS	EL	für Linkslenker for left-hand drive vehicles
			7.08369.11.0	ATS	EL	
			7.08369.26.0	ATS	EL	
1.6 TDI 77 kW (105 PS) CLNA	07.2012→12.2019		7.11190.09.0	DDS		
			7.09720.00.0	AGR-K	EL	<input type="checkbox"/>
			7.09720.01.0	AGR-K	EL	<input type="checkbox"/>
1.6 TDI 66 kW (90 PS) CAYB	08.2013→05.2015		7.09720.01.0	AGR-K	EL	<input type="checkbox"/>
			7.08369.09.0	ATS	EL	für Linkslenker for left-hand drive vehicles
			7.08369.11.0	ATS	EL	für Rechtslenker for right-hand drive vehicles
			7.08369.26.0	ATS	EL	
1.6 TDI 66 kW (90 PS) CAYB	08.2013→05.2015		7.11190.09.0	DDS		
			7.11190.09.0	DDS		

ROOMSTER (5J7)						27
1.2 47 kW (64 PS) BME	05.2006→01.2007		7.05271.20.0	LS	500 mm	
1.2 51 kW (70 PS) BZG, CGPA	01.2007→05.2015		7.05271.20.0	LS	500 mm	

S







ROOMSTER (5J7) **27**

1.2 TDI 55 kW (75 PS) CFWA	03.2010→05.2015	 7.09720.02.0	AGR-K	EL	 für Rechtslenker for right-hand drive vehicles für Linkslenker for left-hand drive vehicles nach Rußpartikelfilter after soot particulate filter Produktionsdatum ab: 31.05.2010 Production date from: 31.05.2010
		7.08369.50.0	ATS	EL	
		7.08369.11.0	ATS	EL	
		7.08369.37.0	ATS	EL	
		7.08369.83.0	ATS	EL	
		7.11190.09.0	DDS		
1.4 63 kW (85-86 PS) BXW, CGGB	09.2006→05.2015	 7.05271.05.0	LS	700 mm	 BXW, CGGB: nach Katalysator Post-catalyst
1.4 TDI 51 kW (70 PS) BNM	07.2006→03.2010	 7.24809.31.0	AGR	PN	
1.4 TDI 59 kW (80 PS) BMS	09.2006→03.2010	 7.00678.04.0*	AGR-M	EL	mit Rohrstutzen with pipe socket
		↳ 7.00907.03.0	AGR	EL	
		7.00678.06.0	AGR-M	EL	
		7.11020.03.0	ATS	EL	 ch. 5J-65012 510→
		7.08369.53.0	ATS	EL	vor Rußpartikelfilter before soot particulate filter
		7.08369.86.0	ATS	EL	für Rechtslenker for right-hand drive vehicles
		7.11020.02.0	ATS	EL	 →ch. 5J-65012 509 nach Rußpartikelfilter after soot particulate filter
		7.11020.07.0	ATS	EL	für Linkslenker for left-hand drive vehicles
		7.11492.00.0	DDS		ohne Zubehör without accessories Fahrgestellnummer ab: F 5J-A5006 000, F 5J-AB600 000 Vehicle Identification Number from: F 5J-A5006 000, F 5J-AB600 000
		7.11492.02.0	DDS		ohne Zubehör without accessories Fahrgestellnummer bis: 5J-95038 314, 5J-9B601 986 Vehicle Identification Number to: 5J-95038 314, 5J-9B601 986
1.4 TDI 59 kW (80 PS) BNV	09.2006→03.2010	 7.24809.31.0	AGR	PN	
1.6 77 kW (105 PS) BTS, CFNA	09.2006→05.2015	 7.05271.18.0	LS	525 mm	
1.6 TDI 66 kW (90 PS) CAYB	03.2010→05.2015	 7.09720.01.0	AGR-K	EL	
		7.08369.09.0	ATS	EL	für Linkslenker for left-hand drive vehicles
		7.08369.11.0	ATS	EL	für Rechtslenker for right-hand drive vehicles
		7.08369.26.0	ATS	EL	
		7.11190.09.0	DDS		
1.6 TDI 77 kW (105 PS) CAYC	03.2010→05.2015	 7.09720.01.0	AGR-K	EL	
		7.08369.09.0	ATS	EL	für Linkslenker for left-hand drive vehicles
		7.08369.11.0	ATS	EL	für Rechtslenker for right-hand drive vehicles
		7.08369.26.0	ATS	EL	



S



ROOMSTER (5J7) 27













			7.11190.09.0	DDS		
1.9 TDI 74 kW (100 PS) AXR	03.2006→05.2006		7.24809.16.0	AGR	PN	
1.9 TDI 77 kW (105 PS) BLS	09.2006→03.2010		7.00678.04.0*	AGR-M	EL	mit Rohrstutzen with pipe socket
			↳ 7.00907.03.0	AGR	EL	
			7.00678.06.0	AGR-M	EL	
			7.08369.00.0	ATS	EL	
			7.08369.53.0	ATS	EL	vor Rußpartikelfilter before soot particulate filter
			7.11020.02.0	ATS	EL	
			7.11020.07.0	ATS	EL	für OE-Nummer: 045 906 088 C, 045 906 088 G for OE number: 045 906 088 C, 045 906 088 G
			7.11492.00.0	DDS		ohne Zubehör without accessories Fahrgestellnummer ab: F 5J-A5006 000, F 5J-AB600 000 Vehicle Identification Number from: F 5J-A5006 000, F 5J-AB600 000
			7.11492.02.0	DDS		ohne Zubehör without accessories Fahrgestellnummer bis: 5J-95038 314, 5J-9B601 986 Vehicle Identification Number to: 5J-95038 314, 5J-9B601 986
1.9 TDI 77 kW (105 PS) BSW	09.2006→03.2010		7.24809.16.0	AGR	PN	



























SCALA (NW1) 28

1.6 TDI 85 kW (115 PS) DGTA	02.2019→		7.10334.02.0	AGR	EL	
			7.11020.17.0	ATS	EL	Euro 6 Euro 6 für Vorkatalysator for pre-catalyst
			7.11020.23.0	ATS	EL	Euro 6d-Temp Euro 6d-Temp
			7.11492.05.0	DDS		ohne Zubehör without accessories für OE-Nummer: 04L 906 051 AB, 04L 906 051 F, 04L 906 051 L for OE number: 04L 906 051 AB, 04L 906 051 F, 04L 906 051 L
			7.07696.00.0	SRM-AK	EL	

S

























SUPERB I (3U4) 29

1.8 T 110 kW (150 PS) AWT	12.2001→03.2008		7.22560.43.0	ARV	PN	
			7.22738.08.0	SLP	EL	
1.9 TDI 96 kW (130 PS) AVF, AWX	12.2001→03.2008		7.24809.20.0	AGR	PN	
1.9 TDI 74 kW (101 PS) AVB	08.2002→10.2005		7.24809.19.0	AGR	PN	
1.9 TDI 77 kW (105 PS) BSV	10.2005→05.2007		7.00365.06.0	AGR	EL	
1.9 TDI 85 kW (115 PS) BPZ	01.2007→03.2008		7.00365.06.0	AGR	EL	
2.0 85 kW (115 PS) AZM	12.2001→03.2008		7.05271.07.0	LS	1100 mm	
			7.22738.08.0	SLP	EL	
			7.22778.95.0	SLV	PN	



					
SUPERB I (3U4)					29
2.0 TDI 103 kW (140 PS) BSS	10.2005→03.2008		7.00365.06.0	AGR	EL 
			7.08369.40.0	ATS	EL Euro 4
			7.08369.72.0	ATS	EL Euro 4
			7.11190.00.0	DDS	EL vor Rußpartikelfilter before soot particulate filter
2.8 V6 142 kW (193 PS) AMX	12.2001→03.2008		7.22560.40.0	ARV	PN  links Left
			7.22560.41.0	ARV	PN  rechts Right
			7.22738.08.0	SLP	EL
2.8 V6 140 kW (190 PS) BBG	06.2002→03.2008		7.22560.40.0	ARV	PN  links Left
			7.22560.41.0	ARV	PN  rechts Right
			7.22738.08.0	SLP	EL
SUPERB II (3T4)					30
1.6 TDI 77 kW (105 PS) CAYC	09.2010→05.2015		7.09720.00.0	AGR-K	EL 
			7.08369.01.0	ATS	EL Fahrgestellnummer ab: 3T-8-000 001 Vehicle Identification Number from: 3T-8-000 001
			7.08369.04.0	ATS	EL Fahrgestellnummer ab: 3T-8-000 001 Vehicle Identification Number from: 3T-8-000 001
			7.11492.00.0	DDS	EL ohne Zubehör without accessories  ch. 3T-8-000 001→
1.8 TSI 118 kW (160 PS) BZB	03.2008→05.2015		7.05271.19.0	LS	975 mm vorne Front Diagnosesonde Diagnostic Probe
			7.05271.11.0	LS	800 mm Regelsonde Regulating Probe
1.9 TDI 77 kW (105 PS) BLS	03.2008→11.2010		7.00907.03.0	AGR	EL   ch. 3T-8-000 001→
			7.00678.06.0	AGR-M	EL  ch. 3T-8-000 001→
			7.08369.00.0	ATS	EL Fahrgestellnummer ab: 3T-8-000 001 Vehicle Identification Number from: 3T-8-000 001
			7.08369.02.0	ATS	EL Fahrgestellnummer ab: 3T-8-000 001 Vehicle Identification Number from: 3T-8-000 001
			7.08369.03.0	ATS	EL Fahrgestellnummer ab: 3T-8-000 001 Vehicle Identification Number from: 3T-8-000 001
			7.11492.02.0	DDS	EL ohne Zubehör without accessories  ch. 3T-8-000 001→
1.9 TDI 77 kW (105 PS) BXE	03.2008→11.2010		7.24809.16.0	AGR	PN 
2.0 TDI 103 kW (140 PS) BMP	03.2008→05.2010		7.00678.04.0*	AGR-M	EL mit Rohrstutzen with pipe socket  ch. 3T-8-000 001→
			↪7.00907.03.0	AGR	EL
			7.00678.06.0	AGR-M	EL



SUPERB II (3T4) 30

			7.08369.00.0	ATS	EL	Fahrgestellnummer ab: 3T-8-000 001 Vehicle Identification Number from: 3T-8-000 001
			7.08369.02.0	ATS	EL	Fahrgestellnummer ab: 3T-8-000 001 Vehicle Identification Number from: 3T-8-000 001
			7.08369.03.0	ATS	EL	Fahrgestellnummer ab: 3T-8-000 001 Vehicle Identification Number from: 3T-8-000 001
			7.11492.02.0	DDS		ohne Zubehör without accessories  ch. 3T-8-000 001→
2.0 TDI 125 kW (170 PS) CBBB	07.2008→05.2015		7.10334.00.0	AGR	EL	  ch. 3T-8-000 001→
			7.08369.01.0	ATS	EL	Fahrgestellnummer ab: 3T-8-000 001 Vehicle Identification Number from: 3T-8-000 001
			7.08369.04.0	ATS	EL	Fahrgestellnummer ab: 3T-8-000 001 Vehicle Identification Number from: 3T-8-000 001
2.0 TDI 125 kW (170 PS) CFGB	07.2008→05.2015		7.09720.00.0	AGR-K	EL	  ch. 3T-8-000 001→
			7.11190.09.0	DDS		 ch. 3T-8-000 001→
2.0 TDI 16V 103 kW (140 PS) BKD	01.2009→05.2015		7.24809.16.0	AGR	PN	
2.0 TDI 16V 103 kW (140 PS) CFFB, CLJA	01.2009→05.2015		7.09720.00.0	AGR-K	EL	 CFFB, CLJA:  ch. 3T-8-000 001→
			7.11190.09.0	DDS		CFFB, CLJA:  ch. 3T-8-000 001→
2.0 TDI 16V 4x4 103 kW (140 PS) CFFB	11.2010→05.2015		7.09720.00.0	AGR-K	EL	
			7.11190.09.0	DDS		 ch. 3T-8-000 001→
2.0 TDI 4x4 125 kW (170 PS) CBBB	09.2008→05.2015		7.10334.00.0	AGR	EL	  ch. 3T-8-000 001→
			7.08369.01.0	ATS	EL	Fahrgestellnummer ab: 3T-8-000 001 Vehicle Identification Number from: 3T-8-000 001
			7.08369.04.0	ATS	EL	Fahrgestellnummer ab: 3T-8-000 001 Vehicle Identification Number from: 3T-8-000 001
2.0 TDI 4x4 125 kW (170 PS) CFGB	09.2008→05.2015		7.09720.00.0	AGR-K	EL	  ch. 3T-8-000 001→
			7.11190.09.0	DDS		 ch. 3T-8-000 001→
3.6 FSI 4x4 191 kW (260 PS) CDVA	11.2008→05.2015		7.05271.29.0	LS	900 mm	
			7.05271.12.0	LS	800 mm	
			7.02604.41.0	LS	700 mm	vor Katalysator, links in front of the catalyst, Left

SUPERB II Estate (3T5) 31

1.6 TDI 77 kW (105 PS) CAYC	09.2010→05.2015		7.09720.00.0	AGR-K	EL	
			7.08369.01.0	ATS	EL	Fahrgestellnummer ab: 3T-8-000 001 Vehicle Identification Number from: 3T-8-000 001
			7.08369.04.0	ATS	EL	Fahrgestellnummer ab: 3T-8-000 001 Vehicle Identification Number from: 3T-8-000 001
			7.11492.00.0	DDS		ohne Zubehör without accessories  ch. 3T-8-000 001→



SUPERB II Estate (3T5) **31**

1.9 TDI 77 kW (105 PS) BLS	10.2009→11.2010		7.00907.03.0	AGR	EL	ch. 3T-8-000 001→
			7.08369.00.0	ATS	EL	Fahrgestellnummer ab: 3T-8-000 001 Vehicle Identification Number from: 3T-8-000 001
			7.08369.02.0	ATS	EL	Fahrgestellnummer ab: 3T-8-000 001 Vehicle Identification Number from: 3T-8-000 001
			7.08369.03.0	ATS	EL	Fahrgestellnummer ab: 3T-8-000 001 Vehicle Identification Number from: 3T-8-000 001
			7.11492.02.0	DDS		ohne Zubehör without accessories ch. 3T-8-000 001→
1.9 TDI 77 kW (105 PS) BXE	10.2009→11.2010		7.24809.16.0	AGR	PN	
2.0 TDI 125 kW (170 PS) CBBB	10.2009→05.2015		7.10334.00.0	AGR	EL	ch. 3T-8-000 001→
			7.08369.01.0	ATS	EL	Fahrgestellnummer ab: 3T-8-000 001 Vehicle Identification Number from: 3T-8-000 001
			7.08369.04.0	ATS	EL	Fahrgestellnummer ab: 3T-8-000 001 Vehicle Identification Number from: 3T-8-000 001
2.0 TDI 125 kW (170 PS) CFGB	10.2009→05.2015		7.09720.00.0	AGR-K	EL	ch. 3T-8-000 001→
			7.11190.09.0	DDS		ch. 3T-8-000 001→
2.0 TDI 103 kW (140 PS) BMP	10.2009→03.2010		7.00678.04.0*	AGR-M	EL	mit Rohrstutzen with pipe socket ch. 3T-8-000 001→
			7.00907.03.0	AGR	EL	
			7.08369.00.0	ATS	EL	Fahrgestellnummer ab: 3T-8-000 001 Vehicle Identification Number from: 3T-8-000 001
			7.08369.02.0	ATS	EL	Fahrgestellnummer ab: 3T-8-000 001 Vehicle Identification Number from: 3T-8-000 001
			7.08369.03.0	ATS	EL	Fahrgestellnummer ab: 3T-8-000 001 Vehicle Identification Number from: 3T-8-000 001
			7.11492.02.0	DDS		ohne Zubehör without accessories ch. 3T-8-000 001→
2.0 TDI 16V 103 kW (140 PS) BKD	10.2009→05.2015		7.24809.16.0	AGR	PN	
2.0 TDI 16V 103 kW (140 PS) CFFB, CLJA	10.2009→05.2015		7.09720.00.0	AGR-K	EL	CFFB, CLJA: ch. 3T-8-000 001→
			7.11190.09.0	DDS		CFFB, CLJA: ch. 3T-8-000 001→
2.0 TDI 16V 4x4 103 kW (140 PS) CFFB	11.2010→05.2015		7.09720.00.0	AGR-K	EL	
			7.11190.09.0	DDS		ch. 3T-8-000 001→
2.0 TDI 4x4 125 kW (170 PS) CBBB	10.2009→05.2015		7.10334.00.0	AGR	EL	ch. 3T-8-000 001→
			7.08369.01.0	ATS	EL	Fahrgestellnummer ab: 3T-8-000 001 Vehicle Identification Number from: 3T-8-000 001
			7.08369.04.0	ATS	EL	Fahrgestellnummer ab: 3T-8-000 001 Vehicle Identification Number from: 3T-8-000 001
2.0 TDI 4x4 125 kW (170 PS) CFGB	10.2009→05.2015		7.09720.00.0	AGR-K	EL	ch. 3T-8-000 001→
			7.11190.09.0	DDS		ch. 3T-8-000 001→































S



SUPERB II Estate (3T5) 31

3.6 V6 4x4 191 kW (260 PS) CDVA	10.2009→05.2015		7.05271.29.0	LS	900 mm	vor Katalysator, links in front of the catalyst, Left
			7.05271.12.0	LS	800 mm	
			7.02604.41.0	LS	700 mm	

SUPERB III (3V3) 32

1.6 TDI 88 kW (120 PS) DCXA	03.2015→		7.10334.02.0	AGR	EL	 ch. NP-F7000 001→
			7.08369.95.0	ATS	EL	 ch. NP-F7000 001→ für Fahrzeuge ohne Aktivkohlebehälter for vehicles without charcoal canister
			7.11020.17.0	ATS	EL	 ch. NP-F7000 001→ für Vorkatalysator for pre-catalyst
			7.11020.22.0	ATS	EL	 DCXA:  ch. NP-F7000 001→ für PR-Nummer: 1E9 for PR number: 1E9  DCXA:  ch. NP-F7000 001→ Euro 6c, Euro 6d-Temp Euro 6c, Euro 6d-Temp
			7.11020.23.0	ATS	EL	 DCXA:  ch. NP-F7000 001→ für PR-Nummer: 1E9 for PR number: 1E9  DCXA:  ch. NP-F7000 001→ Euro 6c, Euro 6d-Temp Euro 6c, Euro 6d-Temp
			7.11492.03.0	DDS		ohne Zubehör without accessories  ch. NP-F7000 001→
1.6 TDI 88 kW (120 PS) DCZA	03.2015→		7.10334.02.0	AGR	EL	 ch. NP-F7000 001→
			7.11020.17.0	ATS	EL	 ch. NP-F7000 001→ für Vorkatalysator for pre-catalyst
			7.11020.23.0	ATS	EL	 DCZA:  ch. NP-F7000 001→ für PR-Nummer: 1E9 for PR number: 1E9  DCZA:  ch. NP-F7000 001→ Euro 6c, Euro 6d-Temp Euro 6c, Euro 6d-Temp
			7.11492.03.0	DDS		ohne Zubehör without accessories  ch. NP-F7000 001→
2.0 TDI 110 kW (150 PS) CRLB	03.2015→		7.10334.02.0	AGR	EL	 ch. NP-F7000 001→
			7.03608.16.0	AK	EL	 ch. NP-F7000 001→
			↳ 7.07696.00.0	SRM-AK	EL	
			7.08369.81.0	ATS	EL	 CRLB: für PR-Nummer: 7CN / 7CP / 7MV for PR number: 7CN / 7CP / 7MV Produktionsdatum ab: 30.04.2018 Production date from: 30.04.2018  CRLB: Produktionsdatum bis: 30.04.2018 Production date to: 30.04.2018
			7.11492.03.0	DDS		ohne Zubehör without accessories  ch. NP-F7000 001→
2.0 TDI 110 kW (150 PS) DFEA	03.2015→		7.10334.02.0	AGR	EL	 ch. NP-F7000 001→
			7.03608.16.0	AK	EL	 ch. NP-F7000 001→

S





















SUPERB III (3V3) 32

		↳ 7.07696.00.0 7.08369.81.0	SRM-AK ATS	EL EL	DFEA: Produktionsdatum bis: 30.04.2018 Production date to: 30.04.2018 DFEA: für PR-Nummer: 7CN / 7CP / 7MV for PR number: 7CN / 7CP / 7MV Produktionsdatum ab: 30.04.2018 Production date from: 30.04.2018 ohne Zubehör without accessories für OE-Nummer: 04L 906 051 AB, 04L 906 051 F, 04L 906 051 G, 04L 906 051 L for OE number: 04L 906 051 AB, 04L 906 051 F, 04L 906 051 G, 04L 906 051 L
		7.11492.05.0	DDS		
2.0 TDI 110 kW (150 PS) DFGA	03.2015→	7.10334.02.0 7.03608.16.0 7.08369.81.0	AGR AK ATS	EL EL EL	ch. NP-F7000 001→ ch. NP-F7000 001→ DFGA: Produktionsdatum bis: 30.04.2018 Production date to: 30.04.2018 DFGA: für PR-Nummer: 7CN/ 7CP / 7MV for PR number: 7CN/ 7CP / 7MV Produktionsdatum ab: 30.04.2018 Production date from: 30.04.2018 ohne Zubehör without accessories für OE-Nummer: 04L 906 051 AB, 04L 906 051 F, 04L 906 051 G, 04L 906 051 L for OE number: 04L 906 051 AB, 04L 906 051 F, 04L 906 051 G, 04L 906 051 L
		7.11492.05.0	DDS		
2.0 TDI 110 kW (150 PS) DSRA, DSRB	03.2015→	7.07696.00.0	SRM-AK	EL	DSRA, DSRB: ch. NP-F7000 001→
2.0 TDI 140 kW (190 PS) DDAA, DFCA	03.2015→	7.10334.02.0 7.03608.16.0 ↳ 7.07696.00.0 7.11020.26.0 7.11492.03.0	AGR AK SRM-AK ATS DDS	EL EL EL EL	DDAA, DFCA: ch. NP-F7000 001→ DDAA, DFCA: ch. NP-F7000 001→ DDAA, DFCA: ch. NP-F7000 001→ ohne Zubehör without accessories DDAA, DFCA: ch. NP-F7000 001→
2.0 TDI 140 kW (190 PS) DFHA	03.2015→	7.03608.16.0 ↳ 7.07696.00.0 7.11020.26.0 7.11492.05.0	AK SRM-AK ATS DDS	EL EL EL	ch. NP-F7000 001→ ch. NP-F7000 001→ Euro 6c, Euro 6d-Temp Euro 6c, Euro 6d-Temp ohne Zubehör without accessories für OE-Nummer: 04L 906 051 AB, 04L 906 051 F, 04L 906 051 G, 04L 906 051 L for OE number: 04L 906 051 AB, 04L 906 051 F, 04L 906 051 G, 04L 906 051 L
2.0 TDI 130 kW (177 PS) CRGA	03.2015→	7.10334.02.0 7.11492.03.0	AGR DDS	EL	ch. NP-F7000 001→ ohne Zubehör without accessories ch. NP-F7000 001→
2.0 TDI 4x4 110 kW (150 PS) CRLB	03.2015→	7.03608.16.0	AK	EL	ch. NP-F7000 001→

S



SUPERB III (3V3) **32**

			↳ 7.07696.00.0 7.08369.81.0	SRM-AK ATS	EL EL	 CRLB: für PR-Nummer: 7CN, 7CP, 7MV for PR number: 7CN, 7CP, 7MV Produktionsdatum ab: 30.04.2018 Production date from: 30.04.2018  CRLB: Produktionsdatum bis: 30.04.2018 Production date to: 30.04.2018 ohne Zubehör without accessories  ch. NP-F7000 001→
			7.11492.03.0	DDS		ohne Zubehör without accessories  ch. NP-F7000 001→
2.0 TDI 4x4 110 kW (150 PS) DFEA	03.2015→		7.03608.16.0	AK	EL	 ch. NP-F7000 001→
			↳ 7.07696.00.0 7.08369.81.0	SRM-AK ATS	EL EL	 DFEA: Produktionsdatum bis: 30.04.2018 Production date to: 30.04.2018  DFEA: für PR-Nummer: 7CN , 7CP, 7MV for PR number: 7CN , 7CP, 7MV Produktionsdatum ab: 30.04.2018 Production date from: 30.04.2018 ohne Zubehör without accessories für OE-Nummer: 04L 906 051 AB, 04L 906 051 F, 04L 906 051 G, 04L 906 051 L for OE number: 04L 906 051 AB, 04L 906 051 F, 04L 906 051 G, 04L 906 051 L
			7.11492.05.0	DDS		ohne Zubehör without accessories für OE-Nummer: 04L 906 051 AB, 04L 906 051 F, 04L 906 051 G, 04L 906 051 L for OE number: 04L 906 051 AB, 04L 906 051 F, 04L 906 051 G, 04L 906 051 L
2.0 TDI 4x4 110 kW (150 PS) DFGA	03.2015→		7.03608.16.0	AK	EL	 ch. NP-F7000 001→
			7.08369.81.0	ATS	EL	 DFGA: Produktionsdatum bis: 30.04.2018 Production date to: 30.04.2018  DFGA: für PR-Nummer: 7CN, 7CP, 7MV for PR number: 7CN, 7CP, 7MV Produktionsdatum ab: 30.04.2018 Production date from: 30.04.2018 ohne Zubehör without accessories für OE-Nummer: 04L 906 051 AB, 04L 906 051 F, 04L 906 051 G, 04L 906 051 L for OE number: 04L 906 051 AB, 04L 906 051 F, 04L 906 051 G, 04L 906 051 L
			7.11492.05.0	DDS		ohne Zubehör without accessories für OE-Nummer: 04L 906 051 AB, 04L 906 051 F, 04L 906 051 G, 04L 906 051 L for OE number: 04L 906 051 AB, 04L 906 051 F, 04L 906 051 G, 04L 906 051 L
2.0 TDI 4x4 140 kW (190 PS) DDAA, DFCA	03.2015→		7.03608.16.0	AK	EL	 DDAA, DFCA:  ch. NP-F7000 001→
			↳ 7.07696.00.0 7.11020.26.0	SRM-AK ATS	EL EL	 DDAA, DFCA:  ch. NP-F7000 001→ ohne Zubehör without accessories  DDAA, DFCA:  ch. NP-F7000 001→
			7.11492.03.0	DDS		ohne Zubehör without accessories  ch. NP-F7000 001→
2.0 TDI 4x4 140 kW (190 PS) DFHA	03.2015→		7.03608.16.0	AK	EL	 ch. NP-F7000 001→
			↳ 7.07696.00.0 7.11020.26.0	SRM-AK ATS	EL EL	 ch. NP-F7000 001→ Euro 6c, Euro 6d-Temp Euro 6c, Euro 6d-Temp ohne Zubehör without accessories für OE-Nummer: 04L 906 051 AB, 04L 906 051 F, 04L 906 051 G, 04L 906 051 L for OE number: 04L 906 051 AB, 04L 906 051 F, 04L 906 051 G, 04L 906 051 L
			7.11492.05.0	DDS		ohne Zubehör without accessories für OE-Nummer: 04L 906 051 AB, 04L 906 051 F, 04L 906 051 G, 04L 906 051 L for OE number: 04L 906 051 AB, 04L 906 051 F, 04L 906 051 G, 04L 906 051 L

S

SUPERB III Estate (3V5) 33

























1.6 TDI 88 kW (120 PS) DCXA	03.2015→		7.10334.02.0 AGR EL	ch. NP-F7000 001→
			7.08369.95.0 ATS EL	ch. NP-F7000 001→ für Fahrzeuge ohne Aktivkohlebehälter for vehicles without charcoal canister
			7.11020.17.0 ATS EL	ch. NP-F7000 001→ für Vorkatalysator for pre-catalyst
			7.11020.22.0 ATS EL	DCXA: ch. NP-F7000 001→ Euro 6c, Euro 6d-Temp Euro 6c, Euro 6d-Temp DCXA: ch. NP-F7000 001→ für PR-Nummer: 1E9 for PR number: 1E9
			7.11020.23.0 ATS EL	DCXA: ch. NP-F7000 001→ für PR-Nummer: 1E9 for PR number: 1E9 DCXA: ch. NP-F7000 001→ Euro 6c, Euro 6d-Temp Euro 6c, Euro 6d-Temp
			7.11492.03.0 DDS	ohne Zubehör without accessories ch. NP-F7000 001→
			7.07696.00.0 SRM-AK EL	ch. NP-F7000 001→
1.6 TDI 88 kW (120 PS) DCZA	03.2015→		7.10334.02.0 AGR EL	ch. NP-F7000 001→
			7.11020.17.0 ATS EL	ch. NP-F7000 001→ für Vorkatalysator for pre-catalyst
			7.11020.23.0 ATS EL	DCZA: ch. NP-F7000 001→ für PR-Nummer: 1E9 for PR number: 1E9 DCZA: ch. NP-F7000 001→ Euro 6c, Euro 6d-Temp Euro 6c, Euro 6d-Temp
			7.11492.03.0 DDS	ohne Zubehör without accessories ch. NP-F7000 001→
7.07696.00.0 SRM-AK EL	ch. NP-F7000 001→			
2.0 TDI 110 kW (150 PS) CRLB	03.2015→		7.10334.02.0 AGR EL	ch. NP-F7000 001→
			7.03608.16.0 AK EL	ch. NP-F7000 001→
			7.07696.00.0 SRM-AK EL	
			7.08369.81.0 ATS EL	CRLB: für PR-Nummer: 7CMV, 7CN , 7CNP for PR number: 7CMV, 7CN , 7CNP Produktionsdatum ab: 30.04.2018 Production date from: 30.04.2018 CRLB: Produktionsdatum bis: 30.04.2018 Production date to: 30.04.2018
			7.11492.03.0 DDS	ohne Zubehör without accessories ch. NP-F7000 001→
2.0 TDI 110 kW (150 PS) DFEA	03.2015→		7.10334.02.0 AGR EL	ch. NP-F7000 001→
			7.03608.16.0 AK EL	ch. NP-F7000 001→
			7.07696.00.0 SRM-AK EL	

S



SUPERB III Estate (3V5)

33

			7.08369.81.0	ATS	EL	 DFEA: für PR-Nummer: 7CN, 7CP, 7MV for PR number: 7CN, 7CP, 7MV Produktionsdatum ab: 30.04.2018 Production date from: 30.04.2018  DFEA: Produktionsdatum bis: 30.04.2018 Production date to: 30.04.2018 ohne Zubehör without accessories für OE-Nummer: 04L 906 051 AB, 04L 906 051 F, 04L 906 051 G, 04L 906 051 L for OE number: 04L 906 051 AB, 04L 906 051 F, 04L 906 051 G, 04L 906 051 L
			7.11492.05.0	DDS		
2.0 TDI 110 kW (150 PS) DFGA	03.2015→		7.10334.02.0	AGR	EL	 ch. NP-F7000 001→
			7.03608.16.0	AK	EL	 ch. NP-F7000 001→
			7.08369.81.0	ATS	EL	 DFGA: für PR-Nummer: 7CN , 7CNP, 7MV for PR number: 7CN , 7CNP, 7MV Produktionsdatum ab: 30.04.2018 Production date from: 30.04.2018  DFGA: Produktionsdatum ab: 30.04.2018 Production date from: 30.04.2018 ohne Zubehör without accessories für OE-Nummer: 04L 906 051 AB, 04L 906 051 F, 04L 906 051 G, 04L 906 051 L for OE number: 04L 906 051 AB, 04L 906 051 F, 04L 906 051 G, 04L 906 051 L
			7.11492.05.0	DDS		
2.0 TDI 110 kW (150 PS) DSRA, DSRB	03.2015→		7.07696.00.0	SRM-AK	EL	 DSRA, DSRB:  ch. NP-F7000 001→
2.0 TDI 140 kW (190 PS) DDAA, DFCA	03.2015→		7.10334.02.0	AGR	EL	 DDAA, DFCA:  ch. NP-F7000 001→
			7.03608.16.0	AK	EL	 DDAA, DFCA:  ch. NP-F7000 001→
			↳ 7.07696.00.0	SRM-AK	EL	
			7.11020.26.0	ATS	EL	 DDAA, DFCA:  ch. NP-F7000 001→
			7.11492.03.0	DDS		ohne Zubehör without accessories  DDAA, DFCA:  ch. NP-F7000 001→
2.0 TDI 140 kW (190 PS) DFHA	03.2015→		7.10334.02.0	AGR	EL	 ch. NP-F7000 001→
			7.03608.16.0	AK	EL	 ch. NP-F7000 001→
			↳ 7.07696.00.0	SRM-AK	EL	
			7.11020.26.0	ATS	EL	 ch. NP-F7000 001→ Euro 6c, Euro 6d-Temp Euro 6c, Euro 6d-Temp ohne Zubehör without accessories
			7.11492.05.0	DDS		für OE-Nummer: 04L 906 051 AB, 04L 906 051 F, 04L 906 051 G, 04L 906 051 L for OE number: 04L 906 051 AB, 04L 906 051 F, 04L 906 051 G, 04L 906 051 L
2.0 TDI 4x4 110 kW (150 PS) CRLB	03.2015→		7.03608.16.0	AK	EL	 ch. NP-F7000 001→
			↳ 7.07696.00.0	SRM-AK	EL	

S















SUPERB III Estate (3V5) **33**

			7.08369.81.0	ATS	EL	CRLB: für PR-Nummer: 7CN, 7CP, 7MV for PR number: 7CN, 7CP, 7MV Produktionsdatum ab: 30.04.2018 Production date from: 30.04.2018 CRLB: Produktionsdatum bis: 30.04.2018 Production date to: 30.04.2018 ohne Zubehör without accessories ch. NP-F7000 001→
			7.11492.03.0	DDS		ohne Zubehör without accessories ch. NP-F7000 001→
2.0 TDI 4x4 110 kW (150 PS) DFEA	03.2015→		7.03608.16.0	AK	EL	ch. NP-F7000 001→
			↳ 7.07696.00.0	SRM-AK	EL	
			7.08369.81.0	ATS	EL	DFEA: für PR-Nummer: 7CN, 7CP, 7MV for PR number: 7CN, 7CP, 7MV Produktionsdatum ab: 30.04.2018 Production date from: 30.04.2018 DFEA: Produktionsdatum bis: 30.04.2018 Production date to: 30.04.2018 ohne Zubehör without accessories für OE-Nummer: 04L 906 051 AB, 04L 906 051 F, 04L 906 051 G, 04L 906 051 L for OE number: 04L 906 051 AB, 04L 906 051 F, 04L 906 051 G, 04L 906 051 L
			7.11492.05.0	DDS		ohne Zubehör without accessories für OE-Nummer: 04L 906 051 AB, 04L 906 051 F, 04L 906 051 G, 04L 906 051 L for OE number: 04L 906 051 AB, 04L 906 051 F, 04L 906 051 G, 04L 906 051 L
2.0 TDI 4x4 110 kW (150 PS) DFGA	03.2015→		7.03608.16.0	AK	EL	ch. NP-F7000 001→
			7.08369.81.0	ATS	EL	DFGA: für PR-Nummer: 7CN, 7CP, 7MV for PR number: 7CN, 7CP, 7MV Produktionsdatum ab: 30.04.2018 Production date from: 30.04.2018 DFGA: Produktionsdatum bis: 30.04.2018 Production date to: 30.04.2018 ohne Zubehör without accessories für OE-Nummer: 04L 906 051 AB, 04L 906 051 F, 04L 906 051 G, 04L 906 051 L for OE number: 04L 906 051 AB, 04L 906 051 F, 04L 906 051 G, 04L 906 051 L
			7.11492.05.0	DDS		ohne Zubehör without accessories für OE-Nummer: 04L 906 051 AB, 04L 906 051 F, 04L 906 051 G, 04L 906 051 L for OE number: 04L 906 051 AB, 04L 906 051 F, 04L 906 051 G, 04L 906 051 L
2.0 TDI 4x4 140 kW (190 PS) DDAA, DFCA	03.2015→		7.03608.16.0	AK	EL	DDAA, DFCA: ch. NP-F7000 001→
			↳ 7.07696.00.0	SRM-AK	EL	
			7.11020.26.0	ATS	EL	DDAA, DFCA: ch. NP-F7000 001→
			7.11492.03.0	DDS		ohne Zubehör without accessories DDAA, DFCA: ch. NP-F7000 001→
2.0 TDI 4x4 140 kW (190 PS) DFHA	03.2015→		7.03608.16.0	AK	EL	ch. NP-F7000 001→
			↳ 7.07696.00.0	SRM-AK	EL	
			7.11020.26.0	ATS	EL	ch. NP-F7000 001→ Euro 6c, Euro 6d-Temp
			7.11492.05.0	DDS		ohne Zubehör without accessories für OE-Nummer: 04L 906 051 AB, 04L 906 051 F, 04L 906 051 G, 04L 906 051 L for OE number: 04L 906 051 AB, 04L 906 051 F, 04L 906 051 G, 04L 906 051 L

S



YETI (5L) **34**

1.6 TDI 77 kW (105 PS) CAYC	11.2010→05.2015		7.09720.00.0	AGR-K	EL	○ ohne Zubehör without accessories
			7.08369.01.0	ATS	EL	
			7.08369.04.0	ATS	EL	
			7.11492.00.0	DDS		
2.0 TDI 81 kW (110 PS) CFHA, CLCA	11.2009→12.2017		7.09720.00.0	AGR-K	EL	○ ohne Zubehör without accessories
			7.11492.00.0	DDS		
2.0 TDI 81 kW (110 PS) CUUA, DFSA	11.2009→12.2017		7.11492.03.0	DDS		ohne Zubehör without accessories
2.0 TDI 103 kW (140 PS) CFHC, CLCB	11.2011→12.2017		7.09720.00.0	AGR-K	EL	○ ohne Zubehör without accessories
			7.11492.00.0	DDS		
2.0 TDI 110 kW (150 PS) CUUB	05.2015→12.2017		7.11492.03.0	DDS		ohne Zubehör without accessories
			7.07696.00.0	SRM-AK	EL	
2.0 TDI 110 kW (150 PS) DFSB	05.2015→12.2017		7.11492.03.0	DDS		ohne Zubehör without accessories
2.0 TDI 4x4 103 kW (140 PS) CBDB	05.2009→12.2017		7.10334.00.0	AGR	EL	○ ohne Zubehör without accessories
			7.08369.01.0	ATS	EL	
			7.08369.04.0	ATS	EL	
			7.11492.02.0	DDS		
2.0 TDI 4x4 103 kW (140 PS) CFHC, CLCB	05.2009→12.2017		7.09720.00.0	AGR-K	EL	○ ohne Zubehör without accessories
			7.11492.00.0	DDS		
2.0 TDI 4x4 81 kW (110 PS) CFHF	11.2009→12.2017		7.09720.00.0	AGR-K	EL	○ ohne Zubehör without accessories
			7.11492.00.0	DDS		
2.0 TDI 4x4 81 kW (110 PS) CUUA, DFSA	11.2009→12.2017		7.11492.03.0	DDS		ohne Zubehör without accessories
2.0 TDI 4x4 125 kW (170 PS) CEGA	11.2009→05.2015		7.10334.00.0	AGR	EL	○ ohne Zubehör without accessories
			7.08369.00.0	ATS	EL	
			7.08369.01.0	ATS	EL	
			7.08369.04.0	ATS	EL	
			7.11492.00.0	DDS		
2.0 TDI 4x4 125 kW (170 PS) CFJA	11.2009→05.2015		7.09720.00.0	AGR-K	EL	○
2.0 TDI 4x4 110 kW (150 PS) CUUB	05.2015→12.2017		7.11492.03.0	DDS		ohne Zubehör without accessories
			7.07696.00.0	SRM-AK	EL	
2.0 TDI 4x4 110 kW (150 PS) DFSB	05.2015→12.2017		7.11492.03.0	DDS		ohne Zubehör without accessories







S



















FABIA I Praktik (6Y5)						35
1.2 40 kW (54 PS) AWY, BMD	07.2001→12.2007		7.05271.05.0	LS	700 mm AWY: →ch. 6Y-4-095 989 vor Katalysator in front of the catalyst BMD: ch. 6Y-4-095 990→ vor Katalysator in front of the catalyst	
1.2 47 kW (64 PS) AZQ, BME	01.2003→12.2007		7.22785.16.0	AGR	EL AZQ, BME: →ch. 6Y-64562 417	
			7.05271.20.0	LS	500 mm	
1.4 50 kW (68 PS) AME	07.2001→05.2003		7.05271.02.0	LS	500 mm Regelsonde Regulating Probe	
1.4 55 kW (75 PS) BKY	05.2004→12.2007		7.05271.05.0	LS	700 mm nach Katalysator Post-catalyst	
1.4 TDI 55 kW (75 PS) AMF	08.2004→10.2005		7.24809.17.0	AGR	PN 	
1.4 TDI 51 kW (70 PS) BNM	10.2005→12.2007		7.24809.31.0	AGR	PN 	
1.9 SDI 47 kW (64 PS) ASY	05.2003→12.2007		7.22477.10.0	AGR	PN ch. 6Y-2-386 001→	
1.9 TDI 74 kW (100 PS) ATD	01.2000→12.2007		7.24809.30.0	AGR	PN 	
1.9 TDI 74 kW (100 PS) AXR	01.2000→12.2007		7.24809.16.0	AGR	PN 	
OCTAVIA I Estate Van (1U5)						36
1.9 TDI 66 kW (90 PS) ALH	08.2000→03.2010		7.24809.30.0	AGR	PN 03.2003→	
ROOMSTER Praktik (5J)						37
1.2 51 kW (70 PS) BZG, CGPA	03.2007→05.2015		7.05271.20.0	LS	500 mm	
1.2 TDI 55 kW (75 PS) CFWA	03.2010→05.2015		7.09720.02.0	AGR-K	EL 	
			7.08369.50.0	ATS	EL	
			7.08369.11.0	ATS	EL für Rechtslenker for right-hand drive vehicles	
			7.08369.37.0	ATS	EL für Linkslenker for left-hand drive vehicles nach Rußpartikelfilter after soot particulate filter Produktionsdatum ab: 31.05.2010 Production date from: 31.05.2010	
			7.08369.83.0	ATS	EL	
			7.11190.09.0	DDS		
1.4 63 kW (85-86 PS) BXW, CGGB	03.2007→05.2015		7.05271.05.0	LS	700 mm BXW, CGGB: nach Katalysator Post-catalyst	
1.4 TDI 59 kW (80 PS) BMS	03.2007→03.2010		7.00678.04.0*	AGR-M	EL mit Rohrstützen with pipe socket	
			7.00907.03.0	AGR	EL	
			7.00678.06.0	AGR-M	EL	
			7.11020.03.0	ATS	EL ch. 5J-65012 510→	
			7.08369.53.0	ATS	EL vor Rußpartikelfilter before soot particulate filter	
			7.08369.86.0	ATS	EL für Rechtslenker for right-hand drive vehicles	
			7.11020.02.0	ATS	EL →ch. 5J-65012 509 nach Rußpartikelfilter after soot particulate filter	
			7.11020.07.0	ATS	EL für Linkslenker for left-hand drive vehicles	























ROOMSTER Praktik (5J)

37

			7.11492.00.0	DDS		ohne Zubehör without accessories Fahrgestellnummer ab: 5J-A5006 000, 5J-AB600 000 Vehicle Identification Number from: 5J-A5006 000, 5J-AB600 000
			7.11492.02.0	DDS		ohne Zubehör without accessories Fahrgestellnummer bis: 5J-95038 314, 5J-9B601 986 Vehicle Identification Number to: 5J-95038 314, 5J-9B601 986
1.4 TDI 59 kW (80 PS) BNV	03.2007→03.2010		7.24809.31.0	AGR	PN	
1.4 TDI 51 kW (70 PS) BNM	03.2007→03.2010		7.24809.31.0	AGR	PN	
1.6 TDI 66 kW (90 PS) CAYB	03.2010→05.2015		7.09720.01.0	AGR-K	EL	
			7.08369.09.0	ATS	EL	für Linkslenker for left-hand drive vehicles
			7.08369.11.0	ATS	EL	für Rechtslenker for right-hand drive vehicles
			7.08369.26.0	ATS	EL	
			7.11190.09.0	DDS		



					
FORFOUR (454) 1					
1.5 CDI (454.000) 50-70 kW (58-95 PS) OM 639.939	09.2004→06.2006		7.00306.36.0	AGR	PN 
			7.08369.85.0	ATS	EL
1.5 CDI (454.001) 50-70 kW (58-95 PS) OM 639.939	09.2004→06.2006		7.00306.36.0	AGR	PN 
			7.08369.85.0	ATS	EL
FORTWO Cabrio (451) 2					
0.8 CDi (451.400) 33 kW (45 PS) OM 660.950	01.2007→		7.00306.36.0	AGR	PN 
			7.11020.11.0	ATS	EL Abgasturbolader Exhaust Turbocharger für Fahrzeuge mit Diesel-Partikel-Filter (DPF) for vehicles with diesel soot filter
0.8 CDi (451.401) 40 kW (54 PS) OM 660.951	08.2009→		7.00306.36.0	AGR	PN 
			7.02604.99.0	LS	400 mm
FORTWO Coupe (451) 3					
0.8 CDi (451.300) 33 kW (45 PS) OM 660.950	01.2007→		7.00306.36.0	AGR	PN 
			7.11020.11.0	ATS	EL Abgasturbolader Exhaust Turbocharger für Fahrzeuge mit Diesel-Partikel-Filter (DPF) for vehicles with diesel soot filter
0.8 CDi (451.301) 40 kW (54 PS) OM 660.951	08.2009→		7.00306.36.0	AGR	PN 
			7.02604.99.0	LS	400 mm

S





























						
IMPREZA Coupe (GFC)						1
1.6 66-70 kW (90-95 PS) EJ161, EJ16E	12.1996→12.2000		7.02604.03.0	LS	200 mm	
1.6 66-70 kW (90-95 PS) EJ161	09.1998→09.2000		7.02604.03.0	LS	200 mm	
1.6 AWD 66-70 kW (90-95 PS) EJ161	12.1996→12.2000		7.02604.03.0	LS	200 mm	
IMPREZA Estate (GF)						2
1.6 66-70 kW (90-95 PS) EJ161, EJ16E	01.1993→08.1998		7.02604.03.0	LS	200 mm	
1.6 i (GF3) 66-70 kW (90-95 PS) EJ161	06.1998→12.2000		7.02604.03.0	LS	200 mm	
1.6 i AWD 66-70 kW (90-95 PS) EJ16	08.1992→12.2000		7.02604.03.0	LS	200 mm	
1.6 i AWD 66-70 kW (90-95 PS) EJ161	06.1998→12.2000		7.02604.03.0	LS	200 mm	
1.8 i AWD (GF6) 76-82 kW (103-112 PS) EJ18	08.1992→12.2000		7.02604.03.0	LS	200 mm	
IMPREZA Estate (GG)						3
1.6 AWD 66-70 kW (90-95 PS) EJ161	12.2000→09.2006		7.02604.03.0	LS	200 mm	
IMPREZA Saloon (GC)						4
1.6 i (GC3) 66-70 kW (90-95 PS) EJ16	08.1992→12.2000		7.02604.03.0	LS	200 mm	
1.6 i (GC3) 66-70 kW (90-95 PS) EJ161	06.1998→12.2000		7.02604.03.0	LS	200 mm	
1.6 i AWD 66-70 kW (90-95 PS) EJ16	08.1992→12.2000		7.02604.03.0	LS	200 mm	
1.6 i AWD 66-70 kW (90-95 PS) EJ161	06.1998→12.2000		7.02604.03.0	LS	200 mm	
1.8 i AWD (GC6) 76-82 kW (103-112 PS) EJ18, EJ18E	08.1992→12.2000		7.02604.03.0	LS	200 mm	
IMPREZA Saloon (GD)						5
1.6 AWD 66-70 kW (90-95 PS) EJ161	12.2000→06.2009		7.02604.03.0	LS	200 mm	
JUSTY II (JMA, MS)						6
1.3 4x4 62-63 kW (84-86 PS) G13BB	04.2001→11.2003		7.05271.35.0	LS	400 mm	
			7.02604.15.0	LS	360 mm	
1.3 GX 4x4 50 kW (68 PS) EF13	10.1995→11.2003		7.05271.35.0	LS	400 mm	
JUSTY III (G3X)						7
1.3 AWD 60-69 kW (82-94 PS) M13A	09.2003→		7.05271.54.0	LS	500 mm	
1.5 AWD 73-80 kW (99-109 PS) M15A	09.2003→		7.05271.54.0	LS	500 mm	
SVX (CX)						8
3.3 AWD 162-184 kW (220-250 PS) EG33 DOHC	02.1994→12.1997		7.02604.03.0	LS	200 mm	









S























SVX (CX)
8





















3.3 i 24V 4WD (CXW) 162-184 kW (220-250 PS) EG33 DOHC	09.1992→09.1994	 7.02604.03.0	LS	200 mm	
3.3 i 24V 4WD (CXW) 162-184 kW (220-250 PS) EG33 DOHC	09.1994→12.1997	 7.02604.03.0	LS	200 mm	

						
BALENO (EG)						1
1.3 i 16V (SY413) 56-63 kW (76-86 PS) G13BB	07.1995→05.2002		7.02604.01.0	LS	200 mm	
1.6 i 16V (SY416) 68-73 kW (92-99 PS) G16B	07.1995→05.2002		7.02604.01.0	LS	200 mm	
1.6 i 16V 4x4 (SY416) 68-73 kW (92-99 PS) G16B	07.1995→05.2002		7.02604.01.0	LS	200 mm	
1.8 GTX (SY418) 89-91 kW (121-124 PS) J18A	03.1996→05.2002		7.05271.59.0	LS	350 mm	
BALENO Estate (EG)						2
1.3 16V (SY413) 56-63 kW (76-86 PS) G13BB	03.1997→05.2002		7.02604.01.0	LS	200 mm	
1.6 i 16V (SY416) 68-73 kW (92-99 PS) G16B	08.1996→05.2002		7.02604.01.0	LS	200 mm	
1.6 i 16V 4x4 (SY416) 68-73 kW (92-99 PS) G16B	08.1996→05.2002		7.02604.01.0	LS	200 mm	
1.8 i 16V (SY418) 89-91 kW (121-124 PS) J18A	08.1996→05.2002		7.05271.59.0	LS	350 mm	
BALENO Hatchback (EG)						3
1.3 i 16V (SY413) 56-63 kW (76-86 PS) G13BB	07.1995→05.2002		7.02604.01.0	LS	200 mm	
1.6 i 16V (SY416) 68-73 kW (92-99 PS) G16B	07.1995→05.2002		7.02604.01.0	LS	200 mm	
1.6 i 16V 4x4 (SY416) 68-73 kW (92-99 PS) G16B	07.1995→05.2002		7.02604.01.0	LS	200 mm	
1.8 GTX (SY418) 89-91 kW (121-124 PS) J18A	03.1996→05.2002		7.05271.59.0	LS	350 mm	
GRAND VITARA I (FT, HT)						4
1.6 4x4 (SQ 416) 68-73 kW (92-99 PS) G16B	03.1998→07.2003		7.05271.35.0	LS	400 mm	
2.0 4x4 (TA52, TL52, SQ 420) 94-108 kW (128-147 PS) J20A	03.1998→07.2003		7.05271.35.0	LS	400 mm	
GRAND VITARA II (JT, TE, TD)						5
1.9 DDiS (JB419WD, JB419XD) 95 kW (129 PS) F9QB	03.2006→08.2008		7.11190.08.0	DDS		
1.9 DDiS All-wheel Drive (JT419, TD44, JB419WD, JB419XD) 95 kW (129 PS) F9QB	10.2005→02.2015		7.11237.02.0	AGR-K	EL 03.2009→ Euro 5 Euro 5	
			7.11190.08.0	DDS	Baumuster: JB419WD, JB419XD Type: JB419WD, JB419XD	

						
IGNIS I (FH)						6
1.3 (HV51, HX51, RG413) 59-69 kW (80-94 PS) M13A	10.2000→09.2003		7.05271.54.0	LS	500 mm	
1.3 4WD (RG413) 59-69 kW (80-94 PS) M13A	10.2000→09.2003		7.05271.54.0	LS	500 mm	
1.5 Sport (RG415) 73-83 kW (99-113 PS) M15A	12.2003→12.2005		7.05271.54.0	LS	500 mm	
IGNIS II (MH)						7
1.3 (RM413) 59-69 kW (80-94 PS) M13A	09.2003→		7.05271.54.0	LS	500 mm	
1.3 4x4 (RM413) 59-69 kW (80-94 PS) M13A	09.2003→		7.05271.54.0	LS	500 mm	
1.3 DDiS (RM413D) 51 kW (69 PS) Z13DT	09.2003→		7.00020.24.0	AGR	EL	
1.5 (RM415) 73-83 kW (99-113 PS) M15A	09.2003→		7.05271.54.0	LS	500 mm	
1.5 4x4 (RM415) 73-83 kW (99-113 PS) M15A	09.2003→		7.05271.54.0	LS	500 mm	
JIMNY Closed Off-Road Vehicle (SN)						8
1.3 16V (SN413) 56-63 kW (76-86 PS) G13BB	09.1998→		7.05271.35.0	LS	400 mm	 ch. S00280001→ch. 85G0621128
1.3 16V 4WD (SN413) 56-63 kW (76-86 PS) G13BB	09.1998→		7.05271.35.0	LS	400 mm	
1.3 16V 4WD (SN413) 59-69 kW (80-94 PS) M13A	02.2001→		7.05271.59.0	LS	350 mm	
1.3 16V 4x4 (SN413) 59-69 kW (80-94 PS) M13A	08.2005→		7.05271.59.0	LS	350 mm	
1.5 DDiS 4WD (SN415D) 48-50 kW (65-68 PS) K9K 700	12.2003→		7.22818.58.0	AGR	EL	
1.5 DDiS 4x4 63 kW (86 PS) K9K 266	08.2005→		7.00368.15.0	AGR	EL	
LIANA (ER, RH_)						9
1.4 DDiS (RH 414D) 66 kW (90 PS) 8HY	04.2004→		7.24809.06.0	AGR	PN	mit Rohrstützen with pipe socket  Euro 3 Euro 3
1.6 (RH 416) 65-104 kW (88-142 PS) M16A	03.2002→		7.05271.54.0	LS	500 mm	
1.6 4WD (RH 416) 65-104 kW (88-142 PS) M16A	03.2002→		7.05271.54.0	LS	500 mm	
LIANA Hatchback						10
1.4 DDiS 66 kW (90 PS) 8HY	04.2004→12.2007		7.24809.06.0	AGR	PN	mit Rohrstützen with pipe socket  Euro 3 Euro 3



















						
SAMURAI Closed Off-Road Vehicle (SJ_)						11
1.3 All-wheel Drive (SJ 413) 47-59 kW (64-80 PS) G13BA	11.1988→12.2004		7.05271.35.0	LS	400 mm	
1.3 All-wheel Drive (SJ 413) 44-54 kW (60-73 PS) G13A	11.1988→12.2004		7.02604.01.0	LS	200 mm	
1.3 All-wheel Drive (SJ 413) 44-54 kW (60-73 PS) G13A	11.1988→12.2004		7.02604.01.0	LS	200 mm	
SPLASH (EX)						12
1.3 CDTI (A5B 413D) 55 kW (75 PS) D13A	01.2008→		7.00020.50.0	AGR	EL 	
			7.11190.04.0	DDS		
SWIFT Convertible (SF413)						13
1.3 i 44-74 kW (60-101 PS) G13B	01.1992→10.1996		7.02604.15.0	LS	360 mm	
1.3 i (SF413, AK35, SY415, E35) 47-59 kW (64-80 PS) G13BA	09.1991→10.1996		7.02604.15.0	LS	360 mm	
SWIFT I (AA)						14
1.0 (SA310, AA41/43) 36-52 kW (48-70 PS) G10, G10A	10.1983→03.1989		7.02604.15.0	LS	360 mm	
1.0 Turbo (SA310) 52-59 kW (71-80 PS) G10T	02.1985→12.1989		7.02604.15.0	LS	360 mm	
1.3 (SA413, AA51) 44-54 kW (60-73 PS) G13A	10.1984→03.1989		7.02604.15.0	LS	360 mm	
1.3 (SA413, AA51/53) 44-54 kW (60-73 PS) G13A	10.1984→03.1989		7.02604.15.0	LS	360 mm	
1.3 (SA413, AA53) 44-54 kW (60-73 PS) G13A	08.1986→03.1989		7.02604.15.0	LS	360 mm	
1.3 GTi/GXi (SA413, AA33) 44-74 kW (60-101 PS) G13B	08.1985→03.1989		7.02604.15.0	LS	360 mm für OE-Nummer: 18213-82010 for OE number: 18213-82010	
SWIFT II Hatchback (EA, MA)						15
1.0 (SF310, AA44) 36-52 kW (48-70 PS) G10, G10A	03.1989→05.2001		7.02604.01.0	LS	200 mm	
1.0 i (SF310, AA44) 37-41 kW (50-56 PS) G10A	03.1989→12.1991		7.02604.01.0	LS	200 mm	
1.0 i (SF310, AA44) 37-41 kW (50-56 PS) G10A	01.1995→12.2005		7.05271.35.0	LS	400 mm	
			7.02604.01.0	LS	200 mm	
1.3 (SF 413) 47-59 kW (64-80 PS) G13BA	03.1989→12.1997		7.02604.15.0	LS	360 mm	
1.3 (SF 413) 47-59 kW (64-80 PS) G13BA	03.1989→10.1996		7.02604.15.0	LS	360 mm	
1.3 (SF 413) 44-74 kW (60-101 PS) G13B	09.1997→12.2001		7.02604.15.0	LS	360 mm	

						
SWIFT II Hatchback (EA, MA)						15
1.3 (SF 413) 56-63 kW (76-86 PS) G13BB	06.2001→12.2003		7.05271.35.0	LS	400 mm	
			7.02604.15.0	LS	360 mm	
1.3 (SF413, AB35)	03.1989→05.2001		7.02604.15.0	LS	360 mm	
1.3 4WD (SF413, AA35) 44-54 kW (60-73 PS) G13A	03.1989→05.2001		7.02604.15.0	LS	360 mm	
1.3 4WD (SF413, AF35) 44-54 kW (60-73 PS) G13A	10.1989→12.1991		7.02604.15.0	LS	360 mm	
1.3 GTi (SF413, AA34) 44-74 kW (60-101 PS) G13B	03.1989→05.2001		7.02604.15.0	LS	360 mm	für OE-Nummer: 18213-64B00 for OE number: 18213-64B00
1.6 (SF 416) 68-73 kW (92-99 PS) G16B	09.1991→12.1993		7.02604.15.0	LS	360 mm	Abgaskrümmer Exhaust Manifold Benzineinspritzung Petrol Injection
1.6 4x4 (SF 416) 68-73 kW (92-99 PS) G16B	03.1989→10.1996		7.02604.15.0	LS	360 mm	Abgaskrümmer Exhaust Manifold
SWIFT II Saloon (AH, AJ)						16
1.3 (SF413, AH35, MA) 44-74 kW (60-101 PS) G13B	01.1991→12.1995		7.05271.35.0	LS	400 mm	
1.6 (SF416, AH14) 68-73 kW (92-99 PS) G16B	11.1989→12.1991		7.02604.15.0	LS	360 mm	Abgaskrümmer Exhaust Manifold Benzineinspritzung Petrol Injection
1.6 4WD (SF416, AJ14) 68-73 kW (92-99 PS) G16B	11.1989→12.1991		7.02604.15.0	LS	360 mm	Abgaskrümmer Exhaust Manifold Benzineinspritzung Petrol Injection
1.6 i (SF416, AH14, SF406) 68-73 kW (92-99 PS) G16B	01.1990→05.2001		7.02604.15.0	LS	360 mm	Abgaskrümmer Exhaust Manifold Benzineinspritzung Petrol Injection
1.6 i 4WD (SF416, AJ14) 68-73 kW (92-99 PS) G16B	01.1990→05.2001		7.02604.15.0	LS	360 mm	Abgaskrümmer Exhaust Manifold
SWIFT III (MZ, EZ)						17
1.3 (RS 413) 59-69 kW (80-94 PS) M13A	02.2005→		7.05271.66.0	LS	650 mm	
			7.05271.54.0	LS	500 mm	
1.3 4x4 (RS 413) 59-69 kW (80-94 PS) M13A	01.2006→		7.05271.66.0	LS	650 mm	
			7.05271.54.0	LS	500 mm	
1.3 DDiS (RS 413D) 55 kW (75 PS) D13A	08.2005→		7.00020.50.0	AGR	EL	
			7.11190.04.0	DDS		
1.5 (RS 415) 73-83 kW (99-113 PS) M15A	02.2005→		7.05271.66.0	LS	650 mm	
			7.05271.54.0	LS	500 mm	
1.6 (RS 416) 65-104 kW (88-142 PS) M16A	05.2006→		7.05271.66.0	LS	650 mm	

			 PIERBURG			
SWIFT IV (FZ, NZ)						18
1.3 DDiS (AZG 413D) 55 kW (75 PS) D13A	10.2010→		7.00020.50.0	AGR	EL	<input type="checkbox"/>
			7.01599.10.0 7.11190.03.0	AGR DDS	EL	<input type="checkbox"/> ohne Zubehör without accessories
1.3 DDiS (AZG 413D) 55 kW (75 PS) D13AA	10.2010→		7.01599.10.0	AGR	EL	<input type="checkbox"/>
			7.11190.03.0	DDS		ohne Zubehör without accessories
SWIFT V (AZ)						19
1.0 (A2L310) 50-82 kW (68-111 PS) K10C	04.2017→		7.11190.08.0	DDS		
1.0 SHVS (A2L310) 50-82 kW (68-111 PS) K10C	04.2017→		7.11190.08.0	DDS		
SX4 (EY, GY)						20
1.5 (RW 415) 73-83 kW (99-113 PS) M15A	06.2006→07.2010		7.05271.66.0	LS	650 mm	
1.5 VVT (RW 415) 73-83 kW (99-113 PS) M15A	07.2010→		7.05271.66.0	LS	650 mm	
1.6 DDiS (RW 416D) 66 kW (90 PS) 9HX	04.2007→		7.24809.39.0	AGR	EL	<input type="checkbox"/>
1.6 VVT (RW 416) 65-104 kW (88-142 PS) M16A	06.2006→		7.05271.66.0	LS	650 mm	
1.6 VVT (RW 416) 65-104 kW (88-142 PS) M16A	07.2009→		7.05271.66.0	LS	650 mm	
1.6 VVT 4x4 (RW 416) 65-104 kW (88-142 PS) M16A	06.2006→		7.05271.66.0	LS	650 mm	
1.6 VVT 4x4 (RW 416) 65-104 kW (88-142 PS) M16A	07.2009→		7.05271.66.0	LS	650 mm	
1.6 VVT 4x4 (RW 416) 65-104 kW (88-142 PS) M16A	07.2009→		7.05271.66.0	LS	650 mm	
1.9 DDiS (RW 419D) 88 kW (120 PS) D19AA	06.2006→		7.22946.38.0	AGR	EL	<input type="checkbox"/>
			7.11190.04.0	DDS		
1.9 DDiS 4x4 (RW 419D) 88 kW (120 PS) D19AA	06.2006→		7.22946.38.0	AGR	EL	<input type="checkbox"/>
			7.11190.04.0	DDS		
2.0 DDiS (RW 420D) 99 kW (135 PS) D20AA	07.2009→		7.24809.77.0	AGR	ET	<input checked="" type="checkbox"/>
			7.11190.03.0	DDS		ohne Zubehör without accessories
			7.05270.21.0	LS	600 mm	für OE-Nummer: 18213-79J80 for OE number: 18213-79J80
2.0 DDiS 4x4 (RW 420D) 99 kW (135 PS) D20AA	07.2009→		7.24809.77.0	AGR	ET	<input checked="" type="checkbox"/>

S







						
SX4 (EY, GY)						20
			7.11190.03.0	DDS	ohne Zubehör without accessories	
			7.05270.21.0	LS	600 mm für OE-Nummer: 18213-79J80 for OE number: 18213-79J80	
SX4 S-CROSS (JY)						21
1.0 (AKK 310) 50-82 kW (68-111 PS) K10C	08.2016→		7.11190.08.0	DDS		
1.0 AllGrip (AKK 310) 50-82 kW (68-111 PS) K10C	08.2016→		7.11190.08.0	DDS		
1.4 T (AKK 414) 100-107 kW (136-146 PS) K14C	08.2016→		7.11190.08.0	DDS		
1.4 T AllGrip (AKK 414) 100-107 kW (136-146 PS) K14C	08.2016→		7.11190.08.0	DDS		
1.6 DDiS (AKK 416D) 88 kW (120 PS) D16AA	08.2013→		7.24809.77.0	AGR	ET <input checked="" type="checkbox"/>	
			7.11190.03.0	DDS	ohne Zubehör without accessories	
1.6 DDiS AllGrip (AKK 416D) 88 kW (120 PS) D16AA	08.2013→		7.24809.77.0	AGR	ET <input checked="" type="checkbox"/>	
			7.11190.03.0	DDS	ohne Zubehör without accessories	
SX4 Saloon (GY, RW)						22
1.6 (RW 416) 65-104 kW (88-142 PS) M16A	10.2007→		7.05271.66.0	LS	650 mm	
1.6 (RW 416) 65-104 kW (88-142 PS) M16A	10.2007→		7.05271.66.0	LS	650 mm	
VITARA (ET, TA, TD)						23
2.0 16V All-wheel Drive (SV420) 94-108 kW (128-147 PS) J20A	12.1996→03.1998		7.05271.59.0	LS	350 mm	
2.0 V6 24V All-wheel Drive (SV620) 100 kW (136 PS) H 20 A	12.1994→03.1998		7.05271.59.0	LS	350 mm	
VITARA (LY)						24
1.0 (APK 310) 50-82 kW (68-111 PS) K10C	10.2018→		7.11190.08.0	DDS		
1.0 AllGrip (APK 310) 50-82 kW (68-111 PS) K10C	10.2018→		7.11190.08.0	DDS		
1.4 T (APK 414) 100-107 kW (136-146 PS) K14C	09.2015→		7.11190.08.0	DDS		
1.4 T AllGrip (APK 414) 100-107 kW (136-146 PS) K14C	09.2015→		7.11190.08.0	DDS		
1.4 VVT AllGrip (APK414) 100-107 kW (136-146 PS) K14C	06.2019→		7.11190.08.0	DDS		

			 PIERBURG			
VITARA (LY)						24
1.6 DDiS (APK 416D) 88 kW (120 PS) D16AA	02.2015→		7.24809.77.0	AGR	ET <input checked="" type="checkbox"/>	
			7.11190.03.0	DDS	ohne Zubehör without accessories	
1.6 DDiS AllGrip (APK 416D) 88 kW (120 PS) D16AA	02.2015→		7.24809.77.0	AGR	ET <input checked="" type="checkbox"/>	
			7.11190.03.0	DDS	ohne Zubehör without accessories	
VITARA Cabrio (ET, TA)						25
2.0 16V (TA51, SV420) 94-108 kW (128-147 PS) J20A	12.1996→03.1999		7.05271.59.0	LS	350 mm	
WAGON R Hatchback						26
1.0 37-41 kW (50-56 PS) G10A	07.2003→08.2005		7.05271.35.0	LS	400 mm	 ch. S00280001→ch. 85G062128
WAGON R+ Hatchback (MM)						27
1.3 (RB 413) 56-63 kW (76-86 PS) G13BB	05.2000→12.2004		7.05271.54.0	LS	500 mm	
			7.05271.35.0	LS	400 mm	
1.3 (RB 413) 59-69 kW (80-94 PS) M13A	09.2003→		7.05271.54.0	LS	500 mm	
1.3 4WD (RB 413) 56-63 kW (76-86 PS) G13BB	10.2001→		7.05271.54.0	LS	500 mm	
			7.05271.35.0	LS	400 mm	
1.3 4WD (RB 413) 59-69 kW (80-94 PS) M13A	09.2003→		7.05271.54.0	LS	500 mm	
			7.05271.35.0	LS	400 mm	
1.3 DDiS (RB 413D) 51 kW (69 PS) Z13DT	09.2003→		7.00020.24.0	AGR	EL <input type="checkbox"/>	
CARRY Platform/Chassis (FD, DA5_T, DA6_T)						28
1.3 4x4 (DA32T) 56-63 kW (76-86 PS) G13BB	10.2000→07.2005		7.05271.35.0	LS	400 mm	
S CARRY Van (FD)						29
1.3 16 V (DA32V) 56-63 kW (76-86 PS) G13BB	03.2000→		7.05271.35.0	LS	400 mm	
1.3 4x4 56-63 kW (76-86 PS) G13BB	02.1999→09.2004		7.05271.35.0	LS	400 mm	



							
AURIS (_E15_)							1
1.33 Dual-VVTi (NRE150_) 62-74 kW (84-101 PS) 1NR-FE	05.2009→09.2012		7.05271.36.0	LS	360 mm	→10.2009	
1.6 (ZRE151_) 81-132 kW (110-180 PS) 1ZR-FAE	05.2009→09.2012		7.05271.36.0	LS	360 mm		
1.8 (ZRE152_) 92-108 kW (125-147 PS) 2ZR-FAE	02.2009→09.2012		7.05271.36.0	LS	360 mm		
1.8 (ZRE152_, ZZE122) 92-108 kW (125-147 PS) 2ZR-FAE	10.2006→09.2012		7.05271.36.0	LS	360 mm		
AURIS (_E18_)							2
1.6 (ZRE181_, ZRE185_) 81-132 kW (110-180 PS) 1ZR-FAE	10.2012→12.2018		7.05271.36.0	LS	360 mm		
1.6 D4-D (WWE185_) 82 kW (112 PS) 1WW	04.2015→12.2018		7.04493.17.0	AGR	EL		
			7.11190.12.0	DDS		ohne Zubehör without accessories	
1.8 (ZRE186_) 92-108 kW (125-147 PS) 2ZR-FAE	10.2012→12.2018		7.05271.36.0	LS	360 mm		
AURIS Estate (_E18_)							3
1.6 (ZRE185_) 81-132 kW (110-180 PS) 1ZR-FAE	07.2013→12.2018		7.05271.36.0	LS	360 mm		
1.6 D4-D (WWE185_) 82 kW (112 PS) 1WW	04.2015→12.2018		7.04493.17.0	AGR	EL		
			7.11190.12.0	DDS		ohne Zubehör without accessories	
AVENSIS (_T22_)							4
1.6 VVT-i (ZZT220_) 80-81 kW (109-110 PS) 3ZZ-FE	10.2000→02.2003		7.05271.36.0	LS	360 mm	Xenon	
1.8 VVT-i (ZZT221_) 89-107 kW (121-146 PS) 1ZZ-FE	10.2000→02.2003		7.05271.36.0	LS	360 mm	Xenon	
2.0 VVT-i (AZT220_) 92-132 kW (125-179 PS) 1AZ-FSE	10.2000→02.2003		7.05271.65.0	LS	400 mm		
AVENSIS Estate (_T22_)							5
1.6 (ZZT220_) 80-81 kW (109-110 PS) 3ZZ-FE	07.2000→02.2003		7.05271.36.0	LS	360 mm	Xenon	
1.8 (ZZT221_) 89-107 kW (121-146 PS) 1ZZ-FE	10.2000→02.2003		7.05271.36.0	LS	360 mm	Xenon	
2.0 (AZT220_) 92-132 kW (125-179 PS) 1AZ-FSE	10.2000→02.2003		7.05271.65.0	LS	400 mm		
AVENSIS Estate (_T25_)							6
1.8 (ZZT251_) 89-107 kW (121-146 PS) 1ZZ-FE	04.2003→11.2008		7.05271.65.0	LS	400 mm		









AVENSIS Estate (_T27_) 7

1.6 (ZRT270_) 81-132 kW (110-180 PS) 1ZR-FAE	02.2009→10.2018	 7.05271.36.0	LS	360 mm	
1.6 D4-D (WWT270_) 82 kW (112 PS) 1WW	04.2015→10.2018	 7.04493.17.0 7.11190.12.0	AGR DDS	EL	 ohne Zubehör without accessories
1.8 (ZRT271_) 92-108 kW (125-147 PS) 2ZR-FAE	02.2009→10.2018	 7.05271.36.0	LS	360 mm	
2.0 (ZRT272_) 106-116 kW (144-158 PS) 3ZR-FAE	02.2009→10.2018	 7.05271.36.0	LS	360 mm	
2.0 D-4D (WWT271_) 105 kW (143 PS) 2WW	04.2015→10.2018	 7.04493.17.0 7.11190.12.0	AGR DDS	EL	 ohne Zubehör without accessories



AVENSIS Liftback (_T22_) 8

1.6 (ZZT220_) 80-81 kW (109-110 PS) 3ZZ-FE	10.2000→02.2003	 7.05271.36.0	LS	360 mm	Xenon
1.8 (ZZT221_) 89-107 kW (121-146 PS) 1ZZ-FE	10.2000→02.2003	 7.05271.36.0	LS	360 mm	Xenon
2.0 (AZT220_) 92-132 kW (125-179 PS) 1AZ-FSE	10.2000→02.2003	 7.05271.65.0	LS	400 mm	

AVENSIS Saloon (_T27_) 9

1.6 (ZRT270_) 81-132 kW (110-180 PS) 1ZR-FAE	11.2008→10.2018	 7.05271.36.0	LS	360 mm	
1.6 D4-D (WWT270_) 82 kW (112 PS) 1WW	04.2015→10.2018	 7.04493.17.0 7.11190.12.0	AGR DDS	EL	 ohne Zubehör without accessories
1.8 (ZRT271_) 92-108 kW (125-147 PS) 2ZR-FAE	11.2008→10.2018	 7.05271.36.0	LS	360 mm	
2.0 (ZRT272_) 106-116 kW (144-158 PS) 3ZR-FAE	11.2008→10.2018	 7.05271.36.0	LS	360 mm	
2.0 D-4D (WWT271_) 105 kW (143 PS) 2WW	04.2015→10.2018	 7.04493.17.0 7.11190.12.0	AGR DDS	EL	 ohne Zubehör without accessories















AYGO (_B1_) 10

1.0 (KGB10_) 48-53 kW (65-72 PS) 1KR-FE	07.2005→05.2014	 7.05271.39.0 7.05271.51.0	LS LS	425 mm 300 mm	
1.4 HDi (WNB10_) 40 kW (54 PS) 2WZ-TV	07.2005→08.2010	 7.24809.76.0	AGR	EL	

AYGO (_B4_) 11

1.0 (KGB40) 48-53 kW (65-72 PS) 1KR-FE	05.2014→	 7.05271.39.0	LS	425 mm	
--	----------	---	----	--------	--



















T

						
CAMRY (_V1_)						12
3.0 (MCV10_) 135-164 kW (184-223 PS) 1MZ-FE	09.1993→07.1996		7.02604.01.0	LS	200 mm	
3.0 (VCV10_) 106-147 kW (144-200 PS) 3VZ-FE	06.1991→08.1996		7.02604.01.0	LS	200 mm	
3.0 (VCV10_) 106-147 kW (144-200 PS) 3VZ-FE	06.1991→09.1995		7.02604.01.0	LS	200 mm	
CAMRY (_V2_)						13
2.2 (SXV20) 93-103 kW (126-140 PS) 5S-FE	08.1997→09.2002		7.05271.53.0	LS	750 mm	
2.2 (SXV20_) 93-103 kW (126-140 PS) 5S-FE	08.1996→11.2001		7.05271.53.0	LS	750 mm	
			7.05271.56.0	LS	600 mm	→07.2000
3.0 24V (MCV20_, MCV20) 135-164 kW (184-223 PS) 1MZ-FE	08.1996→11.2001		7.05271.56.0	LS	600 mm	07.1997→
			7.02604.01.0	LS	200 mm	
3.0 V6 (MCV20_) 135-164 kW (184-223 PS) 1MZ-FE	08.1996→11.2001		7.02604.01.0	LS	200 mm	
CAMRY Estate (_V1_)						14
3.0 (VCV10_) 106-147 kW (144-200 PS) 3VZ-FE	09.1991→07.1996		7.02604.01.0	LS	200 mm	
3.0 (VCV10_) 106-147 kW (144-200 PS) 3VZ-FE	09.1991→07.1996		7.02604.01.0	LS	200 mm	
CAMRY Estate (_V2_)						15
3.0 (MCV20_, MCV20) 135-164 kW (184-223 PS) 1MZ-FE	08.1996→07.2001		7.02604.01.0	LS	200 mm	
CAMRY Saloon (_V3_)						16
2.4 (ACV30, ACV36) 105-127 kW (143-173 PS) 2AZ-FE	11.2001→11.2006		7.05271.36.0	LS	360 mm	
CELICA Coupe (_T23_)						17
1.8 16V TS (ZZT231_) 122-165 kW (166-224 PS) 2ZZ-GE	08.1999→09.2005		7.05271.38.0	LS	680 mm	Regelsonde Regulating Probe vor Katalysator in front of the catalyst
1.8 16V VT-i (ZZT230_) 89-107 kW (121-146 PS) 1ZZ-FE	08.1999→07.2005		7.05271.38.0	LS	680 mm	Diagnosesonde Diagnostic Probe nach Katalysator Post-catalyst
COROLLA (_E11_)						18
1.4 16V (ZZE111_) 71-74 kW (97-101 PS) 4ZZ-FE	02.2000→11.2001		7.05271.39.0	LS	425 mm	
COROLLA (_E12_)						19
1.4 VVT-i (ZZE120_) 71-74 kW (97-101 PS) 4ZZ-FE	11.2001→02.2007		7.05271.39.0	LS	425 mm	























T

						
COROLLA (_E7_)						20
1.3 (KE70) 41-48 kW (56-65 PS) 4K	09.1979→06.1983		7.02604.01.0	LS	200 mm	
1.3 (KE70) 41-48 kW (56-65 PS) 4K	02.1982→06.1983		7.02604.01.0	LS	200 mm	
COROLLA Compact (_E11_)						21
1.4 (ZZE111_) 71-74 kW (97-101 PS) 4ZZ-FE	10.1999→01.2002		7.05271.39.0	LS	425 mm	
COROLLA Compact (_E9_)						22
1.3 (EE90) 48-60 kW (65-82 PS) 2E, 2E-E	08.1987→04.1992		7.02604.01.0	LS	200 mm	
COROLLA Estate (_E11_)						23
1.4 16V (ZZE111_) 71-74 kW (97-101 PS) 4ZZ-FE	02.2000→10.2001		7.05271.39.0	LS	425 mm	
COROLLA Estate (_E12_)						24
1.4 VVT-i (ZZE120_) 71-74 kW (97-101 PS) 4ZZ-FE	01.2002→02.2007		7.05271.39.0	LS	425 mm	
COROLLA Estate (_E7_)						25
1.3 (KE70) 42-44 kW (57-60 PS) 4K-C	12.1979→01.1982		7.02604.01.0	LS	200 mm	
1.3 (KE70) 41-48 kW (56-65 PS) 4K	02.1982→08.1987		7.02604.01.0	LS	200 mm	
COROLLA FX Compact (E8B)						26
1.3 (EE80_) 48-61 kW (65-83 PS) 2E-L	09.1985→08.1987		7.02604.01.0	LS	200 mm	
COROLLA Hatchback (_E7_)						27
1.3 (KE70) 41-48 kW (56-65 PS) 4K	09.1979→01.1982		7.02604.01.0	LS	200 mm	
1.3 (KE70) 41-48 kW (56-65 PS) 4K	02.1982→05.1983		7.02604.01.0	LS	200 mm	
COROLLA Liftback (_E11_)						28
1.4 (ZZE111_) 71-74 kW (97-101 PS) 4ZZ-FE	10.1999→01.2002		7.05271.39.0	LS	425 mm	
COROLLA Saloon (_E12_)						29
1.4 VVT-i (ZZE120_) 71-74 kW (97-101 PS) 4ZZ-FE	10.2001→10.2006		7.05271.39.0	LS	425 mm	
COROLLA Station Wagon (_E9_)						30
1.3 (EE90) 48-60 kW (65-82 PS) 2E	06.1989→12.1989		7.02604.01.0	LS	200 mm	
IQ (_J1_)						31
1.0 (KGJ10_) 48-53 kW (65-72 PS) 1KR-FE	01.2009→12.2015		7.05271.36.0	LS	360 mm	
1.33 (NGJ10_) 62-74 kW (84-101 PS) 1NR-FE	01.2009→12.2015		7.05271.36.0	LS	360 mm	
LAND CRUISER 80 (_J8_)						32
4.5 24V (FZJ80_) 151-215 kW (205-292 PS) 1FZ-FE	08.1992→12.1997		7.02604.03.0	LS	200 mm	

T

						
LAND CRUISER PRADO (_J12_)						33
2.7 (TRJ125, RZJ120) 92-112 kW (125-152 PS) 3RZ-FE	09.2002→08.2004		7.05271.56.0	LS	600 mm	
MR2 II (SW2_)						34
2.0 16V (SW20_) 103-154 kW (140-209 PS) 3S-GE	12.1989→07.1999		7.05271.56.0	LS	600 mm	
2.0 16V (SW20_) 103-154 kW (140-209 PS) 3S-GE	12.1989→05.2000		7.05271.56.0	LS	600 mm	
MR2 III (ZZW3_)						35
1.8 16V VT-i (ZZW30) 89-107 kW (121-146 PS) 1ZZ-FE	10.1999→06.2007		7.05271.56.0	LS	600 mm	
PREVIA II (_R3_)						36
2.4 (ACR30) 105-127 kW (143-173 PS) 2AZ-FE	02.2000→02.2006		7.05271.38.0	LS	680 mm	
					→04.2003 rechts Right Diagnosesonde Diagnostic Probe nach Katalysator Post-catalyst	
PRIUS (_W3_)						37
1.8 Hybrid (ZVW3_) 70-132 kW (95-180 PS) 2ZR-FXE	06.2008→		7.05271.48.0	LS	575 mm	
					Regelsonde Regulating Probe vor Katalysator in front of the catalyst	
PRIUS Liftback (_W2_)						38
1.5 Hybrid (NHW20_) 43-74 kW (58-101 PS) 1NZ-FXE	09.2003→12.2009		7.05271.38.0	LS	680 mm	
					Diagnosesonde Diagnostic Probe nach Katalysator Post-catalyst	
PRIUS Saloon (_W1_)						39
1.5 Hybrid (NHW1_) 43-74 kW (58-101 PS) 1NZ-FXE	05.2000→01.2004		7.05271.38.0	LS	680 mm	
			7.05271.56.0	LS	600 mm	
					Diagnosesonde Diagnostic Probe nach Katalysator Post-catalyst 09.2000→08.2003	
RAV 4 II (_A2_)						40
2.0 4WD (ACA21, ACA20) 92-132 kW (125-179 PS) 1AZ-FE, 1AZ-FSE	05.2000→11.2005		7.05271.53.0	LS	750 mm	
RAV 4 IV (_A4_)						41
2.0 D (WWA42_) 105 kW (143 PS) 2WW	10.2015→11.2018		7.04493.17.0	AGR	EL 	
			7.11190.12.0	DDS	ohne Zubehör without accessories  →ch. 05.2018 für OE-Nummer: 89481-YV020 für OE number: 89481-YV020	
SOLARA Coupe (_V3_)						42
2.4 (ACV30_) 105-127 kW (143-173 PS) 2AZ-FE	07.2003→11.2008		7.05271.36.0	LS	360 mm	

T



					
TERCEL (AL2_) 43					
1.5 4WD (AL25) 46-52 kW (63-71 PS) 3A-C	09.1982→01.1988		7.02604.01.0	LS	200 mm
TERCEL (_L1_, _L2_) 44					
1.5 (AL21) 46-52 kW (63-71 PS) 3A-C	08.1983→05.1985		7.02604.01.0	LS	200 mm
VERSO (_R2_) 45					
1.6 D4-D (WAR20_) 82 kW (112 PS) 1WW	11.2013→08.2018		7.03051.04.0	AGR	PN mit Potentiometer with potentiometer  01.2014→02.2015
			7.04493.17.0	AGR	EL  03.2015→
			7.11190.12.0	DDS	ohne Zubehör without accessories 03.2015→
YARIS (_P13_) 46					
1.0 (KSP130_) 48-53 kW (65-72 PS) 1KR-FE	12.2010→		7.05271.39.0	LS	425 mm
YARIS (_P1_) 47					
1.0 (SCP10_) 48-50 kW (65-68 PS) 1SZ-FE	04.1999→09.2005		7.05271.53.0	LS	750 mm
			7.05271.51.0	LS	300 mm  1SZ-FE: 02.2003→ Regelsonde Regulating Probe vor Katalysator in front of the catalyst
					 1SZ-FE: 01.2001→02.2003 Diagnosesonde Diagnostic Probe nach Katalysator Post-catalyst
1.3 (NCP10_, SCP12_) 57-66 kW (78-90 PS) 2NZ-FE	08.1999→11.2005		7.05271.56.0	LS	600 mm →12.2002
1.4 D-4D (NLP10_) 50-66 kW (68-90 PS) 1ND-TV	10.2001→09.2005		7.05271.30.0	LS	400 mm
1.5 (NCP13_) 68-110 kW (92-150 PS) 1NZ-FE	04.2001→09.2005		7.05271.56.0	LS	600 mm →08.2005
1.5 (NCP13_) 68-110 kW (92-150 PS) 1NZ-FE	01.2003→11.2005		7.05271.56.0	LS	600 mm →08.2005
YARIS (_P9_) 48					
1.0 VVT-i (KSP90_) 48-53 kW (65-72 PS) 1KR-FE	08.2005→12.2011		7.05271.39.0	LS	425 mm
1.4 D-4D (NLP90_) 50-66 kW (68-90 PS) 1ND-TV	08.2005→12.2012		7.05271.30.0	LS	400 mm
YARIS VERSO (_P2_) 49					
1.3 (NCP20_, NCP22_) 57-66 kW (78-90 PS) 2NZ-FE	08.1999→10.2002		7.05271.56.0	LS	600 mm 03.2000→







































T





































YARIS VERSO (_P2_)

49

1.3 (NCP20_, NCP22_) 57-66 kW (78-90 PS) 2NZ-FE	11.2002→09.2005	 7.05271.56.0	LS 600 mm	
1.4 D-4D (NLP20_, NLP22_) 50-66 kW (68-90 PS) 1ND-TV	09.2000→09.2005	 7.05271.30.0	LS 400 mm	

			 PIERBURG		
ADAM (M13)					1
1.0 85 kW (115 PS) D 10 XFT	07.2014→11.2018		7.11190.08.0	DDS	
AGILA Mk I (A) (H00)					2
1.0 12V 44 kW (60 PS) Z 10 XEP	02.2000→11.2006		7.22875.16.0	AGR	EL   ch. 5G000001→
			7.22875.13.0	AGR	EL   →ch. 4G999999
			7.02604.07.0	LS	570  →ch. 5G999999 mm vor Katalysator in front of the catalyst
			7.05271.81.0	LS	210 vor Katalysator mm in front of the catalyst
1.0 12V 43 kW (58 PS) Z 10 XE	09.2000→08.2005		7.22875.13.0	AGR	EL 
			7.02604.07.0	LS	570 vor Katalysator mm in front of the catalyst
			7.02604.08.0	LS	350 Diagnosesonde mm Diagnostic Probe
			7.05271.81.0	LS	210  →ch. 4G999999 mm vor Katalysator in front of the catalyst
1.2 16V 55 kW (75 PS) Z 12 XE	09.2000→03.2008		7.22875.13.0	AGR	EL 
			7.05271.68.0	LS	750 vor Katalysator mm in front of the catalyst
			7.02604.08.0	LS	350 Diagnosesonde mm Diagnostic Probe
			7.05271.81.0	LS	210  →ch. 4G999999 mm nach Katalysator Post-catalyst
1.2 16V Twinport 59 kW (80 PS) Z 12 XEP	07.2004→11.2006		7.22875.16.0	AGR	EL   ch. 5G000001→
			7.22875.13.0	AGR	EL   →ch. 4G999999
			7.05271.68.0	LS	750  →ch. 5G999999 mm vor Katalysator in front of the catalyst
			7.05271.81.0	LS	210 vor Katalysator mm in front of the catalyst
AGILA Mk II (B) (H08)					3
1.3 CDTi 51-55 kW (69-75 PS) Z 13 DTJ	01.2008→11.2014		7.00020.24.0	AGR	EL 
1.3 CDTi 55 kW (75 PS) D13A	01.2008→11.2014		7.00020.50.0	AGR	EL 
			7.11190.04.0	DDS	
ANTARA A (L07)					4
2.0 CDTi 110 kW (150 PS) Z 20 DMH	08.2006→04.2015		7.08369.70.0	ATS	EL
2.0 CDTi 4x4 110 kW (150 PS) Z 20 DMH	08.2006→04.2015		7.08369.70.0	ATS	EL
2.0 CDTi 93 kW (126 PS) Z 20 DM	08.2006→04.2015		7.08369.70.0	ATS	EL
2.2 CDTi 4x4 120 kW (163 PS) A 22 DM	12.2010→		7.11020.49.0	ATS	EL
2.2 CDTi FWD 120 kW (163 PS) A 22 DM	12.2010→		7.11020.49.0	ATS	EL
2.4 103 kW (140 PS) Z 24 XE	08.2006→04.2015		7.09002.13.0	AGR	ET 
2.4 LPG 4x4 103 kW (140 PS) Z 24 XE	08.2006→		7.09002.13.0	AGR	ET 













V

					
ASTRA MK IV 5					
1.6i 16V (Gas) 69-74 kW (94-101 PS) Z 16 YNG	09.2002→		7.05270.25.0	LS	800 mm
			7.05270.26.0	LS	300 mm
ASTRA MK V 6					
1.2i 16V 59 kW (80 PS) Z 12 XEP	04.2005→		7.22875.16.0	AGR	EL 
			7.22875.13.0	AGR	EL 
ASTRA Mk II Belmont (T85) 7					
1.4 i 44 kW (60 PS) C 14 NZ	01.1990→12.1991		7.02604.15.0	LS	360 mm
ASTRA Mk II Convertible (T85) 8					
2.0 i Cat 85 kW (115 PS) C 20 NE	01.1991→08.1993		7.02604.03.0	LS	200 mm
ASTRA Mk II Hatchback (T85) 9					
1.4 i 44 kW (60 PS) C 14 NZ	01.1990→08.1991		7.02604.15.0	LS	360 mm
1.9 110 kW (150 PS) C 20 XE	03.1988→08.1991		7.02604.03.0	LS	200 mm
2.0 GTE 16V 115 kW (156 PS) 20 XE	05.1988→08.1991		7.02604.03.0	LS	200 mm
ASTRA Mk III (F) Convertible (T92) 10					
1.6 i 52 kW (71 PS) X 16 SZ	03.1993→08.1996		7.02604.15.0	LS	360 mm
1.6 i 55 kW (75 PS) X 16 SZR	01.1996→03.2001		7.02604.15.0	LS	360 mm
1.8 92 kW (125 PS) C 18 XE	09.1994→08.1996		7.05270.32.0	LS	825 mm  →ch. T8100001
			7.05270.33.0	LS	705 mm  ch. T2500015→
1.8 16V 85 kW (116 PS) C 18 XEL	11.1994→03.2001		7.05270.32.0	LS	825 mm
1.8 16V 85 kW (116 PS) X 18 XE	11.1994→03.2001		7.22296.02.0	ARV	PN 
			7.05270.33.0	LS	705 mm  ch. T5000074→
1.8 i (F08) 66 kW (90 PS) C 18 NZ	09.1991→02.1998		7.02604.15.0	LS	360 mm
2.0 i 85 kW (115 PS) C 20 NE	03.1993→10.1994		7.02604.03.0	LS	200 mm
2.0 i 16V 100 kW (136 PS) X 20 XEV	01.1994→02.1998		7.22296.02.0	ARV	PN 
ASTRA Mk III (F) Estate (T92) 11					
1.4 i 60 kW (82 PS) C 14 SE	03.1991→02.1998		7.02604.15.0	LS	360 mm
1.4 i 44 kW (60 PS) C 14 NZ	09.1991→02.1998		7.02604.15.0	LS	360 mm
1.4 i 16V 66 kW (90 PS) X 14 XE	02.1996→01.1998		7.22296.02.0	ARV	PN 
			7.02604.15.0	LS	360 mm
1.6 Si 74 kW (101 PS) C 16 SE	03.1991→12.1994		7.02604.15.0	LS	360 mm
1.6 i 55-61 kW (75-83 PS) C 16 NZ, X 16 SZR	09.1991→12.1998		7.02604.15.0	LS	360 mm













V



ASTRA Mk III (F) Estate (T92) **11**

1.6 i 52 kW (71 PS) X 16 SZ	07.1994→02.1998		7.02604.15.0	LS	360 mm	
1.6 i 16V 74 kW (101 PS) X 16 XEL	01.1994→02.1998		7.22296.02.0	ARV	PN	
			7.02604.15.0	LS	360 mm	Fahrgestellnummer ab: S2531219, S3, S4, S5223657, S6, SA, SB, SE, SP, SS Vehicle Identification Number from: S2531219, S3, S4, S5223657, S6, SA, SB, SE, SP, SS Japan Japan
			7.05270.26.0	LS	300 mm	
1.8 i 66 kW (90 PS) C 18 NZ	09.1991→02.1998		7.02604.15.0	LS	360 mm	
			7.02604.01.0	LS	200 mm	
1.8 i 16V 92 kW (125 PS) C 18 XE	09.1994→02.1998		7.05270.32.0	LS	825 mm	 →ch. T8100001
			7.05270.33.0	LS	705 mm	 ch. T2500015→
1.8 i 16V 85 kW (116 PS) C 18 XEL	09.1994→02.1998		7.05270.32.0	LS	825 mm	
2.0 i 85 kW (115 PS) C 20 NE	09.1991→02.1998		7.02604.03.0	LS	200 mm	
2.0 i 16V 100 kW (136 PS) X 20 XEV	01.1994→02.1998		7.22296.02.0	ARV	PN	
			7.05270.32.0	LS	825 mm	 →ch. T8100001
			7.05270.33.0	LS	705 mm	 ch. T8100001→

ASTRA Mk III (F) Hatchback (T92) **12**

1.4 i 44 kW (60 PS) C 14 NZ	09.1991→02.1998		7.02604.15.0	LS	360 mm	
1.4 i 60 kW (82 PS) C 14 SE	03.1992→02.1998		7.02604.15.0	LS	360 mm	
1.4 i 16V 66 kW (90 PS) X 14 XE	02.1996→02.1998		7.22296.02.0	ARV	PN	
			7.02604.15.0	LS	360 mm	
1.6 i 55-61 kW (75-83 PS) C 16 NZ	09.1991→02.1998		7.02604.15.0	LS	360 mm	
1.6 i 74 kW (101 PS) C 16 SE	03.1992→02.1998		7.02604.15.0	LS	360 mm	
1.6 i 52 kW (71 PS) X 16 SZ	02.1993→12.1996		7.02604.15.0	LS	360 mm	
1.6 i 16V 74 kW (101 PS) X 16 XEL	01.1994→02.1998		7.22296.02.0	ARV	PN	
			7.02604.15.0	LS	360 mm	Fahrgestellnummer ab: S2531219, S3, S4, S5223657, S6, S8, SA, SB, SE, SP, SS Vehicle Identification Number from: S2531219, S3, S4, S5223657, S6, S8, SA, SB, SE, SP, SS Japan Japan
			7.05270.26.0	LS	300 mm	
1.8 i 66 kW (90 PS) C 18 NZ	09.1991→02.1998		7.02604.15.0	LS	360 mm	
1.8 i 16V 92 kW (125 PS) C 18 XE	09.1994→02.1998		7.05270.32.0	LS	825 mm	 →ch. T8100001

V



ASTRA Mk III (F) Hatchback (T92) 12

			7.05270.33.0	LS	705 mm	ch. T2500015→
1.8 i 16V 85 kW (116 PS) C 18 XEL	09.1994→02.1998		7.05270.32.0	LS	825 mm	
2.0 i 85 kW (115 PS) C 20 NE	09.1991→02.1998		7.02604.03.0	LS	200 mm	
2.0 i 16V 100 kW (136 PS) X 20 XEV	01.1994→02.1998		7.22296.02.0	ARV	PN	
			7.05270.32.0	LS	825 mm	→ch. T8100001
			7.05270.33.0	LS	705 mm	ch. T8100001→

ASTRA Mk III (F) Saloon (T92) 13

1.4 i 44 kW (60 PS) C 14 NZ	04.1992→09.1998		7.02604.15.0	LS	360 mm	
1.4 i 60 kW (82 PS) C 14 SE	04.1992→09.1998		7.02604.15.0	LS	360 mm	
1.4 i 16V 66 kW (90 PS) X 14 XE	02.1996→09.1998		7.22296.02.0	ARV	PN	
			7.02604.15.0	LS	360 mm	
1.6 i 55-61 kW (75-83 PS) C 16 NZ, X 16 SZR	03.1992→09.1998		7.02604.15.0	LS	360 mm	
1.6 i 74 kW (101 PS) C 16 SE	05.1992→12.1994		7.02604.15.0	LS	360 mm	
1.6 i 52 kW (71 PS) X 16 SZ	08.1994→07.1996		7.02604.15.0	LS	360 mm	
1.6 i 16V 74 kW (101 PS) X 16 XEL	08.1994→09.1998		7.22296.02.0	ARV	PN	
			7.02604.15.0	LS	360 mm	Fahrgestellnummer ab: S2531219, S3, S4, S5223657, S6, S8, SA, SB, SE, SP, SS Vehicle Identification Number from: S2531219, S3, S4, S5223657, S6, S8, SA, SB, SE, SP, SS Japan Japan
			7.05270.26.0	LS	300 mm	
1.8 i 66 kW (90 PS) C 18 NZ	03.1992→09.1998		7.02604.15.0	LS	360 mm	
1.8 i 16V 92 kW (125 PS) C 18 XE	06.1993→10.1994		7.05270.32.0	LS	825 mm	→ch. T8100001
			7.05270.33.0	LS	705 mm	ch. T2500015→
1.8 i 16V 85 kW (116 PS) C 18 XEL	01.1994→12.1996		7.05270.32.0	LS	825 mm	
2.0 i 85 kW (115 PS) C 20 NE	03.1992→09.1998		7.02604.03.0	LS	200 mm	
2.0 i 16V 100 kW (136 PS) X 20 XEV	02.1995→09.1998		7.22296.02.0	ARV	PN	
			7.05270.32.0	LS	825 mm	→ch. T8100001
			7.05270.33.0	LS	705 mm	ch. T8100001→

ASTRA Mk IV (G) Convertible (T98) 14

1.6 16V 63-74 kW (85-101 PS) Z 16 XE	03.2001→10.2005		7.24809.10.0	AGR	EL	→ch. 42999999
			7.05270.25.0	LS	800 mm	→ch. 12999999 Diagnosesonde Diagnostic Probe



ASTRA Mk IV (G) Convertible (T98)

14

			7.05271.76.0	LS	630 mm	
1.6 16V 74-77 kW (101-105 PS) Z 16 XEP	03.2003→10.2005		7.28384.13.0	AGR	EL	
			7.02604.05.0	LS	550 mm	vor Katalysator in front of the catalyst
1.8 16V 87-92 kW (118-125 PS) Z 18 XE	03.2001→10.2005		7.05271.55.0	LS	800 mm	
			7.02604.07.0	LS	570 mm	vor Katalysator in front of the catalyst
2.0 Turbo 140-162 kW (190-220 PS) Z 20 LET	03.2002→10.2005		7.02604.07.0	LS	570 mm	vor Katalysator in front of the catalyst
			7.05270.29.0	LS	630 mm	
2.2 16V 106-108 kW (144-147 PS) Z 22 SE	03.2001→10.2005		7.22630.28.0	AGR	EL	→11292859
			7.05270.29.0	LS	630 mm	
			7.05270.30.0	LS	1275 mm	

ASTRA Mk IV (G) Coupe (T98)

15

1.6 16V 74-77 kW (101-105 PS) Z 16 XEP	03.2000→08.2005		7.28384.13.0	AGR	EL	
			7.02604.05.0	LS	550 mm	vor Katalysator in front of the catalyst
1.8 16V 85 kW (116 PS) X 18 XE1	03.2000→08.2005		7.24809.10.0	AGR	EL	
			7.05270.32.0	LS	825 mm	
1.8 16V 87-92 kW (118-125 PS) Z 18 XE	09.2000→08.2005		7.05271.55.0	LS	800 mm	
			7.02604.07.0	LS	570 mm	vor Katalysator in front of the catalyst
2.2 16V 106-108 kW (144-147 PS) Z 22 SE	03.2000→08.2005		7.22630.28.0	AGR	EL	→11292859
			7.05270.29.0	LS	630 mm	
			7.05270.30.0	LS	1275 mm	

ASTRA Mk IV (G) Estate (T98)

16

1.4 16V 66 kW (90 PS) Z 14 XE	02.1998→05.2005		7.05270.26.0	LS	300 mm	
			7.24809.10.0	AGR	EL	→ch. 42999999
				7.05270.25.0	LS	800 mm
			7.05271.76.0	LS	630 mm	
1.4 16V Dualfuel 66 kW (90 PS) Z 14 XE	09.1999→06.2003		7.24809.10.0	AGR	EL	→ch. 42999999
			7.05271.76.0	LS	630 mm	
1.6 55 kW (75 PS) X 16 SZR	03.1998→04.2004		7.24809.10.0	AGR	EL	
			7.02604.15.0	LS	360 mm	

V



























ASTRA Mk IV (G) Estate (T98)					
1.6 62-64 kW (84-87 PS) Z 16 SE	03.1998→04.2004		7.24809.10.0 AGR EL	300 mm ch. 22000001→ Diagnosesonde Diagnostic Probe	
			7.05270.26.0 LS		
1.6 74-77 kW (101-105 PS) Z 16 XEP	12.2002→05.2005		7.28384.13.0 AGR EL	550 mm	
			7.02604.05.0 LS		
1.6 16V 63-74 kW (85-101 PS) Z 16 XE	03.1998→04.2004		7.24809.10.0 AGR EL	800 mm →ch. 42999999 Diagnosesonde Diagnostic Probe	
			7.05270.25.0 LS		
			7.05271.76.0 LS 630 mm		
1.6 16V 74 kW (101 PS) X 16 XEL	03.1998→04.2004		7.05270.26.0 LS 300 mm ch. 22000001→ Diagnosesonde Diagnostic Probe		
1.6 Dualfuel 55 kW (75 PS) X 16 SZR	02.1998→12.2000		7.24809.10.0 AGR EL	360 mm	
			7.02604.15.0 LS		
1.6 Dualfuel 62-64 kW (84-87 PS) Z 16 SE	03.1998→04.2004		7.24809.10.0 AGR EL		
1.6 Dualfuel 63-74 kW (85-101 PS) Z 16 XE	09.1999→08.2004		7.24809.10.0 AGR EL	630 mm →ch. 42999999	
			7.05271.76.0 LS		
1.6 Dualfuel 62-64 kW (84-87 PS) Z 16 SE	07.2000→05.2005		7.24809.10.0 AGR EL		
1.7 DTI 16V 55 kW (75 PS) Y 17 DT	02.2000→05.2005		7.22772.12.0 AGR PN		
1.8 16V 85 kW (116 PS) X 18 XE1	02.1998→08.2000		7.24809.10.0 AGR EL	825 mm	
			7.05270.32.0 LS		
1.8 16V 87-92 kW (118-125 PS) Z 18 XE	09.2000→05.2005		7.05271.55.0 LS 800 mm		
2.0 DI 60 kW (82 PS) X 20 DTL	03.1998→04.2004		7.24809.24.0* AGR PN mit Saugrohr with suction pipe	für Hersteller-Abgasnorm: NC8 for manufacturer exhaust norm: NC8	
			↳ 7.24809.27.0 AGR PN		
			7.24809.25.0* AGR PN mit Saugrohr with suction pipe		
			↳ 7.24809.28.0 AGR PN 96 EEC, D3 96 EEC, D3		
2.0 DI 60 kW (82 PS) Y 20 DTL	03.1998→04.2004		7.24809.25.0* AGR PN mit Saugrohr with suction pipe		
			↳ 7.24809.28.0 AGR PN		
2.0 DTI 16V 74 kW (101 PS) Y 20 DTH	03.1998→04.2004		7.24809.25.0* AGR PN mit Saugrohr with suction pipe	→ch. 22999999	
			↳ 7.24809.28.0 AGR PN		
			7.24809.29.0 AGR ET		
2.2 16V 106-108 kW (144-147 PS) Z 22 SE	03.2001→05.2005		7.22630.28.0 AGR EL	→11292859	



ASTRA Mk IV (G) Estate (T98) 16

			7.05270.29.0	LS	630 mm	
			7.05270.30.0	LS	1275 mm	

ASTRA Mk IV (G) Hatchback (T98) 17

1.4 16V (F08, F48) 66 kW (90 PS) X 14 XE	02.1998→05.2005		7.05270.26.0	LS	300 mm	
1.4 16V (F08, F48) 66 kW (90 PS) Z 14 XE	02.1998→05.2005		7.24809.10.0	AGR	EL	 →ch. 42999999
			7.05270.25.0	LS	800 mm	 →ch. 12999999 Diagnosesonde Diagnostic Probe
			7.05271.76.0	LS	630 mm	
			7.05270.26.0	LS	300 mm	
1.4 16V Dualfuel (F08, F48) 66 kW (90 PS) Z 14 XE	09.1999→06.2003		7.24809.10.0	AGR	EL	 →ch. 42999999
			7.05271.76.0	LS	630 mm	
1.6 (F08, F48) 55 kW (75 PS) X 16 SZR	02.1998→09.2000		7.24809.10.0	AGR	EL	
			7.02604.15.0	LS	360 mm	
1.6 (F08, F48) 62-64 kW (84-87 PS) Z 16 SE	09.2000→05.2005		7.24809.10.0	AGR	EL	
			7.05270.26.0	LS	300 mm	 ch. 22000001→ Diagnosesonde Diagnostic Probe
1.6 (F08, F48) 74-77 kW (101-105 PS) Z 16 XEP	12.2002→05.2005		7.28384.13.0	AGR	EL	
			7.02604.05.0	LS	550 mm	vor Katalysator in front of the catalyst
1.6 16V (F08, F48) 63-74 kW (85-101 PS) Z 16 XE	02.1998→05.2005		7.24809.10.0	AGR	EL	 →ch. 42999999
			7.05270.25.0	LS	800 mm	 →ch. 12999999 Diagnosesonde Diagnostic Probe
			7.05271.76.0	LS	630 mm	
1.6 16V (F08, F48) 74 kW (101 PS) X 16 XEL	02.1998→05.2005		7.05270.26.0	LS	300 mm	 ch. 22000001→ Diagnosesonde Diagnostic Probe
1.6 Dualfuel (F08) 62-64 kW (84-87 PS) Z 16 SE	07.2000→05.2005		7.24809.10.0	AGR	EL	
1.6 Dualfuel (F08, F48) 55 kW (75 PS) X 16 SZR	02.1998→12.2000		7.24809.10.0	AGR	EL	
			7.02604.15.0	LS	360 mm	
1.6 Dualfuel (F08, F48) 63-74 kW (85-101 PS) Z 16 XE	09.1999→08.2004		7.24809.10.0	AGR	EL	 →ch. 42999999
			7.24809.10.0	AGR	EL	
1.6 Dualfuel (F08, F48) 62-64 kW (84-87 PS) Z 16 SE	09.2002→05.2005		7.24809.10.0	AGR	EL	

V



ASTRA Mk IV (G) Hatchback (T98) 17































1.7 DTI 16V (F08, F48) 55 kW (75 PS) Y 17 DT	02.2000→05.2005	7.22772.12.0	AGR	PN	
1.8 16V (F08, F48) 85 kW (116 PS) X 18 XE1	02.1998→09.2000	7.24809.10.0	AGR	EL	
		7.05270.32.0	LS	825 mm	
1.8 16V (F08, F48) 87-92 kW (118-125 PS) Z 18 XE	09.2000→05.2005	7.05271.55.0	LS	800 mm	
2.0 (F08) 140-162 kW (190-220 PS) Z 20 LET	08.2002→05.2005	7.02604.07.0	LS	570 mm	vor Katalysator in front of the catalyst
2.0 16V (F08) 100 kW (136 PS) X 20 XEV	02.1998→05.2005	7.05270.33.0	LS	705 mm	
2.0 DI (F48) 60 kW (82 PS) X 20 DTL	02.1998→05.2005	7.24809.24.0*	AGR	PN	mit Saugrohr with suction pipe für Hersteller-Abgasnorm: NC8 for manufacturer exhaust norm: NC8
		↳ 7.24809.27.0	AGR	PN	
		7.24809.25.0*	AGR	PN	mit Saugrohr with suction pipe 96 EEC, D3 96 EEC, D3
		↳ 7.24809.28.0	AGR	PN	
2.0 DI (F48) 60 kW (82 PS) Y 20 DTL	02.1998→05.2005	7.24809.25.0*	AGR	PN	mit Saugrohr with suction pipe
		↳ 7.24809.28.0	AGR	PN	
2.0 DTI 16V (F48) 74 kW (101 PS) Y 20 DTH	08.1999→05.2005	7.24809.25.0*	AGR	PN	mit Saugrohr with suction pipe ↳ ch. 22999999
		↳ 7.24809.28.0	AGR	PN	
		7.24809.29.0	AGR	ET	
2.0 SRI Turbo (F08) 140-162 kW (190-220 PS) Z 20 LET	11.2001→05.2005	7.02604.07.0	LS	570 mm	vor Katalysator in front of the catalyst
2.2 16V (F08, F48) 106-108 kW (144-147 PS) Z 22 SE	03.2001→05.2005	7.22630.28.0	AGR	EL	→11292859
		7.05270.29.0	LS	630 mm	
		7.05270.30.0	LS	1275 mm	

ASTRA Mk IV (G) Saloon (T98) 18





1.4 16V 66 kW (90 PS) X 14 XE	09.1998→05.2005	7.05270.26.0	LS	300 mm	
1.4 16V 66 kW (90 PS) Z 14 XE	09.1998→05.2005	7.24809.10.0	AGR	EL	→ch. 42999999
		7.05270.25.0	LS	800 mm	→ch. 12999999 Diagnosesonde Diagnostic Probe
		7.05271.76.0	LS	630 mm	
		7.05270.26.0	LS	300 mm	
1.6 55 kW (75 PS) X 16 SZR	09.1998→09.2000	7.24809.10.0	AGR	EL	
		7.02604.15.0	LS	360 mm	



ASTRA Mk IV (G) Saloon (T98) **18**

1.6 62-64 kW (84-87 PS) Z 16 SE	09.2000→05.2005		7.24809.10.0	AGR	EL	
			7.05270.26.0	LS	300 mm	 ch. 22000001→ Diagnosesonde Diagnostic Probe
1.6 16V 63-74 kW (85-101 PS) Z 16 XE	09.1998→05.2005		7.24809.10.0	AGR	EL	  →ch. 42999999
			7.05270.25.0	LS	800 mm	 →ch. 12999999 Diagnosesonde Diagnostic Probe
1.6 16V 74 kW (101 PS) X 16 XEL	09.1998→05.2005		7.05270.26.0	LS	300 mm	 ch. 22000001→ Diagnosesonde Diagnostic Probe
1.6 Dualfuel 63-74 kW (85-101 PS) Z 16 XE	09.1999→08.2004		7.24809.10.0	AGR	EL	  →ch. 42999999
1.6 Dualfuel 62-64 kW (84-87 PS) Z 16 SE	07.2000→05.2005		7.24809.10.0	AGR	EL	
1.6 Dualfuel 62-64 kW (84-87 PS) Z 16 SE	09.2002→05.2005		7.24809.10.0	AGR	EL	
1.7 DTI 16V 55 kW (75 PS) Y 17 DT	02.2000→05.2005		7.22772.12.0	AGR	PN	
1.8 16V 85 kW (116 PS) X 18 XE1	02.1998→07.2004		7.24809.10.0	AGR	EL	
			7.05270.32.0	LS	825 mm	
1.8 16V 87-92 kW (118-125 PS) Z 18 XE	02.1998→07.2004		7.05271.55.0	LS	800 mm	
2.0 16V 100 kW (136 PS) X 20 XEV	09.1998→05.2005		7.05270.33.0	LS	705 mm	
2.0 DI 60 kW (82 PS) X 20 DTL	02.1998→07.2004		7.24809.24.0*	AGR	PN	mit Saugrohr with suction pipe  für Hersteller-Abgasnorm: NC8 for manufacturer exhaust norm: NC8
			↳ 7.24809.27.0	AGR	PN	
			7.24809.25.0*	AGR	PN	mit Saugrohr with suction pipe  96 EEC, D3 96 EEC, D3
			↳ 7.24809.28.0	AGR	PN	
2.0 DI 60 kW (82 PS) Y 20 DTL	02.1998→07.2004		7.24809.25.0*	AGR	PN	mit Saugrohr with suction pipe 
			↳ 7.24809.28.0	AGR	PN	
2.0 DTI 16V 74 kW (101 PS) Y 20 DTH	02.1998→07.2004		7.24809.25.0*	AGR	PN	mit Saugrohr with suction pipe   →ch. 22999999
			↳ 7.24809.28.0	AGR	PN	
			7.24809.29.0	AGR	ET	

V ASTRA Mk V (H) (A04) **19**

1.3 CDTI (L48) 66-74 kW (90-101 PS) Z 13 DTH	01.2004→05.2009		7.00020.25.0	AGR	EL	
			7.08369.15.0	ATS	EL	
			7.11190.04.0	DDS		
1.4 (L48) 66 kW (90 PS) Z 14 XEP	01.2004→05.2009		7.22875.16.0	AGR	EL	
			7.22875.13.0	AGR	EL	







ASTRA Mk V (H) (A04) **19**

			7.02604.07.0	LS	570 mm	→12.2005 vor Katalysator in front of the catalyst
			7.02604.08.0	LS	350 mm	Regelsonde, Diagnosesonde
			7.05271.81.0	LS	210 mm	Z 14 XEP: nach Katalysator Post-catalyst Z 14 XEP: Fahrgestellnummer ab: 62, 65, 68, 6G Vehicle Identification Number from: 62, 65, 68, 6G vor Katalysator in front of the catalyst
1.6 (L48) 74-77 kW (101-105 PS) Z 16 XEP	01.2004→05.2009		7.28384.13.0	AGR	EL	
			7.04879.00.0	AGR-TH		 Öffnungstemperatur/opening temperature 105C
			7.02604.05.0	LS	550 mm	→20HH5427 vor Katalysator in front of the catalyst
1.6 (L48) 85 kW (116 PS) Z 16 XER	01.2004→05.2009		7.04879.00.0	AGR-TH		 Öffnungstemperatur/opening temperature 105C
1.6 Turbo (L48) 132 kW (180 PS) Z 16 LET	09.2006→09.2009		7.05271.81.0	LS	210 mm	
1.7 CDTi (L48) 81 kW (110 PS) A 17 DTJ	01.2004→03.2011		7.10334.08.0	AGR	EL	
			7.08369.49.0	ATS	EL	
			7.08369.75.0	ATS	EL	
			7.11190.04.0	DDS		
1.7 CDTi (L48) 81 kW (110 PS) Z 17 DTJ	01.2004→03.2011		7.10334.08.0	AGR	EL	
			7.08369.49.0	ATS	EL	
			7.08369.74.0	ATS	EL	
			7.11190.04.0	DDS		
1.8 (L48) 103 kW (140 PS) A 18 XER, Z 18 XER	01.2004→05.2009		7.04879.00.0	AGR-TH		 Öffnungstemperatur/opening temperature 105C
1.9 CDTi (L48) 110 kW (150 PS) Z 19 DTH	01.2004→05.2009		7.00063.10.0	AGR	EL	
			7.08369.05.0	ATS	EL	
			7.08369.32.0	ATS	EL	
			7.11190.03.0	DDS		
			7.11190.04.0	DDS		ohne Zubehör without accessories Fahrgestellnummer bis: 62167207, 65165230, 68124718 Vehicle Identification Number to: 62167207, 65165230, 68124718 Fahrgestellnummer ab: 62167207, 65165231, 68124719, 8B000001 Vehicle Identification Number from: 62167207, 65165231, 68124719, 8B000001
1.9 CDTi (L48) 88 kW (120 PS) Z 19 DT	01.2004→05.2009		7.22946.38.0	AGR	EL	
			7.08369.05.0	ATS	EL	
			7.08369.32.0	ATS	EL	





























ASTRA Mk V (H) (A04) **19**

			7.11190.03.0	DDS		ohne Zubehör without accessories Fahrgestellnummer bis: 62167207, 65165230, 68124718 Vehicle Identification Number to: 62167207, 65165230, 68124718
			7.11190.04.0	DDS		Fahrgestellnummer ab: 62167207, 65165231, 68124719, 8B000001 Vehicle Identification Number from: 62167207, 65165231, 68124719, 8B000001
1.9 CDTI 16V (L48) 88 kW (120 PS) Z 19 DTJ	01.2004→05.2009		7.00063.10.0	AGR	EL	
			7.08369.05.0	ATS	EL	
			7.08369.32.0	ATS	EL	
			7.11190.03.0	DDS		ohne Zubehör without accessories Fahrgestellnummer bis: 62167207, 65165230, 68124718 Vehicle Identification Number to: 62167207, 65165230, 68124718
2.0 Turbo (L48) 125 kW (170 PS) Z 20 LEL	01.2004→05.2009		7.02604.07.0	LS	570 mm	vor Katalysator in front of the catalyst
2.0 Turbo (L48) 147 kW (200 PS) Z 20 LER	01.2004→05.2009		7.02604.07.0	LS	570 mm	vor Katalysator in front of the catalyst
2.0 Turbo (L48) 176-177 kW (240-241 PS) Z 20 LEH	01.2004→05.2009		7.02604.07.0	LS	570 mm	vor Katalysator in front of the catalyst

ASTRA Mk V (H) Estate (A04) **20**

1.3 CDTi (L35) 66-74 kW (90-101 PS) Z 13 DTH	08.2004→03.2009		7.00020.25.0	AGR	EL	
			7.08369.15.0	ATS	EL	
			7.11190.04.0	DDS		
1.4 (L35) 66 kW (90 PS) Z 14 XEP	08.2004→03.2009		7.22875.16.0	AGR	EL	
			7.22875.13.0	AGR	EL	
			7.02604.07.0	LS	570 mm	→12.2005 vor Katalysator in front of the catalyst
			7.02604.08.0	LS	350 mm	Regelsonde, Diagnosesonde Regulating Probe, Diagnostic Probe
			7.05271.81.0	LS	210 mm	Post-catalyst Z 14 XEP: nach Katalysator Z 14 XEP: Fahrgestellnummer ab: 62, 65, 68, 6G Vehicle Identification Number from: 62, 65, 68, 6G vor Katalysator in front of the catalyst
1.6 (L35) 74-77 kW (101-105 PS) Z 16 XEP	08.2004→03.2009		7.28384.13.0	AGR	EL	
			7.04879.00.0	AGR-TH		
			7.02604.05.0	LS	550 mm	→20HH5427 vor Katalysator in front of the catalyst
1.6 (L35) 132 kW (180 PS) Z 16 LET	08.2004→03.2009		7.02604.08.0	LS	350 mm	Regelsonde Regulating Probe
			7.05271.81.0	LS	210 mm	



















V

					
ASTRA Mk V (H) Estate (A04)					
1.6 (L35) 85 kW (116 PS) Z 16 XER	08.2004→03.2011		7.04879.00.0	AGR-TH	⊙ Öffnungstemperatur/opening temperature 105C
1.7 CDTi (L35) 81 kW (110 PS) A 17 DTJ	08.2004→10.2012		7.10334.08.0	AGR	EL ⊙
			7.08369.49.0	ATS	EL
			7.08369.75.0	ATS	EL
			7.11190.04.0	DDS	
1.7 CDTi (L35) 81 kW (110 PS) Z 17 DTJ	08.2004→10.2012		7.10334.08.0	AGR	EL ⊙
			7.08369.49.0	ATS	EL
			7.08369.74.0	ATS	EL
			7.11190.04.0	DDS	
1.8 (L35) 103 kW (140 PS) A 18 XER, Z 18 XER	12.2005→10.2010		7.04879.00.0	AGR-TH	⊙ Öffnungstemperatur/opening temperature 105C
1.9 CDTi (L35) 88 kW (120 PS) Z 19 DT	08.2004→03.2009		7.22946.38.0	AGR	EL ⊙
			7.08369.05.0	ATS	EL
			7.08369.32.0	ATS	EL
			7.11190.03.0	DDS	
			7.11190.04.0	DDS	ohne Zubehör without accessories Fahrgestellnummer bis: 62167207, 65165230, 68124718 Vehicle Identification Number to: 62167207, 65165230, 68124718 für OE-Nummer: 62167207, 65165231, 68124719, 8B000001 for OE number: 62167207, 65165231, 68124719, 8B000001
1.9 CDTi (L35) 110 kW (150 PS) Z 19 DTH	08.2004→03.2009		7.00063.10.0	AGR	EL ⊙
			7.08369.05.0	ATS	EL
			7.08369.32.0	ATS	EL
			7.11190.03.0	DDS	
			7.11190.04.0	DDS	ohne Zubehör without accessories Fahrgestellnummer bis: 62167207, 65165230, 68124718 Vehicle Identification Number to: 62167207, 65165230, 68124718 Fahrgestellnummer ab: 62167207, 65165231, 68124719, 8B000001 Vehicle Identification Number from: 62167207, 65165231, 68124719, 8B000001
1.9 CDTi 16V (L35) 88 kW (120 PS) Z 19 DTJ	08.2004→03.2009		7.00063.10.0	AGR	EL ⊙
			7.08369.05.0	ATS	EL
			7.08369.32.0	ATS	EL
			7.11190.03.0	DDS	
					ohne Zubehör without accessories Fahrgestellnummer bis: 62167207, 65165230, 68124718 Vehicle Identification Number to: 62167207, 65165230, 68124718
2.0 Turbo (L35) 125 kW (170 PS) Z 20 LEL	08.2004→10.2010		7.02604.07.0	LS	570 mm vor Katalysator in front of the catalyst
2.0 Turbo (L35) 147 kW (200 PS) Z 20 LER	08.2004→10.2010		7.02604.07.0	LS	570 mm vor Katalysator in front of the catalyst

V







ASTRA Mk V (H) Sport Hatch (A04) 21













1.3 CDTi (L08) 66-74 kW (90-101 PS) Z 13 DTH	04.2005→11.2010		7.00020.25.0	AGR	EL		
			7.08369.15.0	ATS	EL		
			7.11190.04.0	DDS			
1.4 i 16V (L08) 66 kW (90 PS) Z 14 XEP	03.2005→11.2010		7.22875.16.0	AGR	EL		
			7.22875.13.0	AGR	EL		570 mm →12.2005 vor Katalysator in front of the catalyst
			7.02604.07.0	LS			
			7.05271.81.0	LS			
1.6 (L08) 74-77 kW (101-105 PS) Z 16 XEP	02.2005→11.2010		7.28384.13.0	AGR	EL		
			7.04879.00.0	AGR-TH			 Öffnungstemperatur/opening temperature 105C
			7.02604.05.0	LS			
1.6 (L08) 132 kW (180 PS) Z 16 LET	10.2006→11.2010		7.02604.08.0	LS	350 mm	Regelsonde Regulating Probe	
			7.05271.81.0	LS	210 mm		
1.6 i 16V (L08) 85 kW (116 PS) Z 16 XER	12.2006→11.2010		7.04879.00.0	AGR-TH		 Öffnungstemperatur/opening temperature 105C	
1.7 CDTi (L08) 81 kW (110 PS) A 17 DTJ	02.2007→11.2009		7.10334.08.0	AGR	EL		
			7.08369.49.0	ATS	EL		
			7.08369.75.0	ATS	EL		
			7.11190.04.0	DDS			
1.7 CDTi (L08) 81 kW (110 PS) Z 17 DTJ	02.2007→11.2009		7.08369.49.0	ATS	EL		
1.8 i 16V (L08) 103 kW (140 PS) A 18 XER, Z 18 XER	03.2007→11.2010		7.04879.00.0	AGR-TH		 Öffnungstemperatur/opening temperature 105C	
1.9 CDTi (L08) 88 kW (120 PS) Z 19 DT	02.2005→11.2010		7.22946.38.0	AGR	EL		
			7.08369.05.0	ATS	EL		
			7.08369.32.0	ATS	EL		
			7.11190.03.0	DDS			
			7.11190.04.0	DDS			ohne Zubehör without accessories Fahrgestellnummer bis: 62167207, 65165230, 68124718 Vehicle Identification Number to: 62167207, 65165230, 68124718 Fahrgestellnummer ab: 62167207, 65165231, 68124719, 8B000001 Vehicle Identification Number from: 62167207, 65165231, 68124719, 8B000001
1.9 CDTi (L08) 110 kW (150 PS) Z 19 DTH	02.2005→11.2010		7.00063.10.0	AGR	EL		
			7.08369.05.0	ATS	EL		
			7.08369.32.0	ATS	EL		



ASTRA Mk V (H) Sport Hatch (A04) 21

			7.11190.03.0	DDS		ohne Zubehör without accessories Fahrgestellnummer bis: 62167207, 65165230, 68124718 Vehicle Identification Number to: 62167207, 65165230, 68124718
			7.11190.04.0	DDS		Fahrgestellnummer ab: 62167207, 65165231, 68124719, 8B000001 Vehicle Identification Number from: 62167207, 65165231, 68124719, 8B000001
1.9 CDTi (L08) 74 kW (100 PS) Z 19 DTL	08.2005→11.2010		7.22946.38.0	AGR	EL	 ohne Zubehör without accessories Fahrgestellnummer bis: 62167207, 65165230, 68124718 Vehicle Identification Number to: 62167207, 65165230, 68124718 Fahrgestellnummer ab: 62167207, 65165231, 68124719, 8B000001 Vehicle Identification Number from: 62167207, 65165231, 68124719, 8B000001
			7.08369.05.0	ATS	EL	
			7.08369.32.0	ATS	EL	
			7.11190.03.0	DDS		
			7.11190.04.0	DDS		
2.0 Turbo (L08) 125 kW (170 PS) Z 20 LEL	02.2005→11.2010		7.02604.07.0	LS	570 mm	vor Katalysator in front of the catalyst
2.0 VXR (L08) 176-177 kW (240-241 PS) Z 20 LEH	02.2009→11.2010		7.02604.07.0	LS	570 mm	vor Katalysator in front of the catalyst

























ASTRA Mk V (H) TwinTop (A04) 22

1.6 (L67) 74-77 kW (101-105 PS) Z 16 XEP	09.2005→11.2010		7.28384.13.0	AGR	EL	  Öffnungstemperatur/opening temperature 105C  →20HH5427 vor Katalysator in front of the catalyst
			7.04879.00.0	AGR-TH		
			7.02604.05.0	LS	550 mm	
1.6 i 16V (L67) 85 kW (116 PS) A 16 XER, Z 16 XER	10.2006→08.2011		7.04879.00.0	AGR-TH		 Öffnungstemperatur/opening temperature 105C
1.8 (L67) 103 kW (140 PS) A 18 XER, Z 18 XER	05.2008→11.2010		7.04879.00.0	AGR-TH		 Öffnungstemperatur/opening temperature 105C
1.9 CDTi (L67) 110 kW (150 PS) Z 19 DTH	01.2006→11.2010		7.00063.10.0	AGR	EL	 ohne Zubehör without accessories Fahrgestellnummer bis: 62167207, 65165230, 68124718 Vehicle Identification Number to: 62167207, 65165230, 68124718
			7.08369.05.0	ATS	EL	
			7.08369.32.0	ATS	EL	
			7.11190.03.0	DDS		
2.0 (L67) 125 kW (170 PS) Z 20 LEL	02.2006→11.2010		7.02604.07.0	LS	570 mm	vor Katalysator in front of the catalyst
2.0 Turbo (L67) 147 kW (200 PS) Z 20 LER	01.2006→11.2010		7.02604.07.0	LS	570 mm	vor Katalysator in front of the catalyst





ASTRA Mk VI (J) (P10) **23**

1.3 CDTi 70 kW (95 PS) A 13 DTE	12.2009→10.2015		7.01599.10.0	AGR	EL	
			7.03622.11.0	AGR-K	EL	
			7.03622.10.0	AGR-K	EL	
			7.03622.09.0	AGR-K		
			7.03622.06.0	AGR-K		
			7.08369.46.0 7.11190.04.0	ATS DDS	EL	 →ch. BG999999
1.6 85 kW (116 PS) A 16 XER, B 16 XER	12.2009→10.2015		7.02604.07.0	LS	570 mm	 A 16 XER, B 16 XER: vor Katalysator in front of the catalyst
1.6 CDTi 81 kW (110 PS) B 16 DTL	11.2013→10.2015		7.24809.81.0	AGR	EL	
			7.11020.42.0	ATS	EL	 B 16 DTL:  ch. F0000001→ch. F0999999 für RPO Nummer: WM3 for RPO number: WM3  B 16 DTL:  ch. F1000001→ch. F1999999 für RPO Nummer: WM3 for RPO number: WM3  B 16 DTL:  ch. F3000001→ch. F3999999 für RPO Nummer: WM3 for RPO number: WM3  B 16 DTL:  ch. F8000001→ch. F8999999 für RPO Nummer: WM3 for RPO number: WM3  B 16 DTL:  ch. FG000001→ch. FG999999 für RPO Nummer: WM3 for RPO number: WM3  B 16 DTL: Fahrgestellnummer ab: G0000001, G1000001, G8000001, GG000001 Vehicle Identification Number from: G0000001, G1000001, G8000001, GG000001
			7.11020.27.0	ATS	EL	
1.6 CDTi 88-100 kW (120-136 PS) B 16 DTH	11.2013→10.2015		7.24809.81.0	AGR	EL	



ASTRA Mk VI (J) (P10) 23

			7.11020.42.0	ATS	EL	B 16 DTH: ch. F0000001→ch. F0999999 für RPO Nummer: WM3 for RPO number: WM3 B 16 DTH: ch. F1000001→ch. F1999999 für RPO Nummer: WM3 for RPO number: WM3 B 16 DTH: ch. F3000001→ch. F3999999 für RPO Nummer: WM3 for RPO number: WM3 B 16 DTH: ch. F8000001→ch. F8999999 für RPO Nummer: WM3 for RPO number: WM3 B 16 DTH: ch. FG000001→ch. FG999999 für RPO Nummer: WM3 for RPO number: WM3 B 16 DTH: Fahrgestellnummer ab: G0000001, G1000001, G8000001, GG000001 Vehicle Identification Number from: G0000001, G1000001, G8000001, GG000001
			7.11020.27.0	ATS	EL	
1.7 CDTi 74 kW (101 PS) A 17 DTL	10.2010→10.2015		7.10334.08.0	AGR	EL	
			7.11190.04.0	DDS		
1.7 CDTi 81 kW (110 PS) A 17 DTC, A 17 DTE	12.2009→10.2015		7.10334.08.0	AGR	EL	
			7.11020.38.0	ATS	EL	
			7.11190.04.0	DDS		
1.7 CDTi 81 kW (110 PS) A 17 DTJ	12.2009→10.2015		7.10334.08.0	AGR	EL	
			7.11190.04.0	DDS		
1.7 CDTi 92 kW (125 PS) A 17 DTR	12.2009→10.2015		7.10334.08.0	AGR	EL	
			7.11190.04.0	DDS		
1.7 CDTi 96 kW (131 PS) A 17 DTF, A 17 DTS	06.2011→10.2015		7.10334.08.0	AGR	EL	
			7.11020.38.0	ATS	EL	
			7.11190.04.0	DDS		
2.0 BiTurbo CDTi 140-143 kW (190-194 PS) A 20 DTR	12.2012→10.2015		7.24809.78.0	AGR	ET	
			7.11190.04.0	DDS		
2.0 CDTi 118-121 kW (160-165 PS) A 20 DTH	12.2009→06.2011		7.24809.78.0	AGR	ET	
			7.08369.17.0	ATS	EL	
			7.11190.04.0	DDS		
			7.02604.44.0	LS	500 mm	vor Katalysator in front of the catalyst
2.0 CDTi 118-121 kW (160-165 PS) A 20 DTH	08.2011→10.2015		7.24809.78.0	AGR	ET	
			7.08369.17.0	ATS	EL	
			7.11190.04.0	DDS		
			7.02604.44.0	LS	500 mm	vor Katalysator in front of the catalyst





ASTRA Mk VI (J) Estate (P10) **24**

1.3 CDTi 70 kW (95 PS) A 13 DTE	10.2010→10.2015		7.01599.10.0	AGR	EL <input type="checkbox"/>
			7.03622.11.0	AGR-K	EL <input type="checkbox"/>
			7.03622.10.0	AGR-K	EL <input type="checkbox"/>
			7.03622.09.0	AGR-K	<input type="checkbox"/>
			7.03622.06.0	AGR-K	<input type="checkbox"/>
7.11190.04.0	DDS	→ch. BG999999			
1.6 85 kW (116 PS) A 16 XER, B 16 XER	10.2010→10.2015		7.02604.07.0	LS	570 mm A 16 XER, B 16 XER: vor Katalysator in front of the catalyst
			7.24809.81.0	AGR	EL <input type="checkbox"/>
1.6 CDTi 88-100 kW (120-136 PS) B 16 DTH	01.2014→10.2015		7.11020.42.0	ATS	EL B 16 DTH: ch. F0000001→ch. F0999999 für RPO Nummer: WM3 for RPO number: WM3 B 16 DTH: ch. F1000001→ch. F1999999 für RPO Nummer: WM3 for RPO number: WM3 B 16 DTH: ch. F3000001→ch. F3999999 für RPO Nummer: WM3 for RPO number: WM3 B 16 DTH: ch. F8000001→ch. F8999999 für RPO Nummer: WM3 for RPO number: WM3 B 16 DTH: ch. FG000001→ch. FG999999 für RPO Nummer: WM3 for RPO number: WM3 B 16 DTH: Fahrgestellnummer ab: G0000001, G1000001, G8000001, GG000001 Vehicle Identification Number from: G0000001, G1000001, G8000001, GG000001
			7.11020.27.0	ATS	EL <input type="checkbox"/>
			7.24809.81.0	AGR	EL <input type="checkbox"/>
			7.11020.42.0	ATS	EL B 16 DTL: ch. F0000001→ch. F0999999 für RPO Nummer: WM3 for RPO number: WM3 B 16 DTL: ch. F1000001→ch. F1999999 für RPO Nummer: WM3 for RPO number: WM3 B 16 DTL: ch. F3000001→ch. F3999999 für RPO Nummer: WM3 for RPO number: WM3 B 16 DTL: ch. F8000001→ch. F8999999 für RPO Nummer: WM3 for RPO number: WM3 B 16 DTL: ch. FG000001→ch. FG999999 für RPO Nummer: WM3 for RPO number: WM3 B 16 DTL: Fahrgestellnummer ab: G0000001, G1000001, G8000001, GG000001 Vehicle Identification Number from: G0000001, G1000001, G8000001, GG000001
			7.11020.27.0	ATS	EL <input type="checkbox"/>
1.6 CDTi 81 kW (110 PS) B 16 DTL	01.2014→10.2015		7.24809.81.0	AGR	EL <input type="checkbox"/>
			7.11020.42.0	ATS	EL B 16 DTL: ch. F0000001→ch. F0999999 für RPO Nummer: WM3 for RPO number: WM3 B 16 DTL: ch. F1000001→ch. F1999999 für RPO Nummer: WM3 for RPO number: WM3 B 16 DTL: ch. F3000001→ch. F3999999 für RPO Nummer: WM3 for RPO number: WM3 B 16 DTL: ch. F8000001→ch. F8999999 für RPO Nummer: WM3 for RPO number: WM3 B 16 DTL: ch. FG000001→ch. FG999999 für RPO Nummer: WM3 for RPO number: WM3 B 16 DTL: Fahrgestellnummer ab: G0000001, G1000001, G8000001, GG000001 Vehicle Identification Number from: G0000001, G1000001, G8000001, GG000001



ASTRA Mk VI (J) Estate (P10) 24

			7.11020.27.0	ATS	EL	
1.7 CDTi 81 kW (110 PS) A 17 DTC, A 17 DTE	10.2010→10.2015		7.10334.08.0	AGR	EL	
			7.11020.38.0 7.11190.04.0	ATS DDS	EL	
1.7 CDTi 81 kW (110 PS) A 17 DTJ	10.2010→10.2015		7.10334.08.0	AGR	EL	
			7.11190.04.0	DDS		
1.7 CDTi 92 kW (125 PS) A 17 DTR	10.2010→10.2015		7.10334.08.0	AGR	EL	
			7.11190.04.0	DDS		
1.7 CDTi 96 kW (131 PS) A 17 DTF, A 17 DTS	06.2011→10.2015		7.10334.08.0	AGR	EL	
			7.11020.38.0 7.11190.04.0	ATS DDS	EL	
2.0 BiTurbo CDTi 140-143 kW (190-194 PS) A 20 DTR	12.2012→10.2015		7.24809.78.0	AGR	ET	
			7.11190.04.0	DDS		
2.0 CDTi 118-121 kW (160-165 PS) A 20 DTH	10.2010→06.2011		7.24809.78.0	AGR	ET	
			7.08369.17.0	ATS	EL	
			7.11190.04.0	DDS		
			7.02604.44.0	LS	500 mm	vor Katalysator in front of the catalyst
2.0 CDTi 118-121 kW (160-165 PS) A 20 DTH	08.2011→10.2015		7.24809.78.0	AGR	ET	
			7.08369.17.0	ATS	EL	
			7.11190.04.0	DDS		
			7.02604.44.0	LS	500 mm	vor Katalysator in front of the catalyst



















ASTRA Mk VI (J) GTC (P10) 25

1.6 CDTi 81 kW (110 PS) B 16 DTL	07.2014→10.2015		7.24809.81.0	AGR	EL	
			7.11020.42.0	ATS	EL	B 16 DTL: ch. F0000001→ch. F0999999 für RPO Nummer: WM3 for RPO number: WM3 B 16 DTL: ch. F1000001→ch. F1999999 für RPO Nummer: WM3 for RPO number: WM3 B 16 DTL: ch. F3000001→ch. F3999999 für RPO Nummer: WM3 for RPO number: WM3 B 16 DTL: ch. F8000001→ch. F8999999 für RPO Nummer: WM3 for RPO number: WM3 B 16 DTL: ch. FG000001→ch. FG999999 für RPO Nummer: WM3 for RPO number: WM3 B 16 DTL: Fahrgestellnummer ab: G0000001, G1000001, G8000001, GG000001 Vehicle Identification Number from: G0000001, G1000001, G8000001, GG000001
			7.11020.27.0	ATS	EL	



















ASTRA Mk VI (J) GTC (P10) **25**

1.6 CDTi 88-100 kW (120-136 PS) B 16 DTH	07.2014→10.2015		7.24809.81.0	AGR	EL	  B 16 DTH:  ch. F0000001→ch. F0999999 für RPO Nummer: WM3 for RPO number: WM3  B 16 DTH:  ch. F1000001→ch. F1999999 für RPO Nummer: WM3 for RPO number: WM3  B 16 DTH:  ch. F3000001→ch. F3999999 für RPO Nummer: WM3 for RPO number: WM3  B 16 DTH:  ch. F8000001→ch. F8999999 für RPO Nummer: WM3 for RPO number: WM3  B 16 DTH:  ch. FG000001→ch. FG999999 für RPO Nummer: WM3 for RPO number: WM3  B 16 DTH: Fahrgestellnummer ab: G0000001, G1000001, G8000001, GG000001 Vehicle Identification Number from: G0000001, G1000001, G8000001, GG000001
			7.11020.42.0	ATS	EL	
1.7 CDTi 81 kW (110 PS) A 17 DTC, A 17 DTE	10.2011→10.2015		7.11020.27.0	ATS	EL	
			7.10334.08.0	AGR	EL	
			7.11020.38.0	ATS	EL	
1.7 CDTi 81 kW (110 PS) A 17 DTJ	10.2011→10.2015		7.11190.04.0	DDS		
			7.10334.08.0	AGR	EL	
1.7 CDTi 96 kW (131 PS) A 17 DTF, A 17 DTS	10.2011→10.2015		7.11190.04.0	DDS		
			7.10334.08.0	AGR	EL	
			7.11020.38.0	ATS	EL	
2.0 BiTurbo CDTi 140-143 kW (190-194 PS) A 20 DTR	12.2012→10.2015		7.11190.04.0	DDS		
			7.24809.78.0	AGR	ET	
2.0 CDTi 118-121 kW (160-165 PS) A 20 DTH	10.2011→10.2015		7.24809.78.0	AGR	ET	
			7.08369.17.0	ATS	EL	
			7.11190.04.0	DDS		
			7.02604.44.0	LS	500 mm	



















ASTRA Mk VI (J) Saloon (P10) **26**

1.3 CDTi 70 kW (95 PS) A 13 DTE	06.2012→10.2015		7.01599.10.0	AGR	EL	      →ch. BG999999
			7.03622.11.0	AGR-K	EL	
			7.03622.10.0	AGR-K	EL	
			7.03622.09.0	AGR-K		
			7.03622.06.0	AGR-K		
1.6 85 kW (116 PS) A 16 XER	06.2012→10.2015		7.08369.46.0	ATS	EL	
			7.11190.04.0	DDS		
			7.02604.07.0	LS	570 mm	

ASTRA Mk VI (J) Saloon (P10) 26

1.7 CDTi 81 kW (110 PS) A 17 DTC, A 17 DTE	06.2012→10.2015		7.10334.08.0	AGR	EL	
			7.11020.38.0	ATS	EL	
			7.11190.04.0	DDS		
1.7 CDTi 81 kW (110 PS) A 17 DTJ	06.2012→10.2015		7.10334.08.0	AGR	EL	
			7.11190.04.0	DDS		
1.7 CDTi 96 kW (131 PS) A 17 DTF, A 17 DTS	06.2012→10.2015		7.10334.08.0	AGR	EL	
			7.11020.38.0	ATS	EL	
			7.11190.04.0	DDS		

































ASTRA Mk VII (K) (B16) 27

1.0 66-77 kW (90-105 PS) B 10 XFL, D 10 XFL	07.2015→		7.11190.08.0	DDS		
1.4 Turbo 88-92 kW (120-125 PS) B 14 XFL	07.2015→		7.11190.08.0	DDS		
1.4 Turbo 103-112 kW (140-152 PS) B 14 XFT	07.2015→		7.11190.08.0	DDS		
1.6 BiTurbo 110 kW (150 PS) D 16 DTR	08.2018→		7.24809.81.0	AGR	EL	
1.6 CDTi 70-81 kW (95-110 PS) B 16 DTE, B 16 DTU	07.2015→		7.24809.81.0	AGR	EL	
			7.11020.27.0	ATS	EL	
			7.11020.42.0	ATS	EL	
1.6 CDTi 88-100 kW (120-136 PS) B 16 DTH	07.2015→		7.24809.81.0	AGR	EL	
			7.11020.27.0	ATS	EL	
			7.11020.42.0	ATS	EL	
1.6 CDTi 100 kW (136 PS) D 16 DTH	07.2015→		7.24809.81.0	AGR	EL	
1.6 CDTi 70-81 kW (95-110 PS) B 16 DTE	07.2015→		7.24809.81.0	AGR	EL	
			7.11020.27.0	ATS	EL	
			7.11020.42.0	ATS	EL	
1.6 CDTi 118 kW (160 PS) B 16 DTR	11.2015→		7.24809.81.0	AGR	EL	

ASTRA Mk VII (K) Estate (B16) 28

1.0 66-77 kW (90-105 PS) B 10 XFL, D 10 XFL	11.2015→		7.11190.08.0	DDS		
1.4 Turbo 88-92 kW (120-125 PS) B 14 XFL	11.2015→		7.11190.08.0	DDS		
1.4 Turbo 103-112 kW (140-152 PS) B 14 XFT	11.2015→		7.11190.08.0	DDS		
1.6 BiTurbo 110 kW (150 PS) D 16 DTR	08.2018→		7.24809.81.0	AGR	EL	
1.6 CDTi 70-81 kW (95-110 PS) B 16 DTE, B 16 DTU	07.2015→		7.24809.81.0	AGR	EL	
			7.11020.27.0	ATS	EL	
			7.11020.42.0	ATS	EL	
1.6 CDTi 88-100 kW (120-136 PS) B 16 DTH	11.2015→		7.24809.81.0	AGR	EL	
			7.11020.27.0	ATS	EL	
			7.11020.42.0	ATS	EL	
1.6 CDTi 100 kW (136 PS) D 16 DTH	11.2015→		7.24809.81.0	AGR	EL	



			 PIERBURG			
ASTRA Mk VII (K) Estate (B16)						28
1.6 CDTi 118 kW (160 PS) B 16 DTR	11.2015→		7.24809.81.0	AGR	EL 	
1.6 CDTi 70-81 kW (95-110 PS) B 16 DTE	11.2015→		7.24809.81.0	AGR	EL 	
			7.11020.27.0	ATS	EL	
			7.11020.42.0	ATS	EL	
BRAVA Pickup (TF0, TF1)						29
2.3 (TFR16) 69-72 kW (94-98 PS) 4 ZD1	08.1991→08.1994		7.02604.15.0	LS	360 mm	
2.3 4x4 (TFS16) 69-72 kW (94-98 PS) 4 ZD1	06.1990→08.1994		7.02604.15.0	LS	360 mm 10.1992→06.1994	
CALIBRA (C89)						30
2.0 i 16V 100 kW (136 PS) X 20 XEV	06.1990→07.1997		7.22296.02.0	ARV	PN  Fahrgestellnummer ab: T1000001 Vehicle Identification Number from: T1000001	
			7.05270.32.0	LS	825 mm  →ch. T9004511	
			7.05270.33.0	LS	705 mm  ch. T9004512→	
2.0 i 16V 4x4 100 kW (136 PS) X 20 XEV	02.1994→07.1997		7.22296.02.0	ARV	PN  Fahrgestellnummer ab: T1000001 Vehicle Identification Number from: T1000001	
			7.05270.32.0	LS	825 mm  →ch. T9004511	
			7.05270.33.0	LS	705 mm  ch. T9004512→	
2.5 i V6 125-143 kW (170-194 PS) X 25 XE	04.1993→07.1997		7.22296.02.0	ARV	PN 	
CARLTON Mk III Estate (V87)						31
3.0 24V 147 kW (200 PS) C 30 SEJ	09.1989→03.1994		7.02604.03.0	LS	200 mm	
CARLTON Mk III Saloon (V87)						32
3.0 3000 24V 150 kW (204 PS) C 30 SE	09.1989→03.1994		7.02604.03.0	LS	200 mm	
3000 24V 147 kW (200 PS) C 30 SEJ	09.1989→03.1994		7.02604.03.0	LS	200 mm	
CASCADE Convertible (W13)						33
2.0 CDTi 118-121 kW (160-165 PS) A 20 DTH	02.2013→		7.24809.78.0	AGR	ET 	
			7.08369.17.0	ATS	EL	
			7.11190.04.0	DDS		
			7.02604.44.0	LS	500 mm vor Katalysator in front of the catalyst	
2.0 CDTi 140-143 kW (190-194 PS) A 20 DTR	02.2013→		7.24809.78.0	AGR	ET 	
			7.11190.04.0	DDS		
2.0 CDTi 125 kW (170 PS) B 20 DTH	07.2015→		7.24809.87.0	AGR	EL	
CAVALIER Mk II Hatchback (J82)						34
2.0 4x4 95 kW (129 PS) 20 SEH	09.1987→08.1988		7.02604.03.0	LS	200 mm	
2.0 SRi 130 95 kW (129 PS) 20 SEH	03.1987→08.1988		7.02604.03.0	LS	200 mm	

V

CAVALIER Mk II Hatchback (J82) 34

2.0 i Cat 85 kW (115 PS) C 20 NE	09.1986→08.1988	7.02604.03.0	LS	200 mm
2000i 85-90 kW (116-122 PS) 20 SE	09.1986→08.1988	7.02604.03.0	LS	200 mm

CAVALIER Mk II Saloon (J82) 35

1.6 i 55-61 kW (75-83 PS) E 16 NZ	08.1986→08.1988	7.02604.15.0	LS	360 mm
1.6 i Cat 55-61 kW (75-83 PS) C 16 LZ, C 16 NZ	08.1986→08.1988	7.02604.15.0	LS	360 mm
2.0 4x4 95 kW (129 PS) 20 SEH	09.1987→08.1988	7.02604.03.0	LS	200 mm
2.0 SRi 130 95 kW (129 PS) 20 SEH	03.1987→08.1988	7.02604.03.0	LS	200 mm
2.0 i 85 kW (116 PS) 20 NE	09.1986→08.1988	7.02604.03.0	LS	200 mm
2.0 i Cat 85 kW (115 PS) C 20 NE	09.1986→08.1988	7.02604.03.0	LS	200 mm
2000i 85-90 kW (116-122 PS) 20 SE	09.1986→08.1988	7.02604.03.0	LS	200 mm

CAVALIER Mk III Hatchback (J89) 36

1.6 i 55-61 kW (75-83 PS) E 16 NZ	09.1988→11.1995	7.02604.15.0	LS	360 mm
1.6 i 52 kW (71 PS) X 16 SZ	09.1993→11.1995	7.02604.15.0	LS	360 mm
1.8 i Cat 66 kW (90 PS) C 18 NZ	03.1990→11.1995	7.02604.15.0	LS	360 mm
2.0 i 16V 100 kW (136 PS) X 20 XEV	09.1992→08.1995	7.05270.32.0	LS	825 mm

CAVALIER Mk III Saloon (J89) 37

1.6 i 52 kW (71 PS) X 16 SZ	09.1993→11.1995	7.02604.15.0	LS	360 mm
1.8 i Cat 66 kW (90 PS) C 18 NZ	03.1990→11.1995	7.02604.15.0	LS	360 mm
2.0 SRi 16V 100 kW (136 PS) X 20 XEV	09.1992→08.1995	7.05270.32.0	LS	825 mm

COMBO 38

1.6i 62-64 kW (84-87 PS) Z 16 SE	10.2001→08.2004	7.24809.10.0	AGR	EL
--	-----------------	---------------------	-----	----

COMBO Mk IV (E) Life (X19) 39

1.5 75 kW (102 PS) D 15 DT (DV5RD)	06.2018→	7.07794.23.0	AGR	EL mit Dichtring with O-ring
1.5 88-96 kW (120-131 PS) D 15 DTH (DV5RC)	06.2018→	7.07794.23.0	AGR	EL mit Dichtring with O-ring



COMBO TOUR Mk II (C) (F25) 40

1.3 CDTI 16V 51-55 kW (69-75 PS) Z 13 DTJ	07.2006→02.2012	7.08369.15.0	ATS	EL
1.4 66 kW (90 PS) Z 14 XEP	10.2004→09.2010	7.22875.13.0	AGR	EL
		7.22875.16.0	AGR	EL
1.6 62-64 kW (84-87 PS) Z 16 SE	10.2001→06.2004	7.24809.10.0	AGR	EL →ch. 46999999
1.7 DI 16V 48 kW (65 PS) Y 17 DTL	09.2001→06.2004	7.22772.11.0	AGR	PN mit Potentiometer with potentiometer
		7.22772.12.0	AGR	PN ch. 00782974→ →ch. 00782973



















V











COMBO TOUR Mk II (C) (F25) 40

1.7 DTI 16V 55 kW (75 PS) Y 17 DT	10.2001→02.2012		7.22772.11.0	AGR	PN	mit Potentiometer with potentiometer  ch. 00782974→  →ch. 00782973
			7.22772.12.0	AGR	PN	

CORSA Mk I (B) (S93) 41

1.0 i 12V 40 kW (54 PS) X 10 XE	11.1996→09.2000		7.22414.04.0	AGR	EL	
			7.05271.76.0	LS	630 mm	
1.2 i 33 kW (45 PS) C 12 NZ, X 12 SZ	03.1993→09.2000		7.02604.15.0	LS	360 mm	
1.2 i 16V 48 kW (65 PS) X 12 XE	03.1998→09.2000		7.22414.08.0	AGR	EL	
			7.05271.76.0	LS	630 mm	
1.4 i 40-44 kW (54-60 PS) C 14 NZ, X 14 SZ	03.1993→09.2000		7.02604.15.0	LS	360 mm	
1.4 i 16V 66 kW (90 PS) X 14 XE	09.1994→09.2000		7.22296.02.0	ARV	PN	
			7.02604.15.0	LS	360 mm	
1.4 i S 60 kW (82 PS) C 14 SE	03.1993→09.2000		7.02604.15.0	LS	360 mm	 ch. T6→ch. T6
1.6 GSI 16V 78-80 kW (106-109 PS) C 16 XE	03.1993→09.2000		7.02604.15.0	LS	360 mm	 C 16 XE:  ch. T3013886→  C 16 XE:  ch. S6011905→  C 16 XE:  ch. S4269628→
1.6 i 16V 78-80 kW (106-109 PS) X 16 XE	09.1994→09.2000		7.22296.02.0	ARV	PN	
			7.02604.15.0	LS	360 mm	

CORSA Mk II (C) (X01) 42

1.0 12V (F08, F68) 43 kW (58 PS) Z 10 XE	09.2000→10.2003		7.22875.13.0	AGR	EL		
			7.02604.08.0	LS	350 mm		
			7.05271.81.0	LS	210 mm		Diagnosesonde Diagnostic Probe vor Katalysator in front of the catalyst
1.0 12V (F08, F68) 44 kW (60 PS) Z 10 XEP	11.2003→10.2006		7.22875.16.0	AGR	EL	 ch. 53000001→	
			7.22875.13.0	AGR	EL		 →ch. 43999999
			7.02604.08.0	LS	350 mm		
			7.05271.81.0	LS	210 mm		vor Katalysator in front of the catalyst
1.2 16V (F08, F68) 55 kW (75 PS) Z 12 XE	09.2000→10.2006		7.22875.13.0	AGR	EL	 →ch. 24999999	
			7.02604.07.0	LS	570 mm		vor Katalysator in front of the catalyst
			7.05271.81.0	LS	210 mm		vor Katalysator in front of the catalyst
1.2 16V Dualfuel (F08) 55 kW (75 PS) Z 12 XE	08.2001→10.2006		7.22875.13.0	AGR	EL	 →ch. 24999999	
			7.02604.07.0	LS	570 mm		vor Katalysator in front of the catalyst

V



CORSA Mk II (C) (X01) 42

















































1.2 Twinport (F08, F68) 59 kW (80 PS) Z 12 XEP	07.2004→10.2006		7.22875.16.0 AGR EL
			7.22875.13.0 AGR EL
			7.02604.07.0 LS 570 mm →12.2005 vor Katalysator in front of the catalyst
			7.05271.81.0 LS 210 mm Z 12 XEP: vor Katalysator in front of the catalyst Z 12 XEP: nach Katalysator Post-catalyst
1.3 CDTI 16V (F08, F68) 51-52 kW (70-71 PS) Z 13 DT	10.2003→04.2007		7.00020.24.0 AGR EL
1.4 16V (F08, F68) 66 kW (90 PS) Z 14 XE	09.2000→10.2006		7.24809.10.0 AGR EL
			7.05270.25.0 LS 800 mm →ch. 13999999 Regelsonde, Diagnosesonde Regulating Probe, Diagnostic Probe
			7.05271.76.0 LS 630 mm
			7.05270.26.0 LS 300 mm ch. 24000001→ Regelsonde, Diagnosesonde Regulating Probe, Diagnostic Probe
1.4 Twinport (F08, F68) 66 kW (90 PS) Z 14 XEP	06.2003→10.2006		7.22875.16.0 AGR EL
			7.22875.13.0 AGR EL
			7.02604.07.0 LS 570 mm →12.2005 vor Katalysator in front of the catalyst
			7.05271.81.0 LS 210 mm vor Katalysator in front of the catalyst
1.7 DI 16V (F08, F68) 48 kW (65 PS) Y 17 DTL	08.2000→09.2006		7.22772.12.0 AGR PN
1.7 DTI 16V (F08, F68) 55 kW (75 PS) Y 17 DT	08.2000→09.2006		7.22772.12.0 AGR PN
1.8 16V (F08, F68) 87-92 kW (118-125 PS) Z 18 XE	08.2000→09.2006		7.24809.10.0 AGR EL
			7.05271.55.0 LS 800 mm →ch. 43999999

CORSA Mk III (D) (S07) 43































1.0 (L08) 44 kW (60 PS) Z 10 XEP	08.2006→08.2014		7.22875.16.0 AGR EL
			7.02604.08.0 LS 350 mm
1.0 i 12V (L08) 44-48 kW (60-65 PS) A 10 XEP	01.2010→08.2014		7.22875.16.0 AGR EL
			7.05271.81.0 LS 210 mm vor Katalysator, nach Katalysator in front of the catalyst, Post-catalyst
1.2 (L08) 59 kW (80 PS) Z 12 XEP	08.2006→08.2014		7.22875.16.0 AGR EL
			7.02604.08.0 LS 350 mm
			7.05271.81.0 LS 210 mm vor Katalysator, nach Katalysator in front of the catalyst, Post-catalyst



CORSA Mk III (D) (S07) **43**

1.2 (L08) 51 kW (69 PS) A 12 XEL	06.2010→08.2014	 7.02604.08.0	LS	350 mm	
1.2 LPG (L08) 59 kW (80 PS) Z 12 XEP	09.2009→08.2014	 7.22875.16.0	AGR	EL	
		 7.02604.08.0	LS	350 mm	
1.2 LPG (L08) 61-63 kW (83-86 PS) A 12 XER	08.2011→08.2014	 7.02604.08.0	LS	350 mm	
1.2 i 16V (L08) 61-63 kW (83-86 PS) A 12 XER	12.2009→08.2014	 7.02604.08.0	LS	350 mm	
1.3 CDTI (L08) 51-55 kW (69-75 PS) Z 13 DTJ	08.2006→08.2014	 7.00020.24.0	AGR	EL	
		 7.08369.67.0	ATS	EL	
1.3 CDTI (L08) 55 kW (75 PS) A 13 DTC	08.2006→08.2014	 7.01599.10.0	AGR	EL	
		 7.03622.10.0	AGR-K	EL	 mit AGR-Ventil with EGR valve
		 7.03622.09.0	AGR-K		 A 13 DTC:  ch. C4000001→ ohne AGR-Ventil without EGR valve
		 7.03622.06.0	AGR-K		 A 13 DTC:  ch. C6000001→ ohne AGR-Ventil without EGR valve
		 7.08369.46.0	ATS	EL	
 7.02604.44.0	LS	500 mm		für OE-Nummer: 55564978 for OE number: 55564978	
1.3 CDTI (L08) 66-74 kW (90-101 PS) Z 13 DTH	08.2006→08.2014	 7.00020.25.0	AGR	EL	
		 7.03622.10.0	AGR-K	EL	
		 7.08369.67.0	ATS	EL	
1.3 CDTI (L08) 70 kW (95 PS) A 13 DTE, A 13 DTR, Z 13 DTE	07.2010→08.2014	 7.01599.10.0	AGR	EL	
		 7.03622.10.0	AGR-K	EL	
		 7.03622.09.0	AGR-K		
		 7.03622.06.0	AGR-K		
		 7.08369.46.0	ATS	EL	
		 7.02604.44.0	LS	500 mm	
1.4 (L08) 66 kW (90 PS) Z 14 XEP	08.2006→08.2014	 7.22875.16.0	AGR	EL	
		 7.02604.08.0	LS	350 mm	
		 7.05271.81.0	LS	210 mm	
1.4 (L08) 88 kW (120 PS) A 14 NEL	08.2012→08.2014	 7.02604.08.0	LS	350 mm	
		 7.22875.16.0	AGR	EL	
1.4 LPG (L08) 66 kW (90 PS) Z 14 XEP	07.2006→08.2014	 7.22875.16.0	AGR	EL	
		 7.02604.08.0	LS	350 mm	
1.6 SRi (L08) 110 kW (150 PS) A 16 LEL, Z 16 LEL	05.2007→08.2014	 7.05271.81.0	LS	210 mm	 A 16 LEL, Z 16 LEL: vor Katalysator in front of the catalyst









V

						
CORSA Mk III (D) (S07)						43
1.6 VXR (L08) 141-151 kW (192-205 PS) A 16 LER, B 16 LER	11.2006→08.2014		7.05271.81.0	LS	210 mm  A 16 LER, B 16 LER: vor Katalysator in front of the catalyst	
1.6 VXR (L08) 141-150 kW (192-204 PS) Z 16 LER	11.2006→08.2014		7.02604.08.0	LS	350 mm Regelsonde Regulating Probe	
			7.05271.81.0	LS	210 mm vor Katalysator in front of the catalyst	
1.6 VXR (L08) 150-155 kW (204-211 PS) A 16 LES	06.2011→03.2012		7.05271.81.0	LS	210 mm vor Katalysator in front of the catalyst	
1.7 CDTi (L08) 92 kW (125 PS) Z 17 DTR	11.2006→08.2014		7.10334.08.0	AGR	EL 	
			7.08369.49.0	ATS	EL	
			7.11190.04.0	DDS		
1.7 CDTi (L08) 96 kW (131 PS) A 17 DTS	03.2007→08.2014		7.10334.08.0	AGR	EL 	
CORSA Mk IV (E) (X15)						44
1.0 66 kW (90 PS) F 10 XFL	08.2014→		7.11190.08.0	DDS		
1.3 CDTi 55 kW (75 PS) B 13 DTC, B 13 DTN	08.2014→		7.05031.06.0	AGR-M	EL 	
			7.05031.06.0	AGR-M	EL 	
1.6 VXR 151-155 kW (205-211 PS) B 16 LES	04.2015→		7.05271.81.0	LS	210 mm vor Katalysator in front of the catalyst 2019 2019	
CROSSLAND X (P17)						45
1.5 Turbo D (75) 75 kW (102 PS) D 15 DT (DV5RD)	06.2018→		7.07794.23.0	AGR	EL mit Dichtring with O-ring	
1.6 Turbo D (75) 73 kW (99 PS) B 16 DT (DV6FD)	03.2017→		7.11492.01.0	DDS	ohne Zubehör without accessories	
FRONTERA Mk II (B) (U99)						46
2.2 DTi 85-88 kW (116-120 PS) X 22 DTH, Y 22 DTH	10.1998→09.2004		7.24809.27.0	AGR	PN   X 22 DTH, Y 22 DTH: Fahrgestellnummer bis: 2V599999 Vehicle Identification Number to: 2V599999 für OE-Nummer: 8 49 104, 9117505 for OE number: 8 49 104, 9117505	
			7.24809.29.0	AGR	ET 	
2.2 DTi 85-88 kW (116-120 PS) Y 22 DTH	09.2000→10.2004		7.24809.27.0	AGR	PN  Fahrgestellnummer bis: 2V599999 Vehicle Identification Number to: 2V599999 für OE-Nummer: 8 49 104, 9117505 for OE number: 8 49 104, 9117505	
			7.24809.29.0	AGR	ET 	
GRANDLAND X (A18)						47
1.5 Turbo D (75) 88-96 kW (120-131 PS) D 15 DTH (DV5RC)	04.2018→		7.07794.23.0	AGR	EL mit Dichtring with O-ring	
INSIGNIA Mk I (A) Country Tourer (G09)						48
1.6 CDTi (47) 88-100 kW (120-136 PS) B 16 DTH	07.2015→05.2017		7.24809.81.0	AGR	EL 	
			7.11020.27.0	ATS	EL	











V



INSIGNIA Mk I (A) Country Tourer (G09) 48















2.0 Biturbo CDTI 4x4 (47) 140-143 kW (190-194 PS) A 20 DTR	09.2013→05.2017		7.24809.78.0	AGR	ET	
			7.11190.04.0	DDS		
2.0 CDTI (47) 118-121 kW (160-165 PS) A 20 DTH	07.2013→05.2017		7.24809.78.0	AGR	ET	
			7.08369.17.0	ATS	EL	
			7.11190.04.0	DDS		
			7.02604.44.0	LS	500 mm vor Katalysator in front of the catalyst	
2.0 CDTI (47) 118-121 kW (160-165 PS) A 20 DTH	07.2013→05.2017		7.24809.78.0	AGR	ET	
			7.08369.17.0	ATS	EL	
			7.11190.04.0	DDS		
			7.02604.44.0	LS	500 mm vor Katalysator in front of the catalyst	
2.0 CDTI (47) 125 kW (170 PS) B 20 DTH	11.2014→05.2017		7.24809.87.0	AGR	EL	
2.0 CDTI 4x4 (47) 125 kW (170 PS) B 20 DTH	11.2014→05.2017		7.24809.87.0	AGR	EL	

INSIGNIA Mk I (A) Hatchback (G09) 49







1.6 85 kW (116 PS) A 16 XER	07.2008→07.2012		7.02604.07.0	LS	570 mm	vor Katalysator in front of the catalyst
1.6 CDTI (68) 88-100 kW (120-136 PS) B 16 DTH	07.2015→05.2017		7.24809.81.0	AGR	EL	
			7.11020.27.0	ATS	EL	
1.8 (68) 103 kW (140 PS) A 18 XER, B 18 XER	07.2008→05.2017		7.04879.00.0	AGR-TH		 Öffnungstemperatur/opening temperature 105C
			7.02604.07.0	LS	570 mm	 A 18 XER, B 18 XER: vor Katalysator in front of the catalyst
2.0 Biturbo CDTI (68) 140-143 kW (190-194 PS) A 20 DTR	03.2012→05.2017		7.24809.78.0	AGR	ET	
			7.11190.04.0	DDS		
2.0 Biturbo CDTI 4x4 (68) 140-143 kW (190-194 PS) A 20 DTR	03.2012→05.2017		7.24809.78.0	AGR	ET	
			7.11190.04.0	DDS		
2.0 CDTI (68) 81 kW (110 PS) A 20 DTC, A 20 DTL	07.2008→05.2017		7.24809.78.0	AGR	ET	
			7.08369.17.0	ATS	EL	
			7.11190.04.0	DDS		
			7.02604.44.0	LS	500 mm  A 20 DTC, A 20 DTL: vor Katalysator in front of the catalyst	
2.0 CDTI (68) 96 kW (131 PS) A 20 DT, A 20 DTJ	07.2008→12.2014		7.24809.78.0	AGR	ET	
			7.08369.17.0	ATS	EL	
			7.11190.04.0	DDS		
			7.02604.44.0	LS	500 mm  A 20 DT, A 20 DTJ: vor Katalysator in front of the catalyst	
2.0 CDTI (68) 118-121 kW (160-165 PS) A 20 DTH	07.2008→05.2017		7.24809.78.0	AGR	ET	
			7.08369.17.0	ATS	EL	
			7.11190.04.0	DDS		

V

INSIGNIA Mk I (A) Hatchback (G09)
49

			7.02604.44.0	LS	500 mm	vor Katalysator in front of the catalyst
2.0 CDTi (68) 140-143 kW (190-194 PS) A 20 DTR	10.2008→05.2017		7.24809.78.0	AGR	ET	
			7.11190.04.0	DDS		
2.0 CDTi (68) 88-103 kW (120-140 PS) A 20 DTE	03.2012→03.2016		7.24809.78.0	AGR	ET	
			7.08369.17.0	ATS	EL	
			7.11190.04.0	DDS		
			7.02604.44.0	LS	500 mm	vor Katalysator in front of the catalyst
2.0 CDTi (68) 118-121 kW (160-165 PS) A 20 DTH	07.2013→05.2017		7.24809.78.0	AGR	ET	
			7.08369.17.0	ATS	EL	
			7.11190.04.0	DDS		
			7.02604.44.0	LS	500 mm	vor Katalysator in front of the catalyst
2.0 CDTi (68) 88-103 kW (120-140 PS) A 20 DTE	07.2013→05.2017		7.24809.78.0	AGR	ET	
			7.08369.17.0	ATS	EL	
			7.11190.04.0	DDS		
			7.02604.44.0	LS	500 mm	vor Katalysator in front of the catalyst
2.0 CDTi (68) 125 kW (170 PS) B 20 DTH	11.2014→05.2017		7.24809.87.0	AGR	EL	
2.0 CDTi 4x4 (68) 118-121 kW (160-165 PS) A 20 DTH	07.2008→05.2017		7.24809.78.0	AGR	ET	
			7.08369.17.0	ATS	EL	
			7.11190.04.0	DDS		
			7.02604.44.0	LS	500 mm	vor Katalysator in front of the catalyst
2.0 CDTi 4x4 (68) 140-143 kW (190-194 PS) A 20 DTR	05.2009→05.2017		7.24809.78.0	AGR	ET	
			7.11190.04.0	DDS		
2.0 CDTi 4x4 (68) 125 kW (170 PS) B 20 DTH	11.2014→05.2017		7.24809.87.0	AGR	EL	



















INSIGNIA Mk I (A) Saloon (G09)
50

1.6 85 kW (116 PS) A 16 XER	07.2008→07.2012		7.02604.07.0	LS	570 mm	vor Katalysator in front of the catalyst
1.6 CDTi (69) 88-100 kW (120-136 PS) B 16 DTH	07.2015→05.2017		7.24809.81.0	AGR	EL	
			7.11020.27.0	ATS	EL	
1.8 (69) 103 kW (140 PS) A 18 XER	07.2008→05.2017		7.04879.00.0	AGR-TH		 Öffnungstemperatur/opening temperature 105C
			7.02604.07.0	LS	570 mm	vor Katalysator in front of the catalyst
2.0 Biturbo CDTi (69) 140-143 kW (190-194 PS) A 20 DTR	03.2012→05.2017		7.24809.78.0	AGR	ET	
			7.11190.04.0	DDS		



V



INSIGNIA Mk I (A) Saloon (G09) 50











2.0 Biturbo CDTI 4x4 (69) 140-143 kW (190-194 PS) A 20 DTR	03.2012→05.2017		7.24809.78.0	AGR	ET	
			7.11190.04.0	DDS		
2.0 CDTI (69) 96 kW (131 PS) A 20 DT, A 20 DTJ	07.2008→12.2014		7.24809.78.0	AGR	ET	 A 20 DT, A 20 DTJ: vor Katalysator in front of the catalyst
			7.08369.17.0	ATS	EL	
			7.11190.04.0	DDS		
			7.02604.44.0	LS	500 mm	
2.0 CDTI (69) 118-121 kW (160-165 PS) A 20 DTH	07.2008→05.2017		7.24809.78.0	AGR	ET	 vor Katalysator in front of the catalyst
			7.08369.17.0	ATS	EL	
			7.11190.04.0	DDS		
			7.02604.44.0	LS	500 mm	
2.0 CDTI (69) 140-143 kW (190-194 PS) A 20 DTR	11.2008→05.2017		7.24809.78.0	AGR	ET	
			7.11190.04.0	DDS		
2.0 CDTI (69) 118-121 kW (160-165 PS) A 20 DTH	07.2013→05.2017		7.24809.78.0	AGR	ET	 vor Katalysator in front of the catalyst
			7.08369.17.0	ATS	EL	
			7.11190.04.0	DDS		
			7.02604.44.0	LS	500 mm	
2.0 CDTI (69) 88-103 kW (120-140 PS) A 20 DTE	07.2013→05.2017		7.24809.78.0	AGR	ET	 vor Katalysator in front of the catalyst
			7.08369.17.0	ATS	EL	
			7.11190.04.0	DDS		
			7.02604.44.0	LS	500 mm	
2.0 CDTI (69) 125 kW (170 PS) B 20 DTH	11.2014→05.2017		7.24809.87.0	AGR	EL	
2.0 CDTI 4x4 (69) 118-121 kW (160-165 PS) A 20 DTH	07.2008→05.2017		7.24809.78.0	AGR	ET	 vor Katalysator in front of the catalyst
			7.08369.17.0	ATS	EL	
			7.11190.04.0	DDS		
			7.02604.44.0	LS	500 mm	
2.0 CDTI 4x4 (69) 140-143 kW (190-194 PS) A 20 DTR	05.2009→05.2017		7.24809.78.0	AGR	ET	
			7.11190.04.0	DDS		
2.0 CDTI 4x4 (69) 125 kW (170 PS) B 20 DTH	11.2014→05.2017		7.24809.87.0	AGR	EL	

INSIGNIA Mk I (A) Sports Tourer (G09) 51

































1.6 85 kW (116 PS) A 16 XER	07.2008→07.2012		7.02604.07.0	LS	570 mm	vor Katalysator in front of the catalyst
1.6 CDTI (35) 88-100 kW (120-136 PS) B 16 DTH	07.2015→05.2017		7.24809.81.0	AGR	EL	
			7.11020.27.0	ATS	EL	



INSIGNIA Mk I (A) Sports Tourer (G09) 51

1.8 (35) 103 kW (140 PS) A 18 XER	07.2008→05.2017		7.04879.00.0	AGR-TH		⊙	Öffnungstemperatur/opening temperature 105C vor Katalysator in front of the catalyst
			7.02604.07.0	LS	570 mm		
2.0 Biturbo CDTI (35) 140-143 kW (190-194 PS) A 20 DTR	03.2012→05.2017		7.24809.78.0	AGR		⊙	
			7.11190.04.0	DDS			
2.0 Biturbo CDTI 4x4 (35) 140-143 kW (190-194 PS) A 20 DTR	03.2012→05.2017		7.24809.78.0	AGR		⊙	
			7.11190.04.0	DDS			
2.0 CDTI (35) 81 kW (110 PS) A 20 DTC	07.2008→05.2017		7.24809.78.0	AGR		⊙	vor Katalysator in front of the catalyst
			7.08369.17.0	ATS			
			7.11190.04.0	DDS			
			7.02604.44.0	LS	500 mm		
2.0 CDTI (35) 96 kW (131 PS) A 20 DT, A 20 DTJ	07.2008→12.2014		7.24809.78.0	AGR		⊙	A 20 DT, A 20 DTJ: vor Katalysator in front of the catalyst
			7.08369.17.0	ATS			
			7.11190.04.0	DDS			
			7.02604.44.0	LS	500 mm		
2.0 CDTI (35) 118-121 kW (160-165 PS) A 20 DTH	07.2008→05.2017		7.24809.78.0	AGR		⊙	vor Katalysator in front of the catalyst
			7.08369.17.0	ATS			
			7.11190.04.0	DDS			
			7.02604.44.0	LS	500 mm		
2.0 CDTI (35) 140-143 kW (190-194 PS) A 20 DTR	11.2008→05.2017		7.24809.78.0	AGR		⊙	
			7.11190.04.0	DDS			
2.0 CDTI (35) 88-103 kW (120-140 PS) A 20 DTE	03.2012→03.2016		7.24809.78.0	AGR		⊙	vor Katalysator in front of the catalyst
			7.08369.17.0	ATS			
			7.11190.04.0	DDS			
			7.02604.44.0	LS	500 mm		
2.0 CDTI (35) 88-103 kW (120-140 PS) A 20 DTE	07.2013→05.2017		7.24809.78.0	AGR		⊙	vor Katalysator in front of the catalyst
			7.08369.17.0	ATS			
			7.11190.04.0	DDS			
			7.02604.44.0	LS	500 mm		
2.0 CDTI (35) 118-121 kW (160-165 PS) A 20 DTH	07.2013→05.2017		7.24809.78.0	AGR		⊙	vor Katalysator in front of the catalyst
			7.08369.17.0	ATS			
			7.11190.04.0	DDS			
			7.02604.44.0	LS	500 mm		
2.0 CDTI (35) 125 kW (170 PS) B 20 DTH	11.2014→05.2017		7.24809.87.0	AGR		EL	



			 PIERBURG		
INSIGNIA Mk I (A) Sports Tourer (G09) 51					
2.0 CDTI 4x4 (35) 118-121 kW (160-165 PS) A 20 DTH	07.2008→05.2017		7.24809.78.0	AGR	ET 
			7.08369.17.0	ATS	EL
			7.11190.04.0	DDS	
			7.02604.44.0	LS	500 mm vor Katalysator in front of the catalyst
2.0 CDTI 4x4 (35) 140-143 kW (190-194 PS) A 20 DTR	05.2009→05.2017		7.24809.78.0	AGR	ET 
			7.11190.04.0	DDS	
2.0 CDTI 4x4 (35) 125 kW (170 PS) B 20 DTH	11.2014→05.2017		7.24809.87.0	AGR	EL
INSIGNIA Mk II (B) Country Tourer (Z18) 52					
2.0 D 4x4 (47) 154 kW (209 PS) D 20 DTR	07.2017→		7.24809.87.0	AGR	EL
2.0 D 4x4 (47) 125 kW (170 PS) B 20 DTH, D 20 DTH	09.2017→		7.24809.87.0	AGR	EL
INSIGNIA Mk II (B) Hatchback (Z18) 53					
1.6 D (68) 70-81 kW (95-110 PS) B 16 DTE, D 16 DTE, D 16 DTN	03.2017→		7.24809.81.0	AGR	EL 
			7.11020.42.0	ATS	EL
1.6 D (68) 88-100 kW (120-136 PS) B 16 DTH, D 16 DTH	03.2017→		7.24809.81.0	AGR	EL 
			7.11020.42.0	ATS	EL
2.0 D (68) 125 kW (170 PS) B 20 DTH, D 20 DTH	03.2017→		7.24809.87.0	AGR	EL
2.0 D 4x4 (68) 154 kW (209 PS) D 20 DTR	07.2017→		7.24809.87.0	AGR	EL
INSIGNIA Mk II (B) Sports Tourer (Z18) 54					
1.6 D (35) 70-81 kW (95-110 PS) B 16 DTE, D 16 DTE, D 16 DTN	03.2017→		7.24809.81.0	AGR	EL 
			7.11020.42.0	ATS	EL
1.6 D (35) 88-100 kW (120-136 PS) B 16 DTH, D 16 DTH	03.2017→		7.24809.81.0	AGR	EL 
			7.11020.42.0	ATS	EL
2.0 D (35) 125 kW (170 PS) B 20 DTH, D 20 DTH	03.2017→		7.24809.87.0	AGR	EL
2.0 D 4x4 (35) 154 kW (209 PS) D 20 DTR	07.2017→		7.24809.87.0	AGR	EL
MERIVA A (X03) 55					
1.3 CDTI 51-55 kW (69-75 PS) Z 13 DTJ	01.2003→10.2009		7.00020.24.0	AGR	EL 
			7.08369.15.0	ATS	EL
			7.11190.04.0	DDS	
1.3 CDTI 51-52 kW (69-71 PS) Y 13 DT, Z 13 DT	04.2005→06.2010		7.00020.24.0	AGR	EL 
1.4 16V Twinport 66 kW (90 PS) Z 14 XEP	01.2003→06.2010		7.22875.16.0	AGR	EL  ch. 54000001→
			7.22875.13.0	AGR	EL  →ch. 44999999
			7.02604.07.0	LS	570 mm  →ch. 54999999 vor Katalysator in front of the catalyst

V



MERIVA A (X03) 55

			7.05271.81.0	LS	210 mm	Z 14 XEP: nach Katalysator Post-catalyst Z 14 XEP: ch. 64→ vor Katalysator in front of the catalyst
1.6 Turbo 132 kW (180 PS) Z 16 LET	05.2006→06.2010		7.02604.08.0	LS	350 mm	
			7.05271.81.0	LS	210 mm	vor Katalysator in front of the catalyst
1.6 i 62-64 kW (84-87 PS) Z 16 SE	01.2003→06.2010		7.24809.10.0	AGR	EL	→ch. 44999999
			7.05270.26.0	LS	300 mm	
1.6 i 16V 63-74 kW (85-101 PS) Z 16 XE	01.2003→09.2005		7.24809.10.0	AGR	EL	→ch. 44999999
			7.05271.76.0	LS	630 mm	
			7.05270.26.0	LS	300 mm	Diagnosesonde Diagnostic Probe
1.6 i 16V Twinport 74-77 kW (101-105 PS) Z 16 XEP	05.2003→06.2010		7.28384.13.0	AGR	EL	
			7.04879.00.0	AGR-TH		Öffnungstemperatur/opening temperature 105C
			7.02604.05.0	LS	550 mm	→20HH5427 vor Katalysator in front of the catalyst
1.8 i 16V 87-92 kW (118-125 PS) Z 18 XE	05.2003→06.2010		7.24809.10.0	AGR	EL	→ch. 44999999

















MERIVA Mk II (B) (S10) 56

1.3 CDTi 55 kW (75 PS) A 13 DTC	06.2010→		7.01599.10.0	AGR	EL	
			7.03622.11.0	AGR-K	EL	ch. C4000001→ch. C4999999 mit AGR-Ventil with EGR valve
			7.03622.10.0	AGR-K	EL	
			7.03622.09.0	AGR-K		
			7.03622.06.0	AGR-K		
			7.08369.46.0	ATS	EL	
			7.11190.04.0	DDS		
1.3 CDTi 70 kW (95 PS) A 13 DTE	06.2010→		7.01599.10.0	AGR	EL	
			7.03622.11.0	AGR-K	EL	ch. C4000001→ch. C4999999 mit AGR-Ventil with EGR valve
			7.03622.10.0	AGR-K	EL	
			7.03622.09.0	AGR-K		
			7.03622.06.0	AGR-K		
			7.08369.46.0	ATS	EL	
			7.11190.04.0	DDS		
1.6 CDTi 70 kW (95 PS) B 16 DTC	01.2014→		7.24809.81.0	AGR	EL	
			7.11020.27.0	ATS	EL	









































MERIVA Mk II (B) (S10) **56**

1.6 CDTi 88-100 kW (120-136 PS) B 16 DTH	08.2013→		7.24809.81.0	AGR	EL		
			7.11020.27.0	ATS	EL		
1.6 CDTi 70-81 kW (95-110 PS) B 16 DTE, B 16 DTL	07.2014→		7.24809.81.0	AGR	EL		
			7.11020.27.0	ATS	EL		
1.6 CDTi 81 kW (110 PS) B 16 DTN	07.2014→		7.24809.81.0	AGR	EL		
			7.11020.42.0	ATS	EL		 B 16 DTN:  ch. F4000001→ch. F4999999 für RPO Nummer: WM3 for RPO number: WM3  B 16 DTN:  ch. G4000001→
			7.11020.27.0	ATS	EL		
1.7 CDTi 74 kW (101 PS) A 17 DT	06.2010→		7.10334.08.0	AGR	EL		
			7.11190.04.0	DDS			
1.7 CDTi 96 kW (131 PS) A 17 DTS	06.2010→		7.10334.08.0	AGR	EL		
			7.11190.04.0	DDS			
1.7 CDTi 81 kW (110 PS) A 17 DTC, A 17 DTI	06.2010→		7.10334.08.0	AGR	EL		
			7.11190.04.0	DDS			

MOKKA / MOKKA X (J13) **57**







1.6 85 kW (116 PS) A 16 XER, B 16 XER, D 16 XER	06.2012→		7.02604.07.0	LS	570 mm	 A 16 XER, B 16 XER, D 16 XER: vor Katalysator in front of the catalyst	
1.6 CDTi 81 kW (110 PS) B 16 DTN, B 16 DTU	06.2015→		7.24809.81.0	AGR	EL		
			7.11020.27.0	ATS	EL		 B 16 DTN, B 16 DTU: Fahrgestellnummer bis: F4999999, FB999999 Vehicle Identification Number to: F4999999, FB999999
			7.11020.42.0	ATS	EL		
1.6 CDTi 88-100 kW (120-136 PS) A 16 DTH, B 16 DTH	01.2015→		7.24809.81.0	AGR	EL		
			7.11020.27.0	ATS	EL		 A 16 DTH, B 16 DTH: Fahrgestellnummer bis: F4999999, FB999999 Vehicle Identification Number to: F4999999, FB999999
			7.11020.42.0	ATS	EL		
V 1.6 CDTi 4x4 88-100 kW (120-136 PS) A 16 DTH, B 16 DTH	01.2015→		7.24809.81.0	AGR	EL		
			7.11020.27.0	ATS	EL		 A 16 DTH, B 16 DTH: Fahrgestellnummer bis: F4999999, FB999999 Vehicle Identification Number to: F4999999, FB999999

					
MOKKA / MOKKA X (J13)					57
			7.11020.42.0	ATS	EL  A 16 DTH, B 16 DTH: Fahrgestellnummer ab: F4000001, FB000001 Vehicle Identification Number from: F4000001, FB000001
1.7 CDTI 96 kW (131 PS) A 17 DTS	06.2012→		7.11020.38.0	ATS	EL
			7.11190.04.0	DDS	
1.7 CDTI 4x4 96 kW (131 PS) A 17 DTS	06.2012→		7.11020.38.0	ATS	EL
			7.11190.04.0	DDS	
NOVA Hatchback (S83)					58
1.2 33 kW (45 PS) C 12 NZ	09.1989→03.1993		7.02604.15.0	LS	360 mm →12.1992
1.4 i 44 kW (60 PS) C 14 NZ	01.1990→03.1993		7.02604.15.0	LS	360 mm →12.1992
1.4 i S 60 kW (82 PS) C 14 SE	09.1991→03.1993		7.02604.15.0	LS	360 mm →12.1992
1.6 GSI 60-74 kW (81-101 PS) E 16 SE	05.1988→03.1992		7.02604.03.0	LS	200 mm
1.6 GSI 72 kW (98 PS) C 16 SEI	01.1990→12.1992		7.02604.03.0	LS	200 mm
1.6 GSI Cat 74 kW (101 PS) C 16 SE	02.1992→03.1993		7.02604.15.0	LS	360 mm →12.1992
			7.02604.03.0	LS	200 mm
NOVA Saloon (S83)					59
1.2 33 kW (45 PS) C 12 NZ	02.1992→12.1993		7.02604.15.0	LS	360 mm
1.4 60 kW (82 PS) C 14 SE	09.1990→08.1992		7.02604.15.0	LS	360 mm
1.4 44 kW (60 PS) C 14 NZ	10.1990→08.1992		7.02604.15.0	LS	360 mm
OMEGA (B) Estate (V94)					60
2.0 16V 100 kW (136 PS) X 20 XEV	03.1994→07.2001		7.05270.34.0	LS	340 mm
2.0 DTI 16V 74 kW (101 PS) X 20 DTH	01.1998→09.2000		7.24809.24.0*	AGR	PN mit Saugrohr with suction pipe  für Hersteller-Abgasnorm: NC8 for manufacturer exhaust norm: NC8
			↳7.24809.27.0	AGR	PN mit Saugrohr with suction pipe
			7.24809.25.0*	AGR	PN  96 EEC, D3 96 EEC, D3
			↳7.24809.28.0	AGR	PN
2.2 16V 106-108 kW (144-147 PS) Y 22 XE, Z 22 XE	02.1994→06.2003		7.05271.55.0	LS	800 mm
2.2 DTI 16V 85-88 kW (116-120 PS) Y 22 DTH	08.2000→06.2003		7.24809.24.0*	AGR	PN mit Saugrohr with suction pipe  für Hersteller-Abgasnorm: NC8 for manufacturer exhaust norm: NC8
			↳7.24809.27.0	AGR	PN mit Saugrohr with suction pipe
			7.24809.25.0*	AGR	PN 
			↳7.24809.28.0	AGR	PN











V



OMEGA (B) Estate (V94) 60

2.5 TD 96 kW (131 PS) U 25 DT, U 25 TD, X 25 DT, X 25 TD	04.1994→07.2001		7.21920.62.0	AGR	PN	mit Rohrstützen with pipe socket 
2.6 V6 125-132 kW (170-180 PS) Y 26 SE	08.2000→06.2003		7.05271.68.0	LS	750 mm	Automatikgetriebe Automatic Transmission vorne Front
			7.02604.07.0	LS	570 mm	nach Katalysator Post-catalyst
			7.02604.08.0	LS	350 mm	
			7.05271.81.0	LS	210 mm	 Y 26 SE:  →ch. 21059096 nach Katalysator Post-catalyst  Y 26 SE: vor Katalysator in front of the catalyst
3.2 V6 160 kW (218 PS) Y 32 SE	02.2001→06.2003		7.05271.68.0	LS	750 mm	Automatikgetriebe Automatic Transmission vorne Front
			7.02604.07.0	LS	570 mm	nach Katalysator Post-catalyst
			7.05271.81.0	LS	210 mm	für Schaltgetriebe for manual transmission vor Katalysator in front of the catalyst

OMEGA (B) Saloon (V94) 61

2.0 16V 100 kW (136 PS) X 20 XEV	03.1994→07.2001		7.05270.34.0	LS	340 mm	
2.0 DTI 16V 74 kW (101 PS) X 20 DTH	01.1998→09.2000		7.24809.24.0*	AGR	PN	mit Saugrohr with suction pipe  für Hersteller-Abgasnorm: NC8 for manufacturer exhaust norm: NC8
			↳ 7.24809.27.0	AGR	PN	
			7.24809.25.0*	AGR	PN	mit Saugrohr with suction pipe  96 EEC, D3 96 EEC, D3
			↳ 7.24809.28.0	AGR	PN	
2.2 16V 106-108 kW (144-147 PS) Y 22 XE, Z 22 XE	01.1994→06.2003		7.05271.55.0	LS	800 mm	
2.2 DTI 16V 85-88 kW (116-120 PS) Y 22 DTH	08.2000→07.2003		7.24809.27.0	AGR	PN	 für OE-Nummer: 8 49 087, 8 49 105, 90530760, 9128573 for OE number: 8 49 087, 8 49 105, 90530760, 9128573 für Hersteller-Abgasnorm: NC8 for manufacturer exhaust norm: NC8
			7.24809.28.0	AGR	PN	 für OE-Nummer: 849124, 849156, 9192805, 93170138 for OE number: 849124, 849156, 9192805, 93170138
2.5 TD 96 kW (131 PS) U 25 DT, U 25 TD, X 25 DT, X 25 TD	04.1994→07.2001		7.21920.62.0	AGR	PN	mit Rohrstützen with pipe socket 
2.6 V6 125-132 kW (170-180 PS) Y 26 SE	08.2000→07.2003		7.05271.68.0	LS	750 mm	Automatikgetriebe Automatic Transmission vorne Front
			7.02604.07.0	LS	570 mm	nach Katalysator Post-catalyst

V



















































OMEGA (B) Saloon (V94) 61

		7.02604.08.0	LS	350 mm	
		7.05271.81.0	LS	210 mm	Y 26 SE: →ch. 21059096 nach Katalysator Post-catalyst
					Y 26 SE: vor Katalysator in front of the catalyst
3.2 V6 160 kW (218 PS) Y 32 SE	02.2001→07.2003	7.05271.68.0	LS	750 mm	Automatikgetriebe Automatic Transmission vorne Front
		7.02604.07.0	LS	570 mm	nach Katalysator Post-catalyst
		7.05271.81.0	LS	210 mm	für Schaltgetriebe for manual transmission vor Katalysator in front of the catalyst

SIGNUM (Z03) 62

1.8 103 kW (140 PS) Z 18 XER	08.2005→05.2008	7.04879.00.0	AGR-TH		Öffnungstemperatur/opening temperature 105C
1.9 CDTI 88 kW (120 PS) Z 19 DT	04.2004→03.2008	7.22946.38.0	AGR	EL	
		7.08369.05.0	ATS	EL	
		7.08369.38.0	ATS	EL	Fahrgestellnummer ab: 51065674 Vehicle Identification Number from: 51065674 nach Rußpartikelfilter after soot particulate filter
		7.11190.04.0	DDS		ch. 71021892→
		7.11190.03.0	DDS		ohne Zubehör without accessories →ch. 71021891
1.9 CDTI 16V 110 kW (150 PS) Z 19 DTH	04.2004→03.2008	7.00063.10.0	AGR	EL	
		7.08369.05.0	ATS	EL	
		7.08369.38.0	ATS	EL	Fahrgestellnummer ab: 51065674 Vehicle Identification Number from: 51065674 nach Rußpartikelfilter after soot particulate filter
		7.11190.04.0	DDS		ch. 71021892→
		7.11190.03.0	DDS		ohne Zubehör without accessories →ch. 71021891
2.0 DTI 74 kW (101 PS) Y 20 DTH	05.2003→04.2004	7.24809.29.0	AGR	ET	
2.0 i Turbo 129 kW (175 PS) Z 20 NET	03.2003→10.2008	7.05270.27.0	LS	400 mm	→ch. 41039263
2.2 DTI 92 kW (125 PS) Y 22 DTR	05.2003→05.2008	7.24809.29.0	AGR	ET	
2.8 V6 Turbo 169 kW (230 PS) Z 28 NEL	07.2005→05.2008	7.02604.08.0	LS	350 mm	Diagnosesonde Diagnostic Probe
3.0 V6 CDTI 135 kW (184 PS) Z 30 DT	07.2005→06.2008	7.11190.04.0	DDS		
3.2 V6 155 kW (211 PS) Z 32 SE	05.2003→05.2008	7.02604.08.0	LS	350 mm	
		7.05271.81.0	LS	210 mm	vor Katalysator, nach Katalysator in front of the catalyst, Post-catalyst



					
SINTRA (APV)					63
2.2 DTI 85 kW (116 PS) X 22 DTH	07.1997→04.1999		7.24809.27.0	AGR	PN  für OE-Nummer: 8 49 104, 9117505 for OE number: 8 49 104, 9117505
2.2 i 16V 100-104 kW (136-141 PS) X 22 XE	11.1996→04.1999		7.22296.02.0	ARV	PN 
3.0 i 24V 148-155 kW (201-211 PS) X 30 XE	11.1996→04.1999		7.22296.02.0	ARV	PN 
TIGRA Mk I (S93)					64
1.4 16V 66 kW (90 PS) X 14 XE	07.1994→12.2000		7.22296.02.0	ARV	PN 
			7.02604.15.0	LS	360 mm  X 14 XE:  ch. S6011905→  X 14 XE:  ch. S4269628→  X 14 XE:  ch. T3013886→
1.6 16V 78-80 kW (106-109 PS) X 16 XE	07.1994→12.2000		7.22296.02.0	ARV	PN 
			7.02604.15.0	LS	360 mm  X 16 XE:  ch. T3013886→  X 16 XE:  ch. S6011905→  X 16 XE:  ch. S4269628→
TIGRA TwinTop (X04)					65
1.3 CDTI 51-52 kW (70-71 PS) Z 13 DT	06.2004→08.2009		7.00020.24.0	AGR	EL 
1.4 66 kW (90 PS) Z 14 XEP	06.2004→08.2009		7.22875.16.0	AGR	EL   ch. 5E000001→
			7.22875.13.0	AGR	EL 
			7.02604.07.0	LS	570 mm  →ch. 5E999999 vor Katalysator in front of the catalyst
			7.02604.08.0	LS	350 mm
			7.05271.81.0	LS	210 mm nach Katalysator Post-catalyst
1.8 87-92 kW (118-125 PS) Z 18 XE	06.2004→08.2009		7.24809.10.0	AGR	EL 
VECTRA (B) Estate (J96)					66
1.8 i 16V (F35) 85 kW (116 PS) X 18 XE	09.1996→09.2000		7.22296.02.0	ARV	PN 
1.8 i 16V (F35) 85 kW (116 PS) X 18 XE1	11.1996→09.2000		7.24809.10.0	AGR	EL 
			7.05270.32.0	LS	825 mm
1.8 i 16V (F35) 87-92 kW (118-125 PS) Z 18 XE	09.2000→03.2002		7.05271.55.0	LS	800 mm
2.0 DI 16V (F35) 60 kW (82 PS) X 20 DTL	08.1995→10.2001		7.24809.25.0*	AGR	PN mit Saugrohr with suction pipe  96 EEC, D3 96 EEC, D3
			↳ 7.24809.28.0	AGR	PN 
			7.24809.27.0	AGR	PN  für OE-Nummer: 8 49 067, 8 49 104, 90500935, 9117505 for OE number: 8 49 067, 8 49 104, 90500935, 9117505 für Hersteller-Abgasnorm: NC8 for manufacturer exhaust norm: NC8
2.0 DTI 16V (F35) 74 kW (101 PS) X 20 DTH	08.1995→10.2001		7.24809.24.0*	AGR	PN mit Saugrohr with suction pipe  für Hersteller-Abgasnorm: NC8 for manufacturer exhaust norm: NC8
			↳ 7.24809.27.0	AGR	PN 



VECTRA (B) Estate (J96) 66























			7.24809.25.0*	AGR	PN	mit Saugrohr with suction pipe ○ 96 EEC, D3 96 EEC, D3
			↳ 7.24809.28.0	AGR	PN	
2.0 DTI 16V (F35) 74 kW (101 PS) Y 20 DTH	08.1995→10.2001		7.24809.25.0*	AGR	PN	mit Saugrohr with suction pipe ○
			↳ 7.24809.28.0	AGR	PN	
2.0 Dualfuel (F35) 100 kW (136 PS) X 20 XEV	10.1998→01.2001		7.22296.02.0	ARV	PN	○
2.0 i 16V (F35) 100 kW (136 PS) X 20 XEV	10.1995→01.2001		7.22296.02.0	ARV	PN	○
			7.05270.33.0	LS	705 mm	
2.2 DTI 16V (F35) 92 kW (125 PS) Y 22 DTR	08.1995→10.2001		7.24809.25.0*	AGR	PN	mit Saugrohr with suction pipe ○
			↳ 7.24809.28.0	AGR	PN	
2.2 i 16V (F35) 106-108 kW (144-147 PS) Z 22 SE	08.1995→10.2001		7.22630.28.0	AGR	EL	○
			7.05270.29.0	LS	630 mm	
			7.05270.30.0	LS	1275 mm	
2.5 i GSi (F35) 125-143 kW (170-194 PS) X 25 XE	05.1998→09.1999		7.22296.02.0	ARV	PN	○
2.5 i V6 (F35) 125-143 kW (170-194 PS) X 25 XE	11.1996→08.2000		7.22296.02.0	ARV	PN	○
2.6 i V6 (F35) 125-132 kW (170-180 PS) Y 26 SE	09.2000→03.2002		7.05271.68.0	LS	750 mm	hinten Rear für Fahrzeuge mit Katalysator for vehicles with catalytic converter

VECTRA (B) Hatchback (J96) 67

1.6 i (F68) 55 kW (75 PS) X 16 SZR	08.1995→10.2001		7.02604.15.0	LS	360 mm	X 16 SZR: →ch. W5276825 X 16 SZR: ch. T1→ch. W1 X 16 SZR: ch. T7000001→ X 16 SZR: ch. TL→ch. WL X 16 SZR: ch. TP→ch. WP X 16 SZR: ch. TS→ch. WS
1.6 i 16V (F68) 63-74 kW (85-101 PS) Y 16 XE, Z 16 XE	08.1995→10.2001		7.24809.10.0	AGR	EL	○
			7.05270.25.0	LS	800 mm	Y 16 XE, Z 16 XE: Regelsonde Regulating Probe
			7.02604.15.0	LS	360 mm	
1.6 i 16V (F68) 74 kW (101 PS) X 16 XEL	08.1995→10.2001		7.22296.02.0	ARV	PN	○ Fahrgestellnummer bis: W5276825 Vehicle Identification Number to: W5276825
			7.02604.15.0	LS	360 mm	X 16 XEL: →ch. W5276825 X 16 XEL: ch. T7000001→ch. W7154258 X 16 XEL: ch. TL→ch. WL X 16 XEL: →ch. W1285446 X 16 XEL: ch. TS→ch. WS
1.8 i 16V (F68) 85 kW (116 PS) X 18 XE	09.1995→09.2000		7.22296.02.0	ARV	PN	○



VECTRA (B) Hatchback (J96) **67**

1.8 i 16V (F68) 85 kW (116 PS) X 18 XE1	10.1995→09.2000		7.24809.10.0	AGR	EL		
			7.05270.32.0	LS	825 mm		
1.8 i 16V (F68) 87-92 kW (118-125 PS) Z 18 XE	09.2000→07.2003		7.05271.55.0	LS	800 mm		
2.0 DTi 16V (F68) 74 kW (101 PS) X 20 DTH	06.1997→10.2001		7.24809.24.0*	AGR	PN	mit Saugrohr with suction pipe  für Hersteller-Abgasnorm: NC8 for manufacturer exhaust norm: NC8	
			↳7.24809.27.0	AGR	PN		
			7.24809.25.0*	AGR	PN		mit Saugrohr with suction pipe  96 EEC, D3 96 EEC, D3
			↳7.24809.28.0	AGR	PN		
2.0 DTi 16V (F68) 74 kW (101 PS) Y 20 DTH	06.1997→10.2001		7.24809.25.0*	AGR	PN	mit Saugrohr with suction pipe 	
			↳7.24809.28.0	AGR	PN		
2.0 Di 16V (F68) 60 kW (82 PS) X 20 DTL	08.1995→10.2001		7.24809.25.0*	AGR	PN	mit Saugrohr with suction pipe  96 EEC, D3 96 EEC, D3	
			↳7.24809.28.0	AGR	PN		
			7.24809.27.0	AGR	PN		für OE-Nummer: 8 49 067, 8 49 104, 90500935, 9117505 for OE number: 8 49 067, 8 49 104, 90500935, 9117505 für Hersteller-Abgasnorm: NC8 for manufacturer exhaust norm: NC8
2.0 Dualfuel (F68) 100 kW (136 PS) X 20 XEV	08.1998→01.2001		7.22296.02.0	ARV	PN		
2.0 i 16V (F68) 100 kW (136 PS) X 20 XEV	10.1995→01.2001		7.22296.02.0	ARV	PN		
			7.05270.33.0	LS	705 mm		
2.2 DTi 16V (F68) 92 kW (125 PS) Y 22 DTR	08.1995→10.2001		7.24809.25.0*	AGR	PN	mit Saugrohr with suction pipe 	
			↳7.24809.28.0	AGR	PN		
2.2 i 16V (F68) 106-108 kW (144-147 PS) Z 22 SE	09.2000→07.2003		7.22630.28.0	AGR	EL		
			7.05270.29.0	LS	630 mm		
			7.05270.30.0	LS	1275 mm		
2.5 i GSi (F68) 125-143 kW (170-194 PS) X 25 XE	03.1998→07.2000		7.22296.02.0	ARV	PN		
2.5 i V6 (F68) 125-143 kW (170-194 PS) X 25 XE	09.1995→08.2000		7.22296.02.0	ARV	PN		
2.6 i V6 (F68) 125-132 kW (170-180 PS) Y 26 SE	09.2000→07.2003		7.05271.68.0	LS	750 mm	hinten Rear für Fahrzeuge mit Katalysator for vehicles with catalytic converter	









V

VECTRA (B) Saloon (J96)						
1.6 i (F19) 55 kW (75 PS) X 16 SZR	08.1995→10.2001	 7.02604.15.0	LS	360 mm	X 16 SZR: →ch. W5276825 X 16 SZR: ch. T1→ch. W1 X 16 SZR: ch. T7000001→ X 16 SZR: ch. TL→ch. WL X 16 SZR: ch. TP→ch. WP X 16 SZR: ch. TS→ch. WS	
			AGR	EL		
1.6 i 16V (F19) 63-74 kW (85-101 PS) Y 16 XE, Z 16 XE	08.1995→10.2001	 7.24809.10.0	LS	800 mm	Y 16 XE, Z 16 XE: Regelsonde Regulating Probe	
			ARV	PN		
1.6 i 16V (F19) 74 kW (101 PS) X 16 XEL	08.1995→10.2001	 7.22296.02.0	ARV	PN	 Fahrgestellnummer bis: W5276825 Vehicle Identification Number to: W5276825	
			LS	360 mm	X 16 XEL: ch. TL→ch. WL X 16 XEL: ch. T7000001→ch. W7154258 X 16 XEL: →ch. W1285446 X 16 XEL: ch. TS→ch. WS X 16 XEL: ch. TP→ch. WP X 16 XEL: →ch. W5276828	
1.8 i 16V (F19) 85 kW (116 PS) X 18 XE	10.1995→09.2000	 7.22296.02.0	ARV	PN		
			LS	705 mm		
1.8 i 16V (F19) 87-92 kW (118-125 PS) Z 18 XE	09.2000→03.2002	 7.05271.55.0	LS	800 mm		
2.0 DI 16V (F19) 60 kW (82 PS) X 20 DTL	08.1995→10.2001	 7.24809.25.0*	AGR	PN	mit Saugrohr with suction pipe 96 EEC, D3 96 EEC, D3	
			↪ 7.24809.28.0	AGR	PN	
			7.24809.27.0	AGR	PN	 für OE-Nummer: 8 49 067, 8 49 104, 90500935, 9117505 for OE number: 8 49 067, 8 49 104, 90500935, 9117505 für Hersteller-Abgasnorm: NC8 for manufacturer exhaust norm: NC8
2.0 DTI 16V (F19) 74 kW (101 PS) X 20 DTH	08.1995→10.2001	 7.24809.24.0*	AGR	PN	mit Saugrohr with suction pipe für Hersteller-Abgasnorm: NC8 for manufacturer exhaust norm: NC8	
			↪ 7.24809.27.0	AGR	PN	
			7.24809.25.0*	AGR	PN	mit Saugrohr with suction pipe 96 EEC, D3 96 EEC, D3
			↪ 7.24809.28.0	AGR	PN	
2.0 DTI 16V (F19) 74 kW (101 PS) Y 20 DTH	08.1995→10.2001	 7.24809.25.0*	AGR	PN	mit Saugrohr with suction pipe 	
			↪ 7.24809.28.0	AGR	PN	
2.0 Dualfuel (F19) 100 kW (136 PS) X 20 XEV	05.1998→01.2001	 7.22296.02.0	ARV	PN		
2.0 i 16V (F19) 100 kW (136 PS) X 20 XEV	10.1995→01.2001	 7.22296.02.0	ARV	PN		
			LS	705 mm		



















VECTRA (B) Saloon (J96) 68

2.2 DTI 16V (F19) 92 kW (125 PS) Y 22 DTR	08.1995→10.2001		7.24809.28.0	AGR	PN	 für OE-Nummer: 849124, 849156, 9192805, 93170138 for OE number: 849124, 849156, 9192805, 93170138
2.2 i 16V (F19) 106-108 kW (144-147 PS) Z 22 SE	08.1995→10.2001		7.22630.28.0	AGR	EL	
			7.05270.29.0	LS	630 mm	
			7.05270.30.0	LS	1275 mm	
2.5 i GSi (F19) 125-143 kW (170-194 PS) X 25 XE	03.1998→07.2000		7.22296.02.0	ARV	PN	
2.5 i V6 (F19) 125-143 kW (170-194 PS) X 25 XE	09.1995→08.2000		7.22296.02.0	ARV	PN	
2.6 i V6 (F19) 125-132 kW (170-180 PS) Y 26 SE	09.2000→03.2002		7.05271.68.0	LS	750 mm	hinten Rear für Fahrzeuge mit Katalysator for vehicles with catalytic converter

VECTRA Mk II (C) (Z02) 69

1.8 103 kW (140 PS) Z 18 XER	01.2006→07.2008		7.04879.00.0	AGR-TH		 Öffnungstemperatur/opening temperature 105C
1.8 16V 87-92 kW (118-125 PS) Z 18 XE	04.2002→07.2008		7.24809.10.0	AGR	EL	  →ch. 20AN8144
			7.00063.10.0	AGR	EL	  →ch. 20AN8144
1.8 16V Dualfuel 87-92 kW (118-125 PS) Z 18 XE	04.2002→07.2008		7.24809.10.0	AGR	EL	  →ch. 20AN8144
1.9 CDTI 88 kW (120 PS) Z 19 DT	04.2002→09.2008		7.22946.38.0	AGR	EL	
			7.08369.05.0	ATS	EL	Fahrgestellnummer ab: 51065674, 58 Vehicle Identification Number from: 51065674, 58 nach Rußpartikelfilter after soot particulate filter ohne Zubehör without accessories Fahrgestellnummer bis: 48999999, 71021891 Vehicle Identification Number to: 48999999, 71021891 Fahrgestellnummer ab: 71021892, 78 Vehicle Identification Number from: 71021892, 78
			7.08369.38.0	ATS	EL	
			7.11190.03.0	DDS		
			7.11190.04.0	DDS		
1.9 CDTI 16V 110 kW (150 PS) Z 19 DTH	04.2004→08.2008		7.00063.10.0	AGR	EL	
			7.08369.05.0	ATS	EL	Fahrgestellnummer ab: 51065674, 58 Vehicle Identification Number from: 51065674, 58 nach Rußpartikelfilter after soot particulate filter ohne Zubehör without accessories Fahrgestellnummer bis: 48999999, 71021891 Vehicle Identification Number to: 48999999, 71021891
			7.08369.38.0	ATS	EL	
7.11190.03.0	DDS					



VECTRA Mk II (C) (Z02) 69

			7.11190.04.0	DDS		Fahrgestellnummer ab: 71021892, 78 Vehicle Identification Number from: 71021892, 78
2.0 16V Turbo 129 kW (175 PS) Z 20 NET	01.2000→10.2008		7.05270.27.0	LS	400 mm	→ch. 41039263
2.0 DTI 16V 74 kW (101 PS) Y 20 DTH	04.2002→10.2008		7.24809.29.0	AGR	ET	
2.2 16V 106-108 kW (144-147 PS) Z 22 SE	01.2002→10.2008		7.22630.28.0	AGR	EL	→11293531
2.2 DTI 16V 92 kW (125 PS) Y 22 DTR	04.2002→10.2008		7.24809.29.0	AGR	ET	
3.0 CDTi 135 kW (184 PS) Z 30 DT	08.2005→07.2008		7.11190.04.0	DDS		
3.2 V6 155 kW (211 PS) Z 32 SE	06.2003→07.2008		7.02604.08.0	LS	350 mm	vor Katalysator, nach Katalysator in front of the catalyst, Post-catalyst
			7.05271.81.0	LS	210 mm	





VECTRA Mk II (C) Estate (Z02) 70

1.8 103 kW (140 PS) Z 18 XER	01.2006→07.2008		7.04879.00.0	AGR-TH		 Öffnungstemperatur/opening temperature 105C
1.8 16V 87-92 kW (118-125 PS) Z 18 XE	10.2003→08.2005		7.24809.10.0	AGR	EL	→ch. 20AN8144
1.9 CDTi 88 kW (120 PS) Z 19 DT	04.2004→07.2008		7.22946.38.0	AGR	EL	
			7.08369.05.0	ATS	EL	Fahrgestellnummer ab: 51065674, 58 Vehicle Identification Number from: 51065674, 58 nach Rußpartikelfilter after soot particulate filter ohne Zubehör without accessories Fahrgestellnummer bis: 48999999, 71021891 Vehicle Identification Number to: 48999999, 71021891 für OE-Nummer: 71021892, 78 for OE number: 71021892, 78
			7.08369.38.0	ATS	EL	
			7.11190.03.0	DDS		
7.11190.04.0	DDS					
1.9 CDTi 16V 110 kW (150 PS) Z 19 DTH	04.2004→05.2009		7.00063.10.0	AGR	EL	
			7.08369.05.0	ATS	EL	Fahrgestellnummer ab: 51065674, 58 Vehicle Identification Number from: 51065674, 58 nach Rußpartikelfilter after soot particulate filter ohne Zubehör without accessories Fahrgestellnummer bis: 48999999, 71021891 Vehicle Identification Number to: 48999999, 71021891 Fahrgestellnummer ab: 71021892, 78 Vehicle Identification Number from: 71021892, 78
			7.08369.38.0	ATS	EL	
			7.11190.03.0	DDS		
7.11190.04.0	DDS					
2.0 16V Turbo 129 kW (175 PS) Z 20 NET	10.2003→07.2008		7.05270.27.0	LS	400 mm	→ch. 41039263
2.0 DTI 16V 74 kW (101 PS) Y 20 DTH	10.2003→07.2008		7.24809.29.0	AGR	ET	
2.2 DTI 16V 92 kW (125 PS) Y 22 DTR	10.2003→07.2008		7.24809.29.0	AGR	ET	

























VECTRA Mk II (C) Estate (Z02) 70

2.8 V6 Turbo 169 kW (230 PS) Z 28 NEL	08.2005→05.2009		7.02604.08.0	LS	350 mm	
2.8 V6 Turbo 184-206 kW (250-280 PS) Z 28 NET	08.2006→05.2009		7.02604.08.0	LS	350 mm	
3.0 CDTi 135 kW (184 PS) Z 30 DT	08.2005→07.2008		7.11190.04.0	DDS		
3.2 V6 155 kW (211 PS) Z 32 SE	10.2003→08.2005		7.02604.08.0	LS	350 mm	
			7.05271.81.0	LS	210 mm	vor Katalysator, nach Katalysator in front of the catalyst, Post-catalyst

VECTRA Mk II (C) GTS (Z02) 71

1.8 103 kW (140 PS) Z 18 XER	01.2006→07.2008		7.04879.00.0	AGR-TH		 Öffnungstemperatur/opening temperature 105C
1.8 16V 87-92 kW (118-125 PS) Z 18 XE	08.2002→07.2008		7.24809.10.0	AGR	EL	  →ch. 20AN8144
1.8 16V Dualfuel 87-92 kW (118-125 PS) Z 18 XE	08.2002→07.2008		7.24809.10.0	AGR	EL	  →ch. 20AN8144
1.9 CDTI 88 kW (120 PS) Z 19 DT	08.2002→07.2008		7.22946.38.0	AGR	EL	
			7.08369.05.0	ATS	EL	
			7.08369.38.0	ATS	EL	Fahrgestellnummer ab: 51065674, 58 Vehicle Identification Number from: 51065674, 58 nach Rußpartikelfilter after soot particulate filter
			7.11190.03.0	DDS		ohne Zubehör without accessories Fahrgestellnummer bis: 48999999, 71021891 Vehicle Identification Number to: 48999999, 71021891
1.9 CDTI 16V 110 kW (150 PS) Z 19 DTH	04.2004→07.2008		7.11190.04.0	DDS		Fahrgestellnummer ab: 71021892, 78 Vehicle Identification Number from: 71021892, 78
			7.00063.10.0	AGR	EL	
			7.08369.05.0	ATS	EL	
			7.08369.38.0	ATS	EL	Fahrgestellnummer ab: 51065674, 58 Vehicle Identification Number from: 51065674, 58 nach Rußpartikelfilter after soot particulate filter
2.0 16V Turbo 129 kW (175 PS) Z 20 NET	03.2003→07.2008		7.11190.03.0	DDS		ohne Zubehör without accessories Fahrgestellnummer bis: 48999999, 71021891 Vehicle Identification Number to: 48999999, 71021891
			7.11190.04.0	DDS		Fahrgestellnummer ab: 71021892, 78 Vehicle Identification Number from: 71021892, 78
			7.05270.27.0	LS	400 mm	 →ch. 41039263
2.0 DTI 16V 74 kW (101 PS) Y 20 DTH	08.2002→07.2008		7.24809.29.0	AGR	ET	
2.2 16V 106-108 kW (144-147 PS) Z 22 SE	08.2002→07.2008		7.22630.28.0	AGR	EL	 →11293531
2.2 DTI 16V 92 kW (125 PS) Y 22 DTR	08.2002→07.2008		7.24809.29.0	AGR	ET	

V

VECTRA Mk II (C) GTS (Z02)						71
2.8 V6 Turbo 169 kW (230 PS) Z 28 NEL	08.2005→05.2009		7.02604.08.0	LS	350 mm	
2.8 V6 Turbo 184-206 kW (250-280 PS) Z 28 NET	08.2005→08.2006		7.02604.08.0	LS	350 mm	
2.8 V6 Turbo 184-206 kW (250-280 PS) Z 28 NET	02.2006→05.2009		7.02604.08.0	LS	350 mm	
3.0 CDTi 135 kW (184 PS) Z 30 DT	08.2005→07.2008		7.11190.04.0	DDS		
3.2 V6 155 kW (211 PS) Z 32 SE	08.2002→07.2008		7.02604.08.0	LS	350 mm	
			7.05271.81.0	LS	210 mm	vor Katalysator, nach Katalysator in front of the catalyst, Post-catalyst
VX220 Convertible (E01)						72
2.0 VXR 140-162 kW (190-220 PS) Z 20 LET	10.2003→07.2005		7.02604.07.0	LS	570 mm	vor Katalysator in front of the catalyst
2.0 i Turbo 140-162 kW (190-220 PS) Z 20 LET	03.2001→07.2005		7.02604.07.0	LS	570 mm	vorne Front
2.2 i 106-108 kW (144-147 PS) Z 22 SE	09.2000→07.2005		7.05270.29.0	LS	630 mm	
			7.05270.30.0	LS	1275 mm	
ZAFIRA A (T98)						73
1.6 16V 63-74 kW (85-101 PS) Z 16 XE	04.1999→08.2005		7.24809.10.0	AGR	EL	→ch. 42999999
			7.05270.25.0	LS	800 mm	→ch. 12999999 Diagnosesonde Diagnostic Probe
			7.05270.26.0	LS	300 mm	
1.6 16V 74 kW (101 PS) X 16 XEL	04.1999→08.2005		7.05270.26.0	LS	300 mm	
1.6 CNG 69-74 kW (94-101 PS) Z 16 YNG	09.2001→06.2005		7.24809.10.0	AGR	EL	→ch. 48030275
			7.05270.25.0	LS	800 mm	
			7.05271.76.0	LS	630 mm	
			7.05270.26.0	LS	300 mm	
1.8 16V 85 kW (116 PS) X 18 XE1	05.1999→08.2000		7.24809.10.0	AGR	EL	
			7.05270.32.0	LS	825 mm	
1.8 16V 87-92 kW (118-125 PS) Z 18 XE	09.2000→08.2005		7.05271.55.0	LS	800 mm	
2.0 140-162 kW (190-220 PS) Z 20 LET	06.2002→06.2005		7.02604.07.0	LS	570 mm	vor Katalysator in front of the catalyst
2.0 DI 16V 60 kW (82 PS) X 20 DTL	10.1999→08.2005		7.24809.24.0*	AGR	PN	mit Saugrohr with suction pipe
			↳ 7.24809.27.0	AGR	PN	 für Hersteller-Abgasnorm: NC8 for manufacturer exhaust norm: NC8
			7.24809.25.0*	AGR	PN	mit Saugrohr with suction pipe
						 96 EEC, D3 96 EEC, D3







V



ZAFIRA A (T98) 73

2.0 DTI 16V 74 kW (101 PS) Y 20 DTH	04.1999→08.2005	↳ 7.24809.28.0	AGR	PN	mit Saugrohr with suction pipe  →ch. 25999999
		7.24809.25.0*	AGR	PN	
2.0 GSI Turbo 140-162 kW (190-220 PS) Z 20 LET	09.2001→06.2005	↳ 7.24809.28.0	AGR	PN	vor Katalysator in front of the catalyst
		7.24809.29.0	AGR	ET	
2.2 16V 106-108 kW (144-147 PS) Z 22 SE	11.1998→08.2004	7.02604.07.0	LS	570 mm	→11292859
		7.22630.28.0	AGR	EL	
		7.05270.29.0	LS	630 mm	
		7.05270.30.0	LS	1275 mm	







ZAFIRA Mk II (B) (A05) 74

1.6 74-77 kW (101-105 PS) Z 16 XE1, Z 16 XEP	07.2005→11.2014	7.28384.13.0	AGR	EL	
		7.04879.00.0	AGR-TH		Öffnungstemperatur/opening temperature 105C
		7.02604.05.0	LS	550 mm	Z 16 XE1, Z 16 XEP:  →20HH5427 vor Katalysator in front of the catalyst
1.6 85 kW (116 PS) A 16 XER, Z 16 XER	12.2007→11.2014	7.04879.00.0	AGR-TH		Öffnungstemperatur/opening temperature 105C
1.7 CDTI 92 kW (125 PS) A 17 DTR	01.2008→11.2014	7.10334.08.0	AGR	EL	
		7.08369.49.0	ATS	EL	
		7.08369.75.0	ATS	EL	
		7.11190.04.0	DDS		
1.7 CDTI 81 kW (110 PS) A 17 DTJ	04.2009→11.2014	7.10334.08.0	AGR	EL	
		7.08369.49.0	ATS	EL	
		7.08369.75.0	ATS	EL	
		7.11190.04.0	DDS		
1.7 CDTI 81 kW (110 PS) Z 17 DTJ	04.2009→11.2014	7.10334.08.0	AGR	EL	
		7.08369.49.0	ATS	EL	
		7.08369.74.0	ATS	EL	
		7.11190.04.0	DDS		
1.8 103 kW (140 PS) A 18 XER, Z 18 XER	04.2005→11.2014	7.04879.00.0	AGR-TH		Öffnungstemperatur/opening temperature 105C
1.8 85-88 kW (116-120 PS) A 18 XEL	04.2013→11.2014	7.04879.00.0	AGR-TH		Öffnungstemperatur/opening temperature 105C
1.9 CDTI 88 kW (120 PS) Z 19 DT	07.2005→11.2014	7.22946.38.0	AGR	EL	
		7.08369.05.0	ATS	EL	
		7.08369.32.0	ATS	EL	
		7.11190.03.0	DDS		ohne Zubehör without accessories Fahrgestellnummer bis: 62167884, 6G119243 Vehicle Identification Number to: 62167884, 6G119243

















V





































ZAFIRA Mk II (B) (A05) 74

			7.11190.04.0	DDS		Fahrgestellnummer ab: 62127885, 6G119244 Vehicle Identification Number from: 62127885, 6G119244
1.9 CDTi 110 kW (150 PS) Z 19 DTH	07.2005→11.2014		7.00063.10.0	AGR	EL	ohne Zubehör without accessories Fahrgestellnummer bis: 62167884, 6G119243 Vehicle Identification Number to: 62167884, 6G119243 Fahrgestellnummer ab: 62127885, 6G119244 Vehicle Identification Number from: 62127885, 6G119244
			7.08369.05.0	ATS	EL	
			7.08369.32.0	ATS	EL	
			7.11190.03.0	DDS		
			7.11190.04.0	DDS		
2.0 147 kW (200 PS) Z 20 LER	07.2005→11.2014		7.02604.07.0	LS	570 mm	vor Katalysator in front of the catalyst
2.0 176-177 kW (240-241 PS) Z 20 LEH	01.2006→11.2014		7.02604.07.0	LS	570 mm	vor Katalysator in front of the catalyst
2.2 100-114 kW (136-155 PS) Z 22 YH	07.2005→11.2014		7.02604.08.0	LS	350 mm	

ZAFIRA Mk III (P12) 75

1.6 CDTi (75) 88-100 kW (120-136 PS) B 16 DTH	03.2013→08.2018		7.24809.81.0	AGR	EL	 B 16 DTH:  ch. F1000001→ch. F1999999 für RPO Nummer: WM3 für RPO number: WM3  B 16 DTH:  ch. F2000001→ch. F2999999 für RPO Nummer: WM3 für RPO number: WM3  B 16 DTH:  ch. G1000001→ Fahrgestellnummer ab: E2000001, F1000001 Vehicle Identification Number from: E2000001, F1000001
			7.11020.42.0	ATS	EL	
			7.11020.27.0	ATS	EL	
1.6 CDTi (75) 88-100 kW (120-136 PS) B 16 DTH	10.2016→08.2018		7.24809.81.0	AGR	EL	 B 16 DTH:  ch. F1000001→ch. F1999999 für RPO Nummer: WM3 für RPO number: WM3  B 16 DTH:  ch. F2000001→ch. F2999999 für RPO Nummer: WM3 für RPO number: WM3 Fahrgestellnummer ab: E2000001, F1000001 Vehicle Identification Number from: E2000001, F1000001
			7.11020.42.0	ATS	EL	
			7.11020.27.0	ATS	EL	
1.8 (75) 85-88 kW (116-120 PS) A 18 XEL	10.2011→08.2018		7.02604.07.0	LS	570 mm	vor Katalysator in front of the catalyst
1.8 (75) 103 kW (140 PS) A 18 XER	10.2011→08.2018		7.02604.07.0	LS	570 mm	vor Katalysator in front of the catalyst
2.0 BiTurbo CDTi (75) 140-143 kW (190-194 PS) A 20 DTR	11.2012→08.2018		7.24809.78.0	AGR	ET	
			7.11190.04.0	DDS		



			 PIERBURG		
ZAFIRA Mk III (P12)					75
2.0 CDTi (75) 81 kW (110 PS) A 20 DTL	10.2011→08.2018		7.24809.78.0	AGR	ET 
			7.08369.17.0	ATS	EL
			7.11190.04.0	DDS	
2.0 CDTi (75) 96 kW (131 PS) A 20 DT, Y 20 DTJ, Z 20 DTJ	10.2011→08.2018		7.24809.78.0	AGR	ET 
			7.08369.17.0	ATS	EL
			7.11190.04.0	DDS	
			7.02604.44.0	LS	500 mm  A 20 DT, Y 20 DTJ, Z 20 DTJ: vor Katalysator in front of the catalyst
2.0 CDTi (75) 118-121 kW (160-165 PS) A 20 DTH	10.2011→08.2018		7.24809.78.0	AGR	ET 
			7.08369.17.0	ATS	EL
			7.11190.04.0	DDS	
			7.02604.44.0	LS	500 mm vor Katalysator in front of the catalyst
2.0 CDTi (75) 125 kW (170 PS) B 20 DTH	01.2015→08.2018		7.24809.87.0	AGR	EL
ASTRAVAN Mk III (F) Estate Van (T92)					76
1.4 i (F70) 44 kW (60 PS) C 14 NZ	09.1991→08.1995		7.02604.15.0	LS	360 mm
1.6 i (F70) 55-61 kW (75-83 PS) C 16 NZ	10.1991→08.1998		7.02604.15.0	LS	360 mm
1.6 i (F70) 52 kW (71 PS) X 16 SZ	09.1994→08.1996		7.02604.15.0	LS	360 mm
ASTRAVAN Mk IV (G) Estate Van (T98)					77
1.4 16V 66 kW (90 PS) Z 14 XE	09.2000→05.2005		7.05271.76.0	LS	630 mm
1.6 Dualfuel 55 kW (75 PS) X 16 SZR	02.1998→12.2000		7.02604.15.0	LS	360 mm
1.6 Dualfuel 63-74 kW (85-101 PS) Z 16 XE	07.2000→08.2005		7.24809.10.0	AGR	EL 
			7.05271.76.0	LS	630 mm
1.6 Dualfuel 62-64 kW (84-87 PS) Z 16 SE	09.2000→10.2004		7.24809.10.0	AGR	EL 
1.6 Dualfuel 16V 74-77 kW (101-105 PS) Z 16 XEP	10.2004→12.2005		7.28384.13.0	AGR	EL 
1.6 i 55 kW (75 PS) X 16 SZR	08.1998→09.2000		7.24809.10.0	AGR	EL 
			7.02604.15.0	LS	360 mm
1.6 i 62-64 kW (84-87 PS) Z 16 SE	09.2000→08.2006		7.24809.10.0	AGR	EL 
			7.05270.26.0	LS	300 mm  ch. 22000001→ Diagnosesonde Diagnostic Probe
1.7 DTI 16V 55 kW (75 PS) Y 17 DT	04.2001→08.2006		7.22772.12.0	AGR	PN 
2.0 DI 60 kW (82 PS) X 20 DTL	08.1998→08.2006		7.24809.24.0*	AGR	PN mit Saugrohr with suction pipe  für Hersteller-Abgasnorm: NC8 for manufacturer exhaust norm: NC8
			↳ 7.24809.27.0	AGR	PN











V



ASTRAVAN Mk IV (G) Estate Van (T98) 77

			7.24809.25.0*	AGR	PN	mit Saugrohr with suction pipe ○ 96 EEC, D3 96 EEC, D3
2.0 DTi 74 kW (101 PS) Y 20 DTH	04.2004→08.2006		↳7.24809.28.0	AGR	PN	
			7.24809.25.0*	AGR	PN	mit Saugrohr with suction pipe ○ →ch. 22999999
			↳7.24809.28.0	AGR	PN	
			7.24809.29.0	AGR	ET	○

ASTRAVAN Mk V (H) Estate Van (A04) 78

1.3 CDTi 66-74 kW (90-101 PS) Z 13 DTH	08.2005→		7.00020.25.0	AGR	EL	○
			7.08369.15.0	ATS	EL	
1.4 i 66 kW (90 PS) Z 14 XEP	03.2005→		7.22875.16.0	AGR	EL	○
			7.22875.13.0	AGR	EL	○
			7.02604.07.0	LS	570 mm	→12.2005 vor Katalysator in front of the catalyst
			7.02604.08.0	LS	350 mm	Regelsonde, Diagnosesonde Regulating Probe, Diagnostic Probe
			7.05271.81.0	LS	210 mm	nach Katalysator Post-catalyst
1.6 74-77 kW (101-105 PS) Z 16 XEP	03.2005→		7.28384.13.0	AGR	EL	○
			7.04879.00.0	AGR-TH		○ Öffnungstemperatur/opening temperature 105C
			7.02604.05.0	LS	550 mm	für OE-Nummer: 8 55 510, 93174519 for OE number: 8 55 510, 93174519
1.6 77 kW (105 PS) Z 16 XE1	03.2005→		7.04879.00.0	AGR-TH		○ Öffnungstemperatur/opening temperature 105C
			7.02604.05.0	LS	550 mm	für OE-Nummer: 8 55 510, 93174519 for OE number: 8 55 510, 93174519
1.7 CDTi 81 kW (110 PS) A 17 DTJ	06.2011→12.2013		7.08369.75.0	ATS	EL	
1.7 CDTi 81 kW (110 PS) Z 17 DTJ	06.2011→12.2013		7.08369.74.0	ATS	EL	
1.7 CDTi 92 kW (125 PS) A 17 DTR	11.2011→		7.08369.75.0	ATS	EL	
1.7 CDTi 92 kW (125 PS) Z 17 DTR	11.2011→		7.08369.74.0	ATS	EL	
1.9 CDTi 88 kW (120 PS) Z 19 DT	03.2005→11.2011		7.22946.38.0	AGR	EL	○
			7.08369.05.0	ATS	EL	
			7.08369.32.0	ATS	EL	
			7.11190.03.0	DDS		ohne Zubehör without accessories Fahrgestellnummer bis: 62167207, 65165230, 68124718 Vehicle Identification Number to: 62167207, 65165230, 68124718
1.9 CDTi 110 kW (150 PS) Z 19 DTH	03.2005→11.2011		7.00063.10.0	AGR	EL	○
			7.08369.05.0	ATS	EL	





























ASTRAVAN Mk V (H) Estate Van (A04) 78

			7.08369.32.0	ATS	EL	ohne Zubehör without accessories Fahrgestellnummer bis: 62167207, 65165230, 68124718 Vehicle Identification Number to: 62167207, 65165230, 68124718
			7.11190.03.0	DDS		









COMBO Mk I (B) (S93) 79

1.4 40-44 kW (54-60 PS) C 14 NZ, X 14 SZ	07.1994→10.2001		7.02604.01.0	LS	200 mm	
1.4 16V 66 kW (90 PS) X 14 XE	08.1999→10.2001		7.22296.02.0	ARV	PN	

COMBO Mk II (C) Box Body/MPV (F25) 80









































1.3 CDTi 16V 51-55 kW (69-75 PS) Z 13 DTJ	10.2005→11.2011		7.00020.24.0	AGR	EL	
			7.08369.15.0	ATS	EL	
1.4 16V 66 kW (90 PS) Z 14 XE	10.2001→05.2007		7.24809.10.0	AGR	EL	  →ch. 43999999
1.4 i 16V 66 kW (90 PS) Z 14 XEP	01.2004→11.2011		7.22875.13.0	AGR	EL	
			7.22875.16.0	AGR	EL	
1.6 62-64 kW (84-87 PS) Z 16 SE	09.2001→10.2004		7.24809.10.0	AGR	EL	  →ch. 46999999
1.6 62-64 kW (84-87 PS) Z 16 SE	10.2001→11.2011		7.24809.10.0	AGR	EL	  →ch. 46999999
1.7 DI 16V 48 kW (65 PS) Y 17 DTL	09.2001→11.2011		7.22772.11.0	AGR	PN	mit Potentiometer with potentiometer   ch. 00782974→
			7.22772.12.0	AGR	PN	  →ch. 00782973
1.7 DTi 16V 55 kW (75 PS) Y 17 DT	10.2001→11.2011		7.22772.11.0	AGR	PN	mit Potentiometer with potentiometer   ch. 00782974→
			7.22772.12.0	AGR	PN	  →ch. 00782973

COMBO Mk III (D) Box Body/MPV (X12) 81

































1.3 CDTi 55-70 kW (75-90 PS) A 13 FD	11.2011→		7.04589.06.0	AGR	EL	 03.2016→ Euro 6 Euro 6
			7.03622.10.0	AGR-K	EL	 Euro 5 Euro 5 mit AGR-Ventil with EGR valve
			7.11190.03.0	DDS		ohne Zubehör without accessories
1.3 CDTi 55-70 kW (75-90 PS) A 13 FD	03.2016→		7.04589.06.0	AGR	EL	
1.6 CDTi 66-88 kW (90-120 PS) A 16 FDL	11.2011→		7.24809.77.0	AGR	ET	
			7.11020.41.0	ATS	EL	ohne Zubehör without accessories
			7.11190.03.0	DDS		
1.6 CDTi 74-77 kW (101-105 PS) A 16 FDH	11.2011→		7.24809.77.0	AGR	ET	
			7.11020.41.0	ATS	EL	ohne Zubehör without accessories
			7.11190.03.0	DDS		

V

COMBO Mk III (D) Box Body/MPV (X12)					81
1.6 CDTi 74-77 kW (101-105 PS) A 16 FDH	11.2011→		7.24809.77.0	AGR	ET
			7.11020.41.0	ATS	EL
			7.11190.03.0	DDS	ohne Zubehör without accessories
2.0 CDTi 99 kW (135 PS) A 20 FD	11.2011→		7.24809.77.0	AGR	ET
			7.11020.41.0	ATS	EL
			7.11190.03.0	DDS	ohne Zubehör without accessories
COMBO Mk IV (E) Box Body/MPV					82
1.5 D 75 kW (102 PS) D 15 DT (DV5RD)	08.2018→		7.07794.23.0	AGR	EL mit Dichtring with O-ring
1.5 D 88-96 kW (120-131 PS) D 15 DTH (DV5RC)	08.2018→		7.07794.23.0	AGR	EL mit Dichtring with O-ring
CORSAVAN Mk I (B) Hatchback Van (S93)					83
1.4 i 44 kW (60 PS) C 14 NZ	01.1994→09.2000		7.02604.15.0	LS	360 mm C 14 NZ: ch. T4→ch. T4 C 14 NZ: ch. T6→ch. T6 C 14 NZ: ch. T3→ch. T3
CORSAVAN Mk II (C) Hatchback Van (X01)					84
1.2 16V (F08) 55 kW (75 PS) Z 12 XE	09.2000→06.2006		7.22875.13.0	AGR	EL →ch. 24999999
			7.02604.07.0	LS	570 mm vor Katalysator in front of the catalyst
1.2 16V (F08) 59 kW (80 PS) Z 12 XEP	07.2004→11.2006		7.22875.16.0	AGR	EL
			7.22875.13.0	AGR	EL →ch. 43999999
			7.02604.07.0	LS	570 mm vor Katalysator in front of the catalyst
1.2 16V Dualfuel (F08) 55 kW (75 PS) Z 12 XE	08.2001→06.2006		7.22875.13.0	AGR	EL →ch. 24999999
			7.02604.07.0	LS	570 mm vor Katalysator in front of the catalyst
1.2 16V Dualfuel (F08) 59 kW (80 PS) Z 12 XEP	07.2004→12.2005		7.22875.16.0	AGR	EL
			7.22875.13.0	AGR	EL →ch. 43999999
1.3 CDTi 16V (F08) 51-52 kW (70-71 PS) Z 13 DT	04.2004→06.2006		7.00020.24.0	AGR	EL
1.4 (F08) 66 kW (90 PS) Z 14 XEP	11.2003→06.2006		7.22875.16.0	AGR	EL ch. 53000001→
			7.22875.13.0	AGR	EL →ch. 43999999
			7.02604.07.0	LS	570 mm →12.2005 vor Katalysator in front of the catalyst
			7.02604.08.0	LS	350 mm Diagnosesonde Diagnostic Probe
1.7 DI 16V (F08) 48 kW (65 PS) Y 17 DTL	09.2000→06.2006		7.22772.12.0	AGR	PN
1.7 DTi 16V (F08) 55 kW (75 PS) Y 17 DT	09.2000→06.2006		7.22772.12.0	AGR	PN

			 PIERBURG			
CORSAVAN Mk III (D) Hatchback Van (S07)						
85						
1.2 59 kW (80 PS) Z 12 XEP	07.2009→		7.22875.16.0	AGR	EL 	
1.3 CDTI 70 kW (95 PS) A 13 DTE, A 13 DTR, Z 13 DTE	07.2006→		7.01599.10.0	AGR	EL 	
			7.03622.10.0	AGR-K	EL   A 13 DTE, A 13 DTR, Z 13 DTE: mit AGR-Ventil with EGR valve	
			7.03622.09.0	AGR-K	  A 13 DTE, A 13 DTR, Z 13 DTE:  ch. C4000001→ ohne AGR-Ventil without EGR valve	
			7.03622.06.0	AGR-K	  A 13 DTE, A 13 DTR, Z 13 DTE:  ch. C6000001→ ohne AGR-Ventil without EGR valve	
7.08369.46.0	ATS	EL	7.08369.46.0	ATS	EL	
1.3 CDTI 51-55 kW (69-75 PS) Z 13 DTJ	07.2006→		7.00020.24.0	AGR	EL 	
1.3 CDTI 55 kW (75 PS) A 13 DTC	07.2006→		7.01599.10.0	AGR	EL 	
			7.03622.10.0	AGR-K	EL  mit AGR-Ventil with EGR valve	
			7.03622.09.0	AGR-K	  A 13 DTC:  ch. C4000001→ ohne AGR-Ventil without EGR valve	
			7.03622.06.0	AGR-K	  A 13 DTC:  ch. C6000001→ ohne AGR-Ventil without EGR valve	
7.08369.67.0	ATS	EL	7.08369.67.0	ATS	EL	
1.3 CDTI 66-74 kW (90-101 PS) Z 13 DTH	07.2006→		7.03622.10.0	AGR-K	EL 	
			7.08369.67.0	ATS	EL	
CORSAVAN Mk IV (E) Hatchback Van (X15)						
86						
1.3 CDTi 55 kW (75 PS) B 13 DTC, B 13 DTN	10.2014→		7.05031.06.0	AGR-M	EL 	
1.3 CDTi 70 kW (95 PS) B 13 DTE, B 13 DTR	10.2014→		7.05031.06.0	AGR-M	EL 	
MOVANO Mk I (A) Chassis/Cab (X70)						
87						
2.2 DTI (UD0) 66 kW (90 PS) G9T 720, G9T 722, G9T 750	09.2000→05.2010		7.22818.59.0	AGR	EL  Durchmesser Ventilteller/diameter valve head 30 mm	
2.5 CDTI (ED, UD0) 74-107 kW (101-146 PS) G9U 632, G9U 650	08.2006→05.2010		7.02604.44.0	LS	500 mm	 G9U 632, G9U 650: Abgaskrümmer Exhaust Manifold
2.5 DTI (ED, UD0) 84-85 kW (115-116 PS) G9U 720, G9U 750	01.2001→12.2006		7.22818.59.0	AGR	EL  Durchmesser Ventilteller/diameter valve head 30 mm	





V

						
MOVANO Mk I (A) Combi (X70)						88
1.9 DTI (JD) 60 kW (82 PS) F9Q 774	10.2001→05.2010		7.22818.57.0	AGR	EL 	
2.2 DTI (JD) 66 kW (90 PS) G9T 720, G9T 722, G9T 750	09.2000→05.2010		7.22818.59.0	AGR	EL  Durchmesser Ventilteller/diameter valve head 30 mm	
2.5 CDTI (JD) 74-107 kW (101-146 PS) G9U 632, G9U 650	02.2003→08.2009		7.02604.44.0	LS	500 mm  G9U 632, G9U 650: Abgaskrümmer Exhaust Manifold	
2.5 CDTI (JD) 88-107 kW (120-146 PS) G9U 632	08.2006→05.2010		7.02604.44.0	LS	500 mm Abgaskrümmer Exhaust Manifold	
2.5 DTI (JD) 84-85 kW (115-116 PS) G9U 720, G9U 750	10.2001→08.2009		7.22818.59.0	AGR	EL  Durchmesser Ventilteller/diameter valve head 30 mm	
MOVANO Mk I (A) Van (X70)						89
1.9 DTI (FD) 60 kW (82 PS) F9Q 774	10.2001→05.2010		7.22818.57.0	AGR	EL 	
2.2 DTI (FD) 66 kW (90 PS) G9T 720, G9T 722, G9T 750	09.2000→05.2010		7.22818.59.0	AGR	EL  Durchmesser Ventilteller/diameter valve head 30 mm	
2.5 CDTI (FD) 88-107 kW (120-146 PS) G9U 632	08.2006→05.2010		7.02604.44.0	LS	500 mm Abgaskrümmer Exhaust Manifold	
2.5 CDTI (FD) 74-107 kW (101-146 PS) G9U 632, G9U 650	08.2006→05.2010		7.02604.44.0	LS	500 mm  G9U 632, G9U 650: Abgaskrümmer Exhaust Manifold	
2.5 DTI (FD) 84-85 kW (115-116 PS) G9U 720	10.2001→05.2010		7.22818.59.0	AGR	EL  Durchmesser Ventilteller/diameter valve head 30 mm	
MOVANO Mk II (B) Chassis/Cab (X62)						90
2.3 CDTI FWD (UV, HV) 100-120 kW (136-163 PS) M9T 702	05.2014→		7.11190.08.0	DDS	Produktionsdatum bis: 09.09.2018 Production date to: 09.09.2018	
2.3 CDTI FWD (UV, HV) 107-125 kW (145-170 PS) M9T 706	11.2016→		7.11492.07.0	DDS	ohne Zubehör without accessories	
2.3 CDTI RWD (UV, HV) 100-120 kW (136-163 PS) M9T 700	05.2014→		7.11190.08.0	DDS	Produktionsdatum bis: 09.09.2018 Production date to: 09.09.2018	
2.3 CDTI RWD (UV, HV) 100-120 kW (136-163 PS) M9T 700	05.2014→		7.11190.08.0	DDS	Produktionsdatum bis: 09.09.2018 Production date to: 09.09.2018	
MOVANO Mk II (B) Combi (X62)						91
2.3 CDTI FWD (JV) 100-120 kW (136-163 PS) M9T 702	05.2014→		7.11190.08.0	DDS	Produktionsdatum bis: 09.09.2018 Production date to: 09.09.2018	
2.3 CDTI FWD (JV) 100-120 kW (136-163 PS) M9T 702	05.2014→		7.11190.08.0	DDS	Produktionsdatum bis: 09.09.2018 Production date to: 09.09.2018	
2.3 CDTI FWD (JV) 107-125 kW (145-170 PS) M9T 706	07.2015→		7.11492.07.0	DDS	ohne Zubehör without accessories	
MOVANO Mk II (B) VAN (X62)						92
2.3 CDTI FWD (FV) 100-120 kW (136-163 PS) M9T 702	05.2014→		7.11190.08.0	DDS	Produktionsdatum bis: 09.09.2018 Production date to: 09.09.2018	
2.3 CDTI FWD (FV) 100-120 kW (136-163 PS) M9T 700	05.2014→		7.11190.08.0	DDS	Produktionsdatum bis: 09.09.2018 Production date to: 09.09.2018	



























V



MOVANO Mk II (B) VAN (X62) 92

2.3 CDTI FWD (FV) 107-125 kW (145-170 PS) M9T 706	11.2016→		7.11492.07.0	DDS		ohne Zubehör without accessories
2.3 CDTI RWD (FV) 100-120 kW (136-163 PS) M9T 700	05.2014→		7.11190.08.0	DDS		Produktionsdatum bis: 09.09.2018 Production date to: 09.09.2018
2.3 CDTI RWD (FV) 100-120 kW (136-163 PS) M9T 700, M9T 702	05.2014→		7.11190.08.0	DDS		 M9T 700, M9T 702: Produktionsdatum bis: 09.09.2018 Production date to: 09.09.2018

VIVARO A Bus (X83) 93

1.9 DI 59-60 kW (80-82 PS) F9Q 762	08.2001→12.2006		7.22818.57.0	AGR	EL	
1.9 DTI 74 kW (101 PS) F9Q 760	08.2001→12.2006		7.22818.57.0	AGR	EL	
2.0 16V 88 kW (120 PS) F4R 720	08.2001→12.2006		7.02604.10.0	LS	560 mm	vor Katalysator, nach Katalysator in front of the catalyst, Post-catalyst
2.0 CDTI 66-84 kW (90-114 PS) M9R 630	01.2006→07.2014		7.10334.03.0	AGR	EL	
2.0 CDTI 66-84 kW (90-114 PS) M9R 780, M9R 782, M9R 786	01.2006→07.2014		7.10334.03.0	AGR	EL	 M9R 780, M9R 782: Produktionsdatum ab: 12.04.2010 Production date from: 12.04.2010  M9R 786: Produktionsdatum ab: 19.10.2010 Production date from: 19.10.2010
			7.10334.05.0	AGR	EL	 M9R 780, M9R 782:  C015660→ Produktionsdatum bis: 12.04.2010 Production date to: 12.04.2010  M9R 786: Produktionsdatum bis: 19.10.2010 Production date to: 19.10.2010
2.0 CDTI 66-84 kW (90-114 PS) M9R 630	08.2006→07.2014		7.10334.03.0	AGR	EL	
2.0 CDTI 66-84 kW (90-114 PS) M9R 780, M9R 784, M9R 786, M9R 788	08.2006→07.2014		7.10334.03.0	AGR	EL	 M9R 780, M9R 784: Produktionsdatum ab: 12.04.2010 Production date from: 12.04.2010  M9R 786, M9R 788: Produktionsdatum ab: 19.10.2010 Production date from: 19.10.2010
			7.10334.05.0	AGR	EL	 M9R 780, M9R 784:  C015660→ Produktionsdatum bis: 12.04.2010 Production date to: 12.04.2010  M9R 786, M9R 788: Produktionsdatum bis: 19.10.2010 Production date to: 19.10.2010
2.5 CDTI 84-107 kW (114-146 PS) G9U 630	01.2006→07.2014		7.02604.44.0	LS	500 mm	vor Katalysator in front of the catalyst
2.5 CDTI 84-107 kW (114-146 PS) G9U 630	08.2006→07.2014		7.02604.44.0	LS	500 mm	vor Katalysator in front of the catalyst
2.5 DTI 99 kW (135 PS) G9U 730	07.2003→07.2014		7.22818.59.0	AGR	EL	 Durchmesser Ventilteller/diameter valve head 30 mm
			7.22818.63.0	AGR	EL	 Durchmesser Ventilteller/diameter valve head 16 mm

V



VIVARO A Platform/Chassis (X83) 94

2.0 CDTI 66-84 kW (90-114 PS) M9R 630	01.2006→07.2014		7.10334.03.0	AGR	EL	
2.0 CDTI 66-84 kW (90-114 PS) M9R 780, M9R 782, M9R 786	01.2006→07.2014		7.10334.03.0	AGR	EL	M9R 780: für OE-Nummer: 12.04.2010 for OE number: 12.04.2010 M9R 782: Produktionsdatum ab: 12.04.2010 Production date from: 12.04.2010 M9R 786: Produktionsdatum ab: 19.10.2010 Production date from: 19.10.2010
			7.10334.05.0	AGR	EL	M9R 780, M9R 782: C015660→ Produktionsdatum bis: 12.04.2010 Production date to: 12.04.2010 M9R 786: Produktionsdatum bis: 19.10.2010 Production date to: 19.10.2010
2.0 CDTI 66-84 kW (90-114 PS) M9R 630	08.2006→07.2014		7.10334.03.0	AGR	EL	
2.0 CDTI 66-84 kW (90-114 PS) M9R 780, M9R 788	08.2006→07.2014		7.10334.03.0	AGR	EL	M9R 780, M9R 788: Produktionsdatum ab: 19.10.2010 Production date from: 19.10.2010
			7.10334.05.0	AGR	EL	M9R 780: C015660→ Produktionsdatum bis: 12.04.2010 Production date to: 12.04.2010 M9R 788: Produktionsdatum bis: 19.10.2010 Production date to: 19.10.2010
2.5 CDTI 99 kW (135 PS) G9U 730	04.2003→07.2006		7.22818.59.0	AGR	EL	Durchmesser Ventilteller/diameter valve head 30 mm
			7.22818.63.0	AGR	EL	Durchmesser Ventilteller/diameter valve head 16 mm
2.5 CDTI 84-107 kW (114-146 PS) G9U 630	08.2006→07.2014		7.02604.44.0	LS	500 mm	vor Katalysator in front of the catalyst
2.5 CDTI 84-107 kW (114-146 PS) G9U 630	08.2006→07.2014		7.02604.44.0	LS	500 mm	vor Katalysator in front of the catalyst









VIVARO A Van (X83) 95

1.9 DI 59-60 kW (80-82 PS) F9Q 762	08.2001→12.2006		7.22818.57.0	AGR	EL	
1.9 DTI 74 kW (101 PS) F9Q 760	08.2001→12.2006		7.22818.57.0	AGR	EL	
2.0 16V 88 kW (120 PS) F4R 720	08.2001→12.2006		7.02604.10.0	LS	560 mm	vor Katalysator, nach Katalysator in front of the catalyst, Post-catalyst
2.0 CDTI 66-84 kW (90-114 PS) M9R 630, M9R 692	01.2006→07.2014		7.10334.03.0	AGR	EL	Produktionsdatum ab: 01.06.2010 Production date from: 01.06.2010
2.0 CDTI 66-84 kW (90-114 PS) M9R 780, M9R 782, M9R 786	01.2006→07.2014		7.10334.03.0	AGR	EL	M9R 780, M9R 782, M9R 786: Produktionsdatum ab: 12.04.2010 Production date from: 12.04.2010
			7.10334.05.0	AGR	EL	M9R 780, M9R 782: C015660→ Produktionsdatum bis: 12.04.2010 Production date to: 12.04.2010 M9R 786: Produktionsdatum bis: 19.10.2010 Production date to: 19.10.2010













V







VIVARO A Van (X83) 95

2.0 CDTI 66-84 kW (90-114 PS) M9R 630, M9R 692	08.2006→07.2014	 7.10334.03.0	AGR	EL 	Produktionsdatum ab: 01.06.2010 Production date from: 01.06.2010
2.0 CDTI 66-84 kW (90-114 PS) M9R 780, M9R 788	08.2006→07.2014	 7.10334.03.0	AGR	EL 	M9R 780: Produktionsdatum ab: 12.04.2010 Production date from: 12.04.2010 M9R 788: Produktionsdatum ab: 19.10.2010 Production date from: 19.10.2010
2.5 CDTI 84-107 kW (114-146 PS) G9U 630	08.2006→07.2014	 7.02604.44.0	LS	500 mm	vor Katalysator in front of the catalyst
2.5 CDTI 84-107 kW (114-146 PS) G9U 630	08.2006→08.2008	 7.02604.44.0	LS	500 mm	vor Katalysator in front of the catalyst
2.5 DTI 99 kW (135 PS) G9U 730	07.2003→07.2014	 7.22818.59.0	AGR	EL 	Durchmesser Ventilteller/diameter valve head 30 mm







VIVARO B Bus (X82) 96

1.6 CDTI 70-89 kW (95-121 PS) R9M 415	01.2019→	 7.11457.07.0*	DDS		ab Euro 6 From Euro 6
		↳ 7.11492.07.0	DDS		
1.6 CDTi 66-85 kW (90-116 PS) R9M 408	05.2014→	 7.24809.90.0	AGR	EL 	→06.2015
			7.11190.08.0	DDS	
1.6 CDTi 66-85 kW (90-116 PS) R9M 408	05.2014→	 7.24809.90.0	AGR	EL 	→06.2015
			7.11190.08.0	DDS	
1.6 CDTi 85-107 kW (116-146 PS) R9M 450	05.2014→	 7.24809.90.0	AGR	EL 	→01.2019
			7.11190.08.0	DDS	
1.6 CDTi 85-107 kW (116-146 PS) R9M 450	06.2014→	 7.11190.08.0	DDS		
1.6 CDTi 85-107 kW (116-146 PS) R9M 450	08.2016→	 7.24809.90.0	AGR	EL 	→01.2019
			7.11190.08.0	DDS	
1.6 CDTi 70-89 kW (95-121 PS) R9M 413	08.2016→	 7.24809.90.0	AGR	EL 	→01.2019
			7.11457.07.0*	DDS	ab Euro 6 From Euro 6
			↳ 7.11492.07.0	DDS	
1.6 CDTi 70-89 kW (95-121 PS) R9M 415	01.2019→	 7.11457.07.0*	DDS		ab Euro 6 From Euro 6
			↳ 7.11492.07.0	DDS	

















VIVARO B Platform/Chassis (X82) 97

1.6 CDTI 85-107 kW (116-146 PS) R9M 450	08.2016→	 7.24809.90.0	AGR	EL 	→01.2019
		7.11190.08.0	DDS		
1.6 CDTi 66-85 kW (90-116 PS) R9M 408	05.2014→	 7.24809.90.0	AGR	EL 	→03.2016
			7.11190.08.0	DDS	

VIVARO B Platform/Chassis (X82) 97

1.6 CDTi 85-107 kW (116-146 PS) R9M 450	05.2014→		7.24809.90.0	AGR	EL	 →01.2019
			7.11190.08.0	DDS		
1.6 CDTi 85-107 kW (116-146 PS) R9M 450	05.2014→		7.24809.90.0	AGR	EL	 →01.2019
			7.11190.08.0	DDS		
1.6 CDTi 85-107 kW (116-146 PS) R9M 450	08.2016→		7.24809.90.0	AGR	EL	 →01.2019
			7.11190.08.0	DDS		



VIVARO B Van (X82) 98

1.6 CDTi 70-89 kW (95-121 PS) R9M 413, R9M 415	08.2016→		7.11457.07.0*	DDS		 R9M 413, R9M 415: ab Euro 6 From Euro 6
			↳7.11492.07.0	DDS		
1.6 CDTi 85-107 kW (116-146 PS) R9M 450	05.2014→		7.24809.90.0	AGR	EL	 →01.2019
			7.11190.08.0	DDS		
1.6 CDTi 66-85 kW (90-116 PS) R9M 408	05.2014→		7.24809.90.0	AGR	EL	 →03.2016
			7.11190.08.0	DDS		
1.6 CDTi 66-85 kW (90-116 PS) R9M 408	05.2014→		7.24809.90.0	AGR	EL	 →03.2016
			7.11190.08.0	DDS		
1.6 CDTi 85-107 kW (116-146 PS) R9M 450	05.2014→		7.24809.90.0	AGR	EL	 →01.2019
			7.11190.08.0	DDS		
1.6 CDTi 85-107 kW (116-146 PS) R9M 450	08.2016→		7.24809.90.0	AGR	EL	 →01.2019
			7.11190.08.0	DDS		
1.6 CDTi 85-107 kW (116-146 PS) R9M 450	08.2016→		7.24809.90.0	AGR	EL	 →01.2019
			7.11190.08.0	DDS		
1.6 CDTi 70-89 kW (95-121 PS) R9M 413	08.2016→		7.24809.90.0	AGR	EL	 →01.2019
			7.11457.07.0*	DDS		ab Euro 6 From Euro 6
			↳7.11492.07.0	DDS		
1.6 CDTi 70-89 kW (95-121 PS) R9M 415	01.2019→		7.11457.07.0*	DDS		ab Euro 6 From Euro 6
			↳7.11492.07.0	DDS		

VIVARO C Van (K0) 99

1.5 75 kW (102 PS) D 15 DT (DV5RUCD)	03.2019→		7.07794.23.0	AGR	EL	mit Dichtring with O-ring
1.5 88 kW (120 PS) D 15 DTH (DV5RUC)	03.2019→		7.07794.23.0	AGR	EL	mit Dichtring with O-ring





VIVARO LIFE Bus (K0) 100

1.5 88 kW (120 PS) D 15 DTH (DV5RUC)	03.2019→		7.07794.23.0	AGR	EL	mit Dichtring with O-ring
1.5 75 kW (102 PS) D 15 DT (DV5RUCD)	03.2019→		7.07794.23.0	AGR	EL	mit Dichtring with O-ring

















AMAROK (2HA, 2HB, S1B, S6B, S7A, S7B) **1**

2.0 BiTDI 120 kW (163 PS) CDCA	09.2010→08.2012		7.24809.93.0	AGR	EL	<input type="radio"/> Euro 5 Euro 5
			7.11237.06.0	AGR-K	EL	<input type="radio"/> Euro 5 Euro 5
			7.24809.99.0	AGR-K	EL	<input type="radio"/> Euro 4 Euro 4
			7.11020.19.0	ATS	EL	Euro 5 Euro 5
			7.11020.20.0	ATS	EL	Euro 5 Euro 5
			7.11492.00.0	DDS		ohne Zubehör without accessories Euro 5 Euro 5
2.0 BiTDI 132 kW (180 PS) CNEA	11.2011→		7.24809.93.0	AGR	EL	<input type="radio"/> Euro 5 Euro 5
			7.11237.06.0	AGR-K	EL	<input type="radio"/> →09.2016 Euro 5 Euro 5
			7.08369.59.0	ATS	EL	
			7.11020.19.0	ATS	EL	Euro 5 Euro 5
			7.11020.20.0	ATS	EL	Euro 5 Euro 5
			7.11492.00.0	DDS		ohne Zubehör without accessories Euro 5 Euro 5
2.0 BiTDI 132 kW (180 PS) CSHA	11.2011→		7.24809.93.0	AGR	EL	<input type="radio"/> Euro 5 Euro 5
			7.08369.59.0	ATS	EL	
			7.11020.19.0	ATS	EL	Euro 5 Euro 5
			7.11020.20.0	ATS	EL	Euro 5 Euro 5
			7.11492.00.0	DDS		ohne Zubehör without accessories Euro 5 Euro 5
2.0 BiTDI 4motion 120 kW (163 PS) CDCA	09.2010→08.2012		7.24809.93.0	AGR	EL	<input type="radio"/> Euro 5 Euro 5
			7.11237.06.0	AGR-K	EL	<input type="radio"/> Euro 5 Euro 5
			7.24809.99.0	AGR-K	EL	<input type="radio"/> Euro 4 Euro 4
			7.11020.19.0	ATS	EL	Euro 5 Euro 5
			7.11020.20.0	ATS	EL	Euro 5 Euro 5
			7.11492.00.0	DDS		ohne Zubehör without accessories Euro 5 Euro 5
2.0 BiTDI 4motion 132 kW (180 PS) CNEA	11.2011→		7.24809.93.0	AGR	EL	<input type="radio"/> →09.2016 Euro 5 Euro 5







AMAROK (2HA, 2HB, S1B, S6B, S7A, S7B) **1**

			<p>7.11237.06.0 AGR-K EL </p> <p>→09.2016 Euro 5 Euro 5</p> <p>7.08369.59.0 ATS EL</p> <p>7.11020.19.0 ATS EL Euro 5 Euro 5</p> <p>7.11020.20.0 ATS EL Euro 5 Euro 5</p> <p>7.11492.00.0 DDS ohne Zubehör without accessories Euro 5 Euro 5</p>
<p>2.0 BiTDI 4motion 132 kW (180 PS) CSHA</p>	11.2011→	 <p>7.24809.93.0 AGR EL </p> <p>→09.2016 Euro 5 Euro 5</p> <p>7.11020.19.0 ATS EL Euro 5 Euro 5</p> <p>7.11020.20.0 ATS EL Euro 5 Euro 5</p> <p>7.11492.00.0 DDS ohne Zubehör without accessories Euro 5 Euro 5</p>	
<p>2.0 TDI 90 kW (122 PS) CDBA</p>	09.2010→10.2013	 <p>7.11237.06.0 AGR-K EL </p> <p>→11.2012 Euro 5 Euro 5</p> <p>7.24809.99.0 AGR-K EL </p> <p>Euro 4 Euro 4</p> <p>7.11020.19.0 ATS EL Euro 5 Euro 5</p> <p>7.11020.20.0 ATS EL Euro 5 Euro 5</p> <p>7.11492.00.0 DDS ohne Zubehör without accessories Euro 5 Euro 5</p>	
<p>2.0 TDI 90 kW (122 PS) CNFA</p>	09.2010→10.2013	 <p>7.24809.93.0 AGR EL </p> <p>Euro 5 Euro 5</p> <p>7.08369.59.0 ATS EL</p> <p>7.11020.19.0 ATS EL</p> <p>7.11020.20.0 ATS EL</p> <p>7.11492.00.0 DDS ohne Zubehör without accessories Euro 5 Euro 5</p>	
<p>2.0 TDI 103 kW (140 PS) CNFB</p>	07.2012→10.2016	 <p>7.24809.93.0 AGR EL </p> <p>Euro 5 Euro 5</p> <p>7.08369.59.0 ATS EL</p> <p>7.11020.19.0 ATS EL Euro 5 Euro 5</p> <p>7.11020.20.0 ATS EL Euro 5 Euro 5</p> <p>7.11492.00.0 DDS ohne Zubehör without accessories Euro 5 Euro 5</p>	
<p>2.0 TDI 4motion 90 kW (122 PS) CDBA</p>	09.2010→10.2013	 <p>7.11237.06.0 AGR-K EL </p> <p>→11.2012 Euro 5 Euro 5</p>	













AMAROK (2HA, 2HB, S1B, S6B, S7A, S7B) **1**

			7.24809.99.0	AGR-K	EL	 Euro 4 Euro 4
			7.11020.19.0	ATS	EL	Euro 5 Euro 5
			7.11020.20.0	ATS	EL	Euro 5 Euro 5
			7.11492.00.0	DDS		ohne Zubehör without accessories Euro 5 Euro 5
2.0 TDI 4motion 90 kW (122 PS) CNFA	09.2010→10.2013		7.24809.93.0	AGR	EL	 Euro 5 Euro 5
			7.08369.59.0	ATS	EL	
			7.11020.19.0	ATS	EL	
			7.11020.20.0	ATS	EL	
			7.11492.00.0	DDS		ohne Zubehör without accessories Euro 5 Euro 5
2.0 TDI 4motion 103 kW (140 PS) CNFB	06.2012→10.2016		7.24809.93.0	AGR	EL	 Euro 5 Euro 5
			7.08369.59.0	ATS	EL	
			7.11020.19.0	ATS	EL	Euro 5 Euro 5
			7.11020.20.0	ATS	EL	Euro 5 Euro 5
			7.11492.00.0	DDS		ohne Zubehör without accessories Euro 5 Euro 5

AMEO (631) **2**

1.5 TDI 81 kW (110 PS) CWXC	08.2016→04.2020		7.09720.00.0	AGR-K	EL	
---------------------------------------	-----------------	---	---------------------	-------	----	---











ARTEON (3H7, 3H8) **3**

2.0 TDI 110 kW (150 PS) DBGA	03.2017→11.2019		7.10334.02.0	AGR	EL	
			7.03608.16.0	AK	EL	
			↳ 7.07696.00.0	SRM-AK	EL	
			7.08369.81.0	ATS	EL	
			7.11492.03.0	DDS		ohne Zubehör without accessories
2.0 TDI 110 kW (150 PS) DFGA	03.2017→11.2019		7.10334.02.0	AGR	EL	
			7.03608.16.0	AK	EL	
			↳ 7.07696.00.0	SRM-AK	EL	
			7.08369.81.0	ATS	EL	
			7.11492.05.0	DDS		ohne Zubehör without accessories Euro 6c Euro 6c
2.0 TDI 110 kW (150 PS) DSRB	03.2017→11.2019		7.03608.16.0	AK	EL	
2.0 TDI 140 kW (190 PS) DFHA	05.2017→06.2020		7.10334.02.0	AGR	EL	
			7.11020.26.0	ATS	EL	
			7.11492.05.0	DDS		ohne Zubehör without accessories
			7.07696.00.0	SRM-AK	EL	





























V



ARTEON (3H7, 3H8) 3

2.0 TDI 130 kW (177 PS) CRGA	11.2017→07.2020	 7.10334.02.0	AGR	EL	
2.0 TDI 4motion 176 kW (240 PS) CUAA	03.2017→07.2020	 7.10334.02.0	AGR	EL	
		 7.11492.03.0	DDS		ohne Zubehör without accessories für OE-Nummer: 03N 906 051 B for OE number: 03N 906 051 B
		 7.07696.00.0	SRM-AK	EL	
2.0 TDI 4motion 140 kW (190 PS) DFHA	05.2017→06.2020	 7.10334.02.0	AGR	EL	
		 7.11020.26.0	ATS	EL	ohne Zubehör without accessories Euro 6c Euro 6c
		 7.11492.05.0	DDS		

BEETLE (5C1, 5C2) 4

1.6 TDI 77 kW (105 PS) CAYC	10.2011→07.2016	 7.09720.00.0	AGR-K	EL		
		 7.08369.01.0	ATS	EL		
		 7.08369.04.0	ATS	EL		
		 7.11492.00.0	DDS			ohne Zubehör without accessories
1.8 TSI 125 kW (170 PS) CPKA, CPRA	12.2013→07.2017	 7.03635.37.0	SLP	EL		
		 7.01510.85.0	SLV	EL		 CPKA, CPRA: Produktionsdatum ab: 24.11.2015 Production date from: 24.11.2015
		 7.01510.86.0	SLV	EL		 CPKA, CPRA: Produktionsdatum bis: 23.11.2015 Production date to: 23.11.2015
2.0 TDI 103-104 kW (140-141 PS) CJAA	04.2011→07.2016	 7.01493.07.0	AGR	EL		
		 7.10334.00.0	AGR	EL		
		 7.01300.24.0	AK	EL	 Mexico, USA, Kanada, Südafrika  Mexico, USA, Canada, South Africa	
		 7.08369.01.0	ATS	EL	ohne Zubehör without accessories	
		 7.08369.47.0	ATS	EL		
		 7.11492.00.0	DDS			
2.0 TDI 103 kW (140 PS) CFFB	04.2012→07.2016	 7.09720.00.0	AGR-K	EL		
		 7.11190.09.0	DDS			
2.0 TDI 81 kW (110 PS) CUUA	06.2014→09.2018	 7.11492.03.0	DDS		ohne Zubehör without accessories	
		 7.07696.00.0	SRM-AK	EL		
2.0 TDI 110 kW (150 PS) CVCA	07.2014→03.2016	 7.08369.81.0	ATS	EL		
		 7.11492.03.0	DDS			ohne Zubehör without accessories
2.0 TDI 110 kW (150 PS) CUUB	12.2014→09.2018	 7.11492.03.0	DDS		ohne Zubehör without accessories	
		 7.07696.00.0	SRM-AK	EL		
2.0 TDI 110 kW (150 PS) DELA	06.2015→09.2018	 7.11492.03.0	DDS		ohne Zubehör without accessories	
2.0 TSI 147-157 kW (200-213 PS) CBFA	04.2011→07.2016	 7.01510.31.0	SLV	EL		
2.0 TSI 155 kW (211 PS) CPLA, CPPA	12.2013→07.2019	 7.03635.37.0	SLP	EL		

























BEETLE (5C1, 5C2) 4

			7.01510.85.0	SLV	EL	CPLA, CPPA: Produktionsdatum ab: 24.11.2015 Production date from: 24.11.2015
			7.01510.86.0	SLV	EL	CPLA, CPPA: Produktionsdatum bis: 23.11.2015 Production date to: 23.11.2015
2.0 TSI 130 kW (177 PS) DDSA	07.2017→07.2019		7.03635.37.0	SLP	EL	Produktionsdatum bis: 08.10.2018 Production date to: 08.10.2018
			7.03635.39.0	SLP	EL	
			7.01510.87.0	SLV	EL	

BEETLE Convertible (5C7, 5C8) 5











































1.6 TDI 77 kW (105 PS) CAYC	12.2011→07.2016		7.09720.00.0	AGR-K	EL	 ohne Zubehör without accessories
			7.08369.01.0	ATS	EL	
			7.08369.04.0	ATS	EL	
			7.11492.00.0	DDS		
1.8 TSI 125 kW (170 PS) CPKA, CPRA	12.2013→12.2016		7.03635.37.0	SLP	EL	CPKA, CPRA: Produktionsdatum ab: 17.11.2015 Production date from: 17.11.2015 CPKA, CPRA: Produktionsdatum bis: 16.11.2015 Production date to: 16.11.2015
			7.01510.85.0	SLV	EL	
			7.01510.86.0	SLV	EL	
2.0 TDI 103 kW (140 PS) CFFB	04.2012→07.2016		7.09720.00.0	AGR-K	EL	
			7.11190.09.0	DDS		
2.0 TDI 103-104 kW (140-141 PS) CJAA	04.2012→07.2016		7.01493.07.0	AGR	EL	 Mexico, USA, Kanada, Südafrika Mexico, USA, Canada, South Africa ohne Zubehör without accessories
			7.01300.24.0	AK	EL	
			7.08369.01.0	ATS	EL	
			7.08369.47.0	ATS	EL	
			7.11492.00.0	DDS		
2.0 TDI 81 kW (110 PS) CUUA	06.2014→09.2018		7.11492.03.0	DDS		ohne Zubehör without accessories
			7.07696.00.0	SRM-AK	EL	
2.0 TDI 110 kW (150 PS) CUUB	09.2014→09.2018		7.11492.03.0	DDS		ohne Zubehör without accessories
			7.07696.00.0	SRM-AK	EL	
2.0 TDI 110 kW (150 PS) CVCA, DELA	09.2014→09.2018		7.11492.03.0	DDS		ohne Zubehör without accessories
2.0 TSI 147-157 kW (200-213 PS) CBFA	12.2011→07.2016		7.01510.31.0	SLV	EL	
2.0 TSI 155 kW (211 PS) CPLA, CPPA	12.2012→07.2019		7.03635.37.0	SLP	EL	CPLA, CPPA: Produktionsdatum ab: 27.11.2015 Production date from: 27.11.2015 CPLA, CPPA: Produktionsdatum bis: 26.11.2015 Production date to: 26.11.2015
			7.01510.85.0	SLV	EL	
			7.01510.86.0	SLV	EL	
2.0 TSI 147-157 kW (200-213 PS) CBFA	01.2013→07.2016		7.01510.31.0	SLV	EL	
2.0 TSI 130 kW (177 PS) DDSA	07.2017→07.2019		7.03635.37.0	SLP	EL	

					
BEETLE Convertible (5C7, 5C8)					5
			7.03635.39.0	SLP	EL
			7.01510.87.0	SLV	EL
BORA					6
1.8 Turbo 132-142 kW (180-193 PS) AUQ	09.2010→		7.22769.73.0	ARV	PN →12.2015 " Mexico " Mexico
BORA I (1J2)					7
1.4 16V 55 kW (75 PS) APE	03.2000→05.2000		7.22785.17.0	AGR	EL
			7.05271.23.0	LS	900 mm
			7.05271.24.0	LS	1500 mm vor Katalysator in front of the catalyst
1.4 16V 55 kW (75 PS) BCA	03.2000→05.2005		7.28248.17.0	AGR	EL
			7.05271.23.0	LS	900 mm
			7.05271.24.0	LS	1500 mm vor Katalysator in front of the catalyst
1.4 16V 55 kW (75 PS) AHW	05.2000→05.2005		7.05271.03.0	LS	730 mm Regelsonde Regulating Probe
1.4 16V 55 kW (75 PS) AXP	05.2000→05.2005		7.22785.17.0	AGR	EL
			7.28248.17.0	AGR	EL
			7.05271.23.0	LS	900 mm
			7.05271.24.0	LS	1500 mm vor Katalysator in front of the catalyst
1.6 65-76 kW (100-103 PS) AEH, AKL	10.1998→05.2005		7.05271.04.0	LS	505 mm ⚠ AEH, AKL:  →ch. 1J-X-260 000
			7.05271.21.0	LS	1250 mm ⚠ AEH, AKL:  ch. 1J-X-260 001→ Regelsonde Regulating Probe
1.6 74 kW (101 PS) APF	10.1998→05.2005		7.22574.12.0	AGR	EL
			7.22286.41.0	ARV	PN
			7.05271.24.0	LS	1500 mm vor Katalysator in front of the catalyst
			7.22738.08.0	SLP	EL
1.6 75 kW (102 PS) AVU, BFQ	08.2000→05.2005		7.22574.12.0	AGR	EL
			7.05271.24.0	LS	1500 mm ⚠ AVU, BFQ: vor Katalysator in front of the catalyst
			7.22738.08.0	SLP	EL
			7.22778.96.0	SLV	PN
1.6 78 kW (107 PS) AWB	06.2002→10.2004		7.05271.03.0	LS	730 mm
1.6 16V 77 kW (105 PS) ATN, AUS	05.2000→05.2005		7.22785.17.0	AGR	EL
1.6 16V 77 kW (105 PS) BCB	05.2000→05.2005		7.28248.17.0	AGR	EL
1.6 16V 77 kW (105 PS) AZD	09.2000→05.2005		7.22785.17.0	AGR	EL →04.2001
			7.28248.17.0	AGR	EL 05.2001→
1.6 FSI 81 kW (110 PS) BAD	01.2002→05.2005		7.08369.34.0	ATS	EL
1.8 92 kW (125 PS) AGN	10.1998→05.2005		7.05271.03.0	LS	730 mm

V

























BORA I (1J2) **7**

1.8 92 kW (125 PS) BAF	10.1998→05.2005		7.22785.18.0	AGR	EL	 China  China
1.8 4motion 92 kW (125 PS) AGN	02.1999→05.2005		7.05271.03.0	LS	730 mm	
1.8 T 110 kW (150 PS) AGU	05.2000→05.2005		7.05271.03.0	LS	730 mm	Regelsonde Regulating Probe
1.8 T 110 kW (150 PS) AUM	05.2000→05.2005		7.22769.73.0	ARV	PN	
			7.05271.23.0	LS	900 mm	
			7.05271.24.0	LS	1500 mm	vor Katalysator in front of the catalyst
			7.21851.31.0	SLP	EL	
1.8 T 132-142 kW (180-193 PS) AUQ	03.2002→05.2005		7.22769.73.0	ARV	PN	
			7.05271.23.0	LS	900 mm	
			7.05271.24.0	LS	1500 mm	vor Katalysator in front of the catalyst
			7.21851.31.0	SLP	EL	
1.8 T 132 kW (180 PS) AWP	03.2002→05.2005		7.22769.73.0	ARV	PN	
			7.21851.31.0	SLP	EL	
1.9 SDI 50 kW (68 PS) AGP, AQM	10.1998→05.2005		7.22477.10.0	AGR	PN	
1.9 TDI 66-67 kW (90-91 PS) AGR, ALH	10.1998→05.2005		7.24809.17.0	AGR	PN	
1.9 TDI 81 kW (110 PS) AHF, ASV	10.1998→06.2001		7.24809.17.0	AGR	PN	
1.9 TDI 85 kW (115 PS) AJM, AUJ	12.1998→01.2002		7.24809.17.0	AGR	PN	
1.9 TDI 110 kW (150 PS) ARL	05.2000→05.2005		7.24809.26.0	AGR	PN	
1.9 TDI 74 kW (101 PS) ATD	09.2000→05.2005		7.24809.17.0	AGR	PN	
1.9 TDI 74 kW (101 PS) AXR	09.2000→05.2005		7.24809.16.0	AGR	PN	
1.9 TDI 96 kW (130 PS) ASZ	11.2000→05.2005		7.24809.26.0	AGR	PN	
1.9 TDI 4motion 66 kW (90 PS) AGR	11.1998→04.2002		7.24809.17.0	AGR	PN	
1.9 TDI 4motion 85 kW (115 PS) AJM, AUJ	02.1999→06.2001		7.24809.17.0	AGR	PN	
1.9 TDI 4motion 110 kW (150 PS) ARL	05.2000→05.2005		7.24809.26.0	AGR	PN	
1.9 TDI 4motion 74 kW (101 PS) ATD	09.2000→05.2005		7.24809.17.0	AGR	PN	
1.9 TDI 4motion 96 kW (130 PS) ASZ	11.2000→05.2005		7.24809.26.0	AGR	PN	
2.0 85 kW (116 PS) APK	10.1998→05.2000		7.05271.02.0	LS	500 mm	Diagnosesonde Diagnostic Probe
2.0 85 kW (115 PS) AQY	10.1998→05.2000		7.22286.26.0	ARV	PN	 →ch. 1J-1B073 000
			7.05271.02.0	LS	500 mm	Diagnosesonde Diagnostic Probe
			7.22738.08.0	SLP	EL	 ch. 1J-Y-000 001→
			7.21851.31.0	SLP	EL	 →ch. 1J-X-999 999

V













BORA I (1J2) 7







			7.22778.80.0	SLV	PN	 Fahrgestellnummer ab: 1J-1B073 001, 1J-1D231 001, 1J-1P136 001, 1J-1U044 001, 1J-1W269 001 Vehicle Identification Number from: 1J-1B073 001, 1J-1D231 001, 1J-1P136 001, 1J-1U044 001, 1J-1W269 001
			7.22778.96.0	SLV	PN	
2.0 85 kW (115 PS) AZJ	10.1998→12.2013		7.05270.98.0	LS	700 mm	nach Katalysator Post-catalyst
			7.05271.02.0	LS	500 mm	Diagnosesonde Diagnostic Probe
			7.05271.24.0	LS	1500 mm	vor Katalysator in front of the catalyst
			7.22738.08.0	SLP	EL	
			7.22778.80.0	SLV	PN	
			7.22778.96.0	SLV	PN	
2.0 85-86 kW (116-117 PS) BEV	10.1998→12.2013		7.22778.80.0	SLV	PN	 Fahrgestellnummer bis: 1Y-5-322 000 Vehicle Identification Number to: 1Y-5-322 000
2.0 85 kW (115 PS) AZG	04.2000→12.2013		7.05270.98.0	LS	700 mm	nach Katalysator Post-catalyst
			7.05271.24.0	LS	1500 mm	vor Katalysator in front of the catalyst
			7.22738.08.0	SLP	EL	
			7.22778.80.0	SLV	PN	 Mexico
			7.22778.80.0	SLV	PN	 Mexico
2.0 85 kW (115 PS) AZH	04.2000→06.2001		7.05270.99.0	LS	940 mm	Diagnosesonde Diagnostic Probe
			7.05271.24.0	LS	1500 mm	vor Katalysator in front of the catalyst
			7.22738.08.0	SLP	EL	
			7.22778.80.0	SLV	PN	
2.0 4motion 85 kW (115 PS) AZJ	04.2000→05.2005		7.05271.02.0	LS	500 mm	Diagnosesonde Diagnostic Probe
			7.05271.24.0	LS	1500 mm	vor Katalysator in front of the catalyst
			7.22738.08.0	SLP	EL	
			7.22778.80.0	SLV	PN	
			7.22778.96.0	SLV	PN	
2.0 4motion 85 kW (115 PS) AZH	02.2001→05.2005		7.05270.99.0	LS	940 mm	Diagnosesonde Diagnostic Probe
			7.05271.24.0	LS	1500 mm	vor Katalysator in front of the catalyst
			7.22738.08.0	SLP	EL	
			7.22778.80.0	SLV	PN	
			7.22778.80.0	SLV	PN	
2.3 V5 110 kW (150 PS) AGZ	10.1998→10.2000		7.22286.55.0	ARV	PN	
			7.05271.03.0	LS	730 mm	
2.3 V5 125 kW (170 PS) AQN	10.2000→05.2005		7.22286.55.0	ARV	PN	
			7.05271.01.0	LS	950 mm	
			7.05270.89.0	LS	925 mm	
			7.05271.23.0	LS	900 mm	
			7.05270.91.0	LS	350 mm	

















































BORA I (1J2) **7**

			7.05271.00.0	LS	1525 mm	
			7.05271.24.0	LS	1500 mm	vor Katalysator in front of the catalyst
			7.22738.08.0	SLP	EL	
2.3 V5 4motion 110 kW (150 PS) AGZ	12.1998→10.2000		7.22286.55.0	ARV	PN	
			7.05271.03.0	LS	730 mm	
2.3 V5 4motion 125 kW (170 PS) AQN	10.2000→05.2005		7.22286.55.0	ARV	PN	
			7.05271.01.0	LS	950 mm	
			7.05270.89.0	LS	925 mm	
			7.05271.23.0	LS	900 mm	
			7.05270.98.0	LS	700 mm	nach Katalysator, rechts Post-catalyst, Right
			7.05270.91.0	LS	350 mm	
			7.05271.00.0	LS	1525 mm	
			7.05271.24.0	LS	1500 mm	vor Katalysator in front of the catalyst
			7.22738.08.0	SLP	EL	
2.8 V6 4motion 150 kW (204 PS) BDE	03.1999→05.2005		7.22286.55.0	ARV	PN	
			7.05270.98.0	LS	700 mm	nach Katalysator, rechts Post-catalyst, Right
			7.05270.91.0	LS	350 mm	
			7.05271.00.0	LS	1525 mm	
			7.22738.08.0	SLP	EL	
2.8 V6 4motion 150 kW (204 PS) AQP, AUE	05.1999→05.2005		7.22286.55.0	ARV	PN	
			7.05270.98.0	LS	700 mm	 AQP, AUE: nach Katalysator, rechts Post-catalyst, Right
			7.05270.91.0	LS	350 mm	
			7.05271.00.0	LS	1525 mm	
			7.05271.24.0	LS	1500 mm	 AQP, AUE: vor Katalysator in front of the catalyst
			7.22738.08.0	SLP	EL	































BORA Variant (1J6) **8**

1.4 16V 55 kW (75 PS) AHW	09.2001→05.2005		7.05271.03.0	LS	730 mm	Regelsonde Regulating Probe
1.4 16V 55 kW (75 PS) AXP	09.2001→05.2005		7.22785.17.0	AGR	EL	
			7.28248.17.0	AGR	EL	
			7.05271.23.0	LS	900 mm	
			7.05271.24.0	LS	1500 mm	vor Katalysator in front of the catalyst
1.4 16V 55 kW (75 PS) BCA	09.2001→05.2005		7.28248.17.0	AGR	EL	
			7.05271.23.0	LS	900 mm	
			7.05271.24.0	LS	1500 mm	vor Katalysator in front of the catalyst

						
BORA Variant (1J6)						
1.6 65-76 kW (100-103 PS) AEH, AKL	05.1999→05.2005		7.05271.04.0	LS	505 mm	 AEH, AKL:  →ch. 1J-X-260 000
			7.05271.21.0	LS	1250 mm	 AEH, AKL:  ch. 1J-X-260 001→ Regelsonde Regulating Probe
1.6 74 kW (101 PS) APF	05.1999→09.2000		7.22574.12.0	AGR	EL	
			7.22286.41.0	ARV	PN	
			7.05271.24.0	LS	1500 mm	vor Katalysator in front of the catalyst
			7.22738.08.0	SLP	EL	
1.6 75 kW (102 PS) AVU, BFQ	08.2000→05.2005		7.22574.12.0	AGR	EL	
			7.05271.24.0	LS	1500 mm	 AVU, BFQ: vor Katalysator in front of the catalyst
			7.22738.08.0	SLP	EL	
			7.22778.96.0	SLV	PN	
1.6 16V 77 kW (105 PS) ATN, AUS	02.2000→10.2000		7.22785.17.0	AGR	EL	
1.6 16V 77 kW (105 PS) BCB	02.2000→05.2005		7.28248.17.0	AGR	EL	
1.6 16V 77 kW (105 PS) AZD	09.2000→05.2005		7.22785.17.0	AGR	EL	 →04.2001
			7.28248.17.0	AGR	EL	 05.2001→
1.6 FSI 81 kW (110 PS) BAD	01.2002→05.2005		7.08369.34.0	ATS	EL	
1.8 4motion 92 kW (125 PS) AGN	05.1999→05.2005		7.05271.03.0	LS	730 mm	
1.8 T 110 kW (150 PS) AGU	05.2000→05.2005		7.05271.03.0	LS	730 mm	Regelsonde Regulating Probe
			7.05271.24.0	LS	1500 mm	vor Katalysator in front of the catalyst
1.8 T 110 kW (150 PS) AUM	05.2000→05.2005		7.22769.73.0	ARV	PN	
			7.05271.23.0	LS	900 mm	
			7.21851.31.0	SLP	EL	
1.8 T 132-142 kW (180-193 PS) AUQ	05.2002→05.2005		7.22769.73.0	ARV	PN	
			7.05271.23.0	LS	900 mm	
			7.05271.24.0	LS	1500 mm	vor Katalysator in front of the catalyst
			7.21851.31.0	SLP	EL	
1.9 TDI 85 kW (115 PS) AJM, AU Y	05.1999→06.2001		7.24809.17.0	AGR	PN	
1.9 TDI 81 kW (110 PS) AHF, ASV	05.1999→06.2001		7.24809.17.0	AGR	PN	
1.9 TDI 74 kW (101 PS) ATD	09.2000→05.2005		7.24809.17.0	AGR	PN	
1.9 TDI 74 kW (101 PS) AXR	09.2000→05.2005		7.24809.16.0	AGR	PN	
1.9 TDI 96 kW (130 PS) ASZ	11.2000→05.2005		7.24809.26.0	AGR	PN	
1.9 TDI 110 kW (150 PS) ARL	05.2001→05.2005		7.24809.26.0	AGR	PN	
1.9 TDI 66-67 kW (90-91 PS) AGR, ALH	07.2004→05.2005		7.24809.17.0	AGR	PN	















BORA Variant (1J6) **8**

1.9 TDI 4motion 85 kW (115 PS) AJM, AUY	05.1999→06.2001		7.24809.17.0	AGR	PN	
1.9 TDI 4motion 74 kW (101 PS) ATD	09.2000→05.2005		7.24809.17.0	AGR	PN	
1.9 TDI 4motion 96 kW (130 PS) ASZ	11.2000→05.2005		7.24809.26.0	AGR	PN	
1.9 TDI 4motion 110 kW (150 PS) ARL	05.2001→05.2005		7.24809.26.0	AGR	PN	
2.0 85 kW (116 PS) APK	05.1999→05.2005		7.05271.02.0	LS	500 mm	Diagnosesonde Diagnostic Probe
2.0 85 kW (115 PS) AQY	05.1999→05.2005		7.22286.26.0	ARV	PN	 →ch. 1J-1B073 000
			7.05271.02.0	LS	500 mm	Diagnosesonde Diagnostic Probe
			7.22738.08.0	SLP	EL	 ch. 1J-Y-000 001→
			7.21851.31.0	SLP	EL	 →ch. 1J-X-999 999
			7.22778.80.0	SLV	PN	 Fahrgestellnummer ab: 1J-1B073 001, 1J-1D231 001, 1J-1P136 001, 1J-1U044 001, 1J-1W269 001 Vehicle Identification Number from: 1J-1B073 001, 1J-1D231 001, 1J-1P136 001, 1J-1U044 001, 1J-1W269 001
2.0 85 kW (115 PS) AZG	05.1999→05.2005		7.22778.96.0	SLV	PN	
			7.05270.98.0	LS	700 mm	nach Katalysator Post-catalyst
			7.05271.24.0	LS	1500 mm	vor Katalysator in front of the catalyst
			7.22738.08.0	SLP	EL	
2.0 85 kW (115 PS) AZJ	05.1999→05.2005		7.22778.80.0	SLV	PN	 ■ Mexico ■ Mexico
			7.05270.98.0	LS	700 mm	nach Katalysator Post-catalyst
			7.05271.02.0	LS	500 mm	Diagnosesonde Diagnostic Probe
			7.05271.24.0	LS	1500 mm	vor Katalysator in front of the catalyst
			7.22738.08.0	SLP	EL	
2.0 85-86 kW (116-117 PS) BEV	05.1999→05.2005		7.22778.80.0	SLV	PN	 Fahrgestellnummer bis: 1Y-5-322 000 Vehicle Identification Number to: 1Y-5-322 000
			7.22778.80.0	SLV	PN	
			7.22778.80.0	SLV	PN	
			7.22778.80.0	SLV	PN	
2.0 4motion 85 kW (115 PS) AZH	04.2000→05.2005		7.05270.99.0	LS	940 mm	Diagnosesonde Diagnostic Probe
			7.05271.24.0	LS	1500 mm	vor Katalysator in front of the catalyst
			7.22738.08.0	SLP	EL	
			7.22778.80.0	SLV	PN	
2.0 4motion 85 kW (115 PS) AZJ	04.2000→05.2005		7.05271.02.0	LS	500 mm	Diagnosesonde Diagnostic Probe
			7.05271.24.0	LS	1500 mm	vor Katalysator in front of the catalyst
			7.22738.08.0	SLP	EL	
			7.22778.80.0	SLV	PN	
			7.22778.96.0	SLV	PN	
2.3 V5 110 kW (150 PS) AGZ	05.1999→10.2000		7.22286.55.0	ARV	PN	

V













BORA Variant (1J6) 8

			7.05271.03.0	LS	730 mm	
2.3 V5 125 kW (170 PS) AQN	10.2000→05.2005		7.22286.55.0	ARV	PN	
			7.05271.01.0	LS	950 mm	
			7.05270.89.0	LS	925 mm	
			7.05271.23.0	LS	900 mm	
			7.05270.91.0	LS	350 mm	
			7.05271.00.0	LS	1525 mm	
			7.05271.24.0	LS	1500 mm	vor Katalysator in front of the catalyst
			7.22738.08.0	SLP	EL	
2.3 V5 4motion 110 kW (150 PS) AGZ	05.1999→10.2000		7.22286.55.0	ARV	PN	
			7.05271.03.0	LS	730 mm	
2.3 V5 4motion 125 kW (170 PS) AQN	10.2000→05.2005		7.22286.55.0	ARV	PN	
			7.05271.01.0	LS	950 mm	
			7.05270.89.0	LS	925 mm	
			7.05271.23.0	LS	900 mm	
			7.05270.98.0	LS	700 mm	nach Katalysator, rechts Post-catalyst, Right
			7.05270.91.0	LS	350 mm	
			7.05271.00.0	LS	1525 mm	
			7.05271.24.0	LS	1500 mm	vor Katalysator in front of the catalyst
7.22738.08.0	SLP	EL				
2.8 V6 4motion 150 kW (204 PS) AQP, AUE	05.1999→05.2005		7.22286.55.0	ARV	PN	
			7.05270.98.0	LS	700 mm	 AQP, AUE: nach Katalysator, rechts Post-catalyst, Right
			7.05270.91.0	LS	350 mm	
			7.05271.00.0	LS	1525 mm	
			7.05271.24.0	LS	1500 mm	 AQP, AUE: vor Katalysator in front of the catalyst
7.22738.08.0	SLP	EL				
2.8 V6 4motion 150 kW (204 PS) BDE	05.1999→05.2005		7.22286.55.0	ARV	PN	
			7.05270.98.0	LS	700 mm	nach Katalysator, rechts Post-catalyst, Right
			7.05270.91.0	LS	350 mm	
			7.05271.00.0	LS	1525 mm	
7.22738.08.0	SLP	EL				



















CADDY ALLTRACK MPV (SAB) 9

1.6 TDI 55 kW (75 PS) CAYE	05.2015→11.2017		7.08369.19.0 7.11492.00.0	ATS DDS	EL	ohne Zubehör without accessories
1.6 TDI 75 kW (102 PS) CAYD	05.2015→		7.08369.19.0	ATS	EL	
2.0 TDI 55 kW (75 PS) CUUF	05.2015→		7.11492.03.0 7.07696.00.0	DDS SRM-AK	EL	ohne Zubehör without accessories
2.0 TDI 55 kW (75 PS) DFSF	05.2015→		7.11492.03.0	DDS		ohne Zubehör without accessories
2.0 TDI 75 kW (102 PS) CUUD	05.2015→		7.11492.03.0 7.07696.00.0	DDS SRM-AK	EL	ohne Zubehör without accessories
2.0 TDI 75 kW (102 PS) DFSD	05.2015→		7.11492.03.0	DDS		ohne Zubehör without accessories
2.0 TDI 110 kW (150 PS) CUUB	05.2015→		7.11492.03.0 7.07696.00.0	DDS SRM-AK	EL	ohne Zubehör without accessories
2.0 TDI 110 kW (150 PS) DFSB	05.2015→		7.11492.03.0	DDS		ohne Zubehör without accessories
2.0 TDI 4motion 90 kW (122 PS) CUUE	05.2015→		7.11492.03.0 7.07696.00.0	DDS SRM-AK	EL	ohne Zubehör without accessories
2.0 TDI 4motion 90 kW (122 PS) DFSE	05.2015→		7.11492.03.0	DDS		ohne Zubehör without accessories
2.0 TDI 4motion 110 kW (150 PS) DFSB	11.2015→		7.11492.03.0	DDS		ohne Zubehör without accessories

CADDY II MPV (9K9B) 10

1.4 40-44 kW (54-60 PS) AEX, AKV, APQ	11.1995→06.2003		7.05270.88.0 7.05271.03.0	LS LS	740 mm 730 mm	 AEX, AKV, APQ: ch. 9K-W-502 001→ch. 9K-X-521 000  AEX, AKV, APQ: ch. 9K-X-521 001→ Regelsonde Regulating Probe
1.4 44 kW (60 PS) AUD	09.2000→06.2003		7.05271.01.0 7.05271.77.0 7.05271.02.0 7.05271.00.0	LS LS LS LS	950 mm 800 mm 500 mm 1525 mm	 ch. 9K-1-518 701→ch. 9K-3-501 8 00 Diagnosesonde Diagnostic Probe vor Katalysator in front of the catalyst  ch. 9K-3-501 801→ Regelsonde Regulating Probe  →ch. 9K-1-518 700
1.4 16V 55 kW (75 PS) AUA	08.2000→01.2004		7.28248.17.0 7.22785.17.0	AGR AGR	EL EL	 ch. 9K-2-500 001→  →ch. 9K-2-500 000
1.9 SDI 47 kW (64 PS) AYQ	11.1995→01.2004		7.22477.10.0	AGR	PN	
1.9 TDI 66-67 kW (90-91 PS) ALH	10.1996→01.2004		7.24809.17.0	AGR	PN	























CADDY III MPV (2KB, 2KJ, 2CB, 2CJ) 11

1.4 55 kW (75 PS) BCA	03.2004→05.2006		7.28248.17.0 7.05271.15.0	AGR LS	EL 525 mm	 →ch. 2K-5-150 000
--------------------------	-----------------	---	--	-----------	--------------	---

V























CADDY III MPV (2KB, 2KJ, 2CB, 2CJ) 11

1.6 75 kW (102 PS) BGU	04.2004→05.2015	 7.22574.12.0	AGR	EL	 →12.2008	
		7.22738.08.0	SLP	EL		
		7.22778.96.0	SLV	PN		
1.6 75 kW (102 PS) BSE	04.2004→05.2015	 7.05271.18.0	LS	525 mm		
		7.22738.08.0	SLP	EL		
		7.22778.96.0	SLV	PN		
1.6 75 kW (102 PS) BSF	04.2004→05.2015	 7.05271.18.0	LS	525 mm		
		7.22738.08.0	SLP	EL		
		7.22778.96.0	SLV	PN		
1.6 BiFuel 75 kW (102 PS) CHGA	05.2011→05.2015	 7.05271.18.0	LS	525 mm		
		7.22738.08.0	SLP	EL		
		7.22778.96.0	SLV	PN		
1.6 TDI 55 kW (75 PS) CAYE	08.2010→05.2015	 7.09720.00.0	AGR-K	EL		
		7.08369.19.0	ATS	EL		 ch. 2K-B-200 001→
		7.08369.48.0	ATS	EL		
		7.11492.00.0	DDS			ohne Zubehör without accessories  ch. 2K-B-200 001→
1.6 TDI 75 kW (102 PS) CAYD	08.2010→05.2015	 7.09720.00.0	AGR-K	EL		
		7.08369.19.0	ATS	EL		 ch. 2K-B-200 001→
		7.08369.48.0	ATS	EL		
		7.11492.00.0	DDS			ohne Zubehör without accessories  ch. 2K-B-200 001→
1.9 TDI 77 kW (105 PS) BJB	04.2004→08.2010	 7.24809.32.0	AGR	PN		
1.9 TDI 77 kW (105 PS) BLS	04.2004→08.2010	 7.00678.04.0*	AGR-M	EL	mit Rohrstützen with pipe socket	
		↳7.00907.03.0	AGR	EL		
		7.00678.06.0	AGR-M	EL		
		7.08369.00.0	ATS	EL		
		7.08369.08.0	ATS	EL		
		7.08369.84.0	ATS	EL		
		7.11492.02.0	DDS			ohne Zubehör without accessories
1.9 TDI 55 kW (75 PS) BSU	09.2005→08.2010	 7.00678.04.0*	AGR-M	EL	mit Rohrstützen with pipe socket	
		↳7.00907.03.0	AGR	EL		
		7.00678.06.0	AGR-M	EL		
		7.08369.00.0	ATS	EL		
		7.08369.08.0	ATS	EL		
		7.08369.84.0	ATS	EL		
		7.11492.02.0	DDS			ohne Zubehör without accessories
1.9 TDI 4motion 77 kW (105 PS) BLS	05.2008→08.2010	 7.00678.04.0*	AGR-M	EL	mit Rohrstützen with pipe socket	
		↳7.00907.03.0	AGR	EL		
		7.00678.06.0	AGR-M	EL		
		7.08369.00.0	ATS	EL		
		7.08369.08.0	ATS	EL		
		7.08369.84.0	ATS	EL		
		7.11492.02.0	DDS			ohne Zubehör without accessories

























































CADDY III MPV (2KB, 2KJ, 2CB, 2CJ) 11

2.0 SDI 51 kW (70 PS) BDJ	03.2004→08.2010	 7.22477.10.0	AGR	PN	
2.0 SDI 51 kW (70 PS) BST	03.2004→08.2010	 7.22477.11.0	AGR	PN	
2.0 TDI 103 kW (140 PS) BMM	09.2007→08.2010	 7.00678.04.0* ↳ 7.00907.03.0 7.00678.06.0 7.08369.00.0 7.08369.08.0 7.08369.84.0 7.11492.02.0	AGR-M AGR AGR-M ATS ATS ATS DDS	EL EL EL EL EL EL	mit Rohrstutzen with pipe socket ohne Zubehör without accessories
2.0 TDI 81 kW (110 PS) CLCA	08.2010→05.2015	 7.09720.00.0	AGR-K	EL	
2.0 TDI 125 kW (170 PS) CFJA	05.2012→05.2015	 7.09720.00.0 7.11190.09.0	AGR-K DDS	EL	  ch. 2K-B-200 001→
2.0 TDI 16V 103 kW (140 PS) CFHC	11.2010→05.2015	 7.09720.00.0 7.11190.09.0	AGR-K DDS	EL	  ch. 2K-B-200 001→
2.0 TDI 16V 103 kW (140 PS) CLCB	11.2010→05.2015	 7.09720.00.0	AGR-K	EL	
2.0 TDI 16V 4motion 103 kW (140 PS) CFHC	11.2010→05.2015	 7.09720.00.0 7.11190.09.0	AGR-K DDS	EL	  ch. 2K-B-200 001→
2.0 TDI 4motion 81 kW (110 PS) CFHF	08.2010→05.2015	 7.09720.00.0 7.11190.09.0	AGR-K DDS	EL	  ch. 2K-B-200 001→















CADDY IV MPV (SAB, SAJ) 12

1.6 TDI 55 kW (75 PS) CAYE	05.2015→11.2017	 7.09720.00.0 7.08369.19.0 7.08369.48.0 7.11492.00.0	AGR-K ATS ATS DDS	EL EL EL	ohne Zubehör without accessories
1.6 TDI 75 kW (102 PS) CAYD	05.2015→09.2020	 7.09720.00.0 7.08369.19.0 7.08369.48.0 7.11492.00.0	AGR-K ATS ATS DDS	EL EL EL	nach Katalysator Post-catalyst ohne Zubehör without accessories
2.0 TDI 55 kW (75 PS) CUUF	05.2015→11.2015	 7.11492.03.0 7.07696.00.0	DDS SRM-AK	EL	ohne Zubehör without accessories
2.0 TDI 75 kW (102 PS) CUUD	05.2015→11.2015	 7.11492.03.0 7.07696.00.0	DDS SRM-AK	EL	ohne Zubehör without accessories
2.0 TDI 103 kW (140 PS) CFHC, CLCB	05.2015→09.2020	 7.09720.00.0	AGR-K	EL	  CFHC, CLCB:  ch. 2K-B-200 001→
2.0 TDI 110 kW (150 PS) CUUB	05.2015→11.2015	 7.11492.03.0 7.07696.00.0	DDS SRM-AK	EL	ohne Zubehör without accessories
2.0 TDI 81 kW (110 PS) CLCA	09.2015→09.2020	 7.09720.00.0	AGR-K	EL	  ch. 2K-B-200 001→





						
CADDY IV MPV (SAB, SAJ)						12
2.0 TDI 55 kW (75 PS) DFSF	11.2015→09.2020		7.11492.03.0	DDS	ohne Zubehör without accessories	
2.0 TDI 75 kW (102 PS) DFSD	11.2015→09.2020		7.11492.03.0	DDS	ohne Zubehör without accessories	
2.0 TDI 110 kW (150 PS) DFSB	11.2015→09.2020		7.11492.03.0	DDS	ohne Zubehör without accessories	
2.0 TDI 4motion 81 kW (110 PS) CFHF, CLCA	05.2015→09.2020		7.09720.00.0	AGR-K	EL 	
2.0 TDI 4motion 90 kW (122 PS) CUUE	05.2015→11.2015		7.11492.03.0	DDS	ohne Zubehör without accessories	
			7.07696.00.0	SRM-AK	EL	
2.0 TDI 4motion 103 kW (140 PS) CFHC	05.2015→09.2020		7.09720.00.0	AGR-K	EL   ch. 2K-B-200 001→	
2.0 TDI 4motion 90 kW (122 PS) DFSE	11.2015→09.2020		7.11492.03.0	DDS	ohne Zubehör without accessories	
2.0 TDI 4motion 110 kW (150 PS) DFSB	11.2015→09.2020		7.11492.03.0	DDS	ohne Zubehör without accessories	
CADDY LIFE (2K)						13
1.9 TDI 77 kW (105 PS) BLS	05.2004→08.2010		7.08369.00.0	ATS	EL	
			7.08369.08.0	ATS	EL	
CC B7 (358)						14
2.0 TDI 100 kW (136 PS) CFFA	11.2011→12.2016		7.09720.00.0	AGR-K	EL 	
			7.11492.00.0	DDS	ohne Zubehör without accessories  ch. 3C-C-700 001→	
2.0 TDI 125 kW (170 PS) CFGB	11.2011→12.2016		7.09720.00.0	AGR-K	EL 	
			7.11492.00.0	DDS	ohne Zubehör without accessories  ch. 3C-C-700 001→	
2.0 TDI 125 kW (170 PS) CLLA	11.2011→12.2016		7.09720.00.0	AGR-K	EL 	
2.0 TDI 103 kW (140 PS) CFFB	11.2011→12.2016		7.09720.00.0	AGR-K	EL 	
			7.11492.00.0	DDS	ohne Zubehör without accessories  ch. 3C-C-700 001→	
2.0 TDI 130 kW (177 PS) CFGC	12.2012→12.2016		7.09720.00.0	AGR-K	EL 	
			7.11492.00.0	DDS	ohne Zubehör without accessories  ch. 3C-C-700 001→	
2.0 TDI 110 kW (150 PS) CUVC	05.2015→12.2016		7.11492.03.0	DDS	ohne Zubehör without accessories  ch. 3C-C-700 001→	
2.0 TDI 135 kW (184 PS) CUWA	05.2015→12.2016		7.11492.03.0	DDS	ohne Zubehör without accessories  ch. 3C-C-700 001→	
			7.07696.00.0	SRM-AK	EL	
2.0 TDI 4motion 103 kW (140 PS) CFFB	11.2011→12.2016		7.09720.00.0	AGR-K	EL 	
			7.11492.00.0	DDS	ohne Zubehör without accessories  ch. 3C-C-700 001→	
2.0 TDI 4motion 125 kW (170 PS) CFGB	11.2011→01.2013		7.09720.00.0	AGR-K	EL 	











CC B7 (358) 14

			7.11492.00.0	DDS		ohne Zubehör without accessories  ch. 3C-C-700 001→
2.0 TDI 4motion 130 kW (177 PS) CFGFC	12.2012→12.2016		7.09720.00.0	AGR-K	EL	
			7.11492.00.0	DDS		ohne Zubehör without accessories  ch. 3C-C-700 001→
2.0 TSI 147-157 kW (200-213 PS) CBFA, CCTA	11.2011→12.2016		7.01510.31.0	SLV	EL	
2.0 TSI 155 kW (211 PS) CCZB	11.2011→12.2016		7.01510.31.0	SLV	EL	
3.6 FSI 4motion 206 kW (280 PS) CNNA	11.2011→12.2016		7.02604.41.0	LS	700 mm	 ch. 3C-C-700 001→ vor Katalysator, links in front of the catalyst, Left
3.6 FSI 4motion 220 kW (300 PS) BWS	11.2011→12.2016		7.02604.41.0	LS	700 mm	 ch. 3C-C-700 001→ vor Katalysator, links in front of the catalyst, Left

CORRADO (53I) 15

















1.8 16V 100-102 kW (136-140 PS) KR	04.1989→07.1992		7.02604.01.0	LS	200 mm	
1.8 G60 110-118 kW (150-160 PS) PG	09.1988→09.1993		7.02604.03.0	LS	200 mm	
2.0 i 85 kW (115 PS) 2E, ADY	04.1993→07.1995		7.05270.86.0	LS	625 mm	
2.0 i 16V 100 kW (136 PS) 9A	08.1991→12.1995		7.02604.03.0	LS	200 mm	
2.9 VR6 135-140 kW (184-190 PS) ABV	01.1994→12.1995		7.05270.86.0	LS	625 mm	

EOS (1F7, 1F8) 16













1.4 TSI 90 kW (122 PS) CAXA	11.2007→08.2015		7.05271.18.0	LS	525 mm	Euro 4 Euro 4
1.6 FSI 85 kW (115 PS) BLF	06.2006→05.2008		7.10334.04.0	AGR	EL	
			7.05271.15.0	LS	525 mm	
			7.05271.30.0	LS	400 mm	
2.0 FSI 110 kW (150 PS) BVY	03.2006→05.2008		7.10334.09.0	AGR	EL	
			7.05271.29.0	LS	900 mm	
			7.05271.16.0	LS	1300 mm	hinten, links, rechts Rear, Left, Right Diagnosesonde Diagnostic Probe
2.0 FSI 110 kW (150 PS) BVZ	03.2006→05.2008		7.05271.16.0	LS	1300 mm	hinten Rear Diagnosesonde Diagnostic Probe
V 2.0 TDI 103 kW (140 PS) BMM	06.2006→05.2008		7.00678.04.0*	AGR-M	EL	mit Rohrstützen with pipe socket
			↳ 7.00907.03.0	AGR	EL	
			7.00678.06.0	AGR-M	EL	
			7.08369.00.0	ATS	EL	
			7.08369.02.0	ATS	EL	
			7.08369.03.0	ATS	EL	
			7.11492.02.0	DDS		ohne Zubehör without accessories  ch. 1F-7-025 001→
			7.11190.02.0	DDS		 →ch. 1F-7-025 00





EOS (1F7, 1F8) 16

2.0 TDI 100 kW (136 PS) CFFA	11.2010→08.2015	 7.09720.00.0	AGR-K	EL	
		7.11190.09.0	DDS		 ch. 1F-B-006 377→
2.0 TDI 16V 103 kW (140 PS) CBAB	05.2008→08.2015	 7.10334.00.0	AGR	EL	
		7.08369.01.0	ATS	EL	
		7.08369.04.0	ATS	EL	
		7.11492.02.0	DDS		ohne Zubehör without accessories
2.0 TDI 16V 103 kW (140 PS) CFFB	05.2008→08.2015	 7.09720.00.0	AGR-K	EL	
		7.11190.09.0	DDS		 ch. 1F-B-006 377→  ch. 1F-B-006 377→
2.0 TFSI 147-157 kW (200-213 PS) BWA, CCTA, CCZA	03.2006→08.2015	 7.05271.15.0	LS	525 mm	
2.0 TFSI 147 kW (200 PS) CAWB	03.2006→08.2015	 7.05271.11.0	LS	800 mm	Regelsonde Regulating Probe
2.0 TFSI 147-157 kW (200-213 PS) CBFA	03.2006→08.2015	 7.05271.15.0	LS	525 mm	
		7.01510.31.0	SLV	EL	  ch. 1F-B-006 377→
2.0 TSI 155 kW (211 PS) CCZB	11.2009→08.2015	 7.05271.15.0	LS	525 mm	
3.2 V6 184 kW (250 PS) BUB	06.2006→05.2009	 7.05271.28.0	LS	800 mm	links Left
		7.05271.15.0	LS	525 mm	rechts Right
		7.22738.20.0	SLP	EL	
		7.22778.98.0	SLV	PN	

FOX Hatchback (5Z1, 5Z3, 5Z4) 17

1.0 53-56 kW (72-76 PS) BNX	05.2009→12.2009	 7.05271.05.0	LS	700 mm	 Afrika  Africa Produktionsdatum ab: 01.04.2005 Production date from: 01.04.2005 Produktionsdatum bis: 31.03.2008 Production date to: 31.03.2008
1.0 Total Flex 52-53 kW (71-72 PS) BJE	08.2003→12.2009	 7.05271.05.0	LS	700 mm	 Afrika  Africa Produktionsdatum ab: 01.04.2005 Production date from: 01.04.2005 Produktionsdatum bis: 31.03.2008 Production date to: 31.03.2008
1.2 40 kW (54 PS) BMD, CHFB	04.2005→07.2011	 7.05271.05.0	LS	700 mm	 BMD, CHFB: vor Katalysator in front of the catalyst
1.2 44 kW (60 PS) CHFA	09.2010→12.2011	 7.05271.05.0	LS	700 mm	vor Katalysator in front of the catalyst
1.4 55 kW (75 PS) BKR	04.2005→12.2009	 7.05271.05.0	LS	700 mm	vor Katalysator in front of the catalyst
1.4 TDI 51 kW (70 PS) BNM	04.2005→12.2009	 7.24809.31.0	AGR	PN	

GOLF ALLTRACK VII Variant (BA5, BV5) 18



































1.6 TDI 4motion 81 kW (110 PS) CRKB	12.2014→	 7.08369.79.0	ATS	EL	 ch. AU-D-000 001→ Produktionsdatum bis: 03.11.2014 Production date to: 03.11.2014
		7.08369.82.0	ATS	EL	 ch. AU-D-000 001→ ab Euro 5 From Euro 5 Produktionsdatum bis: 03.11.2014 Production date to: 03.11.2014

























GOLF ALLTRACK VII Variant (BA5, BV5) 18

			7.08369.95.0	ATS	EL	ch. AU-D-000 001→ Euro 6 Euro 6 Produktionsdatum ab: 03.11.2014 Production date from: 03.11.2014
			7.11492.03.0	DDS		ohne Zubehör without accessories ch. AU-E-500 001→ Produktionsdatum ab: 03.11.2014 Production date from: 03.11.2014
1.6 TDI 4motion 81 kW (110 PS) CXXB	12.2014→		7.08369.79.0	ATS	EL	ch. AU-D-000 001→ Produktionsdatum bis: 03.11.2014 Production date to: 03.11.2014
			7.11020.17.0	ATS	EL	ch. BV5***→ vor Katalysator in front of the catalyst
			7.11492.03.0	DDS		ohne Zubehör without accessories CXXB: ch. AU-E-500 001→ Produktionsdatum ab: 03.11.2014 Production date from: 03.11.2014 CXXB: ch. BV5***→
1.8 TSI 4motion 132 kW (180 PS) CJSB	12.2014→		7.01510.85.0	SLV	EL	Fahrgestellnummer ab: BQ1***, BV5*** Vehicle Identification Number from: BQ1***, BV5*** für Hersteller-Abgasnorm: SULEV for manufacturer exhaust norm: SULEV
2.0 TDI 4motion 110 kW (150 PS) CRBC	12.2014→05.2018		7.10334.02.0	AGR	EL	
			7.08369.81.0	ATS	EL	CRBC: ch. AU-E-500 001→ CRBC: ch. BV5***→
			7.11492.03.0	DDS		ohne Zubehör without accessories Fahrgestellnummer ab: AU-D-000 001, BV5*** Vehicle Identification Number from: AU-D-000 001, BV5***
2.0 TDI 4motion 110 kW (150 PS) CRLB	12.2014→05.2018		7.08369.81.0	ATS	EL	ch. BV5***→
			7.11492.03.0	DDS		ohne Zubehör without accessories Fahrgestellnummer ab: AU-D-000 001, BV5*** Vehicle Identification Number from: AU-D-000 001, BV5***
2.0 TDI 4motion 110 kW (150 PS) DCYA	12.2014→05.2018		7.08369.81.0	ATS	EL	ch. BV5***→
			7.11492.05.0	DDS		ohne Zubehör without accessories ch. BV5***→
2.0 TDI 4motion 135 kW (184 PS) CUNA	12.2014→		7.08369.81.0	ATS	EL	ch. AU-E-500 001→
			7.11492.03.0	DDS		ohne Zubehör without accessories ch. AU-D-000 001→
2.0 TDI 4motion 135 kW (184 PS) DGCA, DJGA	12.2014→		7.08369.81.0	ATS	EL	DGCA: ch. AU-E-500 001→ Produktionsdatum ab: 11.04.2016 Production date from: 11.04.2016
			7.11492.05.0	DDS		DGCA, DJGA: ch. BV5***→ ohne Zubehör without accessories DGCA, DJGA: ch. BV5***→
TSI 132 kW (180 PS) CJSB	02.2019→		7.01510.85.0	SLV	EL	Fahrgestellnummer ab: BQ1***, BV5*** Vehicle Identification Number from: BQ1***, BV5*** für Hersteller-Abgasnorm: SULEV for manufacturer exhaust norm: SULEV

V

					
GOLF II (19E, 1G1)					19
1.8 GTI 16V 92-95 kW (125-129 PS) PL	02.1986→10.1991		7.02604.03.0	LS	200 mm
1.8 GTI 16V 100-102 kW (136-140 PS) KR	02.1986→06.1990		7.02604.03.0	LS	200 mm
1.8 GTI G60 110-118 kW (150-160 PS) PG	04.1990→07.1991		7.02604.03.0	LS	200 mm
1.8 GTI G60 Syncro 110-118 kW (150-160 PS) 1H, PG	08.1988→07.1991		7.02604.03.0	LS	200 mm
GOLF III (1H1)					20
1.4 40-44 kW (54-60 PS) ABD	10.1991→07.1995		7.05270.88.0	LS	740 mm  ch. 1H-S-120 001→ für Fahrzeuge ohne Katalysator for vehicles without catalytic converter
			7.05270.86.0	LS	625 mm  →ch. 1H-S-120 000
1.4 40-44 kW (54-60 PS) ABD	11.1991→08.1997		7.05270.88.0	LS	740 mm  ch. 1H-S-120 001→ für Fahrzeuge ohne Katalysator for vehicles without catalytic converter
			7.05270.86.0	LS	625 mm  →ch. 1H-S-120 000
1.4 40-44 kW (54-60 PS) AEX	11.1991→08.1997		7.05270.96.0	LS	1440 mm Regelsonde Regulating Probe
1.4 40-44 kW (54-60 PS) AEX	07.1995→08.1997		7.05270.96.0	LS	1440 mm Regelsonde Regulating Probe
1.6 55 kW (75 PS) ABU	09.1992→09.1994		7.05270.86.0	LS	625 mm  →ch. 1H-S-120 000
1.8 55 kW (75 PS) AAM	11.1991→08.1997		7.02604.01.0	LS	200 mm
1.8 63-67 kW (86-91 PS) ABS, ACC, ADZ	11.1991→08.1997		7.02604.01.0	LS	200 mm
1.8 Syncro (1HX1) 63-66 kW (86-90 PS) ABS, ADZ	01.1993→08.1997		7.02604.01.0	LS	200 mm
2.0 85 kW (115 PS) 2E	11.1991→09.1994		7.05270.86.0	LS	625 mm
2.0 GTI 16V 110 kW (150 PS) ABF	08.1992→08.1997		7.02604.04.0	LS	200 mm
2.8 VR6 120-128 kW (163-174 PS) AAA	01.1992→08.1997		7.22090.11.0	ARV	PN  01.1993→,  ch. 1H-T-000 001→  Mexico, USA  Mexico, USA
			7.05270.88.0	LS	740 mm
			7.05270.86.0	LS	625 mm
2.8 VR6 120-128 kW (163-174 PS) AAA	08.1995→09.1997		7.22090.11.0	ARV	PN  ch. 1H-T-000 001→  Mexico, USA  Mexico, USA
			7.05270.88.0	LS	740 mm
			7.05270.86.0	LS	625 mm
2.9 VR6 Syncro (1HX1) 135-140 kW (184-190 PS) ABV	10.1994→08.1997		7.05270.96.0	LS	1440 mm



						
GOLF III Cabriolet (1E7)						21
1.8 55 kW (75 PS) AAM	07.1993→05.1998		7.02604.01.0	LS	200 mm	
1.8 63-66 kW (86-90 PS) ABS, ADZ	07.1993→05.1998		7.02604.01.0	LS	200 mm	
2.0 85 kW (115 PS) 2E	07.1993→09.1994		7.05270.86.0	LS	625 mm	
GOLF III Variant (1H5)						22
1.4 40-44 kW (54-60 PS) ABD	07.1993→04.1999		7.05270.88.0	LS	740 mm	
			7.05270.86.0	LS	625 mm	
1.4 40-44 kW (54-60 PS) ABD	07.1993→07.1995		7.05270.88.0	LS	740 mm	
			7.05270.86.0	LS	625 mm	
1.4 44 kW (60 PS) APQ	07.1993→04.1999		7.05270.88.0	LS	740 mm	
1.4 40-44 kW (54-60 PS) AEX	07.1995→04.1999		7.05270.96.0	LS	1440 mm	
1.8 55 kW (75 PS) AAM	07.1993→04.1999		7.02604.01.0	LS	200 mm	
1.8 63-66 kW (86-90 PS) ABS, ADZ	07.1993→04.1999		7.02604.01.0	LS	200 mm	
1.8 Syncro 63-66 kW (86-90 PS) ADZ	10.1994→04.1999		7.02604.01.0	LS	200 mm	
2.0 85 kW (115 PS) 2E	07.1993→09.1994		7.05270.86.0	LS	625 mm	
2.9 VR6 Syncro 135-140 kW (184-190 PS) ABV	10.1994→04.1999		7.05270.96.0	LS	1440 mm	
GOLF IV (1J1)						23
1.4 16V 55 kW (75 PS) AHW, AKQ	10.1997→05.2004		7.05271.03.0	LS	730 mm	
1.4 16V 55 kW (75 PS) APE	10.1997→05.2004		7.22785.17.0	AGR	EL	
			7.05271.23.0	LS	900 mm	
			7.05271.24.0	LS	1500 mm	
1.4 16V 55 kW (75 PS) AXP	10.1997→05.2004		7.22785.17.0	AGR	EL	
			7.28248.17.0	AGR	EL	
			7.05271.23.0	LS	900 mm	
			7.05271.24.0	LS	1500 mm	
V 1.4 16V 55 kW (75 PS) BCA	10.1997→05.2004		7.28248.17.0	AGR	EL	
			7.05271.23.0	LS	900 mm	
			7.05271.24.0	LS	1500 mm	
1.6 65-76 kW (100-103 PS) AEH, AKL	08.1997→05.2004		7.05271.04.0	LS	505 mm	
			7.05271.21.0	LS	1250 mm	



















































GOLF IV (1J1) 23

1.6 74 kW (101 PS) APF	08.1997→05.2004		7.22574.12.0	AGR	EL	ch. 1J-W-000 001→
			7.22286.41.0	ARV	PN	ch. 1J-W-000 001→
			7.05271.24.0	LS	1500 mm	ch. 1J-W-000 001→ vor Katalysator in front of the catalyst
			7.22738.08.0	SLP	EL	ch. 1J-Y-000 001→
1.6 75 kW (102 PS) AVU	08.2000→06.2005		7.22574.12.0	AGR	EL	ch. 1J-W-000 001→
			7.05271.24.0	LS	1500 mm	ch. 1J-W-000 001→ vor Katalysator in front of the catalyst
			7.22738.08.0	SLP	EL	ch. 1J-Y-000 001→
			7.22778.96.0	SLV	PN	ch. 1J-W-000 001→
1.6 75 kW (102 PS) BFQ	08.2000→06.2005		7.22574.12.0	AGR	EL	
			7.22738.08.0	SLP	EL	
			7.22778.96.0	SLV	PN	
1.6 16V 77 kW (105 PS) ATN, AUS	02.2000→06.2005		7.22785.17.0	AGR	EL	ATN, AUS: →04.2001, ch. 1J-W-000 001→
1.6 16V 77 kW (105 PS) AZD	02.2000→06.2005		7.22785.17.0	AGR	EL	→04.2001, ch. 1J-W-000 001→
			7.28248.17.0	AGR	EL	05.2001→
1.6 16V 77 kW (105 PS) BCB	02.2000→06.2005		7.28248.17.0	AGR	EL	
1.6 FSI 81 kW (110 PS) BAD	01.2002→06.2005		7.08369.34.0	ATS	EL	
1.8 92 kW (125 PS) AGN	08.1997→06.2005		7.05271.03.0	LS	730 mm	
1.8 4motion 92 kW (125 PS) AGN	05.1998→06.2005		7.05271.03.0	LS	730 mm	
1.8 T 110 kW (150 PS) AGU	08.1997→06.2005		7.05271.03.0	LS	730 mm	Regelsonde Regulating Probe
1.8 T 110 kW (150 PS) ARZ	08.1997→06.2005		7.22769.73.0	ARV	PN	ch. 1J-W-000 001→
			7.21851.31.0	SLP	EL	ch. 1J-W-000 001→
1.8 T 110 kW (150 PS) AUM	08.1997→06.2005		7.22769.73.0	ARV	PN	ch. 1J-W-000 001→
			7.05271.23.0	LS	900 mm	
			7.05271.24.0	LS	1500 mm	vor Katalysator in front of the catalyst
			7.21851.31.0	SLP	EL	ch. 1J-W-000 001→
1.8 T 110 kW (150 PS) AWD, AWW	08.1997→06.2005		7.22769.73.0	ARV	PN	
1.8 T GTI 132-142 kW (180-193 PS) AUQ	08.2001→06.2005		7.22769.73.0	ARV	PN	
			7.05270.99.0	LS	940 mm	Diagnosesonde Diagnostic Probe
			7.05271.23.0	LS	900 mm	
			7.05271.24.0	LS	1500 mm	vor Katalysator in front of the catalyst
			7.21851.31.0	SLP	EL	
1.8 T GTI 132 kW (180 PS) AWP	08.2001→06.2005		7.22769.73.0	ARV	PN	
						Mexico, Argentinien, USA, Brasilien Mexico, Argentina, USA, Brazil





GOLF IV (1J1) **23**

1.9 SDI 50 kW (68 PS) AGP, AQM	08.1997→06.2005	 7.22477.10.0	AGR	PN	  ch. 1J-W-000 001→
1.9 TDI 81 kW (110 PS) AHF, ASV	08.1997→05.2004	 7.24809.17.0	AGR	PN	
1.9 TDI 66-67 kW (90-91 PS) AGR, ALH	10.1997→05.2004	 7.24809.17.0	AGR	PN	
1.9 TDI 85 kW (115 PS) AJM, AUJ	12.1998→06.2001	 7.24809.17.0	AGR	PN	
1.9 TDI 110 kW (150 PS) ARL	05.2000→06.2005	 7.24809.26.0	AGR	PN	  ch. 1J-W-000 001→
1.9 TDI 74 kW (101 PS) ATD	09.2000→06.2005	 7.24809.17.0	AGR	PN	
1.9 TDI 74 kW (101 PS) AXR	09.2000→06.2005	 7.24809.16.0	AGR	PN	
1.9 TDI 96 kW (130 PS) ASZ	11.2000→06.2005	 7.24809.26.0	AGR	PN	  ch. 1J-W-000 001→
1.9 TDI 4motion 66 kW (90 PS) AGR	07.1998→04.2002	 7.24809.17.0	AGR	PN	
1.9 TDI 4motion 85 kW (115 PS) AJM, AUJ	09.1999→06.2001	 7.24809.17.0	AGR	PN	
1.9 TDI 4motion 110 kW (150 PS) ARL	02.2000→06.2005	 7.24809.26.0	AGR	PN	  ch. 1J-W-000 001→
1.9 TDI 4motion 74 kW (101 PS) ATD	09.2000→06.2005	 7.24809.17.0	AGR	PN	
1.9 TDI 4motion 96 kW (130 PS) ASZ	11.2000→06.2005	 7.24809.26.0	AGR	PN	  ch. 1J-W-000 001→
2.0 85 kW (115 PS) AQY	07.1998→05.2004	 7.22286.26.0	ARV	PN	  ch. 1J-W-000 001→ch. 1J-1B073 000
		7.05271.02.0	LS	500 mm	Diagnosesonde Diagnostic Probe
		7.22738.08.0	SLP	EL	 ch. 1J-Y-000 001→
		7.21851.31.0	SLP	EL	 →ch. 1J-X-999 999
		7.22778.80.0	SLV	PN	 Fahrgestellnummer ab: 1J-1B073 001, 1J-1D231 001, 1J-1P136 001, 1J-1U044 001, 1J-1W269 001 Vehicle Identification Number from: 1J-1B073 001, 1J-1D231 001, 1J-1P136 001, 1J-1U044 001, 1J-1W269 001
2.0 85 kW (115 PS) AZG, AZJ	07.1998→05.2004	 7.05270.98.0	LS	700 mm	 AZG, AZJ: nach Katalysator Post-catalyst
		7.05271.02.0	LS	500 mm	 AZG, AZJ: Diagnosesonde Diagnostic Probe
		7.05271.24.0	LS	1500 mm	 AZG, AZJ: vor Katalysator in front of the catalyst
		7.22738.08.0	SLP	EL	
		7.22778.80.0	SLV	PN	
2.0 85 kW (116 PS) APK	08.1998→05.2004	 7.05271.02.0	LS	500 mm	Diagnosesonde Diagnostic Probe
2.0 4motion 85 kW (115 PS) AZH	10.2000→06.2005	 7.05270.99.0	LS	940 mm	Diagnosesonde Diagnostic Probe
		7.05271.24.0	LS	1500 mm	 ch. 1J-W-000 001→ vor Katalysator in front of the catalyst
		7.22738.08.0	SLP	EL	 ch. 1J-Y-000 001→
		7.22778.80.0	SLV	PN	
2.0 4motion 85 kW (115 PS) AZJ	10.2000→06.2005	 7.05271.02.0	LS	500 mm	Diagnosesonde Diagnostic Probe
		7.05271.24.0	LS	1500 mm	vor Katalysator in front of the catalyst

V



















GOLF IV (1J1) 23

			7.22738.08.0	SLP	EL	
			7.22778.80.0	SLV	PN	
2.0 BiFuel 85 kW (116 PS) BEH	05.2002→05.2003		7.05270.98.0	LS	700 mm	nach Katalysator Post-catalyst
			7.05271.24.0	LS	1500 mm	vor Katalysator in front of the catalyst
			7.22738.08.0	SLP	EL	
			7.22778.80.0	SLV	PN	
2.3 V5 110 kW (150 PS) AGZ	08.1997→10.2000		7.22286.55.0	ARV	PN	 Fahrgestellnummer ab: 1J-W-000 001 Vehicle Identification Number from: 1J-W-000 001
			7.05271.03.0	LS	730 mm	
2.3 V5 125 kW (170 PS) AQN	10.2000→06.2005		7.22286.55.0	ARV	PN	 Fahrgestellnummer ab: 1J-W-000 001 Vehicle Identification Number from: 1J-W-000 001
			7.05271.01.0	LS	950 mm	
			7.05270.89.0	LS	925 mm	
			7.05271.23.0	LS	900 mm	
			7.05270.91.0	LS	350 mm	
			7.05271.00.0	LS	1525 mm	
			7.05271.24.0	LS	1500 mm	ch. 1J-W-000 001→ vor Katalysator in front of the catalyst
			7.22738.08.0	SLP	EL	
2.3 V5 4motion 110 kW (150 PS) AGZ	12.1998→10.2000		7.22286.55.0	ARV	PN	 Fahrgestellnummer ab: 1J-W-000 001 Vehicle Identification Number from: 1J-W-000 001
			7.05271.03.0	LS	730 mm	
2.3 V5 4motion 125 kW (170 PS) AQN	10.2000→06.2005		7.22286.55.0	ARV	PN	 Fahrgestellnummer ab: 1J-W-000 001 Vehicle Identification Number from: 1J-W-000 001
			7.05271.01.0	LS	950 mm	
			7.05270.89.0	LS	925 mm	
			7.05271.23.0	LS	900 mm	
			7.05270.98.0	LS	700 mm	ch. 1J-W-000 001→ nach Katalysator, rechts Post-catalyst, Right
			7.05270.91.0	LS	350 mm	
			7.05271.00.0	LS	1525 mm	
			7.05271.24.0	LS	1500 mm	ch. 1J-W-000 001→ vor Katalysator in front of the catalyst
7.22738.08.0	SLP	EL				
2.8 VR6 130 kW (177 PS) AFP	01.1999→12.2002		7.22286.55.0	ARV	PN	 Fahrgestellnummer ab: 1J-W-000 001 Vehicle Identification Number from: 1J-W-000 001









GOLF IV (1J1) **23**

2.8 VR6 4motion 150 kW (204 PS) AQP, AUE	03.1999→06.2005		7.22286.55.0	ARV	PN	 AQP, AUE: Fahrgestellnummer ab: 1J-W-000 001 Vehicle Identification Number from: 1J-W-000 001
			7.05270.98.0	LS	700 mm	 AQP, AUE:  ch. 1J-W-000 001→ nach Katalysator, rechts Post-catalyst, Right
			7.05270.91.0	LS	350 mm	 AQP, AUE: rechts Right Diagnosesonde Diagnostic Probe
			7.05271.00.0	LS	1525 mm	 AQP, AUE: links Left
			7.05271.24.0	LS	1500 mm	 AQP, AUE:  ch. 1J-W-000 001→ vor Katalysator, beidseitig in front of the catalyst, Left and right
			7.22738.08.0	SLP	EL	 AQP, AUE:  ch. 1J-W-000 001→
2.8 VR6 4motion 150 kW (204 PS) BDE	03.1999→06.2005		7.22286.55.0	ARV	PN	
			7.05270.98.0	LS	700 mm	nach Katalysator, rechts Post-catalyst, Right
			7.05270.91.0	LS	350 mm	rechts Right Diagnosesonde Diagnostic Probe
			7.05271.00.0	LS	1525 mm	links Left
			7.22738.08.0	SLP	EL	
3.2 R32 4motion 177 kW (241 PS) BFH	09.2002→06.2005		7.22286.55.0	ARV	PN	
			7.05271.23.0	LS	900 mm	rechts Right
			7.05270.98.0	LS	700 mm	nach Katalysator, rechts Post-catalyst, Right
			7.05270.91.0	LS	350 mm	rechts Right Diagnosesonde Diagnostic Probe
			7.05271.00.0	LS	1525 mm	links Left
	7.22738.08.0	SLP	EL			
3.2 R32 4motion 177-179 kW (241-243 PS) BJS	09.2002→06.2005		7.22738.08.0	SLP	EL	
3.2 R32 4motion 177 kW (241 PS) BML	09.2002→06.2005		7.22286.55.0	ARV	PN	
			7.05271.23.0	LS	900 mm	rechts Right
			7.05270.98.0	LS	700 mm	nach Katalysator, rechts Post-catalyst, Right
			7.22738.08.0	SLP	EL	

V

GOLF IV (9B3) **24**

1.8 GTI 132-142 kW (180-193 PS) AUG	01.2007→12.2010		7.22769.73.0	ARV	PN	 ■ Argentinien, Brasilien ■ Argentina, Brazil
			7.05271.24.0	LS	1500 mm	vor Katalysator in front of the catalyst
1.8 GTI 132-142 kW (180-193 PS) AUG	04.2007→05.2008		7.22769.73.0	ARV	PN	 ■ Argentinien, Brasilien ■ Argentina, Brazil
			7.05271.24.0	LS	1500 mm	vor Katalysator in front of the catalyst



GOLF IV Cabriolet (1E7) 25

2.0 85 kW (115-116 PS) ATU, AWF	06.1998→06.2002		7.22286.26.0	ARV	PN	ATU, AWF: ch. 1E-X-000 001→ch. 1E-Y-020 000
			7.22738.08.0 7.22778.80.0	SLP SLV	EL PN	ATU, AWF: ch. 1E-1-000 001→ ATU, AWF: Fahrgestellnummer ab: 1E-1-000 001 Vehicle Identification Number from: 1E-1-000 001
2.0 85 kW (116 PS) AWG	06.1998→06.2002		7.22286.26.0	ARV	PN	ch. 1E-X-000 001→ch. 1E-Y-020 000
			7.05271.21.0	LS	1250 mm	Regelsonde, Diagnosesonde Regulating Probe, Diagnostic Probe
			7.22738.08.0 7.21851.31.0	SLP SLP	EL EL	ch. 1E-1-000 001→ →ch. 1E-Y-020 000, PKW, Cabriolet/ Passenger car, cabriolet
			7.22778.80.0	SLV	PN	ch. 1E-1-000 001→ Fahrgestellnummer ab: 1E-1-000 001 Vehicle Identification Number from: 1E-1-000 001











































GOLF IV Variant (1J5) 26

1.4 16V 55 kW (75 PS) AHW, AKQ	05.1999→06.2006		7.05271.03.0	LS	730 mm	AHW, AKQ: Regelsonde Regulating Probe
1.4 16V 55 kW (75 PS) APE	05.1999→06.2006		7.22785.17.0	AGR	EL	ch. 1J-W-000 001→
			7.05271.23.0	LS	900 mm	
			7.05271.24.0	LS	1500 mm	vor Katalysator in front of the catalyst
1.4 16V 55 kW (75 PS) AXP	05.1999→06.2006		7.22785.17.0	AGR	EL	→04.2001, ch. 1J-W-000 001→
			7.28248.17.0	AGR	EL	05.2001→
			7.05271.23.0	LS	900 mm	
			7.05271.24.0	LS	1500 mm	vor Katalysator in front of the catalyst
1.4 16V 55 kW (75 PS) BCA	05.1999→06.2006		7.28248.17.0	AGR	EL	→ch. 1K-5-600 000
			7.05271.23.0	LS	900 mm	
			7.05271.24.0	LS	1500 mm	vor Katalysator in front of the catalyst
1.6 65-76 kW (100-103 PS) AEH, AKL	05.1999→04.2002		7.05271.04.0	LS	505 mm	AEH, AKL: →ch. 1J-X-132 000
			7.05271.21.0	LS	1250 mm	AEH, AKL: ch. 1J-X-132 001→ Regelsonde Regulating Probe
1.6 74 kW (101 PS) APF	05.1999→04.2002		7.22574.12.0	AGR	EL	ch. 1J-W-000 001→
			7.22286.41.0	ARV	PN	ch. 1J-W-000 001→
			7.05271.24.0	LS	1500 mm	ch. 1J-W-000 001→ vor Katalysator in front of the catalyst
			7.22738.08.0	SLP	EL	ch. 1J-Y-000 001→
1.6 75 kW (102 PS) AVU	08.2000→06.2006		7.22574.12.0	AGR	EL	ch. 1J-W-000 001→











































GOLF IV Variant (1J5) **26**

			7.05271.24.0	LS	1500 mm	 ch. 1J-W-000 001→ vor Katalysator in front of the catalyst
			7.22738.08.0	SLP	EL	 ch. 1J-Y-000 001→
			7.22778.96.0	SLV	PN	  ch. 1J-W-000 001→
1.6 75 kW (102 PS) BFQ	08.2000→06.2006		7.22574.12.0	AGR	EL	
			7.22738.08.0	SLP	EL	
			7.22778.96.0	SLV	PN	
1.6 16V 77 kW (105 PS) ATN, AUS	02.2000→06.2006		7.22785.17.0	AGR	EL	 ATN, AUS: →04.2001,  ch. 1J-W-000 001→
1.6 16V 77 kW (105 PS) AZD	02.2000→06.2006		7.22785.17.0	AGR	EL	 →04.2001,  ch. 1J-W-000 001→
			7.28248.17.0	AGR	EL	 05.2001→
1.6 16V 77 kW (105 PS) BCB	02.2000→06.2006		7.28248.17.0	AGR	EL	
1.6 FSI 81 kW (110 PS) BAD	01.2002→06.2006		7.08369.34.0	ATS	EL	
1.6 FSi 85 kW (115 PS) BAG	10.2003→07.2004		7.08369.34.0	ATS	EL	Fahrgestellnummer bis: 1K-4-900 000 Vehicle Identification Number to: 1K-4-900 000
1.8 4motion 92 kW (125 PS) AGN	05.1999→06.2006		7.05271.03.0	LS	730 mm	
1.8 T 110 kW (150 PS) AGU	05.2000→06.2006		7.05271.03.0	LS	730 mm	Regelsonde Regulating Probe
1.8 T 110 kW (150 PS) ARZ	05.2000→06.2006		7.22769.73.0	ARV	PN	  ch. 1J-W-000 001→
			7.21851.31.0	SLP	EL	 ch. 1J-W-000 001→
1.8 T 110 kW (150 PS) AUM	09.2000→06.2006		7.22769.73.0	ARV	PN	  ch. 1J-W-000 001→
			7.05271.23.0	LS	900 mm	
			7.05271.24.0	LS	1500 mm	vor Katalysator in front of the catalyst
			7.21851.31.0	SLP	EL	 ch. 1J-W-000 001→
1.8 T 132-142 kW (180-193 PS) AUQ	05.2002→06.2006		7.22769.73.0	ARV	PN	
			7.05270.99.0	LS	940 mm	Diagnosesonde Diagnostic Probe
			7.05271.23.0	LS	900 mm	
			7.05271.24.0	LS	1500 mm	vor Katalysator in front of the catalyst
			7.21851.31.0	SLP	EL	
1.9 SDI 50 kW (68 PS) AGP, AQM	05.1999→06.2006		7.22477.10.0	AGR	PN	 AGP, AQM:  ch. 1J-W-000 001→
1.9 TDI 66-67 kW (90-91 PS) AGR, ALH	05.1999→05.2006		7.24809.17.0	AGR	PN	
1.9 TDI 81 kW (110 PS) AHF, ASV	05.1999→06.2001		7.24809.17.0	AGR	PN	
1.9 TDI 85 kW (115 PS) AJM, AUJ	08.1999→06.2001		7.24809.17.0	AGR	PN	
1.9 TDI 74 kW (101 PS) ATD	09.2000→06.2006		7.24809.17.0	AGR	PN	
1.9 TDI 74 kW (101 PS) AXR	09.2000→06.2006		7.24809.16.0	AGR	PN	

















V

					
GOLF IV Variant (1J5)					
26					
1.9 TDI 96 kW (130 PS) ASZ	11.2000→06.2006		7.24809.26.0	AGR	PN  ch. 1J-W-000 001→
1.9 TDI 110 kW (150 PS) ARL	06.2001→06.2006		7.24809.26.0	AGR	PN  ch. 1J-W-000 001→
1.9 TDI 4motion 66 kW (90 PS) AGR	05.1999→04.2002		7.24809.17.0	AGR	PN 
1.9 TDI 4motion 85 kW (115 PS) AJM	05.1999→06.2001		7.24809.17.0	AGR	PN 
1.9 TDI 4motion 74 kW (101 PS) ATD	09.2000→06.2006		7.24809.17.0	AGR	PN 
1.9 TDI 4motion 96 kW (130 PS) ASZ	11.2000→06.2006		7.24809.26.0	AGR	PN  ch. 1J-W-000 001→
1.9 TDI 4motion 110 kW (150 PS) ARL	05.2002→06.2005		7.24809.26.0	AGR	PN  ch. 1J-W-000 001→
2.0 85 kW (116 PS) APK	05.1999→06.2006		7.05271.02.0	LS	500 mm Diagnosesonde Diagnostic Probe
2.0 85 kW (115 PS) AQY	05.1999→06.2006		7.22286.26.0	ARV	PN  ch. 1J-W-000 001→ch. 1J-1B073 000
			7.05271.02.0	LS	500 mm Diagnosesonde Diagnostic Probe
			7.22738.08.0	SLP	EL  ch. 1J-Y-000 001→
			7.21851.31.0	SLP	EL  →ch. 1J-X-999 999
			7.22778.80.0	SLV	PN  Fahrgestellnummer ab: 1J-1B073 001, 1J-1D231 001, 1J-1P136 001, 1J-1U044 001, 1J-1W269 001 Vehicle Identification Number from: 1J-1B073 001, 1J-1D231 001, 1J-1P136 001, 1J-1U044 001, 1J-1W269 001
2.0 85 kW (115 PS) AZJ	05.1999→06.2006		7.05270.98.0	LS	700 mm nach Katalysator Post-catalyst
			7.05271.02.0	LS	500 mm Diagnosesonde Diagnostic Probe
			7.05271.24.0	LS	1500 mm vor Katalysator in front of the catalyst
			7.22738.08.0	SLP	EL 
			7.22778.80.0	SLV	PN 
2.0 4motion 85 kW (115 PS) AZH	10.2000→06.2006		7.05270.99.0	LS	940 mm Diagnosesonde Diagnostic Probe
			7.05271.24.0	LS	1500 mm  ch. 1J-W-000 001→ vor Katalysator in front of the catalyst
			7.22738.08.0 7.22778.80.0	SLP SLV	EL  ch. 1J-Y-000 001→ PN 
2.0 4motion 85 kW (115 PS) AZJ	10.2000→06.2006		7.05271.02.0	LS	500 mm Diagnosesonde Diagnostic Probe
			7.05271.24.0	LS	1500 mm vor Katalysator in front of the catalyst
			7.22738.08.0	SLP	EL 
			7.22778.80.0	SLV	PN 
2.0 Bi-Fuel 85 kW (116 PS) BEH	02.2002→06.2006		7.05270.98.0	LS	700 mm nach Katalysator Post-catalyst
			7.05271.02.0	LS	500 mm
			7.05271.24.0	LS	1500 mm vor Katalysator in front of the catalyst
			7.22738.08.0	SLP	EL 
			7.22778.80.0	SLV	PN 

V











GOLF IV Variant (1J5) **26**

2.3 V5 110 kW (150 PS) AGZ	05.1999→06.2006	 7.22286.55.0	ARV	PN	 Fahrgestellnummer ab: 1J-W-000 001 Vehicle Identification Number from: 1J-W-000 001	
		7.05271.03.0	LS	730 mm		
2.3 V5 125 kW (170 PS) AQN	10.2000→06.2006	 7.22286.55.0	ARV	PN	 Fahrgestellnummer ab: 1J-W-000 001 Vehicle Identification Number from: 1J-W-000 001	
		7.05271.01.0	LS	950 mm		
		7.05270.89.0	LS	925 mm		
		7.05271.23.0	LS	900 mm		
		7.05270.91.0	LS	350 mm		
		7.05271.00.0	LS	1525 mm		
		7.05271.24.0	LS	1500 mm		 ch. 1J-W-000 001→ vor Katalysator in front of the catalyst
7.22738.08.0	SLP	EL				
2.3 V5 4motion 110 kW (150 PS) AGZ	05.1999→06.2006	 7.22286.55.0	ARV	PN	 Fahrgestellnummer ab: 1J-W-000 001 Vehicle Identification Number from: 1J-W-000 001	
		7.05271.03.0	LS	730 mm		
2.3 V5 4motion 125 kW (170 PS) AQN	10.2000→06.2006	 7.22286.55.0	ARV	PN	 Fahrgestellnummer ab: 1J-W-000 001 Vehicle Identification Number from: 1J-W-000 001	
		7.05271.01.0	LS	950 mm		
		7.05270.89.0	LS	925 mm		
		7.05271.23.0	LS	900 mm		
		7.05270.98.0	LS	700 mm		 ch. 1J-W-000 001→ nach Katalysator, rechts Post-catalyst, Right
		7.05270.91.0	LS	350 mm		
		7.05271.00.0	LS	1525 mm		
7.05271.24.0	LS	1500 mm	 ch. 1J-W-000 001→ vor Katalysator in front of the catalyst			
7.22738.08.0	SLP	EL				
2.8 V6 4motion 150 kW (204 PS) AQP, AUE	05.1999→06.2006	 7.22286.55.0	ARV	PN	 AQP, AUE: Fahrgestellnummer ab: 1J-W-000 001 Vehicle Identification Number from: 1J-W-000 001  AQP, AUE:  ch. 1J-W-000 001→ nach Katalysator, rechts Post-catalyst, Right  AQP, AUE: rechts Right Diagnosesonde Diagnostic Probe  AQP, AUE: links Left	
		7.05270.98.0	LS	700 mm		
		7.05270.91.0	LS	350 mm		
		7.05271.00.0	LS	1525 mm		





















V



GOLF IV Variant (1J5) 26

			7.05271.24.0	LS	1500 mm	 AQP:  ch. 1J-W-000 001→ vor Katalysator, beidseitig in front of the catalyst, Left and right
			7.22738.08.0	SLP	EL	 AUE:  ch. 1J-W-000 001→ vor Katalysator in front of the catalyst
			7.22738.08.0	SLP	EL	 AQP, AUE:  ch. 1J-W-000 001→
2.8 V6 4motion 150 kW (204 PS) BDE	05.1999→06.2006		7.22286.55.0	ARV	PN	
			7.05270.98.0	LS	700 mm	nach Katalysator, rechts Post-catalyst, Right
			7.05270.91.0	LS	350 mm	rechts Right
			7.05271.00.0	LS	1525 mm	links links
			7.22738.08.0	SLP	EL	Left



























GOLF PLUS V (5M1, 521) 27

1.4 16V 55 kW (75 PS) BCA	01.2005→11.2006		7.28248.17.0	AGR	EL	
			7.05271.15.0	LS	525 mm	 →ch. 1K-5-600 000
1.4 16V 59-60 kW (80-82 PS) BUD, CGGA	05.2006→12.2013		7.05271.18.0	LS	525 mm	
1.4 FSI 66 kW (90 PS) BLN	07.2005→11.2006		7.10334.04.0	AGR	EL	
			7.08369.41.0	ATS	EL	
1.4 TSI 90 kW (122 PS) CAXA	06.2007→12.2013		7.05271.18.0	LS	525 mm	
1.6 75 kW (102 PS) BSE, CCSA, CMXA	05.2005→12.2013		7.05271.18.0	LS	525 mm	
			7.22738.08.0	SLP	EL	 ch. 1K-9-900 001→
			7.22778.96.0	SLV	PN	
1.6 75 kW (102 PS) BSF	05.2005→12.2013		7.05271.18.0	LS	525 mm	
1.6 BiFuel 75 kW (102 PS) CHGA	05.2009→12.2013		7.05271.18.0	LS	525 mm	
			7.22738.08.0	SLP	EL	 ch. 1K-9-900 001→
			7.22778.96.0	SLV	PN	
1.6 FSI 85 kW (115 PS) BLF	12.2004→05.2008		7.10334.04.0	AGR	EL	
			7.05271.15.0	LS	525 mm	
			7.05271.30.0	LS	400 mm	
1.6 MultiFuel 75 kW (102 PS) CCSA, CMXA	11.2007→12.2013		7.05271.18.0	LS	525 mm	
			7.22738.08.0	SLP	EL	 ch. 1K-9-900 001→
			7.22778.96.0	SLV	PN	
1.6 TDI 66 kW (90 PS) CAYB	02.2009→12.2013		7.09720.00.0	AGR-K	EL	
			7.08369.01.0	ATS	EL	Fahrgestellnummer ab: 1K-9-900 001 Vehicle Identification Number from: 1K-9-900 001
			7.08369.04.0	ATS	EL	Fahrgestellnummer ab: 1K-9-900 001 Vehicle Identification Number from: 1K-9-900 001

























GOLF PLUS V (5M1, 521) **27**





			7.11492.00.0	DDS		ohne Zubehör without accessories  ch. 1K-9-900 001→
1.6 TDI 77 kW (105 PS) CAYC	03.2009→12.2013		7.09720.00.0	AGR-K	EL	
			7.08369.01.0	ATS	EL	Fahrgestellnummer ab: 1K-9-900 001 Vehicle Identification Number from: 1K-9-900 001
			7.08369.04.0	ATS	EL	Fahrgestellnummer ab: 1K-9-900 001 Vehicle Identification Number from: 1K-9-900 001
			7.11492.00.0	DDS		ohne Zubehör without accessories  ch. 1K-9-900 001→
1.9 TDI 77 kW (105 PS) BLS	01.2005→01.2009		7.00678.04.0*	AGR-M	EL	mit Rohrstützen with pipe socket  ch. 1K-6-000 001→ch. 1K-9-899 9 99
			↳ 7.00907.03.0	AGR	EL	
			7.00678.06.0	AGR-M	EL	
			7.08369.00.0	ATS	EL	
			7.08369.02.0	ATS	EL	
			7.08369.03.0	ATS	EL	
			7.11492.02.0	DDS		ohne Zubehör without accessories  ch. 1K-7-000 001→  →ch. 1K-6-250 000
			7.11190.02.0	DDS		
1.9 TDI 77 kW (105 PS) BXE	01.2005→01.2009		7.24809.16.0	AGR	PN	
1.9 TDI 66 kW (90 PS) BXF	05.2005→12.2008		7.24809.16.0	AGR	PN	
1.9 TDI 66 kW (90 PS) BXJ	05.2005→12.2008		7.00678.04.0*	AGR-M	EL	mit Rohrstützen with pipe socket  →ch. 1K-9-899 999
			↳ 7.00907.03.0	AGR	EL	
			7.00678.06.0	AGR-M	EL	
			7.08369.00.0	ATS	EL	
			7.08369.02.0	ATS	EL	
			7.08369.03.0	ATS	EL	
			7.11492.02.0	DDS		ohne Zubehör without accessories
			7.10334.09.0	AGR	EL	
2.0 FSI 110 kW (150 PS) BLR	05.2005→06.2008		7.10334.09.0	AGR	EL	
2.0 FSI 110 kW (150 PS) BVY	05.2005→06.2008		7.10334.09.0	AGR	EL	
			7.05271.29.0	LS	900 mm	rechts Right
2.0 TDI 96 kW (131 PS) BEE	05.2005→05.2007		7.24809.16.0	AGR	PN	
2.0 TDI 100 kW (136 PS) AZV	05.2005→12.2013		7.24809.16.0	AGR	PN	
2.0 TDI 100 kW (136 PS) CBDA	05.2005→12.2013		7.10334.00.0	AGR	EL	  ch. 1K-9-900 001→
			7.08369.01.0	ATS	EL	Fahrgestellnummer ab: 1K-9-900 001 Vehicle Identification Number from: 1K-9-900 001
			7.08369.04.0	ATS	EL	Fahrgestellnummer ab: 1K-9-900 001 Vehicle Identification Number from: 1K-9-900 001
			7.11492.02.0	DDS		ohne Zubehör without accessories  ch. 1K-9-900 001→



GOLF PLUS V (5M1, 521) 27











2.0 TDI 100 kW (136 PS) CFHB	05.2005→12.2013		7.09720.00.0	AGR-K	EL	 ch. 1K-9-900 001→	
			7.11190.09.0	DDS			 ch. 1K-9-900 001→
2.0 TDI 103 kW (140 PS) BMM	12.2005→05.2011		7.00678.04.0*	AGR-M	EL	mit Rohrstützen with pipe socket  →ch. 1K-9-899 999	
			↳7.00907.03.0	AGR	EL		
			7.00678.06.0	AGR-M	EL		
			7.08369.00.0	ATS	EL		
			7.08369.02.0	ATS	EL		
			7.08369.03.0	ATS	EL		
			7.11492.02.0	DDS			ohne Zubehör without accessories  ch. 1K-7-000 001→
7.11190.02.0	DDS		 →ch. 1K-6-250 000				
2.0 TDI 81 kW (110 PS) CBDC	01.2009→12.2013		7.10334.00.0	AGR	EL	 ch. 1K-9-900 001→	
			7.08369.01.0	ATS	EL		Fahrgestellnummer ab: 1K-9-900 001 Vehicle Identification Number from: 1K-9-900 001
			7.08369.04.0	ATS	EL		Fahrgestellnummer ab: 1K-9-900 001 Vehicle Identification Number from: 1K-9-900 001
			7.11492.02.0	DDS			ohne Zubehör without accessories  ch. 1K-9-900 001→
2.0 TDI 81 kW (110 PS) CLCA	01.2009→12.2013		7.09720.00.0	AGR-K	EL	 ch. 1K-9-900 001→	
2.0 TDI 16V 103 kW (140 PS) BKD	01.2005→12.2013		7.24809.16.0	AGR	PN		
2.0 TDI 16V 103 kW (140 PS) CBDB	01.2005→12.2013		7.10334.00.0	AGR	EL	 ch. 1K-9-900 001→	
			7.08369.01.0	ATS	EL		Fahrgestellnummer ab: 1K-9-900 001 Vehicle Identification Number from: 1K-9-900 001
			7.08369.04.0	ATS	EL		Fahrgestellnummer ab: 1K-9-900 001 Vehicle Identification Number from: 1K-9-900 001
			7.11492.02.0	DDS			ohne Zubehör without accessories  ch. 1K-9-900 001→
2.0 TDI 16V 103 kW (140 PS) CFHC	01.2005→12.2013		7.09720.00.0	AGR-K	EL	 ch. 1K-9-900 001→	
			7.11190.09.0	DDS			 ch. 1K-9-900 001→

GOLF SPORTSVAN VII (AM1, AN1) 28

1.6 TDI 81 kW (110 PS) CRKB	02.2014→		7.10334.02.0	AGR	EL	 ch. AU-D-000 001→
			7.03608.16.0	AK	EL	
			7.08369.79.0	ATS	EL	
			7.08369.82.0	ATS	EL	
			7.11492.03.0	DDS		
1.6 TDI 81 kW (110 PS) CXXB	02.2014→		7.10334.02.0	AGR	EL	 ch. AU-D-000 001→
			7.03608.16.0	AK	EL	
			7.08369.95.0	ATS	EL	
			7.11020.17.0	ATS	EL	









GOLF SPORTSVAN VII (AM1, AN1)

			7.11492.03.0	DDS		ohne Zubehör without accessories für Hersteller-Abgasnorm: Euro 6 plus for manufacturer exhaust norm: Euro 6 plus
1.6 TDI 81 kW (110 PS) DBKA	02.2014→		7.10334.02.0	AGR	EL	 ch. AU-D-000 001→
			7.08369.95.0	ATS	EL	
			7.11020.17.0	ATS	EL	vor Katalysator in front of the catalyst
			7.11492.03.0	DDS		ohne Zubehör without accessories für Hersteller-Abgasnorm: Euro 6 plus for manufacturer exhaust norm: Euro 6 plus
1.6 TDI 66 kW (90 PS) CRKA	02.2014→		7.10334.02.0	AGR	EL	 ch. AU-D-000 001→
			7.03608.16.0	AK	EL	
			7.08369.79.0	ATS	EL	
			7.08369.82.0	ATS	EL	
			7.11492.03.0	DDS		ohne Zubehör without accessories für Hersteller-Abgasnorm: Euro 6 plus for manufacturer exhaust norm: Euro 6 plus
1.6 TDI 66 kW (90 PS) CXXA	02.2014→		7.10334.02.0	AGR	EL	 ch. AU-D-000 001→
			7.03608.16.0	AK	EL	
			7.08369.95.0	ATS	EL	
			7.11020.17.0	ATS	EL	vor Katalysator in front of the catalyst
			7.11492.03.0	DDS		ohne Zubehör without accessories für Hersteller-Abgasnorm: Euro 6 plus for manufacturer exhaust norm: Euro 6 plus
1.6 TDI 66 kW (90 PS) DDYB	02.2014→		7.03608.16.0	AK	EL	
			7.08369.95.0	ATS	EL	
			7.11492.03.0	DDS		ohne Zubehör without accessories für Hersteller-Abgasnorm: Euro 6 plus for manufacturer exhaust norm: Euro 6 plus
1.6 TDI 85 kW (115 PS) DDYA	11.2016→		7.03608.16.0	AK	EL	
			7.08369.95.0	ATS	EL	
			7.11492.03.0	DDS		ohne Zubehör without accessories für Hersteller-Abgasnorm: Euro 6 plus for manufacturer exhaust norm: Euro 6 plus
1.6 TDI 85 kW (115 PS) DGTE	11.2016→		7.03608.16.0	AK	EL	
			7.11020.17.0	ATS	EL	vor Katalysator in front of the catalyst
			7.11020.22.0	ATS	EL	
			7.11020.23.0	ATS	EL	
			7.11492.05.0	DDS		ohne Zubehör without accessories
2.0 TDI 110 kW (150 PS) CRLB	02.2014→		7.10334.02.0	AGR	EL	 ch. AU-D-000 001→
			7.03608.16.0	AK	EL	

V



























GOLF SPORTSVAN VII (AM1, AN1) **28**

			<p>↳ 7.07696.00.0 SRM-AK EL</p> <p>7.08369.81.0 ATS EL</p> <p>7.11492.03.0 DDS</p> <p>7.11492.05.0 DDS</p>		<p>ohne Zubehör without accessories Schaltgetriebe 6 Gang, Getriebeautomatik 6 Gang 6-Speed Manual Transmission, 6-Speed Automatic Transmission</p> <p>ohne Zubehör without accessories für Getriebeautomatik 7 Gang for 7-speed automatic transmission</p>
2.0 TDI 110 kW (150 PS) DCYA	02.2014→		<p>7.03608.16.0 AK EL</p> <p>7.08369.81.0 ATS EL</p> <p>7.11492.03.0 DDS</p> <p>7.11492.05.0 DDS</p>		<p>ohne Zubehör without accessories Schaltgetriebe 6 Gang, Getriebeautomatik 6 Gang 6-Speed Manual Transmission, 6-Speed Automatic Transmission</p> <p>ohne Zubehör without accessories für Getriebeautomatik 7 Gang for 7-speed automatic transmission</p>
2.0 TDI 110 kW (150 PS) DFGA	02.2014→		<p>7.03608.16.0 AK EL</p> <p>7.08369.81.0 ATS EL</p> <p>7.11492.05.0 DDS</p>		<p>ohne Zubehör without accessories</p>
2.0 TDI 81 kW (110 PS) CRVA	05.2014→11.2017		<p>7.10334.02.0 AGR EL</p> <p>7.03608.16.0 AK EL</p> <p>↳ 7.07696.00.0 SRM-AK EL</p>		<p> ch. AU-D-000 001→</p>
2.0 TDI 81 kW (110 PS) CRLD	05.2016→11.2017		<p>7.10334.02.0 AGR EL</p> <p>7.03608.16.0 AK EL</p> <p>7.08369.81.0 ATS EL</p> <p>7.11492.03.0 DDS</p> <p>7.11492.05.0 DDS</p>		<p></p> <p>ohne Zubehör without accessories Schaltgetriebe 6 Gang, Getriebeautomatik 6 Gang 6-Speed Manual Transmission, 6-Speed Automatic Transmission</p> <p>ohne Zubehör without accessories für Getriebeautomatik 7 Gang for 7-speed automatic transmission</p>
2.0 TDI 81 kW (110 PS) DCYB	11.2016→11.2017		<p>7.03608.16.0 AK EL</p> <p>7.08369.81.0 ATS EL</p> <p>7.11492.03.0 DDS</p> <p>7.11492.05.0 DDS</p>		<p>ohne Zubehör without accessories Schaltgetriebe 6 Gang, Getriebeautomatik 6 Gang 6-Speed Manual Transmission, 6-Speed Automatic Transmission</p> <p>ohne Zubehör without accessories für Getriebeautomatik 7 Gang for 7-speed automatic transmission</p>





GOLF V (1K1) **29**

1.4 16V 55 kW (75 PS) BCA	10.2003→05.2006	 7.28248.17.0	AGR	EL	vor Katalysator in front of the catalyst
		7.05271.15.0	LS	525 mm	
		7.05271.24.0	LS	1500 mm	
1.4 16V 59-60 kW (80-82 PS) BUD	05.2006→11.2008	 7.05271.18.0	LS	525 mm	
1.4 FSI 66 kW (90 PS) BKG	10.2003→07.2006	 7.10334.04.0	AGR	EL	 ch. 1K-4-000 001→
		7.08369.34.0	ATS	EL	Fahrgestellnummer bis: 1K-4-900 000 Vehicle Identification Number to: 1K-4-900 000
		7.05271.30.0	LS	400 mm	 ch. 1K-5-000 001→ Schaltgetriebe Manual Transmission
1.4 FSI 66 kW (90 PS) BLN	10.2003→07.2006	 7.10334.04.0	AGR	EL	 ch. 1K-4-000 001→
		7.08369.41.0	ATS	EL	Fahrgestellnummer ab: 1K-4-900 001 Vehicle Identification Number from: 1K-4-900 001
		7.05271.30.0	LS	400 mm	 ch. 1K-5-000 001→
1.4 TSI 90 kW (122 PS) CAXA	05.2007→11.2008	 7.05271.18.0	LS	525 mm	Schaltgetriebe Manual Transmission
1.6 75 kW (102 PS) BGU	01.2004→11.2008	 7.22574.12.0	AGR	EL	 ch. 1K-4-000 001→
		7.05271.18.0	LS	525 mm	
		7.22738.08.0	SLP	EL	 ch. 1K-4-000 001→
		7.22778.96.0	SLV	PN	 ch. 1K-4-000 001→
1.6 75 kW (102 PS) BSE, CCSA	01.2004→11.2008	 7.05271.18.0	LS	525 mm	
		7.22738.08.0	SLP	EL	
		7.22778.96.0	SLV	PN	 ch. 1K-6-000 001→
1.6 75 kW (102 PS) BSF	01.2004→11.2008	 7.05271.18.0	LS	525 mm	
1.6 FSI 85 kW (115 PS) BAG	10.2003→07.2008	 7.10334.04.0	AGR	EL	 ch. 1K-4-000 001→
		7.08369.34.0	ATS	EL	Fahrgestellnummer bis: 1K-4-900 000 Vehicle Identification Number to: 1K-4-900 000
		7.08369.41.0	ATS	EL	Fahrgestellnummer ab: 1K-4-000 001 Vehicle Identification Number from: 1K-4-000 001
1.6 FSI 85 kW (115 PS) BLF	10.2003→07.2008	 7.10334.04.0	AGR	EL	 ch. 1K-4-000 001→
		7.05271.15.0	LS	525 mm	
		7.05271.30.0	LS	400 mm	 ch. 1K-5-000 001→ Schaltgetriebe Manual Transmission
1.6 FSI 85 kW (115 PS) BLP	10.2003→07.2008	 7.10334.04.0	AGR	EL	 ch. 1K-4-000 001→
		7.08369.41.0	ATS	EL	Fahrgestellnummer ab: 1K-4-000 001 Vehicle Identification Number from: 1K-4-000 001
		7.05271.30.0	LS	400 mm	 ch. 1K-5-000 001→ Schaltgetriebe Manual Transmission































GOLF V (1K1) 29

1.6 MultiFuel 75 kW (102 PS) CCSA	10.2007→11.2008		7.05271.18.0	LS	525 mm	
			7.22738.08.0	SLP	EL	
1.9 TDI 77 kW (105 PS) BKC	10.2003→11.2008		7.24809.16.0	AGR	PN	
1.9 TDI 77 kW (105 PS) BLS	10.2003→11.2008		7.00678.04.0*	AGR-M	EL	mit Rohrstützen with pipe socket ch. 1K-6-000 001→ch. 1K-9-899 99
			↳7.00907.03.0	AGR	EL	
			7.00678.06.0	AGR-M	EL	ch. 1K-6-000 001→
			7.08369.00.0	ATS	EL	Fahrgestellnummer ab: 1K-6-000 001 Vehicle Identification Number from: 1K-6-000 001
			7.08369.02.0	ATS	EL	Fahrgestellnummer ab: 1K-6-000 001 Vehicle Identification Number from: 1K-6-000 001
			7.08369.03.0	ATS	EL	Fahrgestellnummer ab: 1K-6-000 001 Vehicle Identification Number from: 1K-6-000 001
			7.11190.02.0	DDS	EL	ch. 1K-6-000 001→ch. 1K-6-250 000
			7.11492.02.0	DDS	EL	ohne Zubehör without accessories ch. 1K-7-000 001→
1.9 TDI 77 kW (105 PS) BXE	10.2003→11.2008		7.24809.16.0	AGR	PN	
			7.08369.00.0	ATS	EL	
			7.08369.02.0	ATS	EL	Fahrgestellnummer ab: 1K-6-000 001 Vehicle Identification Number from: 1K-6-000 001
			7.08369.03.0	ATS	EL	Fahrgestellnummer ab: 1K-6-000 001 Vehicle Identification Number from: 1K-6-000 001
1.9 TDI 66 kW (90 PS) BRU, BXF	05.2004→11.2008		7.24809.16.0	AGR	PN	
1.9 TDI 66 kW (90 PS) BXJ	05.2004→11.2008		7.00678.04.0*	AGR-M	EL	mit Rohrstützen with pipe socket →ch. 1K-9-899 999
			↳7.00907.03.0	AGR	EL	
			7.00678.06.0	AGR-M	EL	
			7.08369.00.0	ATS	EL	
			7.08369.02.0	ATS	EL	Fahrgestellnummer ab: 1K-4-000 001 Vehicle Identification Number from: 1K-4-000 001
			7.08369.03.0	ATS	EL	
			7.11492.02.0	DDS	EL	ohne Zubehör without accessories
1.9 TDI 4motion 77 kW (105 PS) BKC	08.2004→11.2008		7.24809.16.0	AGR	PN	
1.9 TDI 4motion 77 kW (105 PS) BLS	08.2004→11.2008		7.00678.04.0*	AGR-M	EL	mit Rohrstützen with pipe socket ch. 1K-6-000 001→ch. 1K-9-899 99
			↳7.00907.03.0	AGR	EL	
			7.00678.06.0	AGR-M	EL	ch. 1K-9-000 001→
			7.08369.00.0	ATS	EL	Fahrgestellnummer ab: 1K-6-000 001 Vehicle Identification Number from: 1K-6-000 001
			7.08369.02.0	ATS	EL	Fahrgestellnummer ab: 1K-6-000 001 Vehicle Identification Number from: 1K-6-000 001





































GOLF V (1K1) **29**

			7.08369.03.0	ATS	EL	Fahrgestellnummer ab: 1K-6-000 001 Vehicle Identification Number from: 1K-6-000 001
			7.11190.02.0	DDS		 ch. 1K-6-000 001→ch. 1K-6-250 000
			7.11492.02.0	DDS		ohne Zubehör without accessories  ch. 1K-7-000 001→
1.9 TDI 4motion 77 kW (105 PS) BXE	08.2004→11.2008		7.24809.16.0	AGR	PN	
			7.08369.00.0	ATS	EL	
			7.08369.02.0	ATS	EL	Fahrgestellnummer ab: 1K-6-000 001 Vehicle Identification Number from: 1K-6-000 001
			7.08369.03.0	ATS	EL	Fahrgestellnummer ab: 1K-6-000 001 Vehicle Identification Number from: 1K-6-000 001
2.0 85 kW (116 PS) BHY	01.2005→11.2008		7.05270.98.0	LS	700 mm	nach Katalysator Post-catalyst
2.0 FSI 110 kW (150 PS) AXW, BLX	01.2004→11.2008		7.10334.09.0	AGR	EL	 AXW: 02.2004→06.2004,  ch. 1K-4-000 001→ BLX: →04.2007,  ch. 1K-4-000 001→
			7.08369.41.0	ATS	EL	 AXW, BLX: Fahrgestellnummer ab: 1K-4-000 001 Vehicle Identification Number from: 1K-4-000 001
			7.05271.29.0	LS	900 mm	 AXW, BLX: rechts Right
			7.05271.16.0	LS	1300 mm	 AXW, BLX: links, rechts Left, Right Diagnosesonde Diagnostic Probe
2.0 FSI 110 kW (150 PS) BLR, BVX, BVY	01.2004→11.2008		7.10334.09.0	AGR	EL	 BLR: →04.2007,  ch. 1K-4-000 001→ BVX, BVY: 01.2006→11.2008,  ch. 1K-6-000 001→
			7.05271.29.0	LS	900 mm	 BLR, BVX, BVY: rechts Right
			7.05271.16.0	LS	1300 mm	 BLR, BVY: links, rechts Left, Right Diagnosesonde Diagnostic Probe  BVX: rechts Right Diagnosesonde Diagnostic Probe
2.0 FSI 110 kW (150 PS) BLY, BVZ	01.2004→11.2008		7.05271.16.0	LS	1300 mm	 BLY, BVZ: Diagnosesonde Diagnostic Probe
2.0 FSI 4motion 110 kW (150 PS) BLX, BVX	08.2004→11.2008		7.10334.09.0	AGR	EL	 BLX: →04.2007,  ch. 1K-4-000 001→ BVX: →11.2008,  ch. 1K-6-000 001→
			7.05271.29.0	LS	900 mm	 BLX, BVX: rechts Right
			7.05271.16.0	LS	1300 mm	 BLX: links, rechts Left, Right Diagnosesonde Diagnostic Probe  BVX: rechts Right Diagnosesonde Diagnostic Probe

V











GOLF V (1K1) 29

2.0 GTI 147 kW (200 PS) BPY, BWA	10.2004→02.2009	 7.05271.15.0	LS	525 mm	
2.0 GTI 147 kW (200 PS) CAWB	10.2004→02.2009	 7.05271.11.0	LS	800 mm	Regelsonde Regulating Probe
2.0 GTI 147-157 kW (200-213 PS) CBFA	10.2004→02.2009	 7.05271.11.0	LS	800 mm	Diagnosesonde Diagnostic Probe
		 7.01510.31.0	SLV	EL	 ch. 1K-9-400 001→
2.0 GTI 169 kW (230 PS) BYD	09.2006→12.2008	 7.05271.15.0	LS	525 mm	
2.0 SDI 55 kW (75 PS) BDK	01.2004→11.2008	 7.22477.11.0	AGR	PN	
2.0 TDI 100 kW (136 PS) AZV	10.2003→11.2008	 7.24809.16.0	AGR	PN	
2.0 TDI 103 kW (140 PS) BMM	12.2004→11.2008	 7.00678.04.0*	AGR-M	EL	mit Rohrstutzen with pipe socket  ch. 1K-4-000 001→
		 7.00907.03.0	AGR	EL	
		7.00678.06.0	AGR-M	EL	 BMM:  ch. 1K-9-000 001→  BMM:  ch. 1K-4-000 001→
		7.08369.00.0	ATS	EL	Fahrgestellnummer ab: 1K-4-000 001 Vehicle Identification Number from: 1K-4-000 001
		7.08369.02.0	ATS	EL	Fahrgestellnummer ab: 1K-4-000 001 Vehicle Identification Number from: 1K-4-000 001
		7.08369.03.0	ATS	EL	Fahrgestellnummer ab: 1K-4-000 001 Vehicle Identification Number from: 1K-4-000 001
		7.11190.02.0	DDS	 ch. 1K-4-000 001→ch. 1K-6-250 000	
		7.11492.02.0	DDS	ohne Zubehör without accessories  ch. 1K-7-000 001→	
		2.0 TDI 125 kW (170 PS) BMN	11.2005→11.2008	 7.10334.00.0	AGR
7.08369.00.0	ATS			EL	Fahrgestellnummer ab: 1K-6-000 001 Vehicle Identification Number from: 1K-6-000 001
7.08369.02.0	ATS			EL	Fahrgestellnummer ab: 1K-6-000 001 Vehicle Identification Number from: 1K-6-000 001
7.08369.03.0	ATS			EL	Fahrgestellnummer ab: 1K-6-000 001 Vehicle Identification Number from: 1K-6-000 001
7.11190.02.0	DDS			 ch. 1K-6-000 001→ch. 1K-6-250 000	
7.11492.02.0	DDS			ohne Zubehör without accessories  ch. 1K-7-000 001→	
2.0 TDI 16V 103 kW (140 PS) BKD	10.2003→11.2008	 7.24809.16.0	AGR	PN	
2.0 TDI 16V 4motion 103 kW (140 PS) BKD	08.2004→11.2008	 7.24809.16.0	AGR	PN	
2.0 TDI 4motion 103 kW (140 PS) BMM	01.2007→11.2008	 7.00678.04.0*	AGR-M	EL	mit Rohrstutzen with pipe socket  ch. 1K-4-000 001→
		 7.00907.03.0	AGR	EL	
		7.00678.06.0	AGR-M	EL	 BMM:  ch. 1K-9-000 001→  BMM:  ch. 1K-4-000 001→















GOLF V (1K1) **29**

			7.08369.00.0	ATS	EL	Fahrgestellnummer ab: 1K-4-000 001 Vehicle Identification Number from: 1K-4-000 001
			7.08369.02.0	ATS	EL	Fahrgestellnummer ab: 1K-6-000 001 Vehicle Identification Number from: 1K-6-000 001
			7.08369.03.0	ATS	EL	Fahrgestellnummer ab: 1K-4-000 001 Vehicle Identification Number from: 1K-4-000 001
			7.11190.02.0	DDS	 ch. 1K-4-000 001→ch. 1K-6-250 000	
			7.11492.02.0	DDS		ohne Zubehör without accessories  ch. 1K-7-000 001→
3.2 R32 4motion 184 kW (250 PS) BUB	11.2005→11.2008		7.05271.28.0	LS	800 mm	links Left
			7.05271.15.0	LS	525 mm	rechts Right
			7.22738.20.0	SLP	EL	Fahrgestellnummer ab: 1K-6-000 001 Vehicle Identification Number from: 1K-6-000 001
			7.22778.98.0	SLV	PN	  ch. 1K-6-000 001→
3.2 R32 4motion 184 kW (250 PS) CBRA	11.2005→11.2008		7.05271.15.0	LS	525 mm	rechts Right ■ Mexico ■ Mexico
2.5 SRE 20V 112-127 kW (152-173 PS) CBUA	05.2007→11.2008		7.05271.13.0	LS	470 mm	
2.5 FSI 20V 112-127 kW (152-173 PS) CBTA	05.2007→05.2008		7.05271.13.0	LS	470 mm	











GOLF V Variant (1K5) **30**

1.4 59-60 kW (80-82 PS) BUD	06.2007→07.2009		7.05271.18.0	LS	525 mm	
1.4 TSI 90 kW (122 PS) CAXA	06.2007→07.2009		7.05271.18.0	LS	525 mm	
1.6 75 kW (102 PS) BSE, CCSA	06.2007→07.2009		7.05271.18.0	LS	525 mm	
			7.22738.08.0	SLP	EL	
			7.22778.96.0	SLV	PN	  ch. 1K-6-000 001→
1.6 75 kW (102 PS) BSF	06.2007→07.2009		7.05271.18.0	LS	525 mm	
			7.22738.08.0	SLP	EL	
1.6 MultiFuel 75 kW (102 PS) CCSA	11.2007→07.2009		7.05271.18.0	LS	525 mm	
			7.22738.08.0	SLP	EL	
1.9 TDI 77 kW (105 PS) BLS	06.2007→07.2009		7.00678.04.0*	AGR-M	EL	mit Rohrstützen with pipe socket  ch. 1K-6-000 001→ch. 1K-9-899 999
			↳ 7.00907.03.0	AGR	EL	
			7.00678.06.0	AGR-M	EL	 ch. 1K-8-054 617→
			7.08369.00.0	ATS	EL	Fahrgestellnummer ab: 1K-6-000 001 Vehicle Identification Number from: 1K-6-000 001
			7.08369.02.0	ATS	EL	
			7.08369.03.0	ATS	EL	Fahrgestellnummer ab: 1K-6-000 001 Vehicle Identification Number from: 1K-6-000 001

V













GOLF V Variant (1K5) **30**

			7.11190.02.0	DDS		für OE-Nummer: 059 906 051 A, 07Z 906 051 B for OE number: 059 906 051 A, 07Z 906 051 B
			7.11492.02.0	DDS		ohne Zubehör without accessories für OE-Nummer: 03G 906 051 A, 076 906 051 A, 076 906 051 C for OE number: 03G 906 051 A, 076 906 051 A, 076 906 051 C
1.9 TDI 77 kW (105 PS) BXE	06.2007→07.2009		7.24809.16.0	AGR	PN	
			7.08369.00.0	ATS	EL	
			7.08369.02.0	ATS	EL	
			7.08369.03.0	ATS	EL	Fahrgestellnummer ab: 1K-6-000 001 Vehicle Identification Number from: 1K-6-000 001
			7.11492.02.0	DDS		ohne Zubehör without accessories
1.9 TDI 4motion 77 kW (105 PS) BLS	01.2008→07.2009		7.00678.04.0*	AGR-M	EL	mit Rohrstützen with pipe socket  ch. 1K-6-000 001→ch. 1K-9-899 999
			↳ 7.00907.03.0	AGR	EL	
			7.00678.06.0	AGR-M	EL	 ch. 1K-8-054 617→
			7.08369.00.0	ATS	EL	Fahrgestellnummer ab: 1K-6-000 001 Vehicle Identification Number from: 1K-6-000 001
			7.08369.02.0	ATS	EL	
			7.08369.03.0	ATS	EL	Fahrgestellnummer ab: 1K-6-000 001 Vehicle Identification Number from: 1K-6-000 001
			7.11190.02.0	DDS		für OE-Nummer: 059 906 051 A, 07Z 906 051 B for OE number: 059 906 051 A, 07Z 906 051 B
			7.11492.02.0	DDS		ohne Zubehör without accessories für OE-Nummer: 03G 906 051 A, 076 906 051 A, 076 906 051 C for OE number: 03G 906 051 A, 076 906 051 A, 076 906 051 C
2.0 147 kW (200 PS) BWA	06.2007→07.2009		7.05271.15.0	LS	525 mm	
2.0 147 kW (200 PS) CAWB	06.2007→07.2009		7.05271.11.0	LS	800 mm	Regelsonde Regulating Probe
2.0 TDI 103 kW (140 PS) BMM	06.2007→07.2009		7.00678.04.0*	AGR-M	EL	mit Rohrstützen with pipe socket  ch. 1K-4-000 001→
			↳ 7.00907.03.0	AGR	EL	
			7.00678.06.0	AGR-M	EL	
			7.08369.00.0	ATS	EL	Fahrgestellnummer ab: 1K-4-000 001 Vehicle Identification Number from: 1K-4-000 001
			7.08369.02.0	ATS	EL	Fahrgestellnummer ab: 1K-6-000 001 Vehicle Identification Number from: 1K-6-000 001
			7.08369.03.0	ATS	EL	Fahrgestellnummer ab: 1K-4-000 001 Vehicle Identification Number from: 1K-4-000 001
			7.11190.02.0	DDS		 ch. 1K-4-000 001→ch. 1K-6-250 000
			7.11492.02.0	DDS		ohne Zubehör without accessories  ch. 1K-7-000 001→











































GOLF V Variant (1K5) **30**



























2.0 TDI 100 kW (136 PS) AZV	06.2007→07.2009	 7.24809.16.0	AGR	PN	
2.0 TDI 96 kW (131 PS) BVB	06.2007→07.2009	 7.08369.00.0	ATS	EL	Fahrgestellnummer ab: 1K-6-000 001 Vehicle Identification Number from: 1K-6-000 001
2.0 TDI 16V 103 kW (140 PS) BKD	06.2007→07.2009	 7.24809.16.0	AGR	PN	
2.0 TDI 16V 103 kW (140 PS) CBDB	06.2007→07.2009	 7.10334.00.0	AGR	EL	
		 7.08369.01.0	ATS	EL	Fahrgestellnummer ab: 1K-9-250 001 Vehicle Identification Number from: 1K-9-250 001
		 7.08369.04.0	ATS	EL	Fahrgestellnummer ab: 1K-9-250 001 Vehicle Identification Number from: 1K-9-250 001
		 7.11492.02.0	DDS		ohne Zubehör without accessories

GOLF VI (5K1) **31**

1.4 59 kW (80 PS) CGGA	10.2008→11.2012	 7.05271.18.0	LS	525 mm	
1.6 75 kW (102 PS) BSE, BSF, CCSA, CMXA	10.2008→11.2012	 7.05271.18.0	LS	525 mm	
		 7.22738.08.0	SLP	EL	 ch. 1K-9-400 001→
		 7.22778.96.0	SLV	PN	  BSE:  ch. 1K-6-000 001→  CMXA:  ch. 1K-9-400 001→
1.6 BiFuel 75 kW (102 PS) CHGA	03.2009→11.2012	 7.05271.18.0	LS	525 mm	
		 7.22738.08.0	SLP	EL	 ch. 1K-9-400 001→
		 7.22778.96.0	SLV	PN	  ch. 1K-9-400 001→
1.6 MultiFuel 75 kW (102 PS) CCSA, CMXA	10.2008→11.2012	 7.05271.18.0	LS	525 mm	
		 7.22738.08.0	SLP	EL	 ch. 1K-9-400 001→
		 7.22778.96.0	SLV	PN	  ch. 1K-9-400 001→
1.6 TDI 77 kW (105 PS) CAYC	02.2009→11.2012	 7.09720.00.0	AGR-K	EL	
		 7.08369.01.0	ATS	EL	Fahrgestellnummer ab: 1K-9-400 001 Vehicle Identification Number from: 1K-9-400 001
		 7.08369.04.0	ATS	EL	Fahrgestellnummer ab: 1K-9-400 001 Vehicle Identification Number from: 1K-9-400 001
		 7.11492.00.0	DDS		ohne Zubehör without accessories  ch. 1K-9-400 001→
1.6 TDI 66 kW (90 PS) CAYB	02.2009→11.2012	 7.09720.00.0	AGR-K	EL	
		 7.08369.01.0	ATS	EL	Fahrgestellnummer ab: 1K-9-400 001 Vehicle Identification Number from: 1K-9-400 001
		 7.08369.04.0	ATS	EL	Fahrgestellnummer ab: 1K-9-400 001 Vehicle Identification Number from: 1K-9-400 001
		 7.11492.00.0	DDS		ohne Zubehör without accessories  ch. 1K-9-400 001→
1.8 TSI 118 kW (160 PS) CDAA	06.2009→01.2011	 7.05271.15.0	LS	525 mm	
2.0 GTI 147-157 kW (200-213 PS) CBFA	01.2010→02.2014	 7.01510.31.0	SLV	EL	  ch. 1K-9-400 001→



















GOLF VI (5K1) **31**

2.0 GTi 155 kW (211 PS) CCZB	04.2009→11.2012		7.05271.15.0	LS	525 mm	
2.0 GTi 147-157 kW (200-213 PS) CBFA	06.2009→11.2013		7.05271.15.0	LS	525 mm	
			7.01510.31.0	SLV	EL	 ch. 1K-9-400 001→
2.0 GTi 147-157 kW (200-213 PS) CCTA, CCZA	06.2009→11.2013		7.05271.15.0	LS	525 mm	
2.0 GTi 173 kW (235 PS) CDLG	05.2011→11.2012		7.05271.15.0	LS	525 mm	
2.0 TDI 103 kW (140 PS) CBAB	10.2008→05.2013		7.10334.00.0	AGR	EL	 ch. 1K-9-400 001→
			7.08369.01.0	ATS	EL	Fahrgestellnummer ab: 1K-9-400 001 Vehicle Identification Number from: 1K-9-400 001
			7.08369.04.0	ATS	EL	Fahrgestellnummer ab: 1K-9-400 001 Vehicle Identification Number from: 1K-9-400 001
			7.11492.02.0	DDS		ohne Zubehör without accessories  ch. 1K-9-400 001→
2.0 TDI 103 kW (140 PS) CFFB	10.2008→05.2013		7.09720.00.0	AGR-K	EL	 ch. 1K-9-400 001→
			7.11190.09.0	DDS		 ch. 1K-9-400 001→
2.0 TDI 103-104 kW (140-141 PS) CJAA	10.2008→05.2013		7.10334.00.0	AGR	EL	 ch. 1K-9-400 001→
			7.01493.07.0	AGR	EL	
			7.01300.24.0	AK	EL	
			7.08369.01.0	ATS	EL	Fahrgestellnummer ab: 1K-9-400 001 Vehicle Identification Number from: 1K-9-400 001
			7.11492.00.0	DDS		ohne Zubehör without accessories  ch. 1K-9-400 001→
2.0 TDI 81 kW (110 PS) CBDC	10.2008→11.2012		7.10334.00.0	AGR	EL	 ch. 1K-9-400 001→
			7.08369.01.0	ATS	EL	Fahrgestellnummer ab: 1K-9-400 001 Vehicle Identification Number from: 1K-9-400 001
			7.08369.04.0	ATS	EL	Fahrgestellnummer ab: 1K-9-400 001 Vehicle Identification Number from: 1K-9-400 001
			7.11492.02.0	DDS		ohne Zubehör without accessories  ch. 1K-9-400 001→
2.0 TDI 81 kW (110 PS) CLCA	10.2008→11.2012		7.09720.00.0	AGR-K	EL	 ch. 1K-9-400 001→
2.0 TDI 100 kW (136 PS) CBAA	10.2008→11.2012		7.10334.00.0	AGR	EL	 ch. 1K-9-400 001→
			7.08369.01.0	ATS	EL	Fahrgestellnummer ab: 1K-9-400 001 Vehicle Identification Number from: 1K-9-400 001
			7.08369.04.0	ATS	EL	Fahrgestellnummer ab: 1K-9-400 001 Vehicle Identification Number from: 1K-9-400 001
			7.11492.02.0	DDS		ohne Zubehör without accessories  ch. 1K-9-400 001→
2.0 TDI 100 kW (136 PS) CFFA	10.2008→11.2012		7.09720.00.0	AGR-K	EL	 ch. 1K-9-400 001→
			7.11190.09.0	DDS		 ch. 1K-9-400 001→















GOLF VI (5K1) **31**

2.0 TDI 125 kW (170 PS) CBBB	04.2009→11.2012		7.10334.00.0	AGR	EL 	 ch. 1K-9-400 001→
			7.08369.00.0	ATS	EL	Fahrgestellnummer ab: 1K-9-400 001 Vehicle Identification Number from: 1K-9-400 001
			7.08369.01.0	ATS	EL	Fahrgestellnummer ab: 1K-9-400 001 Vehicle Identification Number from: 1K-9-400 001
			7.08369.04.0	ATS	EL	Fahrgestellnummer ab: 1K-9-400 001 Vehicle Identification Number from: 1K-9-400 001
			7.11492.00.0	DDS		ohne Zubehör without accessories  ch. 1K-9-400 001→ Euro 5
			7.11492.02.0	DDS		ohne Zubehör without accessories  ch. 1K-9-400 001→ Euro 4
2.0 TDI 125 kW (170 PS) CFGB	04.2009→11.2012		7.09720.00.0	AGR-K	EL 	 ch. 1K-9-400 001→
			7.11190.09.0	DDS		 ch. 1K-9-400 001→
2.0 TDI 4motion 103 kW (140 PS) CBAB	05.2009→11.2012		7.10334.00.0	AGR	EL 	 ch. 1K-9-400 001→
			7.08369.01.0	ATS	EL	Fahrgestellnummer ab: 1K-9-400 001 Vehicle Identification Number from: 1K-9-400 001
			7.08369.04.0	ATS	EL	Fahrgestellnummer ab: 1K-9-400 001 Vehicle Identification Number from: 1K-9-400 001
			7.11492.02.0	DDS		ohne Zubehör without accessories  ch. 1K-9-400 001→
2.0 TDI 4motion 103 kW (140 PS) CFFB	05.2009→11.2012		7.09720.00.0	AGR-K	EL 	 ch. 1K-9-400 001→
			7.11190.09.0	DDS		 ch. 1K-9-400 001→

GOLF VI Convertible (517) **32**



















1.6 TDI 77 kW (105 PS) CAYC	03.2011→05.2016		7.09720.00.0	AGR-K	EL 	
			7.08369.01.0	ATS	EL	
			7.08369.04.0	ATS	EL	
			7.11492.00.0	DDS		ohne Zubehör without accessories
2.0 TDI 103 kW (140 PS) CFHC	11.2011→05.2016		7.09720.00.0	AGR-K	EL 	
			7.11190.09.0	DDS		
2.0 TDI 81 kW (110 PS) CUUA	11.2013→05.2016		7.11492.03.0	DDS		ohne Zubehör without accessories
			7.07696.00.0	SRM-AK	EL 	 ch. AU-D-000 0001→
2.0 TDI 110 kW (150 PS) CUUB	11.2013→05.2016		7.11492.03.0	DDS		ohne Zubehör without accessories

GOLF VI Variant (AJ5) **33**

1.4 59-60 kW (80-82 PS) BUD, CGGA	07.2009→07.2013		7.05271.18.0	LS	525 mm	
1.4 TSI 90 kW (122 PS) CAXA	07.2009→07.2013		7.05271.18.0	LS	525 mm	Schaltgetriebe 6 Gang 6-Speed Manual Transmission Euro 4 Euro 4
1.6 75 kW (102 PS) BSE, BSF, CCSA	07.2009→07.2013		7.05271.18.0	LS	525 mm	









GOLF VI Variant (AJ5) **33**

			7.22738.08.0	SLP	EL	
			7.22778.96.0	SLV	PN	 ch. 1K-6-000 001→
1.6 BiFuel 75 kW (102 PS) BSF	07.2009→12.2010		7.22738.08.0	SLP	EL	
1.6 MultiFuel 75 kW (102 PS) CMXA	07.2010→07.2013		7.05271.18.0	LS	525 mm	
			7.22738.08.0	SLP	EL	 ch. 1K-9-400 001→
			7.22778.96.0	SLV	PN	 ch. 1K-9-400 001→
1.6 TDI 77 kW (105 PS) CAYC	07.2009→07.2013		7.09720.00.0	AGR-K	EL	
			7.08369.01.0	ATS	EL	Fahrgestellnummer ab: 1K-9-400 001 Vehicle Identification Number from: 1K-9-400 001
			7.08369.04.0	ATS	EL	Fahrgestellnummer ab: 1K-9-400 001 Vehicle Identification Number from: 1K-9-400 001
			7.11492.00.0	DDS		ohne Zubehör without accessories
1.6 TDI 66 kW (90 PS) CAYB	12.2009→07.2013		7.09720.00.0	AGR-K	EL	
			7.08369.01.0	ATS	EL	Fahrgestellnummer ab: 1K-9-400 001 Vehicle Identification Number from: 1K-9-400 001
			7.08369.04.0	ATS	EL	Fahrgestellnummer ab: 1K-9-400 001 Vehicle Identification Number from: 1K-9-400 001
			7.11492.00.0	DDS		ohne Zubehör without accessories
1.6 TDI 4motion 77 kW (105 PS) CAYC	07.2009→07.2013		7.09720.00.0	AGR-K	EL	
			7.08369.01.0	ATS	EL	Fahrgestellnummer ab: 1K-9-400 001 Vehicle Identification Number from: 1K-9-400 001
			7.08369.04.0	ATS	EL	Fahrgestellnummer ab: 1K-9-400 001 Vehicle Identification Number from: 1K-9-400 001
			7.11492.00.0	DDS		ohne Zubehör without accessories
2.0 TDI 103 kW (140 PS) CBDB	07.2009→07.2013		7.10334.00.0	AGR	EL	 für OE-Nummer: 03L 131 501 G for OE number: 03L 131 501 G
			7.08369.01.0	ATS	EL	Fahrgestellnummer ab: 1K-9-250 001 Vehicle Identification Number from: 1K-9-250 001
			7.08369.04.0	ATS	EL	Fahrgestellnummer ab: 1K-9-250 001 Vehicle Identification Number from: 1K-9-250 001
			7.11492.02.0	DDS		ohne Zubehör without accessories
2.0 TDI 103 kW (140 PS) CFHC	07.2009→07.2013		7.09720.00.0	AGR-K	EL	
			7.11190.09.0	DDS		
2.0 TDI 103-104 kW (140-141 PS) CJAA	07.2009→07.2013		7.10334.00.0	AGR	EL	 ch. 16-B-000 001→ für OE-Nummer: 03L 131 501 G, 03L 131 501 K for OE number: 03L 131 501 G, 03L 131 501 K
			7.01493.07.0	AGR	EL	
			7.01300.24.0	AK	EL	

























V



GOLF VI Variant (AJ5) **33**

			7.08369.01.0	ATS	EL	Fahrgestellnummer ab: 1K-9-400 001 Vehicle Identification Number from: 1K-9-400 001
			7.08369.47.0	ATS	EL	
2.0 TDI 100 kW (136 PS) CBDA	07.2009→07.2013		7.10334.00.0	AGR	EL	
			7.08369.01.0	ATS	EL	Fahrgestellnummer ab: 1K-9-250 001 Vehicle Identification Number from: 1K-9-250 001
			7.08369.04.0	ATS	EL	Fahrgestellnummer ab: 1K-9-250 001 Vehicle Identification Number from: 1K-9-250 001
			7.11492.02.0	DDS		ohne Zubehör without accessories  ch. 1K-9-250 001→
2.0 TDI 100 kW (136 PS) CFHB	07.2009→07.2013		7.09720.00.0	AGR-K	EL	
			7.11190.09.0	DDS		
2.0 TDI 81 kW (110 PS) CLCA	01.2010→07.2013		7.09720.00.0	AGR-K	EL	





































GOLF VII (5G1, BQ1, BE1, BE2) **34**

1.4 TSI 110 kW (150 PS) DGXA	05.2014→		7.01510.91.0	SLV	EL	mit Dichtring with O-ring Mexico, Argentinien, USA Mexico, Argentinien, USA
1.6 TDI 77 kW (105 PS) CLHA	08.2012→		7.10334.02.0	AGR	EL	  ch. AU-D-000 001→
			7.03608.16.0	AK	EL	 CLHA:  ch. AU-D-000 001→  CLHA:  ch. AU-E-500 001→
			7.08369.95.0	ATS	EL	  ch. AU-D-000 001→ Euro 6 Euro 6 Produktionsdatum ab: 03.11.2014 Production date from: 03.11.2014
			7.08369.79.0	ATS	EL	 CLHA:  ch. AU-D-000 001→ Produktionsdatum bis: 03.11.2014 Production date to: 03.11.2014
			7.08369.82.0	ATS	EL	 CLHA:  ch. BQ1***→  CLHA:  ch. AU-D-000 001→ ab Euro 5 From Euro 5 Produktionsdatum bis: 03.11.2014 Production date to: 03.11.2014
			7.11492.03.0	DDS		ohne Zubehör without accessories Fahrgestellnummer ab: AU-D-000 001, BQ1*** Vehicle Identification Number from: AU-D-000 001, BQ1***
1.6 TDI 81 kW (110 PS) CRKB, CXXB	01.2013→		7.10334.02.0	AGR	EL	  ch. AU-D-000 001→
			7.03608.16.0	AK	EL	 CRKB, CXXB:  ch. AU-D-000 001→  CRKB, CXXB:  ch. AU-É-500 001→
			7.08369.79.0	ATS	EL	 CRKB, CXXB:  ch. AU-D-000 001→ Produktionsdatum bis: 03.11.2014 Production date to: 03.11.2014

V























GOLF VII (5G1, BQ1, BE1, BE2) **34**

			7.08369.82.0	ATS	EL	 CRKB, CXXB:  ch. AU-D-000 001→ ab Euro 5 From Euro 5 Produktionsdatum bis: 03.11.2014 Production date to: 03.11.2014
			7.11020.17.0	ATS	EL	 CRKB, CXXB:  ch. AU-D-000 001→ vor Katalysator in front of the catalyst Euro 6 Euro 6 Produktionsdatum ab: 31.11.2014 Production date from: 31.11.2014  CXXB:  ch. BQ1***→ vor Katalysator in front of the catalyst
			7.08369.95.0	ATS	EL	 CRKB: Euro 6 Euro 6 Produktionsdatum ab: 03.11.2014 Production date from: 03.11.2014  CXXB:  ch. AU-D-000 001→ Euro 6 Euro 6 Produktionsdatum ab: 03.11.2014 Production date from: 03.11.2014  CXXB:  ch. BQ5***→
			7.11492.03.0	DDS		ohne Zubehör without accessories  CRKB, CXXB:  ch. AU-E-500 001→ Produktionsdatum ab: 03.11.2014 Production date from: 03.11.2014  CXXB:  ch. BQ1***→
1.6 TDI 81 kW (110 PS) DBKA	01.2013→		7.10334.02.0	AGR	EL	
			7.03608.16.0	AK	EL	 DBKA:  ch. AU-É-500 001→  DBKA:  ch. AU-D-000 001→
			7.08369.95.0	ATS	EL	 DBKA:  ch. AU-D-000 001→ Euro 6 Euro 6 Produktionsdatum ab: 03.11.2014 Production date from: 03.11.2014  DBKA:  ch. BQ1***→
			7.11020.17.0	ATS	EL	 DBKA:  ch. AU-D-000 001→ vor Katalysator in front of the catalyst Euro 6 Euro 6 Produktionsdatum ab: 31.11.2014 Production date from: 31.11.2014  DBKA:  ch. BQ1***→ vor Katalysator in front of the catalyst
			7.11492.03.0	DDS		ohne Zubehör without accessories  DBKA:  ch. AU-E-500 001→ Produktionsdatum ab: 03.11.2014 Production date from: 03.11.2014  DBKA:  ch. BQ1***→
1.6 TDI 66 kW (90 PS) CLHB	04.2013→		7.10334.02.0	AGR	EL	  ch. AU-D-000 001→
			7.08369.79.0	ATS	EL	 ch. AU-D-000 001→ Produktionsdatum bis: 03.11.2014 Production date to: 03.11.2014





GOLF VII (5G1, BQ1, BE1, BE2) **34**

			7.08369.82.0	ATS	EL	 ch. AU-D-000 001→ ab Euro 5 From Euro 5 Produktionsdatum bis: 03.11.2014 Production date to: 03.11.2014
			7.11492.03.0	DDS		ohne Zubehör without accessories  ch. AU-E-500 001→
1.6 TDI 66 kW (90 PS) CRKA	04.2013→		7.10334.02.0	AGR	EL	  ch. AU-D-000 001→
			7.08369.79.0	ATS	EL	 ch. AU-D-000 001→ Produktionsdatum bis: 03.11.2014 Production date to: 03.11.2014
			7.08369.82.0	ATS	EL	 ch. AU-D-000 001→ ab Euro 5 From Euro 5 Produktionsdatum bis: 03.11.2014 Production date to: 03.11.2014
			7.08369.95.0	ATS	EL	 ch. AU-D-000 001→ Euro 6 Euro 6 Produktionsdatum ab: 03.11.2014 Production date from: 03.11.2014
			7.11020.17.0	ATS	EL	 ch. AU-D-000 001→ vor Katalysator in front of the catalyst Euro 6 Euro 6 Produktionsdatum ab: 31.11.2014 Production date from: 31.11.2014
			7.11020.18.0	ATS	EL	vor Katalysator in front of the catalyst Euro 6 Euro 6 für Hersteller-Abgasnorm: Euro 5 plus for manufacturer exhaust norm: Euro 5 plus Produktionsdatum bis: 03.11.2014 Production date to: 03.11.2014
			7.11492.03.0	DDS		ohne Zubehör without accessories  ch. AU-D-000 001→
1.6 TDI 66 kW (90 PS) CXXA	04.2013→		7.08369.95.0	ATS	EL	 ch. AU-D-000 001→ Euro 6 Euro 6 Produktionsdatum ab: 03.11.2014 Production date from: 03.11.2014
			7.11020.17.0	ATS	EL	 ch. AU-D-000 001→ vor Katalysator in front of the catalyst Euro 6 Euro 6 Produktionsdatum ab: 31.11.2014 Production date from: 31.11.2014
			7.11492.03.0	DDS		ohne Zubehör without accessories  ch. AU-E-500 001→ Produktionsdatum ab: 03.11.2014 Production date from: 03.11.2014
1.6 TDI 66 kW (90 PS) DDYB	04.2013→		7.10334.02.0	AGR	EL	
			7.08369.95.0	ATS	EL	 ch. BQ1***→
			7.11492.05.0	DDS		ohne Zubehör without accessories  ch. BQ1***→
1.6 TDI 85 kW (115 PS) DDYA	11.2016→		7.08369.95.0	ATS	EL	 ch. BQ1***→











































GOLF VII (5G1, BQ1, BE1, BE2) **34**

			7.11492.05.0	DDS		ohne Zubehör without accessories ch. BQ1***→
1.6 TDI 85 kW (115 PS) DGTE	11.2016→		7.10334.02.0	AGR	EL	
			7.11020.17.0	ATS	EL	ch. BQ1***→ vor Katalysator in front of the catalyst
			7.11020.23.0	ATS	EL	ch. BQ1***→
			7.11020.22.0	ATS	EL	
			7.11492.05.0	DDS		ohne Zubehör without accessories ch. BQ1***→
1.6 TDI 4motion 77 kW (105 PS) CLHA	11.2012→		7.10334.02.0	AGR	EL	 ch. AU-D-000 001→
			7.03608.16.0	AK	EL	CLHA: ch. AU-D-000 001→ CLHA: ch. AU-E-500 001→
			7.08369.95.0	ATS	EL	ch. AU-D-000 001→ Euro 6 Euro 6 Produktionsdatum ab: 03.11.2014 Production date from: 03.11.2014
			7.08369.79.0	ATS	EL	CLHA: ch. AU-D-000 001→ Produktionsdatum bis: 03.11.2014 Production date to: 03.11.2014 CLHA: ch. BQ1***→
			7.08369.82.0	ATS	EL	CLHA: ch. AU-D-000 001→ ab Euro 5 From Euro 5 Produktionsdatum bis: 03.11.2014 Production date to: 03.11.2014 CLHA: ch. BQ1***→
			7.11492.03.0	DDS		ohne Zubehör without accessories Fahrgestellnummer ab: AU-D-000 001, BQ1*** Vehicle Identification Number from: AU-D-000 001, BQ1***
1.6 TDI 4motion 81 kW (110 PS) CRKB, CXXB	01.2013→		7.03608.16.0	AK	EL	CRKB, CXXB: ch. AU-D-000 001→ CRKB, CXXB: ch. AU-É-500 001→
			7.08369.79.0	ATS	EL	CRKB, CXXB: ch. AU-D-000 001→ Produktionsdatum bis: 03.11.2014 Production date to: 03.11.2014
			7.08369.82.0	ATS	EL	CRKB, CXXB: ch. AU-D-000 001→ ab Euro 5 From Euro 5 Produktionsdatum bis: 03.11.2014 Production date to: 03.11.2014
			7.11020.17.0	ATS	EL	CRKB: ch. AU-D-000 001→ Euro 6 Euro 6 Produktionsdatum ab: 31.11.2014 Production date from: 31.11.2014 CXXB: ch. BQ1***→ vor Katalysator in front of the catalyst CXXB: ch. AU-D-000 001→ vor Katalysator in front of the catalyst Euro 6 Euro 6 Produktionsdatum ab: 31.11.2014 Production date from: 31.11.2014

























GOLF VII (5G1, BQ1, BE1, BE2) **34**

			7.08369.95.0	ATS	EL	 CRKB, CXXB:  ch. AU-D-000 001→ Euro 6 Euro 6 Produktionsdatum ab: 03.11.2014 Production date from: 03.11.2014
			7.11492.03.0	DDS		 CXXB:  ch. BQ5***→ ohne Zubehör without accessories  CRKB, CXXB:  ch. AU-E-500 001→ Produktionsdatum ab: 03.11.2014 Production date from: 03.11.2014  CXXB:  ch. BQ1***→
1.8 TSI 125 kW (170 PS) CNSA, CNSB	07.2013→		7.03635.39.0	SLP	EL	 CNSA, CNSB:  ch. AU-GM000001→
			7.01510.86.0	SLV	EL	 CNSA, CNSB:  ch. AU-GM000001→
1.8 TSI 125 kW (170 PS) CXBA, CXBB	07.2013→		7.03635.39.0	SLP	EL	 CXBA, CXBB:  ch. AU-GM000001→
			7.01510.85.0	SLV	EL	 CXBA, CXBB:  ch. AU-GM000001→ Produktionsdatum ab: 17.11.2015 Production date from: 17.11.2015
			7.01510.86.0	SLV	EL	 CXBA:  ch. AU-GM000001→  CXBB:  ch. AU-GM000001→ Produktionsdatum bis: 16.11.2015 Production date to: 16.11.2015
2.0 GTD 135 kW (184 PS) CUNA	04.2013→		7.10334.02.0	AGR	EL	
			7.03608.16.0	AK	EL	 CUNA:  ch. AU-É-500 001→  CUNA:  ch. AU-D-000 001→
			7.08369.81.0	ATS	EL	 ch. AU-D-000 001→
			7.11492.03.0	DDS		ohne Zubehör without accessories  ch. AU-D-000 001→
2.0 GTD 135 kW (184 PS) DGCA	04.2013→		7.10334.02.0	AGR	EL	
			7.08369.81.0	ATS	EL	 ch. BQ1***→
			7.11492.05.0	DDS		ohne Zubehör without accessories  ch. BQ1***→
2.0 GTD 135 kW (184 PS) DJGA	04.2013→		7.08369.81.0	ATS	EL	 ch. BQ1***→
			7.11492.05.0	DDS		ohne Zubehör without accessories  ch. BQ1***→
2.0 GTD 130 kW (177 PS) CRGA	11.2016→		7.10334.02.0	AGR	EL	
2.0 GTI 162 kW (220 PS) CHHB, CXCB, CXDA	04.2013→		7.03635.39.0	SLP	EL	 CHHB, CXDA:  ch. AU-D-000 001→ für Hersteller-Abgasnorm: SULEV for manufacturer exhaust norm: SULEV
			7.01510.85.0	SLV	EL	 CXCB:  ch. AU-GM000001→  CHHB, CXDA:  ch. AU-D-000 001→ für Hersteller-Abgasnorm: SULEV for manufacturer exhaust norm: SULEV Produktionsdatum ab: 03.11.2015 Production date from: 03.11.2015  CXCB:  ch. AU-GM000001→ Produktionsdatum ab: 17.11.2015 Production date from: 17.11.2015



GOLF VII (5G1, BQ1, BE1, BE2) **34**

		7.01510.86.0	SLV	EL	 CHHB, CXDA:  ch. AU-D-000 001→ für Hersteller-Abgasnorm: SULEV for manufacturer exhaust norm: SULEV Produktionsdatum bis: 02.11.2015 Production date to: 02.11.2015  CXCB:  ch. AU-GM000001→ Produktionsdatum bis: 16.11.2015 Production date to: 16.11.2015
2.0 GTI 162 kW (220 PS) CNTC	04.2013→	7.03635.39.0	SLP	EL	 Fahrgestellnummer ab: AU-HJ400001, AU-HP300001, AU-HR400001, AU-HW300001, AU-HW850001 Vehicle Identification Number from: AU-HJ400001, AU-HP300001, AU-HR400001, AU-HW300001, AU-HW850001 für Hersteller-Abgasnorm: SULEV for manufacturer exhaust norm: SULEV
2.0 GTI 169 kW (230 PS) CHHA	04.2013→	7.03635.39.0	SLP	EL	  ch. AU-D-000 001→ für Hersteller-Abgasnorm: SULEV for manufacturer exhaust norm: SULEV
		7.01510.85.0	SLV	EL	 ch. AU-D-000 001→ für Hersteller-Abgasnorm: SULEV for manufacturer exhaust norm: SULEV Produktionsdatum ab: 03.11.2015 Production date from: 03.11.2015
		7.01510.86.0	SLV	EL	 ch. AU-D-000 001→ für Hersteller-Abgasnorm: SULEV for manufacturer exhaust norm: SULEV Produktionsdatum bis: 02.11.2015 Production date to: 02.11.2015
2.0 GTI 155 kW (211 PS) CNTA, CXCA	11.2013→	7.03635.39.0	SLP	EL	  CNTA:  ch. AU-D-000 001→ für Hersteller-Abgasnorm: SULEV for manufacturer exhaust norm: SULEV
		7.01510.85.0	SLV	EL	 CNTA:  ch. AU-D-000 001→ für Hersteller-Abgasnorm: SULEV for manufacturer exhaust norm: SULEV Produktionsdatum ab: 03.11.2015 Production date from: 03.11.2015  CXCA:  ch. AU-GM000001→ Produktionsdatum ab: 17.11.2015 Production date from: 17.11.2015
		7.01510.86.0	SLV	EL	 CNTA:  ch. AU-D-000 001→ für Hersteller-Abgasnorm: SULEV for manufacturer exhaust norm: SULEV Produktionsdatum bis: 02.11.2015 Production date to: 02.11.2015  CXCA:  ch. AU-GM000001→ Produktionsdatum bis: 16.11.2015 Production date to: 16.11.2015
2.0 GTI 180 kW (245 PS) DLBA	03.2017→	7.03635.39.0	SLP	EL	 Fahrgestellnummer ab: AU-HJ400001, AU-HP300001, AU-HR400001, AU-HW300001, AU-HW850001 Vehicle Identification Number from: AU-HJ400001, AU-HP300001, AU-HR400001, AU-HW300001, AU-HW850001 für Hersteller-Abgasnorm: SULEV for manufacturer exhaust norm: SULEV
		7.01510.85.0	SLV	EL	Fahrgestellnummer ab: AU-HJ4000001, AU-HP3000001, AU-HR4000001, AU-HW3000001, AU-HW8500001 Vehicle Identification Number from: AU-HJ4000001, AU-HP3000001, AU-HR4000001, AU-HW3000001, AU-HW8500001 für Hersteller-Abgasnorm: SULEV for manufacturer exhaust norm: SULEV





GOLF VII (5G1, BQ1, BE1, BE2) 34

2.0 GTI Clubsport 195 kW (265 PS) CJXE	02.2016→03.2017		7.03635.39.0 SLP EL  ch. AU-D-000 001→ für Hersteller-Abgasnorm: SULEV for manufacturer exhaust norm: SULEV
			7.01510.85.0 SLV EL  ch. AU-D-000 001→ für Hersteller-Abgasnorm: SULEV for manufacturer exhaust norm: SULEV Produktionsdatum ab: 03.11.2015 Production date from: 03.11.2015
			7.01510.86.0 SLV EL  ch. AU-D-000 001→ für Hersteller-Abgasnorm: SULEV for manufacturer exhaust norm: SULEV Produktionsdatum bis: 02.11.2015 Production date to: 02.11.2015
2.0 GTI Clubsport S 228 kW (310 PS) CJXG	09.2016→		7.03635.39.0 SLP EL  ch. AU-D-000 001→ für Hersteller-Abgasnorm: SULEV for manufacturer exhaust norm: SULEV
			7.01510.85.0 SLV EL  ch. AU-D-000 001→ für Hersteller-Abgasnorm: SULEV for manufacturer exhaust norm: SULEV Produktionsdatum ab: 03.11.2015 Production date from: 03.11.2015
			7.01510.86.0 SLV EL  ch. AU-D-000 001→ für Hersteller-Abgasnorm: SULEV for manufacturer exhaust norm: SULEV Produktionsdatum bis: 02.11.2015 Production date to: 02.11.2015
2.0 GTI TCR 213 kW (290 PS) CJXH	11.2018→		7.03635.39.0 SLP EL für Hersteller-Abgasnorm: SULEV for manufacturer exhaust norm: SULEV
			7.01510.85.0 SLV EL Fahrgestellnummer ab: BQ1***, BV5*** Vehicle Identification Number from: BQ1***, BV5*** für Hersteller-Abgasnorm: SULEV for manufacturer exhaust norm: SULEV
2.0 GTI TCR 213 kW (290 PS) DNUC	11.2018→		7.03635.39.0 SLP EL für Hersteller-Abgasnorm: SULEV for manufacturer exhaust norm: SULEV
2.0 R 360S 4motion 221-265 kW (300-360 PS) CJXC	09.2016→		7.01510.85.0 SLV EL  ch. AU-D-000 001→ für Hersteller-Abgasnorm: SULEV for manufacturer exhaust norm: SULEV
2.0 R 4motion 206 kW (280 PS) CJXB	11.2013→		7.03635.39.0 SLP EL  ch. AU-D-000 001→ für Hersteller-Abgasnorm: SULEV for manufacturer exhaust norm: SULEV
			7.01510.85.0 SLV EL  ch. AU-D-000 001→ für Hersteller-Abgasnorm: SULEV for manufacturer exhaust norm: SULEV Produktionsdatum ab: 03.11.2015 Production date from: 03.11.2015
			7.01510.86.0 SLV EL  ch. AU-D-000 001→ für Hersteller-Abgasnorm: SULEV for manufacturer exhaust norm: SULEV Produktionsdatum bis: 02.11.2015 Production date to: 02.11.2015
2.0 R 4motion 221-265 kW (300-360 PS) CJXC	11.2013→		7.03635.39.0 SLP EL  ch. AU-D-000 001→ für Hersteller-Abgasnorm: SULEV for manufacturer exhaust norm: SULEV
			7.01510.85.0 SLV EL  ch. AU-D-000 001→ für Hersteller-Abgasnorm: SULEV for manufacturer exhaust norm: SULEV Produktionsdatum ab: 03.11.2015 Production date from: 03.11.2015
			7.01510.86.0 SLV EL  ch. AU-D-000 001→ für Hersteller-Abgasnorm: SULEV for manufacturer exhaust norm: SULEV Produktionsdatum bis: 02.11.2015 Production date to: 02.11.2015

V





































GOLF VII (5G1, BQ1, BE1, BE2) **34**

2.0 R 4motion 215 kW (292 PS) CYFB	11.2014→	7.03635.39.0	SLP	EL	ch. AU-D-000 001→ für Hersteller-Abgasnorm: SULEV for manufacturer exhaust norm: SULEV
		7.01510.85.0	SLV	EL	ch. AU-D-000 001→ für Hersteller-Abgasnorm: SULEV for manufacturer exhaust norm: SULEV Produktionsdatum ab: 03.11.2015 Production date from: 03.11.2015
		7.01510.86.0	SLV	EL	ch. AU-D-000 001→ für Hersteller-Abgasnorm: SULEV for manufacturer exhaust norm: SULEV Produktionsdatum bis: 02.11.2015 Production date to: 02.11.2015
2.0 R 4motion 215 kW (292 PS) DJJA, DLRA	11.2014→	7.03635.39.0	SLP	EL	DJJA, DLRA: Fahrgestellnummer ab: AU-HJ400001, AU-HP300001, AU-HR400001, AU-HW300001, AU-HW850001 Vehicle Identification Number from: AU-HJ400001, AU-HP300001, AU-HR400001, AU-HW300001, AU-HW850001 für Hersteller-Abgasnorm: SULEV for manufacturer exhaust norm: SULEV
2.0 R 4motion 228 kW (310 PS) CJXG, DJHA	12.2016→	7.03635.39.0	SLP	EL	CJXG: ch. AU-D-000 001→ für Hersteller-Abgasnorm: SULEV for manufacturer exhaust norm: SULEV DJHA: Fahrgestellnummer ab: AU-HJ400001, AU-HP300001, AU-HR400001, AU-HW300001, AU-HW850001 Vehicle Identification Number from: AU-HJ400001, AU-HP300001, AU-HR400001, AU-HW300001, AU-HW850001 für Hersteller-Abgasnorm: SULEV for manufacturer exhaust norm: SULEV
		7.01510.85.0	SLV	EL	CJXG: ch. AU-D-000 001→ für Hersteller-Abgasnorm: SULEV for manufacturer exhaust norm: SULEV Produktionsdatum ab: 03.11.2015 Production date from: 03.11.2015 DJHA: Fahrgestellnummer ab: AU-HJ400001, AU-HP300001, AU-HR400001, AU-HW300001, AU-HW850001 Vehicle Identification Number from: AU-HJ400001, AU-HP300001, AU-HR400001, AU-HW300001, AU-HW850001 für Hersteller-Abgasnorm: SULEV for manufacturer exhaust norm: SULEV
2.0 R 4motion 213 kW (290 PS) CJXD	12.2016→	7.03635.39.0	SLP	EL	Fahrgestellnummer ab: AU-D-000 001 Vehicle Identification Number from: AU-D-000 001 für Hersteller-Abgasnorm: SULEV for manufacturer exhaust norm: SULEV
		7.01510.85.0	SLV	EL	ch. AU-D-000 001→ für Hersteller-Abgasnorm: SULEV for manufacturer exhaust norm: SULEV Produktionsdatum ab: 03.11.2015 Production date from: 03.11.2015
		7.01510.86.0	SLV	EL	Fahrgestellnummer ab: AU-D-000 001 Vehicle Identification Number from: AU-D-000 001 für Hersteller-Abgasnorm: SULEV for manufacturer exhaust norm: SULEV Produktionsdatum bis: 02.11.2015 Production date to: 02.11.2015





GOLF VII (5G1, BQ1, BE1, BE2) **34**

2.0 R 4motion 213 kW (290 PS) DJHB	12.2016→		7.03635.39.0	SLP	EL	Fahrgestellnummer ab: AU-HJ400001, AU-HP300001, AU-HR400001, AU-HW300001, AU-HW850001 Vehicle Identification Number from: AU-HJ400001, AU-HP300001, AU-HR400001, AU-HW300001, AU-HW850001 für Hersteller-Abgasnorm: SULEV for manufacturer exhaust norm: SULEV
			7.01510.85.0	SLV	EL	Fahrgestellnummer ab: AU-HJ400001, AU-HP300001, AU-HR400001, AU-HW300001, AU-HW850001 Vehicle Identification Number from: AU-HJ400001, AU-HP300001, AU-HR400001, AU-HW300001, AU-HW850001 für Hersteller-Abgasnorm: SULEV for manufacturer exhaust norm: SULEV
2.0 R 4motion 213 kW (290 PS) DNUC	12.2016→		7.03635.39.0	SLP	EL	für Hersteller-Abgasnorm: SULEV for manufacturer exhaust norm: SULEV
2.0 TDI 105 kW (143 PS) CRBB	08.2012→		7.10334.02.0	AGR	EL	 ch. AU-D-000 001→
			7.11492.03.0	DDS	EL	ohne Zubehör without accessories  ch. AU-D-000 001→
2.0 TDI 105 kW (143 PS) CRVC	08.2012→		7.10334.02.0	AGR	EL	 ch. AU-D-000 001→
2.0 TDI 110 kW (150 PS) CRBC, CRLB	11.2012→		7.03608.16.0	AK	EL	 CRBC, CRLB:  ch. AU-D-000 001→
			7.08369.81.0	ATS	EL	 CRBC:  ch. BQ1***→  CRLB:  ch. AU-D-000 001→
			7.11492.03.0	DDS	EL	ohne Zubehör without accessories  CRBC, CRLB: Fahrgestellnummer ab: AU-D-000 001, BQ1*** Vehicle Identification Number from: AU-D-000 001, BQ1***
2.0 TDI 110 kW (150 PS) CRUA	11.2012→		7.10334.02.0	AGR	EL	
2.0 TDI 110 kW (150 PS) DCYA	11.2012→		7.10334.02.0	AGR	EL	
			7.08369.81.0	ATS	EL	 ch. BQ1***→
			7.11492.05.0	DDS	EL	ohne Zubehör without accessories  ch. BQ1***→
2.0 TDI 110 kW (150 PS) DEJA	11.2012→		7.10334.02.0	AGR	EL	
			7.08369.81.0	ATS	EL	 DEJA:  ch. AU-D-000 001→  DEJA:  ch. BQ1***→
			7.11492.03.0	DDS	EL	ohne Zubehör without accessories für OE-Nummer: 03L 906 051 B, 03L 906 051 D, 03N 906 051 B for OE number: 03L 906 051 B, 03L 906 051 D, 03N 906 051 B
2.0 TDI 110 kW (150 PS) DFGA	11.2012→		7.07696.00.0	SRM-AK	EL	
			7.08369.81.0	ATS	EL	 ch. BQ1***→
2.0 TDI 110 kW (150 PS) DFGA	11.2012→		7.11492.05.0	DDS	EL	ohne Zubehör without accessories  ch. BQ1***→
			7.10334.02.0	AGR	EL	
2.0 TDI 81 kW (110 PS) CRVA	11.2012→		7.10334.02.0	AGR	EL	



GOLF VII (5G1, BQ1, BE1, BE2) 34

2.0 TDI 81 kW (110 PS) CYKB	11.2014→		7.10334.02.0	AGR	EL	 CYKB: ch. BQ1***→ CYKB: ch. AU-D-000 001 → ohne Zubehör without accessories Fahrgestellnummer ab: AU-D-000 001, BQ1*** Vehicle Identification Number from: AU-D-000 001, BQ1***
			7.08369.81.0	ATS	EL	
			7.11492.03.0	DDS		
2.0 TDI 81 kW (110 PS) DEJB	05.2016→		7.10334.02.0	AGR	EL	 DEJB: ch. AU-D-000 001→ DEJB: ch. BQ1***→ ohne Zubehör without accessories Fahrgestellnummer ab: AU-D-000 001, BQ1*** Vehicle Identification Number from: AU-D-000 001, BQ1***
			7.08369.81.0	ATS	EL	
			7.11492.03.0	DDS		
			7.07696.00.0	SRM-AK	EL	
2.0 TDI 4motion 110 kW (150 PS) CKFC	11.2012→		7.11492.03.0	DDS		ohne Zubehör without accessories ch. AU-E-500 001→
2.0 TDI 4motion 110 kW (150 PS) CRBC, CRLB	11.2012→		7.03608.16.0	AK	EL	CRBC, CRLB: ch. AU-D-000 001→ CRBC, CRLB: ch. AU-E-500 001→ ohne Zubehör without accessories CRBC, CRLB: Fahrgestellnummer ab: AU-D-000 001, BQ1*** Vehicle Identification Number from: AU-D-000 001, BQ1***
			7.11492.03.0	DDS		
2.0 TDI 4motion 110 kW (150 PS) DCYA	11.2012→		7.11492.05.0	DDS		ohne Zubehör without accessories ch. BQ1***→























GOLF VII Variant (BA5, BV5) 35

1.0 TSI 81 kW (110 PS) CHZC	11.2016→		7.11020.23.0	ATS	EL	
1.4 TSI 110 kW (150 PS) DGXA	05.2014→		7.01510.91.0	SLV	EL	mit Dichtring with O-ring Mexico, Argentinien, USA Mexico, Argentina, USA
1.6 TDI 66 kW (90 PS) CLHB	05.2013→03.2017		7.10334.02.0	AGR	EL	 ch. AU-D-000 001→ Produktionsdatum bis: 03.11.2014 Production date to: 03.11.2014 ch. AU-D-000 001→ ab Euro 5 From Euro 5 Produktionsdatum bis: 03.11.2014 Production date to: 03.11.2014 ohne Zubehör without accessories ch. AU-E-500 001→
			7.08369.79.0	ATS	EL	
			7.08369.82.0	ATS	EL	
			7.11492.03.0	DDS		
1.6 TDI 66 kW (90 PS) CRKA	05.2013→03.2017		7.10334.02.0	AGR	EL	 ch. AU-D-000 001→ ab Euro 5 From Euro 5 Produktionsdatum bis: 03.11.2014 Production date to: 03.11.2014
			7.08369.79.0	ATS	EL	
			7.08369.82.0	ATS	EL	





GOLF VII Variant (BA5, BV5) **35**

			7.08369.95.0	ATS	EL	 ch. AU-D-000 001→ Euro 6 Produktionsdatum ab: 03.11.2014 Production date from: 03.11.2014
			7.11020.18.0	ATS	EL	 ch. AU-E-500 001→ vor Katalysator in front of the catalyst
			7.11492.03.0	DDS		ohne Zubehör without accessories  ch. AU-D-000 001→
1.6 TDI 66 kW (90 PS) CXXA	05.2013→03.2017		7.10334.02.0	AGR	EL	 ch. AU-E-500 001→
			7.11020.17.0	ATS	EL	 ch. AU-E-500 001→ vor Katalysator in front of the catalyst
			7.08369.95.0	ATS	EL	Euro 6 Euro 6 Produktionsdatum ab: 03.11.2014 Production date from: 03.11.2014
			7.11492.03.0	DDS		ohne Zubehör without accessories  ch. AU-E-500 001→ Produktionsdatum ab: 03.11.2014 Production date from: 03.11.2014
1.6 TDI 66 kW (90 PS) DDYB	05.2013→03.2017		7.10334.02.0	AGR	EL	
			7.08369.95.0	ATS	EL	 ch. BV5***→
			7.11492.05.0	DDS		ohne Zubehör without accessories  ch. BV5***→
1.6 TDI 81 kW (110 PS) CRKB	05.2013→03.2017		7.10334.02.0	AGR	EL	
			7.03608.16.0	AK	EL	 ch. AU-D-000 001→
			7.08369.79.0	ATS	EL	 ch. AU-D-000 001→ Produktionsdatum bis: 03.11.2014 Production date to: 03.11.2014
			7.08369.82.0	ATS	EL	 ch. AU-D-000 001→ ab Euro 5 From Euro 5 Produktionsdatum bis: 03.11.2014 Production date to: 03.11.2014
			7.08369.95.0	ATS	EL	 ch. AU-D-000 001→ Euro 6 Euro 6 Produktionsdatum ab: 03.11.2014 Production date from: 03.11.2014
			7.11020.18.0	ATS	EL	vor Katalysator in front of the catalyst
			7.11492.03.0	DDS		ohne Zubehör without accessories  ch. AU-E-500 001→ Produktionsdatum ab: 03.11.2014 Production date from: 03.11.2014
V 1.6 TDI 81 kW (110 PS) CXXB	05.2013→03.2017		7.10334.02.0	AGR	EL	
			7.03608.16.0	AK	EL	 ch. AU-D-000 001→
			7.08369.79.0	ATS	EL	 ch. AU-D-000 001→
			7.08369.82.0	ATS	EL	 ch. AU-D-000 001→ ab Euro 5 From Euro 5 Produktionsdatum bis: 03.11.2014 Production date to: 03.11.2014









































GOLF VII Variant (BA5, BV5) **35**

			7.08369.95.0	ATS	EL	ch. AU-D-000 001→ Euro 6 Produktionsdatum ab: 03.11.2014 Production date from: 03.11.2014
			7.11020.17.0	ATS	EL	CXXB: ch. AU-E-500 001→ vor Katalysator in front of the catalyst CXXB: ch. BV5***→ vor Katalysator in front of the catalyst
			7.11492.03.0	DDS		ohne Zubehör without accessories CXXB: ch. AU-E-500 001→ Produktionsdatum ab: 03.11.2014 Production date from: 03.11.2014 CXXB: ch. BV5***→
1.6 TDI 81 kW (110 PS) DBKA	05.2013→03.2017		7.10334.02.0	AGR	EL	
			7.08369.95.0	ATS	EL	DBKA: ch. AU-D-000 001→ Euro 6 Produktionsdatum ab: 03.11.2014 Production date from: 03.11.2014 DBKA: ch. BV5***→
			7.11020.17.0	ATS	EL	DBKA: ch. AU-E-500 001→ vor Katalysator in front of the catalyst DBKA: ch. BV5***→ vor Katalysator in front of the catalyst
			7.11492.03.0	DDS		ohne Zubehör without accessories DBKA: ch. AU-E-500 001→ Produktionsdatum ab: 03.11.2014 Production date from: 03.11.2014 DBKA: ch. BV5***→
1.6 TDI 77 kW (105 PS) CLHA	05.2013→03.2017		7.10334.02.0	AGR	EL	
			7.03608.16.0	AK	EL	ch. AU-D-000 001→
			7.08369.79.0	ATS	EL	ch. AU-D-000 001→
			7.08369.82.0	ATS	EL	CLHA: ch. AU-E-500 001→ CLHA: ch. BV5***→
			7.11492.03.0	DDS		ohne Zubehör without accessories Fahrgestellnummer ab: AU-D-000 001 , BV5*** Vehicle Identification Number from: AU-D-000 001 , BV5***
1.6 TDI 85 kW (115 PS) DDYA	11.2016→		7.08369.95.0	ATS	EL	ch. BV5***→
			7.11020.23.0	ATS	EL	ch. BV5***→
			7.11492.05.0	DDS		ohne Zubehör without accessories ch. BV5***→
1.6 TDI 85 kW (115 PS) DGTE	11.2016→		7.11020.17.0	ATS	EL	ch. BV5***→ vor Katalysator in front of the catalyst
			7.11020.23.0	ATS	EL	ch. BV5***→
			7.11020.22.0	ATS	EL	
			7.11492.05.0	DDS		ohne Zubehör without accessories ch. BV5***→
1.6 TDI 4motion 81 kW (110 PS) CRKB	05.2013→03.2017		7.03608.16.0	AK	EL	CRKB: ch. AU-D-000 001→ CRKB: ch. AU-E-500 001→





GOLF VII Variant (BA5, BV5) 35

			<p>7.08369.79.0 ATS EL  ch. AU-D-000 001→</p> <p>7.08369.82.0 ATS EL  ch. AU-D-000 001→ ab Euro 5 From Euro 5 Produktionsdatum bis: 03.11.2014 Production date to: 03.11.2014</p> <p>7.08369.95.0 ATS EL  ch. AU-D-000 001→ Euro 6 Euro 6 Produktionsdatum ab: 03.11.2014 Production date from: 03.11.2014</p> <p>7.11020.18.0 ATS EL  ch. AU-E-500 001→ vor Katalysator in front of the catalyst</p> <p>7.11492.03.0 DDS ohne Zubehör without accessories  ch. AU-E-500 001→ Produktionsdatum ab: 03.11.2014 Production date from: 03.11.2014</p>		
<p>1.6 TDI 4motion 81 kW (110 PS) CXXB</p>	<p>05.2013→03.2017</p>		<p>7.03608.16.0 AK EL  CXXB:  ch. AU-D-000 001→  CXXB:  ch. AU-E-500 001→</p>		
			<p>7.08369.79.0 ATS EL  ch. AU-D-000 001→ Produktionsdatum bis: 03.11.2014 Production date to: 03.11.2014</p>		
			<p>7.08369.82.0 ATS EL  ch. AU-D-000 001→ ab Euro 5 From Euro 5 Produktionsdatum bis: 03.11.2014 Production date to: 03.11.2014</p>		
			<p>7.08369.95.0 ATS EL  CXXB:  ch. AU-D-000 001→ Euro 6 Euro 6 Produktionsdatum ab: 03.11.2014 Production date from: 03.11.2014</p>		
			<p>7.11020.17.0 ATS EL  CXXB:  ch. BV5***→ vor Rußpartikelfilter before soot particulate filter  CXXB:  ch. BV5***→ vor Katalysator in front of the catalyst</p>		
			<p>7.11492.03.0 DDS ohne Zubehör without accessories  CXXB:  ch. AU-E-500 001→ Produktionsdatum ab: 03.11.2014 Production date from: 03.11.2014  CXXB:  ch. BV5***→</p>		
<p>1.6 TDI 4motion 77 kW (105 PS) CLHA</p>	<p>05.2013→03.2017</p>		<p>7.10334.02.0 AGR EL </p>		
			<p>7.03608.16.0 AK EL  CLHA:  ch. AU-D-000 001→  CLHA:  ch. AU-E-500 001→</p>		
			<p>7.08369.79.0 ATS EL  ch. AU-D-000 001→</p>		
			<p>7.08369.82.0 ATS EL  CLHA:  ch. AU-E-500 001→  CLHA:  ch. BV5***→</p>		
			<p>7.11492.03.0 DDS ohne Zubehör without accessories Fahrgestellnummer ab: AU-D-000 001, BV5*** Vehicle Identification Number from: AU-D-000 001, BV5***</p>		
<p>1.8 TSI 125 kW (170 PS) CXBA, CXBB</p>	<p>07.2013→</p>		<p>7.03635.39.0 SLP EL  CXBA, CXBB:  ch. AU-GM500001→</p>		
			<p>7.01510.85.0 SLV EL  CXBA, CXBB:  ch. AU-GM500001→ Produktionsdatum ab: 17.11.2015 Production date from: 17.11.2015</p>		













































GOLF VII Variant (BA5, BV5) 35

			7.01510.86.0	SLV	EL	 CXBA, CXBB:  ch. AU-GM500001→ Produktionsdatum bis: 16.11.2015 Production date to: 16.11.2015
1.8 TSI 4motion 132 kW (180 PS) CJSB	11.2016→		7.01510.85.0	SLV	EL	Fahrgestellnummer ab: BQ1***, BV5*** Vehicle Identification Number from: BQ1***, BV5*** für Hersteller-Abgasnorm: SULEV for manufacturer exhaust norm: SULEV
2.0 GTD 135 kW (184 PS) CUNA	01.2015→03.2017		7.10334.02.0	AGR	EL	 ch. AU-E-500 001→
			7.08369.81.0	ATS	EL	 ch. AU-E-500 001→ Produktionsdatum ab: 09.12.2013 Production date from: 09.12.2013
			7.11492.03.0	DDS		ohne Zubehör without accessories  ch. AU-D-000 001→
2.0 GTD 135 kW (184 PS) DGCA	01.2015→03.2017		7.10334.02.0	AGR	EL	
			7.08369.81.0	ATS	EL	 DGCA:  ch. AU-E-500 001→ Produktionsdatum ab: 11.04.2016 Production date from: 11.04.2016  DGCA:  ch. BV5***→
			7.11492.05.0	DDS		ohne Zubehör without accessories  DGCA:  ch. AU-E-500 001→  DGCA:  ch. BV5***→
2.0 GTD 135 kW (184 PS) DJGA	01.2015→03.2017		7.08369.81.0	ATS	EL	 ch. BV5***→
			7.11492.05.0	DDS		ohne Zubehör without accessories  ch. BV5***→
2.0 R 360S 4motion 221-265 kW (300-360 PS) CJXC	09.2016→		7.01510.85.0	SLV	EL	 ch. AU-D-000 001→ für Hersteller-Abgasnorm: SULEV for manufacturer exhaust norm: SULEV
2.0 R 4motion 206 kW (280 PS) CJXB	03.2015→03.2017		7.01510.85.0	SLV	EL	 ch. AU-D-000 001→ für Hersteller-Abgasnorm: SULEV for manufacturer exhaust norm: SULEV Produktionsdatum ab: 03.11.2015 Production date from: 03.11.2015
			7.01510.86.0	SLV	EL	 ch. AU-D-000 001→ für Hersteller-Abgasnorm: SULEV for manufacturer exhaust norm: SULEV Produktionsdatum bis: 02.11.2015 Production date to: 02.11.2015
2.0 R 4motion 221-265 kW (300-360 PS) CJXC	03.2015→03.2017		7.03635.39.0	SLP	EL	für Hersteller-Abgasnorm: SULEV for manufacturer exhaust norm: SULEV
			7.01510.85.0	SLV	EL	 ch. AU-D-000 001→ für Hersteller-Abgasnorm: SULEV for manufacturer exhaust norm: SULEV Produktionsdatum ab: 03.11.2015 Production date from: 03.11.2015
			7.01510.86.0	SLV	EL	 ch. AU-D-000 001→ für Hersteller-Abgasnorm: SULEV for manufacturer exhaust norm: SULEV Produktionsdatum bis: 02.11.2015 Production date to: 02.11.2015
2.0 R 4motion 221 kW (300 PS) DNUE	03.2015→03.2017		7.03635.39.0	SLP	EL	für Hersteller-Abgasnorm: SULEV for manufacturer exhaust norm: SULEV
2.0 R 4motion 228 kW (310 PS) CJXG	12.2016→		7.03635.39.0	SLP	EL	 ch. AU-HP750001→ für Hersteller-Abgasnorm: SULEV for manufacturer exhaust norm: SULEV
2.0 R 4motion 228 kW (310 PS) DJHA	12.2016→		7.03635.39.0	SLP	EL	 ch. AU-HP750001→ für Hersteller-Abgasnorm: SULEV for manufacturer exhaust norm: SULEV





GOLF VII Variant (BA5, BV5) **35**

			7.01510.85.0	SLV	EL	 ch. AU-HP750001→ für Hersteller-Abgasnorm: SULEV for manufacturer exhaust norm: SULEV
2.0 R 4motion 213 kW (290 PS) CJXD, DJHB	12.2016→07.2018		7.03635.39.0	SLP	EL	 CJXD, DJHB:  ch. AU-HP750001→ für Hersteller-Abgasnorm: SULEV for manufacturer exhaust norm: SULEV
			7.01510.85.0	SLV	EL	 CJXD, DJHB:  ch. AU-HP750001→ für Hersteller-Abgasnorm: SULEV for manufacturer exhaust norm: SULEV
2.0 R 4motion 213 kW (290 PS) DNUC	09.2018→07.2018		7.03635.39.0	SLP	EL	 ch. AU-HP750001→ für Hersteller-Abgasnorm: SULEV for manufacturer exhaust norm: SULEV
2.0 TDI 110 kW (150 PS) CRBC, CRLB	04.2013→		7.10334.02.0	AGR	EL	
			7.03608.16.0	AK	EL	 CRBC, CRLB:  ch. AU-D-000 001→
			7.08369.81.0	ATS	EL	 CRBC, CRLB:  ch. AU-D-000 001→  CRBC, CRLB:  ch. BV5***→  CRBC:  ch. BQ1***→  CRLB:  ch. AU-E-500 001→ Produktionsdatum ab: 09.12.2016 Production date from: 09.12.2016
			7.11492.03.0	DDS		ohne Zubehör without accessories  CRBC, CRLB: Fahrgestellnummer ab: AU-D-000 001, BV5*** Vehicle Identification Number from: AU-D-000 001, BV5***
2.0 TDI 110 kW (150 PS) CRUA	04.2013→		7.10334.02.0	AGR	EL	
2.0 TDI 110 kW (150 PS) DCYA	04.2013→		7.10334.02.0	AGR	EL	
			7.08369.81.0	ATS	EL	 DCYA:  ch. BV5***→  DCYA:  ch. BQ1***→
			7.11492.05.0	DDS		ohne Zubehör without accessories  ch. BV5***→
2.0 TDI 110 kW (150 PS) DEJA	04.2013→		7.10334.02.0	AGR	EL	
			7.08369.81.0	ATS	EL	 DEJA: Produktionsdatum ab: 09.12.2016 Production date from: 09.12.2016  DEJA:  ch. BV5***→
			7.11492.03.0	DDS		ohne Zubehör without accessories für OE-Nummer: 03L 906 051 B, 03L 906 051 D, 03N 906 051 B for OE number: 03L 906 051 B, 03L 906 051 D, 03N 906 051 B
2.0 TDI 110 kW (150 PS) DFGA	04.2013→		7.08369.81.0	ATS	EL	 ch. BV5***→ Produktionsdatum ab: 12.02.2018 Production date from: 12.02.2018
			7.11492.05.0	DDS		ohne Zubehör without accessories  ch. BV5***→
2.0 TDI 81 kW (110 PS) CRVA	05.2013→03.2017		7.10334.02.0	AGR	EL	
2.0 TDI 81 kW (110 PS) CRLD, CYKB	05.2015→03.2017		7.10334.02.0	AGR	EL	

V





































GOLF VII Variant (BA5, BV5) 35

			7.08369.81.0	ATS	EL	CRLD, CYKB: ch. AU-E-500 001→ Produktionsdatum ab: 09.12.2013 Production date from: 09.12.2013 CRLD, CYKB: ch. BV5***→ ohne Zubehör without accessories CRLD: Fahrgestellnummer ab: AU-E-500 001, BV5*** Vehicle Identification Number from: AU-E-500 001, BV5*** CYKB: Fahrgestellnummer ab: AU-D-000 001, BV5*** Vehicle Identification Number from: AU-D-000 001, BV5***
			7.11492.03.0	DDS		
2.0 TDI 81 kW (110 PS) DCYB	11.2016→03.2017		7.10334.02.0	AGR	EL	
			7.08369.81.0	ATS	EL	ch. BV5***→
			7.11492.05.0	DDS		ohne Zubehör without accessories ch. BV5***→
2.0 TDI 81 kW (110 PS) DEJB	11.2016→03.2017		7.10334.02.0	AGR	EL	
			7.08369.81.0	ATS	EL	ch. AU-E-500 001→ Produktionsdatum ab: 09.12.2013 Production date from: 09.12.2013
			7.11492.03.0	DDS		ohne Zubehör without accessories Fahrgestellnummer ab: AU-E-500 001, BV5*** Vehicle Identification Number from: AU-E-500 001, BV5***
			7.07696.00.0	SRM-AK	EL	
2.0 TDI 4motion 110 kW (150 PS) CRBC	04.2013→05.2018		7.10334.02.0	AGR	EL	
			7.03608.16.0	AK	EL	ch. AU-D-000 001→
			7.08369.81.0	ATS	EL	CRBC: ch. AU-E-500 001→ CRBC: ch. BV5***→
			7.11492.03.0	DDS		ohne Zubehör without accessories Fahrgestellnummer ab: AU-D-000 001, BV5*** Vehicle Identification Number from: AU-D-000 001, BV5***
2.0 TDI 4motion 110 kW (150 PS) CRLB	04.2013→05.2018		7.03608.16.0	AK	EL	ch. AU-D-000 001→
			7.08369.81.0	ATS	EL	CRLB: ch. AU-E-500 001→ Produktionsdatum ab: 09.12.2013 Production date from: 09.12.2013
			7.11492.03.0	DDS		CRLB: ch. BV5***→ ohne Zubehör without accessories Fahrgestellnummer ab: AU-D-000 001, BV5*** Vehicle Identification Number from: AU-D-000 001, BV5***
2.0 TDI 4motion 110 kW (150 PS) DCYA	04.2013→05.2018		7.11492.05.0	DDS		ohne Zubehör without accessories ch. BV5***→

GOLF VIII (CD1) 36





















2.0 TDI 85 kW (116 PS) DSUD	08.2019→		7.11492.05.0	DDS		ohne Zubehör without accessories ch. CD1***→
			7.07696.00.0	SRM-AK	EL	

			 PIERBURG			
JETTA I (16)						37
1.3 44 kW (60 PS) GF	08.1979→02.1984		7.02604.01.0	LS	200 mm	
1.3 43 kW (58 PS) GS	08.1982→02.1984		7.02604.01.0	LS	200 mm	
1.8 82 kW (112 PS) DX, JJ	08.1982→02.1984		7.02604.03.0	LS	200 mm	
JETTA II (19E, 1G2, 165)						38
1.3 40 kW (55 PS) HK, MH	01.1984→06.1987		7.02604.01.0	LS	200 mm	
1.3 43 kW (58 PS) GT	01.1984→10.1986		7.02604.01.0	LS	200 mm	
1.3 Cat 40 kW (54-55 PS) 2G, MH, NZ	06.1987→12.1991		7.02604.01.0	LS	200 mm	
1.8 82 kW (112 PS) EV, GZ, PB	01.1984→10.1991		7.02604.03.0	LS	200 mm	
1.8 79 kW (107 PS) RD	08.1985→10.1987		7.02604.03.0	LS	200 mm	
1.8 16V 92-95 kW (125-129 PS) PL	08.1986→10.1991		7.02604.03.0	LS	200 mm	
1.8 16V 100-102 kW (136-140 PS) KR	06.1987→12.1989		7.02604.03.0	LS	200 mm	
1.8 Cat 75-79 kW (102-107 PS) PF	01.1987→10.1991		7.02604.03.0	LS	200 mm	
1.8 Syncro 72 kW (98 PS) 1P	08.1988→07.1991		7.02604.03.0	LS	200 mm	
JETTA III (1H5)						39
1.8i 55-75 kW (75-102 PS) AAM, ACC, ADD	08.1992→12.1998		7.02604.03.0	LS	200 mm	
JETTA III (1K2)						40
1.4 TSI 90 kW (122 PS) CAXA	05.2007→10.2010		7.05271.18.0	LS	525 mm	
1.6 75 kW (102 PS) BSE, CCSA	09.2004→10.2010		7.22738.08.0	SLP	EL	
			7.22778.96.0	SLV	PN 	
1.6 75 kW (102 PS) BSF	09.2004→10.2010		7.05271.18.0	LS	525 mm	
1.6 FSI 85 kW (115 PS) BLF	09.2005→10.2010		7.10334.04.0	AGR	EL 	
			7.05271.15.0	LS	525 mm	
			7.05271.30.0	LS	400 mm	
1.6 MultiFuel 75 kW (102 PS) CCSA	01.2008→10.2010		7.05271.18.0	LS	525 mm	
			7.22738.08.0	SLP	EL	
			7.22778.96.0	SLV	PN 	
1.6 TDI 77 kW (105 PS) CAYC	06.2009→10.2010		7.09720.00.0	AGR-K	EL 	
			7.08369.01.0	ATS	EL	
			7.08369.04.0	ATS	EL	
1.6 TDI 66 kW (90 PS) CAYB	12.2009→10.2010		7.11492.00.0	DDS	ohne Zubehör without accessories	
1.9 TDI 77 kW (105 PS) BKC	08.2005→10.2010		7.24809.16.0	AGR	PN 	
1.9 TDI 77 kW (105 PS) BLS	08.2005→10.2010		7.00678.06.0	AGR-M	EL  ch. 1K-8-054 617→	

V







































JETTA III (1K2) 40

			7.00678.04.0*	AGR-M	EL	mit Rohrstutzen with pipe socket
			↳7.00907.03.0	AGR	EL	
			7.08369.00.0	ATS	EL	
			7.08369.02.0	ATS	EL	
			7.08369.03.0	ATS	EL	
			7.11492.02.0	DDS		ohne Zubehör without accessories
						 ch. 1K-7-081 925→
						 →ch. 1K-7-081 924
1.9 TDI 77 kW (105 PS) BXE	08.2005→10.2010		7.24809.16.0	AGR	PN	
			7.08369.00.0	ATS	EL	
2.0 85 kW (116 PS) BHY	05.2005→10.2010		7.05270.98.0	LS	700 mm	nach Katalysator Post-catalyst Südafrika South Africa
2.0 FSI 110 kW (150 PS) BLR, BVY	08.2005→10.2010		7.10334.09.0	AGR	EL	 BLR, BVY: →05.2008 BVY: Südafrika South Africa
			7.05271.16.0	LS	1300 mm	BLR, BVY: links, rechts Left, Right Diagnosesonde Diagnostic Probe
2.0 FSI 110 kW (150 PS) BLY, BVZ	08.2005→10.2010		7.05271.16.0	LS	1300 mm	BLY, BVZ: Diagnosesonde Diagnostic Probe
2.0 TDI 100 kW (136 PS) AZV	09.2005→10.2010		7.24809.16.0	AGR	PN	
2.0 TDI 100 kW (136 PS) CBDA	09.2005→10.2010		7.10334.00.0	AGR	EL	
			7.08369.01.0	ATS	EL	
			7.08369.04.0	ATS	EL	
			7.11492.02.0	DDS		ohne Zubehör without accessories
						 ch. 1K-7-081 925→
						 →ch. 1K-7-081 924
2.0 TDI 103 kW (140 PS) BMM	10.2005→10.2010		7.00678.06.0	AGR-M	EL	 ch. 1K-8-054 617→
			7.00678.04.0*	AGR-M	EL	mit Rohrstutzen with pipe socket
			↳7.00907.03.0	AGR	EL	
			7.08369.00.0	ATS	EL	
			7.08369.02.0	ATS	EL	
			7.08369.03.0	ATS	EL	
			7.11492.02.0	DDS		ohne Zubehör without accessories
						 ch. 1K-7-081 925→
						 →ch. 1K-7-081 924
2.0 TDI 125 kW (170 PS) BMN	10.2006→10.2010		7.10334.00.0	AGR	EL	
			7.08369.00.0	ATS	EL	
			7.08369.02.0	ATS	EL	
			7.08369.03.0	ATS	EL	
			7.11190.02.0	DDS		 →ch. 1K-7-081 924
			7.11492.02.0	DDS		ohne Zubehör without accessories für OE-Nummer: 03G 906 051 A, 076 906 051 A for OE number: 03G 906 051 A, 076 906 051 A





JETTA III (1K2) **40**

2.0 TDI 125 kW (170 PS) CEGA	10.2006→10.2010		7.10334.00.0	AGR	EL	 ohne Zubehör without accessories  CEGA:  Südafrika  South Africa  CEGA:  ch. 1K-7-081 925→  →ch. 1K-7-081 924	
			7.08369.00.0	ATS	EL		
			7.08369.01.0	ATS	EL		
			7.08369.04.0	ATS	EL		
			7.11492.02.0	DDS			
2.0 TDI 16V 103 kW (140 PS) BKD	08.2005→10.2010		7.24809.16.0	AGR	PN		
2.0 TDI 16V 103 kW (140 PS) CBDB	08.2005→10.2010		7.10334.00.0	AGR	EL	 ohne Zubehör without accessories  CBDB:  Südafrika  South Africa  CBDB:  ch. 1K-7-081 925→  →ch. 1K-7-081 924	
			7.08369.01.0	ATS	EL		
			7.08369.04.0	ATS	EL		
			7.11492.02.0	DDS			
2.0 TDI 16V 103 kW (140 PS) CBEA	08.2005→10.2010		7.01493.07.0	AGR	EL	  Mexico, Argentinien, USA, Brasilien  Mexico, Argentinien, USA, Brazil	
			7.01300.24.0	AK	EL		 Mexico, USA, Brasilien  Mexico, USA, Brazil
2.0 TDI 16V 103-104 kW (140-141 PS) CJAA	08.2005→10.2010		7.10334.00.0	AGR	EL	  ch. 16-B-000 001→	
			7.08369.01.0	ATS	EL		Fahrgestellnummer ab: 16-B-000 001 Vehicle Identification Number from: 16-B-000 001  USA, Kanada  USA, Canada
			7.08369.47.0	ATS	EL		
2.0 TFSI 147 kW (200 PS) BPY, BWA	10.2005→10.2010		7.05271.15.0	LS	525 mm		
2.0 TFSI 147-157 kW (200-213 PS) CBFA	10.2005→10.2010		7.01510.31.0	SLV	EL	  Mexico, Argentinien, Brasilien  Mexico, Argentinien, Brazil	
2.5 110-112 kW (150-152 PS) BGP, BTK	01.2006→10.2010		7.05271.13.0	LS	470 mm		
2.5 125 kW (170 PS) CCCA	07.2008→10.2010		7.05271.13.0	LS	470 mm		





















































JETTA IV (162, 163, AV3, AV2) **41**

1.4 TSI Hybrid 110 kW (150 PS) CNLA, CRJA	04.2011→		7.03635.37.0	SLP	EL	 CNLA, CRJA: Fahrgestellnummer ab: 16-B-000 001 Vehicle Identification Number from: 16-B-000 001	
1.6 TDI 77 kW (105 PS) CAYC	04.2010→07.2015		7.09720.00.0	AGR-K	EL	 Fahrgestellnummer ab: 16-B-000 001 Vehicle Identification Number from: 16-B-000 001	
			7.08369.01.0	ATS	EL		Fahrgestellnummer ab: 16-B-000 001 Vehicle Identification Number from: 16-B-000 001
			7.08369.04.0	ATS	EL		
			7.11492.00.0	DDS			ohne Zubehör without accessories

V



JETTA IV (162, 163, AV3, AV2) 41

1.8 TSI 125 kW (170 PS) CPKA, CPRA	07.2014→	 7.03635.37.0	SLP	EL	 CPKA, CPRA: Fahrgestellnummer ab: 16-B-000 001 Vehicle Identification Number from: 16-B-000 001
		 7.01510.86.0	SLV	EL	 CPKA, CPRA:  ch. 16-B-000 001→ Produktionsdatum bis: 16.11.2015 Production date to: 16.11.2015
		 7.01510.85.0	SLV	EL	 CPKA, CPRA:  ch. 16-F-000 001→ Produktionsdatum ab: 17.11.2015 Production date from: 17.11.2015
2.0 TDI 81 kW (110 PS) CLCA	10.2010→	 7.09720.00.0	AGR-K	EL	
2.0 TDI 103 kW (140 PS) CFFB, CFHC, CLCB	02.2011→	 7.09720.00.0	AGR-K	EL	 CFFB, CFHC, CLCB:  ch. 16-B-000 001→
2.0 TDI 103-104 kW (140-141 PS) CJAA	02.2011→	 7.10334.00.0	AGR	EL	 ch. 16-B-000 001→
		 7.01493.07.0	AGR	EL	
		 7.01300.24.0	AK	EL	 Mexico, USA, Brasilien, Kanada, Südafrika  Mexico, USA, Brazil, Canada, South Africa
		 7.08369.01.0	ATS	EL	Fahrgestellnummer ab: 16-B-000 001 Vehicle Identification Number from: 16-B-000 001  USA, Kanada  USA, Kanada
		 7.08369.47.0	ATS	EL	ohne Zubehör without accessories
 7.11492.00.0	DDS				
2.0 TDI 110 kW (150 PS) CUUB	07.2014→	 7.11492.03.0	DDS		ohne Zubehör without accessories  ch. 16-F-000 001→
2.0 TDI 110 kW (150 PS) DELA, DGMA	07.2014→	 7.07696.00.0	SRM-AK	EL	 ch. 16-F-000 001→
		 7.08369.81.0	ATS	EL	 DELA, DGMA:  ch. 16-F-000 001→
		 7.11492.03.0	DDS		ohne Zubehör without accessories  DELA, DGMA:  ch. 16-F-000 001→
2.0 TDI 110 kW (150 PS) DELA, DGMA	07.2014→	 7.07696.00.0	SRM-AK	EL	 DELA, DGMA:  ch. 16-F-000 001→
		 7.11492.03.0	DDS		ohne Zubehör without accessories  ch. 16-F-000 001→
2.0 TDI 81 kW (110 PS) CUUA	08.2014→	 7.11492.03.0	DDS		ohne Zubehör without accessories  ch. 16-F-000 001→
		 7.07696.00.0	SRM-AK	EL	 ch. 16-F-000 001→
2.0 TSI 147-157 kW (200-213 PS) CBFA	12.2010→	 7.01510.31.0	SLV	EL	 ch. 16-B-000 001→  Mexico, Brasilien  Mexico, Brasilien
2.0 TSI 155 kW (211 PS) CPLA, CPPA	12.2012→12.2017	 7.03635.37.0	SLP	EL	 CPLA, CPPA: Fahrgestellnummer ab: 16-B-000 001 Vehicle Identification Number from: 16-B-000 001
		 7.01510.86.0	SLV	EL	 CPLA, CPPA:  ch. 16-B-000 001→ Produktionsdatum bis: 16.11.2015 Production date to: 16.11.2015





JETTA IV (162, 163, AV3, AV2) 41

		7.01510.85.0	SLV	EL	CPLA, CPPA: ch. 16-F-000 001→ Produktionsdatum ab: 17.11.2015 Production date from: 17.11.2015
2.5 125 kW (170 PS) CCCA	04.2010→	7.05271.13.0	LS	470 mm	

JETTA VII Saloon (BU3) 42

1.4 TSI 110 kW (150 PS) DGXA	12.2017→	7.03635.38.0	SLP	EL	Produktionsdatum bis: 13.07.2020 Production date to: 13.07.2020
		7.01510.91.0	SLV	EL	mit Dichtring with O-ring DGXA: ch. BU-J-000 001→ USA USA DGXA: Brasilien Brazil DGXA: ch. BU-J-000 001→ch. BU3*** Mexico Mexico











LUPO I (6X1, 6E1) 43

1.0 37 kW (50 PS) AER	09.1998→07.2005	7.05271.04.0	LS	505 mm	
1.0 37 kW (50 PS) ALD, AUC	09.1998→07.2005	7.05270.99.0	LS	940 mm	ALD: Regelsonde Regulating Probe AUC: ch. 6X-5-000 001→ Diagnosesonde Diagnostic Probe
		7.05271.77.0	LS	800 mm	ALD, AUC: vor Katalysator in front of the catalyst
		7.05271.14.0	LS	1700 mm	→ch. 6X-4-060 000
1.0 37 kW (50 PS) ALL	09.1998→07.2005	7.05271.03.0	LS	730 mm	Regelsonde Regulating Probe
1.0 37 kW (50 PS) ANV	09.1998→07.2005	7.05271.77.0	LS	800 mm	vor Katalysator in front of the catalyst
		7.05271.14.0	LS	1700 mm	
1.0 37 kW (50 PS) AHT	10.1998→05.2000	7.05271.03.0	LS	730 mm	Regelsonde Regulating Probe
1.2 TDI 3L 45 kW (61 PS) ANY	07.1999→11.2000	7.24809.17.0	AGR	PN	
1.2 TDI 3L 45 kW (61 PS) AYZ	11.2000→07.2005	7.24809.16.0	AGR	PN	
1.4 44 kW (60 PS) AUD	10.2000→07.2005	7.05270.99.0	LS	940 mm	
		7.05271.77.0	LS	800 mm	vor Katalysator in front of the catalyst
1.4 16V 55 kW (75 PS) AHW, AKQ	09.1998→07.2005	7.05271.03.0	LS	730 mm	AHW, AKQ: Regelsonde Regulating Probe
1.4 16V 55 kW (75 PS) APE, AUA	05.1999→07.2005	7.28248.17.0	AGR	EL	
		7.22785.17.0	AGR	EL	APE: ch. 6E-2-000 001→ AUA: ch. 6X-2-000 001→
		7.05271.06.0	LS	1720 mm	APE, AUA: Fahrgestellnummer bis: 6E-1-010 000, 6X-1-100 000 Vehicle Identification Number to: 6E-1-010 000, 6X-1-100 000
1.4 16V 74 kW (101 PS) AQQ, AUB	08.1999→07.2005	7.28248.17.0	AGR	EL	
					AQQ: ch. 6E-2-000 001→ AUB: ch. 6X-2-000 001→















V



LUPO I (6X1, 6E1) 43

			7.22785.17.0	AGR	EL		AQQ, AUB: Fahrgestellnummer bis: 6E-1-010 000, 6X-1-100 000 Vehicle Identification Number to: 6E-1-010 000, 6X-1-100 000
			7.05271.06.0	LS	1720 mm		
1.4 16V 55 kW (75 PS) BBY	04.2002→07.2005		7.28248.17.0	AGR	EL		ch. 6E-2-000 001→
1.4 FSI 77 kW (105 PS) ARR	02.2001→07.2005		7.08369.34.0	ATS	EL		
			7.05271.77.0	LS	800 mm		für OE-Nummer: 036 906 262 C, 1K0 998 262 F for OE number: 036 906 262 C, 1K0 998 262 F
1.4 TDI 55 kW (75 PS) AMF	01.1999→07.2005		7.24809.17.0	AGR	PN		für Linkslenker for left-hand drive vehicles
			7.24809.57.0	AGR	PN		für Rechtslenker for right-hand drive vehicles
1.6 GTI 92 kW (125 PS) AVY	09.2000→07.2005		7.05271.77.0	LS	800 mm		vor Katalysator in front of the catalyst
			7.05271.02.0	LS	500 mm		
1.7 SDI 44 kW (60 PS) AKU	09.1998→07.2005		7.22477.10.0	AGR	PN		

NEW BEETLE (9C1, 1C1) 44





























1.4 55 kW (75 PS) BCA	11.2001→09.2010		7.22785.17.0	AGR	EL		
			7.05271.77.0	LS	800 mm		vor Katalysator in front of the catalyst
1.6 74 kW (101 PS) AWH	10.1999→09.2000		7.22574.12.0	AGR	EL		
			7.05270.99.0	LS	940 mm		
			7.05271.24.0	LS	1500 mm		vor Katalysator in front of the catalyst
			7.22738.08.0	SLP	EL		
			7.22778.96.0	SLV	PN		
1.6 75 kW (102 PS) AYD	06.2000→09.2010		7.22574.12.0	AGR	EL		
			7.05270.99.0	LS	940 mm		
			7.05271.24.0	LS	1500 mm		vor Katalysator in front of the catalyst
			7.22738.08.0	SLP	EL		
			7.22778.80.0	SLV	PN		
			7.22778.96.0	SLV	PN		
1.6 75 kW (102 PS) BFS	06.2000→09.2010		7.22574.12.0	AGR	EL		
			7.22286.41.0	ARV	PN		
			7.05270.99.0	LS	940 mm		
			7.05271.24.0	LS	1500 mm		vor Katalysator in front of the catalyst
			7.22738.08.0	SLP	EL		
			7.22778.96.0	SLV	PN		
1.8 T 110 kW (150 PS) APH, AVC	10.1999→10.2000		7.22286.41.0	ARV	PN		





NEW BEETLE (9C1, 1C1)

44

			7.05271.23.0	LS	900 mm	
			7.05271.77.0	LS	800 mm	 APH, AVC: vor Katalysator in front of the catalyst
			7.21851.31.0	SLP	EL	
1.8 T 110 kW (150 PS) BKF	10.1999→09.2010		7.22286.41.0	ARV	PN	
			7.05271.29.0	LS	900 mm	
			7.05271.02.0	LS	500 mm	Regelsonde, Diagnosesonde Regulating Probe, Diagnostic Probe
			7.22738.08.0	SLP	EL	
1.8 T 110 kW (150 PS) AWU, AWW	06.2000→09.2010		7.22286.41.0	ARV	PN	
			7.05271.01.0	LS	950 mm	 AWU:  →ch. 9C-8-599 000 Diagnosesonde Diagnostic Probe  AWW: Diagnosesonde Diagnostic Probe
			7.05271.23.0	LS	900 mm	 →ch. 9C-9-551 086
			7.05271.24.0	LS	1500 mm	 AWU, AWW: vor Katalysator in front of the catalyst
			7.22738.08.0	SLP	EL	
1.8 T 132 kW (180 PS) AWP	11.2001→06.2005		7.22286.41.0	ARV	PN	
			7.05271.01.0	LS	950 mm	Diagnosesonde Diagnostic Probe
			7.05271.23.0	LS	900 mm	
			7.05271.24.0	LS	1500 mm	vor Katalysator in front of the catalyst
			7.22738.08.0	SLP	EL	
1.8 T 132 kW (180 PS) BNU	07.2004→06.2005		7.22286.41.0	ARV	PN	
			7.05271.29.0	LS	900 mm	
			7.05271.02.0	LS	500 mm	Regelsonde, Diagnosesonde Regulating Probe, Diagnostic Probe
			7.22738.08.0	SLP	EL	
1.9 TDI 66-67 kW (90-91 PS) ALH	01.1998→06.2004		7.24809.17.0	AGR	PN	
1.9 TDI 74 kW (101 PS) ATD	06.2001→09.2010		7.24809.64.0	AGR	PN	
			7.00365.06.0	AGR	EL	
1.9 TDI 74 kW (101 PS) BEW	07.2005→12.2006		7.00365.06.0	AGR	EL	
1.9 TDI 77 kW (105 PS) BSW	07.2005→09.2010		7.24809.16.0	AGR	PN	
2.0 85 kW (115 PS) AEG	01.1998→09.2010		7.22286.26.0	ARV	PN	  →ch. 1C-1-420 000
			7.05271.01.0	LS	950 mm	Regelsonde Regulating Probe
			7.05271.02.0	LS	500 mm	 ch. 1C-X-460 001→ Diagnosesonde Diagnostic Probe
			7.22738.08.0	SLP	EL	 USA, Kanada  USA, Kanada

V







NEW BEETLE (9C1, 1C1) 44

			7.22778.80.0	SLV	PN	<p>Fahrgestellnummer ab: 1C-1-420 001 Vehicle Identification Number from: 1C-1-420 001 USA, Kanada USA, Kanada</p>
2.0 85 kW (115 PS) AQY	01.1998→09.2010		7.22286.26.0	ARV	PN	<p>→ch. 9C-1-615 000</p>
			7.05271.01.0	LS	950 mm	Regelsonde Regulating Probe
			7.05271.02.0	LS	500 mm	Diagnosesonde Diagnostic Probe
			7.21851.31.0	SLP	EL	→ch. 1C-X-499 000
			7.22738.08.0	SLP	EL	
			7.22778.80.0	SLV	PN	
2.0 85 kW (115 PS) AZG	01.1998→09.2010		7.05270.98.0	LS	700 mm	nach Katalysator Post-catalyst
			7.05271.02.0	LS	500 mm	Diagnosesonde Diagnostic Probe
			7.05271.24.0	LS	1500 mm	vor Katalysator in front of the catalyst
			7.22738.08.0	SLP	EL	USA, Kanada USA, Kanada
			7.22778.80.0	SLV	PN	<p> USA, Kanada USA, Kanada 1999 1999 2001, 2005 2001, 2005</p>
2.0 85-86 kW (115-117 PS) AZJ, BEV	01.1998→09.2010		7.22286.41.0	ARV	PN	
			7.05270.98.0	LS	700 mm	AZJ, BEV: nach Katalysator Post-catalyst
			7.05271.02.0	LS	500 mm	AZJ, BEV: Diagnosesonde Diagnostic Probe
			7.05271.24.0	LS	1500 mm	AZJ, BEV: vor Katalysator in front of the catalyst
			7.22738.08.0	SLP	EL	
			7.22778.80.0	SLV	PN	<p> AZJ: Fahrgestellnummer bis: 9C-8-599 000 Vehicle Identification Number to: 9C-8-599 000 BEV: Fahrgestellnummer bis: 1C-8-549 000 Vehicle Identification Number to: 1C-8-549 000</p>
2.0 85 kW (116 PS) BER	01.1998→09.2010		7.05270.98.0	LS	700 mm	nach Katalysator Post-catalyst
			7.05271.02.0	LS	500 mm	Diagnosesonde Diagnostic Probe
			7.05271.21.0	LS	1250 mm	ch. 1C-3-433 833→ Regelsonde Regulating Probe
2.0 85 kW (116 PS) APK	03.2000→09.2010		7.05271.01.0	LS	950 mm	Regelsonde Regulating Probe
			7.05271.02.0	LS	500 mm	Diagnosesonde Diagnostic Probe
2.3 V5 125 kW (170 PS) AQN	10.2000→09.2010		7.22286.55.0	ARV	PN	
			7.05271.01.0	LS	950 mm	





















NEW BEETLE (9C1, 1C1) 44

			7.05271.23.0	LS	900 mm	
			7.05271.24.0	LS	1500 mm	vor Katalysator in front of the catalyst
			7.22738.08.0	SLP	EL	
2.5 110 kW (150 PS) BPR, BPS	07.2005→09.2010		7.05271.02.0	LS	500 mm	 BPR: Regelsonde, Diagnosesonde Regulating Probe, Diagnostic Probe  BPS: Diagnosesonde Diagnostic Probe
3.2 RSI 4motion (1C9) 165 kW (224 PS) AXJ	04.2000→05.2001		7.22286.55.0	ARV	PN	
			7.05270.98.0	LS	700 mm	nach Katalysator, rechts Post-catalyst, Right
			7.05270.91.0	LS	350 mm	
			7.05271.00.0	LS	1525 mm	
			7.05271.24.0	LS	1500 mm	vor Katalysator in front of the catalyst
			7.22738.08.0	SLP	EL	

NEW BEETLE Convertible (1Y7) 45

1.4 55 kW (75 PS) BCA	01.2003→09.2010		7.22785.17.0	AGR	EL	
			7.05271.77.0	LS	800 mm	vor Katalysator in front of the catalyst
1.6 75 kW (102 PS) BFS	01.2003→09.2010		7.22574.12.0	AGR	EL	
			7.22286.41.0	ARV	PN	
			7.05270.99.0	LS	940 mm	
			7.05271.24.0	LS	1500 mm	vor Katalysator in front of the catalyst
			7.22738.08.0	SLP	EL	
			7.22778.96.0	SLV	PN	
1.8 T 110 kW (150 PS) AWU	01.2003→09.2010		7.22286.41.0	ARV	PN	
			7.05271.01.0	LS	950 mm	 →ch. 9C-8-599 000 Diagnosesonde Diagnostic Probe
			7.05271.23.0	LS	900 mm	 →ch. 9C-9-551 086
			7.05271.24.0	LS	1500 mm	vor Katalysator in front of the catalyst
			7.22738.08.0	SLP	EL	
1.8 T 110 kW (150 PS) AWV	01.2003→09.2010		7.22286.41.0	ARV	PN	
			7.05271.01.0	LS	950 mm	Diagnosesonde Diagnostic Probe
			7.05271.23.0	LS	900 mm	
			7.22738.08.0	SLP	EL	
1.8 T 110 kW (150 PS) BKF	01.2003→09.2010		7.22286.41.0	ARV	PN	
			7.05271.29.0	LS	900 mm	
			7.05271.02.0	LS	500 mm	Regelsonde, Diagnosesonde Regulating Probe, Diagnostic Probe
			7.22738.08.0	SLP	EL	
1.9 TDI 66-67 kW (90-91 PS) ALH	09.2002→06.2004		7.24809.17.0	AGR	PN	

V



NEW BEETLE Convertible (1Y7) 45

1.9 TDI 74 kW (101 PS) AXR	06.2003→09.2010		7.24809.16.0	AGR	PN	
1.9 TDI 77 kW (105 PS) BSW	07.2005→09.2010		7.24809.16.0	AGR	PN	
2.0 85-86 kW (115-117 PS) AZJ, BEV	09.2002→10.2010		7.22286.41.0	ARV	PN	
			7.05271.01.0	LS	950 mm	
			7.05270.98.0	LS	700 mm	AZJ, BEV: nach Katalysator Post-catalyst
			7.05271.02.0	LS	500 mm	AZJ, BEV: Diagnosesonde Diagnostic Probe
			7.05271.24.0	LS	1500 mm	AZJ, BEV: vor Katalysator in front of the catalyst
			7.21851.31.0	SLP	EL	
			7.22738.08.0	SLP	EL	
7.22778.80.0	SLV	PN	AZJ, BEV: Fahrgestellnummer bis: 1Y-8-499 000 Vehicle Identification Number to: 1Y-8-499 000			
2.0 85 kW (115 PS) BDC, BGD	09.2002→10.2010		7.05271.01.0	LS	950 mm	
			7.05270.98.0	LS	700 mm	BDC, BGD: nach Katalysator Post-catalyst
			7.05271.02.0	LS	500 mm	BDC, BGD: Diagnosesonde Diagnostic Probe
			7.05271.24.0	LS	1500 mm	BDC, BGD: vor Katalysator in front of the catalyst
			7.21851.31.0	SLP	EL	
			7.22738.08.0	SLP	EL	
7.22778.80.0	SLV	PN	BDC, BGD: Fahrgestellnummer bis: 1Y-5-322 020 Vehicle Identification Number to: 1Y-5-322 020			
2.5 110 kW (150 PS) BPR, BPS	07.2005→09.2010		7.05271.02.0	LS	500 mm	BPR: Regelsonde, Diagnosesonde Regulating Probe, Diagnostic Probe BPS: Diagnosesonde Diagnostic Probe





















PASSAT ALLTRACK B7 (365) 46

2.0 TDI 103 kW (140 PS) CFFB	01.2012→12.2014		7.10334.00.0	AGR	EL	ch. A3-DC000 001→ für PR-Nummer: TN5 for PR number: TN5
			7.09720.00.0	AGR-K	EL	ohne Zubehör without accessories
			7.11492.00.0	DDS		ch. A3-DC000 001→
2.0 TDI 4motion 103 kW (140 PS) CFFB	01.2012→12.2014		7.10334.00.0	AGR	EL	ch. A3-DC000 001→ für PR-Nummer: TN5 for PR number: TN5
			7.09720.00.0	AGR-K	EL	ohne Zubehör without accessories
			7.11492.00.0	DDS		ch. A3-DC000 001→
2.0 TDI 4motion 125 kW (170 PS) CFGB	01.2012→12.2014		7.09720.00.0	AGR-K	EL	
2.0 TDI 4motion 130 kW (177 PS) CFGC	01.2013→12.2014		7.09720.00.0	AGR-K	EL	







PASSAT ALLTRACK B8 Variant (3G5, CB5) 47

2.0 TDI 4motion 110 kW (150 PS) CRLB	05.2015→11.2017		7.08369.81.0	ATS	EL	 ch. 3C-F-200 001→
			7.11492.05.0	DDS		ohne Zubehör without accessories für OE-Nummer: 04L 906 051 AB, 04L 906 051 F, 04L 906 051 G, 04L 906 051 L for OE number: 04L 906 051 AB, 04L 906 051 F, 04L 906 051 G, 04L 906 051 L
			7.07696.00.0	SRM-AK	EL	 ch. 3C-F-200 001→
2.0 TDI 4motion 110 kW (150 PS) DFEA	05.2015→11.2017		7.10334.02.0	AGR	EL	 ch. 3C-F-200 001→
			7.08369.81.0	ATS	EL	 ch. 3C-F-200 001→
			7.11492.05.0	DDS		ohne Zubehör without accessories für OE-Nummer: 04L 906 051 AB, 04L 906 051 F, 04L 906 051 G, 04L 906 051 L for OE number: 04L 906 051 AB, 04L 906 051 F, 04L 906 051 G, 04L 906 051 L
			7.07696.00.0	SRM-AK	EL	 ch. 3C-F-200 001→
2.0 TDI 4motion 140 kW (190 PS) DDAA, DFHA	05.2015→		7.10334.02.0	AGR	EL	 DDAA, DFHA:  ch. 3C-F-200 001→
			7.11020.26.0	ATS	EL	 DDAA, DFHA:  ch. 3C-F-200 001→
			7.11492.05.0	DDS		ohne Zubehör without accessories für OE-Nummer: 04L 906 051 AB, 04L 906 051 F, 04L 906 051 G, 04L 906 051 L for OE number: 04L 906 051 AB, 04L 906 051 F, 04L 906 051 G, 04L 906 051 L
			7.07696.00.0	SRM-AK	EL	 DDAA, DFHA:  ch. 3C-F-200 001→
2.0 TDI 4motion 140 kW (190 PS) DFCA	05.2015→		7.10334.02.0	AGR	EL	 ch. 3C-F-200 001→
			7.11020.26.0	ATS	EL	 ch. 3C-F-200 001→
			7.07696.00.0	SRM-AK	EL	 ch. 3C-F-200 001→
2.0 TDI 4motion 135 kW (184 PS) CUPA	07.2015→		7.08369.81.0	ATS	EL	 ch. 3C-F-200 001→

PASSAT B1 (32) 48



1.6 53 kW (72 PS) FS	08.1975→07.1980		7.02604.01.0	LS	200 mm	
1.6 GLi 81 kW (110 PS) YS	06.1978→07.1980		7.02604.01.0	LS	200 mm	





































PASSAT B1 Variant (33) 49

1.6 53 kW (72 PS) FS	02.1976→08.1979		7.02604.01.0	LS	200 mm	
1.6 i 81 kW (110 PS) YS	06.1978→07.1980		7.02604.01.0	LS	200 mm	

PASSAT B2 (32B) 50

V











1.6 55 kW (75 PS) WV, WY, YN	09.1979→07.1983		7.02604.01.0	LS	200 mm	
1.6 55 kW (75 PS) DT	08.1980→03.1988		7.02604.01.0	LS	200 mm	
1.6 61-63 kW (85 PS) YP	01.1981→02.1983		7.02604.01.0	LS	200 mm	
1.6 53 kW (72 PS) RL	02.1986→03.1988		7.02604.01.0	LS	200 mm	
1.6 51-55 kW (69-75 PS) DTA, PP	08.1986→03.1988		7.02604.01.0	LS	200 mm	

						
PASSAT B2 (32B)						50
1.8 66-76 kW (90-103 PS) DS, JN, JV	01.1983→03.1988		7.02604.01.0	LS	200 mm	
1.8 63-64 kW (87 PS) RM	05.1986→03.1988		7.02604.01.0	LS	200 mm	
2.2 100 kW (136 PS) KV	01.1985→03.1988		7.02604.01.0	LS	200 mm	
2.2 82-88 kW (112-120 PS) KX	08.1985→03.1988		7.02604.01.0	LS	200 mm	
PASSAT B2 Saloon (32B)						51
1.6 55 kW (75 PS) DT, JU	08.1984→03.1988		7.02604.01.0	LS	200 mm	
1.6 53 kW (72 PS) RL	01.1985→03.1988		7.02604.01.0	LS	200 mm	
1.6 51-55 kW (69-75 PS) DTA, PP	08.1986→03.1988		7.02604.01.0	LS	200 mm	
1.8 66-76 kW (90-103 PS) DS, JN	01.1985→03.1988		7.02604.01.0	LS	200 mm	
1.8 63-64 kW (87 PS) RM	05.1986→03.1988		7.02604.01.0	LS	200 mm	
2.2 82-88 kW (112-120 PS) KX	01.1985→03.1988		7.02604.01.0	LS	200 mm	
PASSAT B2 Variant (33B)						52
1.6 55 kW (75 PS) WV, WY, YN	08.1980→07.1983		7.02604.01.0	LS	200 mm	
1.6 61-63 kW (85 PS) YP	01.1981→02.1983		7.02604.01.0	LS	200 mm	
1.6 55 kW (75 PS) DT, JU	08.1983→03.1988		7.02604.01.0	LS	200 mm	
1.6 53 kW (72 PS) RL	02.1986→03.1988		7.02604.01.0	LS	200 mm	
1.6 51-55 kW (69-75 PS) DTA, PP	08.1986→03.1988		7.02604.01.0	LS	200 mm	
1.8 66-76 kW (90-103 PS) DS, JN, JV	01.1983→03.1988		7.02604.01.0	LS	200 mm	
1.8 63-64 kW (87 PS) RM	05.1986→03.1988		7.02604.01.0	LS	200 mm	
1.8 Syncro 66-76 kW (90-103 PS) DS, JN	01.1986→03.1988		7.02604.01.0	LS	200 mm	
2.2 100 kW (136 PS) KV	01.1985→03.1988		7.02604.01.0	LS	200 mm	
2.2 82-88 kW (112-120 PS) KX	08.1985→03.1988		7.02604.01.0	LS	200 mm	
2.2 Syncro 100 kW (136 PS) HY	08.1984→07.1988		7.02604.01.0	LS	200 mm	
2.2 Syncro 82-88 kW (112-120 PS) JT, KX	08.1985→03.1988		7.02604.01.0	LS	200 mm	
PASSAT B3/B4 (3A2, 35I)						53
1.6 53 kW (72 PS) RF	04.1988→07.1989		7.02604.01.0	LS	200 mm	
1.6 54-55 kW (73-75 PS) 1F, ABN, EZ	04.1988→07.1992		7.02604.01.0	LS	200 mm	
1.6 74 kW (101 PS) AEK, AFT	10.1994→08.1996		7.02604.01.0	LS	200 mm	
2.0 81-87 kW (110-117 PS) ABA, ADY, AGG	02.1990→08.1996		7.22286.26.0	ARV	PN  ABA, ADY, AGG:  ch. 3A-T-000 001→	
2.0 79 kW (107 PS) AEP	03.1995→08.1996		7.22286.26.0	ARV	PN 	























V



PASSAT B3/B4 (3A2, 35I) 53





2.0 16V 100 kW (136 PS) 9A	08.1988→09.1993		7.02604.04.0	LS	200 mm	
2.0 16V 110 kW (150 PS) ABF	01.1994→08.1996		7.22286.26.0	ARV	PN	
			7.05270.86.0	LS	625 mm	 →ch. 3A-S-075 000
			7.02604.04.0	LS	200 mm	
2.0 Syncro 85 kW (115 PS) ADY, AGG	10.1994→08.1996		7.22286.26.0	ARV	PN	 ADY, AGG:  ch. 3A-T-000 001→
2.8 VR6 120-128 kW (163-174 PS) AAA	06.1991→08.1996		7.22090.11.0	ARV	PN	  ch. 3A-T-000 001→
			7.05270.88.0	LS	740 mm	
			7.05270.86.0	LS	625 mm	

PASSAT B3/B4 Variant (3A5, 35I) 54

1.6 53 kW (72 PS) RF	04.1988→07.1989		7.02604.01.0	LS	200 mm	
1.6 55 kW (75 PS) 1F, EZ	04.1988→07.1991		7.02604.01.0	LS	200 mm	
1.6 74 kW (101 PS) AEK, AFT	07.1994→12.1995		7.02604.01.0	LS	200 mm	
2.0 85 kW (115 PS) ADY, AGG	10.1993→10.1996		7.22286.26.0	ARV	PN	 ADY, AGG:  ch. 3A-T-000 001→
2.0 85 kW (115 PS) ADY, AGG	10.1994→05.1997		7.22286.26.0	ARV	PN	 ADY, AGG:  ch. 3A-T-000 001→
2.0 79 kW (107 PS) AEP	03.1995→08.1996		7.22286.26.0	ARV	PN	
2.0 16V 100 kW (136 PS) 9A	08.1988→09.1993		7.02604.04.0	LS	200 mm	
2.0 16V 110 kW (150 PS) ABF	01.1994→05.1997		7.22286.26.0	ARV	PN	
			7.05270.86.0	LS	625 mm	 →ch. 3A-S-075 000
			7.02604.04.0	LS	200 mm	
2.0 Syncro 85 kW (115 PS) ADY, AGG	10.1994→12.1996		7.22286.26.0	ARV	PN	 ADY, AGG:  ch. 3A-T-000 001→
2.8 VR6 120-128 kW (163-174 PS) AAA	06.1991→05.1997		7.22090.11.0	ARV	PN	  ch. 3A-T-000 001→
			7.05270.88.0	LS	740 mm	
			7.05270.86.0	LS	625 mm	
2.9 VR6 Syncro 135-140 kW (184-190 PS) ABV	01.1994→05.1997		7.05270.96.0	LS	1440 mm	

PASSAT B5 (3B2) 55

V

1.6 74 kW (101 PS) ADP, AHL, ARM	10.1996→11.2000		7.02604.01.0	LS	200 mm	
1.6 74 kW (101 PS) ANA	10.1996→11.2000		7.05271.05.0	LS	700 mm	 ch. 3B-V-000 001→ nach Katalysator Post-catalyst
			7.02604.01.0	LS	200 mm	
			7.05271.07.0	LS	1100 mm	
			7.21851.31.0	SLP	EL	 ch. 3B-V-000 001→ch. 3B-YP210 000























PASSAT B5 (3B2) **55**

		7.22738.08.0	SLP	EL	ch. 3B-YE250 001→	
1.8 92 kW (125 PS) ADR, APT	10.1996→11.2000	 7.05271.21.0	LS	1250 mm	ADR, APT: ch. 3B-X-310 001→ Regelsonde Regulating Probe	
1.8 85 kW (115 PS) AFY	01.1997→11.2000	 7.05271.21.0	LS	1250 mm	ch. 3B-X-310 001→ Regelsonde Regulating Probe	
1.8 92 kW (125 PS) ARG	02.1999→11.2000		7.05271.21.0	LS	1250 mm	ch. 3B-X-310 001→ Regelsonde Regulating Probe
			7.21851.31.0	SLP	EL	ch. 3B-V-000 001→ch. 3B-YP210 000 Automatikgetriebe Automatic Transmission
			7.22738.08.0	SLP	EL	ch. 3B-YE250 001→
1.8 Syncro/4motion 92 kW (125 PS) ADR, APT	12.1996→08.2000	 7.05271.21.0	LS	1250 mm	ADR, APT: ch. 3B-X-310 001→ Regelsonde Regulating Probe	
1.8 Syncro/4motion 92 kW (125 PS) ARG	02.1999→08.2000		7.05271.21.0	LS	1250 mm	ch. 3B-X-310 001→ Regelsonde Regulating Probe
			7.21851.31.0	SLP	EL	ch. 3B-V-000 001→ch. 3B-YP210 000 Automatikgetriebe Automatic Transmission
			7.22738.08.0	SLP	EL	ch. 3B-YE250 001→
1.8 T 110 kW (150 PS) ANB	01.1999→11.2000		7.22560.42.0	ARV	PN	
			7.05270.99.0	LS	940 mm	Diagnosesonde Diagnostic Probe
			7.05271.21.0	LS	1250 mm	ch. 3B-X-310 001→ Regelsonde Regulating Probe
			7.21851.31.0	SLP	EL	ch. 3B-V-000 001→ch. 3B-YE250 000
1.8 T 110 kW (150 PS) APU	01.1999→11.2000		7.22738.08.0	SLP	EL	ch. 3B-YE250 001→
			7.05271.21.0	LS	1250 mm	ch. 3B-X-310 001→ Regelsonde Regulating Probe
1.9 TDI 85 kW (115 PS) AJM, ATJ	08.1998→11.2000	 7.24809.19.0	AGR	PN		
1.9 TDI 74 kW (101 PS) AVB	02.2000→11.2000	 7.24809.19.0	AGR	PN		
1.9 TDI 4motion 85 kW (115 PS) ATJ	01.2000→11.2000	 7.24809.19.0	AGR	PN		
2.0 88 kW (120 PS) ASU, AUZ	04.2000→11.2000	 7.22286.26.0	ARV	PN		
2.0 4motion 88 kW (120 PS) ASU	04.2000→11.2000	 7.22286.26.0	ARV	PN		
2.3 VR5 110 kW (150 PS) AGZ	10.1996→11.2000		7.22286.55.0	ARV	PN	 Fahrgestellnummer ab: 3B-V-000 001 Vehicle Identification Number from: 3B-V-000 001
			7.21851.31.0	SLP	EL	ch. 3B-V-000 001→ch. 3B-YE250 000
			7.22738.08.0	SLP	EL	ch. 3B-YE250 001→
2.3 VR5 Syncro/4motion 110 kW (150 PS) AGZ	10.1997→11.2000		7.22286.55.0	ARV	PN	 Fahrgestellnummer ab: 3B-V-000 001 Vehicle Identification Number from: 3B-V-000 001
			7.21851.31.0	SLP	EL	ch. 3B-V-000 001→ch. 3B-YE250 000
			7.22738.08.0	SLP	EL	ch. 3B-YE250 001→





























































PASSAT B5 (3B2) **55**

2.8 V6 142 kW (193 PS) AQD	08.1996→11.2000		7.22560.40.0	ARV	PN	 ch. 3B-V-000 001→ links Left
			7.22560.41.0	ARV	PN	 ch. 3B-V-000 001→ rechts Right
			7.21851.31.0	SLP	EL	 ch. 3B-V-000 001→ch. 3B-YP210 000
			7.22738.08.0	SLP	EL	 ch. 3B-YE250 001→
2.8 V6 140 kW (190 PS) BBG	09.1999→11.2000		7.22738.08.0	SLP	EL	
2.8 V6 Syncro/4motion 142 kW (193 PS) ALG, AQD	06.1997→11.2000		7.22560.41.0	ARV	PN	 ALG: rechts Right  AQD:  ch. 3B-V-000 001→ rechts Right
			7.22560.40.0	ARV	PN	 ALG: links Left  AQD: Fahrgestellnummer ab: 3B-V-000 001 Vehicle Identification Number from: 3B-V-000 001 links Left
			7.21851.31.0	SLP	EL	 ALG:  →ch. 3B-Y-250 000 Allrad All-wheel Drive  AQD:  ch. 3B-V-000 001→ch. 3B-YP210 000
			7.22738.08.0	SLP	EL	 ALG:  ch. 3B-Y-250 001→ Allrad All-wheel Drive  AQD:  ch. 3B-YE250 001→

PASSAT B5 Variant (3B5) **56**









1.6 74 kW (101 PS) ADP, AHL, ARM	06.1997→11.2000		7.02604.01.0	LS	200 mm	
1.6 74 kW (101 PS) ANA	07.1999→11.2000		7.05271.05.0	LS	700 mm	 ch. 3B-V-000 001→ nach Katalysator Post-catalyst
			7.02604.01.0	LS	200 mm	
			7.05271.07.0	LS	1100 mm	
			7.21851.31.0	SLP	EL	 ch. 3B-V-000 001→ch. 3B-YP210 000
			7.22738.08.0	SLP	EL	 ch. 3B-YE250 001→
1.8 92 kW (125 PS) ADR, APT	06.1997→11.2000		7.05271.21.0	LS	1250 mm	 ADR, APT:  ch. 3B-X-310 001→ Regelsonde Regulating Probe
1.8 85 kW (115 PS) AFY	06.1997→11.2000		7.05271.21.0	LS	1250 mm	 ch. 3B-X-310 001→ Regelsonde Regulating Probe
1.8 92 kW (125 PS) ARG	02.1999→11.2000		7.05271.21.0	LS	1250 mm	 ch. 3B-X-310 001→ Regelsonde Regulating Probe
			7.21851.31.0	SLP	EL	 ch. 3B-V-000 001→ch. 3B-YP210 000 Automatikgetriebe Automatic Transmission
			7.22738.08.0	SLP	EL	 ch. 3B-YE250 001→

					
PASSAT B5 Variant (3B5)					
56					
1.8 Syncro/4motion 92 kW (125 PS) ADR, APT	06.1997→11.2000		7.05271.21.0	LS	1250 mm  ADR, APT:  ch. 3B-X-310 001→ Regelsonde Regulating Probe
1.8 Syncro/4motion 92 kW (125 PS) ARG	02.1999→11.2000		7.05271.21.0	LS	1250 mm  ch. 3B-X-310 001→ Regelsonde Regulating Probe
			7.21851.31.0	SLP	EL  ch. 3B-V-000 001→ch. 3B-YP210 000 Automatikgetriebe Automatic Transmission
			7.22738.08.0	SLP	EL  ch. 3B-YE250 001→
1.8 T 110 kW (150 PS) APU	05.1997→11.2000		7.05271.21.0	LS	1250 mm  ch. 3B-X-310 001→ Regelsonde Regulating Probe
1.8 T 110 kW (150 PS) ANB	01.1999→11.2000		7.22560.42.0	ARV	PN  ch. 3B-V-000 001→
			7.05270.99.0	LS	940 mm Diagnosesonde Diagnostic Probe
			7.05271.21.0	LS	1250 mm  ch. 3B-X-310 001→ Regelsonde Regulating Probe
			7.21851.31.0	SLP	EL  ch. 3B-V-000 001→ch. 3B-YE250 000
			7.22738.08.0	SLP	EL  ch. 3B-YE250 001→
1.9 TDI 85 kW (115 PS) AJM, ATJ	08.1998→11.2000		7.24809.19.0	AGR	PN 
1.9 TDI 74 kW (101 PS) AVB	02.2000→11.2000		7.24809.19.0	AGR	PN 
1.9 TDI 4motion 85 kW (115 PS) ATJ	08.1999→11.2000		7.24809.19.0	AGR	PN 
2.0 88 kW (120 PS) ASU, AUZ	04.2000→11.2000		7.22286.26.0	ARV	PN 
2.0 4motion 88 kW (120 PS) ASU, AUZ	04.2000→11.2000		7.22286.26.0	ARV	PN 
2.3 VR5 110 kW (150 PS) AGZ	06.1997→11.2000		7.22286.55.0	ARV	PN  Fahrgestellnummer ab: 3B-V-000 001 Vehicle Identification Number from: 3B-V-000 001
			7.21851.31.0	SLP	EL  ch. 3B-V-000 001→ch. 3B-YE250 000
			7.22738.08.0	SLP	EL  ch. 3B-YE250 001→
2.3 VR5 Syncro/4motion 110 kW (150 PS) AGZ	10.1997→11.2000		7.22286.55.0	ARV	PN  Fahrgestellnummer ab: 3B-V-000 001 Vehicle Identification Number from: 3B-V-000 001
			7.21851.31.0	SLP	EL  ch. 3B-V-000 001→ch. 3B-YE250 000
			7.22738.08.0	SLP	EL  ch. 3B-YE250 001→
2.8 V6 142 kW (193 PS) AQD	06.1997→11.2000		7.22560.41.0	ARV	PN  ch. 3B-V-000 001→ rechts Right
			7.22560.40.0	ARV	PN  Fahrgestellnummer ab: 3B-V-000 001 Vehicle Identification Number from: 3B-V-000 001 links Left
			7.21851.31.0	SLP	EL  ch. 3B-V-000 001→ch. 3B-YP210 000
			7.22738.08.0	SLP	EL  ch. 3B-YE250 001→





















V



PASSAT B5 Variant (3B5) 56

2.8 V6 Syncro/4motion 142 kW (193 PS) ALG, AQD	06.1997→11.2000		7.22560.41.0	ARV	PN	 ALG: rechts Right  AQD: ch. 3B-V-000 001→ rechts Right
			7.22560.40.0	ARV	PN	 ALG: links Left  AQD: Fahrgestellnummer ab: 3B-V-000 001 Vehicle Identification Number from: 3B-V-000 001 links Left
			7.21851.31.0	SLP	EL	 ALG: →ch. 3B-Y-250 000 Allrad All-wheel Drive  AQD: ch. 3B-V-000 001→ch. 3B-YP210 000
			7.22738.08.0	SLP	EL	 ALG: ch. 3B-Y-250 001→ Allrad All-wheel Drive  AQD: ch. 3B-YE250 001→











PASSAT B5.5 (3B3) 57

1.6 75 kW (102 PS) ALZ	11.2000→05.2005		7.22785.20.0	AGR	EL	
			7.05271.05.0	LS	700 mm	nach Katalysator Post-catalyst
			7.02604.01.0	LS	200 mm	
			7.05271.07.0	LS	1100 mm	
			7.22738.08.0	SLP	EL	
			7.22778.99.0	SLV	PN	  ch. 3B-2-155 001→
			7.22560.43.0	ARV	PN	
1.8 T 125 kW (170 PS) AWM	02.2001→11.2005		7.22738.08.0	SLP	EL	
			7.22560.43.0	ARV	PN	
1.8 T 20V 110 kW (150 PS) AWT	11.2000→05.2005		7.05270.99.0	LS	940 mm	Diagnosesonde Diagnostic Probe
			7.22738.08.0	SLP	EL	
			7.22560.43.0	ARV	PN	
1.8 T 4motion 125 kW (170 PS) AWM	11.2003→05.2005		7.22560.43.0	ARV	PN	
			7.22738.08.0	SLP	EL	
1.9 TDI 74 kW (101 PS) AVB	11.2000→05.2005		7.24809.19.0	AGR	PN	
1.9 TDI 96 kW (130 PS) AVF, AWX	11.2000→05.2005		7.24809.20.0	AGR	PN	
1.9 TDI 4motion 96 kW (130 PS) AVF	11.2000→05.2005		7.24809.20.0	AGR	PN	
2.0 85 kW (116 PS) AZM	11.2000→05.2005		7.22286.26.0	ARV	PN	
			7.05271.05.0	LS	700 mm	nach Katalysator Post-catalyst
			7.05271.07.0	LS	1100 mm	
			7.22738.08.0	SLP	EL	
			7.22778.95.0	SLV	PN	

V







PASSAT B5.5 (3B3) 57

2.0 96 kW (130 PS) ALT	11.2001→05.2005		7.05270.99.0	LS	940 mm	
2.0 4motion 85 kW (116 PS) AZM	11.2000→05.2005		7.22286.26.0	ARV	PN	○
			7.05271.05.0	LS	700 mm	nach Katalysator Post-catalyst
			7.05271.07.0	LS	1100 mm	
			7.22738.08.0	SLP	EL	
			7.22778.95.0	SLV	PN	○
2.0 TDI 100 kW (136 PS) BGW	12.2003→05.2005		7.00365.06.0	AGR	EL	○
			7.08369.40.0	ATS	EL	Euro 4
			7.08369.72.0	ATS	EL	Euro 4 vor Rußpartikelfilter before soot particulate filter
			7.11190.00.0	DDS		
2.0 TDI 100 kW (136 PS) BHW	12.2003→05.2005		7.00365.06.0	AGR	EL	○
2.3 V5 125 kW (170 PS) AZX	11.2000→05.2005		7.22286.51.0	ARV	PN	○
			7.05271.14.0	LS	1700 mm	05.2002→
			7.05271.24.0	LS	1500 mm	vor Katalysator in front of the catalyst
			7.05271.21.0	LS	1250 mm	→05.2002 Diagnosesonde Diagnostic Probe
			7.22738.08.0	SLP	EL	
2.3 V5 4motion 125 kW (170 PS) AZX	11.2000→05.2005		7.22286.51.0	ARV	PN	○
			7.05271.14.0	LS	1700 mm	05.2002→
			7.05271.24.0	LS	1500 mm	vor Katalysator in front of the catalyst
			7.05271.21.0	LS	1250 mm	→05.2002 Diagnosesonde Diagnostic Probe
			7.22738.08.0	SLP	EL	
2.8 140 kW (190 PS) BBG	10.2000→05.2005		7.22560.40.0	ARV	PN	○ links Left
			7.22560.41.0	ARV	PN	○ rechts Right
			7.22738.08.0	SLP	EL	
2.8 142 kW (193 PS) AMX, ATQ	05.2002→05.2003		7.22560.40.0	ARV	PN	○
			7.22560.41.0	ARV	PN	○
			7.22738.08.0	SLP	EL	
2.8 4motion 140 kW (190 PS) BBG	10.2000→05.2005		7.22560.40.0	ARV	PN	○ links Left
			7.22560.41.0	ARV	PN	○ rechts Right
			7.22738.08.0	SLP	EL	
2.8 4motion 142 kW (193 PS) AMX, ATQ	11.2000→05.2005		7.22560.40.0	ARV	PN	○
			7.22560.41.0	ARV	PN	○ AMX, ATQ: rechts Right

















































PASSAT B5.5 (3B3) 57









4.0 W8 4motion 202 kW (275 PS) BDN, BDP	09.2001→09.2004	 7.22738.08.0	SLP	EL	
		 7.05271.01.0	LS	950 mm	
		 7.05271.23.0	LS	900 mm	
		 7.22738.08.0	SLP	EL	

PASSAT B5.5 Variant (3B6) 58



1.6 75 kW (102 PS) ALZ	11.2000→05.2005	 7.22785.20.0	AGR	EL	
		 7.05271.05.0	LS	700 mm	nach Katalysator Post-catalyst
		 7.02604.01.0	LS	200 mm	
		 7.05271.07.0	LS	1100 mm	
		 7.22738.08.0	SLP	EL	
		 7.22778.99.0	SLV	PN	  ch. 3B-2-155 001→
1.8 4motion 125 kW (170 PS) AWM	11.2003→05.2005	 7.22560.43.0	ARV	PN	
		 7.22738.08.0	SLP	EL	
1.8 T 125 kW (170 PS) AWM	05.2002→08.2005	 7.22560.43.0	ARV	PN	
		 7.22738.08.0	SLP	EL	
1.8 T 20V 110 kW (150 PS) AWT	11.2000→05.2005	 7.22560.43.0	ARV	PN	
		 7.05270.99.0	LS	940 mm	Diagnosesonde Diagnostic Probe
		 7.22738.08.0	SLP	EL	
1.9 TDI 74 kW (101 PS) AVB	11.2000→05.2005	 7.24809.19.0	AGR	PN	
1.9 TDI 96 kW (130 PS) AVF, AWX	11.2000→05.2005	 7.24809.20.0	AGR	PN	
1.9 TDI 4motion 96 kW (130 PS) AVF	11.2000→05.2005	 7.24809.20.0	AGR	PN	
2.0 85 kW (116 PS) AZM	11.2000→05.2005	 7.22286.26.0	ARV	PN	
		 7.05271.05.0	LS	700 mm	nach Katalysator Post-catalyst
		 7.05271.07.0	LS	1100 mm	
		 7.22738.08.0	SLP	EL	
		 7.22778.95.0	SLV	PN	
2.0 96 kW (130 PS) ALT	11.2001→05.2005	 7.05270.99.0	LS	940 mm	
2.0 4motion 85 kW (116 PS) AZM	11.2000→05.2005	 7.22286.26.0	ARV	PN	
		 7.05271.05.0	LS	700 mm	nach Katalysator Post-catalyst
		 7.05271.07.0	LS	1100 mm	
		 7.22738.08.0	SLP	EL	
		 7.22778.95.0	SLV	PN	
2.0 TDI 100 kW (136 PS) BGW	12.2003→05.2005	 7.00365.06.0	AGR	EL	
		 7.08369.40.0	ATS	EL	Euro 4
		 7.08369.72.0	ATS	EL	vor Rußpartikelfilter before soot particulate filter
		 7.11190.00.0	DDS		



PASSAT B5.5 Variant (3B6) 58

































2.0 TDI 100 kW (136 PS) BHW	12.2003→05.2005		7.00365.06.0	AGR	EL	⊗
2.3 VR5 125 kW (170 PS) AZX	11.2000→05.2005		7.22286.51.0	ARV	PN	⊗
			7.05271.14.0	LS	1700 mm	05.2002→
			7.05271.24.0	LS	1500 mm	vor Katalysator in front of the catalyst
			7.05271.21.0	LS	1250 mm	→05.2002 Diagnosesonde Diagnostic Probe
2.3 VR5 4motion 125 kW (170 PS) AZX	11.2000→05.2005		7.22286.51.0	ARV	PN	⊗
			7.05271.14.0	LS	1700 mm	05.2002→
			7.05271.24.0	LS	1500 mm	vor Katalysator in front of the catalyst
			7.05271.21.0	LS	1250 mm	→05.2002 Diagnosesonde Diagnostic Probe
2.8 142 kW (193 PS) ATQ	10.2000→08.2005		7.22560.40.0	ARV	PN	⊗
			7.22560.41.0	ARV	PN	⊗ rechts Right
			7.22738.08.0	SLP	EL	
2.8 140 kW (190 PS) BBG	10.2000→05.2005		7.22560.40.0	ARV	PN	⊗
			7.22560.41.0	ARV	PN	⊗ rechts Right
			7.22738.08.0	SLP	EL	
2.8 4motion 140 kW (190 PS) BBG	10.2000→05.2005		7.22560.40.0	ARV	PN	⊗
			7.22560.41.0	ARV	PN	⊗ rechts Right
			7.22738.08.0	SLP	EL	
2.8 4motion 142 kW (193 PS) AMX, ATQ	11.2000→05.2005		7.22560.40.0	ARV	PN	⊗
			7.22560.41.0	ARV	PN	⊗ ⊗ AMX, ATQ: rechts Right
			7.22738.08.0	SLP	EL	
4.0 W8 4motion 202 kW (275 PS) BDN, BDP	09.2001→09.2004		7.05271.01.0	LS	950 mm	
			7.05271.23.0	LS	900 mm	
			7.22738.08.0	SLP	EL	

PASSAT B6 (3C2) 59

1.4 TSI 90 kW (122 PS) CAXA	05.2007→07.2010		7.05271.18.0	LS	525 mm	Schaltgetriebe 6 Gang 6-Speed Manual Transmission Euro 4 Euro 4
1.6 75 kW (102 PS) BSE	05.2005→07.2010		7.05271.18.0	LS	525 mm	
			7.02604.01.0	LS	200 mm	
			7.22738.08.0	SLP	EL	 →ch. 3C-B-050 000



PASSAT B6 (3C2) **59**

			7.22778.96.0	SLV	PN	  →ch. 3C-B-050 000
1.6 75 kW (102 PS) BSF	05.2005→07.2010		7.05271.18.0	LS	525 mm	
			7.02604.01.0	LS	200 mm	
1.6 FSI 85 kW (115 PS) BLF	03.2005→06.2008		7.10334.04.0	AGR	EL	
			7.05271.30.0	LS	400 mm	
1.6 TDI 77 kW (105 PS) CAYC	08.2009→07.2010		7.09720.00.0	AGR-K	EL	
			7.08369.07.0	ATS	EL	 ch. 3C-B-200 001→
			7.08369.01.0	ATS	EL	
			7.11492.00.0	DDS		ohne Zubehör without accessories
1.9 TDI 77 kW (105 PS) BKC	03.2005→07.2010		7.24809.16.0	AGR	PN	
1.9 TDI 77 kW (105 PS) BLS	03.2005→07.2010		7.00678.04.0*	AGR-M	EL	mit Rohrstützen with pipe socket  →ch. 3C-B-050 000
			↳ 7.00907.03.0	AGR	EL	
			7.00678.06.0	AGR-M	EL	
			7.08369.00.0	ATS	EL	
			7.08369.07.0	ATS	EL	
			7.08369.84.0	ATS	EL	
			7.11492.02.0	DDS		ohne Zubehör without accessories
1.9 TDI 77 kW (105 PS) BXE	03.2005→07.2010		7.24809.16.0	AGR	PN	
			7.05271.29.0	LS	900 mm	rechts Right
			7.02604.41.0	LS	700 mm	vor Katalysator, links in front of the catalyst, Left
2.0 BlueTDI 105 kW (143 PS) CBAC	01.2009→11.2010		7.10334.00.0	AGR	EL	
			7.08369.01.0	ATS	EL	
			7.11492.00.0	DDS		ohne Zubehör without accessories
2.0 FSI 110 kW (150 PS) BLR, BVY	03.2005→07.2010		7.10334.09.0	AGR	EL	 BLR, BVY: →10.2007  BLR: 10.2009→
			7.05271.29.0	LS	900 mm	 BLR, BVY:  →ch. 3C-9-210 000 rechts Right
2.0 FSI 147-157 kW (200-213 PS) CBFA	07.2005→07.2010		7.01510.31.0	SLV	EL	 Mexico, USA, Kanada  Mexico, USA, Kanada
2.0 FSI 4motion 110 kW (150 PS) BLX, BVX	09.2005→07.2010		7.10334.09.0	AGR	EL	 →10.2007
			7.05271.29.0	LS	900 mm	 BLX, BVX:  →ch. 3C-9-210 000 rechts Right
2.0 FSI 4motion 110 kW (150 PS) BLY	09.2005→07.2010		7.10334.09.0	AGR	EL	
2.0 TDI 103 kW (140 PS) BMP	03.2005→05.2009		7.00678.04.0*	AGR-M	EL	mit Rohrstützen with pipe socket  →ch. 3C-B-050 000
			↳ 7.00907.03.0	AGR	EL	
			7.00678.06.0	AGR-M	EL	
			7.08369.00.0	ATS	EL	

V

















PASSAT B6 (3C2) **59**

			7.08369.07.0 ATS EL 7.08369.84.0 ATS EL 7.11492.02.0 DDS		ohne Zubehör without accessories
2.0 TDI 100 kW (136 PS) BMA	03.2005→11.2010	7.24809.16.0 7.10334.00.0	AGR PN AGR EL	→ch. 3C-6-105 500 Fahrgestellnummer ab: 3C-6-105 501, 3C-6E121 501 Vehicle Identification Number from: 3C-6-105 501, 3C-6E121 501	
2.0 TDI 100 kW (136 PS) CBAA	03.2005→11.2010	7.10334.00.0 7.08369.01.0 7.08369.07.0 7.11492.00.0 7.11492.02.0	AGR EL ATS EL ATS EL DDS	 ohne Zubehör without accessories Fahrgestellnummer ab: 3C-9E079 137, 3C-9G005 642, 3C-9P044 381 Vehicle Identification Number from: 3C-9E079 137, 3C-9G005 642, 3C-9P044 381 ohne Zubehör without accessories Fahrgestellnummer bis: 3C-9E079 136, 3C-9G005 641, 3C-9P044 380 Vehicle Identification Number to: 3C-9E079 136, 3C-9G005 641, 3C-9P044 380	
2.0 TDI 125 kW (170 PS) BMR	08.2005→07.2010	7.10334.00.0 7.08369.00.0 7.08369.07.0 7.08369.84.0 7.11492.02.0	AGR EL ATS EL ATS EL DDS	 ohne Zubehör without accessories Fahrgestellnummer bis: 3C-9G005 641, 3C-9E079 136, 3C-9P044 380 Vehicle Identification Number to: 3C-9G005 641, 3C-9E079 136, 3C-9P044 380	
2.0 TDI 125 kW (170 PS) CBBB	08.2005→07.2010	7.10334.00.0 7.08369.00.0 7.08369.01.0 7.08369.07.0 7.11492.00.0	AGR EL ATS EL ATS EL DDS	 ohne Zubehör without accessories Fahrgestellnummer ab: 3C-9E079 137, 3C-9G005 642, 3C-9P044 38 Vehicle Identification Number from: 3C-9E079 137, 3C-9G005 642, 3C-9P044 38	
2.0 TDI 90 kW (122 PS) BVE	08.2005→07.2006	7.24809.16.0 7.10334.00.0	AGR PN AGR EL	→ch. 3C-6-105 500 Fahrgestellnummer ab: 3C-6-105 501, 3C-6E121 501 Vehicle Identification Number from: 3C-6-105 501, 3C-6E121 501	
2.0 TDI 120 kW (163 PS) BUZ	08.2005→05.2009	7.10334.00.0 7.08369.00.0	AGR EL ATS EL		











PASSAT B6 (3C2) **59**







			7.08369.07.0 7.08369.84.0 7.11492.02.0	ATS ATS DDS	EL EL	ohne Zubehör without accessories
2.0 TDI 88 kW (120 PS) BWV	11.2005→05.2007		7.24809.16.0	AGR	PN	 →ch. 3C-6-105 500
2.0 TDI 81 kW (110 PS) CBDC	11.2008→07.2010		7.10334.00.0	AGR	EL	
			7.08369.01.0 7.11492.00.0	ATS DDS	EL EL	ohne Zubehör without accessories
2.0 TDI 16V 103 kW (140 PS) BKP	03.2005→07.2010		7.24809.16.0	AGR	PN	 →ch. 3C-6-105 500
			7.10334.00.0	AGR	EL	 Fahrgestellnummer ab: 3C-6-105 501, 3C-6E121 501 Vehicle Identification Number from: 3C-6-105 501, 3C-6E121 501
2.0 TDI 16V 103 kW (140 PS) CBAB	03.2005→07.2010		7.10334.00.0	AGR	EL	
			7.08369.01.0 7.08369.07.0 7.11492.00.0	ATS ATS DDS	EL EL	ohne Zubehör without accessories Fahrgestellnummer ab: 3C-9E079 137, 3C-9G005 642, 3C-9P044 381 Vehicle Identification Number from: 3C-9E079 137, 3C-9G005 642, 3C-9P044 381
			7.11492.02.0	DDS		ohne Zubehör without accessories Fahrgestellnummer bis: 3C-9E079 136, 3C-9G005 641, 3C-9P044 380 Vehicle Identification Number to: 3C-9E079 136, 3C-9G005 641, 3C-9P044 380
2.0 TDI 16V 4motion 103 kW (140 PS) BKP	03.2005→08.2010		7.24809.16.0	AGR	PN	 →ch. 3C-6-105 500
			7.10334.00.0	AGR	EL	 Fahrgestellnummer ab: 3C-6-105 501, 3C-6E121 501 Vehicle Identification Number from: 3C-6-105 501, 3C-6E121 501
2.0 TDI 16V 4motion 103 kW (140 PS) CBAB	03.2005→08.2010		7.10334.00.0	AGR	EL	
			7.08369.01.0 7.08369.07.0 7.11492.00.0	ATS ATS DDS	EL EL	ohne Zubehör without accessories Fahrgestellnummer ab: 3C-9E079 137, 3C-9G005 642, 3C-9P044 381 Vehicle Identification Number from: 3C-9E079 137, 3C-9G005 642, 3C-9P044 381
			7.11492.02.0	DDS		ohne Zubehör without accessories Fahrgestellnummer bis: 3C-9E079 136, 3C-9G005 641, 3C-9P044 380 Vehicle Identification Number to: 3C-9E079 136, 3C-9G005 641, 3C-9P044 380



PASSAT B6 (3C2) 59

2.0 TDI 4motion 103 kW (140 PS) BMP	03.2005→05.2009	 7.00907.03.0	AGR	EL	○
		7.00678.06.0	AGR-M	EL	
		7.08369.00.0	ATS	EL	
		7.08369.07.0	ATS	EL	
		7.08369.84.0	ATS	EL	
		7.11492.02.0	DDS		ohne Zubehör without accessories
2.0 TDI 4motion 125 kW (170 PS) CBBB	05.2009→07.2010	 7.10334.00.0	AGR	EL	○
		7.08369.00.0	ATS	EL	
		7.08369.01.0	ATS	EL	
		7.08369.07.0	ATS	EL	
		7.11492.00.0	DDS		
		7.11492.02.0	DDS		ohne Zubehör without accessories Fahrgestellnummer bis: 3C-9E079 136, 3C-9G005 641, 3C-9P044 380 Vehicle Identification Number to: 3C-9E079 136, 3C-9G005 641, 3C-9P044 380
3.2 FSI 4motion 184 kW (250 PS) AXZ	11.2005→07.2010	 7.05271.29.0	LS	900 mm	
		7.05271.12.0	LS	800 mm	
		7.02604.41.0	LS	700 mm	
3.6 FSI 206 kW (280 PS) BLV	06.2005→07.2010	 7.02604.41.0	LS	700 mm	vor Katalysator, links in front of the catalyst, Left
3.6 FSI 4motion 206 kW (280 PS) BLV	09.2005→07.2010	 7.02604.41.0	LS	700 mm	vor Katalysator, links in front of the catalyst, Left
3.6 R36 4motion 220 kW (300 PS) BWS	04.2007→07.2010	 7.05271.29.0	LS	900 mm	
		7.05271.12.0	LS	800 mm	
		7.02604.41.0	LS	700 mm	



































PASSAT B6 Variant (3C5) 60

1.4 TSI 90 kW (122 PS) CAXA	05.2007→11.2010	 7.05271.18.0	LS	525 mm	Schaltgetriebe 6 Gang 6-Speed Manual Transmission Euro 4 Euro 4	
1.6 75 kW (102 PS) BSE	08.2005→11.2010	 7.05271.18.0	LS	525 mm		
		7.02604.01.0	LS	200 mm		
		7.22738.08.0	SLP	EL		 →ch. 3C-B-050 000
		7.22778.96.0	SLV	PN		 →ch. 3C-B-050 000
1.6 75 kW (102 PS) BSF	08.2005→11.2010	 7.05271.18.0	LS	525 mm		
		7.02604.01.0	LS	200 mm		
1.6 FSI 85 kW (115 PS) BLF	08.2005→06.2008	 7.10334.04.0	AGR	EL	○	

















PASSAT B6 Variant (3C5) 60

			7.05271.30.0	LS	400 mm	
1.6 TDI 77 kW (105 PS) CAYC	08.2009→11.2010		7.09720.00.0	AGR-K	EL	
			7.08369.07.0	ATS	EL	 ch. 3C-B-200 001→
			7.08369.01.0	ATS	EL	
			7.11492.00.0	DDS		ohne Zubehör without accessories
1.9 TDI 77 kW (105 PS) BKC	08.2005→11.2010		7.24809.16.0	AGR	PN	
1.9 TDI 77 kW (105 PS) BLS	08.2005→11.2010		7.00678.04.0*	AGR-M	EL	mit Rohrstutzen with pipe socket  →ch. 3C-B-050 000
			↳ 7.00907.03.0	AGR	EL	
			7.00678.06.0	AGR-M	EL	
			7.08369.00.0	ATS	EL	
			7.08369.07.0	ATS	EL	
			7.08369.84.0	ATS	EL	
			7.11492.02.0	DDS		ohne Zubehör without accessories
1.9 TDI 77 kW (105 PS) BXE	08.2005→11.2010		7.24809.16.0	AGR	PN	
			7.05271.29.0	LS	900 mm	rechts Right
			7.02604.41.0	LS	700 mm	vor Katalysator, links in front of the catalyst, Left
2.0 BlueTDI 105 kW (143 PS) CBAC	01.2009→11.2010		7.10334.00.0	AGR	EL	
			7.08369.01.0	ATS	EL	
			7.11492.00.0	DDS		ohne Zubehör without accessories
2.0 FSI 110 kW (150 PS) BLR, BVY	08.2005→11.2010		7.10334.09.0	AGR	EL	  BLR, BVY: →10.2007  BLR: 10.2009→
			7.05271.29.0	LS	900 mm	 BLR, BVY:  →ch. 3C-9-210 000 rechts Right
2.0 FSI 147-157 kW (200-213 PS) CBFA	08.2005→11.2010		7.01510.31.0	SLV	EL	 ☐ Mexico, USA, Kanada ☐ Mexico, USA, Canada
2.0 FSI 4motion 110 kW (150 PS) BLX, BVX	09.2005→11.2010		7.10334.09.0	AGR	EL	  BLX, BVX: →10.2007
			7.05271.29.0	LS	900 mm	 BLX, BVX:  →ch. 3C-9-210 000 rechts Right
2.0 FSI 4motion 110 kW (150 PS) BLY	09.2005→11.2010		7.10334.09.0	AGR	EL	
2.0 TDI 90 kW (122 PS) BVE	08.2005→02.2006		7.24809.16.0	AGR	PN	  →ch. 3C-6-105 500
			7.10334.00.0	AGR	EL	 Fahrgestellnummer ab: 3C-6-105 501, 3C-6E121 501 Vehicle Identification Number from: 3C-6-105 501, 3C-6E121 501
2.0 TDI 100 kW (136 PS) BMA	08.2005→11.2010		7.24809.16.0	AGR	PN	  →ch. 3C-6-105 500
			7.10334.00.0	AGR	EL	 Fahrgestellnummer ab: 3C-6-105 501, 3C-6E121 501 Vehicle Identification Number from: 3C-6-105 501, 3C-6E121 501

V















PASSAT B6 Variant (3C5) 60

2.0 TDI 100 kW (136 PS) CBAA	08.2005→11.2010		7.10334.00.0	AGR	EL	 ohne Zubehör without accessories Fahrgestellnummer ab: 3C-9E079 137, 3C-9G005 642, 3C-9P044 381 Vehicle Identification Number from: 3C-9E079 137, 3C-9G005 642, 3C-9P044 381
			7.08369.01.0	ATS	EL	
			7.08369.07.0	ATS	EL	
			7.11492.00.0	DDS		
			7.11492.02.0	DDS		ohne Zubehör without accessories Fahrgestellnummer bis: 3C-9E079 136, 3C-9G005 641, 3C-9P044 380 Vehicle Identification Number to: 3C-9E079 136, 3C-9G005 641, 3C-9P044 380
2.0 TDI 125 kW (170 PS) BMR	08.2005→11.2010		7.10334.00.0	AGR	EL	 ohne Zubehör without accessories Fahrgestellnummer bis: 3C-9E079 136, 3C-9G005 641, 3C-9P044 380 Vehicle Identification Number to: 3C-9E079 136, 3C-9G005 641, 3C-9P044 380
			7.08369.00.0	ATS	EL	
			7.08369.07.0	ATS	EL	
			7.08369.84.0	ATS	EL	
			7.11492.02.0	DDS		
2.0 TDI 125 kW (170 PS) CBBB	08.2005→11.2010		7.10334.00.0	AGR	EL	 ohne Zubehör without accessories Fahrgestellnummer ab: 3C-9E079 137, 3C-9G005 642, 3C-9P044 381 Vehicle Identification Number from: 3C-9E079 137, 3C-9G005 642, 3C-9P044 381
			7.08369.00.0	ATS	EL	
			7.08369.01.0	ATS	EL	
			7.08369.07.0	ATS	EL	
			7.11492.00.0	DDS		
2.0 TDI 103 kW (140 PS) BMP	08.2005→05.2009		7.00678.04.0*	AGR-M	EL	mit Rohrstützen with pipe socket  →ch. 3C-B-050 000 ohne Zubehör without accessories
			↳7.00907.03.0	AGR	EL	
			7.00678.06.0	AGR-M	EL	
			7.08369.00.0	ATS	EL	
			7.08369.07.0	ATS	EL	
			7.08369.84.0	ATS	EL	
			7.11492.02.0	DDS		
2.0 TDI 120 kW (163 PS) BUZ	08.2005→05.2009		7.10334.00.0	AGR	EL	 ohne Zubehör without accessories
			7.08369.00.0	ATS	EL	
			7.08369.07.0	ATS	EL	
			7.08369.84.0	ATS	EL	
			7.11492.02.0	DDS		
2.0 TDI 88 kW (120 PS) BWV	11.2005→05.2007		7.24809.16.0	AGR	PN	  →ch. 3C-6-105 500











PASSAT B6 Variant (3C5) 60













2.0 TDI 81 kW (110 PS) CBDC	11.2008→11.2010		7.10334.00.0	AGR	EL	 ohne Zubehör without accessories
			7.08369.01.0 7.11492.00.0	ATS DDS	EL	
2.0 TDI 16V 103 kW (140 PS) BKP	08.2005→11.2010		7.24809.16.0	AGR	PN	 →ch. 3C-6-105 500
			7.10334.00.0	AGR	EL	
2.0 TDI 16V 103 kW (140 PS) CBAB	08.2005→11.2010		7.10334.00.0	AGR	EL	 ohne Zubehör without accessories Fahrgestellnummer ab: 3C-9E079 137, 3C-9G005 642, 3C-9P044 381 Vehicle Identification Number from: 3C-9E079 137, 3C-9G005 642, 3C-9P044 381 ohne Zubehör without accessories Fahrgestellnummer bis: 3C-9E079 136, 3C-9G005 641, 3C-9P044 380 Vehicle Identification Number to: 3C-9E079 136, 3C-9G005 641, 3C-9P044 380
			7.08369.01.0	ATS	EL	
			7.08369.07.0	ATS	EL	
			7.11492.00.0	DDS		
2.0 TDI 16V 4motion 103 kW (140 PS) BKP	08.2005→11.2010		7.24809.16.0	AGR	PN	 →ch. 3C-6-105 500
			7.10334.00.0	AGR	EL	
2.0 TDI 16V 4motion 103 kW (140 PS) CBAB	08.2005→11.2010		7.10334.00.0	AGR	EL	 ohne Zubehör without accessories Fahrgestellnummer ab: 3C-9E079 137, 3C-9G005 642, 3C-9P044 381 Vehicle Identification Number from: 3C-9E079 137, 3C-9G005 642, 3C-9P044 381 ohne Zubehör without accessories Fahrgestellnummer bis: 3C-9E079 136, 3C-9G005 641, 3C-9P044 380 Vehicle Identification Number to: 3C-9E079 136, 3C-9G005 641, 3C-9P044 380
			7.08369.01.0	ATS	EL	
			7.08369.07.0	ATS	EL	
			7.11492.00.0	DDS		
2.0 TDI 4motion 103 kW (140 PS) BMP	08.2005→05.2009		7.00678.04.0*	AGR-M	EL	 mit Rohrstützen with pipe socket →ch. 3C-B-050 000
			↳ 7.00907.03.0	AGR	EL	
			7.00678.06.0	AGR-M	EL	
			7.08369.00.0	ATS	EL	
			7.08369.07.0	ATS	EL	



PASSAT B6 Variant (3C5) 60

			7.08369.84.0	ATS	EL	
			7.11492.02.0	DDS		ohne Zubehör without accessories
2.0 TDI 4motion 125 kW (170 PS) CBBB	05.2009→11.2010		7.10334.00.0	AGR	EL	
			7.08369.00.0	ATS	EL	
			7.08369.01.0	ATS	EL	
			7.08369.07.0	ATS	EL	
			7.11492.00.0	DDS		ohne Zubehör without accessories Fahrgestellnummer ab: 3C-9E079 137, 3C-9G005 642, 3C-9P044 381 Vehicle Identification Number from: 3C-9E079 137, 3C-9G005 642, 3C-9P044 381
			7.11492.02.0	DDS		ohne Zubehör without accessories Fahrgestellnummer bis: 3C-9E079 136, 3C-9G005 641, 3C-9P044 380 Vehicle Identification Number to: 3C-9E079 136, 3C-9G005 641, 3C-9P044 380
3.2 FSI 4motion 184 kW (250 PS) AXZ	11.2005→11.2010		7.05271.29.0	LS	900 mm	
			7.05271.12.0	LS	800 mm	
			7.02604.41.0	LS	700 mm	vor Katalysator, links in front of the catalyst, Left
3.6 FSI 206 kW (280 PS) BLV	09.2005→11.2010		7.02604.41.0	LS	700 mm	vor Katalysator, links in front of the catalyst, Left
3.6 FSI 4motion 206 kW (280 PS) BLV	09.2005→11.2010		7.02604.41.0	LS	700 mm	vor Katalysator, links in front of the catalyst, Left
3.6 R36 4motion 220 kW (300 PS) BWS	04.2007→11.2010		7.05271.29.0	LS	900 mm	
			7.05271.12.0	LS	800 mm	
			7.02604.41.0	LS	700 mm	vor Katalysator, links in front of the catalyst, Left









PASSAT B7 (362) 61

1.6 TDI 77 kW (105 PS) CAYC	08.2010→12.2014		7.09720.00.0	AGR-K	EL	
			7.08369.07.0	ATS	EL	 ch. 3C-B-200 001→
			7.08369.01.0	ATS	EL	Fahrgestellnummer ab: 3C-B-200 001 Vehicle Identification Number from: 3C-B-200 001
			7.11492.00.0	DDS		ohne Zubehör without accessories
2.0 TDI 103 kW (140 PS) CFFB	08.2010→12.2014		7.10334.00.0	AGR	EL	
			7.09720.00.0	AGR-K	EL	 ch. A3-DC000 001→
			7.11492.00.0	DDS		für PR-Nummer: TN5 for PR number: TN5
2.0 TDI 125 kW (170 PS) CFGB, CLLA	08.2010→12.2014		7.09720.00.0	AGR-K	EL	
2.0 TDI 100 kW (136 PS) CFFA	08.2010→12.2014		7.09720.00.0	AGR-K	EL	
2.0 TDI 130 kW (177 PS) CFGC	12.2012→12.2014		7.09720.00.0	AGR-K	EL	



























PASSAT B7 (362) **61**

2.0 TDI 4motion 103 kW (140 PS) CFFB	08.2010→12.2014		7.10334.00.0	AGR	EL	 ch. A3-DC000 001→ für PR-Nummer: TN5 for PR number: TN5
			7.09720.00.0	AGR-K	EL	
			7.11492.00.0	DDS		ohne Zubehör without accessories  ch. A3-DC000 001→
2.0 TDI 4motion 125 kW (170 PS) CFGB	08.2010→01.2013		7.09720.00.0	AGR-K	EL	
2.0 TDI 4motion 130 kW (177 PS) CFGC	01.2013→12.2014		7.09720.00.0	AGR-K	EL	
3.6 FSI 4motion 220 kW (300 PS) BWS	01.2011→12.2014		7.05271.29.0	LS	900 mm	
			7.05271.12.0	LS	800 mm	
			7.02604.41.0	LS	700 mm	vor Katalysator, links in front of the catalyst, Left

PASSAT B7 (A32, A33) **62**

1.8 TSI 125 kW (170 PS) CPKA, CPRA	06.2013→		7.03635.39.0	SLP	EL	 CPKA, CPRA:  ch. A3-DC000 001→ für Hersteller-Abgasnorm: SULEV for manufacturer exhaust norm: SULEV
			7.01510.86.0	SLV	EL	 CPKA, CPRA:  ch. A3-DC000 001→ für Hersteller-Abgasnorm: SULEV for manufacturer exhaust norm: SULEV Produktionsdatum bis: 26.10.2015 Production date to: 26.10.2015
			7.01510.85.0	SLV	EL	 CPKA, CPRA:  ch. A3-GC000 001→ für Hersteller-Abgasnorm: SULEV for manufacturer exhaust norm: SULEV Produktionsdatum ab: 27.10.2015 Production date from: 27.10.2015
2.0 TDI 103 kW (140 PS) CFFB, CKRA	04.2011→06.2015		7.10334.00.0	AGR	EL	 CFFB, CKRA:  ch. A3-DC000 001→ für PR-Nummer: TN5 for PR number: TN5
			7.09720.00.0	AGR-K	EL	
			7.11492.00.0	DDS		ohne Zubehör without accessories  CFFB, CKRA:  ch. A3-DC000 001→
2.0 TDI 110 kW (150 PS) CVCA	06.2014→		7.08369.81.0	ATS	EL	 ch. A3-DC000 001→
			7.11492.03.0	DDS		ohne Zubehör without accessories  ch. A3-DC000 001→
			7.07696.00.0	SRM-AK	EL	 ch. A3-DC000 0001→
2.0 TDI 110 kW (150 PS) DEKA	06.2014→		7.08369.81.0	ATS	EL	 ch. A3-DC000 001→
			7.03635.39.0	SLP	EL	 ch. A3-GC000 001→
				7.03635.37.0	SLP	EL
2.0 TSI 130 kW (177 PS) DDSA	07.2017→		7.03635.39.0	SLP	EL	 ch. A3-GC000 001→
			7.01510.87.0	SLV	EL	 ch. A3-GC000 001→

V



PASSAT B7 Variant (365) 63

1.6 TDI 77 kW (105 PS) CAYC	08.2010→12.2014		7.09720.00.0	AGR-K	EL	
			7.08369.07.0	ATS	EL	ch. 3C-B-200 001→
			7.08369.01.0	ATS	EL	Fahrgestellnummer ab: 3C-B-200 001 Vehicle Identification Number from: 3C-B-200 001
			7.11492.00.0	DDS		ohne Zubehör without accessories
2.0 TDI 103 kW (140 PS) CFFB	08.2010→12.2014		7.10334.00.0	AGR	EL	ch. A3-DC000 001→ für PR-Nummer: TN5 for PR number: TN5
			7.09720.00.0	AGR-K	EL	
			7.11492.00.0	DDS		ohne Zubehör without accessories ch. A3-DC000 001→
2.0 TDI 125 kW (170 PS) CFGB, CLLA	08.2010→12.2014		7.09720.00.0	AGR-K	EL	
2.0 TDI 100 kW (136 PS) CFFA	08.2010→12.2014		7.09720.00.0	AGR-K	EL	
2.0 TDI 130 kW (177 PS) CFGC	12.2012→12.2014		7.09720.00.0	AGR-K	EL	
2.0 TDI 4motion 103 kW (140 PS) CFFB	08.2010→12.2014		7.10334.00.0	AGR	EL	ch. A3-DC000 001→ für PR-Nummer: TN5 for PR number: TN5
			7.09720.00.0	AGR-K	EL	
			7.11492.00.0	DDS		ohne Zubehör without accessories ch. A3-DC000 001→
2.0 TDI 4motion 125 kW (170 PS) CFGB	08.2010→01.2013		7.09720.00.0	AGR-K	EL	
2.0 TDI 4motion 130 kW (177 PS) CFGC	01.2013→12.2014		7.09720.00.0	AGR-K	EL	
3.6 FSI 4motion 220 kW (300 PS) BWS	01.2011→12.2014		7.05271.29.0	LS	900 mm	
			7.05271.12.0	LS	800 mm	
			7.02604.41.0	LS	700 mm	vor Katalysator, links in front of the catalyst, Left





















PASSAT B8 (3G2, CB2) 64

1.6 TDI 88 kW (120 PS) DCXA	08.2014→		7.10334.02.0	AGR	EL	ch. 3C-F-200 001→
			7.03608.16.0	AK	EL	ch. 3C-F-200 001→
			↪7.07696.00.0	SRM-AK	EL	
			7.11020.17.0	ATS	EL	ch. 3C-F-200 001→ für Vorkatalysator for pre-catalyst
			7.11020.22.0	ATS	EL	ch. 3C-F-200 001→ für PR-Nummer: 1E9 for PR number: 1E9
			7.11020.23.0	ATS	EL	ch. 3C-F-200 001→ für PR-Nummer: 1E9 for PR number: 1E9
			7.08369.95.0	ATS	EL	für Fahrzeuge ohne Aktivkohlebehälter for vehicles without charcoal canister
			7.11492.03.0	DDS		ohne Zubehör without accessories ch. 3C-F-200 001→ für PR-Nummer: 1E0, 1E9 for PR number: 1E0, 1E9





PASSAT B8 (3G2, CB2) **64**

			7.11492.05.0	DDS		ohne Zubehör without accessories  ch. 3C-F-200 001→ Euro 6d-Temp Euro 6d-Temp
1.6 TDI 88 kW (120 PS) DCZA	08.2014→		7.10334.02.0	AGR	EL	 ch. 3C-F-200 001→
			7.03608.16.0	AK	EL	 ch. 3C-F-200 001→
			7.11020.17.0	ATS	EL	 ch. 3C-F-200 001→ für Vorkatalysator for pre-catalyst
			7.11020.22.0	ATS	EL	 ch. 3C-F-200 001→ für PR-Nummer: 1E9 for PR number: 1E9
			7.11020.23.0	ATS	EL	 ch. 3C-F-200 001→ für PR-Nummer: 1E9 for PR number: 1E9
			7.08369.95.0	ATS	EL	für Fahrzeuge ohne Aktivkohlebehälter for vehicles without charcoal canister
			7.11492.03.0	DDS		ohne Zubehör without accessories  ch. 3C-F-200 001→ für PR-Nummer: 1E0, 1E9 for PR number: 1E0, 1E9
			7.11492.05.0	DDS		ohne Zubehör without accessories  ch. 3C-F-200 001→ Euro 6d-Temp Euro 6d-Temp
2.0 TDI 110 kW (150 PS) CRLB	11.2014→		7.03608.16.0	AK	EL	 ch. 3C-F-200 001→
			↳ 7.07696.00.0	SRM-AK	EL	
			7.04709.13.0	AK	EL	Frontantrieb Front Wheel Drive
			↳ 7.07696.00.0	SRM-AK	EL	
			7.08369.81.0	ATS	EL	 ch. 3C-F-200 001→
			7.11492.03.0	DDS		ohne Zubehör without accessories
			7.11492.05.0	DDS		ohne Zubehör without accessories für OE-Nummer: 04L 906 051 AB, 04L 906 051 F, 04L 906 051 G, 04L 906 051 L for OE number: 04L 906 051 AB, 04L 906 051 F, 04L 906 051 G, 04L 906 051 L
2.0 TDI 110 kW (150 PS) DBGA	11.2014→		7.10334.02.0	AGR	EL	 ch. 3C-F-200 001→
			7.03608.16.0	AK	EL	 ch. 3C-F-200 001→
			↳ 7.07696.00.0	SRM-AK	EL	
			7.08369.81.0	ATS	EL	 ch. 3C-F-200 001→
			7.11492.03.0	DDS		ohne Zubehör without accessories  ch. 3C-F-200 001→ für Hersteller-Abgasnorm: Euro 5 plus, Euro 6 plus for manufacturer exhaust norm: Euro 5 plus, Euro 6 plus
2.0 TDI 110 kW (150 PS) DFGA	11.2014→		7.08369.81.0	ATS	EL	 ch. 3C-F-200 001→
			7.11492.03.0	DDS		ohne Zubehör without accessories  ch. 3C-F-200 001→ für Hersteller-Abgasnorm: Euro 5 plus, Euro 6 plus for manufacturer exhaust norm: Euro 5 plus, Euro 6 plus























PASSAT B8 (3G2, CB2) **64**

			7.07696.00.0	SRM-AK	EL	ch. 3C-F-200 001→
2.0 TDI 110 kW (150 PS) DSRA, DSRB	11.2014→		7.11492.03.0	DDS		ohne Zubehör without accessories
			7.07696.00.0	SRM-AK	EL	DSRA, DSRA, DSRB: ch. 3C-F-200 001→
2.0 TDI 140 kW (190 PS) DDAA	11.2014→		7.10334.02.0	AGR	EL	 ch. 3C-F-200 001→
			7.03608.16.0	AK	EL	ch. 3C-F-200 001→ Allrad All-wheel Drive
			↳ 7.07696.00.0	SRM-AK	EL	
			7.04709.13.0	AK	EL	Frontantrieb Front Wheel Drive
			↳ 7.07696.00.0	SRM-AK	EL	
			7.11020.26.0 7.11492.03.0	ATS DDS	EL	ch. 3C-F-200 001→ ohne Zubehör without accessories ch. 3C-F-200 001→ für Hersteller-Abgasnorm: Euro 5 plus, Euro 6 plus for manufacturer exhaust norm: Euro 5 plus, Euro 6 plus ohne Zubehör without accessories für OE-Nummer: 04L 906 051 AB, 04L 906 051 F, 04L 906 051 G, 04L 906 051 L for OE number: 04L 906 051 AB, 04L 906 051 F, 04L 906 051 G, 04L 906 051 L
7.11492.05.0	DDS					
2.0 TDI 140 kW (190 PS) DFCA	11.2014→		7.10334.02.0	AGR	EL	 ch. 3C-F-200 001→
			7.11020.26.0 7.11492.03.0	ATS DDS	EL	ch. 3C-F-200 001→ ohne Zubehör without accessories ch. 3C-F-200 001→ für Hersteller-Abgasnorm: Euro 5 plus, Euro 6 plus for manufacturer exhaust norm: Euro 5 plus, Euro 6 plus
			7.07696.00.0	SRM-AK	EL	ch. 3C-F-200 001→
2.0 TDI 140 kW (190 PS) DFHA	11.2014→		7.10334.02.0	AGR	EL	 ch. 3C-F-200 001→
			7.11020.26.0 7.11492.05.0	ATS DDS	EL	ch. 3C-F-200 001→ ohne Zubehör without accessories für OE-Nummer: 04L 906 051 AB, 04L 906 051 F, 04L 906 051 G, 04L 906 051 L for OE number: 04L 906 051 AB, 04L 906 051 F, 04L 906 051 G, 04L 906 051 L
			7.07696.00.0	SRM-AK	EL	ch. 3C-F-200 001→
2.0 TDI 135 kW (184 PS) CUA	07.2015→		7.08369.81.0	ATS	EL	ch. 3C-F-200 001→
			7.11492.03.0	DDS		ohne Zubehör without accessories ch. 3C-F-200 001→ für Hersteller-Abgasnorm: Euro 5 plus, Euro 6 plus for manufacturer exhaust norm: Euro 5 plus, Euro 6 plus
2.0 TDI 130 kW (177 PS) CRGA	05.2016→		7.10334.02.0	AGR	EL	 ch. 3C-F-200 001→















PASSAT B8 (3G2, CB2) 64

			7.11492.05.0	DDS		ohne Zubehör without accessories für OE-Nummer: 04L 906 051 AB, 04L 906 051 F, 04L 906 051 G, 04L 906 051 L for OE number: 04L 906 051 AB, 04L 906 051 F, 04L 906 051 G, 04L 906 051 L
2.0 TDI 81 kW (110 PS) DBGB	05.2016→05.2017		7.10334.02.0	AGR	EL	 ch. 3C-F-200 001→
			7.03608.16.0	AK	EL	 ch. 3C-F-200 001→
			↳ 7.07696.00.0	SRM-AK	EL	
			7.08369.81.0	ATS	EL	 ch. 3C-F-200 001→
			7.11492.03.0	DDS		ohne Zubehör without accessories  ch. 3C-F-200 001→ für Hersteller-Abgasnorm: Euro 5 plus, Euro 6 plus for manufacturer exhaust norm: Euro 5 plus, Euro 6 plus
2.0 TDI 4motion 110 kW (150 PS) CRLB	08.2014→11.2017		7.08369.81.0	ATS	EL	 ch. 3C-F-200 001→
			7.11492.03.0	DDS		ohne Zubehör without accessories  ch. 3C-F-200 001→ für Hersteller-Abgasnorm: Euro 5 plus, Euro 6 plus for manufacturer exhaust norm: Euro 5 plus, Euro 6 plus
			7.11492.05.0	DDS		ohne Zubehör without accessories für OE-Nummer: 04L 906 051 AB, 04L 906 051 F, 04L 906 051 G, 04L 906 051 L for OE number: 04L 906 051 AB, 04L 906 051 F, 04L 906 051 G, 04L 906 051 L
2.0 TDI 4motion 110 kW (150 PS) DFEA	08.2014→11.2017		7.07696.00.0	SRM-AK	EL	 ch. 3C-F-200 001→
			7.10334.02.0	AGR	EL	 ch. 3C-F-200 001→
			7.08369.81.0	ATS	EL	 ch. 3C-F-200 001→
			7.11492.03.0	DDS		ohne Zubehör without accessories für Hersteller-Abgasnorm: Euro 5 plus, Euro 6 plus for manufacturer exhaust norm: Euro 5 plus, Euro 6 plus
2.0 TDI 4motion 110 kW (150 PS) DFGA	08.2014→11.2017		7.11492.05.0	DDS		ohne Zubehör without accessories für OE-Nummer: 04L 906 051 AB, 04L 906 051 F, 04L 906 051 G, 04L 906 051 L for OE number: 04L 906 051 AB, 04L 906 051 F, 04L 906 051 G, 04L 906 051 L
			7.07696.00.0	SRM-AK	EL	 ch. 3C-F-200 001→
			7.08369.81.0	ATS	EL	 ch. 3C-F-200 001→
2.0 TDI 4motion 176 kW (240 PS) CUAA	08.2014→		7.11492.03.0	DDS		ohne Zubehör without accessories für Hersteller-Abgasnorm: Euro 5 plus, Euro 6 plus for manufacturer exhaust norm: Euro 5 plus, Euro 6 plus
			7.07696.00.0	SRM-AK	EL	 ch. 3C-F-200 001→
			7.07696.00.0	SRM-AK	EL	 ch. 3C-F-200 001→
2.0 TDI 4motion 140 kW (190 PS) DDAA	11.2014→		7.10334.02.0	AGR	EL	 ch. 3C-F-200 001→







V



PASSAT B8 (3G2, CB2) 64

			7.03608.16.0	AK	EL	 ch. 3C-F-200 001→ Allrad All-wheel Drive
			↳ 7.07696.00.0	SRM-AK	EL	
			7.04709.13.0	AK	EL	Frontantrieb Front Wheel Drive
			↳ 7.07696.00.0	SRM-AK	EL	
			7.11020.26.0	ATS	EL	 ch. 3C-F-200 001→
			7.11492.03.0	DDS	EL	ohne Zubehör without accessories  ch. 3C-F-200 001→ für Hersteller-Abgasnorm: Euro 5 plus, Euro 6 plus for manufacturer exhaust norm: Euro 5 plus, Euro 6 plus
			7.11492.05.0	DDS	EL	ohne Zubehör without accessories für OE-Nummer: 04L 906 051 AB, 04L 906 051 F, 04L 906 051 G, 04L 906 051 L for OE number: 04L 906 051 AB, 04L 906 051 F, 04L 906 051 G, 04L 906 051 L
2.0 TDI 4motion 140 kW (190 PS) DFCA	11.2014→		7.10334.02.0	AGR	EL	 ch. 3C-F-200 001→
			7.11020.26.0	ATS	EL	 ch. 3C-F-200 001→
			7.11492.03.0	DDS	EL	ohne Zubehör without accessories  ch. 3C-F-200 001→ für Hersteller-Abgasnorm: Euro 5 plus, Euro 6 plus for manufacturer exhaust norm: Euro 5 plus, Euro 6 plus
			7.07696.00.0	SRM-AK	EL	 ch. 3C-F-200 001→
2.0 TDI 4motion 140 kW (190 PS) DFHA	11.2014→		7.11020.26.0	ATS	EL	 ch. 3C-F-200 001→
			7.11492.05.0	DDS	EL	ohne Zubehör without accessories für OE-Nummer: 04L 906 051 AB, 04L 906 051 F, 04L 906 051 G, 04L 906 051 L for OE number: 04L 906 051 AB, 04L 906 051 F, 04L 906 051 G, 04L 906 051 L
			7.07696.00.0	SRM-AK	EL	 ch. 3C-F-200 001→





























PASSAT B8 Variant (3G5, CB5) 65

1.6 TDI 88 kW (120 PS) DCXA	08.2014→		7.11020.17.0	ATS	EL	 ch. 3C-F-200 001→ für Vorkatalysator for pre-catalyst
			7.11020.22.0	ATS	EL	 ch. 3C-F-200 001→ für PR-Nummer: 1E9 for PR number: 1E9
			7.11020.23.0	ATS	EL	 ch. 3C-F-200 001→ für PR-Nummer: 1E9 for PR number: 1E9
			7.08369.95.0	ATS	EL	für Fahrzeuge ohne Aktivkohlebehälter for vehicles without charcoal canister
			7.11492.03.0	DDS	EL	ohne Zubehör without accessories  ch. 3C-F-200 001→ für PR-Nummer: 1E0, 1E9 for PR number: 1E0, 1E9
			7.11492.05.0	DDS	EL	ohne Zubehör without accessories  ch. 3C-F-200 001→ Euro 6d-Temp Euro 6d-Temp
			7.07696.00.0	SRM-AK	EL	 ch. 3C-F-200 001→





PASSAT B8 Variant (3G5, CB5) 65

1.6 TDI 88 kW (120 PS) DCZA	08.2014→		7.11020.17.0	ATS	EL	 ch. 3C-F-200 001→ für Vorkatalysator for pre-catalyst
			7.11020.22.0	ATS	EL	 ch. 3C-F-200 001→ für PR-Nummer: 1E9 for PR number: 1E9
			7.11020.23.0	ATS	EL	 ch. 3C-F-200 001→ für PR-Nummer: 1E9 for PR number: 1E9
			7.08369.95.0	ATS	EL	für Fahrzeuge ohne Aktivkohlebehälter for vehicles without charcoal canister
			7.11492.03.0	DDS		ohne Zubehör without accessories  ch. 3C-F-200 001→ für PR-Nummer: 1E0, 1E9 for PR number: 1E0, 1E9
2.0 TDI 110 kW (150 PS) CRLB	11.2014→		7.11492.05.0	DDS		ohne Zubehör without accessories  ch. 3C-F-200 001→ Euro 6d-Temp Euro 6d-Temp
			7.03608.16.0	AK	EL	 ch. 3C-F-200 001→
2.0 TDI 110 kW (150 PS) CRLB	11.2014→		↳ 7.07696.00.0	SRM-AK	EL	
			7.04709.13.0	AK	EL	Frontantrieb Front Wheel Drive
			↳ 7.07696.00.0	SRM-AK	EL	
			7.08369.81.0	ATS	EL	 ch. 3C-F-200 001→ ohne Zubehör without accessories
			7.11492.03.0	DDS		 ch. 3C-F-200 001→ für Hersteller-Abgasnorm: Euro 5 plus, Euro 6 plus for manufacturer exhaust norm: Euro 5 plus, Euro 6 plus
2.0 TDI 110 kW (150 PS) DFGA	11.2014→		7.10334.02.0	AGR	EL	  ch. 3C-F-200 001→
			7.03608.16.0	AK	EL	 ch. 3C-F-200 001→
			↳ 7.07696.00.0	SRM-AK	EL	
			7.08369.81.0	ATS	EL	 ch. 3C-F-200 001→ ohne Zubehör without accessories
			7.11492.03.0	DDS		 ch. 3C-F-200 001→ für Hersteller-Abgasnorm: Euro 5 plus, Euro 6 plus for manufacturer exhaust norm: Euro 5 plus, Euro 6 plus
2.0 TDI 110 kW (150 PS) DFGA	11.2014→		7.08369.81.0	ATS	EL	 ch. 3C-F-200 001→
			7.11492.03.0	DDS		ohne Zubehör without accessories  ch. 3C-F-200 001→ für Hersteller-Abgasnorm: Euro 5 plus, Euro 6 plus for manufacturer exhaust norm: Euro 5 plus, Euro 6 plus
			7.07696.00.0	SRM-AK	EL	 ch. 3C-F-200 001→
2.0 TDI 110 kW (150 PS) DSRA, DSRB	11.2014→		7.07696.00.0	SRM-AK	EL	 DSRA, DSRB:  ch. 3C-F-200 001→
2.0 TDI 140 kW (190 PS) DDAA	11.2014→		7.10334.02.0	AGR	EL	  ch. 3C-F-200 001→
			7.03608.16.0	AK	EL	 ch. 3C-F-200 001→ Allrad All-wheel Drive

























PASSAT B8 Variant (3G5, CB5) **65**

			↳ 7.07696.00.0 7.04709.13.0	SRM-AK AK	EL EL	Frontantrieb Front Wheel Drive
			↳ 7.07696.00.0 7.11020.26.0 7.11492.03.0	SRM-AK ATS DDS	EL EL	ch. 3C-F-200 001→ ohne Zubehör without accessories
			7.11492.05.0	DDS		ohne Zubehör without accessories für OE-Nummer: 04L 906 051 AB, 04L 906 051 F, 04L 906 051 G, 04L 906 051 L for OE number: 04L 906 051 AB, 04L 906 051 F, 04L 906 051 G, 04L 906 051 L
2.0 TDI 140 kW (190 PS) DFCA	11.2014→		7.10334.02.0 7.11020.26.0 7.11492.03.0	AGR ATS DDS	EL EL	ch. 3C-F-200 001→ ch. 3C-F-200 001→ ohne Zubehör without accessories ch. 3C-F-200 001→ für Hersteller-Abgasnorm: Euro 5 plus, Euro 6 plus for manufacturer exhaust norm: Euro 5 plus, Euro 6 plus
			7.07696.00.0	SRM-AK	EL	ch. 3C-F-200 001→
2.0 TDI 140 kW (190 PS) DFHA	11.2014→		7.10334.02.0 7.11020.26.0 7.11492.03.0	AGR ATS DDS	EL EL	ch. 3C-F-200 001→ ch. 3C-F-200 001→ ohne Zubehör without accessories
			7.11492.05.0	DDS		ohne Zubehör without accessories für OE-Nummer: 04L 906 051 AB, 04L 906 051 F, 04L 906 051 G, 04L 906 051 L for OE number: 04L 906 051 AB, 04L 906 051 F, 04L 906 051 G, 04L 906 051 L
			7.07696.00.0	SRM-AK	EL	ch. 3C-F-200 001→
2.0 TDI 135 kW (184 PS) CUPA	07.2015→		7.08369.81.0 7.11492.03.0	ATS DDS	EL	ch. 3C-F-200 001→ ohne Zubehör without accessories ch. 3C-F-200 001→ für Hersteller-Abgasnorm: Euro 5 plus, Euro 6 plus for manufacturer exhaust norm: Euro 5 plus, Euro 6 plus
2.0 TDI 4motion 110 kW (150 PS) CRLB	08.2014→11.2017		7.03608.16.0 ↳ 7.07696.00.0 7.08369.81.0 7.11492.03.0	AK SRM-AK ATS DDS	EL EL EL	ch. 3C-F-200 001→ ch. 3C-F-200 001→ ohne Zubehör without accessories ch. 3C-F-200 001→ für Hersteller-Abgasnorm: Euro 5 plus, Euro 6 plus for manufacturer exhaust norm: Euro 5 plus, Euro 6 plus
			7.11492.05.0	DDS		ohne Zubehör without accessories für OE-Nummer: 04L 906 051 AB, 04L 906 051 F, 04L 906 051 G, 04L 906 051 L for OE number: 04L 906 051 AB, 04L 906 051 F, 04L 906 051 G, 04L 906 051 L
2.0 TDI 4motion 110 kW (150 PS) DFEA	08.2014→11.2017		7.10334.02.0	AGR	EL	ch. 3C-F-200 001→





PASSAT B8 Variant (3G5, CB5) 65

			7.08369.81.0 7.11492.03.0	ATS DDS	EL	 ch. 3C-F-200 001→ ohne Zubehör without accessories  ch. 3C-F-200 001→ für Hersteller-Abgasnorm: Euro 5 plus, Euro 6 plus for manufacturer exhaust norm: Euro 5 plus, Euro 6 plus
			7.11492.05.0	DDS		ohne Zubehör without accessories für OE-Nummer: 04L 906 051 AB, 04L 906 051 F, 04L 906 051 G, 04L 906 051 L for OE number: 04L 906 051 AB, 04L 906 051 F, 04L 906 051 G, 04L 906 051 L
			7.07696.00.0	SRM-AK	EL	 ch. 3C-F-200 001→
2.0 TDI 4motion 110 kW (150 PS) DFGA	08.2014→11.2017		7.08369.81.0 7.11492.03.0	ATS DDS	EL	 ch. 3C-F-200 001→ ohne Zubehör without accessories  ch. 3C-F-200 001→ für Hersteller-Abgasnorm: Euro 5 plus, Euro 6 plus for manufacturer exhaust norm: Euro 5 plus, Euro 6 plus
			7.07696.00.0	SRM-AK	EL	 ch. 3C-F-200 001→
2.0 TDI 4motion 176 kW (240 PS) CUAA	08.2014→		7.11492.03.0	DDS		ohne Zubehör without accessories  ch. 3C-F-200 001→
			7.07696.00.0	SRM-AK	EL	 ch. 3C-F-200 001→
2.0 TDI 4motion 140 kW (190 PS) DDAA	11.2014→		7.10334.02.0	AGR	EL	  ch. 3C-F-200 001→
			7.03608.16.0	AK	EL	Allrad All-wheel Drive
			↳ 7.07696.00.0	SRM-AK	EL	
			7.04709.13.0	AK	EL	Frontantrieb Front Wheel Drive
			↳ 7.07696.00.0	SRM-AK	EL	
			7.11020.26.0	ATS	EL	 ch. 3C-F-200 001→
			7.11492.03.0	DDS		ohne Zubehör without accessories  ch. 3C-F-200 001→ für Hersteller-Abgasnorm: Euro 5 plus, Euro 6 plus for manufacturer exhaust norm: Euro 5 plus, Euro 6 plus
			7.11492.05.0	DDS		ohne Zubehör without accessories für OE-Nummer: 04L 906 051 AB, 04L 906 051 F, 04L 906 051 G, 04L 906 051 L for OE number: 04L 906 051 AB, 04L 906 051 F, 04L 906 051 G, 04L 906 051 L
2.0 TDI 4motion 140 kW (190 PS) DFCA	11.2014→		7.10334.02.0	AGR	EL	  ch. 3C-F-200 001→
			7.11020.26.0	ATS	EL	 ch. 3C-F-200 001→
			7.11492.03.0	DDS		ohne Zubehör without accessories  ch. 3C-F-200 001→ für Hersteller-Abgasnorm: Euro 5 plus, Euro 6 plus for manufacturer exhaust norm: Euro 5 plus, Euro 6 plus
			7.07696.00.0	SRM-AK	EL	 ch. 3C-F-200 001→
2.0 TDI 4motion 140 kW (190 PS) DFHA	11.2014→		7.11020.26.0	ATS	EL	 ch. 3C-F-200 001→









V



PASSAT B8 Variant (3G5, CB5) 65

		7.11492.05.0	DDS		ohne Zubehör without accessories für OE-Nummer: 04L 906 051 AB, 04L 906 051 F, 04L 906 051 G, 04L 906 051 L for OE number: 04L 906 051 AB, 04L 906 051 F, 04L 906 051 G, 04L 906 051 L
		7.07696.00.0	SRM-AK	EL	 ch. 3C-F-200 001→















PASSAT CC B6 (357) 66

2.0 BlueTDI 105 kW (143 PS) CBAC	05.2009→11.2010		7.10334.00.0	AGR	EL	 Produktionsdatum ab: 16.12.2008 Production date from: 16.12.2008 ohne Zubehör without accessories Euro 5, Euro 6 Euro 5, Euro 6 ohne Zubehör without accessories Euro 4 Euro 4
			7.08369.01.0	ATS	EL	
			7.08369.07.0	ATS	EL	
			7.11492.00.0	DDS		
2.0 TDI 120 kW (163 PS) CBBA	05.2008→05.2011		7.08369.01.0	ATS	EL	ohne Zubehör without accessories Euro 5, Euro 6 Euro 5, Euro 6 ohne Zubehör without accessories Euro 4 Euro 4
			7.11492.00.0	DDS		
			7.11492.02.0	DDS		
2.0 TDI 103 kW (140 PS) CBAB	06.2008→01.2012		7.10334.00.0	AGR	EL	 ohne Zubehör without accessories Euro 5, Euro 6 Euro 5, Euro 6 ohne Zubehör without accessories Euro 4 Euro 4
			7.08369.01.0	ATS	EL	
			7.08369.07.0	ATS	EL	
			7.11492.00.0	DDS		
2.0 TDI 103 kW (140 PS) CFFB	06.2008→01.2012		7.09720.00.0	AGR-K	EL	 ohne Zubehör without accessories Euro 5, Euro 6 Euro 5, Euro 6 ohne Zubehör without accessories Euro 4 Euro 4
			7.11492.00.0	DDS		
			7.11492.02.0	DDS		
2.0 TDI 125 kW (170 PS) CBBB	06.2008→01.2012		7.10334.00.0	AGR	EL	 ohne Zubehör without accessories Euro 5, Euro 6 Euro 5, Euro 6
			7.08369.00.0	ATS	EL	
			7.08369.01.0	ATS	EL	
			7.08369.07.0	ATS	EL	
			7.11492.00.0	DDS		













PASSAT CC B6 (357) **66**















			7.11492.02.0	DDS		ohne Zubehör without accessories Euro 4 Euro 4
2.0 TDI 125 kW (170 PS) CFGB, CLLA	06.2008→01.2012		7.09720.00.0	AGR-K	EL	
			7.11492.00.0	DDS		ohne Zubehör without accessories  CFGB, CLLA: Euro 5, Euro 6 Euro 5, Euro 6
			7.11492.02.0	DDS		ohne Zubehör without accessories  CFGB, CLLA: Euro 4 Euro 4
2.0 TDI 100 kW (136 PS) CBAA	06.2008→05.2011		7.10334.00.0	AGR	EL	
			7.08369.01.0	ATS	EL	
			7.08369.07.0	ATS	EL	
			7.11492.00.0	DDS		ohne Zubehör without accessories Euro 5, Euro 6 Euro 5, Euro 6
			7.11492.02.0	DDS		ohne Zubehör without accessories Euro 4 Euro 4
2.0 TDI 100 kW (136 PS) CFFA	06.2008→05.2011		7.09720.00.0	AGR-K	EL	
			7.11492.00.0	DDS		ohne Zubehör without accessories Euro 5, Euro 6 Euro 5, Euro 6
			7.11492.02.0	DDS		ohne Zubehör without accessories Euro 4 Euro 4
2.0 TDI 4motion 103 kW (140 PS) CBAB	08.2009→01.2012		7.10334.00.0	AGR	EL	
			7.08369.01.0	ATS	EL	
			7.08369.07.0	ATS	EL	
			7.11492.00.0	DDS		ohne Zubehör without accessories Euro 5, Euro 6 Euro 5, Euro 6
			7.11492.02.0	DDS		ohne Zubehör without accessories Euro 4 Euro 4
2.0 TDI 4motion 103 kW (140 PS) CFFB	08.2009→01.2012		7.09720.00.0	AGR-K	EL	
			7.11492.00.0	DDS		ohne Zubehör without accessories Euro 5, Euro 6 Euro 5, Euro 6
			7.11492.02.0	DDS		ohne Zubehör without accessories Euro 4 Euro 4
2.0 TDI 4motion 125 kW (170 PS) CBBB	11.2009→01.2012		7.10334.00.0	AGR	EL	
			7.08369.00.0	ATS	EL	
			7.08369.01.0	ATS	EL	
			7.08369.07.0	ATS	EL	



PASSAT CC B6 (357) 66

			7.11492.00.0	DDS		ohne Zubehör without accessories Euro 5, Euro 6
			7.11492.02.0	DDS		ohne Zubehör without accessories Euro 4
2.0 TDI 4motion 125 kW (170 PS) CFGB	11.2009→01.2012		7.09720.00.0	AGR-K	EL	
			7.11492.00.0	DDS		ohne Zubehör without accessories Euro 5, Euro 6
			7.11492.02.0	DDS		ohne Zubehör without accessories Euro 4
2.0 TSI 147-157 kW (200-213 PS) CBFA	06.2008→01.2012		7.01510.31.0	SLV	EL	 ch. 3C-C-700 001→
3.6 FSI 206 kW (280 PS) BLV, CNNA	06.2008→01.2012		7.02604.41.0	LS	700 mm	 BLV, CNNA: vor Katalysator, links in front of the catalyst, Left
3.6 FSI 4motion 220 kW (300 PS) BWS	02.2008→12.2011		7.02604.41.0	LS	700 mm	vor Katalysator, links in front of the catalyst, Left
3.6 FSI 4motion 206 kW (280 PS) BLV, CNNA	06.2008→01.2012		7.02604.41.0	LS	700 mm	 BLV, CNNA: vor Katalysator, links in front of the catalyst, Left





















PHAETON (3D1, 3D2, 3D3, 3D4, 3D6, 3D7, 3D8, 3D9) 67

3.0 V6 TDI 4motion 165 kW (224 PS) BMK	09.2004→05.2007		7.00309.07.0	AGR	PN	
			7.08369.13.0	ATS	EL	
			7.11190.00.0	DDS		für OE-Nummer: 07Z 906 051 A for OE number: 07Z 906 051 A
			7.11190.02.0	DDS		für OE-Nummer: 059 906 051 A, 07Z 906 051 B for OE number: 059 906 051 A, 07Z 906 051 B
			7.11492.02.0	DDS		ohne Zubehör without accessories  →ch. 3D-8-007 000
3.0 V6 TDI 4motion 171 kW (233 PS) CARA	06.2007→11.2008		7.01782.07.0	AGR	EL	
			7.08369.13.0	ATS	EL	
			7.11190.02.0	DDS		 ch. 3D-9-000 001→
			7.11492.02.0	DDS		ohne Zubehör without accessories  →ch. 3D-8-007 000
3.0 V6 TDI 4motion 176 kW (239 PS) CARB	11.2008→03.2016		7.01782.07.0	AGR	EL	
			7.08369.13.0	ATS	EL	
			7.11190.02.0	DDS		 ch. 3D-9-000 001→
			7.11492.02.0	DDS		ohne Zubehör without accessories  →ch. 3D-8-007 000
3.0 V6 TDI 4motion 176 kW (240 PS) CEXA	11.2008→03.2016		7.01782.07.0	AGR	EL	
			7.08369.13.0	ATS	EL	
			7.11190.02.0	DDS		 ch. 3D-9-000 001→
			7.11492.02.0	DDS		ohne Zubehör without accessories  →ch. 3D-8-007 000





PHAETON (3D1, 3D2, 3D3, 3D4, 3D6, 3D7, 3D8, 3D9) 67

3.0 V6 TDI 4motion 180 kW (245 PS) CEXB	11.2013→03.2016		7.01782.07.0	AGR	EL	
			7.08369.13.0	ATS	EL	
			7.11190.02.0	DDS		 ch. 3D-9-000 001→
3.2 V6 177 kW (241 PS) AYT, BKL	04.2002→05.2005		7.22286.55.0	ARV	PN	
			7.05271.01.0	LS	950 mm	
			7.28415.09.0	SLP	EL	
3.2 V6 4motion 177 kW (241 PS) BKL, BRK	02.2004→11.2008		7.22286.55.0	ARV	PN	
			7.05271.01.0	LS	950 mm	
			7.28415.09.0	SLP	EL	
4.2 V8 4motion 246 kW (335 PS) BGH, BGJ	05.2003→03.2016		7.22560.40.0	ARV	PN	
			7.22560.41.0	ARV	PN	 BGH, BGJ: links Left
			7.05271.01.0	LS	950 mm	 BGH, BGJ: rechts Right
			7.05271.23.0	LS	900 mm	
			7.05271.24.0	LS	1500 mm	 BGH, BGJ: vor Katalysator, beidseitig in front of the catalyst, Left and right
5.0 V10 TDI 4motion 230 kW (313 PS) AJS	11.2002→10.2006		7.24809.63.0	AGR	PN	
			7.08369.13.0	ATS	EL	
			7.11190.00.0	DDS		
6.0 W12 4motion 309 kW (420 PS) BAN	04.2002→12.2005		7.05271.01.0	LS	950 mm	
			7.05270.99.0	LS	940 mm	
			7.05271.23.0	LS	900 mm	vorne rechts Right Front
			7.05271.77.0	LS	800 mm	 →ch. 3D-3-000 735 vor Katalysator, hinten links in front of the catalyst, Left Rear
			7.05271.14.0	LS	1700 mm	 →ch. 3D-3-000 735 hinten links Left Rear
			7.05271.24.0	LS	1500 mm	 BAN:  →ch. 3D-3-004-000 vor Katalysator, vorne links in front of the catalyst, Left Front
6.0 W12 4motion 309 kW (420 PS) BAP	04.2002→12.2005		7.05271.01.0	LS	950 mm	
			7.05270.99.0	LS	940 mm	
			7.05271.24.0	LS	1500 mm	vor Katalysator, vorne links in front of the catalyst, Left Front
6.0 W12 4motion 331 kW (450 PS) BRN, BTT	05.2005→03.2016		7.05271.01.0	LS	950 mm	





















































PHAETON (3D1, 3D2, 3D3, 3D4, 3D6, 3D7, 3D8, 3D9) 67

		7.05270.99.0	LS	940 mm	
		7.05271.29.0	LS	900 mm	BRN, BTT: vorne rechts Right Front
		7.05271.28.0	LS	800 mm	BRN, BTT: vorne links Left Front
		7.28415.09.0	SLP	EL	BRN, BTT: rechts Right

































POLO (6N2) 68

1.0 37 kW (50 PS) ALD	10.1999→09.2001	7.05270.99.0	LS	940 mm	Regelsonde Regulating Probe
1.0 37 kW (50 PS) AUC	10.1999→09.2001	7.05271.77.0	LS	800 mm	ch. 6N-YD000 001→ vor Katalysator in front of the catalyst
		7.05271.14.0	LS	1700 mm	
1.4 44 kW (60 PS) AKK	10.1999→09.2001	7.05270.99.0	LS	940 mm	Regelsonde Regulating Probe
1.4 44 kW (60 PS) AUD	10.1999→09.2001	7.05271.77.0	LS	800 mm	ch. 6N-YD000 001→ vor Katalysator in front of the catalyst
		7.05271.14.0	LS	1700 mm	
1.4 40 kW (54 PS) AKP	10.1999→09.2001	7.05271.77.0	LS	800 mm	ch. 6N-YD000 001→ vor Katalysator in front of the catalyst
		7.05271.14.0	LS	1700 mm	
1.4 40 kW (54 PS) ANX	10.1999→09.2001	7.05270.88.0	LS	740 mm	ch. 6K-W-000 001→ch. 6K-X-541 000
		7.05271.03.0	LS	730 mm	ch. 6N-W-000 001→ Regelsonde Regulating Probe
1.4 16V 55 kW (75 PS) AHW	10.1999→09.2001	7.05271.03.0	LS	730 mm	Regelsonde Regulating Probe
1.4 16V 55 kW (75 PS) APE	10.1999→09.2001	7.28248.17.0	AGR	EL	ch. 6N-2-000 001→
		7.22785.17.0	AGR	EL	→ch. 6N-1-350 000
		7.05271.06.0	LS	1720 mm	
		7.05271.21.0	LS	1250 mm	Regelsonde Regulating Probe
1.4 16V 74 kW (101 PS) AFK	10.1999→09.2001	7.05271.03.0	LS	730 mm	Regelsonde Regulating Probe
1.4 16V 74 kW (101 PS) AQQ	10.1999→09.2001	7.28248.17.0	AGR	EL	ch. 6N-2-000 001→
		7.22785.17.0	AGR	EL	→ch. 6N-1-350 000
		7.05271.06.0	LS	1720 mm	
1.4 16V 74 kW (101 PS) AUB	10.1999→09.2001	7.28248.17.0	AGR	EL	ch. 6N-2-000 001→
		7.22785.17.0	AGR	EL	→ch. 6N-1-350 000
1.4 16V 55 kW (75 PS) AUA	05.2000→09.2001	7.28248.17.0	AGR	EL	ch. 6K-2-500 001→
		7.22785.17.0	AGR	EL	→ch. 6N-1-350 000
1.4 TDI 55 kW (75 PS) AMF	10.1999→09.2001	7.24809.17.0	AGR	PN	 für Linkslenker for left-hand drive vehicles
		7.24809.57.0	AGR	PN	





























			 PIERBURG		
POLO (6N2)					
1.6 16V GTI 92 kW (125 PS) ARC, AVY	10.1999→09.2001		7.05271.77.0	LS	800 mm  ARC, AVY:  ch. 6N-YD000 001→ vor Katalysator in front of the catalyst
			7.05271.14.0	LS	1700 mm
1.7 SDI 44 kW (60 PS) AKU	10.1999→09.2001		7.22477.10.0	AGR	
1.9 SDI 47 kW (64 PS) ASX	10.1999→09.2001		7.22477.10.0	AGR	PN   ch. 6N-YD000 001→
POLO (9N_)					
1.2 40 kW (54 PS) AWY, BMD	01.2002→05.2007		7.05271.05.0	LS	700 mm  AWY, BMD:  ch. 9N-2-000 001→ vor Katalysator in front of the catalyst
1.2 44 kW (60 PS) BBM	05.2007→11.2009		7.05271.05.0	LS	700 mm  ch. 9N-5-500 001→ vor Katalysator in front of the catalyst
1.2 12V 47 kW (64 PS) AZQ	10.2001→07.2007		7.22785.16.0	AGR	EL   ch. 9N-2-000 001→
			7.05271.23.0	LS	900 mm
1.2 12V 47 kW (64 PS) BME	10.2001→07.2007		7.22785.16.0	AGR	EL   ch. 9N-2-000 001→ch. 9N-6-210 000
			7.05271.20.0	LS	500 mm
1.2 12V 51 kW (69 PS) BZG	05.2007→11.2009		7.22785.16.0	AGR	EL   ch. 9N-5-500 001→ch. 9N-6-210 000
			7.05271.20.0	LS	500 mm
1.4 16V 55 kW (75 PS) AUA	10.2001→05.2008		7.28248.17.0	AGR	EL   ch. 9N-2-000 001→
			7.05271.05.0	LS	700 mm  ch. 9N-2-000 001→ nach Katalysator Post-catalyst
			7.05271.06.0	LS	1720 mm
1.4 16V 55 kW (75 PS) BBY, BKY	10.2001→05.2008		7.28248.17.0	AGR	EL   BBY:  ch. 9N-2-000 001→  BKY:  →ch. 9N-6-060 000
			7.05271.05.0	LS	700 mm  BBY, BKY:  ch. 9N-2-000 001→ nach Katalysator Post-catalyst
1.4 16V 74 kW (101 PS) AUB	10.2001→05.2008		7.28248.17.0	AGR	EL 
			7.05271.05.0	LS	700 mm  ch. 9N-2-000 001→ nach Katalysator Post-catalyst
			7.05271.06.0	LS	1720 mm
1.4 16V 74 kW (101 PS) BBZ	10.2001→05.2008		7.28248.17.0	AGR	EL   →ch. 9N-50002500
			7.05271.05.0	LS	700 mm  ch. 9N-2-000 001→ nach Katalysator Post-catalyst
1.4 16V 59-60 kW (80-82 PS) BUD	05.2006→11.2009		7.05271.05.0	LS	700 mm  ch. 9N-5-500 001→ nach Katalysator Post-catalyst
1.4 BiFuel 59-60 kW (80-82 PS) BUD	05.2006→11.2009		7.05271.05.0	LS	700 mm  ch. 9N-5-500 001→ nach Katalysator Post-catalyst

V



					
POLO (9N_)					
1.4 FSI 63 kW (86 PS) AXU	02.2002→07.2006		7.10334.04.0	AGR	EL  ch. 9N-2-000 001→
			7.08369.34.0	ATS	EL
1.4 TDI 55 kW (75 PS) AMF	10.2001→06.2005		7.24809.17.0	AGR	PN  für Linkslenker for left-hand drive vehicles
			7.24809.57.0	AGR	PN 
1.4 TDI 55 kW (75 PS) BAY	10.2001→06.2005		7.24809.31.0	AGR	PN 
			7.24809.57.0	AGR	PN 
1.4 TDI 59 kW (80 PS) BMS	04.2005→11.2009		7.00678.04.0*	AGR-M	EL mit Rohrstützen with pipe socket  ch. 9N-5-500 001→
			↳ 7.00907.03.0	AGR	EL
			7.00678.06.0	AGR-M	EL  ch. 9N-5-500 001→
			7.08369.86.0	ATS	EL  ch. 9N-5-500 001→ für Rechtslenker for right-hand drive vehicles
			7.11020.02.0	ATS	EL  ch. 9N-5-500 001→ nach Rußpartikelfilter after soot particulate filter für Linkslenker for left-hand drive vehicles
			7.11020.03.0	ATS	EL  ch. 9N-5-500 001→ für Rechtslenker for right-hand drive vehicles
			7.11020.07.0	ATS	EL  ch. 9N-5-500 001→ für Linkslenker for left-hand drive vehicles
			7.08369.53.0	ATS	EL vor Rußpartikelfilter before soot particulate filter
			7.11492.02.0	DDS	ohne Zubehör without accessories  ch. 9N-5-500 001→
			1.4 TDI 59 kW (80 PS) BNV	04.2005→11.2009	
1.4 TDI 51 kW (70 PS) BNM	04.2005→11.2009		7.24809.31.0	AGR	PN 
1.4 TDI 51 kW (70 PS) BWB	04.2005→11.2009		7.00678.04.0*	AGR-M	EL mit Rohrstützen with pipe socket  ch. 9N-5-500 001→
			↳ 7.00907.03.0	AGR	EL
			7.00678.06.0	AGR-M	EL  ch. 9N-5-500 001→
			7.08369.86.0	ATS	EL  ch. 9N-5-500 001→ für Rechtslenker for right-hand drive vehicles
			7.11020.03.0	ATS	EL  ch. 9N-5-500 001→ für Rechtslenker for right-hand drive vehicles
			7.11020.07.0	ATS	EL  ch. 9N-5-500 001→ für Linkslenker for left-hand drive vehicles
			7.08369.53.0	ATS	EL vor Rußpartikelfilter before soot particulate filter
			7.11020.02.0	ATS	EL nach Rußpartikelfilter after soot particulate filter für Linkslenker for left-hand drive vehicles
			7.11492.02.0	DDS	ohne Zubehör without accessories  ch. 9N-5-500 001→
			1.6 74-76 kW (101-103 PS) BAH	08.2002→05.2005	



POLO (9N_) **69**

1.6 16V 77 kW (105 PS) BTS	05.2006→11.2009		7.05271.18.0	LS	525 mm	
1.8 GTI 110 kW (150 PS) BJX	09.2005→11.2009		7.22286.54.0	ARV	PN	 ch. 9N-5-500 001→
			7.05271.24.0	LS	1500 mm	 ch. 9N-5-500 001→ vor Katalysator in front of the catalyst
			7.22738.20.0	SLP	EL	Fahrgestellnummer ab: 9N-5-500 001 Vehicle Identification Number from: 9N-5-500 001
1.8 GTi Cup Edition 132 kW (180 PS) BBU	05.2006→11.2009		7.22286.54.0	ARV	PN	 ch. 9N-5-500 001→
			7.05271.24.0	LS	1500 mm	 ch. 9N-5-500 001→ vor Katalysator in front of the catalyst
			7.22738.20.0	SLP	EL	Fahrgestellnummer ab: 9N-5-500 001 Vehicle Identification Number from: 9N-5-500 001
1.9 SDI 47 kW (64 PS) ASY	10.2001→11.2009		7.22477.10.0	AGR	PN	 ch. 9N-2-000 001→
1.9 TDI 74 kW (101 PS) ATD	10.2001→11.2009		7.24809.30.0	AGR	PN	 ch. 9N-2-000 001→
1.9 TDI 74 kW (101 PS) AXR	10.2001→11.2009		7.24809.16.0	AGR	PN	 ch. 9N-2-000 001→
1.9 TDI 74 kW (101 PS) BMT	10.2001→11.2009		7.00678.04.0*	AGR-M	EL	mit Rohrstützen with pipe socket  ch. 9N-5-500 001→
			↳ 7.00907.03.0	AGR	EL	
			7.00678.06.0	AGR-M	EL	 ch. 9N-5-500 001→
			7.11020.03.0	ATS	EL	 ch. 03.0:→ für Rechtslenker for right-hand drive vehicles
			7.11020.02.0	ATS	EL	 BMT: für OE-Nummer: 045 906 088 D for OE number: 045 906 088 D vor Abgasturbolader in front of exhaust turbocharger  BMT:  ch. 9N-5-500 00→ nach Rußpartikelfilter after soot particulate filter für Linkslenker for left-hand drive vehicles
			7.08369.86.0	ATS	EL	 ch. 9N-5-500 001→ für Rechtslenker for right-hand drive vehicles
			7.11020.07.0	ATS	EL	 ch. 9N-5-500 001→ für Linkslenker for left-hand drive vehicles
			7.08369.53.0	ATS	EL	vor Rußpartikelfilter before soot particulate filter
7.11492.02.0	DDS		ohne Zubehör without accessories  ch. 9N-5-500 001→			
1.9 TDI 96 kW (130 PS) ASZ	11.2003→11.2009		7.24809.55.0	AGR	PN	
1.9 TDI 96 kW (130 PS) BLT	05.2004→11.2009		7.24809.16.0	AGR	PN	 ch. 9N-2-000 001→



























































POLO Coupe (86C, 80) **70**

1.3 G40 83-85 kW (113-115 PS) PY	01.1987→08.1990		7.02604.03.0	LS	200 mm	
1.3 G40 83-85 kW (113-115 PS) PY	08.1990→09.1994		7.02604.03.0	LS	200 mm	

V























POLO III (6N1)						71
100 1.4 16V 74 kW (100 PS) AFH	04.1996→10.1999		7.05271.03.0	LS	730 mm ch. 6N-X-068 039→ Regelsonde Regulating Probe	
120 1.6 16V GTI 88 kW (120 PS) AJV	09.1998→10.1999		7.05271.03.0	LS	730 mm Regelsonde Regulating Probe	
50 1.0 37 kW (50 PS) AER	09.1996→10.1999		7.05271.04.0	LS	505 mm ch. 6N-W-000 001→	
50 1.0 37 kW (50 PS) ALL	09.1996→10.1999		7.05271.03.0	LS	730 mm ch. 6N-W-000 001→ Regelsonde Regulating Probe	
55 1.3 40 kW (55 PS) ADX	10.1994→04.1997		7.05270.96.0	LS	1440 mm für Fahrzeuge ohne Katalysator for vehicles without catalytic convertor Regelsonde Regulating Probe	
55 1.4 40-44 kW (54-60 PS) AEX	08.1995→10.1999		7.05270.88.0	LS	740 mm ch. 6N-VW038 001→ch. 6N-VW20 3 200	
			7.05271.03.0	LS	730 mm ch. 6N-W-000 001→ Regelsonde Regulating Probe	
60 1.4 40-44 kW (54-60 PS) AEX, AKV, APQ	07.1995→10.1999		7.05270.88.0	LS	740 mm AEX: ch. 6N-VW038 001→ch. 6N-VW20 3 200 AKV, APQ: ch. 6K-W-000 001→ch. 6K-X-541 000	
			7.05271.03.0	LS	730 mm AEX, AKV, APQ: ch. 6N-W-000 001→ Regelsonde Regulating Probe	
60 1.7 SDI 44 kW (60 PS) AKU	08.1997→10.1999		7.22477.10.0	AGR	PN	
POLO III (6N_/6KV_)						72
1.8i 63-75 kW (86-102 PS) ADD	03.1998→09.2001		7.05270.86.0	LS	625 mm	
POLO III CLASSIC (6V2)						73
100 1.6 74 kW (101 PS) APF, AUR	12.1995→09.2001		7.22574.12.0	AGR	EL	
			7.22286.41.0	ARV	PN	
			7.05271.77.0	LS	800 mm APF, AUR: ch. 6K-Y-502 795→ APF, AUR: ch. 6K-Y-502 795→ vor Katalysator in front of the catalyst	
			7.22738.08.0	SLP	EL APF, AUR: ch. 6K-Y-502 795→	
57 1.7 SDI 42 kW (57 PS) AKW	07.1997→09.2001		7.22477.10.0	AGR	PN	
60 1.4 44 kW (60 PS) ANW, AUD	12.1995→09.2001		7.05271.77.0	LS	800 mm ANW, AUD: ch. 6K-Y-502 795→ vor Katalysator in front of the catalyst	
68 1.9 SDI 50 kW (68 PS) AGP, AQM	08.1999→01.2002		7.22477.10.0	AGR	PN	
75 1.4 16V 55 kW (75 PS) APE, AUA	10.1999→09.2001		7.28248.17.0	AGR	EL	
			7.22785.17.0	AGR	EL	
90 1.9 TDI 66-67 kW (90-91 PS) AGR, ALH	09.1996→09.2001		7.24809.17.0	AGR	PN	
					APE, AUA: →ch. 6K-1-562 500 AGR, ALH: ch. 6K-Y-502 795→	

V





			 PIERBURG			
POLO IV Saloon (9A4, 9A2, 9N2, 9A6)						74
1.4 55 kW (75 PS) BBY, BKY	11.2002→04.2012		7.28248.17.0	AGR	EL 	
			7.05271.05.0	LS	700 mm  BBY, BKY:  ch. 9N-2-000 001→ nach Katalysator Post-catalyst	
1.4 74 kW (101 PS) BBZ	11.2003→06.2005		7.28248.17.0	AGR	EL   →ch. 9N-50002 500	
			7.05271.05.0	LS	700 mm  ch. 9N-2-000 001→ nach Katalysator Post-catalyst	
1.4 TDI 55 kW (75 PS) BAY	07.2003→06.2005		7.24809.31.0	AGR	PN 	
1.9 SDI 47 kW (64 PS) ASY	11.2003→04.2012		7.22477.10.0	AGR	PN   ch. 9N-2-000 001→	
1.9 TDi 74 kW (101 PS) ATD	09.2002→		7.24809.30.0	AGR	PN   ch. 9N-2-000 001→	
POLO IV Saloon (9N4)						75
1.4 TDi 55 kW (75 PS) AMF	01.2003→12.2007		7.24809.17.0	AGR	PN 	
1.6 Classic 74 kW (101 PS) BCD	09.2004→12.2006		7.22778.96.0	SLV	PN 	
1.9 TDI 74 kW (101 PS) ATD	07.2003→12.2010		7.24809.30.0	AGR	PN   ch. 9N-2-000 001→	
POLO SEDAN (9A4)						76
2.0i 85-88 kW (115-120 PS) BBX	04.2002→11.2009		7.05270.99.0	LS	940 mm	
POLO V (6R1, 6C1)						77
1.2 TDI 55 kW (75 PS) CFWA	10.2009→		7.09720.02.0	AGR-K	EL   ch. 6R-A-000 001→	
			7.08369.50.0	ATS	EL	
			7.08369.83.0	ATS	EL  CFWA:  ch. 6R-A-000 001→  CFWA:  ch. 60-AT000 001→	
			7.08369.11.0	ATS	EL  Indien  India	
			7.08369.37.0	ATS	EL Fahrgestellnummer ab: 6R-A-000 001 Vehicle Identification Number from: 6R-A-000 001 für Rechtslenker for right-hand drive vehicles	
			7.11190.09.0	DDS	EL für Linkslenker for left-hand drive vehicles nach Rußpartikelfilter after soot particulate filter	
1.4 (6R1) 63 kW (85 PS) CGGB	03.2009→05.2014		7.05271.05.0	LS	700 mm  ch. 6R-A-000 001→ nach Katalysator Post-catalyst	
1.4 TDI 66 kW (90 PS) CUSB	02.2014→		7.09720.00.0	AGR-K	EL   ch. 6R-F-000 001→	
			7.07696.00.0	SRM-AK	EL  ch. 6R-F-000 001→	
1.4 TDI 55 kW (75 PS) CUSA	03.2014→10.2017		7.09720.00.0	AGR-K	EL   ch. 6R-F-000 001→	
			7.07696.00.0	SRM-AK	EL  ch. 6R-F-000 001→	
1.4 TDI 55 kW (75 PS) CYZB	03.2014→10.2017		7.09720.00.0	AGR-K	EL   ch. 6R-F-000 001→	
1.4 TDI 77 kW (105 PS) CUTA	05.2014→		7.09720.00.0	AGR-K	EL   ch. 6R-F-000 001→	
			7.07696.00.0	SRM-AK	EL  ch. 6R-F-000 001→	
1.4 TDI 77 kW (105 PS) CYZA	05.2014→		7.09720.00.0	AGR-K	EL   ch. 6R-F-000 001→	





















































POLO V (6R1, 6C1) 77

1.5 TDI 66 kW (90 PS) CWXA	07.2014→03.2020	 7.09720.00.0	AGR-K	EL 	 ch. 60-FT-000 001→	
1.5 TDI GT 77 kW (105 PS) CWXB	04.2014→	 7.09720.00.0	AGR-K	EL 	 ch. 60-FT-000 001→	
1.5 TDI GT 81 kW (110 PS) CWXC	04.2017→03.2020	 7.09720.00.0	AGR-K	EL 	 ch. 60-FT-000 001→	
1.6 BiFuel 60 kW (82 PS) CNKA	01.2011→05.2014	 7.05271.18.0	LS	525 mm		
1.6 TDI 55 kW (75 PS) CAYA	06.2009→	 7.09720.01.0	AGR-K	EL 		
			7.08369.26.0	ATS	EL  ch. 6R-A-000 001→	
			7.08369.09.0	ATS	EL	Fahrgestellnummer ab: 6R-A-000 001 Vehicle Identification Number from: 6R-A-000 001 für Linkslenker for left-hand drive vehicles
			7.08369.11.0	ATS	EL	Fahrgestellnummer ab: 6R-A-000 001 Vehicle Identification Number from: 6R-A-000 001 für Rechtslenker for right-hand drive vehicles
1.6 TDI 66 kW (90 PS) CAYB	06.2009→	 7.09720.01.0	DDS	 ch. 6R-A-000 001→		
			7.08369.26.0	ATS	EL  ch. 6R-A-000 001→	
			7.08369.09.0	ATS	EL	Fahrgestellnummer ab: 6R-A-000 001 Vehicle Identification Number from: 6R-A-000 001 für Linkslenker for left-hand drive vehicles
			7.08369.11.0	ATS	EL	Fahrgestellnummer ab: 6R-A-000 001 Vehicle Identification Number from: 6R-A-000 001 für Rechtslenker for right-hand drive vehicles
1.6 TDI 77 kW (105 PS) CAYC	06.2009→	 7.09720.01.0	DDS	 ch. 6R-A-000 001→		
			7.08369.26.0	ATS	EL  ch. 6R-A-000 001→	
			7.08369.09.0	ATS	EL	Fahrgestellnummer ab: 6R-A-000 001 Vehicle Identification Number from: 6R-A-000 001 für Linkslenker for left-hand drive vehicles
			7.08369.11.0	ATS	EL	Fahrgestellnummer ab: 6R-A-000 001 Vehicle Identification Number from: 6R-A-000 001 für Rechtslenker for right-hand drive vehicles
1.6 TDI 77 kW (105 PS) CLNA	06.2009→	 7.09720.01.0	DDS	 ch. 6R-A-000 001→		
			7.08369.26.0	ATS	EL  ch. 6R-A-000 001→	
			7.08369.09.0	ATS	EL	Fahrgestellnummer ab: 6R-A-000 001 Vehicle Identification Number from: 6R-A-000 001 für Linkslenker for left-hand drive vehicles
			7.11190.09.0	DDS		





































POLO V Saloon (602, 604, 612, 614) 78

1.5 TDI 77 kW (105 PS) CWXB	02.2014→	 7.09720.00.0	AGR-K	EL 	 ch. 60-FT-000 001→
1.5 TDI 81 kW (110 PS) CWXC	08.2016→	 7.09720.00.0	AGR-K	EL 	 ch. 60-FT-000 001→

							
POLO V Saloon (602, 604, 612, 614)						78	
1.6 TDI 77 kW (105 PS) CLNA	07.2010→		7.09720.01.0	AGR-K	EL 		
			7.11190.09.0	DDS	 ch. 6R-A-000 001→		
POLO VI (AW1, BZ1)						79	
1.6 TDI 59 kW (80 PS) DGTC	11.2017→		7.10334.02.0	AGR	EL   ch. AW-J-000 001→		
			7.11020.22.0	ATS	EL  ch. AW-J-000 001→		
			7.11020.23.0	ATS	EL  ch. AW-J-000 001→		
			7.11020.17.0	ATS	EL vor Katalysator in front of the catalyst		
			7.11492.05.0	DDS	ohne Zubehör without accessories  ch. AW-J-000 001→		
1.6 TDI 70 kW (95 PS) DGTD	11.2017→		7.10334.02.0	AGR	EL   ch. AW-J-000 001→		
			7.11020.22.0	ATS	EL  ch. AW-J-000 001→		
			7.11020.23.0	ATS	EL  ch. AW-J-000 001→		
			7.11020.17.0	ATS	EL vor Katalysator in front of the catalyst		
			7.11492.05.0	DDS	ohne Zubehör without accessories  ch. AW-J-000 001→		
7.07696.00.0			SRM-AK	EL  ch. AW-J-000 001→			
POLO Variant (6V5)						80	
1.4 40-44 kW (54-60 PS) AEX, AKV, APQ	05.1997→09.2001		7.05270.88.0	LS	740 mm  AEX:  ch. 6N-VW038 001→ch. 6N-VW203 200		
			7.05271.03.0	LS	730 mm  AKV, APQ:  ch. 6K-W-000 001→ch. 6K-X-541 000		
1.4 44 kW (60 PS) AKK	05.1997→09.2001		7.05270.99.0	LS	940 mm Regelsonde Regulating Probe		
1.4 44 kW (60 PS) ANW, AUD	05.1997→09.2001		7.05271.14.0	LS	1700 mm		
1.4 40 kW (54 PS) AKP	12.1998→09.2001		7.05271.14.0	LS	1700 mm		
1.4 16V 55 kW (75 PS) APE	10.1999→09.2001		7.28248.17.0	AGR	EL   ch. 6N-2-000 001→		
			7.22785.17.0	AGR	EL   →ch. 6N-1-350 000		
			7.05271.06.0	LS	1720 mm		
			7.05271.21.0	LS	1250 mm Regelsonde Regulating Probe		
1.4 16V 55 kW (75 PS) AUA	05.2000→09.2001		7.28248.17.0	AGR	EL   ch. 6K-2-500 001→		
			7.22785.17.0	AGR	EL   →ch. 6N-1-350 000		
1.6 74 kW (101 PS) APF, AUR	05.1997→09.2001		7.22574.12.0	AGR	EL   APF, AUR:  ch. 6K-Y-502 795→		
			7.22286.41.0	ARV	PN   APF, AUR:  ch. 6K-Y-502 795→		
			7.05271.00.0	LS	1525 mm		
			7.22738.08.0	SLP	EL   APF, AUR:  ch. 6K-Y-502 795→		

V























POLO Variant (6V5)						80
1.6 65-76 kW (100-103 PS) AEH, AKL	08.1997→09.2001	 7.05271.01.0	LS	950 mm	 AEH, AKL: Regelsonde Regulating Probe	
1.7 SDI 42 kW (57 PS) AKW	08.1997→09.2001	 7.22477.10.0	AGR	PN		
1.9 SDI 50 kW (68 PS) AGP, AQM	08.1999→09.2001	 7.22477.10.0	AGR	PN	  AGP, AQM:  ch. 6K-Y-502 795→	
1.9 TDI 66-67 kW (90-91 PS) AGR, ALH	05.1997→09.2001	 7.24809.17.0	AGR	PN	  AGR, ALH:  ch. 6K-Y-502 795→	
1.9 TDI 81 kW (110 PS) ASV	06.1998→09.2001	 7.24809.17.0	AGR	PN	  ch. 6K-Y-502 795→	
SCIROCCO (53B)						81
1.8 16V 100-102 kW (136-140 PS) KR	10.1985→07.1989	 7.02604.01.0	LS	200 mm		
1.8 16V 92-95 kW (125-129 PS) PL	03.1986→07.1992	 7.02604.01.0	LS	200 mm		
SCIROCCO III (137, 138)						82
2.0 TDI 103 kW (140 PS) CBDB	08.2008→11.2017	 7.10334.00.0	AGR	EL	 ohne Zubehör without accessories	
		7.08369.01.0	ATS	EL		
		7.08369.04.0	ATS	EL		
		7.11492.02.0	DDS			
2.0 TDI 103 kW (140 PS) CFHC	08.2008→11.2017	 7.09720.00.0	AGR-K	EL		
		7.11190.09.0	DDS			
2.0 TDI 125 kW (170 PS) CBBB	05.2009→11.2017	 7.10334.00.0	AGR	EL	 ohne Zubehör without accessories	
		7.08369.00.0	ATS	EL		
		7.08369.01.0	ATS	EL		
		7.08369.04.0	ATS	EL		
7.11492.00.0	DDS					
2.0 TDI 125 kW (170 PS) CFGB	05.2009→11.2017	 7.09720.00.0	AGR-K	EL		
		7.11190.09.0	DDS			
2.0 TDI 100 kW (136 PS) CFHB	11.2010→11.2017	 7.09720.00.0	AGR-K	EL		
		7.11190.09.0	DDS			
2.0 TDI 130 kW (177 PS) CFGC	01.2013→11.2017	 7.09720.00.0	AGR-K	EL		
2.0 TDI 110 kW (150 PS) CUUB	11.2013→11.2017	 7.11492.03.0	DDS		ohne Zubehör without accessories	
2.0 TDI 135 kW (184 PS) CUWA, CUXA	05.2014→11.2017	 7.11492.03.0	DDS		ohne Zubehör without accessories	
2.0 TSI 147 kW (200 PS) CAWB	05.2008→11.2009	 7.05271.11.0	LS	800 mm	Regelsonde Regulating Probe	
SHARAN (7M8, 7M9, 7M6)						83
1.8 T 20V 110 kW (150 PS) AJH	09.1997→03.2010	 7.22286.41.0	ARV	PN	 Regelsonde Regulating Probe	
		7.05271.03.0	LS	730 mm		
1.8 T 20V 110 kW (150 PS) AWC	04.2000→03.2010	 7.28070.03.0	AGR	EL		
		7.05271.23.0	LS	900 mm		
		7.05271.77.0	LS	800 mm		vor Katalysator in front of the catalyst

V



SHARAN (7M8, 7M9, 7M6) **83**

			7.22738.08.0	SLP	EL	
			7.22778.79.0	SLV	PN	⊗
1.9 TDI 66 kW (90 PS) ANU	09.1999→03.2010		7.24809.19.0	AGR	PN	⊗
1.9 TDI 85 kW (115 PS) AUY, BVK	04.2000→03.2010		7.24809.20.0	AGR	PN	⊗
1.9 TDI 96 kW (130 PS) ASZ	11.2002→03.2010		7.24809.20.0	AGR	PN	⊗
1.9 TDI 110 kW (150 PS) BTB	06.2005→03.2010		7.24809.20.0	AGR	PN	⊗
1.9 TDI 4motion 85 kW (115 PS) AUY	04.2000→03.2010		7.24809.20.0	AGR	PN	⊗
2.0 85 kW (115 PS) ADY	09.1995→04.2000		7.05270.96.0	LS	1440 mm	 →ch. 7M-T-036 895 Regelsonde Regulating Probe
2.0 85 kW (115 PS) ATM	04.2000→03.2010		7.22574.12.0	AGR	EL	⊗
			7.05271.23.0	LS	900 mm	
			7.05271.77.0	LS	800 mm	vor Katalysator in front of the catalyst
			7.22738.08.0	SLP	EL	
			7.22778.80.0	SLV	PN	⊗
2.0 LPG 85 kW (115 PS) ATM	04.2006→03.2010		7.22574.12.0	AGR	EL	⊗
			7.05271.77.0	LS	800 mm	vor Katalysator in front of the catalyst
			7.22738.08.0	SLP	EL	
			7.22778.80.0	SLV	PN	⊗
2.0 TDI 100 kW (136 PS) BVH	11.2005→03.2010		7.08369.43.0	ATS	EL	vor Turbolader before turbocharger
			7.11492.02.0	DDS		ohne Zubehör without accessories  ch. 7M-7-000 001→
			7.11190.02.0	DDS		 →ch. 7M-6-030 000
2.0 TDI 103 kW (140 PS) BRT	11.2005→03.2010		7.08369.43.0	ATS	EL	vor Turbolader before turbocharger
			7.11492.02.0	DDS		ohne Zubehör without accessories  ch. 7M-7-000 001→
			7.11190.02.0	DDS		 →ch. 7M-6-030 000
2.8 V6 24V 150 kW (204 PS) AYL	04.2000→03.2010		7.22286.55.0	ARV	PN	⊗
			7.05270.89.0	LS	925 mm	
			7.22738.08.0	SLP	EL	
2.8 V6 24V 4motion 150 kW (204 PS) AYL	04.2000→03.2010		7.22286.55.0	ARV	PN	⊗
			7.05270.89.0	LS	925 mm	
			7.22738.08.0	SLP	EL	
2.8 VR6 120-128 kW (163-174 PS) AAA	09.1995→04.2000		7.22090.11.0	ARV	PN	⊗
			7.05270.88.0	LS	740 mm	 ch. 7M-T-021 999→ch. 7M-W-050 000
			7.05270.96.0	LS	1440 mm	 →ch. 7M-T-021 998 Regelsonde Regulating Probe
2.8 VR6 128 kW (174 PS) AMY	09.1995→04.2000		7.22090.11.0	ARV	PN	⊗

V



SHARAN (7M8, 7M9, 7M6) 83

2.8 VR6 Syncro 120-128 kW (163-174 PS) AAA	11.1996→04.2000	7.22090.11.0	ARV	PN	
		7.05270.88.0	LS	740 mm	ch. 7M-T-021 999→ch. 7M-W-050 000
		7.05270.96.0	LS	1440 mm	→ch. 7M-T-021 998 Regelsonde Regulating Probe
2.8 VR6 Syncro 128 kW (174 PS) AMY	11.1996→04.2000	7.22090.11.0	ARV	PN	





















SHARAN (7N1, 7N2) 84

1.4 TSI 110 kW (150 PS) CZDA, DJKA	05.2015→	7.03635.37.0	SLP	EL	CZDA, DJKA: Fahrgestellnummer ab: 7N-G-200 001 Vehicle Identification Number from: 7N-G-200 001
2.0 TDI 103 kW (140 PS) CFFB	05.2010→	7.09720.00.0	AGR-K	EL	
		7.11492.00.0	DDS		ohne Zubehör without accessories
2.0 TDI 100 kW (136 PS) CFFA	05.2010→	7.09720.00.0	AGR-K	EL	
		7.11492.00.0	DDS		ohne Zubehör without accessories
2.0 TDI 125 kW (170 PS) CFGB	08.2010→	7.09720.00.0	AGR-K	EL	
		7.11492.00.0	DDS		ohne Zubehör without accessories
2.0 TDI 85 kW (115 PS) CFFE	05.2011→07.2019	7.09720.00.0	AGR-K	EL	
		7.11492.00.0	DDS		ohne Zubehör without accessories
		7.07696.00.0	SRM-AK	EL	
2.0 TDI 85 kW (115 PS) CUVA, DFLD	05.2011→07.2019	7.10334.02.0	AGR	EL	CUVA, DFLD: ch. 7N-H-200 001_→
		7.11492.03.0	DDS		ohne Zubehör without accessories
		7.07696.00.0	SRM-AK	EL	CUVA, DFLD: ch. 7N-G-200 001_→
2.0 TDI 85 kW (115 PS) DLTC	05.2011→07.2019	7.07696.00.0	SRM-AK	EL	
2.0 TDI 130 kW (177 PS) CFGC	01.2013→11.2015	7.09720.00.0	AGR-K	EL	
		7.11492.00.0	DDS		ohne Zubehör without accessories
		7.07696.00.0	SRM-AK	EL	
2.0 TDI 130 kW (177 PS) DLUB	01.2013→11.2015	7.10334.02.0	AGR	EL	ch. 7N-H-200 001_→
		7.08369.81.0	ATS	EL	ch. 7N-G-200 001_→
		7.11492.03.0	DDS		ohne Zubehör without accessories
		7.07696.00.0	SRM-AK	EL	ch. 7N-G-200 001_→
2.0 TDI 110 kW (150 PS) CUVC	05.2015→11.2015	7.11492.03.0	DDS		ohne Zubehör without accessories
		7.07696.00.0	SRM-AK	EL	ch. 7N-G-200 001_→
2.0 TDI 110 kW (150 PS) DFLA	05.2015→11.2015	7.10334.02.0	AGR	EL	ch. 7N-H-200 001_→







SHARAN (7N1, 7N2) 84



			7.11492.03.0	DDS		ohne Zubehör without accessories  ch. 7N-G-200 001_→
			7.07696.00.0	SRM-AK	EL	
2.0 TDI 135 kW (184 PS) CUWA, DFMA	05.2015→		7.10334.02.0	AGR	EL	 CUWA, DFMA:  ch. 7N-H-200 001_→
			7.11492.03.0	DDS		ohne Zubehör without accessories
			7.07696.00.0	SRM-AK	EL	 CUWA, DFMA:  ch. 7N-G-200 001_→
2.0 TDI 4motion 103 kW (140 PS) CFFB	05.2011→11.2015		7.09720.00.0	AGR-K	EL	
			7.11492.00.0	DDS		ohne Zubehör without accessories
2.0 TDI 4motion 110 kW (150 PS) CUVC, DLTA	05.2015→		7.11492.03.0	DDS		ohne Zubehör without accessories
			7.07696.00.0	SRM-AK	EL	 CUVC, DLTA:  ch. 7N-G-200 001_→
2.0 TDI 4motion 110 kW (150 PS) DFLA	05.2015→		7.10334.02.0	AGR	EL	 ch. 7N-H-200 001_→
			7.11492.03.0	DDS		ohne Zubehör without accessories
			7.07696.00.0	SRM-AK	EL	 ch. 7N-G-200 001_→
2.0 TDI 4motion 135 kW (184 PS) DFMA	05.2016→		7.10334.02.0	AGR	EL	 ch. 7N-H-200 001_→
			7.11492.03.0	DDS		ohne Zubehör without accessories
			7.07696.00.0	SRM-AK	EL	 ch. 7N-G-200 001_→
2.0 TDI 4motion 130 kW (177 PS) DLUB	11.2018→		7.10334.02.0	AGR	EL	 ch. 7N-H-200 001_→
			7.08369.81.0	ATS	EL	 ch. 7N-G-200 001_→
			7.11492.03.0	DDS		ohne Zubehör without accessories
			7.07696.00.0	SRM-AK	EL	 ch. 7N-G-200 001_→

T-CROSS (C11) 85

1.6 TDi 70 kW (95 PS) DGTD	12.2018→		7.10334.02.0	AGR	EL	
			7.11020.17.0	ATS	EL	für Vorkatalysator for pre-catalyst
			7.11020.22.0	ATS	EL	
			7.11020.23.0	ATS	EL	
			7.11492.05.0	DDS		ohne Zubehör without accessories





T-ROC (A11) 86

V





1.6 TDI 85 kW (115 PS) DGTE	03.2018→		7.10334.02.0	AGR	EL	
			7.11020.17.0	ATS	EL	vor Katalysator in front of the catalyst
			7.11020.22.0	ATS	EL	
			7.11020.23.0	ATS	EL	
			7.11492.05.0	DDS		ohne Zubehör without accessories
			7.07696.00.0	SRM-AK	EL	Euro 6d-Temp Euro 6d-Temp



T-ROC (A11) 86







2.0 TDI 110 kW (150 PS) DFFA	03.2018→		7.10334.02.0	AGR	EL	
			7.08369.81.0	ATS	EL	für OE-Nummer: 04L 906 088 DQ, 04L 906 088 HT for OE number: 04L 906 088 DQ, 04L 906 088 HT
			7.11020.26.0	ATS	EL	für OE-Nummer: 04L 919 529 D for OE number: 04L 919 529 D
			7.11492.05.0	DDS		ohne Zubehör without accessories für OE-Nummer: 04L 906 051 AB, 04L 906 051 F, 04L 906 051 G, 04L 906 051 L for OE number: 04L 906 051 AB, 04L 906 051 F, 04L 906 051 G, 04L 906 051 L
			7.07696.00.0	SRM-AK	EL	
2.0 TDI 4motion 110 kW (150 PS) DFFA	09.2017→		7.10334.02.0	AGR	EL	
			7.08369.81.0	ATS	EL	für OE-Nummer: 04L 906 088 DQ, 04L 906 088 HT for OE number: 04L 906 088 DQ, 04L 906 088 HT
			7.11020.26.0	ATS	EL	für OE-Nummer: 04L 919 529 D for OE number: 04L 919 529 D
			7.11492.05.0	DDS		ohne Zubehör without accessories für OE-Nummer: 04L 906 051 AB, 04L 906 051 F, 04L 906 051 G, 04L 906 051 L for OE number: 04L 906 051 AB, 04L 906 051 F, 04L 906 051 G, 04L 906 051 L
			7.07696.00.0	SRM-AK	EL	
2.0 TDI 4motion 140 kW (190 PS) DFHA	07.2019→		7.08369.81.0	ATS	EL	für OE-Nummer: 04L 906 088 DQ, 04L 906 088 HT for OE number: 04L 906 088 DQ, 04L 906 088 HT
			7.11020.26.0	ATS	EL	für OE-Nummer: 04L 919 529 D for OE number: 04L 919 529 D
			7.11492.05.0	DDS		ohne Zubehör without accessories für OE-Nummer: 04L 906 051 AB, 04L 906 051 F, 04L 906 051 G, 04L 906 051 L for OE number: 04L 906 051 AB, 04L 906 051 F, 04L 906 051 G, 04L 906 051 L
			7.07696.00.0	SRM-AK	EL	

TIGUAN (5N_) 87

2.0 TDI 103 kW (140 PS) CBAB	03.2008→07.2018		7.10334.00.0	AGR	EL	
			7.08369.03.0	ATS	EL	Fahrgestellnummer bis: 5N-9-060 000 Vehicle Identification Number to: 5N-9-060 000
			7.08369.04.0	ATS	EL	Fahrgestellnummer ab: 5N-9-060 001 Vehicle Identification Number from: 5N-9-060 001
			7.08369.56.0	ATS	EL	vor Rußpartikelfilter before soot particulate filter
			7.11492.00.0	DDS		ohne Zubehör without accessories Produktionsdatum ab: 21.05.2009 Production date from: 21.05.2009
			7.11492.02.0	DDS		ohne Zubehör without accessories Produktionsdatum bis: 20.05.2009 Production date to: 20.05.2009
2.0 TDI 103 kW (140 PS) CFFB	03.2008→07.2018		7.10334.02.0	AGR	EL	
			7.09720.00.0	AGR-K	EL	







TIGUAN (5N_) 87

			7.11492.00.0	DDS		ohne Zubehör without accessories Produktionsdatum ab: 21.05.2009 Production date from: 21.05.2009
			7.11492.02.0	DDS		ohne Zubehör without accessories Produktionsdatum bis: 20.05.2009 Production date to: 20.05.2009
2.0 TDI 81 kW (110 PS) CFFD	05.2010→07.2018		7.10334.02.0	AGR	EL	<input type="checkbox"/>
			7.09720.00.0	AGR-K	EL	<input type="checkbox"/>
			7.11492.00.0	DDS		ohne Zubehör without accessories Produktionsdatum ab: 21.05.2009 Production date from: 21.05.2009
			7.11492.02.0	DDS		ohne Zubehör without accessories Produktionsdatum bis: 20.05.2009 Production date to: 20.05.2009
2.0 TDI 81 kW (110 PS) CUVE	05.2010→07.2018		7.10334.02.0	AGR	EL	<input type="checkbox"/>
			7.11492.03.0	DDS		ohne Zubehör without accessories
			7.07696.00.0	SRM-AK	EL	
2.0 TDI 110 kW (150 PS) CUVC	05.2015→07.2018		7.10334.02.0	AGR	EL	<input type="checkbox"/>
			7.11492.03.0	DDS		ohne Zubehör without accessories
			7.07696.00.0	SRM-AK	EL	
2.0 TDI 4motion 103 kW (140 PS) CBAB	09.2007→07.2018		7.10334.00.0	AGR	EL	<input type="checkbox"/>
			7.08369.03.0	ATS	EL	Fahrgestellnummer bis: 5N-9-060 000 Vehicle Identification Number to: 5N-9-060 000
			7.08369.04.0	ATS	EL	Fahrgestellnummer ab: 5N-9-060 001 Vehicle Identification Number from: 5N-9-060 001
			7.08369.56.0	ATS	EL	vor Rußpartikelfilter before soot particulate filter
			7.11492.00.0	DDS		ohne Zubehör without accessories Produktionsdatum ab: 21.05.2009 Production date from: 21.05.2009
			7.11492.02.0	DDS		ohne Zubehör without accessories Produktionsdatum bis: 20.05.2009 Production date to: 20.05.2009
2.0 TDI 4motion 103 kW (140 PS) CFFB	09.2007→07.2018		7.10334.02.0	AGR	EL	<input type="checkbox"/>
			7.09720.00.0	AGR-K	EL	<input type="checkbox"/>
			7.11492.02.0	DDS		ohne Zubehör without accessories Produktionsdatum bis: 20.05.2009 Production date to: 20.05.2009
2.0 TDI 4motion 103 kW (140 PS) CLJA	09.2007→07.2018		7.09720.00.0	AGR-K	EL	<input type="checkbox"/>
			7.11492.00.0	DDS		ohne Zubehör without accessories Produktionsdatum ab: 21.05.2009 Production date from: 21.05.2009
			7.11492.02.0	DDS		ohne Zubehör without accessories Produktionsdatum bis: 20.05.2009 Production date to: 20.05.2009

V









TIGUAN (5N_) 87

2.0 TDI 4motion 125 kW (170 PS) CBBB	09.2007→07.2018		7.10334.00.0	AGR	EL	<p>○</p> <p>Fahrgestellnummer bis: 5N-9-060 000 Vehicle Identification Number to: 5N-9-060 000</p> <p>Fahrgestellnummer ab: 5N-9-060 001 Vehicle Identification Number from: 5N-9-060 001</p> <p>vor Rußpartikelfilter before soot particulate filter ohne Zubehör without accessories Produktionsdatum ab: 21.05.2009 Production date from: 21.05.2009</p> <p>ohne Zubehör without accessories Produktionsdatum bis: 20.05.2009 Production date to: 20.05.2009</p>
			7.08369.00.0	ATS	EL	
			7.08369.03.0	ATS	EL	
			7.08369.04.0	ATS	EL	
			7.08369.56.0	ATS	EL	
			7.11492.00.0	DDS	EL	
2.0 TDI 4motion 125 kW (170 PS) CFGB	09.2007→07.2018		7.10334.02.0	AGR	EL	<p>○</p> <p>ohne Zubehör without accessories Produktionsdatum ab: 21.05.2009 Production date from: 21.05.2009</p> <p>ohne Zubehör without accessories Produktionsdatum bis: 20.05.2009 Production date to: 20.05.2009</p>
			7.09720.00.0	AGR-K	EL	
			7.11492.00.0	DDS	EL	
			7.11492.02.0	DDS	EL	
2.0 TDI 4motion 100 kW (136 PS) CBAA	11.2007→07.2018		7.10334.00.0	AGR	EL	<p>○</p> <p>Fahrgestellnummer bis: 5N-9-060 000 Vehicle Identification Number to: 5N-9-060 000</p> <p>Fahrgestellnummer ab: 5N-9-060 001 Vehicle Identification Number from: 5N-9-060 001</p> <p>vor Rußpartikelfilter before soot particulate filter ohne Zubehör without accessories Produktionsdatum ab: 21.05.2009 Production date from: 21.05.2009</p> <p>ohne Zubehör without accessories Produktionsdatum bis: 20.05.2009 Production date to: 20.05.2009</p>
			7.08369.03.0	ATS	EL	
			7.08369.04.0	ATS	EL	
			7.08369.56.0	ATS	EL	
			7.11492.00.0	DDS	EL	
			7.11492.02.0	DDS	EL	
2.0 TDI 4motion 100 kW (136 PS) CFFA	11.2007→07.2018		7.10334.02.0	AGR	EL	<p>○</p> <p>ohne Zubehör without accessories Produktionsdatum ab: 21.05.2009 Production date from: 21.05.2009</p> <p>ohne Zubehör without accessories Produktionsdatum bis: 20.05.2009 Production date to: 20.05.2009</p>
			7.09720.00.0	AGR-K	EL	
			7.11492.00.0	DDS	EL	
			7.11492.02.0	DDS	EL	
2.0 TDI 4motion 120 kW (163 PS) CBBA	02.2008→08.2009		7.10334.00.0	AGR	EL	<p>○</p> <p>Fahrgestellnummer bis: 5N-9-060 000 Vehicle Identification Number to: 5N-9-060 000</p>
			7.08369.00.0	ATS	EL	
			7.08369.03.0	ATS	EL	















TIGUAN (5N_) 87

			7.08369.04.0	ATS	EL	Fahrgestellnummer ab: 5N-9-060 001 Vehicle Identification Number from: 5N-9-060 001
			7.08369.56.0	ATS	EL	vor Rußpartikelfilter before soot particulate filter
			7.11492.00.0	DDS		ohne Zubehör without accessories Produktionsdatum ab: 21.05.2009 Production date from: 21.05.2009
			7.11492.02.0	DDS		ohne Zubehör without accessories Produktionsdatum bis: 20.05.2009 Production date to: 20.05.2009
2.0 TDI 4motion 130 kW (177 PS) CFGC	11.2012→07.2018		7.10334.02.0	AGR	EL	
			7.09720.00.0	AGR-K	EL	
			7.11492.00.0	DDS		ohne Zubehör without accessories Produktionsdatum ab: 21.05.2009 Production date from: 21.05.2009
			7.11492.02.0	DDS		ohne Zubehör without accessories Produktionsdatum bis: 20.05.2009 Production date to: 20.05.2009
2.0 TDI 4motion 110 kW (150 PS) CUVC	05.2015→07.2018		7.10334.02.0	AGR	EL	
			7.11492.03.0	DDS		ohne Zubehör without accessories
			7.07696.00.0	SRM-AK	EL	
2.0 TDI 4motion 135 kW (184 PS) CUWA	05.2015→07.2018		7.10334.02.0	AGR	EL	
			7.11492.03.0	DDS		ohne Zubehör without accessories
			7.07696.00.0	SRM-AK	EL	

TIGUAN (AD1, AX1) 88

1.6 TDI 85 kW (115 PS) DGDB	05.2016→06.2020		7.10334.02.0	AGR	EL	 ch. WVGZZZ5NZG-000001→ch. AD1***
			7.11492.03.0	DDS		ohne Zubehör without accessories  ch. WVGZZZ5NZG-000001→ch. AD1***
2.0 TDI 110 kW (150 PS) DFGA	01.2016→07.2020		7.10334.02.0	AGR	EL	 ch. WVGZZZ5NZG-000001→ch. AD1***
			7.08369.81.0	ATS	EL	 ch. WVGZZZ5NZG-000001 →ch. AD1***
			7.11492.03.0	DDS		ohne Zubehör without accessories  ch. WVGZZZ5NZG-000001→ch. AD1*** Produktionsdatum bis: 29.05.2016 Production date to: 29.05.2016
			7.11492.05.0	DDS		ohne Zubehör without accessories  ch. WVGZZZ5NZG-000001→ch. AD1*** Produktionsdatum ab: 29.05.2016 Production date from: 29.05.2016 Produktionsdatum bis: 29.08.2018 Production date to: 29.08.2018
			7.07696.00.0	SRM-AK	EL	
2.0 TDI 85 kW (115 PS) DFGC	05.2016→07.2019		7.10334.02.0	AGR	EL	 ch. WVGZZZ5NZG-000001→ch. AD1***



































V



TIGUAN (AD1, AX1) 88























			7.08369.81.0	ATS	EL	ch. WVGZZZ5NZG-000001→ch. A D1***
			7.11492.05.0	DDS		ohne Zubehör without accessories ch. WVGZZZ5NZG-000001→ch. A D1*** Produktionsdatum ab: 29.05.2016 Production date from: 29.05.2016 Produktionsdatum bis: 29.08.2018 Production date to: 29.08.2018
			7.07696.00.0	SRM-AK	EL	
2.0 TDI 81 kW (110 PS) CYKC	08.2016→07.2020		7.10334.02.0	AGR	EL	 ch. WVGZZZ5NZG-000001→ch. A D1***
			7.08369.81.0	ATS	EL	CYKC: ch. WVGZZZ5NZG-000001→ CYKC: ch. AD1***→
2.0 TDI 4motion 110 kW (150 PS) DBGC	01.2016→07.2020		7.10334.02.0	AGR	EL	 ch. WVGZZZ5NZG-000001→
			7.08369.81.0	ATS	EL	ch. WVGZZZ5NZG-000001→ch. A D1***
			7.11492.03.0	DDS		ohne Zubehör without accessories DBGC: ch. WVGZZZ5NZG-000001→ch. A D1*** DBGC: ch. XW8ZZZ5NZHG000001→ " " Russland " " Russia
			7.07696.00.0	SRM-AK	EL	
2.0 TDI 4motion 110 kW (150 PS) DFGA	01.2016→07.2020		7.08369.81.0	ATS	EL	ch. WVGZZZ5NZG-000001→ch. A D1***
			7.11492.03.0	DDS		ohne Zubehör without accessories ch. WVGZZZ5NZG-000001→ch. A D1*** Produktionsdatum bis: 29.05.2016 Production date to: 29.05.2016
			7.11492.05.0	DDS		ohne Zubehör without accessories ch. WVGZZZ5NZG-000001→ch. A D1*** Produktionsdatum ab: 29.05.2016 Production date from: 29.05.2016 Produktionsdatum bis: 29.08.2018 Production date to: 29.08.2018
			7.07696.00.0	SRM-AK	EL	
2.0 TDI 4motion 140 kW (190 PS) DFHA	04.2016→07.2020		7.10334.02.0	AGR	EL	 ch. WVGZZZ5NZG-000001→ch. A D1***
			7.11020.26.0	ATS	EL	ch. WVGZZZ5NZG-000001→ch. A D1***
			7.11492.05.0	DDS		ohne Zubehör without accessories ch. WVGZZZ5NZG-000001→ch. A D1*** Produktionsdatum bis: 16.07.2018 Production date to: 16.07.2018
2.0 TDI 4motion 176 kW (240 PS) CUAA	05.2016→07.2020		7.10334.02.0	AGR	EL	 ch. WVGZZZ5NZG-000001→ch. A D1***
			7.11492.03.0	DDS		ohne Zubehör without accessories ch. WVGZZZ5NZG-000001→ch. A D1***



			 PIERBURG		
TIGUAN (AD1, AX1)					88
2.0 TDI 4motion 105 kW (143 PS) CRFD	06.2016→07.2020		7.10334.02.0	AGR	EL  ch. WVGZZZ5NZG-000001→ch. A D1***
2.0 TDI 4motion 130 kW (177 PS) CRGB	08.2016→07.2020		7.10334.02.0	AGR	EL  ch. WVGZZZ5NZG-000001→ch. A D1***
TIGUAN ALLSPACE (BW2)					89
2.0 TDI 110 kW (150 PS) DFGA	06.2017→		7.10334.02.0	AGR	EL  ch. WVGZZZ5NZG-000001→ch. A D1***
			7.08369.81.0	ATS	EL
			7.11492.03.0	DDS	ohne Zubehör without accessories
			7.07696.00.0	SRM-AK	EL
2.0 TDI 4motion 110 kW (150 PS) DBGC	06.2017→		7.10334.02.0	AGR	EL  ch. WVGZZZ5NZG-000001→
			7.11492.03.0	DDS	ohne Zubehör without accessories
2.0 TDI 4motion 110 kW (150 PS) DFGA	06.2017→		7.08369.81.0	ATS	EL
			7.11492.03.0	DDS	ohne Zubehör without accessories
2.0 TDI 4motion 140 kW (190 PS) DFHA	06.2017→		7.11020.26.0	ATS	EL
			7.11492.03.0	DDS	ohne Zubehör without accessories
			7.07696.00.0	SRM-AK	EL
2.0 TDI 4motion 176 kW (240 PS) CUAA	06.2017→		7.10334.02.0	AGR	EL  ch. WVGZZZ5NZG-000001→ch. A D1***
			7.11492.03.0	DDS	ohne Zubehör without accessories
			7.07696.00.0	SRM-AK	EL
2.0 TSI 137 kW (186 PS) DGUA, DTEA	04.2017→		7.03635.39.0	SLP	EL  DGUA, DTEA: Produktionsdatum bis: 08.10.2018 Production date to: 08.10.2018
			7.01510.85.0	SLV	EL
2.0 TSI 4motion 137 kW (186 PS) DGUA, DTEA	04.2017→		7.03635.39.0	SLP	EL  DGUA, DTEA: Produktionsdatum bis: 08.10.2018 Production date to: 08.10.2018
			7.01510.85.0	SLV	EL
TOUAREG (7LA, 7L6, 7L7)					90
2.5 R5 TDI 128 kW (174 PS) BAC	01.2003→05.2010		7.24809.56.0	AGR	PN 
2.5 R5 TDI 128 kW (174 PS) BPE	01.2003→05.2010		7.00823.06.0	AGR	EL 
			7.08369.18.0	ATS	EL  →ch. 7L-7-040 000
			7.11190.02.0	DDS	
2.5 R5 TDI 120 kW (163 PS) BLK	08.2003→05.2010		7.24809.56.0	AGR	PN 
2.5 R5 TDI 120 kW (163 PS) BPD	08.2003→05.2010		7.00823.06.0	AGR	EL 
			7.08369.18.0	ATS	EL  →ch. 7L-7-040 000
			7.11190.02.0	DDS	
3.0 TDI 155 kW (211 PS) BUN	04.2006→05.2010		7.00309.07.0	AGR	PN 
			7.08369.13.0	ATS	EL
			7.08369.62.0	ATS	EL Fahrgestellnummer bis: 7L-8-080 000 Vehicle Identification Number to: 7L-8-080 000













TOUAREG (7LA, 7L6, 7L7) **90**

			7.11190.02.0 DDS 7.11492.02.0 DDS		 ch. 7L-8-080 001→ ohne Zubehör without accessories  ch. 7L6***→ch. 7L-8-080 000*
3.0 TDI 155 kW (211 PS) CASB	04.2006→05.2010		7.01782.07.0 AGR 7.08369.13.0 ATS 7.11190.02.0 DDS	EL EL	
3.0 V6 TDI 165 kW (224 PS) BKS	11.2004→05.2010		7.00309.07.0 AGR 7.08369.13.0 ATS 7.08369.62.0 ATS 7.11190.00.0 DDS 7.11492.02.0 DDS	PN EL EL DDS DDS	 2006 2006 ohne Zubehör without accessories 2007 2007
3.0 V6 TDI 165 kW (224 PS) CATA	11.2004→05.2010		7.02132.07.0 AGR 7.08369.13.0 ATS 7.08369.68.0 ATS 7.11190.02.0 DDS	EL EL EL DDS	 nach Rußpartikelfilter after soot particulate filter  ch. 7L6***→
3.0 V6 TDI 176 kW (240 PS) CASA	11.2007→05.2010		7.01782.07.0 AGR 7.08369.13.0 ATS 7.08369.45.0 ATS 7.11190.02.0 DDS	EL EL EL DDS	  ch. 7L6***→
3.0 V6 TDI 176 kW (240 PS) CASC	11.2007→05.2010		7.01782.07.0 AGR 7.08369.13.0 ATS 7.11190.02.0 DDS	EL EL DDS	  ch. 7L6***→
3.2 V6 162-177 kW (220-241 PS) AZZ, BKJ, BMV, BMX, BRJ	10.2002→11.2006		7.22286.51.0 ARV 7.05270.99.0 LS 7.05270.98.0 LS 7.22738.08.0 SLP	PN 940 mm 700 mm EL	 AZZ, BKJ, BMV, BMX, BRJ: nach Katalysator, rechts Post-catalyst, Right
3.2 V6 162-177 kW (220-241 PS) BMV	11.2004→11.2006		7.22286.51.0 ARV 7.05270.99.0 LS 7.05270.98.0 LS 7.22738.08.0 SLP	PN 940 mm 700 mm EL	 nach Katalysator, rechts Post-catalyst, Right
3.6 V6 FSI 206 kW (280 PS) BHK	10.2005→05.2010		7.05271.11.0 LS 7.05271.15.0 LS 7.05271.27.0 LS 7.05271.30.0 LS	800 mm 525 mm 475 mm 400 mm	links Left Diagnosesonde Diagnostic Probe rechts Right links Left rechts Right
4.2 V8 228 kW (310 PS) AXQ	12.2002→11.2006		7.22560.40.0 ARV 7.22560.41.0 ARV	PN PN	 











TOUAREG (7LA, 7L6, 7L7) 90

			7.05271.23.0	LS	900 mm	
			7.05271.00.0	LS	1525 mm	
			7.05271.24.0	LS	1500 mm	vor Katalysator, beidseitig in front of the catalyst, Left and right
			7.05271.21.0	LS	1250 mm	
			7.22738.08.0	SLP	EL	
4.2 V8 FSI 231-257 kW (314-350 PS) BAR	06.2006→05.2010		7.22769.79.0	ARV	PN	 ch. 7L-8-050 001→ch. 7L-9-030-000
			7.06712.24.0	ARV	PN	 ch. 7L-9-030 001→ ■ Mexico ■ Mexico
			7.05271.23.0	LS	900 mm	
			7.05271.16.0	LS	1300 mm	
			7.22738.08.0	SLP	EL	
			7.22778.97.0	SLV	PN	 Fahrgestellnummer bis: 7L-7-150 000 Vehicle Identification Number to: 7L-7-150 000 ■ Mexico ■ Mexico
5.0 R50 TDI 230-257 kW (313-350 PS) CBWA	08.2007→05.2010		7.11190.00.0	DDS		
5.0 V10 TDI 230 kW (313 PS) AYH	10.2002→05.2010		7.24809.63.0	AGR	PN	
5.0 V10 TDI 230 kW (313 PS) BLE, BWF	10.2002→05.2010		7.11190.00.0	DDS		
6.0 W12 331 kW (450 PS) BJN	08.2004→05.2010		7.05270.98.0	LS	700 mm	nach Katalysator, hinten links Post-catalyst, Left Rear
			7.28415.09.0	SLP	EL	links Left
6.0 W12 331 kW (450 PS) CFRA	08.2004→05.2010		7.28415.09.0	SLP	EL	 ch. 7L6***→ links Left



TOUAREG (7P5, 7P6) 91

3.0 V6 TDI 150 kW (204 PS) CASD	01.2010→03.2018		7.02132.07.0	AGR	EL	
			7.01106.38.0	AGR-K	EL	mit AGR-Ventil with EGR valve
			7.08369.13.0	ATS	EL	
			7.08369.45.0	ATS	EL	
			7.11190.02.0	DDS		
3.0 V6 TDI 150 kW (204 PS) CJMA, CRCD	01.2010→03.2018		7.08369.73.0	ATS	EL	 CJMA, CRCD: vor Turbolader before turbocharger
			7.11190.02.0	DDS		 CJMA, CRCD: Euro 5, ULEV2 Euro 5, ULEV2
			7.11492.03.0	DDS		ohne Zubehör without accessories  CJMA, CRCD: für PR-Nummer: 7CF, 7MM for PR number: 7CF, 7MM
3.0 V6 TDI 150 kW (204 PS) CVWA	01.2010→03.2018		7.11190.02.0	DDS		Euro 5, ULEV2 Euro 5, ULEV2



































V



TOUAREG (7P5, 7P6) **91**





















			7.11492.03.0	DDS		ohne Zubehör without accessories für PR-Nummer: 7CF, 7MM for PR number: 7CF, 7MM
3.0 V6 TDI 176 kW (240 PS) CASA	01.2010→03.2018		7.02132.07.0	AGR	EL	 06.2010→
			7.01106.38.0	AGR-K	EL	06.2010→ mit AGR-Ventil with EGR valve
			7.08369.13.0	ATS	EL	
			7.08369.45.0	ATS	EL	
			7.11190.02.0	DDS		
3.0 V6 TDI 176 kW (240 PS) CNRB	01.2010→03.2018		7.11492.03.0	DDS		ohne Zubehör without accessories für PR-Nummer: 7CM , 7MM for PR number: 7CM , 7MM
3.0 V6 TDI 165 kW (224 PS) CATA	06.2010→03.2018		7.02132.07.0	AGR	EL	
			7.08369.13.0	ATS	EL	
			7.08369.68.0	ATS	EL	
			7.11190.02.0	DDS		
3.0 V6 TDI 180 kW (245 PS) CRCA	05.2011→03.2018		7.08369.73.0	ATS	EL	
			7.11190.02.0	DDS		Euro 5, ULEV2 Euro 5, ULEV2
			7.11492.03.0	DDS		ohne Zubehör without accessories für PR-Nummer: 7CF, 7MM for PR number: 7CF, 7MM
3.0 V6 TDI 193 kW (262 PS) CVVA	09.2014→03.2018		7.11190.02.0	DDS		Euro 5, ULEV2 Euro 5, ULEV2
			7.11492.03.0	DDS		ohne Zubehör without accessories für PR-Nummer: 7CF, 7MM for PR number: 7CF, 7MM
3.0 V6 TSI 213 kW (290 PS) CJTA	08.2010→03.2018		7.22286.52.0	ARV	PN	 rechts Right
			7.22286.53.0	ARV	PN	 links Left
3.0 V6 TSI 235 kW (320 PS) CYJA	01.2015→03.2018		7.22286.52.0	ARV	PN	 rechts Right
			7.22286.53.0	ARV	PN	 links Left
3.0 V6 TSI Hybrid 245-283 kW (333-385 PS) CGEA, CGFA	04.2010→03.2018		7.22286.52.0	ARV	PN	  CGEA, CGFA: rechts Right
			7.22286.53.0	ARV	PN	  CGEA, CGFA: links Left
3.0 V6 TSI Hybrid 245-283 kW (333-385 PS) CGFA	09.2010→03.2018		7.22286.52.0	ARV	PN	 rechts Right
			7.22286.53.0	ARV	PN	 links Left
4.2 V8 FSI 265 kW (360 PS) CGNA	01.2011→03.2018		7.06712.24.0	ARV	PN	
			7.22738.08.0	SLP	EL	

V

































					
TOUAREG (7P5, 7P6) 91					
4.2 V8 TDI 250 kW (340 PS) CKDA	01.2010→03.2018		7.00789.10.0	AGR	EL 
			7.11190.02.0	DDS	Euro 5, ULEV2 Euro 5, ULEV2
TOUAREG (CR7) 92					
2.0 TSI 4motion 180 kW (245 PS) DMFA, DNEA	08.2018→11.2020		7.03635.46.0	SLP	EL
			7.01510.94.0	SLV	EL 
3.0 TDI 190 kW (258 PS) CVMC	11.2017→		7.11020.24.0	ATS	EL  ch. CR-J-000 001→ Produktionsdatum bis: 02.04.2018 Production date to: 02.04.2018
			7.07696.00.0	SRM-AK	EL
3.0 TDI 4motion 210 kW (286 PS) DENA	11.2017→		7.11020.24.0	ATS	EL  ch. CR-J-000 001→ Produktionsdatum bis: 02.04.2018 Production date to: 02.04.2018
			7.07696.00.0	SRM-AK	EL
3.0 TDI 4motion 183 kW (249 PS) CVMD	01.2018→		7.11020.24.0	ATS	EL  ch. CR-J-000 001→ Produktionsdatum bis: 02.04.2018 Production date to: 02.04.2018
			7.07696.00.0	SRM-AK	EL
3.0 TDI 4motion 170 kW (231 PS) DEND	05.2018→		7.11020.24.0	ATS	EL  ch. CR-J-000 001→ Produktionsdatum bis: 02.04.2018 Production date to: 02.04.2018
			7.07696.00.0	SRM-AK	EL
TOURAN (1T1, 1T2) 93					
1.6 75 kW (102 PS) BGU	07.2003→05.2010		7.22574.12.0	AGR	EL 
			7.05271.18.0	LS	525 mm
			7.22738.08.0	SLP	EL
			7.22778.96.0	SLV	PN 
1.6 75 kW (102 PS) BSE	07.2003→05.2010		7.05271.18.0	LS	525 mm
			7.22738.08.0	SLP	EL
			7.22778.96.0	SLV	PN 
1.6 75 kW (102 PS) BSF	07.2003→05.2010		7.05271.18.0	LS	525 mm
1.6 FSI 85 kW (115 PS) BAG	02.2003→01.2007		7.10334.04.0	AGR	EL 
			7.08369.41.0	ATS	EL
1.6 FSI 85 kW (115 PS) BLF	02.2003→01.2007		7.10334.04.0	AGR	EL 
			7.05271.15.0	LS	525 mm
			7.05271.30.0	LS	400 mm Schaltgetriebe Manual Transmission
1.6 FSI 85 kW (115 PS) BLP	02.2003→01.2007		7.10334.04.0	AGR	EL 
			7.08369.41.0	ATS	EL
			7.05271.30.0	LS	400 mm Schaltgetriebe Manual Transmission
1.9 TDI 74 kW (100 PS) AVQ	02.2003→05.2004		7.24809.16.0	AGR	PN 
1.9 TDI 77 kW (105 PS) BKC, BXE	08.2003→05.2010		7.24809.16.0	AGR	PN 
1.9 TDI 77 kW (105 PS) BLS	08.2003→05.2010		7.00678.04.0*	AGR-M	EL mit Rohrstützen with pipe socket
			↳ 7.00907.03.0	AGR	EL
			7.00678.06.0	AGR-M	EL



TOURAN (1T1, 1T2) 93

			7.08369.00.0 ATS EL 7.08369.08.0 ATS EL 7.08369.84.0 ATS EL 7.11492.02.0 DDS		ohne Zubehör without accessories
1.9 TDI 66 kW (90 PS) BRU, BXF	11.2004→05.2010		7.24809.16.0 AGR PN		
1.9 TDI 66 kW (90 PS) BXJ	11.2004→05.2010		7.00678.04.0* AGR-M EL ↳ 7.00907.03.0 AGR EL 7.00678.06.0 AGR-M EL 7.08369.00.0 ATS EL 7.08369.08.0 ATS EL 7.08369.84.0 ATS EL 7.11492.02.0 DDS		mit Rohrstutzen with pipe socket ohne Zubehör without accessories
2.0 FSI 110 kW (150 PS) AXW, BLX	10.2003→01.2007		7.10334.09.0 AGR EL 7.08369.41.0 ATS EL 7.05271.29.0 LS 900 mm 7.05271.16.0 LS 1300 mm		 AXW: →01.2005  BLX: →09.2006  AXW, BLX: rechts Right  AXW, BLX: links, rechts Left, Right Diagnosesonde Diagnostic Probe
2.0 FSI 110 kW (150 PS) BLR, BVY	10.2003→01.2007		7.10334.09.0 AGR EL 7.05271.29.0 LS 900 mm 7.05271.16.0 LS 1300 mm		 BLR, BVY: →09.2006  BLR: rechts Right  BVY:  →ch. 1T-9-128 000 rechts Right  BLR, BVY: links, rechts Left, Right Diagnosesonde Diagnostic Probe
2.0 FSI 110 kW (150 PS) BLY, BVZ	10.2003→01.2007		7.05271.16.0 LS 1300 mm		 BLY, BVZ: Diagnosesonde Diagnostic Probe
2.0 TDI 100 kW (136 PS) AZV	02.2003→05.2010		7.24809.16.0 AGR PN		
2.0 TDI 125 kW (170 PS) BMN	12.2005→05.2010		7.10334.00.0 AGR EL 7.08369.00.0 ATS EL 7.08369.08.0 ATS EL 7.08369.84.0 ATS EL 7.11492.02.0 DDS		ohne Zubehör without accessories
2.0 TDI 125 kW (170 PS) CFJA	12.2005→05.2010		7.11190.09.0 DDS		
2.0 TDI 103 kW (140 PS) BMM	12.2005→05.2010		7.00678.04.0* AGR-M EL ↳ 7.00907.03.0 AGR EL 7.00678.06.0 AGR-M EL 7.08369.00.0 ATS EL 7.08369.08.0 ATS EL 7.08369.84.0 ATS EL		mit Rohrstutzen with pipe socket



					
TOURAN (1T1, 1T2)					93
			7.11492.02.0	DDS	ohne Zubehör without accessories
2.0 TDI 16V 103 kW (140 PS) BKD	08.2003→05.2010		7.24809.16.0	AGR PN	
TOURAN (1T3)					94
1.6 TDI 66 kW (90 PS) CAYB	05.2010→05.2015		7.09720.00.0	AGR-K EL	
			7.08369.19.0	ATS EL	
			7.08369.48.0	ATS EL	
			7.11492.00.0	DDS	ohne Zubehör without accessories
1.6 TDI 77 kW (105 PS) CAYC	05.2010→05.2015		7.09720.00.0	AGR-K EL	
			7.08369.19.0	ATS EL	
			7.08369.48.0	ATS EL	vor Rußpartikelfilter before soot particulate filter
			7.11492.00.0	DDS	ohne Zubehör without accessories
2.0 TDI 125 kW (170 PS) CFJA	05.2010→01.2013		7.09720.00.0	AGR-K EL	
			7.11190.09.0	DDS	
2.0 TDI 103 kW (140 PS) CFHC	05.2010→05.2015		7.09720.00.0	AGR-K EL	
			7.11190.09.0	DDS	
2.0 TDI 81 kW (110 PS) CFHF, CLCA	11.2010→05.2015		7.09720.00.0	AGR-K EL	
2.0 TDI 130 kW (177 PS) CFJB	01.2013→05.2015		7.09720.00.0	AGR-K EL	
			7.11190.09.0	DDS	
TOURAN (5T1)					95
1.6 TDI 81 kW (110 PS) CRKB	05.2015→05.2016		7.10334.02.0	AGR EL	
			7.11492.03.0	DDS	ohne Zubehör without accessories
1.6 TDI 85 kW (115 PS) DGDA	05.2016→		7.10334.02.0	AGR EL	
2.0 TDI 110 kW (150 PS) DFEA, DFGA	05.2015→		7.10334.02.0	AGR EL	
			7.08369.81.0	ATS EL	
			7.11492.03.0	DDS	ohne Zubehör without accessories
			7.07696.00.0	SRM-AK EL	
					DFEA, DFGA: Produktionsdatum bis: 30.05.2016 Production date to: 30.05.2016
2.0 TDI 81 kW (110 PS) CRVA	11.2015→07.2019		7.10334.02.0	AGR EL	
2.0 TDI 81 kW (110 PS) CYKB, DFEB	11.2015→07.2019		7.10334.02.0	AGR EL	
			7.08369.81.0	ATS EL	
			7.11492.03.0	DDS	ohne Zubehör without accessories
					Produktionsdatum bis: 30.05.2016 Production date to: 30.05.2016
2.0 TDI 140 kW (190 PS) DFHA	11.2015→07.2019		7.10334.02.0	AGR EL	
			7.11020.26.0	ATS EL	

V



TOURAN (5T1) 95

			7.11492.03.0	DDS		ohne Zubehör without accessories Produktionsdatum bis: 30.05.2016 Production date to: 30.05.2016
			7.07696.00.0	SRM-AK	EL	
2.0 TDI 81 kW (110 PS) DFGB	05.2016→07.2018		7.10334.02.0	AGR	EL	
			7.08369.81.0	ATS	EL	
			7.11492.03.0	DDS		ohne Zubehör without accessories Produktionsdatum bis: 30.05.2016 Production date to: 30.05.2016
			7.07696.00.0	SRM-AK	EL	
2.0 TDI 85 kW (115 PS) DFGC	02.2019→		7.10334.02.0	AGR	EL	
			7.08369.81.0	ATS	EL	
			7.07696.00.0	SRM-AK	EL	

VENTO (1H2) 96

1.4 40-44 kW (54-60 PS) ABD	11.1991→09.1998		7.05270.88.0	LS	740 mm	ch. 1H-S-120 001→ für Fahrzeuge ohne Katalysator for vehicles without catalytic convertor
			7.05270.86.0	LS	625 mm	→ch. 1H-S-120 000
1.4 40-44 kW (54-60 PS) AEX	11.1991→09.1998		7.05270.96.0	LS	1440 mm	Regelsonde Regulating Probe
1.4 40-44 kW (54-60 PS) ABD	11.1991→07.1995		7.05270.88.0	LS	740 mm	ch. 1H-S-120 001→ für Fahrzeuge ohne Katalysator for vehicles without catalytic convertor
			7.05270.86.0	LS	625 mm	→ch. 1H-S-120 000
1.4 40-44 kW (54-60 PS) AEX	07.1995→09.1998		7.05270.96.0	LS	1440 mm	Regelsonde Regulating Probe
1.6 55 kW (75 PS) ABU	09.1992→09.1994		7.05270.86.0	LS	625 mm	→ch. 1H-S-120 000
1.8 55 kW (75 PS) AAM	11.1991→09.1998		7.02604.03.0	LS	200 mm	
1.8 63-75 kW (86-102 PS) ABS, ACC, ADD, ADZ	11.1991→09.1998		7.02604.03.0	LS	200 mm	
2.0 85 kW (115 PS) 2E	11.1991→09.1994		7.05270.86.0	LS	625 mm	
2.8 VR6 120-128 kW (163-174 PS) AAA	01.1992→09.1998		7.05270.88.0	LS	740 mm	
			7.05270.86.0	LS	625 mm	

XL1 (6Z!) 97

0.8 TDI E-Hybrid 35 kW (48 PS) CSCA	02.2014→		7.11492.03.0	DDS		ohne Zubehör without accessories
---	----------	--	---------------------	-----	--	-------------------------------------













AMAROK Platform/Chassis (S1B, S6B, S7B) 98

2.0 BiTDI 132 kW (180 PS) CNEA	09.2011→07.2019		7.24809.93.0	AGR	EL	 Euro 5
			7.11237.06.0	AGR-K	EL	 →09.2016 Euro 5
			7.11020.19.0	ATS	EL	Euro 5
			7.11020.20.0	ATS	EL	Euro 5















AMAROK Platform/Chassis (S1B, S6B, S7B) 98

			7.11492.00.0	DDS		ohne Zubehör without accessories Euro 5 Euro 5
2.0 BiTDI 132 kW (180 PS) CSHA	09.2011→07.2019		7.24809.93.0	AGR	EL	 Euro 5 Euro 5
			7.11020.19.0	ATS	EL	Euro 5 Euro 5
			7.11020.20.0	ATS	EL	Euro 5 Euro 5
			7.11492.00.0	DDS		ohne Zubehör without accessories Euro 5 Euro 5
2.0 BiTDI 4motion 132 kW (180 PS) CNEA	09.2011→07.2019		7.24809.93.0	AGR	EL	 Euro 5 Euro 5
			7.11237.06.0	AGR-K	EL	 →09.2016 Euro 5 Euro 5
			7.11020.19.0	ATS	EL	Euro 5 Euro 5
			7.11020.20.0	ATS	EL	Euro 5 Euro 5
			7.11492.00.0	DDS		ohne Zubehör without accessories Euro 5 Euro 5
2.0 BiTDI 4motion 132 kW (180 PS) CSHA	09.2011→07.2019		7.24809.93.0	AGR	EL	 Euro 5 Euro 5
			7.11020.19.0	ATS	EL	Euro 5 Euro 5
			7.11020.20.0	ATS	EL	Euro 5 Euro 5
			7.11492.00.0	DDS		ohne Zubehör without accessories Euro 5 Euro 5
2.0 TDI 90 kW (122 PS) CDBA	09.2011→10.2013		7.11237.06.0	AGR-K	EL	 →11.2012 Euro 5 Euro 5
			7.24809.99.0	AGR-K	EL	 Euro 4 Euro 4
			7.11020.19.0	ATS	EL	Euro 5 Euro 5
			7.11020.20.0	ATS	EL	Euro 5 Euro 5
			7.11492.00.0	DDS		ohne Zubehör without accessories Euro 5 Euro 5
2.0 TDI 90 kW (122 PS) CNFA	09.2011→10.2013		7.24809.93.0	AGR	EL	 Euro 5 Euro 5
			7.11020.19.0	ATS	EL	
			7.11020.20.0	ATS	EL	
			7.11492.00.0	DDS		ohne Zubehör without accessories Euro 5 Euro 5



V



AMAROK Platform/Chassis (S1B, S6B, S7B) 98

2.0 TDI 103 kW (140 PS) CNFB	09.2011→10.2016		7.11020.19.0	ATS	EL	Euro 5 Euro 5
			7.11020.20.0	ATS	EL	Euro 5 Euro 5
			7.11492.00.0	DDS		ohne Zubehör without accessories Euro 5 Euro 5
2.0 TDI 120 kW (163 PS) CDCA	09.2011→08.2012		7.24809.93.0	AGR	EL	 Euro 5 Euro 5
			7.11237.06.0	AGR-K	EL	 Euro 5 Euro 5
			7.24809.99.0	AGR-K	EL	 Euro 4 Euro 4
			7.11020.19.0	ATS	EL	Euro 5 Euro 5
			7.11020.20.0	ATS	EL	Euro 5 Euro 5
			7.11492.00.0	DDS		ohne Zubehör without accessories Euro 5 Euro 5
2.0 TDI 4motion 120 kW (163 PS) CDCA	09.2011→08.2012		7.24809.93.0	AGR	EL	 Euro 5 Euro 5
			7.11237.06.0	AGR-K	EL	 Euro 5 Euro 5
			7.24809.99.0	AGR-K	EL	 Euro 4 Euro 4
			7.11020.19.0	ATS	EL	Euro 5 Euro 5
			7.11020.20.0	ATS	EL	Euro 5 Euro 5
			7.11492.00.0	DDS		ohne Zubehör without accessories Euro 5 Euro 5
2.0 TDI 4motion 103 kW (140 PS) CNFB	09.2011→10.2016		7.11020.19.0	ATS	EL	Euro 5 Euro 5
			7.11020.20.0	ATS	EL	Euro 5 Euro 5
			7.11492.00.0	DDS		ohne Zubehör without accessories Euro 5 Euro 5







CADDY ALLTRACK Box Body/MPV (SAA) 99

1.6 TDI 55 kW (75 PS) CAYE	05.2015→11.2017		7.08369.19.0	ATS	EL	
			7.11492.00.0	DDS		ohne Zubehör without accessories
1.6 TDI 75 kW (102 PS) CAYD	05.2015→		7.08369.19.0	ATS	EL	
			7.11492.00.0	DDS		ohne Zubehör without accessories
2.0 TDI 55 kW (75 PS) CUUF	05.2015→		7.11492.03.0	DDS		ohne Zubehör without accessories
			7.07696.00.0	SRM-AK	EL	
2.0 TDI 75 kW (102 PS) CUUD	05.2015→		7.11492.03.0	DDS		ohne Zubehör without accessories





























CADDY ALLTRACK Box Body/MPV (SAA) 99

			7.07696.00.0	SRM-AK	EL	
2.0 TDI 110 kW (150 PS) CUUB	05.2015→		7.11492.03.0	DDS		ohne Zubehör without accessories
			7.07696.00.0	SRM-AK	EL	
2.0 TDI 55 kW (75 PS) DFSC, DFSF	11.2015→		7.11492.03.0	DDS		ohne Zubehör without accessories
2.0 TDI 75 kW (102 PS) DFSD	11.2015→		7.11492.03.0	DDS		ohne Zubehör without accessories
2.0 TDI 110 kW (150 PS) DFSB	11.2015→		7.11492.03.0	DDS		ohne Zubehör without accessories
2.0 TDI 4motion 90 kW (122 PS) CUUE	05.2015→		7.11492.03.0	DDS		ohne Zubehör without accessories
			7.07696.00.0	SRM-AK	EL	
2.0 TDI 4motion 90 kW (122 PS) DFSE	05.2015→		7.11492.03.0	DDS		ohne Zubehör without accessories
2.0 TDI 4motion 110 kW (150 PS) DFSB	11.2015→		7.11492.03.0	DDS		ohne Zubehör without accessories

CADDY II Box Body/MPV (9K9A) 100



















1.4 55 kW (75 PS) AUA	08.2000→01.2004		7.28248.17.0	AGR	EL	 ch. 9K-2-500 001→
			7.22785.17.0	AGR	EL	 →ch. 9K-2-500 000
1.9 SDI 47 kW (64 PS) AYQ	11.1995→01.2004		7.22477.10.0	AGR	PN	
1.9 TDI 66-67 kW (90-91 PS) ALH	09.1996→01.2004		7.24809.17.0	AGR	PN	
60 1.4 40-44 kW (54-60 PS) AEX, APQ	11.1995→01.2004		7.05270.88.0	LS	740 mm	 AEX, APQ:  ch. 9K-W-502 001→ch. 9K-X-521 000
			7.05271.03.0	LS	730 mm	 AEX, APQ:  ch. 9K-X-521 001→ Regelsonde Regulating Probe
60 1.4 44 kW (60 PS) AUD	11.1995→01.2004		7.05271.01.0	LS	950 mm	 ch. 9K-1-518 701→ch. 9K-3-501 8 00 Diagnosesonde Diagnostic Probe
			7.05271.77.0	LS	800 mm	vor Katalysator in front of the catalyst
			7.05271.02.0	LS	500 mm	 ch. 9K-3-501 801→ Regelsonde Regulating Probe
			7.05271.00.0	LS	1525 mm	 →ch. 9K-1-518 700

CADDY III Box Body/MPV (2KA, 2KH, 2CA, 2CH) 101

1.4 55 kW (75 PS) BCA	03.2004→05.2006		7.28248.17.0	AGR	EL	 →ch. 2K-5-150 000
			7.05271.15.0	LS	525 mm	
1.6 75 kW (102 PS) BGU	04.2004→05.2015		7.22574.12.0	AGR	EL	 →12.2008
			7.22738.08.0	SLP	EL	
			7.22778.96.0	SLV	PN	
1.6 75 kW (102 PS) BSE	04.2004→05.2015		7.05271.18.0	LS	525 mm	
			7.22738.08.0	SLP	EL	
			7.22778.96.0	SLV	PN	
1.6 75 kW (102 PS) BSF	04.2004→05.2015		7.05271.18.0	LS	525 mm	
1.6 BiFuel 75 kW (102 PS) CHGA	05.2011→05.2015		7.05271.18.0	LS	525 mm	

























CADDY III Box Body/MPV (2KA, 2KH, 2CA, 2CH) 101

			7.22738.08.0	SLP	EL	
			7.22778.96.0	SLV	PN	
1.6 TDI 55 kW (75 PS) CAYE	08.2010→05.2015		7.09720.00.0	AGR-K	EL	
			7.08369.19.0	ATS	EL	 ch. 2K-B-200 001→
			7.08369.48.0	ATS	EL	
			7.11492.00.0	DDS		ohne Zubehör without accessories
						 ch. 2K-B-200 001→
1.6 TDI 75 kW (102 PS) CAYD	08.2010→05.2015		7.09720.00.0	AGR-K	EL	
			7.08369.19.0	ATS	EL	 ch. 2K-B-200 001→
			7.08369.48.0	ATS	EL	
			7.11492.00.0	DDS		ohne Zubehör without accessories
						 ch. 2K-B-200 001→
1.9 TDI 77 kW (105 PS) BJB	04.2004→08.2010		7.24809.32.0	AGR	PN	
1.9 TDI 77 kW (105 PS) BLS	04.2004→08.2010		7.00678.04.0*	AGR-M	EL	mit Rohrstützen with pipe socket
			↳ 7.00907.03.0	AGR	EL	
			7.00678.06.0	AGR-M	EL	
			7.08369.00.0	ATS	EL	
			7.08369.08.0	ATS	EL	
			7.08369.84.0	ATS	EL	
			7.11492.02.0	DDS		ohne Zubehör without accessories
1.9 TDI 55 kW (75 PS) BSU	09.2005→08.2010		7.00678.04.0*	AGR-M	EL	mit Rohrstützen with pipe socket
			↳ 7.00907.03.0	AGR	EL	
			7.00678.06.0	AGR-M	EL	
			7.08369.00.0	ATS	EL	
			7.08369.08.0	ATS	EL	
			7.08369.84.0	ATS	EL	
			7.11492.02.0	DDS		ohne Zubehör without accessories
1.9 TDI 4motion 77 kW (105 PS) BLS	11.2008→08.2010		7.00678.04.0*	AGR-M	EL	mit Rohrstützen with pipe socket
			↳ 7.00907.03.0	AGR	EL	
			7.00678.06.0	AGR-M	EL	
			7.08369.00.0	ATS	EL	
			7.08369.08.0	ATS	EL	
			7.08369.84.0	ATS	EL	
			7.11492.02.0	DDS		ohne Zubehör without accessories
2.0 SDI 51 kW (70 PS) BDJ	03.2004→08.2010		7.22477.10.0	AGR	PN	
			7.22477.11.0	AGR	PN	
2.0 TDI 103 kW (140 PS) BMM	09.2007→08.2010		7.00678.04.0*	AGR-M	EL	mit Rohrstützen with pipe socket
			↳ 7.00907.03.0	AGR	EL	
			7.00678.06.0	AGR-M	EL	
			7.08369.00.0	ATS	EL	
			7.08369.08.0	ATS	EL	
			7.08369.84.0	ATS	EL	
			7.11492.02.0	DDS		ohne Zubehör without accessories





















CADDY III Box Body/MPV (2KA, 2KH, 2CA, 2CH) 101















2.0 TDI 81 kW (110 PS) CLCA	08.2010→05.2015		7.09720.00.0	AGR-K	EL	
2.0 TDI 62 kW (85 PS) CFHE	11.2010→05.2015		7.09720.00.0	AGR-K	EL	
			7.11190.09.0	DDS		 ch. 2K-B-200 001→
2.0 TDI 125 kW (170 PS) CFJA	05.2012→05.2015		7.09720.00.0	AGR-K	EL	
			7.11190.09.0	DDS		 ch. 2K-B-200 001→
2.0 TDI 16V 103 kW (140 PS) CFHC	11.2010→05.2015		7.09720.00.0	AGR-K	EL	
			7.11190.09.0	DDS		 ch. 2K-B-200 001→
2.0 TDI 16V 103 kW (140 PS) CLCB	11.2010→05.2015		7.09720.00.0	AGR-K	EL	
2.0 TDI 16V 4motion 103 kW (140 PS) CFHC	11.2010→05.2015		7.09720.00.0	AGR-K	EL	
			7.11190.09.0	DDS		 ch. 2K-B-200 001→
2.0 TDI 4motion 81 kW (110 PS) CFHF	08.2010→05.2015		7.09720.00.0	AGR-K	EL	
			7.11190.09.0	DDS		 ch. 2K-B-200 001→
2.0 TDI 4motion 62 kW (85 PS) CFHE	12.2010→05.2015		7.09720.00.0	AGR-K	EL	
			7.11190.09.0	DDS		 ch. 2K-B-200 001→

CADDY IV Box Body/MPV (SAA, SAH) 102

1.6 TDI 55 kW (75 PS) CAYE	05.2015→11.2017		7.09720.00.0	AGR-K	EL	
			7.08369.19.0	ATS	EL	nach Katalysator Post-catalyst ohne Zubehör without accessories
			7.08369.48.0	ATS	EL	
			7.11492.00.0	DDS		
1.6 TDI 75 kW (102 PS) CAYD	05.2015→09.2020		7.09720.00.0	AGR-K	EL	
			7.08369.19.0	ATS	EL	nach Katalysator Post-catalyst ohne Zubehör without accessories
			7.08369.48.0	ATS	EL	
			7.11492.00.0	DDS		
2.0 TDI 55 kW (75 PS) CUUF	05.2015→11.2015		7.11492.03.0	DDS		ohne Zubehör without accessories
			7.07696.00.0	SRM-AK	EL	
2.0 TDI 75 kW (102 PS) CUUD	05.2015→11.2015		7.11492.03.0	DDS		ohne Zubehör without accessories
			7.07696.00.0	SRM-AK	EL	
2.0 TDI 103 kW (140 PS) CFHC, CLCB	05.2015→09.2020		7.09720.00.0	AGR-K	EL	  CFHC, CLCB:  ch. 2K-B-200 001→
2.0 TDI 110 kW (150 PS) CUUB	05.2015→11.2015		7.11492.03.0	DDS		ohne Zubehör without accessories
			7.07696.00.0	SRM-AK	EL	
2.0 TDI 81 kW (110 PS) CLCA	09.2015→09.2020		7.09720.00.0	AGR-K	EL	  ch. 2K-B-200 001→
2.0 TDI 55 kW (75 PS) DFSC, DFSF	11.2015→09.2020		7.11492.03.0	DDS		ohne Zubehör without accessories
2.0 TDI 75 kW (102 PS) DFSD	11.2015→09.2020		7.11492.03.0	DDS		ohne Zubehör without accessories
2.0 TDI 110 kW (150 PS) DFSB	11.2015→09.2020		7.11492.03.0	DDS		ohne Zubehör without accessories

V









CADDY IV Box Body/MPV (SAA, SAH)						102
2.0 TDI 4motion 81 kW (110 PS) CFHF, CLCA	05.2015→09.2020		7.09720.00.0	AGR-K	EL	
2.0 TDI 4motion 90 kW (122 PS) CUUE	05.2015→11.2015		7.11492.03.0	DDS		ohne Zubehör without accessories
			7.07696.00.0	SRM-AK	EL	
2.0 TDI 4motion 103 kW (140 PS) CFHC	05.2015→09.2020		7.09720.00.0	AGR-K	EL	  ch. 2K-B-200 001→
2.0 TDI 4motion 90 kW (122 PS) DFSE	11.2015→09.2020		7.11492.03.0	DDS		ohne Zubehör without accessories
2.0 TDI 4motion 55 kW (75 PS) DFSC	11.2015→07.2019		7.11492.03.0	DDS		ohne Zubehör without accessories
2.0 TDI 4motion 110 kW (150 PS) DFSB	11.2015→09.2020		7.11492.03.0	DDS		ohne Zubehör without accessories
CADDY MAXI (2K)						103
1.9 TDI 77 kW (105 PS) BLS	11.2007→08.2010		7.08369.00.0	ATS	EL	
			7.08369.08.0	ATS	EL	
CRAFTER 30-35 Bus (2E_)						104
2.0 TDI 80 kW (109 PS) CKTB	05.2011→12.2016		7.24809.93.0	AGR	EL	
			7.08369.64.0	ATS	EL	Baujahr bis: 11.2015 Construction year to: 11.2015
			7.08369.78.0	ATS	EL	Produktionsdatum bis: 02.11.2015 Production date to: 02.11.2015
			7.08369.93.0	ATS	EL	
			7.11492.00.0	DDS		ohne Zubehör without accessories Produktionsdatum bis: 27.05.2013 Production date to: 27.05.2013
			7.11492.03.0	DDS		ohne Zubehör without accessories Produktionsdatum ab: 27.05.2013 Production date from: 27.05.2013
2.0 TDI 100 kW (136 PS) CKTC	05.2011→12.2016		7.24809.93.0	AGR	EL	
			7.08369.64.0	ATS	EL	
			7.08369.78.0	ATS	EL	Produktionsdatum bis: 02.11.2015 Production date to: 02.11.2015
			7.08369.93.0	ATS	EL	
			7.11492.00.0	DDS		ohne Zubehör without accessories Produktionsdatum bis: 27.05.2013 Production date to: 27.05.2013
			7.11492.03.0	DDS		ohne Zubehör without accessories Produktionsdatum ab: 27.05.2013 Production date from: 27.05.2013
2.0 TDI 120 kW (163 PS) CKUB	07.2011→12.2016		7.24809.93.0	AGR	EL	
			7.08369.64.0	ATS	EL	Baujahr bis: 11.2015 Construction year to: 11.2015
			7.08369.78.0	ATS	EL	Produktionsdatum bis: 02.11.2015 Production date to: 02.11.2015
			7.08369.93.0	ATS	EL	
			7.11492.00.0	DDS		ohne Zubehör without accessories Produktionsdatum bis: 27.05.2013 Production date to: 27.05.2013





















CRAFTER 30-35 Bus (2E_)

104

			7.11492.03.0	DDS		ohne Zubehör without accessories Produktionsdatum ab: 27.05.2013 Production date from: 27.05.2013
2.0 TDI 120 kW (163 PS) CSNA	07.2011→12.2016		7.24809.93.0	AGR	EL	Produktionsdatum bis: 02.11.2015 Production date to: 02.11.2015 ohne Zubehör without accessories Produktionsdatum ab: 27.05.2013 Production date from: 27.05.2013
			7.08369.59.0	ATS	EL	
			7.08369.78.0	ATS	EL	
			7.11492.03.0	DDS		
2.0 TDI 105 kW (142 PS) CKUC	10.2011→12.2016		7.24809.93.0	AGR	EL	Produktionsdatum bis: 02.11.2015 Production date to: 02.11.2015 ohne Zubehör without accessories Produktionsdatum ab: 27.05.2013 Production date to: 27.05.2013 ohne Zubehör without accessories Produktionsdatum ab: 27.05.2013 Production date from: 27.05.2013
			7.08369.64.0	ATS	EL	
			7.08369.78.0	ATS	EL	
			7.08369.93.0	ATS	EL	
			7.11492.00.0	DDS		
2.0 TDI 84 kW (114 PS) CSLB	11.2013→12.2016		7.24809.93.0	AGR	EL	Produktionsdatum bis: 02.11.2015 Production date to: 02.11.2015 ohne Zubehör without accessories Produktionsdatum bis: 27.05.2013 Production date to: 27.05.2013
			7.08369.59.0	ATS	EL	
			7.08369.64.0	ATS	EL	
			7.08369.78.0	ATS	EL	
			7.11492.03.0	DDS		
2.0 TDI 80 kW (109 PS) CSLA	11.2015→12.2016		7.24809.93.0	AGR	EL	ohne Zubehör without accessories Produktionsdatum ab: 27.05.2013 Production date from: 27.05.2013
			7.08369.59.0	ATS	EL	
			7.11492.03.0	DDS		
2.0 TDI 4motion 120 kW (163 PS) CKUB	11.2011→12.2016		7.24809.93.0	AGR	EL	Baujahr bis: 11.2015 Construction year to: 11.2015 Produktionsdatum bis: 02.11.2015 Production date to: 02.11.2015 ohne Zubehör without accessories Produktionsdatum bis: 27.05.2013 Production date to: 27.05.2013 ohne Zubehör without accessories Produktionsdatum ab: 27.05.2013 Production date from: 27.05.2013
			7.08369.64.0	ATS	EL	
			7.08369.78.0	ATS	EL	
			7.08369.93.0	ATS	EL	
			7.11492.00.0	DDS		
2.0 TDI 4motion 120 kW (163 PS) CSNA	11.2011→12.2016		7.24809.93.0	AGR	EL	
			7.08369.59.0	ATS	EL	









CRAFTER 30-35 Bus (2E_) **104**

			7.08369.78.0	ATS	EL	Produktionsdatum bis: 02.11.2015 Production date to: 02.11.2015 ohne Zubehör without accessories Produktionsdatum ab: 27.05.2013 Production date from: 27.05.2013
			7.11492.03.0	DDS		
2.5 TDI 65 kW (88 PS) BJJ	04.2006→07.2011		7.00823.06.0	AGR	EL	
			7.08369.39.0	ATS	EL	Euro4/Euro5 Euro4/Euro5
			7.08369.58.0	ATS	EL	
			7.11492.02.0	DDS		ohne Zubehör without accessories
2.5 TDI 65 kW (88 PS) CEBA	04.2006→07.2011		7.00823.06.0	AGR	EL	
			7.08369.44.0	ATS	EL	nach Rußpartikelfilter after soot particulate filter
			7.11492.02.0	DDS		ohne Zubehör without accessories Produktionsdatum ab: 26.06.2006 Production date from: 26.06.2006
2.5 TDI 80 kW (109 PS) BJK	04.2006→05.2013		7.00823.06.0	AGR	EL	
			7.08369.39.0	ATS	EL	Euro4/Euro5 Euro4/Euro5
			7.08369.58.0	ATS	EL	
			7.11492.02.0	DDS		ohne Zubehör without accessories
2.5 TDI 80 kW (109 PS) CEBB	04.2006→05.2013		7.00823.06.0	AGR	EL	
			7.08369.44.0	ATS	EL	nach Rußpartikelfilter after soot particulate filter
			7.11492.02.0	DDS		ohne Zubehör without accessories Produktionsdatum ab: 26.06.2006 Production date from: 26.06.2006
2.5 TDI 100 kW (136 PS) BJL	04.2006→05.2013		7.00823.06.0	AGR	EL	
			7.08369.39.0	ATS	EL	Euro4/Euro5 Euro4/Euro5
			7.08369.58.0	ATS	EL	
			7.11492.02.0	DDS		ohne Zubehör without accessories
2.5 TDI 100 kW (136 PS) CECA	04.2006→05.2013		7.00823.06.0	AGR	EL	
			7.08369.44.0	ATS	EL	nach Rußpartikelfilter after soot particulate filter
			7.11492.02.0	DDS		ohne Zubehör without accessories Produktionsdatum ab: 26.06.2006 Production date from: 26.06.2006
2.5 TDI 120 kW (163 PS) BJM	04.2006→07.2011		7.00823.06.0	AGR	EL	
			7.08369.39.0	ATS	EL	Euro4/Euro5 Euro4/Euro5
			7.08369.58.0	ATS	EL	
2.5 TDI 120 kW (163 PS) CECB	04.2006→07.2011		7.00823.06.0	AGR	EL	
			7.08369.44.0	ATS	EL	nach Rußpartikelfilter after soot particulate filter
			7.11492.02.0	DDS		ohne Zubehör without accessories



















CRAFTER 30-50 Platform/Chassis (2F_) 105

2.0 TDI 80 kW (109 PS) CKTB	05.2011→12.2016		7.24809.93.0	AGR	EL	<input type="checkbox"/> Baujahr bis: 11.2015 Construction year to: 11.2015 Produktionsdatum bis: 02.11.2015 Production date to: 02.11.2015 ohne Zubehör without accessories Produktionsdatum bis: 27.05.2013 Production date to: 27.05.2013 ohne Zubehör without accessories Produktionsdatum ab: 27.05.2013 Production date from: 27.05.2013
			7.08369.64.0	ATS	EL	
			7.08369.78.0	ATS	EL	
			7.08369.93.0	ATS	EL	
			7.11492.00.0	DDS	EL	
2.0 TDI 80 kW (109 PS) CSLA	05.2011→12.2016		7.24809.93.0	AGR	EL	<input type="checkbox"/> ohne Zubehör without accessories Produktionsdatum ab: 27.05.2013 Production date from: 27.05.2013
			7.11492.03.0	DDS		
2.0 TDI 100 kW (136 PS) CKTC	05.2011→12.2016		7.24809.93.0	AGR	EL	<input type="checkbox"/> Produktionsdatum bis: 02.11.2015 Production date to: 02.11.2015 ohne Zubehör without accessories Produktionsdatum bis: 27.05.2013 Production date to: 27.05.2013 ohne Zubehör without accessories Produktionsdatum ab: 27.05.2013 Production date from: 27.05.2013
			7.08369.64.0	ATS	EL	
			7.08369.78.0	ATS	EL	
			7.08369.93.0	ATS	EL	
			7.11492.00.0	DDS		
2.0 TDI 105 kW (142 PS) CKUC	10.2011→12.2016		7.24809.93.0	AGR	EL	<input type="checkbox"/> Produktionsdatum bis: 02.11.2015 Production date to: 02.11.2015
			7.08369.64.0	ATS	EL	
2.0 TDI 120 kW (163 PS) CKUB	07.2011→12.2016		7.24809.93.0	AGR	EL	<input type="checkbox"/> Baujahr bis: 11.2015 Construction year to: 11.2015 Produktionsdatum bis: 02.11.2015 Production date to: 02.11.2015 ohne Zubehör without accessories Produktionsdatum bis: 27.05.2013 Production date to: 27.05.2013 ohne Zubehör without accessories Produktionsdatum ab: 27.05.2013 Production date from: 27.05.2013
			7.08369.64.0	ATS	EL	
			7.08369.78.0	ATS	EL	
			7.08369.93.0	ATS	EL	
			7.11492.00.0	DDS		
2.0 TDI 120 kW (163 PS) CSNA	07.2011→12.2016		7.24809.93.0	AGR	EL	<input type="checkbox"/> Produktionsdatum bis: 02.11.2015 Production date to: 02.11.2015 ohne Zubehör without accessories Produktionsdatum ab: 27.05.2013 Production date from: 27.05.2013
			7.08369.78.0	ATS	EL	
			7.11492.03.0	DDS		

V













CRAFTER 30-50 Platform/Chassis (2F_) **105**

			7.11492.00.0	DDS		ohne Zubehör without accessories Produktionsdatum bis: 27.05.2013 Production date to: 27.05.2013
			7.11492.03.0	DDS		ohne Zubehör without accessories Produktionsdatum ab: 27.05.2013 Production date from: 27.05.2013
2.0 TDI 84 kW (114 PS) CSLB	11.2013→12.2016		7.24809.93.0	AGR	EL	
			7.08369.64.0	ATS	EL	
			7.08369.78.0	ATS	EL	Produktionsdatum bis: 02.11.2015 Production date to: 02.11.2015
			7.11492.03.0	DDS		ohne Zubehör without accessories Produktionsdatum bis: 27.05.2013 Production date to: 27.05.2013
2.0 TDI 103 kW (140 PS) CSLC	11.2015→12.2016		7.24809.93.0	AGR	EL	
			7.11492.03.0	DDS		ohne Zubehör without accessories Produktionsdatum ab: 27.05.2013 Production date from: 27.05.2013
2.0 TDI 4motion 120 kW (163 PS) CKUB	11.2011→12.2016		7.24809.93.0	AGR	EL	
			7.08369.64.0	ATS	EL	Baujahr bis: 11.2015 Construction year to: 11.2015
			7.08369.78.0	ATS	EL	Produktionsdatum bis: 02.11.2015 Production date to: 02.11.2015
			7.08369.93.0	ATS	EL	
			7.11492.00.0	DDS		ohne Zubehör without accessories Produktionsdatum bis: 27.05.2013 Production date to: 27.05.2013
			7.11492.03.0	DDS		ohne Zubehör without accessories Produktionsdatum ab: 27.05.2013 Production date from: 27.05.2013
2.0 TDI 4motion 120 kW (163 PS) CSNA	11.2011→12.2016		7.24809.93.0	AGR	EL	
			7.08369.78.0	ATS	EL	Produktionsdatum bis: 02.11.2015 Production date to: 02.11.2015
			7.11492.03.0	DDS		ohne Zubehör without accessories Produktionsdatum ab: 27.05.2013 Production date from: 27.05.2013
2.5 TDI 65 kW (88 PS) BJJ	04.2006→07.2011		7.00823.06.0	AGR	EL	
			7.08369.39.0	ATS	EL	Euro4/Euro5 Euro4/Euro5
			7.08369.58.0	ATS	EL	
			7.11492.02.0	DDS		ohne Zubehör without accessories
2.5 TDI 65 kW (88 PS) CEBA	04.2006→07.2011		7.00823.06.0	AGR	EL	
			7.08369.44.0	ATS	EL	nach Rußpartikelfilter after soot particulate filter
			7.11492.02.0	DDS		ohne Zubehör without accessories Produktionsdatum ab: 26.06.2006 Production date from: 26.06.2006
2.5 TDI 80 kW (109 PS) BJK	04.2006→05.2013		7.00823.06.0	AGR	EL	





CRAFTER 30-50 Platform/Chassis (2F_) **105**





			7.08369.39.0	ATS	EL	Euro4/Euro5 Euro4/Euro5
			7.08369.58.0	ATS	EL	
			7.11492.02.0	DDS		ohne Zubehör without accessories
2.5 TDI 80 kW (109 PS) CEBB	04.2006→05.2013		7.00823.06.0	AGR	EL	
			7.08369.44.0	ATS	EL	nach Rußpartikelfilter after soot particulate filter
			7.11492.02.0	DDS		ohne Zubehör without accessories Produktionsdatum ab: 26.06.2006 Production date from: 26.06.2006
2.5 TDI 100 kW (136 PS) BJL	04.2006→05.2013		7.00823.06.0	AGR	EL	
			7.08369.39.0	ATS	EL	Euro4/Euro5 Euro4/Euro5
			7.08369.58.0	ATS	EL	
			7.11492.02.0	DDS		ohne Zubehör without accessories
2.5 TDI 100 kW (136 PS) CECA	04.2006→05.2013		7.00823.06.0	AGR	EL	
			7.08369.44.0	ATS	EL	nach Rußpartikelfilter after soot particulate filter
			7.11492.02.0	DDS		ohne Zubehör without accessories Produktionsdatum ab: 26.06.2006 Production date from: 26.06.2006
2.5 TDI 120 kW (163 PS) BJM	04.2006→07.2011		7.00823.06.0	AGR	EL	
			7.08369.39.0	ATS	EL	Euro4/Euro5 Euro4/Euro5
			7.08369.58.0	ATS	EL	
2.5 TDI 120 kW (163 PS) CECB	04.2006→07.2011		7.00823.06.0	AGR	EL	
			7.08369.44.0	ATS	EL	nach Rußpartikelfilter after soot particulate filter
			7.11492.02.0	DDS		ohne Zubehör without accessories Produktionsdatum ab: 26.06.2006 Production date from: 26.06.2006

CRAFTER 30-50 Van (2E_) **106**

2.0 TDI 80 kW (109 PS) CKTB	05.2011→12.2016		7.24809.93.0	AGR	EL	
			7.08369.64.0	ATS	EL	Baujahr bis: 11.2015 Construction year to: 11.2015
			7.08369.78.0	ATS	EL	Produktionsdatum bis: 02.11.2015 Production date to: 02.11.2015
			7.08369.93.0	ATS	EL	
			7.11492.00.0	DDS		ohne Zubehör without accessories Produktionsdatum bis: 27.05.2013 Production date to: 27.05.2013
			7.11492.03.0	DDS		ohne Zubehör without accessories Produktionsdatum ab: 27.05.2013 Production date from: 27.05.2013
2.0 TDI 80 kW (109 PS) CSLA	05.2011→12.2016		7.08369.59.0	ATS	EL	
			7.11492.03.0	DDS		ohne Zubehör without accessories Produktionsdatum ab: 27.05.2013 Production date from: 27.05.2013











CRAFTER 30-50 Van (2E_) **106**

2.0 TDI 100 kW (136 PS) CKTC	05.2011→12.2016		7.24809.93.0	AGR	EL	<input type="radio"/> Produktionsdatum bis: 02.11.2015 Production date to: 02.11.2015 ohne Zubehör without accessories Produktionsdatum bis: 27.05.2013 Production date to: 27.05.2013 ohne Zubehör without accessories Produktionsdatum ab: 27.05.2013 Production date from: 27.05.2013
			7.08369.64.0	ATS	EL	
			7.08369.78.0	ATS	EL	
			7.08369.93.0	ATS	EL	
			7.11492.00.0	DDS		
2.0 TDI 120 kW (163 PS) CKUB	07.2011→12.2016		7.24809.93.0	AGR	EL	<input type="radio"/> Baujahr bis: 11.2015 Construction year to: 11.2015 Produktionsdatum bis: 02.11.2015 Production date to: 02.11.2015 ohne Zubehör without accessories Produktionsdatum bis: 27.05.2013 Production date to: 27.05.2013 ohne Zubehör without accessories Produktionsdatum ab: 27.05.2013 Production date from: 27.05.2013
			7.08369.64.0	ATS	EL	
			7.08369.78.0	ATS	EL	
			7.08369.93.0	ATS	EL	
			7.11492.00.0	DDS		
2.0 TDI 120 kW (163 PS) CSNA	07.2011→12.2016		7.24809.93.0	AGR	EL	<input type="radio"/> Produktionsdatum bis: 02.11.2015 Production date to: 02.11.2015 ohne Zubehör without accessories Produktionsdatum ab: 27.05.2013 Production date from: 27.05.2013
			7.08369.59.0	ATS	EL	
			7.08369.78.0	ATS	EL	
			7.11492.03.0	DDS		
2.0 TDI 105 kW (142 PS) CKUC	10.2011→12.2016		7.24809.93.0	AGR	EL	<input type="radio"/> Produktionsdatum bis: 02.11.2015 Production date to: 02.11.2015 ohne Zubehör without accessories Produktionsdatum bis: 27.05.2013 Production date to: 27.05.2013 ohne Zubehör without accessories Produktionsdatum ab: 27.05.2013 Production date from: 27.05.2013
			7.08369.64.0	ATS	EL	
			7.08369.78.0	ATS	EL	
			7.08369.93.0	ATS	EL	
			7.11492.00.0	DDS		
2.0 TDI 84 kW (114 PS) CSLB	11.2013→12.2016		7.24809.93.0	AGR	EL	<input type="radio"/> Produktionsdatum bis: 02.11.2015 Production date to: 02.11.2015 ohne Zubehör without accessories Produktionsdatum bis: 27.05.2013 Production date to: 27.05.2013
			7.08369.59.0	ATS	EL	
			7.08369.64.0	ATS	EL	
			7.08369.78.0	ATS	EL	
			7.11492.03.0	DDS		





CRAFTER 30-50 Van (2E_) **106**

2.0 TDI 103 kW (140 PS) CSLC	11.2015→12.2016		7.24809.93.0	AGR	EL	<input type="checkbox"/> ohne Zubehör without accessories
			7.08369.59.0	ATS	EL	
			7.11492.03.0	DDS		
2.0 TDI 4motion 120 kW (163 PS) CKUB	07.2011→12.2016		7.24809.93.0	AGR	EL	<input type="checkbox"/> Baujahr bis: 11.2015 Construction year to: 11.2015 Produktionsdatum bis: 02.11.2015 Production date to: 02.11.2015 ohne Zubehör without accessories Produktionsdatum bis: 27.05.2013 Production date to: 27.05.2013 ohne Zubehör without accessories Produktionsdatum ab: 27.05.2013 Production date from: 27.05.2013
			7.08369.64.0	ATS	EL	
			7.08369.78.0	ATS	EL	
			7.08369.93.0	ATS	EL	
			7.11492.00.0	DDS		
2.0 TDI 4motion 120 kW (163 PS) CSNA	11.2013→12.2016		7.24809.93.0	AGR	EL	<input type="checkbox"/> Produktionsdatum bis: 02.11.2015 Production date to: 02.11.2015 ohne Zubehör without accessories Produktionsdatum ab: 27.05.2013 Production date from: 27.05.2013
			7.08369.59.0	ATS	EL	
			7.08369.78.0	ATS	EL	
			7.11492.03.0	DDS		
2.5 TDI 65 kW (88 PS) BJJ	04.2006→07.2011		7.00823.06.0	AGR	EL	<input type="checkbox"/> Euro4/Euro5 Euro4/Euro5 ohne Zubehör without accessories Produktionsdatum ab: 26.06.2006 Production date from: 26.06.2006
			7.08369.39.0	ATS	EL	
			7.11492.02.0	DDS		
2.5 TDI 65 kW (88 PS) CEBA	04.2006→07.2011		7.00823.06.0	AGR	EL	<input type="checkbox"/> nach Rußpartikelfilter after soot particulate filter
			7.08369.44.0	ATS	EL	
2.5 TDI 80 kW (109 PS) BJK	04.2006→05.2013		7.00823.06.0	AGR	EL	<input type="checkbox"/> Euro4/Euro5 Euro4/Euro5 ohne Zubehör without accessories
			7.08369.39.0	ATS	EL	
			7.08369.58.0	ATS	EL	
			7.11492.02.0	DDS		
2.5 TDI 80 kW (109 PS) CEBB	04.2006→05.2013		7.00823.06.0	AGR	EL	<input type="checkbox"/> nach Rußpartikelfilter after soot particulate filter ohne Zubehör without accessories Produktionsdatum ab: 26.06.2006 Production date from: 26.06.2006
			7.08369.44.0	ATS	EL	
			7.11492.02.0	DDS		
2.5 TDI 100 kW (136 PS) BJL	04.2006→05.2013		7.00823.06.0	AGR	EL	<input type="checkbox"/> Euro4/Euro5 Euro4/Euro5
			7.08369.39.0	ATS	EL	
			7.08369.58.0	ATS	EL	



CRAFTER 30-50 Van (2E_) 106

			7.11492.02.0	DDS		ohne Zubehör without accessories Produktionsdatum ab: 26.06.2006 Production date from: 26.06.2006
2.5 TDI 100 kW (136 PS) CECA	04.2006→05.2013		7.00823.06.0	AGR	EL	
			7.08369.44.0	ATS	EL	nach Rußpartikelfilter after soot particulate filter
2.5 TDI 120 kW (163 PS) BJM	04.2006→07.2011		7.00823.06.0	AGR	EL	
			7.08369.39.0	ATS	EL	Euro4/Euro5 Euro4/Euro5
			7.08369.58.0	ATS	EL	
2.5 TDI 120 kW (163 PS) CECB	04.2006→07.2011		7.00823.06.0	AGR	EL	
			7.08369.44.0	ATS	EL	nach Rußpartikelfilter after soot particulate filter
			7.11492.02.0	DDS		ohne Zubehör without accessories Produktionsdatum ab: 26.06.2006 Production date from: 26.06.2006



















CRAFTER Bus (SYI, SYJ) 107

2.0 TDI 103 kW (140 PS) DAUA	09.2016→		7.04999.35.0*	AGR-K	EL	ch. SY-H-000 001→
			7.04999.34.0	AGR-M	EL	
			7.11020.22.0	ATS	EL	DAUA: ch. SZ-H-000 001→ für Hersteller-Abgasnorm: Euro 6 Plus for manufacturer exhaust norm: Euro 6 Plus
			7.11492.05.0	DDS		DAUA: ch. SY-H-000 001→ für Hersteller-Abgasnorm: Euro 6 Plus for manufacturer exhaust norm: Euro 6 Plus ohne Zubehör without accessories DAUA: ch. SZ-H-000 001→ DAUA: ch. SY-H-000 001→
2.0 TDI 130 kW (177 PS) DAVA	09.2016→		7.11020.22.0	ATS	EL	ch. SY-H-000 001→ für Hersteller-Abgasnorm: Euro 6 Plus for manufacturer exhaust norm: Euro 6 Plus
			7.11492.05.0	DDS		ohne Zubehör without accessories DAVA: ch. SZ-H-000 001→ DAVA: ch. SY-H-000 001→
2.0 TDI 75 kW (102 PS) DAUB	10.2016→		7.04999.35.0*	AGR-K	EL	ch. SY-H-000 01→
			7.04999.34.0	AGR-M	EL	
			7.11020.22.0	ATS	EL	DAUB: ch. SZ-H-000 001→ für Hersteller-Abgasnorm: Euro 6 Plus for manufacturer exhaust norm: Euro 6 Plus
			7.11492.05.0	DDS		DAUB: ch. SY-H-000 001→ für Hersteller-Abgasnorm: Euro 6 Plus for manufacturer exhaust norm: Euro 6 Plus ohne Zubehör without accessories DAUB: ch. SZ-H-000 001 → DAUB: ch. SY-H-000 001 →





























CRAFTER Bus (SYI, SYJ) 107

<p>2.0 TDI 4motion 130 kW (177 PS) DAVA</p>	<p>03.2017→</p>	<p> 7.11020.22.0 7.11492.05.0</p>	<p>ATS DDS</p>	<p>EL  DAVA:  ch. SY-H-000 001→ für Hersteller-Abgasnorm: Euro 6 Plus for manufacturer exhaust norm: Euro 6 Plus  DAVA:  ch. SZ-H-000 001→ für Hersteller-Abgasnorm: Euro 6 Plus for manufacturer exhaust norm: Euro 6 Plus ohne Zubehör without accessories  DAVA:  ch. SZ-H-000 001→  DAVA:  ch. SY-H-000 001→</p>
<p>2.0 TDI 4motion 103 kW (140 PS) DAUA</p>	<p>04.2017→</p>	<p> 7.04999.35.0* ↳ 7.04999.34.0 7.11020.22.0 7.11492.05.0</p>	<p>AGR-K AGR-M ATS DDS</p>	<p>EL  ch. SY-H-000 001→ EL EL  DAUA:  ch. SY-H-000 001→ für Hersteller-Abgasnorm: Euro 6 Plus for manufacturer exhaust norm: Euro 6 Plus  DAUA:  ch. SZ-H-000 001→ für Hersteller-Abgasnorm: Euro 6 Plus for manufacturer exhaust norm: Euro 6 Plus ohne Zubehör without accessories  DAUA:  ch. SZ-H-000 001→  DAUA:  ch. SY-H-000 001→</p>

CRAFTER Platform/Chassis (SZ_) 108

<p>2.0 TDI 75 kW (102 PS) DAUB</p>	<p>11.2016→</p>	<p> 7.04999.35.0* ↳ 7.04999.34.0 7.11020.22.0 7.11492.05.0</p>	<p>AGR-K AGR-M ATS DDS</p>	<p>EL  ch. SZ-H-000 01→ EL EL  DAUB:  ch. SY-H-000 001→ für Hersteller-Abgasnorm: Euro 6 Plus for manufacturer exhaust norm: Euro 6 Plus  DAUB:  ch. SZ-H-000 001→ für Hersteller-Abgasnorm: Euro 6 Plus for manufacturer exhaust norm: Euro 6 Plus ohne Zubehör without accessories  DAUB:  ch. SZ-H-000 001→  DAUB:  ch. SY-H-000 001→</p>
<p>2.0 TDI 103 kW (140 PS) DAUA</p>	<p>11.2016→</p>	<p> 7.04999.35.0* ↳ 7.04999.34.0 7.11020.22.0 7.11492.05.0</p>	<p>AGR-K AGR-M ATS DDS</p>	<p>EL  ch. SZ-H-000 01→ EL EL  DAUA:  ch. SZ-H-000 001 → für Hersteller-Abgasnorm: Euro 6 Plus for manufacturer exhaust norm: Euro 6 Plus  DAUA:  ch. SY-H-000 001 → für Hersteller-Abgasnorm: Euro 6 Plus for manufacturer exhaust norm: Euro 6 Plus ohne Zubehör without accessories  DAUA:  ch. SZ-H-000 001→  DAUA:  ch. SY-H-000 001→</p>
<p>2.0 TDI 130 kW (177 PS) DAVA</p>	<p>11.2016→</p>	<p> 7.11492.05.0</p>	<p>DDS</p>	<p>ohne Zubehör without accessories  DAVA:  ch. SZ-H-000 001→  DAVA:  ch. SY-H-000 001→</p>

V



CRAFTER Platform/Chassis (SZ_) 108

2.0 TDI 4motion 130 kW (177 PS) DAVA	03.2017→		7.11020.22.0 7.11492.05.0	ATS DDS	EL EL	<p> DAVA: ch. SZ-H-000 001→ für Hersteller-Abgasnorm: Euro 6 Plus for manufacturer exhaust norm: Euro 6 Plus</p> <p> DAVA: ch. SY-H-000 001→ für Hersteller-Abgasnorm: Euro 6 Plus for manufacturer exhaust norm: Euro 6 Plus</p> <p>ohne Zubehör without accessories</p> <p> DAVA: ch. SZ-H-000 001→</p> <p> DAVA: ch. SY-H-000 001→</p>
2.0 TDI 4motion 103 kW (140 PS) DAUA	11.2017→		7.04999.35.0* ↳7.04999.34.0 7.11020.22.0 7.11492.05.0	AGR-K AGR-M ATS DDS	EL EL EL	<p> ch. SZ-H-000 01→</p> <p> DAUA: ch. SY-H-000 001→ für Hersteller-Abgasnorm: Euro 6 Plus for manufacturer exhaust norm: Euro 6 Plus</p> <p> DAUA: ch. SZ-H-000 001→ für Hersteller-Abgasnorm: Euro 6 Plus for manufacturer exhaust norm: Euro 6 Plus</p> <p>ohne Zubehör without accessories</p> <p> DAUA: ch. SZ-H-000 001→</p> <p> DAUA: ch. SY-H-000 001→</p>
2.0 TDI RWD 80 kW (109 PS) DASC	11.2016→		7.04999.35.0* ↳7.04999.34.0	AGR-K AGR-M	EL EL	<p> ch. SY-H-000 001→</p>
2.0 TDI RWD 130 kW (177 PS) DAWA	07.2017→		7.11492.05.0	DDS		<p>ohne Zubehör without accessories</p> <p> DAWA: ch. SZ-H-000 001→</p> <p> DAWA: ch. SY-H-000 001→</p>
2.0 TDI RWD 90 kW (122 PS) DASA	08.2017→		7.04999.35.0* ↳7.04999.34.0 7.11492.05.0	AGR-K AGR-M DDS	EL EL	<p> ch. SY-H-000 001→</p> <p>ohne Zubehör without accessories</p> <p> DASA: ch. SZ-H-000 001→</p> <p> DASA: ch. SY-H-000 001→</p>
2.0 TDI RWD 103 kW (140 PS) DASB	11.2017→		7.04999.35.0* ↳7.04999.34.0	AGR-K AGR-M	EL EL	<p> ch. SZ-H-000 01→</p>























CRAFTER Van (SY_, SX_) 109

2.0 TDI 103 kW (140 PS) DAUA	09.2016→		7.04999.35.0* ↳7.04999.34.0 7.11020.22.0 7.11492.05.0	AGR-K AGR-M ATS DDS	EL EL EL	<p> ch. SY-H-000 01→</p> <p> DAUA: ch. SZ-H-000 001→ für Hersteller-Abgasnorm: Euro 6 Plus for manufacturer exhaust norm: Euro 6 Plus</p> <p> DAUA: ch. SY-H-000 001→ für Hersteller-Abgasnorm: Euro 6 Plus for manufacturer exhaust norm: Euro 6 Plus</p> <p>ohne Zubehör without accessories</p> <p> DAUA: ch. SY-H-000 001→</p> <p> DAUA: ch. SZ-H-000 001→</p>
---------------------------------	----------	--	--	--------------------------------------	--------------------	--











CRAFTER Van (SY_, SX_) 109

<p>2.0 TDI 130 kW (177 PS) DAVA</p>	<p>09.2016→</p>	<p> 7.11020.22.0 7.11492.05.0</p>	<p>ATS DDS</p>	<p>EL  DAVA:  ch. SY-H-000 001→ für Hersteller-Abgasnorm: Euro 6 Plus for manufacturer exhaust norm: Euro 6 Plus  DAVA:  ch. SZ-H-000 001→ für Hersteller-Abgasnorm: Euro 6 Plus for manufacturer exhaust norm: Euro 6 Plus ohne Zubehör without accessories  DAVA:  ch. SZ-H-000 001→  DAVA:  ch. SY-H-000 001→</p>
<p>2.0 TDI 75 kW (102 PS) DAUB</p>	<p>10.2016→</p>	<p> 7.04999.35.0* ↳ 7.04999.34.0 7.11020.22.0 7.11492.05.0</p>	<p>AGR-K AGR-M ATS DDS</p>	<p>EL  ch. SY-H-000 01→ EL  DAUB: für Hersteller-Abgasnorm: Euro 6 Plus for manufacturer exhaust norm: Euro 6 Plus  DAUB:  ch. SZ-H-000 001→ für Hersteller-Abgasnorm: Euro 6 Plus for manufacturer exhaust norm: Euro 6 Plus ohne Zubehör without accessories  DAUB:  ch. SZ-H-000 001→  DAUB:  ch. SY-H-000 001→</p>
<p>2.0 TDI 4motion 130 kW (177 PS) DAVA</p>	<p>03.2017→</p>	<p> 7.11020.22.0 7.11492.05.0</p>	<p>ATS DDS</p>	<p>EL  DAVA:  ch. SZ-H-000 001→ für Hersteller-Abgasnorm: Euro 6 Plus for manufacturer exhaust norm: Euro 6 Plus  DAVA:  ch. SY-H-000 001→ für Hersteller-Abgasnorm: Euro 6 Plus for manufacturer exhaust norm: Euro 6 Plus ohne Zubehör without accessories  DAVA:  ch. SZ-H-000 001→  DAVA:  ch. SY-H-000 001→</p>
<p>2.0 TDI 4motion 103 kW (140 PS) DAUA</p>	<p>04.2017→</p>	<p> 7.04999.35.0* ↳ 7.04999.34.0 7.11020.22.0 7.11492.05.0</p>	<p>AGR-K AGR-M ATS DDS</p>	<p>EL  ch. SY-H-000 01→ EL  DAUA:  ch. SY-H-000 001→ für Hersteller-Abgasnorm: Euro 6 Plus for manufacturer exhaust norm: Euro 6 Plus  DAUA:  ch. SZ-H-000 001→ für Hersteller-Abgasnorm: Euro 6 Plus for manufacturer exhaust norm: Euro 6 Plus ohne Zubehör without accessories  DAUA:  ch. SZ-H-000 001→  DAUA:  ch. SY-H-000 001→</p>
<p>2.0 TDI RWD 130 kW (177 PS) DAWA</p>	<p>05.2017→</p>	<p> 7.11492.05.0</p>	<p>DDS</p>	<p>ohne Zubehör without accessories  DAWA:  ch. SZ-H-000 001→  DAWA:  ch. SYZ-H-000 001→</p>
<p>2.0 TDI RWD 80 kW (109 PS) DASC</p>	<p>05.2017→</p>	<p> 7.04999.35.0* ↳ 7.04999.34.0 7.11492.05.0</p>	<p>AGR-K AGR-M DDS</p>	<p>EL  ch. SY-H-000 001→ EL ohne Zubehör without accessories  ch. SZ-H-000 001→</p>
<p>2.0 TDI RWD 90 kW (122 PS) DASA</p>	<p>08.2017→</p>	<p> 7.04999.35.0*</p>	<p>AGR-K</p>	<p>EL  ch. SY-H-000 001→</p>









CRAFTER Van (SY_, SX_) 109

			↳ 7.04999.34.0 7.11492.05.0	AGR-M DDS	EL	ohne Zubehör without accessories für OE-Nummer: SY-H-000 001, SZ-H-000 001 for OE number: SY-H-000 001, SZ-H-000 001
2.0 TDI RWD 103 kW (140 PS) DASB	10.2017→		7.04999.35.0*	AGR-K	EL	 ch. SY-H-000 01→
			↳ 7.04999.34.0 7.11492.05.0	AGR-M DDS	EL	ohne Zubehör without accessories  DASB:  ch. SZ-H-000 001→  DASB:  ch. SY-H-000 001→











FOX Van (5Z1) 110

1.2 44 kW (60 PS) CHFA	09.2010→12.2011		7.05271.05.0	LS	700 mm	vor Katalysator in front of the catalyst
----------------------------------	-----------------	---	---------------------	----	--------	---





GOLF IV Van (1J1) 111

1.9 TDI 81 kW (110 PS) AHF	10.1997→05.2004		7.24809.17.0	AGR	PN	
1.9 TDI 66 kW (90 PS) AGR	05.2000→09.2002		7.24809.17.0	AGR	PN	
1.9 TDI 96 kW (130 PS) ASZ	04.2001→05.2004		7.24809.26.0	AGR	PN	

GOLF PLUS Van (521) 112







1.4 TSi 90 kW (122 PS) CAXA	01.2009→08.2014		7.05271.18.0	LS	525 mm	
1.6 TDi 66 kW (90 PS) CAYB	02.2009→08.2014		7.09720.00.0	AGR-K	EL	
			7.08369.01.0	ATS	EL	Fahrgestellnummer ab: 1K-9-900 001 Vehicle Identification Number from: 1K-9-900 001
			7.08369.04.0	ATS	EL	Fahrgestellnummer ab: 1K-9-900 001 Vehicle Identification Number from: 1K-9-900 001
			7.11492.00.0	DDS	EL	ohne Zubehör without accessories  ch. 1K-9-900 001→
1.6 TDi 77 kW (105 PS) CAYC	02.2009→08.2014		7.09720.00.0	AGR-K	EL	
			7.08369.01.0	ATS	EL	Fahrgestellnummer ab: 1K-9-900 001 Vehicle Identification Number from: 1K-9-900 001
			7.08369.04.0	ATS	EL	Fahrgestellnummer ab: 1K-9-900 001 Vehicle Identification Number from: 1K-9-900 001
			7.11492.00.0	DDS	EL	ohne Zubehör without accessories  ch. 1K-9-900 001→
2.0 TDi 103 kW (140 PS) CFHC	11.2009→08.2014		7.09720.00.0	AGR-K	EL	
			7.11190.09.0	DDS	EL	 ch. 1K-9-900 001→

GOLF VAN IV Variant (1J5) 113









1.4 55 kW (75 PS) AXP	05.2000→06.2006		7.22785.17.0	AGR	EL	 →04.2001,  ch. 1J-W-000 001→
			7.05271.24.0	LS	1500 mm	vor Katalysator in front of the catalyst
1.4 55 kW (75 PS) BCA	05.2000→06.2006		7.05271.24.0	LS	1500 mm	vor Katalysator in front of the catalyst







GOLF VAN IV Variant (1J5) 113

1.6 77 kW (105 PS) AUS, AZD	05.2000→06.2006	 7.22785.17.0	AGR	EL	 AUS, AZD: →04.2001,  ch. 1J-W-000 001→
1.9 TDI 66-67 kW (90-91 PS) AGR, ALH	05.1999→05.2006	 7.24809.17.0	AGR	PN	
1.9 TDI 81 kW (110 PS) AHF, ASV	05.1999→05.2006	 7.24809.17.0	AGR	PN	
1.9 TDI 85 kW (115 PS) AJM	05.1999→04.2002	 7.24809.17.0	AGR	PN	
1.9 TDI 74 kW (101 PS) ATD	02.2000→06.2006	 7.24809.17.0	AGR	PN	
1.9 TDI 74 kW (101 PS) AXR	02.2000→06.2006	 7.24809.16.0	AGR	PN	

GOLF VAN VI Variant (AJ5) 114

1.4 TSi 90 kW (122 PS) CAXA	07.2009→05.2014	 7.05271.18.0	LS	525 mm	Schaltgetriebe 6 Gang 6-Speed Manual Transmission Euro 4 Euro 4
1.6 TDi 66 kW (90 PS) CAYB	12.2009→10.2012	 7.09720.00.0	AGR-K	EL	
		7.08369.01.0	ATS	EL	Fahrgestellnummer ab: 1K-9-400 001 Vehicle Identification Number from: 1K-9-400 001
		7.08369.04.0	ATS	EL	Fahrgestellnummer ab: 1K-9-900 001 Vehicle Identification Number from: 1K-9-900 001
1.6 TDi BlueMotion 77 kW (105 PS) CAYC	07.2009→05.2014	 7.09720.00.0	AGR-K	EL	
		7.08369.01.0	ATS	EL	Fahrgestellnummer ab: 1K-9-400 001 Vehicle Identification Number from: 1K-9-400 001
		7.08369.04.0	ATS	EL	Fahrgestellnummer ab: 1K-9-400 001 Vehicle Identification Number from: 1K-9-400 001
2.0 TDi 103 kW (140 PS) CBDB	07.2009→05.2014	 7.08369.01.0	ATS	EL	Fahrgestellnummer ab: 1K-9-400 001 Vehicle Identification Number from: 1K-9-400 001
		7.08369.04.0	ATS	EL	Fahrgestellnummer ab: 1K-9-250 001 Vehicle Identification Number from: 1K-9-250 001
		7.11492.02.0	DDS		ohne Zubehör without accessories
2.0 TDi 103 kW (140 PS) CFHC	07.2009→05.2014	 7.09720.00.0	AGR-K	EL	
		7.11190.09.0	DDS		

GOLF VAN VII Variant (BA5) 115

1.6 TDi BlueMotion 66 kW (90 PS) CLHB	05.2013→03.2017	 7.10334.02.0	AGR	EL	
		7.08369.82.0	ATS	EL	 ch. AU-D-000 001→ ab Euro 5 From Euro 5 Produktionsdatum bis: 03.11.2014 Production date to: 03.11.2014
		7.08369.79.0	ATS	EL	Produktionsdatum bis: 03.11.2014 Production date to: 03.11.2014
		7.11492.03.0	DDS		ohne Zubehör without accessories  ch. AU-E-500 001→































GOLF VAN VII Variant (BA5) 115

1.6 TDi BlueMotion 66 kW (90 PS) CRKA	05.2013→03.2017		7.10334.02.0	AGR	EL	
			7.08369.79.0	ATS	EL	ch. AU-D-000 001→
			7.08369.95.0	ATS	EL	ch. AU-D-000 001→ Euro 6 Produktionsdatum ab: 03.11.2014 Production date from: 03.11.2014
			7.08369.82.0	ATS	EL	CRKA: ch. AU-D-000 001→ Euro 5, Euro 6 Produktionsdatum bis: 03.11.2014 Production date to: 03.11.2014 CRKA: ch. AU-E-500 001→
			7.11020.18.0	ATS	EL	vor Katalysator in front of the catalyst
			7.11492.03.0	DDS		ohne Zubehör without accessories ch. AU-D-000 001→
1.6 TDi BlueMotion 66 kW (90 PS) CXXA	05.2013→03.2017		7.10334.02.0	AGR	EL	
			7.08369.95.0	ATS	EL	ch. AU-D-000 001→ Euro 6 Produktionsdatum ab: 03.11.2014 Production date from: 03.11.2014
			7.11020.17.0	ATS	EL	ch. AU-E-500 001→ vor Katalysator in front of the catalyst
			7.11492.03.0	DDS		ohne Zubehör without accessories ch. AU-E-500 001→ Produktionsdatum ab: 03.11.2014 Production date from: 03.11.2014
1.6 TDi BlueMotion 77 kW (105 PS) CLHA	05.2013→03.2017		7.03608.16.0	AK	EL	ch. AU-D-000 001→
			7.08369.79.0	ATS	EL	ch. AU-D-000 001→
			7.08369.82.0	ATS	EL	ch. AU-E-500 001→
			7.11492.03.0	DDS		ohne Zubehör without accessories ch. AU-D-000 001→
1.6 TDi BlueMotion 81 kW (110 PS) CRKB	05.2013→03.2017		7.03608.16.0	AK	EL	ch. AU-D-000 001→
			7.08369.79.0	ATS	EL	ch. AU-D-000 001→
			7.08369.95.0	ATS	EL	ch. AU-D-000 001→ Euro 6 Produktionsdatum ab: 03.11.2014 Production date from: 03.11.2014
			7.08369.82.0	ATS	EL	CRKB: ch. AU-D-000 001→ Euro 5 Euro 6 CRKB: ch. AU-D-000 001→ Euro 6 Produktionsdatum bis: 03.11.2014 Production date to: 03.11.2014 CRKB: ch. AU-E-500 001→
			7.11020.18.0	ATS	EL	ch. AU-E-500 001→ vor Katalysator in front of the catalyst













GOLF VAN VII Variant (BA5) 115

			7.11492.03.0	DDS		ohne Zubehör without accessories  ch. AU-E-500 001→ Produktionsdatum ab: 03.11.2014 Production date from: 03.11.2014
1.6 TDi BlueMotion 4motion 77 kW (105 PS) CLHA	05.2013→03.2017		7.03608.16.0	AK	EL	 CLHA:  ch. AU-D-000 001→  CLHA:  ch. AU-E-500 001→
			7.08369.79.0	ATS	EL	 ch. AU-D-000 001→
			7.08369.82.0	ATS	EL	 ch. AU-E-500 001→
			7.08369.81.0	ATS	EL	
			7.11492.03.0	DDS		ohne Zubehör without accessories
2.0 TDi BlueMotion 110 kW (150 PS) CRBC	04.2013→03.2017		7.10334.02.0	AGR	EL	
			7.03608.16.0	AK	EL	 CRBC:  ch. AU-D-000 001→  CRBC:  ch. AU-E-500 001→
			7.08369.81.0	ATS	EL	 ch. BV5***→
			7.11492.03.0	DDS		ohne Zubehör without accessories  ch. AU-D-000 001→
2.0 TDi BlueMotion 110 kW (150 PS) CRLB	04.2013→03.2017		7.03608.16.0	AK	EL	 ch. AU-D-000 001→
			7.08369.81.0	ATS	EL	 ch. AU-E-500 001→
			7.11492.03.0	DDS		ohne Zubehör without accessories  ch. AU-D-000 001→
2.0 TDi BlueMotion 4motion 110 kW (150 PS) CRBC, CRLB	04.2013→03.2017		7.03608.16.0	AK	EL	 CRBC, CRLB:  ch. AU-D-000 001→
			7.08369.81.0	ATS	EL	 CRBC:  ch. BV5***→  CRLB:  ch. AU-E-500 001 →
			7.11492.03.0	DDS		ohne Zubehör without accessories  CRBC, CRLB:  ch. AU-D-000 001→

GOLF VI Van (5K1_) 116

1.6 TDi 66 kW (90 PS) CAYB	02.2009→11.2012		7.09720.00.0	AGR-K	EL	
			7.08369.01.0	ATS	EL	Fahrgestellnummer ab: 1K-9-400 001 Vehicle Identification Number from: 1K-9-400 001
			7.08369.04.0	ATS	EL	Fahrgestellnummer ab: 1K-9-400 001 Vehicle Identification Number from: 1K-9-400 001
1.6 TDi BlueMotion 77 kW (105 PS) CAYC	05.2009→11.2012		7.09720.00.0	AGR-K	EL	
			7.08369.01.0	ATS	EL	Fahrgestellnummer ab: 1K-9-400 001 Vehicle Identification Number from: 1K-9-400 001
			7.08369.04.0	ATS	EL	Fahrgestellnummer ab: 1K-9-400 001 Vehicle Identification Number from: 1K-9-400 001
2.0 TDi 103 kW (140 PS) CFFB	09.2009→11.2012		7.09720.00.0	AGR-K	EL	
			7.11190.09.0	DDS		
2.0 TDi 103-104 kW (140-141 PS) CJAA	09.2009→11.2012		7.01493.07.0	AGR	EL	



GOLF VI Van (5K1_) 116

			7.08369.01.0	ATS	EL	Fahrgestellnummer ab: 1K-9-400 001 Vehicle Identification Number from: 1K-9-400 001
			7.11190.09.0	DDS		
			7.11492.00.0	DDS		ohne Zubehör without accessories ch. 1K-9-400 001→
2.0 TDi 125 kW (170 PS) CFGFB	05.2010→11.2012		7.09720.00.0	AGR-K	EL	
			7.11190.09.0	DDS		ch. 1K-9-400 001→



















GOLF VII Van (5G1) 117

1.6 TDi BlueMotion 77 kW (105 PS) CLHA	08.2012→		7.10334.02.0	AGR	EL	
			7.03608.16.0	AK	EL	CLHA: ch. AU-D-000 001→ CLHA: ch. AU-E-500 001→
			7.08369.79.0	ATS	EL	CLHA: ch. AU-D-000 001→ Produktionsdatum bis: 03.11.2014 Production date to: 03.11.2014 CLHA: ch. BQ1***→
			7.08369.82.0	ATS	EL	CLHA: ch. BQ1***→ CLHA: ch. AU-D-000 001→ Euro 5, Euro 6 Euro 5, Euro 6 Produktionsdatum bis: 03.11.2014 Production date to: 03.11.2014 ohne Zubehör without accessories ch. AU-D-000 001→
1.6 TDi BlueMotion 66 kW (90 PS) CRKA	04.2013→		7.08369.79.0	ATS	EL	ch. AU-D-000 001→ Produktionsdatum bis: 03.11.2014 Production date to: 03.11.2014
			7.08369.82.0	ATS	EL	ch. AU-D-000 001→ Euro 5, Euro 6 Euro 5, Euro 6 Produktionsdatum bis: 03.11.2014 Production date to: 03.11.2014
			7.08369.95.0	ATS	EL	ch. AU-D-000 001→ Euro 6 Euro 6 Produktionsdatum ab: 03.11.2014 Production date from: 03.11.2014
			7.11492.03.0	DDS		ohne Zubehör without accessories ch. AU-D-000 001→
1.6 TDi BlueMotion 81 kW (110 PS) CRKB, CXXB	11.2013→		7.03608.16.0	AK	EL	CRKB, CXXB: ch. AU-D-000 001→ CRKB, CXXB: ch. AU-E-500 001→
			7.08369.79.0	ATS	EL	CRKB, CXXB: ch. AU-D-000 001→ Produktionsdatum bis: 03.11.2014 Production date to: 03.11.2014
			7.08369.82.0	ATS	EL	CRKB, CXXB: ch. AU-D-000 001→ Euro 5, Euro 6 Euro 5, Euro 6 Produktionsdatum bis: 03.11.2014 Production date to: 03.11.2014























GOLF VII Van (5G1) 117































			7.08369.95.0	ATS	EL	 CRKB:  ch. AU-D-000 001→ Euro 6 Produktionsdatum ab: 03.11.2014 Production date from: 03.11.2014  CXXB: Euro 6 Euro 6 Produktionsdatum ab: 03.11.2014 Production date from: 03.11.2014
			7.11492.03.0	DDS		ohne Zubehör without accessories  CRKB, CXXB:  ch. AU-E-500 001→ Produktionsdatum ab: 03.11.2014 Production date from: 03.11.2014
2.0 GTD 135 kW (184 PS) CUNA	04.2013→		7.10334.02.0	AGR	EL	  ch. AU-D-000 001→
			7.11492.03.0	DDS		ohne Zubehör without accessories  ch. AU-D-000 001→
2.0 GTi 162 kW (220 PS) CHHB	04.2013→		7.01510.85.0	SLV	EL	 ch. AU-D-000 001→ für Hersteller-Abgasnorm: SULEV for manufacturer exhaust norm: SULEV Produktionsdatum ab: 03.11.2015 Production date from: 03.11.2015
			7.01510.86.0	SLV	EL	 ch. AU-D-000 001→ für Hersteller-Abgasnorm: SULEV for manufacturer exhaust norm: SULEV Produktionsdatum bis: 02.11.2015 Production date to: 02.11.2015
2.0 GTi 169 kW (230 PS) CHHA	04.2015→		7.01510.85.0	SLV	EL	 ch. AU-D-000 001→ für Hersteller-Abgasnorm: SULEV for manufacturer exhaust norm: SULEV Produktionsdatum ab: 03.11.2015 Production date from: 03.11.2015
			7.01510.86.0	SLV	EL	 ch. AU-D-000 001→ für Hersteller-Abgasnorm: SULEV for manufacturer exhaust norm: SULEV Produktionsdatum bis: 02.11.2015 Production date to: 02.11.2015
2.0 TDi BlueMotion 4motion 110 kW (150 PS) CRBC	05.2013→		7.10334.02.0	AGR	EL	  ch. AU-D-000 001→
			7.11492.03.0	DDS		ohne Zubehör without accessories  ch. AU-D-000 001→

LT 28-35 II Bus (2DB, 2DE, 2DK) 118

2.5 TDI 75 kW (102 PS) AHD	05.1996→08.1999		7.24809.52.0	AGR	PN	  ch. 2D-Y-000 002→
2.5 TDI 66 kW (90 PS) APA	05.1999→07.2006		7.24809.52.0	AGR	PN	
2.5 TDI 80 kW (109 PS) ANJ, AVR	05.1999→07.2006		7.24809.52.0	AGR	PN	
2.5 TDI 61 kW (83 PS) BBE	05.2001→07.2006		7.24809.52.0	AGR	PN	
2.5 TDI 70 kW (95 PS) BBF	05.2001→07.2006		7.24809.52.0	AGR	PN	















LT 28-46 II Platform/Chassis (2DC, 2DF, 2DG, 2DL, 2DM) 119

2.5 TDI 75 kW (102 PS) AHD	06.1996→08.1999		7.24809.52.0	AGR	PN	  ch. 2D-Y-000 002→
2.5 TDI 66 kW (90 PS) APA	05.1999→07.2006		7.24809.52.0	AGR	PN	
2.5 TDI 80 kW (109 PS) ANJ, AVR	05.1999→07.2006		7.24809.52.0	AGR	PN	

					
LT 28-46 II Platform/Chassis (2DC, 2DF, 2DG, 2DL, 2DM)					
119					
2.5 TDI 61 kW (83 PS) BBE	05.2001→07.2006		7.24809.52.0	AGR	PN 
2.5 TDI 70 kW (95 PS) BBF	05.2001→07.2006		7.24809.52.0	AGR	PN 
LT 28-46 II Van (2DA, 2DD, 2DH)					
120					
2.5 TDI 75 kW (102 PS) AHD	05.1996→08.1999		7.24809.52.0	AGR	PN   ch. 2D-Y-000 002→
2.5 TDI 66 kW (90 PS) APA	05.1999→07.2006		7.24809.52.0	AGR	PN 
2.5 TDI 80 kW (109 PS) ANJ, AVR	05.1999→07.2006		7.24809.52.0	AGR	PN 
2.5 TDI 61 kW (83 PS) BBE	05.2001→07.2006		7.24809.52.0	AGR	PN 
2.5 TDI 70 kW (95 PS) BBF	05.2001→07.2006		7.24809.52.0	AGR	PN 
MULTIVAN V (7HM, 7HN, 7HF, 7EF, 7EM, 7EN)					
121					
1.9 TDI 77 kW (105 PS) AXB	04.2003→11.2009		7.24809.20.0	AGR	PN 
			7.11492.02.0	DDS	ohne Zubehör without accessories
1.9 TDI 63 kW (85 PS) AXC	04.2003→11.2009		7.24809.20.0	AGR	PN 
			7.11492.02.0	DDS	ohne Zubehör without accessories
1.9 TDI 62 kW (84 PS) BRR	01.2006→11.2009		7.00365.06.0	AGR	EL 
			7.08369.33.0	ATS	EL
			7.08369.36.0	ATS	EL vor Rußpartikelfilter before soot particulate filter
			7.08369.63.0	ATS	EL
1.9 TDI 75 kW (102 PS) BRS	06.2006→11.2009		7.11492.02.0	DDS	ohne Zubehör without accessories
			7.00365.06.0	AGR	EL 
			7.08369.33.0	ATS	EL
			7.08369.36.0	ATS	EL vor Rußpartikelfilter before soot particulate filter
2.0 85 kW (115 PS) AXA	11.2003→08.2015		7.08369.63.0	ATS	EL
			7.11492.02.0	DDS	ohne Zubehör without accessories



































MULTIVAN V (7HM, 7HN, 7HF, 7EF, 7EM, 7EN) 121

			7.22778.80.0	SLV	PN	 <p>Fahrgestellnummer ab: 7H-3-000 001, 7H-6-000 001, 7H-7-000 001, 7H-8-000 001, 7H-9-000 001, 7H-A-200 001, 7H-C-000 001, 7J-3-000 001, 7J-6-000 001, 7J-7-000 001, 7J-8-000 001, 7J-9-000 001, 7J-A-200 001, 7J-C-000 001 Vehicle Identification Number from: 7H-3-000 001, 7H-6-000 001, 7H-7-000 001, 7H-8-000 001, 7H-9-000 001, 7H-A-200 001, 7H-C-000 001, 7J-3-000 001, 7J-6-000 001, 7J-7-000 001, 7J-8-000 001, 7J-9-000 001, 7J-A-200 001, 7J-C-000 001 Fahrgestellnummer bis: 7H-3-001 000, 7H-6-200 000, 7H-7-200 000, 7H-8-200 000, 7H-9-200 000, 7J-3-001 000, 7J-6-050 000, 7J-7-040 000, 7J-8-030 000, 7J-9-020 000 Vehicle Identification Number to: 7H-3-001 000, 7H-6-200 000, 7H-7-200 000, 7H-8-200 000, 7H-9-200 000, 7J-3-001 000, 7J-6-050 000, 7J-7-040 000, 7J-8-030 000, 7J-9-020 000</p>
2.0 BiTDI 132 kW (180 PS) CFCA	09.2009→08.2015		7.03196.09.0	AGR	EL	 <p>Fahrgestellnummer ab: 7H-A-200 001 Vehicle Identification Number from: 7H-A-200 001 Fahrgestellnummer ab: 7H-A-200 001 Vehicle Identification Number from: 7H-A-200 001 ohne Zubehör without accessories  ch. 7H-A-200 001→</p>
			7.02756.07.0	AGR-K		
			7.08369.20.0	ATS	EL	
			7.08369.24.0	ATS	EL	
2.0 BiTDI 4motion 132 kW (180 PS) CFCA	09.2009→08.2015		7.03196.09.0	AGR	EL	 <p> ch. 7H-A-200 001→ Fahrgestellnummer ab: 7H-A-200 001 Vehicle Identification Number from: 7H-A-200 001 ohne Zubehör without accessories  ch. 7H-A-200 001→</p>
			7.02756.07.0	AGR-K		
			7.08369.21.0	ATS	EL	
			7.08369.25.0	ATS	EL	
2.0 TDI 62 kW (84 PS) CAAA	09.2009→08.2015		7.09720.04.0	AGR-K	EL	 <p> ch. 7H-A-200 001→ Fahrgestellnummer ab: 7H-A-200 001 Vehicle Identification Number from: 7H-A-200 001 Fahrgestellnummer ab: 7H-A-200 001 Vehicle Identification Number from: 7H-A-200 001</p>
			7.11020.06.0	ATS	EL	
			7.08369.20.0	ATS	EL	
2.0 TDI 75 kW (102 PS) CAAB	09.2009→08.2015		7.09720.04.0	AGR-K	EL	 <p> ch. 7H-A-200 001→  ch. 7H-A-200 001→ Fahrgestellnummer ab: 7H-A-200 001 Vehicle Identification Number from: 7H-A-200 001 Fahrgestellnummer ab: 7H-A-200 001 Vehicle Identification Number from: 7H-A-200 001</p>
			7.11020.06.0	ATS	EL	
			7.08369.20.0	ATS	EL	
			7.08369.24.0	ATS	EL	Fahrgestellnummer ab: 7H-A-200 001 Vehicle Identification Number from: 7H-A-200 001

V









































MULTIVAN V (7HM, 7HN, 7HF, 7EF, 7EM, 7EN) 121

			7.11492.00.0	DDS		ohne Zubehör without accessories  ch. 7H-A-200 001→
2.0 TDI 103 kW (140 PS) CAAC	09.2009→08.2015		7.09720.04.0	AGR-K	EL 	 ch. 7H-A-200 001→
			7.08369.93.0	ATS	EL 	ch. 7H-A-200 001→ch. 7H-C-000 000
			7.08369.92.0	ATS	EL 	ch. 7J-C-000 001→
			7.08369.20.0	ATS	EL	Fahrgestellnummer ab: 7H-A-200 001 Vehicle Identification Number from: 7H-A-200 001
			7.08369.24.0	ATS	EL	Fahrgestellnummer ab: 7H-A-200 001 Vehicle Identification Number from: 7H-A-200 001
2.0 TDI 103 kW (140 PS) CCHA	09.2009→08.2015		7.09720.04.0	AGR-K	EL 	 ch. 7H-A-200 001→
			7.08369.93.0	ATS	EL 	ch. 7H-A-200 001→ch. 7H-C-000 000
			7.08369.92.0	ATS	EL 	ch. 7J-C-000 001→
			7.08369.20.0	ATS	EL	Fahrgestellnummer ab: 7H-A-200 001 Vehicle Identification Number from: 7H-A-200 001
			7.08369.24.0	ATS	EL	Fahrgestellnummer ab: 7H-A-200 001 Vehicle Identification Number from: 7H-A-200 001
2.0 TDI 100 kW (136 PS) CAAE, CCHB	05.2010→08.2015		7.09720.04.0	AGR-K	EL 	 CAAE, CCHB:  ch. 7H-A-200 001→
			7.08369.93.0	ATS	EL 	CAAE, CCHB:  ch. 7H-A-200 001→ch. 7H-C-000 000
			7.08369.92.0	ATS	EL 	CAAE, CCHB:  ch. 7H-C-000 001→
			7.08369.20.0	ATS	EL 	CAAE, CCHB: Fahrgestellnummer ab: 7H-A-200 001 Vehicle Identification Number from: 7H-A-200 001
			7.08369.24.0	ATS	EL 	CAAE, CCHB: Fahrgestellnummer ab: 7H-A-200 001 Vehicle Identification Number from: 7H-A-200 001
2.0 TDI 84 kW (114 PS) CAAD	05.2011→08.2015		7.09720.04.0	AGR-K	EL 	
			7.08369.92.0	ATS	EL 	ch. 7H-C-000 001→
			7.08369.20.0	ATS	EL	
			7.08369.24.0	ATS	EL	
2.0 TDI 4motion 103 kW (140 PS) CAAC	09.2009→08.2015		7.09720.04.0	AGR-K	EL 	 ch. 7H-A-200 001→
			7.08369.93.0	ATS	EL 	ch. 7H-A-200 001→ch. 7H-C-000 000
			7.08369.92.0	ATS	EL 	ch. 7H-C-000 001→
			7.08369.21.0	ATS	EL	
			7.08369.25.0	ATS	EL	Fahrgestellnummer ab: 7H-A-200 001 Vehicle Identification Number from: 7H-A-200 001
			7.11492.00.0	DDS		ohne Zubehör without accessories  ch. 7H-A-200 001→
2.0 TDI 4motion 103 kW (140 PS) CCHA	09.2009→08.2015		7.09720.04.0	AGR-K	EL 	 ch. 7H-A-200 001→

V











MULTIVAN V (7HM, 7HN, 7HF, 7EF, 7EM, 7EN) 121





			<p>7.08369.21.0 ATS EL  ch. 7H-A-200 001→</p> <p>7.08369.93.0 ATS EL  ch. 7H-A-200 001→ch. 7H-C-000 000</p> <p>7.08369.92.0 ATS EL  ch. 7H-C-000 001→</p> <p>7.08369.25.0 ATS EL Fahrgestellnummer ab: 7H-A-200 001 Vehicle Identification Number from: 7H-A-200 001</p>
<p>2.0 TDI 4motion 100 kW (136 PS) CAAE, CCHB</p>	05.2010→08.2015		<p>7.09720.04.0 AGR-K EL  CAAE, CCHB:  ch. 7H-A-200 001→</p> <p>7.08369.21.0 ATS EL  ch. 7H-A-200 001→</p> <p>7.08369.93.0 ATS EL  CAAE, CCHB:  ch. 7H-A-200 001→ch. 7H-C-000 000</p> <p>7.08369.92.0 ATS EL  CAAE, CCHB:  ch. 7H-C-000 001→</p> <p>7.08369.25.0 ATS EL Fahrgestellnummer ab: 7H-A-200 001 Vehicle Identification Number from: 7H-A-200 001</p>
<p>2.5 TDI 96 kW (130 PS) AXD</p>	04.2003→11.2009		<p>7.24809.38.0 AGR PN </p>
<p>2.5 TDI 96 kW (130 PS) BNZ</p>	04.2003→11.2009		<p>7.00823.06.0 AGR EL </p> <p>7.08369.96.0 ATS EL  BNZ:  ch. 7H-6-000 001→ch. 7H-6-200 000</p> <p> BNZ:  ch. 7H-7-000 001→ch. 7H-7-200 000</p> <p> BNZ:  ch. 7H-8-000 001→ch. 7H-8-200 000</p> <p> BNZ:  ch. 7H-9-000 001→ch. 7H-9-200 000</p> <p>7.08369.18.0 ATS EL</p> <p>7.08369.31.0 ATS EL vor Rußpartikelfilter before soot particulate filter ohne Zubehör without accessories</p> <p>7.11492.02.0 DDS</p>
<p>2.5 TDI 96-128 kW (131-174 PS) AXE</p>	04.2003→11.2009		<p>7.24809.38.0 AGR PN </p>
<p>2.5 TDI 128 kW (174 PS) BPC</p>	04.2003→11.2009		<p>7.00823.06.0 AGR EL </p> <p>7.08369.96.0 ATS EL  BPC:  ch. 7H-6-000 001→ch. 7H-6-200 000</p> <p> BPC:  ch. 7H-7-000 001→ch. 7H-7-200 000</p> <p> BPC:  ch. 7H-8-000 001→ch. 7H-8-200 000</p> <p> BPC:  ch. 7H-9-000 001→ch. 7H-9-200 000</p> <p>7.08369.18.0 ATS EL</p> <p>7.08369.31.0 ATS EL vor Rußpartikelfilter before soot particulate filter ohne Zubehör without accessories</p> <p>7.11492.02.0 DDS</p>
<p>2.5 TDI 120 kW (163 PS) BLJ</p>	11.2003→11.2009		<p>7.24809.38.0 AGR PN </p>
<p>2.5 TDI 4motion 96 kW (130 PS) AXD</p>	07.2004→11.2009		<p>7.24809.38.0 AGR PN </p>



MULTIVAN V (7HM, 7HN, 7HF, 7EF, 7EM, 7EN) 121

2.5 TDI 4motion 96 kW (130 PS) BNZ	07.2004→11.2009		7.00823.06.0	AGR	EL	○ vor Rußpartikelfilter before soot particulate filter ohne Zubehör without accessories
			7.08369.18.0	ATS	EL	
			7.08369.31.0	ATS	EL	
			7.11492.02.0	DDS		
2.5 TDI 4motion 96-128 kW (131-174 PS) AXE	07.2004→11.2009		7.24809.38.0	AGR	PN	○
2.5 TDI 4motion 128 kW (174 PS) BPC	07.2004→11.2009		7.00823.06.0	AGR	EL	○ vor Rußpartikelfilter before soot particulate filter ohne Zubehör without accessories
			7.08369.18.0	ATS	EL	
			7.08369.31.0	ATS	EL	
			7.11492.02.0	DDS		
3.2 V6 170 kW (231 PS) BDL	02.2004→06.2004		7.22286.41.0	ARV	PN	○
3.2 V6 173 kW (235 PS) BKK	02.2004→12.2009		7.22286.41.0	ARV	PN	○
			7.22934.63.0	SLP	EL	
3.2 V6 173 kW (235 PS) CFLA	05.2008→12.2009		7.22934.63.0	SLP	EL	
3.2 V6 4motion 173 kW (235 PS) BKK	07.2004→12.2009		7.22286.41.0	ARV	PN	○
			7.22934.63.0	SLP	EL	
3.2 V6 4motion 173 kW (235 PS) CFLA	05.2008→12.2009		7.22934.63.0	SLP	EL	





















MULTIVAN VI (SGF, SGM, SGN, SHM, SHN) 122

2.0 TDI 62 kW (84 PS) CXGA	04.2015→		7.04999.35.0*	AGR-K	EL	🚗 ch. 7H-G-000 001→ für OE-Nummer: 04L 131 512 CF for OE number: 04L 131 512 CF	
			↳7.04999.34.0	AGR-M	EL		
			7.09720.04.0	AGR-K	EL		○ für OE-Nummer: 03L 131 512 DS for OE number: 03L 131 512 DS
2.0 TDI 75 kW (102 PS) CAAB	04.2015→		7.04999.35.0*	AGR-K	EL	für OE-Nummer: 04L 131 512 CF for OE number: 04L 131 512 CF	
			↳7.04999.34.0	AGR-M	EL		
			7.09720.04.0	AGR-K	EL		○ für OE-Nummer: 03L 131 512 DS for OE number: 03L 131 512 DS
			7.08369.20.0	ATS	EL		
			7.08369.24.0	ATS	EL		
7.11492.00.0	DDS		ohne Zubehör without accessories				
2.0 TDI 75 kW (102 PS) CXGB	04.2015→		7.04999.35.0*	AGR-K	EL	für OE-Nummer: 04L 131 512 CF for OE number: 04L 131 512 CF	
			↳7.04999.34.0	AGR-M	EL		
			7.09720.04.0	AGR-K	EL		○ für OE-Nummer: 03L 131 512 DS for OE number: 03L 131 512 DS
2.0 TDI 103 kW (140 PS) CAAC	04.2015→		7.09720.04.0	AGR-K	EL	○	
			7.08369.20.0	ATS	EL		
			7.08369.24.0	ATS	EL		
			7.11492.00.0	DDS			ohne Zubehör without accessories







MULTIVAN VI (SGF, SGM, SGN, SHM, SHN) 122

2.0 TDI 110 kW (150 PS) CXFA, CXHA	04.2015 →		7.04999.35.0*	AGR-K	EL	 CXFA, CXHA:  ch. 7H-G-000 001 →
			↳ 7.04999.34.0 7.11492.05.0	AGR-M DDS	EL	
2.0 TDI 132 kW (180 PS) CFCA	04.2015 →		7.03196.09.0	AGR	EL	
			7.02756.07.0	AGR-K		
			7.08369.20.0	ATS	EL	
			7.08369.24.0 7.11492.00.0	ATS DDS	EL	
2.0 TDI 150 kW (204 PS) CXEB	06.2015 →		7.04999.35.0*	AGR-K	EL	 ch. 7H-G-000 001 →
			↳ 7.04999.34.0	AGR-M	EL	
2.0 TDI 84 kW (114 PS) CXHB	05.2016 →		7.04999.35.0*	AGR-K	EL	 ch. 7H-G-000 001 →
			↳ 7.04999.34.0	AGR-M	EL	
2.0 TDI 146 kW (199 PS) CXEC	11.2018 →		7.04999.35.0*	AGR-K	EL	
			↳ 7.04999.34.0 7.11492.05.0	AGR-M DDS	EL	
2.0 TDI 81 kW (110 PS) CXHC	07.2019 →		7.04999.35.0*	AGR-K	EL	
			↳ 7.04999.34.0	AGR-M	EL	
			7.11492.05.0	DDS		
2.0 TDI 4motion 103 kW (140 PS) CAAC	06.2015 →		7.09720.04.0	AGR-K	EL	
			7.08369.21.0	ATS	EL	
			7.08369.25.0	ATS	EL	
			7.11492.00.0	DDS		
2.0 TDI 4motion 132 kW (180 PS) CFCA	06.2015 →		7.03196.09.0	AGR	EL	
			7.02756.07.0	AGR-K		
			7.08369.21.0	ATS	EL	
			7.08369.25.0	ATS	EL	
			7.11492.00.0	DDS		
2.0 TDI 4motion 150 kW (204 PS) CXEB	06.2015 →		7.04999.35.0*	AGR-K	EL	 ch. 7H-G-000 001 →
			↳ 7.04999.34.0	AGR-M	EL	
2.0 TDI 4motion 110 kW (150 PS) CXFA, CXHA	08.2015 →		7.04999.35.0*	AGR-K	EL	 CXFA, CXHA:  ch. 7H-G-000 001 →
			↳ 7.04999.34.0	AGR-M	EL	
			7.11492.05.0	DDS		
2.0 TDI 4motion 146 kW (199 PS) CXEC	12.2018 →		7.04999.35.0*	AGR-K	EL	
			↳ 7.04999.34.0 7.11492.05.0	AGR-M DDS	EL	

PASSAT B3/B4 (315, 3A5) 123

2.0 85 kW (115 PS) 2E	08.1991 → 12.1995		7.22286.26.0	ARV	PN	
--------------------------	-------------------	---	--------------	-----	----	---



PASSAT B7 Estate Van (365) 124

1.6 TDi BlueMotion 77 kW (105 PS) CAYC	08.2010→12.2014	7.09720.00.0	AGR-K	EL	
		7.08369.07.0	ATS	EL	ch. 3C-B-200 001→
		7.08369.01.0	ATS	EL	Fahrgestellnummer ab: 3C-B-200 001 Vehicle Identification Number from: 3C-B-200 001 ohne Zubehör without accessories
2.0 TDi BlueMotion 103 kW (140 PS) CFFB	08.2010→12.2014	7.10334.00.0	AGR	EL	
		7.09720.00.0	AGR-K	EL	ch. A3-DC000 001→ für PR-Nummer: TN5 for PR number: TN5
		7.11492.00.0	DDS	EL	
2.0 TDi BlueMotion 125 kW (170 PS) CFGB, CLLA	08.2010→12.2014	7.09720.00.0	AGR-K	EL	
3.6 FSi 4motion 220 kW (300 PS) BWS	01.2011→12.2014	7.02604.41.0	LS	700 mm	vor Katalysator, links in front of the catalyst, Left









POLO Van (6R) 125

1.2 TDi BlueMotion 55 kW (75 PS) CFWA	10.2009→05.2014	7.09720.02.0	AGR-K	EL	
		7.08369.83.0	ATS	EL	CFWA: ch. 60-AT000 001→ Indien India
		7.08369.11.0	ATS	EL	CFWA: ch. 6R-A-000 001→ Fahrgestellnummer ab: 6R-A-000 001 Vehicle Identification Number from: 6R-A-000 001 für Rechtslenker for right-hand drive vehicles
		7.08369.37.0	ATS	EL	für Linkslenker for left-hand drive vehicles nach Rußpartikelfilter after soot particulate filter
		7.11190.09.0	DDS		ch. 6R-A-000 001→
1.4 63 kW (85 PS) CGGB	03.2009→05.2014	7.05271.05.0	LS	700 mm	ch. 6R-A-000 001→ nach Katalysator Post-catalyst
1.4 TDI 66 kW (90 PS) CUSB	02.2014→	7.09720.00.0	AGR-K	EL	
		7.07696.00.0	SRM-AK	EL	ch. 6R-F-000 001→
1.4 TDI 55 kW (75 PS) CUSA	03.2014→	7.09720.00.0	AGR-K	EL	
		7.07696.00.0	SRM-AK	EL	ch. 6R-F000 001→
1.4 TDI 55 kW (75 PS) CYZB	03.2014→	7.09720.00.0	AGR-K	EL	
1.6 TDi 55 kW (75 PS) CAYA	06.2009→05.2014	7.09720.01.0	AGR-K	EL	
		7.08369.26.0	ATS	EL	ch. 6R-A-000 001→
		7.08369.09.0	ATS	EL	Fahrgestellnummer ab: 6R-A-000 001 Vehicle Identification Number from: 6R-A-000 001 für Linkslenker for left-hand drive vehicles
		7.08369.11.0	ATS	EL	Fahrgestellnummer ab: 6R-A-000 001 Vehicle Identification Number from: 6R-A-000 001 für Rechtslenker for right-hand drive vehicles
		7.11190.09.0	DDS		ch. 6R-A-000 001→















POLO Van (6R) 125

1.6 TDi 77 kW (105 PS) CAYC	06.2009→05.2014		7.09720.01.0	AGR-K	EL	
			7.08369.26.0	ATS	EL	 ch. 6R-A-000 001→
			7.08369.09.0	ATS	EL	Fahrgestellnummer ab: 6R-A-000 001 Vehicle Identification Number from: 6R-A-000 001 für Linkslenker for left-hand drive vehicles
			7.08369.11.0	ATS	EL	Fahrgestellnummer ab: 6R-A-000 001 Vehicle Identification Number from: 6R-A-000 001 für Rechtslenker for right-hand drive vehicles
1.6 TDi BlueMotion 66 kW (90 PS) CAYB	06.2009→05.2014		7.11190.09.0	DDS		 ch. 6R-A-000 001→
			7.09720.01.0	AGR-K	EL	
			7.08369.26.0	ATS	EL	 ch. 6R-A-000 001→
			7.08369.09.0	ATS	EL	Fahrgestellnummer ab: 6R-A-000 001 Vehicle Identification Number from: 6R-A-000 001 für Linkslenker for left-hand drive vehicles
			7.08369.11.0	ATS	EL	Fahrgestellnummer ab: 6R-A-000 001 Vehicle Identification Number from: 6R-A-000 001 für Rechtslenker for right-hand drive vehicles
			7.11190.09.0	DDS		 ch. 6R-A-000 001→







POLO Van Estate Van (6V5) 126

























1.4 55 kW (75 PS) AUA	06.2000→09.2001		7.22785.17.0	AGR	EL	  →ch. 6N-1-350 000
1.7 SDI 44 kW (60 PS) AKU	08.1997→12.1999		7.22477.10.0	AGR	PN	

SCIROCCO Van (137) 127

2.0 TDi 103 kW (140 PS) CBDB	08.2008→05.2014		7.08369.01.0	ATS	EL	
			7.08369.04.0	ATS	EL	
			7.11492.02.0	DDS		ohne Zubehör without accessories
2.0 TDi 103 kW (140 PS) CFHC	08.2008→05.2014		7.09720.00.0	AGR-K	EL	
2.0 TDi 125 kW (170 PS) CBBB	05.2009→05.2014		7.08369.00.0	ATS	EL	
			7.08369.01.0	ATS	EL	
			7.08369.04.0	ATS	EL	
			7.11492.00.0	DDS		ohne Zubehör without accessories
2.0 TDi 125 kW (170 PS) CFGB	05.2009→05.2014		7.09720.00.0	AGR-K	EL	

V SHARAN VAN (7M_) 128

























2.0 (7M8, 7M9) 85 kW (115 PS) ATM	06.2000→07.2002		7.22778.80.0	SLV	PN	
2.8 VR6 (7M8) 120-128 kW (163-174 PS) AAA	09.1996→04.2000		7.22090.11.0	ARV	PN	
2.8 VR6 (7M9) 150 kW (204 PS) AYL	08.2001→05.2003		7.22286.55.0	ARV	PN	

						
TIGUAN VAN (5N_)					129	
2.0 TDI 4motion (5N1, 5N2) 103 kW (140 PS) CBAB	11.2007→07.2018		7.08369.03.0	ATS	EL	Fahrgestellnummer bis: 5N-9-060 000 Vehicle Identification Number to: 5N-9-060 000
			7.08369.04.0	ATS	EL	Fahrgestellnummer ab: 5N-9-060 001 Vehicle Identification Number from: 5N-9-060 001
TOURAN VAN (1T1, 1T2)					130	
1.9 TDI 66 kW (90 PS) BXJ	11.2004→05.2010		7.08369.00.0	ATS	EL	
			7.08369.08.0	ATS	EL	
2.0 FSI 110 kW (150 PS) BLX	05.2004→01.2007		7.08369.41.0	ATS	EL	
2.0 TDi 103 kW (140 PS) BMM	12.2005→05.2010		7.08369.00.0	ATS	EL	
			7.08369.08.0	ATS	EL	
FSI 85 kW (115 PS) BAG, BLP	02.2003→05.2005		7.08369.41.0	ATS	EL	
TOURAN VAN (1T3)					131	
1.6 TDI 66 kW (90 PS) CAYB	05.2010→05.2015		7.08369.19.0	ATS	EL	
TRANSPORTER / CARAVELLE VI Bus (SGB, SGG, SGJ, SGC, SHB, SHJ)					132	
2.0 TDI 62 kW (84 PS) CAAA	04.2015→		7.04999.35.0*	AGR-K	EL	 ch. 7H-G-000 001→ für OE-Nummer: 04L 131 512 CF for OE number: 04L 131 512 CF
			↳ 7.04999.34.0	AGR-M	EL	
			7.09720.04.0	AGR-K	EL	 für OE-Nummer: 03L 131 512 DS for OE number: 03L 131 512 DS
			7.08369.20.0	ATS	EL	Fahrgestellnummer ab: 7H-G-000 001, 7J-G-000 001 Vehicle Identification Number from: 7H-G-000 001, 7J-G-000 001
2.0 TDI 62 kW (84 PS) CXGA	04.2015→		7.04999.35.0*	AGR-K	EL	 ch. 7H-G-000 001→ für OE-Nummer: 04L 131 512 CF for OE number: 04L 131 512 CF
			↳ 7.04999.34.0	AGR-M	EL	
			7.09720.04.0	AGR-K	EL	 für OE-Nummer: 03L 131 512 DS for OE number: 03L 131 512 DS ohne Zubehör without accessories
2.0 TDI 75 kW (102 PS) CAAB	04.2015→		7.04999.35.0*	AGR-K	EL	 ch. 7J-G-000 001→ für OE-Nummer: 04L 131 512 CF for OE number: 04L 131 512 CF
			↳ 7.04999.34.0	AGR-M	EL	
			7.09720.04.0	AGR-K	EL	 für OE-Nummer: 03L 131 512 DS for OE number: 03L 131 512 DS
			7.08369.20.0	ATS	EL	
2.0 TDI 75 kW (102 PS) CXGB	04.2015→		7.08369.24.0	ATS	EL	
			7.04999.35.0*	AGR-K	EL	für OE-Nummer: 04L 131 512 CF for OE number: 04L 131 512 CF
2.0 TDI 75 kW (102 PS) CXGB	04.2015→		↳ 7.04999.34.0	AGR-M	EL	
			7.09720.04.0	AGR-K	EL	 für OE-Nummer: 03L 131 512 DS for OE number: 03L 131 512 DS

V



TRANSPORTER / CARAVELLE VI Bus (SGB, SGG, SGJ, SGC, SHB, SHJ) 132

			7.11492.05.0	DDS		ohne Zubehör without accessories  ch. 7J-G-000 001→
2.0 TDI 103 kW (140 PS) CAAC	04.2015→		7.09720.04.0 7.08369.20.0 7.08369.24.0 7.11492.00.0	AGR-K ATS ATS DDS	EL EL EL	
2.0 TDI 110 kW (150 PS) CXFA	04.2015→		7.04999.35.0*	AGR-K	EL	 ch. 7H-G-000 001→
			↳ 7.04999.34.0	AGR-M	EL	
2.0 TDI 110 kW (150 PS) CXHA	04.2015→		7.04999.35.0*	AGR-K	EL	 ch. 7H-G-000 001→
			↳ 7.04999.34.0 7.11492.05.0	AGR-M DDS	EL	ohne Zubehör without accessories  ch. 7J-G-000 001→
2.0 TDI 132 kW (180 PS) CFCA	04.2015→		7.03196.09.0 7.02756.07.0 7.08369.20.0 7.08369.24.0	AGR AGR-K ATS ATS	EL EL EL	 Fahrgestellnummer ab: 7H-G-000 001, 7J-G-000 001 Vehicle Identification Number from: 7H-G-000 001, 7J-G-000 001 Fahrgestellnummer ab: 7H-G-000 001, 7J-G-000 001 Vehicle Identification Number from: 7H-G-000 001, 7J-G-000 001
2.0 TDI 150 kW (204 PS) CXEB	06.2015→		7.04999.35.0*	AGR-K	EL	 ch. 7H-G-000 001→
			↳ 7.04999.34.0 7.11492.05.0	AGR-M DDS	EL	ohne Zubehör without accessories  ch. 7J-G-000 001→
2.0 TDI 84 kW (114 PS) CXHB	05.2016→		7.04999.35.0*	AGR-K	EL	
			↳ 7.04999.34.0 7.11492.05.0	AGR-M DDS	EL	ohne Zubehör without accessories  ch. 7J-G-000 001→
2.0 TDI 146 kW (199 PS) CXEC	11.2018→		7.04999.35.0*	AGR-K	EL	
			↳ 7.04999.34.0	AGR-M	EL	
2.0 TDI 81 kW (110 PS) CXHC	07.2019→		7.04999.35.0*	AGR-K	EL	
			↳ 7.04999.34.0	AGR-M	EL	
2.0 TDI 66 kW (90 PS) CXGD	10.2019→		7.11492.05.0	DDS		ohne Zubehör without accessories  ch. 7H-L-000 001→
2.0 TDI 4motion 103 kW (140 PS) CAAC	06.2015→		7.09720.04.0 7.08369.21.0 7.08369.25.0 7.11492.00.0	AGR-K ATS ATS DDS	EL EL EL	  ch. 7H-G-000 001→ ohne Zubehör without accessories  ch. 7J-A-200 001→
2.0 TDI 4motion 132 kW (180 PS) CFCA	06.2015→		7.03196.09.0 7.02756.07.0	AGR AGR-K	EL	

V



TRANSPORTER / CARAVELLE VI Bus (SGB, SGG, SGJ, SGC, SHB, SHJ) 132

			7.08369.21.0 7.08369.25.0 7.11492.00.0	ATS ATS DDS	EL EL	ch. 7H-G-000 001→ ohne Zubehör without accessories ch. 7J-A-200 001→
2.0 TDI 4motion 150 kW (204 PS) CXEB	06.2015→		7.04999.35.0* ↳7.04999.34.0 7.11492.05.0	AGR-K AGR-M DDS	EL EL	ch. 7H-G-000 001→ ohne Zubehör without accessories ch. 7J-G-000 001→
2.0 TDI 4motion 110 kW (150 PS) CXFA, CXHA	08.2015→		7.04999.35.0* ↳7.04999.34.0 7.11492.05.0	AGR-K AGR-M DDS	EL EL	CXFA, CXHA: ch. 7H-G-000 001→ ohne Zubehör without accessories CXFA, CXHA: ch. 7J-G-000 001→
2.0 TDI 4motion 146 kW (199 PS) CXEC	08.2018→		7.04999.35.0* ↳7.04999.34.0	AGR-K AGR-M	EL EL	





















TRANSPORTER IV Bus (70B, 70C, 7DB, 7DK, 70J, 70K, 7DC, 7DJ) 133

2.5 85 kW (115 PS) APL, AVT	08.1996→04.2003		7.05271.21.0	LS	1250 mm	APL, AVT: Diagnosesonde Diagnostic Probe
2.5 Syncro 85 kW (115 PS) APL, AVT	07.1996→04.2003		7.05271.21.0	LS	1250 mm	APL, AVT: Diagnosesonde Diagnostic Probe
2.5 TDI 75 kW (102 PS) ACV, AUF, AYC	09.1995→04.2003		7.22939.03.0	AGR	PN	mit Rohrstutzen with pipe socket ACV, AUF: ch. 70-1-048 286→
2.5 TDI 65 kW (88 PS) AJT, AYY	05.1998→04.2003		7.22939.03.0	AGR	PN	mit Rohrstutzen with pipe socket AJT, AYY: ch. 70-1-048 286→
2.5 TDI 111 kW (151 PS) AHY, AXG	05.1998→04.2003		7.24809.61.0	AGR	PN	AHY, AXG: ch. 70-1-048 286→
2.5 TDI Syncro 75 kW (102 PS) ACV	01.1996→04.2003		7.22939.03.0	AGR	PN	mit Rohrstutzen with pipe socket ch. 70-1-048 286→
2.5 TDI Syncro 75 kW (102 PS) AXL	01.1996→04.2003		7.22939.03.0 7.24809.61.0	AGR AGR	PN PN	mit Rohrstutzen with pipe socket ch. 70-1-048 286→
2.8 VR 6 103 kW (140 PS) AES	11.1995→04.2000		7.22090.11.0 7.05270.88.0 7.05270.96.0	ARV LS LS	PN 740 mm 1440 mm	Fahrgestellnummer ab: 70-T-200 001 Vehicle Identification Number from: 70-T-200 001 Diagnosesonde Diagnostic Probe
2.8 VR6 150 kW (204 PS) AMV	04.2000→04.2003		7.22286.41.0 7.05271.23.0 7.05271.24.0 7.05271.21.0 7.22738.08.0	ARV LS LS LS SLP	PN 900 mm 1500 mm 1250 mm EL	 vor Katalysator in front of the catalyst Diagnosesonde Diagnostic Probe



























TRANSPORTER IV Platform/Chassis (70E, 70L, 70M, 7DE, 7DL, 7D) 134

2.5 85 kW (115 PS) APL, AVT	08.1996→04.2003		7.05271.21.0	LS	1250 mm	 APL, AVT: Diagnosesonde Diagnostic Probe
2.5 Syncro 85 kW (115 PS) APL, AVT	08.1996→04.2003		7.05271.21.0	LS	1250 mm	 APL, AVT: Diagnosesonde Diagnostic Probe
2.5 TDI 75 kW (102 PS) ACV, AUF, AYC	09.1995→04.2003		7.22939.03.0	AGR	PN	mit Rohrstutzen with pipe socket  ACV, AUF:  ch. 70-1-048 286→
2.5 TDI 65 kW (88 PS) AJT, AYY	05.1998→04.2003		7.22939.03.0	AGR	PN	mit Rohrstutzen with pipe socket  AJT, AYY:  ch. 70-1-048 286→
2.5 TDI Syncro 75 kW (102 PS) ACV	05.1998→04.2003		7.22939.03.0	AGR	PN	mit Rohrstutzen with pipe socket   ch. 70-1-048 286→
2.5 TDI Syncro 75 kW (102 PS) AXL	05.1998→04.2003		7.22939.03.0	AGR	PN	mit Rohrstutzen with pipe socket   ch. 70-1-048 286→
			7.24809.61.0	AGR	PN	
2.8 103 kW (140 PS) AES	05.1996→05.2000		7.22090.11.0	ARV	PN	 Fahrgestellnummer ab: 70-T-200 001 Vehicle Identification Number from: 70-T-200 001
			7.05270.88.0	LS	740 mm	
			7.05270.96.0	LS	1440 mm	Diagnosesonde Diagnostic Probe
2.8 VR6 150 kW (204 PS) AMV	06.2000→04.2003		7.22286.41.0	ARV	PN	
			7.05271.23.0	LS	900 mm	
			7.05271.24.0	LS	1500 mm	vor Katalysator in front of the catalyst
			7.05271.21.0	LS	1250 mm	Diagnosesonde Diagnostic Probe
			7.22738.08.0	SLP	EL	



TRANSPORTER IV Van (70A, 70H, 7DA, 7DH) 135

2.5 85 kW (115 PS) APL, AVT	08.1996→04.2003		7.05271.21.0	LS	1250 mm	 APL, AVT: Diagnosesonde Diagnostic Probe
2.5 Syncro 85 kW (115 PS) APL, AVT	08.1996→04.2003		7.05271.21.0	LS	1250 mm	 APL, AVT: Diagnosesonde Diagnostic Probe
2.5 TDI 75 kW (102 PS) ACV, AUF, AYC	09.1995→04.2003		7.22939.03.0	AGR	PN	mit Rohrstutzen with pipe socket  ACV, AUF:  ch. 70-1-048 286→
2.5 TDI 65 kW (88 PS) AJT, AYY	12.1998→04.2003		7.22939.03.0	AGR	PN	mit Rohrstutzen with pipe socket  AJT, AYY:  ch. 70-1-048 286→
2.5 TDI 111 kW (151 PS) AXG	09.2000→04.2003		7.24809.61.0	AGR	PN	 AXG:  ch. 70-1-048 286→  AXG:  ch. 70-1-048 286→
2.5 TDI Syncro 75 kW (102 PS) ACV	09.1995→04.2003		7.22939.03.0	AGR	PN	mit Rohrstutzen with pipe socket   ch. 70-1-048 286→
2.5 TDI Syncro 75 kW (102 PS) AXL	09.1995→04.2003		7.22939.03.0	AGR	PN	mit Rohrstutzen with pipe socket   ch. 70-1-048 286→
			7.24809.61.0	AGR	PN	







V



TRANSPORTER IV Van (70A, 70H, 7DA, 7DH) 135

2.8 VR6 103 kW (140 PS) AES	05.1996→05.2000		7.22090.11.0	ARV	PN	<input type="checkbox"/> Fahrgestellnummer ab: 70-T-200 001 Vehicle Identification Number from: 70-T-200 001
			7.05270.88.0	LS	740 mm	
			7.05270.96.0	LS	1440 mm	
2.8 VR6 150 kW (204 PS) AMV	06.2000→04.2003		7.22286.41.0	ARV	PN	<input type="checkbox"/> vor Katalysator in front of the catalyst Diagnosesonde Diagnostic Probe
			7.05271.23.0	LS	900 mm	
			7.05271.24.0	LS	1500 mm	
			7.05271.21.0	LS	1250 mm	
			7.22738.08.0	SLP	EL	



























TRANSPORTER V Bus (7HB, 7HJ, 7EB, 7EJ, 7EF, 7EG, 7HF, 7EC) 136

1.9 TDI 63 kW (85 PS) AXC	04.2003→11.2009		7.24809.20.0	AGR	PN	<input type="checkbox"/>
1.9 TDI 77 kW (105 PS) AXB	04.2003→11.2009		7.24809.20.0	AGR	PN	<input type="checkbox"/>
1.9 TDI 62 kW (84 PS) BRR	01.2006→11.2009		7.00365.06.0	AGR	EL	<input type="checkbox"/> vor Rußpartikelfilter before soot particulate filter für OE-Nummer: 059 906 051 A, 07Z 906 051 B for OE number: 059 906 051 A, 07Z 906 051 B ohne Zubehör without accessories für OE-Nummer: 076 906 051 A for OE number: 076 906 051 A
			7.08369.33.0	ATS	EL	
			7.08369.36.0	ATS	EL	
			7.08369.63.0	ATS	EL	
			7.11190.02.0	DDS		
1.9 TDI 75 kW (102 PS) BRS	06.2006→11.2009		7.00365.06.0	AGR	EL	<input type="checkbox"/> vor Rußpartikelfilter before soot particulate filter für OE-Nummer: 07Z 906 051 B, 059 906 051 A for OE number: 07Z 906 051 B, 059 906 051 A ohne Zubehör without accessories für OE-Nummer: 076 906 051 A for OE number: 076 906 051 A
			7.08369.33.0	ATS	EL	
			7.08369.36.0	ATS	EL	
			7.08369.63.0	ATS	EL	
			7.11190.02.0	DDS		
2.0 85 kW (115 PS) AXA	11.2003→08.2015		7.22934.63.0	SLP	EL	<input type="checkbox"/> Fahrgestellnummer ab: 7H-3-000 001, 7J-3-000 001 Vehicle Identification Number from: 7H-3-000 001, 7J-3-000 001
			7.22778.80.0	SLV	PN	
2.0 BiTDI 132 kW (180 PS) CFCA	09.2009→08.2015		7.03196.09.0	AGR	EL	<input type="checkbox"/>
			7.02756.07.0	AGR-K		











































TRANSPORTER V Bus (7HB, 7HJ, 7EB, 7EJ, 7EF, 7EG, 7HF, 7EC) 136

			7.08369.20.0	ATS	EL	Fahrgestellnummer ab: 7H-A-200 001, 7J-A-200 001 Vehicle Identification Number from: 7H-A-200 001, 7J-A-200 001
			7.08369.24.0	ATS	EL	Fahrgestellnummer ab: 7H-A-200 001, 7J-A-200 001 Vehicle Identification Number from: 7H-A-200 001, 7J-A-200 001
			7.11492.00.0	DDS		ohne Zubehör without accessories  ch. 7J-A-200 001→
2.0 BiTDI 4motion 132 kW (180 PS) CFCA	09.2009→08.2015		7.03196.09.0	AGR	EL	
			7.02756.07.0	AGR-K		
			7.08369.21.0	ATS	EL	 CFCA:  ch. 7H-A-200 001→  CFCA:  ch. 7H-C-000 001→
			7.08369.25.0	ATS	EL	Fahrgestellnummer ab: 7H-A-200 001, 7J-A-200 001 Vehicle Identification Number from: 7H-A-200 001, 7J-A-200 001
			7.11492.00.0	DDS		ohne Zubehör without accessories  ch. 7J-A-200 001→
2.0 CNG 85 kW (115 PS) AXA	01.2006→08.2015		7.22934.63.0	SLP	EL	
			7.22778.80.0	SLV	PN	 Fahrgestellnummer ab: 7H-3-000 001, 7J-3-000 001 Vehicle Identification Number from: 7H-3-000 001, 7J-3-000 001
2.0 TDI 62 kW (84 PS) CAAA	09.2009→08.2015		7.09720.04.0	AGR-K	EL	
			7.11020.06.0	ATS	EL	 ch. 7H-A-200 001→
			7.08369.20.0	ATS	EL	Fahrgestellnummer ab: 7H-A-200 001, 7J-A-200 001 Vehicle Identification Number from: 7H-A-200 001, 7J-A-200 001
			7.08369.24.0	ATS	EL	Fahrgestellnummer ab: 7H-A-200 001, 7J-A-200 001 Vehicle Identification Number from: 7H-A-200 001, 7J-A-200 001
2.0 TDI 75 kW (102 PS) CAAB	09.2009→08.2015		7.09720.04.0	AGR-K	EL	  ch. 7H-A-200 001→
			7.11020.06.0	ATS	EL	 ch. 7H-A-200 001→
			7.08369.20.0	ATS	EL	Fahrgestellnummer ab: 7H-A-200 001, 7J-A-200 001 Vehicle Identification Number from: 7H-A-200 001, 7J-A-200 001
			7.08369.24.0	ATS	EL	Fahrgestellnummer ab: 7H-A-200 001, 7J-A-200 001 Vehicle Identification Number from: 7H-A-200 001, 7J-A-200 001
V 2.0 TDI 103 kW (140 PS) CAAC, CCHA	09.2009→08.2015		7.09720.04.0	AGR-K	EL	  CAAC, CCHA:  ch. 7H-A-200 001→
			7.08369.93.0	ATS	EL	 CAAC, CCHA:  ch. 7H-A-200 001→ch. 7H-C-000 000
			7.08369.92.0	ATS	EL	 CAAC, CCHA:  ch. 7H-C-000 001→
			7.08369.20.0	ATS	EL	 CAAC, CCHA: Fahrgestellnummer ab: 7H-A-200 001, 7J-A-200 001 Vehicle Identification Number from: 7H-A-200 001, 7J-A-200 001



TRANSPORTER V Bus (7HB, 7HJ, 7EB, 7EJ, 7EF, 7EG, 7HF, 7EC) 136

			7.08369.24.0	ATS	EL	 CAAC, CCHA: Fahrgestellnummer ab: 7H-A-200 001, 7J-A-200 001 Vehicle Identification Number from: 7H-A-200 001, 7J-A-200 001
			7.11492.00.0	DDS		ohne Zubehör without accessories  CAAC:  ch. 7J-A-200 001→  CCHA:  ch. 7H-A-200 001→
2.0 TDI 100 kW (136 PS) CAAE, CCHB	05.2010→08.2015		7.09720.04.0	AGR-K	EL	 CAAE, CCHB:  ch. 7H-A-200 001→
			7.08369.93.0	ATS	EL	 CAAE, CCHB:  ch. 7H-A-200 001→ch. 7H-C-000 000
			7.08369.92.0	ATS	EL	 CAAE, CCHB:  ch. 7H-C-000 001→
			7.08369.20.0	ATS	EL	 CAAE, CCHB: Fahrgestellnummer ab: 7H-A-200 001, 7J-A-200 001 Vehicle Identification Number from: 7H-A-200 001, 7J-A-200 001
			7.08369.24.0	ATS	EL	 CAAE, CCHB: Fahrgestellnummer ab: 7H-A-200 001, 7J-A-200 001 Vehicle Identification Number from: 7H-A-200 001, 7J-A-200 001
			7.11492.00.0	DDS		ohne Zubehör without accessories  CAAE, CCHB:  ch. 7J-A-200 001→
2.0 TDI 84 kW (114 PS) CAAD	05.2011→08.2015		7.09720.04.0	AGR-K	EL	
			7.08369.92.0	ATS	EL	 ch. 7H-C-000 001→
			7.08369.20.0	ATS	EL	Fahrgestellnummer ab: 7H-C-000 001, 7J-C-000 001 Vehicle Identification Number from: 7H-C-000 001, 7J-C-000 001
			7.08369.24.0	ATS	EL	Fahrgestellnummer ab: 7H-C-000 001, 7J-C-000 001 Vehicle Identification Number from: 7H-C-000 001, 7J-C-000 001
2.0 TDI 4motion 103 kW (140 PS) CAAC, CCHA	09.2009→08.2015		7.09720.04.0	AGR-K	EL	 CAAC, CCHA:  ch. 7H-A-200 001→
			7.08369.93.0	ATS	EL	 CAAC, CCHA:  ch. 7H-A-200 001→ch. 7H-C-000 000
			7.08369.21.0	ATS	EL	 CAAC, CCHA:  ch. 7H-A-200 001→  CAAC, CCHA:  ch. 7H-C-000 001→
			7.08369.92.0	ATS	EL	 CAAC, CCHA:  ch. 7H-C-000 001→
			7.08369.25.0	ATS	EL	 CAAC: Fahrgestellnummer ab: 7H-A-200 001, 7J-A-200 001 Vehicle Identification Number from: 7H-A-200 001, 7J-A-200 001  CCHA: Fahrgestellnummer ab: 7H-C-200 001, 7J-C-200 001 Vehicle Identification Number from: 7H-C-200 001, 7J-C-200 001
			7.11492.00.0	DDS		ohne Zubehör without accessories  CAAC:  ch. 7J-A-200 001→  CCHA:  ch. 7H-A-200 001→
2.0 TDI 4motion 100 kW (136 PS) CAAE, CCHB	05.2010→08.2015		7.09720.04.0	AGR-K	EL	 CAAE, CCHB:  ch. 7H-A-200 001→















TRANSPORTER V Bus (7HB, 7HJ, 7EB, 7EJ, 7EF, 7EG, 7HF, 7EC) 136

			7.08369.93.0	ATS	EL	CAAE, CCHB: ch. 7H-A-200 001→ch. 7H-C-000 000
			7.08369.21.0	ATS	EL	CAAE, CCHB: ch. 7H-A-200 001→ CAAE: ch. 7H-C-000 001→
			7.08369.92.0	ATS	EL	CAAE, CCHB: ch. 7H-C-000 001→
			7.08369.25.0	ATS	EL	CAAE, CCHB: Fahrgestellnummer ab: 7H-A-200 001, 7J-A-200 001 Vehicle Identification Number from: 7H-A-200 001, 7J-A-200 001
			7.11492.00.0	DDS		ohne Zubehör without accessories CAAE: ch. 7J-A-200 001→ CCHB: ch. 7H-A-200 001 →
2.5 TDI 96 kW (130 PS) AXD	04.2003→11.2009		7.24809.38.0	AGR	PN	
2.5 TDI 96 kW (130 PS) BNZ	04.2003→11.2009		7.00823.06.0	AGR	EL	
			7.08369.96.0	ATS	EL	BNZ: ch. 7H-6-000 001→ch. 7H-6-200 000 BNZ: ch. 7H-7-000 001→ch. 7H-7-200 000 BNZ: ch. 7H-8-000 001→ch. 7H-8-200 000 BNZ: ch. 7H-9-000 001→ch. 7H-9-200 000
			7.08369.18.0	ATS	EL	Fahrgestellnummer ab: 7H-6-000 001, 7J-6-000 001 Vehicle Identification Number from: 7H-6-000 001, 7J-6-000 001
			7.08369.31.0	ATS	EL	Fahrgestellnummer ab: 7H-6-000 001, 7J-6-000 001 Vehicle Identification Number from: 7H-6-000 001, 7J-6-000 001 vor Rußpartikelfilter before soot particulate filter
			7.11190.02.0	DDS		für OE-Nummer: 059 906 051 A, 07Z 906 051 B for OE number: 059 906 051 A, 07Z 906 051 B
			7.11492.02.0	DDS		ohne Zubehör without accessories für OE-Nummer: 076 906 051 A for OE number: 076 906 051 A
2.5 TDI 96-128 kW (131-174 PS) AXE	04.2003→11.2009		7.24809.38.0	AGR	PN	
2.5 TDI 128 kW (174 PS) BPC	04.2003→11.2009		7.00823.06.0	AGR	EL	
			7.08369.96.0	ATS	EL	BPC: ch. 7H-6-000 001→ch. 7H-6-200 000 BPC: ch. 7H-7-000 001→ch. 7H-7-200 000 BPC: ch. 7H-8-000 001→ch. 7H-8-200 000 BPC: ch. 7H-9-000 001→ch. 7H-9-200 000

V









TRANSPORTER V Bus (7HB, 7HJ, 7EB, 7EJ, 7EF, 7EG, 7HF, 7EC) 136

			7.08369.18.0	ATS	EL	Fahrgestellnummer ab: 7H-6-000 001, 7J-6-000 001 Vehicle Identification Number from: 7H-6-000 001, 7J-6-000 001
			7.08369.31.0	ATS	EL	Fahrgestellnummer ab: 7H-6-000 001, 7J-6-000 001 Vehicle Identification Number from: 7H-6-000 001, 7J-6-000 001 vor Rußpartikelfilter before soot particulate filter
			7.11190.02.0	DDS		für OE-Nummer: 059 906 051 A, 07Z 906 051 B for OE number: 059 906 051 A, 07Z 906 051 B
			7.11492.02.0	DDS		ohne Zubehör without accessories für OE-Nummer: 7.11492.02.0 for OE number: 7.11492.02.0
2.5 TDI 4motion 96 kW (130 PS) AXD	07.2004→11.2009		7.24809.38.0	AGR	PN	
2.5 TDI 4motion 96 kW (130 PS) BNZ	07.2004→11.2009		7.00823.06.0	AGR	EL	
			7.08369.18.0	ATS	EL	Fahrgestellnummer ab: 7H-6-000 001, 7J-6-000 001 Vehicle Identification Number from: 7H-6-000 001, 7J-6-000 001
			7.08369.31.0	ATS	EL	Fahrgestellnummer ab: 7H-6-000 001, 7J-6-000 001 Vehicle Identification Number from: 7H-6-000 001, 7J-6-000 001 vor Rußpartikelfilter before soot particulate filter
			7.11190.02.0	DDS		für OE-Nummer: 059 906 051 A, 07Z 906 051 B for OE number: 059 906 051 A, 07Z 906 051 B
			7.11492.02.0	DDS		ohne Zubehör without accessories für OE-Nummer: 076 906 051 A for OE number: 076 906 051 A
2.5 TDI 4motion 96-128 kW (131-174 PS) AXE	07.2004→11.2009		7.24809.38.0	AGR	PN	
2.5 TDI 4motion 128 kW (174 PS) BPC	07.2004→11.2009		7.00823.06.0	AGR	EL	
			7.08369.18.0	ATS	EL	Fahrgestellnummer ab: 7H-6-000 001, 7J-6-000 001 Vehicle Identification Number from: 7H-6-000 001, 7J-6-000 001
			7.08369.31.0	ATS	EL	Fahrgestellnummer ab: 7H-6-000 001, 7J-6-000 001 Vehicle Identification Number from: 7H-6-000 001, 7J-6-000 001 vor Rußpartikelfilter before soot particulate filter
			7.11190.02.0	DDS		für OE-Nummer: 059 906 051 A, 07Z 906 051 B for OE number: 059 906 051 A, 07Z 906 051 B
			7.11492.02.0	DDS		ohne Zubehör without accessories für OE-Nummer: 076 906 051 A for OE number: 076 906 051 A
2.5 TDi 120 kW (163 PS) BLJ	11.2003→11.2009		7.24809.38.0	AGR	PN	











TRANSPORTER V Bus (7HB, 7HJ, 7EB, 7EJ, 7EF, 7EG, 7HF, 7EC) 136

3.2 V6 170 kW (231 PS) BDL	02.2004→06.2004	 7.22286.41.0	ARV	PN	<input type="checkbox"/>
		7.22934.63.0	SLP	EL	
3.2 V6 173 kW (235 PS) BKK	02.2004→11.2009	 7.22286.41.0	ARV	PN	<input type="checkbox"/>
		7.22934.63.0	SLP	EL	
3.2 V6 173 kW (235 PS) CFLA	02.2004→11.2009	 7.22934.63.0	SLP	EL	
3.2 V6 4motion 173 kW (235 PS) BKK	11.2003→12.2009	 7.22286.41.0	ARV	PN	<input type="checkbox"/>
		7.22934.63.0	SLP	EL	
3.2 V6 4motion 170 kW (231 PS) BDL	11.2003→11.2009	 7.22286.41.0	ARV	PN	<input type="checkbox"/>
		7.22934.63.0	SLP	EL	
3.2 V6 4motion 173 kW (235 PS) CFLA	05.2008→12.2009	 7.22934.63.0	SLP	EL	





















TRANSPORTER V Platform/Chassis (7JD, 7JE, 7JL, 7JY, 7JZ, 7FD) 137

1.9 TDI 63 kW (85 PS) AXC	04.2003→11.2009	 7.24809.20.0	AGR	PN	<input type="checkbox"/>	
1.9 TDI 77 kW (105 PS) AXB	04.2003→11.2009	 7.24809.20.0	AGR	PN	<input type="checkbox"/>	
1.9 TDI 62 kW (84 PS) BRR	01.2006→11.2009	 7.00365.06.0	AGR	EL	<input type="checkbox"/>	
		7.08369.33.0	ATS	EL		
		7.08369.36.0	ATS	EL		vor Rußpartikelfilter before soot particulate filter
		7.08369.63.0	ATS	EL		
		7.11190.02.0	DDS			für OE-Nummer: 059 906 051 A, 07Z 906 051 B for OE number: 059 906 051 A, 07Z 906 051 B
		7.11492.02.0	DDS			ohne Zubehör without accessories für OE-Nummer: 076 906 051 A for OE number: 076 906 051 A
1.9 TDI 75 kW (102 PS) BRS	06.2006→11.2009	 7.00365.06.0	AGR	EL	<input type="checkbox"/>	
		7.08369.33.0	ATS	EL		
		7.08369.36.0	ATS	EL		vor Rußpartikelfilter before soot particulate filter
		7.08369.63.0	ATS	EL		
		7.11190.02.0	DDS			für OE-Nummer: 059 906 051 A, 07Z 906 051 B for OE number: 059 906 051 A, 07Z 906 051 B
		7.11492.02.0	DDS			ohne Zubehör without accessories für OE-Nummer: 076 906 051 A for OE number: 076 906 051 A
2.0 85 kW (115 PS) AXA	11.2003→05.2013	 7.22934.63.0	SLP	EL	<input type="checkbox"/>	
		7.22778.80.0	SLV	PN		Fahrgestellnummer ab: 7H-3-000 001, 7J-3-000 001 Vehicle Identification Number from: 7H-3-000 001, 7J-3-000 001
2.0 BiTDI 132 kW (180 PS) CFCA	09.2009→08.2015	 7.03196.09.0	AGR	EL	<input type="checkbox"/>	
		7.02756.07.0	AGR-K			

V

























TRANSPORTER V Platform/Chassis (7JD, 7JE, 7JL, 7JY, 7JZ, 7FD) 137

			7.08369.20.0	ATS	EL	Fahrgestellnummer ab: 7H-A-200 001, 7J-A-200 001 Vehicle Identification Number from: 7H-A-200 001, 7J-A-200 001
			7.08369.24.0	ATS	EL	Fahrgestellnummer ab: 7H-A-200 001, 7J-A-200 001 Vehicle Identification Number from: 7H-A-200 001, 7J-A-200 001
			7.11492.00.0	DDS		ohne Zubehör without accessories  ch. 7J-A-200 001→
2.0 BiTDI 4motion 132 kW (180 PS) CFCA	09.2009→08.2015		7.03196.09.0	AGR	EL	
			7.02756.07.0	AGR-K		
			7.08369.21.0	ATS	EL	 CFCA:  ch. 7J-A-200 001→  CFCA:  ch. 7J-C-000 001→
			7.08369.25.0	ATS	EL	Fahrgestellnummer ab: 7H-A-200 001, 7J-A-200 001 Vehicle Identification Number from: 7H-A-200 001, 7J-A-200 001
			7.11492.00.0	DDS		ohne Zubehör without accessories  ch. 7J-A-200 001→
2.0 CNG 85 kW (115 PS) AXA	11.2003→05.2011		7.22934.63.0	SLP	EL	
			7.22778.80.0	SLV	PN	 Fahrgestellnummer ab: 7H-3-000 001, 7J-3-000 001 Vehicle Identification Number from: 7H-3-000 001, 7J-3-000 001
2.0 TDI 62 kW (84 PS) CAAA	09.2009→08.2015		7.09720.04.0	AGR-K	EL	
			7.11020.06.0	ATS	EL	
			7.08369.20.0	ATS	EL	Fahrgestellnummer ab: 7H-A-200 001, 7J-A-200 001 Vehicle Identification Number from: 7H-A-200 001, 7J-A-200 001
			7.08369.24.0	ATS	EL	Fahrgestellnummer ab: 7H-A-200 001, 7J-A-200 001 Vehicle Identification Number from: 7H-A-200 001, 7J-A-200 001
2.0 TDI 75 kW (102 PS) CAAB	09.2009→08.2015		7.09720.04.0	AGR-K	EL	  ch. 7J-A-200 001→
			7.11020.06.0	ATS	EL	 ch. 7J-A-200 001→
			7.08369.20.0	ATS	EL	Fahrgestellnummer ab: 7H-A-200 001, 7J-A-200 001 Vehicle Identification Number from: 7H-A-200 001, 7J-A-200 001
			7.08369.24.0	ATS	EL	Fahrgestellnummer ab: 7H-A-200 001, 7J-A-200 001 Vehicle Identification Number from: 7H-A-200 001, 7J-A-200 001
2.0 TDI 103 kW (140 PS) CAAC	09.2009→08.2015		7.09720.04.0	AGR-K	EL	  ch. 7J-A-200 001→
			7.08369.93.0	ATS	EL	 ch. 7H-A-200 001→ch. 7H-C-000 000
			7.08369.92.0	ATS	EL	 ch. 7J-C-000 001→
			7.08369.20.0	ATS	EL	Fahrgestellnummer ab: 7H-A-200 001, 7J-A-200 001 Vehicle Identification Number from: 7H-A-200 001, 7J-A-200 001































TRANSPORTER V Platform/Chassis (7JD, 7JE, 7JL, 7JY, 7JZ, 7FD) 137

			7.08369.24.0	ATS	EL	Fahrgestellnummer ab: 7H-A-200 001, 7J-A-200 001 Vehicle Identification Number from: 7H-A-200 001, 7J-A-200 001
			7.11492.00.0	DDS		ohne Zubehör without accessories  ch. 7J-A-200 001→
2.0 TDI 103 kW (140 PS) CCHA	09.2009→08.2015		7.09720.04.0	AGR-K	EL	  ch. 7J-A-200 001→
			7.08369.20.0	ATS	EL	Fahrgestellnummer ab: 7H-A-200 001, 7J-A-200 001 Vehicle Identification Number from: 7H-A-200 001, 7J-A-200 001
			7.08369.24.0	ATS	EL	Fahrgestellnummer ab: 7H-A-200 001, 7J-A-200 001 Vehicle Identification Number from: 7H-A-200 001, 7J-A-200 001
			7.11492.00.0	DDS		ohne Zubehör without accessories  ch. 7H-A-200 001→
2.0 TDI 100 kW (136 PS) CAAE	05.2010→08.2015		7.09720.04.0	AGR-K	EL	
			7.08369.93.0	ATS	EL	 ch. 7H-A-200 001→ch. 7H-C-000 000
			7.08369.92.0	ATS	EL	 ch. 7J-C-000 001→
			7.08369.20.0	ATS	EL	Fahrgestellnummer ab: 7H-A-200 001, 7J-A-200 001 Vehicle Identification Number from: 7H-A-200 001, 7J-A-200 001
			7.08369.24.0	ATS	EL	Fahrgestellnummer ab: 7H-A-200 001, 7J-A-200 001 Vehicle Identification Number from: 7H-A-200 001, 7J-A-200 001
2.0 TDI 84 kW (114 PS) CAAD	05.2011→08.2015		7.09720.04.0	AGR-K	EL	
			7.08369.20.0	ATS	EL	Fahrgestellnummer ab: 7H-C-000 001, 7J-C-000 001 Vehicle Identification Number from: 7H-C-000 001, 7J-C-000 001
			7.08369.24.0	ATS	EL	Fahrgestellnummer ab: 7H-C-000 001, 7J-C-000 001 Vehicle Identification Number from: 7H-C-000 001, 7J-C-000 001
			7.11492.00.0	DDS		ohne Zubehör without accessories  ch. 7J-A-200 001→
2.0 TDI 4motion 103 kW (140 PS) CAAC	09.2009→08.2015		7.09720.04.0	AGR-K	EL	  ch. 7J-A-200 001→
			7.08369.93.0	ATS	EL	 ch. 7H-A-200 001→ch. 7H-C-000 000
			7.08369.92.0	ATS	EL	 ch. 7H-C-000 001→
			7.08369.21.0	ATS	EL	CAAC:  ch. 7J-A-200 001→ CAAC:  ch. 7J-C-000 001→
			7.08369.25.0	ATS	EL	Fahrgestellnummer ab: 7H-A-200 001, 7J-A-200 001 Vehicle Identification Number from: 7H-A-200 001, 7J-A-200 001
			7.11492.00.0	DDS		ohne Zubehör without accessories  ch. 7J-A-200 001→
2.0 TDI 4motion 103 kW (140 PS) CCHA	09.2009→08.2015		7.09720.04.0	AGR-K	EL	  ch. 7J-A-200 001→





















TRANSPORTER V Platform/Chassis (7JD, 7JE, 7JL, 7JY, 7JZ, 7FD) 137

			7.08369.25.0	ATS	EL	Fahrgestellnummer ab: 7H-C-000 001, 7J-C-000 001 Vehicle Identification Number from: 7H-C-000 001, 7J-C-000 001
			7.11492.00.0	DDS		ohne Zubehör without accessories  ch. 7H-A-200 001→
2.0 TDI 4motion 100 kW (136 PS) CAAE	05.2010→08.2015		7.09720.04.0	AGR-K	EL	 ch. 7J-A-200 001→
			7.08369.93.0	ATS	EL	 ch. 7H-A-200 001→ch. 7H-C-000 000
			7.08369.21.0	ATS	EL	 CAAE:  ch. 7J-C-000 001→  CAAE:  ch. 7J-A-200 001→
			7.08369.92.0	ATS	EL	 ch. 7J-C-000 001→
			7.08369.25.0	ATS	EL	Fahrgestellnummer ab: 7H-A-200 001, 7J-A-200 001 Vehicle Identification Number from: 7H-A-200 001, 7J-A-200 001
			7.11492.00.0	DDS		ohne Zubehör without accessories  ch. 7J-A-200 001→
2.0 TDI 4motion 100 kW (136 PS) CCHB	05.2010→08.2015		7.09720.04.0	AGR-K	EL	 ch. 7J-A-200 001→
			7.08369.25.0	ATS	EL	Fahrgestellnummer ab: 7H-A-200 001, 7J-A-200 001 Vehicle Identification Number from: 7H-A-200 001, 7J-A-200 001
			7.11492.00.0	DDS		ohne Zubehör without accessories  ch. 7H-A-200 001→
2.5 TDI 96 kW (130 PS) AXD	04.2003→11.2009		7.24809.38.0	AGR	PN	
2.5 TDI 96 kW (130 PS) BNZ	04.2003→11.2009		7.00823.06.0	AGR	EL	
			7.08369.96.0	ATS	EL	 BNZ:  ch. 7J-6-000 001→ch. 7J-6-050 000
						 BNZ:  ch. 7J-7-000 001→ch. 7J-7-040 000
						 BNZ:  ch. 7J-8-000 001→ch. 7J-8-030 000
						 BNZ:  ch. 7J-9-000 001→ch. 7J-9-020 000
			7.08369.18.0	ATS	EL	Fahrgestellnummer ab: 7H-6-000 001, 7J-6-000 001 Vehicle Identification Number from: 7H-6-000 001, 7J-6-000 001
			7.08369.31.0	ATS	EL	Fahrgestellnummer ab: 7H-6-000 001, 7J-6-000 001 Vehicle Identification Number from: 7H-6-000 001, 7J-6-000 001 vor Rußpartikelfilter before soot particulate filter
			7.11190.02.0	DDS		für OE-Nummer: 059 906 051 A, 07Z 906 051 B for OE number: 059 906 051 A, 07Z 906 051 B
7.11492.02.0	DDS		ohne Zubehör without accessories für OE-Nummer: 076 906 051 A for OE number: 076 906 051 A			
2.5 TDI 96-128 kW (131-174 PS) AXE	04.2003→11.2009		7.24809.38.0	AGR	PN	











TRANSPORTER V Platform/Chassis (7JD, 7JE, 7JL, 7JY, 7JZ, 7FD) 137

2.5 TDI 128 kW (174 PS) BPC	04.2003→11.2009		7.00823.06.0	AGR	EL 
			7.08369.96.0	ATS	EL  BPC:  ch. 7J-6-000 001→ch. 7J-6-050 000  BPC:  ch. 7J-7-000 001→ch. 7J-7-040 000  BPC:  ch. 7J-8-000 001→ch. 7J-8-030 000  BPC:  ch. 7J-9-000 001→ch. 7J-9-020 000
			7.08369.18.0	ATS	EL Fahrgestellnummer ab: 7H-6-000 001, 7J-6-000 001 Vehicle Identification Number from: 7H-6-000 001, 7J-6-000 001
			7.08369.31.0	ATS	EL Fahrgestellnummer ab: 7H-6-000 001, 7J-6-000 001 Vehicle Identification Number from: 7H-6-000 001, 7J-6-000 001 vor Rußpartikelfilter before soot particulate filter
			7.11190.02.0	DDS	für OE-Nummer: 059 906 051 A, 07Z 906 051 B for OE number: 059 906 051 A, 07Z 906 051 B
7.11492.02.0	DDS	ohne Zubehör without accessories für OE-Nummer: 076 906 051 A for OE number: 076 906 051 A			
2.5 TDI 4motion 96-128 kW (131-174 PS) AXE	04.2004→11.2009		7.24809.38.0	AGR	PN 
2.5 TDI 4motion 128 kW (174 PS) BPC	04.2004→11.2009		7.00823.06.0	AGR	EL 
			7.08369.18.0	ATS	EL Fahrgestellnummer ab: 7H-6-000 001, 7J-6-000 001 Vehicle Identification Number from: 7H-6-000 001, 7J-6-000 001
			7.08369.31.0	ATS	EL Fahrgestellnummer ab: 7H-6-000 001, 7J-6-000 001 Vehicle Identification Number from: 7H-6-000 001, 7J-6-000 001 vor Rußpartikelfilter before soot particulate filter
			7.11190.02.0	DDS	für OE-Nummer: 059 906 051 A, 07Z 906 051 B for OE number: 059 906 051 A, 07Z 906 051 B
7.11492.02.0	DDS	ohne Zubehör without accessories für OE-Nummer: 076 906 051 A for OE number: 076 906 051 A			
2.5 TDI 4motion 96 kW (130 PS) AXD	07.2004→11.2009		7.24809.38.0	AGR	PN 
2.5 TDI 4motion 96 kW (130 PS) BNZ	07.2004→11.2009		7.00823.06.0	AGR	EL 
			7.08369.18.0	ATS	EL Fahrgestellnummer ab: 7H-6-000 001, 7J-6-000 001 Vehicle Identification Number from: 7H-6-000 001, 7J-6-000 001











V



TRANSPORTER V Platform/Chassis (7JD, 7JE, 7JL, 7JY, 7JZ, 7FD) 137















			7.08369.31.0	ATS	EL	Fahrgestellnummer ab: 7H-6-000 001, 7J-6-000 001 Vehicle Identification Number from: 7H-6-000 001, 7J-6-000 001 vor Rußpartikelfilter before soot particulate filter für OE-Nummer: 059 906 051 A, 07Z 906 051 B for OE number: 059 906 051 A, 07Z 906 051 B ohne Zubehör without accessories für OE-Nummer: 076 906 051 A for OE number: 076 906 051 A
			7.11190.02.0	DDS		
			7.11492.02.0	DDS		
3.2 4motion 170 kW (231 PS) BDL	11.2003→11.2009		7.22286.41.0	ARV	PN	
			7.22934.63.0	SLP	EL	
3.2 V6 173 kW (235 PS) BKK	08.2003→05.2006		7.22286.41.0	ARV	PN	
			7.22934.63.0	SLP	EL	
3.2 V6 170 kW (231 PS) BDL	02.2004→11.2009		7.22286.41.0	ARV	PN	
			7.22934.63.0	SLP	EL	

TRANSPORTER V Van (7HA, 7HH, 7EA, 7EH) 138

1.9 TDI 63 kW (85 PS) AXC	04.2003→11.2009		7.24809.20.0	AGR	PN		
1.9 TDI 77 kW (105 PS) AXB	04.2003→11.2009		7.24809.20.0	AGR	PN		
1.9 TDI 62 kW (84 PS) BRR	01.2006→11.2009		7.00365.06.0	AGR	EL		
			7.08369.33.0	ATS	EL		
			7.08369.36.0	ATS	EL		vor Rußpartikelfilter before soot particulate filter
			7.08369.63.0	ATS	EL		
			7.11190.02.0	DDS			für OE-Nummer: 059 906 051 A, 07Z 906 051 B for OE number: 059 906 051 A, 07Z 906 051 B ohne Zubehör without accessories für OE-Nummer: 076 906 051 A for OE number: 076 906 051 A
			7.11492.02.0	DDS		ohne Zubehör without accessories für OE-Nummer: 076 906 051 A for OE number: 076 906 051 A	
1.9 TDI 75 kW (102 PS) BRS	06.2006→11.2009		7.00365.06.0	AGR	EL		
			7.08369.33.0	ATS	EL		
			7.08369.36.0	ATS	EL		vor Rußpartikelfilter before soot particulate filter
			7.08369.63.0	ATS	EL		
			7.11190.02.0	DDS			für OE-Nummer: 059 906 051 A, 07Z 906 051 B for OE number: 059 906 051 A, 07Z 906 051 B ohne Zubehör without accessories für OE-Nummer: 076 906 051 A for OE number: 076 906 051 A
			7.11492.02.0	DDS		ohne Zubehör without accessories für OE-Nummer: 076 906 051 A for OE number: 076 906 051 A	
2.0 85 kW (115 PS) AXA	11.2003→08.2015		7.22934.63.0	SLP	EL		
			7.22778.80.0	SLV	PN		
						Fahrgestellnummer ab: 7H-3-000 001, 7J-3-000 001 Vehicle Identification Number from: 7H-3-000 001, 7J-3-000 001	



TRANSPORTER V Van (7HA, 7HH, 7EA, 7EH) 138

2.0 BiFuel 85 kW (115 PS) AXA	05.2011→08.2015		7.22934.63.0	SLP	EL	<input type="checkbox"/> Fahrgestellnummer ab: 7H-3-000 001, 7J-3-000 001 Vehicle Identification Number from: 7H-3-000 001, 7J-3-000 001
			7.22778.80.0	SLV	PN	
2.0 BiTDI 132 kW (180 PS) CFCA	09.2009→08.2015		7.03196.09.0	AGR	EL	<input type="checkbox"/> Fahrgestellnummer ab: 7H-A-200 001, 7J-A-200 001 Vehicle Identification Number from: 7H-A-200 001, 7J-A-200 001 Fahrgestellnummer ab: 7H-A-200 001, 7J-A-200 001 Vehicle Identification Number from: 7H-A-200 001, 7J-A-200 001 ohne Zubehör without accessories  ch. 7J-A-200 001→
			7.02756.07.0	AGR-K	EL	
			7.08369.20.0	ATS	EL	
			7.08369.24.0	ATS	EL	
2.0 BiTDI 4motion 132 kW (180 PS) CFCA	09.2009→08.2015		7.03196.09.0	AGR	EL	<input type="checkbox"/> CFCA:  ch. 7H-A-200 001→ <input type="checkbox"/> CFCA:  ch. 7H-C-000 001→ Fahrgestellnummer ab: 7H-A-200 001, 7J-A-200 001 Vehicle Identification Number from: 7H-A-200 001, 7J-A-200 001 ohne Zubehör without accessories  ch. 7J-A-200 001→
			7.02756.07.0	AGR-K	EL	
			7.08369.21.0	ATS	EL	
			7.08369.25.0	ATS	EL	
2.0 TDI 62 kW (84 PS) CAAA	09.2009→08.2015		7.09720.04.0	AGR-K	EL	<input type="checkbox"/>  ch. 7H-A-200 001→ Fahrgestellnummer ab: 7H-A-200 001, 7J-A-200 001 Vehicle Identification Number from: 7H-A-200 001, 7J-A-200 001 Fahrgestellnummer ab: 7H-A-200 001, 7J-A-200 001 Vehicle Identification Number from: 7H-A-200 001, 7J-A-200 001
			7.11020.06.0	ATS	EL	
			7.08369.20.0	ATS	EL	
			7.08369.24.0	ATS	EL	
2.0 TDI 75 kW (102 PS) CAAB	09.2009→08.2015		7.09720.04.0	AGR-K	EL	<input type="checkbox"/>  ch. 7H-A-200 001→ Fahrgestellnummer ab: 7H-A-200 001, 7J-A-200 001 Vehicle Identification Number from: 7H-A-200 001, 7J-A-200 001 Fahrgestellnummer ab: 7H-A-200 001, 7J-A-200 001 Vehicle Identification Number from: 7H-A-200 001, 7J-A-200 001
			7.11020.06.0	ATS	EL	
			7.08369.20.0	ATS	EL	
			7.08369.24.0	ATS	EL	
2.0 TDI 103 kW (140 PS) CAAC, CCHA	09.2009→08.2015		7.09720.04.0	AGR-K	EL	<input type="checkbox"/> CAAC, CCHA:  ch. 7H-A-200 001→ <input type="checkbox"/> CAAC, CCHA:  ch. 7H-A-200 001→ch. 7H-C-000 000 <input type="checkbox"/> CAAC, CCHA:  ch. 7H-C-000 001→
			7.08369.93.0	ATS	EL	
			7.08369.92.0	ATS	EL	

V



































TRANSPORTER V Van (7HA, 7HH, 7EA, 7EH) 138

			7.08369.20.0	ATS	EL	CAAC, CCHA: Fahrgestellnummer ab: 7H-A-200 001, 7J-A-200 001 Vehicle Identification Number from: 7H-A-200 001, 7J-A-200 001
			7.08369.24.0	ATS	EL	CAAC, CCHA: Fahrgestellnummer ab: 7H-A-200 001, 7J-A-200 001 Vehicle Identification Number from: 7H-A-200 001, 7J-A-200 001
			7.11492.00.0	DDS		ohne Zubehör without accessories CAAC: ch. 7J-A-200 001→ CCHA: ch. 7H-A-200 001→
2.0 TDI 100 kW (136 PS) CAAE, CCHB	05.2010→08.2015		7.09720.04.0	AGR-K	EL	CAAE, CCHB: ch. 7H-A-200 001→
			7.08369.93.0	ATS	EL	CAAE, CCHB: ch. 7H-A-200 001→ch. 7H-C-000 000
			7.08369.92.0	ATS	EL	CAAE, CCHB: ch. 7H-C-000 001→
			7.08369.20.0	ATS	EL	CAAE, CCHB: Fahrgestellnummer ab: 7H-A-200 001, 7J-A-200 001 Vehicle Identification Number from: 7H-A-200 001, 7J-A-200 001
			7.08369.24.0	ATS	EL	CAAE, CCHB: Fahrgestellnummer ab: 7H-A-200 001, 7J-A-200 001 Vehicle Identification Number from: 7H-A-200 001, 7J-A-200 001
			7.11492.00.0	DDS		ohne Zubehör without accessories CAAE: ch. 7J-A-200 001→ CCHB: ch. 7H-A-200 001→
2.0 TDI 84 kW (114 PS) CAAD	05.2011→08.2015		7.09720.04.0	AGR-K	EL	
			7.08369.92.0	ATS	EL	ch. 7H-C-000 001→
			7.08369.20.0	ATS	EL	Fahrgestellnummer ab: 7H-C-000 001, 7J-C-000 001 Vehicle Identification Number from: 7H-C-000 001, 7J-C-000 001
			7.08369.24.0	ATS	EL	Fahrgestellnummer ab: 7H-C-000 001, 7J-C-000 001 Vehicle Identification Number from: 7H-C-000 001, 7J-C-000 001
2.0 TDI 4motion 103 kW (140 PS) CAAC, CCHA	09.2009→08.2015		7.09720.04.0	AGR-K	EL	CAAC, CCHA: ch. 7H-A-200 001→
			7.08369.93.0	ATS	EL	CAAC, CCHA: ch. 7H-A-200 001→ch. 7H-C-000 000
			7.08369.21.0	ATS	EL	CAAC, CCHA: ch. 7H-C-000 001→ CAAC, CCHA: ch. 7H-A-200 001→
			7.08369.92.0	ATS	EL	CAAC, CCHA: ch. 7H-C-000 001→
			7.08369.25.0	ATS	EL	CAAC: Fahrgestellnummer ab: 7H-A-200 01, 7J-A-200 01 Vehicle Identification Number from: 7H-A-200 01, 7J-A-200 01 CCHA: Fahrgestellnummer ab: 7H-C-200 001, 7J-C-200 001 Vehicle Identification Number from: 7H-C-200 001, 7J-C-200 001
			7.11492.00.0	DDS		ohne Zubehör without accessories CAAC: ch. 7J-A-200 001→ CCHA: ch. 7H-A-200 001→





TRANSPORTER V Van (7HA, 7HH, 7EA, 7EH) 138

2.0 TDI 4motion 100 kW (136 PS) CAAE, CCHB	05.2010→08.2015		7.09720.04.0	AGR-K	EL  CAAE, CCHB:  ch. 7H-A-200 001→
			7.08369.93.0	ATS	EL  CAAE, CCHB:  ch. 7H-A-200 001→ch. 7H-C-000 000
			7.08369.21.0	ATS	EL  CAAE:  ch. 7H-C-000 001→  CAAE, CCHB:  ch. 7H-A-200 001→
			7.08369.92.0	ATS	EL  CAAE, CCHB:  ch. 7H-C-000 001→
			7.08369.25.0	ATS	EL  CAAE, CCHB: Fahrgestellnummer ab: 7H-A-200 001, 7J-A-200 001 Vehicle Identification Number from: 7H-A-200 001, 7J-A-200 001
			7.11492.00.0	DDS	ohne Zubehör without accessories  CAAE:  ch. 7J-A-200 001→  CCHB:  ch. 7H-A-200 001→
2.5 TDI 96 kW (130 PS) AXD	04.2003→11.2009		7.24809.38.0	AGR	PN 
2.5 TDI 96 kW (130 PS) BNZ	04.2003→11.2009		7.00823.06.0	AGR	EL 
			7.08369.96.0	ATS	EL  BNZ:  ch. 7H-6-000 001→ch. 7H-6-200 000
					 BNZ:  ch. 7H-7-000 001→ch. 7H-7-200 000
					 BNZ:  ch. 7H-8-000 001→ch. 7H-8-200 000
					 BNZ:  ch. 7H-9-000 001→ch. 7H-9-200 000
			7.08369.18.0	ATS	EL Fahrgestellnummer ab: 7H-6-000 001, 7J-6-000 001 Vehicle Identification Number from: 7H-6-000 001, 7J-6-000 001
7.08369.31.0	ATS	EL Fahrgestellnummer ab: 7H-6-000 001, 7J-6-000 001 Vehicle Identification Number from: 7H-6-000 001, 7J-6-000 001 vor Rußpartikelfilter before soot particulate filter			
7.11190.02.0	DDS	für OE-Nummer: 059 906 051 A, 07Z 906 051 B for OE number: 059 906 051 A, 07Z 906 051 B			
7.11492.02.0	DDS	ohne Zubehör without accessories für OE-Nummer: 076 906 051 A for OE number: 076 906 051 A			
2.5 TDI 96-128 kW (131-174 PS) AXE	04.2003→11.2009		7.24809.38.0	AGR	PN 
2.5 TDI 128 kW (174 PS) BPC	04.2003→11.2009		7.00823.06.0	AGR	EL 

V











TRANSPORTER V Van (7HA, 7HH, 7EA, 7EH) 138

			7.08369.96.0	ATS	EL	BPC: ch. 7H-6-000 001→ch. 7H-6-200 000 BPC: ch. 7H-7-000 001→ch. 7H-7-200 000 BPC: ch. 7H-8-000 001→ch. 7H-8-200 000 BPC: ch. 7H-9-000 001→ch. 7H-9-200 000
			7.08369.18.0	ATS	EL	Fahrgestellnummer ab: 7H-6-000 001, 7J-6-000 001 Vehicle Identification Number from: 7H-6-000 001, 7J-6-000 001
			7.08369.31.0	ATS	EL	Fahrgestellnummer ab: 7H-6-000 001, 7J-6-000 001 Vehicle Identification Number from: 7H-6-000 001, 7J-6-000 001 vor Rußpartikelfilter before soot particulate filter
			7.11190.02.0	DDS		für OE-Nummer: 059 906 051 A, 07Z 906 051 B for OE number: 059 906 051 A, 07Z 906 051 B
			7.11492.02.0	DDS		ohne Zubehör without accessories für OE-Nummer: 076 906 051 A for OE number: 076 906 051 A
2.5 TDI 4motion 96 kW (130 PS) AXD	07.2004→11.2009		7.24809.38.0	AGR	PN	
2.5 TDI 4motion 96 kW (130 PS) BNZ	07.2004→11.2009		7.00823.06.0	AGR	EL	
			7.08369.18.0	ATS	EL	Fahrgestellnummer ab: 7H-6-000 001, 7J-6-000 001 Vehicle Identification Number from: 7H-6-000 001, 7J-6-000 001
			7.08369.31.0	ATS	EL	Fahrgestellnummer ab: 7H-6-000 001, 7J-6-000 001 Vehicle Identification Number from: 7H-6-000 001, 7J-6-000 001 vor Rußpartikelfilter before soot particulate filter
			7.11190.02.0	DDS		für OE-Nummer: 059 906 051 A, 07Z 906 051 B for OE number: 059 906 051 A, 07Z 906 051 B
			7.11492.02.0	DDS		ohne Zubehör without accessories für OE-Nummer: 076 906 051 A for OE number: 076 906 051 A
2.5 TDI 4motion 96-128 kW (131-174 PS) AXE	07.2004→11.2009		7.24809.38.0	AGR	PN	
2.5 TDI 4motion 128 kW (174 PS) BPC	07.2004→11.2009		7.00823.06.0	AGR	EL	
			7.08369.18.0	ATS	EL	Fahrgestellnummer ab: 7H-6-000 001, 7J-6-000 001 Vehicle Identification Number from: 7H-6-000 001, 7J-6-000 001
			7.08369.31.0	ATS	EL	Fahrgestellnummer ab: 7H-6-000 001, 7J-6-000 001 Vehicle Identification Number from: 7H-6-000 001, 7J-6-000 001 vor Rußpartikelfilter before soot particulate filter























TRANSPORTER V Van (7HA, 7HH, 7EA, 7EH) 138

			7.11190.02.0	DDS		für OE-Nummer: 059 906 051 A, 07Z 906 051 B for OE number: 059 906 051 A, 07Z 906 051 B
			7.11492.02.0	DDS		ohne Zubehör without accessories für OE-Nummer: 076 906 051 A for OE number: 076 906 051 A
3.2 4motion 173 kW (235 PS) BKK	11.2003→11.2009		7.22286.41.0	ARV	PN	
			7.22934.63.0	SLP	EL	
3.2 4motion 173 kW (235 PS) CFLA	11.2003→11.2009		7.22934.63.0	SLP	EL	
3.2 V6 170 kW (231 PS) BDL	04.2003→06.2005		7.22286.41.0	ARV	PN	
			7.22934.63.0	SLP	EL	
3.2 V6 173 kW (235 PS) BKK	02.2004→11.2009		7.22286.41.0	ARV	PN	
			7.22934.63.0	SLP	EL	
3.2 V6 173 kW (235 PS) CFLA	02.2004→11.2009		7.22934.63.0	SLP	EL	



























TRANSPORTER VI Platform/Chassis (SFD, SFE, SFL, SFZ, SJD, SJ) 139

2.0 TDI 62 kW (84 PS) CAAA	04.2015→06.2016		7.04999.35.0*	AGR-K	EL	 ch. 7J-G-000 001→ für OE-Nummer: 04L 131 512 CF for OE number: 04L 131 512 CF
			↳ 7.04999.34.0	AGR-M	EL	
			7.09720.04.0	AGR-K	EL	 für OE-Nummer: 03L 131 512 DS for OE number: 03L 131 512 DS
			7.08369.20.0	ATS	EL	
			7.08369.24.0	ATS	EL	
2.0 TDI 62 kW (84 PS) CXGA	04.2015→06.2016		7.04999.35.0*	AGR-K	EL	 ch. 7J-G-000 001→ für OE-Nummer: 04L 131 512 CF for OE number: 04L 131 512 CF
			↳ 7.04999.34.0	AGR-M	EL	
			7.09720.04.0	AGR-K	EL	 für OE-Nummer: 03L 131 512 DS for OE number: 03L 131 512 DS
			7.11492.05.0	DDS		ohne Zubehör without accessories  ch. 7J-G-000 001→
2.0 TDI 75 kW (102 PS) CAAB	04.2015→		7.04999.35.0*	AGR-K	EL	 ch. 7J-G-000 001→ für OE-Nummer: 04L 131 512 CF for OE number: 04L 131 512 CF
			↳ 7.04999.34.0	AGR-M	EL	
			7.09720.04.0	AGR-K	EL	 für OE-Nummer: 03L 131 512 DS for OE number: 03L 131 512 DS
			7.08369.20.0	ATS	EL	 ch. 7J-G-000 001→
			7.08369.24.0	ATS	EL	 ch. 7J-G-000 001→
2.0 TDI 75 kW (102 PS) CXGB	04.2015→		7.04999.35.0*	AGR-K	EL	 ch. 7J-G-000 001→ für OE-Nummer: 04L 131 512 CF for OE number: 04L 131 512 CF
			↳ 7.04999.34.0	AGR-M	EL	
			7.09720.04.0	AGR-K	EL	 für OE-Nummer: 03L 131 512 DS for OE number: 03L 131 512 DS
			7.11492.05.0	DDS		ohne Zubehör without accessories  ch. 7J-G-000 001→
2.0 TDI 103 kW (140 PS) CAAC	04.2015→		7.09720.04.0	AGR-K	EL	

V





TRANSPORTER VI Platform/Chassis (SFD, SFE, SFL, SFZ, SJD, SJ) 139

			7.08369.20.0 ATS EL 7.08369.24.0 ATS EL 7.11492.00.0 DDS		ohne Zubehör without accessories  ch. 7J-A-200 001 →
2.0 TDI 132 kW (180 PS) CFCA	04.2015→	 7.03196.09.0 AGR EL 7.02756.07.0 AGR-K 7.08369.20.0 ATS EL 7.08369.24.0 ATS EL 7.11492.00.0 DDS		 ohne Zubehör without accessories  ch. 7J-A-200 001 →	
2.0 TDI 110 kW (150 PS) CXHA	08.2015→	 7.04999.35.0* AGR-K EL ↳ 7.04999.34.0 AGR-M EL 7.11492.05.0 DDS		 ch. 7J-G-000 001 → ohne Zubehör without accessories  ch. 7J-G-000 001 →	
2.0 TDI 84 kW (114 PS) CXHB	05.2016→	 7.04999.35.0* AGR-K EL ↳ 7.04999.34.0 AGR-M EL 7.11492.05.0 DDS		 ch. 7J-G-000 001 → ohne Zubehör without accessories  ch. 7J-G-000 001 →	
2.0 TDI 150 kW (204 PS) CXEB	05.2016→	 7.04999.35.0* AGR-K EL ↳ 7.04999.34.0 AGR-M EL 7.11492.05.0 DDS		 ch. 7J-G-000 001 → ohne Zubehör without accessories  ch. 7J-G-000 001 →	
2.0 TDI 81 kW (110 PS) CXHC	07.2019→	 7.04999.35.0* AGR-K EL ↳ 7.04999.34.0 AGR-M EL			
2.0 TDI 146 kW (199 PS) CXEC	08.2019→	 7.04999.35.0* AGR-K EL ↳ 7.04999.34.0 AGR-M EL			
2.0 TDI 4motion 103 kW (140 PS) CAAC	06.2015→	 7.09720.04.0 AGR-K EL 7.08369.21.0 ATS EL 7.08369.25.0 ATS EL 7.11492.00.0 DDS		  ch. 7J-G-000 001 → ohne Zubehör without accessories  ch. 7J-A-200 001 →	
2.0 TDI 4motion 132 kW (180 PS) CFCA	06.2015→	 7.03196.09.0 AGR EL 7.02756.07.0 AGR-K 7.08369.21.0 ATS EL 7.08369.25.0 ATS EL		 ch. 7J-G-000 001 →	
2.0 TDI 4motion 110 kW (150 PS) CXHA	05.2016→	 7.04999.35.0* AGR-K EL ↳ 7.04999.34.0 AGR-M EL 7.11492.05.0 DDS		 ch. 7J-G-000 001 → ohne Zubehör without accessories  ch. 7J-G-000 001 →	
2.0 TDI 4motion 150 kW (204 PS) CXEB	05.2016→	 7.04999.35.0* AGR-K EL ↳ 7.04999.34.0 AGR-M EL		 ch. 7J-G-000 001 →	



























TRANSPORTER VI Platform/Chassis (SFD, SFE, SFL, SFZ, SJD, SJ) 139

			7.11492.05.0	DDS		ohne Zubehör without accessories  ch. 7J-G-000 001→
2.0 TDI 4motion 146 kW (199 PS) CXEC	08.2019→		7.04999.35.0*	AGR-K	EL	
			↳ 7.04999.34.0	AGR-M	EL	

TRANSPORTER VI Van (SGA, SGH, SHA, SHH) 140

2.0 TDI 62 kW (84 PS) CAAA	04.2015→06.2016		7.04999.35.0*	AGR-K	EL	 ch. 7H-G-000 001→ für OE-Nummer: 04L 131 512 CF for OE number: 04L 131 512 CF
			↳ 7.04999.34.0	AGR-M	EL	
			7.09720.04.0	AGR-K	EL	 für OE-Nummer: 03L 131 512 DS for OE number: 03L 131 512 DS
			7.08369.20.0	ATS	EL	Fahrgestellnummer ab: 7H-G-000 001, 7J-G-000 001 Vehicle Identification Number from: 7H-G-000 001, 7J-G-000 001
			7.08369.24.0	ATS	EL	Fahrgestellnummer ab: 7H-G-000 001, 7J-G-000 001 Vehicle Identification Number from: 7H-G-000 001, 7J-G-000 001
2.0 TDI 62 kW (84 PS) CXGA	04.2015→06.2016		7.04999.35.0*	AGR-K	EL	 ch. 7H-G-000 001→ für OE-Nummer: 04L 131 512 CF for OE number: 04L 131 512 CF
			↳ 7.04999.34.0	AGR-M	EL	
			7.09720.04.0	AGR-K	EL	 für OE-Nummer: 03L 131 512 DS for OE number: 03L 131 512 DS
			7.11492.05.0	DDS		ohne Zubehör without accessories  ch. 7J-G-000 001→
2.0 TDI 75 kW (102 PS) CAAB	04.2015→		7.04999.35.0*	AGR-K	EL	 ch. 7H-G-000 001→ für OE-Nummer: 04L 131 512 CF for OE number: 04L 131 512 CF
			↳ 7.04999.34.0	AGR-M	EL	
			7.09720.04.0	AGR-K	EL	 für OE-Nummer: 03L 131 512 DS for OE number: 03L 131 512 DS
			7.08369.20.0	ATS	EL	
			7.08369.24.0	ATS	EL	
2.0 TDI 75 kW (102 PS) CXGB	04.2015→		7.04999.35.0*	AGR-K	EL	 ch. 7H-G-000 001→ für OE-Nummer: 04L 131 512 CF for OE number: 04L 131 512 CF
			↳ 7.04999.34.0	AGR-M	EL	
			7.09720.04.0	AGR-K	EL	 für OE-Nummer: 03L 131 512 DS for OE number: 03L 131 512 DS
			7.11492.05.0	DDS		ohne Zubehör without accessories  ch. 7J-G-000 001→
2.0 TDI 103 kW (140 PS) CAAC	04.2015→		7.09720.04.0	AGR-K	EL	
			7.08369.20.0	ATS	EL	
			7.08369.24.0	ATS	EL	
			7.11492.00.0	DDS		ohne Zubehör without accessories  ch. 7J-A-200 001→
2.0 TDI 110 kW (150 PS) CXFA, CXHA	04.2015→		7.04999.35.0*	AGR-K	EL	 CXFA, CXHA:  ch. 7H-G-000 001→
			↳ 7.04999.34.0	AGR-M	EL	
2.0 TDI 132 kW (180 PS) CFCA	04.2015→		7.03196.09.0	AGR	EL	

V



TRANSPORTER VI Van (SGA, SGH, SHA, SHH) 140

			7.02756.07.0 7.08369.20.0 7.08369.24.0 7.11492.00.0	AGR-K ATS ATS DDS	EL EL	ohne Zubehör without accessories ch. 7J-A-200 001 →
2.0 TDI 150 kW (204 PS) CXEB	06.2015→	7.04999.35.0* ↳ 7.04999.34.0 7.11492.05.0	AGR-K AGR-M DDS	EL EL	ch. 7H-G-000 001 → ohne Zubehör without accessories ch. 7J-G-000 001 →	
2.0 TDI 84 kW (114 PS) CXHB	05.2016→	7.04999.35.0* ↳ 7.04999.34.0 7.11492.05.0	AGR-K AGR-M DDS	EL EL	ohne Zubehör without accessories ch. 7J-G-000 001 →	
2.0 TDI 146 kW (199 PS) CXEC	08.2018→	7.04999.35.0* ↳ 7.04999.34.0	AGR-K AGR-M	EL EL		
2.0 TDI 81 kW (110 PS) CXHC	07.2019→	7.04999.35.0* ↳ 7.04999.34.0	AGR-K AGR-M	EL EL		
2.0 TDI 4motion 103 kW (140 PS) CAAC	06.2015→	7.09720.04.0 7.08369.21.0 7.08369.25.0 7.11492.00.0	AGR-K ATS ATS DDS	EL EL EL	 ch. 7H-G-000 001 → ohne Zubehör without accessories ch. 7J-A-200 001 →	
2.0 TDI 4motion 132 kW (180 PS) CFCA	06.2015→	7.03196.09.0 7.02756.07.0 7.08369.21.0 7.08369.25.0 7.11492.00.0	AGR AGR-K ATS ATS DDS	EL EL EL	 ch. 7H-G-000 001 → ohne Zubehör without accessories ch. 7J-A-200 001 →	
2.0 TDI 4motion 150 kW (204 PS) CXEB	06.2015→	7.04999.35.0* ↳ 7.04999.34.0 7.11492.05.0	AGR-K AGR-M DDS	EL EL	ch. 7H-G-000 001 → ohne Zubehör without accessories ch. 7J-G-000 001 →	
2.0 TDI 4motion 110 kW (150 PS) CXFA, CXHA	08.2015→	7.04999.35.0* ↳ 7.04999.34.0	AGR-K AGR-M	EL EL	CXFA, CXHA: ch. 7H-G-000 001 →	
2.0 TDI 4motion 146 kW (199 PS) CXEC	08.2018→	7.04999.35.0* ↳ 7.04999.34.0	AGR-K AGR-M	EL EL		







ENGINE 141

































ENGINE 36-55 kW (49-75 PS) CPYB, CPYC, CPYD, CPYE, CPYF, CPYG		7.08369.01.0 7.11492.03.0	ATS DDS	EL	ohne Zubehör without accessories
ENGINE 45 kW (61 PS) CEEA, CKYA		7.05271.05.0	LS	700 mm	



























ENGINE

141

ENGINE 55 kW (75 PS) CPYA		 7.11492.03.0	DDS		ohne Zubehör without accessories
ENGINE 63 kW (86 PS) AVM	11.2000→	 7.24809.17.0	AGR	PN	
ENGINE 74 kW (101 PS) CBKA	05.2007→	 7.08369.00.0	ATS	EL	ohne Zubehör without accessories
		7.08369.84.0	ATS	EL	
		7.11492.02.0	DDS		
ENGINE 195 kW (265 PS) CEZA	12.2007→	 7.08369.13.0	ATS	EL	
ENGINE 75 kW (102 PS) CJDA, CJDD	08.2009→	 7.08369.01.0	ATS	EL	ohne Zubehör without accessories
		7.08369.14.0	ATS	EL	
		7.11020.03.0	ATS	EL	
		7.11492.00.0	DDS		

						
440 (445)						1
1.6 61 kW (83 PS) B 16 F	09.1988→12.1996		7.02604.03.0	LS	200 mm	
1.8 66 kW (90 PS) B 18 U	01.1992→07.1996		7.02604.03.0	LS	200 mm	
1.8 66 kW (90 PS) B 18 U	09.1995→12.1996		7.02604.03.0	LS	200 mm	
2.0 80-88 kW (108-120 PS) B 20 F	01.1993→07.1995		7.02604.03.0	LS	200 mm	
2.0 80-88 kW (108-120 PS) B 20 F	08.1993→07.1996		7.02604.03.0	LS	200 mm	
460 (464)						2
1.6 61 kW (83 PS) B 16 F	07.1992→07.1996		7.02604.03.0	LS	200 mm	
1.8 66 kW (90 PS) B 18 U	01.1992→07.1996		7.02604.03.0	LS	200 mm	
2.0 80-88 kW (108-120 PS) B 20 F	01.1993→07.1995		7.02604.03.0	LS	200 mm	
2.0 80-88 kW (108-120 PS) B 20 F	08.1993→07.1996		7.02604.03.0	LS	200 mm	
480 (482)						3
2.0 80-88 kW (108-120 PS) B 20 F	01.1993→09.1995		7.02604.03.0	LS	200 mm	
850 (854)						4
2.0 Turbo 155 kW (211 PS) B 5204 T	08.1993→12.1996		7.21857.59.0	SLP	EL 09.1995→	
2.3 106 kW (144 PS) B 5234 FS	01.1996→10.1996		7.22299.03.0	ARV	PN 	
			7.21857.59.0	SLP	EL	
2.3 T5 166-170 kW (225-231 PS) B 5234 FT	01.1994→07.1996		7.02604.04.0	LS	200 mm	
2.3 T5 R 176 kW (239 PS) B 5234 T2	04.1996→10.1996		7.02604.04.0	LS	200 mm	
2.3 T5-R 176-184 kW (239-250 PS) B 5234 T4	08.1995→12.1996		7.02604.04.0	LS	200 mm	
			7.21857.59.0	SLP	EL	
2.3 Turbo R 177-179 kW (241-243 PS) B 5234 T5	09.1994→10.1997		7.21857.59.0	SLP	EL 01.1996→	
2.3 Turbo R 177-179 kW (241-243 PS) B 5234 T5	06.1995→10.1996		7.02604.04.0	LS	200 mm	
2.4 121-125 kW (165-170 PS) B 5254 S	01.1992→12.1996		7.21857.59.0	SLP	EL 09.1995→	
2.4 GLE 142 kW (193 PS) B 5254 T	05.1996→10.1997		7.22299.03.0	ARV	PN 	
850 Estate (855)						5
2.0 Turbo 155 kW (211 PS) B 5204 T	08.1993→12.1996		7.21857.59.0	SLP	EL 09.1995→	
2.3 106 kW (144 PS) B 5234 FS	01.1996→10.1996		7.21857.59.0	SLP	EL	
2.3 T5 166-170 kW (225-231 PS) B 5234 FT	01.1994→12.1996		7.02604.04.0	LS	200 mm	
2.3 T5 R 176 kW (239 PS) B 5234 T2	04.1996→10.1996		7.02604.04.0	LS	200 mm	
2.3 T5-R 176-184 kW (239-250 PS) B 5234 T4	08.1995→12.1996		7.02604.04.0	LS	200 mm	
			7.21857.59.0	SLP	EL	

V

			 PIERBURG			
850 Estate (855)						5
2.3 Turbo R 177-179 kW (241-243 PS) B 5234 T5	09.1994→10.1997		7.21857.59.0	SLP	EL	01.1996→
2.3 Turbo R 177-179 kW (241-243 PS) B 5234 T5	06.1995→10.1997		7.02604.04.0	LS	200 mm	
			7.21857.59.0	SLP	EL	01.1996→
2.4 121-125 kW (165-170 PS) B 5254 S	09.1992→12.1996		7.21857.59.0	SLP	EL	09.1995→
C30 (533)						6
1.6 74 kW (101 PS) B 4164 S3	10.2006→12.2012		7.02604.64.0	LS	450 mm	
1.6 D 80-81 kW (109-110 PS) D 4164 T	10.2006→12.2012		7.24809.39.0	AGR	EL	 ch. 208725→
			7.24809.91.0	AGR	EL	 →ch. 208724
			7.11190.10.0	DDS		ohne Zubehör without accessories für Hersteller-Abgasnorm: Emission Code 3, Emission Code 5, Emission Code E, Emission Code F, Emission Code H for manufacturer exhaust norm: Emission Code 3, Emission Code 5, Emission Code E, Emission Code F, Emission Code H 2007 2007 2010 2010
1.6 D2 84 kW (114 PS) D 4162 T	10.2010→12.2012		7.02209.11.0	AGR	EL	
			7.02156.24.0	AGR-K	EL	mit Sensor with sensor
			7.02156.33.0	AGR-K		mit Sensor with sensor ohne AGR-Ventil without EGR valve
1.8 92 kW (125 PS) B 4184 S11	10.2006→12.2012		7.24809.73.0	AGR	EL	
			7.02604.65.0	LS	525 mm	
			7.02604.64.0	LS	450 mm	
1.8 FlexFuel 92 kW (125 PS) B 4184 S8	01.2007→12.2012		7.24809.73.0	AGR	EL	
			7.02604.65.0	LS	525 mm	
			7.02604.64.0	LS	450 mm	
2.0 107 kW (146 PS) B 4204 S3	10.2006→12.2012		7.24809.73.0	AGR	EL	
			7.02604.65.0	LS	525 mm	
			7.02604.64.0	LS	450 mm	
2.0 D 100 kW (136 PS) D 4204 T	10.2006→12.2012		7.24809.68.0	AGR	EL	
			7.09730.00.0	AGR-K		
2.0 FlexFuel 107 kW (146 PS) B 4204 S4	01.2010→12.2012		7.24809.73.0	AGR	EL	

















V

C30 (533)						6
2.4 i 125 kW (170 PS) B 5244 S4	10.2006→12.2012		7.05270.82.0	LS	630 mm	
			7.05270.69.0	LS	475 mm	
D3 110 kW (150 PS) D 5204 T5	10.2010→12.2012		7.05363.00.0	AGR	EL	
			7.02107.09.0	AGR-K		
			7.11020.45.0	ATS	EL	
			7.11190.08.0	DDS	ch. 265017→	
D4 130 kW (177 PS) D 5204 T	10.2010→12.2012		7.05363.00.0	AGR	EL	
			7.02107.09.0	AGR-K		
			7.11020.45.0	ATS	EL	
			7.11190.08.0	DDS	ch. 265017→	
D5 132 kW (180 PS) D 5244 T13, D 5244 T8	10.2006→12.2012		7.00555.06.0	AGR	EL ohne Elektronikeinheit without the electronics unit	
			7.00555.07.0	AGR	EL nur Elektronikeinheit electronics unit only	
			7.01604.02.0	AGR	EL ohne Elektronikeinheit without the electronics unit	
			7.08369.27.0	ATS	EL D 5244 T13, D 5244 T8: 572277→	
			7.11020.14.0	ATS	EL D 5244 T13: vor Rußpartikelfilter before soot particulate filter 2008 2010 2010	
			7.11190.08.0	DDS	D 5244 T8: vor Rußpartikelfilter before soot particulate filter 2010 2010	
			7.11190.08.0	DDS	D 5244 T13, D 5244 T8: ch. 265017→ 2010 2010	
D5 120 kW (163 PS) D 5244 T9	10.2006→12.2012		7.00555.06.0	AGR	EL ohne Elektronikeinheit without the electronics unit	
			7.00555.07.0	AGR	EL →572276	
			7.01604.02.0	AGR	EL nur Elektronikeinheit electronics unit only	
			7.08369.27.0	ATS	EL ohne Elektronikeinheit without the electronics unit	
			7.11020.14.0	ATS	EL 572277→	
T5 162 kW (220 PS) B 5254 T3	10.2006→12.2012		7.08369.27.0	ATS	EL 2010	
			7.11020.14.0	ATS	EL 2010	
			7.11190.08.0	DDS	ch. 265017→ 2010 2010	
C70 I Convertible (873)						7
2.0 132 kW (180 PS) B 5204 T2	03.1998→10.2005		7.22299.03.0	ARV	PN	
			7.21857.01.0	SLP	EL	
2.0 T 166 kW (226 PS) B 5204 T3	03.1998→10.2005		7.22299.03.0	ARV	PN	















V



C70 I Convertible (873) **7**





















			7.05270.67.0	LS	770 mm	09.1998→ Diagnosesonde Diagnostic Probe
			7.05270.80.0	LS	650 mm	09.1998→09.1999
			7.05270.81.0	LS	1200 mm	09.1999→ links, rechts Left, Right
			7.21857.01.0	SLP	EL	
2.0 T 120 kW (163 PS) B 5204 T4	03.2000→10.2005		7.22299.03.0	ARV	PN	
			7.05270.67.0	LS	770 mm	Diagnosesonde Diagnostic Probe
			7.05270.81.0	LS	1200 mm	links, rechts Left, Right
			7.21857.01.0	SLP	EL	
2.3 147-184 kW (239-250 PS) B 5234 T3	09.2002→12.2003		7.22299.03.0	ARV	PN	
			7.21857.01.0	SLP	EL	
2.3 T5 147-184 kW (239-250 PS) B 5234 T3	03.1998→10.2005		7.22299.03.0	ARV	PN	
			7.05270.67.0	LS	770 mm	09.1998→ Diagnosesonde Diagnostic Probe
			7.05270.80.0	LS	650 mm	
			7.05270.81.0	LS	1200 mm	09.1999→
			7.21857.01.0	SLP	EL	
2.3 T5 180 kW (245 PS) B 5234 T9	07.2002→10.2005		7.22299.03.0	ARV	PN	
			7.05270.67.0	LS	770 mm	Diagnosesonde Diagnostic Probe
			7.05270.81.0	LS	1200 mm	links, rechts Left, Right
2.4 121-125 kW (165-170 PS) B 5254 S	06.1998→10.2005		7.22299.03.0	ARV	PN	
			7.05270.66.0	LS	810 mm	
2.4 T 142 kW (193 PS) B 5244 T	03.1998→10.2005		7.22299.03.0	ARV	PN	
			7.05270.80.0	LS	650 mm	
			7.21857.01.0	SLP	EL	
2.4 T 142 kW (193 PS) B 5254 T	03.1998→10.2005		7.22299.03.0	ARV	PN	
			7.05270.67.0	LS	770 mm	09.1998→ Diagnosesonde Diagnostic Probe
			7.05270.80.0	LS	650 mm	
			7.21857.01.0	SLP	EL	
2.4 T 147 kW (200 PS) B 5244 T7	07.2002→10.2005		7.22299.03.0	ARV	PN	
			7.05270.67.0	LS	770 mm	
			7.05270.81.0	LS	1200 mm	

V























						
C70 I Coupe (872)						
2.0 132 kW (180 PS) B 5204 T2	03.1997→09.2002		7.22299.03.0	ARV	PN	⊗
			7.21857.01.0	SLP	EL	
2.0 T 166 kW (226 PS) B 5204 T3	03.1997→09.2002		7.22299.03.0	ARV	PN	⊗
			7.05270.67.0	LS	770 mm	09.1998→ Diagnosesonde Diagnostic Probe
			7.05270.80.0	LS	650 mm	09.1998→09.1999
			7.05270.81.0	LS	1200 mm	09.1999→ links, rechts Left, Right
2.0 T 120 kW (163 PS) B 5204 T4	03.2000→09.2002		7.22299.03.0	ARV	PN	⊗
			7.05270.67.0	LS	770 mm	Diagnosesonde Diagnostic Probe
			7.05270.81.0	LS	1200 mm	links, rechts Left, Right
			7.21857.01.0	SLP	EL	
2.3 T-5 147-184 kW (239-250 PS) B 5234 T3	03.1997→09.2002		7.22299.03.0	ARV	PN	⊗
			7.21857.01.0	SLP	EL	
2.4 121-125 kW (165-170 PS) B 5254 S	03.1999→09.2002		7.22299.03.0	ARV	PN	⊗
			7.05270.66.0	LS	810 mm	
2.4 121-125 kW (165-170 PS) B 5244 S, B 5254 S	05.1999→09.2002		7.22299.03.0	ARV	PN	⊗
			7.21857.01.0	SLP	EL	
2.4 T 142 kW (193 PS) B 5244 T, B 5254 T	03.1997→09.2002		7.22299.03.0	ARV	PN	⊗
			7.21857.01.0	SLP	EL	
C70 II Convertible (542)						
2.0 D 100 kW (136 PS) D 4204 T	01.2008→10.2009		7.24809.68.0	AGR	EL	⊗
			7.09730.00.0	AGR-K		
			7.11190.10.0	DDS		ohne Zubehör without accessories für Hersteller-Abgasnorm: Emission Code 3, Emission Code 4, Emission Code 5 for manufacturer exhaust norm: Emission Code 3, Emission Code 4, Emission Code 5 2008 2008 2010 2010
2.4 D 120 kW (163 PS) D 5244 T9	03.2007→06.2013		7.00555.06.0	AGR	EL	⊗ ohne Elektronikeinheit without the electronics unit
			7.00555.07.0	AGR	EL	nur Elektronikeinheit electronics unit only
			7.01604.02.0	AGR	EL	⊗ ohne Elektronikeinheit without the electronics unit
			7.08369.27.0	ATS	EL	⊗ 572277→

































C70 II Convertible (542) **9**

			7.11020.14.0	ATS	EL	vor Rußpartikelfilter before soot particulate filter
			7.11190.08.0	DDS		2009 2009 2010 2010
2.4 i 125 kW (170 PS) B 5244 S4	03.2006→10.2009		7.05270.82.0	LS	630 mm	
			7.05270.69.0	LS	475 mm	
D3 110 kW (150 PS) D 5204 T5	10.2010→06.2013		7.05363.00.0	AGR	EL	
			7.02107.09.0	AGR-K		
			7.11020.45.0	ATS	EL	
			7.11190.08.0	DDS		 ch. 123010→
D4 130 kW (177 PS) D 5204 T	10.2010→06.2013		7.05363.00.0	AGR	EL	
			7.02107.09.0	AGR-K		
			7.11020.45.0	ATS	EL	
			7.11190.08.0	DDS		 ch. 123010→
D5 132 kW (180 PS) D 5244 T13	03.2006→06.2013		7.00555.06.0	AGR	EL	 ohne Elektronikeinheit without the electronics unit
			7.00555.07.0	AGR	EL	nur Elektronikeinheit electronics unit only
			7.01604.02.0	AGR	EL	 ohne Elektronikeinheit without the electronics unit
			7.08369.27.0	ATS	EL	 572277→
			7.11020.14.0	ATS	EL	 D 5244 T13: vor Rußpartikelfilter before soot particulate filter
						2010 2010
			7.11190.08.0	DDS		 D 5244 T13: vor Rußpartikelfilter before soot particulate filter
						2008 2008 2010 2010 2010 2008 2008 2010 2010
D5 132 kW (180 PS) D 5244 T8	03.2006→06.2013		7.00555.06.0	AGR	EL	 ohne Elektronikeinheit without the electronics unit
			7.00555.07.0	AGR	EL	nur Elektronikeinheit electronics unit only
			7.01604.02.0	AGR	EL	 ohne Elektronikeinheit without the electronics unit
			7.08369.27.0	ATS	EL	 572277→
			7.11190.08.0	DDS		2007 2007 2010 2010
T5 162 kW (220 PS) B 5254 T3	03.2006→02.2007		7.05270.67.0	LS	770 mm	
T5 169-184 kW (230-250 PS) B 5254 T7	03.2007→06.2013		7.05270.67.0	LS	770 mm	

S40 I (644)						10
1.6 77 kW (105 PS) B 4164 S	09.1995→08.1999		7.05270.71.0	LS	1060 mm	
1.6 80 kW (109 PS) B 4164 S2	01.2000→12.2003		7.05270.73.0	LS	760 mm	
			7.05270.72.0	LS	680 mm →ch. 800053	
1.8 85 kW (115 PS) B 4184 S	01.1996→08.1999		7.05270.71.0	LS	1060 mm	
1.8 85-90 kW (116-122 PS) B 4184 S2	03.1999→12.2003		7.05270.73.0	LS	760 mm	
			7.05270.72.0	LS	680 mm →ch. 800053	
1.8 85-90 kW (116-122 PS) B 4184 S2	06.2001→08.2003		7.05270.73.0	LS	760 mm	
			7.05270.72.0	LS	680 mm →ch. 800053	
1.9 DI 75 kW (102 PS) D 4192 T4	07.2000→12.2003		7.22818.57.0	AGR	EL	
1.9 DI 85 kW (116 PS) D 4192 T3	07.2000→12.2003		7.22818.57.0	AGR	EL	
2.0 100-103 kW (136-140 PS) B 4204 S	07.1995→12.2003		7.05270.71.0	LS	1060 mm	
2.0 100 kW (136 PS) B 4204 S2	07.1995→12.2003		7.05270.73.0	LS	760 mm	
			7.05270.72.0	LS	680 mm →ch. 800053	
2.0 100-103 kW (136-140 PS) B 4204 S	07.1995→08.1999		7.05270.71.0	LS	1060 mm	
2.0 D 100 kW (136 PS) D 4204 T	12.2002→06.2004		7.24809.68.0	AGR	EL	
			7.11190.10.0	DDS	ohne Zubehör without accessories für Hersteller-Abgasnorm: Emission Code 3, Emission Code 4, Emission Code 5 for manufacturer exhaust norm: Emission Code 3, Emission Code 4, Emission Code 5	
S40 II (544)						11
1.6 74 kW (101 PS) B 4164 S3	01.2005→12.2012		7.05270.82.0	LS	630 mm	
			7.05270.69.0	LS	475 mm	
1.6 D 80-81 kW (109-110 PS) D 4164 T	01.2005→12.2012		7.24809.39.0	AGR	EL ch. 177504→	
			7.24809.91.0	AGR	EL →ch. 177503	
1.6 D2 84 kW (114 PS) D 4162 T	10.2010→12.2012		7.02209.11.0	AGR	EL	
			7.02156.24.0	AGR-K	EL mit Sensor with sensor	
			7.02156.33.0	AGR-K	EL mit Sensor with sensor ohne AGR-Ventil without EGR valve	
1.8 92 kW (125 PS) B 4184 S11	04.2004→12.2010		7.24809.73.0	AGR	EL	
			7.05270.69.0	LS	475 mm	
			7.02604.64.0	LS	450 mm	













			 PIERBURG		
S40 II (544)					
1.8 FlexFuel 92 kW (125 PS) B 4184 S8	01.2006→12.2010		7.24809.73.0	AGR	EL 
			7.05270.69.0	LS	475 mm
			7.02604.64.0	LS	450 mm
2.0 107 kW (146 PS) B 4204 S3	10.2006→12.2012		7.24809.73.0	AGR	EL 
			7.02604.64.0	LS	450 mm
2.0 CDI 96-98 kW (131-133 PS) D 4204 T2	07.2005→12.2006		7.09730.00.0	AGR-K	ohne Zubehör without accessories für Hersteller-Abgasnorm: Emission Code 3, Emission Code 4, Emission Code 5 for manufacturer exhaust norm: Emission Code 3, Emission Code 4, Emission Code 5
			7.11190.10.0	DDS	
2.0 D 100 kW (136 PS) D 4204 T	01.2004→12.2010		7.24809.68.0	AGR	EL 
			7.09730.00.0	AGR-K	ohne Zubehör without accessories für Hersteller-Abgasnorm: Emission Code 3, Emission Code 4, Emission Code 5 for manufacturer exhaust norm: Emission Code 3, Emission Code 4, Emission Code 5
			7.11190.10.0	DDS	
2.0 D4 96-98 kW (131-133 PS) D 4204 T2	07.2005→12.2006		7.09730.00.0	AGR-K	ohne Zubehör without accessories für Hersteller-Abgasnorm: Emission Code 3, Emission Code 4, Emission Code 5 for manufacturer exhaust norm: Emission Code 3, Emission Code 4, Emission Code 5
			7.11190.10.0	DDS	
2.0 F 107 kW (146 PS) B 4204 S4	10.2009→12.2012		7.24809.73.0	AGR	EL 
2.4 103 kW (140 PS) B 5244 S5	01.2004→12.2010		7.05270.82.0	LS	630 mm
			2.4 125 kW (170 PS) B 5244 S4	01.2004→12.2012	
7.05270.69.0	LS	475 mm			
2.4 CDI 120 kW (163 PS) D 5244 T9	03.2007→12.2010		7.00555.06.0	AGR	EL 
			7.00555.07.0	AGR	EL nur Elektronikeinheit electronics unit only
			7.01604.02.0	AGR	EL 
			7.08369.27.0	ATS	EL ohne Elektronikeinheit without the electronics unit
			7.11020.14.0	ATS	EL vor Rußpartikelfilter before soot particulate filter
			7.11190.08.0	DDS	 ch. 565003→

					
S40 II (544)					
2.4 D5 132 kW (180 PS) D 5244 T13	03.2006→12.2010		7.00555.06.0	AGR	EL  ohne Elektronikeinheit without the electronics unit
			7.00555.07.0	AGR	EL nur Elektronikeinheit electronics unit only
			7.01604.02.0	AGR	EL  ohne Elektronikeinheit without the electronics unit  572277→
			7.08369.27.0	ATS	EL
			7.11190.08.0	DDS	 ch. 565003→ 2008 2008
2.4 D5 132 kW (180 PS) D 5244 T8	03.2006→12.2010		7.00555.06.0	AGR	EL  ohne Elektronikeinheit without the electronics unit
			7.00555.07.0	AGR	EL nur Elektronikeinheit electronics unit only
			7.01604.02.0	AGR	EL  ohne Elektronikeinheit without the electronics unit  572277→
			7.08369.27.0	ATS	EL
			7.11020.14.0	ATS	EL vor Rußpartikelfilter before soot particulate filter
7.11190.08.0	DDS	 ch. 565003→			
D3 110 kW (150 PS) D 5204 T5	10.2010→12.2012		7.05363.00.0	AGR	EL 
			7.02107.09.0	AGR-K	
			7.11020.45.0	ATS	EL
			7.11190.08.0	DDS	 ch. 565003→
D4 130 kW (177 PS) D 5204 T	10.2010→12.2012		7.05363.00.0	AGR	EL 
			7.02107.09.0	AGR-K	
			7.11020.45.0	ATS	EL
			7.11190.08.0	DDS	 ch. 565003→
T5 162 kW (220 PS) B 5254 T3	01.2004→12.2007		7.05270.67.0	LS	770 mm
			7.05270.67.0	LS	770 mm
T5 169-184 kW (230-250 PS) B 5254 T7	03.2007→12.2012		7.05270.67.0	LS	770 mm
			7.05270.67.0	LS	770 mm
T5 AWD 162 kW (220 PS) B 5254 T3	04.2004→12.2007		7.05270.67.0	LS	770 mm
			7.05270.67.0	LS	770 mm
T5 AWD 169-184 kW (230-250 PS) B 5254 T7	03.2007→12.2010		7.05270.67.0	LS	770 mm
			7.05270.67.0	LS	770 mm
S60 I (384)					
2.0 T 132 kW (180 PS) B 5204 T5	07.2000→04.2010		7.05270.67.0	LS	770 mm
			7.05270.81.0	LS	1200 mm
2.3 T5 195 kW (265 PS) B 5234 T7	07.2000→09.2002		7.05270.69.0	LS	475 mm
			7.05270.81.0	LS	1200 mm
2.4 103 kW (140 PS) B 5244 S2	07.2000→04.2010		7.05270.70.0	LS	875 mm
			7.05270.66.0	LS	810 mm
			7.05270.82.0	LS	630 mm
			7.05270.69.0	LS	475 mm











11
12
V



S60 I (384) 12

2.4 125 kW (170 PS) B 5244 S	11.2000→04.2010	 7.05270.70.0	LS	875 mm	
		7.05270.66.0	LS	810 mm	
		7.05270.82.0	LS	630 mm	
		7.05270.69.0	LS	475 mm	
2.4 Bifuel (CNG) 103 kW (140 PS) B 5244 SG	07.2001→04.2010	 7.05270.70.0	LS	875 mm	
2.4 Bifuel (LPG) 103 kW (140 PS) B 5244 SG2	07.2001→04.2010	 7.05270.70.0	LS	875 mm	
2.4 CDI 85 kW (116 PS) D 5244 T3	10.2003→12.2005	 7.22996.11.0	AGR	ME	ohne Elektronikeinheit without the electronics unit
		7.22996.12.0	AGR	EL	nur Elektronikeinheit electronics unit only
2.4 D 96-120 kW (131-163 PS) D 5244 T2	05.2001→04.2010	 7.22996.11.0	AGR	ME	ohne Elektronikeinheit without the electronics unit
		7.22996.12.0	AGR	EL	nur Elektronikeinheit electronics unit only
2.4 D 93 kW (126 PS) D 5244 T7	03.2005→04.2010	 7.00555.06.0	AGR	EL	 ohne Elektronikeinheit without the electronics unit 01.2006→12.2009
		7.00555.07.0	AGR	EL	nur Elektronikeinheit electronics unit only
		7.08369.69.0	ATS	EL	 ch. 720008→ vor Katalysator in front of the catalyst
		7.08369.55.0	ATS	EL	
		7.11190.10.0	DDS	EL	ohne Zubehör without accessories für Hersteller-Abgasnorm: Emission Code 4 for manufacturer exhaust norm: Emission Code 4 2006 2006 2009 2009
2.4 D 90 kW (122 PS) D 5244 T6	05.2005→12.2006	 7.00555.06.0	AGR	EL	 ohne Elektronikeinheit without the electronics unit
		7.00555.07.0	AGR	EL	nur Elektronikeinheit electronics unit only
		7.08369.69.0	ATS	EL	 ch. 720008→ vor Katalysator in front of the catalyst 2006 2006
		7.08369.55.0	ATS	EL	
		7.11190.10.0	DDS	EL	ohne Zubehör without accessories für Hersteller-Abgasnorm: Emission Code 4 for manufacturer exhaust norm: Emission Code 4 2006 2006
2.4 D 120 kW (163 PS) D 5244 T5	07.2005→12.2009	 7.00555.06.0	AGR	EL	 ohne Elektronikeinheit without the electronics unit
		7.00555.07.0	AGR	EL	nur Elektronikeinheit electronics unit only























S60 I (384) 12

































			7.08369.69.0 ATS 7.08369.55.0 ATS 7.11190.10.0 DDS	EL  ch. 720008→ vor Katalysator in front of the catalyst EL ohne Zubehör without accessories für Hersteller-Abgasnorm: Emission Code 4 for manufacturer exhaust norm: Emission Code 4 2006 2006 2009 2009
2.4 D5 120 kW (163 PS) D 5244 T	01.2001→04.2010		7.22996.11.0 AGR 7.22996.12.0 AGR	ME ohne Elektronikeinheit without the electronics unit EL nur Elektronikeinheit electronics unit only
2.4 D5 136 kW (185 PS) D 5244 T4	03.2005→04.2010		7.00555.06.0 AGR 7.08369.55.0 ATS 7.11190.10.0 DDS	EL  ohne Elektronikeinheit without the electronics unit EL ohne Zubehör without accessories für Hersteller-Abgasnorm: Emission Code 4 for manufacturer exhaust norm: Emission Code 4 2006 2006 2009 2009
2.4 T 147 kW (200 PS) B 5244 T3	07.2000→04.2010		7.05270.67.0 LS 7.05270.81.0 LS	770 mm 1200 mm
2.4 T AWD 147 kW (200 PS) B 5244 T3	06.2001→04.2010		7.05270.67.0 LS 7.05270.81.0 LS	770 mm 1200 mm
2.4 T5 191 kW (260 PS) B 5244 T5	04.2004→04.2010		7.05270.67.0 LS	770 mm
2.5 T 153-162 kW (209-220 PS) B 5254 T2	01.2003→04.2010		7.05270.67.0 LS 7.05270.81.0 LS	770 mm 1200 mm
2.5 T AWD 153-162 kW (209-220 PS) B 5254 T2	07.2002→04.2010		7.05270.67.0 LS 7.05270.81.0 LS	770 mm 1200 mm
R 2,5 T AWD 220-224 kW (299-305 PS) B 5254 T4	01.2003→04.2010		7.05270.67.0 LS 7.05270.81.0 LS	770 mm 1200 mm
T5 147-184 kW (239-250 PS) B 5234 T3	07.2000→04.2010		7.05270.69.0 LS 7.05270.81.0 LS	475 mm 1200 mm





S60 II (134) **13**













2.0 D2 88 kW (120 PS) D 4204 T20	03.2015→05.2018		7.11020.43.0	ATS	EL	2018 2018
			7.11190.08.0	DDS		
2.0 D2 88-145 kW (120-197 PS) D 4204 T8	03.2015→05.2018		7.11020.43.0	ATS	EL	
2.0 D3 110 kW (150 PS) D 4204 T9	03.2015→05.2018		7.11020.43.0	ATS	EL	2018 2018
			7.11190.08.0	DDS		
2.0 D4 140-147 kW (190-200 PS) D 4204 T14	03.2015→05.2018		7.11190.08.0	DDS		2018 2018
2.0 D5 165-171 kW (224-232 PS) D 4204 T11	03.2015→05.2018		7.11020.43.0	ATS	EL	2018 2018
			7.11190.08.0	DDS		
2.4 D4 AWD 140-162 kW (190-220 PS) D 5244 T21	03.2015→05.2018		7.05363.00.0	AGR	EL	
			7.02107.09.0	AGR-K		
			7.11020.14.0	ATS	EL	Getriebetyp: TF-80SD Transmission Type: TF-80SD vor Rußpartikelfilter before soot particulate filter 2018 2018
			7.11020.44.0	ATS	EL	Getriebetyp: TF-80SD Transmission Type: TF-80SD für Hersteller-Abgasnorm: Emission Code 5 for manufacturer exhaust norm: Emission Code 5 2018 2018
D3 120 kW (163 PS) D 5204 T2, D 5204 T3	04.2010→12.2014		7.05363.00.0	AGR	EL	
			7.02107.09.0	AGR-K		
			7.11020.45.0	ATS	EL	2011 2011
			7.11190.08.0	DDS		 D 5204 T2:  ch. 76075→ 2011 2011  D 5204 T3:  ch. 76075→ 2012 2015 2015
V D3 100 kW (136 PS) D 5204 T7	05.2012→12.2015		7.05363.00.0	AGR	EL	
			7.02107.09.0	AGR-K		
			7.11020.45.0	ATS	EL	Getriebetyp: M66 / TF-80SD Transmission Type: M66 / TF-80SD
			7.11190.08.0	DDS		Getriebetyp: M66, TF-80SD Transmission Type: M66, TF-80SD
D4 120 kW (163 PS) D 5204 T3	04.2010→12.2014		7.05363.00.0	AGR	EL	
			7.02107.09.0	AGR-K		
			7.11020.45.0	ATS	EL	



























					
S60 II (134)					13
			7.11190.08.0	DDS	 ch. 76075→ 2012 2012
D4 133 kW (181 PS) D 4204 T5	09.2013→12.2015		7.11020.43.0	ATS	EL
			7.11190.08.0	DDS	
D4 Drive-E Polestar 140-147 kW (190-200 PS) D 4204 T14	03.2015→05.2018		7.11020.43.0	ATS	EL
			7.11190.08.0	DDS	
D4 Polestar AWD 140-162 kW (190-220 PS) D 5244 T21	03.2015→07.2018		7.02107.09.0	AGR-K	
			7.11020.14.0	ATS	EL Getriebetyp: TF-80SD Transmission Type: TF-80SD vor Rußpartikelfilter before soot particulate filter
			7.11020.44.0	ATS	EL Getriebetyp: TF-80SD Transmission Type: TF-80SD für Hersteller-Abgasnorm: Emission Code 5 for manufacturer exhaust norm: Emission Code 5
			7.11190.08.0	DDS	 ch. 76075→ Getriebetyp: TF-80SD Transmission Type: TF-80SD
D5 151 kW (205 PS) D 5244 T10	04.2010→12.2011		7.05363.00.0	AGR	EL 
			7.02107.09.0	AGR-K	
			7.11020.45.0	ATS	EL Getriebetyp: TF-80SC / M66 Transmission Type: TF-80SC / M66 2011 2011
			7.11190.08.0	DDS	 ch. 76075→ Getriebetyp: M66, TF-80SC Transmission Type: M66, TF-80SC
D5 158-169 kW (215-230 PS) D 5244 T11, D 5244 T15	04.2011→12.2015		7.05363.00.0	AGR	EL 
			7.02107.09.0	AGR-K	
			7.11020.45.0	ATS	EL  D 5244 T11: Getriebetyp: M66 Transmission Type: M66  D 5244 T15: Getriebetyp: TF-80SC Transmission Type: TF-80SC
			7.11190.08.0	DDS	 D 5244 T11:  ch. 76075→ Getriebetyp: M66 Transmission Type: M66  D 5244 T15:  ch. 76075→ Getriebetyp: TF-80SC Transmission Type: TF-80SC
D5 158-169 kW (215-230 PS) D 5244 T15	04.2014→12.2015		7.05363.00.0	AGR	EL 
			7.02107.09.0	AGR-K	
			7.11020.45.0	ATS	EL Getriebetyp: TF-80SC Transmission Type: TF-80SC
			7.11190.08.0	DDS	 ch. 76075→ Getriebetyp: TF-80SC Transmission Type: TF-80SC
D5 AWD 151 kW (205 PS) D 5244 T10	04.2010→12.2011		7.05363.00.0	AGR	EL 
			7.02107.09.0	AGR-K	





S60 II (134) **13**

			7.11020.14.0	ATS	EL	für Getriebeautomatik 6 Gang for 6-speed automatic transmission nach Katalysator Post-catalyst Euro 5 Euro 5
			7.11020.44.0	ATS	EL	Getriebetyp: TF-80SC Transmission Type: TF-80SC für Hersteller-Abgasnorm: Emission Code 5 for manufacturer exhaust norm: Emission Code 5
			7.11190.08.0	DDS		Getriebetyp: TF-80SC Transmission Type: TF-80SC Euro 5 Euro 5
D5 AWD 158-169 kW (215-230 PS) D 5244 T15	04.2011→12.2015		7.05363.00.0	AGR	EL	
			7.02107.09.0	AGR-K	EL	
			7.11020.14.0	ATS	EL	für Getriebeautomatik 6 Gang for 6-speed automatic transmission nach Katalysator Post-catalyst Euro 5 Euro 5
			7.11020.44.0	ATS	EL	Getriebetyp: TF-80SC Transmission Type: TF-80SC für Hersteller-Abgasnorm: Emission Code 5 for manufacturer exhaust norm: Emission Code 5
			7.11190.08.0	DDS		Getriebetyp: TF-80SC Transmission Type: TF-80SC Euro 5 Euro 5
D5 AWD 158-169 kW (215-230 PS) D 5244 T15	04.2014→12.2015		7.05363.00.0	AGR	EL	
			7.02107.09.0	AGR-K	EL	
			7.11020.14.0	ATS	EL	für Getriebeautomatik 6 Gang for 6-speed automatic transmission nach Katalysator Post-catalyst Euro 5 Euro 5
			7.11020.44.0	ATS	EL	Getriebetyp: TF-80SC Transmission Type: TF-80SC für Hersteller-Abgasnorm: Emission Code 5 for manufacturer exhaust norm: Emission Code 5
			7.11190.08.0	DDS		 ch. 76075→
D5 Drive-E Polestar 165-171 kW (224-232 PS) D 4204 T11	03.2015→05.2018		7.11020.43.0	ATS	EL	
DRIVE / D2 84 kW (114 PS) D 4162 T	01.2011→12.2015		7.02209.11.0	AGR	EL	
			7.02156.35.0	AGR-K	EL	ohne Sensor without sensor  ch. 219573→ mit AGR-Ventil with EGR valve
			7.02156.24.0	AGR-K	EL	mit Sensor with sensor 

					
S60 II (134)					13
			7.02156.34.0	AGR-K	ohne Sensor without sensor  ch. 219573→
			7.02156.33.0	AGR-K	ohne AGR-Ventil without EGR valve mit Sensor with sensor ohne AGR-Ventil without EGR valve
S70 (874)					14
2.0 93 kW (126 PS) B 5202 FS	01.1997→11.2000		7.22299.03.0	ARV	PN 
			7.21857.01.0	SLP	EL
2.0 93 kW (126 PS) B 5202 S	01.1997→11.2000		7.22299.03.0	ARV	PN 
2.0 105 kW (143 PS) B 5204 F	01.1997→11.2000		7.22299.03.0	ARV	PN 
2.0 132 kW (180 PS) B 5204 T2	01.1997→11.2000		7.22299.03.0	ARV	PN 
			7.05270.67.0	LS	770 mm
			7.05270.80.0	LS	650 mm
			7.05270.81.0	LS	1200 mm
			7.21857.01.0	SLP	EL
2.0 120 kW (163 PS) B 5204 T4	01.1997→11.2000		7.22299.03.0	ARV	PN 
			7.21857.01.0	SLP	EL
2.0 Turbo 155 kW (211 PS) B 5204 T	01.1997→11.2000		7.22299.03.0	ARV	PN 
			7.05270.67.0	LS	770 mm
			7.05270.80.0	LS	650 mm
			7.05270.81.0	LS	1200 mm
			7.21857.01.0	SLP	EL
2.0 Turbo 166 kW (226 PS) B 5204 T3	01.1997→11.2000		7.22299.03.0	ARV	PN 
			7.05270.67.0	LS	770 mm
			7.05270.80.0	LS	650 mm
			7.05270.81.0	LS	1200 mm
			7.21857.01.0	SLP	EL
2.3 147-184 kW (239-250 PS) B 5234 T3	11.1996→11.2000		7.22299.03.0	ARV	PN 
			7.21857.01.0	SLP	EL
2.3 195 kW (265 PS) B 5234 T7	04.1999→09.2000		7.22299.03.0	ARV	PN 
			7.05270.67.0	LS	770 mm
			7.05270.81.0	LS	1200 mm
			7.21857.01.0	SLP	EL
2.3 T-5 147-184 kW (239-250 PS) B 5234 T3	01.1997→11.2000		7.22299.03.0	ARV	PN 
			7.05270.67.0	LS	770 mm

V



S70 (874) **14**

			7.05270.80.0	LS	650 mm	
			7.21857.01.0	SLP	EL	
2.3 T5 AWD 147-184 kW (239-250 PS) B 5234 T3	11.1996→09.1998		7.22299.03.0	ARV	PN	
			7.05270.67.0	LS	770 mm	
			7.05270.80.0	LS	650 mm	
			7.21857.01.0	SLP	EL	
2.3 T5 AWD 176-184 kW (239-250 PS) B 5234 T4	07.1997→09.2000		7.22299.03.0	ARV	PN	
			7.05270.67.0	LS	770 mm	
			7.05270.81.0	LS	1200 mm	
			7.21857.01.0	SLP	EL	
2.3 Turbo 176-184 kW (239-250 PS) B 5234 T4	01.1997→11.2000		7.22299.03.0	ARV	PN	
			7.05270.67.0	LS	770 mm	
			7.05270.81.0	LS	1200 mm	
2.4 104-106 kW (141-144 PS) B 5252 FS	01.1997→11.2000		7.22299.03.0	ARV	PN	
			7.05270.79.0	LS	530 mm	
			7.21857.01.0	SLP	EL	
2.4 121-125 kW (165-170 PS) B 5244 S, B 5254 S	01.1997→11.2000		7.22299.03.0	ARV	PN	
			7.05270.66.0	LS	810 mm	
			7.21857.01.0	SLP	EL	
2.4 121-125 kW (165-170 PS) B 5254 S	06.1998→11.2000		7.22299.03.0	ARV	PN	
			7.05270.66.0	LS	810 mm	
2.4 103 kW (140 PS) B 5244 S2, B 5244 SG	08.1999→11.2000		7.22299.03.0	ARV	PN	
			7.05270.66.0	LS	810 mm	
			7.21857.01.0	SLP	EL	
2.4 AWD 104-106 kW (141-144 PS) B 5252 FS	11.1996→05.1999		7.22299.03.0	ARV	PN	
			7.21857.01.0	SLP	EL	
2.4 AWD 121-125 kW (165-170 PS) B 5254 S	10.1998→05.1999		7.22299.03.0	ARV	PN	
2.4 AWD 103 kW (140 PS) B 5244 S2	04.1999→09.2000		7.22299.03.0	ARV	PN	
			7.05270.66.0	LS	810 mm	
			7.21857.01.0	SLP	EL	
2.4 AWD 125 kW (170 PS) B 5244 S	04.1999→09.2000		7.22299.03.0	ARV	PN	
			7.05270.66.0	LS	810 mm	
			7.21857.01.0	SLP	EL	











V

						
S70 (874)						14
2.4 Bifuel 106 kW (144 PS) GB 5252 S	10.1998→11.2000		7.22299.03.0	ARV	PN	
			7.21857.01.0	SLP	EL	
2.4 Bifuel 103 kW (140 PS) B 5244 SG	07.1999→11.2000		7.22299.03.0	ARV	PN	
			7.05270.79.0	LS	530 mm	
			7.21857.01.0	SLP	EL	
2.4 Blu-Fuel 103 kW (140 PS) B 5244 S2, B 5244 SG	07.1997→09.2000		7.22299.03.0	ARV	PN	
			7.21857.01.0	SLP	EL	
2.4 T5 AWD 142 kW (193 PS) B 5254 T	11.1996→04.1999		7.22299.03.0	ARV	PN	
			7.05270.67.0	LS	770 mm	
			7.05270.80.0	LS	650 mm	
			7.21857.01.0	SLP	EL	
2.4 Turbo 142 kW (193 PS) B 5244 T, B 5254 T	01.1997→11.2000		7.22299.03.0	ARV	PN	
			7.05270.67.0	LS	770 mm	
			7.05270.80.0	LS	650 mm	
			7.05270.81.0	LS	1200 mm	
7.21857.01.0	SLP	EL				
2.5 TDI 103 kW (140 PS) D 5252 T	01.1997→11.2000		7.22299.03.0	ARV	PN	
2.5 TDi AWD 103 kW (140 PS) D 5252 T	10.1999→09.2000		7.22299.03.0	ARV	PN	
2.0i 20V 93-105 kW (126-143 PS) B 5204 S	01.1997→07.1998		7.22299.03.0	ARV	PN	
2.3i 120 kW (163 PS) B 5234 S	01.1997→07.1999		7.22299.03.0	ARV	PN	
S80 I (184)						15
2.0 120 kW (163 PS) B 5204 T4	06.1998→07.2006		7.05270.67.0	LS	770 mm	
			7.05270.81.0	LS	1200 mm	
2.0 T 166 kW (226 PS) B 5204 T3	06.1998→07.2006		7.05270.67.0	LS	770 mm	
			7.05270.81.0	LS	1200 mm	
2.0 T 132 kW (180 PS) B 5204 T5	12.1999→07.2006		7.05270.67.0	LS	770 mm	
			7.05270.81.0	LS	1200 mm	
2.4 103 kW (140 PS) B 5244 S2	01.1999→07.2006		7.05270.70.0	LS	875 mm	
			7.05270.66.0	LS	810 mm	
			7.05270.69.0	LS	475 mm	
			7.05270.83.0	LS	475 mm	
2.4 125 kW (170 PS) B 5244 S	01.1999→07.2006		7.05270.70.0	LS	875 mm	
			7.05270.66.0	LS	810 mm	







V



S80 I (184) **15**

			7.05270.69.0	LS	475 mm	
			7.05270.83.0	LS	475 mm	
2.4 Bifuel (CNG) 103 kW (140 PS) B 5244 SG2	09.2001→07.2006		7.05270.70.0	LS	875 mm	
2.4 D 96-120 kW (131-163 PS) D 5244 T2	10.2001→07.2006		7.22996.11.0	AGR	ME	ohne Elektronikeinheit without the electronics unit
			7.22996.12.0	AGR	EL	nur Elektronikeinheit electronics unit only
2.4 D5 120 kW (163 PS) D 5244 T	08.2001→07.2006		7.22996.11.0	AGR	ME	ohne Elektronikeinheit without the electronics unit
			7.22996.12.0	AGR	EL	nur Elektronikeinheit electronics unit only
2.4 T 147 kW (200 PS) B 5244 T3	06.2000→07.2006		7.05270.67.0	LS	770 mm	
			7.05270.81.0	LS	1200 mm	
2.4 T5 AWD 147 kW (200 PS) B 5244 T3	04.2000→09.2003		7.05270.67.0	LS	770 mm	
			7.05270.81.0	LS	1200 mm	
2.5 T 153-162 kW (209-220 PS) B 5254 T2	03.2003→07.2006		7.05270.67.0	LS	770 mm	
			7.05270.81.0	LS	1200 mm	
2.5 T AWD 153-162 kW (209-220 PS) B 5254 T2	07.2003→07.2006		7.05270.67.0	LS	770 mm	
			7.05270.81.0	LS	1200 mm	
2.8 T6 200 kW (272 PS) B 6284 T	05.1998→12.2001		7.05270.37.0	LS	1640 mm	
3.0 T6 200 kW (272 PS) B 6294 T	06.2001→07.2006		7.05270.81.0	LS	1200 mm	
2.4F 20V (CNG) 103 kW (140 PS) B 5244 SG	01.2001→09.2005		7.05270.70.0	LS	875 mm	

S80 II (124) **16**





























	01.2010→12.2011		7.24809.39.0	AGR	EL	
			7.24809.91.0	AGR	EL	
			7.11190.10.0	DDS		
						ohne Zubehör without accessories für Hersteller-Abgasnorm: Emission Code 5 for manufacturer exhaust norm: Emission Code 5 2010, 2011 2010, 2011
V	06.2011→01.2014		7.02209.11.0	AGR	EL	
			7.02156.35.0	AGR-K	EL	ohne Sensor without sensor  ch. 172249→ mit AGR-Ventil with EGR valve
			7.02156.24.0	AGR-K	EL	mit Sensor with sensor 

S80 II (124)					16
			7.02156.33.0	AGR-K	mit Sensor with sensor
			7.02156.34.0	AGR-K	01.2012→ ohne AGR-Ventil without EGR valve
			7.02156.34.0	AGR-K	ohne Sensor without sensor
			7.02156.34.0	AGR-K	ch. 172249→ ohne AGR-Ventil without EGR valve
2.0 107 kW (146 PS) B 4204 S3	01.2008→09.2012		7.24809.73.0	AGR	EL
2.0 FlexFuel 107 kW (146 PS) B 4204 S4	01.2008→12.2011		7.24809.73.0	AGR	EL
2.0 TDi 100 kW (136 PS) D 4204 T	02.2008→03.2011		7.24809.68.0	AGR	EL
			7.09730.00.0	AGR-K	
			7.11190.08.0	DDS	ch. 151014→
2.4 D 120 kW (163 PS) D 5244 T5	03.2006→06.2009		7.00555.07.0	AGR	EL nur Elektronikeinheit electronics unit only →12.2009
			7.00555.06.0	AGR	EL ohne Elektronikeinheit without the electronics unit 01.2007→
			7.08369.27.0	ATS	EL
			7.11020.14.0	ATS	EL vor Rußpartikelfilter before soot particulate filter Euro 4 Euro 4 2009 2009
			7.11190.08.0	DDS	ch. 151014→ Euro 4 Euro 4 2009 2009
2.4 D 120 kW (163 PS) D 5244 T19	07.2009→03.2011		7.11020.44.0	ATS	EL ch. 134001→ 2010 2010 für Variant Code: AG02 for variant code: AG02
			7.08369.27.0	ATS	EL Fahrgestellnummer bis: 134000 Vehicle Identification Number to: 134000
			7.11020.14.0	ATS	EL 2010 2010
			7.11190.08.0	DDS	ch. 151014→
2.4 D 129 kW (175 PS) D 5244 T14	01.2010→03.2011		7.05363.00.0	AGR	EL
			7.11020.44.0	ATS	EL ch. 134001→ für Variant Code: AG02 for variant code: AG02
			7.08369.27.0	ATS	EL Fahrgestellnummer bis: 134000 Vehicle Identification Number to: 134000
			7.11020.14.0	ATS	EL vor Rußpartikelfilter before soot particulate filter
			7.11190.08.0	DDS	ch. 151014→
4.4 V8 AWD 232-235 kW (316-320 PS) B 8444 S	03.2006→03.2012		7.05270.70.0	LS	875 mm
			7.05270.82.0	LS	630 mm
			7.05270.69.0	LS	475 mm





S80 II (124) **16**

D3 100 kW (136 PS) D 5204 T7	05.2012→05.2014		7.05363.00.0 AGR EL 
			7.02107.09.0 AGR-K EL 
			7.11020.45.0 ATS EL  Getriebetyp: TF-80SD / M66 Transmission Type: TF-80SD / M66 2014 2014  ch. 151014→ 2014 2014
D3 / D4 120 kW (163 PS) D 5204 T2, D 5204 T3	01.2010→12.2016		7.05363.00.0 AGR EL 
			7.02107.09.0 AGR-K EL 
			7.11020.45.0 ATS EL  D 5204 T2: 2011 2011 D 5204 T3: 2012, 2015 2012, 2015 D 5204 T2:  ch. 151014→ 2011 2011 D 5204 T3:  ch. 151014→ 2012 2012 2015 2015
D4 133 kW (181 PS) D 4204 T5	09.2013→12.2016		7.11020.43.0 ATS EL 
			7.11190.08.0 DDS EL  2016 2016
D5 136 kW (185 PS) D 5244 T4	03.2006→08.2009		7.00555.06.0 AGR EL  ohne Elektronikeinheit without the electronics unit 01.2007→
			7.00555.07.0 AGR EL  nur Elektronikeinheit electronics unit only
			7.08369.27.0 ATS EL 
			7.11020.14.0 ATS EL  Ausstattungsvariante: AG02 Equipment Variant: AG02 vor Rußpartikelfilter before soot particulate filter
			7.11190.08.0 DDS EL  Euro 4 Euro 4 2007 2007 2009 2009
D5 151 kW (205 PS) D 5244 T10	01.2010→12.2011		7.05363.00.0 AGR EL 
			7.02107.09.0 AGR-K EL 
			7.11020.44.0 ATS EL   ch. 134001→ für Variant Code: AG02 for variant code: AG02
			7.11020.45.0 ATS EL  D 5244 T10:  ch. 134001→ für Variant Code: AG01 for variant code: AG01 D 5244 T10: Getriebetyp: TF-80SC / M66 Transmission Type: TF-80SC / M66 2011 2011
			7.08369.27.0 ATS EL  Fahrgestellnummer bis: 134000 Vehicle Identification Number to: 134000
			7.11020.13.0 ATS EL  Ausstattungsvariante: AG01 Equipment Variant: AG01







V

S80 II (124)					16	
			7.11020.14.0	ATS	EL	Ausstattungsvariante: AG02 Equipment Variant: AG02 vor Rußpartikelfilter before soot particulate filter
			7.11190.08.0	DDS		ch. 151014→ 2011 2011
D5 158 kW (215 PS) D 5244 T11	06.2011→04.2015		7.05363.00.0	AGR	EL	
			7.02107.09.0	AGR-K		
			7.11020.45.0	ATS	EL	Getriebetyp: M66 Transmission Type: M66 2014 2014
			7.11190.08.0	DDS		Getriebetyp: M66 Transmission Type: M66 2012 2012 2014 2014
D5 158-169 kW (215-230 PS) D 5244 T15	06.2011→04.2015		7.05363.00.0	AGR	EL	
			7.02107.09.0	AGR-K		
			7.11020.44.0	ATS	EL	ch. 134001→ 2015 2015 für Variant Code: AG02 for variant code: AG02
			7.11020.45.0	ATS	EL	D 5244 T15: ch. 134001→ 2015 2015 für Variant Code: AG01 for variant code: AG01 D 5244 T15: ch. 134001→ Getriebetyp: TF-80SC Transmission Type: TF-80SC 2015 2015
			7.08369.27.0	ATS	EL	→ch. 134000
			7.11020.13.0	ATS	EL	Ausstattungsvariante: AG01 Equipment Variant: AG01 2015 2015
			7.11020.14.0	ATS	EL	Ausstattungsvariante: AG02 Equipment Variant: AG02 vor Rußpartikelfilter before soot particulate filter 2015 2015
			7.11190.08.0	DDS		2015 2015
D5 AWD 136 kW (185 PS) D 5244 T4	01.2007→05.2009		7.00555.06.0	AGR	EL	 ohne Elektronikeinheit without the electronics unit
			7.00555.07.0	AGR	EL	nur Elektronikeinheit electronics unit only
			7.08369.27.0	ATS	EL	
			7.11190.08.0	DDS		ch. 151014→ Euro 4 Euro 4 2009 2009
D5 AWD 151 kW (205 PS) D 5244 T10	01.2010→12.2011		7.05363.00.0	AGR	EL	
			7.02107.09.0	AGR-K		











V







S80 II (124) 16

			7.11020.44.0	ATS	EL	 ch. 134001→ für Variant Code: AG02 for variant code: AG02
			7.08369.27.0	ATS	EL	Fahrgestellnummer bis: 134000 Vehicle Identification Number to: 134000
			7.11020.13.0	ATS	EL	Ausstattungsvariante: AG01 Equipment Variant: AG01
			7.11020.14.0	ATS	EL	Ausstattungsvariante: AG02 Equipment Variant: AG02 vor Rußpartikelfilter before soot particulate filter
			7.11190.08.0	DDS		 ch. 151014→ 2011 2011
D5 AWD 158-169 kW (215-230 PS) D 5244 T15	06.2011→04.2015		7.05363.00.0	AGR	EL	
			7.02107.09.0	AGR-K		
			7.08369.27.0	ATS	EL	 →ch. 134000
			7.11020.13.0	ATS	EL	Ausstattungsvariante: AG01 Equipment Variant: AG01 2015 2015
			7.11020.14.0	ATS	EL	Ausstattungsvariante: AG02 Equipment Variant: AG02 vor Rußpartikelfilter before soot particulate filter 2015 2015
			7.11190.08.0	DDS		2015 2015
3.2i 24V 168-177 kW (228-238 PS) B 6324 S	07.2006→		7.05270.69.0	LS	475 mm	

S90 I (964) 17

2.5 125 kW (170 PS) B 6254 FS	11.1996→10.1998		7.22299.03.0	ARV	PN	
2.5 132 kW (180 PS) B 6244 FS	11.1996→10.1997		7.22299.03.0	ARV	PN	
2.9 132-135 kW (180-184 PS) B 6304 S2	11.1996→12.1998		7.22299.03.0	ARV	PN	
2.9 132-135 kW (180-184 PS) B 6304 S2	01.1997→05.1998		7.22299.03.0	ARV	PN	
2.9 150 kW (204 PS) B 6304 GS	01.1997→05.1998		7.22299.03.0	ARV	PN	

S90 II (234) 18

2.0 D3 110 kW (150 PS) D 4204 T16, D 4204 T9	03.2016→08.2018		7.11020.43.0	ATS	EL	 D 4204 T16: Getriebetyp: M66, TG-81SC Transmission Type: M66, TG-81SC 2019 2019  D 4204 T9: Getriebetyp: M66, TG-71SC Transmission Type: M66, TG-71SC  D 4204 T16: Getriebetyp: M66, TG-81SC Transmission Type: M66, TG-81SC 2019 2019  D 4204 T9: Getriebetyp: TF-71SC Transmission Type: TF-71SC 2018 2018
			7.11190.08.0	DDS		

V

S90 II (234) 18



















2.0 D4 140-147 kW (190-200 PS) D 4204 T14	03.2016→		7.11020.43.0	ATS	EL	D 4204 T14: Getriebetyp: M66, TG-81SC Transmission Type: M66, TG-81SC 2018 2018 D 4204 T14: Ausstattungsvariante: G101 / G102 Equipment Variant: G101 / G102 Getriebetyp: M66, TG-81SC Transmission Type: M66, TG-81SC 2019 2019
			7.11190.08.0	DDS		Getriebetyp: M66, TG-81SC Transmission Type: M66, TG-81SC
2.0 D4 120 kW (163 PS) D 4204 T7	09.2018→		7.11020.43.0	ATS	EL	Ausstattungsvariante: G101 / G102 Equipment Variant: G101 / G102 Getriebetyp: TG-81SC Transmission Type: TG-81SC 2019 2019
			7.11190.08.0	DDS		
2.0 D4 AWD 140-147 kW (190-200 PS) D 4204 T14	03.2016→		7.11020.43.0	ATS	EL	Getriebetyp: TG-81SC Transmission Type: TG-81SC 2017 2017 2019 2019
			7.11190.08.0	DDS		Getriebetyp: M66, TG-81SC Transmission Type: M66, TG-81SC 2019 2019
2.0 D5 AWD 173-177 kW (235-241 PS) D 4204 T23	03.2016→		7.11020.43.0	ATS	EL	Ausstattungsvariante: G101 / G102 Equipment Variant: G101 / G102 Getriebetyp: TG-81SC Transmission Type: TG-81SC 2017 2017
			7.11190.08.0	DDS		Ausstattungsvariante: G102 Equipment Variant: G102 Getriebetyp: TG-81SC AWD Transmission Type: TG-81SC AWD
D4 Drive-E Polestar 140-147 kW (190-200 PS) D 4204 T14	03.2016→		7.11020.43.0	ATS	EL	D 4204 T14: Getriebetyp: TG-81SC / M66 Transmission Type: TG-81SC / M66 2018 2018 D 4204 T14: Ausstattungsvariante: G101 / G102 Equipment Variant: G101 / G102 Getriebetyp: M66, TG-81SC Transmission Type: M66, TG-81SC 2019 2019
D4 Drive-E Polestar AWD 140-147 kW (190-200 PS) D 4204 T14	03.2016→		7.11020.43.0	ATS	EL	Getriebetyp: TG-81SC Transmission Type: TG-81SC 2017 2017 2019 2019

V40 Estate (645) 19

1.9 DI 75 kW (102 PS) D 4192 T4	07.2000→06.2004		7.22818.57.0	AGR	EL	
			7.22818.57.0	AGR	EL	
1.9 DI 85 kW (116 PS) D 4192 T3	07.2000→06.2004					



V40 Hatchback (525, 526) 20

D2 84 kW (114 PS) D 4162 T	03.2012→		7.02209.11.0	AGR	EL			
			7.02156.35.0	AGR-K	EL		ohne Sensor without sensor  ch. 44762→ mit AGR-Ventil with EGR valve	
			7.02156.33.0	AGR-K			mit Sensor with sensor 01.2013→12.2015 ohne AGR-Ventil without EGR valve	
			7.02156.34.0	AGR-K			ohne Sensor without sensor  ch. 44762→ ohne AGR-Ventil without EGR valve	
D2 88-145 kW (120-197 PS) D 4204 T13, D 4204 T8	02.2015→08.2018		7.11020.43.0	ATS	EL	 D 4204 T13: Getriebetyp: M76, TF-71SC Transmission Type: M76, TF-71SC 2019 2019  D 4204 T8: Getriebetyp: M66, TF-71SC Transmission Type: M66, TF-71SC 2016 2016  D 4204 T8: Getriebetyp: M66, M76, TF-71SC Transmission Type: M66, M76, TF-71SC 2017 2017  D 4204 T8: Getriebetyp: M76, TF-71SC Transmission Type: M76, TF-71SC 2018, 2019 2018, 2019  D 4204 T13: Getriebetyp: M76, TF-71SC Transmission Type: M76, TF-71SC 2020 2020  D 4204 T8: Getriebetyp: M76, TF-71SC Transmission Type: M76, TF-71SC 2016 2016 2018 2018  D 4204 T8: Getriebetyp: M66 Transmission Type: M66 2016 2016 2017 2017		
			7.11190.08.0	DDS			 D 4204 T13: Getriebetyp: M76, TF-71SC Transmission Type: M76, TF-71SC 2020 2020  D 4204 T8: Getriebetyp: M76, TF-71SC Transmission Type: M76, TF-71SC 2016 2016 2018 2018  D 4204 T8: Getriebetyp: M66 Transmission Type: M66 2016 2016 2017 2017	
D3 110 kW (150 PS) D 5204 T6	03.2012→03.2015		7.05363.00.0	AGR	EL			
			7.02107.09.0	AGR-K				
			7.11020.45.0	ATS	EL			2016 2016
			7.11190.08.0	DDS				















V

V40 Hatchback (525, 526)					
20					
D3 110 kW (150 PS) D 4204 T16, D 4204 T9	04.2015→		7.11020.43.0	ATS	EL D 4204 T16: Getriebetyp: M76, TF-71SC Transmission Type: M76, TF-71SC 2019 2019 D 4204 T9: Getriebetyp: M76, TF-71SC Transmission Type: M76, TF-71SC 2017 2017 2019 2019 D 4204 T9: Getriebetyp: M76, TF-71SC Transmission Type: M76, TF-71SC 2016 2016 2017 2017
			7.11190.08.0	DDS	D 4204 T16: Getriebetyp: M76, TF-71SC Transmission Type: M76, TF-71SC 2019 2019 D 4204 T9: Getriebetyp: M76, TF-71SC Transmission Type: M76, TF-71SC 2016 2016 2019 2019 D 4204 T9: Getriebetyp: M66 Transmission Type: M66 2016 2016 2017 2017
D4 130 kW (177 PS) D 5204 T4	03.2012→		7.05363.00.0	AGR	EL
			7.02107.09.0	AGR-K	
			7.11020.45.0	ATS	EL
			7.11190.08.0	DDS	2013 2013 2015 2015
D4 140-147 kW (190-200 PS) D 4204 T14	05.2014→		7.11020.43.0	ATS	EL Getriebetyp: M66, TG-81SC Transmission Type: M66, TG-81SC 2015 2015 2018 2018
			7.11190.08.0	DDS	Getriebetyp: M66, TG-81SC Transmission Type: M66, TG-81SC 2018 2018
D4 Polestar 140-147 kW (190-200 PS) D 4204 T14	05.2014→		7.11020.43.0	ATS	EL Getriebetyp: M66, TG-81SC Transmission Type: M66, TG-81SC 2015 2015 2018 2018
			7.11190.08.0	DDS	Getriebetyp: M66, TG-81SC Transmission Type: M66, TG-81SC 2018 2018

V



V50 (545) **21**

1.6 74 kW (101 PS) B 4164 S3	01.2005→12.2012	 7.05270.82.0	LS	630 mm	
		7.05270.69.0	LS	475 mm	
1.6 D 80-81 kW (109-110 PS) D 4164 T	01.2005→12.2011	 7.24809.39.0	AGR	EL	 ch. 179692→  →ch. 179691 ohne Zubehör without accessories für Hersteller-Abgasnorm: Emission Code 3, Emission Code 5, Emission Code E, Emission Code F for manufacturer exhaust norm: Emission Code 3, Emission Code 5, Emission Code E, Emission Code F 2004 2004 2011 2011
		7.24809.91.0	AGR	EL	
		7.11190.10.0	DDS		
1.6 D 80-81 kW (109-110 PS) D 4164 T	03.2005→12.2012	 7.11190.10.0	DDS		ohne Zubehör without accessories für Hersteller-Abgasnorm: Emission Code 3, Emission Code 5, Emission Code E, Emission Code F for manufacturer exhaust norm: Emission Code 3, Emission Code 5, Emission Code E, Emission Code F 2004 2004 2011 2011
1.6 D2 84 kW (114 PS) D 4162 T	01.2010→12.2012	 7.02209.11.0	AGR	EL	 mit Sensor with sensor  mit Sensor with sensor 01.2011→ ohne AGR-Ventil without EGR valve
		7.02156.24.0	AGR-K	EL	
		7.02156.33.0	AGR-K		
1.8 92 kW (125 PS) B 4184 S11	04.2004→12.2010	 7.24809.73.0	AGR	EL	
		7.05270.82.0	LS	630 mm	
		7.05270.69.0	LS	475 mm	
1.8 FlexFuel 92 kW (125 PS) B 4184 S8	01.2005→12.2010	 7.24809.73.0	AGR	EL	
		7.02604.64.0	LS	450 mm	
2.0 107 kW (146 PS) B 4204 S3	10.2006→12.2012	 7.24809.73.0	AGR	EL	
		7.05270.82.0	LS	630 mm	
		7.05270.69.0	LS	475 mm	
2.0 CDI 96-98 kW (131-133 PS) D 4204 T2	12.2003→12.2006	 7.09730.00.0	AGR-K		ohne Zubehör without accessories 2004 2004 2006 2006
		7.11190.10.0	DDS		

V

V50 (545)					
2.0 D 100 kW (136 PS) D 4204 T	04.2004→12.2010		7.24809.68.0	AGR	EL
			7.09730.00.0	AGR-K	ohne Zubehör without accessories 2004 2004 2010 2010
			7.11190.10.0	DDS	
2.0 D4 96-98 kW (131-133 PS) D 4204 T2	07.2005→12.2006		7.11190.10.0	DDS	ohne Zubehör without accessories 2004 2004 2006 2006
2.0 FlexFuel 107 kW (146 PS) B 4204 S4	01.2010→12.2012		7.24809.73.0	AGR	EL
2.4 103 kW (140 PS) B 5244 S5	04.2004→12.2010		7.05270.82.0	LS	630 mm
			7.05270.69.0	LS	475 mm
2.4 125 kW (170 PS) B 5244 S4	04.2004→12.2010		7.05270.82.0	LS	630 mm
			7.05270.69.0	LS	475 mm
2.4 AWD 125 kW (170 PS) B 5244 S4	08.2006→12.2009		7.05270.82.0	LS	630 mm
			7.05270.69.0	LS	475 mm
2.4 D5 132 kW (180 PS) D 5244 T13, D 5244 T8	03.2006→12.2010		7.00555.06.0	AGR	EL ohne Elektronikeinheit without the electronics unit
			7.00555.07.0	AGR	EL nur Elektronikeinheit electronics unit only
			7.01604.02.0	AGR	EL ohne Elektronikeinheit without the electronics unit
			7.08369.27.0	ATS	EL D 5244 T13, D 5244 T8: 572277→
			7.11020.14.0	ATS	EL D 5244 T13, D 5244 T8: vor Rußpartikelfilter before soot particulate filter
			7.11190.08.0	DDS	 D 5244 T13, D 5244 T8: ch. 650005→
2.4 Tdi 120 kW (163 PS) D 5244 T9	05.2007→12.2010		7.00555.06.0	AGR	EL ohne Elektronikeinheit without the electronics unit
			7.00555.07.0	AGR	EL nur Elektronikeinheit electronics unit only
			7.01604.02.0	AGR	EL ohne Elektronikeinheit without the electronics unit
			7.08369.27.0	ATS	EL 572277→
			7.11020.14.0	ATS	EL vor Rußpartikelfilter before soot particulate filter
			7.11190.08.0	DDS	 ch. 650005→
D3 110 kW (150 PS) D 5204 T5	10.2010→12.2012		7.05363.00.0	AGR	EL
			7.02107.09.0	AGR-K	
			7.11020.45.0	ATS	EL
			7.11190.08.0	DDS	ch. 650005→

















V



V50 (545) 21

D4 130 kW (177 PS) D 5204 T	10.2010→12.2012		7.05363.00.0	AGR	EL	
			7.02107.09.0	AGR-K		
			7.11020.45.0	ATS	EL	
			7.11190.08.0	DDS		 ch. 650005→
T5 162 kW (220 PS) B 5254 T3	04.2004→12.2007		7.05270.67.0	LS	770 mm	
T5 AWD 162 kW (220 PS) B 5254 T3	04.2004→12.2007		7.05270.67.0	LS	770 mm	

V60 I (155, 157) 22

1.6 DRIVe 84 kW (114 PS) D 4162 T	02.2011→12.2015		7.02209.11.0	AGR	EL	
			7.02156.35.0	AGR-K	EL	ohne Sensor without sensor  ch. 131885→
			7.02156.24.0	AGR-K	EL	mit AGR-Ventil with EGR valve
			7.02156.34.0	AGR-K		mit Sensor with sensor 
			7.02156.33.0	AGR-K		ohne Sensor without sensor  ch. 131885→ ohne AGR-Ventil without EGR valve mit Sensor with sensor ohne AGR-Ventil without EGR valve
2.0 D2 88-145 kW (120-197 PS) D 4204 T20, D 4204 T8	03.2015→05.2018		7.11020.43.0	ATS	EL	 D 4204 T20, D 4204 T8: 2016 2016
			7.11190.08.0	DDS		
2.0 D3 110 kW (150 PS) D 4204 T4	03.2015→05.2018		7.11190.08.0	DDS		
			7.11020.43.0	ATS	EL	2016 2016
2.0 D3 110 kW (150 PS) D 4204 T9	03.2015→05.2018		7.11020.43.0	ATS	EL	2016 2016
			7.11190.08.0	DDS		
2.0 D4 140-147 kW (190-200 PS) D 4204 T14	03.2015→05.2018		7.11020.43.0	ATS	EL	2016 2016
			7.11190.08.0	DDS		2018 2018
2.0 D4 Drive-E Polestar 140-147 kW (190-200 PS) D 4204 T14	03.2015→05.2018		7.11020.43.0	ATS	EL	2016 2016 2018 2018
			7.11190.08.0	DDS		2018 2018
2.4 D5 158 kW (215 PS) D 5244 T11	04.2011→12.2015		7.05363.00.0	AGR	EL	
			7.02107.09.0	AGR-K		
			7.11020.45.0	ATS	EL	Getriebetyp: M66 Transmission Type: M66
2.4 D5 158-169 kW (215-230 PS) D 5244 T15	04.2011→12.2015		7.05363.00.0	AGR	EL	
			7.02107.09.0	AGR-K		
			7.11020.45.0	ATS	EL	Getriebetyp: TF-80SC Transmission Type: TF-80SC

V





















V60 I (155, 157) 22

			7.11190.08.0	DDS		D 5244 T15: ch. 35017→ Getriebetyp: TF-80SC Transmission Type: TF-80SC D 5244 T15: ch. 35017→ Getriebetyp: M66 Transmission Type: M66
2.4 D5 AWD 158-169 kW (215-230 PS) D 5244 T15	04.2011→12.2015		7.05363.00.0	AGR	EL	
			7.02107.09.0	AGR-K		
			7.11020.14.0	ATS	EL	für Getriebeautomatik 6 Gang for 6-speed automatic transmission nach Katalysator Post-catalyst Euro 5 Euro 5
			7.11020.44.0	ATS	EL	Getriebetyp: TF-80SC Transmission Type: TF-80SC für Hersteller-Abgasnorm: Emission Code 5 for manufacturer exhaust norm: Emission Code 5
			7.11190.08.0	DDS		ch. 35017→ Getriebetyp: TF-80SC Transmission Type: TF-80SC Euro 5 Euro 5
2.4 D5 Hybrid AWD 120 kW (163 PS) D87PHEV	03.2015→05.2018		7.05363.00.0	AGR	EL	
			7.02107.09.0	AGR-K		
			7.11020.45.0	ATS	EL	Getriebetyp: TF-80SD Transmission Type: TF-80SD
			7.11190.08.0	DDS		ch. 35017→ Getriebetyp: TE-80SD Transmission Type: TE-80SD 2018 2018
2.4 Hybrid D6 AWD 158 kW (215 PS) D82PHEV	06.2012→12.2015		7.05363.00.0	AGR	EL	
			7.02107.09.0	AGR-K		
			7.11020.45.0	ATS	EL	Getriebetyp: TF-80SD Transmission Type: TF-80SD
			7.11190.08.0	DDS		ch. 35017,→ Getriebetyp: TF-80SD Transmission Type: TF-80SD
D3 100 kW (136 PS) D 5204 T7	05.2012→12.2015		7.05363.00.0	AGR	EL	
			7.02107.09.0	AGR-K		
			7.11020.45.0	ATS	EL	D 5204 T7: Getriebetyp: TF-80SC / TF-80SD Transmission Type: TF-80SC / TF-80SD 2012 2012 D 5204 T7: Getriebetyp: M66 Transmission Type: M66 D 5204 T7: Getriebetyp: TF-80SD Transmission Type: TF-80SD 2014 2014

V





















V60 I (155, 157) 22

			7.11190.08.0	DDS		 D 5204 T7:  ch. 35017→ Getriebetyp: TF-80SC Transmission Type: TF-80SC 2013  D 5204 T7:  ch. 35017→ Getriebetyp: M66, TF-80SD Transmission Type: M66, TF-80SD 2013 2015 2015
D3 / D4 120 kW (163 PS) D 5204 T2, D 5204 T3	07.2010→12.2014		7.05363.00.0	AGR	EL	
			7.02107.09.0	AGR-K		
			7.11020.45.0	ATS	EL	 D 5204 T2: 2011  D 5204 T3: 2012  D 5204 T2, D 5204 T3:  ch. 35017→
D4 133 kW (181 PS) D 4204 T5	10.2013→12.2015		7.11020.43.0	ATS	EL	
			7.11190.08.0	DDS		
D4 AWD 120 kW (163 PS) D 5244 T17	05.2012→12.2015		7.05363.00.0	AGR	EL	
			7.02107.09.0	AGR-K		
			7.11020.14.0	ATS	EL	für OE-Nummer: 30713642, 31370465, 31431047 for OE number: 30713642, 31370465, 31431047 vor Rußpartikelfilter before soot particulate filter
			7.11020.44.0	ATS	EL	Getriebetyp: TF-80SC Transmission Type: TF-80SC für Hersteller-Abgasnorm: Emission Code 5 for manufacturer exhaust norm: Emission Code 5 2015 2015
D4 AWD 133 kW (181 PS) D 5244 T12	10.2013→12.2015		7.11190.08.0	DDS		 ch. 35017→ Getriebetyp: TF-80SC Transmission Type: TF-80SC Euro 5 Euro 5 2013 2013 2015 2015
			7.05363.00.0	AGR	EL	
			7.02107.09.0	AGR-K		
			7.11020.14.0	ATS	EL	Getriebetyp: TF-80SC Transmission Type: TF-80SC vor Rußpartikelfilter before soot particulate filter Euro 5 Euro 5 2014 2014 2015 2015

V











V60 I (155, 157) **22**

			7.11020.44.0	ATS	EL	Getriebetyp: TF-80SC Transmission Type: TF-80SC für Hersteller-Abgasnorm: Emission Code 5 for manufacturer exhaust norm: Emission Code 5
			7.11190.08.0	DDS		 ch. 35017→ Getriebetyp: TF-80SC Transmission Type: TF-80SC Euro 5 Euro 5
D4 AWD 140-162 kW (190-220 PS) D 5244 T21	03.2015→05.2018		7.05363.00.0	AGR	EL	
			7.02107.09.0	AGR-K		
			7.11020.14.0	ATS	EL	für OE-Nummer: 30713642, 31370465, 31431047 for OE number: 30713642, 31370465, 31431047 vor Rußpartikelfilter before soot particulate filter
			7.11020.44.0	ATS	EL	Getriebetyp: TF-80SC Transmission Type: TF-80SC für Hersteller-Abgasnorm: Emission Code 5 for manufacturer exhaust norm: Emission Code 5
D4 Polestar AWD 140-162 kW (190-220 PS) D 5244 T21	03.2015→05.2018		7.02107.09.0	AGR-K		
			7.11020.14.0	ATS	EL	für OE-Nummer: 30713642, 31370465, 31431047 for OE number: 30713642, 31370465, 31431047 vor Rußpartikelfilter before soot particulate filter
			7.11020.44.0	ATS	EL	Getriebetyp: TF-80SC Transmission Type: TF-80SC für Hersteller-Abgasnorm: Emission Code 5 for manufacturer exhaust norm: Emission Code 5
D5 151 kW (205 PS) D 5244 T10	07.2010→12.2011		7.05363.00.0	AGR	EL	
			7.02107.09.0	AGR-K		
			7.11020.45.0	ATS	EL	Getriebetyp: TF-80SC / M66 Transmission Type: TF-80SC / M66
			7.11190.08.0	DDS		 ch. 35017→ Getriebetyp: M66, TF-80SC Transmission Type: M66, TF-80SC
D5 169 kW (230 PS) D 5244 T23	04.2014→12.2015		7.05363.00.0	AGR	EL	
			7.02107.09.0	AGR-K		
			7.11020.45.0	ATS	EL	Getriebetyp: TF-80SC Transmission Type: TF-80SC
			7.11190.08.0	DDS		 ch. 35017→ Getriebetyp: TF-80SC Transmission Type: TF-80SC
D5 165-171 kW (224-232 PS) D 4204 T11	03.2015→05.2018		7.11020.43.0	ATS	EL	2016 2016
			7.11190.08.0	DDS		2018 2018
D5 AWD 151 kW (205 PS) D 5244 T10	07.2010→12.2011		7.05363.00.0	AGR	EL	
			7.02107.09.0	AGR-K		



V



V60 I (155, 157) 22

			7.11020.14.0	ATS	EL	für Getriebeautomatik 6 Gang for 6-speed automatic transmission nach Katalysator Post-catalyst Euro 5 Euro 5 2011 2011
			7.11020.44.0	ATS	EL	Getriebetyp: TF-80SC Transmission Type: TF-80SC für Hersteller-Abgasnorm: Emission Code 5 for manufacturer exhaust norm: Emission Code 5
			7.11190.08.0	DDS		 ch. 35017→ Getriebetyp: TF-80SC Transmission Type: TF-80SC Euro 5 Euro 5
D5 AWD 158-169 kW (215-230 PS) D 5244 T15	04.2014→12.2015		7.05363.00.0	AGR	EL	
			7.02107.09.0	AGR-K		
			7.11020.14.0	ATS	EL	für Getriebeautomatik 6 Gang for 6-speed automatic transmission nach Katalysator Post-catalyst Euro 5 Euro 5
			7.11020.44.0	ATS	EL	Getriebetyp: TF-80SC Transmission Type: TF-80SC für Hersteller-Abgasnorm: Emission Code 5 for manufacturer exhaust norm: Emission Code 5
			7.11190.08.0	DDS		 ch. 35017→ Getriebetyp: TF-80SC Transmission Type: TF-80SC Euro 5 Euro 5
			7.05363.00.0	AGR	EL	
D6 Hybrid AWD 162 kW (220 PS) D97PHEV	03.2015→05.2018		7.02107.09.0	AGR-K		
			7.11020.45.0	ATS	EL	Getriebetyp: TF-80SD Transmission Type: TF-80SD
			7.11190.08.0	DDS		 ch. 35017→ Getriebetyp: TF-80SD Transmission Type: TF-80SD 2018 2018

V60 II (225, 227) 23

D3 AWD 110 kW (150 PS) D 4204 T4	09.2018→		7.11020.43.0	ATS	EL	Getriebetyp: TG-81SC Transmission Type: TG-81SC 2018 2018
			7.11190.08.0	DDS		Getriebetyp: TG-81SC Transmission Type: TG-81SC
D4 140-147 kW (190-200 PS) D 4204 T14	02.2018→		7.11020.43.0	ATS	EL	Ausstattungsvariante: G101 / G102 Equipment Variant: G101 / G102 Getriebetyp: M66, TG-81SC Transmission Type: M66, TG-81SC 2019 2019 2021 2021

V





V60 II (225, 227) 23

		7.11190.08.0	DDS	D 4204 T14: Ausstattungsvariante: G101 / G102 Equipment Variant: G101 / G102 Getriebetyp: TG-81SC Transmission Type: TG-81SC 2019 D 4204 T14: Ausstattungsvariante: G101 / G102 Equipment Variant: G101 / G102 Getriebetyp: M66 Transmission Type: M66 2019
D4 AWD 140-147 kW (190-200 PS) D 4204 T14	09.2018->	7.11020.43.0	ATS	EL Ausstattungsvariante: G101 / G102 Equipment Variant: G101 / G102 Getriebetyp: TG-81SC / M66 Transmission Type: TG-81SC / M66 2021
		7.11190.08.0	DDS	D 4204 T14: Ausstattungsvariante: G101 / G102 Equipment Variant: G101 / G102 Getriebetyp: M66 Transmission Type: M66 D 4204 T14: Ausstattungsvariante: G101 / G102 Equipment Variant: G101 / G102 Getriebetyp: TG-81SC Transmission Type: TG-81SC
D4 Polestar 140-147 kW (190-200 PS) D 4204 T14	02.2018->	7.11020.43.0	ATS	EL Getriebetyp: TG-81SC / M66 Transmission Type: TG-81SC / M66 2019 2019 2021 2021
		7.11190.08.0	DDS	D 4204 T14: Ausstattungsvariante: G101 / G102 Equipment Variant: G101 / G102 Getriebetyp: M66 Transmission Type: M66 2019 D 4204 T14: Ausstattungsvariante: G101 / G102 Equipment Variant: G101 / G102 Getriebetyp: TG-81SC Transmission Type: TG-81SC 2019 2019



V









V60 II (225, 227) 23

D4 Polestar AWD 140-147 kW (190-200 PS) D 4204 T14	02.2018→12.2020	 	7.11020.43.0	ATS	EL	Ausstattungsvariante: G101 / G102 Equipment Variant: G101 / G102 Getriebetyp: M66 / TG-81SC Transmission Type: M66 / TG-81SC 2021 2021  D 4204 T14: Ausstattungsvariante: G 101 / G 102 Equipment Variant: G 101 / G 102 Getriebetyp: M66 Transmission Type: M66 2019 2019  D 4204 T14: Ausstattungsvariante: G 101 / G 102 Equipment Variant: G 101 / G 102 Getriebetyp: TG-81SC Transmission Type: TG-81SC 2019 2019
			7.11190.08.0	DDS		

V70 24





2.0i 20V 93-105 kW (126-143 PS) B 5204 S	01.1997→03.2000		7.22299.03.0	ARV	PN	<input type="checkbox"/>
2.4F 20V (LPG) 103 kW (140 PS) B 5244 SG2	08.1999→03.2000		7.22299.03.0	ARV	PN	<input type="checkbox"/>

V70 I (875, 876) 25

2.0 93 kW (126 PS) B 5202 FS	12.1995→03.2000		7.05270.79.0	LS	530 mm	
			7.21857.01.0	SLP	EL	
2.0 105 kW (143 PS) B 5204 F	12.1995→03.2000		7.22299.03.0	ARV	PN	<input type="checkbox"/>
			7.05270.79.0	LS	530 mm	
2.0 93 kW (126 PS) B 5202 S	01.1997→03.2000		7.22299.03.0	ARV	PN	<input type="checkbox"/>
			7.05270.79.0	LS	530 mm	
2.0 132 kW (180 PS) B 5204 T2	01.1997→03.2000		7.22299.03.0	ARV	PN	<input type="checkbox"/>
			7.05270.67.0	LS	770 mm	
			7.05270.80.0	LS	650 mm	
			7.05270.81.0	LS	1200 mm	
			7.21857.01.0	SLP	EL	
2.0 120 kW (163 PS) B 5204 T4	01.1997→12.2000		7.22299.03.0	ARV	PN	<input type="checkbox"/>
			7.05270.79.0	LS	530 mm	
			7.21857.01.0	SLP	EL	
			7.05270.67.0	LS	770 mm	
2.0 Turbo 155 kW (211 PS) B 5204 T	01.1997→03.2000		7.22299.03.0	ARV	PN	<input type="checkbox"/>
			7.05270.67.0	LS	770 mm	
			7.05270.80.0	LS	650 mm	
			7.05270.81.0	LS	1200 mm	
			7.21857.01.0	SLP	EL	
2.0 Turbo 166 kW (226 PS) B 5204 T3	01.1997→12.2000		7.22299.03.0	ARV	PN	<input type="checkbox"/>

V



















V70 I (875, 876) 25

			7.05270.67.0	LS	770 mm	
			7.05270.80.0	LS	650 mm	
			7.05270.81.0	LS	1200 mm	
			7.21857.01.0	SLP	EL	
2.0 Turbo AWD 166 kW (226 PS) B 5204 T3	01.1997→12.2000		7.22299.03.0	ARV	PN	⊙
			7.05270.67.0	LS	770 mm	
			7.05270.80.0	LS	650 mm	
			7.05270.81.0	LS	1200 mm	
			7.21857.01.0	SLP	EL	
2.3 147-184 kW (239-250 PS) B 5234 T3	11.1996→11.2000		7.22299.03.0	ARV	PN	⊙
			7.21857.01.0	SLP	EL	
2.3 AWD 147-184 kW (239-250 PS) B 5234 T3	04.1997→09.1998		7.22299.03.0	ARV	PN	⊙
			7.21857.01.0	SLP	EL	
2.3 AWD 195 kW (265 PS) B 5234 T7, B 5234 T8	12.1998→02.2000		7.22299.03.0	ARV	PN	⊙
			7.21857.01.0	SLP	EL	
2.3 T AWD 176-184 kW (239-250 PS) B 5234 T4	04.1997→03.2000		7.22299.03.0	ARV	PN	⊙
			7.21857.01.0	SLP	EL	
2.3 T-5 147-184 kW (239-250 PS) B 5234 T3	11.1996→12.2000		7.22299.03.0	ARV	PN	⊙
			7.21857.01.0	SLP	EL	
2.3 T-5 AWD 147-184 kW (239-250 PS) B 5234 T3	01.1997→12.2000		7.22299.03.0	ARV	PN	⊙
			7.21857.01.0	SLP	EL	
2.3 Turbo 176-184 kW (239-250 PS) B 5234 T4	12.1995→03.2000		7.22299.03.0	ARV	PN	⊙
2.4 104-106 kW (141-144 PS) B 5252 FS	12.1995→03.2000		7.22299.03.0	ARV	PN	⊙
			7.05270.79.0	LS	530 mm	
			7.21857.01.0	SLP	EL	
2.4 121-125 kW (165-170 PS) B 5244 S, B 5254 FS, B 5254 S	12.1995→05.2000		7.22299.03.0	ARV	PN	⊙
			7.05270.66.0	LS	810 mm	
			7.21857.01.0	SLP	EL	
2.4 121-125 kW (165-170 PS) B 5254 S	06.1998→12.1999		7.22299.03.0	ARV	PN	⊙
			7.05270.66.0	LS	810 mm	
			7.21857.01.0	SLP	EL	
2.4 103 kW (140 PS) B 5244 S2, B 5244 SG2	03.1999→12.2000		7.22299.03.0	ARV	PN	⊙
			7.21857.01.0	SLP	EL	
2.4 AWD 121-125 kW (165-170 PS) B 5254 S	06.1998→12.1999		7.22299.03.0	ARV	PN	⊙



V







V70 I (875, 876) 25

2.4 Bifuel 106 kW (144 PS) GB 5252 S	05.1998→12.1999		7.22299.03.0	ARV	PN		
			7.21857.01.0	SLP	EL		
2.4 Bifuel 103 kW (140 PS) B 5244 SG	08.1999→12.2000		7.22299.03.0	ARV	PN		
			7.21857.01.0	SLP	EL		
2.4 Turbo 142 kW (193 PS) B 5244 T	04.1996→12.2000		7.22299.03.0	ARV	PN		
			7.05270.67.0	LS	770 mm		08.1998→ Diagnosesonde Diagnostic Probe
			7.05270.80.0	LS	650 mm		
			7.21857.01.0	SLP	EL		
2.4 Turbo 142 kW (193 PS) B 5254 T	01.1997→12.2000		7.22299.03.0	ARV	PN		
			7.21857.01.0	SLP	EL		
2.4 Turbo AWD 142 kW (193 PS) B 5244 T	04.1996→12.2000		7.22299.03.0	ARV	PN		
			7.05270.67.0	LS	770 mm		08.1998→ Diagnosesonde Diagnostic Probe
			7.05270.80.0	LS	650 mm		
			7.21857.01.0	SLP	EL		
2.4 Turbo AWD 142 kW (193 PS) B 5254 T	01.1997→12.2000		7.22299.03.0	ARV	PN		
			7.21857.01.0	SLP	EL		
2.4 Turbo AWD 195 kW (265 PS) B 5244 T2	03.1999→12.2000		7.22299.03.0	ARV	PN		
			7.05270.67.0	LS	770 mm		
			7.05270.80.0	LS	650 mm		
			7.21857.01.0	SLP	EL		
2.5 TDI 103 kW (140 PS) D 5252 T	01.1997→12.2000		7.22299.03.0	ARV	PN		
2.5 TDi AWD 103 kW (140 PS) D 5252 T	11.1996→02.2000		7.22299.03.0	ARV	PN		

V70 II 26











3.0i Turbo 24V 210 kW (285-286 PS) B 6304 T2, B 6395 T2	04.2007→		7.05270.69.0	LS	475 mm
3.2i 24V 168-177 kW (228-238 PS) B 6324 S	04.2007→		7.05270.69.0	LS	475 mm

V70 II (285) 27

2.0 T 132 kW (180 PS) B 5204 T5	11.1999→08.2007		7.22299.03.0	ARV	PN	
			7.05270.67.0	LS	770 mm	
			7.05270.81.0	LS	1200 mm	
2.3 T5 147-184 kW (239-250 PS) B 5234 T3	11.1999→12.2004		7.05270.67.0	LS	770 mm	Diagnosesonde Diagnostic Probe
			7.05270.81.0	LS	1200 mm	
2.4 103 kW (140 PS) B 5244 S2	03.2000→08.2007		7.05270.66.0	LS	810 mm	

V

V70 II (285)
27







			7.05270.82.0	LS	630 mm	
			7.05270.69.0	LS	475 mm	
2.4 125 kW (170 PS) B 5244 S	03.2000→08.2007		7.05270.66.0	LS	810 mm	09.2002→
			7.05270.69.0	LS	475 mm	
			7.05270.83.0	LS	475 mm	
2.4 AWD 121-125 kW (165-170 PS) B 5254 S	03.2000→09.2003		7.05270.66.0	LS	810 mm	
			7.05270.69.0	LS	475 mm	
2.4 Bifuel (CNG) 103 kW (140 PS) B 5244 SG	09.2001→08.2007		7.05270.70.0	LS	875 mm	
2.4 Bifuel (LPG) 103 kW (140 PS) B 5244 SG2	09.2001→08.2007		7.05270.70.0	LS	875 mm	
2.4 CDI 90 kW (122 PS) D 5244 T6	07.2005→12.2008		7.00555.06.0	AGR	EL	 ohne Elektronikeinheit without the electronics unit nur Elektronikeinheit electronics unit only für OE-Nummer: 31431045 for OE number: 31431045 vor Katalysator in front of the catalyst ohne Zubehör without accessories für Hersteller-Abgasnorm: Emission Code 4 for manufacturer exhaust norm: Emission Code 4 2006 2006
			7.00555.07.0	AGR	EL	
			7.08369.55.0	ATS	EL	
			7.08369.69.0	ATS	EL	
			7.11190.10.0	DDS	EL	
2.4 D 96-120 kW (131-163 PS) D 5244 T2	07.2001→08.2007		7.22996.11.0	AGR	ME	ohne Elektronikeinheit without the electronics unit
			7.22996.12.0	AGR	EL	nur Elektronikeinheit electronics unit only
2.4 D 93 kW (126 PS) D 5244 T7	04.2005→12.2008		7.00555.06.0	AGR	EL	 ohne Elektronikeinheit without the electronics unit nur Elektronikeinheit electronics unit only für OE-Nummer: 31431045 for OE number: 31431045 vor Katalysator in front of the catalyst ohne Zubehör without accessories für Hersteller-Abgasnorm: Emission Code 4 for manufacturer exhaust norm: Emission Code 4 2006 2006 2012 2012
			7.00555.07.0	AGR	EL	
			7.08369.55.0	ATS	EL	
			7.08369.69.0	ATS	EL	
			7.11190.10.0	DDS	EL	
2.4 D5 96-120 kW (131-163 PS) D 5244 T2, D 5244 T5	01.2001→12.2008		7.22996.11.0	AGR	ME	ohne Elektronikeinheit without the electronics unit
			7.00555.06.0	AGR	EL	 ohne Elektronikeinheit without the electronics unit

V









V70 II (285)

27

2.4 D5 120 kW (163 PS) D 5244 T	01.2001→12.2008		7.08369.55.0	ATS	EL				
			7.22996.11.0	AGR	ME	ohne Elektronikeinheit without the electronics unit			
			7.00555.06.0	AGR	EL	 ohne Elektronikeinheit without the electronics unit			
			7.22996.12.0	AGR	EL	nur Elektronikeinheit electronics unit only			
			7.08369.55.0	ATS	EL				
			7.08369.69.0	ATS	EL	für OE-Nummer: 31431045 for OE number: 31431045 vor Katalysator in front of the catalyst			
2.4 D5 136 kW (185 PS) D 5244 T4	04.2005→12.2008		7.00555.06.0	AGR	EL	 ohne Elektronikeinheit without the electronics unit			
			7.00555.07.0	AGR	EL	nur Elektronikeinheit electronics unit only			
			7.08369.55.0	ATS	EL				
			7.08369.69.0	ATS	EL	für OE-Nummer: 31431045 for OE number: 31431045 vor Katalysator in front of the catalyst			
			7.11190.10.0	DDS		ohne Zubehör without accessories für Hersteller-Abgasnorm: Emission Code 4 for manufacturer exhaust norm: Emission Code 4 2006, 2007 2006, 2007			
			2.4 D5 AWD 96-120 kW (131-163 PS) D 5244 T2	07.2002→08.2007		7.22996.11.0	AGR	ME	ohne Elektronikeinheit without the electronics unit
7.22996.12.0	AGR	EL				nur Elektronikeinheit electronics unit only			
7.08369.55.0	ATS	EL							
7.08369.69.0	ATS	EL				für OE-Nummer: 31431045 for OE number: 31431045 vor Katalysator in front of the catalyst			
2.4 D5 AWD 120 kW (163 PS) D 5244 T	07.2002→08.2007					7.22996.11.0	AGR	ME	ohne Elektronikeinheit without the electronics unit
						7.22996.12.0	AGR	EL	nur Elektronikeinheit electronics unit only
			7.08369.55.0	ATS	EL				
			7.08369.69.0	ATS	EL	für OE-Nummer: 31431045 for OE number: 31431045 vor Katalysator in front of the catalyst			
			7.11190.10.0	DDS		ohne Zubehör without accessories für Hersteller-Abgasnorm: Emission Code 4 for manufacturer exhaust norm: Emission Code 4 2006 2006			

V70 II (285) **27**

2.4 D5 AWD 120 kW (163 PS) D 5244 T5	07.2002→08.2007	 7.00555.06.0	AGR	EL	<input type="checkbox"/> ohne Elektronikeinheit without the electronics unit nur Elektronikeinheit electronics unit only ohne Zubehör without accessories für Hersteller-Abgasnorm: Emission Code 4 for manufacturer exhaust norm: Emission Code 4 2006 2006 2008 2008
		7.00555.07.0	AGR	EL	
		7.08369.55.0	ATS	EL	
		7.11190.10.0	DDS		
2.4 D5 AWD 136 kW (185 PS) D 5244 T4	05.2005→08.2007	 7.00555.06.0	AGR	EL	<input type="checkbox"/> ohne Elektronikeinheit without the electronics unit nur Elektronikeinheit electronics unit only für OE-Nummer: 31431045 for OE number: 31431045 vor Katalysator in front of the catalyst
		7.00555.07.0	AGR	EL	
		7.08369.55.0	ATS	EL	
		7.08369.69.0	ATS	EL	
2.4 T 147 kW (200 PS) B 5244 T3	11.1999→08.2003	 7.05270.67.0	LS	770 mm	
		7.05270.81.0	LS	1200 mm	
2.4 T AWD 147 kW (200 PS) B 5244 T3	09.2001→08.2002	 7.05270.67.0	LS	770 mm	
		7.05270.81.0	LS	1200 mm	
2.5 T 153-162 kW (209-220 PS) B 5254 T2	07.2001→08.2007	 7.05270.67.0	LS	770 mm	09.2004→ Diagnosesonde Diagnostic Probe
		7.05270.81.0	LS	1200 mm	
2.5 T AWD 153-162 kW (209-220 PS) B 5254 T2	07.2002→08.2007	 7.05270.67.0	LS	770 mm	09.2004→ Diagnosesonde Diagnostic Probe
		7.05270.81.0	LS	1200 mm	
R 2,5 T AWD 220-224 kW (299-305 PS) B 5254 T4	03.2003→08.2007	 7.22299.03.0	ARV	PN	<input type="checkbox"/>
		7.05270.67.0	LS	770 mm	
		7.05270.81.0	LS	1200 mm	

















V70 III (135) **28**

1.6 D 80-81 kW (109-110 PS) D 4164 T	07.2009→12.2011	 7.24809.39.0	AGR	EL	<input type="checkbox"/>
		7.24809.91.0	AGR	EL	<input type="checkbox"/>

V



V70 III (135) **28**

			7.11190.10.0	DDS		ohne Zubehör without accessories für Hersteller-Abgasnorm: Emission Code 5 for manufacturer exhaust norm: Emission Code 5 2010 2010 2011 2011
1.6 DRiVe / D2 84 kW (114 PS) D 4162 T	04.2011→12.2015		7.02209.11.0	AGR	EL	
			7.02156.35.0	AGR-K	EL	ohne Sensor without sensor  ch. 271228→ mit AGR-Ventil with EGR valve
			7.02156.24.0	AGR-K	EL	mit Sensor with sensor 
			7.02156.33.0	AGR-K		mit Sensor with sensor 01.2012→ ohne AGR-Ventil without EGR valve
			7.02156.34.0	AGR-K		ohne Sensor without sensor  ch. 271228→ ohne AGR-Ventil without EGR valve
2.0 107 kW (146 PS) B 4204 S3	10.2007→12.2011		7.24809.73.0	AGR	EL	
2.0 D 100 kW (136 PS) D 4204 T	10.2007→12.2015		7.24809.68.0	AGR	EL	
			7.09730.00.0	AGR-K		
			7.11190.08.0	DDS		 ch. 213027→ 2010 2010
2.0 FlexiFuel 107 kW (146 PS) B 4204 S4	01.2008→12.2011		7.24809.73.0	AGR	EL	
2.4 D 120 kW (163 PS) D 5244 T5	04.2007→07.2009		7.00555.06.0	AGR	EL	 ohne Elektronikeinheit without the electronics unit
			7.00555.07.0	AGR	EL	nur Elektronikeinheit electronics unit only
			7.08369.27.0	ATS	EL	
			7.08369.55.0	ATS	EL	Euro 4 Euro 4
			7.11020.13.0	ATS	EL	für OE-Nummer: 31303026, 31319842, 31370468, 31431049 for OE number: 31303026, 31319842, 31370468, 31431049
			7.11020.14.0	ATS	EL	für OE-Nummer: 30713642, 31370465, 31431047 for OE number: 30713642, 31370465, 31431047 vor Rußpartikelfilter before soot particulate filter
7.11020.44.0	ATS	EL	für Hersteller-Abgasnorm: Emission Code 3 for manufacturer exhaust norm: Emission Code 3 für Variant Code: AG02 for variant code: AG02			
2.4 D 129 kW (175 PS) D 5244 T14	04.2009→12.2010		7.05363.00.0	AGR	EL	













V70 III (135) **28**

			7.08369.27.0 ATS EL 7.11020.14.0 ATS EL vor Rußpartikelfilter before soot particulate filter 7.11190.08.0 DDS ch. 213027→
2.4 D 120 kW (163 PS) D 5244 T19	08.2009→12.2010	7.08369.27.0 ATS EL 7.11020.14.0 ATS EL vor Rußpartikelfilter before soot particulate filter 2010 2010 7.11190.08.0 DDS ch. 213027→	
D2 88 kW (120 PS) D 4204 T20	03.2015→04.2016	7.11020.43.0 ATS EL 7.11190.08.0 DDS 2016 2016	
D3 100 kW (136 PS) D 5204 T7	10.2007→12.2015	7.05363.00.0 AGR EL 7.02107.09.0 AGR-K 7.11020.45.0 ATS EL Getriebetyp: TF-80SD / M66 Transmission Type: TF-80SD / M66 2013 2013 7.11190.08.0 DDS ch. 213027→ Getriebetyp: M66, TF-80SD Transmission Type: M66, TF-80SD 2013 2013	
D3 110 kW (150 PS) D 4204 T9	03.2015→04.2016	7.11020.43.0 ATS EL 7.11190.08.0 DDS 2016 2016	
D3 / D4 120 kW (163 PS) D 5204 T2, D 5204 T3	03.2010→12.2015	7.05363.00.0 AGR EL 7.02107.09.0 AGR-K 7.11020.45.0 ATS EL D 5204 T2: 2011 2011 D 5204 T3: 2012 2012 7.11190.08.0 DDS D 5204 T2: ch. 213027→ 2011 2011 D 5204 T3: ch. 213027→ 2012 2012	
D4 133 kW (181 PS) D 4204 T5	10.2013→04.2016	7.11020.43.0 ATS EL 7.11190.08.0 DDS 2016 2016	
D4 AWD 120 kW (163 PS) D 5244 T17	10.2007→12.2015	7.05363.00.0 AGR EL 7.02107.09.0 AGR-K 7.11020.14.0 ATS EL Getriebetyp: TF-80SC Transmission Type: TF-80SC vor Rußpartikelfilter before soot particulate filter 2013 2013 7.11020.44.0 ATS EL Getriebetyp: TF-80SC Transmission Type: TF-80SC 2013 2013 für Variant Code: AG02 for variant code: AG02	























V



V70 III (135) **28**





			7.11020.45.0	ATS	EL	Getriebetyp: TF-80SC Transmission Type: TF-80SC 2013 2013 für Variant Code: AG01 for variant code: AG01
			7.11190.08.0	DDS		 ch. 213027→ Getriebetyp: TF-80SC Transmission Type: TF-80SC 2013 2013 2015 2015
D4 AWD 133 kW (181 PS) D 5244 T12	10.2013→04.2016		7.05363.00.0	AGR	EL	
			7.02107.09.0	AGR-K		
			7.11020.14.0	ATS	EL	Getriebetyp: TF-80SD Transmission Type: TF-80SD vor Rußpartikelfilter before soot particulate filter 2016 2016
			7.11020.44.0	ATS	EL	Getriebetyp: TF-80SC Transmission Type: TF-80SC für Variant Code: AG02 for variant code: AG02
			7.11020.45.0	ATS	EL	Getriebetyp: TF-80SC Transmission Type: TF-80SC für Variant Code: AG01 for variant code: AG01
			7.11190.08.0	DDS		 ch. 213027→ Getriebetyp: TF-80SC Transmission Type: TF-80SC 2016 2016
D5 136 kW (185 PS) D 5244 T4	04.2007→12.2009		7.00555.06.0	AGR	EL	 ohne Elektronikeinheit without the electronics unit
			7.00555.07.0	AGR	EL	nur Elektronikeinheit electronics unit only
			7.08369.27.0	ATS	EL	
			7.08369.55.0	ATS	EL	
			7.11020.13.0	ATS	EL	Ausstattungsvariante: AG01 Equipment Variant: AG01
			7.11020.14.0	ATS	EL	 D 5244 T4: Ausstattungsvariante: AG02 Equipment Variant: AG02 vor Rußpartikelfilter before soot particulate filter Euro 3 Euro 3  D 5244 T4: Schaltgetriebe 6 Gang, für Getriebeautomatik 6 Gang 6-Speed Manual Transmission, for 6-speed automatic transmission vor Rußpartikelfilter before soot particulate filter Euro 4 Euro 4
			7.11020.44.0	ATS	EL	für Hersteller-Abgasnorm: Emission Code 3 for manufacturer exhaust norm: Emission Code 3 für Variant Code: AG02 for variant code: AG02
D5 151 kW (205 PS) D 5244 T10	10.2008→12.2011		7.05363.00.0	AGR	EL	

V









					
V70 III (135)					
			7.02107.09.0 AGR-K 7.08369.27.0 ATS 7.11020.14.0 ATS 7.11020.45.0 ATS 7.11190.08.0 DDS		 für OE-Nummer: 31431050 for OE number: 31431050 vor Rußpartikelfilter before soot particulate filter 2009 2009 2010 2010 EL Getriebetyp: TF-80SC / M66 Transmission Type: TF-80SC / M66 2011 2011  ch. 213027→ Getriebetyp: M66, TF-80SC Transmission Type: M66, TF-80SC
D5 158-169 kW (215-230 PS) D 5244 T11, D 5244 T15	04.2011→12.2015		7.05363.00.0 AGR 7.02107.09.0 AGR-K 7.11020.45.0 ATS 7.11190.08.0 DDS		  EL  D 5244 T11: Getriebetyp: M66 Transmission Type: M66  D 5244 T15: Getriebetyp: TD-80SC Transmission Type: TD-80SC  D 5244 T11:  ch. 213027→ Getriebetyp: M66 Transmission Type: M66  D 5244 T15:  ch. 213027→
D5 AWD 136 kW (185 PS) D 5244 T4	04.2007→12.2009		7.00555.06.0 AGR 7.00555.07.0 AGR 7.08369.27.0 ATS 7.08369.55.0 ATS 7.11020.14.0 ATS 7.11020.44.0 ATS		 ohne Elektronikeinheit without the electronics unit EL nur Elektronikeinheit electronics unit only EL EL EL für OE-Nummer: 30713642, 31370465, 31431047 for OE number: 30713642, 31370465, 31431047 vor Rußpartikelfilter before soot particulate filter EL für Hersteller-Abgasnorm: Emission Code 3 for manufacturer exhaust norm: Emission Code 3 für Variant Code: AG02 for variant code: AG02
D5 AWD 151 kW (205 PS) D 5244 T10	12.2009→12.2011		7.05363.00.0 AGR 7.02107.09.0 AGR-K 7.11020.14.0 ATS 7.11020.44.0 ATS 7.11020.45.0 ATS 7.11190.08.0 DDS		  EL Getriebetyp: TF-80SC Transmission Type: TF-80SC vor Rußpartikelfilter before soot particulate filter 2011 2011 EL Getriebetyp: TF-80SC Transmission Type: TF-80SC für Variant Code: AG02 for variant code: AG02 EL Getriebetyp: TF-80SC Transmission Type: TF-80SC für Variant Code: AG01 for variant code: AG01  ch. 213027→ Getriebetyp: TF-80SC Transmission Type: TF-80SC







V70 III (135) **28**

D5 AWD 158-169 kW (215-230 PS) D 5244 T15	04.2011→12.2015		7.05363.00.0	AGR	EL	
			7.02107.09.0	AGR-K		
			7.11020.14.0	ATS	EL	für Getriebeautomatik 6 Gang for 6-speed automatic transmission nach Katalysator Post-catalyst
			7.11020.44.0	ATS	EL	Getriebetyp: TF-80SC Transmission Type: TF-80SC für Variant Code: AG02 for variant code: AG02
			7.11020.45.0	ATS	EL	Getriebetyp: TF-80SC Transmission Type: TF-80SC für Variant Code: AG01 for variant code: AG01
			7.11190.08.0	DDS		 ch. 213027→

V90 I Estate (965) **29**

2.5 125 kW (170 PS) B 6254 FS	11.1996→10.1998		7.22299.03.0	ARV	PN	
2.9 132-135 kW (180-184 PS) B 6304 S2	01.1997→12.1998		7.22299.03.0	ARV	PN	
2.9 132-150 kW (180-204 PS) B 6304 FS, B 6304 GS	01.1997→12.1998		7.22299.03.0	ARV	PN	
2.9 132-135 kW (180-184 PS) B 6304 S2	09.1997→12.1998		7.22299.03.0	ARV	PN	

V90 II Estate (235, 236) **30**

2.0 D3 110 kW (150 PS) D 4204 T16	03.2016→08.2018		7.11020.43.0	ATS	EL	Getriebetyp: M66, TG-81SC Transmission Type: M66, TG-81SC 2019
			7.11190.08.0	DDS		Getriebetyp: M66, TG-81SC Transmission Type: M66, TG-81SC
2.0 D3 110 kW (150 PS) D 4204 T9	03.2016→08.2018		7.11020.43.0	ATS	EL	Getriebetyp: M66, TF-71SC Transmission Type: M66, TF-71SC 2017 2018 2018
2.0 D3 AWD 110 kW (150 PS) D 4204 T4	03.2016→		7.11020.43.0	ATS	EL	Getriebetyp: TG-81SC Transmission Type: TG-81SC
			7.11190.08.0	DDS		Getriebetyp: TG-81SC Transmission Type: TG-81SC
2.0 D4 140-147 kW (190-200 PS) D 4204 T14	03.2016→		7.11020.43.0	ATS	EL	Getriebetyp: M66, TG-81SC Transmission Type: M66, TG-81SC
			7.11190.08.0	DDS		Getriebetyp: M66, TG-81SC Transmission Type: M66, TG-81SC
2.0 D4 120 kW (163 PS) D 4204 T7	09.2018→		7.11020.43.0	ATS	EL	Getriebetyp: TG-81SC Transmission Type: TG-81SC
			7.11190.08.0	DDS		Getriebetyp: TG-81SC Transmission Type: TG-81SC
2.0 D4 AWD 140-147 kW (190-200 PS) D 4204 T14	03.2016→		7.11020.43.0	ATS	EL	Getriebetyp: TG-81SC Transmission Type: TG-81SC
			7.11190.08.0	DDS		Getriebetyp: M66, TG-81SC Transmission Type: M66, TG-81SC
2.0 D4 AWD 120 kW (163 PS) D 4204 T7	09.2018→		7.11020.43.0	ATS	EL	Getriebetyp: TG-81SC Transmission Type: TG-81SC 2019 2019
			7.11190.08.0	DDS		Getriebetyp: TG-81SC Transmission Type: TG-81SC













V

V90 II Estate (235, 236)						30
2.0 D5 AWD 173-177 kW (235-241 PS) D 4204 T23	03.2016→		7.11020.43.0	ATS	EL	Getriebetyp: TG-81SC Transmission Type: TG-81SC
			7.11190.08.0	DDS		Getriebetyp: TG-81SC Transmission Type: TG-81SC
2.0 Polestar AWD 140-147 kW (190-200 PS) D 4204 T14	10.2016→		7.11020.43.0	ATS	EL	Getriebetyp: TG-81SC Transmission Type: TG-81SC
2.0 Polestar AWD 173-177 kW (235-241 PS) D 4204 T23	10.2016→		7.11020.43.0	ATS	EL	Getriebetyp: TG-81SC Transmission Type: TG-81SC
			7.11190.08.0	DDS		Getriebetyp: TG-81SC Transmission Type: TG-81SC
XC40 (536)						31
2.0 D3 110 kW (150 PS) D 4204 T16	09.2018→		7.11020.43.0	ATS	EL	Getriebetyp: M66, TG-81SC Transmission Type: M66, TG-81SC
			7.11190.08.0	DDS		Getriebetyp: M76, TG-81SC Transmission Type: M76, TG-81SC 2020 2020
2.0 D3 AWD 110 kW (150 PS) D 4204 T16	09.2018→		7.11020.43.0	ATS	EL	Getriebetyp: M66, TG-81SC Transmission Type: M66, TG-81SC
			7.11190.08.0	DDS		Getriebetyp: M66, TG-81SC Transmission Type: M66, TG-81SC 2020 2020
2.0 D4 AWD 140-147 kW (190-200 PS) D 4204 T12	10.2017→		7.11190.08.0	DDS		Getriebetyp: TG-81SC Transmission Type: TG-81SC
D4 Polestar AWD 140-147 kW (190-200 PS) D 4204 T12	01.2019→		7.11020.43.0	ATS	EL	Getriebetyp: TG-81SC Transmission Type: TG-81SC
			7.11190.08.0	DDS		Getriebetyp: TG-81SC Transmission Type: TG-81SC
XC60 I SUV (156)						32
2.4 D 129 kW (175 PS) D 5244 T14	04.2009→12.2010		7.05363.00.0	AGR	EL	
			7.08369.27.0	ATS	EL	
			7.11020.14.0	ATS	EL	Ausstattungsvariante: GK01 / GK02 Equipment Variant: GK01 / GK02 vor Rußpartikelfilter before soot particulate filter 2010 2010 ch. 237068→
			7.11190.08.0	DDS		
2.4 D / D3 / D4 AWD 120 kW (163 PS) D 5244 T16	05.2008→02.2017		7.05363.00.0	AGR	EL	
			7.02107.09.0	AGR-K		
			7.08369.27.0	ATS	EL	
			7.11020.13.0	ATS	EL	Ausstattungsvariante: AG01 Equipment Variant: AG01 2011 2011

V



XC60 I SUV (156) **32**

			7.11020.14.0	ATS	EL	 D 5244 T16: Ausstattungsvariante: AG02 Equipment Variant: AG02 vor Rußpartikelfilter before soot particulate filter 2011 2011  D 5244 T16: Ausstattungsvariante: GK01 / GK02 Equipment Variant: GK01 / GK02 vor Rußpartikelfilter before soot particulate filter 2010 2010
			7.11020.44.0	ATS	EL	2011 2011 für Variant Code: AG02 for variant code: AG02
			7.11020.45.0	ATS	EL	2011 2011 für Variant Code: AG01 for variant code: AG01
			7.11190.08.0	DDS		 ch. 237068→ 2010, 2011 2010, 2011
2.4 D / D3 / D4 AWD 120 kW (163 PS) D 5244 T17	05.2008→02.2017		7.05363.00.0	AGR	EL	
			7.02107.09.0	AGR-K		
			7.11020.13.0	ATS	EL	Ausstattungsvariante: AG01 Equipment Variant: AG01 2012 2012
			7.11020.14.0	ATS	EL	Ausstattungsvariante: AG02 Equipment Variant: AG02 vor Rußpartikelfilter before soot particulate filter 2012 2012
			7.11020.44.0	ATS	EL	2012 2012 für Variant Code: AG02 for variant code: AG02
			7.11020.45.0	ATS	EL	2012 2012 für Variant Code: AG01 for variant code: AG01
			7.11190.08.0	DDS		 ch. 237068→ 2012 2012
2.4 D / D3 / D4 AWD 120 kW (163 PS) D 5244 T5	05.2008→02.2017		7.00555.06.0	AGR	EL	 ohne Elektronikeinheit without the electronics unit →12.2009
			7.00555.07.0	AGR	EL	nur Elektronikeinheit electronics unit only →12.2009
			7.08369.27.0	ATS	EL	
			7.11020.14.0	ATS	EL	vor Rußpartikelfilter before soot particulate filter 2009 2009
			7.11190.08.0	DDS		 ch. 237068→
D3 100 kW (136 PS) D 5204 T7	04.2012→12.2015		7.05363.00.0	AGR	EL	
			7.02107.09.0	AGR-K		

V















XC60 I SUV (156) **32**

			7.11020.45.0	ATS	EL	
			7.11190.08.0	DDS		ch. 237068→
D3 110 kW (150 PS) D 4204 T4	03.2015→04.2017		7.11020.43.0	ATS	EL	
			7.11190.08.0	DDS		
D3 / D4 120 kW (163 PS) D 5204 T2, D 5204 T3	03.2010→12.2014		7.05363.00.0	AGR	EL	
			7.02107.09.0	AGR-K		
			7.11020.45.0	ATS	EL	D 5204 T2: 2011 D 5204 T3: 2012 2012
			7.11190.08.0	DDS		D 5204 T2: ch. 237068,→ 2011 D 5204 T3: ch. 237068→ 2012 2012
D4 133 kW (181 PS) D 4204 T5	10.2013→12.2015		7.11020.43.0	ATS	EL	
			7.11190.08.0	DDS		
D4 140-147 kW (190-200 PS) D 4204 T14	03.2015→02.2017		7.11020.43.0	ATS	EL	
			7.11190.08.0	DDS		
D4 AWD 133 kW (181 PS) D 5244 T12	10.2013→12.2015		7.05363.00.0	AGR	EL	
			7.02107.09.0	AGR-K		
			7.11020.13.0	ATS	EL	Ausstattungsvariante: AG01 Equipment Variant: AG01
			7.11020.14.0	ATS	EL	Ausstattungsvariante: AG02 Equipment Variant: AG02 vor Rußpartikelfilter before soot particulate filter
			7.11020.44.0	ATS	EL	für Variant Code: AG02 for variant code: AG02
			7.11020.45.0	ATS	EL	für Variant Code: AG01 for variant code: AG01
			7.11190.08.0	DDS		ch. 237068→
D4 AWD 140-162 kW (190-220 PS) D 5244 T21	03.2015→02.2017		7.05363.00.0	AGR	EL	
			7.02107.09.0	AGR-K		
			7.11020.13.0	ATS	EL	Ausstattungsvariante: AG01 Equipment Variant: AG01
			7.11020.14.0	ATS	EL	Ausstattungsvariante: AG02 Equipment Variant: AG02 vor Rußpartikelfilter before soot particulate filter 2016 2016
			7.11020.44.0	ATS	EL	2015 2015 für Variant Code: AG02 for variant code: AG02
			7.11020.45.0	ATS	EL	für Variant Code: AG01 for variant code: AG01
			7.11190.08.0	DDS		ch. 237068→
D5 158 kW (215 PS) D 5244 T11	06.2011→02.2017		7.05363.00.0	AGR	EL	
			7.02107.09.0	AGR-K		
			7.11020.13.0	ATS	EL	Ausstattungsvariante: AG01 Equipment Variant: AG01 2015 2015

V



XC60 I SUV (156) **32**

			7.11020.14.0	ATS	EL	Ausstattungsvariante: AG02 Equipment Variant: AG02 vor Rußpartikelfilter before soot particulate filter
			7.11020.44.0	ATS	EL	für Variant Code: AG02 for variant code: AG02
			7.11020.45.0	ATS	EL	2015 2015 für Variant Code: AG01 for variant code: AG01
			7.11190.08.0	DDS		 ch. 237068→ 2015 2015
D5 158-169 kW (215-230 PS) D 5244 T15	06.2011→02.2017		7.05363.00.0	AGR	EL	
			7.02107.09.0	AGR-K		
			7.11020.13.0	ATS	EL	Ausstattungsvariante: AG01 Equipment Variant: AG01 2015 2015
			7.11020.44.0	ATS	EL	2015 2015 für Variant Code: AG02 for variant code: AG02
			7.11020.45.0	ATS	EL	2015 2015 für Variant Code: AG01 for variant code: AG01
			7.11190.08.0	DDS		 ch. 237068→ 2015 2015
D5 AWD 136 kW (185 PS) D 5244 T4	05.2008→12.2009		7.00555.06.0	AGR	EL	 ohne Elektronikeinheit without the electronics unit
			7.00555.07.0	AGR	EL	nur Elektronikeinheit electronics unit only
			7.08369.27.0	ATS	EL	
			7.11020.14.0	ATS	EL	vor Rußpartikelfilter before soot particulate filter
			7.11190.08.0	DDS		 ch. 237068→
D5 AWD 151 kW (205 PS) D 5244 T10	07.2009→06.2011		7.05363.00.0	AGR	EL	
			7.02107.09.0	AGR-K		
			7.11020.13.0	ATS	EL	Ausstattungsvariante: AG01 Equipment Variant: AG01 2011 2011
			7.11020.14.0	ATS	EL	 D 5244 T10: Ausstattungsvariante: AG02 Equipment Variant: AG02 2011 2011  D 5244 T10: Ausstattungsvariante: GK01 / GK02 Equipment Variant: GK01 / GK02 vor Rußpartikelfilter before soot particulate filter 2010 2010
			7.11020.44.0	ATS	EL	für Variant Code: AG02 for variant code: AG02
			7.11020.45.0	ATS	EL	für Variant Code: AG01 for variant code: AG01
			7.11190.08.0	DDS		





XC60 I SUV (156) **32**

D5 AWD 158 kW (215 PS) D 5244 T11	04.2011→12.2015		7.05363.00.0	AGR	EL	
			7.02107.09.0	AGR-K		
			7.11020.13.0	ATS	EL	Ausstattungsvariante: AG01 Equipment Variant: AG01
			7.11020.14.0	ATS	EL	Ausstattungsvariante: AG02 Equipment Variant: AG02 vor Rußpartikelfilter before soot particulate filter
			7.11020.44.0	ATS	EL	für Variant Code: AG02 for variant code: AG02
D5 AWD 158-169 kW (215-230 PS) D 5244 T15	04.2011→12.2015		7.05363.00.0	AGR	EL	
			7.02107.09.0	AGR-K		
			7.11020.13.0	ATS	EL	Ausstattungsvariante: AG01 Equipment Variant: AG01
			7.11020.44.0	ATS	EL	für Variant Code: AG02 for variant code: AG02
			7.11190.08.0	DDS		ch. 237068→
D5 AWD 169 kW (230 PS) D 5244 T23	04.2014→12.2015		7.05363.00.0	AGR	EL	
			7.02107.09.0	AGR-K		
			7.11020.13.0	ATS	EL	Ausstattungsvariante: AG01 Equipment Variant: AG01
			7.11020.14.0	ATS	EL	Ausstattungsvariante: AG02 Equipment Variant: AG02 vor Rußpartikelfilter before soot particulate filter
			7.11020.44.0	ATS	EL	für Variant Code: AG02 for variant code: AG02
D5 AWD 162 kW (220 PS) D 5244 T20, D 5244 T22	03.2015→02.2017		7.05363.00.0	AGR	EL	
			7.02107.09.0	AGR-K		
			7.11020.13.0	ATS	EL	D 5244 T20: Ausstattungsvariante: AG01 Equipment Variant: AG01 2016 D 5244 T22: Ausstattungsvariante: AG01 Equipment Variant: AG01
			7.11020.14.0	ATS	EL	D 5244 T20, D 5244 T22: Ausstattungsvariante: AG02 Equipment Variant: AG02 vor Rußpartikelfilter before soot particulate filter 2016 2016
			7.11020.44.0	ATS	EL	D 5244 T20, D 5244 T22: 2015 2015 für Variant Code: AG02 for variant code: AG02
			7.11020.45.0	ATS	EL	D 5244 T20, D 5244 T22: für Variant Code: AG01 for variant code: AG01
			7.11190.08.0	DDS	D 5244 T20, D 5244 T22: ch. 237068→	















XC60 I SUV (156) **32**

2.4 D3 120 kW (163 PS) D 5244 T16, D 5244 T17	03.2010→04.2012	 7.05363.00.0	AGR	EL	
3.0i Turbo 24V 210 kW (285-286 PS) B 6304 T2, B 6395 T2	05.2008→	 7.05270.69.0	LS	475 mm	

XC60 II (246) **33**

2.0 D3 110 kW (150 PS) D 4204 T4	03.2017→	 7.11020.43.0	ATS	EL	Getriebetyp: M66 Transmission Type: M66 2019
		7.11190.08.0	DDS		Getriebetyp: M66 Transmission Type: M66 2019
2.0 D4 140-147 kW (190-200 PS) D 4204 T14	03.2017→	 7.11190.08.0	DDS		Getriebetyp: M66, TG-81SC Transmission Type: M66, TG-81SC 2019
2.0 D4 120 kW (163 PS) D 4204 T7	12.2018→	 7.11020.43.0	ATS	EL	Getriebetyp: TG-81SC Transmission Type: TG-81SC 2019
		7.11190.08.0	DDS		Getriebetyp: TG-81SC Transmission Type: TG-81SC 2019
2.0 D4 AWD 140-147 kW (190-200 PS) D 4204 T14	03.2017→	 7.11020.43.0	ATS	EL	Ausstattungsvariante: G101 / G102 Equipment Variant: G101 / G102 Getriebetyp: M66, TG-81SC Transmission Type: M66, TG-81SC
		7.11190.08.0	DDS		 D 4204 T14: Ausstattungsvariante: G101 Equipment Variant: G101 Getriebetyp: M66, TG-81SC Transmission Type: M66, TG-81SC  D 4204 T14: Ausstattungsvariante: G102 Equipment Variant: G102 Getriebetyp: M66 Transmission Type: M66 2018, 2019
2.0 D4 Polestar 140-147 kW (190-200 PS) D 4204 T14	05.2020→	 7.11020.43.0	ATS	EL	Getriebetyp: M66 / TG-81SC Transmission Type: M66 / TG-81SC
		7.11190.08.0	DDS		Getriebetyp: M66, TG-81SC Transmission Type: M66, TG-81SC
2.0 D4 Polestar AWD 140-147 kW (190-200 PS) D 4204 T14	05.2020→	 7.11020.43.0	ATS	EL	Ausstattungsvariante: G101 / G102 Equipment Variant: G101 / G102 Getriebetyp: M66, TG-81SC Transmission Type: M66, TG-81SC
		7.11190.08.0	DDS		 D 4204 T14: Ausstattungsvariante: G101 Equipment Variant: G101 Getriebetyp: TG-81SC Transmission Type: TG-81SC  D 4204 T14: Ausstattungsvariante: G102 Equipment Variant: G102 Getriebetyp: M66, TG-81SC Transmission Type: M66, TG-81SC 2018



















V

XC60 II (246)						33
2.0 D5 AWD 173-177 kW (235-241 PS) D 4204 T23	03.2017→		7.11020.43.0	ATS	EL	Getriebetyp: TG-81SC Transmission Type: TG-81SC
			7.11190.08.0	DDS		Ausstattungsvariante: G 101 / G 102 Equipment Variant: G 101 / G 102 Getriebetyp: TG-81SC Transmission Type: TG-81SC 2018 2018 2019 2019
2.0 D5 Polestar AWD 173-177 kW (235-241 PS) D 4204 T23	10.2018→		7.11020.43.0	ATS	EL	Ausstattungsvariante: G102 Equipment Variant: G102 Getriebetyp: TG-81SC Transmission Type: TG-81SC
			7.11190.08.0	DDS		Ausstattungsvariante: G 101 / G 102 Equipment Variant: G 101 / G 102 Getriebetyp: TG-81SC Transmission Type: TG-81SC 2019 2019
XC70						34
2.4i Turbo 20V 147 kW (200 PS) B 5244 T3	03.2000→09.2002		7.05270.67.0	LS	770 mm	
			7.05270.81.0	LS	1200 mm	
XC70 CROSS COUNTRY I (295)						35
2.0 T5 AWD 166 kW (226 PS) B 5204 T3	10.1997→03.1999		7.22299.03.0	ARV	PN	
			7.21857.01.0	SLP	EL	
2.4 D5 AWD 136 kW (185 PS) D 5244 T4	12.2005→08.2007		7.00555.06.0	AGR	EL	 ohne Elektronikeinheit without the electronics unit
			7.00555.07.0	AGR	EL	nur Elektronikeinheit electronics unit only
			7.08369.69.0	ATS	EL	ch. 234794→ vor Katalysator in front of the catalyst
			7.08369.27.0	ATS	EL	
			7.08369.55.0	ATS	EL	für OE-Nummer: 31431046 for OE number: 31431046
2.4 D5 XC AWD 120 kW (163 PS) D 5244 T	09.2002→08.2007		7.22996.11.0	AGR	ME	ohne Elektronikeinheit without the electronics unit
			7.22996.12.0	AGR	EL	nur Elektronikeinheit electronics unit only
2.4 T XC AWD 142 kW (193 PS) B 5254 T	11.1997→09.2002		7.22299.03.0	ARV	PN	
			7.21857.01.0	SLP	EL	
2.5 T XC AWD 153-162 kW (209-220 PS) B 5254 T2	09.2002→08.2007		7.05270.67.0	LS	770 mm	
			7.05270.81.0	LS	1200 mm	
XC70 II						36
2.4 D3 120 kW (163 PS) D 5244 T16, D 5244 T17	04.2010→04.2012		7.05363.00.0	AGR	EL	

V



XC70 II (136) **37**

2.4 D 129 kW (175 PS) D 5244 T14	06.2009→12.2010		7.05363.00.0	AGR	EL	
			7.11020.44.0	ATS	EL	 ch. 94001→ für Variant Code: AG02 for variant code: AG02
			7.08369.27.0	ATS	EL	 →ch. 94000
			7.11190.08.0	DDS	EL	 ch. 118009→
2.4 D / D4 AWD 120 kW (163 PS) D 5244 T16, D 5244 T17	08.2007→04.2016		7.05363.00.0	AGR	EL	
			7.02107.09.0	AGR-K		
			7.11020.44.0	ATS	EL	 D 5244 T16:  ch. 94001→ 2010 2010 2011 2011 für Variant Code: AG02 for variant code: AG02  D 5244 T17:  ch. 94001→ 2012 2012 2016 2016 für Variant Code: AG02 for variant code: AG02
			7.11020.45.0	ATS	EL	 D 5244 T16:  ch. 94001→ 2010 2010 2011 2011 für Variant Code: AG01 for variant code: AG01  D 5244 T17:  ch. 94001→ 2012 2012 2016 2016 für Variant Code: AG01 for variant code: AG01
			7.08369.27.0	ATS	EL	 D 5244 T16, D 5244 T17: Fahrgestellnummer bis: 94000 Vehicle Identification Number to: 94000
			7.11020.13.0	ATS	EL	 D 5244 T16: Ausstattungsvariante: AG01 Equipment Variant: AG01 2011 2011  D 5244 T17: Ausstattungsvariante: AG01 Equipment Variant: AG01 2012 2012 2016 2016

V

























XC70 II (136) **37**

			7.11020.14.0	ATS	EL	D 5244 T16: Ausstattungsvariante: GK01 / GK02 Equipment Variant: GK01 / GK02 vor Rußpartikelfilter before soot particulate filter 2010 D 5244 T16: Ausstattungsvariante: AG02 Equipment Variant: AG02 vor Rußpartikelfilter before soot particulate filter 2011 D 5244 T17: Ausstattungsvariante: AG02 Equipment Variant: AG02 vor Rußpartikelfilter before soot particulate filter
			7.11190.08.0	DDS		D 5244 T16: ch. 118009→ 2010 2011 D 5244 T17: ch. 118009→ 2012 2016 2016
2.4 D / D4 AWD 120 kW (163 PS) D 5244 T5	08.2007→04.2016		7.00555.06.0	AGR	EL	ohne Elektronikeinheit without the electronics unit
			7.00555.07.0	AGR	EL	nur Elektronikeinheit electronics unit only
			7.08369.27.0	ATS	EL	
			7.11020.14.0	ATS	EL	vor Rußpartikelfilter before soot particulate filter Euro 4 Euro 4 2009 2009
			7.11190.08.0	DDS		ch. 118009→ 2009 2009
3.2 AWD 168-177 kW (228-238 PS) B 6324 S	08.2007→12.2011		7.05270.69.0	LS	475 mm	
D3 120 kW (163 PS) D 5204 T2, D 5204 T3	04.2010→12.2015		7.05363.00.0	AGR	EL	
			7.02107.09.0	AGR-K		
			7.11020.45.0	ATS	EL	D 5204 T2: 2011 2011 D 5204 T3: 2012 2012
			7.11190.08.0	DDS		D 5204 T2: ch. 118009→ 2011 2011 D 5204 T3: ch. 118009→ 2012 2012
D4 133 kW (181 PS) D 4204 T5	10.2013→04.2016		7.11020.43.0	ATS	EL	
			7.11190.08.0	DDS		
D4 AWD 133 kW (181 PS) D 5244 T12	10.2013→04.2016		7.05363.00.0	AGR	EL	
			7.02107.09.0	AGR-K		





XC70 II (136) 37

			<p>7.08369.27.0 ATS EL Fahrgestellnummer bis: 94000 Vehicle Identification Number to: 94000</p> <p>7.11020.13.0 ATS EL 2017 2017</p> <p>7.11020.14.0 ATS EL Ausstattungsvariante: AG02 Equipment Variant: AG02 vor Rußpartikelfilter before soot particulate filter 2016 2016</p> <p>7.11190.08.0 DDS  ch. 118009→ 2016 2016</p>
<p>D5 AWD 136 kW (185 PS) D 5244 T4</p>	<p>04.2007→12.2009</p>		<p>7.00555.06.0 AGR EL  ohne Elektronikeinheit without the electronics unit</p>
			<p>7.00555.07.0 AGR EL nur Elektronikeinheit electronics unit only</p>
			<p>7.08369.27.0 ATS EL</p>
			<p>7.08369.55.0 ATS EL für OE-Nummer: 31431046 for OE number: 31431046</p>
<p>D5 AWD 151 kW (205 PS) D 5244 T10</p>	<p>04.2009→12.2011</p>		<p>7.11190.08.0 DDS  ch. 118009→</p>
			<p>7.05363.00.0 AGR EL </p>
			<p>7.02107.09.0 AGR-K </p>
			<p>7.11020.44.0 ATS EL  ch. 94001→ für Variant Code: AG02 for variant code: AG02</p>
			<p>7.11020.45.0 ATS EL  ch. 94001→ für Variant Code: AG01 for variant code: AG01</p>
			<p>7.08369.27.0 ATS EL Fahrgestellnummer bis: 94000 Vehicle Identification Number to: 94000</p>
			<p>7.11020.13.0 ATS EL Ausstattungsvariante: AG01 Equipment Variant: AG01 2011 2011</p>
<p>D5 AWD 158-169 kW (215-230 PS) D 5244 T11, D 5244 T15</p>	<p>04.2011→12.2015</p>		<p>7.11020.14.0 ATS EL  D 5244 T10: Ausstattungsvariante: GK01 / GK02 Equipment Variant: GK01 / GK02 vor Rußpartikelfilter before soot particulate filter 2010 2010  D 5244 T10: Ausstattungsvariante: AG02 Equipment Variant: AG02 vor Rußpartikelfilter before soot particulate filter 2011 2011</p>
			<p>7.11190.08.0 DDS  ch. 118009→</p>
			<p>7.11190.08.0 DDS EL </p>
<p>D5 AWD 158-169 kW (215-230 PS) D 5244 T11, D 5244 T15</p>	<p>04.2011→12.2015</p>		<p>7.05363.00.0 AGR EL </p>
			<p>7.02107.09.0 AGR-K </p>
			<p>7.11020.44.0 ATS EL  D 5244 T11, D 5244 T15:  ch. 94001→ für Variant Code: AG02 for variant code: AG02</p>
			<p>7.11020.45.0 ATS EL  D 5244 T11, D 5244 T15:  ch. 94001→ für Variant Code: AG01 for variant code: AG01</p>
<p>D5 AWD 158-169 kW (215-230 PS) D 5244 T11, D 5244 T15</p>	<p>04.2011→12.2015</p>		<p>7.08369.27.0 ATS EL  D 5244 T11, D 5244 T15: Fahrgestellnummer bis: 94000 Vehicle Identification Number to: 94000</p>
			<p>7.08369.27.0 ATS EL  D 5244 T11, D 5244 T15: Fahrgestellnummer bis: 94000 Vehicle Identification Number to: 94000</p>

V

XC70 II (136) **37**

			7.11020.13.0	ATS	EL	D 5244 T11, D 5244 T15: Ausstattungsvariante: AG01 Equipment Variant: AG01
			7.11020.14.0	ATS	EL	D 5244 T11, D 5244 T15: Ausstattungsvariante: AG02 Equipment Variant: AG02 vor Rußpartikelfilter before soot particulate filter
			7.11190.08.0	DDS		D 5244 T11, D 5244 T15: ch. 118009→
D5 AWD 158-169 kW (215-230 PS) D 5244 T15	11.2013→04.2016		7.05363.00.0	AGR	EL	
			7.02107.09.0	AGR-K		
			7.08369.27.0	ATS	EL	Fahrgestellnummer bis: 94000 Vehicle Identification Number to: 94000
D5 AWD 162 kW (220 PS) D 5244 T20	03.2015→04.2016		7.05363.00.0	AGR	EL	
			7.02107.09.0	AGR-K		
			7.11020.44.0	ATS	EL	ch. 94001→ 2016 2016 für Variant Code: AG02 for variant code: AG02
			7.11020.45.0	ATS	EL	ch. 94001→ 2016 2016 für Variant Code: AG01 for variant code: AG01
			7.08369.27.0	ATS	EL	Fahrgestellnummer bis: 94000 Vehicle Identification Number to: 94000
			7.11020.13.0	ATS	EL	Ausstattungsvariante: AG01 Equipment Variant: AG01 2016 2016
			7.11190.08.0	DDS		ch. 118009→ 2016 2016







XC90 I (275) **38**

2.5 T AWD 153-162 kW (209-220 PS) B 5254 T2	10.2002→09.2014		7.05270.67.0	LS	770 mm	
			7.05270.81.0	LS	1200 mm	
D3 / D5 120 kW (163 PS) D 5244 T5	04.2009→12.2014		7.00555.06.0	AGR	EL	 ohne Elektronikeinheit without the electronics unit
			7.08369.55.0	ATS	EL	
			7.08369.69.0	ATS	EL	für OE-Nummer: 31431045 for OE number: 31431045
			7.11190.10.0	DDS		ohne Zubehör without accessories 2008 2008 2014 2014
D5 AWD 120 kW (163 PS) D 5244 T	10.2002→12.2006		7.22996.11.0	AGR	ME	ohne Elektronikeinheit without the electronics unit
			7.22996.12.0	AGR	EL	nur Elektronikeinheit electronics unit only
			7.08369.55.0	ATS	EL	
D5 AWD 136 kW (185 PS) D 5244 T4	04.2005→12.2010		7.00555.06.0	AGR	EL	 ohne Elektronikeinheit without the electronics unit







XC90 I (275) 38

			7.00555.07.0	AGR	EL	nur Elektronikeinheit electronics unit only
			7.08369.55.0	ATS	EL	
			7.08369.69.0	ATS	EL	für OE-Nummer: 31431045 for OE number: 31431045
			7.11190.10.0	DDS		ohne Zubehör without accessories 2006 2006
D5 AWD 120 kW (163 PS) D 5244 T5	10.2007→12.2010		7.00555.06.0	AGR	EL	 ohne Elektronikeinheit without the electronics unit
			7.00555.07.0	AGR	EL	nur Elektronikeinheit electronics unit only
			7.08369.55.0	ATS	EL	
			7.08369.69.0	ATS	EL	für OE-Nummer: 31431045 for OE number: 31431045
			7.11190.10.0	DDS		ohne Zubehör without accessories 2008 2008 2014 2014
D5 AWD 147-155 kW (200-211 PS) D 5244 T18	01.2011→12.2014		7.00555.06.0	AGR	EL	 ohne Elektronikeinheit without the electronics unit
			7.00555.07.0	AGR	EL	nur Elektronikeinheit electronics unit only
			7.08369.55.0	ATS	EL	
			7.08369.69.0	ATS	EL	für OE-Nummer: 31431045 for OE number: 31431045
			7.11190.10.0	DDS		ohne Zubehör without accessories
D5 AWD 147-155 kW (200-211 PS) D 5244 T18	11.2013→09.2014		7.00555.06.0	AGR	EL	 ohne Elektronikeinheit without the electronics unit
			7.00555.07.0	AGR	EL	nur Elektronikeinheit electronics unit only
			7.08369.55.0	ATS	EL	
			7.11190.10.0	DDS		ohne Zubehör without accessories 2011 2011 2014 2014
T6 AWD 200 kW (272 PS) B 6294 T	10.2002→12.2006		7.05270.67.0	LS	770 mm	
			7.05270.81.0	LS	1200 mm	

XC90 II (256) 39

2.0 D5 Polestar AWD 173-177 kW (235-241 PS) D 4204 T23	10.2018→		7.11020.43.0	ATS	EL	Ausstattungsvariante: G101 / G102 Equipment Variant: G101 / G102 Getriebetyp: TG-81SC Transmission Type: TG-81SC
			7.11190.08.0	DDS		Ausstattungsvariante: G 101 / G 102 Equipment Variant: G 101 / G 102 Getriebetyp: TG-81SC Transmission Type: TG-81SC
D4 140-147 kW (190-200 PS) D 4204 T14	06.2015→12.2018		7.11020.43.0	ATS	EL	Getriebetyp: TG-81SC Transmission Type: TG-81SC
			7.11190.08.0	DDS		Getriebetyp: TG-81SC Transmission Type: TG-81SC
D4 AWD 140 kW (190 PS) D 4204 T6	10.2015→12.2018		7.11020.43.0	ATS	EL	Getriebetyp: TG-81SC Transmission Type: TG-81SC

XC90 II (256) 39

			7.11190.08.0	DDS		Getriebetyp: TG-81SC Transmission Type: TG-81SC
D5 AWD 165-171 kW (224-232 PS) D 4204 T11	09.2014→12.2016		7.11020.43.0	ATS	EL	Getriebetyp: TG-81SC Transmission Type: TG-81SC 2016 2016
			7.11190.08.0	DDS		2016 2016
D5 AWD 173-177 kW (235-241 PS) D 4204 T23	03.2016→12.2019		7.11020.43.0	ATS	EL	Ausstattungsvariante: G101 / G102 Equipment Variant: G101 / G102 Getriebetyp: TG-81SC Transmission Type: TG-81SC
			7.11190.08.0	DDS		Ausstattungsvariante: G101 / G102 Equipment Variant: G101 / G102 Getriebetyp: TG-81SC Transmission Type: TG-81SC 2017 2017
D5 DRIVE Polestar AWD 173-177 kW (235-241 PS) D 4204 T23	03.2016→		7.11020.43.0	ATS	EL	Ausstattungsvariante: G101 / G102 Equipment Variant: G101 / G102 Getriebetyp: TG-81SC Transmission Type: TG-81SC

V40 Hatchback Van (525, 526) 40

1.6 D2/ DRIVE 84 kW (114 PS) D 4162 T	09.2013→12.2015		7.02209.11.0	AGR	EL	
			7.02156.35.0	AGR-K	EL	ohne Sensor without sensor ch. 44762→ mit AGR-Ventil with EGR valve
			7.02156.34.0	AGR-K		ohne Sensor without sensor ch. 44762→ ohne AGR-Ventil without EGR valve
2.0 D3 110 kW (150 PS) D 5204 T6	09.2013→12.2015		7.05363.00.0	AGR	EL	
			7.02107.09.0	AGR-K		
2.0 D4 130 kW (177 PS) D 5204 T4	09.2013→12.2014		7.05363.00.0	AGR	EL	
			7.02107.09.0	AGR-K		



V60 I Estate Van (155) 41

1.6 DRIVE 84 kW (114 PS) D 4162 T	09.2013→12.2015		7.02209.11.0	AGR	EL	
			7.02156.35.0	AGR-K	EL	ohne Sensor without sensor ch. 131885→ mit AGR-Ventil with EGR valve
			7.02156.24.0	AGR-K	EL	mit Sensor with sensor
2.0 D3 100 kW (136 PS) D 5204 T7	09.2013→12.2015		7.02156.34.0	AGR-K		ohne Sensor without sensor ch. 131885→ ohne AGR-Ventil without EGR valve
			7.02107.09.0	AGR-K		
2.0 D4 120 kW (163 PS) D 5204 T3	09.2013→12.2015		7.02107.09.0	AGR-K		
2.4 D5 158-169 kW (215-230 PS) D 5244 T15	09.2013→12.2015		7.02107.09.0	AGR-K		



V



















































V70 III Estate Van (135) 42

2.0 D3 DRIVe 100 kW (136 PS) D 5204 T7	09.2013→		7.05363.00.0	AGR	EL	<input type="checkbox"/>
			7.02107.09.0	AGR-K		<input type="checkbox"/>
2.4 D5 158-169 kW (215-230 PS) D 5244 T11, D 5244 T15	09.2013→		7.05363.00.0	AGR	EL	<input type="checkbox"/>
			7.02107.09.0	AGR-K		<input type="checkbox"/>

XC70 II VAN (136) 43



2.4 D4 AWD 120 kW (163 PS) D 5244 T17	09.2013→04.2016		7.08369.27.0	ATS	EL	Fahrgestellnummer bis: 94000 Vehicle Identification Number to: 94000
2.4 D5 AWD 158-169 kW (215-230 PS) D 5244 T15	09.2013→		7.08369.27.0	ATS	EL	Fahrgestellnummer bis: 94000 Vehicle Identification Number to: 94000

V



						
BORA (1J2, 9D2)						1
1.6 74-78 kW (101-106 PS) AWB	06.2002→06.2006		7.05271.05.0	LS	700 mm	
1.6 74-75 kW (101-102 PS) BJH	10.2004→09.2006		7.22738.08.0	SLP	EL  ch. 1J-73013 568→ Produktionsdatum bis: 09.10.2006 Production date to: 09.10.2006	
1.8 92 kW (125 PS) BAF	12.2001→12.2006		7.22785.18.0	AGR	EL 	
1.8 T 110 kW (150 PS) BAE	01.2001→12.2006		7.22769.73.0	ARV	PN 	
R Turbo 1.8 130 kW (177 PS) BTH	08.2005→12.2006		7.22769.73.0	ARV	PN 	
BORA GP Saloon (9D2)						2
1.6 74-75 kW (101-102 PS) BJH, BWG	07.2006→12.2008		7.22738.08.0	SLP	EL  BJH:  ch. 1J-73013 568→ Produktionsdatum bis: 09.10.2006 Production date to: 09.10.2006  BWG: Produktionsdatum bis: 09.10.2006 Production date to: 09.10.2006	
			7.22778.96.0	SLV	PN 	
1.8 92 kW (125 PS) BAF	07.2006→12.2008		7.22785.18.0	AGR	EL 	
			7.22286.26.0	ARV	PN 	
			7.22738.08.0	SLP	EL  ch. 1J-73013 568→  ch. 1J-73013 568→	
BORA HS Hatchback (9D1)						3
1.6 74-75 kW (101-102 PS) BJH, BWG	10.2006→12.2008		7.22738.08.0	SLP	EL  BJH, BWG:  ch. 1J-73013 568→ Produktionsdatum bis: 09.10.2006 Production date to: 09.10.2006	
			7.22778.96.0	SLV	PN 	
1.8 92 kW (125 PS) BAF	10.2006→12.2008		7.22785.18.0	AGR	EL 	
			7.22286.26.0	ARV	PN 	
			7.22738.08.0	SLP	EL  ch. 1J-73013 568→  ch. 1J-73013 568→	
GOLF IV (1J1)						4
1.6 75 kW (102 PS) BFQ	08.2003→12.2008		7.22574.12.0	AGR	EL 	
			7.22778.96.0	SLV	PN 	
1.6 74-78 kW (101-106 PS) AWB	08.2003→01.2005		7.05271.05.0	LS	700 mm	
1.8 92 kW (125 PS) BAF	07.2003→07.2009		7.22785.18.0	AGR	EL 	
MAGOTAN (B6, 9X2)						5
2.0 85 kW (115 PS) BJZ	06.2007→04.2008		7.22778.80.0	SLV	PN 	
SAGITAR (9L2)						6
1.6 74-75 kW (101-102 PS) BWH	02.2006→12.2012		7.22778.96.0	SLV	PN 	
2.0 85 kW (115 PS) BJZ	04.2006→06.2009		7.22778.80.0	SLV	PN 	
CADDY (9HB)						7
1.6 74 kW (101 PS) BRY	03.2005→12.2007		7.22778.96.0	SLV	PN 	

PASSAT B5 (9F8)						1
2.0 85 kW (116 PS) BNL	02.2003→04.2009		7.22738.08.0	SLP	EL ch. 9F→	
			7.22778.95.0	SLV	PN ch. 9F→	
2.8 140 kW (190 PS) BBG	12.2001→12.2006		7.22560.40.0	ARV	PN links Left	
			7.22560.41.0	ARV	PN rechts Right	
PASSAT LINGYU (B5, 9F0, 9F9)						2
1.8 120 kW (163 PS) CEDA	08.2007→10.2012		7.22560.43.0	ARV	PN	
			7.22738.08.0	SLP	EL	
1.8 T 110 kW (150 PS) BGC	11.2005→10.2012		7.22560.43.0	ARV	PN	
			7.22738.08.0	SLP	EL	
2.0 85 kW (116 PS) BNL	04.2006→10.2012		7.22738.08.0	SLP	EL	
			7.22778.95.0	SLV	PN	
2.8 140 kW (190 PS) BBG	11.2005→10.2012		7.22560.40.0	ARV	PN links Left	
			7.22560.41.0	ARV	PN rechts Right	
			7.22738.08.0	SLP	EL	
PHIDEON (3E9)						3
3.0 All-wheel Drive 220 kW (299 PS) CREB	10.2016→		7.06714.21.0	ARV	PN rechts Right	
POLO Hatchback (9J1)						4
1.4 55 kW (75 PS) BCC	01.2002→03.2006		7.05271.05.0	LS	700 mm Ausstattungsvariante: Polo Classic Equipment Variant: Polo Classic nach Katalysator Post-catalyst Euro 3 Euro 3 China China	
1.6 74-77 kW (101-105 PS) BCD	01.2002→01.2006		7.22778.96.0	SLV	PN	
POLO Saloon (9J2)						5
1.4 55 kW (75 PS) BCC	06.2003→03.2006		7.05271.05.0	LS	700 mm Ausstattungsvariante: Polo Classic Equipment Variant: Polo Classic nach Katalysator Post-catalyst Euro 3 Euro 3 China China	
1.6 74-77 kW (101-105 PS) BCD	01.2002→01.2006		7.22778.96.0	SLV	PN	
SANTANA 3000 (345)						6
1.8 74 kW (101 PS) BKT	06.2005→12.2008		7.22738.08.0	SLP	EL	
			7.22778.95.0	SLV	PN	
2.0 80-85 kW (109-116 PS) BTL	05.2006→10.2007		7.22738.08.0	SLP	EL	
			7.22778.95.0	SLV	PN	

SANTANA VISTA (345) 7

1.8 74 kW (101 PS) BKT, BKU, CKZA	01.2008→12.2014		7.22738.08.0	SLP	EL	
			7.22778.95.0	SLV	PN	<input type="checkbox"/>
2.0 80-85 kW (109-116 PS) BTL	01.2008→12.2012		7.22778.95.0	SLV	PN	<input type="checkbox"/>

TOURAN (9R1, 9R3) 8





1.8 Turbo 110 kW (150 PS) CFUA	05.2005→12.2011		7.22286.54.0	ARV	PN	<input type="checkbox"/>
			7.22738.08.0	SLP	EL	
2.0 85 kW (114 PS) BJZ	11.2004→01.2008		7.22778.80.0	SLV	PN	<input type="checkbox"/>









MF3 Roadster

1

<p>3.2 239-252 kW (325-343 PS) S54326S4</p>	<p>05.2001→08.2003</p>	<p> 7.22748.18.0</p>	<p>SLV</p>	<p>PN</p>	<p></p>
<p>3.2 239-252 kW (325-343 PS) S54326S4</p>	<p>07.2003→</p>	<p> 7.22748.18.0</p>	<p>SLV</p>	<p>PN</p>	<p></p>



CHANCE Hatchback (TF_, TA_) 1					
1.5 (TF48YP) 63 kW (86 PS) A15SM	01.2009→03.2014	 7.09002.02.0	AGR	PN	<input checked="" type="checkbox"/>
CHANCE Saloon (TF_, TA_) 2					
1.5 (TF69Y0) 63 kW (86 PS) A15SMS	01.2009→03.2014	 7.09002.02.0	AGR	PN	<input checked="" type="checkbox"/>
LANOS Hatchback (TA_, TF_) 3					
1.5 (TF48YP) 63 kW (86 PS) A15SM	10.2004→02.2017	 7.09002.02.0	AGR	PN	<input checked="" type="checkbox"/>
LANOS Saloon (TA_, TF_) 4					
1.5 63 kW (86 PS) A15SM	10.2004→02.2017	 7.09002.02.0	AGR	PN	<input checked="" type="checkbox"/>
LANOS PICK-UP 5					
1.5 63 kW (86 PS) A15SM	10.2004→	 7.09002.02.0	AGR	PN	<input checked="" type="checkbox"/>



Proxima

1

95 66-70 kW (90-95 PS)
Z 1005



7.22946.33.0

AGR

EL



7.22946.34.0

AGR

EL



D



ALPHANUMERISCHE LISTE



E

ALPHANUMERICAL LIST

REF-No.	PIERBURG	REF-No.	PIERBURG		
0003961005	VOLKSWAGEN	7.02604.01.0	021906265AD	SKODA	7.05270.88.0
001-10-26232	BBR AUTOMOTIVE	7.08369.04.0	021906265AD	VOLKSWAGEN	7.05270.88.0
0035426918	STEYR	7.02604.99.0	021906265AE	AUDI	7.05270.96.0
0039	NGK	7.02604.60.0	021906265AE	VOLKSWAGEN	7.05270.96.0
004165019	AUDI	7.05270.86.0	021906265AK	AUDI	7.05270.88.0
004165019	SEAT	7.05270.86.0	021906265AK	SEAT	7.05270.88.0
004165019	SKODA	7.05270.86.0	021906265AK	SKODA	7.05270.88.0
004165019	VOLKSWAGEN	7.05270.86.0	021906265AK	VOLKSWAGEN	7.05270.88.0
0043	NGK	7.05271.72.0	021906265AN	SEAT	7.05271.23.0
0045427318	STEYR	7.05270.21.0	021906265AN	SKODA	7.05271.23.0
0052	NGK	7.02604.60.0	021906265AN	VOLKSWAGEN	7.05271.23.0
0061	NGK	7.05271.71.0	021906265AQ	AUDI	7.05270.96.0
0076	NGK	7.05271.46.0	021906265AQ	SEAT	7.05270.96.0
0123	NGK	7.05270.51.0	021906265AQ	SKODA	7.05270.96.0
0124	NGK	7.05270.71.0	021906265AQ	VOLKSWAGEN	7.05270.96.0
0126	NGK	7.05270.49.0	021906265C	VOLKSWAGEN	7.02604.04.0
013163232	PERKINS	7.04210.06.0	021906265C	VOLKSWAGEN	7.05270.86.0
0145	NGK	7.05270.47.0	021906265M	VOLKSWAGEN	7.02604.04.0
0183	NGK	7.05270.86.0	021906265N	AUDI	7.05270.86.0
0190	NGK	7.02604.61.0	021906265N	SEAT	7.05270.86.0
0199	NGK	7.02604.61.0	021906265N	SKODA	7.05270.86.0
0199	NGK	7.02604.62.0	021906265N	VOLKSWAGEN	7.05270.86.0
02.16.029	TRUCKTEC	7.24809.35.0	022131101B	AUDI	7.22286.51.0
	FAHRZEUGTEILE GM		022131101B	VOLKSWAGEN	7.22286.51.0
02.16.030	TRUCKTEC	7.24809.34.0	022131101C	AUDI	7.22286.55.0
	FAHRZEUGTEILE GM		022131101C	SEAT	7.22286.55.0
02.16.031	TRUCKTEC	7.24809.54.0	022131101C	VOLKSWAGEN	7.22286.55.0
	FAHRZEUGTEILE GM		022131101E	AUDI	7.22286.55.0
02.16.032	TRUCKTEC	7.24809.60.0	022131101E	SEAT	7.22286.55.0
	FAHRZEUGTEILE GM		022131101E	VOLKSWAGEN	7.22286.55.0
02.16.033	TRUCKTEC	7.24809.37.0	022131101F	VOLKSWAGEN	7.22286.41.0
	FAHRZEUGTEILE GM		022131351	VOLKSWAGEN	7.22778.98.0
02.16.034	TRUCKTEC	7.24809.59.0	022131351A	AUDI	7.22778.98.0
	FAHRZEUGTEILE GM		022131351A	VOLKSWAGEN	7.22778.98.0
02.16.037	TRUCKTEC	7.24809.33.0	0223	NGK	7.02604.51.0
	FAHRZEUGTEILE GM		022906262AC	VOLKSWAGEN	7.05271.12.0
02.16.038	TRUCKTEC	7.24809.36.0	022906262AF	AUDI	7.05271.11.0
	FAHRZEUGTEILE GM		022906262AF	VOLKSWAGEN	7.05271.11.0
02.16.039	TRUCKTEC	7.24809.48.0	022906262AG	AUDI	7.05271.15.0
	FAHRZEUGTEILE GM		022906262AG	SEAT	7.05271.15.0
02.16.040	TRUCKTEC	7.24809.49.0	022906262AG	SKODA	7.05271.15.0
	FAHRZEUGTEILE GM		022906262AG	VOLKSWAGEN	7.05271.15.0
02.16.042	TRUCKTEC	7.24809.47.0	022906262AH	AUDI	7.05270.99.0
	FAHRZEUGTEILE GM		022906262AH	SEAT	7.05270.99.0
021131101A	VOLKSWAGEN	7.22090.11.0	022906262AH	SKODA	7.05270.99.0
021131101E	AUDI	7.22286.55.0	022906262AH	VOLKSWAGEN	7.05270.99.0
021131101E	SEAT	7.22286.55.0	022906262AN	SKODA	7.02604.41.0
021131101E	VOLKSWAGEN	7.22286.55.0	022906262AN	VOLKSWAGEN	7.02604.41.0
021906262	VOLKSWAGEN	7.02604.04.0	022906262AP	AUDI	7.05271.12.0
021906262B	AUDI	7.05271.24.0	022906262AP	SEAT	7.05271.12.0
021906262B	SEAT	7.05271.24.0	022906262AP	SKODA	7.05271.12.0
021906262B	VOLKSWAGEN	7.05271.24.0	022906262AP	VOLKSWAGEN	7.05271.12.0
021906262C	AUDI	7.05271.01.0	022906262AQ	AUDI	7.05271.11.0
021906262C	SEAT	7.05271.01.0	022906262AQ	SEAT	7.05271.11.0
021906262C	SKODA	7.05271.01.0	022906262AQ	SKODA	7.05271.11.0
021906262C	VOLKSWAGEN	7.05271.01.0	022906262AT	VOLKSWAGEN	7.05270.98.0
021906265	AUDI	7.05270.86.0	022906262BB	AUDI	7.05271.23.0
021906265	SEAT	7.05270.86.0	022906262BB	SEAT	7.05271.23.0
021906265	SKODA	7.05270.86.0	022906262BB	SKODA	7.05271.23.0
021906265	VOLKSWAGEN	7.05270.86.0	022906262BB	VOLKSWAGEN	7.05271.23.0
021906265A	AUDI	7.05270.86.0	022906262BG	AUDI	7.05270.98.0
021906265A	SEAT	7.05270.86.0	022906262BG	SEAT	7.05270.98.0
021906265A	SKODA	7.05270.86.0	022906262BG	SKODA	7.05270.98.0
021906265A	VOLKSWAGEN	7.05270.86.0	022906262BG	VOLKSWAGEN	7.05270.98.0
021906265AC	AUDI	7.05270.96.0	022906262BH	AUDI	7.05270.99.0
021906265AC	SEAT	7.05270.96.0	022906262BH	SEAT	7.05270.99.0
021906265AC	SKODA	7.05270.96.0	022906262BH	SKODA	7.05270.99.0
021906265AC	VOLKSWAGEN	7.05270.96.0	022906262BH	VOLKSWAGEN	7.05270.99.0
021906265AD	AUDI	7.05270.88.0			
021906265AD	SEAT	7.05270.88.0			

REF-No.	 PIERBURG	REF-No.	 PIERBURG		
022906262BK	VOLKSWAGEN	7.05271.12.0	022906265B	SKODA	7.05270.99.0
022906262BM	AUDI	7.05271.15.0	022906265B	VOLKSWAGEN	7.05270.99.0
022906262BM	SEAT	7.05271.15.0	022906265C	AUDI	7.05270.98.0
022906262BM	SKODA	7.05271.15.0	022906265C	SEAT	7.05270.98.0
022906262BM	VOLKSWAGEN	7.05271.15.0	022906265C	SKODA	7.05270.98.0
022906262BP	AUDI	7.05271.01.0	022906265C	VOLKSWAGEN	7.05270.98.0
022906262BP	SEAT	7.05271.01.0	022959253	AUDI	7.22738.20.0
022906262BP	SKODA	7.05271.01.0	022959253	SEAT	7.22738.20.0
022906262BP	VOLKSWAGEN	7.05271.01.0	022959253	VOLKSWAGEN	7.22738.20.0
022906262BR	AUDI	7.05271.12.0	022959253A	AUDI	7.22738.20.0
022906262BR	SEAT	7.05271.12.0	022959253A	SEAT	7.22738.20.0
022906262BR	SKODA	7.05271.12.0	022959253A	VOLKSWAGEN	7.22738.20.0
022906262BR	VOLKSWAGEN	7.05271.12.0	02300.02510	HELLA INCORPORATED	7.24809.68.0
022906262BT	AUDI	7.05271.19.0	0239	NGK	7.02604.62.0
022906262BT	SEAT	7.05271.19.0	023906262	AUDI	7.05271.21.0
022906262BT	SKODA	7.05271.19.0	023906262	SEAT	7.05271.21.0
022906262BT	VOLKSWAGEN	7.05271.19.0	023906262	SKODA	7.05271.21.0
022906262CA	AUDI	7.05271.30.0	023906262	VOLKSWAGEN	7.05271.21.0
022906262CA	SEAT	7.05271.30.0	0245	NGK	7.02604.47.0
022906262CA	SKODA	7.05271.30.0	0254	NGK	7.05270.86.0
022906262CA	VOLKSWAGEN	7.05271.30.0	0258-00-2035	MAZDA	7.02604.01.0
022906262CC	VOLKSWAGEN	7.05271.12.0	0258002058	BOSCH	7.05270.45.0
022906262CD	AUDI	7.05271.27.0	0258003006	BOSCH	7.05270.51.0
022906262CD	SEAT	7.05271.27.0	0258003009	BOSCH	7.05270.51.0
022906262CD	SKODA	7.05271.27.0	0258003014	BOSCH	7.05270.51.0
022906262CD	VOLKSWAGEN	7.05271.27.0	0258003019	BOSCH	7.05270.51.0
022906262CE	AUDI	7.05271.15.0	0258003022	BOSCH	7.02604.63.0
022906262CE	SEAT	7.05271.15.0	0258003028	BOSCH	7.05270.51.0
022906262CE	SKODA	7.05271.15.0	0258003040	BOSCH	7.05270.51.0
022906262CE	VOLKSWAGEN	7.05271.15.0	0258003075	BOSCH	7.05270.51.0
022906262CF	AUDI	7.05271.11.0	0258003076	BOSCH	7.02604.61.0
022906262CF	SEAT	7.05271.11.0	0258003077	BOSCH	7.05270.51.0
022906262CF	SKODA	7.05271.11.0	0258003081	BOSCH	7.05270.51.0
022906262CF	VOLKSWAGEN	7.05271.11.0	0258003083	BOSCH	7.05270.51.0
022906262CH	AUDI	7.05271.28.0	0258003085	BOSCH	7.05270.51.0
022906262CH	SEAT	7.05271.28.0	0258003086	BOSCH	7.05270.51.0
022906262CH	SKODA	7.05271.28.0	0258003090	BOSCH	7.05270.51.0
022906262CH	VOLKSWAGEN	7.05271.28.0	0258003122	BOSCH	7.02604.61.0
022906262D	VOLKSWAGEN	7.05271.24.0	0258003175	BOSCH	7.05270.51.0
022906262E	VOLKSWAGEN	7.05271.24.0	0258003181	BOSCH	7.05270.88.0
022906262F	AUDI	7.05270.98.0	0258003189	BOSCH	7.05270.51.0
022906262F	SEAT	7.05270.98.0	0258003190	BOSCH	7.05270.48.0
022906262F	SKODA	7.05270.98.0	0258003195	BOSCH	7.05270.00.0
022906262F	VOLKSWAGEN	7.05270.98.0	0258003197	BOSCH	7.05270.00.0
022906262G	VOLKSWAGEN	7.05271.00.0	0258003199	BOSCH	7.05270.00.0
022906262H	SEAT	7.05271.24.0	0258003201	BOSCH	7.05270.51.0
022906262H	VOLKSWAGEN	7.05271.24.0	0258003206	BOSCH	7.05270.51.0
022906262J	SEAT	7.05271.24.0	0258003216	BOSCH	7.05270.86.0
022906262J	VOLKSWAGEN	7.05271.24.0	0258003234	BOSCH	7.05270.51.0
022906262K	SEAT	7.05270.98.0	0258003241	BOSCH	7.05270.51.0
022906262K	VOLKSWAGEN	7.05270.98.0	0258003253	BOSCH	7.02604.62.0
022906262L	AUDI	7.05271.00.0	0258003254	BOSCH	7.05270.51.0
022906262L	SEAT	7.05271.00.0	0258003259	BOSCH	7.02604.61.0
022906262L	SKODA	7.05271.00.0	0258003265	BOSCH	7.05270.86.0
022906262L	VOLKSWAGEN	7.05271.00.0	0258003267	BOSCH	7.05270.86.0
022906262M	AUDI	7.05270.89.0	0258003288	BOSCH	7.05270.86.0
022906262M	SEAT	7.05270.89.0	0258003291	BOSCH	7.02604.61.0
022906262M	SKODA	7.05270.89.0	0258003298	BOSCH	7.05270.51.0
022906262M	VOLKSWAGEN	7.05270.89.0	0258003303	BOSCH	7.05270.86.0
022906262P	AUDI	7.05271.23.0	0258003326	BOSCH	7.05270.00.0
022906262P	SEAT	7.05271.23.0	0258003328	BOSCH	7.05270.00.0
022906262P	SKODA	7.05271.23.0	0258003331	BOSCH	7.05270.88.0
022906262P	VOLKSWAGEN	7.05271.23.0	0258003334	BOSCH	7.05270.86.0
022906262S	AUDI	7.05270.89.0	0258003341	BOSCH	7.02604.62.0
022906262S	SEAT	7.05270.89.0	0258003342	BOSCH	7.02604.61.0
022906262S	SKODA	7.05270.89.0	0258003371	BOSCH	7.05270.86.0
022906262S	VOLKSWAGEN	7.05270.89.0	0258003373	BOSCH	7.05270.36.0
022906265B	AUDI	7.05270.99.0	0258003392	BOSCH	7.02604.61.0
022906265B	SEAT	7.05270.99.0	0258003395	BOSCH	7.02604.04.0

REF-No.	 PIERBURG	REF-No.	 PIERBURG
0258003423	BOSCH 7.02604.62.0	0258005088	BOSCH 7.05270.03.0
0258003427	BOSCH 7.05270.00.0	0258005096	BOSCH 7.02604.49.0
0258003429	BOSCH 7.05270.00.0	0258005097	BOSCH 7.02604.04.0
0258003439	BOSCH 7.05270.86.0	0258005109	BOSCH 7.02604.21.0
0258003443	BOSCH 7.05270.00.0	0258005115	BOSCH 7.05271.04.0
0258003446	BOSCH 7.05270.47.0	0258005126	BOSCH 7.05270.86.0
0258003447	BOSCH 7.05270.47.0	0258005128	BOSCH 7.05270.86.0
0258003448	BOSCH 7.05270.47.0	0258005134	BOSCH 7.05270.54.0
0258003454	BOSCH 7.05270.88.0	0258005135	BOSCH 7.05270.54.0
0258003456	BOSCH 7.02604.61.0	0258005136	BOSCH 7.02604.10.0
0258003457	BOSCH 7.02604.61.0	0258005138	BOSCH 7.02604.28.0
0258003477	BOSCH 7.02604.31.0	0258005143	BOSCH 7.05271.03.0
0258003484	BOSCH 7.02604.61.0	0258005157	BOSCH 7.02604.49.0
0258003485	BOSCH 7.02604.62.0	0258005158	BOSCH 7.05270.88.0
0258003486	BOSCH 7.02604.61.0	0258005160	BOSCH 7.05270.96.0
0258003558	BOSCH 7.02604.04.0	0258005163	BOSCH 7.05270.03.0
0258003560	BOSCH 7.02604.54.0	0258005177	BOSCH 7.02604.30.0
0258003580	BOSCH 7.05270.15.0	0258005179	BOSCH 7.05270.88.0
0258003611	BOSCH 7.05270.96.0	0258005185	BOSCH 7.05270.86.0
0258003626	BOSCH 7.02604.04.0	0258005191	BOSCH 7.02604.49.0
0258003630	BOSCH 7.05270.96.0	0258005192	BOSCH 7.02604.49.0
0258003632	BOSCH 7.05270.96.0	0258005202	BOSCH 7.05270.15.0
0258003638	BOSCH 7.05270.15.0	0258005234	BOSCH 7.05270.25.0
0258003640	BOSCH 7.05270.03.0	0258005235	BOSCH 7.05270.25.0
0258003646	BOSCH 7.05270.88.0	0258005236	BOSCH 7.05271.03.0
0258003655	BOSCH 7.02604.04.0	0258005253	BOSCH 7.02604.77.0
0258003657	BOSCH 7.02604.04.0	0258005256	BOSCH 7.05271.76.0
0258003658	BOSCH 7.02604.04.0	0258005271	BOSCH 7.02604.32.0
0258003666	BOSCH 7.05270.86.0	0258005281	BOSCH 7.02604.28.0
0258003667	BOSCH 7.05270.39.0	0258005283	BOSCH 7.05270.36.0
0258003668	BOSCH 7.05270.36.0	0258005291	BOSCH 7.05270.26.0
0258003669	BOSCH 7.05270.38.0	0258005297	BOSCH 7.02604.32.0
0258003672	BOSCH 7.05270.36.0	0258005298	BOSCH 7.02604.32.0
0258003673	BOSCH 7.05270.38.0	0258005309	BOSCH 7.02604.31.0
0258003690	BOSCH 7.05270.96.0	0258005310	BOSCH 7.02604.21.0
0258003694	BOSCH 7.05270.88.0	0258005321	BOSCH 7.02604.32.0
0258003696	BOSCH 7.05270.88.0	0258005339	BOSCH 7.02604.32.0
0258003698	BOSCH 7.05270.96.0	0258005703	BOSCH 7.05271.52.0
0258003705	BOSCH 7.05270.36.0	0258005708	BOSCH 7.05271.73.0
0258003713	BOSCH 7.02604.61.0	0258005716	BOSCH 7.02604.60.0
0258003714	BOSCH 7.02604.61.0	0258005717	BOSCH 7.02604.60.0
0258003716	BOSCH 7.05270.39.0	0258006018	BOSCH 7.05270.12.0
0258003734	BOSCH 7.05270.88.0	0258006021	BOSCH 7.02604.56.0
0258003738	BOSCH 7.05270.88.0	0258006029	BOSCH 7.05270.37.0
0258003745	BOSCH 7.05270.86.0	0258006032	BOSCH 7.05271.02.0
0258003748	BOSCH 7.02604.28.0	0258006041	BOSCH 7.05270.80.0
0258003749	BOSCH 7.02604.30.0	0258006046	BOSCH 7.02604.10.0
0258003754	BOSCH 7.05270.36.0	0258006047	BOSCH 7.05270.80.0
0258003757	BOSCH 7.05270.96.0	0258006050	BOSCH 7.05270.67.0
0258003779	BOSCH 7.02604.62.0	0258006053	BOSCH 7.02604.64.0
0258003782	BOSCH 7.05270.15.0	0258006055	BOSCH 7.02604.64.0
0258003794	BOSCH 7.05270.96.0	0258006072	BOSCH 7.02604.55.0
0258003802	BOSCH 7.02604.31.0	0258006115	BOSCH 7.05270.89.0
0258003805	BOSCH 7.02604.47.0	0258006127	BOSCH 7.05271.75.0
0258003811	BOSCH 7.05270.96.0	0258006135	BOSCH 7.05270.91.0
0258003842	BOSCH 7.05270.88.0	0258006155	BOSCH 7.02604.64.0
0258003931	BOSCH 7.05270.51.0	0258006161	BOSCH 7.05270.89.0
0258003957	BOSCH 7.05270.51.0	0258006163	BOSCH 7.05270.89.0
0258003965	BOSCH 7.05270.51.0	0258006165	BOSCH 7.02604.64.0
0258003994	BOSCH 7.05270.51.0	0258006167	BOSCH 7.05270.12.0
0258003995	BOSCH 7.05270.51.0	0258006171	BOSCH 7.02604.07.0
0258005005	BOSCH 7.05270.15.0	0258006174	BOSCH 7.05270.67.0
0258005026	BOSCH 7.05270.96.0	0258006181	BOSCH 7.05270.12.0
0258005049	BOSCH 7.05270.88.0	0258006183	BOSCH 7.02604.26.0
0258005066	BOSCH 7.05270.88.0	0258006186	BOSCH 7.05270.37.0
0258005068	BOSCH 7.05270.88.0	0258006190	BOSCH 7.02604.56.0
0258005075	BOSCH 7.05270.88.0	0258006191	BOSCH 7.02604.56.0
0258005081	BOSCH 7.05271.03.0	0258006192	BOSCH 7.02604.53.0
0258005087	BOSCH 7.02604.47.0	0258006193	BOSCH 7.02604.55.0

REF-No.	 PIERBURG	REF-No.	 PIERBURG
0258006197	BOSCH 7.05270.67.0	0258006683	BOSCH 7.05271.15.0
0258006198	BOSCH 7.05270.37.0	0258006687	BOSCH 7.05270.17.0
0258006199	BOSCH 7.05270.67.0	0258006689	BOSCH 7.05270.18.0
0258006201	BOSCH 7.05271.02.0	0258006700	BOSCH 7.05271.13.0
0258006206	BOSCH 7.02604.53.0	0258006702	BOSCH 7.05271.02.0
0258006217	BOSCH 7.05270.99.0	0258006704	BOSCH 7.05271.02.0
0258006219	BOSCH 7.05270.89.0	0258006720	BOSCH 7.05271.39.0
0258006221	BOSCH 7.05270.89.0	0258006741	BOSCH 7.05271.15.0
0258006243	BOSCH 7.05270.89.0	0258006747	BOSCH 7.05270.18.0
0258006259	BOSCH 7.05271.21.0	0258006749	BOSCH 7.05270.17.0
0258006268	BOSCH 7.05270.11.0	0258006753	BOSCH 7.02604.26.0
0258006274	BOSCH 7.05270.12.0	0258006755	BOSCH 7.02604.34.0
0258006294	BOSCH 7.02604.10.0	0258006789	BOSCH 7.02604.34.0
0258006295	BOSCH 7.02604.10.0	0258006790	BOSCH 7.02604.27.0
0258006296	BOSCH 7.05270.89.0	0258006792	BOSCH 7.02604.26.0
0258006302	BOSCH 7.05271.00.0	0258006793	BOSCH 7.02604.25.0
0258006307	BOSCH 7.05271.21.0	0258006794	BOSCH 7.02604.34.0
0258006311	BOSCH 7.02604.10.0	0258006795	BOSCH 7.02604.34.0
0258006316	BOSCH 7.05270.91.0	0258006796	BOSCH 7.02604.26.0
0258006318	BOSCH 7.05270.11.0	0258006797	BOSCH 7.05271.11.0
0258006322	BOSCH 7.02604.27.0	0258006808	BOSCH 7.02604.25.0
0258006328	BOSCH 7.02604.26.0	0258006809	BOSCH 7.02604.26.0
0258006332	BOSCH 7.05271.02.0	0258006839	BOSCH 7.05271.11.0
0258006334	BOSCH 7.05270.99.0	0258006851	BOSCH 7.05271.16.0
0258006346	BOSCH 7.05271.68.0	0258006864	BOSCH 7.02604.25.0
0258006359	BOSCH 7.05270.11.0	0258006887	BOSCH 7.05271.13.0
0258006361	BOSCH 7.05270.89.0	0258006889	BOSCH 7.05271.15.0
0258006363	BOSCH 7.05270.89.0	0258006895	BOSCH 7.05271.12.0
0258006375	BOSCH 7.02604.55.0	0258006911	BOSCH 7.05271.19.0
0258006376	BOSCH 7.02604.53.0	0258006953	BOSCH 7.02604.10.0
0258006382	BOSCH 7.05271.15.0	0258006977	BOSCH 7.02604.34.0
0258006384	BOSCH 7.05270.11.0	0258006980	BOSCH 7.05270.99.0
0258006387	BOSCH 7.02604.07.0	0258006984	BOSCH 7.05271.12.0
0258006392	BOSCH 7.05270.91.0	0258006984	BOSCH 7.05271.16.0
0258006411	BOSCH 7.02604.56.0	0258007006	BOSCH 7.05271.23.0
0258006420	BOSCH 7.02604.27.0	0258007008	BOSCH 7.05270.80.0
0258006427	BOSCH 7.05270.37.0	0258007027	BOSCH 7.05270.80.0
0258006436	BOSCH 7.05270.12.0	0258007033	BOSCH 7.05270.81.0
0258006438	BOSCH 7.05270.12.0	0258007038	BOSCH 7.05270.80.0
0258006446	BOSCH 7.05270.67.0	0258007039	BOSCH 7.05270.80.0
0258006448	BOSCH 7.05270.67.0	0258007040	BOSCH 7.05271.23.0
0258006450	BOSCH 7.02604.64.0	0258007053	BOSCH 7.05271.23.0
0258006456	BOSCH 7.05270.11.0	0258007057	BOSCH 7.05271.23.0
0258006475	BOSCH 7.05270.11.0	0258007061	BOSCH 7.05271.23.0
0258006501	BOSCH 7.02604.07.0	0258007070	BOSCH 7.05270.81.0
0258006513	BOSCH 7.05271.37.0	0258007105	BOSCH 7.05271.23.0
0258006522	BOSCH 7.05270.67.0	0258007114	BOSCH 7.05271.23.0
0258006524	BOSCH 7.05270.67.0	0258007125	BOSCH 7.05271.23.0
0258006525	BOSCH 7.05270.89.0	0258007135	BOSCH 7.05270.81.0
0258006527	BOSCH 7.05271.01.0	0258007136	BOSCH 7.05270.81.0
0258006529	BOSCH 7.05270.99.0	0258007137	BOSCH 7.05270.81.0
0258006535	BOSCH 7.05270.99.0	0258007140	BOSCH 7.05271.23.0
0258006541	BOSCH 7.05270.67.0	0258007144	BOSCH 7.05271.22.0
0258006555	BOSCH 7.05271.16.0	0258007156	BOSCH 7.05270.80.0
0258006559	BOSCH 7.05270.99.0	0258007159	BOSCH 7.05271.23.0
0258006573	BOSCH 7.02604.64.0	0258007160	BOSCH 7.05271.22.0
0258006582	BOSCH 7.05271.21.0	0258007161	BOSCH 7.05271.23.0
0258006589	BOSCH 7.05271.01.0	0258007185	BOSCH 7.05270.80.0
0258006595	BOSCH 7.05271.81.0	0258007187	BOSCH 7.05270.81.0
0258006598	BOSCH 7.05270.67.0	0258007188	BOSCH 7.05270.81.0
0258006599	BOSCH 7.02604.64.0	0258007189	BOSCH 7.05271.23.0
0258006601	BOSCH 7.02604.65.0	0258007204	BOSCH 7.05270.80.0
0258006603	BOSCH 7.02604.64.0	0258007208	BOSCH 7.05271.23.0
0258006605	BOSCH 7.02604.64.0	0258007211	BOSCH 7.05271.30.0
0258006609	BOSCH 7.05270.89.0	0258007227	BOSCH 7.05271.23.0
0258006613	BOSCH 7.05271.15.0	0258007240	BOSCH 7.05270.80.0
0258006661	BOSCH 7.05271.12.0	0258007244	BOSCH 7.05271.23.0
0258006663	BOSCH 7.05271.00.0	0258007255	BOSCH 7.05271.23.0
0258006665	BOSCH 7.05271.14.0	0258007264	BOSCH 7.05270.80.0

NUMBERFINDER

REF-No.		 PIERBURG	REF-No.		 PIERBURG
0258007273	BOSCH	7.05271.22.0	0281006082	BOSCH	7.11492.00.0
0258007274	BOSCH	7.05271.23.0	0281006083	BOSCH	7.11190.09.0
0258007285	BOSCH	7.05271.23.0	0281006287	BOSCH	7.11190.03.0
0258007315	BOSCH	7.05271.23.0	0293	NGK	7.02604.61.0
0258007351	BOSCH	7.05271.24.0	0298	NGK	7.05270.39.0
0258007353	BOSCH	7.05271.77.0	030906262	AUDI	7.05271.14.0
0258007359	BOSCH	7.05271.23.0	030906262	SEAT	7.05271.14.0
0258010002	BOSCH	7.05271.15.0	030906262	SKODA	7.05271.14.0
0258010030	BOSCH	7.02604.27.0	030906262	VOLKSWAGEN	7.05271.14.0
0258010071	BOSCH	7.02604.65.0	030906262A	AUDI	7.05270.99.0
0258010115	BOSCH	7.05270.18.0	030906262A	SEAT	7.05270.99.0
0258017004	BOSCH	7.05271.29.0	030906262A	SKODA	7.05270.99.0
0258017010	BOSCH	7.05271.29.0	030906262A	VOLKSWAGEN	7.05270.99.0
0258017016	BOSCH	7.05270.21.0	030906262C	AUDI	7.05271.06.0
0258017018	BOSCH	7.05270.22.0	030906262C	SEAT	7.05271.06.0
0258017029	BOSCH	7.05270.21.0	030906262C	SKODA	7.05271.06.0
0258017032	BOSCH	7.05271.29.0	030906262C	VOLKSWAGEN	7.05271.06.0
0258017046	BOSCH	7.05271.29.0	030906262D	AUDI	7.05270.99.0
0258017049	BOSCH	7.05270.21.0	030906262D	SEAT	7.05270.99.0
0258017053	BOSCH	7.05271.29.0	030906262D	SKODA	7.05270.99.0
0258017068	BOSCH	7.05271.29.0	030906262D	VOLKSWAGEN	7.05270.99.0
0258017072	BOSCH	7.05271.27.0	030906262E	AUDI	7.05270.99.0
0258017082	BOSCH	7.05271.30.0	030906262E	SEAT	7.05270.99.0
0258017084	BOSCH	7.05271.27.0	030906262E	SKODA	7.05270.99.0
0258017088	BOSCH	7.05271.28.0	030906262E	VOLKSWAGEN	7.05270.99.0
0258017091	BOSCH	7.02604.42.0	030906262F	SEAT	7.05271.06.0
0258017092	BOSCH	7.02604.42.0	030906262F	VOLKSWAGEN	7.05271.06.0
0258017099	BOSCH	7.02604.42.0	030906262G	VOLKSWAGEN	7.05271.77.0
0258017101	BOSCH	7.02604.43.0	030906262J	VOLKSWAGEN	7.05271.77.0
0258017102	BOSCH	7.02604.43.0	030906262L	AUDI	7.05270.99.0
0258017112	BOSCH	7.02604.41.0	030906262L	SEAT	7.05270.99.0
0258017124	BOSCH	7.02604.42.0	030906262L	SKODA	7.05270.99.0
0258017126	BOSCH	7.02604.41.0	030906262L	VOLKSWAGEN	7.05270.99.0
0258017153	BOSCH	7.05271.27.0	030906262M	AUDI	7.05271.02.0
0258017209	BOSCH	7.02604.41.0	030906262M	SEAT	7.05271.02.0
0258017241	BOSCH	7.05271.29.0	030906262M	SKODA	7.05271.02.0
0258986501	BOSCH	7.02604.01.0	030906262M	VOLKSWAGEN	7.05271.02.0
0258986505	BOSCH	7.02604.04.0	030906262N	AUDI	7.05270.99.0
0258986506	BOSCH	7.02604.04.0	030906262N	SEAT	7.05270.99.0
0258986507	BOSCH	7.05271.46.0	030906262N	SKODA	7.05270.99.0
0258986605	BOSCH	7.05271.58.0	030906262N	VOLKSWAGEN	7.05270.99.0
0258986607	BOSCH	7.05271.38.0	030906262R	AUDI	7.05270.99.0
0258986615	BOSCH	7.05270.56.0	030906262R	SEAT	7.05270.99.0
0258986627	BOSCH	7.02604.73.0	030906262R	SKODA	7.05270.99.0
0258986668	BOSCH	7.05271.35.0	030906262R	VOLKSWAGEN	7.05270.99.0
0258986676	BOSCH	7.05270.79.0	030906262S	AUDI	7.05270.99.0
0258986680	BOSCH	7.05270.67.0	030906262S	SEAT	7.05270.99.0
0258986682	BOSCH	7.05270.67.0	030906262S	SKODA	7.05270.99.0
0258986684	BOSCH	7.02604.80.0	030906262S	VOLKSWAGEN	7.05270.99.0
0258986687	BOSCH	7.05271.53.0	030906265AC	VOLKSWAGEN	7.02604.04.0
0258986716	BOSCH	7.05271.36.0	030906265AD	VOLKSWAGEN	7.05270.88.0
0258986777	BOSCH	7.02604.64.0	030906265BS	AUDI	7.05271.03.0
0258987000	BOSCH	7.05270.81.0	030906265BS	SEAT	7.05271.03.0
025906265	VOLKSWAGEN	7.02604.01.0	030906265BS	SKODA	7.05271.03.0
0261230600	BOSCH	7.11190.08.0	030906265BS	VOLKSWAGEN	7.05271.03.0
0270	NGK	7.05271.04.0	030906265BT	AUDI	7.05271.03.0
0275	NGK	7.05270.96.0	030906265BT	SEAT	7.05271.03.0
0281002558	BOSCH	7.11190.00.0	030906265BT	SKODA	7.05271.03.0
0281002710	BOSCH	7.11190.00.0	030906265BT	VOLKSWAGEN	7.05271.03.0
0281002710	BOSCH	7.11492.02.0	030906265CB	AUDI	7.05271.04.0
0281002770	BOSCH	7.11190.04.0	030906265CB	SEAT	7.05271.04.0
0281004019	BOSCH	7.02604.44.0	030906265CB	SKODA	7.05271.04.0
0281004026	BOSCH	7.02604.99.0	030906265CB	VOLKSWAGEN	7.05271.04.0
0281004028	BOSCH	7.02604.44.0	030906265T	AUDI	7.05270.86.0
0281004044	BOSCH	7.02604.99.0	030906265T	SEAT	7.05270.86.0
0281004069	BOSCH	7.02604.99.0	030906265T	SKODA	7.05270.86.0
0281004080	BOSCH	7.05270.21.0	030906265T	VOLKSWAGEN	7.05270.86.0
0281006005	BOSCH	7.11190.02.0	032906265	VOLKSWAGEN	7.05270.88.0
0281006082	BOSCH	7.11190.09.0	032906265C	AUDI	7.05271.07.0

REF-No.		 PIERBURG	REF-No.		 PIERBURG
032906265C	SKODA	7.05271.07.0	037906265J	SEAT	7.02604.04.0
032906265C	VOLKSWAGEN	7.05271.07.0	037906265J	VOLKSWAGEN	7.02604.04.0
032906265D	AUDI	7.05271.07.0	037906265P	AUDI	7.02604.04.0
032906265D	SKODA	7.05271.07.0	037906265P	VOLKSWAGEN	7.02604.04.0
032906265D	VOLKSWAGEN	7.05271.07.0	0380	NGK	7.02604.10.0
032906265E	AUDI	7.05271.03.0	038129637D	VOLKSWAGEN	7.24809.16.0
032906265E	SEAT	7.05271.03.0	038131501	SEAT	7.22477.10.0
032906265E	SKODA	7.05271.03.0	038131501	VOLKSWAGEN	7.22477.10.0
032906265E	VOLKSWAGEN	7.05271.03.0	038131501AA	SEAT	7.24809.20.0
034906265C	AUDI	7.02604.03.0	038131501AA	VOLKSWAGEN	7.24809.20.0
034906265C	SEAT	7.02604.03.0	038131501AB	SEAT	7.24809.55.0
034906265C	VOLKSWAGEN	7.02604.03.0	038131501AB	SKODA	7.24809.55.0
035133533A	VOLKSWAGEN	7.02604.01.0	038131501AB	VOLKSWAGEN	7.24809.55.0
035906265	VOLKSWAGEN	7.02604.01.0	038131501AD	AUDI	7.00365.06.0
035906265A	VOLKSWAGEN	7.02604.01.0	038131501AD	SKODA	7.00365.06.0
035906265B	VOLKSWAGEN	7.02604.01.0	038131501AD	VOLKSWAGEN	7.00365.06.0
035906265C	VOLKSWAGEN	7.02604.01.0	038131501AF	AUDI	7.24809.16.0
036131503M	AUDI	7.22785.17.0	038131501AF	VOLKSWAGEN	7.24809.16.0
036131503M	SEAT	7.22785.17.0	038131501AG	VOLKSWAGEN	7.22477.10.0
036131503M	SKODA	7.22785.17.0	038131501AH	VOLKSWAGEN	7.22477.11.0
036131503M	VOLKSWAGEN	7.22785.17.0	038131501AL	AUDI	7.24809.20.0
036131503R	AUDI	7.28248.17.0	038131501AL	SEAT	7.24809.20.0
036131503R	SEAT	7.28248.17.0	038131501AL	SKODA	7.24809.20.0
036131503R	SKODA	7.28248.17.0	038131501AL	VOLKSWAGEN	7.24809.20.0
036131503R	VOLKSWAGEN	7.28248.17.0	038131501AM	SEAT	7.24809.55.0
036131503T	AUDI	7.28248.17.0	038131501AM	SKODA	7.24809.55.0
036131503T	SEAT	7.28248.17.0	038131501AM	VOLKSWAGEN	7.24809.55.0
036131503T	SKODA	7.28248.17.0	038131501AN	AUDI	7.24809.16.0
036131503T	VOLKSWAGEN	7.28248.17.0	038131501AN	SEAT	7.24809.16.0
0368	NGK	7.02604.75.0	038131501AN	SKODA	7.24809.16.0
036906088C	AUDI	7.08369.34.0	038131501AN	VOLKSWAGEN	7.24809.16.0
036906088C	VOLKSWAGEN	7.08369.34.0	038131501AQ	AUDI	7.24809.19.0
036906262A	VOLKSWAGEN	7.05271.77.0	038131501AQ	SEAT	7.24809.19.0
036906262C	VOLKSWAGEN	7.05271.77.0	038131501AQ	SKODA	7.24809.19.0
036906262H	AUDI	7.05270.99.0	038131501AQ	VOLKSWAGEN	7.24809.19.0
036906262H	SEAT	7.05270.99.0	038131501AR	SEAT	7.24809.30.0
036906262H	SKODA	7.05270.99.0	038131501AR	SKODA	7.24809.30.0
036906262H	VOLKSWAGEN	7.05270.99.0	038131501AR	VOLKSWAGEN	7.24809.30.0
036906262M	SEAT	7.05271.06.0	038131501AT	AUDI	7.24809.26.0
036906262M	VOLKSWAGEN	7.05271.06.0	038131501AT	SEAT	7.24809.26.0
036906262P	AUDI	7.05271.15.0	038131501AT	SKODA	7.24809.26.0
036906262P	SEAT	7.05271.15.0	038131501AT	VOLKSWAGEN	7.24809.26.0
036906262P	SKODA	7.05271.15.0	038131501BB	SEAT	7.22477.10.0
036906262P	VOLKSWAGEN	7.05271.15.0	038131501BB	SKODA	7.22477.10.0
036906262Q	SEAT	7.05271.06.0	038131501BB	VOLKSWAGEN	7.22477.10.0
036906262Q	VOLKSWAGEN	7.05271.06.0	038131501BC	VOLKSWAGEN	7.22477.11.0
036906265	AUDI	7.05271.03.0	038131501BF	AUDI	7.00365.06.0
036906265	SEAT	7.05271.03.0	038131501BF	SKODA	7.00365.06.0
036906265	SKODA	7.05271.03.0	038131501BF	VOLKSWAGEN	7.00365.06.0
036906265	VOLKSWAGEN	7.05271.03.0	038131501BH	AUDI	7.00365.06.0
036906265A	AUDI	7.05271.03.0	038131501BH	SKODA	7.00365.06.0
036906265A	SEAT	7.05271.03.0	038131501BH	VOLKSWAGEN	7.00365.06.0
036906265A	SKODA	7.05271.03.0	038131501C	VOLKSWAGEN	7.22477.10.0
036906265A	VOLKSWAGEN	7.05271.03.0	038131501D	VOLKSWAGEN	7.24809.19.0
036906265B	AUDI	7.05271.03.0	038131501E	VOLKSWAGEN	7.24809.17.0
036906265B	SEAT	7.05271.03.0	038131501G	AUDI	7.24809.19.0
036906265B	SKODA	7.05271.03.0	038131501G	SEAT	7.24809.19.0
036906265B	VOLKSWAGEN	7.05271.03.0	038131501G	VOLKSWAGEN	7.24809.19.0
036906265E	AUDI	7.05271.03.0	038131501H	AUDI	7.24809.26.0
036906265E	SEAT	7.05271.03.0	038131501H	VOLKSWAGEN	7.24809.26.0
036906265E	SKODA	7.05271.03.0	038131501J	VOLKSWAGEN	7.24809.20.0
036906265E	VOLKSWAGEN	7.05271.03.0	038131501M	SEAT	7.24809.30.0
036906265H	AUDI	7.05271.05.0	038131501M	SKODA	7.24809.30.0
037131351C	SKODA	7.22286.26.0	038131501M	VOLKSWAGEN	7.24809.30.0
037131351C	VOLKSWAGEN	7.22286.26.0	038131501N	VOLKSWAGEN	7.24809.64.0
037906265AB	AUDI	7.05270.88.0	038131501S	AUDI	7.24809.16.0
037906265AB	SEAT	7.05270.88.0	038131501S	VOLKSWAGEN	7.24809.16.0
037906265AB	SKODA	7.05270.88.0	038131501T	AUDI	7.24809.26.0
037906265AB	VOLKSWAGEN	7.05270.88.0	038131501T	VOLKSWAGEN	7.24809.26.0

NUMBERFINDER

REF-No.			REF-No.		
0385	NGK	7.05271.14.0	03G131501D	SKODA	7.00678.06.0
0387	NGK	7.02604.10.0	03G131501D	VOLKSWAGEN	7.00678.06.0
038906088A	AUDI	7.08369.66.0	03G131501J	AUDI	7.10334.10.0
038906088A	VOLKSWAGEN	7.08369.66.0	03G131501M	SEAT	7.24809.32.0
038906088B	VOLKSWAGEN	7.08369.72.0	03G131501M	SKODA	7.24809.32.0
038906088C	AUDI	7.08369.40.0	03G131501M	VOLKSWAGEN	7.24809.32.0
038906088C	SKODA	7.08369.40.0	03G131501N	AUDI	7.00678.06.0
038906088C	VOLKSWAGEN	7.08369.40.0	03G131501N	SEAT	7.00678.06.0
038906088D	AUDI	7.08369.42.0	03G131501N	SKODA	7.00678.06.0
038906088E	AUDI	7.08369.40.0	03G131501N	VOLKSWAGEN	7.00678.06.0
038906088E	VOLKSWAGEN	7.08369.40.0	03G131501P	AUDI	7.10334.00.0
0390	NGK	7.05271.14.0	03G131501P	SEAT	7.10334.00.0
0391	NGK	7.05271.21.0	03G131501P	SKODA	7.10334.00.0
0392	NGK	7.05271.02.0	03G131501P	VOLKSWAGEN	7.10334.00.0
0395	NGK	7.05270.37.0	03G131501Q	AUDI	7.10334.10.0
0399	NGK	7.05271.21.0	03G131501R	AUDI	7.10334.10.0
039906265	VOLKSWAGEN	7.02604.01.0	03G131502	AUDI	7.00907.03.0
03C131503B	AUDI	7.10334.04.0	03G131502	SEAT	7.00907.03.0
03C131503B	SKODA	7.10334.04.0	03G131502	SKODA	7.00907.03.0
03C131503B	VOLKSWAGEN	7.10334.04.0	03G131502	VOLKSWAGEN	7.00907.03.0
03C906262AA	AUDI	7.05271.18.0	03G131502B	AUDI	7.00907.03.0
03C906262AA	SEAT	7.05271.18.0	03G131502B	SEAT	7.00907.03.0
03C906262AA	VOLKSWAGEN	7.05271.18.0	03G131502B	SKODA	7.00907.03.0
03C906262AG	VOLKSWAGEN	7.05271.12.0	03G131502B	VOLKSWAGEN	7.00907.03.0
03C906262AH	AUDI	7.05271.12.0	03G906051A	AUDI	7.11492.02.0
03C906262AH	SEAT	7.05271.12.0	03G906051A	SEAT	7.11492.02.0
03C906262AH	SKODA	7.05271.12.0	03G906051A	SKODA	7.11492.02.0
03C906262AH	VOLKSWAGEN	7.05271.12.0	03G906051A	VOLKSWAGEN	7.11492.02.0
03C906262AK	AUDI	7.05271.12.0	03G906051G	AUDI	7.11492.00.0
03C906262AK	SKODA	7.05271.12.0	03G906051G	SEAT	7.11492.00.0
03C906262AK	VOLKSWAGEN	7.05271.12.0	03G906051G	SKODA	7.11492.00.0
03C906262AL	AUDI	7.05271.12.0	03G906051G	VOLKSWAGEN	7.11492.00.0
03C906262AL	VOLKSWAGEN	7.05271.12.0	03G906088	VOLKSWAGEN	7.08369.84.0
03C906262BK	VOLKSWAGEN	7.05271.12.0	03G906088A	AUDI	7.08369.00.0
03C906262BM	VOLKSWAGEN	7.05271.12.0	03G906088A	SEAT	7.08369.00.0
03C906262F	VOLKSWAGEN	7.05271.12.0	03G906088A	SKODA	7.08369.00.0
03C906262G	VOLKSWAGEN	7.05271.12.0	03G906088A	VOLKSWAGEN	7.08369.00.0
03C906262H	VOLKSWAGEN	7.05271.12.0	03G906088AB	SEAT	7.11020.07.0
03C906262J	SKODA	7.05271.12.0	03G906088AB	SKODA	7.11020.07.0
03C906262J	VOLKSWAGEN	7.05271.12.0	03G906088AB	VOLKSWAGEN	7.11020.07.0
03C906262K	SKODA	7.05271.12.0	03G906088AC	SEAT	7.08369.53.0
03C906262K	VOLKSWAGEN	7.05271.12.0	03G906088AC	SKODA	7.08369.53.0
03C906262L	SKODA	7.05271.12.0	03G906088AC	VOLKSWAGEN	7.08369.53.0
03C906262L	VOLKSWAGEN	7.05271.12.0	03G906088AF	AUDI	7.08369.11.0
03C906262M	AUDI	7.05271.18.0	03G906088AF	SEAT	7.08369.11.0
03C906262M	SEAT	7.05271.18.0	03G906088AF	SKODA	7.08369.11.0
03C906262M	SKODA	7.05271.18.0	03G906088AF	VOLKSWAGEN	7.08369.11.0
03C906262M	VOLKSWAGEN	7.05271.18.0	03G906088AG	AUDI	7.08369.22.0
03D131503B	SEAT	7.22785.16.0	03G906088AK	AUDI	7.08369.40.0
03D131503B	VOLKSWAGEN	7.22785.16.0	03G906088AK	SKODA	7.08369.40.0
03D131503D	SEAT	7.22785.16.0	03G906088AK	VOLKSWAGEN	7.08369.40.0
03D131503D	VOLKSWAGEN	7.22785.16.0	03G906088AM	AUDI	7.08369.00.0
03E906262	AUDI	7.05271.23.0	03G906088AM	SEAT	7.08369.00.0
03E906262	SEAT	7.05271.23.0	03G906088AM	SKODA	7.08369.00.0
03E906262	SKODA	7.05271.23.0	03G906088AM	VOLKSWAGEN	7.08369.00.0
03E906262	VOLKSWAGEN	7.05271.23.0	03G906088AN	AUDI	7.08369.00.0
03E906262B	AUDI	7.05271.20.0	03G906088AN	SEAT	7.08369.00.0
03E906262B	SEAT	7.05271.20.0	03G906088AN	SKODA	7.08369.00.0
03E906262B	SKODA	7.05271.20.0	03G906088AN	VOLKSWAGEN	7.08369.00.0
03E906262B	VOLKSWAGEN	7.05271.20.0	03G906088AP	AUDI	7.08369.65.0
03G131501	AUDI	7.10334.00.0	03G906088AP	VOLKSWAGEN	7.08369.65.0
03G131501	SEAT	7.10334.00.0	03G906088AQ	VOLKSWAGEN	7.08369.36.0
03G131501	SKODA	7.10334.00.0	03G906088AR	VOLKSWAGEN	7.08369.33.0
03G131501	VOLKSWAGEN	7.10334.00.0	03G906088AS	VOLKSWAGEN	7.08369.63.0
03G131501A	SEAT	7.24809.32.0	03G906088AT	AUDI	7.08369.00.0
03G131501A	SKODA	7.24809.32.0	03G906088AT	SEAT	7.08369.00.0
03G131501A	VOLKSWAGEN	7.24809.32.0	03G906088AT	SKODA	7.08369.00.0
03G131501D	AUDI	7.00678.06.0	03G906088AT	VOLKSWAGEN	7.08369.00.0
03G131501D	SEAT	7.00678.06.0	03G906088B	VOLKSWAGEN	7.08369.07.0

REF-No.		 PIERBURG	REF-No.		 PIERBURG
03G906088BA	AUDI	7.08369.22.0	03L131512AS	VOLKSWAGEN	7.09720.01.0
03G906088D	AUDI	7.08369.03.0	03L131512AT	AUDI	7.09720.00.0
03G906088D	SEAT	7.08369.03.0	03L131512AT	SEAT	7.09720.00.0
03G906088D	SKODA	7.08369.03.0	03L131512AT	SKODA	7.09720.00.0
03G906088D	VOLKSWAGEN	7.08369.03.0	03L131512AT	VOLKSWAGEN	7.09720.00.0
03G906088F	SEAT	7.08369.08.0	03L131512BB	AUDI	7.09720.00.0
03G906088F	VOLKSWAGEN	7.08369.08.0	03L131512BB	VOLKSWAGEN	7.09720.00.0
03G906088J	AUDI	7.08369.00.0	03L131512BG	AUDI	7.09720.03.0
03G906088J	SEAT	7.08369.00.0	03L131512BH	AUDI	7.09720.01.0
03G906088J	SKODA	7.08369.00.0	03L131512BH	SEAT	7.09720.01.0
03G906088J	VOLKSWAGEN	7.08369.00.0	03L131512BH	SKODA	7.09720.01.0
03G906088K	AUDI	7.08369.02.0	03L131512BH	VOLKSWAGEN	7.09720.01.0
03G906088K	SEAT	7.08369.02.0	03L131512BJ	AUDI	7.09720.00.0
03G906088K	SKODA	7.08369.02.0	03L131512BJ	SEAT	7.09720.00.0
03G906088K	VOLKSWAGEN	7.08369.02.0	03L131512BJ	SKODA	7.09720.00.0
03G906088L	SEAT	7.08369.43.0	03L131512BJ	VOLKSWAGEN	7.09720.00.0
03G906088L	VOLKSWAGEN	7.08369.43.0	03L131512BL	AUDI	7.09720.00.0
03G906088N	VOLKSWAGEN	7.08369.36.0	03L131512BL	SEAT	7.09720.00.0
03G906088S	VOLKSWAGEN	7.08369.63.0	03L131512BL	VOLKSWAGEN	7.09720.00.0
03H906262B	VOLKSWAGEN	7.05271.12.0	03L131512BM	VOLKSWAGEN	7.09720.04.0
03K906088A	VOLKSWAGEN	7.08369.24.0	03L131512BN	VOLKSWAGEN	7.24809.99.0
03K906088B	VOLKSWAGEN	7.08369.20.0	03L131512BP	VOLKSWAGEN	7.11237.06.0
03L115512	VOLKSWAGEN	7.02756.07.0	03L131512BQ	AUDI	7.09720.03.0
03L115512A	VOLKSWAGEN	7.02756.07.0	03L131512CB	VOLKSWAGEN	7.09720.04.0
03L115512C	VOLKSWAGEN	7.02756.07.0	03L131512CC	VOLKSWAGEN	7.09720.04.0
03L115512D	VOLKSWAGEN	7.02756.07.0	03L131512CD	AUDI	7.09720.03.0
03L131477	VOLKSWAGEN	7.03196.09.0	03L131512CD	SEAT	7.09720.03.0
03L131477A	VOLKSWAGEN	7.03196.09.0	03L131512CE	AUDI	7.09720.01.0
03L131501	VOLKSWAGEN	7.01493.07.0	03L131512CE	SEAT	7.09720.01.0
03L131501AA	VOLKSWAGEN	7.24809.93.0	03L131512CE	SKODA	7.09720.01.0
03L131501C	AUDI	7.10334.00.0	03L131512CE	VOLKSWAGEN	7.09720.01.0
03L131501C	SEAT	7.10334.00.0	03L131512CF	AUDI	7.09720.00.0
03L131501C	SKODA	7.10334.00.0	03L131512CF	SEAT	7.09720.00.0
03L131501C	VOLKSWAGEN	7.10334.00.0	03L131512CF	SKODA	7.09720.00.0
03L131501D	AUDI	7.10334.00.0	03L131512CF	VOLKSWAGEN	7.09720.00.0
03L131501D	SEAT	7.10334.00.0	03L131512CG	AUDI	7.09720.01.0
03L131501D	SKODA	7.10334.00.0	03L131512CG	SEAT	7.09720.01.0
03L131501D	VOLKSWAGEN	7.10334.00.0	03L131512CG	SKODA	7.09720.01.0
03L131501E	AUDI	7.10334.00.0	03L131512CG	VOLKSWAGEN	7.09720.01.0
03L131501E	SEAT	7.10334.00.0	03L131512CH	AUDI	7.09720.00.0
03L131501E	SKODA	7.10334.00.0	03L131512CH	SEAT	7.09720.00.0
03L131501E	VOLKSWAGEN	7.10334.00.0	03L131512CH	VOLKSWAGEN	7.09720.00.0
03L131501F	VOLKSWAGEN	7.01493.07.0	03L131512DJ	VOLKSWAGEN	7.11237.06.0
03L131501G	AUDI	7.10334.00.0	03L131512DK	VOLKSWAGEN	7.09720.04.0
03L131501G	SEAT	7.10334.00.0	03L131512DL	VOLKSWAGEN	7.24809.99.0
03L131501G	SKODA	7.10334.00.0	03L131512DM	VOLKSWAGEN	7.11237.06.0
03L131501G	VOLKSWAGEN	7.10334.00.0	03L131512DN	AUDI	7.09720.03.0
03L131501H	VOLKSWAGEN	7.03196.09.0	03L131512DP	AUDI	7.09720.01.0
03L131501K	AUDI	7.10334.00.0	03L131512DP	SEAT	7.09720.01.0
03L131501K	SEAT	7.10334.00.0	03L131512DP	SKODA	7.09720.01.0
03L131501K	SKODA	7.10334.00.0	03L131512DP	VOLKSWAGEN	7.09720.01.0
03L131501K	VOLKSWAGEN	7.10334.00.0	03L131512DQ	AUDI	7.09720.00.0
03L131501L	VOLKSWAGEN	7.24809.93.0	03L131512DQ	SEAT	7.09720.00.0
03L131501Q	VOLKSWAGEN	7.03196.09.0	03L131512DQ	SKODA	7.09720.00.0
03L131501R	VOLKSWAGEN	7.24809.93.0	03L131512DQ	VOLKSWAGEN	7.09720.00.0
03L131501S	VOLKSWAGEN	7.24809.93.0	03L131512DS	VOLKSWAGEN	7.09720.04.0
03L131501T	VOLKSWAGEN	7.03196.09.0	03L131512DT	AUDI	7.09720.03.0
03L131512AN	AUDI	7.09720.01.0	03L131512M	AUDI	7.09720.01.0
03L131512AN	SEAT	7.09720.01.0	03L131512M	SEAT	7.09720.01.0
03L131512AN	SKODA	7.09720.01.0	03L131512M	SKODA	7.09720.01.0
03L131512AN	VOLKSWAGEN	7.09720.01.0	03L131512M	VOLKSWAGEN	7.09720.01.0
03L131512AP	AUDI	7.09720.00.0	03L131512N	VOLKSWAGEN	7.09720.00.0
03L131512AP	SKODA	7.09720.00.0	03L131512Q	VOLKSWAGEN	7.09720.04.0
03L131512AP	VOLKSWAGEN	7.09720.00.0	03L131527AX	AUDI	7.09720.00.0
03L131512AQ	VOLKSWAGEN	7.24809.99.0	03L131527AX	SEAT	7.09720.00.0
03L131512AR	VOLKSWAGEN	7.11237.06.0	03L131527AX	SKODA	7.09720.00.0
03L131512AS	AUDI	7.09720.01.0	03L131527AX	VOLKSWAGEN	7.09720.00.0
03L131512AS	SEAT	7.09720.01.0	03L906051B	AUDI	7.11492.03.0
03L131512AS	SKODA	7.09720.01.0	03L906051B	SEAT	7.11492.03.0

REF-No.			REF-No.		
03L906051B	SKODA	7.11492.03.0	03L906088JN	VOLKSWAGEN	7.08369.92.0
03L906051B	VOLKSWAGEN	7.11492.03.0	03L906088M	AUDI	7.08369.04.0
03L906051D	AUDI	7.11492.03.0	03L906088M	SEAT	7.08369.04.0
03L906051D	SEAT	7.11492.03.0	03L906088M	SKODA	7.08369.04.0
03L906051D	SKODA	7.11492.03.0	03L906088M	VOLKSWAGEN	7.08369.04.0
03L906051D	VOLKSWAGEN	7.11492.03.0	03L906088N	AUDI	7.08369.01.0
03L906088AE	VOLKSWAGEN	7.11020.20.0	03L906088N	SEAT	7.08369.01.0
03L906088AF	VOLKSWAGEN	7.11020.19.0	03L906088N	SKODA	7.08369.01.0
03L906088AJ	AUDI	7.08369.01.0	03L906088N	VOLKSWAGEN	7.08369.01.0
03L906088AJ	SEAT	7.08369.01.0	03L906088P	AUDI	7.08369.09.0
03L906088AJ	SKODA	7.08369.01.0	03L906088P	SEAT	7.08369.09.0
03L906088AJ	VOLKSWAGEN	7.08369.01.0	03L906088P	SKODA	7.08369.09.0
03L906088AK	AUDI	7.08369.04.0	03L906088P	VOLKSWAGEN	7.08369.09.0
03L906088AK	SEAT	7.08369.04.0	03L906088T	VOLKSWAGEN	7.08369.47.0
03L906088AK	SKODA	7.08369.04.0	03N906051B	AUDI	7.11492.03.0
03L906088AK	VOLKSWAGEN	7.08369.04.0	03N906051B	SEAT	7.11492.03.0
03L906088AT	VOLKSWAGEN	7.08369.19.0	03N906051B	SKODA	7.11492.03.0
03L906088BA	VOLKSWAGEN	7.08369.56.0	03N906051B	VOLKSWAGEN	7.11492.03.0
03L906088BN	VOLKSWAGEN	7.11020.06.0	03P131512B	SEAT	7.09720.02.0
03L906088BP	VOLKSWAGEN	7.08369.21.0	03P131512B	SKODA	7.09720.02.0
03L906088BQ	VOLKSWAGEN	7.08369.25.0	03P131512B	VOLKSWAGEN	7.09720.02.0
03L906088BS	AUDI	7.08369.00.0	03P131512C	SEAT	7.09720.02.0
03L906088BS	SEAT	7.08369.00.0	03P131512C	SKODA	7.09720.02.0
03L906088BS	SKODA	7.08369.00.0	03P131512C	VOLKSWAGEN	7.09720.02.0
03L906088BS	VOLKSWAGEN	7.08369.00.0	03P131512D	SEAT	7.09720.02.0
03L906088C	VOLKSWAGEN	7.08369.56.0	03P131512D	SKODA	7.09720.02.0
03L906088CC	AUDI	7.08369.04.0	03P131512D	VOLKSWAGEN	7.09720.02.0
03L906088CC	SEAT	7.08369.04.0	03P131512E	SEAT	7.09720.02.0
03L906088CC	SKODA	7.08369.04.0	03P131512E	SKODA	7.09720.02.0
03L906088CC	VOLKSWAGEN	7.08369.04.0	03P131512E	VOLKSWAGEN	7.09720.02.0
03L906088CE	VOLKSWAGEN	7.08369.07.0	03P906088A	SEAT	7.08369.83.0
03L906088CH	AUDI	7.08369.26.0	03P906088A	SKODA	7.08369.83.0
03L906088CH	SEAT	7.08369.26.0	03P906088A	VOLKSWAGEN	7.08369.83.0
03L906088CH	SKODA	7.08369.26.0	03P906088C	SEAT	7.08369.50.0
03L906088CH	VOLKSWAGEN	7.08369.26.0	03P906088C	SKODA	7.08369.50.0
03L906088D	AUDI	7.08369.14.0	03P906088C	VOLKSWAGEN	7.08369.50.0
03L906088D	SEAT	7.08369.14.0	03P906088D	SEAT	7.08369.37.0
03L906088D	VOLKSWAGEN	7.08369.14.0	03P906088D	SKODA	7.08369.37.0
03L906088DC	VOLKSWAGEN	7.08369.93.0	03P906088D	VOLKSWAGEN	7.08369.37.0
03L906088DF	VOLKSWAGEN	7.08369.24.0	03P906088E	SEAT	7.08369.50.0
03L906088DH	SKODA	7.08369.48.0	03P906088E	SKODA	7.08369.50.0
03L906088DH	VOLKSWAGEN	7.08369.48.0	03P906088E	VOLKSWAGEN	7.08369.50.0
03L906088DM	VOLKSWAGEN	7.08369.78.0	0400	NGK	7.05270.12.0
03L906088DN	VOLKSWAGEN	7.08369.64.0	0409	NGK	7.02604.47.0
03L906088DP	VOLKSWAGEN	7.08369.24.0	04120012	DEUTZ	7.04256.35.0
03L906088E	AUDI	7.08369.16.0	04120024	DEUTZ	7.04257.19.0
03L906088F	VOLKSWAGEN	7.08369.52.0	04120377	DEUTZ	7.04039.13.0
03L906088FB	VOLKSWAGEN	7.08369.92.0	04120412	DEUTZ	7.04256.35.0
03L906088FC	VOLKSWAGEN	7.11020.06.0	04120424	DEUTZ	7.04257.19.0
03L906088FE	VOLKSWAGEN	7.11020.20.0	04121248	DEUTZ	7.04039.13.0
03L906088FF	VOLKSWAGEN	7.08369.24.0	04123082	DEUTZ	7.04038.08.0
03L906088FG	AUDI	7.08369.09.0	04123084	DEUTZ	7.04039.13.0
03L906088FG	SEAT	7.08369.09.0	04123212	DEUTZ	7.04256.35.0
03L906088FG	SKODA	7.08369.09.0	04124516	DEUTZ	7.04402.02.0
03L906088FG	VOLKSWAGEN	7.08369.09.0	04124767	DEUTZ	7.04402.02.0
03L906088FQ	VOLKSWAGEN	7.08369.59.0	04125024	DEUTZ	7.04038.08.0
03L906088HG	VOLKSWAGEN	7.08369.24.0	04125434	DEUTZ	7.04371.07.0
03L906088HH	VOLKSWAGEN	7.08369.20.0	04130812	DEUTZ	7.04256.36.0
03L906088HJ	VOLKSWAGEN	7.08369.21.0	04130824	DEUTZ	7.04257.20.0
03L906088HK	VOLKSWAGEN	7.08369.25.0	04133012	DEUTZ	7.04433.02.0
03L906088HL	AUDI	7.08369.11.0	04133023	DEUTZ	7.04256.36.0
03L906088HL	SKODA	7.08369.11.0	04134412	DEUTZ	7.04256.36.0
03L906088HM	VOLKSWAGEN	7.08369.07.0	04134424	DEUTZ	7.04257.20.0
03L906088J	AUDI	7.08369.01.0	0415	NGK	7.05270.54.0
03L906088J	SEAT	7.08369.01.0	0416	NGK	7.02604.31.0
03L906088J	SKODA	7.08369.01.0	0416260	BMW	7.02604.25.0
03L906088J	VOLKSWAGEN	7.08369.01.0	0418078	BMW	7.02604.41.0
03L906088JK	VOLKSWAGEN	7.08369.59.0	0420	NGK	7.05270.34.0
03L906088JL	VOLKSWAGEN	7.08369.93.0	04257888	DEUTZ	7.01268.03.0

REF-No.		 PIERBURG	REF-No.		 PIERBURG
0426	NGK	7.05271.04.0	04627465AD	CHRYSLER	7.04739.09.0
04265310	DEUTZ	7.03379.03.0	04627465AE	CHRYSLER	7.04739.09.0
0427	NGK	7.02604.31.0	04627465AF	CHRYSLER	7.04739.09.0
0431	NGK	7.05270.34.0	04627465AG	CHRYSLER	7.04739.09.0
0435	NGK	7.05271.05.0	0468	NGK	7.02604.10.0
0438	NGK	7.02604.21.0	0470	NGK	7.02604.62.0
0442	NGK	7.05270.33.0	0472	NGK	7.05270.48.0
0445	NGK	7.05270.38.0	0474	NGK	7.05271.05.0
04509500	DEUTZ	7.03527.12.0	0478	NGK	7.02604.49.0
04509502	DEUTZ	7.04382.09.0	047906265B	AUDI	7.05271.02.0
04510628	DEUTZ	7.04382.09.0	047906265B	SEAT	7.05271.02.0
04512727	DEUTZ	7.04788.06.0	047906265B	SKODA	7.05271.02.0
045131501	AUDI	7.24809.57.0	047906265B	VOLKSWAGEN	7.05271.02.0
045131501C	AUDI	7.24809.17.0	047906265C	AUDI	7.05271.02.0
045131501C	SEAT	7.24809.17.0	047906265C	SEAT	7.05271.02.0
045131501C	VOLKSWAGEN	7.24809.17.0	047906265C	SKODA	7.05271.02.0
045131501D	AUDI	7.24809.57.0	047906265C	VOLKSWAGEN	7.05271.02.0
045131501D	SEAT	7.24809.57.0	0480	NGK	7.05270.54.0
045131501D	VOLKSWAGEN	7.24809.57.0	0485	NGK	7.05271.55.0
045131501F	AUDI	7.24809.31.0	0486	NGK	7.02604.37.0
045131501F	SEAT	7.24809.31.0	0489	NGK	7.02604.51.0
045131501F	SKODA	7.24809.31.0	04891832AA	CHRYSLER	7.28247.13.0
045131501F	VOLKSWAGEN	7.24809.31.0	04891832AB	CHRYSLER	7.28247.13.0
045131501K	AUDI	7.24809.31.0	0491	NGK	7.05271.06.0
045131501K	SEAT	7.24809.31.0	04914700	DEUTZ	7.04723.10.0
045131501K	SKODA	7.24809.31.0	04915700	DEUTZ	7.04787.12.0
045131501K	VOLKSWAGEN	7.24809.31.0	04915797	DEUTZ	7.04723.10.0
045131501L	AUDI	7.24809.17.0	04915830	DEUTZ	7.04787.12.0
045131501L	SEAT	7.24809.17.0	04915962	DEUTZ	7.04787.12.0
045131501L	SKODA	7.24809.17.0	0492	NGK	7.05270.39.0
045131501L	VOLKSWAGEN	7.24809.17.0	0493	NGK	7.05270.96.0
04513698	DEUTZ	7.05506.14.0	04E131097L	AUDI	7.01510.91.0
045139N	DASIS VERTRIEBS GMBH	7.22785.18.0	04E131097P	VOLKSWAGEN	7.01510.91.0
04514020	DEUTZ	7.04448.18.0	04E131097Q	AUDI	7.01510.91.0
045142N	DASIS VERTRIEBS GMBH	7.24809.17.0	04E131333A	AUDI	7.03635.37.0
04514444	DEUTZ	7.05506.14.0	04E131333A	SEAT	7.03635.37.0
04514700	DEUTZ	7.04784.06.0	04E131333A	VOLKSWAGEN	7.03635.37.0
04514702	DEUTZ	7.05107.12.0	04E131333B	AUDI	7.03635.38.0
04516118	DEUTZ	7.05107.12.0	04E959231	AUDI	7.03635.39.0
04516121	DEUTZ	7.04448.18.0	04E959231	VOLKSWAGEN	7.03635.39.0
04516128	DEUTZ	7.04784.06.0	04E959231A	AUDI	7.03635.39.0
04516172	DEUTZ	7.05107.12.0	04E959231A	VOLKSWAGEN	7.03635.39.0
04516210	DEUTZ	7.04788.06.0	04E959231B	AUDI	7.03635.39.0
04516372	DEUTZ	7.04448.18.0	04E959231B	VOLKSWAGEN	7.03635.39.0
045165N	DASIS VERTRIEBS GMBH	7.22477.11.0	04E959231C	AUDI	7.03635.39.0
04516696	DEUTZ	7.05506.14.0	04E959231C	VOLKSWAGEN	7.03635.39.0
045167N	DASIS VERTRIEBS GMBH	7.24809.57.0	04E959253	VOLKSWAGEN	7.03635.37.0
04516980	DEUTZ	7.04784.06.0	04E959253A	VOLKSWAGEN	7.03635.37.0
0452	NGK	7.05271.07.0	04E959253B	VOLKSWAGEN	7.03635.39.0
045906088C	SEAT	7.11020.07.0	04E959253D	VOLKSWAGEN	7.03635.39.0
045906088C	SKODA	7.11020.07.0	04L131501C	VOLKSWAGEN	7.10334.02.0
045906088C	VOLKSWAGEN	7.11020.07.0	04L131501M	VOLKSWAGEN	7.10334.02.0
045906088D	SEAT	7.11020.02.0	04L131512BN	VOLKSWAGEN	7.04999.35.0
045906088D	SKODA	7.11020.02.0	04L131512CF	VOLKSWAGEN	7.04999.35.0
045906088D	VOLKSWAGEN	7.11020.02.0	04L131512CG	VOLKSWAGEN	7.04999.35.0
045906088F	AUDI	7.11020.03.0	04L131512T	VOLKSWAGEN	7.04999.35.0
045906088F	SEAT	7.11020.03.0	04L906051AB	AUDI	7.11492.05.0
045906088F	SKODA	7.11020.03.0	04L906051AB	SEAT	7.11492.05.0
045906088F	VOLKSWAGEN	7.11020.03.0	04L906051AB	SKODA	7.11492.05.0
045906088G	SEAT	7.11020.07.0	04L906051AB	VOLKSWAGEN	7.11492.05.0
045906088G	SKODA	7.11020.07.0	04L906051F	AUDI	7.11492.05.0
045906088G	VOLKSWAGEN	7.11020.07.0	04L906051F	SEAT	7.11492.05.0
045906088H	SEAT	7.08369.86.0	04L906051F	SKODA	7.11492.05.0
045906088H	SKODA	7.08369.86.0	04L906051F	VOLKSWAGEN	7.11492.05.0
045906088H	VOLKSWAGEN	7.08369.86.0	04L906051G	AUDI	7.11492.05.0
045906088J	SEAT	7.08369.86.0	04L906051G	SEAT	7.11492.05.0
045906088J	SKODA	7.08369.86.0	04L906051G	SKODA	7.11492.05.0
045906088J	VOLKSWAGEN	7.08369.86.0	04L906051G	VOLKSWAGEN	7.11492.05.0
0460	NGK	7.05270.88.0	04L906051L	AUDI	7.11492.05.0

NUMBERFINDER

REF-No.		 PIERBURG	REF-No.		 PIERBURG
04L906051L	SEAT	7.11492.05.0	05149027AA	DODGE	7.05270.21.0
04L906051L	SKODA	7.11492.05.0	05149027AA	JEEP	7.05270.21.0
04L906051L	VOLKSWAGEN	7.11492.05.0	05149277AB	CHRYSLER	7.11190.01.0
04L906088	AUDI	7.08369.81.0	05149277AB	DODGE	7.11190.01.0
04L906088	SEAT	7.08369.81.0	05149277AB	JEEP	7.11190.01.0
04L906088	SKODA	7.08369.81.0	05166555AA	CHRYSLER	7.00632.13.0
04L906088	VOLKSWAGEN	7.08369.81.0	05166555AB	CHRYSLER	7.08369.74.0
04L906088AE	AUDI	7.08369.81.0	051906265C	VOLKSWAGEN	7.02604.01.0
04L906088AE	SEAT	7.08369.81.0	051906265E	AUDI	7.02604.01.0
04L906088AE	SKODA	7.08369.81.0	051906265E	SEAT	7.02604.01.0
04L906088AE	VOLKSWAGEN	7.08369.81.0	051906265E	VOLKSWAGEN	7.02604.01.0
04L906088B	AUDI	7.08369.79.0	055025N	DASIS VERTRIEBS GMBH	7.00450.09.0
04L906088B	SEAT	7.08369.79.0	055566086	GENERAL MOTORS	7.08369.74.0
04L906088B	SKODA	7.08369.79.0	055566621	GENERAL MOTORS	7.08369.75.0
04L906088B	VOLKSWAGEN	7.08369.79.0	056161440	PERKINS	7.04209.06.0
04L906088BD	AUDI	7.11020.17.0	05653	OSSCA	7.22738.08.0
04L906088BD	SEAT	7.11020.17.0	057131501C	AUDI	7.00789.10.0
04L906088BD	SKODA	7.11020.17.0	057131501C	VOLKSWAGEN	7.00789.10.0
04L906088BD	VOLKSWAGEN	7.11020.17.0	057131501D	AUDI	7.00789.10.0
04L906088BF	AUDI	7.11020.22.0	057131501D	VOLKSWAGEN	7.00789.10.0
04L906088BF	SEAT	7.11020.22.0	057131501E	AUDI	7.00789.10.0
04L906088BF	SKODA	7.11020.22.0	057131501E	VOLKSWAGEN	7.00789.10.0
04L906088BF	VOLKSWAGEN	7.11020.22.0	057131501F	AUDI	7.00789.10.0
04L906088CK	AUDI	7.11020.21.0	057131501F	VOLKSWAGEN	7.00789.10.0
04L906088DA	AUDI	7.08369.95.0	057131501G	AUDI	7.00789.10.0
04L906088DA	SEAT	7.08369.95.0	057131501G	VOLKSWAGEN	7.00789.10.0
04L906088DA	SKODA	7.08369.95.0	0580000010	BOSCH	7.04389.00.0
04L906088DA	VOLKSWAGEN	7.08369.95.0	0580000011	BOSCH	7.04389.00.0
04L906088DH	AUDI	7.11020.23.0	0580000017	BOSCH	7.04389.04.0
04L906088DH	SEAT	7.11020.23.0	0580000018	BOSCH	7.04389.04.0
04L906088DH	SKODA	7.11020.23.0	0580000020	BOSCH	7.04389.05.0
04L906088DH	VOLKSWAGEN	7.11020.23.0	0580000021	BOSCH	7.04389.05.0
04L906088DQ	AUDI	7.08369.81.0	0580000025	BOSCH	7.04389.02.0
04L906088DQ	SEAT	7.08369.81.0	0580000026	BOSCH	7.04389.02.0
04L906088DQ	SKODA	7.08369.81.0	0580000032	BOSCH	7.04389.06.0
04L906088DQ	VOLKSWAGEN	7.08369.81.0	0580000033	BOSCH	7.04389.06.0
04L906088DR	AUDI	7.11020.21.0	0580000036	BOSCH	7.04389.09.0
04L906088E	AUDI	7.08369.82.0	0580000037	BOSCH	7.04389.09.0
04L906088E	SEAT	7.08369.82.0	0580000040	BOSCH	7.04389.07.0
04L906088E	SKODA	7.08369.82.0	0580000041	BOSCH	7.04389.07.0
04L906088E	VOLKSWAGEN	7.08369.82.0	0580000042	BOSCH	7.04389.08.0
04L906088HT	AUDI	7.08369.81.0	0580000043	BOSCH	7.04389.08.0
04L906088HT	SEAT	7.08369.81.0	0580000044	BOSCH	7.04389.09.0
04L906088HT	SKODA	7.08369.81.0	0580000045	BOSCH	7.04389.09.0
04L906088HT	VOLKSWAGEN	7.08369.81.0	058131101	AUDI	7.22560.42.0
04L906088K	AUDI	7.11020.18.0	058131101	VOLKSWAGEN	7.22560.42.0
04L906088K	SEAT	7.11020.18.0	058131101B	AUDI	7.22560.42.0
04L906088K	SKODA	7.11020.18.0	058131101B	VOLKSWAGEN	7.22560.42.0
04L906088K	VOLKSWAGEN	7.11020.18.0	058906265B	AUDI	7.05271.21.0
04L919529D	AUDI	7.11020.26.0	058906265B	SEAT	7.05271.21.0
04L919529D	SEAT	7.11020.26.0	058906265B	SKODA	7.05271.21.0
04L919529D	SKODA	7.11020.26.0	058906265B	VOLKSWAGEN	7.05271.21.0
04L919529D	VOLKSWAGEN	7.11020.26.0	059131501C	AUDI	7.01782.07.0
04L919529E	AUDI	7.11020.31.0	059131501C	VOLKSWAGEN	7.01782.07.0
041131512TX	VOLKSWAGEN	7.04999.35.0	059131501D	AUDI	7.01782.07.0
05.16.009	TRUCKTEC	7.22841.08.0	059131501D	VOLKSWAGEN	7.01782.07.0
	FAHRZEUGTEILE GM		059131501H	AUDI	7.01782.07.0
05035213AA	CHRYSLER	7.11190.04.0	059131501H	VOLKSWAGEN	7.01782.07.0
05035213AA	DODGE	7.11190.04.0	059131502B	AUDI	7.02132.07.0
05035213AA	JEEP	7.11190.04.0	059131502B	VOLKSWAGEN	7.02132.07.0
05035213AA	LANCIA	7.11190.04.0	059131502G	AUDI	7.02132.07.0
05066800AA	CHRYSLER	7.28270.14.0	059131502G	VOLKSWAGEN	7.02132.07.0
05066800AB	CHRYSLER	7.28270.14.0	059131503H	AUDI	7.00309.07.0
050906265	VOLKSWAGEN	7.02604.01.0	059131503H	VOLKSWAGEN	7.00309.07.0
05096234AA	CHRYSLER	7.28270.14.0	059131515AD	AUDI	7.01106.38.0
05098830AA	CHRYSLER	7.04389.00.0	059131515BP	AUDI	7.01106.38.0
05146181AA	DODGE	7.11190.03.0	059131515CB	AUDI	7.01106.38.0
05146181AA	FIAT	7.11190.03.0	059131515CC	AUDI	7.01106.38.0
05146223AA	JEEP	7.11020.09.0	059131515CC	VOLKSWAGEN	7.01106.38.0

REF-No.		 PIERBURG	REF-No.		 PIERBURG
059131515D	AUDI	7.01106.38.0	06A131351E	SEAT	7.22778.79.0
059131515ET	AUDI	7.01106.38.0	06A131351E	VOLKSWAGEN	7.22778.79.0
059131515ET	VOLKSWAGEN	7.01106.38.0	06A131351F	AUDI	7.22778.96.0
059131515M	AUDI	7.01106.38.0	06A131351F	SEAT	7.22778.96.0
059131515R	AUDI	7.01106.38.0	06A131351F	SKODA	7.22778.96.0
059131515R	VOLKSWAGEN	7.01106.38.0	06A131351F	VOLKSWAGEN	7.22778.96.0
059906051A	AUDI	7.11190.02.0	06A131351H	AUDI	7.22286.26.0
059906051A	SEAT	7.11190.02.0	06A131351H	SEAT	7.22286.26.0
059906051A	SKODA	7.11190.02.0	06A131351H	VOLKSWAGEN	7.22286.26.0
059906051A	VOLKSWAGEN	7.11190.02.0	06A131351J	AUDI	7.22286.26.0
059906051C	AUDI	7.11190.09.0	06A131501E	SEAT	7.28070.03.0
059906051C	SEAT	7.11190.09.0	06A131501E	VOLKSWAGEN	7.28070.03.0
059906051C	SKODA	7.11190.09.0	06A131501F	AUDI	7.22574.12.0
059906051C	VOLKSWAGEN	7.11190.09.0	06A131501F	SEAT	7.22574.12.0
059906088A	AUDI	7.08369.13.0	06A131501F	SKODA	7.22574.12.0
059906088A	VOLKSWAGEN	7.08369.13.0	06A131501F	VOLKSWAGEN	7.22574.12.0
059906088AC	VOLKSWAGEN	7.08369.68.0	06A131501G	AUDI	7.22785.18.0
059906088BJ	VOLKSWAGEN	7.08369.73.0	06A131501G	SEAT	7.22785.18.0
059906088C	AUDI	7.08369.62.0	06A131501G	VOLKSWAGEN	7.22785.18.0
059906088C	VOLKSWAGEN	7.08369.62.0	06A131501N	SEAT	7.28070.03.0
059906088CL	VOLKSWAGEN	7.08369.73.0	06A131501N	VOLKSWAGEN	7.28070.03.0
059906088P	AUDI	7.08369.45.0	06A131501P	SEAT	7.22574.12.0
059906088P	VOLKSWAGEN	7.08369.45.0	06A131501P	VOLKSWAGEN	7.22574.12.0
06.14.006	TRUCKTEC	7.24809.10.0	06A131501R	VOLKSWAGEN	7.22574.12.0
	FAHRZEUGTEILE GM		06A906262	AUDI	7.05270.99.0
065012N	DASIS VERTRIEBS GMBH	7.24809.68.0	06A906262	SEAT	7.05270.99.0
065015N	DASIS VERTRIEBS GMBH	7.00578.12.0	06A906262	SKODA	7.05270.99.0
065018N	DASIS VERTRIEBS GMBH	7.22843.06.0	06A906262	VOLKSWAGEN	7.05270.99.0
066131101	VOLKSWAGEN	7.22286.51.0	06A906262AC	AUDI	7.05271.21.0
066906262A	AUDI	7.05271.14.0	06A906262AC	VOLKSWAGEN	7.05271.21.0
066906262A	SEAT	7.05271.14.0	06A906262AD	AUDI	7.05270.91.0
066906262A	SKODA	7.05271.14.0	06A906262AD	SEAT	7.05270.91.0
066906262A	VOLKSWAGEN	7.05271.14.0	06A906262AD	SKODA	7.05270.91.0
06A131101B	AUDI	7.22286.54.0	06A906262AD	VOLKSWAGEN	7.05270.91.0
06A131101B	VOLKSWAGEN	7.22286.54.0	06A906262AE	SEAT	7.05271.77.0
06A131101C	VOLKSWAGEN	7.22286.54.0	06A906262AE	VOLKSWAGEN	7.05271.77.0
06A131101D	AUDI	7.22286.54.0	06A906262AF	VOLKSWAGEN	7.05271.24.0
06A131101D	SEAT	7.22286.54.0	06A906262AH	AUDI	7.05270.99.0
06A131101D	VOLKSWAGEN	7.22286.54.0	06A906262AH	SEAT	7.05270.99.0
06A131102	AUDI	7.22769.73.0	06A906262AH	SKODA	7.05270.99.0
06A131102	VOLKSWAGEN	7.22769.73.0	06A906262AH	VOLKSWAGEN	7.05270.99.0
06A131102A	AUDI	7.22769.73.0	06A906262AJ	AUDI	7.05270.99.0
06A131102A	VOLKSWAGEN	7.22769.73.0	06A906262AJ	SEAT	7.05270.99.0
06A131102F	AUDI	7.22769.73.0	06A906262AJ	SKODA	7.05270.99.0
06A131102F	SEAT	7.22769.73.0	06A906262AJ	VOLKSWAGEN	7.05270.99.0
06A131102F	SKODA	7.22769.73.0	06A906262AK	AUDI	7.05271.21.0
06A131102F	VOLKSWAGEN	7.22769.73.0	06A906262AK	SEAT	7.05271.21.0
06A131102H	AUDI	7.22769.73.0	06A906262AK	SKODA	7.05271.21.0
06A131102H	VOLKSWAGEN	7.22769.73.0	06A906262AK	VOLKSWAGEN	7.05271.21.0
06A131229	AUDI	7.22286.41.0	06A906262AL	AUDI	7.05271.21.0
06A131229	SEAT	7.22286.41.0	06A906262AL	SEAT	7.05271.21.0
06A131229	VOLKSWAGEN	7.22286.41.0	06A906262AL	SKODA	7.05271.21.0
06A131229C	SEAT	7.22286.41.0	06A906262AL	VOLKSWAGEN	7.05271.21.0
06A131229C	VOLKSWAGEN	7.22286.41.0	06A906262AM	AUDI	7.05270.99.0
06A131333D	AUDI	7.22934.63.0	06A906262AM	SEAT	7.05270.99.0
06A131333D	VOLKSWAGEN	7.22934.63.0	06A906262AM	SKODA	7.05270.99.0
06A131333K	AUDI	7.22934.63.0	06A906262AM	VOLKSWAGEN	7.05270.99.0
06A131333K	VOLKSWAGEN	7.22934.63.0	06A906262AN	AUDI	7.05271.24.0
06A131351	SEAT	7.22778.80.0	06A906262AN	SEAT	7.05271.24.0
06A131351	VOLKSWAGEN	7.22778.80.0	06A906262AN	SKODA	7.05271.24.0
06A131351A	SEAT	7.22778.79.0	06A906262AN	VOLKSWAGEN	7.05271.24.0
06A131351A	VOLKSWAGEN	7.22778.79.0	06A906262AQ	AUDI	7.05271.00.0
06A131351B	AUDI	7.22778.96.0	06A906262AQ	SEAT	7.05271.00.0
06A131351B	SEAT	7.22778.96.0	06A906262AQ	SKODA	7.05271.00.0
06A131351B	SKODA	7.22778.96.0	06A906262AQ	VOLKSWAGEN	7.05271.00.0
06A131351B	VOLKSWAGEN	7.22778.96.0	06A906262AR	AUDI	7.05270.99.0
06A131351D	SEAT	7.22778.80.0	06A906262AR	SEAT	7.05270.99.0
06A131351D	SKODA	7.22778.80.0	06A906262AR	SKODA	7.05270.99.0
06A131351D	VOLKSWAGEN	7.22778.80.0	06A906262AR	VOLKSWAGEN	7.05270.99.0

REF-No.		 PIERBURG	REF-No.		 PIERBURG
06A906262AS	AUDI	7.05270.91.0	06A906262CN	SEAT	7.05271.02.0
06A906262AS	SEAT	7.05270.91.0	06A906262CN	SKODA	7.05271.02.0
06A906262AS	SKODA	7.05270.91.0	06A906262CN	VOLKSWAGEN	7.05271.02.0
06A906262AS	VOLKSWAGEN	7.05270.91.0	06A906262CS	VOLKSWAGEN	7.05271.18.0
06A906262AT	AUDI	7.05271.02.0	06A906262CT	AUDI	7.05271.02.0
06A906262AT	SEAT	7.05271.02.0	06A906262CT	SEAT	7.05271.02.0
06A906262AT	SKODA	7.05271.02.0	06A906262CT	SKODA	7.05271.02.0
06A906262AT	VOLKSWAGEN	7.05271.02.0	06A906262CT	VOLKSWAGEN	7.05271.02.0
06A906262B	VOLKSWAGEN	7.05271.00.0	06A906262D	AUDI	7.05271.02.0
06A906262BA	AUDI	7.05270.89.0	06A906262D	SEAT	7.05271.02.0
06A906262BA	SEAT	7.05270.89.0	06A906262DB	VOLKSWAGEN	7.05271.12.0
06A906262BA	SKODA	7.05270.89.0	06A906262DC	VOLKSWAGEN	7.05271.12.0
06A906262BA	VOLKSWAGEN	7.05270.89.0	06A906262DE	AUDI	7.05271.29.0
06A906262BB	AUDI	7.05270.99.0	06A906262DE	SEAT	7.05271.29.0
06A906262BB	SEAT	7.05270.99.0	06A906262DE	SKODA	7.05271.29.0
06A906262BB	SKODA	7.05270.99.0	06A906262DE	VOLKSWAGEN	7.05271.29.0
06A906262BB	VOLKSWAGEN	7.05270.99.0	06A906262DK	VOLKSWAGEN	7.05271.24.0
06A906262BC	AUDI	7.05271.24.0	06A906262DL	AUDI	7.05270.99.0
06A906262BC	SEAT	7.05271.24.0	06A906262DL	SEAT	7.05270.99.0
06A906262BC	SKODA	7.05271.24.0	06A906262DL	SKODA	7.05270.99.0
06A906262BC	VOLKSWAGEN	7.05271.24.0	06A906262DL	VOLKSWAGEN	7.05270.99.0
06A906262BD	AUDI	7.05271.77.0	06A906262DP	VOLKSWAGEN	7.05271.12.0
06A906262BE	AUDI	7.05271.77.0	06A906262DR	AUDI	7.05270.99.0
06A906262BE	SEAT	7.05271.77.0	06A906262DR	SEAT	7.05270.99.0
06A906262BF	AUDI	7.05271.77.0	06A906262DR	SKODA	7.05270.99.0
06A906262BF	SEAT	7.05271.77.0	06A906262DR	VOLKSWAGEN	7.05270.99.0
06A906262BF	SKODA	7.05271.77.0	06A906262EA	AUDI	7.05270.99.0
06A906262BG	SKODA	7.05270.98.0	06A906262EA	SEAT	7.05270.99.0
06A906262BG	VOLKSWAGEN	7.05270.98.0	06A906262EA	SKODA	7.05270.99.0
06A906262BH	AUDI	7.05271.24.0	06A906262EA	VOLKSWAGEN	7.05270.99.0
06A906262BH	VOLKSWAGEN	7.05271.24.0	06A906262EC	AUDI	7.05270.99.0
06A906262BL	AUDI	7.05271.14.0	06A906262EC	SEAT	7.05270.99.0
06A906262BL	SEAT	7.05271.14.0	06A906262EC	SKODA	7.05270.99.0
06A906262BL	SKODA	7.05271.14.0	06A906262EC	VOLKSWAGEN	7.05270.99.0
06A906262BL	VOLKSWAGEN	7.05271.14.0	06A906262ED	VOLKSWAGEN	7.05271.12.0
06A906262BM	AUDI	7.05270.99.0	06A906262EG	AUDI	7.05270.99.0
06A906262BM	SEAT	7.05270.99.0	06A906262EG	SEAT	7.05270.99.0
06A906262BM	SKODA	7.05270.99.0	06A906262EG	SKODA	7.05270.99.0
06A906262BM	VOLKSWAGEN	7.05270.99.0	06A906262EG	VOLKSWAGEN	7.05270.99.0
06A906262BP	AUDI	7.05270.99.0	06A906262F	AUDI	7.05271.02.0
06A906262BP	SEAT	7.05270.99.0	06A906262F	SEAT	7.05271.02.0
06A906262BP	SKODA	7.05270.99.0	06A906262F	SKODA	7.05271.02.0
06A906262BP	VOLKSWAGEN	7.05270.99.0	06A906262H	AUDI	7.05270.89.0
06A906262BS	AUDI	7.05271.18.0	06A906262H	SEAT	7.05270.89.0
06A906262BS	SEAT	7.05271.18.0	06A906262H	SKODA	7.05270.89.0
06A906262BS	SKODA	7.05271.18.0	06A906262H	VOLKSWAGEN	7.05270.89.0
06A906262BS	VOLKSWAGEN	7.05271.18.0	06A906262K	AUDI	7.05270.99.0
06A906262C	AUDI	7.05270.99.0	06A906262K	SEAT	7.05270.99.0
06A906262C	SEAT	7.05270.99.0	06A906262K	SKODA	7.05270.99.0
06A906262C	SKODA	7.05270.99.0	06A906262K	VOLKSWAGEN	7.05270.99.0
06A906262C	VOLKSWAGEN	7.05270.99.0	06A906262N	AUDI	7.05270.99.0
06A906262CG	AUDI	7.05271.29.0	06A906262N	SEAT	7.05270.99.0
06A906262CG	SEAT	7.05271.29.0	06A906262N	SKODA	7.05270.99.0
06A906262CG	SKODA	7.05271.29.0	06A906262N	VOLKSWAGEN	7.05270.99.0
06A906262CG	VOLKSWAGEN	7.05271.29.0	06A906262P	AUDI	7.05270.89.0
06A906262CH	AUDI	7.05270.99.0	06A906262P	SEAT	7.05270.89.0
06A906262CH	SEAT	7.05270.99.0	06A906262P	SKODA	7.05270.89.0
06A906262CH	SKODA	7.05270.99.0	06A906262P	VOLKSWAGEN	7.05270.89.0
06A906262CH	VOLKSWAGEN	7.05270.99.0	06A906262R	AUDI	7.05270.99.0
06A906262CJ	VOLKSWAGEN	7.05270.98.0	06A906262R	SEAT	7.05270.99.0
06A906262CL	AUDI	7.05271.13.0	06A906262R	SKODA	7.05270.99.0
06A906262CL	SEAT	7.05271.13.0	06A906262R	VOLKSWAGEN	7.05270.99.0
06A906262CL	SKODA	7.05271.13.0	06A906265A	AUDI	7.05271.03.0
06A906262CL	VOLKSWAGEN	7.05271.13.0	06A906265A	SEAT	7.05271.03.0
06A906262CM	AUDI	7.05271.02.0	06A906265A	SKODA	7.05271.03.0
06A906262CM	SEAT	7.05271.02.0	06A906265A	VOLKSWAGEN	7.05271.03.0
06A906262CM	SKODA	7.05271.02.0	06A906265AC	AUDI	7.05271.03.0
06A906262CM	VOLKSWAGEN	7.05271.02.0	06A906265AC	SEAT	7.05271.03.0
06A906262CN	AUDI	7.05271.02.0	06A906265AC	SKODA	7.05271.03.0

REF-No.	 PIERBURG	REF-No.	 PIERBURG		
06A906265AC	VOLKSWAGEN	7.05271.03.0	06B131101J	VOLKSWAGEN	7.22778.99.0
06A906265AJ	AUDI	7.05270.99.0	06B131101K	AUDI	7.22560.43.0
06A906265AJ	SEAT	7.05270.99.0	06B131101K	SEAT	7.22560.43.0
06A906265AJ	SKODA	7.05270.99.0	06B131351A	SKODA	7.22778.95.0
06A906265AJ	VOLKSWAGEN	7.05270.99.0	06B131351A	VOLKSWAGEN	7.22778.95.0
06A906265AM	AUDI	7.05271.04.0	06B131351C	SKODA	7.22778.95.0
06A906265AM	SEAT	7.05271.04.0	06B131351C	VOLKSWAGEN	7.22778.95.0
06A906265AM	SKODA	7.05271.04.0	06B131501	AUDI	7.22785.20.0
06A906265AM	VOLKSWAGEN	7.05271.04.0	06B131501	VOLKSWAGEN	7.22785.20.0
06A906265AP	AUDI	7.05271.03.0	06B131501A	AUDI	7.22785.20.0
06A906265AP	SEAT	7.05271.03.0	06B131501A	SEAT	7.22785.20.0
06A906265AP	SKODA	7.05271.03.0	06B906265A	AUDI	7.05271.05.0
06A906265AP	VOLKSWAGEN	7.05271.03.0	06B906265A	SEAT	7.05271.05.0
06A906265B	AUDI	7.05271.03.0	06B906265A	SKODA	7.05271.05.0
06A906265B	SEAT	7.05271.03.0	06B906265A	VOLKSWAGEN	7.05271.05.0
06A906265B	SKODA	7.05271.03.0	06B906265B	AUDI	7.05271.07.0
06A906265B	VOLKSWAGEN	7.05271.03.0	06B906265B	SEAT	7.05271.07.0
06A906265E	AUDI	7.05271.04.0	06B906265B	SKODA	7.05271.07.0
06A906265E	SEAT	7.05271.04.0	06B906265B	VOLKSWAGEN	7.05271.07.0
06A906265E	SKODA	7.05271.04.0	06C131101	AUDI	7.22560.44.0
06A906265E	VOLKSWAGEN	7.05271.04.0	06C131101E	AUDI	7.22560.44.0
06A906265F	AUDI	7.05271.03.0	06C131101E	VOLKSWAGEN	7.22560.44.0
06A906265F	SEAT	7.05271.03.0	06C131102	AUDI	7.22560.45.0
06A906265F	SKODA	7.05271.03.0	06C131102E	AUDI	7.22560.45.0
06A906265F	VOLKSWAGEN	7.05271.03.0	06C131102E	VOLKSWAGEN	7.22560.45.0
06A906265G	AUDI	7.05271.03.0	06C902265M	VOLKSWAGEN	7.05270.98.0
06A906265G	SEAT	7.05271.03.0	06C906265	AUDI	7.05270.99.0
06A906265G	SKODA	7.05271.03.0	06C906265	SEAT	7.05270.99.0
06A906265G	VOLKSWAGEN	7.05271.03.0	06C906265	SKODA	7.05270.99.0
06A906265H	AUDI	7.05271.03.0	06C906265	VOLKSWAGEN	7.05270.99.0
06A906265H	SEAT	7.05271.03.0	06C906265A	AUDI	7.05270.99.0
06A906265H	SKODA	7.05271.03.0	06C906265A	SEAT	7.05270.99.0
06A906265H	VOLKSWAGEN	7.05271.03.0	06C906265A	SKODA	7.05270.99.0
06A906265L	AUDI	7.05271.07.0	06C906265A	VOLKSWAGEN	7.05270.99.0
06A906265L	SKODA	7.05271.07.0	06C906265B	AUDI	7.05271.77.0
06A906265L	VOLKSWAGEN	7.05271.07.0	06C906265C	AUDI	7.05271.21.0
06A906265P	AUDI	7.05271.03.0	06C906265C	SEAT	7.05271.21.0
06A906265P	SEAT	7.05271.03.0	06C906265C	SKODA	7.05271.21.0
06A906265P	SKODA	7.05271.03.0	06C906265C	VOLKSWAGEN	7.05271.21.0
06A906265P	VOLKSWAGEN	7.05271.03.0	06C906265C	AUDI	7.05270.99.0
06A906265Q	AUDI	7.05271.03.0	06C906265F	SEAT	7.05270.99.0
06A906265Q	SEAT	7.05271.03.0	06C906265F	SKODA	7.05270.99.0
06A906265Q	SKODA	7.05271.03.0	06C906265F	VOLKSWAGEN	7.05270.99.0
06A906265Q	VOLKSWAGEN	7.05271.03.0	06C906265G	AUDI	7.05270.99.0
06A906265R	AUDI	7.05271.21.0	06C906265G	SEAT	7.05270.99.0
06A906265R	VOLKSWAGEN	7.05271.21.0	06C906265G	SKODA	7.05270.99.0
06A959253	AUDI	7.21851.31.0	06C906265G	VOLKSWAGEN	7.05270.99.0
06A959253	SEAT	7.21851.31.0	06C906265H	AUDI	7.05271.77.0
06A959253	SKODA	7.21851.31.0	06C906265L	AUDI	7.05270.98.0
06A959253	VOLKSWAGEN	7.21851.31.0	06C906265L	VOLKSWAGEN	7.05270.98.0
06A959253B	AUDI	7.22738.08.0	06C906265M	AUDI	7.05270.98.0
06A959253B	SEAT	7.22738.08.0	06C906265M	VOLKSWAGEN	7.05270.98.0
06A959253B	VOLKSWAGEN	7.22738.08.0	06D906265	AUDI	7.05271.11.0
06A959253E	AUDI	7.22738.08.0	06D906265	SEAT	7.05271.11.0
06A959253E	SEAT	7.22738.08.0	06D906265	SKODA	7.05271.11.0
06A959253E	SKODA	7.22738.08.0	06D906265	VOLKSWAGEN	7.05271.11.0
06A959253E	VOLKSWAGEN	7.22738.08.0	06E131101A	AUDI	7.22778.94.0
06B131101C	AUDI	7.22560.43.0	06E131101C	AUDI	7.22778.94.0
06B131101C	VOLKSWAGEN	7.22560.43.0	06E131101D	AUDI	7.05574.01.0
06B131101F	AUDI	7.22778.99.0	06E131101E	AUDI	7.22286.53.0
06B131101F	VOLKSWAGEN	7.22778.99.0	06E131101E	VOLKSWAGEN	7.22286.53.0
06B131101G	AUDI	7.22560.43.0	06E131101H	AUDI	7.06714.23.0
06B131101G	SKODA	7.22560.43.0	06E131101J	VOLKSWAGEN	7.22286.53.0
06B131101G	VOLKSWAGEN	7.22560.43.0	06E131101K	AUDI	7.22286.53.0
06B131101H	AUDI	7.22560.43.0	06E131101K	VOLKSWAGEN	7.22286.53.0
06B131101H	SKODA	7.22560.43.0	06E131101L	AUDI	7.06714.23.0
06B131101H	VOLKSWAGEN	7.22560.43.0	06E131101M	AUDI	7.06714.23.0
06B131101J	AUDI	7.22778.99.0	06E131102A	AUDI	7.05574.00.0
06B131101J	SEAT	7.22778.99.0			

NUMBERFINDER



REF-No.		 PIERBURG	REF-No.		 PIERBURG
06E131102B	AUDI	7.22286.52.0	06G906262A	SKODA	7.05271.12.0
06E131102B	VOLKSWAGEN	7.22286.52.0	06G906262A	VOLKSWAGEN	7.05271.12.0
06E131102G	AUDI	7.06714.21.0	06G906262G	VOLKSWAGEN	7.05271.12.0
06E131102H	AUDI	7.06714.22.0	06G906262L	VOLKSWAGEN	7.05271.12.0
06E131102J	AUDI	7.22286.52.0	06H131097C	AUDI	7.01510.57.0
06E131102J	VOLKSWAGEN	7.22286.52.0	06H906262A	AUDI	7.05271.12.0
06E131102K	AUDI	7.22286.52.0	06J131097C	AUDI	7.01510.31.0
06E131102K	VOLKSWAGEN	7.22286.52.0	06J131097C	VOLKSWAGEN	7.01510.31.0
06E131102M	AUDI	7.06714.22.0	06J131097D	AUDI	7.01510.31.0
06E131102N	AUDI	7.06714.21.0	06J131097D	VOLKSWAGEN	7.01510.31.0
06E131102P	AUDI	7.06714.21.0	06J906262A	AUDI	7.05271.19.0
06E131102P	VOLKSWAGEN	7.06714.21.0	06J906262A	SEAT	7.05271.19.0
06E906262D	VOLKSWAGEN	7.05271.12.0	06J906262A	SKODA	7.05271.19.0
06E906265Q	AUDI	7.05271.18.0	06J906262A	VOLKSWAGEN	7.05271.19.0
06E906265Q	SEAT	7.05271.18.0	06J906262J	AUDI	7.05271.11.0
06E906265Q	SKODA	7.05271.18.0	06J906262J	SEAT	7.05271.11.0
06E906265Q	VOLKSWAGEN	7.05271.18.0	06J906262J	SKODA	7.05271.11.0
06E906601	AUDI	7.03446.01.0	06J906262J	VOLKSWAGEN	7.05271.11.0
06E906601A	AUDI	7.03446.01.0	06J906262K	AUDI	7.05271.15.0
06F131503A	AUDI	7.10334.09.0	06J906262K	SEAT	7.05271.15.0
06F131503A	VOLKSWAGEN	7.10334.09.0	06J906262K	SKODA	7.05271.15.0
06F131503B	AUDI	7.10334.09.0	06J906262K	VOLKSWAGEN	7.05271.15.0
06F131503B	SEAT	7.10334.09.0	06J906262N	AUDI	7.05271.12.0
06F131503B	SKODA	7.10334.09.0	06J906262N	VOLKSWAGEN	7.05271.12.0
06F131503B	VOLKSWAGEN	7.10334.09.0	06K131097AA	AUDI	7.01510.85.0
06F906088	AUDI	7.08369.41.0	06K131097AA	VOLKSWAGEN	7.01510.85.0
06F906088	SKODA	7.08369.41.0	06K131097AB	VOLKSWAGEN	7.01510.87.0
06F906088	VOLKSWAGEN	7.08369.41.0	06K131097H	AUDI	7.01510.86.0
06F906088D	AUDI	7.08369.41.0	06K131097H	VOLKSWAGEN	7.01510.86.0
06F906088D	SKODA	7.08369.41.0	06K131097J	AUDI	7.01510.86.0
06F906088D	VOLKSWAGEN	7.08369.41.0	06K131097J	VOLKSWAGEN	7.01510.86.0
06F906262	AUDI	7.05271.29.0	06K131097K	AUDI	7.01510.85.0
06F906262	SEAT	7.05271.29.0	06K131097K	VOLKSWAGEN	7.01510.85.0
06F906262	SKODA	7.05271.29.0	06K131097L	AUDI	7.01510.86.0
06F906262	VOLKSWAGEN	7.05271.29.0	06K131097L	VOLKSWAGEN	7.01510.86.0
06F906262AE	AUDI	7.05271.12.0	06K131097M	AUDI	7.01510.86.0
06F906262AE	SEAT	7.05271.12.0	06K131097M	VOLKSWAGEN	7.01510.86.0
06F906262AE	SKODA	7.05271.12.0	06K131097N	VOLKSWAGEN	7.01510.87.0
06F906262AE	VOLKSWAGEN	7.05271.12.0	06K906262A	VOLKSWAGEN	7.05271.12.0
06F906262AJ	AUDI	7.05271.29.0	06K906262D	AUDI	7.05271.12.0
06F906262AJ	SEAT	7.05271.29.0	06K906262D	SEAT	7.05271.12.0
06F906262AJ	SKODA	7.05271.29.0	06K906262D	SKODA	7.05271.12.0
06F906262AJ	VOLKSWAGEN	7.05271.29.0	06K906262D	VOLKSWAGEN	7.05271.12.0
06F906262D	AUDI	7.05271.16.0	06L131097B	AUDI	7.01510.94.0
06F906262D	SEAT	7.05271.16.0	06L131097B	VOLKSWAGEN	7.01510.94.0
06F906262D	SKODA	7.05271.16.0	06L959231	AUDI	7.03635.46.0
06F906262D	VOLKSWAGEN	7.05271.16.0	06L959231	VOLKSWAGEN	7.03635.46.0
06F906262E	AUDI	7.05271.16.0	06L959231B	AUDI	7.03635.46.0
06F906262E	SEAT	7.05271.16.0	06L959231B	VOLKSWAGEN	7.03635.46.0
06F906262E	SKODA	7.05271.16.0	07.14.040	TRUCKTEC	7.28248.17.0
06F906262E	VOLKSWAGEN	7.05271.16.0		FAHRZEUGTEILE GM	
06F906262H	AUDI	7.05271.29.0	07.16.007	TRUCKTEC	7.24809.16.0
06F906262H	SEAT	7.05271.29.0		FAHRZEUGTEILE GM	
06F906262H	SKODA	7.05271.29.0	07.16.008	TRUCKTEC	7.24809.26.0
06F906262H	VOLKSWAGEN	7.05271.29.0		FAHRZEUGTEILE GM	
06F906262N	AUDI	7.05271.12.0	07.16.009	TRUCKTEC	7.24809.17.0
06F906262P	AUDI	7.05271.15.0		FAHRZEUGTEILE GM	
06F906262P	SEAT	7.05271.15.0	07.16.010	TRUCKTEC	7.24809.19.0
06F906262P	SKODA	7.05271.15.0		FAHRZEUGTEILE GM	
06F906262P	VOLKSWAGEN	7.05271.15.0	07.16.011	TRUCKTEC	7.24809.57.0
06F906262S	AUDI	7.05271.16.0		FAHRZEUGTEILE GM	
06F906262S	SEAT	7.05271.16.0	07.16.012	TRUCKTEC	7.24809.31.0
06F906262S	SKODA	7.05271.16.0		FAHRZEUGTEILE GM	
06F906262S	VOLKSWAGEN	7.05271.16.0	07.16.013	TRUCKTEC	7.24809.55.0
06F906262T	AUDI	7.05271.16.0		FAHRZEUGTEILE GM	
06F906262T	SEAT	7.05271.16.0	07.16.014	TRUCKTEC	7.24809.30.0
06F906262T	SKODA	7.05271.16.0		FAHRZEUGTEILE GM	
06F906262T	VOLKSWAGEN	7.05271.16.0	07.16.015	TRUCKTEC	7.24809.32.0
06F906265	VOLKSWAGEN	7.05271.16.0		FAHRZEUGTEILE GM	



REF-No.		 PIERBURG	REF-No.		 PIERBURG
07.16.017	TRUCKTEC	7.24809.64.0	077906262C	VOLKSWAGEN	7.05271.00.0
	FAHRZEUGTEILE GM		077906262D	VOLKSWAGEN	7.05271.24.0
07.16.018	TRUCKTEC	7.24809.38.0	077906262E	VOLKSWAGEN	7.05271.24.0
	FAHRZEUGTEILE GM		077906262G	AUDI	7.05270.99.0
07.16.019	TRUCKTEC	7.24809.56.0	077906262G	SEAT	7.05270.99.0
	FAHRZEUGTEILE GM		077906262G	SKODA	7.05270.99.0
07.16.020	TRUCKTEC	7.24809.52.0	077906262G	VOLKSWAGEN	7.05270.99.0
	FAHRZEUGTEILE GM		077906265AB	AUDI	7.05271.24.0
07.16.021	TRUCKTEC	7.24809.63.0	077906265AC	AUDI	7.05271.24.0
	FAHRZEUGTEILE GM		077906265AC	SEAT	7.05271.24.0
07.16.022	TRUCKTEC	7.24809.61.0	077906265AC	SKODA	7.05271.24.0
	FAHRZEUGTEILE GM		077906265AC	VOLKSWAGEN	7.05271.24.0
07.16.029	TRUCKTEC	7.24809.20.0	077906265AD	AUDI	7.05271.01.0
	FAHRZEUGTEILE GM		077906265AD	SEAT	7.05271.01.0
07.16.046	TRUCKTEC	7.09720.01.0	077906265AD	SKODA	7.05271.01.0
	FAHRZEUGTEILE GM		077906265AD	VOLKSWAGEN	7.05271.01.0
07.17.079	TRUCKTEC	7.08369.14.0	077906265AD	VOLKSWAGEN	7.05271.01.0
	FAHRZEUGTEILE GM		077906265AE	AUDI	7.05271.01.0
07.17.088	TRUCKTEC	7.08369.45.0	077906265AE	SEAT	7.05271.01.0
	FAHRZEUGTEILE GM		077906265AE	SKODA	7.05271.01.0
07.17.105	TRUCKTEC	7.08369.36.0	077906265AE	VOLKSWAGEN	7.05271.01.0
	FAHRZEUGTEILE GM		077906265M	VOLKSWAGEN	7.05271.77.0
07.59.070	TRUCKTEC	7.22738.08.0	077906265N	VOLKSWAGEN	7.05271.77.0
	FAHRZEUGTEILE GM		078131101AB	AUDI	7.22769.78.0
07.59.074	TRUCKTEC	7.22934.63.0	078131101AC	AUDI	7.22560.40.0
	FAHRZEUGTEILE GM		078131101AC	SKODA	7.22560.40.0
070128070B	VOLKSWAGEN	7.24809.38.0	078131101AC	VOLKSWAGEN	7.22560.40.0
070128070C	VOLKSWAGEN	7.24809.56.0	078131101AD	VOLKSWAGEN	7.22560.40.0
070128070E	VOLKSWAGEN	7.24809.38.0	078131101AG	AUDI	7.22560.40.0
070128070F	VOLKSWAGEN	7.24809.56.0	078131101F	AUDI	7.22560.40.0
070906088	VOLKSWAGEN	7.08369.58.0	078131101F	VOLKSWAGEN	7.22560.40.0
070906088AA	VOLKSWAGEN	7.08369.39.0	078131101M	AUDI	7.22769.76.0
070906088AC	VOLKSWAGEN	7.08369.18.0	078131101N	AUDI	7.22560.40.0
070906088AD	VOLKSWAGEN	7.08369.31.0	078131101N	VOLKSWAGEN	7.22560.40.0
070906088AF	VOLKSWAGEN	7.08369.96.0	078131101P	AUDI	7.22769.78.0
070906088B	VOLKSWAGEN	7.08369.39.0	078131102	AUDI	7.22560.41.0
070906088C	VOLKSWAGEN	7.08369.18.0	078131102	SKODA	7.22560.41.0
070906088F	VOLKSWAGEN	7.08369.31.0	078131102	VOLKSWAGEN	7.22560.41.0
070906088G	VOLKSWAGEN	7.08369.33.0	078131102D	AUDI	7.22769.77.0
070906088P	VOLKSWAGEN	7.08369.96.0	078131102E	AUDI	7.22769.77.0
070906088R	VOLKSWAGEN	7.08369.18.0	078131102F	AUDI	7.22560.41.0
074129463A	VOLKSWAGEN	7.24809.52.0	078131102F	SKODA	7.22560.41.0
074129463B	VOLKSWAGEN	7.24809.61.0	078131102F	VOLKSWAGEN	7.22560.41.0
074129499E	VOLKSWAGEN	7.22939.03.0	078131102L	AUDI	7.22560.41.0
075006N	DASIS VERTRIEBS GMBH	7.00368.15.0	078131102L	SKODA	7.22560.41.0
076131501A	VOLKSWAGEN	7.00823.06.0	078131102L	VOLKSWAGEN	7.22560.41.0
076131501B	VOLKSWAGEN	7.00823.06.0	078131102M	AUDI	7.22769.77.0
076906051A	AUDI	7.11492.02.0	078131102N	AUDI	7.22560.41.0
076906051A	SEAT	7.11492.02.0	078131102N	SKODA	7.22560.41.0
076906051A	SKODA	7.11492.02.0	078131102N	VOLKSWAGEN	7.22560.41.0
076906051A	VOLKSWAGEN	7.11492.02.0	078131102Q	VOLKSWAGEN	7.22560.41.0
076906051B	AUDI	7.11492.00.0	078131102T	AUDI	7.22560.41.0
076906051B	SEAT	7.11492.00.0	078905265T	VOLKSWAGEN	7.05271.00.0
076906051B	SKODA	7.11492.00.0	078906265AA	AUDI	7.05271.00.0
076906051B	VOLKSWAGEN	7.11492.00.0	078906265AA	SEAT	7.05271.00.0
076906051C	AUDI	7.11492.02.0	078906265AA	SKODA	7.05271.00.0
076906051C	SEAT	7.11492.02.0	078906265AA	VOLKSWAGEN	7.05271.00.0
076906051C	SKODA	7.11492.02.0	078906265H	AUDI	7.05270.96.0
076906051C	VOLKSWAGEN	7.11492.02.0	078906265H	SEAT	7.05270.96.0
076906088E	VOLKSWAGEN	7.08369.44.0	078906265H	SKODA	7.05270.96.0
077906262	VOLKSWAGEN	7.05271.24.0	078906265H	VOLKSWAGEN	7.05270.96.0
077906262A	SEAT	7.05271.24.0	078906265L	AUDI	7.05270.88.0
077906262A	VOLKSWAGEN	7.05271.24.0	078906265L	SEAT	7.05270.88.0
077906262B	AUDI	7.05271.21.0	078906265L	SKODA	7.05270.88.0
077906262B	SEAT	7.05271.21.0	078906265L	VOLKSWAGEN	7.05270.88.0
077906262B	SKODA	7.05271.21.0	078906265T	AUDI	7.05271.00.0
077906262B	VOLKSWAGEN	7.05271.21.0	078906265T	SEAT	7.05271.00.0
077906262C	AUDI	7.05271.00.0	078906265T	SKODA	7.05271.00.0
077906262C	SEAT	7.05271.00.0	078906265T	VOLKSWAGEN	7.05271.00.0
077906262C	SKODA	7.05271.00.0	078906601D	AUDI	7.21851.31.0

NUMBERFINDER



REF-No.			REF-No.		
078906601D	SEAT	7.21851.31.0	079959231H	AUDI	7.03635.41.0
078906601D	SKODA	7.21851.31.0	079959231J	AUDI	7.22934.57.0
078906601D	VOLKSWAGEN	7.21851.31.0	079959231K	AUDI	7.22934.57.0
078906601F	AUDI	7.21851.32.0	079959231L	AUDI	7.22934.57.0
078906601M	AUDI	7.21851.31.0	079959231M	AUDI	7.22934.57.0
078906601M	SEAT	7.21851.31.0	079959253	AUDI	7.22934.57.0
078906601M	SKODA	7.21851.31.0	079959253B	AUDI	7.03635.12.0
078906601M	VOLKSWAGEN	7.21851.31.0	079959253D	AUDI	7.03635.41.0
079131101AC	AUDI	7.06712.23.0	079959253E	AUDI	7.03635.12.0
079131101AD	AUDI	7.06713.09.0	079959253F	AUDI	7.03635.41.0
079131101AD	BENTLEY	7.06713.09.0	079959253G	AUDI	7.22934.57.0
079131101AE	AUDI	7.06713.10.0	07C131101G	AUDI	7.22778.79.0
079131101AE	BENTLEY	7.06713.10.0	07C131101L	AUDI	7.22778.79.0
079131101AF	VOLKSWAGEN	7.06712.24.0	07C906262A	AUDI	7.05270.99.0
079131101AG	AUDI	7.22769.80.0	07C906262A	SEAT	7.05270.99.0
079131101AG	LAMBORGHINI	7.22769.80.0	07C906262A	SKODA	7.05270.99.0
079131101AH	AUDI	7.06712.23.0	07C906262A	VOLKSWAGEN	7.05270.99.0
079131101AH	BENTLEY	7.06712.23.0	07C906262AE	AUDI	7.05271.00.0
079131101AJ	AUDI	7.06713.09.0	07C906262AE	SEAT	7.05271.00.0
079131101AJ	BENTLEY	7.06713.09.0	07C906262AE	SKODA	7.05271.00.0
079131101AK	AUDI	7.06713.10.0	07C906262AE	VOLKSWAGEN	7.05271.00.0
079131101AK	BENTLEY	7.06713.10.0	07C906262AF	AUDI	7.05271.14.0
079131101AN	AUDI	7.06712.24.0	07C906262AF	SEAT	7.05271.14.0
079131101AP	AUDI	7.22769.80.0	07C906262AF	SKODA	7.05271.14.0
079131101AP	LAMBORGHINI	7.22769.80.0	07C906262AF	VOLKSWAGEN	7.05271.14.0
079131101AR	AUDI	7.22560.43.0	07C906262AR	VOLKSWAGEN	7.05270.98.0
079131101AR	VOLKSWAGEN	7.22560.43.0	07C906262AS	BENTLEY	7.05271.24.0
079131101F	AUDI	7.22769.80.0	07C906262AT	BENTLEY	7.05271.24.0
079131101F	LAMBORGHINI	7.22769.80.0	07C906262B	VOLKSWAGEN	7.05271.77.0
079131101G	AUDI	7.22778.97.0	07C906262BD	AUDI	7.05271.28.0
079131101G	VOLKSWAGEN	7.22778.97.0	07C906262BD	SEAT	7.05271.28.0
079131101H	AUDI	7.22778.97.0	07C906262BD	SKODA	7.05271.28.0
079131101H	VOLKSWAGEN	7.22778.97.0	07C906262BD	VOLKSWAGEN	7.05271.28.0
079131101L	AUDI	7.05574.02.0	07C906262BE	AUDI	7.05271.28.0
079131101N	AUDI	7.22769.79.0	07C906262BE	SEAT	7.05271.28.0
079131101N	VOLKSWAGEN	7.22769.79.0	07C906262BE	SKODA	7.05271.28.0
079131101P	VOLKSWAGEN	7.06712.24.0	07C906262BE	VOLKSWAGEN	7.05271.28.0
079131101R	AUDI	7.22769.80.0	07C906262BQ	VOLKSWAGEN	7.05271.12.0
079131101R	LAMBORGHINI	7.22769.80.0	07C906262C	AUDI	7.05271.14.0
079131102A	AUDI	7.05574.03.0	07C906262C	SEAT	7.05271.14.0
079906262E	AUDI	7.05271.23.0	07C906262C	SKODA	7.05271.14.0
079906262E	SEAT	7.05271.23.0	07C906262C	VOLKSWAGEN	7.05271.14.0
079906262E	SKODA	7.05271.23.0	07C906262D	AUDI	7.05271.23.0
079906262E	VOLKSWAGEN	7.05271.23.0	07C906262D	SEAT	7.05271.23.0
079906262G	AUDI	7.05271.16.0	07C906262D	SKODA	7.05271.23.0
079906262G	SEAT	7.05271.16.0	07C906262D	VOLKSWAGEN	7.05271.23.0
079906262G	SKODA	7.05271.16.0	07C906262G	AUDI	7.05271.77.0
079906262G	VOLKSWAGEN	7.05271.16.0	07C906262H	AUDI	7.05270.99.0
079906262H	VOLKSWAGEN	7.05271.16.0	07C906262H	SEAT	7.05270.99.0
079906265	AUDI	7.05271.11.0	07C906262H	SKODA	7.05270.99.0
079906265	SEAT	7.05271.11.0	07C906262H	VOLKSWAGEN	7.05270.99.0
079906265	SKODA	7.05271.11.0	07C906262J	AUDI	7.05271.14.0
079906265	VOLKSWAGEN	7.05271.11.0	07C906262J	SEAT	7.05271.14.0
079906265A	AUDI	7.05271.12.0	07C906262J	SKODA	7.05271.14.0
079906265A	SEAT	7.05271.12.0	07C906262J	VOLKSWAGEN	7.05271.14.0
079906265A	SKODA	7.05271.12.0	07C906262K	VOLKSWAGEN	7.05271.24.0
079906265A	VOLKSWAGEN	7.05271.12.0	07C906262M	AUDI	7.05270.99.0
079906265D	AUDI	7.05271.12.0	07C906262M	SEAT	7.05270.99.0
079906265E	AUDI	7.05271.12.0	07C906262M	SKODA	7.05270.99.0
079906265F	AUDI	7.05271.12.0	07C906262M	VOLKSWAGEN	7.05270.99.0
079906601A	AUDI	7.00216.06.0	07C906262N	VOLKSWAGEN	7.05271.24.0
079906601E	AUDI	7.00216.06.0	07C906262P	AUDI	7.05271.01.0
079959231	AUDI	7.22934.57.0	07C906262P	SEAT	7.05271.01.0
079959231A	AUDI	7.22934.57.0	07C906262P	SKODA	7.05271.01.0
079959231C	AUDI	7.03635.12.0	07C906262P	VOLKSWAGEN	7.05271.01.0
079959231C	BENTLEY	7.03635.12.0	07C906262Q	BENTLEY	7.05271.77.0
079959231E	AUDI	7.03635.41.0	07C906262R	BENTLEY	7.05271.24.0
079959231G	AUDI	7.03635.12.0	07C959253A	VOLKSWAGEN	7.28415.09.0
079959231G	BENTLEY	7.03635.12.0	07C959253C	VOLKSWAGEN	7.28415.09.0

REF-No.		 PIERBURG	REF-No.		 PIERBURG
07D906262A	AUDI	7.05271.01.0	08.16.017	TRUCKTEC	7.00450.09.0
07D906262A	SEAT	7.05271.01.0		FAHRZEUGTEILE GM	
07D906262A	SKODA	7.05271.01.0	0824010019	BERU AG	7.05270.00.0
07D906262A	VOLKSWAGEN	7.05271.01.0	0824010035	BERU AG	7.05270.51.0
07D906262B	AUDI	7.05270.99.0	0824010045	BERU AG	7.05270.86.0
07D906262B	SEAT	7.05270.99.0	0824010047	BERU AG	7.02604.61.0
07D906262B	SKODA	7.05270.99.0	0824010063	BERU AG	7.05270.47.0
07D906262B	VOLKSWAGEN	7.05270.99.0	0824010063	BERU AG	7.05270.51.0
07D906262C	AUDI	7.05271.23.0	0824010065	BERU AG	7.02604.61.0
07D906262C	SEAT	7.05271.23.0	0824010070	BERU AG	7.02604.47.0
07D906262C	SKODA	7.05271.23.0	0824010080	BERU AG	7.05270.39.0
07D906262C	VOLKSWAGEN	7.05271.23.0	0824010089	BERU AG	7.05270.38.0
07D906262E	AUDI	7.05271.01.0	0824010098	BERU AG	7.05270.47.0
07D906262E	SEAT	7.05271.01.0	0824010121	BERU AG	7.05270.86.0
07D906262E	SKODA	7.05271.01.0	0824010129	BERU AG	7.05270.36.0
07D906262E	VOLKSWAGEN	7.05271.01.0	0824010139	BERU AG	7.05270.48.0
07L131101F	AUDI	7.06714.24.0	0824010143	BERU AG	7.05270.45.0
07L131101M	AUDI	7.06714.24.0	0824010152	BERU AG	7.02604.51.0
07L131101N	AUDI	7.06714.24.0	0824010159	BERU AG	7.05270.49.0
07L906262L	AUDI	7.05271.27.0	0824010162	BERU AG	7.05271.05.0
07L906262L	SEAT	7.05271.27.0	0824010164	BERU AG	7.05270.71.0
07L906262L	SKODA	7.05271.27.0	0824010169	BERU AG	7.02604.47.0
07L906262L	VOLKSWAGEN	7.05271.27.0	0824010177	BERU AG	7.05270.15.0
07L906262N	AUDI	7.05271.27.0	0824010184	BERU AG	7.05270.88.0
07L906262N	SEAT	7.05271.27.0	0824010185	BERU AG	7.05270.88.0
07L906262N	SKODA	7.05271.27.0	0824010187	BERU AG	7.05270.96.0
07L906262N	VOLKSWAGEN	7.05271.27.0	0824010202	BERU AG	7.02604.21.0
07L906262S	AUDI	7.05271.27.0	0824010203	BERU AG	7.05271.04.0
07L906262S	SEAT	7.05271.27.0	0824010207	BERU AG	7.02604.31.0
07L906262S	SKODA	7.05271.27.0	0824010211	BERU AG	7.05271.03.0
07L906262S	VOLKSWAGEN	7.05271.27.0	0824010214	BERU AG	7.02604.51.0
07L906265F	AUDI	7.05271.13.0	0824010215	BERU AG	7.05270.96.0
07L906265F	SEAT	7.05271.13.0	0824010218	BERU AG	7.02604.10.0
07L906265F	SKODA	7.05271.13.0	0824010224	BERU AG	7.05271.05.0
07L906265F	VOLKSWAGEN	7.05271.13.0	0824010239	BERU AG	7.05270.36.0
07L906265G	AUDI	7.05271.15.0	0824010240	BERU AG	7.05270.38.0
07L906265G	SEAT	7.05271.15.0	0824010252	BERU AG	7.02604.30.0
07L906265G	SKODA	7.05271.15.0	0824010254	BERU AG	7.05270.15.0
07L906265G	VOLKSWAGEN	7.05271.15.0	0824010258	BERU AG	7.02604.32.0
07L959231	AUDI	7.01486.10.0	085015N	DASIS VERTRIEBS GMBH	7.24809.77.0
07L959231C	AUDI	7.01486.10.0	0855412	OPEL	7.08369.32.0
07L959253	AUDI	7.01486.10.0	0855412	VAUXHALL	7.08369.32.0
07L959253A	AUDI	7.01486.08.0	0855415	OPEL	7.08369.38.0
07L959253B	AUDI	7.01486.10.0	0855415	VAUXHALL	7.08369.38.0
07L959253C	AUDI	7.01486.08.0	0855438	OPEL	7.08369.49.0
07L959253K	AUDI	7.05315.05.0	0855457	VAUXHALL	7.08369.46.0
07P906265B	VOLKSWAGEN	7.05271.11.0	0872674	MINI (BMW)	7.05271.72.0
07V906262E	AUDI	7.05271.24.0	0892001	METZGER	7.00063.10.0
07V906262E	SEAT	7.05271.24.0	0892003	METZGER	7.24809.10.0
07V906262E	SKODA	7.05271.24.0	0892004	METZGER	7.24809.39.0
07V906262E	VOLKSWAGEN	7.05271.24.0	0892005	METZGER	7.24809.06.0
07Z131501A	VOLKSWAGEN	7.24809.63.0	0892006	METZGER	7.24809.91.0
07Z906051	AUDI	7.11190.00.0	0892007	METZGER	7.24809.92.0
07Z906051	SKODA	7.11190.00.0	0892008	METZGER	7.24809.76.0
07Z906051	VOLKSWAGEN	7.11190.00.0	0892010	METZGER	7.22630.28.0
07Z906051A	AUDI	7.11190.00.0	0892012	METZGER	7.22414.08.0
07Z906051A	SKODA	7.11190.00.0	0892013	METZGER	7.24809.73.0
07Z906051A	VOLKSWAGEN	7.11190.00.0	0892024	METZGER	7.24809.07.0
07Z906051B	AUDI	7.11190.02.0	0892034	METZGER	7.22818.57.0
07Z906051B	SEAT	7.11190.02.0	0892035	METZGER	7.22818.59.0
07Z906051B	SKODA	7.11190.02.0	0892036	METZGER	7.22818.62.0
07Z906051B	VOLKSWAGEN	7.11190.02.0	0892037	METZGER	7.22818.63.0
08.16.009	TRUCKTEC	7.24809.50.0	0892038	METZGER	7.22875.16.0
	FAHRZEUGTEILE GM		0892039	METZGER	7.22946.38.0
08.16.014	TRUCKTEC	7.00512.03.0	0892040	METZGER	7.28384.13.0
	FAHRZEUGTEILE GM		0892041	METZGER	7.21920.62.0
08.16.015	TRUCKTEC	7.28264.07.0	0892044	METZGER	7.09002.05.0
	FAHRZEUGTEILE GM		0892047	METZGER	7.22785.16.0
			0892048	METZGER	7.22818.58.0



REF-No.	 PIERBURG	REF-No.	 PIERBURG
0892049	METZGER 7.22946.34.0	0892371	METZGER 7.01106.38.0
0892050	METZGER 7.22574.12.0	0892380	METZGER 7.24809.68.0
0892051	METZGER 7.28248.17.0	0892385	METZGER 7.24809.36.0
0892053	METZGER 7.11237.08.0	0892398	METZGER 7.03435.05.0
0892054	METZGER 7.24809.29.0	0892399	METZGER 7.24809.46.0
0892055	METZGER 7.22785.17.0	0892401	METZGER 7.24809.34.0
0892057	METZGER 7.28070.03.0	0892402	METZGER 7.24809.35.0
0892058	METZGER 7.22785.18.0	0892403	METZGER 7.24809.52.0
0892069	METZGER 7.01621.08.0	0892404	METZGER 7.24809.49.0
0892069	METZGER 7.24809.40.0	0892405	METZGER 7.24809.54.0
0892074	METZGER 7.00578.12.0	0892407	METZGER 7.24809.32.0
0892075	METZGER 7.00368.16.0	0892409	METZGER 7.24809.50.0
0892076	METZGER 7.24809.69.0	0892411	METZGER 7.24809.51.0
0892083	METZGER 7.00907.03.0	0892414	METZGER 7.24809.56.0
0892111	METZGER 7.02209.11.0	0892425	METZGER 7.00020.25.0
0892140	METZGER 7.24809.16.0	0892432	METZGER 7.10334.04.0
0892161	METZGER 7.24809.30.0	0892451	METZGER 7.24809.59.0
0892172	METZGER 7.03784.34.0	0892452	METZGER 7.24809.61.0
0892173	METZGER 7.00555.06.0	0892458	METZGER 7.09720.02.0
0892177	METZGER 7.00368.15.0	0892459	METZGER 7.09720.01.0
0892180	METZGER 7.01493.07.0	0892460	METZGER 7.09720.00.0
0892185	METZGER 7.22875.13.0	0892463	METZGER 7.11237.01.0
0892186	METZGER 7.28264.06.0	0892464	METZGER 7.09720.03.0
0892187	METZGER 7.00450.09.0	0892465	METZGER 7.10334.00.0
0892188	METZGER 7.00450.10.0	0892471	METZGER 7.24809.87.0
0892189	METZGER 7.22888.02.0	0892472	METZGER 7.24809.81.0
0892194	METZGER 7.22843.06.0	0892478	METZGER 7.04512.08.0
0892196	METZGER 7.22477.10.0	0892479	METZGER 7.00309.07.0
0892204	METZGER 7.28264.07.0	0892486	METZGER 7.10334.03.0
0892205	METZGER 7.00684.14.0	0892500	METZGER 7.24809.74.0
0892206	METZGER 7.03196.09.0	0892503	METZGER 7.03051.04.0
0892208	METZGER 7.24809.20.0	0892513	METZGER 7.02156.33.0
0892209	METZGER 7.01782.07.0	0892514	METZGER 7.02156.34.0
0892210	METZGER 7.22414.07.0	0892517	METZGER 7.03622.09.0
0892220	METZGER 7.05574.00.0	0892519	METZGER 7.22996.12.0
0892221	METZGER 7.05574.01.0	0892527	METZGER 7.24809.28.0
0892225	METZGER 7.22286.51.0	0892529	METZGER 7.24809.69.0
0892226	METZGER 7.22286.52.0	0892548	METZGER 7.22414.04.0
0892227	METZGER 7.22286.53.0	0892551	METZGER 7.03571.16.0
0892229	METZGER 7.22560.40.0	0892552	METZGER 7.24809.77.0
0892230	METZGER 7.22560.41.0	0892558	METZGER 7.09730.00.0
0892232	METZGER 7.22560.43.0	0892576	METZGER 7.10992.00.0
0892233	METZGER 7.22560.44.0	0892577	METZGER 7.11010.00.0
0892238	METZGER 7.22778.94.0	0892578	METZGER 7.22785.20.0
0892239	METZGER 7.22778.95.0	0892595	METZGER 7.09720.04.0
0892240	METZGER 7.22778.96.0	0892597	METZGER 7.02209.20.0
0892247	METZGER 7.28238.55.0	0892598	METZGER 7.05320.04.0
0892248	METZGER 7.28238.56.0	0892637	METZGER 7.24809.88.0
0892249	METZGER 7.28238.61.0	0892642	METZGER 7.24809.99.0
0892250	METZGER 7.28238.58.0	0892643	METZGER 7.11237.06.0
0892251	METZGER 7.22295.68.0	0892646	METZGER 7.24809.94.0
0892252	METZGER 7.22295.61.0	0892721	METZGER 7.07696.00.0
0892253	METZGER 7.22295.62.0	0892726	METZGER 7.28290.11.0
0892254	METZGER 7.22769.73.0	0892735	METZGER 7.10993.00.0
0892255	METZGER 7.22938.06.0	0893008	METZGER 7.05271.62.0
0892260	METZGER 7.00512.03.0	0893013	METZGER 7.05271.52.0
0892261	METZGER 7.00306.36.0	0893077	METZGER 7.05271.68.0
0892319	METZGER 7.02156.24.0	0893105	METZGER 7.05271.65.0
0892325	METZGER 7.24809.70.0	0893106	METZGER 7.05271.59.0
0892326	METZGER 7.10334.07.0	0893128	METZGER 7.05271.54.0
0892330	METZGER 7.24809.17.0	0893144	METZGER 7.05271.37.0
0892331	METZGER 7.24809.19.0	0893167	METZGER 7.05271.39.0
0892334	METZGER 7.24809.31.0	0893320	METZGER 7.05271.58.0
0892341	METZGER 7.24809.47.0	0893327	METZGER 7.05271.75.0
0892342	METZGER 7.24809.33.0	0893349	METZGER 7.05271.22.0
0892344	METZGER 7.00020.39.0	0893359	METZGER 7.05271.67.0
0892346	METZGER 7.22946.34.0	0893402	METZGER 7.02604.41.0
0892356	METZGER 7.02107.09.0	0893581	METZGER 7.05271.71.0
0892357	METZGER 7.00018.50.0	0894001	METZGER 7.08369.04.0



REF-No.	 PIERBURG	REF-No.	 PIERBURG
0894002	METZGER 7.08369.06.0	0894171	METZGER 7.08369.64.0
0894003	METZGER 7.08369.01.0	0894182	METZGER 7.08369.94.0
0894004	METZGER 7.08369.26.0	0894183	METZGER 7.08369.66.0
0894005	METZGER 7.08369.17.0	0894197	METZGER 7.08369.43.0
0894006	METZGER 7.08369.03.0	0894199	METZGER 7.08369.68.0
0894007	METZGER 7.08369.02.0	0894206	METZGER 7.08369.69.0
0894008	METZGER 7.08369.14.0	0894209	METZGER 7.08369.99.0
0894009	METZGER 7.08369.13.0	0894211	METZGER 7.08369.98.0
0894011	METZGER 7.08369.00.0	0894214	METZGER 7.08369.70.0
0894013	METZGER 7.08369.07.0	0894227	METZGER 7.08369.54.0
0894014	METZGER 7.08369.19.0	0894261	METZGER 7.11020.49.0
0894015	METZGER 7.08369.20.0	0894287	METZGER 7.08369.41.0
0894016	METZGER 7.08369.83.0	0894296	METZGER 7.11020.03.0
0894018	METZGER 7.11020.35.0	0894298	METZGER 7.08369.34.0
0894019	METZGER 7.08369.16.0	0894299	METZGER 7.08369.87.0
0894020	METZGER 7.08369.45.0	0894300	METZGER 7.08369.72.0
0894023	METZGER 7.08369.08.0	0894305	METZGER 7.08369.86.0
0894024	METZGER 7.08369.46.0	0894345	METZGER 7.11020.29.0
0894026	METZGER 7.08369.01.0	0894349	METZGER 7.11020.32.0
0894031	METZGER 7.08369.05.0	0894365	METZGER 7.11020.18.0
0894034	METZGER 7.08369.37.0	0894367	METZGER 7.11020.21.0
0894037	METZGER 7.11020.13.0	0894382	METZGER 7.08369.73.0
0894038	METZGER 7.11020.45.0	0894399	METZGER 7.08369.24.0
0894045	METZGER 7.08369.12.0	0894402	METZGER 7.08369.95.0
0894047	METZGER 7.08369.42.0	0894405	METZGER 7.11020.01.0
0894048	METZGER 7.08369.32.0	0894417	METZGER 7.11020.42.0
0894049	METZGER 7.08369.09.0	0894496	METZGER 7.08369.30.0
0894052	METZGER 7.11020.00.0	0894502	METZGER 7.11020.04.0
0894056	METZGER 7.08369.51.0	0894510	METZGER 7.11020.24.0
0894061	METZGER 7.11020.44.0	0894512	METZGER 7.11020.23.0
0894066	METZGER 7.08369.18.0	0894529	METZGER 7.11020.26.0
0894067	METZGER 7.08369.15.0	0894532	METZGER 7.11020.31.0
0894068	METZGER 7.08369.22.0	0894533	METZGER 7.11020.22.0
0894072	METZGER 7.08369.31.0	0894551	METZGER 7.08369.11.0
0894074	METZGER 7.11020.02.0	0894602	METZGER 7.08369.35.0
0894076	METZGER 7.08369.91.0	0894603	METZGER 7.11020.08.0
0894081	METZGER 7.11020.07.0	0894609	METZGER 7.11020.15.0
0894085	METZGER 7.08369.55.0	0894610	METZGER 7.11020.37.0
0894087	METZGER 7.11020.14.0	0894612	METZGER 7.08369.92.0
0894088	METZGER 7.08369.27.0	0894646	METZGER 7.11020.33.0
0894089	METZGER 7.08369.96.0	0895161	METZGER 7.05271.55.0
0894090	METZGER 7.08369.52.0	0895293	METZGER 7.05271.72.0
0894091	METZGER 7.11020.28.0	0895473	METZGER 7.05271.74.0
0894092	METZGER 7.08369.23.0	0899013	METZGER 7.21851.31.0
0894093	METZGER 7.11020.19.0	0899014	METZGER 7.22166.00.0
0894100	METZGER 7.11020.20.0	0899015	METZGER 7.04389.02.0
0894102	METZGER 7.08369.56.0	0899016	METZGER 7.04389.00.0
0894103	METZGER 7.11020.11.0	0899017	METZGER 7.28124.19.0
0894106	METZGER 7.11020.12.0	0899018	METZGER 7.28124.20.0
0894108	METZGER 7.11020.09.0	0899019	METZGER 7.21852.24.0
0894110	METZGER 7.08369.39.0	0899020	METZGER 7.03635.12.0
0894111	METZGER 7.08369.57.0	0899021	METZGER 7.22934.57.0
0894112	METZGER 7.08369.58.0	0899022	METZGER 7.22166.66.0
0894114	METZGER 7.08369.59.0	0899025	METZGER 7.21857.01.0
0894115	METZGER 7.11020.06.0	0899026	METZGER 7.22166.02.0
0894116	METZGER 7.08369.60.0	0899027	METZGER 7.21852.85.0
0894117	METZGER 7.08369.25.0	0899043	METZGER 7.22934.63.0
0894122	METZGER 7.08369.40.0	0899059	METZGER 7.22738.08.0
0894125	METZGER 7.11020.25.0	0906029	METZGER 7.11492.01.0
0894129	METZGER 7.08369.78.0	0906030	METZGER 7.11190.08.0
0894133	METZGER 7.11020.30.0	0906155	METZGER 7.11190.02.0
0894135	METZGER 7.08369.61.0	0906286	METZGER 7.11492.05.0
0894135	METZGER 7.11020.16.0	0906304	METZGER 7.11492.07.0
0894154	METZGER 7.08369.21.0	0906400	METZGER 7.11190.12.0
0894155	METZGER 7.08369.33.0	09157671	VAUXHALL 7.22875.13.0
0894163	METZGER 7.08369.62.0	09196675	OPEL 7.24809.29.0
0894165	METZGER 7.08369.44.0	09196675	VAUXHALL 7.24809.29.0
0894166	METZGER 7.08369.63.0	09202575	OPEL 7.05271.55.0
0894167	METZGER 7.08369.36.0	095036N	DASIS VERTRIEBS GMBH 7.03784.34.0

REF-No.			REF-No.		
095037N	DASIS VERTRIEBS GMBH	7.01621.08.0	100823	FEBI	7.08369.12.0
0986259000	BOSCH	7.08369.35.0	100825	FEBI	7.08369.77.0
0986259003	BOSCH	7.11020.38.0	100832	FEBI	7.08369.51.0
0986259005	BOSCH	7.11020.00.0	100833	FEBI	7.08369.30.0
0986259008	BOSCH	7.11020.45.0	100835	FEBI	7.08369.61.0
0986259010	BOSCH	7.11020.04.0	100844	FEBI	7.08369.01.0
0986259011	BOSCH	7.08369.14.0	100846	FEBI	7.08369.42.0
0986259013	BOSCH	7.08369.97.0	100848	FEBI	7.08369.37.0
0986259015	BOSCH	7.08369.01.0	1008490104	AUTOMEGA	7.24809.24.0
0986259021	BOSCH	7.08369.05.0	1008490104	AUTOMEGA	7.24809.27.0
0986259022	BOSCH	7.11020.40.0	1008490156	AUTOMEGA	7.24809.25.0
0986259025	BOSCH	7.08369.30.0	1008490156	AUTOMEGA	7.24809.28.0
0986259028	BOSCH	7.08369.19.0	1008510038	AUTOMEGA	7.24809.10.0
0986259029	BOSCH	7.08369.38.0	1008510288	AUTOMEGA	7.24809.78.0
0986259031	BOSCH	7.08369.08.0	1008510341	AUTOMEGA	7.00063.10.0
0986259032	BOSCH	7.11020.10.0	1008510364	AUTOMEGA	7.00020.24.0
0986259036	BOSCH	7.11020.21.0	1008510368	AUTOMEGA	7.00020.25.0
0986259037	BOSCH	7.11020.19.0	1008510593	AUTOMEGA	7.22875.13.0
0986259038	BOSCH	7.11020.12.0	1008510706	AUTOMEGA	7.22414.04.0
0986259045	BOSCH	7.11020.02.0	100872	FEBI	7.10334.07.0
0986259046	BOSCH	7.11020.18.0	1010006	FORD	7.02604.63.0
0986259048	BOSCH	7.11020.37.0	10100549	SWAG	7.24809.59.0
0986259052	BOSCH	7.08369.34.0	10100823	SWAG	7.08369.12.0
0986259055	BOSCH	7.11020.41.0	10100833	SWAG	7.08369.30.0
0986259057	BOSCH	7.11020.07.0	1010620	FORD	7.02604.61.0
0986259058	BOSCH	7.11020.03.0	101310501038AQ	AUTOMEGA	7.24809.19.0
0986259060	BOSCH	7.08369.86.0	101310503036T	AUTOMEGA	7.28248.17.0
0986259061	BOSCH	7.08369.89.0	1013764	FORD	7.02604.61.0
0986259064	BOSCH	7.08369.04.0	1022476	FORD	7.05270.88.0
0986259066	BOSCH	7.08369.82.0	102597	FEBI	7.22818.57.0
0986259068	BOSCH	7.08369.03.0	1026160FA230	NAVISTAR	7.11492.03.0
0986259070	BOSCH	7.08369.84.0	102618	FEBI	7.09730.00.0
0986259072	BOSCH	7.08369.02.0	102665	FEBI	7.24809.70.0
0986259073	BOSCH	7.08369.95.0	102800	FEBI	7.24809.88.0
0986259077	BOSCH	7.08369.26.0	102844	FEBI	7.24809.75.0
0986259078	BOSCH	7.08369.94.0	1029790	FORD	7.22090.11.0
0986259079	BOSCH	7.11020.28.0	103437	FEBI	7.24809.68.0
0986259080	BOSCH	7.11020.17.0	1035595	FORD	7.02604.60.0
0986259082	BOSCH	7.11020.08.0	103571	FEBI	7.24809.77.0
0986259083	BOSCH	7.11020.20.0	103572	FEBI	7.24809.07.0
0986259086	BOSCH	7.11020.11.0	103574	FEBI	7.03784.34.0
0986280714	BOSCH	7.11492.01.0	103576	FEBI	7.01621.08.0
0986280715	BOSCH	7.11492.03.0	104400	FEBI	7.24809.87.0
0986280719	BOSCH	7.11492.07.0	104401	FEBI	7.24809.87.0
0986280725	BOSCH	7.11492.05.0	1044150923	AUTOMEGA	7.22818.59.0
0986AG2204	BOSCH	7.05271.67.0	1044150923	AUTOMEGA	7.22818.63.0
OK32A-18-861	KIA	7.02604.77.0	104416	FEBI	7.22875.13.0
OK32B-18-861	KIA	7.02604.77.0	104801	FEBI	7.24809.81.0
OK900-18-861	KIA	7.02604.01.0	1053108	FORD	7.02604.60.0
OK9A5-18-861	KIA	7.02604.03.0	1058510027	AUTOMEGA	7.22414.07.0
OPB131139	PORSCHE	7.22938.06.0	1058510029	AUTOMEGA	7.22414.08.0
OPB131139A	PORSCHE	7.22938.06.0	1058510057	AUTOMEGA	7.22875.16.0
OPH089	BERU AG	7.05271.37.0	1058510580	AUTOMEGA	7.22630.28.0
1,72E+11	MAGNETI MARELLI	7.08369.31.0	1058510594	AUTOMEGA	7.24809.29.0
1000169	FORD	7.05270.88.0	106648	FEBI	7.03784.34.0
1001702	FORD	7.02604.61.0	1067580	FORD	7.02604.64.0
100275	FEBI	7.10334.04.0	107161	FEBI	7.24809.68.0
100276	FEBI	7.10334.09.0	107782	FEBI	7.00020.25.0
10042186	GMC	7.02604.01.0	107783	FEBI	7.24809.17.0
100549	FEBI	7.24809.59.0	107784	FEBI	7.10334.07.0
100562	FEBI	7.09720.00.0	107785	FEBI	7.00823.06.0
100801	FEBI	7.08369.26.0	107786	FEBI	7.24809.06.0
100804	FEBI	7.08369.19.0	107787	FEBI	7.00684.14.0
100807	FEBI	7.08369.24.0	108786	FEBI	7.00368.16.0
100808	FEBI	7.08369.79.0	108787	FEBI	7.24809.26.0
100815	FEBI	7.08369.50.0	108841	FEBI	7.24809.79.0
100819	FEBI	7.08369.35.0	108842	FEBI	7.24809.86.0
100821	FEBI	7.08369.09.0	1088851	FORD	7.02604.64.0
100822	FEBI	7.08369.46.0	108909	FEBI	7.00368.15.0



REF-No.		 PIERBURG	REF-No.		 PIERBURG
109141	FEBI	7.24809.19.0	1148000111	MEYLE	7.08369.19.0
1094175	FORD	7.02604.60.0	1148000112	MEYLE	7.08369.48.0
10948839	SWAG	7.08369.06.0	1148000114	MEYLE	7.08369.44.0
10949299	SWAG	7.08369.76.0	1148000115	MEYLE	7.08369.21.0
109633	FEBI	7.10334.08.0	1148000119	MEYLE	7.08369.45.0
109636	FEBI	7.24809.92.0	1148000133	MEYLE	7.08369.73.0
11.16500	DT-DIESEL TECHNIC AG	7.24809.52.0	1148000139	MEYLE	7.08369.62.0
11.80629	DT-DIESEL TECHNIC AG	7.08369.39.0	1148000144	MEYLE	7.08369.42.0
1100628	FORD	7.24809.19.0	1148000150	MEYLE	7.08369.23.0
1108510038	AUTOMEGA	7.24809.10.0	1148000153	MEYLE	7.08369.65.0
1108510341	AUTOMEGA	7.00063.10.0	1148000154	MEYLE	7.08369.66.0
1108510342	AUTOMEGA	7.22946.38.0	1148000167	MEYLE	7.08369.11.0
1108510364	AUTOMEGA	7.00020.24.0	1148000195	MEYLE	7.08369.39.0
1108510368	AUTOMEGA	7.00020.25.0	1148070	FORD	7.02604.60.0
1108640	FORD	7.02604.64.0	1148077	FORD	7.24809.06.0
1108795	FORD	7.02604.63.0	1158510057	AUTOMEGA	7.22875.16.0
1109004	FORD	7.05271.77.0	1158510586	AUTOMEGA	7.28384.13.0
1110671	FORD	7.22738.08.0	1166460	VALEO	7.22843.06.0
1110702	FORD	7.22738.08.0	116851101600	ALFA ROMEO	7.02604.01.0
111310501038AH	AUTOMEGA	7.22477.11.0	116851101600/00	ALFA ROMEO	7.02604.01.0
1113382	FORD	7.02604.60.0	116969	TOPRAN	7.08369.04.0
1116180NR	AUTOMEGA	7.24809.39.0	11712246145	BMW	7.21920.62.0
1119320	FORD	7.24809.20.0	11712247177	BMW	7.21920.62.0
1119890	FORD	7.24809.73.0	11712248139	BMW	7.21920.62.0
112016	FIAT	7.02604.01.0	11717563241	BMW	7.24809.50.0
112016	LANCIA	7.02604.01.0	11717785452	BMW	7.28264.06.0
1123897	FORD	7.02604.60.0	11717789999	BMW	7.28264.07.0
11311009701	VIKA	7.22785.17.0	11717792077	BMW	7.00512.03.0
113163	TOPRAN	7.24809.31.0	11717793484	BMW	7.00450.09.0
1134210	FORD	7.24809.73.0	11717801942	BMW	7.00684.14.0
113755	TOPRAN	7.22785.17.0	11717804351	BMW	7.00450.10.0
114283	TOPRAN	7.22738.08.0	11717804352	BMW	7.00450.10.0
1143514	FORD	7.02604.60.0	11717804378	BMW	7.28264.06.0
1144300902	AUTOMEGA	7.22818.57.0	11717804379	BMW	7.28264.07.0
11451	OSSCA	7.21852.24.0	11717804380	BMW	7.00450.09.0
1148000046	MEYLE	7.08369.00.0	11717804381	BMW	7.00512.03.0
1148000047	MEYLE	7.08369.01.0	11717804382	BMW	7.00450.09.0
1148000048	MEYLE	7.08369.04.0	11717804950	MINI (BMW)	7.24809.39.0
1148000049	MEYLE	7.08369.03.0	11717805447	BMW	7.10334.07.0
1148000050	MEYLE	7.08369.02.0	11717810871	BMW	7.10334.07.0
1148000052	MEYLE	7.08369.07.0	11717823210	BMW	7.10992.00.0
1148000053	MEYLE	7.08369.14.0	11717823316	BMW	7.03051.04.0
1148000054	MEYLE	7.08369.16.0	11718474377	BMW	7.05343.18.0
1148000055	MEYLE	7.08369.26.0	11718476680	BMW	7.07417.39.0
1148000056	MEYLE	7.08369.09.0	11718479637	BMW	7.05838.08.0
1148000057	MEYLE	7.08369.08.0	11718513132	BMW	7.04493.17.0
1148000058	MEYLE	7.08369.53.0	11718513132	MINI (BMW)	7.04493.17.0
1148000063	MEYLE	7.08369.13.0	11718513691	BMW	7.11010.00.0
1148000064	MEYLE	7.08369.18.0	11718517724	BMW	7.10993.00.0
1148000065	MEYLE	7.08369.22.0	11718574815	BMW	7.05343.18.0
1148000066	MEYLE	7.08369.31.0	11718576810	BMW	7.05838.08.0
1148000067	MEYLE	7.08369.24.0	11718580442	BMW	7.04493.17.0
1148000070	MEYLE	7.08369.41.0	11718594492	BMW	7.04493.17.0
1148000072	MEYLE	7.08369.34.0	11718594492	MINI (BMW)	7.04493.17.0
1148000076	MEYLE	7.08369.33.0	11719886714	BMW	7.10334.07.0
1148000077	MEYLE	7.08369.36.0	11721427078	BMW	7.22295.61.0
1148000078	MEYLE	7.08369.63.0	11721433713	BMW	7.22295.66.0
1148000081	MEYLE	7.08369.40.0	11721433818	BMW	7.22166.38.0
1148000083	MEYLE	7.08369.20.0	11721433900	BMW	7.21852.82.0
1148000086	MEYLE	7.08369.37.0	11721433958	BMW	7.22166.02.0
1148000088	MEYLE	7.08369.68.0	11721433959	BMW	7.22166.66.0
1148000089	MEYLE	7.08369.50.0	11721435364	BMW	7.21852.24.0
1148000091	MEYLE	7.08369.58.0	11721435365	BMW	7.22166.50.0
1148000099	MEYLE	7.08369.72.0	11721435420	BMW	7.22295.62.0
1148000102	MEYLE	7.08369.47.0	11721435811	BMW	7.22295.67.0
1148000104	MEYLE	7.08369.56.0	11721437015	BMW	7.22295.63.0
1148000106	MEYLE	7.08369.25.0	11721437700	BMW	7.22166.39.0
1148000108	MEYLE	7.08369.43.0	11721437910	BMW	7.22166.65.0
1148000109	MEYLE	7.08369.01.0	11721437911	BMW	7.22166.52.0

NUMBERFINDER



REF-No.		 PIERBURG	REF-No.		 PIERBURG
11721437911	BMW	7.22166.64.0	11781286638	BMW	7.02604.03.0
11721707585	BMW	7.22166.20.0	11781401276	BMW	7.02604.04.0
11721707589	BMW	7.21852.78.0	11781404696	BMW	7.02604.28.0
11721707619	BMW	7.22295.68.0	11781404697	BMW	7.02604.30.0
11721708575	BMW	7.22295.69.0	11781405324	BMW	7.05270.03.0
11721715293	BMW	7.22166.50.0	11781406621	BMW	7.02604.28.0
11721715347	BMW	7.22166.00.0	11781427884	BMW	7.05271.70.0
11721744255	BMW	7.22295.70.0	11781433075	BMW	7.02604.31.0
11721744490	BMW	7.21852.85.0	11781433940	BMW	7.02604.21.0
11721745907	BMW	7.22295.71.0	11781437586	BMW	7.02604.30.0
11727500378	BMW	7.22295.67.0	11781464492	BMW	7.02604.04.0
11727505993	BMW	7.28238.55.0	11781716156	BMW	7.02604.03.0
11727506210	BMW	7.28124.19.0	11781730025	BMW	7.05271.70.0
11727508049	BMW	7.28238.58.0	11781739846	BMW	7.02604.31.0
11727508273	BMW	7.28238.56.0	11781742050	BMW	7.02604.31.0
11727513890	BMW	7.28129.14.0	11781742053	BMW	7.02604.04.0
11727514858	BMW	7.28238.57.0	11781748762	BMW	7.02604.38.0
11727514953	BMW	7.28124.20.0	11787506539	BMW	7.02604.32.0
11727515008	BMW	7.22295.65.0	11787506939	BMW	7.02604.32.0
11727519310	BMW	7.28124.21.0	11787512002	BMW	7.02604.32.0
11727520225	BMW	7.28129.22.0	11787512567	BMW	7.02604.32.0
11727523306	BMW	7.22295.65.0	11787512973	BMW	7.02604.32.0
11727523530	BMW	7.28238.61.0	11787512982	BMW	7.05271.22.0
11727527598	BMW	7.28129.32.0	11787513962	BMW	7.02604.31.0
11727533043	BMW	7.22166.50.0	11787513963	BMW	7.02604.21.0
11727540466	BMW	7.22295.70.0	11787516149	BMW	7.05271.22.0
11727540467	BMW	7.22295.71.0	11787516150	BMW	7.05271.23.0
11727540468	BMW	7.22295.61.0	11787521705	BMW	7.05271.22.0
11727540469	BMW	7.22295.62.0	11787526262	BMW	7.02604.34.0
11727540471	BMW	7.22295.63.0	11787530282	BMW	7.05271.22.0
11727540472	BMW	7.22295.67.0	11787530283	BMW	7.05271.23.0
11727553056	BMW	7.21852.24.0	11787530736	BMW	7.05271.23.0
11727553063	BMW	7.22295.62.0	11787535269	BMW	7.02604.41.0
11727553064	BMW	7.22295.65.0	11787537984	BMW	7.02604.99.0
11727553066	BMW	7.28238.61.0	11787537993	BMW	7.02604.99.0
11727553067	BMW	7.28238.58.0	11787539123	BMW	7.05270.21.0
11727553068	BMW	7.28238.55.0	11787539124	BMW	7.05270.21.0
11727553101	BMW	7.28238.56.0	11787539125	BMW	7.02604.25.0
11727553102	BMW	7.28238.57.0	11787539126	BMW	7.02604.34.0
11727553102	ROLLS-ROYCE	7.28238.57.0	11787539136	BMW	7.02604.34.0
11727557909	BMW	7.01318.20.0	11787539137	BMW	7.02604.26.0
11727571589	BMW	7.28124.19.0	11787540166	BMW	7.02604.42.0
11727571591	BMW	7.28124.20.0	11787540167	BMW	7.02604.42.0
11727571592	BMW	7.28124.21.0	11787540168	BMW	7.05270.21.0
11727572084	BMW	7.28129.52.0	11787544654	BMW	7.02604.25.0
11727573932	BMW	7.22295.65.0	11787544655	BMW	7.02604.26.0
11727577709	BMW	7.01318.24.0	11787545074	BMW	7.02604.34.0
11727830679	BMW	7.21852.79.0	11787545075	BMW	7.02604.26.0
11727830680	BMW	7.22748.18.0	11787545243	BMW	7.02604.34.0
11727832045	BMW	7.21852.79.0	11787545244	BMW	7.02604.27.0
11727837138	BMW	7.21852.79.0	11787548961	BMW	7.05271.74.0
11727837456	BMW	7.22748.18.0	11787549860	MINI (BMW)	7.02604.41.0
11727838028	BMW	7.28238.62.0	11787557223	BMW	7.02604.42.0
11727838029	BMW	7.28238.63.0	11787557758	BMW	7.02604.43.0
11727838313	BMW	7.28124.30.0	11787558054	BMW	7.02604.42.0
11737672792	BMW MOTORCYCLES	7.00411.05.0	11787558073	BMW	7.02604.42.0
11737681005	BMW MOTORCYCLES	7.00411.05.0	11787558087	BMW	7.02604.43.0
11737694376	BMW MOTORCYCLES	7.01859.03.0	11787558179	BMW	7.02604.25.0
11737694806	BMW MOTORCYCLES	7.01240.03.0	11787561410	BMW	7.02604.41.0
11737708937	BMW MOTORCYCLES	7.00748.06.0	11787561410	ROLLS-ROYCE	7.02604.41.0
117552	TOPRAN	7.08369.39.0	11787569930	BMW	7.02604.41.0
11761277565	BMW	7.02604.01.0	11787569968	BMW	7.02604.34.0
11761466063	BMW	7.02604.01.0	11787570480	BMW	7.02604.26.0
11780149835	BMW	7.02604.25.0	11787570481	BMW	7.02604.26.0
11780416260	BMW	7.02604.25.0	11787573319	BMW	7.02604.42.0
11780418078	BMW	7.02604.41.0	11787577666	BMW	7.02604.34.0
11780872674	BMW	7.05271.72.0	11787577667	BMW	7.02604.27.0
11781247406	BMW	7.02604.31.0	11787586693	BMW	7.02604.42.0
11781277565	BMW	7.02604.01.0	11787589138	BMW	7.02604.42.0

REF-No.		 PIERBURG	REF-No.		 PIERBURG
11787614322	BMW	7.02604.34.0	12229	MEAT&DORIA	7.08369.56.0
11787651149	BMW	7.05271.22.0	12238	MEAT&DORIA	7.08369.68.0
11787832035	BMW	7.02604.28.0	12245	MEAT&DORIA	7.08369.73.0
11787836451	BMW	7.02604.32.0	12249	MEAT&DORIA	7.08369.64.0
118220	TOPRAN	7.03635.39.0	12252	MEAT&DORIA	7.08369.42.0
118485	TOPRAN	7.22934.63.0	12254	MEAT&DORIA	7.08369.59.0
11916	MEAT&DORIA	7.08369.03.0	12256	MEAT&DORIA	7.08369.24.0
11916	MEAT&DORIA	7.08369.04.0	12258	MEAT&DORIA	7.08369.52.0
11917	MEAT&DORIA	7.08369.26.0	12261	MEAT&DORIA	7.08369.01.0
11918	MEAT&DORIA	7.08369.09.0	12264	MEAT&DORIA	7.08369.51.0
11919	MEAT&DORIA	7.08369.34.0	12307	MEAT&DORIA	7.08369.20.0
11921	MEAT&DORIA	7.08369.37.0	1231964	FORD	7.24809.68.0
11924	MEAT&DORIA	7.08369.72.0	1233381	FORD	7.09730.00.0
11926	MEAT&DORIA	7.08369.43.0	12442	MEAT&DORIA	7.08369.80.0
11928	MEAT&DORIA	7.08369.01.0	1247406	BMW	7.02604.31.0
11929	MEAT&DORIA	7.08369.07.0	1247419	OPEL	7.11190.03.0
11930	MEAT&DORIA	7.08369.41.0	1247419	VAUXHALL	7.11190.03.0
11931	MEAT&DORIA	7.08369.19.0	1247539	OPEL	7.11020.41.0
11933	MEAT&DORIA	7.08369.00.0	1247539	VAUXHALL	7.11020.41.0
11935	MEAT&DORIA	7.08369.02.0	1247806	OPEL	7.11020.27.0
11937	MEAT&DORIA	7.08369.08.0	1247806	VAUXHALL	7.11020.27.0
11939	MEAT&DORIA	7.08369.14.0	1249064	CHEVROLET	7.11020.42.0
11940	MEAT&DORIA	7.08369.16.0	1249064	OPEL	7.11020.42.0
11941	MEAT&DORIA	7.08369.21.0	1249064	VAUXHALL	7.11020.42.0
11942	MEAT&DORIA	7.08369.25.0	1254382	FORD	7.24809.92.0
11943	MEAT&DORIA	7.08369.05.0	1254739	FORD	7.02604.64.0
11944	MEAT&DORIA	7.08369.32.0	12565428	OPEL	7.05270.29.0
11949	MEAT&DORIA	7.08369.38.0	12565428	VAUXHALL	7.05270.29.0
11950	MEAT&DORIA	7.08369.46.0	12565517	OPEL	7.22630.28.0
11951	MEAT&DORIA	7.08369.17.0	12565517	VAUXHALL	7.22630.28.0
11959	MEAT&DORIA	7.08369.54.0	12567680	OPEL	7.05270.30.0
11963	MEAT&DORIA	7.08369.06.0	12567680	VAUXHALL	7.05270.30.0
11968	MEAT&DORIA	7.08369.60.0	12567681	OPEL	7.05270.30.0
11972	MEAT&DORIA	7.08369.12.0	12567681	VAUXHALL	7.05270.30.0
11980	MEAT&DORIA	7.08369.30.0	12569391	OPEL	7.05270.29.0
11985	MEAT&DORIA	7.08369.35.0	12569391	VAUXHALL	7.05270.29.0
11995	MEAT&DORIA	7.08369.57.0	12569552	OPEL	7.22630.28.0
1199900200	JP GROUP	7.22738.08.0	12569552	VAUXHALL	7.22630.28.0
11H0100CP.02	MCLAREN	7.05270.17.0	12571041	OPEL	7.22630.28.0
12.27003	DT-DIESEL TECHNIC AG	7.24809.51.0	12571041	VAUXHALL	7.22630.28.0
12.27004	DT-DIESEL TECHNIC AG	7.24809.70.0	12571768	BUICK	7.05271.81.0
12004	MEAT&DORIA	7.08369.27.0	12571768	CHEVROLET	7.05271.81.0
12006	MEAT&DORIA	7.08369.55.0	12571768	OPEL	7.05271.81.0
12007	MEAT&DORIA	7.08369.69.0	12571768	VAUXHALL	7.05271.81.0
12056	MEAT&DORIA	7.08369.44.0	12620176	BUICK	7.02604.99.0
12057	MEAT&DORIA	7.08369.13.0	12620176	OPEL	7.02604.99.0
12084	MEAT&DORIA	7.08369.70.0	12620176	SAAB	7.02604.99.0
1208560	FORD	7.02604.60.0	12625219	GENERAL MOTORS	7.01317.10.0
12088	MEAT&DORIA	7.08369.15.0	12637806	GENERAL MOTORS	7.05012.01.0
12090	MEAT&DORIA	7.08369.67.0	1270557	VOLVO	7.21857.59.0
12104	MEAT&DORIA	7.08369.76.0	1270558	VOLVO	7.21857.59.0
1211356	FORD	7.24809.73.0	1271765	VOLVO	7.22299.03.0
12120	MEAT&DORIA	7.08369.61.0	1271998	VOLVO	7.02604.04.0
1212966	FORD	7.24809.20.0	1274367	VOLVO	7.02604.01.0
1215538	FORD	7.02604.64.0	1274746	VOLVO	7.02604.01.0
12162	MEAT&DORIA	7.08369.36.0	1276951	VOLVO	7.02604.01.0
12163	MEAT&DORIA	7.08369.33.0	12788129	SAAB	7.05270.27.0
12164	MEAT&DORIA	7.08369.63.0	12791285	SAAB	7.22936.08.0
12166	MEAT&DORIA	7.08369.22.0	13.45001	DT-DIESEL TECHNIC AG	7.03784.34.0
12167	MEAT&DORIA	7.08369.40.0	13.45006	DT-DIESEL TECHNIC AG	7.24809.07.0
1219142	VOLVO	7.02604.01.0	1300544	FORD	7.02604.64.0
1220819	FORD	7.24809.07.0	1302221	FORD	7.02604.64.0
12212	MEAT&DORIA	7.08369.62.0	1306214	FORD	7.02604.64.0
12213	MEAT&DORIA	7.08369.58.0	1309292	FORD	7.02604.64.0
12216	MEAT&DORIA	7.08369.23.0	13103981	OPEL	7.05271.81.0
12222	MEAT&DORIA	7.08369.45.0	13103981	VAUXHALL	7.05271.81.0
12223	MEAT&DORIA	7.08369.31.0	1313847	FORD	7.24809.92.0
12225	MEAT&DORIA	7.08369.39.0	1315684	FORD	7.11190.10.0
12226	MEAT&DORIA	7.08369.18.0	1322705	FORD	7.02604.64.0

REF-No.			REF-No.		
1322706	FORD	7.02604.65.0	137065	HITACHI LI	7.08369.33.0
1326415	FORD	7.02604.64.0	137066	HITACHI	7.08369.36.0
1326416	FORD	7.02604.64.0	137066	HITACHI LI	7.08369.36.0
1327547	FORD	7.02604.64.0	137084	HITACHI LI	7.11020.38.0
1327548	FORD	7.02604.64.0	137092	HITACHI	7.08369.15.0
1333572	FORD	7.24809.07.0	137092	HITACHI LI	7.08369.15.0
1333611	FORD	7.24809.76.0	137405	HITACHI LI	7.11190.10.0
133393	HITACHI LI	7.05271.22.0	137407	HITACHI LI	7.11492.03.0
1337	NGK	7.05271.18.0	137408	HITACHI LI	7.11190.04.0
13370	STANDARD	7.02604.64.0	1374195	FORD	7.02604.64.0
13371	STANDARD	7.02604.64.0	1376242	FORD	7.24809.72.0
13372	STANDARD	7.02604.64.0	1376444	FORD	7.02604.64.0
13375	STANDARD	7.02604.64.0	1384616	FORD	7.24809.70.0
1338	NGK	7.02604.77.0	138464	HITACHI	7.24809.19.0
1338178	OPEL	7.04879.00.0	138468	HITACHI	7.24809.70.0
1338178	VAUXHALL	7.04879.00.0	138473	HITACHI	7.24809.20.0
1338675	FORD	7.24809.39.0	138477	HITACHI	7.22946.38.0
1339	NGK	7.02604.77.0	138478	HITACHI	7.09002.11.0
1345002	DT-DIESEL TECHNIC AG	7.01621.08.0	138480	HITACHI	7.00063.10.0
1346366	FORD	7.02604.64.0	138494	HITACHI	7.09002.09.0
1349	NGK	7.05270.11.0	138495	HITACHI	7.09002.05.0
1351337	FORD	7.02604.64.0	138496	HITACHI	7.09002.12.0
1352475	FORD	7.24809.72.0	138499	HITACHI	7.09002.08.0
1353152	FORD	7.24809.91.0	1387083	FORD	7.24809.72.0
135501	HITACHI LI	7.08369.35.0	1387084	FORD	7.24809.71.0
135502	HITACHI LI	7.11020.05.0	14.16.003	TRUCKTEC FAHRZEUGTEILE GM	7.24809.53.0
135505	HITACHI	7.08369.23.0	140002510	AUTOMEGA	7.22818.59.0
135505	HITACHI LI	7.08369.23.0	140026410	AUTOMEGA	7.22414.08.0
1358360	FORD	7.24809.73.0	1404696	BMW	7.02604.28.0
13627791592	BMW	7.02604.44.0	1404697	BMW	7.02604.30.0
13627793825	BMW	7.02604.44.0	1405324	BMW	7.05270.03.0
13627794634	BMW	7.02604.41.0	1406621	BMW	7.02604.28.0
13627805472	MINI (BMW)	7.11492.01.0	1414	NGK	7.05271.00.0
13627805758	BMW	7.11190.12.0	1415606	FORD	7.11190.10.0
13627805758	MINI (BMW)	7.11190.12.0	1417557	FORD	7.24809.74.0
13628515640	BMW	7.02604.42.0	1419900100	JP GROUP	7.00450.09.0
1363422	FORD	7.24809.71.0	1421	NGK	7.02604.65.0
1363591	FORD	7.24809.76.0	14225	STANDARD	7.22738.08.0
1367823	FORD	7.05270.80.0	1427078	BMW	7.22295.61.0
1367825	FORD	7.05270.67.0	1427355	FORD	7.00578.12.0
1369213	FORD	7.24809.71.0	14275	STANDARD	7.22934.63.0
137001	HITACHI	7.08369.01.0	1427884	BMW	7.02604.37.0
137001	HITACHI LI	7.08369.01.0	14300	STANDARD	7.24809.51.0
137002	HUECO	7.08369.04.0	14301	STANDARD	7.24809.32.0
137003	HITACHI LI	7.08369.03.0	14302	STANDARD	7.28069.04.0
137004	HITACHI LI	7.08369.02.0	14303	STANDARD	7.24809.55.0
137007	HITACHI	7.08369.11.0	14304	STANDARD	7.24809.37.0
137007	HITACHI LI	7.08369.11.0	14305	STANDARD	7.24809.36.0
137012	HITACHI	7.08369.26.0	14306	STANDARD	7.28069.03.0
137012	HITACHI LI	7.08369.26.0	14309	STANDARD	7.00020.25.0
137013	HITACHI	7.08369.08.0	14310	STANDARD	7.22818.58.0
137013	HITACHI LI	7.08369.08.0	14310	STANDARD	7.22818.59.0
137015	HITACHI LI	7.08369.05.0	14311	STANDARD	7.22818.58.0
137034	HITACHI	7.08369.09.0	14312	STANDARD	7.00063.10.0
137034	HITACHI LI	7.08369.09.0	14313	STANDARD	7.22946.38.0
137035	HITACHI LI	7.11020.35.0	14314	STANDARD	7.28384.13.0
137036	HITACHI LI	7.08369.41.0	14315	STANDARD	7.22818.63.0
137042	HITACHI LI	7.08369.14.0	14317	STANDARD	7.28248.17.0
137046	HITACHI LI	7.08369.22.0	14318	STANDARD	7.00368.15.0
137053	HITACHI	7.08369.18.0	14319	STANDARD	7.00020.24.0
137053	HITACHI LI	7.08369.18.0	14320	STANDARD	7.22136.50.0
137054	HITACHI	7.08369.45.0	14321	STANDARD	7.22574.12.0
137054	HITACHI LI	7.08369.45.0	14322	STANDARD	7.22785.16.0
137055	HITACHI	7.08369.31.0	14323	STANDARD	7.22785.18.0
137055	HITACHI LI	7.08369.31.0	14324	STANDARD	7.22818.62.0
137058	HITACHI	7.08369.34.0	14325	STANDARD	7.22946.33.0
137058	HITACHI LI	7.08369.34.0	14325	STANDARD	7.22946.34.0
137064	HITACHI LI	7.11020.19.0	14326	STANDARD	7.22946.34.0
137065	HITACHI	7.08369.33.0			

REF-No.		 PIERBURG	REF-No.		 PIERBURG
14327	STANDARD	7.28070.03.0	1461874	FORD	7.24809.19.0
14329	STANDARD	7.24809.68.0	1466340	FORD	7.24809.70.0
14330	STANDARD	7.24809.70.0	1469779	FORD	7.22738.08.0
1433075	BMW	7.02604.31.0	14710-00Q0B	NISSAN	7.22818.62.0
14335	STANDARD	7.24809.69.0	14710-00Q0E	NISSAN	7.00368.15.0
14336	STANDARD	7.03784.34.0	14710-00Q0G	NISSAN	7.00368.15.0
1433713	BMW	7.22295.66.0	14710-00Q0K	NISSAN	7.00368.16.0
1433818	BMW	7.22166.38.0	14710-00Q0P	NISSAN	7.02014.07.0
1433900	BMW	7.21852.82.0	14710-00Q0S	NISSAN	7.02014.07.0
1433940	BMW	7.02604.21.0	14710-00Q0X	NISSAN	7.03435.05.0
1433958	BMW	7.22166.02.0	14710-00Q0Y	NISSAN	7.10334.03.0
1433959	BMW	7.22166.66.0	14710-00Q1B	NISSAN	7.24809.90.0
14352	STANDARD	7.00578.12.0	14710-00Q1C	NISSAN	7.05320.04.0
1435364	BMW	7.21852.24.0	14710-00Q1G	NISSAN	7.24809.90.0
1435365	BMW	7.22166.50.0	14710-00Q1L	NISSAN	7.24809.90.0
1435420	BMW	7.22295.62.0	14710-AW301	NISSAN	7.22818.57.0
1435811	BMW	7.22295.67.0	14710-AW302	NISSAN	7.22818.57.0
14359	STANDARD	7.22772.12.0	14710-AW303	NISSAN	7.22818.57.0
1436390	FORD	7.24809.68.0	147100385R	RENAULT	7.10334.03.0
1437015	BMW	7.22295.63.0	147105039R	RENAULT	7.24809.90.0
1437586	BMW	7.02604.30.0	147105308R	RENAULT	7.03435.05.0
1437700	BMW	7.22166.39.0	147105543R	RENAULT	7.10334.03.0
1437910	BMW	7.22166.65.0	147106293R	RENAULT	7.11237.05.0
1437911	BMW	7.22166.52.0	147106672R	RENAULT	7.10334.06.0
1437911	BMW	7.22166.64.0	147107172R	DACIA	7.05320.04.0
14383	STANDARD	7.24809.59.0	147107172R	RENAULT	7.05320.04.0
14392	STANDARD	7.24809.77.0	147109816R	RENAULT	7.24809.90.0
14393	STANDARD	7.00823.06.0	147109948R	RENAULT	7.24809.90.0
1439414	FORD	7.24809.39.0	1471423	FORD	7.02604.60.0
14404	STANDARD	7.24809.25.0	1472884	FORD	7.24809.73.0
14404	STANDARD	7.24809.28.0	1472941	FORD	7.02604.64.0
14406	STANDARD	7.28264.06.0	1473111	EFI AUTO	7.08369.11.0
14409	STANDARD	7.28264.07.0	1473905	EFI AUTO	7.08369.32.0
14410	STANDARD	7.00450.09.0	1473906	EFI AUTO	7.08369.03.0
14423	STANDARD	7.24809.78.0	1473908	EFI AUTO	7.08369.02.0
14424	STANDARD	7.00020.40.0	1473910	EFI AUTO	7.08369.15.0
14430	STANDARD	7.24809.61.0	1473911	EFI AUTO	7.08369.41.0
14431	STANDARD	7.24809.64.0	1473919	EFI AUTO	7.08369.17.0
14435	STANDARD	7.24809.35.0	1473923	EFI AUTO	7.08369.22.0
14436	STANDARD	7.24809.54.0	1473929	EFI AUTO	7.08369.04.0
14437	STANDARD	7.24809.48.0	1473930	EFI AUTO	7.08369.26.0
1444	NGK	7.02604.64.0	1473940	EFI AUTO	7.08369.01.0
14441	STANDARD	7.22772.11.0	1473948	EFI AUTO	7.08369.40.0
14444	STANDARD	7.00512.03.0	1473977	EFI AUTO	7.08369.05.0
14445	STANDARD	7.24809.65.0	1479057	FORD	7.24809.39.0
14451	STANDARD	7.24809.46.0	1479845	FORD	7.24809.76.0
1446266	FORD	7.24809.07.0	147B05725R	RENAULT	7.03083.20.0
14465	STANDARD	7.24809.72.0	147B05725R	SAMSUNG	7.03083.20.0
14466	STANDARD	7.24809.71.0	147B07424R	RENAULT	7.03571.16.0
14467	STANDARD	7.24809.50.0	147B07424R	SAMSUNG	7.03571.16.0
14469	STANDARD	7.02156.24.0	147B08010R	RENAULT	7.03571.16.0
14471	STANDARD	7.00306.36.0	147B08010R	SAMSUNG	7.03571.16.0
14472	STANDARD	7.00450.10.0	1480549	FORD	7.24809.69.0
14473	STANDARD	7.00684.14.0	1480560	FORD	7.24809.70.0
14474	STANDARD	7.00555.06.0	1483814	FORD	7.24809.06.0
14475	STANDARD	7.00789.10.0	1484862	FORD	7.05270.80.0
14476	STANDARD	7.02132.07.0	14903	STANDARD	7.24809.10.0
14479	STANDARD	7.01621.08.0	1490335	FORD	7.05270.67.0
14479	STANDARD	7.24809.40.0	14916	STANDARD	7.21920.62.0
14481	STANDARD	7.00020.50.0	14920-00Q0B	NISSAN	7.22818.57.0
14485	STANDARD	7.01599.10.0	14920-00QAD	NISSAN	7.22818.57.0
14486	STANDARD	7.01604.02.0	14920-00QAE	NISSAN	7.22818.57.0
14487	STANDARD	7.02209.11.0	14920-00QAF	NISSAN	7.22818.57.0
14489	STANDARD	7.00368.16.0	14920-00QAG	NISSAN	7.22818.57.0
14491	STANDARD	7.01782.07.0	14922	STANDARD	7.22414.08.0
1449125	FORD	7.24809.75.0	14928	STANDARD	7.22414.04.0
14493	STANDARD	7.24809.53.0	14935	STANDARD	7.22875.13.0
1451966	FORD	7.05270.67.0	14938	STANDARD	7.24809.73.0
1461304	FORD	7.24809.20.0	14939	STANDARD	7.24809.06.0

NUMBERFINDER

REF-No.			REF-No.		
14940	STANDARD	7.24809.07.0	1609520080	PEUGEOT	7.08369.98.0
14950	STANDARD	7.22630.28.0	1609520380	CITROEN	7.08369.99.0
14951	STANDARD	7.24809.29.0	1609520380	PEUGEOT	7.08369.99.0
14952	STANDARD	7.24809.25.0	1610	NGK	7.02604.07.0
14953	STANDARD	7.24809.16.0	1610531380	CITROEN	7.11190.03.0
14954	STANDARD	7.24809.30.0	1610531380	OPEL	7.11190.03.0
14955	STANDARD	7.24809.34.0	1610531380	PEUGEOT	7.11190.03.0
14956	STANDARD	7.24809.24.0	1610531380	VAUXHALL	7.11190.03.0
14956	STANDARD	7.24809.27.0	1611	NGK	7.05270.12.0
14956-00Q0F	NISSAN	7.10334.05.0	1612	NGK	7.02604.56.0
14956-00Q0J	NISSAN	7.10334.05.0	1613	NGK	7.02604.55.0
14956-00Q1A	NISSAN	7.10334.05.0	1614	NGK	7.05271.01.0
14956-00Q1E	NISSAN	7.10334.03.0	1617639	GMC	7.02604.01.0
14956-00Q1J	NISSAN	7.10334.03.0	1618	NGK	7.05270.11.0
14957	STANDARD	7.24809.20.0	161835	CITROEN	7.09730.00.0
1495746	FORD	7.05270.80.0	161835	PEUGEOT	7.09730.00.0
14958	STANDARD	7.24809.19.0	161846	CITROEN	7.24809.76.0
14960	STANDARD	7.24809.31.0	161846	PEUGEOT	7.24809.76.0
14961	STANDARD	7.24809.26.0	161848	CITROEN	7.02604.12.0
14962	STANDARD	7.24809.17.0	161848	PEUGEOT	7.02604.12.0
14973	STANDARD	7.24809.76.0	161849	CITROEN	7.02604.11.0
14974	STANDARD	7.24809.39.0	161849	PEUGEOT	7.02604.11.0
14976	STANDARD	7.24809.49.0	161859	CITROEN	7.24809.39.0
14977	STANDARD	7.24809.52.0	161859	PEUGEOT	7.24809.39.0
14978	STANDARD	7.24809.57.0	161872	CITROEN	7.05270.38.0
14979	STANDARD	7.24809.63.0	161872	PEUGEOT	7.05270.38.0
14980	STANDARD	7.24809.33.0	1618AL	CITROEN	7.02604.13.0
14981	STANDARD	7.24809.38.0	1618AL	PEUGEOT	7.02604.13.0
14982	STANDARD	7.24809.56.0	1618AN	CITROEN	7.02604.11.0
14983	STANDARD	7.22875.16.0	1618AN	PEUGEOT	7.02604.11.0
14984	STANDARD	7.00365.06.0	1618AS	CITROEN	7.05270.21.0
14985	STANDARD	7.22818.57.0	1618AS	PEUGEOT	7.05270.21.0
14986	STANDARD	7.22477.10.0	1618AV	CITROEN	7.02604.99.0
14987	STANDARD	7.22477.11.0	1618AV	PEUGEOT	7.02604.99.0
14990	STANDARD	7.22888.02.0	1618E7	PEUGEOT	7.02604.13.0
14991	STANDARD	7.00907.03.0	1618EY	CITROEN	7.08369.98.0
14992	STANDARD	7.00075.07.0	1618EY	PEUGEOT	7.08369.98.0
14993	STANDARD	7.22843.07.0	1618FY	CITROEN	7.08369.99.0
14997	STANDARD	7.22843.06.0	1618FY	PEUGEOT	7.08369.99.0
14998	STANDARD	7.22785.17.0	1618GZ	CITROEN	7.24809.68.0
15-148000004	MEYLE	7.08369.57.0	1618GZ	PEUGEOT	7.24809.68.0
1516718	FORD	7.02604.60.0	1618HG	CITROEN	7.02604.41.0
1523	NGK	7.05270.67.0	1618HG	DS	7.02604.41.0
1524	NGK	7.05270.03.0	1618HG	PEUGEOT	7.02604.41.0
1526689	FORD	7.24809.39.0	1618HQ	CITROEN	7.24809.70.0
1536	NGK	7.02604.32.0	1618HQ	PEUGEOT	7.24809.70.0
1536254	FORD	7.02604.65.0	1618K9	CITROEN	7.05271.51.0
155017N	DASIS VERTRIEBS GMBH	7.22818.59.0	1618K9	PEUGEOT	7.05271.51.0
155027N	DASIS VERTRIEBS GMBH	7.22414.08.0	1618KN	CITROEN	7.02604.99.0
1557672	FORD	7.11190.04.0	1618KN	PEUGEOT	7.02604.99.0
1558	NGK	7.02604.64.0	1618LC	CITROEN	7.02156.24.0
1560	NGK	7.02604.07.0	1618LC	PEUGEOT	7.02156.24.0
1563296	FORD	7.24809.71.0	1618LN	CITROEN	7.02209.11.0
1563425	FORD	7.11190.04.0	1618LN	DS	7.02209.11.0
1581	NGK	7.05270.11.0	1618LN	PEUGEOT	7.02209.11.0
1588A00	VOLVO	7.02604.99.0	1618N6	CITROEN	7.24809.96.0
1588A001	MITSUBISHI	7.02604.99.0	1618N6	PEUGEOT	7.24809.96.0
1588A020	MITSUBISHI	7.05271.63.0	1618N7	CITROEN	7.11237.01.0
1588A081	MITSUBISHI	7.05271.63.0	1618N7	PEUGEOT	7.11237.01.0
1590848	FORD	7.24809.73.0	1618N8	CITROEN	7.24809.76.0
1592	NGK	7.05270.67.0	1618N8	PEUGEOT	7.24809.76.0
1606305880	CITROEN	7.03647.10.0	1618NE	CITROEN	7.02604.99.0
1606305880	PEUGEOT	7.03647.10.0	1618NE	PEUGEOT	7.02604.99.0
1606636180	CITROEN	7.03622.06.0	1618NR	CITROEN	7.24809.39.0
1606636180	PEUGEOT	7.03622.06.0	1618NR	PEUGEOT	7.24809.39.0
1609345280	CITROEN	7.02604.41.0	1618PF	CITROEN	7.24809.76.0
1609345280	DS	7.02604.41.0	1618PF	PEUGEOT	7.24809.76.0
1609345280	PEUGEOT	7.02604.41.0	1618Q5	CITROEN	7.05271.39.0
1609520080	CITROEN	7.08369.98.0	1618Q5	PEUGEOT	7.05271.39.0



REF-No.		 PIERBURG	REF-No.		 PIERBURG
1618QF	CITROEN	7.24809.96.0	1628NN	PEUGEOT	7.22888.02.0
1618QF	PEUGEOT	7.24809.96.0	1628PL	CITROEN	7.02604.13.0
1618QR	CITROEN	7.01599.10.0	1628PL	PEUGEOT	7.02604.13.0
1618QR	PEUGEOT	7.01599.10.0	1628PX	CITROEN	7.05270.38.0
1618QS	CITROEN	7.03622.06.0	1628PX	PEUGEOT	7.05270.38.0
1618QS	PEUGEOT	7.03622.06.0	1628QY	CITROEN	7.05270.38.0
1618R5	CITROEN	7.24809.70.0	1628QY	PEUGEOT	7.05270.38.0
1618R5	PEUGEOT	7.24809.70.0	1628RH	CITROEN	7.28069.03.0
1618S8	CITROEN	7.24809.68.0	1628RH	PEUGEOT	7.28069.03.0
1618S8	PEUGEOT	7.24809.68.0	1628SV	CITROEN	7.22843.06.0
1618SV	CITROEN	7.11190.03.0	1628SV	PEUGEOT	7.22843.06.0
1618SV	PEUGEOT	7.11190.03.0	1628SW	CITROEN	7.05270.54.0
1618T1	CITROEN	7.00578.12.0	1628SW	PEUGEOT	7.05270.54.0
1618T1	PEUGEOT	7.00578.12.0	1628TG	CITROEN	7.05270.38.0
1618T9	CITROEN	7.02604.41.0	1628TG	PEUGEOT	7.05270.38.0
1618T9	DS	7.02604.41.0	1628VT	CITROEN	7.22843.07.0
1618T9	PEUGEOT	7.02604.41.0	1628VT	PEUGEOT	7.22843.07.0
1618V3	CITROEN	7.05271.74.0	1628WV	CITROEN	7.11237.04.0
1618V3	PEUGEOT	7.05271.74.0	1628WV	PEUGEOT	7.11237.04.0
1618Z7	CITROEN	7.02604.12.0	1628XP	CITROEN	7.28069.04.0
1618Z7	PEUGEOT	7.02604.12.0	1628XP	PEUGEOT	7.28069.04.0
1618Z8	CITROEN	7.02604.13.0	1628XV	CITROEN	7.24809.06.0
1618Z8	PEUGEOT	7.02604.13.0	1628XV	PEUGEOT	7.24809.06.0
1618Z9	CITROEN	7.11492.01.0	1630	NGK	7.02604.64.0
1618Z9	DS	7.11492.01.0	1638	NGK	7.02604.63.0
1618Z9	PEUGEOT	7.11492.01.0	1643292	GMC	7.02604.01.0
1619	NGK	7.05270.12.0	1649	NGK	7.05271.39.0
162635	CITROEN	7.24809.53.0	1665	NGK	7.05270.99.0
162635	PEUGEOT	7.24809.53.0	1668578	FORD	7.24809.72.0
162642	CITROEN	7.24809.51.0	1673226	FORD	7.01621.08.0
162642	PEUGEOT	7.24809.51.0	1673226	FORD	7.24809.40.0
162644	CITROEN	7.02156.33.0	1673972	FORD	7.02604.60.0
162644	PEUGEOT	7.02156.33.0	1682007	FORD	7.24809.94.0
1627	NGK	7.05270.99.0	1682736	FORD	7.24809.76.0
162858	CITROEN	7.02604.01.0	1682737	FORD	7.24809.39.0
162858	PEUGEOT	7.02604.01.0	1685740	FORD	7.02156.24.0
16286R	CITROEN	7.05270.39.0	1688	NGK	7.05271.37.0
16286R	PEUGEOT	7.05270.39.0	1690	NGK	7.02604.64.0
16286W	CITROEN	7.05270.38.0	1696587	FORD	7.02209.11.0
16286W	PEUGEOT	7.05270.38.0	1701766	FORD	7.02604.99.0
16287R	CITROEN	7.02604.04.0	1702178	FORD	7.02209.11.0
16287R	CITROEN	7.05270.39.0	170327	FEBI	7.10334.10.0
16287R	PEUGEOT	7.02604.04.0	1704	NGK	7.05270.56.0
16287R	PEUGEOT	7.05270.39.0	170555	FEBI	7.09002.00.0
16289A	CITROEN	7.05270.36.0	1706	NGK	7.05271.62.0
16289A	PEUGEOT	7.05270.36.0	1707585	BMW	7.22166.20.0
16289S	CITROEN	7.05270.38.0	1707589	BMW	7.21852.78.0
16289S	PEUGEOT	7.05270.38.0	1707619	BMW	7.22295.68.0
16289W	CITROEN	7.05270.39.0	1708	NGK	7.02604.60.0
16289W	PEUGEOT	7.05270.39.0	1708004	FORD	7.02156.33.0
1628A4	CITROEN	7.02604.03.0	1708575	BMW	7.22295.69.0
1628A4	PEUGEOT	7.02604.03.0	17089050	CHEVROLET	7.09002.02.0
1628CP	CITROEN	7.05270.36.0	17089050	GENERAL MOTORS	7.09002.02.0
1628CP	PEUGEOT	7.05270.36.0	17092164	CHEVROLET	7.09002.01.0
1628CX	CITROEN	7.05270.37.0	17092164	DAEWOO	7.09002.01.0
1628CX	PEUGEOT	7.05270.37.0	17092164	GENERAL MOTORS	7.09002.01.0
1628HQ	CITROEN	7.02604.13.0	17097086	CHEVROLET	7.09002.13.0
1628HQ	PEUGEOT	7.02604.13.0	17097086	OPEL	7.09002.13.0
1628HR	CITROEN	7.02604.12.0	17097086	VAUXHALL	7.09002.13.0
1628HR	PEUGEOT	7.02604.12.0	17098055	CHEVROLET	7.24809.10.0
1628HV	CITROEN	7.05270.37.0	17098055	GM HOLDEN LTD	7.24809.10.0
1628HV	PEUGEOT	7.05270.37.0	17098055	OPEL	7.24809.10.0
1628JZ	CITROEN	7.22843.06.0	17098055	VAUXHALL	7.24809.10.0
1628JZ	PEUGEOT	7.22843.06.0	1710918	FORD	7.00020.39.0
1628KC	CITROEN	7.09730.01.0	171175	FERRARI	7.22296.02.0
1628KC	PEUGEOT	7.09730.01.0	171175	MASERATI	7.22296.02.0
1628KY	CITROEN	7.05270.37.0	1715293	BMW	7.22166.50.0
1628KY	PEUGEOT	7.05270.37.0	1715347	BMW	7.22166.00.0
1628NN	CITROEN	7.22888.02.0	17200011010	MAGNETI MARELLI	7.08369.01.0

NUMBERFINDER

REF-No.		REF-No.	
172000019010	MAGNETI MARELLI 7.08369.84.0	1745907	BMW 7.22295.71.0
172000023010	MAGNETI MARELLI 7.08369.91.0	1746711	FORD 7.02604.60.0
172000023010	MAGNETI MARELLI 7.08369.97.0	1748264	FORD 7.24809.92.0
172000025010	MAGNETI MARELLI 7.08369.09.0	1748265	FORD 7.24809.91.0
172000027010	MAGNETI MARELLI 7.08369.08.0	1748762	BMW 7.02604.38.0
172000031010	MAGNETI MARELLI 7.08369.32.0	1748918	FORD 7.03991.12.0
172000035010	MAGNETI MARELLI 7.11020.35.0	1751357	FORD 7.24809.94.0
172000041010	MAGNETI MARELLI 7.08369.96.0	1754	NGK 7.05270.67.0
172000043010	MAGNETI MARELLI 7.08369.05.0	1760	NGK 7.02604.51.0
172000047010	MAGNETI MARELLI 7.08369.17.0	1762	NGK 7.02604.51.0
172000051010	MAGNETI MARELLI 7.08369.22.0	1764	NGK 7.02604.47.0
172000055010	MAGNETI MARELLI 7.08369.34.0	1765	NGK 7.05270.79.0
172000057010	MAGNETI MARELLI 7.08369.33.0	1766	NGK 7.02604.60.0
172000059010	MAGNETI MARELLI 7.08369.35.0	1768	NGK 7.05270.73.0
172000075010	MAGNETI MARELLI 7.08369.14.0	1769289	FORD 7.11190.03.0
172000089010	MAGNETI MARELLI 7.11020.14.0	1776	NGK 7.05271.20.0
172000093010	MAGNETI MARELLI 7.08369.41.0	1778	NGK 7.05271.05.0
172000101010	MAGNETI MARELLI 7.11020.07.0	1789	NGK 7.05271.01.0
172000105010	MAGNETI MARELLI 7.08369.23.0	1790	NGK 7.05270.36.0
172000109010	MAGNETI MARELLI 7.08369.94.0	1798	NGK 7.02604.47.0
172000117010	MAGNETI MARELLI 7.11020.13.0	18017	STANDARD 7.24809.47.0
172000129010	MAGNETI MARELLI 7.08369.83.0	18038	STANDARD 7.03051.04.0
172000141010	MAGNETI MARELLI 7.11020.45.0	1804	NGK 7.05270.55.0
172000151010	MAGNETI MARELLI 7.11020.01.0	18043	STANDARD 7.03784.34.0
172000151010	MAGNETI MARELLI 7.11020.11.0	18053	STANDARD 7.24809.81.0
172000153010	MAGNETI MARELLI 7.11020.19.0	18064	STANDARD 7.24809.79.0
172000155010	MAGNETI MARELLI 7.11020.16.0	1807	NGK 7.05270.45.0
172000183010	MAGNETI MARELLI 7.11020.44.0	18111-80KA0	SUZUKI 7.11237.02.0
172000185010	MAGNETI MARELLI 7.08369.87.0	18111-80KA1	SUZUKI 7.11237.02.0
172000191010	MAGNETI MARELLI 7.11020.03.0	18111-84E50-000	SUZUKI 7.00020.24.0
172000205010	MAGNETI MARELLI 7.11020.00.0	18111-84E51-000	SUZUKI 7.00020.24.0
172000209010	MAGNETI MARELLI 7.11020.38.0	18111-84E52-000	SUZUKI 7.00020.24.0
172000217010	MAGNETI MARELLI 7.11020.02.0	181197	FERRARI 7.22472.07.0
172000219010	MAGNETI MARELLI 7.11020.08.0	181197	MASERATI 7.22472.07.0
172000223010	MAGNETI MARELLI 7.11020.09.0	1814	NGK 7.05270.38.0
172000227010	MAGNETI MARELLI 7.11020.10.0	1815	NGK 7.05270.37.0
172000229010	MAGNETI MARELLI 7.08369.82.0	1818	NGK 7.05270.38.0
172000247010	MAGNETI MARELLI 7.11020.18.0	1819	NGK 7.05270.38.0
172000249010	MAGNETI MARELLI 7.08369.95.0	1821-286Z-00	SUZUKI 7.05271.73.0
172000251010	MAGNETI MARELLI 7.11020.17.0	18213-60B00	SUBARU 7.02604.15.0
172000273010	MAGNETI MARELLI 7.11020.41.0	18213-60B00	SUZUKI 7.02604.01.0
172000297010	MAGNETI MARELLI 7.11020.06.0	18213-60B00	SUZUKI 7.02604.15.0
172000299010	MAGNETI MARELLI 7.11020.49.0	18213-60B00-000	SUZUKI 7.02604.15.0
172000325010	MAGNETI MARELLI 7.11020.20.0	18213-62J00	SUBARU 7.05271.54.0
172000341010	MAGNETI MARELLI 7.11020.12.0	18213-62J01	SUZUKI 7.05271.54.0
172000413010	MAGNETI MARELLI 7.11020.25.0	18213-62J12	SUZUKI 7.05271.66.0
172000451010	MAGNETI MARELLI 7.11020.21.0	18213-63J00	SUZUKI 7.05271.54.0
172000517010	MAGNETI MARELLI 7.11020.05.0	18213-63J12	SUZUKI 7.05271.66.0
172000539010	MAGNETI MARELLI 7.11020.32.0	18213-64B00	SUBARU 7.02604.15.0
172000547010	MAGNETI MARELLI 7.11020.23.0	18213-64B00	SUZUKI 7.02604.15.0
172000551010	MAGNETI MARELLI 7.11020.22.0	18213-65D10	SUZUKI 7.05271.59.0
172000611010	MAGNETI MARELLI 7.11020.29.0	18213-65D20	SUZUKI 7.05271.66.0
172000663010	MAGNETI MARELLI 7.11020.36.0	18213-65D21	SUZUKI 7.05271.66.0
172000689010	MAGNETI MARELLI 7.11020.27.0	18213-65D30	SUZUKI 7.05271.59.0
172000699010	MAGNETI MARELLI 7.11020.37.0	18213-65D31	SUZUKI 7.05271.59.0
17200272	CHEVROLET 7.24809.10.0	18213-65D32	SUZUKI 7.05271.59.0
17200272	GM HOLDEN LTD 7.24809.10.0	18213-65D50	SUZUKI 7.05271.59.0
17200272	OPEL 7.24809.10.0	18213-65D51	SUZUKI 7.05271.59.0
17200272	VAUXHALL 7.24809.10.0	18213-65D71	SUZUKI 7.05271.59.0
1721	NGK 7.05271.18.0	18213-67D00	SUZUKI 7.05271.59.0
172643	FEBI 7.09002.05.0	18213-68H00	SUZUKI 7.05271.59.0
1729036	FORD 7.11190.03.0	18213-74F00	SUZUKI 7.02604.01.0
1730025	BMW 7.05271.70.0	18213-76G00	SUZUKI 7.02604.01.0
1730360	FORD 7.03784.34.0	18213-76J01	SUZUKI 7.05271.59.0
1733300	FORD 7.03622.06.0	18213-77E00	SUZUKI 7.05271.59.0
1739846	BMW 7.02604.31.0	18213-79J80	SUZUKI 7.05270.21.0
1742050	BMW 7.02604.31.0	18213-79J80-000	SUZUKI 7.05270.21.0
1744255	BMW 7.22295.70.0	18213-80A01	SUZUKI 7.05271.59.0
1744490	BMW 7.21852.85.0	18213-80G00	SUZUKI 7.05271.54.0



REF-No.	 PIERBURG	REF-No.	 PIERBURG		
18213-80G01	SUZUKI	7.05271.54.0	1938	NGK	7.05270.32.0
18213-80G02	SUZUKI	7.05271.54.0	1950	NGK	7.05270.96.0
18213-82010	SUZUKI	7.02604.15.0	19500.05749	WAHLER	7.24809.36.0
18213-86G00	SUZUKI	7.05271.54.0	1954	NGK	7.05270.32.0
18213-86G01	SUZUKI	7.05271.54.0	19590173601	VIKA	7.22738.08.0
1821350F00	SUZUKI	7.02604.01.0	19591091201	VIKA	7.22738.20.0
1821350G00	SUZUKI	7.05271.35.0	19591091501	VIKA	7.28415.09.0
1821350G01	SUZUKI	7.05271.35.0	1963	NGK	7.02604.38.0
1821357B10	SUZUKI	7.02604.01.0	1981	NGK	7.05270.36.0
1821360B00	SUZUKI	7.02604.01.0	1982	NGK	7.05270.38.0
1821363A00	SUZUKI	7.02604.01.0	1FAA-18-861	MAZDA	7.02604.64.0
1821363E60	SUZUKI	7.02604.01.0	1FAA18861	MAZDA	7.02604.64.0
1821364B00	SUZUKI	7.02604.01.0	1JE998262	AUDI	7.05270.99.0
1821378A01	SUZUKI	7.02604.01.0	1JE998262	SEAT	7.05270.99.0
1821382001	SUZUKI	7.02604.01.0	1JE998262	SKODA	7.05270.99.0
1821383000	SUZUKI	7.02604.01.0	1JE998262	VOLKSWAGEN	7.05270.99.0
1821383E00	SUZUKI	7.05271.35.0	1K0253691B	VOLKSWAGEN	7.01300.24.0
1821383E01	SUZUKI	7.05271.35.0	1K0253691C	VOLKSWAGEN	7.01300.24.0
18215-53SA0	SUZUKI	7.11190.08.0	1K0253691D	VOLKSWAGEN	7.01300.24.0
1823924	FORD	7.02156.34.0	1K0253691E	VOLKSWAGEN	7.01300.24.0
1835009	FORD	7.03784.34.0	1K0253691F	VOLKSWAGEN	7.01300.24.0
1836229	FORD	7.24809.94.0	1K0253691G	VOLKSWAGEN	7.01300.24.0
1845923	FORD	7.22286.55.0	1K0253691J	VOLKSWAGEN	7.01300.24.0
18501	OSSCA	7.28124.19.0	1K0998262A	AUDI	7.05270.99.0
185021N	DASIS VERTRIEBS GMBH	7.22818.58.0	1K0998262A	SEAT	7.05270.99.0
185022N	DASIS VERTRIEBS GMBH	7.22818.62.0	1K0998262A	SKODA	7.05270.99.0
185025N	DASIS VERTRIEBS GMBH	7.03435.05.0	1K0998262A	VOLKSWAGEN	7.05270.99.0
185028N	DASIS VERTRIEBS GMBH	7.00075.07.0	1K0998262AC	AUDI	7.05270.99.0
18507	OSSCA	7.21852.85.0	1K0998262AC	SEAT	7.05270.99.0
18509	OSSCA	7.21851.32.0	1K0998262AC	SKODA	7.05270.99.0
18513	OSSCA	7.22738.20.0	1K0998262AC	VOLKSWAGEN	7.05270.99.0
1852	NGK	7.05270.36.0	1K0998262B	AUDI	7.05271.14.0
18520-63P00	SUZUKI	7.01599.10.0	1K0998262B	SEAT	7.05271.14.0
18520-68L00	SUZUKI	7.01599.10.0	1K0998262B	SKODA	7.05271.14.0
18520-69K00	SUZUKI	7.24809.39.0	1K0998262B	VOLKSWAGEN	7.05271.14.0
18520-69K01	SUZUKI	7.24809.39.0	1K0998262C	AUDI	7.05271.16.0
18520-69K02	SUZUKI	7.24809.39.0	1K0998262C	SEAT	7.05271.16.0
18520-73J00	SUZUKI	7.24809.06.0	1K0998262C	SKODA	7.05271.16.0
18520-73J00-000	SUZUKI	7.24809.06.0	1K0998262C	VOLKSWAGEN	7.05271.16.0
18520-79J52	SUZUKI	7.22946.38.0	1K0998262D	AUDI	7.05271.24.0
18520-79J80	SUZUKI	7.24809.77.0	1K0998262D	BENTLEY	7.05271.24.0
18520-79J82	SUZUKI	7.24809.77.0	1K0998262D	SEAT	7.05271.24.0
18520-84A53	SUZUKI	7.00368.15.0	1K0998262D	SKODA	7.05271.24.0
18520-86J01	SUZUKI	7.00020.50.0	1K0998262D	VOLKSWAGEN	7.05271.24.0
18521-63P00	SUZUKI	7.01599.10.0	1K0998262E	AUDI	7.05271.16.0
1853	NGK	7.05270.38.0	1K0998262E	SEAT	7.05271.16.0
1855876	FORD	7.24809.94.0	1K0998262E	SKODA	7.05271.16.0
18590-62M00	SUZUKI	7.11190.03.0	1K0998262E	VOLKSWAGEN	7.05271.16.0
18590-67JB0	SUZUKI	7.11190.08.0	1K0998262F	AUDI	7.05271.77.0
18590-68L50	SUZUKI	7.11190.03.0	1K0998262F	SEAT	7.05271.77.0
18590-79J50	SUZUKI	7.11190.04.0	1K0998262F	SKODA	7.05271.77.0
18590-79J80	SUZUKI	7.11190.03.0	1K0998262F	VOLKSWAGEN	7.05271.77.0
1863	NGK	7.05270.30.0	1K0998262N	AUDI	7.05271.29.0
1867	NGK	7.02604.62.0	1K0998262N	SEAT	7.05271.29.0
1869	NGK	7.05270.29.0	1K0998262N	SKODA	7.05271.29.0
1873721	FORD	7.02209.20.0	1K0998262N	VOLKSWAGEN	7.05271.29.0
1878	NGK	7.05270.47.0	1K0998262Q	AUDI	7.05270.99.0
1884	NGK	7.05271.18.0	1K0998262Q	SEAT	7.05270.99.0
1890	NGK	7.02604.61.0	1K0998262Q	SKODA	7.05270.99.0
1891365	FORD	7.04512.08.0	1K0998262Q	VOLKSWAGEN	7.05270.99.0
1895826	FORD	7.03784.34.0	1K0998262R	AUDI	7.05270.98.0
1896	NGK	7.05270.27.0	1K0998262R	SEAT	7.05270.98.0
18993	OSSCA	7.09720.00.0	1K0998262R	SKODA	7.05270.98.0
19061091101	VIKA	7.21851.32.0	1K0998262R	VOLKSWAGEN	7.05270.98.0
1908	NGK	7.05270.72.0	1K0998262S	AUDI	7.05271.12.0
1920	NGK	7.05270.33.0	1K0998262S	SEAT	7.05271.12.0
1932	NGK	7.05271.70.0	1K0998262S	SKODA	7.05271.12.0
1932037	FORD	7.03784.34.0	1K0998262S	VOLKSWAGEN	7.05271.12.0
19372524	A C DELCO	7.04879.00.0	1K0998262T	AUDI	7.05271.12.0



NUMBERFINDER

REF-No.			REF-No.		
1K0998262T	SEAT	7.05271.12.0	22690-40F00	NISSAN	7.02604.01.0
1K0998262T	SKODA	7.05271.12.0	22690-50Y00	NISSAN	7.02604.01.0
1K0998262T	VOLKSWAGEN	7.05271.12.0	22690-55Y00	NISSAN	7.02604.01.0
1M219D475AA	FORD	7.24809.20.0	22690-70J10	NISSAN	7.02604.01.0
1S7F9F472AB	FORD	7.02604.60.0	22690-73C00	NISSAN	7.02604.01.0
1S7G-9D475-AF	FORD	7.24809.73.0	22690-81N00	NISSAN	7.02604.01.0
1S7G-9D475-AG	FORD	7.24809.73.0	22690-8J001	NISSAN	7.05271.69.0
1S7G-9D475-AH	FORD	7.24809.73.0	22690-95E00	NISSAN	7.02604.01.0
1S7G-9D475-AJ	FORD	7.24809.73.0	22690-BX000	NISSAN	7.05271.69.0
1S7G-9D475-AK	FORD	7.24809.73.0	22690-ED000	NISSAN	7.05271.67.0
1S7G-9D475-AL	FORD	7.24809.73.0	22690-F2510	NISSAN	7.02604.01.0
2007718	FORD	7.05483.25.0	22690-F5100	NISSAN	7.02604.01.0
2017121	FORD	7.03784.34.0	22690-F5300	NISSAN	7.02604.01.0
2017409	FORD	7.02209.20.0	22690-J8000	NISSAN	7.02604.01.0
2026142	FORD	7.03784.34.0	22690-J9200	NISSAN	7.02604.01.0
2068415	FORD	7.05483.25.0	22690-P6510	NISSAN	7.02604.01.0
207441	TOPRAN	7.00063.10.0	22690-V4060	NISSAN	7.02604.01.0
207932	TOPRAN	7.04879.00.0	22690-V9410	NISSAN	7.02604.01.0
208155642R	RENAULT	7.11190.08.0	2269000QAC	NISSAN	7.02604.04.0
208156551R	DACIA	7.11492.07.0	2269000QAE	NISSAN	7.02604.04.0
208156551R	RENAULT	7.11492.07.0	226902A000	RENAULT	7.05270.55.0
208158341R	RENAULT	7.11457.07.0	22690AA370	SUBARU	7.02604.03.0
20827-00Q0G	NISSAN	7.11190.08.0	22691-2A000	NISSAN	7.05270.55.0
20827-00Q0L	NISSAN	7.11492.07.0	22691-8U000	NISSAN	7.05270.55.0
20827-00Q0M	NISSAN	7.11190.08.0	226910W00	NISSAN	7.02604.03.0
20948457	SWAG	7.00450.09.0	22693-JG70A	NISSAN	7.02604.44.0
21-0409	MAXGEAR	7.08369.38.0	226935G70A	RENAULT	7.02604.44.0
210008610	AUTOMEGA	7.09720.00.0	226937S000	NISSAN	7.05270.80.0
210173010	AUTOMEGA	7.22738.08.0	226937Y020	NISSAN	7.05270.80.0
21159	FEBI	7.24809.10.0	22693CD700	NISSAN	7.05270.80.0
21355	FEBI	7.05270.47.0	22693JG70A	RENAULT	7.02604.44.0
21355	FEBI	7.05270.51.0	2269684	FORD	7.05578.15.0
21383	FEBI	7.02604.64.0	226A0-0W001	NISSAN	7.02604.04.0
21418	FEBI	7.05271.03.0	226A0-AU001	NISSAN	7.05271.69.0
21420	FEBI	7.05271.03.0	226A0-AU011	NISSAN	7.05271.69.0
21428	FEBI	7.05270.86.0	226A0-EA000	NISSAN	7.05271.37.0
21448	FEBI	7.05270.86.0	226A0-EN21A	NISSAN	7.05271.67.0
2148000027	MEYLE	7.08369.35.0	226A07S001	NISSAN	7.05271.37.0
215910000100	MAGNETI MARELLI	7.11190.04.0	226A08U300	NISSAN	7.05271.37.0
215910000200	MAGNETI MARELLI	7.11190.02.0	226A1-0W002	NISSAN	7.02604.04.0
215910000300	MAGNETI MARELLI	7.11492.02.0	226A1-8U700	NISSAN	7.05271.69.0
215910000400	MAGNETI MARELLI	7.11190.09.0	226A1-AR210	NISSAN	7.05271.69.0
215910000500	MAGNETI MARELLI	7.11492.00.0	226A4-7142R	NISSAN	7.02604.41.0
215910000600	MAGNETI MARELLI	7.11190.10.0	226A40301R	RENAULT	7.02604.44.0
215910000800	MAGNETI MARELLI	7.11492.01.0	226A42455R	RENAULT	7.02604.99.0
215910001300	MAGNETI MARELLI	7.11190.03.0	226A42850R	RENAULT	7.02604.44.0
215910001500	MAGNETI MARELLI	7.11190.00.0	226A47142R	RENAULT	7.02604.41.0
2191075	FORD	7.07794.22.0	226A49071R	RENAULT	7.02604.99.0
2215572	FORD	7.05483.25.0	22770-00Q0C	NISSAN	7.11190.08.0
2225536	FORD	7.05742.11.0	22770-1177R	NISSAN	7.11492.07.0
2246145	BMW	7.21920.62.0	227701177R	DACIA	7.11492.07.0
2247177	BMW	7.21920.62.0	227701177R	RENAULT	7.11492.07.0
2248139	BMW	7.21920.62.0	227701454R	RENAULT	7.11190.08.0
22690-00Q0L	NISSAN	7.02604.99.0	227702184R	RENAULT	7.11190.08.0
22690-00QAF	NISSAN	7.05270.54.0	22771-JG70A	NISSAN	7.11190.08.0
22690-01Y00	NISSAN	7.02604.01.0	22771JG70A	RENAULT	7.11190.08.0
22690-06F00	NISSAN	7.02604.01.0	2278822	FORD	7.04511.29.0
22690-07G00	NISSAN	7.02604.01.0	2283246	FORD	7.05483.25.0
22690-07G01	NISSAN	7.02604.01.0	2308541	FORD	7.06036.14.0
22690-0S200	NISSAN	7.02604.01.0	2309809	FORD	7.05742.11.0
22690-0U000	NISSAN	7.02604.01.0	2327797	FORD	7.07794.22.0
22690-17B00	NISSAN	7.02604.01.0	2342011	FORD	7.07794.22.0
22690-19B10	NISSAN	7.02604.01.0	2348052	FORD	7.04511.29.0
22690-1E400	NISSAN	7.02604.01.0	2374578	FORD	7.05483.25.0
22690-1F701	NISSAN	7.05271.69.0	2388154	FORD	7.04511.29.0
22690-2A000	NISSAN	7.05270.55.0	240640280	WE-PARTS	7.07696.00.0
22690-2A010	NISSAN	7.05270.55.0	240640281	WE-PARTS	7.03608.16.0
22690-30R00	NISSAN	7.02604.01.0	240640373	WE-PARTS	7.03571.16.0
22690-30R15	NISSAN	7.02604.01.0	2409355	FORD	7.24809.89.0



REF-No.		 PIERBURG	REF-No.		 PIERBURG
24133391	GENERAL MOTORS	7.02604.15.0	2507058	HITACHI	7.08369.34.0
24133391	GMC	7.02604.15.0	2507058	HITACHI LI	7.08369.34.0
24229	FEBI	7.02604.31.0	2507059	HITACHI LI	7.08369.96.0
24237	FEBI	7.02604.21.0	2507065	HITACHI	7.08369.33.0
24238	FEBI	7.02604.31.0	2507065	HITACHI LI	7.08369.33.0
24403182	OPEL	7.05271.68.0	2507066	HITACHI	7.08369.36.0
24403182	VAUXHALL	7.05271.68.0	2507066	HITACHI LI	7.08369.36.0
24405922	OPEL	7.04879.00.0	2507070	HITACHI LI	7.08369.78.0
24405922	VAUXHALL	7.04879.00.0	2507071	HITACHI LI	7.11020.01.0
24411440	OPEL	7.05271.68.0	2507071	HITACHI LI	7.11020.11.0
24411440	VAUXHALL	7.05271.68.0	2507072	HITACHI LI	7.08369.81.0
24420591	GENERAL MOTORS	7.02604.07.0	2507073	HITACHI LI	7.08369.86.0
24420591	OPEL	7.02604.07.0	2507075	HITACHI LI	7.11020.21.0
24420594	GENERAL MOTORS	7.05271.81.0	2507077	HITACHI LI	7.11020.17.0
24420594	OPEL	7.05271.81.0	2507082	HITACHI LI	7.11020.06.0
24420594	VAUXHALL	7.05271.81.0	2507083	HITACHI LI	7.11020.04.0
24432940	OPEL	7.05271.81.0	2507091	HITACHI LI	7.11020.18.0
24432940	VAUXHALL	7.05271.81.0	2507092	HITACHI	7.08369.15.0
24445720	OPEL	7.28384.13.0	2507092	HITACHI LI	7.08369.15.0
24445720	VAUXHALL	7.28384.13.0	2508478	HITACHI	7.09002.11.0
24610	OSSCA	7.08369.08.0	2508494	HITACHI	7.09002.09.0
250-25007	WALKER	7.05271.77.0	2508495	HITACHI	7.09002.05.0
250-25008	WALKER	7.05271.24.0	2508496	HITACHI	7.09002.12.0
2505501	HITACHI LI	7.08369.35.0	2508499	HITACHI	7.09002.08.0
2505502	HITACHI LI	7.11020.05.0	25105107	OPEL	7.02604.15.0
2505505	HITACHI	7.08369.23.0	25105107	TOYOTA	7.02604.01.0
2505505	HITACHI LI	7.08369.23.0	25105107	VAUXHALL	7.02604.15.0
2505509	HITACHI LI	7.11020.45.0	25105901	GENERAL MOTORS	7.02604.15.0
2505511	HITACHI LI	7.11020.25.0	25106073	GMC	7.02604.01.0
2505526	HITACHI LI	7.11020.44.0	25106073	OPEL	7.02604.15.0
2505528	HITACHI LI	7.11020.41.0	25106073	VAUXHALL	7.02604.15.0
2507001	HITACHI	7.08369.01.0	25106169	GMC	7.02604.01.0
2507001	HITACHI LI	7.08369.01.0	25106169	TOYOTA	7.02604.01.0
2507002	HITACHI LI	7.08369.04.0	25133391	OPEL	7.02604.15.0
2507003	HITACHI LI	7.08369.03.0	25133391	VAUXHALL	7.02604.15.0
2507004	HITACHI LI	7.08369.02.0	25162012	OPEL	7.02604.15.0
2507006	HITACHI LI	7.08369.84.0	25162012	VAUXHALL	7.02604.15.0
2507007	HITACHI	7.08369.11.0	25162600	GENERAL MOTORS	7.02604.15.0
2507007	HITACHI LI	7.08369.11.0	25162693	GENERAL MOTORS	7.02604.15.0
2507009	HITACHI LI	7.08369.82.0	25162753	CHEVROLET	7.02604.15.0
2507012	HITACHI	7.08369.26.0	25164596	OPEL	7.02604.15.0
2507012	HITACHI LI	7.08369.26.0	25164596	VAUXHALL	7.02604.15.0
2507013	HITACHI	7.08369.08.0	25165118	GMC	7.02604.01.0
2507013	HITACHI LI	7.08369.08.0	25165119	GMC	7.02604.01.0
2507014	HITACHI LI	7.11020.02.0	25166816	GENERAL MOTORS	7.02604.15.0
2507015	HITACHI LI	7.08369.05.0	25168561	GENERAL MOTORS	7.02604.01.0
2507016	HITACHI LI	7.08369.99.0	25172586	GMC	7.02604.01.0
2507017	HITACHI LI	7.08369.98.0	25172587	GMC	7.02604.01.0
2507018	HITACHI LI	7.08369.90.0	25172592	GMC	7.02604.01.0
2507019	HITACHI LI	7.08369.97.0	25172610	OPEL	7.02604.03.0
2507021	HITACHI LI	7.11020.03.0	25176706	GMC	7.02604.01.0
2507022	HITACHI LI	7.11020.00.0	25176707	GMC	7.02604.01.0
2507023	HITACHI LI	7.11020.08.0	25177968	OPEL	7.05271.52.0
2507028	HITACHI LI	7.08369.32.0	25177968	VAUXHALL	7.05271.52.0
2507029	HITACHI LI	7.11020.09.0	25182127	CHEVROLET	7.09002.10.0
2507034	HITACHI	7.08369.09.0	25183476	CHEVROLET	7.09002.04.0
2507034	HITACHI LI	7.08369.09.0	25183477	CHEVROLET	7.09002.10.0
2507036	HITACHI LI	7.08369.41.0	25183662	OPEL	7.08369.54.0
2507042	HITACHI LI	7.08369.14.0	25183665	GENERAL MOTORS	7.08369.70.0
2507043	HITACHI LI	7.11020.07.0	25186658	CHEVROLET	7.11020.49.0
2507046	HITACHI LI	7.08369.22.0	25198484	OPEL	7.02604.07.0
2507051	HITACHI LI	7.11020.10.0	25198484	VAUXHALL	7.02604.07.0
2507053	HITACHI	7.08369.18.0	25321313	OPEL	7.05270.25.0
2507053	HITACHI LI	7.08369.18.0	25321313	VAUXHALL	7.05270.25.0
2507054	HITACHI	7.08369.45.0	25324206	OPEL	7.05270.25.0
2507054	HITACHI LI	7.08369.45.0	25324206	VAUXHALL	7.05270.25.0
2507055	HITACHI	7.08369.31.0	25327304	OPEL	7.05271.76.0
2507055	HITACHI LI	7.08369.31.0	25327304	VAUXHALL	7.05271.76.0
2507056	HITACHI LI	7.11020.13.0	25327985	GENERAL MOTORS	7.05271.52.0



NUMBERFINDER

REF-No.			REF-No.		
25335280	OPEL	7.05270.26.0	273-20035	WALKER	7.08369.49.0
25335280	VAUXHALL	7.05270.26.0	273-20037	WALKER	7.11020.13.0
25361764	GENERAL MOTORS	7.05271.52.0	273-20043	WALKER	7.08369.30.0
25368889	GENERAL MOTORS	7.02604.05.0	273-20045	WALKER	7.08369.87.0
25368889	OPEL	7.02604.05.0	273-20047	WALKER	7.08369.42.0
25368889	VAUXHALL	7.02604.05.0	273-20048	WALKER	7.08369.32.0
25620-WA010	TOYOTA	7.03051.04.0	273-20049	WALKER	7.08369.09.0
25620-WA020	TOYOTA	7.04493.17.0	273-20052	WALKER	7.11020.00.0
25670-WA010	TOYOTA	7.03051.04.0	273-20065	WALKER	7.08369.30.0
25906265	VOLKSWAGEN	7.02604.01.0	273-20066	WALKER	7.08369.18.0
26171	FEBI	7.05270.37.0	273-20068	WALKER	7.08369.22.0
26171	FEBI	7.05270.38.0	273-20069	WALKER	7.08369.74.0
26172	FEBI	7.05270.36.0	273-20072	WALKER	7.08369.31.0
26297	FEBI	7.02604.53.0	273-20074	WALKER	7.11020.02.0
26577	OSSCA	7.22934.57.0	273-20076	WALKER	7.08369.97.0
27-0152	MAXGEAR	7.22818.58.0	273-20080	WALKER	7.08369.75.0
27-0153	MAXGEAR	7.22818.59.0	273-20081	WALKER	7.11020.07.0
27-0161	MAXGEAR	7.22818.62.0	273-20087	WALKER	7.11020.14.0
27-0163	MAXGEAR	7.22414.08.0	273-20088	WALKER	7.08369.27.0
27-0228	MAXGEAR	7.24809.68.0	273-20089	WALKER	7.08369.96.0
27-0633	MAXGEAR	7.22843.06.0	273-20091	WALKER	7.11020.12.0
27-0657	MAXGEAR	7.00450.09.0	273-20092	WALKER	7.08369.23.0
27-4063	MAXGEAR	7.09002.08.0	273-20093	WALKER	7.11020.19.0
27-4067	MAXGEAR	7.09002.12.0	273-20100	WALKER	7.11020.20.0
27047	STANDARD	7.08369.05.0	273-20101	WALKER	7.08369.11.0
27062	STANDARD	7.08369.03.0	273-20102	WALKER	7.08369.56.0
27066	STANDARD	7.08369.41.0	273-20105	WALKER	7.08369.15.0
27072	STANDARD	7.08369.34.0	273-20108	WALKER	7.11020.09.0
27080	STANDARD	7.08369.08.0	273-20110	WALKER	7.08369.39.0
27082	STANDARD	7.08369.09.0	273-20115	WALKER	7.11020.06.0
27110	STANDARD	7.08369.17.0	273-20117	WALKER	7.08369.25.0
27111	STANDARD	7.08369.38.0	273-20120	WALKER	7.08369.35.0
27143	STANDARD	7.08369.43.0	273-20122	WALKER	7.08369.40.0
27162	STANDARD	7.08369.15.0	273-20128	WALKER	7.11020.10.0
27202	STANDARD	7.08369.30.0	273-20129	WALKER	7.08369.78.0
27229	STANDARD	7.08369.33.0	273-20134	WALKER	7.11020.04.0
27232	STANDARD	7.08369.22.0	273-20147	WALKER	7.08369.82.0
27245	STANDARD	7.08369.23.0	273-20154	WALKER	7.08369.21.0
27279	STANDARD	7.08369.11.0	273-20155	WALKER	7.08369.33.0
273-10345	WALKER	7.11020.25.0	273-20163	WALKER	7.08369.62.0
273-10354	WALKER	7.08369.89.0	273-20165	WALKER	7.08369.44.0
273-20001	WALKER	7.08369.04.0	273-20167	WALKER	7.08369.36.0
273-20002	WALKER	7.08369.06.0	273-20169	WALKER	7.08369.38.0
273-20003	WALKER	7.08369.01.0	273-20182	WALKER	7.08369.94.0
273-20004	WALKER	7.08369.26.0	273-20191	WALKER	7.11020.08.0
273-20005	WALKER	7.08369.17.0	273-20197	WALKER	7.08369.43.0
273-20006	WALKER	7.08369.03.0	273-20199	WALKER	7.08369.68.0
273-20007	WALKER	7.08369.02.0	273-20246	WALKER	7.08369.80.0
273-20008	WALKER	7.08369.14.0	273-20287	WALKER	7.08369.41.0
273-20009	WALKER	7.08369.13.0	273-20294	WALKER	7.11020.15.0
273-20010	WALKER	7.08369.84.0	273-20296	WALKER	7.11020.03.0
273-20011	WALKER	7.08369.00.0	273-20298	WALKER	7.08369.34.0
273-20013	WALKER	7.08369.07.0	273-20299	WALKER	7.08369.88.0
273-20014	WALKER	7.08369.19.0	273-20305	WALKER	7.08369.86.0
273-20015	WALKER	7.08369.20.0	273-20359	WALKER	7.08369.76.0
273-20016	WALKER	7.08369.83.0	273-20365	WALKER	7.11020.18.0
273-20019	WALKER	7.08369.16.0	273-20367	WALKER	7.11020.21.0
273-20020	WALKER	7.08369.45.0	273-20634	WALKER	7.11020.24.0
273-20023	WALKER	7.08369.08.0	273-20968	WALKER	7.11020.27.0
273-20024	WALKER	7.08369.46.0	27380	STANDARD	7.08369.39.0
273-20025	WALKER	7.08369.47.0	28410-27000	HYUNDAI	7.09002.06.0
273-20026	WALKER	7.08369.01.0	28410-27000	KIA	7.09002.06.0
273-20027	WALKER	7.08369.24.0	28410-27001	HYUNDAI	7.09002.06.0
273-20029	WALKER	7.08369.12.0	28410-27001	KIA	7.09002.06.0
273-20030	WALKER	7.08369.48.0	28410-27250	HYUNDAI	7.09002.03.0
273-20031	WALKER	7.08369.05.0	28410-27250	KIA	7.09002.03.0
273-20032	WALKER	7.11020.01.0	28410-27400	HYUNDAI	7.09002.05.0
273-20032	WALKER	7.11020.11.0	28410-27400	KIA	7.09002.05.0
273-20034	WALKER	7.08369.37.0	28410-27410	HYUNDAI	7.09002.05.0



REF-No.		 PIERBURG	REF-No.		 PIERBURG
28410-27410	KIA	7.09002.05.0	2S6Q-9D475-BB	FORD	7.24809.76.0
28410-27700	HYUNDAI	7.09002.03.0	2S6Q-9D475-BC	FORD	7.24809.76.0
28410-27700	KIA	7.09002.03.0	2S6Q-9D475-BD	FORD	7.24809.76.0
28410-2A100	HYUNDAI (HUATAI)	7.09002.09.0	2S6Q9D475AA	FORD	7.24809.06.0
28410-2A100	KIA	7.09002.09.0	2S6Q9D475AB	FORD	7.24809.06.0
28410-2A120	HYUNDAI (HUATAI)	7.09002.07.0	2S7A-9G444-BA	FORD	7.02604.60.0
28410-2A120	KIA	7.09002.07.0	2S7Q9D475AC	FORD	7.24809.07.0
28410-2A300	HYUNDAI	7.11237.07.0	2S7Q9D475AD	FORD	7.24809.07.0
28410-2A300	KIA	7.11237.07.0	3.16152	DT-DIESEL TECHNIC AG	7.01268.03.0
28410-2A350	HYUNDAI (HUATAI)	7.09002.08.0	30004243	CHRYSLER	7.02604.15.0
28410-2A350	KIA	7.09002.08.0	30028574	CADILLAC	7.05271.59.0
28410-2F000	HYUNDAI (HUATAI)	7.09002.12.0	30028574	CHEVROLET	7.05271.59.0
28410-2F000	KIA	7.09002.12.0	30100562	SWAG	7.09720.00.0
28410-4A100	HYUNDAI	7.09002.11.0	30100801	SWAG	7.08369.26.0
28410-4A100	KIA	7.09002.11.0	30100804	SWAG	7.08369.19.0
28410-4A410	KIA	7.11237.08.0	30100807	SWAG	7.08369.24.0
28420-2A770	HYUNDAI	7.05052.00.0	30100821	SWAG	7.08369.09.0
28420-2A770	KIA	7.05052.00.0	30100844	SWAG	7.08369.01.0
28450-38210	HYUNDAI	7.09002.14.0	30100846	SWAG	7.08369.42.0
28450-38210	KIA	7.09002.14.0	30100848	SWAG	7.08369.37.0
28692	FEBI	7.05270.25.0	30107783	SWAG	7.24809.17.0
290960104	WE-PARTS	7.05271.22.0	3011099	FORD	7.02604.60.0
2910000212900	VDO	7.08369.01.0	3017003	VALEO	7.22843.06.0
2910000213000	VDO	7.08369.26.0	3040432	FORD	7.02604.64.0
2910000213100	VDO	7.08369.02.0	30611510	VOLVO	7.05270.72.0
2910000213300	VDO	7.08369.00.0	30622243	VOLVO	7.05270.70.0
2910000213400	VDO	7.08369.19.0	30622251	VOLVO	7.05270.69.0
2910000213500	VDO	7.08369.09.0	30622252	VOLVO	7.05270.70.0
2910000213600	VDO	7.08369.45.0	30630132	VOLVO	7.05270.73.0
2910000213700	VDO	7.08369.73.0	30637016	VOLVO	7.05270.67.0
2910000213800	VDO	7.08369.48.0	30637519	VOLVO	7.05270.81.0
2910000214000	VDO	7.08369.42.0	30637520	VOLVO	7.05270.67.0
2910000214200	VDO	7.08369.18.0	30637521	VOLVO	7.05270.67.0
2910000214300	VDO	7.08369.53.0	30637837	VOLVO	7.05270.67.0
2910000214400	VDO	7.08369.31.0	30650089	VOLVO	7.05270.69.0
2910000214500	VDO	7.08369.11.0	30650090	VOLVO	7.05270.70.0
2910000214700	VDO	7.08369.40.0	30650109	VOLVO	7.05270.67.0
2910000214800	VDO	7.11020.25.0	30651723	VOLVO	7.05270.82.0
2910000215000	VDO	7.08369.79.0	30677175	VOLVO	7.05270.69.0
2910000215100	VDO	7.08369.82.0	30684336	VOLVO	7.11190.10.0
2910000215300	VDO	7.08369.66.0	30684355	VOLVO	7.02604.65.0
2910000215700	VDO	7.08369.41.0	30713592	VOLVO	7.05270.69.0
2910000215900	VDO	7.11020.03.0	30713593	VOLVO	7.05270.70.0
2910000216000	VDO	7.08369.34.0	30713594	VOLVO	7.05270.82.0
2910000216100	VDO	7.08369.86.0	30713642	VOLVO	7.11020.14.0
2910000809700	VEMO	7.11020.07.0	30713739	VOLVO	7.08369.27.0
2910000809800	VDO	7.11020.02.0	30713979	VOLVO	7.05270.69.0
2910000810300	VDO	7.08369.22.0	30729648	VOLVO	7.08369.55.0
2910000810700	VDO	7.11020.21.0	30731563	VOLVO	7.02604.64.0
2910000810900	VDO	7.08369.81.0	30735327	VOLVO	7.05270.82.0
2910000811000	VDO	7.08369.37.0	30735329	VOLVO	7.05270.69.0
2910000811100	VDO	7.08369.50.0	30735330	VOLVO	7.05270.70.0
2910000826800	VDO	7.08369.23.0	30750092	VOLVO	7.24809.91.0
2910000827200	VDO	7.08369.65.0	30750460	VOLVO	7.11190.10.0
2910000827300	VDO	7.08369.47.0	30751797	VOLVO	7.05270.82.0
2910000827600	VDO	7.08369.43.0	30751865	VOLVO	7.05270.70.0
2910000854800	VDO	7.11020.19.0	30756122	VOLVO	7.05270.69.0
2910000855100	VDO	7.08369.93.0	30757183	VOLVO	7.11190.10.0
2910000977700	VDO	7.08369.96.0	30757189	VOLVO	7.11190.10.0
2910000977800	VDO	7.11020.13.0	30757402	VOLVO	7.24809.73.0
2910000977900	VDO	7.11020.45.0	30757555	VOLVO	7.02604.64.0
2910000978000	VDO	7.11020.44.0	30757769	VOLVO	7.02604.65.0
2910000978200	VDO	7.11020.14.0	30757778	VOLVO	7.02107.09.0
2910000978300	VDO	7.08369.27.0	30774570	VOLVO	7.05270.67.0
29332	FEBI	7.02604.07.0	30774578	VOLVO	7.05363.00.0
2D0906265	VOLKSWAGEN	7.02604.04.0	30774579	VOLVO	7.02107.09.0
2S6A9F472BB	FORD	7.02604.60.0	30774700	VOLVO	7.05270.69.0
2S6A9G444BA	FORD	7.02604.60.0	30774848	VOLVO	7.00555.06.0
2S6Q-9D475-BA	FORD	7.24809.76.0	30788039	VOLVO	7.22996.12.0



NUMBERFINDER

REF-No.			REF-No.		
30814907	VOLVO	7.05270.71.0	31439823	VOLVO	7.11020.43.0
30939250	SWAG	7.22738.08.0	31439824	VOLVO	7.11020.45.0
30939417	SWAG	7.28248.17.0	31628	FEBI	7.02604.80.0
30939713	SWAG	7.24809.16.0	31697984	VOLVO	7.11190.08.0
30946806	SWAG	7.24809.31.0	320900183	WE-PARTS	7.05271.22.0
30948837	SWAG	7.08369.02.0	32307	OSSCA	7.08369.27.0
30948838	SWAG	7.08369.13.0	32323	OSSCA	7.08369.35.0
30948841	SWAG	7.08369.01.0	32344	OSSCA	7.08369.22.0
30948842	SWAG	7.08369.18.0	32347	OSSCA	7.08369.33.0
30948844	SWAG	7.08369.07.0	3236666	AMC USA	7.02604.01.0
30948845	SWAG	7.08369.00.0	3238765	AMC USA	7.02604.01.0
30948847	SWAG	7.08369.31.0	32464	OSSCA	7.08369.38.0
30948848	SWAG	7.08369.41.0	32489	OSSCA	7.08369.43.0
30948849	SWAG	7.08369.03.0	33004243	CHRYSLER	7.02604.15.0
30948850	SWAG	7.08369.08.0	330690002	WE-PARTS	7.22818.58.0
30948851	SWAG	7.08369.34.0	330690002	WE-PARTS	7.22818.59.0
30948852	SWAG	7.24809.30.0	330690011	WE-PARTS	7.22414.08.0
30949267	SWAG	7.08369.43.0	330690017	WE-PARTS	7.22414.08.0
30949270	SWAG	7.08369.23.0	330690026	WE-PARTS	7.22785.17.0
30949272	SWAG	7.08369.40.0	330690028	WE-PARTS	7.22818.59.0
30949279	SWAG	7.08369.14.0	330690029	WE-PARTS	7.22818.59.0
30949282	SWAG	7.08369.45.0	330690030	WE-PARTS	7.22818.59.0
30949284	SWAG	7.08369.36.0	330690034	WE-PARTS	7.22818.58.0
30949285	SWAG	7.08369.33.0	330690035	WE-PARTS	7.22818.58.0
30949287	SWAG	7.08369.16.0	330690036	WE-PARTS	7.22818.58.0
30949293	SWAG	7.08369.22.0	330690054	WE-PARTS	7.22630.28.0
30949305	SWAG	7.08369.04.0	330690066	WE-PARTS	7.22414.08.0
30949306	SWAG	7.08369.44.0	330690067	WE-PARTS	7.22414.08.0
30949483	SWAG	7.22785.16.0	330690080	WE-PARTS	7.22477.11.0
30949485	SWAG	7.22785.17.0	330690083	WE-PARTS	7.22818.62.0
30949839	SWAG	7.09720.01.0	330690084	WE-PARTS	7.22818.62.0
30949844	SWAG	7.09720.02.0	330690085	WE-PARTS	7.22818.62.0
30SKV010	ESEN SKV	7.08369.39.0	330690129	WE-PARTS	7.00368.15.0
30SKV093	ESEN SKV	7.08369.15.0	330690130	WE-PARTS	7.00368.15.0
30SKV107	ESEN SKV	7.08369.33.0	330690140	WE-PARTS	7.24809.31.0
3119900300	JP GROUP	7.24809.68.0	330690143	WE-PARTS	7.24809.52.0
31216573	VOLVO	7.00555.07.0	330690154	WE-PARTS	7.22843.06.0
31219041	VOLVO	7.01604.02.0	330690155	WE-PARTS	7.22843.06.0
31251243	VOLVO	7.24809.73.0	330690169	WE-PARTS	7.00075.07.0
31259249	VOLVO	7.24809.39.0	330690170	WE-PARTS	7.00075.07.0
31293031	VOLVO	7.08369.27.0	330690171	WE-PARTS	7.24809.51.0
31293139	VOLVO	7.08369.55.0	330690173	WE-PARTS	7.24809.68.0
31293629	VOLVO	7.11190.10.0	330690175	WE-PARTS	7.24809.68.0
31293659	VOLVO	7.11190.08.0	330690184	WE-PARTS	7.09002.08.0
31293881	VOLVO	7.11020.43.0	330690187	WE-PARTS	7.09002.05.0
31303026	VOLVO	7.11020.13.0	330690190	WE-PARTS	7.11237.08.0
31303032	VOLVO	7.11020.45.0	330690204	WE-PARTS	7.28069.04.0
31319368	VOLVO	7.11190.10.0	330690205	WE-PARTS	7.00578.12.0
31319549	VOLVO	7.02156.33.0	330690206	WE-PARTS	7.28069.03.0
31319840	VOLVO	7.11020.44.0	330690210	WE-PARTS	7.09002.00.0
31319841	VOLVO	7.11020.45.0	330690217	WE-PARTS	7.24809.36.0
31319842	VOLVO	7.11020.13.0	330690222	WE-PARTS	7.21949.51.0
31359796	VOLVO	7.24809.73.0	330690232	WE-PARTS	7.09002.11.0
31370160	VOLVO	7.11190.08.0	330690233	WE-PARTS	7.09002.12.0
31370463	VOLVO	7.08369.69.0	330690239	WE-PARTS	7.24809.59.0
31370464	VOLVO	7.08369.55.0	330690245	WE-PARTS	7.24809.80.0
31370465	VOLVO	7.11020.14.0	330690246	WE-PARTS	7.00450.09.0
31370466	VOLVO	7.11020.44.0	330690262	WE-PARTS	7.24809.47.0
31370467	VOLVO	7.11020.45.0	330690263	WE-PARTS	7.24809.47.0
31370468	VOLVO	7.11020.13.0	330690264	WE-PARTS	7.24809.53.0
31370469	VOLVO	7.08369.27.0	330690271	WE-PARTS	7.00306.36.0
31370621	VOLVO	7.02156.33.0	330690273	WE-PARTS	7.00789.10.0
31370692	VOLVO	7.11020.45.0	330690276	WE-PARTS	7.02156.24.0
31431045	VOLVO	7.08369.69.0	330690276	WE-PARTS	7.02156.35.0
31431046	VOLVO	7.08369.55.0	330690308	WE-PARTS	7.10334.08.0
31431047	VOLVO	7.11020.14.0	330690318	WE-PARTS	7.01493.07.0
31431048	VOLVO	7.11020.44.0	330690319	WE-PARTS	7.01604.02.0
31431049	VOLVO	7.11020.13.0	330690328	WE-PARTS	7.22996.11.0
31431050	VOLVO	7.08369.27.0	330690378	WE-PARTS	7.09720.05.0



REF-No.		 PIERBURG	REF-No.		 PIERBURG
330690381	WE-PARTS	7.11237.07.0	35312511	VOLVO	7.02604.03.0
330690401	WE-PARTS	7.03435.05.0	35360	OSSCA	7.03635.12.0
330690407	WE-PARTS	7.24809.87.0	3553616	OPEL	7.07794.23.0
330690409	WE-PARTS	7.00020.50.0	3559458	FORD	7.02604.60.0
330690414	WE-PARTS	7.03295.03.0	359000603670	MAGNETI MARELLI	7.22574.12.0
330690485	WE-PARTS	7.01621.08.0	359000603920	MAGNETI MARELLI	7.24809.16.0
330690491	WE-PARTS	7.02156.24.0	359000604170	MAGNETI MARELLI	7.00368.15.0
330690503	WE-PARTS	7.03051.04.0	359000604180	MAGNETI MARELLI	7.22818.57.0
330690505	WE-PARTS	7.24809.86.0	359000604410	MAGNETI MARELLI	7.22818.59.0
330690530	WE-PARTS	7.01106.38.0	359000604410	MAGNETI MARELLI	7.22843.06.0
330690531	WE-PARTS	7.01881.07.0	359000604490	MAGNETI MARELLI	7.22875.16.0
330690545	WE-PARTS	7.22414.08.0	359000604500	MAGNETI MARELLI	7.22875.13.0
330690548	WE-PARTS	7.22818.59.0	359000604540	MAGNETI MARELLI	7.22414.08.0
330690550	WE-PARTS	7.22818.58.0	359000604770	MAGNETI MARELLI	7.01782.07.0
330690558	WE-PARTS	7.22818.62.0	36000666	VOLVO	7.24809.73.0
330690579	WE-PARTS	7.02156.24.0	36000974	VOLVO	7.22996.11.0
330690592	WE-PARTS	7.05052.03.0	36000976	VOLVO	7.24809.73.0
330690607	WE-PARTS	7.24809.68.0	36000977	VOLVO	7.24809.39.0
330690677	WE-PARTS	7.05320.04.0	36000977	VOLVO	7.24809.91.0
330690709	WE-PARTS	7.22996.12.0	36000978	VOLVO	7.24809.91.0
330690816	WE-PARTS	7.09002.09.0	36000979	VOLVO	7.22818.57.0
331460001	WE-PARTS	7.22738.08.0	36000980	VOLVO	7.24809.68.0
331460002	WE-PARTS	7.22934.57.0	36000997	VOLVO	7.00555.06.0
331460003	WE-PARTS	7.28124.19.0	36000998	VOLVO	7.05363.00.0
331460005	WE-PARTS	7.01486.10.0	36001412	VOLVO	7.24809.39.0
331460006	WE-PARTS	7.04389.00.0	36001458	VOLVO	7.02209.11.0
331460008	WE-PARTS	7.04389.02.0	36001479	VOLVO	7.02209.11.0
331460009	WE-PARTS	7.21851.31.0	36001487	VOLVO	7.02209.11.0
331460010	WE-PARTS	7.21852.24.0	36001738	VOLVO	7.01604.02.0
331460012	WE-PARTS	7.28238.55.0	36013551	VOLVO	7.24809.73.0
331460013	WE-PARTS	7.22296.02.0	36050570	VOLVO	7.00555.06.0
331460014	WE-PARTS	7.05574.00.0	36050870	VOLVO	7.24809.68.0
331460015	WE-PARTS	7.05574.01.0	3607837	PERKINS	7.03390.09.0
331460016	WE-PARTS	7.22778.97.0	3607839	PERKINS	7.03761.09.0
331460017	WE-PARTS	7.22769.77.0	36151	OSSCA	7.08369.02.0
331460018	WE-PARTS	7.22769.78.0	3639257	OPEL	7.11492.01.0
331460019	WE-PARTS	7.22769.73.0	3639257	VAUXHALL	7.11492.01.0
331460023	WE-PARTS	7.22166.02.0	36531-P01-004	HONDA	7.02604.01.0
331460026	WE-PARTS	7.21852.85.0	36531-P01-G01	HONDA	7.02604.01.0
331460027	WE-PARTS	7.21851.32.0	36531-P01-G02	HONDA	7.02604.01.0
331460029	WE-PARTS	7.22166.38.0	36531-P05-A01	HONDA	7.02604.01.0
331460030	WE-PARTS	7.22934.63.0	36531-P05-A02	HONDA	7.02604.01.0
331460031	WE-PARTS	7.21857.59.0	36531-P06-A01	HONDA	7.02604.01.0
331460032	WE-PARTS	7.22738.20.0	36531-P06-A11	HONDA	7.05271.71.0
331460036	WE-PARTS	7.21857.01.0	36531-P06-A12	HONDA	7.05271.71.0
331460038	WE-PARTS	7.21852.79.0	36531-P07-A01	HONDA	7.02604.01.0
331460040	WE-PARTS	7.03446.01.0	36531-P08-004	HONDA	7.02604.01.0
331460041	WE-PARTS	7.28415.09.0	36531-P1K-E01	HONDA	7.05271.71.0
331460046	WE-PARTS	7.22778.96.0	36531-P1K-E02	HONDA	7.05271.71.0
331460047	WE-PARTS	7.04389.07.0	36531-P1K-E021	HONDA	7.05271.71.0
331460048	WE-PARTS	7.22560.43.0	36531-P2A-J02	HONDA	7.02604.01.0
332110002	WE-PARTS	7.05052.00.0	36531-P2Y-G01	HONDA	7.02604.01.0
332110023	WE-PARTS	7.05031.06.0	36531-P3Y-G01	HONDA	7.02604.01.0
332120034	DIPA SPORT	7.00837.01.0	36531-P3Y-G02	HONDA	7.02604.01.0
332120070	WE-PARTS	7.02107.09.0	36531-P64-901	HONDA	7.02604.01.0
33683	FEBI	7.04879.00.0	36531-P64-902	HONDA	7.02604.01.0
3397015	FORD	7.05271.73.0	36531-P7A-003	HONDA	7.02604.01.0
33D906262B	VOLKSWAGEN	7.05271.12.0	36531-P8A-A01	ACURA	7.05271.58.0
34010.00150	HELLA INCORPORATED	7.00578.12.0	36531-P9L-E011	HONDA	7.05271.58.0
34010.00192	FEBI	7.22414.08.0	36531-PC7-663	HONDA	7.02604.01.0
34388	FEBI	7.05270.99.0	36531-PC7-665	HONDA	7.02604.01.0
3462685	VOLVO	7.02604.03.0	36531-PC7-682	HONDA	7.02604.01.0
34925	FEBI	7.24809.39.0	36531-PC7-682	HONDA	7.02604.01.0
3496736	PERKINS	7.03390.09.0	36531-PD2-662	HONDA	7.02604.01.0
3496737	PERKINS	7.03761.09.0	36531-PD2-663	HONDA	7.02604.01.0
3502335	PERKINS	7.03391.11.0	36531-PD2-664	HONDA	7.02604.01.0
3502336	PERKINS	7.03762.10.0	36531-PD6-662	HONDA	7.02604.01.0
350397	ERA SPA	7.04879.00.0	36531-PE1-305	HONDA	7.02604.01.0
352061110500	MAGNETI MARELLI	7.04879.00.0	36531-PE1-662	HONDA	7.02604.01.0
			36531-PE1-663	HONDA	7.02604.01.0

NUMBERFINDER

REF-No.		REF-No.			
36531-PE2-902	HONDA	7.02604.01.0	36532P8DJ01	HONDA	7.05271.61.0
36531-PE2-903	HONDA	7.02604.01.0	36532P8FA11	HONDA	7.05271.61.0
36531-PE2-904	HONDA	7.02604.01.0	36532PAAL01	HONDA	7.05271.61.0
36531-PE2-905	HONDA	7.02604.01.0	36532PAAL02	HONDA	7.05271.61.0
36531-PE7-663	HONDA	7.02604.01.0	36532PDCE01	HONDA	7.05271.61.0
36531-PG7-661	HONDA	7.02604.01.0	36532PDEE01	HONDA	7.05271.61.0
36531-PG7-A01	HONDA	7.02604.01.0	36532PDEE02	HONDA	7.05271.61.0
36531-PH2-004	HONDA	7.02604.01.0	36532PLRA01	HONDA	7.05271.61.0
36531-PH2-014	HONDA	7.02604.01.0	36532PLRA11	HONDA	7.05271.61.0
36531-PH4-682	HONDA	7.02604.01.0	36532PSAJ01	HONDA	7.05271.61.0
36531-PH7-003	HONDA	7.02604.01.0	36532RNAA01	HONDA	7.05271.46.0
36531-PJ0-661	HONDA	7.02604.01.0	36532RSHE01	HONDA	7.05271.46.0
36531-PJ0-L01	HONDA	7.02604.01.0	36541PR7A01	HONDA	7.05271.58.0
36531-PK2-003	HONDA	7.02604.01.0	36542PR7A51	HONDA	7.05271.61.0
36531-PK2-L01	HONDA	7.02604.01.0	36675	FEBI	7.22843.06.0
36531-PK3-A05	HONDA	7.05271.71.0	36750	FEBI	7.24809.76.0
36531-PLM-307	HONDA	7.05271.71.0	36760	FEBI	7.22843.06.0
36531-PLM-A01	HONDA	7.05271.71.0	36760	FEBI	7.22843.07.0
36531-PLM307	HONDA	7.05271.71.0	36892	FEBI	7.05271.05.0
36531-PM3-004	HONDA	7.02604.01.0	3721930	FORD	7.02604.60.0
36531-PM4-014	HONDA	7.02604.01.0	37430	FEBI	7.24809.29.0
36531-PM5-L01	HONDA	7.02604.01.0	37475	FEBI	7.00063.10.0
36531-PM8-305	HONDA	7.02604.01.0	37565	FEBI	7.05271.15.0
36531-PM8-A01	HONDA	7.02604.01.0	3772853	PERKINS	7.03390.09.0
36531-PM8-A03	HONDA	7.02604.01.0	3772854	PERKINS	7.03761.09.0
36531-PMS-A01	HONDA	7.05271.71.0	3793586	PERKINS	7.03762.10.0
36531-PO5-A01	HONDA	7.02604.01.0	3793587	PERKINS	7.03391.11.0
36531-PP0-014	HONDA	7.02604.01.0	3802644	FORD	7.05271.73.0
36531-PR4-A01	HONDA	7.02604.01.0	38331	OSSCA	7.01106.38.0
36531-PR4-L02	HONDA	7.02604.01.0	38341	OSSCA	7.22818.59.0
36531-PT0-N02	HONDA	7.02604.01.0	38358	OSSCA	7.00368.15.0
36531-PT2-J02	HONDA	7.05271.71.0	383700139	FERRARI	7.02604.55.0
36531-PT2-J04	HONDA	7.05271.71.0	38500	FEBI	7.24809.39.0
36531-PT2-J05	HONDA	7.05271.71.0	38906088A	AUDI	7.08369.66.0
36531-PT6-A02	HONDA	7.05271.71.0	38906088A	VOLKSWAGEN	7.08369.66.0
36531P07L01	HONDA	7.05271.58.0	3898281	FORD	7.02604.03.0
36531P07L02	HONDA	7.05271.58.0	39210-02610	HYUNDAI	7.02604.96.0
36531P0GA01	HONDA	7.05271.58.0	39210-02610	KIA	7.02604.96.0
36531P1HE01	HONDA	7.05271.58.0	39210-02620	HYUNDAI	7.02604.96.0
36531P1KE03	HONDA	7.05271.58.0	39210-02620	KIA	7.02604.96.0
36531P1KE11	HONDA	7.05271.58.0	39210-02630	HYUNDAI	7.02604.95.0
36531P28A01	HONDA	7.05271.58.0	39210-02630	KIA	7.02604.95.0
36531P28A02	HONDA	7.05271.58.0	39210-02640	HYUNDAI	7.02604.96.0
36531P2EA01	HONDA	7.05271.58.0	39210-02640	KIA	7.02604.96.0
36531P2EG01	HONDA	7.05271.58.0	39210-02660	HYUNDAI	7.02604.95.0
36531P2RA01	HONDA	7.05271.58.0	39210-02660	KIA	7.02604.95.0
36531P5P004	HONDA	7.05271.61.0	39210-02950	HYUNDAI	7.02604.95.0
36531P5P014	HONDA	7.05271.61.0	39210-02950	KIA	7.02604.95.0
36531P7AG01	HONDA	7.05271.58.0	39210-22610	HYUNDAI	7.02604.73.0
36531P7AG02	HONDA	7.05271.58.0	39210-22610	KIA	7.02604.73.0
36531P8CA01	HONDA	7.05271.58.0	39210-22620	HYUNDAI	7.02604.73.0
36531P9LE01	HONDA	7.05271.58.0	39210-22620	KIA	7.02604.73.0
36531P9LE02	HONDA	7.05271.58.0	39210-23500	HYUNDAI	7.02604.80.0
36531PELG01	HONDA	7.05271.58.0	39210-23710	HYUNDAI	7.02604.80.0
36531PELG02	HONDA	7.05271.58.0	39210-23750	HYUNDAI	7.02604.73.0
36531PELG03	HONDA	7.05271.58.0	39210-23750	KIA	7.02604.73.0
36531PGM003	HONDA	7.05271.58.0	39210-23950	HYUNDAI	7.02604.73.0
36531PLD003	HONDA	7.05271.61.0	39210-23950	KIA	7.02604.73.0
36531PLD013	HONDA	7.05271.61.0	39210-26700	HYUNDAI	7.02604.73.0
36532-PH7-003	HONDA	7.02604.01.0	39210-26700	KIA	7.02604.73.0
36532-PJ0-661	HONDA	7.02604.01.0	39210-2X010	HYUNDAI	7.02604.77.0
36532-PJ0-L01	HONDA	7.02604.01.0	39210-2X020	HYUNDAI	7.02604.77.0
36532-PK2-003	HONDA	7.02604.01.0	39210-33340	HYUNDAI	7.02604.75.0
36532-PK2-L01	HONDA	7.02604.01.0	39210-33340	KIA	7.02604.75.0
36532-PL2-003	HONDA	7.02604.01.0	39210-36700	HYUNDAI	7.02604.79.0
36532P2EA51	HONDA	7.05271.58.0	39210-36700	KIA	7.02604.79.0
36532P8CL01	HONDA	7.05271.61.0	39210-38005	HYUNDAI	7.02604.79.0
36532P8CL02	HONDA	7.05271.61.0	39210-38005	KIA	7.02604.79.0
36532P8CL21	HONDA	7.05271.61.0	39210-38015	HYUNDAI	7.02604.75.0

REF-No.		 PIERBURG	REF-No.		 PIERBURG
39210-38015	KIA	7.02604.75.0	40104401	SWAG	7.24809.87.0
39210-38025	HYUNDAI	7.02604.79.0	40104801	SWAG	7.24809.81.0
39210-38025	KIA	7.02604.79.0	408-265-001-002Z	VDO	7.10334.09.0
39210-38225	HYUNDAI	7.02604.75.0	408-265-001-005Z	VDO	7.10334.04.0
39210-38225	KIA	7.02604.75.0	408-265-001-010Z	VDO	7.10334.06.0
39210-39010	HYUNDAI	7.02604.79.0	408-265-001-014Z	VDO	7.10334.05.0
39210-39010	KIA	7.02604.79.0	408-275-002-001Z	VDO	7.10334.10.0
39210-39015	HYUNDAI	7.02604.79.0	4080233	FORD	7.02604.60.0
39210-39015	KIA	7.02604.79.0	40921159	SWAG	7.24809.10.0
39210-39030	HYUNDAI	7.02604.79.0	40933683	SWAG	7.04879.00.0
39210-39030	KIA	7.02604.79.0	40937430	SWAG	7.24809.29.0
39210-39040	HYUNDAI	7.02604.79.0	40937475	SWAG	7.00063.10.0
39210-39040	KIA	7.02604.79.0	40939543	SWAG	7.00020.24.0
39210-3C200	HYUNDAI	7.02604.92.0	40939544	SWAG	7.22414.08.0
39210-3C200	KIA	7.02604.92.0	40939545	SWAG	7.22414.04.0
39210-3C910	HYUNDAI	7.02604.92.0	40945157	SWAG	7.22946.38.0
39210-3C910	KIA	7.02604.92.0	40948833	SWAG	7.08369.38.0
3921002500	HYUNDAI	7.02604.01.0	40948834	SWAG	7.08369.32.0
3921002500	KIA	7.02604.01.0	40948840	SWAG	7.08369.15.0
3921002510	HYUNDAI	7.02604.01.0	40949261	SWAG	7.08369.05.0
3921022100	HYUNDAI	7.02604.03.0	40949288	SWAG	7.08369.17.0
3921024310	HYUNDAI	7.02604.01.0	409577	TOPRAN	7.08369.30.0
3921024560	HYUNDAI	7.02604.01.0	410590290	WE-PARTS	7.11190.00.0
3921024560	MITSUBISHI	7.02604.01.0	411420017	WE-PARTS	7.08369.03.0
3921032510	HYUNDAI	7.02604.01.0	411420017	WE-PARTS	7.08369.04.0
3921032630	HYUNDAI	7.02604.01.0	411420019	WE-PARTS	7.08369.26.0
3921032810	HYUNDAI	7.02604.01.0	411420020	WE-PARTS	7.08369.09.0
3921036700	MITSUBISHI	7.02604.79.0	411420022	WE-PARTS	7.08369.34.0
39250	FEBI	7.22738.08.0	411420025	WE-PARTS	7.08369.37.0
39350-2A420	HYUNDAI	7.02604.99.0	411420025	WE-PARTS	7.11020.02.0
39350-2A420	KIA	7.02604.99.0	411420029	WE-PARTS	7.08369.43.0
3935032510	HYUNDAI	7.02604.01.0	411420030	WE-PARTS	7.08369.01.0
393504A410	HYUNDAI	7.02604.99.0	411420032	WE-PARTS	7.08369.41.0
393504A410	KIA	7.02604.99.0	411420033	WE-PARTS	7.08369.19.0
39417	FEBI	7.28248.17.0	411420034	WE-PARTS	7.08369.48.0
39543	FEBI	7.00020.24.0	411420038	WE-PARTS	7.08369.02.0
39544	FEBI	7.22414.08.0	411420040	WE-PARTS	7.08369.08.0
39545	FEBI	7.22414.04.0	411420044	WE-PARTS	7.08369.14.0
39713	FEBI	7.24809.16.0	411420049	WE-PARTS	7.08369.05.0
39906265	VOLKSWAGEN	7.02604.01.0	411420051	WE-PARTS	7.08369.32.0
3C1Q-9D475-AA	FORD	7.24809.74.0	411420056	WE-PARTS	7.08369.38.0
3G906088AP	AUDI	7.08369.65.0	411420057	WE-PARTS	7.08369.46.0
3G906088AP	VOLKSWAGEN	7.08369.65.0	411420068	WE-PARTS	7.11020.00.0
3L906088DN	VOLKSWAGEN	7.08369.64.0	411420073	WE-PARTS	7.11020.12.0
3M51-9F472-BA	FORD	7.02604.64.0	411420075	WE-PARTS	7.11020.05.0
3M51-9F472-CA	FORD	7.02604.64.0	411420076	WE-PARTS	7.11020.35.0
3M51-9F472-DB	FORD	7.02604.64.0	411420078	WE-PARTS	7.11020.28.0
3M51-9G444-BB	FORD	7.02604.65.0	411420081	WE-PARTS	7.08369.90.0
3M519F472AA	FORD	7.02604.64.0	411420083	WE-PARTS	7.08369.30.0
3M519F472AB	FORD	7.02604.64.0	411420085	WE-PARTS	7.08369.94.0
3M519F472AC	FORD	7.02604.64.0	411420086	WE-PARTS	7.08369.35.0
3M519F472BA	FORD	7.02604.64.0	411420089	WE-PARTS	7.11020.09.0
3M519F472BB	FORD	7.02604.64.0	411420090	WE-PARTS	7.11020.10.0
3M519F472BC	FORD	7.02604.64.0	411420102	WE-PARTS	7.11020.08.0
3M519F472CA	FORD	7.02604.64.0	411420109	WE-PARTS	7.11020.14.0
3M519F472CB	FORD	7.02604.64.0	411420112	WE-PARTS	7.11020.44.0
3M519F472DA	FORD	7.02604.64.0	411420113	WE-PARTS	7.11020.45.0
3M519F472DB	FORD	7.02604.64.0	411420114	WE-PARTS	7.11020.13.0
3M519F472DC	FORD	7.02604.64.0	411420119	WE-PARTS	7.11020.11.0
3M519G444BC	FORD	7.02604.65.0	411420151	WE-PARTS	7.08369.82.0
3M5A-5L200-AA	FORD	7.11190.10.0	411420152	WE-PARTS	7.11020.19.0
3M5A-5L200-AB	FORD	7.11190.10.0	411420153	WE-PARTS	7.08369.93.0
3M5Q-9F464-AA	FORD	7.09730.00.0	411420155	WE-PARTS	7.08369.92.0
3Q0253691F	VOLKSWAGEN	7.04709.13.0	411420156	WE-PARTS	7.11020.07.0
3S7A9G444CA	FORD	7.02604.64.0	411420164	WE-PARTS	7.08369.83.0
4.69089	DT-DIESEL TECHNIC AG	7.08369.30.0	411420166	WE-PARTS	7.11020.49.0
4004675	CHRYSLER	7.02604.01.0	411420169	WE-PARTS	7.11020.37.0
4006056	METZGER	7.04879.00.0	411420186	WE-PARTS	7.08369.15.0
40100822	SWAG	7.08369.46.0	411420187	WE-PARTS	7.08369.49.0

REF-No.			REF-No.		
411420198	WE-PARTS	7.08369.88.0	4400651	OPEL	7.10334.03.0
411420234	WE-PARTS	7.08369.98.0	4400651	VAUXHALL	7.10334.03.0
411420235	WE-PARTS	7.08369.99.0	4404463	OPEL	7.22818.59.0
411420241	WE-PARTS	7.11020.15.0	4404463	VAUXHALL	7.22818.59.0
411420248	WE-PARTS	7.08369.36.0	4407955	OPEL	7.11190.08.0
411420249	WE-PARTS	7.08369.33.0	4407955	VAUXHALL	7.11190.08.0
411420252	WE-PARTS	7.08369.22.0	4408954	OPEL	7.02604.10.0
411420253	WE-PARTS	7.08369.40.0	4408954	VAUXHALL	7.02604.10.0
411420281	WE-PARTS	7.11020.27.0	4409585	OPEL	7.22818.57.0
411420282	WE-PARTS	7.11020.42.0	4409585	VAUXHALL	7.22818.57.0
411420286	WE-PARTS	7.11020.20.0	4411697	OPEL	7.22818.59.0
411420294	WE-PARTS	7.08369.23.0	4411697	VAUXHALL	7.22818.59.0
411420295	WE-PARTS	7.11020.03.0	4411757	OPEL	7.22818.57.0
411420298	WE-PARTS	7.08369.86.0	4411757	VAUXHALL	7.22818.57.0
411420300	WE-PARTS	7.08369.45.0	4412632	OPEL	7.22818.57.0
411420301	WE-PARTS	7.08369.31.0	4412632	VAUXHALL	7.22818.57.0
411420303	WE-PARTS	7.08369.39.0	4412634	OPEL	7.22818.59.0
411420304	WE-PARTS	7.08369.18.0	4412634	VAUXHALL	7.22818.59.0
411420306	WE-PARTS	7.08369.96.0	4413408	OPEL	7.22818.57.0
411420312	WE-PARTS	7.08369.78.0	4413408	VAUXHALL	7.22818.57.0
411420341	WE-PARTS	7.08369.47.0	4415798	OPEL	7.22818.57.0
411420349	WE-PARTS	7.08369.95.0	4415798	VAUXHALL	7.22818.57.0
411420377	WE-PARTS	7.11020.17.0	4415923	OPEL	7.22818.59.0
411420423	WE-PARTS	7.11020.18.0	4415923	VAUXHALL	7.22818.59.0
411420441	WE-PARTS	7.08369.91.0	4416575	OPEL	7.22818.57.0
411420445	WE-PARTS	7.08369.87.0	4416575	VAUXHALL	7.22818.57.0
411420446	WE-PARTS	7.11020.16.0	4420704	OPEL	7.10334.03.0
411420484	WE-PARTS	7.11020.04.0	4420704	VAUXHALL	7.10334.03.0
411420620	WE-PARTS	7.08369.45.0	4422694	OPEL	7.11190.08.0
411420655	WE-PARTS	7.11020.48.0	4422694	VAUXHALL	7.11190.08.0
411420677	WE-PARTS	7.11020.43.0	4424052	OPEL	7.11492.07.0
411420680	WE-PARTS	7.08369.17.0	4424052	VAUXHALL	7.11492.07.0
411420712	WE-PARTS	7.11020.29.0	4430291	FIAT	7.02604.01.0
411420731	WE-PARTS	7.08369.05.0	4430291	LANCIA	7.02604.01.0
411420740	WE-PARTS	7.11020.01.0	4430902	OPEL	7.22818.57.0
411420824	WE-PARTS	7.08369.01.0	4430902	VAUXHALL	7.22818.57.0
411420834	WILMINK	7.08369.86.0	4431.105D	WAHLER	7.04879.00.0
411420838	WE-PARTS	7.11020.25.0	4431717	OPEL	7.02604.44.0
411420896	WE-PARTS	7.08369.23.0	4431717	VAUXHALL	7.02604.44.0
411420897	WE-PARTS	7.08369.39.0	4434381	OPEL	7.22818.63.0
411420904	WE-PARTS	7.08369.30.0	4434381	VAUXHALL	7.22818.63.0
411420915	WE-PARTS	7.11020.33.0	4434941	OPEL	7.10334.05.0
411420923	WE-PARTS	7.08369.26.0	4434941	VAUXHALL	7.10334.05.0
411420927	WE-PARTS	7.11020.06.0	444599	KARMANN	7.02604.99.0
411420947	WE-PARTS	7.11020.26.0	4453017	OPEL	7.10334.03.0
411420948	WE-PARTS	7.11020.31.0	4453017	VAUXHALL	7.10334.03.0
411770002	WE-PARTS	7.11190.04.0	45-8000	IPD INDUSTRIAL PARTS DISTRIBUT	7.24809.06.0
411770008	WE-PARTS	7.11190.08.0	45-8004	IPD INDUSTRIAL PARTS DISTRIBUT	7.22630.28.0
411770010	WE-PARTS	7.11190.02.0	45-8006	IPD INDUSTRIAL PARTS DISTRIBUT	7.24809.10.0
411770011	WE-PARTS	7.11190.09.0	45-8007	IPD INDUSTRIAL PARTS DISTRIBUT	7.22785.17.0
411770019	WE-PARTS	7.11190.10.0	45-8007	IPD INDUSTRIAL PARTS DISTRIBUT	7.22785.17.0
411770047	WE-PARTS	7.11492.05.0	45-8008	IPD INDUSTRIAL PARTS DISTRIBUT	7.22414.04.0
4254167	PERKINS	7.03391.11.0	45-8009	IPD INDUSTRIAL PARTS DISTRIBUT	7.22414.08.0
4254171	PERKINS	7.03762.10.0	45-8011	IPD INDUSTRIAL PARTS DISTRIBUT	7.22946.34.0
42577107	IVECO	7.05632.04.0	45-8012	IPD INDUSTRIAL PARTS DISTRIBUT	7.22818.59.0
4300009	GENERAL MOTORS	7.02604.15.0	45-8013	IPD INDUSTRIAL PARTS DISTRIBUT	7.22818.57.0
4301175	CHRYSLER	7.02604.01.0	45-8014	IPD INDUSTRIAL PARTS DISTRIBUT	7.22818.58.0
4301246	CHRYSLER	7.02604.01.0	45-8015	IPD INDUSTRIAL PARTS DISTRIBUT	7.00063.10.0
4301275	CHRYSLER	7.02604.01.0	45-8017	IPD INDUSTRIAL PARTS DISTRIBUT	7.22875.13.0
4301346	CHRYSLER	7.02604.01.0			
4301375	CHRYSLER	7.02604.01.0			
4319900100	JP GROUP	7.00368.15.0			
4319900200	JP GROUP	7.22818.58.0			
4319900200	JP GROUP	7.22818.59.0			
4319900600	JP GROUP	7.00075.07.0			
4319900700	JP GROUP	7.22818.62.0			
434642	KARMANN	7.02604.99.0			
437463	KARMANN	7.05270.17.0			
43978	FEBI	7.10334.00.0			

REF-No.		 PIERBURG	REF-No.		 PIERBURG
45-8019	IPD INDUSTRIAL PARTS DISTRIBUT	7.00020.24.0	45-8109	IPD INDUSTRIAL PARTS DISTRIBUT	7.24809.30.0
45-8023	IPD INDUSTRIAL PARTS DISTRIBUT	7.22574.12.0	45-8110	IPD INDUSTRIAL PARTS DISTRIBUT	7.24809.31.0
45-8024	IPD INDUSTRIAL PARTS DISTRIBUT	7.28248.17.0	45-8111	IPD INDUSTRIAL PARTS DISTRIBUT	7.24809.59.0
45-8025	IPD INDUSTRIAL PARTS DISTRIBUT	7.22785.18.0	45-8112	IPD INDUSTRIAL PARTS DISTRIBUT	7.24809.49.0
45-8026	IPD INDUSTRIAL PARTS DISTRIBUT	7.22785.16.0	45-8114	IPD INDUSTRIAL PARTS DISTRIBUT	7.24809.48.0
45-8028	IPD INDUSTRIAL PARTS DISTRIBUT	7.22946.38.0	45-8116	IPD INDUSTRIAL PARTS DISTRIBUT	7.24809.32.0
45-8029	IPD INDUSTRIAL PARTS DISTRIBUT	7.24809.07.0	45-8117	IPD INDUSTRIAL PARTS DISTRIBUT	7.24809.54.0
45-8030	IPD INDUSTRIAL PARTS DISTRIBUT	7.00020.25.0	45-8118	IPD INDUSTRIAL PARTS DISTRIBUT	7.24809.61.0
45-8033	IPD INDUSTRIAL PARTS DISTRIBUT	7.24809.27.0	45-8119	IPD INDUSTRIAL PARTS DISTRIBUT	7.24809.56.0
45-8034	IPD INDUSTRIAL PARTS DISTRIBUT	7.24809.28.0	45-8120	IPD INDUSTRIAL PARTS DISTRIBUT	7.24809.46.0
45-8035	IPD INDUSTRIAL PARTS DISTRIBUT	7.24809.20.0	45-8122	IPD INDUSTRIAL PARTS DISTRIBUT	7.24809.55.0
45-8036	IPD INDUSTRIAL PARTS DISTRIBUT	7.22818.63.0	45-8123	IPD INDUSTRIAL PARTS DISTRIBUT	7.24809.77.0
45-8037	IPD INDUSTRIAL PARTS DISTRIBUT	7.24809.76.0	45-8125	IPD INDUSTRIAL PARTS DISTRIBUT	7.24809.50.0
45-8038	IPD INDUSTRIAL PARTS DISTRIBUT	7.09002.05.0	45-8126	IPD INDUSTRIAL PARTS DISTRIBUT	7.24809.52.0
45-8039	IPD INDUSTRIAL PARTS DISTRIBUT	7.22875.16.0	45-8127	IPD INDUSTRIAL PARTS DISTRIBUT	7.24809.57.0
45-8040	IPD INDUSTRIAL PARTS DISTRIBUT	7.21920.62.0	45-8129	IPD INDUSTRIAL PARTS DISTRIBUT	7.24809.35.0
45-8043	IPD INDUSTRIAL PARTS DISTRIBUT	7.00020.39.0	45-8130	IPD INDUSTRIAL PARTS DISTRIBUT	7.24809.63.0
45-8044	IPD INDUSTRIAL PARTS DISTRIBUT	7.00020.40.0	45-8131	IPD INDUSTRIAL PARTS DISTRIBUT	7.24809.53.0
45-8045	IPD INDUSTRIAL PARTS DISTRIBUT	7.24809.70.0	45-8132	IPD INDUSTRIAL PARTS DISTRIBUT	7.24809.64.0
45-8047	IPD INDUSTRIAL PARTS DISTRIBUT	7.22818.62.0	45-8133	IPD INDUSTRIAL PARTS DISTRIBUT	7.00823.06.0
45-8048	IPD INDUSTRIAL PARTS DISTRIBUT	7.24809.39.0	45-8134	IPD INDUSTRIAL PARTS DISTRIBUT	7.00365.06.0
45-8090	IPD INDUSTRIAL PARTS DISTRIBUT	7.28070.03.0	45-8135	IPD INDUSTRIAL PARTS DISTRIBUT	7.28384.13.0
45-8091	IPD INDUSTRIAL PARTS DISTRIBUT	7.24809.16.0	45-8136	IPD INDUSTRIAL PARTS DISTRIBUT	7.00450.09.0
45-8092	IPD INDUSTRIAL PARTS DISTRIBUT	7.24809.29.0	45-8138	IPD INDUSTRIAL PARTS DISTRIBUT	7.28264.06.0
45-8093	IPD INDUSTRIAL PARTS DISTRIBUT	7.24809.33.0	45-8139	IPD INDUSTRIAL PARTS DISTRIBUT	7.22414.07.0
45-8094	IPD INDUSTRIAL PARTS DISTRIBUT	7.24809.17.0	45-8140	IPD INDUSTRIAL PARTS DISTRIBUT	7.02132.07.0
45-8095	IPD INDUSTRIAL PARTS DISTRIBUT	7.24809.19.0	45-8141	IPD INDUSTRIAL PARTS DISTRIBUT	7.00368.15.0
45-8096	IPD INDUSTRIAL PARTS DISTRIBUT	7.24809.37.0	45-8142	IPD INDUSTRIAL PARTS DISTRIBUT	7.00578.12.0
45-8097	IPD INDUSTRIAL PARTS DISTRIBUT	7.24809.36.0	45-8143	IPD INDUSTRIAL PARTS DISTRIBUT	7.22843.06.0
45-8100	IPD INDUSTRIAL PARTS DISTRIBUT	7.24809.65.0	45-8144	IPD INDUSTRIAL PARTS DISTRIBUT	7.28264.07.0
45-8101	IPD INDUSTRIAL PARTS DISTRIBUT	7.24809.26.0	45-8145	IPD INDUSTRIAL PARTS DISTRIBUT	7.00555.06.0
45-8102	IPD INDUSTRIAL PARTS DISTRIBUT	7.24809.51.0	45-8146	IPD INDUSTRIAL PARTS DISTRIBUT	7.22477.10.0
45-8103	IPD INDUSTRIAL PARTS DISTRIBUT	7.24809.47.0	45-8147	IPD INDUSTRIAL PARTS DISTRIBUT	7.00306.36.0
45-8104	IPD INDUSTRIAL PARTS DISTRIBUT	7.24809.60.0	45-8148	IPD INDUSTRIAL PARTS DISTRIBUT	7.00555.07.0
45-8105	IPD INDUSTRIAL PARTS DISTRIBUT	7.24809.38.0	45-8149	IPD INDUSTRIAL PARTS DISTRIBUT	7.00512.03.0
45-8106	IPD INDUSTRIAL PARTS DISTRIBUT	7.24809.34.0	45-8150	IPD INDUSTRIAL PARTS DISTRIBUT	7.22477.11.0

REF-No.	PIERBURG	REF-No.	PIERBURG
45-8152	IPD INDUSTRIAL PARTS DISTRIBUT 7.01782.07.0	45-8390	IPD INDUSTRIAL PARTS DISTRIBUT 7.22996.11.0
45-8153	IPD INDUSTRIAL PARTS DISTRIBUT 7.22888.02.0	45-8396	IPD INDUSTRIAL PARTS DISTRIBUT 7.28270.14.0
45-8154	IPD INDUSTRIAL PARTS DISTRIBUT 7.22843.07.0	45-8422	IPD INDUSTRIAL PARTS DISTRIBUT 7.09002.08.0
45-8155	IPD INDUSTRIAL PARTS DISTRIBUT 7.22772.12.0	45-8424	IPD INDUSTRIAL PARTS DISTRIBUT 7.09002.09.0
45-8158	IPD INDUSTRIAL PARTS DISTRIBUT 7.01599.10.0	45-8436	IPD INDUSTRIAL PARTS DISTRIBUT 7.09002.11.0
45-8159	IPD INDUSTRIAL PARTS DISTRIBUT 7.22136.50.0	45-8437	IPD INDUSTRIAL PARTS DISTRIBUT 7.09002.12.0
45-8161	IPD INDUSTRIAL PARTS DISTRIBUT 7.28069.04.0	45-8447	IPD INDUSTRIAL PARTS DISTRIBUT 7.05052.00.0
45-8162	IPD INDUSTRIAL PARTS DISTRIBUT 7.03196.09.0	45-8503	IPD INDUSTRIAL PARTS DISTRIBUT 7.00632.13.0
45-8163	IPD INDUSTRIAL PARTS DISTRIBUT 7.28069.03.0	45-8528	IPD INDUSTRIAL PARTS DISTRIBUT 7.22996.12.0
45-8164	IPD INDUSTRIAL PARTS DISTRIBUT 7.02209.11.0	45-8529	IPD INDUSTRIAL PARTS DISTRIBUT 7.24809.74.0
45-8165	IPD INDUSTRIAL PARTS DISTRIBUT 7.00450.10.0	45-8530	IPD INDUSTRIAL PARTS DISTRIBUT 7.24809.80.0
45-8166	IPD INDUSTRIAL PARTS DISTRIBUT 7.00368.16.0	45-8532	IPD INDUSTRIAL PARTS DISTRIBUT 7.24809.83.0
45-8167	IPD INDUSTRIAL PARTS DISTRIBUT 7.05363.00.0	45-8551	IPD INDUSTRIAL PARTS DISTRIBUT 7.01881.07.0
45-8168	IPD INDUSTRIAL PARTS DISTRIBUT 7.01621.08.0	45-8552	IPD INDUSTRIAL PARTS DISTRIBUT 7.05320.04.0
45-8168	IPD INDUSTRIAL PARTS DISTRIBUT 7.24809.40.0	45-8553	IPD INDUSTRIAL PARTS DISTRIBUT 7.24809.82.0
45-8170	IPD INDUSTRIAL PARTS DISTRIBUT 7.28290.11.0	45157	FEBI 7.22946.38.0
45-8178	IPD INDUSTRIAL PARTS DISTRIBUT 7.24809.68.0	45167	FEBI 7.05271.39.0
45-8179	IPD INDUSTRIAL PARTS DISTRIBUT 7.00789.10.0	45200	FEBI 7.02209.11.0
45-8182	IPD INDUSTRIAL PARTS DISTRIBUT 7.21949.51.0	45210	FEBI 7.24809.68.0
45-8190	IPD INDUSTRIAL PARTS DISTRIBUT 7.01493.07.0	45421	FEBI 7.24809.71.0
45-8191	IPD INDUSTRIAL PARTS DISTRIBUT 7.22772.11.0	45422	FEBI 7.24809.72.0
45-8192	IPD INDUSTRIAL PARTS DISTRIBUT 7.01268.03.0	45676	FEBI 7.22946.34.0
45-8194	IPD INDUSTRIAL PARTS DISTRIBUT 7.01604.02.0	4570909	SAAB 7.05270.67.0
45-8281	IPD INDUSTRIAL PARTS DISTRIBUT 7.24809.69.0	4571477	SAAB 7.05270.37.0
45-8296	IPD INDUSTRIAL PARTS DISTRIBUT 7.00075.07.0	45962123F	VM MOTORI 7.02604.99.0
45-8315	IPD INDUSTRIAL PARTS DISTRIBUT 7.22841.08.0	46-2001	IPD INDUSTRIAL PARTS DISTRIBUT 7.02156.24.0
45-8340	IPD INDUSTRIAL PARTS DISTRIBUT 7.09002.00.0	46-2037	IPD INDUSTRIAL PARTS DISTRIBUT 7.02107.09.0
45-8343	IPD INDUSTRIAL PARTS DISTRIBUT 7.22843.06.0	460000123010	MAGNETI MARELLI 7.05270.51.0
45-8377	IPD INDUSTRIAL PARTS DISTRIBUT 7.03051.04.0	460000124010	MAGNETI MARELLI 7.05270.71.0
45-8378	IPD INDUSTRIAL PARTS DISTRIBUT 7.03295.03.0	460000126010	MAGNETI MARELLI 7.05270.49.0
45-8379	IPD INDUSTRIAL PARTS DISTRIBUT 7.03435.05.0	460000145010	MAGNETI MARELLI 7.05270.47.0
45-8380	IPD INDUSTRIAL PARTS DISTRIBUT 7.03527.12.0	460000147010	MAGNETI MARELLI 7.05270.47.0
45-8381	IPD INDUSTRIAL PARTS DISTRIBUT 7.04256.35.0	460000183010	MAGNETI MARELLI 7.05270.86.0
45-8381	IPD INDUSTRIAL PARTS DISTRIBUT 7.04256.36.0	460000190010	MAGNETI MARELLI 7.02604.61.0
45-8383	IPD INDUSTRIAL PARTS DISTRIBUT 7.04257.19.0	460000199010	MAGNETI MARELLI 7.02604.61.0
45-8385	IPD INDUSTRIAL PARTS DISTRIBUT 7.04371.07.0	460000223010	MAGNETI MARELLI 7.02604.51.0
		460000239010	MAGNETI MARELLI 7.02604.62.0
		460000244010	MAGNETI MARELLI 7.02604.64.0
		460000245010	MAGNETI MARELLI 7.02604.47.0
		460000254010	MAGNETI MARELLI 7.05270.86.0
		460000270010	MAGNETI MARELLI 7.05271.04.0
		460000283010	MAGNETI MARELLI 7.05270.86.0
		460000293010	MAGNETI MARELLI 7.02604.61.0
		460000298010	MAGNETI MARELLI 7.05270.39.0
		460000409010	MAGNETI MARELLI 7.02604.47.0
		460000416010	MAGNETI MARELLI 7.02604.31.0
		460000420010	MAGNETI MARELLI 7.05270.34.0
		460000426010	MAGNETI MARELLI 7.05271.04.0
		460000427010	MAGNETI MARELLI 7.02604.31.0
		460000431010	MAGNETI MARELLI 7.05270.34.0
		460000434010	MAGNETI MARELLI 7.05270.36.0
		460000435010	MAGNETI MARELLI 7.05271.05.0
		460000438010	MAGNETI MARELLI 7.02604.21.0



REF-No.	 PIERBURG	REF-No.	 PIERBURG
46000442010	MAGNETI MARELLI 7.05270.33.0	46408190	FIAT 7.02604.04.0
46000445010	MAGNETI MARELLI 7.05270.38.0	46422649	FIAT 7.02604.04.0
46000452010	MAGNETI MARELLI 7.05271.07.0	46423987	ALFA ROMEO 7.02604.54.0
46000460010	MAGNETI MARELLI 7.05270.88.0	46423987	FIAT 7.02604.54.0
46000462010	MAGNETI MARELLI 7.02604.60.0	46423987	LANCIA 7.02604.54.0
46000470010	MAGNETI MARELLI 7.02604.62.0	46426389	ALFA ROMEO 7.02604.49.0
46000472010	MAGNETI MARELLI 7.05270.48.0	46426389	FIAT 7.02604.49.0
46000474010	MAGNETI MARELLI 7.05271.05.0	46426389	LANCIA 7.02604.49.0
46000478010	MAGNETI MARELLI 7.02604.49.0	46430175	ALFA ROMEO 7.02604.47.0
46000482010	MAGNETI MARELLI 7.05270.03.0	46430175	FIAT 7.02604.47.0
46000485010	MAGNETI MARELLI 7.05271.55.0	46430175	LANCIA 7.02604.47.0
46000486010	MAGNETI MARELLI 7.02604.37.0	46434552	FIAT 7.02604.04.0
46000489010	MAGNETI MARELLI 7.02604.51.0	46444284	ALFA ROMEO 7.02604.04.0
46000491010	MAGNETI MARELLI 7.05271.06.0	46444284	FERRARI 7.02604.04.0
46000493010	MAGNETI MARELLI 7.05270.96.0	46447841	FIAT 7.02604.49.0
460001754010	MAGNETI MARELLI 7.05270.67.0	46455802	ALFA ROMEO 7.02604.47.0
460001760010	MAGNETI MARELLI 7.02604.51.0	46455802	FIAT 7.02604.47.0
460001762010	MAGNETI MARELLI 7.02604.51.0	46455802	LANCIA 7.02604.47.0
460001764010	MAGNETI MARELLI 7.02604.47.0	46460055	ALFA ROMEO 7.02604.47.0
460001766010	MAGNETI MARELLI 7.02604.60.0	46460055	FIAT 7.02604.47.0
460001768010	MAGNETI MARELLI 7.05270.73.0	46460055	LANCIA 7.02604.47.0
460001776010	MAGNETI MARELLI 7.05271.20.0	46462006	ALFA ROMEO 7.02604.56.0
460001778010	MAGNETI MARELLI 7.05271.05.0	46462006	FIAT 7.02604.56.0
460001789010	MAGNETI MARELLI 7.05271.01.0	46481458	ALFA ROMEO 7.02604.51.0
460001790010	MAGNETI MARELLI 7.05270.36.0	46481458	FIAT 7.02604.51.0
460001804010	MAGNETI MARELLI 7.05270.55.0	46481458	LANCIA 7.02604.51.0
460001807010	MAGNETI MARELLI 7.05270.45.0	46481568	ALFA ROMEO 7.02604.55.0
460001814010	MAGNETI MARELLI 7.05270.38.0	46481568	FIAT 7.02604.55.0
460001815010	MAGNETI MARELLI 7.05270.37.0	46481568	LANCIA 7.02604.55.0
460001818010	MAGNETI MARELLI 7.05270.38.0	46519513	FIAT 7.02604.54.0
460001819010	MAGNETI MARELLI 7.05270.38.0	46521170	ALFA ROMEO 7.02604.51.0
460001820010	MAGNETI MARELLI 7.02604.60.0	46521170	FIAT 7.02604.51.0
460001827010	MAGNETI MARELLI 7.05270.51.0	46521170	LANCIA 7.02604.51.0
460001852010	MAGNETI MARELLI 7.05270.36.0	46523129	FIAT 7.02604.49.0
460001853010	MAGNETI MARELLI 7.05270.38.0	46523129	LANCIA 7.02604.49.0
460001863010	MAGNETI MARELLI 7.05270.30.0	46523499	FIAT 7.02604.54.0
460001867010	MAGNETI MARELLI 7.02604.62.0	46529385	ALFA ROMEO 7.02604.47.0
460001869010	MAGNETI MARELLI 7.05270.29.0	46529385	FIAT 7.02604.47.0
460001878010	MAGNETI MARELLI 7.05270.47.0	46529385	LANCIA 7.02604.47.0
460001882010	MAGNETI MARELLI 7.02604.01.0	46530857	FIAT 7.22946.33.0
460001884010	MAGNETI MARELLI 7.05271.18.0	46530857	FIAT 7.22946.34.0
460001890010	MAGNETI MARELLI 7.02604.61.0	46530857	LANCIA 7.22946.33.0
460001896010	MAGNETI MARELLI 7.05270.27.0	46530857	LANCIA 7.22946.34.0
460001901010	MAGNETI MARELLI 7.05270.79.0	46545432	ALFA ROMEO 7.02604.47.0
460001908010	MAGNETI MARELLI 7.05270.72.0	46545432	FIAT 7.02604.47.0
460001920010	MAGNETI MARELLI 7.05270.33.0	46545432	LANCIA 7.02604.47.0
460001932010	MAGNETI MARELLI 7.05271.70.0	46552313	ALFA ROMEO 7.02604.49.0
460001938010	MAGNETI MARELLI 7.05270.32.0	46552313	FIAT 7.02604.49.0
460001950010	MAGNETI MARELLI 7.05270.96.0	46552313	LANCIA 7.02604.49.0
460001954010	MAGNETI MARELLI 7.05270.32.0	466016355015	MAGNETI MARELLI 7.02604.07.0
460001963010	MAGNETI MARELLI 7.02604.38.0	466016355150	MAGNETI MARELLI 7.05271.24.0
460002009410	MAGNETI MARELLI 7.05271.51.0	4667874	CATERPILLAR 7.03391.11.0
460002010310	MAGNETI MARELLI 7.02604.53.0	4667874	PERKINS 7.03391.11.0
460002013010	MAGNETI MARELLI 7.02604.60.0	4667875	CATERPILLAR 7.03762.10.0
460002016010	MAGNETI MARELLI 7.05271.72.0	4667875	PERKINS 7.03762.10.0
460002025010	MAGNETI MARELLI 7.02604.60.0	46750241	ALFA ROMEO 7.02604.56.0
460002041010	MAGNETI MARELLI 7.05271.71.0	46750241	FIAT 7.02604.56.0
460002049010	MAGNETI MARELLI 7.05271.46.0	46750241	LANCIA 7.02604.56.0
460002097010	MAGNETI MARELLI 7.05271.38.0	46750242	FIAT 7.02604.56.0
460002138910	MAGNETI MARELLI 7.05271.03.0	46750243	ALFA ROMEO 7.02604.55.0
460002140210	MAGNETI MARELLI 7.05271.04.0	46750243	FIAT 7.02604.55.0
460002140710	MAGNETI MARELLI 7.05271.04.0	46750243	LANCIA 7.02604.55.0
460002144910	MAGNETI MARELLI 7.05271.05.0	46750245	ALFA ROMEO 7.02604.53.0
460002145610	MAGNETI MARELLI 7.05271.74.0	46750245	FIAT 7.02604.53.0
46338628	ALFA ROMEO 7.05194.26.0	46750245	LANCIA 7.02604.53.0
46339121	FIAT 7.07969.06.0	46750249	ALFA ROMEO 7.02604.51.0
46345298	ALFA ROMEO 7.05194.26.0	46750249	FIAT 7.02604.51.0
46346531	ALFA ROMEO 7.05194.26.0	46750249	LANCIA 7.02604.51.0
46346609	ALFA ROMEO 7.05194.26.0	46751082	ALFA ROMEO 7.02604.53.0

NUMBERFINDER

REF-No.			REF-No.		
46751082	FIAT	7.02604.53.0	48384	NRF	7.09002.05.0
46751082	LANCIA	7.02604.53.0	484035	NEDCAR	7.22286.26.0
46760867	ALFA ROMEO	7.02604.47.0	48457	FEBI	7.00450.09.0
46760867	FIAT	7.02604.47.0	48833	FEBI	7.08369.38.0
46760867	LANCIA	7.02604.47.0	48834	FEBI	7.08369.32.0
46762182	ALFA ROMEO	7.02604.53.0	48837	FEBI	7.08369.02.0
46762182	FIAT	7.02604.53.0	48838	FEBI	7.08369.13.0
46762182	LANCIA	7.02604.53.0	48839	FEBI	7.08369.06.0
46762653	ABARTH	7.02604.55.0	48840	FEBI	7.08369.15.0
46762653	ALFA ROMEO	7.02604.55.0	48841	FEBI	7.08369.01.0
46762653	FIAT	7.02604.55.0	48842	FEBI	7.08369.18.0
46762653	LANCIA	7.02604.55.0	48844	FEBI	7.08369.07.0
46774531	ALFA ROMEO	7.02604.51.0	48845	FEBI	7.08369.00.0
46774531	FIAT	7.02604.51.0	48846	FEBI	7.08369.74.0
46774531	LANCIA	7.02604.51.0	48847	FEBI	7.08369.31.0
46778209	FIAT	7.22946.33.0	48848	FEBI	7.08369.41.0
46778209	FIAT	7.22946.34.0	48849	FEBI	7.08369.03.0
46778209	LANCIA	7.22946.33.0	48850	FEBI	7.08369.08.0
46778209	LANCIA	7.22946.34.0	48851	FEBI	7.08369.34.0
46785766	ALFA ROMEO	7.22946.34.0	48852	FEBI	7.24809.30.0
46785766	FIAT	7.22946.34.0	49002013F	VM MOTORI	7.28270.14.0
46785766	LANCIA	7.22946.34.0	49002016F	VM MOTORI	7.00632.13.0
46786046	ALFA ROMEO	7.02604.47.0	49002016G	VM MOTORI	7.00632.13.0
46786046	FIAT	7.02604.47.0	49002021F	VM MOTORI	7.28290.11.0
46786046	LANCIA	7.02604.47.0	49002023F	VM MOTORI	7.24809.80.0
46786048	ALFA ROMEO	7.02604.56.0	49002024F	VM MOTORI	7.01317.10.0
46786048	FIAT	7.02604.56.0	49002026F	VM MOTORI	7.03295.03.0
46786048	LANCIA	7.02604.56.0	49002027F	VM MOTORI	7.28290.11.0
46806	FEBI	7.24809.31.0	49002028F	VM MOTORI	7.05012.01.0
46807	FEBI	7.24809.20.0	49002031F	VM MOTORI	7.28290.11.0
46807454	FIAT	7.02604.49.0	49260	FEBI	7.08369.72.0
46811311	ALFA ROMEO	7.05270.80.0	49261	FEBI	7.08369.05.0
46823850	ALFA ROMEO	7.00063.10.0	49263	FEBI	7.08369.62.0
46823850	FIAT	7.00063.10.0	49264	FEBI	7.08369.58.0
46823850	LANCIA	7.00063.10.0	49267	FEBI	7.08369.43.0
46823880	FIAT	7.02604.49.0	49270	FEBI	7.08369.23.0
4683932	PERKINS	7.04209.06.0	49271	FEBI	7.08369.53.0
4683934	PERKINS	7.04210.06.0	49272	FEBI	7.08369.40.0
4708961	OPEL	7.00020.50.0	49275	FEBI	7.08369.65.0
4708961	VAUXHALL	7.00020.50.0	49279	FEBI	7.08369.14.0
4709270	OPEL	7.11190.04.0	49282	FEBI	7.08369.45.0
4709270	VAUXHALL	7.11190.04.0	49283	FEBI	7.08369.63.0
4711527	OPEL	7.00020.50.0	49284	FEBI	7.08369.36.0
4711527	VAUXHALL	7.00020.50.0	49285	FEBI	7.08369.33.0
47640	FEBI	7.22574.12.0	49287	FEBI	7.08369.16.0
47708	FEBI	7.22875.16.0	49288	FEBI	7.08369.17.0
4774311	SAAB	7.24809.29.0	49290	FEBI	7.08369.75.0
4795919	CATERPILLAR	7.03390.09.0	49293	FEBI	7.08369.22.0
4795919	PERKINS	7.03390.09.0	49295	FEBI	7.08369.68.0
4795920	CATERPILLAR	7.03761.09.0	49305	FEBI	7.08369.04.0
4795920	PERKINS	7.03761.09.0	49306	FEBI	7.08369.44.0
4803502	CHEVROLET	7.05271.81.0	49483	FEBI	7.22785.16.0
4803502	OPEL	7.05271.81.0	49484	FEBI	7.00907.03.0
4803502	VAUXHALL	7.05271.81.0	49485	FEBI	7.22785.17.0
4803532	OPEL	7.05271.73.0	49514	FEBI	7.11237.06.0
4803539	OPEL	7.08369.70.0	49558	FEBI	7.24809.99.0
4805204	OPEL	7.09002.13.0	49839	FEBI	7.09720.01.0
4805204	VAUXHALL	7.09002.13.0	49840	FEBI	7.09720.03.0
4811588	OPEL	7.09002.13.0	49840/143	FEBI	7.09720.03.0
4811588	VAUXHALL	7.09002.13.0	49841	FEBI	7.09720.04.0
4818226	OPEL	7.11020.49.0	49844	FEBI	7.09720.02.0
4818226	VAUXHALL	7.11020.49.0	49847	FEBI	7.02756.07.0
4818661	OPEL	7.08369.70.0	4F0131552AK	AUDI	7.11190.00.0
4820363	OPEL	7.11020.49.0	4L0959231	AUDI	7.03635.40.0
4820363	VAUXHALL	7.11020.49.0	4L0959231A	AUDI	7.03635.40.0
48333	NRF	7.24809.17.0	4L0959253	AUDI	7.03635.40.0
48343	NRF	7.22630.28.0	4M0906088AA	AUDI	7.11020.24.0
48383	NRF	7.24809.24.0	4M0906088AA	VOLKSWAGEN	7.11020.24.0
48383	NRF	7.24809.27.0	4M0906088K	AUDI	7.11020.24.0



REF-No.		 PIERBURG	REF-No.		 PIERBURG
4M0906088K	VOLKSWAGEN	7.11020.24.0	51799538	ALFA ROMEO	7.11020.04.0
4M5J-9D475-BA	FORD	7.24809.89.0	51799538	FIAT	7.11020.04.0
4M5Q-9424-BB	FORD	7.24809.72.0	51822931	ALFA ROMEO	7.11020.10.0
4M5Q-9424-BC	FORD	7.24809.72.0	51822931	FIAT	7.11020.10.0
4M5Q-9424-BD	FORD	7.24809.72.0	51822931	LANCIA	7.11020.10.0
4M5Q-9424-BE	FORD	7.24809.72.0	51825673	FIAT	7.08369.99.0
4M5Q-9424-CA	FORD	7.24809.71.0	51825674	FIAT	7.08369.98.0
4M5Q-9424-CB	FORD	7.24809.71.0	51825680	ALFA ROMEO	7.11020.04.0
4M5Q-9424-CC	FORD	7.24809.71.0	51825680	FIAT	7.11020.04.0
4M5Q-9424-CD	FORD	7.24809.71.0	51825681	ALFA ROMEO	7.11020.10.0
4R8Q-9D475-AA	JAGUAR	7.11237.01.0	51825681	FIAT	7.11020.10.0
4R8Q-9D475-AB	JAGUAR	7.11237.01.0	51825681	LANCIA	7.11020.10.0
4R8Q-9D475-AD	LAND ROVER	7.11237.01.0	51825683	FIAT	7.11020.36.0
4R8Q-9d475-AC	JAGUAR	7.11237.01.0	51825684	FIAT	7.11020.37.0
4R8Q9-D475-AC	LAND ROVER	7.11237.01.0	51825697	FIAT	7.11020.41.0
4R8Q9D475BA	JAGUAR	7.24809.96.0	51825699	FIAT	7.11020.15.0
4R8Q9D475BB	JAGUAR	7.24809.96.0	51827385	ALFA ROMEO	7.02604.44.0
4R8Q9D475BC	JAGUAR	7.24809.96.0	51827385	FIAT	7.02604.44.0
4R8Q9D475BD	LAND ROVER	7.24809.96.0	51827385	LANCIA	7.02604.44.0
4S0906601	AUDI	7.05315.05.0	51830436	FIAT	7.11020.41.0
4S0906601A	AUDI	7.05315.05.0	51852762	ALFA ROMEO	7.11020.09.0
4S0906601B	AUDI	7.05315.05.0	51852762	FIAT	7.11020.09.0
4S7Q-9D475-JA	LAND ROVER	7.11237.01.0	51855119	FIAT	7.11190.03.0
4S7Q9D475KD	FORD	7.24809.07.0	51861682	LANCIA	7.11020.37.0
5,71822E+11	MAGNETI MARELLI	7.09002.00.0	51891441	FIAT	7.11020.41.0
500014	ERA SPA	7.09730.00.0	51908411	ALFA ROMEO	7.11190.03.0
500322055	FIAT	7.24809.53.0	51908411	FIAT	7.11190.03.0
500322055	IVECO	7.24809.53.0	51908411	JEEP	7.11190.03.0
50102618	SWAG	7.09730.00.0	51908411	LANCIA	7.11190.03.0
50103437	SWAG	7.24809.68.0	5204549	FORD	7.24809.73.0
50103572	SWAG	7.24809.07.0	5234921	CHRYSLER	7.02604.01.0
50103574	SWAG	7.03784.34.0	5281535ah	JEEP	7.07044.12.0
50103576	SWAG	7.01621.08.0	53000886	CHRYSLER	7.02604.15.0
5014780AA	CHRYSLER	7.02604.15.0	53034192AA	CHRYSLER	7.00992.36.0
504121701	FIAT	7.24809.51.0	53034192AB	CHRYSLER	7.00992.36.0
504121701	IVECO	7.24809.51.0	53034194AA	CHRYSLER	7.02769.05.0
504135503	IVECO	7.02604.99.0	53034194AB	CHRYSLER	7.02769.05.0
504150396	FIAT	7.09002.00.0	53034194AD	CHRYSLER	7.02769.05.0
504150396	IVECO	7.09002.00.0	5380654	SAAB	7.22936.08.0
504178568	IVECO	7.24809.88.0	54015	BUGIAD	7.00063.10.0
504264081	FIAT	7.09720.05.0	54016	BUGIAD	7.24809.10.0
504334481	IVECO	7.02321.17.0	54017	BUGIAD	7.22946.38.0
504372730	IVECO	7.11190.03.0	54020	BUGIAD	7.24809.20.0
504375822	IVECO	7.11190.03.0	54021	BUGIAD	7.24809.16.0
504384188	IVECO	7.05052.01.0	54022	BUGIAD	7.24809.17.0
504388655	IVECO	7.24809.79.0	546762182	ALFA ROMEO	7.02604.53.0
50945421	SWAG	7.24809.71.0	546762182	FIAT	7.02604.53.0
50945422	SWAG	7.24809.72.0	546762182	LANCIA	7.02604.53.0
51.08150-0011	MAN	7.22841.08.0	550828	ERA SPA	7.08369.17.0
51.08150-0011	NEOPLAN BUS GMBH	7.22841.08.0	550828A	ERA SPA	7.08369.17.0
51.08150-0029	MAN	7.01268.03.0	550901	ERA SPA	7.08369.46.0
51.08150-0029	NEOPLAN BUS GMBH	7.01268.03.0	550902	ERA SPA	7.08369.05.0
51.08150-0070	MAN	7.05454.07.0	550902A	ERA SPA	7.08369.05.0
51.08150-0076	MAN	7.05454.07.0	550903	ERA SPA	7.08369.32.0
51.08150-6014	MAN	7.22841.08.0	550903A	ERA SPA	7.08369.32.0
51.08150-6014	NEOPLAN BUS GMBH	7.22841.08.0	550907	ERA SPA	7.08369.38.0
51.08150-6019	MAN	7.22841.08.0	550907A	ERA SPA	7.08369.38.0
51.08150-6019	NEOPLAN BUS GMBH	7.22841.08.0	550967	ERA SPA	7.08369.04.0
5148000029	MEYLE	7.08369.69.0	550967A	ERA SPA	7.08369.04.0
5148000030	MEYLE	7.08369.55.0	550990	ERA SPA	7.08369.08.0
5148000032	MEYLE	7.08369.27.0	550990A	ERA SPA	7.08369.08.0
5149012AA	CHRYSLER	7.02604.99.0	550991	ERA SPA	7.08369.14.0
5149012AA	DODGE	7.02604.99.0	550991A	ERA SPA	7.08369.14.0
5149012AA	JEEP	7.02604.99.0	551023	ERA SPA	7.08369.15.0
5149027AA	CHRYSLER	7.05270.21.0	551023A	ERA SPA	7.08369.15.0
51779770	FIAT	7.08369.35.0	551118	ERA SPA	7.08369.03.0
51792301	ALFA ROMEO	7.11190.04.0	551119	ERA SPA	7.08369.02.0
51792301	FIAT	7.11190.04.0	551120	ERA SPA	7.08369.23.0
51792301	LANCIA	7.11190.04.0	551120A	ERA SPA	7.08369.23.0

REF-No.			REF-No.		
551122	ERA SPA	7.08369.41.0	55204235	FIAT	7.22946.34.0
551122A	ERA SPA	7.08369.41.0	55204235	LANCIA	7.22946.34.0
551133	ERA SPA	7.08369.44.0	55204236	FIAT	7.22946.33.0
551136	ERA SPA	7.08369.37.0	55204236	FIAT	7.22946.34.0
551140	ERA SPA	7.08369.09.0	55204236	LANCIA	7.22946.33.0
551140A	ERA SPA	7.08369.09.0	55204236	LANCIA	7.22946.34.0
551143	ERA SPA	7.08369.01.0	55204250	ALFA ROMEO	7.00063.10.0
551143A	ERA SPA	7.08369.01.0	55204250	CADILLAC	7.00063.10.0
551244	ERA SPA	7.08369.35.0	55204250	FIAT	7.00063.10.0
551501A	ERA SPA	7.08369.30.0	55204250	LANCIA	7.00063.10.0
551504A	ERA SPA	7.08369.27.0	55204250	OPEL	7.00063.10.0
551510A	ERA SPA	7.08369.34.0	55204250	SAAB	7.00063.10.0
551528A	ERA SPA	7.08369.22.0	55204250	VAUXHALL	7.00063.10.0
551529A	ERA SPA	7.08369.39.0	55204352	FIAT	7.11190.04.0
551533A	ERA SPA	7.08369.40.0	55204765	ALFA ROMEO	7.11020.08.0
55182482	ALFA ROMEO	7.22946.34.0	55204765	FIAT	7.11020.08.0
55182482	FIAT	7.22946.34.0	55204941	ALFA ROMEO	7.00020.25.0
55182482	LANCIA	7.22946.34.0	55204941	FIAT	7.00020.25.0
55182483	FIAT	7.22946.33.0	55204941	LANCIA	7.00020.25.0
55182483	FIAT	7.22946.34.0	55205455	ALFA ROMEO	7.22946.38.0
55182483	LANCIA	7.22946.33.0	55205455	FIAT	7.22946.38.0
55182483	LANCIA	7.22946.34.0	55206931	FIAT	7.00020.39.0
55182912	FIAT	7.02604.99.0	55206932	FIAT	7.00020.40.0
55184545	ALFA ROMEO	7.02604.47.0	55208498	FIAT	7.00020.50.0
55184545	FIAT	7.02604.47.0	55209609	SAAB	7.24809.77.0
55184545	LANCIA	7.02604.47.0	55211656	FIAT	7.08369.98.0
55184651	ALFA ROMEO	7.00020.24.0	55215029	ALFA ROMEO	7.22946.34.0
55184651	FIAT	7.00020.24.0	55215029	FIAT	7.22946.34.0
55184651	LANCIA	7.00020.24.0	55215029	LANCIA	7.22946.34.0
55186214	ALFA ROMEO	7.22946.38.0	55215030	FIAT	7.22946.33.0
55186214	FIAT	7.22946.38.0	55215030	FIAT	7.22946.34.0
55188205	ALFA ROMEO	7.05270.21.0	55215030	LANCIA	7.22946.33.0
551882050	FIAT	7.05270.21.0	55215030	LANCIA	7.22946.34.0
55189996	FIAT	7.02604.99.0	55215031	ALFA ROMEO	7.00063.10.0
55189996	OPEL	7.02604.99.0	55215031	FIAT	7.00063.10.0
55189996	SAAB	7.02604.99.0	55215031	LANCIA	7.00063.10.0
55192348	ALFA ROMEO	7.00020.25.0	55215031	OPEL	7.00063.10.0
55192348	FIAT	7.00020.25.0	55215031	SAAB	7.00063.10.0
55192348	LANCIA	7.00020.25.0	55215031	VAUXHALL	7.00063.10.0
55194734	ALFA ROMEO	7.22946.38.0	55215032	ALFA ROMEO	7.22946.38.0
55194734	FIAT	7.22946.38.0	55215032	FIAT	7.22946.38.0
55194735	ALFA ROMEO	7.00063.10.0	55215032	OPEL	7.22946.38.0
55194735	FIAT	7.00063.10.0	55215032	VAUXHALL	7.22946.38.0
55194735	LANCIA	7.00063.10.0	55215116	FIAT	7.08369.99.0
55194788	FIAT	7.11190.03.0	55216292	FIAT	7.01599.10.0
55195196	ALFA ROMEO	7.00020.25.0	55218474	FIAT	7.11020.36.0
55195196	FIAT	7.00020.25.0	55218475	FIAT	7.11020.37.0
55195196	LANCIA	7.00020.25.0	55218487	FIAT	7.11020.41.0
55198037	FIAT	7.02604.08.0	55219315	FIAT	7.02604.44.0
55198037	OPEL	7.02604.08.0	55219498	ALFA ROMEO	7.00020.24.0
55198717	FIAT	7.11190.04.0	55219498	FIAT	7.00020.24.0
55198717	LANCIA	7.11190.04.0	55219498	LANCIA	7.00020.24.0
55199543	ALFA ROMEO	7.08369.57.0	55219499	FIAT	7.00020.25.0
55199543	FIAT	7.08369.57.0	55219500	FIAT	7.00020.50.0
55200301	ALFA ROMEO	7.11190.03.0	55219501	FIAT	7.00020.39.0
55200301	FIAT	7.11190.03.0	55219501	LANCIA	7.00020.39.0
55201144	ALFA ROMEO	7.00020.24.0	55219502	FIAT	7.00020.40.0
55201144	FIAT	7.00020.24.0	55219502	LANCIA	7.00020.40.0
55201144	LANCIA	7.00020.24.0	55227306	FIAT	7.11190.03.0
55201610	ALFA ROMEO	7.02604.47.0	55228650	FIAT	7.11020.37.0
55201610	FIAT	7.02604.47.0	55230929	CHEVROLET	7.03622.10.0
55201610	LANCIA	7.02604.47.0	55230929	CHRYSLER	7.03622.10.0
55202582	ALFA ROMEO	7.02604.44.0	55230929	FIAT	7.03622.10.0
55202582	FIAT	7.02604.44.0	55230929	LANCIA	7.03622.10.0
55202582	LANCIA	7.02604.44.0	55230929	OPEL	7.03622.10.0
55203808	FIAT	7.11020.09.0	55230929	VAUXHALL	7.03622.10.0
55204005	ALFA ROMEO	7.05270.21.0	55236303	OPEL	7.03622.11.0
552040050	FIAT	7.05270.21.0	55236303	VAUXHALL	7.03622.11.0
55204235	ALFA ROMEO	7.22946.34.0	55241075	IVECO	7.11190.03.0

REF-No.		 PIERBURG	REF-No.		 PIERBURG
55249455	OPEL	7.04589.06.0	555061	ERA SPA	7.22946.38.0
55249455	VAUXHALL	7.04589.06.0	555062	ERA SPA	7.24809.17.0
55249869	OPEL	7.05031.06.0	555066	ERA SPA	7.10334.10.0
55249869	VAUXHALL	7.05031.06.0	555067	ERA SPA	7.24809.77.0
55252380	FIAT	7.01599.10.0	555068	ERA SPA	7.24809.78.0
55259913	ALFA ROMEO	7.11020.48.0	555069	ERA SPA	7.24809.07.0
55259913	JEEP	7.11020.48.0	555070	ERA SPA	7.00020.25.0
55277746	ALFA ROMEO	7.05194.26.0	555074	ERA SPA	7.24809.19.0
55278867	ALFA ROMEO	7.04589.06.0	555076	ERA SPA	7.24809.24.0
55278867	FIAT	7.04589.06.0	555076	ERA SPA	7.24809.27.0
55278867	OPEL	7.04589.06.0	555077	ERA SPA	7.24809.34.0
55278867	VAUXHALL	7.04589.06.0	555078	ERA SPA	7.24809.25.0
55278868	CHRYSLER	7.03622.10.0	555078	ERA SPA	7.24809.28.0
55278868	FIAT	7.03622.10.0	555079	ERA SPA	7.24809.52.0
55278868	LANCIA	7.03622.10.0	555080	ERA SPA	7.24809.49.0
55283264	ALFA ROMEO	7.05194.26.0	555081	ERA SPA	7.24809.63.0
55351836	OPEL	7.05270.27.0	555082	ERA SPA	7.24809.31.0
55351836	VAUXHALL	7.05270.27.0	555083	ERA SPA	7.24809.30.0
55353148	CADILLAC	7.02604.11.0	555084	ERA SPA	7.24809.57.0
55353148	SAAB	7.02604.11.0	555085	ERA SPA	7.24809.55.0
55353811	GENERAL MOTORS	7.05271.62.0	555086	ERA SPA	7.24809.26.0
55353812	FIAT	7.05271.62.0	555088	ERA SPA	7.24809.32.0
55355404	CADILLAC	7.08369.05.0	555089	ERA SPA	7.24809.33.0
55355404	OPEL	7.08369.05.0	555090	ERA SPA	7.24809.51.0
55355404	SAAB	7.08369.05.0	555091	ERA SPA	7.24809.38.0
55355404	VAUXHALL	7.08369.05.0	555092	ERA SPA	7.24809.56.0
55489472	OPEL	7.08369.17.0	555093	ERA SPA	7.22818.63.0
55489472	VAUXHALL	7.08369.17.0	555096	ERA SPA	7.24809.36.0
55489548	CHEVROLET	7.11020.42.0	555099	ERA SPA	7.11237.05.0
55489548	OPEL	7.11020.42.0	555102	ERA SPA	7.11237.00.0
55489548	VAUXHALL	7.11020.42.0	555103	ERA SPA	7.24809.97.0
55497866	OPEL	7.11020.42.0	555104	ERA SPA	7.11237.03.0
55497866	VAUXHALL	7.11020.42.0	555105	ERA SPA	7.24809.95.0
555005	ERA SPA	7.22843.06.0	555106	ERA SPA	7.09720.04.0
555008	ERA SPA	7.11237.04.0	555110	ERA SPA	7.24809.99.0
555009	ERA SPA	7.11237.01.0	555112	ERA SPA	7.24809.76.0
555010	ERA SPA	7.24809.06.0	555116	ERA SPA	7.09720.03.0
555011	ERA SPA	7.24809.96.0	555122	ERA SPA	7.09002.05.0
555013	ERA SPA	7.24809.91.0	555125	ERA SPA	7.11237.08.0
555014	ERA SPA	7.24809.92.0	555126	ERA SPA	7.09002.08.0
555017	ERA SPA	7.22630.28.0	555127	ERA SPA	7.09002.09.0
555017A	ERA SPA	7.22630.28.0	555134	ERA SPA	7.22414.07.0
555019	ERA SPA	7.24809.10.0	555134	ERA SPA	7.22818.62.0
555020	ERA SPA	7.22785.17.0	555143	ERA SPA	7.21920.62.0
555021	ERA SPA	7.28248.17.0	555145	ERA SPA	7.22477.11.0
555024	ERA SPA	7.22414.04.0	555148	ERA SPA	7.22136.50.0
555024	ERA SPA	7.22414.07.0	555149	ERA SPA	7.24809.35.0
555027	ERA SPA	7.22414.08.0	555154	ERA SPA	7.22875.16.0
555030	ERA SPA	7.22946.34.0	555165	ERA SPA	7.24809.37.0
555031	ERA SPA	7.22818.59.0	555168	ERA SPA	7.21920.62.0
555032	ERA SPA	7.22818.57.0	555169	ERA SPA	7.00368.15.0
555033	ERA SPA	7.22818.58.0	555181	ERA SPA	7.22772.11.0
555034	ERA SPA	7.00063.10.0	555183	ERA SPA	7.22818.62.0
555034A	ERA SPA	7.00063.10.0	555185	ERA SPA	7.22772.12.0
555035	ERA SPA	7.22946.33.0	555187	ERA SPA	7.24809.39.0
555035	ERA SPA	7.22946.34.0	555188	ERA SPA	7.24809.68.0
555037	ERA SPA	7.22875.13.0	555189	ERA SPA	7.24809.80.0
555038	ERA SPA	7.24809.29.0	555190	ERA SPA	7.05052.01.0
555040	ERA SPA	7.00020.24.0	555190	ERA SPA	7.24809.79.0
555041	ERA SPA	7.28384.13.0	555192	ERA SPA	7.00907.03.0
55504479	OPEL	7.11190.08.0	555200	ERA SPA	7.22888.02.0
55504479	VAUXHALL	7.11190.08.0	555203	ERA SPA	7.10334.09.0
555045	ERA SPA	7.21949.51.0	555205	ERA SPA	7.00075.07.0
555046	ERA SPA	7.22574.12.0	555206	ERA SPA	7.22843.07.0
555047	ERA SPA	7.28248.17.0	555208	ERA SPA	7.09002.00.0
555048	ERA SPA	7.00365.06.0	555209	ERA SPA	7.22843.06.0
555049	ERA SPA	7.22785.18.0	555215	ERA SPA	7.09002.11.0
555051	ERA SPA	7.22785.16.0	555216	ERA SPA	7.09002.12.0
555060	ERA SPA	7.24809.16.0	555223	ERA SPA	7.01599.10.0



NUMBERFINDER

REF-No.			REF-No.		
555224	ERA SPA	7.00020.39.0	55561052	GENERAL MOTORS	7.08369.15.0
555225	ERA SPA	7.00020.40.0	55561425	OPEL	7.02604.05.0
555226	ERA SPA	7.28069.03.0	55561554	OPEL	7.05271.81.0
555227	ERA SPA	7.00823.06.0	55561554	VAUXHALL	7.05271.81.0
555228	ERA SPA	7.00512.03.0	55561863	OPEL	7.05271.81.0
555229	ERA SPA	7.28264.06.0	55561863	VAUXHALL	7.05271.81.0
555230	ERA SPA	7.28264.07.0	55562205	CHEVROLET	7.02604.07.0
555242	ERA SPA	7.24809.70.0	55562205	OPEL	7.02604.07.0
555244	ERA SPA	7.02156.24.0	55562205	VAUXHALL	7.02604.07.0
555245	ERA SPA	7.00578.12.0	55562433	GENERAL MOTORS	7.08369.49.0
555246	ERA SPA	7.24809.59.0	55562433	OPEL	7.08369.49.0
555247	ERA SPA	7.24809.46.0	55563955	OPEL	7.08369.67.0
555250	ERA SPA	7.24809.60.0	55563955	VAUXHALL	7.08369.67.0
555251	ERA SPA	7.24809.53.0	55563958	OPEL	7.05271.81.0
555252	ERA SPA	7.24809.47.0	55563958	VAUXHALL	7.05271.81.0
555252A	ERA SPA	7.24809.47.0	55564977	CHEVROLET	7.08369.46.0
555254	ERA SPA	7.24809.50.0	55564977	OPEL	7.08369.46.0
555255	ERA SPA	7.24809.65.0	55564977	VAUXHALL	7.08369.46.0
555256	ERA SPA	7.24809.48.0	55564978	OPEL	7.02604.44.0
555264	ERA SPA	7.00020.50.0	55564978	VAUXHALL	7.02604.44.0
555265	ERA SPA	7.00306.36.0	55566052	CHEVROLET	7.24809.78.0
555266	ERA SPA	7.00450.09.0	55566052	OPEL	7.24809.78.0
555267	ERA SPA	7.00450.10.0	55566052	SAAB	7.24809.78.0
555268	ERA SPA	7.00684.14.0	55566052	VAUXHALL	7.24809.78.0
555269	ERA SPA	7.28069.04.0	55566086	GENERAL MOTORS	7.08369.74.0
555270	ERA SPA	7.00555.06.0	55566086	OPEL	7.08369.74.0
555271	ERA SPA	7.00789.10.0	55566086	VAUXHALL	7.08369.74.0
555272	ERA SPA	7.02132.07.0	55566184	OPEL	7.02604.44.0
555278343	FIAT	7.01599.10.0	55566184	VAUXHALL	7.02604.44.0
555290	ERA SPA	7.01621.08.0	55566185	OPEL	7.08369.17.0
555290	ERA SPA	7.24809.40.0	55566185	VAUXHALL	7.08369.17.0
555292	ERA SPA	7.24809.74.0	55566186	CHEVROLET	7.11190.04.0
555296	ERA SPA	7.24809.81.0	55566186	OPEL	7.11190.04.0
555298	ERA SPA	7.01782.07.0	55566186	VAUXHALL	7.11190.04.0
555306	ERA SPA	7.24809.71.0	55566592	OPEL	7.05271.81.0
555309	ERA SPA	7.00368.16.0	55566592	SAAB	7.05271.81.0
555317	ERA SPA	7.24809.72.0	55566592	VAUXHALL	7.05271.81.0
555319	ERA SPA	7.24809.54.0	55566621	GENERAL MOTORS	7.08369.75.0
555321	ERA SPA	7.24809.61.0	55566621	OPEL	7.08369.75.0
555328	ERA SPA	7.22996.11.0	55566621	VAUXHALL	7.08369.75.0
555353	ERA SPA	7.24809.94.0	55570005	CHEVROLET	7.24809.81.0
555354	ERA SPA	7.03622.06.0	55570005	OPEL	7.24809.81.0
555355	ERA SPA	7.24809.87.0	55570005	VAUXHALL	7.24809.81.0
555357	ERA SPA	7.11237.07.0	55572215	CHEVROLET	7.02604.07.0
555363	ERA SPA	7.22477.10.0	55574183	CHEVROLET	7.11020.38.0
555368	ERA SPA	7.01604.02.0	55574183	OPEL	7.11020.38.0
555374	ERA SPA	7.09720.00.0	55574183	VAUXHALL	7.11020.38.0
555410	ERA SPA	7.10334.02.0	55577072	OPEL	7.04879.00.0
555415	ERA SPA	7.03435.05.0	55577072	VAUXHALL	7.04879.00.0
555420	ERA SPA	7.22785.20.0	55577162	CHEVROLET	7.02604.44.0
555422	ERA SPA	7.09720.02.0	55577162	OPEL	7.02604.44.0
555428	ERA SPA	7.09720.01.0	55577162	VAUXHALL	7.02604.44.0
555466	ERA SPA	7.03784.34.0	55577947	OPEL	7.01599.10.0
555474	ERA SPA	7.02014.07.0	55577947	VAUXHALL	7.01599.10.0
555488	ERA SPA	7.03295.03.0	55577950	CHEVROLET	7.03622.06.0
555489	ERA SPA	7.28270.14.0	55577950	OPEL	7.03622.06.0
555490	ERA SPA	7.03051.04.0	55577950	VAUXHALL	7.03622.06.0
555493A	ERA SPA	7.03196.09.0	55578264	OPEL	7.24809.87.0
555494A	ERA SPA	7.24809.69.0	55578264	VAUXHALL	7.24809.87.0
55555625	FIAT	7.02604.08.0	55578419	CHEVROLET	7.04879.00.0
55555625	OPEL	7.02604.08.0	55583791	CHEVROLET	7.03622.06.0
55555625	OPEL	7.05271.81.0	55583791	OPEL	7.03622.06.0
55555625	VAUXHALL	7.05271.81.0	55583791	VAUXHALL	7.03622.06.0
55556720	OPEL	7.22875.16.0	55585855	OPEL	7.03622.09.0
55556720	VAUXHALL	7.22875.16.0	55585855	VAUXHALL	7.03622.09.0
55557466	OPEL	7.08369.38.0	55592366	CHEVROLET	7.11020.27.0
55557466	VAUXHALL	7.08369.38.0	55592366	OPEL	7.11020.27.0
55558578	OPEL	7.08369.32.0	55592366	VAUXHALL	7.11020.27.0
55558578	VAUXHALL	7.08369.32.0	55594609	GENERAL MOTORS	7.05012.01.0



REF-No.		 PIEBURG	REF-No.		 PIEBURG
55599946	OPEL	7.01599.10.0	571822112109	MAGNETI MARELLI	7.24809.07.0
55599946	VAUXHALL	7.01599.10.0	571822112110	MAGNETI MARELLI	7.24809.69.0
556288	ERA SPA	7.03571.16.0	571822112112	MAGNETI MARELLI	7.24809.07.0
56044587AA	CHRYSLER	7.11190.01.0	571822112117	MAGNETI MARELLI	7.22772.11.0
56044587AA	DODGE	7.11190.01.0	571822112118	MAGNETI MARELLI	7.22772.12.0
56044587AA	JEEP	7.11190.01.0	571822112121	MAGNETI MARELLI	7.24809.49.0
56044587AB	CHRYSLER	7.11190.01.0	571822112122	MAGNETI MARELLI	7.00306.36.0
56044587AB	DODGE	7.11190.01.0	571822112127	MAGNETI MARELLI	7.00368.16.0
56044587AB	JEEP	7.11190.01.0	571822112130	MAGNETI MARELLI	7.24809.28.0
56044587AC	CHRYSLER	7.11190.01.0	571822112131	MAGNETI MARELLI	7.24809.24.0
56044587AC	DODGE	7.11190.01.0	571822112131	MAGNETI MARELLI	7.24809.27.0
56044587AC	JEEP	7.11190.01.0	571822112137	MAGNETI MARELLI	7.24809.97.0
5656	NGK	7.05270.26.0	571822112138	MAGNETI MARELLI	7.11237.00.0
5681	NGK	7.05271.76.0	571822112150	MAGNETI MARELLI	7.24809.56.0
5682	NGK	7.05270.15.0	571822112151	MAGNETI MARELLI	7.24809.61.0
5685	NGK	7.05270.25.0	571822112152	MAGNETI MARELLI	7.24809.52.0
5695	NGK	7.05270.25.0	5719	NGK	7.02604.10.0
570037A	ERA SPA	7.02604.07.0	5737	NGK	7.05270.36.0
5709	NGK	7.05270.48.0	5739	NGK	7.05270.38.0
571822112001	MAGNETI MARELLI	7.00020.25.0	5753	NGK	7.02604.53.0
571822112002	MAGNETI MARELLI	7.00020.39.0	5801356473	IVECO	7.11190.03.0
571822112005	MAGNETI MARELLI	7.00063.10.0	5801365344	IVECO	7.05052.01.0
571822112007	MAGNETI MARELLI	7.22946.38.0	5801478830	IVECO	7.05270.21.0
571822112009	MAGNETI MARELLI	7.22818.58.0	5801529676	IVECO	7.02604.44.0
571822112010	MAGNETI MARELLI	7.22818.59.0	5801600484	IVECO	7.11190.03.0
571822112012	MAGNETI MARELLI	7.09002.05.0	5801602383	IHC-CASE (CNH)	7.05500.02.0
571822112014	MAGNETI MARELLI	7.22574.12.0	5801602383	IVECO	7.05500.02.0
571822112015	MAGNETI MARELLI	7.22818.62.0	5801602385	IHC-CASE (CNH)	7.05501.02.0
571822112016	MAGNETI MARELLI	7.22818.57.0	5801602385	IVECO	7.05501.02.0
571822112017	MAGNETI MARELLI	7.22875.13.0	5801602387	IHC-CASE (CNH)	7.05502.02.0
571822112018	MAGNETI MARELLI	7.22785.17.0	5801602387	IVECO	7.05502.02.0
571822112020	MAGNETI MARELLI	7.28070.03.0	5801608732	IVECO	7.04275.09.0
571822112022	MAGNETI MARELLI	7.22785.18.0	5801608746	IVECO	7.03693.12.0
571822112025	MAGNETI MARELLI	7.24809.10.0	5801668924	FUSO	7.04930.06.0
571822112030	MAGNETI MARELLI	7.24809.92.0	5801668925	IVECO	7.04931.04.0
571822112031	MAGNETI MARELLI	7.24809.91.0	5801669147	IVECO	7.04275.09.0
571822112032	MAGNETI MARELLI	7.24809.95.0	5801669153	IVECO	7.03693.12.0
571822112034	MAGNETI MARELLI	7.11237.03.0	5801717197	IVECO	7.05243.04.0
571822112035	MAGNETI MARELLI	7.24809.96.0	5801726411	IHC-CASE (CNH)	7.05499.05.0
571822112037	MAGNETI MARELLI	7.10334.10.0	5801726411	IVECO	7.05499.05.0
571822112038	MAGNETI MARELLI	7.24809.70.0	5801726415	IHC-CASE (CNH)	7.04799.08.0
571822112044	MAGNETI MARELLI	7.00075.07.0	5801726415	IVECO	7.04799.08.0
571822112045	MAGNETI MARELLI	7.24809.16.0	5801726415	NEW HOLLAND	7.04799.08.0
571822112048	MAGNETI MARELLI	7.24809.30.0	5801730514	IVECO	7.02321.17.0
571822112049	MAGNETI MARELLI	7.24809.32.0	5801763775	IVECO	7.04239.04.0
571822112050	MAGNETI MARELLI	7.24809.20.0	5801789419	IVECO	7.02321.17.0
571822112051	MAGNETI MARELLI	7.24809.26.0	5801814914	FUSO	7.03692.11.0
571822112056	MAGNETI MARELLI	7.22414.08.0	5801856571	IVECO	7.05052.01.0
571822112057	MAGNETI MARELLI	7.22414.04.0	5801856913	FIAT	7.05052.03.0
571822112061	MAGNETI MARELLI	7.24809.57.0	5802528634	FIAT	7.05052.03.0
571822112063	MAGNETI MARELLI	7.01621.08.0	5802528663	IVECO	7.05052.01.0
571822112066	MAGNETI MARELLI	7.22875.16.0	5802531805	IVECO	7.24809.79.0
571822112071	MAGNETI MARELLI	7.22785.20.0	5802531806	FIAT	7.24809.86.0
571822112076	MAGNETI MARELLI	7.24809.19.0	5851014	OPEL	7.21920.62.0
571822112078	MAGNETI MARELLI	7.10334.09.0	5851014	VAUXHALL	7.21920.62.0
571822112082	MAGNETI MARELLI	7.24809.31.0	5851020	OPEL	7.22414.04.0
571822112087	MAGNETI MARELLI	7.21920.62.0	5851020	VAUXHALL	7.22414.04.0
571822112091	MAGNETI MARELLI	7.00512.03.0	5851024	CHEVROLET	7.24809.10.0
571822112092	MAGNETI MARELLI	7.28264.07.0	5851024	GM HOLDEN LTD	7.24809.10.0
571822112093	MAGNETI MARELLI	7.00450.10.0	5851024	OPEL	7.24809.10.0
571822112095	MAGNETI MARELLI	7.28264.06.0	5851024	VAUXHALL	7.24809.10.0
571822112097	MAGNETI MARELLI	7.02209.11.0	5851027	OPEL	7.22414.07.0
571822112098	MAGNETI MARELLI	7.24809.68.0	5851027	VAUXHALL	7.22414.07.0
571822112099	MAGNETI MARELLI	7.24809.51.0	5851029	OPEL	7.22414.08.0
571822112100	MAGNETI MARELLI	7.24809.06.0	5851029	VAUXHALL	7.22414.08.0
571822112102	MAGNETI MARELLI	7.28069.03.0	5851040	OPEL	7.22630.28.0
571822112103	MAGNETI MARELLI	7.11237.04.0	5851040	VAUXHALL	7.22630.28.0
571822112104	MAGNETI MARELLI	7.22888.02.0	5851041	OPEL	7.24809.29.0
571822112105	MAGNETI MARELLI	7.28069.04.0	5851041	VAUXHALL	7.24809.29.0



NUMBERFINDER

REF-No.			REF-No.		
5851049	OPEL	7.00020.24.0	5X0998262	AUDI	7.05270.99.0
5851049	VAUXHALL	7.00020.24.0	5X0998262	SEAT	7.05270.99.0
5851056	OPEL	7.00063.10.0	5X0998262	SKODA	7.05270.99.0
5851056	VAUXHALL	7.00063.10.0	5X0998262	VOLKSWAGEN	7.05270.99.0
5851057	OPEL	7.22875.16.0	5Z0906262	AUDI	7.05270.99.0
5851057	VAUXHALL	7.22875.16.0	5Z0906262	SEAT	7.05270.99.0
5851060	OPEL	7.00020.25.0	5Z0906262	SKODA	7.05270.99.0
5851060	VAUXHALL	7.00020.25.0	5Z0906262	VOLKSWAGEN	7.05270.99.0
5851065	OPEL	7.00020.25.0	6.23175	DT-DIESEL TECHNIC AG	7.22818.59.0
5851065	VAUXHALL	7.00020.25.0	6.23176	DT-DIESEL TECHNIC AG	7.22818.57.0
5851067	OPEL	7.00063.10.0	60000040230	MAGNETI MARELLI	7.05271.53.0
5851067	VAUXHALL	7.00063.10.0	60000040670	MAGNETI MARELLI	7.05271.58.0
5851076	OPEL	7.10334.08.0	60000041020	MAGNETI MARELLI	7.05271.35.0
5851089	OPEL	7.01599.10.0	60000041060	MAGNETI MARELLI	7.05271.59.0
5851089	VAUXHALL	7.01599.10.0	60000041420	MAGNETI MARELLI	7.05271.36.0
5851579	OPEL	7.22630.28.0	60000042190	MAGNETI MARELLI	7.05271.32.0
5851579	VAUXHALL	7.22630.28.0	6000616923	FIAT	7.11190.08.0
5851580	OPEL	7.22630.28.0	6000616924	FIAT	7.11492.07.0
5851580	VAUXHALL	7.22630.28.0	6000625574	ALFA ROMEO	7.24809.77.0
5851586	OPEL	7.28384.13.0	6000625574	CHRYSLER	7.24809.77.0
5851586	VAUXHALL	7.28384.13.0	6000625574	FIAT	7.24809.77.0
5851594	OPEL	7.24809.29.0	6001549007	RENAULT	7.05270.54.0
5851594	VAUXHALL	7.24809.29.0	60537650	ALFA ROMEO	7.02604.03.0
5851596	OPEL	7.22946.38.0	60733358	FIAT	7.02604.01.0
5851596	VAUXHALL	7.22946.38.0	60733358	LANCIA	7.02604.01.0
5851604	CHEVROLET	7.24809.10.0	60808457	ALFA ROMEO	7.02604.03.0
5851604	GM HOLDEN LTD	7.24809.10.0	60810814	ALFA ROMEO	7.02604.04.0
5851604	OPEL	7.24809.10.0	60812599	ALFA ROMEO	7.02604.54.0
5851607	OPEL	7.22875.13.0	60812599	FIAT	7.02604.54.0
5851827	OPEL	7.22946.38.0	60812599	LANCIA	7.02604.54.0
5851827	VAUXHALL	7.22946.38.0	60812717	ALFA ROMEO	7.02604.04.0
5855211	OPEL	7.02604.44.0	60814851	ALFA ROMEO	7.02604.55.0
5855211	VAUXHALL	7.02604.44.0	60814851	FIAT	7.02604.55.0
5855375	OPEL	7.08369.74.0	60814851	LANCIA	7.02604.55.0
5855376	OPEL	7.08369.75.0	60815649	ALFA ROMEO	7.02604.56.0
5855376	VAUXHALL	7.08369.75.0	60815649	FIAT	7.02604.56.0
5855380	OPEL	7.02604.44.0	60815649	LANCIA	7.02604.56.0
5855380	VAUXHALL	7.02604.44.0	60815699	ALFA ROMEO	7.02604.55.0
5855387	OPEL	7.08369.17.0	60815699	FIAT	7.02604.55.0
5855387	VAUXHALL	7.08369.17.0	60815699	LANCIA	7.02604.55.0
5855396	OPEL	7.02604.99.0	60816318	ALFA ROMEO	7.02604.53.0
59-0088	MAXGEAR	7.05271.22.0	60816318	FIAT	7.02604.53.0
5963516	ALFA ROMEO	7.02604.01.0	60816318	LANCIA	7.02604.53.0
5963516	FIAT	7.02604.01.0	60816439	ALFA ROMEO	7.22946.34.0
5963516	IVECO	7.02604.01.0	60816439	FIAT	7.22946.34.0
5963516	LANCIA	7.02604.01.0	60816439	LANCIA	7.22946.34.0
59635160	FIAT	7.02604.04.0	60816794	ALFA ROMEO	7.02604.53.0
59635160	LANCIA	7.02604.04.0	60816794	FIAT	7.02604.53.0
5Q0253691F	AUDI	7.03608.16.0	60816794	LANCIA	7.02604.53.0
5Q0253691F	SEAT	7.03608.16.0	60948333	SWAG	7.22818.59.0
5Q0253691F	SKODA	7.03608.16.0	6148000031	MEYLE	7.08369.05.0
5Q0253691F	VOLKSWAGEN	7.03608.16.0	6148000032	MEYLE	7.08369.32.0
5Q0253692	AUDI	7.07696.00.0	6148000034	MEYLE	7.08369.38.0
5Q0253692	SEAT	7.07696.00.0	6148000035	MEYLE	7.08369.15.0
5Q0253692	SKODA	7.07696.00.0	6148000036	MEYLE	7.08369.17.0
5Q0253692	VOLKSWAGEN	7.07696.00.0	6148000042	MEYLE	7.08369.46.0
5Q0253692A	AUDI	7.07696.00.0	6169693	FORD	7.02604.04.0
5Q0253692A	SEAT	7.07696.00.0	6282280002	MEYLE	7.04879.00.0
5Q0253692A	SKODA	7.07696.00.0	62934925	SWAG	7.24809.39.0
5Q0253692A	VOLKSWAGEN	7.07696.00.0	62936750	SWAG	7.24809.76.0
5Q0253692B	AUDI	7.07696.00.0	62936760	SWAG	7.22843.06.0
5Q0253692B	SEAT	7.07696.00.0	62945200	SWAG	7.02209.11.0
5Q0253692B	SKODA	7.07696.00.0	62945210	SWAG	7.24809.68.0
5Q0253692B	VOLKSWAGEN	7.07696.00.0	6338018	OPEL	7.04879.00.0
5S6Q-9D475-AA	FORD	7.24809.39.0	6338018	VAUXHALL	7.04879.00.0
5S6Q-9D475-AB	FORD	7.24809.39.0	638559	TOPRAN	7.08369.22.0
5S6Q-9D475-AC	FORD	7.24809.39.0	638563	TOPRAN	7.08369.18.0
5S6Q-9D475-AD	FORD	7.24809.39.0	638568	TOPRAN	7.08369.09.0
5S6Q-9D475-AE	FORD	7.24809.39.0	638571	TOPRAN	7.08369.45.0



REF-No.	 PIERBURG	REF-No.	 PIERBURG		
638572	TOPRAN	7.08369.27.0	6H4Q-9D475-DD	LAND ROVER	7.24809.97.0
6407	NGK	7.02604.73.0	6H4Q9D475CD	LAND ROVER	7.11237.00.0
6497	NGK	7.05270.55.0	6K0906262C	SEAT	7.05271.77.0
65.08152-6000	MAN	7.04999.35.0	6K0906262C	VOLKSWAGEN	7.05271.77.0
65.08152-6002	MAN	7.04999.35.0	6LS001	CITROEN	7.02604.10.0
65.08152-6003	MAN	7.04999.35.0	6LS001	PEUGEOT	7.02604.10.0
65.15408-0004	MAN	7.11492.05.0	6M21-9A486-AA	FORD	7.22738.08.0
65.15408-0019	MAN	7.11492.05.0	6M219D475AA	FORD	7.24809.20.0
6628848	FORD	7.02604.62.0	6M219D475BA	FORD	7.24809.19.0
6711590058	SSANGYONG	7.11190.08.0	6M34-9D475-AA	FORD	7.24809.75.0
6715400017	SSANGYONG	7.02604.44.0	6M51-9G444-AB	FORD	7.05270.67.0
6716055	FORD	7.02604.61.0	6M5Q-9D475-AA	FORD	7.24809.68.0
6716057	FORD	7.02604.62.0	6NU010171-001	HELLA INCORPORATED	7.24809.73.0
675000335	MASERATI	7.11190.03.0	6NU010171-031	HELLA INCORPORATED	7.24809.06.0
6789246	FORD	7.02604.61.0	6NU010171-041	HELLA INCORPORATED	7.24809.07.0
68001558AA	CHRYSLER	7.24809.16.0	6NU010171-061	HELLA INCORPORATED	7.24809.10.0
68001558AB	CHRYSLER	7.24809.16.0	6NU010171-091	HELLA INCORPORATED	7.24809.39.0
68002448AA	CHRYSLER	7.28290.11.0	6NU010171-101	HELLA INCORPORATED	7.24809.39.0
68002448AB	CHRYSLER	7.28290.11.0	6NU010171-161	HELLA INCORPORATED	7.24809.19.0
68012050AA	DODGE	7.05270.21.0	6NU010171-181	HELLA INCORPORATED	7.02156.24.0
68021770AC	CHRYSLER	7.24809.60.0	6NU010171-211	HELLA INCORPORATED	7.24809.20.0
68029525AA	CHRYSLER	7.01317.10.0	6NU010171-231	HELLA INCORPORATED	7.00578.12.0
68029525AA	DODGE	7.01317.10.0	6NU010171-261	HELLA INCORPORATED	7.24809.68.0
68029525AB	CHRYSLER	7.01317.10.0	6NU010171-271	HELLA INCORPORATED	7.24809.69.0
68029525AB	DODGE	7.01317.10.0	6NU010171-291	HELLA INCORPORATED	7.10334.10.0
68051514AA	CHRYSLER	7.24809.60.0	6NU010171-301	HELLA INCORPORATED	7.24809.16.0
68142877AA	CHRYSLER	7.03295.03.0	6NU010171-321	HELLA INCORPORATED	7.22875.16.0
6814287AA	DODGE	7.03295.03.0	6NU010171-331	HELLA INCORPORATED	7.22946.34.0
68150053AA	CHRYSLER	7.24809.80.0	6NU010171-351	HELLA INCORPORATED	7.22785.17.0
68150053AA	JEEP	7.24809.80.0	6NU010171-371	HELLA INCORPORATED	7.22574.12.0
68150053AA	LANCIA	7.24809.80.0	6NU010171-381	HELLA INCORPORATED	7.22875.13.0
68155263AA	DODGE	7.11190.01.0	6NU010171-401	HELLA INCORPORATED	7.00063.10.0
68155263AA	JEEP	7.11190.01.0	6NU010171-421	HELLA INCORPORATED	7.00020.24.0
68155263AB	DODGE	7.11190.01.0	6NU010171-431	HELLA INCORPORATED	7.28248.17.0
68155263AB	JEEP	7.11190.01.0	6NU010171-441	HELLA INCORPORATED	7.28384.13.0
68155263AC	JEEP	7.11190.01.0	6NU010171-451	HELLA INCORPORATED	7.00020.25.0
68167981AA	CHRYSLER	7.11190.03.0	6NU010171-461	HELLA INCORPORATED	7.24809.70.0
68217109AA	DODGE	7.11190.03.0	6NU010171-471	HELLA INCORPORATED	7.00020.39.0
68217109AA	JEEP	7.11190.03.0	6NU010171-481	HELLA INCORPORATED	7.09002.00.0
68223706AA	CHRYSLER	7.28290.11.0	6NU010171-511	HELLA INCORPORATED	7.00020.40.0
68239573AA	CHRYSLER	7.24809.80.0	6NU010171-531	HELLA INCORPORATED	7.09002.05.0
68239573AA	JEEP	7.24809.80.0	6NU010171-541	HELLA INCORPORATED	7.22946.38.0
68239573AA	LANCIA	7.24809.80.0	6NU010171-571	HELLA INCORPORATED	7.24809.51.0
68302131AA	CHRYSLER	7.11190.01.0	6NU010171-641	HELLA INCORPORATED	7.24809.20.0
68302131AA	DODGE	7.11190.01.0	6NU010171-661	HELLA INCORPORATED	7.03784.34.0
68302131AA	JEEP	7.11190.01.0	6NU010171-691	HELLA INCORPORATED	7.00512.03.0
68302131AB	JEEP	7.11190.01.0	6NU010171-711	HELLA INCORPORATED	7.22414.08.0
68317959AA	CHRYSLER	7.01317.10.0	6NU010171-721	HELLA INCORPORATED	7.10334.09.0
68317959AA	DODGE	7.01317.10.0	6NU010171-741	HELLA INCORPORATED	7.00368.15.0
683551	TOPRAN	7.08369.31.0	6NU010171-751	HELLA INCORPORATED	7.00684.14.0
6842910	VOLVO	7.02604.03.0	6NU010171-811	HELLA INCORPORATED	7.10334.04.0
6847912	FORD	7.02604.61.0	6NU010171-891	HELLA INCORPORATED	7.24809.31.0
6847916	FORD	7.02604.62.0	6NU010171-901	HELLA INCORPORATED	7.01621.08.0
6983291	FORD	7.02604.61.0	6NU010171-911	HELLA INCORPORATED	7.24809.30.0
6C11-9G444-AA	FORD	7.02604.64.0	6NU010171-921	HELLA INCORPORATED	7.28264.07.0
6C119G444AA	FORD	7.02604.64.0	6NU010171-951	HELLA INCORPORATED	7.09002.05.0
6C1Q-9D475-AF	FORD	7.24809.70.0	6NU014864-081	HELLA INCORPORATED	7.00368.16.0
6C1Q-9D475-AG	FORD	7.24809.70.0	6PA009165-001	HELLA INCORPORATED	7.02604.01.0
6G91-9F472-AA	FORD	7.02604.64.0	6PA009165-011	HELLA INCORPORATED	7.02604.61.0
6G91-9F472-CA	FORD	7.02604.64.0	6PA009165-091	HELLA INCORPORATED	7.02604.62.0
6G91-9F472-DB	FORD	7.02604.64.0	6PA009165-561	HELLA INCORPORATED	7.02604.61.0
6G919F472AA	FORD	7.02604.64.0	6PA009166-311	HELLA INCORPORATED	7.02604.62.0
6G919F472CA	FORD	7.02604.64.0	6PA009166-451	HELLA INCORPORATED	7.02604.38.0
6G919F472DB	FORD	7.02604.64.0	6PA009166-461	HELLA INCORPORATED	7.02604.37.0
6G9N-9G444-ZA	FORD	7.05270.67.0	6PA009166-471	HELLA INCORPORATED	7.05270.33.0
6G9N9G444LA	FORD	7.05270.67.0	6PA009166-481	HELLA INCORPORATED	7.05270.34.0
6G9Q9D475AA	FORD	7.00578.12.0	6PA009166-491	HELLA INCORPORATED	7.05270.32.0
6H4Q-9D475-DA	LAND ROVER	7.24809.97.0	6PA009166-531	HELLA INCORPORATED	7.05270.32.0
6H4Q-9D475-DC	LAND ROVER	7.24809.97.0	6PA009166-551	HELLA INCORPORATED	7.05270.34.0



NUMBERFINDER

REF-No.			REF-No.		
6PA009166-651	HELLA INCORPORATED	7.05270.36.0	7.519.295	HOFFER	7.04709.13.0
6PA009166-811	HELLA INCORPORATED	7.05270.21.0	700405	VALEO	7.22843.06.0
6PA009166-821	HELLA INCORPORATED	7.05271.24.0	700406	VALEO	7.11237.04.0
6PA009166-831	HELLA INCORPORATED	7.05271.77.0	700407	VALEO	7.24809.06.0
6PA009166-961	HELLA INCORPORATED	7.02604.31.0	700409	VALEO	7.24809.92.0
6PA009166-981	HELLA INCORPORATED	7.02604.07.0	700410	VALEO	7.11237.01.0
6PA358066-001	HELLA INCORPORATED	7.05271.76.0	700411	VALEO	7.24809.96.0
6PA358066-121	HELLA INCORPORATED	7.05271.81.0	700412	VALEO	7.24809.91.0
6PA358103-571	HELLA INCORPORATED	7.02604.10.0	700413	VALEO	7.24809.76.0
6PP009409-011	HELLA INCORPORATED	7.11190.00.0	700414	VALEO	7.24809.39.0
6PP009409-081	HELLA INCORPORATED	7.11492.00.0	700420	VALEO	7.11237.00.0
6PP009409-101	HELLA INCORPORATED	7.11492.01.0	700421	VALEO	7.24809.97.0
6PP009409-111	HELLA INCORPORATED	7.11492.02.0	700422	VALEO	7.24809.95.0
6PP009409-131	HELLA INCORPORATED	7.11190.04.0	700423	VALEO	7.11237.03.0
6PP009409-161	HELLA INCORPORATED	7.11492.03.0	700424	VALEO	7.10334.00.0
6PP009409-191	HELLA INCORPORATED	7.11190.08.0	700433	VALEO	7.11237.05.0
6PP009409-201	HELLA INCORPORATED	7.11190.03.0	700435	VALEO	7.09720.04.0
6PP009409-231	HELLA INCORPORATED	7.11190.02.0	700436	VALEO	7.09720.03.0
6PP009409-251	HELLA INCORPORATED	7.11190.09.0	700438	VALEO	7.11237.06.0
6PP009409-261	HELLA INCORPORATED	7.11492.00.0	700439	VALEO	7.24809.99.0
6PP009409-271	HELLA INCORPORATED	7.11190.10.0	700444	VALEO	7.24809.39.0
6PT010376-101	HELLA INCORPORATED	7.08369.04.0	700447	VALEO	7.11237.02.0
6PT010376-111	HELLA INCORPORATED	7.08369.01.0	700448	VALEO	7.24809.93.0
6PT010376-141	HELLA INCORPORATED	7.08369.90.0	700449	VALEO	7.24809.90.0
6PT010376-231	HELLA INCORPORATED	7.08369.86.0	700451	VALEO	7.24809.94.0
6PT010376-271	HELLA INCORPORATED	7.08369.79.0	700847	TOPRAN	7.22818.58.0
6PT014494-001	HELLA INCORPORATED	7.11020.08.0	700848	TOPRAN	7.22818.62.0
6PT014494-011	HELLA INCORPORATED	7.08369.91.0	70100819	SWAG	7.08369.35.0
6PT014494-011	HELLA INCORPORATED	7.08369.97.0	70103571	SWAG	7.24809.77.0
6PT014494-111	HELLA INCORPORATED	7.11020.25.0	70107782	SWAG	7.00020.25.0
6PT014494-191	HELLA INCORPORATED	7.11020.40.0	7011190	FORD	7.02604.62.0
6PT014494-281	HELLA INCORPORATED	7.08369.96.0	7038055	FORD	7.02604.63.0
6PT014494-361	HELLA INCORPORATED	7.08369.84.0	70945676	SWAG	7.22946.34.0
6PT014494-421	HELLA INCORPORATED	7.08369.31.0	710023D	WAHLER	7.24809.59.0
6PT014494-461	HELLA INCORPORATED	7.11020.20.0	710072D	WAHLER	7.24809.66.0
6PT014494-481	HELLA INCORPORATED	7.08369.14.0	710073D	WAHLER	7.24809.46.0
6PT014494-601	HELLA INCORPORATED	7.08369.08.0	710327D	WAHLER	7.10334.07.0
6PT014494-631	HELLA INCORPORATED	7.08369.78.0	710476D	WAHLER	7.24809.60.0
6PT014494-801	HELLA INCORPORATED	7.08369.33.0	710559D	WAHLER	7.24809.77.0
6PT014494-831	HELLA INCORPORATED	7.08369.41.0	710570D	WAHLER	7.22477.10.0
6PT014494051	HELLA INCORPORATED	7.08369.03.0	710571D	WAHLER	7.00365.06.0
6PT014494171	HELLA INCORPORATED	7.08369.11.0	710572D	WAHLER	7.00907.03.0
6PT014494181	HELLA INCORPORATED	7.08369.45.0	710575D	WAHLER	7.00823.06.0
6PT014495-011	HELLA INCORPORATED	7.08369.27.0	710661D	WAHLER	7.24809.72.0
6PT014495-041	HELLA INCORPORATED	7.11020.00.0	710665D0	WAHLER	7.24809.71.0
6PT014495-051	HELLA INCORPORATED	7.08369.39.0	710714D0	WAHLER	7.22414.04.0
6PT014495-071	HELLA INCORPORATED	7.11020.02.0	710723D	WAHLER	7.22818.58.0
6PT014495-081	HELLA INCORPORATED	7.11020.07.0	710725D	WAHLER	7.22818.57.0
6PT014495-111	HELLA INCORPORATED	7.11020.14.0	710771D0	WAHLER	7.22785.18.0
6PT014495-121	HELLA INCORPORATED	7.08369.82.0	710773D	WAHLER	7.00020.25.0
6R83-9A486-AA	FORD	7.00224.13.0	710774D	WAHLER	7.22946.34.0
6R83-9A486-AA	JAGUAR	7.00224.13.0	710775D0	WAHLER	7.22414.08.0
6U0906256C	AUDI	7.05270.86.0	710776D	WAHLER	7.22818.59.0
6U0906256C	SEAT	7.05270.86.0	710778D0	WAHLER	7.22785.17.0
6U0906256C	SKODA	7.05270.86.0	710788D0	WAHLER	7.22574.12.0
6U0906256C	VOLKSWAGEN	7.05270.86.0	710829D0	WAHLER	7.28248.17.0
6U0906265B	AUDI	7.05270.86.0	710830D	WAHLER	7.22818.62.0
6U0906265B	SEAT	7.05270.86.0	710831D	WAHLER	7.22875.16.0
6U0906265B	SKODA	7.05270.86.0	710861D	WAHLER	7.09720.00.0
6U0906265B	VOLKSWAGEN	7.05270.86.0	710862D	WAHLER	7.09720.01.0
6U0906265C	AUDI	7.05270.86.0	710863D	WAHLER	7.09720.02.0
6U0906265C	SEAT	7.05270.86.0	710921R	WAHLER	7.28264.06.0
6U0906265C	SKODA	7.05270.86.0	710922R	WAHLER	7.22843.07.0
6U0906265C	VOLKSWAGEN	7.05270.86.0	710923R	WAHLER	7.24809.07.0
6U0906265D	AUDI	7.05270.86.0	710924R	WAHLER	7.00450.09.0
6U0906265D	SEAT	7.05270.86.0	710924R	WAHLER	7.00450.10.0
6U0906265D	SKODA	7.05270.86.0	710925R	WAHLER	7.24809.70.0
6U0906265D	VOLKSWAGEN	7.05270.86.0	710926R	WAHLER	7.24809.68.0
7.24809.26.0	SKODA	7.24809.26.0	710927R	WAHLER	7.24809.39.0



REF-No.		 PIERBURG	REF-No.		 PIERBURG
710928R	WAHLER	7.00368.15.0	71768359	FIAT	7.11190.03.0
710930R	WAHLER	7.10334.04.0	71769760	ALFA ROMEO	7.03622.06.0
710931R	BORGWARNER TURBO SYSTEMS	7.10334.10.0	71769760	FIAT	7.03622.06.0
710932R	WAHLER	7.22574.12.0	71769760	LANCIA	7.03622.06.0
710933R	WAHLER	7.22875.16.0	71770832	FIAT	7.04879.00.0
710936R	BORGWARNER TURBO SYSTEMS	7.24809.92.0	717710035	DRI	7.24809.74.0
710937R	BORGWARNER TURBO SYSTEMS	7.10334.09.0	717710051	DRI	7.24809.30.0
710940R	WAHLER	7.10334.00.0	717710057	DRI	7.24809.35.0
710941R	WAHLER	7.24809.69.0	717710062	DRI	7.22477.10.0
710944R	WAHLER	7.02209.11.0	717710062	DRI	7.22477.11.0
710945R	WAHLER	7.10334.03.0	717710071	DRI	7.28069.03.0
710946	WAHLER	7.09720.04.0	717710090	DRI	7.24809.51.0
710949R	WAHLER	7.00020.24.0	717710121	DRI	7.09002.00.0
710950R	WAHLER	7.22818.58.0	717710149	DRI	7.24809.52.0
710950R	WAHLER	7.22818.59.0	717710177	DRI	7.28069.04.0
710951R	WAHLER	7.22818.57.0	717710187	DRI	7.00306.37.0
710953R	WAHLER	7.28248.17.0	717710245	DRI	7.24809.53.0
710956R	WAHLER	7.22818.62.0	717710259	DRI	7.24809.61.0
710957R	WAHLER	7.22875.13.0	717710333	DRI	7.22939.03.0
710959R	WAHLER	7.00075.07.0	717720010	DRI	7.22630.28.0
710960R	WAHLER	7.22946.34.0	717720034	DRI	7.22785.16.0
710965D	WAHLER	7.24809.85.0	717720037	DRI	7.22414.07.0
710966D	WAHLER	7.24809.84.0	717720080	DRI	7.22785.18.0
710967D	WAHLER	7.24809.83.0	717720080	DRI	7.28070.03.0
710968D	WAHLER	7.24809.82.0	717720083	DRI	7.24809.77.0
710973R	WAHLER	7.24809.06.0	717720112	DRI	7.22785.20.0
71229960	FORD	7.24809.92.0	717730079	DRI	7.01621.08.0
7126155	FORD	7.02604.62.0	717730189	DRI	7.24809.79.0
717.710.026	DRI	7.24809.17.0	717730237	DRI	7.00789.10.0
717.720.020	DRI	7.22946.38.0	717730313	DRI	7.24809.80.0
717.720.025	DRI	7.22785.17.0	717730315	DRI	7.01881.06.0
717.720.028	DRI	7.00020.25.0	717730315	DRI	7.01881.07.0
717.720.028	DRI	7.00020.40.0	717730347	DRI	7.03295.03.0
717.730.019	DRI	7.24809.33.0	717730349	DRI	7.24809.82.0
71723451	ALFA ROMEO	7.22946.34.0	717730369	DRI	7.01493.07.0
71723451	FIAT	7.22946.34.0	717730380	DRI	7.24809.87.0
71723451	LANCIA	7.22946.34.0	717730395	DRI	7.05578.15.0
71723453	FIAT	7.00063.10.0	717730396	DRI	7.04511.29.0
71739859	FIAT	7.02604.05.0	71777783	ALFA ROMEO	7.24809.77.0
71742160	FIAT	7.05271.54.0	71777783	CHRYSLER	7.24809.77.0
71744389	FIAT	7.04879.00.0	71777783	FIAT	7.24809.77.0
71744403	FIAT	7.05271.62.0	71778231	ALFA ROMEO	7.24809.77.0
71747243	FIAT	7.05271.54.0	71778231	FIAT	7.24809.77.0
71747292	FIAT	7.11190.04.0	71788549	ALFA ROMEO	7.00020.25.0
71748280	FIAT	7.05271.62.0	71788549	FIAT	7.00020.25.0
71749240	ALFA ROMEO	7.24809.77.0	71788549	LANCIA	7.00020.25.0
71749240	CHRYSLER	7.24809.77.0	71788573	FIAT	7.11237.04.0
71749240	FIAT	7.24809.77.0	71789468	ALFA ROMEO	7.00020.25.0
71749240	LANCIA	7.24809.77.0	71789468	FIAT	7.00020.25.0
71750558	FIAT	7.11190.03.0	71789468	LANCIA	7.00020.25.0
71752862	ALFA ROMEO	7.24809.77.0	71789685	FIAT	7.24809.70.0
71752862	CHRYSLER	7.24809.77.0	71793027	FIAT	7.24809.68.0
71752862	FIAT	7.24809.77.0	71793404	FIAT	7.24809.68.0
71752862	LANCIA	7.24809.77.0	71793436	FIAT	7.24809.70.0
71753846	ALFA ROMEO	7.01599.10.0	71795160	FIAT	7.01599.10.0
71753846	CHRYSLER	7.01599.10.0	71795160	LANCIA	7.01599.10.0
71753846	FIAT	7.01599.10.0	71797454	FIAT	7.07549.09.0
71753846	LANCIA	7.01599.10.0	7187D	WAHLER	7.24809.61.0
71754796	ALFA ROMEO	7.24809.77.0	7188D	WAHLER	7.24809.27.0
71754796	CHRYSLER	7.24809.77.0	7206D	WAHLER	7.24809.34.0
71754796	FIAT	7.24809.77.0	7211D	WAHLER	7.24809.28.0
71754796	LANCIA	7.24809.77.0	7220D	WAHLER	7.24809.35.0
71754815	ALFA ROMEO	7.24809.77.0	7223D	WAHLER	7.24809.52.0
71754815	CHRYSLER	7.24809.77.0	7234D	WAHLER	7.24809.49.0
71754815	FIAT	7.24809.77.0	7241D	WAHLER	7.24809.19.0
71754815	LANCIA	7.24809.77.0	7256D	WAHLER	7.24809.54.0
			7268D	WAHLER	7.24809.63.0
			7271D	WAHLER	7.24809.31.0
			7283D	WAHLER	7.24809.30.0



NUMBERFINDER

REF-No.			REF-No.		
7293D	WAHLER	7.24809.17.0	7452307	HOFFER	7.08369.20.0
7294D	WAHLER	7.24809.64.0	7481063	HOFFER	7.05271.73.0
7301D	WAHLER	7.24809.57.0	7481075	HOFFER	7.05271.35.0
7318042	FORD	7.02604.63.0	7481076	HOFFER	7.05271.58.0
7325143	FORD	7.05270.96.0	7481077	LUCAS	7.05271.61.0
7327D	WAHLER	7.24809.55.0	7481084	HOFFER	7.05271.70.0
73504052	FIAT	7.07549.09.0	7481511	HOFFER	7.05271.75.0
73504376	FIAT	7.07549.09.0	7481528	HOFFER	7.05271.22.0
7350D	WAHLER	7.24809.53.0	7481528E	HOFFER	7.05271.22.0
7353D	WAHLER	7.24809.37.0	7481536	HOFFER	7.05271.38.0
7371D	WAHLER	7.24809.26.0	7481567	HOFFER	7.05271.52.0
7372D	WAHLER	7.24809.20.0	7481585	HOFFER	7.05271.39.0
7375D	WAHLER	7.24809.29.0	7481587	HOFFER	7.05271.37.0
7389D	WAHLER	7.24809.36.0	7481611	HOFFER	7.05271.59.0
7451904E	HOFFER	7.11020.36.0	7481620	HOFFER	7.05271.54.0
7451916	HOFFER	7.08369.03.0	7481634	HOFFER	7.05271.67.0
7451916	HOFFER	7.08369.04.0	7481650	HOFFER	7.05271.71.0
7451917	HOFFER	7.08369.26.0	7481670	HOFFER	7.05271.65.0
7451918	HOFFER	7.08369.09.0	7481677	HOFFER	7.05271.36.0
7451919	HOFFER	7.08369.34.0	7481707	GM HOLDEN LTD	7.05271.05.0
7451921	HOFFER	7.08369.37.0	7481721	HOFFER	7.05271.46.0
7451926	HOFFER	7.08369.43.0	7481744	HOFFER	7.05271.74.0
7451928	HOFFER	7.08369.01.0	7481746	HOFFER	7.05271.68.0
7451929	HOFFER	7.08369.07.0	7481749	HOFFER	7.05271.72.0
7451930	HOFFER	7.08369.41.0	7481816	HOFFER	7.05271.69.0
7451931	HOFFER	7.08369.19.0	7481860	HOFFER	7.05271.32.0
7451933	HOFFER	7.08369.00.0	7496D	WAHLER	7.24809.16.0
7451935	HOFFER	7.08369.02.0	7500378	BMW	7.22295.67.0
7451937	HOFFER	7.08369.08.0	7504D	WAHLER	7.24809.33.0
7451939	HOFFER	7.08369.14.0	7505993	BMW	7.28238.55.0
7451940	HOFFER	7.08369.16.0	7506210	BMW	7.28124.19.0
7451941	HOFFER	7.08369.21.0	7506539	BMW	7.02604.32.0
7451942	HOFFER	7.08369.25.0	7508049	BMW	7.28238.58.0
7451943	HOFFER	7.08369.05.0	7508273	BMW	7.28238.56.0
7451944	HOFFER	7.08369.32.0	7512002	BMW	7.02604.32.0
7451949	HOFFER	7.08369.38.0	7512567	BMW	7.02604.32.0
7451950	HOFFER	7.08369.46.0	7512973	BMW	7.02604.32.0
7451951	HOFFER	7.08369.17.0	7512982	BMW	7.05271.22.0
7451963	HOFFER	7.08369.06.0	7513890	BMW	7.28129.14.0
7451968	HOFFER	7.08369.60.0	7513962	BMW	7.02604.31.0
7451972	HOFFER	7.08369.12.0	7513963	BMW	7.02604.21.0
7451980	HOFFER	7.08369.30.0	7514858	BMW	7.28238.57.0
7451985	HOFFER	7.08369.35.0	7514953	BMW	7.28124.20.0
7451995	HOFFER	7.08369.57.0	7515008	BMW	7.22295.65.0
7451D	WAHLER	7.24809.32.0	7516149	BMW	7.05271.22.0
7452004	HOFFER	7.08369.27.0	7516150	BMW	7.05271.23.0
7452007	HOFFER	7.08369.69.0	7518002	HOFFER	7.22414.04.0
7452056	HOFFER	7.08369.44.0	7518002	HOFFER	7.22414.07.0
7452057	HOFFER	7.08369.13.0	7518003	HOFFER	7.24809.10.0
7452084	HOFFER	7.08369.70.0	7518007	HOFFER	7.22946.34.0
7452088	HOFFER	7.08369.15.0	7518009	HOFFER	7.22785.17.0
7452090	HOFFER	7.08369.67.0	7518010	HOFFER	7.28248.17.0
7452120	HOFFER	7.08369.61.0	7518011	HOFFER	7.22818.59.0
7452162	HOFFER	7.08369.36.0	7518012	HOFFER	7.22818.57.0
7452163	HOFFER	7.08369.33.0	7518013	HOFFER	7.22818.58.0
7452166	HOFFER	7.08369.22.0	7518015	HOFFER	7.00063.10.0
7452167	HOFFER	7.08369.40.0	7518016	HOFFER	7.22946.33.0
7452216	HOFFER	7.08369.23.0	7518016	HOFFER	7.22946.34.0
7452222	HOFFER	7.08369.45.0	7518023	HOFFER	7.22136.50.0
7452223	HOFFER	7.08369.31.0	7518028	HOFFER	7.21920.62.0
7452225	HOFFER	7.08369.39.0	7518035	HOFFER	7.22875.13.0
7452226	HOFFER	7.08369.18.0	7518037	HOFFER	7.22630.28.0
7452238	HOFFER	7.08369.68.0	7518039	HOFFER	7.24809.06.0
7452245	HOFFER	7.08369.73.0	7518040	HOFFER	7.24809.73.0
7452249	HOFFER	7.08369.64.0	7518041	HOFFER	7.24809.07.0
7452252	HOFFER	7.08369.42.0	7518043	HOFFER	7.00020.24.0
7452254	HOFFER	7.08369.59.0	7518045	HOFFER	7.22414.08.0
7452256	HOFFER	7.08369.24.0	7518046	HOFFER	7.28384.13.0
7452261	HOFFER	7.08369.01.0	7518047	HOFFER	7.22785.16.0



REF-No.		 PIERBURG	REF-No.		 PIERBURG
7518050	HOFFER	7.22574.12.0	7518154	HOFFER	7.00823.06.0
7518051	HOFFER	7.24809.16.0	7518158	HOFFER	7.21949.51.0
7518052	HOFFER	7.24809.17.0	7518175	HOFFER	7.22477.10.0
7518053	HOFFER	7.22477.11.0	7518176	HOFFER	7.28070.03.0
7518054	HOFFER	7.00365.06.0	7518180	HOFFER	7.09002.12.0
7518055	HOFFER	7.03196.09.0	7518181	MEAT&DORIA	7.24809.37.0
7518056	HOFFER	7.22818.62.0	7518182	HOFFER	7.24809.54.0
7518063	HOFFER	7.24809.29.0	7518183	HOFFER	7.24809.35.0
7518064	HOFFER	7.24809.24.0	7518184	HOFFER	7.24809.48.0
7518064	HOFFER	7.24809.27.0	7518185	HOFFER	7.24809.59.0
7518065	HOFFER	7.24809.25.0	7518186	HOFFER	7.24809.60.0
7518065	HOFFER	7.24809.28.0	7518188	HOFFER	7.05052.01.0
7518067	HOFFER	7.24809.49.0	7518188	HOFFER	7.24809.79.0
7518068	HOFFER	7.24809.26.0	7518189	HOFFER	7.24809.86.0
7518069	HOFFER	7.24809.20.0	7518190	HOFFER	7.24809.80.0
7518070	HOFFER	7.24809.19.0	7518191	HOFFER	7.00450.09.0
7518071	HOFFER	7.24809.33.0	7518192	HOFFER	7.00512.03.0
7518072	HOFFER	7.28248.17.0	7518193	HOFFER	7.28264.06.0
7518079	HOFFER	7.11237.04.0	7518194	HOFFER	7.28264.07.0
7518081	HOFFER	7.24809.92.0	7518195	HOFFER	7.00684.14.0
7518082	HOFFER	7.11237.01.0	7518196	HOFFER	7.00450.10.0
7518083	HOFFER	7.24809.96.0	7518197	HOFFER	7.11237.00.0
7518084	HOFFER	7.24809.91.0	7518198	HOFFER	7.24809.94.0
7518085	HOFFER	7.24809.76.0	7518199	HOFFER	7.11237.05.0
7518086	HOFFER	7.24809.39.0	7518201	HOFFER	7.11237.06.0
7518088	HOFFER	7.22785.18.0	7518202	HOFFER	7.24809.99.0
7518090	HOFFER	7.22875.16.0	7518204	HOFFER	7.24809.47.0
7518091	HOFFER	7.00368.15.0	7518205	HOFFER	7.24809.53.0
7518092	HOFFER	7.00020.25.0	7518207	HOFFER	7.24809.65.0
7518093	HOFFER	7.22818.63.0	7518208	HOFFER	7.24809.61.0
7518094	HOFFER	7.22946.38.0	7518209	HOFFER	7.24809.64.0
7518095	HOFFER	7.24809.31.0	7518211	HOFFER	7.00306.36.0
7518096	HOFFER	7.24809.30.0	7518212	HOFFER	7.00555.06.0
7518097	HOFFER	7.24809.57.0	7518213	HOFFER	7.00789.10.0
7518098	HOFFER	7.24809.52.0	7518214	HOFFER	7.02132.07.0
7518099	HOFFER	7.24809.34.0	7518215	HOFFER	7.02156.24.0
7518100	HOFFER	7.24809.38.0	7518215	HOFFER	7.02156.35.0
7518101	HOFFER	7.24809.56.0	7518216	HOFFER	7.02209.11.0
7518102	HOFFER	7.10334.10.0	7518217	HOFFER	7.02756.07.0
7518103	HOFFER	7.24809.77.0	7518222	HOFFER	7.24809.97.0
7518104	HOFFER	7.24809.78.0	7518223	HOFFER	7.24809.95.0
7518105	HOFFER	7.22772.11.0	7518224	HOFFER	7.11237.03.0
7518106	HOFFER	7.22772.12.0	7518225	HOFFER	7.00368.16.0
7518107	HOFFER	7.22843.06.0	7518227	HOFFER	7.24809.46.0
7518109	HOFFER	7.22888.02.0	7518240	HOFFER	7.10334.08.0
7518113	HOFFER	7.10334.09.0	7518245	HOFFER	7.28290.11.0
7518115	HOFFER	7.00075.07.0	7518248	HOFFER	7.01493.07.0
7518116	HOFFER	7.24809.51.0	7518249	HOFFER	7.01604.02.0
7518117	HOFFER	7.24809.68.0	7518250	HOFFER	7.01782.07.0
7518119	HOFFER	7.24809.32.0	7518252	HOFFER	7.05363.00.0
7518120	HOFFER	7.22843.07.0	7518253	HOFFER	7.00555.07.0
7518121	HOFFER	7.24809.63.0	7518256	HOFFER	7.22996.11.0
7518124	HOFFER	7.01599.10.0	7518259	HOFFER	7.09720.00.0
7518125	HOFFER	7.09002.09.0	7518260	HOFFER	7.09720.02.0
7518126	HOFFER	7.09002.08.0	7518261	HOFFER	7.24809.81.0
7518129	HOFFER	7.09002.05.0	7518271	HOFFER	7.09720.01.0
7518137	HOFFER	7.24809.70.0	7518274	HOFFER	7.24809.50.0
7518139	HOFFER	7.00020.39.0	7518278	HOFFER	7.05052.03.0
751814	HOFFER	7.28069.03.0	7518281	HOFFER	7.24809.90.0
7518140	HOFFER	7.00020.40.0	7518300	HOFFER	7.24809.93.0
7518140E	HOFFER	7.00020.40.0	7518301	HOFFER	7.24809.88.0
7518141	HOFFER	7.28069.04.0	7518305	HOFFER	7.11237.07.0
7518142	HOFFER	7.00578.12.0	7518322	HOFFER	7.00999.08.0
7518144	HOFFER	7.28069.03.0	7518331	HOFFER	7.24809.87.0
7518146	HOFFER	7.03622.06.0	7518334	HOFFER	7.00020.50.0
7518149	HOFFER	7.09002.00.0	7518337	HOFFER	7.03295.03.0
7518151	HOFFER	7.24809.55.0	7518350	HOFFER	7.24809.74.0
7518152	HOFFER	7.00907.03.0	7518364	HOFFER	7.09730.01.0
7518153	HOFFER	7.24809.36.0	7518365	HOFFER	7.09730.00.0



NUMBERFINDER

REF-No.			REF-No.		
7518378	HOFFER	7.04999.35.0	7558073	BMW	7.02604.42.0
7518396	HOFFER	7.00632.13.0	7558087	BMW	7.02604.43.0
7518428	HOFFER	7.01621.08.0	7558179	BMW	7.02604.25.0
7518459	HOFFER	7.09720.03.0	7561410	BMW	7.02604.41.0
7518460	HOFFER	7.09720.04.0	7563241	BMW	7.24809.50.0
7518470	HOFFER	7.22939.03.0	75671	STANDARD	7.04879.00.0
7518477	HOFFER	7.01881.07.0	7569930	BMW	7.02604.41.0
7518500	HOFFER	7.02209.20.0	7569968	BMW	7.02604.34.0
7518747	HOFFER	7.05052.00.0	7571589	BMW	7.28124.19.0
7518748	HOFFER	7.05320.04.0	7571591	BMW	7.28124.20.0
7518749	HOFFER	7.22996.12.0	7571592	BMW	7.28124.21.0
7518750	HOFFER	7.00837.01.0	7572084	BMW	7.28129.52.0
7518752	HOFFER	7.05031.06.0	7573932	BMW	7.22295.65.0
7518820	HOFFER	7.04923.18.0	7574D	WAHLER	7.24809.50.0
7518828	HOFFER	7.03647.10.0	7577666	BMW	7.02604.34.0
7518835	HOFFER	7.09720.05.0	7577667	BMW	7.02604.27.0
7519293	HOFFER	7.07696.00.0	7577709	BMW	7.01318.24.0
7519294	HOFFER	7.03608.16.0	7610D	WAHLER	7.24809.65.0
7519310	BMW	7.28124.21.0	7625D	WAHLER	7.24809.48.0
7519403	HOFFER	7.03571.16.0	7631D	WAHLER	7.24809.51.0
7520225	BMW	7.28129.22.0	7649D	WAHLER	7.24809.38.0
7521705	BMW	7.05271.22.0	7650D	WAHLER	7.24809.56.0
7523306	BMW	7.22295.65.0	7654221	FIAT	7.02604.03.0
7523530	BMW	7.28238.61.0	7654221	LANCIA	7.02604.03.0
7526262	BMW	7.02604.34.0	7672792	BMW MOTORCYCLES	7.00411.05.0
7527598	BMW	7.28129.32.0	7681005	BMW MOTORCYCLES	7.00411.05.0
7527D	WAHLER	7.24809.47.0	7694376	BMW MOTORCYCLES	7.01859.03.0
753000	DT-DIESEL TECHNIC AG	7.24809.79.0	7694806	BMW MOTORCYCLES	7.01240.03.0
7530140	SAAB	7.02604.01.0	7700052062	RENAULT	7.05270.54.0
7530282	BMW	7.05271.22.0	7700103504	RENAULT	7.02604.04.0
7530283	BMW	7.05271.23.0	7700103504	RENAULT	7.05270.56.0
7530736	BMW	7.05271.23.0	7700107433	RENAULT	7.02604.10.0
7533043	BMW	7.22166.50.0	7700107434	RENAULT	7.05270.54.0
7534795	SAAB	7.02604.01.0	7700107541	RENAULT	7.02604.10.0
7537984	STEYR	7.02604.99.0	7700107561	RENAULT	7.02604.10.0
7537993	STEYR	7.02604.99.0	7700107563	RENAULT	7.05270.54.0
7539123	BMW	7.05270.21.0	7700107797	RENAULT	7.22818.57.0
7539124	BMW	7.05270.21.0	7700108027	RENAULT	7.02604.10.0
7539125	BMW	7.02604.25.0	7700109844	DACIA	7.02604.10.0
7539126	BMW	7.02604.34.0	7700109844	RENAULT	7.02604.10.0
7539137	BMW	7.02604.26.0	7700273715	RENAULT	7.05270.49.0
7540166	BMW	7.02604.42.0	7700274190	RENAULT	7.02604.04.0
7540167	BMW	7.02604.42.0	7700708605	RENAULT	7.02604.01.0
7540168	BMW	7.05270.21.0	7700708955	RENAULT	7.02604.01.0
7540466	BMW	7.22295.70.0	7700729063	RENAULT	7.02604.01.0
7540467	BMW	7.22295.71.0	7700729963	RENAULT	7.02604.01.0
7540468	BMW	7.22295.61.0	7700746375	RENAULT	7.05270.51.0
7540469	BMW	7.22295.62.0	7700854136	RENAULT	7.02604.01.0
7540471	BMW	7.22295.63.0	7700854148	RENAULT	7.05270.51.0
7540472	BMW	7.22295.67.0	7700854506	RENAULT	7.05270.47.0
7544654	BMW	7.02604.25.0	7700860246	RENAULT	7.05270.45.0
7545074	BMW	7.02604.34.0	7700862426	RENAULT	7.05270.51.0
7545243	BMW	7.02604.34.0	7700864987	RENAULT	7.02604.03.0
7545244	BMW	7.02604.27.0	7700867295	RENAULT	7.05270.47.0
7548961	MINI (BMW)	7.05271.74.0	7700869034	RENAULT	7.02604.01.0
7549860	MINI (BMW)	7.02604.41.0	7700870318	RENAULT	7.05270.51.0
7549860	STEYR	7.02604.41.0	7700872820	RENAULT	7.05270.49.0
7553056	BMW	7.21852.24.0	7700872878	RENAULT	7.05270.48.0
7553063	BMW	7.22295.62.0	7700875342	RENAULT	7.02604.04.0
7553064	BMW	7.22295.65.0	7701055236	RENAULT	7.00837.01.0
7553066	BMW	7.28238.61.0	7701058850	RENAULT	7.00075.07.0
7553067	BMW	7.28238.58.0	7701058851	RENAULT	7.00837.01.0
7553068	BMW	7.28238.55.0	7701065038	RENAULT	7.00075.07.0
7553101	BMW	7.28238.56.0	7701067308	RENAULT	7.00075.07.0
7553102	BMW	7.28238.57.0	7701068472	RENAULT	7.05270.45.0
7553102	ROLLS-ROYCE	7.28238.57.0	7706754	FIAT	7.02604.01.0
7557223	BMW	7.02604.42.0	7708937	BMW MOTORCYCLES	7.00748.06.0
7557758	BMW	7.02604.43.0	7760	NGK	7.05270.03.0
7557909	BMW	7.01318.20.0	7785452	BMW	7.28264.06.0



REF-No.		 PIERBURG	REF-No.		 PIERBURG
7789999	BMW	7.28264.07.0	8029608	HOFFER	7.21851.31.0
7791592	BMW	7.02604.44.0	8029609	HOFFER	7.21852.24.0
7792077	BMW	7.00512.03.0	8029611	HOFFER	7.28238.55.0
7793484	BMW	7.00450.09.0	8029612	HOFFER	7.22296.02.0
7793825	BMW	7.02604.44.0	8029613	HOFFER	7.05574.00.0
7793825	STEYR	7.02604.44.0	8029614	HOFFER	7.05574.01.0
7794634	BMW	7.02604.41.0	8029616	HOFFER	7.22769.77.0
7794634	STEYR	7.02604.41.0	8029617	HOFFER	7.22769.78.0
7801942	BMW	7.00684.14.0	8029623	HOFFER	7.22166.66.0
7804351	BMW	7.00450.10.0	8029625	HOFFER	7.21852.85.0
7804352	BMW	7.00450.10.0	8029626	HOFFER	7.21851.32.0
7804378	BMW	7.28264.06.0	8029628	HOFFER	7.22166.38.0
7804379	BMW	7.28264.07.0	8029630	HOFFER	7.21857.59.0
7804380	BMW	7.00450.09.0	8029631	HOFFER	7.22738.20.0
7804381	BMW	7.00512.03.0	8029637	HOFFER	7.21852.79.0
7804382	BMW	7.00450.09.0	8029639	HOFFER	7.03446.01.0
7805447	BMW	7.10334.07.0	8029641	HOFFER	7.28415.09.0
7810871	BMW	7.10334.07.0	8029646	HOFFER	7.22778.96.0
7823210	BMW	7.10992.00.0	8029651	HOFFER	7.22560.43.0
7823316	BMW	7.03051.04.0	81.312	SIDAT	7.22738.08.0
7830679	BMW	7.21852.79.0	81.313	SIDAT	7.22934.57.0
7830680	BMW	7.22748.18.0	81.314	SIDAT	7.28124.19.0
7832035	BMW	7.02604.28.0	81.315	SIDAT	7.28124.20.0
7832045	BMW	7.21852.79.0	81.316	SIDAT	7.01486.10.0
7836451	BMW	7.02604.32.0	81.317	SIDAT	7.04389.00.0
7837138	BMW	7.21852.79.0	81.319	SIDAT	7.04389.02.0
7837456	BMW	7.22748.18.0	81.320	SIDAT	7.21851.31.0
7838028	BMW	7.28238.62.0	81.321	SIDAT	7.21852.24.0
7838029	BMW	7.28238.63.0	81.323	SIDAT	7.28238.55.0
7838313	BMW	7.28124.30.0	81.325	SIDAT	7.05574.00.0
7858	NGK	7.02604.10.0	81.326	SIDAT	7.05574.01.0
7946	NGK	7.05270.99.0	81.329	SIDAT	7.22769.78.0
7953	NGK	7.05271.53.0	81.330	SIDAT	7.22769.73.0
7978	NGK	7.02604.53.0	81.344	SIDAT	7.22166.02.0
7979	NGK	7.05270.39.0	81.345	SIDAT	7.22166.66.0
7H0959253	AUDI	7.22934.63.0	81.347	SIDAT	7.21852.85.0
7H0959253	VOLKSWAGEN	7.22934.63.0	81.348	SIDAT	7.21851.32.0
7H0959253A	AUDI	7.22934.63.0	81.350	SIDAT	7.22166.38.0
7H0959253A	VOLKSWAGEN	7.22934.63.0	81.351	SIDAT	7.22934.63.0
7H2Q-9D475-DD	LAND ROVER	7.11237.03.0	81.352	SIDAT	7.21857.59.0
7H2Q-9D475-DE	LAND ROVER	7.11237.03.0	81.357	SIDAT	7.21857.01.0
7H2Q9D475CE	LAND ROVER	7.24809.95.0	81.359	SIDAT	7.21852.79.0
7H2Q9D475CF	LAND ROVER	7.24809.95.0	81.361	SIDAT	7.03446.01.0
7L0906262A	PORSCHE	7.05271.77.0	81.363	SIDAT	7.28415.09.0
7L0906262C	AUDI	7.05270.99.0	81.528	SIDAT	7.04389.07.0
7L0906262C	PORSCHE	7.05270.99.0	81.580	SIDAT	7.03635.39.0
7L0906262C	SEAT	7.05270.99.0	81.589	SIDAT	7.22560.43.0
7L0906262C	SKODA	7.05270.99.0	81013	MEAT&DORIA	7.05270.45.0
7L0906262C	VOLKSWAGEN	7.05270.99.0	81015	MEAT&DORIA	7.05270.47.0
7L0906262F	PORSCHE	7.05271.77.0	81015	MEAT&DORIA	7.05270.51.0
7M0906265C	AUDI	7.05270.88.0	81017	MEAT&DORIA	7.05270.48.0
7M0906265C	SEAT	7.05270.88.0	81029	MEAT&DORIA	7.02604.60.0
7M0906265C	SKODA	7.05270.88.0	81029	MEAT&DORIA	7.02604.64.0
7M0906265C	VOLKSWAGEN	7.05270.88.0	81041	MEAT&DORIA	7.05270.32.0
7PP131109	PORSCHE	7.00018.55.0	81041	MEAT&DORIA	7.05270.33.0
7PP131109A	PORSCHE	7.00018.56.0	81044	MEAT&DORIA	7.05270.86.0
8-08990-741-0	ISUZU	7.02604.01.0	81048	MEAT&DORIA	7.02604.61.0
8-25105-107-0	ISUZU	7.02604.01.0	81049	MEAT&DORIA	7.02604.62.0
8-25105-901-0	ISUZU	7.02604.01.0	81051	MEAT&DORIA	7.02604.51.0
8-25133-185-0	ISUZU	7.02604.15.0	81060	MEAT&DORIA	7.02604.63.0
8-25162-600-0	ISUZU	7.02604.15.0	81063	MEAT&DORIA	7.05271.73.0
8-94408-151-0	ISUZU	7.02604.01.0	81067	MEAT&DORIA	7.05270.86.0
8-97018-586-0	ISUZU	7.02604.15.0	81075	MEAT&DORIA	7.05271.35.0
802629	HOFFER	7.22934.63.0	81076	MEAT&DORIA	7.05271.58.0
8029601	HOFFER	7.22934.57.0	81077	MEAT&DORIA	7.05271.61.0
8029602	HOFFER	7.28124.19.0	81080	MEAT&DORIA	7.02604.37.0
8029603	HOFFER	7.28124.20.0	81082	MEAT&DORIA	7.05270.34.0
8029604	HOFFER	7.01486.10.0	81084	MEAT&DORIA	7.05271.70.0
8029605	HOFFER	7.04389.00.0	81086	MEAT&DORIA	7.05271.07.0



NUMBERFINDER

REF-No.			REF-No.		
81087	MEAT&DORIA	7.02604.56.0	81661	MEAT&DORIA	7.05270.39.0
81088	MEAT&DORIA	7.02604.53.0	81664	MEAT&DORIA	7.05270.96.0
81088	MEAT&DORIA	7.02604.55.0	81669	MEAT&DORIA	7.05270.22.0
81090	MEAT&DORIA	7.05270.37.0	81670	MEAT&DORIA	7.05271.65.0
81091	MEAT&DORIA	7.05270.67.0	81677	MEAT&DORIA	7.05271.36.0
81092	MEAT&DORIA	7.02604.77.0	81707	MEAT&DORIA	7.05271.05.0
81093	MEAT&DORIA	7.05270.49.0	81708	MEAT&DORIA	7.05271.01.0
81094	MEAT&DORIA	7.02604.38.0	81721	MEAT&DORIA	7.05271.46.0
81096	MEAT&DORIA	7.02604.64.0	81744	MEAT&DORIA	7.05271.74.0
81099	MEAT&DORIA	7.05270.56.0	81746	MEAT&DORIA	7.05271.68.0
81324	SIDAT	7.22296.02.0	81749	MEAT&DORIA	7.05271.72.0
81327	SIDAT	7.22778.97.0	817751	VALEO	7.09730.01.0
81328	SIDAT	7.22769.77.0	817753	VALEO	7.09730.00.0
81353	SIDAT	7.22738.20.0	81816	MEAT&DORIA	7.05271.69.0
81368	SIDAT	7.22778.96.0	81860	MEAT&DORIA	7.05271.32.0
81500	MEAT&DORIA	7.05271.23.0	8192692	HOFFER	7.04879.00.0
81501	MEAT&DORIA	7.05271.24.0	819705	VALEO	7.04879.00.0
81502	MEAT&DORIA	7.05270.25.0	82.1004	SIDAT	7.08369.87.0
81503	MEAT&DORIA	7.02604.10.0	82.1005	SIDAT	7.11020.40.0
81504	MEAT&DORIA	7.02604.04.0	82.1006	SIDAT	7.11020.16.0
81504	MEAT&DORIA	7.05270.54.0	82.1011	SIDAT	7.08369.89.0
81511	MEAT&DORIA	7.05271.75.0	82.104	SIDAT	7.08369.03.0
81516	MEAT&DORIA	7.02604.26.0	82.104	SIDAT	7.08369.04.0
81519	MEAT&DORIA	7.05271.24.0	82.1041	SIDAT	7.08369.98.0
81520	MEAT&DORIA	7.05270.80.0	82.1042	SIDAT	7.08369.99.0
81528	MEAT&DORIA	7.05271.22.0	82.1049	SIDAT	7.11020.15.0
81528E	MEAT&DORIA	7.05271.22.0	82.105	SIDAT	7.08369.26.0
81529	MEAT&DORIA	7.05270.80.0	82.1057	SIDAT	7.08369.36.0
81530	MEAT&DORIA	7.05270.80.0	82.1058	SIDAT	7.08369.33.0
81530	MEAT&DORIA	7.05270.81.0	82.106	SIDAT	7.08369.09.0
81534	MEAT&DORIA	7.02604.31.0	82.1061	SIDAT	7.08369.22.0
81535	MEAT&DORIA	7.05271.38.0	82.1061A2	SIDAT	7.08369.22.0
81540	MEAT&DORIA	7.02604.49.0	82.1062	SIDAT	7.08369.40.0
81544	MEAT&DORIA	7.05270.67.0	82.106A2	SIDAT	7.08369.09.0
81545	MEAT&DORIA	7.05270.88.0	82.107	SIDAT	7.08369.34.0
81547	MEAT&DORIA	7.05270.96.0	82.107A2	SIDAT	7.08369.34.0
81554	MEAT&DORIA	7.05270.26.0	82.109	SIDAT	7.08369.37.0
81555	MEAT&DORIA	7.05270.86.0	82.109	SIDAT	7.11020.02.0
81564	MEAT&DORIA	7.05271.00.0	82.1098	SIDAT	7.11020.27.0
81564	MEAT&DORIA	7.05271.14.0	82.1099	SIDAT	7.11020.42.0
81569	MEAT&DORIA	7.02604.47.0	82.1103	SIDAT	7.11020.20.0
81571	MEAT&DORIA	7.02604.73.0	82.1107	SIDAT	7.08369.62.0
81572	MEAT&DORIA	7.05270.55.0	82.1111	SIDAT	7.08369.23.0
81574	MEAT&DORIA	7.05270.17.0	82.1115	SIDAT	7.08369.86.0
81574	MEAT&DORIA	7.05270.18.0	82.1117	SIDAT	7.08369.45.0
81578	MEAT&DORIA	7.05270.37.0	82.1118	SIDAT	7.08369.31.0
81578	MEAT&DORIA	7.05270.38.0	82.1120	SIDAT	7.08369.39.0
81585	MEAT&DORIA	7.05271.39.0	82.1121	SIDAT	7.08369.18.0
81587	MEAT&DORIA	7.05271.37.0	82.1123A2	SIDAT	7.08369.96.0
81601	MEAT&DORIA	7.05270.30.0	82.1124	SIDAT	7.08369.56.0
81603	MEAT&DORIA	7.05271.30.0	82.1130	SIDAT	7.08369.78.0
81605	MEAT&DORIA	7.05270.29.0	82.1133	SIDAT	7.08369.68.0
81607	MEAT&DORIA	7.05271.28.0	82.114	SIDAT	7.08369.43.0
81607	MEAT&DORIA	7.05271.29.0	82.1142	SIDAT	7.11020.25.0
81608	MEAT&DORIA	7.05271.27.0	82.1147	SIDAT	7.08369.42.0
81611	MEAT&DORIA	7.05271.59.0	82.1151	SIDAT	7.08369.24.0
81617	MEAT&DORIA	7.02604.80.0	82.1156	SIDAT	7.08369.01.0
81620	MEAT&DORIA	7.05271.54.0	82.116	SIDAT	7.08369.01.0
81623	MEAT&DORIA	7.05271.18.0	82.117	SIDAT	7.08369.07.0
81626	MEAT&DORIA	7.05270.82.0	82.1173	SIDAT	7.08369.95.0
81626	MEAT&DORIA	7.05270.83.0	82.119	SIDAT	7.08369.19.0
81633	MEAT&DORIA	7.02604.25.0	82.1202	SIDAT	7.08369.20.0
81633	MEAT&DORIA	7.02604.34.0	82.1203	SIDAT	7.11020.26.0
81634	MEAT&DORIA	7.05271.67.0	82.1204	SIDAT	7.11020.31.0
81644	MEAT&DORIA	7.05271.30.0	82.1208	SIDAT	7.11020.21.0
81645	MEAT&DORIA	7.02604.65.0	82.121	SIDAT	7.08369.00.0
81649	MEAT&DORIA	7.02604.99.0	82.1212	SIDAT	7.11020.17.0
81650	MEAT&DORIA	7.05271.71.0	82.1218	SIDAT	7.11020.18.0
81660	MEAT&DORIA	7.05270.47.0	82.1221	SIDAT	7.11020.24.0

REF-No.		 PIERBURG	REF-No.		 PIERBURG
82.1224	SIDAT	7.11020.23.0	8200088888	RENAULT	7.22818.59.0
82.123	SIDAT	7.08369.02.0	8200129863	RENAULT	7.03435.05.0
82.123	SIDAT	7.08369.84.0	8200130609	RENAULT	7.22818.58.0
82.1247	SIDAT	7.11020.22.0	8200157971	RENAULT	7.22818.62.0
82.125	SIDAT	7.08369.08.0	8200164563	RENAULT	7.22818.58.0
82.127	SIDAT	7.08369.14.0	8200169634	RENAULT	7.22818.59.0
82.128	SIDAT	7.08369.16.0	8200196260	RENAULT	7.02604.10.0
82.129	SIDAT	7.08369.21.0	8200198965	RENAULT	7.11190.08.0
82.130	SIDAT	7.08369.25.0	8200229190	RENAULT	7.22818.57.0
82.131	SIDAT	7.08369.05.0	8200230256	RENAULT	7.02604.41.0
82.132	SIDAT	7.08369.32.0	8200231630	RENAULT	7.22818.57.0
82.132A2	SIDAT	7.08369.32.0	8200235232	RENAULT	7.22818.59.0
82.1335	SIDAT	7.11020.48.0	8200247250	RENAULT	7.22818.58.0
82.1363	SIDAT	7.11020.43.0	8200270177	RENAULT	7.00368.15.0
82.137	SIDAT	7.08369.38.0	8200270539	RENAULT	7.22818.59.0
82.137A2	SIDAT	7.08369.38.0	8200282879	RENAULT	7.22818.62.0
82.138	SIDAT	7.08369.46.0	8200282880	RENAULT	7.22818.57.0
82.139	SIDAT	7.08369.17.0	8200293950	RENAULT	7.22818.62.0
82.1412	SIDAT	7.08369.77.0	8200294794	RENAULT	7.22818.59.0
82.1415	SIDAT	7.11020.33.0	8200327004	RENAULT	7.10334.05.0
82.143	SIDAT	7.11020.38.0	8200351037	RENAULT	7.02604.41.0
82.1444	SIDAT	7.11020.29.0	8200360200	RENAULT	7.22818.57.0
82.1445	SIDAT	7.11020.30.0	8200360201	RENAULT	7.22818.62.0
82.1448	SIDAT	7.11020.14.0	8200374875	RENAULT	7.22818.63.0
82.145	SIDAT	7.08369.41.0	8200420670	RENAULT	7.02604.44.0
82.151	SIDAT	7.11020.00.0	8200452876	RENAULT	7.00368.15.0
82.152	SIDAT	7.08369.06.0	8200463548	RENAULT	7.00075.07.0
82.154	SIDAT	7.08369.91.0	8200467001	RENAULT	7.22818.57.0
82.154	SIDAT	7.08369.97.0	8200467030	RENAULT	7.22818.62.0
82.155A2	SIDAT	7.11020.12.0	8200467059	RENAULT	7.00075.07.0
82.158	SIDAT	7.11020.05.0	8200469586	RENAULT	7.22818.58.0
82.159	SIDAT	7.11020.35.0	8200469905	RENAULT	7.11190.08.0
82.161	SIDAT	7.08369.12.0	8200485076	RENAULT	7.05270.54.0
82.162	SIDAT	7.11020.28.0	8200488774	RENAULT	7.22818.58.0
82.165	SIDAT	7.08369.90.0	8200507299	RENAULT	7.10334.06.0
82.169	SIDAT	7.08369.30.0	8200542997	RENAULT	7.22818.57.0
82.171	SIDAT	7.08369.94.0	8200542998	RENAULT	7.22818.62.0
82.174	SIDAT	7.08369.35.0	8200542999	RENAULT	7.00075.07.0
82.176	SIDAT	7.11020.04.0	8200550348	RENAULT	7.00368.15.0
82.177	SIDAT	7.11020.09.0	8200550361	RENAULT	7.00368.15.0
82.178	SIDAT	7.11020.10.0	8200551743	RENAULT	7.02604.10.0
82.187	SIDAT	7.11020.08.0	8200561269	RENAULT	7.00368.15.0
82.193	SIDAT	7.08369.27.0	8200609274	RENAULT	7.10334.06.0
82.197	SIDAT	7.11020.44.0	8200616106	RENAULT	7.02604.41.0
82.198	SIDAT	7.11020.45.0	8200630740	RENAULT	7.10334.06.0
82.199	SIDAT	7.11020.13.0	8200656008	RENAULT	7.22818.58.0
82.203	SIDAT	7.11020.06.0	8200691292	RENAULT	7.10334.05.0
82.206	SIDAT	7.11020.11.0	8200693739	RENAULT	7.10334.05.0
82.2258	SIDAT	7.08369.80.0	8200762517	RENAULT	7.11237.05.0
82.2268	SIDAT	7.11020.01.0	8200796571	RENAULT	7.10334.06.0
82.240	SIDAT	7.11020.19.0	8200796674	RENAULT	7.10334.03.0
82.241	SIDAT	7.08369.93.0	8200797706	RENAULT	7.10334.05.0
82.242	SIDAT	7.08369.92.0	8200846454	RENAULT	7.00368.16.0
82.243	SIDAT	7.11020.07.0	8200939136	RENAULT	7.02014.07.0
82.245	SIDAT	7.08369.44.0	8200988750	RENAULT	7.00999.08.0
82.246	SIDAT	7.08369.13.0	8201016581	RENAULT	7.02014.07.0
82.252	SIDAT	7.08369.83.0	8201027384	RENAULT	7.11237.05.0
82.254	SIDAT	7.11020.49.0	8201028297	RENAULT	7.02604.99.0
82.257	SIDAT	7.11020.37.0	8201030496	RENAULT	7.02604.44.0
82.277	SIDAT	7.08369.15.0	8201238402	RENAULT	7.11190.08.0
82.292	SIDAT	7.08369.88.0	82094016	HJS	7.08369.34.0
82.293	SIDAT	7.08369.76.0	82125A2	SIDAT	7.08369.08.0
82.304	SIDAT	7.11020.36.0	82127A2	SIDAT	7.08369.14.0
82.305	SIDAT	7.11020.41.0	82533	MEAT&DORIA	7.02604.21.0
820004883	RENAULT	7.22818.58.0	827000	MEAT&DORIA	7.11492.07.0
8200033864	RENAULT	7.02604.10.0	83.1000	SIDAT	7.24809.81.0
8200034961	RENAULT	7.02604.10.0	83.1003	SIDAT	7.09002.13.0
8200034964	RENAULT	7.02604.10.0	83.1011	SIDAT	7.09720.01.0
8200052063	RENAULT	7.05270.54.0	83.1015	SIDAT	7.24809.50.0



NUMBERFINDER



REF-No.			REF-No.		
83.1022	SIDAT	7.24809.90.0	83.634	SIDAT	7.28248.17.0
83.1029	SIDAT	7.09002.14.0	83.635	SIDAT	7.22630.28.0
83.1058	SIDAT	7.24809.93.0	83.636	SIDAT	7.22946.34.0
83.1059	SIDAT	7.24809.88.0	83.638	SIDAT	7.22818.58.0
83.1104	SIDAT	7.00999.08.0	83.639	SIDAT	7.28384.13.0
83.1105	SIDAT	7.02014.07.0	83.640	SIDAT	7.24809.96.0
83.1106	SIDAT	7.03435.05.0	83.643	SIDAT	7.22414.08.0
83.1106A2	SIDAT	7.03435.05.0	83.644	SIDAT	7.11237.04.0
83.1106R	SIDAT	7.03435.05.0	83.646	SIDAT	7.22818.59.0
83.1108	SIDAT	7.10334.10.0	83.646R	SIDAT	7.22818.59.0
83.1109	SIDAT	7.00306.37.0	83.647	SIDAT	7.24809.10.0
83.1113	SIDAT	7.24809.87.0	83.648	SIDAT	7.00063.10.0
83.1121	SIDAT	7.00020.50.0	83.649	SIDAT	7.22785.17.0
83.1123	SIDAT	7.05052.00.0	83.652	SIDAT	7.10334.00.0
83.1125	SIDAT	7.03295.03.0	83.653	SIDAT	7.22818.57.0
83.1128	SIDAT	7.28270.14.0	83.653R	SIDAT	7.22818.57.0
83.1149	SIDAT	7.24809.74.0	83.654	SIDAT	7.11237.01.0
83.1150A2	SIDAT	7.24809.69.0	83.658	SIDAT	7.24809.29.0
83.1216	SIDAT	7.09730.01.0	83.665	SIDAT	7.24809.77.0
83.1217	SIDAT	7.09730.00.0	83.667	SIDAT	7.24809.07.0
83.1230	SIDAT	7.04999.35.0	83.668	SIDAT	7.00020.25.0
83.1254	SIDAT	7.00632.13.0	83.697	SIDAT	7.21920.62.0
83.1291	SIDAT	7.22785.20.0	83.710	SIDAT	7.22136.50.0
83.1319	SIDAT	7.09720.03.0	83.715	SIDAT	7.22414.07.0
83.1320	SIDAT	7.09720.04.0	83.716	SIDAT	7.22477.10.0
83.1387	SIDAT	7.05052.03.0	83.717	SIDAT	7.22477.11.0
83.1436	SIDAT	7.01106.38.0	83.718	SIDAT	7.22818.62.0
83.1437	SIDAT	7.03051.04.0	83.719	SIDAT	7.22818.63.0
83.1438	SIDAT	7.22939.03.0	83.722	SIDAT	7.24809.19.0
83.1468	SIDAT	7.01881.07.0	83.723	SIDAT	7.24809.20.0
83.1499	SIDAT	7.03196.09.0	83.725	SIDAT	7.28070.03.0
83.1507	SIDAT	7.24809.84.0	83.733	SIDAT	7.24809.24.0
83.1508	SIDAT	7.24809.83.0	83.733	SIDAT	7.24809.27.0
83.1509	SIDAT	7.24809.82.0	83.734	SIDAT	7.24809.25.0
83.1510	SIDAT	7.02209.20.0	83.734	SIDAT	7.24809.28.0
83.1561	SIDAT	7.24809.85.0	83.735	SIDAT	7.24809.49.0
83.1580	SIDAT	7.22996.12.0	83.737	SIDAT	7.24809.38.0
83.1581	SIDAT	7.05031.06.0	83.738	SIDAT	7.24809.56.0
83.1677	SIDAT	7.04923.18.0	83.739	SIDAT	7.24809.34.0
83.1697	SIDAT	7.03647.10.0	83.740	SIDAT	7.24809.52.0
83.1702AS	SIDAT	7.09720.05.0	83.741	SIDAT	7.24809.30.0
83.1741	SIDAT	7.05052.01.0	83.742	SIDAT	7.24809.31.0
83.1762	SIDAT	7.04511.29.0	83.743	SIDAT	7.00368.15.0
83.1771	SIDAT	7.05578.15.0	83.744	SIDAT	7.22875.16.0
83.4609	SIDAT	7.22414.04.0	83.745	SIDAT	7.24809.33.0
83.4617	SIDAT	7.24809.16.0	83.746	SIDAT	7.24809.26.0
83.4829	SIDAT	7.24809.70.0	83.747	SIDAT	7.24809.57.0
83.601	SIDAT	7.24809.76.0	83.786	SIDAT	7.09002.03.0
83.604	SIDAT	7.22946.38.0	83.788	SIDAT	7.09002.04.0
83.605	SIDAT	7.24809.92.0	83.790	SIDAT	7.09002.05.0
83.607	SIDAT	7.22574.12.0	83.791	SIDAT	7.09002.06.0
83.608	SIDAT	7.09002.01.0	83.792	SIDAT	7.09002.07.0
83.609	SIDAT	7.22414.04.0	83.793	SIDAT	7.11237.08.0
83.613	SIDAT	7.24809.39.0	83.795	SIDAT	7.09002.08.0
83.617	SIDAT	7.24809.16.0	83.796	SIDAT	7.09002.09.0
83.618	SIDAT	7.22785.18.0	83.797	SIDAT	7.09002.10.0
83.619	SIDAT	7.22785.16.0	83.805	SIDAT	7.24809.78.0
83.620	SIDAT	7.22946.33.0	83.812	SIDAT	7.22772.11.0
83.620	SIDAT	7.22946.34.0	83.813	SIDAT	7.22772.12.0
83.621	SIDAT	7.24809.17.0	83.814	SIDAT	7.22843.06.0
83.622	SIDAT	7.24809.91.0	83.816	SIDAT	7.22888.02.0
83.623	SIDAT	7.24809.06.0	83.817	SIDAT	7.10334.05.0
83.624	SIDAT	7.24809.73.0	83.819	SIDAT	7.10334.09.0
83.626	SIDAT	7.21949.51.0	83.820	SIDAT	7.10334.04.0
83.627	SIDAT	7.28248.17.0	83.821	SIDAT	7.00075.07.0
83.628	SIDAT	7.09002.02.0	83.821R	SIDAT	7.00075.07.0
83.629	SIDAT	7.22875.13.0	83.822	SIDAT	7.24809.51.0
83.630	SIDAT	7.00365.06.0	83.823	SIDAT	7.24809.68.0
83.632	SIDAT	7.00020.24.0	83.823A2	SIDAT	7.24809.68.0



REF-No.		 PIERBURG	REF-No.		 PIERBURG
83.824	SIDAT	7.24809.32.0	83.994	SIDAT	7.03784.34.0
83.825	SIDAT	7.22843.07.0	83.994	SIDAT	7.24809.40.0
83.827	SIDAT	7.01599.10.0	83.995	SIDAT	7.22996.11.0
83.829	SIDAT	7.24809.70.0	83.997	SIDAT	7.10334.03.0
83.829A2	SIDAT	7.24809.70.0	83.998	SIDAT	7.09720.00.0
83.830	SIDAT	7.00020.39.0	83.999	SIDAT	7.09720.02.0
83.831	SIDAT	7.00020.40.0	83003	MAPCO	7.00020.40.0
83.832	SIDAT	7.28069.04.0	83100	MAPCO	7.22818.58.0
83.833	SIDAT	7.00578.12.0	83102	MAPCO	7.22818.62.0
83.834	SIDAT	7.28069.03.0	83104	MAPCO	7.22818.59.0
83.836	SIDAT	7.03622.06.0	83105	MAPCO	7.00075.07.0
83.838	SIDAT	7.09002.00.0	83107	MAPCO	7.00368.15.0
83.839	SIDAT	7.24809.55.0	831084	SIDAT	7.00309.07.0
83.840	SIDAT	7.00907.03.0	8328551	SAAB	7.02604.01.0
83.841	SIDAT	7.00823.06.0	83405	MAPCO	7.22843.06.0
83.856	SIDAT	7.24809.63.0	834609	SIDAT	7.22414.08.0
83.888	SIDAT	7.24809.36.0	834638	SIDAT	7.22818.58.0
83.890	SIDAT	7.24809.59.0	834643	SIDAT	7.22414.08.0
83.891	SIDAT	7.24809.60.0	834646	SIDAT	7.22818.59.0
83.892	SIDAT	7.24809.35.0	834653	SIDAT	7.22818.57.0
83.893	SIDAT	7.24809.54.0	83606	MAPCO	7.24809.69.0
83.894	SIDAT	7.24809.37.0	83609	MAPCO	7.24809.06.0
83.895	MEAT&DORIA	7.24809.48.0	83630	SIDAT	7.00365.06.0
83.896	SIDAT	7.09002.11.0	83632	SIDAT	7.00020.24.0
83.897	SIDAT	7.09002.12.0	83639	SIDAT	7.28384.13.0
83.912	SIDAT	7.05052.01.0	83707	MAPCO	7.00063.10.0
83.912	SIDAT	7.24809.79.0	83708	MAPCO	7.22414.08.0
83.913	SIDAT	7.24809.86.0	83710	SIDAT	7.22136.50.0
83.914	SIDAT	7.24809.80.0	83712	MAPCO	7.22946.38.0
83.918	SIDAT	7.00450.09.0	83743R	SIDAT	7.00368.15.0
83.918A2	SIDAT	7.00450.09.0	83796	SIDAT	7.09002.09.0
83.919	SIDAT	7.00512.03.0	83804	MAPCO	7.22785.18.0
83.920	SIDAT	7.28264.06.0	83810	MAPCO	7.24809.17.0
83.921	SIDAT	7.28264.07.0	83817	MAPCO	7.10334.09.0
83.922	SIDAT	7.00684.14.0	83822	MAPCO	7.24809.57.0
83.923	SIDAT	7.00450.10.0	83824	MAPCO	7.24809.31.0
83.924	SIDAT	7.11237.00.0	83825	SIDAT	7.22843.07.0
83.925	SIDAT	7.24809.94.0	83828	MAPCO	7.24809.52.0
83.926	SIDAT	7.11237.05.0	83829R	SIDAT	7.24809.70.0
83.928	SIDAT	7.11237.06.0	83839	SIDAT	7.24809.55.0
83.929	SIDAT	7.24809.99.0	83845	MAPCO	7.09720.00.0
83.931	SIDAT	7.24809.53.0	83943R	SIDAT	7.02209.11.0
83.932	SIDAT	7.24809.47.0	83944	SIDAT	7.02756.07.0
83.934	SIDAT	7.24809.65.0	84.276	SIDAT	7.11190.04.0
83.935	SIDAT	7.24809.64.0	84.280	SIDAT	7.11492.01.0
83.937	SIDAT	7.24809.61.0	84.3049	SIDAT	7.11492.07.0
83.938	SIDAT	7.00306.36.0	84.3072	SIDAT	7.11492.05.0
83.939	SIDAT	7.00555.06.0	84.315	SIDAT	7.11190.00.0
83.940	SIDAT	7.00789.10.0	84.315	SIDAT	7.11492.02.0
83.941	SIDAT	7.02132.07.0	84.317	SIDAT	7.11190.09.0
83.942	SIDAT	7.02156.24.0	84.318	SIDAT	7.11190.03.0
83.942	SIDAT	7.02156.35.0	84.359	SIDAT	7.11190.10.0
83.942R	SIDAT	7.02156.24.0	84.450	SIDAT	7.11492.03.0
83.943	SIDAT	7.02209.11.0	84286040	IHC-CASE (CNH)	7.02604.99.0
83.944	SIDAT	7.02756.07.0	84286040	NEW HOLLAND	7.02604.99.0
83.952	SIDAT	7.24809.97.0	8474377	BMW	7.05343.18.0
83.953	SIDAT	7.24809.95.0	8476680	BMW	7.07417.39.0
83.954	SIDAT	7.11237.03.0	8479637	BMW	7.05838.08.0
83.958	SIDAT	7.00368.16.0	849087	OPEL	7.24809.24.0
83.959	SIDAT	7.10334.06.0	849087	VAUXHALL	7.24809.24.0
83.973	SIDAT	7.24809.46.0	849105	OPEL	7.24809.24.0
83.982	SIDAT	7.10334.08.0	849105	VAUXHALL	7.24809.24.0
83.988	SIDAT	7.01493.07.0	849124	OPEL	7.24809.25.0
83.989	SIDAT	7.01604.02.0	849124	VAUXHALL	7.24809.25.0
83.990	SIDAT	7.01782.07.0	849156	OPEL	7.24809.25.0
83.991	SIDAT	7.00555.07.0	849156	VAUXHALL	7.24809.25.0
83.992	SIDAT	7.05363.00.0	850772	OPEL	7.24809.81.0
83.993	SIDAT	7.10334.07.0	850772	VAUXHALL	7.24809.81.0
83.994	SIDAT	7.01621.08.0	850785	OPEL	7.10334.05.0

NUMBERFINDER

REF-No.			REF-No.		
850785	VAUXHALL	7.10334.05.0	855313	OPEL	7.05270.32.0
851038	CHEVROLET	7.24809.10.0	855313	VAUXHALL	7.05270.32.0
851038	GM HOLDEN LTD	7.24809.10.0	855315	OPEL	7.02604.15.0
851038	OPEL	7.24809.10.0	855315	VAUXHALL	7.02604.15.0
851038	VAUXHALL	7.24809.10.0	855324	OPEL	7.05270.34.0
851045	OPEL	7.01599.10.0	855324	VAUXHALL	7.05270.34.0
851045	VAUXHALL	7.01599.10.0	855327	OPEL	7.02604.03.0
851048	CHEVROLET	7.03622.06.0	855327	VAUXHALL	7.02604.03.0
851048	OPEL	7.03622.06.0	855328	OPEL	7.02604.15.0
851048	VAUXHALL	7.03622.06.0	855328	VAUXHALL	7.02604.15.0
851073	CHEVROLET	7.03622.10.0	855329	OPEL	7.02604.15.0
851073	OPEL	7.03622.10.0	855329	VAUXHALL	7.02604.15.0
851073	VAUXHALL	7.03622.10.0	855330	OPEL	7.05270.33.0
851074	CHEVROLET	7.03622.06.0	855330	VAUXHALL	7.05270.33.0
851074	OPEL	7.03622.06.0	855331	OPEL	7.05270.34.0
851074	VAUXHALL	7.03622.06.0	855331	VAUXHALL	7.05270.34.0
851091	OPEL	7.03622.11.0	855333	OPEL	7.02604.15.0
851091	VAUXHALL	7.03622.11.0	855333	VAUXHALL	7.02604.15.0
851094	OPEL	7.03622.09.0	855338	OPEL	7.02604.03.0
851094	VAUXHALL	7.03622.09.0	855338	SAAB	7.02604.03.0
851105	OPEL	7.24809.77.0	855338	VAUXHALL	7.02604.03.0
851105	VAUXHALL	7.24809.77.0	855341	OPEL	7.05271.76.0
851151	OPEL	7.22772.12.0	855341	VAUXHALL	7.05271.76.0
851151	VAUXHALL	7.22772.12.0	855342	OPEL	7.05270.33.0
851152	OPEL	7.22772.12.0	855342	VAUXHALL	7.05270.33.0
851152	VAUXHALL	7.22772.12.0	855343	OPEL	7.05270.32.0
851176	OPEL	7.01599.10.0	855343	VAUXHALL	7.05270.32.0
851176	VAUXHALL	7.01599.10.0	855348	OPEL	7.05271.52.0
851185	OPEL	7.05031.06.0	855348	VAUXHALL	7.05271.52.0
851185	VAUXHALL	7.05031.06.0	855350	OPEL	7.02604.10.0
851288	OPEL	7.24809.78.0	855350	VAUXHALL	7.02604.10.0
851288	VAUXHALL	7.24809.78.0	855351	OPEL	7.05271.81.0
8513132	BMW	7.04493.17.0	855351	VAUXHALL	7.05271.81.0
8513132	MINI (BMW)	7.04493.17.0	855353	OPEL	7.05270.25.0
851341	OPEL	7.00063.10.0	855353	VAUXHALL	7.05270.25.0
851341	VAUXHALL	7.00063.10.0	855355	OPEL	7.02604.07.0
851342	OPEL	7.22946.38.0	855355	VAUXHALL	7.02604.07.0
851342	VAUXHALL	7.22946.38.0	855356	OPEL	7.05271.55.0
851364	OPEL	7.00020.24.0	855358	OPEL	7.05271.62.0
851364	VAUXHALL	7.00020.24.0	855360	OPEL	7.05270.25.0
851368	OPEL	7.00020.25.0	855360	VAUXHALL	7.05270.25.0
851368	VAUXHALL	7.00020.25.0	855362	OPEL	7.05271.68.0
8513691	BMW	7.11010.00.0	855362	VAUXHALL	7.05271.68.0
851593	OPEL	7.22875.13.0	855363	OPEL	7.05270.29.0
851593	VAUXHALL	7.22875.13.0	855363	VAUXHALL	7.05270.29.0
851649	OPEL	7.21920.62.0	855368	OPEL	7.05271.68.0
851649	VAUXHALL	7.21920.62.0	855368	VAUXHALL	7.05271.68.0
851706	OPEL	7.22414.04.0	855371	OPEL	7.05270.30.0
851706	VAUXHALL	7.22414.04.0	855371	VAUXHALL	7.05270.30.0
851708	OPEL	7.22414.04.0	855372	OPEL	7.05270.30.0
851708	VAUXHALL	7.22414.04.0	855372	VAUXHALL	7.05270.30.0
851744	OPEL	7.00020.24.0	855375	OPEL	7.05271.76.0
851744	VAUXHALL	7.00020.24.0	855375	VAUXHALL	7.05271.76.0
851757	OPEL	7.22946.38.0	855380	OPEL	7.05271.52.0
851757	VAUXHALL	7.22946.38.0	855380	VAUXHALL	7.05271.52.0
8517724	BMW	7.10993.00.0	855382	OPEL	7.05270.29.0
855253	OPEL	7.05271.81.0	855382	VAUXHALL	7.05270.29.0
855253	VAUXHALL	7.05271.81.0	855385	OPEL	7.02604.07.0
855267	OPEL	7.08369.15.0	855385	VAUXHALL	7.02604.07.0
855267	VAUXHALL	7.08369.15.0	855386	OPEL	7.05271.81.0
855268	OPEL	7.02604.05.0	855386	VAUXHALL	7.05271.81.0
855268	VAUXHALL	7.02604.05.0	855388	OPEL	7.05271.68.0
855300	OPEL	7.02604.03.0	855388	VAUXHALL	7.05271.68.0
855303	OPEL	7.05271.52.0	855390	OPEL	7.05270.26.0
855303	VAUXHALL	7.05271.52.0	855390	VAUXHALL	7.05270.26.0
855304	OPEL	7.02604.03.0	855397	OPEL	7.05270.27.0
855305	OPEL	7.02604.15.0	855397	VAUXHALL	7.05270.27.0
855305	VAUXHALL	7.02604.15.0	855402	OPEL	7.02604.07.0
855306	SAAB	7.02604.03.0	855402	VAUXHALL	7.02604.07.0



REF-No.	 PIERBURG	REF-No.	 PIERBURG		
855405	OPEL	7.05271.81.0	862715	OPEL	7.11190.04.0
855405	VAUXHALL	7.05271.81.0	862715	VAUXHALL	7.11190.04.0
855406	GENERAL MOTORS	7.05271.81.0	8627202	VOLVO	7.05270.66.0
855406	OPEL	7.05271.81.0	8627599	VOLVO	7.05270.82.0
855406	VAUXHALL	7.05271.81.0	8627600	VOLVO	7.05270.70.0
855408	OPEL	7.02604.12.0	8627750	VOLVO	7.05270.81.0
855408	VAUXHALL	7.02604.12.0	8631668	VOLVO	7.05270.67.0
855409	OPEL	7.05270.37.0	8631670	VOLVO	7.05270.81.0
855409	VAUXHALL	7.05270.37.0	8642230	VOLVO	7.05270.67.0
855410	OPEL	7.08369.05.0	8642738	VOLVO	7.05270.81.0
855410	VAUXHALL	7.08369.05.0	86465-60200	TOYOTA	7.05271.56.0
855411	OPEL	7.05271.68.0	865014	OPEL	7.24809.87.0
855411	VAUXHALL	7.05271.68.0	865014	VAUXHALL	7.24809.87.0
855418	OPEL	7.05270.37.0	8653653	VOLVO	7.02604.64.0
855418	VAUXHALL	7.05270.37.0	8653691	VOLVO	7.09730.00.0
855422	OPEL	7.05271.62.0	8658090	VOLVO	7.05270.37.0
855426	OPEL	7.05271.62.0	8658134	VOLVO	7.05270.81.0
855428	GENERAL MOTORS	7.05271.81.0	8658237	VOLVO	7.05270.83.0
855428	OPEL	7.02604.08.0	8670131	VOLVO	7.05270.67.0
855428	OPEL	7.05271.81.0	8677894	VOLVO	7.02604.13.0
855428	VAUXHALL	7.05271.81.0	8692769	VOLVO	7.05270.67.0
855432	OPEL	7.11020.38.0	8694697	VOLVO	7.24809.73.0
855432	VAUXHALL	7.11020.38.0	8699530	VOLVO	7.11190.10.0
855445	OPEL	7.02604.44.0	87AB9F472AA	FORD	7.02604.04.0
855445	VAUXHALL	7.02604.44.0	88.284	SIDAT	7.07696.00.0
855457	OPEL	7.08369.46.0	88.286	SIDAT	7.04709.13.0
855506	OPEL	7.02604.99.0	88.362	SIDAT	7.03571.16.0
855506	VAUXHALL	7.02604.99.0	88002	MEAT&DORIA	7.22414.04.0
855510	OPEL	7.02604.05.0	88002	MEAT&DORIA	7.22414.07.0
855510	VAUXHALL	7.02604.05.0	88003	MEAT&DORIA	7.24809.10.0
855516	OPEL	7.05271.81.0	88007	MEAT&DORIA	7.22946.34.0
855516	VAUXHALL	7.05271.81.0	88009	MEAT&DORIA	7.22785.17.0
855518	OPEL	7.08369.67.0	88010	MEAT&DORIA	7.28248.17.0
855518	VAUXHALL	7.08369.67.0	88011	MEAT&DORIA	7.22818.59.0
855523	OPEL	7.05271.76.0	88012	MEAT&DORIA	7.22818.57.0
855523	VAUXHALL	7.05271.76.0	88013	MEAT&DORIA	7.22818.58.0
855524	OPEL	7.05270.26.0	88015	MEAT&DORIA	7.00063.10.0
855524	VAUXHALL	7.05270.26.0	88016	MEAT&DORIA	7.22946.33.0
855528	OPEL	7.05271.81.0	88016	MEAT&DORIA	7.22946.34.0
855528	VAUXHALL	7.05271.81.0	88023	MEAT&DORIA	7.22136.50.0
855530	OPEL	7.02604.07.0	88028	MEAT&DORIA	7.21920.62.0
855530	VAUXHALL	7.02604.07.0	88035	MEAT&DORIA	7.22875.13.0
855632	OPEL	7.08369.17.0	88037	MEAT&DORIA	7.22630.28.0
855632	VAUXHALL	7.08369.17.0	88039	MEAT&DORIA	7.24809.06.0
855678	OPEL	7.05271.81.0	88040	MEAT&DORIA	7.24809.73.0
855678	VAUXHALL	7.05271.81.0	88041	MEAT&DORIA	7.24809.07.0
857022	OPEL	7.22296.02.0	88043	MEAT&DORIA	7.00020.24.0
857022	VAUXHALL	7.22296.02.0	88045	MEAT&DORIA	7.22414.08.0
857062	OPEL	7.22296.02.0	88046	MEAT&DORIA	7.28384.13.0
857062	VAUXHALL	7.22296.02.0	88047	MEAT&DORIA	7.22785.16.0
8574815	BMW	7.05343.18.0	88050	MEAT&DORIA	7.22574.12.0
8574820	BMW	7.05343.17.0	88051	MEAT&DORIA	7.24809.16.0
8576810	BMW	7.05838.08.0	88052	MEAT&DORIA	7.24809.17.0
8580442	BMW	7.04493.17.0	88053	MEAT&DORIA	7.22477.11.0
8594492	BMW	7.04493.17.0	88054	MEAT&DORIA	7.00365.06.0
8594492	MINI (BMW)	7.04493.17.0	88055	MEAT&DORIA	7.03196.09.0
860441	OPEL	7.22772.11.0	88056	MEAT&DORIA	7.22818.62.0
860441	VAUXHALL	7.22772.11.0	88063	MEAT&DORIA	7.24809.29.0
860639	OPEL	7.22772.12.0	88064	MEAT&DORIA	7.24809.24.0
860639	VAUXHALL	7.22772.12.0	88064	MEAT&DORIA	7.24809.27.0
862023	OPEL	7.11190.03.0	88065	MEAT&DORIA	7.24809.25.0
862023	VAUXHALL	7.11190.03.0	88065	MEAT&DORIA	7.24809.28.0
8620259105	TRISCAN A/S	7.04879.00.0	88067	MEAT&DORIA	7.24809.49.0
862040	CHEVROLET	7.11190.04.0	88068	MEAT&DORIA	7.24809.26.0
862040	OPEL	7.11190.04.0	88069	MEAT&DORIA	7.24809.20.0
862040	VAUXHALL	7.11190.04.0	88070	MEAT&DORIA	7.24809.19.0
862107	OPEL	7.11190.03.0	88071	MEAT&DORIA	7.24809.33.0
862107	VAUXHALL	7.11190.03.0	88072	MEAT&DORIA	7.28248.17.0
862715	CADILLAC	7.11190.04.0	88079	MEAT&DORIA	7.11237.04.0

REF-No.			REF-No.		
88081	MEAT&DORIA	7.24809.92.0	881329001	TRISCAN A/S	7.24809.17.0
88082	MEAT&DORIA	7.11237.01.0	881329004	TRISCAN A/S	7.22785.17.0
88083	MEAT&DORIA	7.24809.96.0	881329011	TRISCAN A/S	7.24809.31.0
88084	MEAT&DORIA	7.24809.91.0	881329034	TRISCAN A/S	7.22477.10.0
88085	MEAT&DORIA	7.24809.76.0	881329102	TRISCAN A/S	7.09720.00.0
88086	MEAT&DORIA	7.24809.39.0	881329307	TRISCAN A/S	7.22477.11.0
88087	MEAT&DORIA	7.10334.00.0	881329325	TRISCAN A/S	7.09720.01.0
88088	MEAT&DORIA	7.22785.18.0	881329330	TRISCAN A/S	7.09720.02.0
88090	MEAT&DORIA	7.22875.16.0	881343002	TRISCAN A/S	7.09002.05.0
88091	MEAT&DORIA	7.00368.15.0	881343009	TRISCAN A/S	7.09002.09.0
88092	MEAT&DORIA	7.00020.25.0	881343010	TRISCAN A/S	7.09002.12.0
88093	MEAT&DORIA	7.22818.63.0	881343021	TRISCAN A/S	7.09002.08.0
88094	MEAT&DORIA	7.22946.38.0	881343024	TRISCAN A/S	7.09002.11.0
88095	MEAT&DORIA	7.24809.31.0	881343041	TRISCAN A/S	7.05052.00.0
88096	MEAT&DORIA	7.24809.30.0	881343200	TRISCAN A/S	7.11237.08.0
88097	MEAT&DORIA	7.24809.57.0	88137	MEAT&DORIA	7.24809.70.0
88098	MEAT&DORIA	7.24809.52.0	88139	MEAT&DORIA	7.00020.39.0
88099	MEAT&DORIA	7.24809.34.0	88140	MEAT&DORIA	7.00020.40.0
88100	MEAT&DORIA	7.24809.38.0	88141	MEAT&DORIA	7.28069.04.0
88101	MEAT&DORIA	7.24809.56.0	88142	MEAT&DORIA	7.00578.12.0
88102	MEAT&DORIA	7.10334.10.0	88144	MEAT&DORIA	7.28069.03.0
88103	MEAT&DORIA	7.24809.77.0	88146	MEAT&DORIA	7.02756.07.0
88104	MEAT&DORIA	7.24809.78.0	88146	MEAT&DORIA	7.03622.06.0
88105	MEAT&DORIA	7.22772.11.0	88149	MEAT&DORIA	7.01604.02.0
88106	MEAT&DORIA	7.22772.12.0	88149	MEAT&DORIA	7.09002.00.0
88107	MEAT&DORIA	7.22843.06.0	88151	MEAT&DORIA	7.24809.55.0
88109	MEAT&DORIA	7.22888.02.0	88152	MEAT&DORIA	7.00907.03.0
88110	MEAT&DORIA	7.10334.05.0	88153	MAPCO	7.08369.40.0
88113	MEAT&DORIA	7.10334.09.0	88153	MEAT&DORIA	7.24809.36.0
88114	MEAT&DORIA	7.10334.04.0	88154	MEAT&DORIA	7.00823.06.0
88115	MEAT&DORIA	7.00075.07.0	88157	MAPCO	7.08369.31.0
88116	MEAT&DORIA	7.24809.51.0	88158	MEAT&DORIA	7.21949.51.0
88117	MEAT&DORIA	7.24809.68.0	88159	MAPCO	7.08369.22.0
88119	MEAT&DORIA	7.24809.32.0	88161	MAPCO	7.08369.02.0
88120	MEAT&DORIA	7.22843.07.0	88164	MAPCO	7.08369.33.0
88121	MEAT&DORIA	7.24809.63.0	88175	MEAT&DORIA	7.22477.10.0
88124	MEAT&DORIA	7.01599.10.0	88176	MEAT&DORIA	7.28070.03.0
88125	MEAT&DORIA	7.09002.09.0	88180	MEAT&DORIA	7.09002.12.0
88126	MEAT&DORIA	7.09002.08.0	88181	MEAT&DORIA	7.24809.37.0
88128	MAPCO	7.08369.26.0	88182	MAPCO	7.08369.41.0
88129	MAPCO	7.08369.01.0	88182	MEAT&DORIA	7.24809.54.0
88129	MEAT&DORIA	7.09002.05.0	88183	MEAT&DORIA	7.24809.35.0
88131	MEAT&DORIA	7.11237.08.0	88184	MEAT&DORIA	7.24809.48.0
881310001	TRISCAN A/S	7.24809.68.0	88185	MEAT&DORIA	7.24809.59.0
881310007	TRISCAN A/S	7.00578.12.0	88186	MEAT&DORIA	7.24809.60.0
881310011	TRISCAN A/S	7.22843.06.0	88188	MAPCO	7.08369.23.0
881310015	TRISCAN A/S	7.22946.38.0	88188	MEAT&DORIA	7.05052.01.0
881310100	TRISCAN A/S	7.22818.62.0	88188	MEAT&DORIA	7.24809.79.0
881310103	TRISCAN A/S	7.02156.24.0	88189	MEAT&DORIA	7.24809.86.0
881311003	TRISCAN A/S	7.00450.09.0	88190	MEAT&DORIA	7.24809.80.0
881312100	TRISCAN A/S	7.24809.53.0	88191	MEAT&DORIA	7.00450.09.0
881315029	TRISCAN A/S	7.09002.00.0	88192	MEAT&DORIA	7.00512.03.0
881316002	TRISCAN A/S	7.05578.15.0	88193	MEAT&DORIA	7.28264.06.0
881316036	TRISCAN A/S	7.01621.08.0	88194	MEAT&DORIA	7.28264.07.0
881316036	TRISCAN A/S	7.03784.34.0	88195	MEAT&DORIA	7.00684.14.0
881316054	TRISCAN A/S	7.24809.74.0	88196	MEAT&DORIA	7.00450.10.0
881323006	TRISCAN A/S	7.24809.36.0	88197	MEAT&DORIA	7.11237.00.0
881323101	TRISCAN A/S	7.24809.47.0	88198	MEAT&DORIA	7.24809.94.0
881324017	TRISCAN A/S	7.10334.08.0	88199	MEAT&DORIA	7.11237.05.0
881324102	TRISCAN A/S	7.22414.08.0	88201	MEAT&DORIA	7.11237.06.0
881324104	TRISCAN A/S	7.03622.09.0	88202	MEAT&DORIA	7.24809.99.0
881324209	TRISCAN A/S	7.24809.87.0	88204	MEAT&DORIA	7.24809.47.0
881325005	TRISCAN A/S	7.22818.59.0	88205	MEAT&DORIA	7.24809.53.0
881325036	TRISCAN A/S	7.00368.15.0	88207	MEAT&DORIA	7.24809.65.0
881325038	TRISCAN A/S	7.22818.58.0	88208	MEAT&DORIA	7.24809.61.0
881325040	TRISCAN A/S	7.03435.05.0	88209	MEAT&DORIA	7.24809.64.0
881325100	TRISCAN A/S	7.00075.07.0	88211	MEAT&DORIA	7.00306.36.0
881325102	TRISCAN A/S	7.00837.01.0	88212	MEAT&DORIA	7.00555.06.0
881327101	TRISCAN A/S	7.22996.11.0	88213	MEAT&DORIA	7.00789.10.0



REF-No.		 PIERBURG	REF-No.		 PIERBURG
88214	MEAT&DORIA	7.02132.07.0	89,295	MEAT&DORIA	7.04709.13.0
88215	MEAT&DORIA	7.02156.24.0	892176	METZGER	7.00365.06.0
88215	MEAT&DORIA	7.02156.35.0	892178	METZGER	7.22772.12.0
88216	MEAT&DORIA	7.02209.11.0	892193	METZGER	7.22843.07.0
88217	MEAT&DORIA	7.02756.07.0	892207	METZGER	7.00020.24.0
88222	MEAT&DORIA	7.24809.97.0	892231	METZGER	7.22560.42.0
88224	MEAT&DORIA	7.11237.03.0	892234	METZGER	7.22560.45.0
88225	MEAT&DORIA	7.00368.16.0	892235	METZGER	7.22769.79.0
88226	MEAT&DORIA	7.10334.06.0	892237	METZGER	7.22778.80.0
88227	MEAT&DORIA	7.24809.46.0	892242	METZGER	7.22778.99.0
88240	MEAT&DORIA	7.10334.08.0	892355	METZGER	7.03622.06.0
88245	MEAT&DORIA	7.28290.11.0	892372	METZGER	7.02756.07.0
88248	MEAT&DORIA	7.01493.07.0	892518	METZGER	7.03622.10.0
88250	MEAT&DORIA	7.01782.07.0	892550	METZGER	7.09002.00.0
88252	MEAT&DORIA	7.05363.00.0	892589	METZGER	7.01510.86.0
88253	MEAT&DORIA	7.00555.07.0	892590	METZGER	7.01510.85.0
88254	MEAT&DORIA	7.10334.07.0	892720	METZGER	7.09002.08.0
88255	MEAT&DORIA	7.01621.08.0	892740	METZGER	7.00678.06.0
88255	MEAT&DORIA	7.24809.40.0	89293	MEAT&DORIA	7.07696.00.0
88256	MEAT&DORIA	7.22996.11.0	89294	MEAT&DORIA	7.03608.16.0
88258	MEAT&DORIA	7.10334.03.0	8933000598	AMC USA	7.02604.01.0
88259	MEAT&DORIA	7.09720.00.0	8933002455	AMC USA	7.02604.01.0
88260	MEAT&DORIA	7.09720.02.0	8933002455	RENAULT	7.02604.01.0
88261	MEAT&DORIA	7.24809.81.0	894169	METZGER	7.08369.38.0
88271	MEAT&DORIA	7.09720.01.0	894497	METZGER	7.08369.80.0
88274	MEAT&DORIA	7.24809.50.0	89465-0D010	TOYOTA	7.05271.56.0
88278	MEAT&DORIA	7.05052.03.0	89465-17180	TOYOTA	7.05271.56.0
88281	MEAT&DORIA	7.24809.90.0	89465-20280	DAIHATSU	7.05271.56.0
88285	SIDAT	7.03608.16.0	89465-20450	DAIHATSU	7.05271.56.0
88300	MEAT&DORIA	7.24809.93.0	89465-20520	TOYOTA	7.05271.56.0
88301	MEAT&DORIA	7.24809.88.0	89465-20560	TOYOTA	7.05271.56.0
88305	MEAT&DORIA	7.11237.07.0	89465-28220	TOYOTA	7.05271.56.0
88322	MEAT&DORIA	7.00999.08.0	89465-30180	LEXUS	7.05271.56.0
88331	MEAT&DORIA	7.24809.87.0	89465-30180	TOYOTA	7.05271.56.0
88337	MEAT&DORIA	7.03295.03.0	89465-33130	TOYOTA	7.05271.56.0
88350	MEAT&DORIA	7.24809.74.0	89465-33160	TOYOTA	7.05271.56.0
88365	MEAT&DORIA	7.09730.00.0	89465-33170	TOYOTA	7.05271.56.0
88396	MEAT&DORIA	7.00632.13.0	89465-33230	TOYOTA	7.05271.53.0
88428	MEAT&DORIA	7.01621.08.0	89465-33340	TOYOTA	7.05271.53.0
884511030	TRISCAN A/S	7.05271.22.0	89465-39815	TOYOTA	7.05271.56.0
884511500	TRISCAN A/S	7.05271.72.0	89465-47050	TOYOTA	7.05271.56.0
884511501	TRISCAN A/S	7.05271.74.0	89465-52050	TOYOTA	7.05271.56.0
884512079	TRISCAN A/S	7.05271.62.0	89465-52480	TOYOTA	7.05271.56.0
884514518	TRISCAN A/S	7.05271.67.0	89465-53040	TOYOTA	7.05271.56.0
884517003	TRISCAN A/S	7.05271.75.0	89465-60200	LEXUS	7.05271.56.0
884524008	TRISCAN A/S	7.05271.55.0	89465-60200	TOYOTA	7.05271.56.0
884524070	TRISCAN A/S	7.05271.68.0	89465-87113	DAIHATSU	7.05271.56.0
884540054	TRISCAN A/S	7.05271.58.0	89465-87210-000	DAIHATSU	7.02604.01.0
884569067	TRISCAN A/S	7.05271.35.0	89465-87708	DAIHATSU	7.05271.56.0
88459	MEAT&DORIA	7.09720.03.0	89465-97203-000	DAIHATSU	7.02604.01.0
88460	MEAT&DORIA	7.09720.04.0	8946502060	TOYOTA	7.05271.39.0
88470	MEAT&DORIA	7.22939.03.0	8946502280	TOYOTA	7.05271.36.0
88477	MEAT&DORIA	7.01881.07.0	8946505110	TOYOTA	7.05271.65.0
88500	MEAT&DORIA	7.02209.20.0	8946505130	TOYOTA	7.05271.53.0
88710	MAPCO	7.08369.05.0	8946505190	TOYOTA	7.05271.36.0
88711	MAPCO	7.08369.17.0	8946506010	TOYOTA	7.05271.56.0
88747	MEAT&DORIA	7.05052.00.0	8946506070	TOYOTA	7.05271.65.0
88748	MEAT&DORIA	7.05320.04.0	8946506130	TOYOTA	7.05271.65.0
88749	MEAT&DORIA	7.22996.12.0	8946507060	TOYOTA	7.05271.65.0
88750	MEAT&DORIA	7.00837.01.0	8946507080	TOYOTA	7.05271.65.0
88752	MEAT&DORIA	7.05031.06.0	8946508040	LEXUS	7.05271.36.0
88820	MEAT&DORIA	7.04923.18.0	894650D020	TOYOTA	7.05271.51.0
88826	MAPCO	7.08369.14.0	894650D050	TOYOTA	7.05271.51.0
88827	MAPCO	7.08369.09.0	894650E120	LEXUS	7.05271.48.0
88828	MEAT&DORIA	7.03647.10.0	894650E120	TOYOTA	7.05271.48.0
88830	MAPCO	7.08369.68.0	894650H010	TOYOTA	7.05271.39.0
88831	MAPCO	7.08369.45.0	894650H020	TOYOTA	7.05271.51.0
88833	MAPCO	7.08369.34.0	8946510020	TOYOTA	7.02604.01.0
88835	MEAT&DORIA	7.09720.05.0	8946512270	TOYOTA	7.02604.01.0

NUMBERFINDER



REF-No.			REF-No.		
8946512280	TOYOTA	7.02604.01.0	8946587108000	DAIHATSU	7.02604.01.0
8946512430	TOYOTA	7.02604.01.0	8946587109000	DAIHATSU	7.02604.01.0
8946512540	TOYOTA	7.05271.56.0	8946587202	DAIHATSU	7.02604.01.0
8946512800	TOYOTA	7.05271.36.0	8946587202000	DAIHATSU	7.02604.01.0
8946513020	TOYOTA	7.02604.01.0	8946587210	DAIHATSU	7.02604.01.0
8946516040	TOYOTA	7.02604.01.0	8946587211	DAIHATSU	7.02604.01.0
8946519025	TOYOTA	7.02604.01.0	8946587211000	DAIHATSU	7.02604.01.0
8946519026	TOYOTA	7.02604.01.0	8946587212	DAIHATSU	7.02604.01.0
8946520300	TOYOTA	7.02604.04.0	8946587212000	DAIHATSU	7.02604.01.0
8946520660	TOYOTA	7.05271.65.0	8946587601	DAIHATSU	7.02604.01.0
8946520680	TOYOTA	7.05271.38.0	8946587601000	DAIHATSU	7.02604.01.0
8946520690	TOYOTA	7.05271.38.0	8946587704	DAIHATSU	7.02604.01.0
8946520710	TOYOTA	7.05271.38.0	8946587704000	DAIHATSU	7.02604.01.0
8946520790	TOYOTA	7.05271.65.0	8946587707	TOYOTA	7.02604.01.0
8946528230	TOYOTA	7.05271.65.0	8946597203	DAIHATSU	7.02604.01.0
8946528290	TOYOTA	7.05271.38.0	8946597405	DAIHATSU	7.02604.01.0
8946528330	TOYOTA	7.05271.65.0	8946597405000	DAIHATSU	7.02604.01.0
8946530100	TOYOTA	7.02604.01.0	8946597408	DAIHATSU	7.05271.32.0
8946530430	TOYOTA	7.05271.53.0	8946597408000	DAIHATSU	7.05271.32.0
8946530470	TOYOTA	7.05271.65.0	89481-YV020	TOYOTA	7.11190.12.0
8946530630	LEXUS	7.05271.38.0	8950	NGK	7.05271.38.0
8946530630	TOYOTA	7.05271.38.0	8953000886	AMC / KAVO	7.02604.15.0
8946532060	TOYOTA	7.02604.01.0	8953000886	AMC USA	7.02604.01.0
8946532140	TOYOTA	7.02604.01.0	8953004243	AMC / KAVO	7.02604.15.0
8946533220	TOYOTA	7.05271.36.0	8953004243	AMC USA	7.02604.01.0
8946533260	LEXUS	7.05271.65.0	8971849255	ISUZU	7.22772.12.0
8946533260	TOYOTA	7.05271.65.0	8972240110	ISUZU	7.05271.52.0
8946533370	TOYOTA	7.05271.65.0	897353973Y	ISUZU	7.22772.11.0
8946533420	TOYOTA	7.05271.65.0	8980919250	ISUZU	7.22772.12.0
8946539405	TOYOTA	7.02604.01.0	899024	METZGER	7.22738.20.0
8946542090	TOYOTA	7.05271.53.0	8990469	GMC	7.02604.01.0
8946542100	TOYOTA	7.05271.53.0	8990625	GMC	7.02604.01.0
8946544050	TOYOTA	7.05271.53.0	8990741	GMC	7.02604.01.0
8946544060	TOYOTA	7.05271.53.0	89FB9F472BA	FORD	7.02604.61.0
8946547070	TOYOTA	7.05271.38.0	89FB9F472CA	FORD	7.02604.61.0
8946548060	TOYOTA	7.05271.53.0	8C1Q-9D475-AA	FORD	7.24809.69.0
8946548070	TOYOTA	7.05271.53.0	8C1Q-9D475-BA	FORD	7.24809.70.0
8946548170	LEXUS	7.05271.36.0	8C3Z-9D475-D	FORD	7.01293.38.0
8946548210	LEXUS	7.05271.36.0	8E0906088	AUDI	7.08369.23.0
8946548220	LEXUS	7.05271.36.0	8K0906088	AUDI	7.11020.25.0
8946548270	LEXUS	7.05271.48.0	8K0906262	AUDI	7.05271.13.0
8946548270	TOYOTA	7.05271.48.0	8ME376775-691	HELLA INCORPORATED	7.24809.88.0
8946550130	LEXUS	7.05271.65.0	8MT354778-011	HELLA INCORPORATED	7.04879.00.0
8946550130	TOYOTA	7.05271.65.0	8S6A-9F472-AA	FORD	7.02604.60.0
8946550170	LEXUS	7.05271.38.0	8V21-9G444-AA	FORD	7.02604.60.0
8946550170	TOYOTA	7.05271.38.0	8V21-9G444-AB	FORD	7.02604.60.0
8946552010	TOYOTA	7.05271.53.0	8V21-9G444-AC	FORD	7.02604.60.0
8946552020	TOYOTA	7.05271.53.0	8W0253691	AUDI	7.07141.01.0
8946553100	TOYOTA	7.05271.65.0	8W0253691	SEAT	7.07141.01.0
8946553150	LEXUS	7.05271.65.0	8W0253691	SKODA	7.07141.01.0
8946553210	TOYOTA	7.05271.56.0	8W0253691	VOLKSWAGEN	7.07141.01.0
8946560440	TOYOTA	7.05271.65.0	8W0253691A	AUDI	7.07141.01.0
8946568050	LEXUS	7.05271.36.0	8W0253691A	SEAT	7.07141.01.0
8946569015	TOYOTA	7.02604.03.0	8W0253691A	SKODA	7.07141.01.0
8946569085	TOYOTA	7.02604.03.0	8W0253691A	VOLKSWAGEN	7.07141.01.0
8946574010	TOYOTA	7.05271.36.0	90057	SIDAT	7.05271.58.0
8946574020	TOYOTA	7.05271.36.0	90063	SIDAT	7.05271.38.0
8946574030	TOYOTA	7.05271.36.0	90067	SIDAT	7.05271.39.0
8946576010	LEXUS	7.05271.48.0	90068	SIDAT	7.05271.59.0
8946576010	TOYOTA	7.05271.48.0	90110	SIDAT	7.05271.73.0
8946587101	DAIHATSU	7.02604.01.0	90117	SIDAT	7.05271.35.0
8946587101000	DAIHATSU	7.02604.01.0	90118	SIDAT	7.05271.61.0
8946587102	DAIHATSU	7.02604.01.0	90122	SIDAT	7.05271.70.0
8946587102000	DAIHATSU	7.02604.01.0	90141	SIDAT	7.05271.75.0
8946587105	DAIHATSU	7.02604.01.0	90151	SIDAT	7.05271.22.0
8946587105000	DAIHATSU	7.02604.01.0	90151A2	SIDAT	7.05271.77.0
8946587106	DAIHATSU	7.02604.01.0	90188	SIDAT	7.05271.52.0
8946587106000	DAIHATSU	7.02604.01.0	90203	SIDAT	7.05271.37.0
8946587108	DAIHATSU	7.02604.01.0	90232	SIDAT	7.05271.54.0

REF-No.		 PIEBURG	REF-No.		 PIEBURG
90246	SIDAT	7.05271.67.0	9135329	VOLVO	7.05270.79.0
90261	SIDAT	7.05271.71.0	91517978	CITROEN	7.02604.01.0
90272	SIDAT	7.05271.65.0	9151797880	CITROEN	7.02604.01.0
90279	SIDAT	7.05271.36.0	91540672	CITROEN	7.02604.03.0
90319	SIDAT	7.05271.46.0	9157671	OPEL	7.22875.13.0
90344	SIDAT	7.05271.74.0	9179271	VOLVO	7.21857.01.0
90346	SIDAT	7.05271.72.0	9186934	VOLVO	7.05270.67.0
90350	SIDAT	7.05271.68.0	9192805	OPEL	7.24809.25.0
90411959	OPEL	7.05270.32.0	9192805	VAUXHALL	7.24809.25.0
90411959	VAUXHALL	7.05270.32.0	9192922	OPEL	7.05271.81.0
90416	SIDAT	7.05271.69.0	9192922	VAUXHALL	7.05271.81.0
90448458	OPEL	7.02604.03.0	9193148	OPEL	7.02604.07.0
90460	SIDAT	7.05271.32.0	9193148	VAUXHALL	7.02604.07.0
90470420	OPEL	7.22296.02.0	9195606	OPEL	7.05271.68.0
90470420	VAUXHALL	7.22296.02.0	9195606	VAUXHALL	7.05271.68.0
90509132	OPEL	7.21920.62.0	9199469	OPEL	7.02604.07.0
90509132	VAUXHALL	7.21920.62.0	9199469	VAUXHALL	7.02604.07.0
90509276	OPEL	7.05270.34.0	9199470	OPEL	7.05271.81.0
90509276	VAUXHALL	7.05270.34.0	9199470	VAUXHALL	7.05271.81.0
90510147	OPEL	7.02604.03.0	9199591	OPEL	7.05271.68.0
90528253	OPEL	7.05270.33.0	9199591	VAUXHALL	7.05271.68.0
90528253	VAUXHALL	7.05270.33.0	9202575	CADILLAC	7.05271.55.0
90528640	OPEL	7.05270.34.0	9202575	GENERAL MOTORS	7.05271.55.0
90528640	VAUXHALL	7.05270.34.0	9202575	SAAB	7.05271.55.0
90530068	OPEL	7.05271.76.0	9202577	OPEL	7.05271.62.0
90530068	VAUXHALL	7.05271.76.0	9207999	VOLVO	7.05270.79.0
90530586	OPEL	7.05270.33.0	92090922	HJS	7.11190.00.0
90530586	VAUXHALL	7.05270.33.0	92091007	HJS	7.11492.02.0
90530760	OPEL	7.24809.24.0	92091014	HJS	7.11190.04.0
90530760	VAUXHALL	7.24809.24.0	92091015	HJS	7.11190.10.0
90536393	OPEL	7.05270.32.0	92091022	HJS	7.11492.01.0
90536393	VAUXHALL	7.05270.32.0	92091028	HJS	7.11190.08.0
90541691	OPEL	7.21920.62.0	92091031	HJS	7.11190.03.0
90541691	VAUXHALL	7.21920.62.0	92091040	HJS	7.11190.09.0
90542830	OPEL	7.22296.02.0	92091040	HJS	7.11492.00.0
90542830	VAUXHALL	7.22296.02.0	92091042	HJS	7.11492.03.0
90543031	OPEL	7.22414.04.0	92091055	HJS	7.11492.07.0
90543031	VAUXHALL	7.22414.04.0	92091067	HJS	7.11492.05.0
90543281	OPEL	7.05271.76.0	92094000	HJS	7.08369.00.0
90543281	VAUXHALL	7.05271.76.0	92094001	HJS	7.08369.18.0
90570475	OPEL	7.22414.04.0	92094002	HJS	7.08369.13.0
90570475	VAUXHALL	7.22414.04.0	92094003	HJS	7.08369.42.0
90570476	OPEL	7.22414.04.0	92094004	HJS	7.08369.02.0
90570476	VAUXHALL	7.22414.04.0	92094005	HJS	7.08369.01.0
90570477	OPEL	7.22414.08.0	92094007	HJS	7.08369.14.0
90570477	VAUXHALL	7.22414.08.0	92094008	HJS	7.08369.31.0
90570478	OPEL	7.22414.08.0	92094009	HJS	7.08369.03.0
90570478	VAUXHALL	7.22414.08.0	92094010	HJS	7.08369.04.0
90571101	OPEL	7.22414.07.0	92094011	HJS	7.08369.26.0
90571101	VAUXHALL	7.22414.07.0	92094013	HJS	7.08369.08.0
9061420619	EOBUS	7.24809.66.0	92094014	HJS	7.08369.96.0
91109417700	PORSCHE	7.02604.01.0	92094015	HJS	7.08369.16.0
9112463	OPEL	7.22818.59.0	92094017	HJS	7.08369.41.0
9112463	VAUXHALL	7.22818.59.0	92094018	HJS	7.08369.20.0
91160174	OPEL	7.02604.10.0	92094019	HJS	7.08369.39.0
91160174	VAUXHALL	7.02604.10.0	92094020	HJS	7.08369.17.0
91160612300	PORSCHE	7.02604.01.0	92094021	HJS	7.08369.38.0
9117397	OPEL	7.22414.08.0	92094022	HJS	7.08369.32.0
9117397	VAUXHALL	7.22414.08.0	92094023	HJS	7.08369.15.0
9125546	VOLVO	7.05270.66.0	92094026	HJS	7.11020.35.0
9125623	VOLVO	7.22299.03.0	92094027	HJS	7.08369.05.0
9128573	OPEL	7.24809.24.0	92094028	HJS	7.11020.00.0
9128573	VAUXHALL	7.24809.24.0	92094029	HJS	7.08369.33.0
9129885	GENERAL MOTORS	7.05271.81.0	92094030	HJS	7.08369.24.0
9129885	OPEL	7.05271.81.0	92094031	HJS	7.08369.23.0
9129885	VAUXHALL	7.05271.81.0	92094032	HJS	7.08369.36.0
91299	NGK	7.02604.44.0	92094033	HJS	7.08369.22.0
9129954	OPEL	7.05271.81.0	92094034	HJS	7.08369.58.0
9129954	VAUXHALL	7.05271.81.0	92094036	HJS	7.08369.40.0

NUMBERFINDER



REF-No.			REF-No.		
92094039	HJS	7.08369.09.0	92101010	HJS	7.08369.84.0
92094040	HJS	7.08369.19.0	92692	MEAT&DORIA	7.04879.00.0
92094041	HJS	7.08369.83.0	92860612801	PORSCHE	7.02604.03.0
92094042	HJS	7.08369.45.0	92AB9F472AA	FORD	7.02604.62.0
92094043	HJS	7.08369.48.0	92VB9F472AB	FORD	7.02604.62.0
92094044	HJS	7.08369.37.0	93041	NGK	7.05271.04.0
92094045	HJS	7.11020.13.0	93160003	OPEL	7.22818.57.0
92094046	HJS	7.11020.45.0	93160003	VAUXHALL	7.22818.57.0
92094047	HJS	7.08369.50.0	93160620600	PORSCHE	7.02604.01.0
92094051	HJS	7.08369.53.0	93160741	OPEL	7.22818.59.0
92094053	HJS	7.11020.02.0	93160741	VAUXHALL	7.22818.59.0
92094054	HJS	7.08369.93.0	93160754	OPEL	7.22818.57.0
92094057	HJS	7.11020.07.0	93160754	VAUXHALL	7.22818.57.0
92094062	HJS	7.11020.06.0	93161069	OPEL	7.22818.57.0
92094066	HJS	7.08369.78.0	93161069	VAUXHALL	7.22818.57.0
92094070	HJS	7.08369.21.0	93161071	OPEL	7.22818.59.0
92094071	HJS	7.08369.62.0	93161071	VAUXHALL	7.22818.59.0
92094072	HJS	7.08369.44.0	93161219	OPEL	7.22818.57.0
92094073	HJS	7.08369.63.0	93161219	VAUXHALL	7.22818.57.0
92094075	HJS	7.08369.65.0	93161487	OPEL	7.22818.57.0
92094076	HJS	7.08369.43.0	93161487	VAUXHALL	7.22818.57.0
92094078	HJS	7.08369.68.0	93161831	OPEL	7.02604.44.0
92094090	HJS	7.11020.03.0	93161831	VAUXHALL	7.02604.44.0
92094091	HJS	7.08369.72.0	93168407	OPEL	7.10334.03.0
92094092	HJS	7.08369.86.0	93168407	VAUXHALL	7.10334.03.0
92094093	HJS	7.08369.97.0	93169064	OPEL	7.22946.38.0
92094094	HJS	7.11020.01.0	93169064	VAUXHALL	7.22946.38.0
92094094	HJS	7.11020.11.0	93169072	OPEL	7.09002.13.0
92094095	HJS	7.11020.38.0	93169072	VAUXHALL	7.09002.13.0
92094096	HJS	7.08369.90.0	93170138	OPEL	7.24809.25.0
92094097	HJS	7.08369.82.0	93170138	VAUXHALL	7.24809.25.0
92094098	HJS	7.08369.79.0	93174519	OPEL	7.02604.05.0
92094101	HJS	7.08369.73.0	93174519	VAUXHALL	7.02604.05.0
92094102	HJS	7.08369.25.0	93176989	OPEL	7.24809.29.0
92094106	HJS	7.08369.94.0	93176989	SAAB	7.24809.29.0
92094108	HJS	7.08369.30.0	93176989	VAUXHALL	7.24809.29.0
92094109	HJS	7.08369.12.0	93177169	OPEL	7.02604.07.0
92094110	HJS	7.08369.61.0	93177169	VAUXHALL	7.02604.07.0
92094112	HJS	7.08369.57.0	93177422	OPEL	7.00020.24.0
92094115	HJS	7.08369.64.0	93177422	VAUXHALL	7.00020.24.0
92094122	HJS	7.08369.77.0	93177450	OPEL	7.05271.81.0
92094122	HJS	7.08369.91.0	93177450	VAUXHALL	7.05271.81.0
92094132	HJS	7.08369.49.0	93177451	OPEL	7.05271.81.0
92094136	HJS	7.08369.46.0	93177451	VAUXHALL	7.05271.81.0
92094139	HJS	7.11020.44.0	9317751	SAAB	7.02604.01.0
92094140	HJS	7.08369.55.0	93178886	OPEL	7.22946.38.0
92094142	HJS	7.08369.66.0	93178886	VAUXHALL	7.22946.38.0
92094146	HJS	7.11020.28.0	93179226	OPEL	7.02604.99.0
92094151	HJS	7.08369.95.0	93179226	SAAB	7.02604.99.0
92094152	HJS	7.11020.09.0	93179226	VAUXHALL	7.02604.99.0
92094154	HJS	7.11020.22.0	93180669	OPEL	7.02604.12.0
92094155	HJS	7.11020.17.0	93180669	VAUXHALL	7.02604.12.0
92094157	HJS	7.11020.23.0	93180670	OPEL	7.05270.37.0
92094165	HJS	7.08369.89.0	93180670	VAUXHALL	7.05270.37.0
92094168	HJS	7.11020.20.0	93181910	OPEL	7.02604.05.0
92094173	HJS	7.11020.21.0	93181910	VAUXHALL	7.02604.05.0
92094177	HJS	7.11020.12.0	93181981	OPEL	7.00063.10.0
92094178	HJS	7.08369.76.0	93181981	SAAB	7.00063.10.0
92094180	HJS	7.08369.35.0	93181981	VAUXHALL	7.00063.10.0
92094181	HJS	7.11020.08.0	93182927	OPEL	7.05271.68.0
92094184	HJS	7.08369.88.0	93182927	VAUXHALL	7.05271.68.0
92094187	HJS	7.08369.60.0	93183146	OPEL	7.22818.57.0
92094192	HJS	7.08369.59.0	93183146	VAUXHALL	7.22818.57.0
92094193	HJS	7.11020.10.0	93183942	OPEL	7.22818.59.0
92094195	HJS	7.11020.29.0	93183942	VAUXHALL	7.22818.59.0
92094205	HJS	7.11020.05.0	93184196	OPEL	7.00020.25.0
92094212	HJS	7.11020.04.0	93184196	VAUXHALL	7.00020.25.0
92094215	HJS	7.11020.14.0	93184704	OPEL	7.05270.37.0
92094216	HJS	7.08369.27.0	93184704	VAUXHALL	7.05270.37.0

REF-No.	 PIERBURG	REF-No.	 PIERBURG		
93184997	CHEVROLET	7.24809.10.0	93955202582	PININFARINA	7.02604.44.0
93184997	GM HOLDEN LTD	7.24809.10.0	93955204005	PININFARINA	7.05270.21.0
93184997	OPEL	7.24809.10.0	93AB9F472AA	FORD	7.02604.62.0
93185000	OPEL	7.22875.13.0	93FB9F472AA	FORD	7.02604.61.0
93185456	GENERAL MOTORS	7.05271.62.0	93GB9F472DA	FORD	7.02604.62.0
93185493	GENERAL MOTORS	7.05271.62.0	93VB9F472AA	FORD	7.02604.62.0
93185556	CADILLAC	7.11190.03.0	94.692	SIDAT	7.04879.00.0
93185556	OPEL	7.11190.03.0	94418	NGK	7.05271.24.0
93185556	SAAB	7.11190.03.0	94460613300	PORSCHE	7.02604.01.0
93185556	VAUXHALL	7.11190.03.0	9454596	VOLVO	7.05270.66.0
93186233	GENERAL MOTORS	7.05271.81.0	9458188	VOLVO	7.05270.67.0
93186233	OPEL	7.02604.08.0	9467633780	FIAT	7.02209.11.0
93186233	OPEL	7.05271.81.0	9470406	VOLVO	7.05270.80.0
93186233	VAUXHALL	7.05271.81.0	9470983	VOLVO	7.05270.80.0
93186800	OPEL	7.05271.81.0	94773	NGK	7.05271.67.0
93186800	VAUXHALL	7.05271.81.0	94811320301	PORSCHE	7.00018.51.0
93187247	CADILLAC	7.11190.04.0	94811320351	PORSCHE	7.00018.50.0
93187247	OPEL	7.11190.04.0	9497317	VOLVO	7.05270.80.0
93187247	VAUXHALL	7.11190.04.0	9497345	VOLVO	7.05270.67.0
93188473	OPEL	7.08369.15.0	9497346	VOLVO	7.05270.37.0
93188473	VAUXHALL	7.08369.15.0	9497347	VOLVO	7.05270.67.0
93188701	OPEL	7.22818.57.0	9497468	VOLVO	7.05270.66.0
93188701	VAUXHALL	7.22818.57.0	9497790	VOLVO	7.05270.66.0
93188772	OPEL	7.00020.25.0	94BB9F472DA	FORD	7.02604.62.0
93188772	VAUXHALL	7.00020.25.0	95452	NGK	7.05271.69.0
93189082	OPEL	7.22946.38.0	95494924	CITROEN	7.02604.01.0
93189082	SAAB	7.22946.38.0	95507577	OPEL	7.00020.50.0
93189082	VAUXHALL	7.22946.38.0	95507577	VAUXHALL	7.00020.50.0
93189198	GENERAL MOTORS	7.08369.49.0	95508569	OPEL	7.10334.03.0
93189198	VAUXHALL	7.08369.49.0	95508569	VAUXHALL	7.10334.03.0
93189335	OPEL	7.00020.24.0	95510744	OPEL	7.11190.03.0
93189335	VAUXHALL	7.00020.24.0	95510744	VAUXHALL	7.11190.03.0
93189914	OPEL	7.08369.67.0	95511105100	PORSCHE	7.01782.07.0
93189914	VAUXHALL	7.08369.67.0	95511105101	PORSCHE	7.01782.07.0
93189974	OPEL	7.05271.76.0	95512486	OPEL	7.24809.77.0
93189974	VAUXHALL	7.05271.76.0	95512486	VAUXHALL	7.24809.77.0
93189975	OPEL	7.05270.26.0	95513839	OPEL	7.11020.41.0
93189975	VAUXHALL	7.05270.26.0	95513839	VAUXHALL	7.11020.41.0
93190419	OPEL	7.05271.81.0	95515266	OPEL	7.10334.05.0
93190419	VAUXHALL	7.05271.81.0	95515266	VAUXHALL	7.10334.05.0
93193795	OPEL	7.00020.50.0	95516902	OPEL	7.11190.03.0
93193795	VAUXHALL	7.00020.50.0	95516902	VAUXHALL	7.11190.03.0
93194121	OPEL	7.11190.04.0	95518009	OPEL	7.24809.90.0
93194121	VAUXHALL	7.11190.04.0	95518010	OPEL	7.24809.90.0
93195431	OPEL	7.01599.10.0	95523829	OPEL	7.10334.08.0
93195431	VAUXHALL	7.01599.10.0	95525570	OPEL	7.24809.77.0
93196798	OPEL	7.00020.24.0	95525570	VAUXHALL	7.24809.77.0
93196798	VAUXHALL	7.00020.24.0	95525935	OPEL	7.24809.77.0
93196799	OPEL	7.00020.25.0	95525935	VAUXHALL	7.24809.77.0
93196799	VAUXHALL	7.00020.25.0	95527051	OPEL	7.24809.90.0
93198327	OPEL	7.22818.63.0	95528937	OPEL	7.24809.90.0
93198327	VAUXHALL	7.22818.63.0	95529392	OPEL	7.11190.08.0
93198436	OPEL	7.10334.05.0	95529392	VAUXHALL	7.11190.08.0
93198436	VAUXHALL	7.10334.05.0	95560560100	PORSCHE	7.22738.08.0
93198888	OPEL	7.10334.03.0	95560560101	PORSCHE	7.22738.08.0
93198888	VAUXHALL	7.10334.03.0	95560612601	PORSCHE	7.05271.77.0
93232414	GMC	7.02604.01.0	95560612602	PORSCHE	7.05271.77.0
9337726	SAAB	7.02604.01.0	95560613601	PORSCHE	7.05270.99.0
93407	NGK	7.05271.04.0	95560613610	PORSCHE	7.05270.99.0
93455375	OPEL	7.11492.07.0	95560613620	PORSCHE	7.05270.99.0
93455375	VAUXHALL	7.11492.07.0	95560613630	PORSCHE	7.05271.15.0
93455603	OPEL	7.11190.08.0	95560613730	PORSCHE	7.05271.11.0
93455603	VAUXHALL	7.11190.08.0	95560615100	PORSCHE	7.11190.02.0
93457569	OPEL	7.11492.07.0	95666	NGK	7.02604.41.0
93816	NGK	7.05271.58.0	95793	NGK	7.02604.41.0
93868338	OPEL	7.11190.08.0	95811101100	PORSCHE	7.01106.38.0
93868338	VAUXHALL	7.11190.08.0	95811101102	PORSCHE	7.01106.38.0
93951827385	PININFARINA	7.02604.44.0	95811101103	PORSCHE	7.01106.38.0
93955188205	PININFARINA	7.05270.21.0	95811101104	PORSCHE	7.01106.38.0



REF-No.			REF-No.		
95811105100	PORSCHE	7.02132.07.0	959125	AUTEX	7.24809.46.0
95811105101	PORSCHE	7.02132.07.0	959127	AUTEX	7.24809.55.0
95811105120	PORSCHE	7.00789.10.0	959128	AUTEX	7.24809.77.0
95811322301	PORSCHE	7.22286.53.0	959130	AUTEX	7.24809.50.0
95811322302	PORSCHE	7.22286.53.0	959131	AUTEX	7.24809.52.0
95811322401	PORSCHE	7.22286.52.0	959132	AUTEX	7.24809.57.0
95811322402	PORSCHE	7.22286.52.0	959134	AUTEX	7.24809.35.0
95860615110	PORSCHE	7.11190.02.0	959135	AUTEX	7.24809.63.0
95860615111	PORSCHE	7.11492.03.0	959136	AUTEX	7.24809.53.0
95860668800	PORSCHE	7.08369.45.0	959137	AUTEX	7.24809.64.0
95860668831	PORSCHE	7.08369.73.0	959138	AUTEX	7.00823.06.0
95890608830	PORSCHE	7.11020.25.0	959139	AUTEX	7.00365.06.0
959005	AUTEX	7.24809.06.0	959140	AUTEX	7.28384.13.0
959009	AUTEX	7.22630.28.0	959141	AUTEX	7.00450.09.0
959011	AUTEX	7.24809.10.0	959143	AUTEX	7.28264.06.0
959012	AUTEX	7.22785.17.0	959144	AUTEX	7.22414.07.0
959013	AUTEX	7.22414.04.0	959145	AUTEX	7.02132.07.0
959014	AUTEX	7.22414.08.0	959146	AUTEX	7.00368.15.0
959016	AUTEX	7.22946.34.0	959147	AUTEX	7.00578.12.0
959017	AUTEX	7.22818.59.0	959148	AUTEX	7.22843.06.0
959018	AUTEX	7.22818.57.0	959149	AUTEX	7.28264.07.0
959019	AUTEX	7.22818.58.0	959150	AUTEX	7.00555.06.0
959020	AUTEX	7.00063.10.0	959151	AUTEX	7.22477.10.0
959022	AUTEX	7.22875.13.0	959152	AUTEX	7.00306.36.0
959024	AUTEX	7.00020.24.0	959153	AUTEX	7.00555.07.0
959028	AUTEX	7.22574.12.0	959154	AUTEX	7.00512.03.0
959029	AUTEX	7.28248.17.0	959155	AUTEX	7.22477.11.0
959030	AUTEX	7.22785.18.0	959157	AUTEX	7.01782.07.0
959031	AUTEX	7.22785.16.0	959158	AUTEX	7.22888.02.0
959033	AUTEX	7.22946.38.0	959159	AUTEX	7.22843.07.0
959034	AUTEX	7.24809.07.0	959160	AUTEX	7.22772.12.0
959035	AUTEX	7.00020.25.0	959163	AUTEX	7.01599.10.0
959038	AUTEX	7.24809.27.0	959164	AUTEX	7.22136.50.0
959039	AUTEX	7.24809.28.0	959166	AUTEX	7.28069.04.0
959040	AUTEX	7.24809.20.0	959167	AUTEX	7.03196.09.0
959041	AUTEX	7.22818.63.0	959168	AUTEX	7.28069.03.0
959042	AUTEX	7.24809.76.0	959169	AUTEX	7.02209.11.0
959043	AUTEX	7.09002.05.0	959170	AUTEX	7.00450.10.0
959044	AUTEX	7.22875.16.0	959171	AUTEX	7.00368.16.0
959045	AUTEX	7.21920.62.0	959172	AUTEX	7.05363.00.0
959048	AUTEX	7.00020.39.0	959173	AUTEX	7.01621.08.0
959049	AUTEX	7.00020.40.0	959173	AUTEX	7.24809.40.0
959050	AUTEX	7.24809.70.0	959175	AUTEX	7.28290.11.0
959052	AUTEX	7.22818.62.0	959183	AUTEX	7.24809.68.0
959053	AUTEX	7.24809.39.0	959184	AUTEX	7.00789.10.0
959095	AUTEX	7.28070.03.0	959195	AUTEX	7.01493.07.0
959096	AUTEX	7.24809.16.0	959196	AUTEX	7.22772.11.0
959097	AUTEX	7.24809.29.0	959197	AUTEX	7.01268.03.0
959098	AUTEX	7.24809.33.0	959199	AUTEX	7.01604.02.0
959099	AUTEX	7.24809.17.0	959286	AUTEX	7.24809.69.0
959100	AUTEX	7.24809.19.0	959296	AUTEX	7.10334.09.0
959101	AUTEX	7.24809.37.0	959301	AUTEX	7.00075.07.0
959102	AUTEX	7.24809.36.0	959318	AUTEX	7.22785.20.0
959105	AUTEX	7.24809.65.0	959320	AUTEX	7.22841.08.0
959106	AUTEX	7.24809.26.0	959345	AUTEX	7.09002.00.0
959107	AUTEX	7.24809.51.0	959348	AUTEX	7.22843.06.0
959108	AUTEX	7.24809.47.0	959382	AUTEX	7.03051.04.0
959109	AUTEX	7.24809.60.0	959384	AUTEX	7.03435.05.0
959110	AUTEX	7.24809.38.0	959385	AUTEX	7.03527.12.0
959111	AUTEX	7.24809.34.0	959386	AUTEX	7.04256.35.0
959114	AUTEX	7.24809.30.0	959386	AUTEX	7.04256.36.0
959115	AUTEX	7.24809.31.0	959388	AUTEX	7.04257.19.0
959116	AUTEX	7.24809.59.0	959390	AUTEX	7.04371.07.0
959117	AUTEX	7.24809.49.0	959401	AUTEX	7.28270.14.0
959119	AUTEX	7.24809.48.0	959427	AUTEX	7.09002.08.0
959121	AUTEX	7.24809.32.0	959429	AUTEX	7.09002.09.0
959122	AUTEX	7.24809.54.0	959441	AUTEX	7.09002.11.0
959123	AUTEX	7.24809.61.0	959442	AUTEX	7.09002.12.0
959124	AUTEX	7.24809.56.0	959508	AUTEX	7.00632.13.0



REF-No.		 PIERBURG	REF-No.		 PIERBURG
959533	AUTEX	7.22996.12.0	96375	NGK	7.05271.74.0
959534	AUTEX	7.24809.74.0	9637517280	FIAT	7.28069.03.0
959535	AUTEX	7.24809.80.0	9637517280	LANCIA	7.28069.03.0
959537	AUTEX	7.24809.83.0	9638035080	CITROEN	7.22888.02.0
959555	AUTEX	7.01881.06.0	9638231480	PSA	7.28069.03.0
959556	AUTEX	7.01881.07.0	9638246980	CITROEN	7.22888.02.0
959557	AUTEX	7.05320.04.0	9638374480	PSA	7.28069.04.0
959558	AUTEX	7.24809.82.0	96386735	CHEVROLET	7.09002.04.0
959587	AUTEX	7.00678.06.0	9639	MEAT&DORIA	7.03446.01.0
959600	AUTEX	7.11237.08.0	96394003	GENERAL MOTORS	7.05271.52.0
95FB9F472BA	FORD	7.02604.61.0	96394004	GENERAL MOTORS	7.05271.52.0
95FB9F472CB	FORD	7.02604.62.0	96396530	GENERAL MOTORS	7.05271.52.0
95VW9F472CB	FORD	7.05270.96.0	9639853680	CITROEN	7.05270.54.0
95VW9F472FA	FORD	7.05270.88.0	9639853680	PEUGEOT	7.05270.54.0
9601	MEAT&DORIA	7.22934.57.0	9640185580	PSA	7.22843.07.0
9602	MEAT&DORIA	7.28124.19.0	9640341280	FIAT	7.11237.04.0
9604	MEAT&DORIA	7.01486.10.0	96408500	CHEVROLET	7.09002.10.0
9605	MEAT&DORIA	7.04389.00.0	9641	MEAT&DORIA	7.28415.09.0
96060174	GMC	7.02604.01.0	96415639	CHEVROLET	7.05271.73.0
9608	MEAT&DORIA	7.21851.31.0	96418965	CADILLAC	7.05271.73.0
9609	MEAT&DORIA	7.21852.24.0	96418965	CHEVROLET	7.05271.73.0
9611	MEAT&DORIA	7.28238.55.0	96418965	OPEL	7.05271.73.0
9612	MEAT&DORIA	7.22296.02.0	96419315	CHEVROLET	7.05271.73.0
9613	MEAT&DORIA	7.05574.00.0	96436268	GENERAL MOTORS	7.08369.54.0
9614	MEAT&DORIA	7.05574.01.0	96436269	GENERAL MOTORS	7.08369.70.0
9615	HOFFER	7.22778.97.0	9646	MEAT&DORIA	7.22778.96.0
9615	MEAT&DORIA	7.22778.97.0	96506	NGK	7.05270.71.0
9616	MEAT&DORIA	7.22769.77.0	96507986	CHEVROLET	7.05271.52.0
9617	MEAT&DORIA	7.22769.78.0	96507986	DAEWOO	7.05271.52.0
9622997780	ALFA ROMEO	7.05270.37.0	9651	MEAT&DORIA	7.22560.43.0
9622997780	FIAT	7.05270.37.0	9656612380	FIAT	7.24809.68.0
9622997780	LANCIA	7.05270.37.0	9656911780	FIAT	7.00578.12.0
96230003	CITROEN	7.05270.36.0	9656911780	PSA	7.00578.12.0
96230003	PEUGEOT	7.05270.36.0	9659694780	FIAT	7.24809.70.0
96230005	CITROEN	7.05270.36.0	9660276280	FIAT	7.24809.39.0
96230005	PEUGEOT	7.05270.36.0	9662143180	FIAT	7.11492.01.0
9625	MEAT&DORIA	7.21852.85.0	9662143180	LANCIA	7.11492.01.0
9626	MEAT&DORIA	7.21851.32.0	9663278880	CITROEN	7.02604.12.0
9628	MEAT&DORIA	7.22166.38.0	9663278880	PEUGEOT	7.02604.12.0
9628693880	FIAT	7.22843.06.0	9665414480	CITROEN	7.02604.41.0
9628693880	LANCIA	7.22843.06.0	9665414480	PSA	7.02604.41.0
9629	MEAT&DORIA	7.22934.63.0	9665752480	FIAT	7.24809.70.0
96291087	CHEVROLET	7.09002.01.0	9671146480	FIAT	7.02156.33.0
96291087	DAEWOO	7.09002.01.0	9671146480	FIAT	7.02156.34.0
96291087	GENERAL MOTORS	7.09002.01.0	9671187780	FIAT	7.02156.24.0
96291099	CHEVROLET	7.05271.73.0	9671187780	FIAT	7.02156.35.0
9630	MEAT&DORIA	7.21857.59.0	9671398180	FIAT	7.24809.94.0
963006	AUTEX	7.02156.24.0	9672234980	CITROEN	7.03647.10.0
963042	AUTEX	7.02107.09.0	9672234980	PEUGEOT	7.03647.10.0
9631	MEAT&DORIA	7.22738.20.0	9672880080	FIAT	7.24809.39.0
96324	NGK	7.05270.67.0	9673258680	CITROEN	7.24809.76.0
96325533	OPEL	7.05271.73.0	9673258680	PEUGEOT	7.24809.76.0
96335925	CHEVROLET	7.02604.15.0	9678257280	CITROEN	7.24809.94.0
96335930	CHEVROLET	7.09002.02.0	9678257280	DS	7.24809.94.0
96335930	GENERAL MOTORS	7.09002.02.0	9678257280	FIAT	7.24809.94.0
9633602180	PSA	7.22843.06.0	9678257280	PEUGEOT	7.24809.94.0
9635651080	FIAT	7.22843.06.0	9681825280	FIAT	7.24809.68.0
9635651080	LANCIA	7.22843.06.0	9681852780	CITROEN	7.02604.99.0
9635978280	FIAT	7.02604.13.0	9682216680	CITROEN	7.05270.21.0
9635978280	LANCIA	7.02604.13.0	9682216680	FIAT	7.05270.21.0
9635978980	FIAT	7.02604.13.0	9682216680	PEUGEOT	7.05270.21.0
9635978980	LANCIA	7.02604.13.0	96868946	OPEL	7.11020.49.0
9636148880	ALFA ROMEO	7.05270.37.0	96868946	VAUXHALL	7.11020.49.0
9636148880	FIAT	7.05270.37.0	9687161080	CITROEN	7.02604.99.0
9636148880	LANCIA	7.05270.37.0	96980318	CHEVROLET	7.04879.00.0
9636876580	FIAT	7.02604.11.0	96984104	CHEVROLET	7.04879.00.0
9636876580	LANCIA	7.02604.11.0	96BB9F472AA	FORD	7.02604.62.0
9636876680	FIAT	7.02604.13.0	96BB9F472BA	FORD	7.02604.61.0
9637	MEAT&DORIA	7.21852.79.0	96FB9F472CA	FORD	7.02604.61.0

REF-No.			REF-No.		
96FB9F472DA	FORD	7.02604.61.0	99061805001	VIKA	7.08369.43.0
96SKV201	ESEN SKV	7.21851.31.0	99611324901	PORSCHE	7.22938.06.0
96VB9F472DB	FORD	7.02604.63.0	99611324902	PORSCHE	7.22938.06.0
97018586	OPEL	7.02604.15.0	99711320370	PORSCHE	7.00018.52.0
97018586	VAUXHALL	7.02604.15.0	99711320371	PORSCHE	7.00018.52.0
97172293	OPEL	7.05271.52.0	99711320372	PORSCHE	7.00018.52.0
97172293	VAUXHALL	7.05271.52.0	99711324990	PORSCHE	7.22938.06.0
97184925	OPEL	7.22772.12.0	99760617600	PORSCHE	7.02604.07.0
97184925	VAUXHALL	7.22772.12.0	99760617601	PORSCHE	7.02604.07.0
97224011	OPEL	7.05271.52.0	9C1Q-9D475-AB	FORD	7.01621.08.0
97224011	VAUXHALL	7.05271.52.0	9C1Q-9D475-AB	FORD	7.24809.40.0
97318476	OPEL	7.22772.12.0	9M5Q-9D475-CA	FORD	7.24809.94.0
97318476	VAUXHALL	7.22772.12.0	9M5Q-9D475-DA	FORD	7.24809.94.0
97353973	OPEL	7.22772.11.0	9M5Q-9D475-DB	FORD	7.24809.94.0
97353973	VAUXHALL	7.22772.11.0	9M5Q-9D475-DC	FORD	7.24809.94.0
97376663	OPEL	7.10334.08.0	9S51-5E260-AA	FORD	7.11190.04.0
97669	NGK	7.05271.36.0	9S51-5E260-AB	FORD	7.11190.04.0
97739	NGK	7.05270.21.0	9X2Q-9U438-CA	LAND ROVER	7.01881.06.0
97VW9F472AA	FORD	7.05270.88.0	9X2Q-9U438-CA	LAND ROVER	7.01881.08.0
9800125180	CITROEN	7.02156.33.0	9X2Q-9U438-DA	LAND ROVER	7.01881.07.0
9800125180	FIAT	7.02156.33.0	9X2Q-9U438-DA	LAND ROVER	7.01881.09.0
9800125180	FIAT	7.02156.34.0	A0001403785	MERCEDES-BENZ	7.04389.00.0
9800125180	PEUGEOT	7.02156.33.0	A0001404285	MERCEDES-BENZ	7.04389.04.0
9800555380	CITROEN	7.03784.34.0	A0001404385	MERCEDES-BENZ	7.04389.05.0
9800555380	PEUGEOT	7.03784.34.0	A0001404685	MERCEDES-BENZ	7.04389.02.0
980121	GEBE	7.08369.04.0	A0001405185	MERCEDES-BENZ	7.04389.02.0
9802194080	CITROEN	7.02156.35.0	A0001405785	MERCEDES-BENZ	7.04389.06.0
9802194080	PEUGEOT	7.02156.35.0	A0001405985	MERCEDES-BENZ	7.04389.09.0
9802981580	CITROEN	7.02156.34.0	A0001406785	MERCEDES-BENZ	7.04389.07.0
9802981580	PEUGEOT	7.02156.34.0	A0001407085	MERCEDES-BENZ	7.04389.08.0
980361	GEBE	7.08369.45.0	A0001407185	MERCEDES-BENZ	7.04389.09.0
980481	GEBE	7.08369.08.0	A0005402417	MERCEDES-BENZ	7.05270.00.0
980501	GEBE	7.08369.23.0	A0005402617	MERCEDES-BENZ	7.05270.00.0
980531	GEBE	7.08369.15.0	A0005402717	MERCEDES-BENZ	7.05270.00.0
980571	GEBE	7.08369.05.0	A0005403917	MERCEDES-BENZ	7.02604.04.0
980581	GEBE	7.08369.09.0	A0005404017	MERCEDES-BENZ	7.02604.04.0
980621	GEBE	7.08369.22.0	A0005404217	MERCEDES-BENZ	7.02604.04.0
980661	GEBE	7.08369.41.0	A0005404317	MERCEDES-BENZ	7.02604.04.0
98091825	OPEL	7.22772.12.0	A0005404517	MERCEDES-BENZ	7.05270.00.0
98091825	VAUXHALL	7.22772.12.0	A0005405517	MERCEDES-BENZ	7.05270.00.0
9813063580	PSA	7.07794.22.0	A0005405617	MERCEDES-BENZ	7.05270.00.0
9813064280	PSA	7.07794.23.0	A0005405717	MERCEDES-BENZ	7.02604.04.0
98167	NISSENS	7.09002.05.0	A0005406117	MERCEDES-BENZ	7.05270.15.0
9829870080	PSA	7.07794.23.0	A0005406517	MERCEDES-BENZ	7.02604.04.0
9829870280	PSA	7.07794.22.0	A0005407417	MERCEDES-BENZ	7.05270.15.0
98308	NISSENS	7.09002.11.0	A0005407517	MERCEDES-BENZ	7.05270.03.0
98311	NISSENS	7.09002.08.0	A0005408117	MERCEDES-BENZ	7.05270.15.0
98760612302	PORSCHE	7.05271.68.0	A0005409717	MERCEDES-BENZ	7.05270.15.0
98760612400	PORSCHE	7.05271.68.0	A0009050232	MERCEDES-BENZ	7.11020.33.0
98760613202	PORSCHE	7.05271.68.0	A0009050701	MERCEDES-BENZ	7.11020.32.0
98831-6F720	NISSAN	7.02604.01.0	A0009050805	MERCEDES-BENZ	7.11020.33.0
9886714	BMW	7.10334.07.0	A0009051405	MERCEDES-BENZ	7.11020.40.0
98AB-9F472-BB	FORD	7.02604.60.0	A0009053300	MERCEDES-BENZ	7.11020.40.0
98AB9G444BB	FORD	7.02604.60.0	A0009053705	MERCEDES-BENZ	7.08369.30.0
98FB-9F472-BB	FORD	7.02604.64.0	A0009053905	MERCEDES-BENZ	7.11020.16.0
98FB-9F472-DA	FORD	7.02604.64.0	A0009054305	MERCEDES-BENZ	7.11020.28.0
98FB9F472BB	FORD	7.02604.64.0	A0009054308	MERCEDES-BENZ	7.08369.97.0
98FB9F472CA	FORD	7.02604.64.0	A0009054405	MERCEDES-BENZ	7.08369.80.0
98FB9F472DA	FORD	7.02604.64.0	A0009054805	MERCEDES-BENZ	7.08369.87.0
99061788501	VIKA	7.08369.45.0	A0009055105	MERCEDES-BENZ	7.08369.51.0
99061790601	VIKA	7.08369.22.0	A0009055202	MERCEDES-BENZ	7.08369.76.0
99061790701	VIKA	7.08369.23.0	A0009055205	MERCEDES-BENZ	7.08369.97.0
99061793501	VIKA	7.08369.03.0	A0009056404	MERCEDES-BENZ	7.08369.06.0
99061793601	VIKA	7.08369.04.0	A0009056504	MERCEDES-BENZ	7.08369.90.0
99061793701	VIKA	7.08369.08.0	A0009056704	MERCEDES-BENZ	7.11020.01.0
99061795101	VIKA	7.08369.33.0	A0009056804	MERCEDES-BENZ	7.08369.12.0
99061803901	VIKA	7.08369.39.0	A0009056904	MERCEDES-BENZ	7.11020.29.0
99061804201	VIKA	7.08369.41.0	A0009057004	MERCEDES-BENZ	7.08369.89.0
99061804801	VIKA	7.08369.11.0	A0009057104	MERCEDES-BENZ	7.11020.30.0



REF-No.		 PIERBURG	REF-No.		 PIERBURG
A0009057204	MERCEDES-BENZ	7.08369.61.0	A0051537728	SMART	7.11190.01.0
A0009057705	MERCEDES-BENZ	7.11020.32.0	A0051537928	MERCEDES-BENZ	7.08369.12.0
A0009058105	MERCEDES-BENZ	7.11020.32.0	A0051538028	MERCEDES-BENZ	7.08369.80.0
A0009058501	MERCEDES-BENZ	7.08369.89.0	A0051539328	MERCEDES-BENZ	7.08369.60.0
A0009058604	MERCEDES-BENZ	7.08369.77.0	A0055422417	MERCEDES-BENZ	7.02604.01.0
A0009058804	MERCEDES-BENZ	7.11020.35.0	A0055426217	MERCEDES-BENZ	7.02604.01.0
A0009058904	MERCEDES-BENZ	7.08369.76.0	A0055426317	MERCEDES-BENZ	7.02604.01.0
A0009059004	MERCEDES-BENZ	7.08369.88.0	A0055427317	MERCEDES-BENZ	7.02604.01.0
A0009059006	MERCEDES-BENZ	7.11020.01.0	A0055428517	MERCEDES-BENZ	7.02604.01.0
A0009059105	MERCEDES-BENZ	7.11020.32.0	A0061534928	MERCEDES-BENZ	7.11190.01.0
A0011406560	MERCEDES-BENZ	7.21949.51.0	A0061534928	SMART	7.11190.01.0
A0011409160	MERCEDES-BENZ	7.21949.51.0	A0061536228	SMART	7.08369.85.0
A0015400617	MERCEDES-BENZ	7.05270.12.0	A0061539528	MERCEDES-BENZ	7.11190.01.0
A0015400717	MERCEDES-BENZ	7.05270.11.0	A0061539528	SMART	7.11190.01.0
A0015400817	MERCEDES-BENZ	7.05270.03.0	A0065421917	MERCEDES-BENZ	7.02604.01.0
A0015401317	MERCEDES-BENZ	7.05270.00.0	A0065422117	MERCEDES-BENZ	7.02604.01.0
A0015402117	MERCEDES-BENZ	7.05270.03.0	A0065422217	MERCEDES-BENZ	7.02604.01.0
A0015402817	MERCEDES-BENZ	7.05270.15.0	A0065422317	MERCEDES-BENZ	7.02604.01.0
A0015404617	MERCEDES-BENZ	7.02604.26.0	A0071533428	MERCEDES-BENZ	7.11020.35.0
A0015404717	MERCEDES-BENZ	7.05270.11.0	A0071533528	MERCEDES-BENZ	7.08369.87.0
A0015405017	MERCEDES-BENZ	7.05270.12.0	A0071534728	MERCEDES-BENZ	7.08369.12.0
A0015405117	MERCEDES-BENZ	7.05270.12.0	A0071536128	MERCEDES-BENZ	7.11190.01.0
A0015407117	MERCEDES-BENZ	7.02604.25.0	A0071536228	MERCEDES-BENZ	7.08369.30.0
A0015407417	MERCEDES-BENZ	7.05270.11.0	A0071536328	MERCEDES-BENZ	7.08369.94.0
A0015407517	MERCEDES-BENZ	7.02604.27.0	A0071536528	MERCEDES-BENZ	7.08369.77.0
A0015407617	MERCEDES-BENZ	7.02604.26.0	A0071536628	MERCEDES-BENZ	7.11020.11.0
A0015408717	MERCEDES-BENZ	7.05270.11.0	A0071536628	SMART	7.11020.11.0
A0015408917	MERCEDES-BENZ	7.02604.27.0	A0071536728	MERCEDES-BENZ	7.11020.16.0
A0015409117	MERCEDES-BENZ	7.05270.11.0	A0071537528	MERCEDES-BENZ	7.08369.91.0
A0015409217	MERCEDES-BENZ	7.02604.27.0	A0071538428	MERCEDES-BENZ	7.11020.28.0
A0015409517	MERCEDES-BENZ	7.05270.12.0	A0071538528	MERCEDES-BENZ	7.08369.80.0
A0019050600	MERCEDES-BENZ	7.08369.61.0	A0071539228	MERCEDES-BENZ	7.08369.60.0
A0019050700	MERCEDES-BENZ	7.08369.90.0	A0071539328	SMART	7.08369.85.0
A0019050900	MERCEDES-BENZ	7.11020.12.0	A0071539428	MERCEDES-BENZ	7.11020.00.0
A0019052200	MERCEDES-BENZ	7.11020.29.0	A0071539528	MERCEDES-BENZ	7.11020.35.0
A0019052300	MERCEDES-BENZ	7.11020.30.0	A0071539628	MERCEDES-BENZ	7.08369.87.0
A0019052400	MERCEDES-BENZ	7.11020.05.0	A0081532228	MERCEDES-BENZ	7.08369.06.0
A0019052900	MERCEDES-BENZ	7.08369.88.0	A0081532728	MERCEDES-BENZ	7.08369.12.0
A0021400560	MERCEDES-BENZ	7.21949.51.0	A0081532828	MERCEDES-BENZ	7.08369.60.0
A0021401060	MERCEDES-BENZ	7.21949.51.0	A0081533428	MERCEDES-BENZ	7.08369.77.0
A0021404260	MERCEDES-BENZ	7.22090.11.0	A0081533628	MERCEDES-BENZ	7.08369.51.0
A0025400617	MERCEDES-BENZ	7.05270.11.0	A0081533728	MERCEDES-BENZ	7.11020.01.0
A0025400817	MERCEDES-BENZ	7.05270.11.0	A0081534128	MERCEDES-BENZ	7.08369.97.0
A0025401817	MERCEDES-BENZ	7.05271.23.0	A0085422918	MERCEDES-BENZ	7.02604.44.0
A0025405617	MERCEDES-BENZ	7.02604.26.0	A0085423018	MERCEDES-BENZ	7.02604.44.0
A0025421218	MERCEDES-BENZ	7.02604.01.0	A0085424418	MERCEDES-BENZ	7.02604.44.0
A0035420418	MERCEDES-BENZ	7.05270.81.0	A0095424317	MERCEDES-BENZ	7.02604.03.0
A0035426918	MERCEDES-BENZ	7.02604.99.0	A0095425618	MERCEDES-BENZ	7.05270.21.0
A0035426918	SMART	7.02604.99.0	A0095425918	MERCEDES-BENZ	7.02604.44.0
A0035427018	MERCEDES-BENZ	7.05270.21.0	A0095426018	MERCEDES-BENZ	7.02604.44.0
A0035427118	MERCEDES-BENZ	7.05270.22.0	A0095426318	MERCEDES-BENZ	7.02604.44.0
A0035427318	MERCEDES-BENZ	7.05271.23.0	A1121400060	MERCEDES-BENZ	7.22136.50.0
A0035428218	MERCEDES-BENZ	7.05270.17.0	A1121400460	MERCEDES-BENZ	7.22136.50.0
A0041539528	MERCEDES-BENZ	7.11190.01.0	A2701420119	MERCEDES-BENZ	7.24809.84.0
A0041539528	SMART	7.11190.01.0	A2741420419	MERCEDES-BENZ	7.24809.85.0
A0045420718	MERCEDES-BENZ	7.05270.17.0	A2741420519	MERCEDES-BENZ	7.24809.83.0
A0045420718	SMART	7.05270.17.0	A2741420619	MERCEDES-BENZ	7.24809.85.0
A0045420818	MERCEDES-BENZ	7.05270.18.0	A2C59507002Z	VDO	7.08369.04.0
A0045426918	MERCEDES-BENZ	7.02604.99.0	A2C59507003Z	VDO	7.08369.17.0
A0045427318	MERCEDES-BENZ	7.05270.21.0	A2C59507004Z	VDO	7.08369.03.0
A0051531028	MERCEDES-BENZ	7.08369.30.0	A2C59507005Z	VDO	7.08369.14.0
A0051531128	MERCEDES-BENZ	7.08369.94.0	A2C59507006Z	VDO	7.08369.13.0
A0051531928	MERCEDES-BENZ	7.11020.11.0	A2C59507007Z	VDO	7.08369.07.0
A0051531928	SMART	7.11020.11.0	A2C59507008Z	VDO	7.08369.83.0
A0051532028	MERCEDES-BENZ	7.08369.61.0	A2C59507009Z	VDO	7.08369.08.0
A0051534128	MERCEDES-BENZ	7.08369.91.0	A2C59507010Z	VDO	7.08369.05.0
A0051537428	MERCEDES-BENZ	7.11190.01.0	A2C59507498Z	VDO	7.08369.06.0
A0051537428	SMART	7.11190.01.0	A2C59507499Z	VDO	7.11020.35.0
A0051537728	MERCEDES-BENZ	7.11190.01.0	A2C59507500Z	VDO	7.08369.16.0



NUMBERFINDER

REF-No.			REF-No.		
A2C59507501Z	VDO	7.11020.00.0	A2C59513347Z	VDO	7.05271.21.0
A2C59507502Z	VDO	7.08369.46.0	A2C59513871Z	VDO	7.05271.53.0
A2C59507507Z	VDO	7.08369.74.0	A2C59513875Z	VDO	7.02604.73.0
A2C59507509Z	VDO	7.08369.75.0	A2C59513878Z	VDO	7.05270.67.0
A2C59507510Z	CONTINENTAL	7.11020.38.0	A2C59513883Z	VDO	7.05271.75.0
A2C59507510Z	VDO	7.11020.38.0	A2C59513888Z	VDO	7.05271.72.0
A2C59507762	VDO	7.10334.02.0	A2C59513890Z	VDO	7.05271.37.0
A2C59513167Z	VDO	7.02604.01.0	A2C59513891Z	VDO	7.05271.65.0
A2C59513167Z	VDO	7.02604.15.0	A2C59513892Z	VDO	7.02604.96.0
A2C59513168Z	VDO	7.02604.04.0	A2C59516597	VDO	7.10334.03.0
A2C59513168Z	VDO	7.02604.49.0	A3389460	VALEO	7.22843.06.0
A2C59513169Z	VDO	7.02604.53.0	A3865510	METZGER	7.22818.59.0
A2C59513171Z	VDO	7.02604.60.0	A4259010	METZGER	7.22818.58.0
A2C59513174Z	VDO	7.05270.27.0	A4704904500	MERCEDES-BENZ	7.11457.07.0
A2C59513174Z	VDO	7.05270.39.0	A6071400060	MERCEDES-BENZ	7.03435.05.0
A2C59513175Z	VDO	7.05271.03.0	A6071400260	MERCEDES-BENZ	7.05320.04.0
A2C59513176Z	VDO	7.05270.36.0	A6079050500	MERCEDES-BENZ	7.11190.08.0
A2C59513183Z	VDO	7.02604.03.0	A6110900254	MERCEDES-BENZ	7.24809.35.0
A2C59513185Z	VDO	7.05270.86.0	A6110900354	MERCEDES-BENZ	7.24809.34.0
A2C59513186Z	VDO	7.02604.10.0	A6110900954	MERCEDES-BENZ	7.24809.34.0
A2C59513188Z	VDO	7.02604.01.0	A6120980117	MERCEDES-BENZ	7.24809.54.0
A2C59513190Z	VDO	7.05270.88.0	A6120980217	MERCEDES-BENZ	7.24809.54.0
A2C59513192Z	VDO	7.05270.48.0	A6120980317	MERCEDES-BENZ	7.24809.54.0
A2C59513213Z	VDO	7.05271.03.0	A6120980417	MERCEDES-BENZ	7.24809.54.0
A2C59513215Z	VDO	7.02604.47.0	A6171400260	MERCEDES-BENZ	7.21949.51.0
A2C59513216Z	VDO	7.02604.61.0	A6261400060	MERCEDES-BENZ	7.24809.90.0
A2C59513217Z	VDO	7.02604.07.0	A6261400260	MERCEDES-BENZ	7.24809.90.0
A2C59513222Z	VDO	7.05270.51.0	A6261400700	MERCEDES-BENZ	7.24809.90.0
A2C59513223Z	VDO	7.05270.26.0	A6269052200	MERCEDES-BENZ	7.11492.07.0
A2C59513228Z	VDO	7.05271.04.0	A6391400160	MERCEDES-BENZ	7.00306.36.0
A2C59513229Z	VDO	7.02604.31.0	A6391400560	MERCEDES-BENZ	7.00306.36.0
A2C59513230Z	VDO	7.02604.62.0	A6401400760	MERCEDES-BENZ	7.24809.33.0
A2C59513231Z	VDO	7.02604.64.0	A6401401460	MERCEDES-BENZ	7.24809.33.0
A2C59513232Z	VDO	7.02604.63.0	A6401401860	MERCEDES-BENZ	7.24809.33.0
A2C59513233Z	VDO	7.02604.21.0	A6401401960	MERCEDES-BENZ	7.24809.46.0
A2C59513234Z	VDO	7.05271.14.0	A6401402060	MERCEDES-BENZ	7.00306.37.0
A2C59513235Z	VDO	7.05271.01.0	A6421400160	MERCEDES-BENZ	7.24809.47.0
A2C59513238Z	VDO	7.05270.25.0	A6421400360	MERCEDES-BENZ	7.24809.47.0
A2C59513241Z	VDO	7.05270.88.0	A6421400860	MERCEDES-BENZ	7.24809.47.0
A2C59513289Z	VDO	7.05270.45.0	A6421401760	MERCEDES-BENZ	7.24809.60.0
A2C59513290Z	VDO	7.02604.03.0	A6429050100	MERCEDES-BENZ	7.11190.01.0
A2C59513291Z	VDO	7.05270.47.0	A6461400460	MERCEDES-BENZ	7.24809.36.0
A2C59513297Z	VDO	7.02604.03.0	A6461400760	MERCEDES-BENZ	7.24809.36.0
A2C59513299Z	VDO	7.05270.49.0	A6461400860	MERCEDES-BENZ	7.24809.37.0
A2C59513304Z	VDO	7.02604.04.0	A6461400960	MERCEDES-BENZ	7.24809.59.0
A2C59513313Z	VDO	7.05270.96.0	A6461401760	MERCEDES-BENZ	7.24809.48.0
A2C59513314Z	VDO	7.05271.00.0	A6461401960	MERCEDES-BENZ	7.24809.59.0
A2C59513314Z	VDO	7.05271.21.0	A6461402360	MERCEDES-BENZ	7.24809.48.0
A2C59513316Z	VDO	7.05270.89.0	A6461402460	MERCEDES-BENZ	7.24809.59.0
A2C59513316Z	VDO	7.05270.99.0	A6461402760	MERCEDES-BENZ	7.24809.59.0
A2C59513317Z	VDO	7.05270.11.0	A6461420019	MERCEDES-BENZ	7.24809.65.0
A2C59513319Z	VDO	7.05270.91.0	A6461420119	MERCEDES-BENZ	7.24809.65.0
A2C59513319Z	VDO	7.05271.02.0	A6471420019	MERCEDES-BENZ	7.24809.65.0
A2C59513320Z	VDO	7.02604.49.0	A6471420219	MERCEDES-BENZ	7.24809.65.0
A2C59513321Z	VDO	7.05270.38.0	A6511400560	MERCEDES-BENZ	7.24809.82.0
A2C59513322Z	VDO	7.02604.51.0	A6511401160	MERCEDES-BENZ	7.24809.82.0
A2C59513323Z	VDO	7.05271.05.0	A6601400360	MERCEDES-BENZ	7.00306.36.0
A2C59513325Z	VDO	7.05271.04.0	A6680900154	MERCEDES-BENZ	7.24809.49.0
A2C59513326Z	VDO	7.05270.54.0	A6680900454	MERCEDES-BENZ	7.24809.49.0
A2C59513327Z	VDO	7.05271.55.0	A6711590058	MERCEDES-BENZ	7.11190.08.0
A2C59513329Z	VDO	7.05271.07.0	A9041400060	MERCEDES-BENZ	7.01268.03.0
A2C59513330Z	VDO	7.02604.30.0	A9061420619	EVOBUS	7.24809.66.0
A2C59513333Z	VDO	7.05270.18.0	A9061420619	MERCEDES-BENZ	7.24809.66.0
A2C59513338Z	VDO	7.05271.16.0	AC59513335Z	VDO	7.02604.55.0
A2C59513340Z	VDO	7.05270.32.0	AC59513337Z	VDO	7.02604.56.0
A2C59513341Z	VDO	7.02604.04.0	AAGR-1084	AVESA	7.24809.87.0
A2C59513342Z	VDO	7.05270.33.0	AGU1870	JAGUAR	7.02604.03.0
A2C59513343Z	VDO	7.02604.37.0	AJ811155	JAGUAR	7.00578.12.0
A2C59513345Z	VDO	7.02604.04.0	AL3Q-9U483-EC	FORD	7.02751.02.0



REF-No.		 PIERBURG	REF-No.		 PIERBURG
AL3Q-9U483-ED	FORD	7.02751.02.0	AV6083	AUTLOG	7.00450.09.0
AM15-18-861	MAZDA	7.02604.01.0	AV6085	AUTLOG	7.09002.05.0
AM30-18-861	MAZDA	7.02604.01.0	AV6087	AUTLOG	7.22843.06.0
AS3011	AUTLOG	7.08369.00.0	AV6089	AUTLOG	7.03784.34.0
AS3016	AUTLOG	7.08369.05.0	AV6111	AUTLOG	7.09002.08.0
AS3017	AUTLOG	7.08369.17.0	AV6Q-9D475-AC	FORD	7.02156.35.0
AS3018	AUTLOG	7.08369.30.0	AV6Q-9E456-AA	FORD	7.02209.11.0
AS3021	AUTLOG	7.08369.08.0	AV6Q-9E456-BA	FORD	7.02209.11.0
AS3023	AUTLOG	7.08369.14.0	AV6Q-9U433-AA	FORD	7.02156.33.0
AS3041	AUTLOG	7.08369.39.0	AV6Q-9U433-AB	FORD	7.02156.34.0
AS3042	AUTLOG	7.08369.31.0	AV6Q9D475AB	FORD	7.02156.24.0
AS3043	AUTLOG	7.08369.37.0	AW327504	MITSUBISHI	7.02604.01.0
AS3044	AUTLOG	7.08369.09.0	B2690-30R00	NISSAN	7.02604.01.0
AS3047	AUTLOG	7.08369.60.0	B3C7-18-861A	MAZDA	7.02604.01.0
AS3048	AUTLOG	7.08369.34.0	B61R-18-861A	MAZDA	7.02604.01.0
AS3050	AUTLOG	7.08369.53.0	B61Z-18-861A	MAZDA	7.02604.01.0
AS3051	AUTLOG	7.08369.02.0	B64N-18-861	MAZDA	7.02604.01.0
AS3052	AUTLOG	7.08369.01.0	B6DC-18-861	MAZDA	7.02604.03.0
AS3054	AUTLOG	7.08369.04.0	B6EX-18-861	MAZDA	7.05271.73.0
AS3055	AUTLOG	7.08369.48.0	BC3Q-9D475-BG	FORD	7.02738.13.0
AS3062	AUTLOG	7.08369.41.0	BC3Q-9D475-BH	FORD	7.02738.13.0
AS3064	AUTLOG	7.08369.47.0	BC3Q-9D475-CF	FORD	7.02187.12.0
AS3065	AUTLOG	7.08369.03.0	BC3Z-9D475-C	FORD	7.02738.13.0
AS3069	AUTLOG	7.08369.45.0	BC3Z-9D475-D	FORD	7.02187.12.0
AS3071	AUTLOG	7.08369.65.0	BG91-9D375-AA	FORD	7.02604.99.0
AS3072	AUTLOG	7.08369.73.0	BGR13003	BUGIAD	7.24809.16.0
AS3102	AUTLOG	7.08369.38.0	BGR13019	BUGIAD	7.24809.31.0
AS3103	AUTLOG	7.08369.32.0	BGR13034	BUGIAD	7.22818.58.0
AS3105	AUTLOG	7.08369.72.0	BGR13035	BUGIAD	7.22818.62.0
AS3127	AUTLOG	7.08369.43.0	BGR13043	BUGIAD	7.22818.59.0
AS3130	AUTLOG	7.08369.19.0	BGR13044	BUGIAD	7.09002.05.0
AS3138	AUTLOG	7.08369.50.0	BGR13053	BUGIAD	7.09002.05.0
AS3142	AUTLOG	7.08369.26.0	BGR13054	BUGIAD	7.00020.39.0
AS3143	AUTLOG	7.08369.51.0	BGR13055	BUGIAD	7.24809.70.0
AS3149	AUTLOG	7.08369.35.0	BGR13061	BUGIAD	7.24809.69.0
AS3160	AUTLOG	7.08369.15.0	BGR13071	BUGIAD	7.00368.15.0
AS3162	AUTLOG	7.08369.22.0	BGR13073	BUGIAD	7.00075.07.0
AS3163	AUTLOG	7.08369.33.0	BGR13081	BUGIAD	7.24809.49.0
AS3164	AUTLOG	7.08369.40.0	BGR13085	BUGIAD	7.00450.10.0
AS3172	AUTLOG	7.08369.56.0	BGR13086	BUGIAD	7.22888.02.0
AS3179	AUTLOG	7.08369.61.0	BGR13088	BUGIAD	7.02209.11.0
AS3180	AUTLOG	7.08369.36.0	BGR13091	BUGIAD	7.28264.06.0
AS3181	AUTLOG	7.08369.63.0	BGR13100	BUGIAD	7.24809.29.0
AS3182	AUTLOG	7.08369.66.0	BK2Q-9D475-CB	FORD	7.03784.34.0
AS3183	AUTLOG	7.08369.23.0	BK2Q-9D475-CC	FORD	7.03784.34.0
AS3184	AUTLOG	7.08369.49.0	BK2Q-9D475-CD	FORD	7.03784.34.0
AS3198	AUTLOG	7.08369.55.0	BK2Z-9D475-A	FORD	7.03784.34.0
AS3206	AUTLOG	7.08369.64.0	BP03-18-861B	MAZDA	7.02604.01.0
AS3214	AUTLOG	7.08369.54.0	BS51-9D475-BB	FORD	7.03622.06.0
AS3370	AUTLOG	7.08369.27.0	BS515E260AA	FORD	7.11190.03.0
AS51-9D475-AA	FORD	7.00020.39.0	BS515E260AB	FORD	7.11190.03.0
ASTE-0001	AVESA	7.08369.04.0	BSP24721	BUGIAD	7.09720.00.0
ASTE-0005	AVESA	7.08369.17.0	C201-18-861	MAZDA	7.02604.60.0
ASTE-0006	AVESA	7.08369.03.0	C2C39730	JAGUAR	7.11190.10.0
ASTE-0008	AVESA	7.08369.14.0	C2C40183	JAGUAR	7.11237.01.0
ASTE-0017	AVESA	7.08369.09.0	C2C40184	JAGUAR	7.24809.96.0
ASTE-0020	AVESA	7.08369.45.0	C2P16397	JAGUAR	7.05270.70.0
AV6003	AUTLOG	7.22818.58.0	C601-18-861	MAZDA	7.02604.60.0
AV6007	AUTLOG	7.22818.59.0	CBS7312	CSV ELECTRONIC PARTS	7.22738.08.0
AV6020	AUTLOG	7.22414.08.0	CBS7313	CSV ELECTRONIC PARTS	7.22934.57.0
AV6026	AUTLOG	7.24809.68.0	CBS7317	CSV ELECTRONIC PARTS	7.04389.00.0
AV6029	AUTLOG	7.00075.07.0	CBS7319	CSV ELECTRONIC PARTS	7.04389.02.0
AV6040	AUTLOG	7.00578.12.0	CBS7321	CSV ELECTRONIC PARTS	7.21852.24.0
AV6043	AUTLOG	7.09720.02.0	CBS7323	CSV ELECTRONIC PARTS	7.28238.55.0
AV6044	AUTLOG	7.09720.00.0	CBS7327	CSV ELECTRONIC PARTS	7.22778.97.0
AV6052	AUTLOG	7.22818.62.0	CBS7329	CSV ELECTRONIC PARTS	7.22769.78.0
AV6064	AUTLOG	7.00368.15.0	CBS7330	CSV ELECTRONIC PARTS	7.22769.73.0
AV6069	AUTLOG	7.09720.01.0	CBS7344	CSV ELECTRONIC PARTS	7.22166.02.0
AV6077	AUTLOG	7.03435.05.0	CBS7347	CSV ELECTRONIC PARTS	7.21852.85.0



NUMBERFINDER



REF-No.		REF-No.	
CBS7350	CSV ELECTRONIC PARTS 7.22166.38.0	DOX-0410	DENSO EUROPE B.V. 7.05270.82.0
CBS7357	CSV ELECTRONIC PARTS 7.21857.01.0	DOX-0411	DENSO EUROPE B.V. 7.05270.70.0
CBS7361	CSV ELECTRONIC PARTS 7.03446.01.0	DOX-0412	DENSO EUROPE B.V. 7.05270.83.0
CBS7363	CSV ELECTRONIC PARTS 7.28415.09.0	DOX-1068	DENSO EUROPE B.V. 7.05271.35.0
CBS7528	CSV ELECTRONIC PARTS 7.04389.07.0	DOX-1098	DENSO EUROPE B.V. 7.05270.15.0
CBS9601	CSV ELECTRONIC PARTS 7.22934.57.0	DOX-1100	DENSO EUROPE B.V. 7.05270.15.0
CBS9607	CSV ELECTRONIC PARTS 7.04389.02.0	DOX-1105	DENSO EUROPE B.V. 7.05270.03.0
CBS9609	CSV ELECTRONIC PARTS 7.21852.24.0	DOX-1171	DENSO EUROPE B.V. 7.05270.88.0
CCM8362	CSV ELECTRONIC PARTS 7.03571.16.0	DOX-1172	DENSO EUROPE B.V. 7.05270.86.0
CGR4795	CSV ELECTRONIC PARTS 7.09002.08.0	DOX-1173	DENSO EUROPE B.V. 7.05270.96.0
CGR4796	CSV ELECTRONIC PARTS 7.09002.09.0	DOX-1174	DENSO EUROPE B.V. 7.02604.31.0
CGR4896	CSV ELECTRONIC PARTS 7.09002.11.0	DOX-1350	DENSO EUROPE B.V. 7.05270.47.0
CGR4897	CSV ELECTRONIC PARTS 7.09002.12.0	DOX-1353	DENSO EUROPE B.V. 7.02604.62.0
CGR4932	CSV ELECTRONIC PARTS 7.24809.47.0	DOX-1360	DENSO EUROPE B.V. 7.05270.36.0
CGR4932R	CSV ELECTRONIC PARTS 7.24809.47.0	DOX-1361	DENSO EUROPE B.V. 7.02604.61.0
CGR4982	CSV ELECTRONIC PARTS 7.10334.08.0	DOX-1363	DENSO EUROPE B.V. 7.05270.96.0
CGR5113	CSV ELECTRONIC PARTS 7.24809.87.0	DOX-1368	DENSO EUROPE B.V. 7.02604.37.0
CGR5149	CSV ELECTRONIC PARTS 7.24809.74.0	DOX-1371	DENSO EUROPE B.V. 7.02604.60.0
CGR5321	CSV ELECTRONIC PARTS 7.24809.86.0	DOX-1371	DENSO EUROPE B.V. 7.02604.64.0
CGR6471	CSV ELECTRONIC PARTS 7.05320.04.0	DOX-1372	DENSO EUROPE B.V. 7.02604.60.0
CSP3072	CSV ELECTRONIC PARTS 7.11492.05.0	DOX-1403	DENSO EUROPE B.V. 7.05271.32.0
CST1057	CSV ELECTRONIC PARTS 7.08369.36.0	DOX-1416	DENSO EUROPE B.V. 7.05270.66.0
CST1058	CSV ELECTRONIC PARTS 7.08369.33.0	DOX-1420	DENSO EUROPE B.V. 7.05270.66.0
CST1118	CSV ELECTRONIC PARTS 7.08369.31.0	DOX-1459	DENSO EUROPE B.V. 7.05271.58.0
CST1120	CSV ELECTRONIC PARTS 7.08369.39.0	DOX-1541	DENSO EUROPE B.V. 7.02604.47.0
CST1160	CSV ELECTRONIC PARTS 7.08369.47.0	DOX-1542	DENSO EUROPE B.V. 7.02604.51.0
CST2107	CSV ELECTRONIC PARTS 7.08369.34.0	DOX-1543	DENSO EUROPE B.V. 7.02604.49.0
CST2109	CSV ELECTRONIC PARTS 7.08369.37.0	DOX-1545	DENSO EUROPE B.V. 7.02604.49.0
CST2120	CSV ELECTRONIC PARTS 7.08369.48.0	DOX-1546	DENSO EUROPE B.V. 7.02604.49.0
CST2131	CSV ELECTRONIC PARTS 7.08369.05.0	DOX-1548	DENSO EUROPE B.V. 7.02604.51.0
CST2131C	CSV ELECTRONIC PARTS 7.08369.05.0	DOX-1569	DENSO EUROPE B.V. 7.05271.55.0
CST2132	CSV ELECTRONIC PARTS 7.08369.32.0	DOX-2000	DENSO EUROPE B.V. 7.05270.98.0
CST2132C	CSV ELECTRONIC PARTS 7.08369.32.0	DOX-2002	DENSO EUROPE B.V. 7.02604.10.0
CST2137	CSV ELECTRONIC PARTS 7.08369.38.0	DOX-2003	DENSO EUROPE B.V. 7.02604.07.0
CST2139	CSV ELECTRONIC PARTS 7.08369.17.0	DOX-2004	DENSO EUROPE B.V. 7.02604.64.0
CST2139C	CSV ELECTRONIC PARTS 7.08369.17.0	DOX-2006	DENSO EUROPE B.V. 7.02604.53.0
CST2174	CSV ELECTRONIC PARTS 7.08369.35.0	DOX-2007	DENSO EUROPE B.V. 7.05270.12.0
CST2252	CSV ELECTRONIC PARTS 7.08369.83.0	DOX-2009	DENSO EUROPE B.V. 7.05270.37.0
CST2277	CSV ELECTRONIC PARTS 7.08369.15.0	DOX-2010	DENSO EUROPE B.V. 7.05270.88.0
CST2278	CSV ELECTRONIC PARTS 7.08369.49.0	DOX-2011	DENSO EUROPE B.V. 7.05270.11.0
CST2375	CSV ELECTRONIC PARTS 7.08369.11.0	DOX-2012	DENSO EUROPE B.V. 7.05271.21.0
CV61-5L200-AA	FORD 7.11190.08.0	DOX-2013	DENSO EUROPE B.V. 7.02604.63.0
CV6Q-9D475-AA	FORD 7.03991.12.0	DOX-2014	DENSO EUROPE B.V. 7.05271.37.0
CX-2366	MOTORCRAFT (FORD) 7.01293.38.0	DOX-2016	DENSO EUROPE B.V. 7.05271.15.0
CY03-18-861B	MAZDA 7.02604.60.0	DOX-2017	DENSO EUROPE B.V. 7.05271.75.0
D9EE9F472AA	FORD 7.02604.01.0	DOX-2018	DENSO EUROPE B.V. 7.05271.01.0
D9EE9F472AB	FORD 7.02604.01.0	DOX-2020	DENSO EUROPE B.V. 7.02604.55.0
D9FZ9F472A	FORD 7.02604.01.0	DOX-2021	DENSO EUROPE B.V. 7.05270.67.0
DAC2549	JAGUAR 7.02604.01.0	DOX-2023	DENSO EUROPE B.V. 7.05271.00.0
DOX-0109	DENSO EUROPE B.V. 7.05271.36.0	DOX-2024	DENSO EUROPE B.V. 7.05270.18.0
DOX-0113	DENSO EUROPE B.V. 7.05271.63.0	DOX-2025	DENSO EUROPE B.V. 7.02604.56.0
DOX-0117	DENSO EUROPE B.V. 7.02604.21.0	DOX-2026	DENSO EUROPE B.V. 7.02604.26.0
DOX-0121	DENSO EUROPE B.V. 7.05271.72.0	DOX-2028	DENSO EUROPE B.V. 7.05271.39.0
DOX-0150	DENSO EUROPE B.V. 7.05271.13.0	DOX-2030	DENSO EUROPE B.V. 7.05271.21.0
DOX-0205	DENSO EUROPE B.V. 7.05271.56.0	DOX-2036	DENSO EUROPE B.V. 7.05271.11.0
DOX-0206	DENSO EUROPE B.V. 7.05271.53.0	DOX-2037	DENSO EUROPE B.V. 7.02604.25.0
DOX-0238	DENSO EUROPE B.V. 7.05271.65.0	DOX-2038	DENSO EUROPE B.V. 7.05271.14.0
DOX-0274	DELPHI 7.05271.38.0	DOX-2039	DENSO EUROPE B.V. 7.02604.27.0
DOX-0326	DENSO EUROPE B.V. 7.05271.66.0	DOX-2040	DELPHI 7.05271.68.0
DOX-0351	DENSO EUROPE B.V. 7.05271.54.0	DOX-2041	DENSO EUROPE B.V. 7.05271.12.0
DOX-0354	DENSO EUROPE B.V. 7.05271.59.0	DOX-2041	DENSO EUROPE B.V. 7.05271.15.0
DOX-0401	DENSO EUROPE B.V. 7.05270.69.0	DOX-2044	DENSO EUROPE B.V. 7.05270.17.0
DOX-0402	DENSO EUROPE B.V. 7.05270.70.0	DOX-2046	DENSO EUROPE B.V. 7.02604.34.0
DOX-0403	DENSO EUROPE B.V. 7.05270.69.0	DOX-2047	DENSO EUROPE B.V. 7.05270.89.0
DOX-0404	DENSO EUROPE B.V. 7.05270.70.0	DOX-2050	DENSO EUROPE B.V. 7.05271.81.0
DOX-0405	DENSO EUROPE B.V. 7.05270.82.0	DOX-2051	DENSO EUROPE B.V. 7.02604.56.0
DOX-0406	DENSO EUROPE B.V. 7.05270.69.0	DOX-2055	DENSO EUROPE B.V. 7.02604.65.0
DOX-0408	DENSO EUROPE B.V. 7.05270.69.0	DOX-2063	DENSO EUROPE B.V. 7.02604.05.0
DOX-0409	DENSO EUROPE B.V. 7.05270.69.0	DOX-2066	DENSO EUROPE B.V. 7.05271.51.0



REF-No.		 PIERBURG	REF-No.		 PIERBURG
DPS00001	DELPHI	7.11492.00.0	EG10291-12B1	DELPHI	7.22630.28.0
DPS00002	DELPHI	7.11190.00.0	EG10300-12B1	DELPHI	7.22875.13.0
DPS00003	DELPHI	7.11190.02.0	EG10302-12B1	DELPHI	7.22946.34.0
DPS00006	DELPHI	7.11492.01.0	EG10309-12B1	DELPHI	7.28248.17.0
DPS00007	DELPHI	7.11190.03.0	EG10310-12B1	DELPHI	7.28384.13.0
DPS00009	DELPHI	7.11190.04.0	EG10312-12B1	DELPHI	7.24809.17.0
DPS00010	DELPHI	7.11190.10.0	EG10323-12B1	DELPHI	7.22818.62.0
DZ107232	JOHN DEERE	7.05448.07.0	EG10339-12B1	DELPHI	7.28070.03.0
DZ107233	JOHN DEERE	7.08965.03.0	EG10348-12B1	DELPHI	7.21920.62.0
DZ107533	JOHN DEERE	7.05446.07.0	EG10360-12B1	DELPHI	7.22477.11.0
DZ107534	JOHN DEERE	7.05447.08.0	EG10371-12B1	DELPHI	7.22946.38.0
DZ108049	JOHN DEERE	7.07419.06.0	EG10372-12B1	DELPHI	7.22136.50.0
DZ111683	JOHN DEERE	7.07420.09.0	EG10395-12B1	DELPHI	7.24809.68.0
DZ112856	JOHN DEERE	7.08965.03.0	EG10399-12B1	DELPHI	7.24809.70.0
DZ115247	JOHN DEERE	7.07420.09.0	EG10401-12B1	DELPHI	7.24809.39.0
DZ115405	JOHN DEERE	7.08965.03.0	EG10402-12B1	DELPHI	7.22818.58.0
DZ117254	JOHN DEERE	7.10197.01.0	EG10405-12B1	DELPHI	7.22818.59.0
DZ119214	JOHN DEERE	7.05447.08.0	EG10406-12B1	DELPHI	7.24809.07.0
E1AF9F472AA	FORD	7.02604.01.0	EG10408-12B1	DELPHI	7.22785.17.0
E1AZ9F472A	FORD	7.02604.01.0	EG10409-12B1	DELPHI	7.24809.20.0
E3EF9F472AA	FORD	7.02604.01.0	EG10411-12B1	DELPHI	7.10334.04.0
E3FZ9F472A	FORD	7.02604.01.0	EG10414-12B1	DELPHI	7.00075.07.0
E3TZ9F472B	FORD	7.02604.01.0	EG10419-12B1	DELPHI	7.24809.19.0
E43Z9F472A	FORD	7.02604.01.0	EG10421-12B1	DELPHI	7.24809.16.0
E47F9F472AA	FORD	7.02604.01.0	EG10422-12B1	DELPHI	7.24809.29.0
E53Z9F472B	FORD	7.02604.01.0	EG10423-12B1	DELPHI	7.22843.06.0
E564-18-861	MAZDA	7.02604.01.0	EG10425-12B1	DELPHI	7.00368.15.0
E63F9F472AA	FORD	7.02604.01.0	EG10427-12B1	DELPHI	7.00907.03.0
E63F9F472AB	FORD	7.02604.01.0	EG10432-12B1	DELPHI	7.09720.02.0
E63F9F472BA	FORD	7.02604.01.0	EG10436-12B1	DELPHI	7.24809.69.0
E63Z9F472A	FORD	7.02604.01.0	EG10437-12B1	DELPHI	7.00578.12.0
E6DF9F472B1A	FORD	7.02604.01.0	EG10438-12B1	DELPHI	7.01621.08.0
E6DZ9F472A	FORD	7.02604.01.0	EG10442-12B1	DELPHI	7.09002.05.0
E6DZ9F472B	FORD	7.02604.01.0	EG10444-12B1	DELPHI	7.24809.28.0
E6SZ9F472A	FORD	7.02604.01.0	EG10452-12B1	DELPHI	7.02156.24.0
E6ZF9F472AB	FORD	7.02604.01.0	EG10452-12B1	DELPHI	7.02209.11.0
E6ZF9F472BA	FORD	7.02604.01.0	EG10458-12B1	DELPHI	7.22477.10.0
E6ZZ9F472A	FORD	7.02604.01.0	EG10465-12B1	DELPHI	7.28264.07.0
E6ZZ9F472B	FORD	7.02604.01.0	EG10466-12B1	DELPHI	7.00512.03.0
E8BZ9F472A	FORD	7.02604.01.0	EG10469-12B1	DELPHI	7.24809.30.0
E8GY9F472A	FORD	7.02604.01.0	EG10475-12B1	DELPHI	7.09002.08.0
E9BZ9F472A	FORD	7.02604.01.0	EG10476-12B1	DELPHI	7.09002.00.0
EE6006	ELTA	7.24809.68.0	EG10477-12B1	DELPHI	7.00020.39.0
EE6013	ELTA	7.03784.34.0	EGR-0102	JAPANPARTS	7.00450.09.0
EE6016	ELTA	7.22818.58.0	EGR-0208	JAPANPARTS	7.09002.00.0
EE6020	ELTA	7.22843.06.0	EGR-0302	JAPANPARTS	7.24809.68.0
EE6038	ELTA	7.22818.59.0	EGR-0313	JAPANPARTS	7.24809.69.0
EE6042	ELTA	7.00578.12.0	EGR-0400	JAPANPARTS	7.22414.08.0
EE6044	ELTA	7.00368.15.0	EGR-0700	JAPANPARTS	7.00075.07.0
EE6056	ELTA	7.24809.36.0	EGR-0701	JAPANPARTS	7.03435.05.0
EE6060	ELTA	7.22414.08.0	EGR-0916	JAPANPARTS	7.22477.10.0
EE6078	ELTA	7.22818.62.0	EGR-0932	JAPANPARTS	7.24809.57.0
EE6104	ELTA	7.24809.47.0	EGR-100	JAPANPARTS	7.22818.58.0
EE6119	ELTA	7.00075.07.0	EGR-101	JAPANPARTS	7.22818.62.0
EE6127	ELTA	7.00450.09.0	EGR-103	JAPANPARTS	7.00368.15.0
EE6159	ELTA	7.22738.08.0	EGR-112	JAPANPARTS	7.22818.59.0
EE6238	ELTA	7.03435.05.0	EGR-800	JAPANPARTS	7.22946.38.0
EE6245	ELTA	7.24809.86.0	EGR-803	JAPANPARTS	7.22843.06.0
EE6503	ELTA	7.02156.24.0	EGR-H00	JAPANPARTS	7.09002.05.0
EE6937	ELTA	7.05052.03.0	EGR-H07	JAPANPARTS	7.09002.11.0
EG10003-12B1	DELPHI	7.24809.10.0	EGR-H08	JAPANPARTS	7.09002.12.0
EG10186-12B1	DELPHI	7.21949.51.0	EGR-K00	JAPANPARTS	7.11237.08.0
EG10257-12B1	DELPHI	7.00020.24.0	EGR-L06	JAPANPARTS	7.00578.12.0
EG10258-12B1	DELPHI	7.00020.25.0	EGR002	STANDARD	7.24809.10.0
EG10259-12B1	DELPHI	7.00063.10.0	EGR003	STANDARD	7.22946.34.0
EG10260-12B1	DELPHI	7.00365.06.0	EGR003N	DIPA SPORT	7.00063.10.0
EG10287-12B1	DELPHI	7.22414.04.0	EGR005AN	DIPA SPORT	7.22818.59.0
EG10288-12B1	DELPHI	7.22414.08.0	EGR005N	DIPA SPORT	7.22818.59.0
EG10289-12B1	DELPHI	7.22875.16.0	EGR005R	DIPA SPORT	7.22818.59.0



NUMBERFINDER



REF-No.			REF-No.		
EGR008	STANDARD	7.22414.04.0	EGR141R	DIPA SPORT	7.03435.05.0
EGR009	STANDARD	7.22414.08.0	EGR153	STANDARD	7.22414.07.0
EGR011AN	DIPA SPORT	7.24809.68.0	EGR154	STANDARD	7.22477.10.0
EGR011N	DIPA SPORT	7.24809.68.0	EGR155	STANDARD	7.22477.11.0
EGR011R	DIPA SPORT	7.24809.68.0	EGR157	STANDARD	7.22772.12.0
EGR016	STANDARD	7.21920.62.0	EGR159	STANDARD	7.22843.06.0
EGR018N	DIPA SPORT	7.24809.96.0	EGR162N	DIPA SPORT	7.24809.93.0
EGR025N	DIPA SPORT	7.10334.10.0	EGR164	STANDARD	7.22946.33.0
EGR029N	DIPA SPORT	7.11237.01.0	EGR164	STANDARD	7.22946.34.0
EGR030R	DIPA SPORT	7.24809.68.0	EGR164N	DIPA SPORT	7.11237.02.0
EGR031N	DIPA SPORT	7.24809.91.0	EGR166	STANDARD	7.28070.03.0
EGR032N	DIPA SPORT	7.24809.36.0	EGR166N	DIPA SPORT	7.24809.99.0
EGR032R	DIPA SPORT	7.24809.36.0	EGR169AN	DIPA SPORT	7.03784.34.0
EGR036N	DIPA SPORT	7.24809.57.0	EGR169N	DIPA SPORT	7.03784.34.0
EGR050AN	DIPA SPORT	7.00075.07.0	EGR169R	DIPA SPORT	7.03784.34.0
EGR050N	DIPA SPORT	7.00075.07.0	EGR176AN	DIPA SPORT	7.00578.12.0
EGR050R	DIPA SPORT	7.00075.07.0	EGR176N	DIPA SPORT	7.00578.12.0
EGR051N	DIPA SPORT	7.10334.08.0	EGR179	STANDARD	7.24809.77.0
EGR057	STANDARD	7.22136.50.0	EGR180	STANDARD	7.24809.78.0
EGR069	STANDARD	7.22818.57.0	EGR183	STANDARD	7.22818.63.0
EGR070	STANDARD	7.22875.13.0	EGR184	STANDARD	7.24809.51.0
EGR075	STANDARD	7.22785.16.0	EGR184N	DIPA SPORT	7.11237.00.0
EGR076N	DIPA SPORT	7.00368.15.0	EGR185	STANDARD	7.24809.68.0
EGR076R	DIPA SPORT	7.00368.15.0	EGR187	STANDARD	7.24809.56.0
EGR077	STANDARD	7.22785.17.0	EGR188	STANDARD	7.00823.06.0
EGR078	STANDARD	7.00020.25.0	EGR189	STANDARD	7.24809.38.0
EGR078N	DIPA SPORT	7.10334.09.0	EGR189AN	DIPA SPORT	7.00450.09.0
EGR079	STANDARD	7.00020.24.0	EGR189N	DIPA SPORT	7.00450.09.0
EGR082	STANDARD	7.24809.24.0	EGR189R	DIPA SPORT	7.00450.09.0
EGR082	STANDARD	7.24809.27.0	EGR190	STANDARD	7.24809.32.0
EGR083	STANDARD	7.24809.25.0	EGR191	STANDARD	7.24809.30.0
EGR083	STANDARD	7.24809.28.0	EGR192	STANDARD	7.24809.70.0
EGR083N	DIPA SPORT	7.24809.47.0	EGR194	STANDARD	7.00020.40.0
EGR083R	DIPA SPORT	7.24809.47.0	EGR198	STANDARD	7.24809.34.0
EGR084	STANDARD	7.24809.49.0	EGR199	DIPA SPORT	7.09730.00.0
EGR084N	DIPA SPORT	7.11237.08.0	EGR199	STANDARD	7.24809.63.0
EGR085	STANDARD	7.24809.19.0	EGR200	STANDARD	7.24809.31.0
EGR086	STANDARD	7.24809.17.0	EGR201	STANDARD	7.24809.57.0
EGR087	STANDARD	7.24809.26.0	EGR204	DIPA SPORT	7.09730.01.0
EGR088	STANDARD	7.24809.20.0	EGR204	STANDARD	7.22843.07.0
EGR089	DIPA SPORT	7.09720.00.0	EGR208	STANDARD	7.00368.15.0
EGR089	STANDARD	7.24809.29.0	EGR213N	DIPA SPORT	7.02156.24.0
EGR090	STANDARD	7.24809.16.0	EGR213R	DIPA SPORT	7.02156.24.0
EGR091	STANDARD	7.22818.58.0	EGR220	STANDARD	7.28069.04.0
EGR091	STANDARD	7.22818.59.0	EGR221	STANDARD	7.00075.07.0
EGR093	STANDARD	7.22818.58.0	EGR221N	DIPA SPORT	7.24809.87.0
EGR094	STANDARD	7.22818.62.0	EGR225	STANDARD	7.24809.55.0
EGR095	STANDARD	7.24809.73.0	EGR229	STANDARD	7.24809.61.0
EGR097	STANDARD	7.00063.10.0	EGR230	STANDARD	7.24809.64.0
EGR098	STANDARD	7.22946.38.0	EGR231	STANDARD	7.24809.36.0
EGR100CR	DIPA SPORT	7.01106.38.0	EGR232	STANDARD	7.24809.37.0
EGR100NCN	DIPA SPORT	7.01106.38.0	EGR238N	DIPA SPORT	7.03051.04.0
EGR100SR	DIPA SPORT	7.01106.38.0	EGR238R	DIPA SPORT	7.03051.04.0
EGR102	STANDARD	7.24809.07.0	EGR257	STANDARD	7.24809.35.0
EGR103	STANDARD	7.22875.16.0	EGR258	STANDARD	7.28264.06.0
EGR104	DIPA SPORT	7.09720.01.0	EGR264	STANDARD	7.00907.03.0
EGR105	STANDARD	7.24809.06.0	EGR265	STANDARD	7.24809.59.0
EGR106	STANDARD	7.24809.33.0	EGR266	STANDARD	7.24809.54.0
EGR108	STANDARD	7.24809.39.0	EGR267	STANDARD	7.24809.48.0
EGR109	STANDARD	7.28248.17.0	EGR268	STANDARD	7.28069.03.0
EGR109N	DIPA SPORT	7.24809.86.0	EGR268NCN	DIPA SPORT	7.11010.00.0
EGR121	STANDARD	7.24809.76.0	EGR276N	DIPA SPORT	7.05052.03.0
EGR122	STANDARD	7.28384.13.0	EGR278	STANDARD	7.00578.12.0
EGR124	STANDARD	7.22785.18.0	EGR279	STANDARD	7.24809.52.0
EGR125	STANDARD	7.22574.12.0	EGR280	STANDARD	7.22772.11.0
EGR132	DIPA SPORT	7.09720.02.0	EGR281	STANDARD	7.22888.02.0
EGR135	STANDARD	7.00365.06.0	EGR294	STANDARD	7.00512.03.0
EGR137R	DIPA SPORT	7.11237.05.0	EGR295	STANDARD	7.28264.07.0
EGR141N	DIPA SPORT	7.03435.05.0	EGR295N	DIPA SPORT	7.02156.24.0



REF-No.		 PIERBURG	REF-No.		 PIERBURG
EGR295R	DIPA SPORT	7.02156.24.0	ERV058	STANDARD	7.24809.57.0
EGR296	STANDARD	7.00450.09.0	ERV059	STANDARD	7.24809.63.0
EGR297	STANDARD	7.24809.69.0	ERV060	STANDARD	7.24809.33.0
EGR298	STANDARD	7.24809.65.0	ERV061	STANDARD	7.24809.38.0
EGR302	STANDARD	7.03784.34.0	ERV062	STANDARD	7.24809.56.0
EGR303N	DIPA SPORT	7.03051.04.0	ERV063	STANDARD	7.22888.02.0
EGR311	STANDARD	7.24809.46.0	ERV064	STANDARD	7.00907.03.0
EGR319AN	DIPA SPORT	7.22843.06.0	ERV065	STANDARD	7.00075.07.0
EGR319N	DIPA SPORT	7.22843.06.0	ERV066	STANDARD	7.22843.07.0
EGR325	STANDARD	7.24809.72.0	ERV070	STANDARD	7.22843.06.0
EGR326	STANDARD	7.24809.71.0	ERV071	STANDARD	7.22785.17.0
EGR327	STANDARD	7.24809.50.0	ERV073	STANDARD	7.24809.51.0
EGR328	STANDARD	7.02156.24.0	ERV074	STANDARD	7.24809.32.0
EGR330	STANDARD	7.00306.36.0	ERV075	STANDARD	7.28069.04.0
EGR331	STANDARD	7.00450.10.0	ERV076	STANDARD	7.24809.55.0
EGR332	STANDARD	7.00684.14.0	ERV077	STANDARD	7.24809.37.0
EGR333	STANDARD	7.00555.06.0	ERV078	STANDARD	7.24809.36.0
EGR334	STANDARD	7.00789.10.0	ERV079	STANDARD	7.28069.03.0
EGR335	STANDARD	7.02132.07.0	ERV082	STANDARD	7.00020.25.0
EGR338	STANDARD	7.01621.08.0	ERV083	STANDARD	7.22818.58.0
EGR338	STANDARD	7.24809.40.0	ERV083	STANDARD	7.22818.59.0
EGR340	STANDARD	7.00020.50.0	ERV084	STANDARD	7.22818.58.0
EGR344	STANDARD	7.01599.10.0	ERV085	STANDARD	7.00063.10.0
EGR345	STANDARD	7.01604.02.0	ERV086	STANDARD	7.22946.38.0
EGR346	STANDARD	7.02209.11.0	ERV087	STANDARD	7.28384.13.0
EGR348	STANDARD	7.00368.16.0	ERV088	STANDARD	7.22818.63.0
EGR350	STANDARD	7.01782.07.0	ERV090	STANDARD	7.28248.17.0
EGR352	STANDARD	7.24809.53.0	ERV091	STANDARD	7.00368.15.0
EGR375	STANDARD	7.24809.47.0	ERV092	STANDARD	7.00020.24.0
EGR384N	DIPA SPORT	7.11237.04.0	ERV093	STANDARD	7.22136.50.0
EGR397	STANDARD	7.03051.04.0	ERV094	STANDARD	7.22574.12.0
EGR402	STANDARD	7.03784.34.0	ERV095	STANDARD	7.22785.16.0
EGR412	STANDARD	7.24809.81.0	ERV096	STANDARD	7.22785.18.0
EGR419N	DIPA SPORT	7.00992.36.0	ERV097	STANDARD	7.22818.62.0
EGR423	STANDARD	7.24809.79.0	ERV098	STANDARD	7.22946.33.0
EGT-VW-003	NRF	7.08369.43.0	ERV098	STANDARD	7.22946.34.0
EGT-VW-010	NRF	7.08369.08.0	ERV099	STANDARD	7.22946.34.0
EODE9F472AA	FORD	7.02604.01.0	ERV100	STANDARD	7.28070.03.0
EOFZ9F472B	FORD	7.02604.01.0	ERV102	STANDARD	7.24809.68.0
ERV001	STANDARD	7.24809.10.0	ERV103	STANDARD	7.24809.70.0
ERV002	STANDARD	7.24809.73.0	ERV105	STANDARD	7.24809.25.0
ERV003	STANDARD	7.24809.07.0	ERV105	STANDARD	7.24809.28.0
ERV007	STANDARD	7.22875.13.0	ERV109	STANDARD	7.24809.69.0
ERV008	STANDARD	7.22414.04.0	ERV110	STANDARD	7.03784.34.0
ERV009	STANDARD	7.22414.08.0	ERV118	STANDARD	7.00578.12.0
ERV012	STANDARD	7.24809.06.0	ERV123	STANDARD	7.22772.12.0
ERV016	STANDARD	7.22630.28.0	ERV135	STANDARD	7.24809.59.0
ERV021	STANDARD	7.21920.62.0	ERV138	STANDARD	7.24809.77.0
ERV024	STANDARD	7.24809.29.0	ERV139	STANDARD	7.00823.06.0
ERV025	STANDARD	7.24809.25.0	ERV145	STANDARD	7.01621.08.0
ERV026	STANDARD	7.24809.16.0	ERV145	STANDARD	7.24809.40.0
ERV027	STANDARD	7.24809.30.0	ERV147	STANDARD	7.00020.50.0
ERV028	STANDARD	7.24809.34.0	ERV151	STANDARD	7.01599.10.0
ERV029	STANDARD	7.24809.24.0	ERV152	STANDARD	7.01604.02.0
ERV029	STANDARD	7.24809.27.0	ERV153	STANDARD	7.02209.11.0
ERV030	STANDARD	7.24809.20.0	ERV155	STANDARD	7.00368.16.0
ERV031	STANDARD	7.24809.19.0	ERV157	STANDARD	7.01782.07.0
ERV033	STANDARD	7.24809.31.0	ERV159	STANDARD	7.24809.53.0
ERV034	STANDARD	7.24809.26.0	ERV190	STANDARD	7.28264.06.0
ERV035	STANDARD	7.24809.17.0	ERV192	STANDARD	7.28264.07.0
ERV046	STANDARD	7.24809.76.0	ERV193	STANDARD	7.00450.09.0
ERV047	STANDARD	7.24809.39.0	ERV198	STANDARD	7.24809.78.0
ERV049	STANDARD	7.22875.16.0	ERV199	STANDARD	7.00020.40.0
ERV050	STANDARD	7.00365.06.0	ERV205	STANDARD	7.24809.61.0
ERV051	STANDARD	7.22818.57.0	ERV206	STANDARD	7.24809.64.0
ERV052	STANDARD	7.22477.10.0	ERV210	STANDARD	7.24809.35.0
ERV053	STANDARD	7.22477.11.0	ERV211	STANDARD	7.24809.54.0
ERV056	STANDARD	7.24809.49.0	ERV212	STANDARD	7.24809.48.0
ERV057	STANDARD	7.24809.52.0	ERV216	STANDARD	7.22772.11.0



REF-No. 			REF-No. 		
ERV219	STANDARD	7.00512.03.0	ES11053-12B1	DELPHI	7.05270.34.0
ERV220	STANDARD	7.24809.65.0	ES11055-12B1	DELPHI	7.05270.33.0
ERV225	STANDARD	7.24809.46.0	ES11056-12B1	DELPHI	7.05270.32.0
ERV239	STANDARD	7.24809.72.0	ES11074	DELPHI	7.05271.67.0
ERV240	STANDARD	7.24809.71.0	ES20011-12B1	DELPHI	7.05271.81.0
ERV241	STANDARD	7.24809.50.0	ES20025	DELPHI	7.02604.61.0
ERV242	STANDARD	7.02156.24.0	ES20037	DELPHI	7.05271.73.0
ERV244	STANDARD	7.00306.36.0	ES20053	DELPHI	7.05271.58.0
ERV245	STANDARD	7.00450.10.0	ES20112	DELPHI	7.05271.35.0
ERV246	STANDARD	7.00684.14.0	ES20135	DELPHI	7.05271.52.0
ERV247	STANDARD	7.00555.06.0	ES20151	DELPHI	7.02604.60.0
ERV248	STANDARD	7.00789.10.0	ES20151	DELPHI	7.02604.64.0
ERV249	STANDARD	7.02132.07.0	ES20156	DELPHI	7.05271.53.0
ERV281	STANDARD	7.24809.47.0	ES20157	DELPHI	7.05271.65.0
ERV298	STANDARD	7.03051.04.0	ES20166	DELPHI	7.05271.21.0
ERV303	STANDARD	7.03784.34.0	ES20172	DELPHI	7.05271.37.0
ERV313	STANDARD	7.24809.81.0	ES20175	DELPHI	7.05270.12.0
ERV324	STANDARD	7.24809.79.0	ES20177	DELPHI	7.05271.14.0
ES-20265-12B1	DELPHI	7.02604.49.0	ES20177	DELPHI	7.05271.21.0
ES10023-12B1	DELPHI	7.02604.15.0	ES20178	DELPHI	7.05271.01.0
ES10061-12B1	DELPHI	7.05270.39.0	ES20178	DELPHI	7.05271.14.0
ES10062-12B1	DELPHI	7.05270.36.0	ES20209	DELPHI	7.05271.61.0
ES10079-12B1	DELPHI	7.05270.48.0	ES20213	DELPHI	7.05271.36.0
ES10082-12B1	DELPHI	7.05270.47.0	ES20220	DELPHI	7.05271.69.0
ES10082-12B1	DELPHI	7.05270.51.0	ES20222	DELPHI	7.05271.72.0
ES10333-12B1	DELPHI	7.05270.86.0	ES20224	DELPHI	7.05271.38.0
ES10537-12B1	DELPHI	7.05270.25.0	ES20230	DELPHI	7.05270.36.0
ES10581-12B1	DELPHI	7.05270.03.0	ES20236	DELPHI	7.02604.47.0
ES10760-12B1	DELPHI	7.02604.01.0	ES20238	DELPHI	7.02604.56.0
ES10762-12B1	DELPHI	7.02604.03.0	ES20241	DELPHI	7.05270.38.0
ES10763-12B1	DELPHI	7.02604.04.0	ES20242	DELPHI	7.05270.39.0
ES10763-12B1	DELPHI	7.05270.56.0	ES20245	DELPHI	7.05270.39.0
ES10791-12B1	DELPHI	7.02604.07.0	ES20246	DELPHI	7.05270.36.0
ES10792-12B1	DELPHI	7.02604.08.0	ES20252	DELPHI	7.02604.62.0
ES10793-12B1	DELPHI	7.02604.10.0	ES20253	DELPHI	7.02604.62.0
ES10794-12B1	DELPHI	7.02604.11.0	ES20255	DELPHI	7.05270.36.0
ES10795-12B1	DELPHI	7.02604.12.0	ES20258	DELPHI	7.05270.36.0
ES10796-12B1	DELPHI	7.02604.13.0	ES20264	DELPHI	7.02604.49.0
ES10797-12B1	DELPHI	7.05270.36.0	ES20266	DELPHI	7.05270.71.0
ES10857-12B1	DELPHI	7.02604.21.0	ES20267	DELPHI	7.02604.51.0
ES10880-11B1	DELPHI	7.05270.55.0	ES20270	DELPHI	7.05271.05.0
ES10899-12B1	DELPHI	7.02604.31.0	ES20272	DELPHI	7.05270.27.0
ES10921-11B1	DELPHI	7.05271.23.0	ES20272	DELPHI	7.05270.39.0
ES10921-12B1	DELPHI	7.05271.23.0	ES20276	DELPHI	7.02604.47.0
ES10923-12B1	DELPHI	7.05270.80.0	ES20277	DELPHI	7.02604.47.0
ES10924-12B1	DELPHI	7.05270.81.0	ES20278	DELPHI	7.05271.04.0
ES10957-12B1	DELPHI	7.05270.81.0	ES20280	DELPHI	7.05270.54.0
ES10969-12B1	DELPHI	7.05270.47.0	ES20281	DELPHI	7.05271.55.0
ES10969-12B1	DELPHI	7.05270.51.0	ES20283	DELPHI	7.05271.62.0
ES10971-12B1	DELPHI	7.05270.49.0	ES20285	DELPHI	7.05271.07.0
ES10976-12B1	DELPHI	7.05270.86.0	ES20286	DELPHI	7.05271.06.0
ES10977-12B1	DELPHI	7.05270.96.0	ES20289	DELPHI	7.05271.18.0
ES10978-12B1	DELPHI	7.05271.04.0	ES20289	DELPHI	7.05271.20.0
ES10981-12B1	DELPHI	7.05271.03.0	ES20292	DELPHI	7.05270.25.0
ES10983-12B1	DELPHI	7.02604.31.0	ES20301	DELPHI	7.02604.63.0
ES10989-12B1	DELPHI	7.05270.45.0	ES20302	DELPHI	7.02604.53.0
ES10990-12B1	DELPHI	7.05270.47.0	ES20303	DELPHI	7.05271.75.0
ES10990-12B1	DELPHI	7.05270.51.0	ES20307	DELPHI	7.05270.37.0
ES10992-12B1	DELPHI	7.05270.48.0	ES20308	DELPHI	7.05270.36.0
ES11014-12B1	DELPHI	7.05271.24.0	ES20309	DELPHI	7.05270.37.0
ES11026-12B1	DELPHI	7.05271.23.0	ES20309	DELPHI	7.05270.38.0
ES11035-12B1	DELPHI	7.05270.79.0	ES20310	DELPHI	7.02604.10.0
ES11038-12B1	DELPHI	7.05270.72.0	ES20311	DELPHI	7.02604.10.0
ES11044-12B1	DELPHI	7.05270.73.0	ES20312	DELPHI	7.05271.05.0
ES11047	DELPHI	7.05271.70.0	ES20313	DELPHI	7.05270.12.0
ES11049-12B1	DELPHI	7.05270.32.0	ES20314	DELPHI	7.02604.07.0
ES11050-12B1	DELPHI	7.05270.34.0	ES20315	DELPHI	7.05270.67.0
ES11051-12B1	DELPHI	7.02604.37.0	ES20334	DELPHI	7.02604.62.0
ES11052-12B1	DELPHI	7.05270.33.0	ES20338	DELPHI	7.05271.21.0

REF-No.		 PIERBURG	REF-No.		 PIERBURG
ES20340	DELPHI	7.05271.14.0	FDR153	LUCAS	7.28248.17.0
ES20341	DELPHI	7.05270.67.0	FDR154	LUCAS	7.24809.24.0
ES20344	DELPHI	7.02604.53.0	FDR154	LUCAS	7.24809.25.0
ES20345	DELPHI	7.02604.55.0	FDR154	LUCAS	7.24809.28.0
ES20348	DELPHI	7.05271.14.0	FDR155	LUCAS	7.24809.29.0
ES20349	DELPHI	7.02604.60.0	FDR156	LUCAS	7.22946.38.0
ES20356	DELPHI	7.05271.46.0	FDR157	LUCAS	7.22818.59.0
ES20365	DELPHI	7.05271.16.0	FDR159	LUCAS	7.00020.24.0
ES20367	DELPHI	7.05271.13.0	FDR160	LUCAS	7.24809.16.0
ES20374	DELPHI	7.05271.16.0	FDR161	LUCAS	7.24809.24.0
ES20378	DELPHI	7.05271.15.0	FDR161	LUCAS	7.24809.27.0
ES20410	DELPHI	7.05271.48.0	FDR162	LUCAS	7.24809.19.0
ES20413	DELPHI	7.05271.74.0	FDR163	LUCAS	7.24809.20.0
ES20445	DELPHI	7.05271.39.0	FDR167	LUCAS	7.22818.62.0
ESV032	STANDARD	7.22738.08.0	FDR169	LUCAS	7.22946.34.0
EV033	STANDARD	7.22738.08.0	FDR170	LUCAS	7.24809.17.0
EWP-AU-004	NRF	7.22560.40.0	FDR171	LUCAS	7.24809.06.0
EX5000	ELTA	7.08369.17.0	FDR172	LUCAS	7.28384.13.0
EX5001	ELTA	7.08369.03.0	FDR173	LUCAS	7.22296.02.0
EX5001	ELTA	7.08369.04.0	FDR174	LUCAS	7.24809.39.0
EX5008	ELTA	7.08369.02.0	FDR175	LUCAS	7.28248.17.0
EX5018	ELTA	7.08369.34.0	FDR177	LUCAS	7.24809.49.0
EX5035	ELTA	7.08369.08.0	FDR178	LUCAS	7.22875.16.0
EX5037	ELTA	7.08369.46.0	FDR183	LUCAS	7.24809.26.0
EX5039	ELTA	7.08369.05.0	FDR187	LUCAS	7.22574.12.0
EX5052	ELTA	7.08369.40.0	FDR193	LUCAS	7.22136.50.0
EX5086	ELTA	7.08369.41.0	FDR199	LUCAS	7.22477.11.0
F00E192294	BOSCH	7.05271.22.0	FDR200	LUCAS	7.22843.06.0
F00E261080	BOSCH	7.02604.73.0	FDR212	LUCAS	7.22946.33.0
F00E261264	BOSCH	7.02604.37.0	FDR212	LUCAS	7.22946.34.0
F00E263084	BOSCH	7.02604.05.0	FDR216	LUCAS	7.22772.12.0
F00HL00034	BOSCH	7.02604.61.0	FDR220	LUCAS	7.22477.10.0
F00HL00154	BOSCH	7.02604.79.0	FDR223	LUCAS	7.00020.25.0
F00HL00165	BOSCH	7.02604.77.0	FDR228	LUCAS	7.28070.03.0
F00HL00166	BOSCH	7.02604.77.0	FDR231	LUCAS	7.24809.68.0
F00HL00221	BOSCH	7.05270.55.0	FDR233	LUCAS	7.24809.70.0
F00HL00257	BOSCH	7.05271.72.0	FDR244	LUCAS	7.00368.15.0
F00HL00305	BOSCH	7.05270.03.0	FDR246	LUCAS	7.00075.07.0
F00HL00311	BOSCH	7.02604.15.0	FDR249	LUCAS	7.24809.38.0
F00HL00355	BOSCH	7.05271.62.0	FDR250	LUCAS	7.22818.63.0
F00HL00394	BOSCH	7.05271.55.0	FDR251	LUCAS	7.24809.30.0
F02Z9F472A	FORD	7.02604.01.0	FDR252	LUCAS	7.28069.04.0
F02Z9F472AA	FORD	7.02604.01.0	FDR253	LUCAS	7.24809.34.0
F02Z9F472B	FORD	7.02604.01.0	FDR254	LUCAS	7.22843.07.0
F1CZ9F472A	FORD	7.02604.01.0	FDR255	LUCAS	7.24809.31.0
F3Z2-9F47-2C	FORD	7.05271.73.0	FDR257	LUCAS	7.22785.18.0
F438200210030	FENDT	7.04448.18.0	FDR258	LUCAS	7.24809.33.0
F62Z-9F472-BB	FORD	7.05271.73.0	FDR284	LUCAS	7.22414.07.0
F62Z-9F472-CA	FORD	7.05271.73.0	FDR285	LUCAS	7.22738.08.0
F62Z-9F472-CZ	FORD	7.05271.73.0	FDR289	LUCAS	7.24809.57.0
F62Z-9F472-FF	FORD	7.05271.73.0	FDR293	LUCAS	7.00020.39.0
F743200090250	FENDT	7.05107.12.0	FDR294	LUCAS	7.00020.40.0
F85F-9G444-AB	FORD	7.02604.60.0	FDR295	LUCAS	7.24809.51.0
F954200090860	FENDT	7.04787.12.0	FDR296	LUCAS	7.24809.32.0
FB3Q-9D475-AA	FORD	7.03784.34.0	FDR298	LUCAS	7.24809.56.0
FB3Q-9D475-AB	FORD	7.03784.34.0	FDR314	LUCAS	7.24809.36.0
FB3Q-9D475-AC	FORD	7.03784.34.0	FDR322	LUCAS	7.24809.65.0
FDR107	LUCAS	7.21920.62.0	FDR324	LUCAS	7.00450.09.0
FDR113	LUCAS	7.22414.08.0	FDR325	LUCAS	7.00512.03.0
FDR119	LUCAS	7.22414.04.0	FDR326	LUCAS	7.00684.14.0
FDR127	LUCAS	7.24809.10.0	FDR327	LUCAS	7.28264.07.0
FDR133	LUCAS	7.22875.13.0	FDR350	LUCAS	7.24809.69.0
FDR140	LUCAS	7.22630.28.0	FDR350	LUCAS	7.24809.70.0
FDR142	LUCAS	7.22818.57.0	FDR352	LUCAS	7.24809.64.0
FDR143	LUCAS	7.00063.10.0	FDR354	LUCAS	7.03622.06.0
FDR146	LUCAS	7.22818.58.0	FDR355	LUCAS	7.24809.78.0
FDR148	LUCAS	7.24809.07.0	FDR359	LUCAS	7.09002.05.0
FDR150	LUCAS	7.22785.17.0	FDR363	LUCAS	7.24809.48.0
FDR151	LUCAS	7.22785.16.0	FDR364	LUCAS	7.24809.54.0



REF-No.		 PIERBURG	REF-No.		 PIERBURG
FDR365	LUCAS	7.24809.35.0	INJGS091N	DIPA SPORT	7.08369.23.0
FDR366	LUCAS	7.24809.52.0	JDE10760	JAGUAR	7.01881.06.0
FDR367	LUCAS	7.28069.03.0	JDE10760	JAGUAR	7.01881.08.0
FDR368	LUCAS	7.28264.06.0	JDE10761	JAGUAR	7.01881.07.0
FDR373	LUCAS	7.00823.06.0	JDE10761	JAGUAR	7.01881.09.0
FDR374	LUCAS	7.22888.02.0	JDE3314	JAGUAR	7.11237.01.0
FDR376	LUCAS	7.00907.03.0	JDE3315	JAGUAR	7.24809.96.0
FDR379	LUCAS	7.24809.37.0	JDE34437	JAGUAR	7.05590.04.0
FDR380	LUCAS	7.24809.55.0	JDE3905	JAGUAR	7.24809.07.0
FDR383	LUCAS	7.01621.08.0	JDE39090	JAGUAR	7.04924.14.0
FDR383	LUCAS	7.03784.34.0	JDE39242	JAGUAR	7.04923.18.0
FDR383	LUCAS	7.24809.40.0	JDE39607	JAGUAR	7.04923.17.0
FDR384	LUCAS	7.00578.12.0	JDE40036	JAGUAR	7.04924.15.0
FDR385	LUCAS	7.24809.59.0	JDE7436	JAGUAR	7.24809.07.0
FDR390	LUCAS	7.24809.61.0	JDE8783	JAGUAR	7.11237.01.0
FDR391	LUCAS	7.24809.63.0	JDE8785	JAGUAR	7.24809.96.0
FDR401	LUCAS	7.24809.50.0	JE48-18-861A	MAZDA	7.05271.73.0
FDR411	LUCAS	7.24809.71.0	JG9Q-9U438-AA	FORD	7.06036.14.0
FDR412	LUCAS	7.24809.46.0	JG9Q-9U438-AB	FORD	7.06036.14.0
FDR414	LUCAS	7.24809.72.0	JG9Q-9U438-AC	FORD	7.06036.14.0
FDR425	LUCAS	7.00555.07.0	JN1Q-9M425-AB	FORD	7.05742.11.0
FDR429	LUCAS	7.24809.47.0	JN1Q-9M425-AC	FORD	7.05742.11.0
FDR433	LUCAS	7.01599.10.0	JN1Q-9M425-AD	FORD	7.05742.11.0
FDR434	LUCAS	7.24809.60.0	JO854136	AMC USA	7.02604.01.0
FDR435	LUCAS	7.22996.11.0	JX6Q-9D475-AA	FORD	7.07794.22.0
FDR451	LUCAS	7.00555.06.0	JX6Q-9D475-AB	FORD	7.07794.22.0
FDR460	LUCAS	7.02156.24.0	JX6Q-9D475-AC	FORD	7.07794.22.0
FDR509	LUCAS	7.03435.05.0	K05066800AA	JEEP	7.28270.14.0
FDR559	LUCAS	7.02156.34.0	K05066800AB	JEEP	7.28270.14.0
FDR7008	LUCAS	7.22166.66.0	K05096234AA	JEEP	7.28270.14.0
FDR7025	LUCAS	7.22934.63.0	K05098830AA	CHRYSLER	7.04389.00.0
FE05-18-861	MAZDA	7.02604.01.0	K05166555AA	CHRYSLER	7.00632.13.0
FE86-18-861	MAZDA	7.02604.01.0	K05166555AB	CHRYSLER	7.00632.13.0
FE86-18-861A	MAZDA	7.02604.01.0	K05175678AA	CHRYSLER	7.24809.47.0
FE86-18-861B	MAZDA	7.02604.01.0	K05175678AA	JEEP	7.24809.47.0
FEH1-18-861	MAZDA	7.02604.01.0	K05281535ah	JEEP	7.07044.12.0
FM5Q-9E456-AA	FORD	7.02209.20.0	K68002448AA	CHRYSLER	7.28290.11.0
FM5Q-9U433-AA	FORD	7.04512.08.0	K68002448AB	CHRYSLER	7.28290.11.0
FOBZ9F472B	FORD	7.02604.01.0	K68029525AA	JEEP	7.01317.10.0
FOJY9F472B	FORD	7.02604.01.0	K68029525AB	JEEP	7.01317.10.0
FSC1-18-861	MAZDA	7.05271.73.0	K68064963AA	CHRYSLER	7.24809.47.0
FSC1-18-861A	MAZDA	7.05271.73.0	K68064963AA	JEEP	7.24809.47.0
FSC1-18-861B	MAZDA	7.05271.73.0	K68101347AA	CHRYSLER	7.24809.77.0
FW93-4U483-AB	LAND ROVER	7.05590.03.0	K6814287AA	JEEP	7.03295.03.0
FW93-9E456-AA	LAND ROVER	7.05264.03.0	K6814287AA	LANCIA	7.03295.03.0
FW93-9U438-AA	LAND ROVER	7.05590.04.0	K68150053AA	CHRYSLER	7.24809.80.0
FW93-9Y493-AD	LAND ROVER	7.05264.04.0	K68150053AA	JEEP	7.24809.80.0
G4D3-5H273-AC	LAND ROVER	7.04923.17.0	K68150053AA	LANCIA	7.24809.80.0
G4D3-5H273-BA	LAND ROVER	7.04923.18.0	K68220917AA	CHRYSLER	7.24809.77.0
G4D3-5H273-BB	LAND ROVER	7.04923.18.0	K68223706AA	CHRYSLER	7.28290.11.0
G4D3-5H273-CA	JAGUAR	7.04923.18.0	K68239573AA	CHRYSLER	7.24809.80.0
G4D3-5H273-CA	LAND ROVER	7.04923.18.0	K68239573AA	JEEP	7.24809.80.0
G4D3-9D475-AC	LAND ROVER	7.04924.15.0	K68239573AA	LANCIA	7.24809.80.0
G4D3-9D475-AD	LAND ROVER	7.04924.15.0	K68289085AA	CHRYSLER	7.24809.77.0
G4D3-9D475-BB	LAND ROVER	7.04924.14.0	K68317959AA	JEEP	7.01317.10.0
G4D39-D475-BC	LAND ROVER	7.04924.14.0	K802-1886-1C	MAZDA	7.05271.73.0
G609-18-861	MAZDA	7.02604.01.0	K802-18861	MAZDA	7.05271.73.0
GK2Q-9U438-AB	FORD	7.05483.25.0	K802-18861-B	MAZDA	7.05271.73.0
GK2Q-9U438-AC	FORD	7.05483.25.0	KK348-18-861	KIA	7.02604.01.0
GK2Q-9U438-AF	FORD	7.05483.25.0	KLA7-1886-1	MAZDA	7.05271.73.0
GK2Q-9U438-AG	FORD	7.05483.25.0	KLA7-25-3F4	MAZDA	7.05271.73.0
GK2Q-9U438-AH	FORD	7.05483.25.0	KLJ9-1886-1A	MAZDA	7.05271.73.0
HG9Q-9D475-AB	FORD	7.04511.29.0	KLJ9-1886-1B	MAZDA	7.05271.73.0
HG9Q-9D475-AD	FORD	7.04511.29.0	KMD199283	CHRYSLER	7.09002.14.0
HG9q-9D475-AC	FORD	7.04511.29.0	KMD354850	CHRYSLER	7.05271.63.0
HG9q-9m425-ab	FORD	7.05578.15.0	KMD354851	CHRYSLER	7.05271.63.0
INJGS025N	DIPA SPORT	7.08369.43.0	KMN158758	CHRYSLER	7.05271.63.0
INJGS037N	DIPA SPORT	7.08369.14.0	KMN163491	CHRYSLER	7.05271.63.0
INJGS041DLPN	DIPA SPORT	7.08369.01.0	KMR507386	CHRYSLER	7.05271.63.0



REF-No.		 PIERBURG	REF-No.		 PIERBURG
KMR578634	CHRYSLER	7.05271.63.0	LEB873	LUCAS	7.02604.73.0
L3H6-18-861	MAZDA	7.02604.60.0	LEB876	LUCAS	7.05271.71.0
L3H6-18-861A	MAZDA	7.02604.60.0	LEB899	LUCAS	7.02604.60.0
LB1950	STANDARD	7.05271.39.0	LEB908	LUCAS	7.05271.02.0
LB2121	STANDARD	7.05271.37.0	LEB909	LUCAS	7.02604.60.0
LB2151	STANDARD	7.05271.38.0	LEB938	LUCAS	7.05271.23.0
LB2213	STANDARD	7.05271.46.0	LEB947	LUCAS	7.02604.64.0
LEB201	LUCAS	7.05271.70.0	LEB948	LUCAS	7.05271.52.0
LEB208	LUCAS	7.02604.49.0	LEB950	LUCAS	7.05271.38.0
LEB208	LUCAS	7.02604.54.0	LEB951	LUCAS	7.02604.60.0
LEB242	LUCAS	7.02604.62.0	LEB953	LUCAS	7.02604.64.0
LEB263	LUCAS	7.05270.88.0	LEB955	LUCAS	7.05270.71.0
LEB263	LUCAS	7.05270.96.0	LEB971	LUCAS	7.05271.01.0
LEB273	LUCAS	7.02604.54.0	LEB972	LUCAS	7.05270.98.0
LEB278	LUCAS	7.02604.56.0	LEB978	LUCAS	7.05271.39.0
LEB285	LUCAS	7.02604.37.0	LEB979	LUCAS	7.02604.64.0
LEB297	LUCAS	7.05270.79.0	LEB980	LUCAS	7.02604.65.0
LEB298	LUCAS	7.05270.72.0	LEGR020	STANDARD	7.24809.36.0
LEB299	LUCAS	7.05270.33.0	LEGR025	STANDARD	7.22818.58.0
LEB321	LUCAS	7.02604.61.0	LEGR025	STANDARD	7.22818.59.0
LEB321	LUCAS	7.02604.63.0	LEGR030	STANDARD	7.00368.15.0
LEB322	LUCAS	7.05271.75.0	LEGR036	STANDARD	7.22818.62.0
LEB376	LUCAS	7.02604.61.0	LEGR041	STANDARD	7.24809.68.0
LEB376	LUCAS	7.02604.62.0	LEGR044	STANDARD	7.03784.34.0
LEB392	LUCAS	7.05270.47.0	LEGR053	STANDARD	7.00578.12.0
LEB392	LUCAS	7.05270.51.0	LEGR082	STANDARD	7.00450.09.0
LEB394	LUCAS	7.05270.49.0	LEGR086	STANDARD	7.24809.78.0
LEB4004	LUCAS	7.02604.41.0	LEGR128	STANDARD	7.02156.24.0
LEB4012	LUCAS	7.05271.74.0	LEGR138	STANDARD	7.01621.08.0
LEB4017	LUCAS	7.05271.54.0	LEGR163	STANDARD	7.24809.29.0
LEB4020	LUCAS	7.05271.62.0	LEGR184	STANDARD	7.24809.76.0
LEB413	LUCAS	7.05270.45.0	LEGR200	STANDARD	7.00075.07.0
LEB433	LUCAS	7.02604.55.0	LEGR205	STANDARD	7.22843.06.0
LEB441	LUCAS	7.02604.47.0	LEGR230	STANDARD	7.24809.47.0
LEB442	LUCAS	7.05270.67.0	LEGR252	STANDARD	7.03051.04.0
LEB443	LUCAS	7.05270.67.0	LEGR257	STANDARD	7.03784.34.0
LEB444	LUCAS	7.05270.67.0	LEGR267	STANDARD	7.24809.81.0
LEB465	LUCAS	7.02604.10.0	LEGR278	STANDARD	7.24809.79.0
LEB466	LUCAS	7.02604.10.0	LEV0003	LUCAS	7.24809.20.0
LEB474	LUCAS	7.05271.53.0	LEV0005	LUCAS	7.22818.57.0
LEB513	LUCAS	7.05270.37.0	LEV0006	LUCAS	7.24809.68.0
LEB528	LUCAS	7.02604.64.0	LEV0007	LUCAS	7.22785.17.0
LEB533	LUCAS	7.05271.55.0	LEV0009	LUCAS	7.24809.36.0
LEB5355	LUCAS	7.05271.77.0	LEV0009	LUCAS	7.24809.59.0
LEB537	LUCAS	7.05271.72.0	LEV0010	LUCAS	7.00678.06.0
LEB5374	LUCAS	7.05271.22.0	LEV0010	LUCAS	7.00907.03.0
LEB554	LUCAS	7.02604.31.0	LEV0013	LUCAS	7.24809.39.0
LEB585	LUCAS	7.05271.03.0	LEV0014	LUCAS	7.10334.04.0
LEB621	LUCAS	7.02604.60.0	LEV0016	LUCAS	7.00020.24.0
LEB628	LUCAS	7.05270.03.0	LEV0018	LUCAS	7.00365.06.0
LEB655	LUCAS	7.05271.58.0	LEV0019	LUCAS	7.00368.15.0
LEB668	LUCAS	7.05270.56.0	LEV0022	LUCAS	7.22818.58.0
LEB682	LUCAS	7.05270.67.0	LEV0022	LUCAS	7.22818.59.0
LEB701	LUCAS	7.05270.36.0	LEV0023	LUCAS	7.22818.62.0
LEB703	LUCAS	7.05270.36.0	LEV0025	LUCAS	7.28248.17.0
LEB721	LUCAS	7.02604.47.0	LEV0026	LUCAS	7.24809.19.0
LEB726	LUCAS	7.05271.03.0	LEV0030	LUCAS	7.24809.32.0
LEB727	LUCAS	7.05270.96.0	LEV0032	LUCAS	7.22843.07.0
LEB743	LUCAS	7.02604.53.0	LEV0033	LUCAS	7.24809.06.0
LEB770	LUCAS	7.02604.07.0	LEV0037	LUCAS	7.22574.12.0
LEB774	LUCAS	7.05271.24.0	LEV0052	LUCAS	7.22875.16.0
LEB775	LUCAS	7.05270.81.0	LEV0069	LUCAS	7.00684.14.0
LEB781	LUCAS	7.05270.89.0	LEV0069	LUCAS	7.03051.04.0
LEB783	LUCAS	7.02604.53.0	LEV0080	LUCAS	7.24809.70.0
LEB784	LUCAS	7.05271.00.0	LEV0101	LUCAS	7.00075.07.0
LEB814	LUCAS	7.05271.65.0	LEV0105	LUCAS	7.22946.34.0
LEB844	LUCAS	7.02604.73.0	LEV0118	LUCAS	7.24809.30.0
LEB845	LUCAS	7.02604.60.0	LEV0119	LUCAS	7.10334.09.0
LEB870	LUCAS	7.05270.86.0	LEV0122	LUCAS	7.00450.09.0

REF-No.			REF-No.		
LEV0122	LUCAS	7.00450.10.0	LGS6041	LUCAS	7.08369.09.0
LEV0125	LUCAS	7.24809.69.0	LGS6044	LUCAS	7.08369.37.0
LEV0136	LUCAS	7.28384.13.0	LGS6046	LUCAS	7.08369.41.0
LEV0144	LUCAS	7.28264.07.0	LGS6054	LUCAS	7.08369.27.0
LEV0147	LUCAS	7.28264.06.0	LGS6058	LUCAS	7.08369.35.0
LEV0151	LUCAS	7.10334.07.0	LGS6079	LUCAS	7.08369.32.0
LEV0158	LUCAS	7.10334.00.0	LGS6080	LUCAS	7.08369.46.0
LEV0159	LUCAS	7.00368.16.0	LGS6087	LUCAS	7.08369.17.0
LEV0167	LUCAS	7.10334.05.0	LGS6093	LUCAS	7.08369.05.0
LEV0168	LUCAS	7.28069.03.0	LGS6094	LUCAS	7.08369.38.0
LEV0172	LUCAS	7.00578.12.0	LGS7036	LUCAS	7.08369.43.0
LEV0178	LUCAS	7.24809.47.0	LGS7053	LUCAS	7.08369.15.0
LEV0195	LUCAS	7.28070.03.0	LGS7085	LUCAS	7.08369.14.0
LEV0212	LUCAS	7.02209.11.0	LGS7111	LUCAS	7.08369.33.0
LEV0223	LUCAS	7.00512.03.0	LGS7114	LUCAS	7.08369.22.0
LEV0229	LUCAS	7.10334.03.0	LGS7125	LUCAS	7.08369.23.0
LEV0233	LUCAS	7.00555.06.0	LGS7127	LUCAS	7.08369.56.0
LEV0236	LUCAS	7.09720.03.0	LGS7134	LUCAS	7.08369.68.0
LEV0243	LUCAS	7.00306.36.0	LGS7158	LUCAS	7.08369.11.0
LEV0250	LUCAS	7.09720.02.0	LGS7178	LUCAS	7.08369.18.0
LEV0251	LUCAS	7.24809.56.0	LGS7222	LUCAS	7.08369.31.0
LEV0253	LUCAS	7.22785.20.0	LR000997	LAND ROVER	7.00578.12.0
LEV0255	LUCAS	7.11237.07.0	LR003829	LAND ROVER	7.24809.97.0
LEV0257	LUCAS	7.09002.09.0	LR003830	LAND ROVER	7.11237.00.0
LEV0264	LUCAS	7.10334.06.0	LR004534	LAND ROVER	7.11237.03.0
LEV0266	LUCAS	7.01782.07.0	LR005369	LAND ROVER	7.24809.70.0
LEV0267	LUCAS	7.11237.08.0	LR005791	LAND ROVER	7.28264.06.0
LEV027	STANDARD	7.22738.08.0	LR006650	LAND ROVER	7.24809.70.0
LEV0277	LUCAS	7.09720.04.0	LR006960	LAND ROVER	7.24809.95.0
LEV0290	LUCAS	7.09720.01.0	LR006986	LAND ROVER	7.11237.00.0
LEV0310	LUCAS	7.03196.09.0	LR006987	LAND ROVER	7.24809.97.0
LEV0312	LUCAS	7.10334.08.0	LR006988	LAND ROVER	7.24809.95.0
LEV0317	LUCAS	7.24809.55.0	LR006989	LAND ROVER	7.11237.03.0
LEV0325	LUCAS	7.09002.12.0	LR006994	LAND ROVER	7.11237.01.0
LEV0353	LUCAS	7.24809.46.0	LR006995	LAND ROVER	7.24809.96.0
LEV0360	LUCAS	7.03435.05.0	LR008463	LAND ROVER	7.11190.10.0
LEV0370	LUCAS	7.01604.02.0	LR009702	LAND ROVER	7.11237.00.0
LEV0380	LUCAS	7.24809.54.0	LR009735	LAND ROVER	7.24809.97.0
LEV0433	LUCAS	7.00309.07.0	LR009809	LAND ROVER	7.24809.95.0
LEV0435	LUCAS	7.00306.37.0	LR009810	LAND ROVER	7.11237.03.0
LEV0437	LUCAS	7.24809.79.0	LR010124	LAND ROVER	7.11237.01.0
LEV0438	LUCAS	7.24809.81.0	LR010125	LAND ROVER	7.24809.96.0
LEV0439	LUCAS	7.02014.07.0	LR013661	LAND ROVER	7.05270.69.0
LEV083	STANDARD	7.22934.63.0	LR018321	LAND ROVER	7.24809.97.0
LEV0927	LUCAS	7.21920.62.0	LR018322	LAND ROVER	7.11237.00.0
LEV0967	LUCAS	7.22996.11.0	LR018323	LAND ROVER	7.24809.95.0
LEV1038	LUCAS	7.09002.08.0	LR018324	LAND ROVER	7.11237.03.0
LEV1520	LUCAS	7.04999.35.0	LR018465	LAND ROVER	7.11237.01.0
LEV1524	LUCAS	7.24809.53.0	LR018466	LAND ROVER	7.24809.96.0
LEV1578	LUCAS	7.09002.11.0	LR018752	LAND ROVER	7.01881.06.0
LEV2150	LUCAS	7.03784.34.0	LR018752	LAND ROVER	7.01881.08.0
LEV2203	LUCAS	7.01881.06.0	LR018753	LAND ROVER	7.01881.07.0
LEV2204	LUCAS	7.01881.07.0	LR018753	LAND ROVER	7.01881.09.0
LEV2317	LUCAS	7.28270.14.0	LR023158	LAND ROVER	7.02751.02.0
LEV2320	LUCAS	7.22939.03.0	LR030027	LAND ROVER	7.03784.34.0
LEV2360	LUCAS	7.24809.82.0	LR033373	LAND ROVER	7.02751.02.0
LEV2394	LUCAS	7.22136.50.0	LR055534	LAND ROVER	7.03784.34.0
LEV2599	LUCAS	7.05320.04.0	LR063122	LAND ROVER	7.05590.04.0
LEV2967	LUCAS	7.01493.07.0	LR069681	LAND ROVER	7.05264.04.0
LEV3784	LUCAS	7.05578.15.0	LR073752	LAND ROVER	7.04923.18.0
LF01-20-300	MAZDA	7.24809.73.0	LR077847	LAND ROVER	7.04923.18.0
LF01-20-300A	MAZDA	7.24809.73.0	LR081121	LAND ROVER	7.03784.34.0
LF01-20-300B	MAZDA	7.24809.73.0	LR087071	LAND ROVER	7.04923.18.0
LGS6017	LUCAS	7.08369.34.0	LR097167	LAND ROVER	7.04923.17.0
LGS6019	LUCAS	7.08369.40.0	LR110290	LAND ROVER	7.04924.15.0
LGS6023	LUCAS	7.08369.08.0	LR110291	LAND ROVER	7.04924.14.0
LGS6024	LUCAS	7.08369.02.0	LVER118	MOTAQUIP	7.09002.12.0
LGS6028	LUCAS	7.08369.01.0	LVER119	MOTAQUIP	7.00450.09.0
LGS6033	LUCAS	7.08369.03.0	LVER136	MOTAQUIP	7.24809.36.0



REF-No.		 PIERBURG	REF-No.		 PIERBURG
LVER141	MOTAQUIP	7.09720.00.0	LXT165	STANDARD	7.08369.15.0
LVER151	MOTAQUIP	7.09720.01.0	LXT232	STANDARD	7.08369.33.0
LVER159	MOTAQUIP	7.24809.68.0	LXT235	STANDARD	7.08369.22.0
LVER161	MOTAQUIP	7.22414.08.0	LXT248	STANDARD	7.08369.23.0
LVER165	MOTAQUIP	7.22818.58.0	LXT283	STANDARD	7.08369.11.0
LVER171	MOTAQUIP	7.00075.07.0	LXT286	STANDARD	7.08369.14.0
LVER181	MOTAQUIP	7.00578.12.0	LXT365	STANDARD	7.08369.39.0
LVER186	MOTAQUIP	7.10334.10.0	M616666	MITSUBISHI	7.22818.57.0
LVER194	MOTAQUIP	7.00368.15.0	MBP03-18-861B	KIA	7.02604.01.0
LVER199	MOTAQUIP	7.24809.47.0	MD076706	MITSUBISHI	7.02604.01.0
LVER205	MOTAQUIP	7.02156.34.0	MD078791	MITSUBISHI	7.02604.01.0
LVER222	MOTAQUIP	7.11237.08.0	MD088616	MITSUBISHI	7.02604.01.0
LVER223	MOTAQUIP	7.02156.24.0	MD109613	MITSUBISHI	7.02604.01.0
LVER267	MOTAQUIP	7.22843.06.0	MD147878	MITSUBISHI	7.02604.01.0
LVER281	MOTAQUIP	7.22818.59.0	MD149813	MITSUBISHI	7.02604.01.0
LVER295	MOTAQUIP	7.03784.34.0	MD153923	MITSUBISHI	7.02604.01.0
LVER304	MOTAQUIP	7.09720.02.0	MD177969	MITSUBISHI	7.05271.63.0
LVER310	MOTAQUIP	7.22818.62.0	MD199283	MITSUBISHI	7.09002.14.0
LVER368	MOTAQUIP	7.03051.04.0	MD327611	MITSUBISHI	7.05271.63.0
LVER394	MOTAQUIP	7.11237.07.0	MD327693	MITSUBISHI	7.05271.63.0
LVER413	MOTAQUIP	7.24809.87.0	MD335431	MITSUBISHI	7.05271.63.0
LVER414	MOTAQUIP	7.03622.11.0	MD342323	MITSUBISHI	7.05271.63.0
LVET107	MOTAQUIP	7.08369.27.0	MD345772	MITSUBISHI	7.05271.63.0
LVET111	MOTAQUIP	7.08369.08.0	MD351752	MITSUBISHI	7.05271.63.0
LVET113	MOTAQUIP	7.08369.25.0	MD354850	MITSUBISHI	7.05271.63.0
LVET116	MOTAQUIP	7.08369.05.0	MD354851	MITSUBISHI	7.05271.63.0
LVET127	MOTAQUIP	7.08369.37.0	MD357284	MITSUBISHI	7.05271.63.0
LVET129	MOTAQUIP	7.08369.38.0	MHK000210	ROVER	7.02604.31.0
LVET132	MOTAQUIP	7.08369.40.0	MHK000220	ROVER	7.02604.21.0
LVET135	MOTAQUIP	7.08369.17.0	MHK10004	ROVER	7.02604.04.0
LVET138	MOTAQUIP	7.08369.19.0	MHK10023	ROVER	7.02604.01.0
LVET149	MOTAQUIP	7.08369.02.0	MHK100722	ROVER	7.05271.72.0
LVET150	MOTAQUIP	7.08369.09.0	MHK100722L	LAND ROVER	7.05271.72.0
LVET158	MOTAQUIP	7.08369.41.0	MHK100728	ROVER	7.05271.72.0
LVET159	MOTAQUIP	7.08369.12.0	MHK100728L	LAND ROVER	7.05271.72.0
LVET166	MOTAQUIP	7.08369.01.0	MHK100840	LAND ROVER	7.05271.75.0
LVET170	MOTAQUIP	7.08369.32.0	MHK100840	ROVER	7.05271.75.0
LVET173	MOTAQUIP	7.08369.07.0	MHK100840L	LAND ROVER	7.05271.75.0
LVET182	MOTAQUIP	7.08369.35.0	MHK100960	ROVER	7.02604.01.0
LVET183	MOTAQUIP	7.08369.03.0	MHK101280	ROVER	7.02604.01.0
LVET183	MOTAQUIP	7.08369.04.0	MHK500850	LAND ROVER	7.05270.69.0
LVET188	MOTAQUIP	7.08369.00.0	MHK500870	LAND ROVER	7.05270.69.0
LVET198	MOTAQUIP	7.08369.16.0	MHK500910	LAND ROVER	7.05270.69.0
LVET208	MOTAQUIP	7.08369.21.0	MHK500960	LAND ROVER	7.05270.69.0
LVET210	MOTAQUIP	7.08369.34.0	MK667347	FUSO	7.02321.17.0
LVET238	MOTAQUIP	7.08369.22.0	MN137490	MITSUBISHI	7.05271.63.0
LVET239	MOTAQUIP	7.08369.23.0	MN137944	MITSUBISHI	7.05271.63.0
LVET282	MOTAQUIP	7.08369.68.0	MN158757	MITSUBISHI	7.05271.63.0
LVET302	MOTAQUIP	7.08369.11.0	MN158758	MITSUBISHI	7.05271.63.0
LVET307	MOTAQUIP	7.08369.15.0	MN163491	MITSUBISHI	7.05271.63.0
LVET348	MOTAQUIP	7.08369.14.0	MN980163	MITSUBISHI	7.24809.16.0
LVET352	MOTAQUIP	7.08369.43.0	MN980265	MITSUBISHI	7.24809.16.0
LVEV156	MOTAQUIP	7.22738.08.0	MN980325	MITSUBISHI	7.24809.16.0
LVEV198	MOTAQUIP	7.22934.63.0	MN982239	MITSUBISHI	7.00578.12.0
LVO51281	MOTAQUIP	7.05271.22.0	MN982659	MITSUBISHI	7.02156.35.0
LXT004	STANDARD	7.08369.03.0	MN982670	MITSUBISHI	7.02209.11.0
LXT006	STANDARD	7.08369.40.0	MR507385	MITSUBISHI	7.05271.63.0
LXT008	STANDARD	7.08369.41.0	MR507386	MITSUBISHI	7.05271.63.0
LXT009	STANDARD	7.08369.01.0	MR507749	MITSUBISHI	7.05271.63.0
LXT010	STANDARD	7.08369.02.0	MR507750	MITSUBISHI	7.05271.63.0
LXT014	STANDARD	7.08369.34.0	MR507751	MITSUBISHI	7.05271.63.0
LXT022	STANDARD	7.08369.08.0	MR514342	MITSUBISHI	7.05271.63.0
LXT024	STANDARD	7.08369.09.0	MR514477	MITSUBISHI	7.05271.63.0
LXT037	STANDARD	7.08369.32.0	MR560271	MITSUBISHI	7.05271.63.0
LXT046	STANDARD	7.08369.27.0	MR578199	MITSUBISHI	7.05271.63.0
LXT050	STANDARD	7.08369.17.0	MR578634	MITSUBISHI	7.05271.63.0
LXT051	STANDARD	7.08369.38.0	MR985102	MITSUBISHI	7.05271.63.0
LXT105	STANDARD	7.08369.05.0	MW30638635	MITSUBISHI	7.22818.57.0
LXT146	STANDARD	7.08369.43.0	MW30662336	MITSUBISHI	7.22818.57.0



NUMBERFINDER

REF-No.		 PIERBURG	REF-No.		 PIERBURG
MW30662345	MITSUBISHI	7.22818.57.0	V10-63-0002	VEMO	7.22785.17.0
MW30670108	MITSUBISHI	7.22818.57.0	V10-63-0003	VEMO	7.28248.17.0
MW30774534	MITSUBISHI	7.22818.57.0	V10-63-0003-1	VEMO	7.28248.17.0
MW30777076	MITSUBISHI	7.22818.57.0	V10-63-0004	VEMO	7.00365.06.0
N304-18-861	MAZDA	7.02604.01.0	V10-63-0005	VEMO	7.22785.18.0
N350-18-861	MAZDA	7.02604.01.0	V10-63-0006	VEMO	7.22785.16.0
N3A1-18-861	MAZDA	7.02604.01.0	V10-63-0007	VEMO	7.22574.12.0
N3A1-18-861A	MAZDA	7.02604.01.0	V10-63-0009	VEMO	7.10334.10.0
QC000327	FUSO	7.02321.17.0	V10-63-0011	VEMO	7.24809.16.0
QC000397	FUSO	7.02321.17.0	V10-63-0012	VEMO	7.10334.04.0
QTH645K	QUINTON HAZEL	7.04879.00.0	V10-63-0014	VEMO	7.00907.03.0
RE544319	JOHN DEERE	7.03803.03.0	V10-63-0018	VEMO	7.24809.17.0
RE551105	JOHN DEERE	7.05446.07.0	V10-63-0019	VEMO	7.24809.19.0
RE551106	JOHN DEERE	7.05447.08.0	V10-63-0020	VEMO	7.24809.20.0
RE551106	JOHN DEERE	7.05448.07.0	V10-63-0021	VEMO	7.24809.26.0
RE551752	JOHN DEERE	7.08965.03.0	V10-63-0023	VEMO	7.24809.30.0
RE554592	JOHN DEERE	7.07419.06.0	V10-63-0024	VEMO	7.24809.55.0
RE570108	JOHN DEERE	7.08965.03.0	V10-63-0025	VEMO	7.28070.03.0
S550-13J40	MAZDA	7.05662.07.0	V10-63-0026	VEMO	7.24809.56.0
SU001-00730	TOYOTA	7.24809.76.0	V10-63-0027	VEMO	7.24809.64.0
SU001-00884	TOYOTA	7.24809.76.0	V10-63-0029	VEMO	7.24809.32.0
T4N11610	JAGUAR	7.05264.04.0	V10-63-0030	VEMO	7.24809.57.0
TH445105G1	GATES	7.04879.00.0	V10-63-0031	VEMO	7.24809.31.0
TM55105	BEHR GMBH & CO	7.04879.00.0	V10-63-0032	VEMO	7.24809.38.0
TM55105	MAHLE	7.04879.00.0	V10-63-0033	VEMO	7.24809.52.0
TO708955	AMC USA	7.02604.01.0	V10-63-0034	VEMO	7.24809.61.0
TO729963	AMC USA	7.02604.01.0	V10-63-0035	VEMO	7.24809.63.0
TS30006	DELPHI	7.11020.04.0	V10-63-0043	VEMO	7.22477.10.0
TS30008	DELPHI	7.11020.09.0	V10-63-0044	VEMO	7.22477.11.0
TS30011	DELPHI	7.11020.10.0	V10-63-0045	VEMO	7.10334.00.0
TS30021	DELPHI	7.08369.14.0	V10-63-0047	VEMO	7.24809.99.0
TS30022	DELPHI	7.08369.05.0	V10-63-0048	VEMO	7.09720.03.0
TS30028	DELPHI	7.11020.38.0	V10-63-0049	VEMO	7.11237.06.0
TS30039	DELPHI	7.08369.01.0	V10-63-0050	VEMO	7.09720.04.0
TS30039	DELPHI	7.08369.92.0	V10-63-0053	VEMO	7.10334.09.0
TS30045	DELPHI	7.08369.43.0	V10-63-0055	VEMO	7.00823.06.0
TS30050	DELPHI	7.11020.12.0	V10-63-0057	VEMO	7.22738.08.0
TS30052	DELPHI	7.11020.05.0	V10-63-0058	VEMO	7.00789.10.0
TS30055	DELPHI	7.08369.30.0	V10-63-0059	VEMO	7.02132.07.0
TS30057	DELPHI	7.08369.94.0	V10-63-0069	VEMO	7.00309.07.0
TS30058	DELPHI	7.11020.11.0	V10-63-0069	VEMO	7.01782.07.0
TS30061	DELPHI	7.11020.44.0	V10-63-0070	VEMO	7.21851.31.0
TS30062	DELPHI	7.11020.45.0	V10-63-0077	VEMO	7.03196.09.0
TS30063	DELPHI	7.08369.38.0	V10-63-0080	VEMO	7.24809.93.0
TS30064	DELPHI	7.08369.32.0	V10-63-0081	VEMO	7.02756.07.0
TS30066	DELPHI	7.08369.17.0	V10-63-0082	VEMO	7.09720.02.0
TS30069	DELPHI	7.11020.00.0	V10-63-0083	VEMO	7.09720.00.0
TS30072	DELPHI	7.08369.77.0	V10-63-0084	VEMO	7.09720.01.0
TS30074	DELPHI	7.08369.34.0	V10-63-0087	VEMO	7.10334.02.0
TS30075	DELPHI	7.08369.40.0	V10-63-0089	VEMO	7.21851.32.0
TS30076	DELPHI	7.08369.84.0	V10-63-0090	VEMO	7.22738.20.0
TS30078	DELPHI	7.08369.08.0	V10-63-0091	VEMO	7.03446.01.0
TS30079	DELPHI	7.08369.02.0	V10-63-0092	VEMO	7.28415.09.0
TS30081	DELPHI	7.11020.19.0	V10-63-0094	VEMO	7.03635.12.0
TS30082	DELPHI	7.08369.19.0	V10-63-0095	VEMO	7.22934.57.0
TS30085	DELPHI	7.11020.06.0	V10-63-0138	VEMO	7.22934.63.0
TS30086	DELPHI	7.08369.09.0	V10-63-0140	VEMO	7.01106.38.0
TS30089	DELPHI	7.11020.07.0	V10-63-0154	VEMO	7.03635.39.0
TS30090	DELPHI	7.08369.82.0	V10-63-0155	VEMO	7.03635.40.0
TS30091	DELPHI	7.08369.41.0	V10-63-0156	VEMO	7.03635.41.0
TS30109	DELPHI	7.08369.35.0	V10-63-9011	VEMO	7.24809.16.0
TS30111	DELPHI	7.11020.36.0	V10-66-0002	VEMO	7.05574.02.0
TS30237	DELPHI	7.11020.37.0	V10-66-0003	VEMO	7.05574.03.0
TS30260	DELPHI	7.08369.15.0	V10-66-0006	VEMO	7.22778.96.0
TS30262	DELPHI	7.08369.39.0	V10-66-0008	VEMO	7.22778.80.0
UR22163	ROLLS-ROYCE	7.02604.01.0	V10-66-0011	VEMO	7.22778.97.0
UR26474	BENTLEY	7.02604.01.0	V10-66-0017	VEMO	7.22560.40.0
UR26474	ROLLS-ROYCE	7.02604.01.0	V10-66-0018	VEMO	7.22560.41.0
V10-63-0001	VEMO	7.28248.17.0	V10-66-0020	VEMO	7.22560.44.0



REF-No.	 PIERBURG	REF-No.	 PIERBURG
V10-66-0025	VEMO 7.22769.80.0	V10-72-1475	VEMO 7.11020.22.0
V10-72-0001	VEMO 7.08369.34.0	V10-72-1476	VEMO 7.11020.17.0
V10-72-0003	VEMO 7.08369.53.0	V10-72-1477	VEMO 7.11020.23.0
V10-72-0004	VEMO 7.08369.08.0	V10-72-1486	VEMO 7.08369.52.0
V10-72-0005	VEMO 7.08369.02.0	V10-72-1507	VEMO 7.11020.24.0
V10-72-0005	VEMO 7.08369.84.0	V10-76-0011	VEMO 7.05271.24.0
V10-72-0006	VEMO 7.08369.01.0	V10-76-0012	VEMO 7.05271.16.0
V10-72-0008	VEMO 7.08369.21.0	V10-76-0013	VEMO 7.05270.96.0
V10-72-0009	VEMO 7.08369.25.0	V10-76-0016	VEMO 7.05271.00.0
V10-72-0010	VEMO 7.08369.04.0	V10-76-0017	VEMO 7.05271.00.0
V10-72-0011	VEMO 7.08369.07.0	V10-76-0018	VEMO 7.05270.99.0
V10-72-0012	VEMO 7.08369.14.0	V10-76-0024	VEMO 7.05270.86.0
V10-72-0013	VEMO 7.08369.48.0	V10-76-0028	VEMO 7.05270.96.0
V10-72-0016	VEMO 7.08369.09.0	V10-76-0029	VEMO 7.05270.98.0
V10-72-0017	VEMO 7.08369.16.0	V10-76-0030	VEMO 7.05270.99.0
V10-72-0019	VEMO 7.08369.82.0	V10-76-0033	VEMO 7.05270.88.0
V10-72-0020	VEMO 7.08369.41.0	V10-76-0034	VEMO 7.05271.04.0
V10-72-0021	VEMO 7.08369.03.0	V10-76-0035	VEMO 7.05270.96.0
V10-72-0026	VEMO 7.08369.13.0	V10-76-0036	VEMO 7.05271.14.0
V10-72-0039	VEMO 7.11020.20.0	V10-76-0038	VEMO 7.05271.05.0
V10-72-0042	VEMO 7.08369.78.0	V10-76-0039	VEMO 7.05271.21.0
V10-72-0045	VEMO 7.11020.25.0	V10-76-0042	VEMO 7.05271.05.0
V10-72-0072	VEMO 7.08369.27.0	V10-76-0043	VEMO 7.05271.07.0
V10-72-1203-1	VEMO 7.11190.02.0	V10-76-0045	VEMO 7.05271.06.0
V10-72-1207	VEMO 7.11190.09.0	V10-76-0049	VEMO 7.05271.22.0
V10-72-1207	VEMO 7.11492.00.0	V10-76-0049	VEMO 7.05271.23.0
V10-72-1247	VEMO 7.11190.00.0	V10-76-0049	VEMO 7.05271.24.0
V10-72-1247	VEMO 7.11492.02.0	V10-76-0050	VEMO 7.05271.20.0
V10-72-1276	VEMO 7.08369.00.0	V10-76-0051	VEMO 7.05271.01.0
V10-72-1293	VEMO 7.11492.03.0	V10-76-0054	VEMO 7.05271.07.0
V10-72-1334	VEMO 7.08369.72.0	V10-76-0056	VEMO 7.05271.04.0
V10-72-1335	VEMO 7.08369.40.0	V10-76-0057	VEMO 7.05271.03.0
V10-72-1337	VEMO 7.08369.43.0	V10-76-0058	VEMO 7.05271.00.0
V10-72-1338	VEMO 7.08369.20.0	V10-76-0060	VEMO 7.05270.91.0
V10-72-1340	VEMO 7.11020.19.0	V10-76-0061	VEMO 7.05270.99.0
V10-72-1343	VEMO 7.08369.26.0	V10-76-0061	VEMO 7.05271.01.0
V10-72-1346	VEMO 7.08369.92.0	V10-76-0062	VEMO 7.05270.86.0
V10-72-1346	VEMO 7.08369.93.0	V10-76-0064	VEMO 7.05271.15.0
V10-72-1347	VEMO 7.11020.06.0	V10-76-0065	VEMO 7.05271.16.0
V10-72-1348	VEMO 7.08369.24.0	V10-76-0066	VEMO 7.05271.16.0
V10-72-1349	VEMO 7.08369.37.0	V10-76-0067	VEMO 7.05270.99.0
V10-72-1350	VEMO 7.08369.50.0	V10-76-0068	VEMO 7.05270.99.0
V10-72-1352	VEMO 7.08369.81.0	V10-76-0071	VEMO 7.05271.18.0
V10-72-1353	VEMO 7.08369.44.0	V10-76-0073	VEMO 7.05270.86.0
V10-72-1373	VEMO 7.08369.31.0	V10-76-0075	VEMO 7.05271.03.0
V10-72-1374	VEMO 7.08369.22.0	V10-76-0076	VEMO 7.05270.86.0
V10-72-1375	VEMO 7.08369.33.0	V10-76-0081	VEMO 7.05271.05.0
V10-72-1376	VEMO 7.08369.18.0	V10-76-0084	VEMO 7.05271.07.0
V10-72-1377	VEMO 7.08369.11.0	V10-76-0106	VEMO 7.05271.29.0
V10-72-1379	VEMO 7.08369.36.0	V10-76-0107	VEMO 7.05271.29.0
V10-72-1380	VEMO 7.08369.39.0	V10-76-0109	VEMO 7.05271.77.0
V10-72-1381	VEMO 7.08369.42.0	V10-77-1031	VEMO 7.05574.01.0
V10-72-1382	VEMO 7.08369.45.0	V10-77-1032	VEMO 7.05574.00.0
V10-72-1383	VEMO 7.08369.23.0	V10-77-1033	VEMO 7.22286.53.0
V10-72-1384	VEMO 7.08369.65.0	V10-77-1034	VEMO 7.22286.52.0
V10-72-1388	VEMO 7.08369.47.0	V10-77-1035	VEMO 7.22286.51.0
V10-72-1391	VEMO 7.08369.64.0	V10-77-1036	VEMO 7.22286.54.0
V10-72-1392	VEMO 7.08369.56.0	V10-77-1037	VEMO 7.22778.98.0
V10-72-1393	VEMO 7.08369.66.0	V20-63-0003	VEMO 7.21920.62.0
V10-72-1396	VEMO 7.08369.62.0	V20-63-0008	VEMO 7.00450.10.0
V10-72-1397	VEMO 7.08369.68.0	V20-63-0011	VEMO 7.00450.09.0
V10-72-1398	VEMO 7.11020.03.0	V20-63-0012	VEMO 7.10334.07.0
V10-72-1401	VEMO 7.08369.19.0	V20-63-0014	VEMO 7.24809.50.0
V10-72-1402	VEMO 7.08369.58.0	V20-63-0015	VEMO 7.00684.14.0
V10-72-1403	VEMO 7.08369.01.0	V20-63-0016	VEMO 7.21852.24.0
V10-72-1404	VEMO 7.08369.59.0	V20-63-0017	VEMO 7.28124.19.0
V10-72-1457	VEMO 7.11020.18.0	V20-63-0018	VEMO 7.21852.85.0
V10-72-1463	VEMO 7.11020.21.0	V20-63-0021	VEMO 7.22166.02.0
V10-72-1465	VEMO 7.08369.95.0	V20-63-0022	VEMO 7.22166.38.0



NUMBERFINDER

REF-No.	 PIERBURG	REF-No.	 PIERBURG
V20-63-0025	VEMO 7.00512.03.0	V24-76-0017	VEMO 7.02604.47.0
V20-63-0026	VEMO 7.28264.06.0	V24-76-0019	VEMO 7.02604.51.0
V20-63-0030	VEMO 7.28124.20.0	V24-76-0020	VEMO 7.02604.55.0
V20-63-0031	VEMO 7.21852.79.0	V24-76-0026	VEMO 7.02604.51.0
V20-63-0043	VEMO 7.03051.04.0	V24-76-0028	VEMO 7.05270.80.0
V20-63-0046	VEMO 7.28124.30.0	V25-63-0001	VEMO 7.24809.39.0
V20-66-0004	VEMO 7.22748.18.0	V25-63-0008	VEMO 7.24809.07.0
V20-66-0005	VEMO 7.28238.55.0	V25-63-0010	VEMO 7.24809.68.0
V20-66-0006	VEMO 7.28238.56.0	V25-63-0012	VEMO 7.24809.73.0
V20-66-0009	VEMO 7.28238.61.0	V25-63-0013	VEMO 7.24809.06.0
V20-66-0012	VEMO 7.22295.62.0	V25-63-0015	VEMO 7.00578.12.0
V20-66-0013	VEMO 7.22295.61.0	V25-63-0016	VEMO 7.24809.69.0
V20-66-0014	VEMO 7.22295.70.0	V25-63-0016	VEMO 7.24809.70.0
V20-66-0015	VEMO 7.22295.62.0	V25-63-0019	VEMO 7.01621.08.0
V20-76-0012	VEMO 7.02604.31.0	V25-63-0019	VEMO 7.24809.40.0
V20-76-0023	VEMO 7.02604.21.0	V25-63-0038	VEMO 7.09730.00.0
V20-76-0025	VEMO 7.02604.30.0	V25-63-0055	VEMO 7.24809.74.0
V20-76-0026	VEMO 7.02604.31.0	V25-63-0060	VEMO 7.01293.38.0
V20-76-0027	VEMO 7.02604.32.0	V25-72-1104	VEMO 7.11190.10.0
V20-76-0028	VEMO 7.02604.32.0	V25-76-0001	VEMO 7.02604.62.0
V20-76-0033	VEMO 7.02604.28.0	V25-76-0002	VEMO 7.02604.61.0
V20-76-0035	VEMO 7.02604.38.0	V25-76-0002	VEMO 7.02604.62.0
V20-76-0036	VEMO 7.02604.37.0	V25-76-0003	VEMO 7.02604.63.0
V20-76-0037	VEMO 7.05271.70.0	V25-76-0005	VEMO 7.02604.61.0
V20-76-0040	VEMO 7.05271.72.0	V25-76-0006	VEMO 7.02604.60.0
V20-76-0041	VEMO 7.05271.74.0	V25-76-0007	VEMO 7.02604.64.0
V20-76-0043	VEMO 7.02604.27.0	V25-76-0010	VEMO 7.02604.60.0
V20-76-0045	VEMO 7.02604.32.0	V25-76-0011	VEMO 7.02604.62.0
V20-76-0064	VEMO 7.02604.41.0	V25-76-0012	VEMO 7.02604.60.0
V22-63-0003	VEMO 7.11237.01.0	V25-76-0014	VEMO 7.02604.60.0
V22-63-0005	VEMO 7.24809.76.0	V25-76-0015	VEMO 7.02604.60.0
V22-63-0010	VEMO 7.22843.06.0	V25-76-0016	VEMO 7.02604.64.0
V22-63-0011	VEMO 7.22888.02.0	V25-76-0019	VEMO 7.05270.88.0
V22-63-0013	VEMO 7.28069.03.0	V25-76-0023	VEMO 7.02604.60.0
V22-63-0016	VEMO 7.28069.04.0	V26-76-0001	VEMO 7.05271.58.0
V22-63-0019	VEMO 7.03784.34.0	V30-63-0002	VEMO 7.24809.36.0
V22-63-0023	VEMO 7.09730.01.0	V30-63-0003	VEMO 7.24809.59.0
V22-63-0025	VEMO 7.11237.04.0	V30-63-0004	VEMO 7.24809.35.0
V22-72-0096	VEMO 7.11492.01.0	V30-63-0005	VEMO 7.24809.54.0
V22-76-0001	VEMO 7.05270.36.0	V30-63-0006	VEMO 7.24809.37.0
V22-76-0006	VEMO 7.05270.38.0	V30-63-0007	VEMO 7.24809.48.0
V22-76-0008	VEMO 7.05270.36.0	V30-63-0008	VEMO 7.24809.33.0
V22-76-0011	VEMO 7.05270.36.0	V30-63-0010	VEMO 7.24809.34.0
V22-76-0012	VEMO 7.05270.37.0	V30-63-0012	VEMO 7.24809.60.0
V24-63-0001	VEMO 7.24809.77.0	V30-63-0013	VEMO 7.24809.49.0
V24-63-0002	VEMO 7.22946.34.0	V30-63-0015	VEMO 7.24809.65.0
V24-63-0003	VEMO 7.24809.70.0	V30-63-0021	VEMO 7.22136.50.0
V24-63-0004	VEMO 7.00020.39.0	V30-63-0025	VEMO 7.04389.00.0
V24-63-0005	VEMO 7.00020.40.0	V30-63-0027	VEMO 7.00306.36.0
V24-63-0007	VEMO 7.24809.53.0	V30-63-0030	VEMO 7.24809.46.0
V24-63-0008	VEMO 7.24809.51.0	V30-63-0033	VEMO 7.24809.47.0
V24-63-0018	VEMO 7.24809.86.0	V30-63-0036	VEMO 7.04389.02.0
V24-63-0026	VEMO 7.09002.00.0	V30-63-0037	VEMO 7.04389.04.0
V24-72-0141	VEMO 7.11020.09.0	V30-63-0041	VEMO 7.00306.37.0
V24-72-0143	VEMO 7.11020.08.0	V30-63-0053	VEMO 7.21949.51.0
V24-72-0162	VEMO 7.08369.57.0	V30-63-0069	VEMO 7.24809.82.0
V24-72-0172	VEMO 7.08369.35.0	V30-63-0072	VEMO 7.24809.85.0
V24-72-0217	VEMO 7.08369.98.0	V30-63-0073	VEMO 7.24809.84.0
V24-72-0218	VEMO 7.08369.99.0	V30-63-0074	VEMO 7.24809.83.0
V24-72-0221	VEMO 7.11020.04.0	V30-72-0047	VEMO 7.11020.32.0
V24-72-0229	VEMO 7.11020.41.0	V30-72-0185	VEMO 7.11020.05.0
V24-72-0257	VEMO 7.11020.36.0	V30-72-0186	VEMO 7.08369.06.0
V24-72-0265	VEMO 7.11020.15.0	V30-72-0188	VEMO 7.11020.12.0
V24-72-0273	VEMO 7.11020.10.0	V30-72-0193	VEMO 7.08369.30.0
V24-76-0001	VEMO 7.02604.53.0	V30-72-0194	VEMO 7.08369.94.0
V24-76-0004	VEMO 7.02604.53.0	V30-72-0195	VEMO 7.11020.01.0
V24-76-0005	VEMO 7.02604.56.0	V30-72-0195	VEMO 7.11020.11.0
V24-76-0012	VEMO 7.02604.54.0	V30-72-0199	VEMO 7.11020.00.0
V24-76-0014	VEMO 7.02604.49.0	V30-72-0200	VEMO 7.11020.35.0



REF-No.	 PIERBURG	REF-No.	 PIERBURG
V30-72-0202	VEMO 7.11020.28.0	V40-63-0063	VEMO 7.03622.06.0
V30-72-0203	VEMO 7.08369.12.0	V40-63-0064	VEMO 7.10334.08.0
V30-72-0204	VEMO 7.08369.60.0	V40-63-0070	VEMO 7.24809.87.0
V30-72-0205	VEMO 7.08369.91.0	V40-72-0001	VEMO 7.08369.49.0
V30-72-0792	VEMO 7.08369.87.0	V40-72-0008	VEMO 7.11020.27.0
V30-72-0792	VEMO 7.08369.88.0	V40-72-0288	VEMO 7.11020.38.0
V30-72-0822	VEMO 7.08369.61.0	V40-72-0294	VEMO 7.08369.46.0
V30-72-0822	VEMO 7.11020.16.0	V40-72-0295	VEMO 7.08369.38.0
V30-72-0824	VEMO 7.08369.51.0	V40-72-0296	VEMO 7.08369.32.0
V30-72-0825	VEMO 7.11492.07.0	V40-72-0297	VEMO 7.08369.05.0
V30-72-0830	VEMO 7.08369.89.0	V40-72-0298	VEMO 7.08369.17.0
V30-72-0830	VEMO 7.11020.32.0	V40-72-0564	VEMO 7.11190.04.0
V30-72-0831	VEMO 7.11020.29.0	V40-72-0592	VEMO 7.08369.15.0
V30-72-0881	VEMO 7.11020.30.0	V40-72-0608	VEMO 7.08369.54.0
V30-72-0885	VEMO 7.08369.77.0	V40-72-0643	VEMO 7.11020.49.0
V30-72-0886	VEMO 7.11020.40.0	V40-72-0644	VEMO 7.08369.70.0
V30-76-0007	VEMO 7.05270.15.0	V40-76-0006	VEMO 7.05271.55.0
V30-76-0008	VEMO 7.05270.03.0	V40-76-0011	VEMO 7.05270.25.0
V30-76-0009	VEMO 7.05270.15.0	V40-76-0012	VEMO 7.02604.07.0
V30-76-0013	VEMO 7.02604.28.0	V40-76-0014	VEMO 7.05270.32.0
V30-76-0014	VEMO 7.05270.15.0	V40-76-0015	VEMO 7.05270.33.0
V30-76-0016	VEMO 7.05270.12.0	V40-76-0018	VEMO 7.05270.26.0
V30-76-0017	VEMO 7.05270.11.0	V40-76-0019	VEMO 7.05271.52.0
V30-76-0018	VEMO 7.05270.03.0	V40-76-0020	VEMO 7.05270.30.0
V30-76-0022	VEMO 7.05270.03.0	V40-76-0021	VEMO 7.05270.34.0
V30-76-0023	VEMO 7.05270.15.0	V40-76-0022	VEMO 7.05271.62.0
V30-76-0025	VEMO 7.02604.26.0	V40-76-0024	VEMO 7.05271.68.0
V30-76-0026	VEMO 7.05270.11.0	V40-76-0026	VEMO 7.05270.25.0
V30-76-0027	VEMO 7.05270.12.0	V40-76-0027	VEMO 7.05270.27.0
V30-76-0030	VEMO 7.02604.26.0	V40-99-0031	VEMO 7.04879.00.0
V30-76-0031	VEMO 7.05270.11.0	V42-63-0001	VEMO 7.22843.07.0
V30-76-0039	VEMO 7.05270.17.0	V42-63-0002	VEMO 7.24809.39.0
V30-76-0040	VEMO 7.05270.22.0	V42-63-0002-1	VEMO 7.24809.39.0
V30-76-0043	VEMO 7.02604.27.0	V42-63-0009	VEMO 7.24809.94.0
V33-63-0001	VEMO 7.01317.10.0	V42-63-0010	VEMO 7.02156.24.0
V33-63-0002	VEMO 7.03295.03.0	V42-63-0010-1	VEMO 7.02156.24.0
V33-63-0005	VEMO 7.28290.11.0	V42-63-0014	VEMO 7.03647.10.0
V33-63-0006	VEMO 7.28270.14.0	V42-76-0001	VEMO 7.05270.37.0
V33-63-0007	VEMO 7.00632.13.0	V42-76-0006	VEMO 7.05270.36.0
V37-74-0004	VEMO 7.05271.63.0	V42-76-0007	VEMO 7.05270.39.0
V38-63-0008	VEMO 7.02014.07.0	V42-76-0008	VEMO 7.05270.39.0
V38-72-0126	VEMO 7.11190.08.0	V42-76-0009	VEMO 7.05270.37.0
V38-76-0012	VEMO 7.05270.55.0	V42-76-0011	VEMO 7.05270.38.0
V38-76-0015	VEMO 7.05271.69.0	V42-76-0012	VEMO 7.05270.38.0
V40-63-0007	VEMO 7.24809.10.0	V42-76-0013	VEMO 7.05270.38.0
V40-63-0008	VEMO 7.22818.57.0	V45-66-0001	VEMO 7.00018.50.0
V40-63-0009	VEMO 7.22414.04.0	V45-66-0002	VEMO 7.00018.51.0
V40-63-0009	VEMO 7.22414.08.0	V45-66-0003	VEMO 7.00018.52.0
V40-63-0010	VEMO 7.22875.16.0	V46-63-0001	VEMO 7.00075.07.0
V40-63-0011	VEMO 7.22875.13.0	V46-63-0002	VEMO 7.22818.58.0
V40-63-0014	VEMO 7.00063.10.0	V46-63-0005	VEMO 7.22818.59.0
V40-63-0015	VEMO 7.22946.38.0	V46-63-0006	VEMO 7.22818.62.0
V40-63-0016	VEMO 7.00020.24.0	V46-63-0009	VEMO 7.00368.15.0
V40-63-0016	VEMO 7.10334.05.0	V46-63-0009-1	VEMO 7.00368.15.0
V40-63-0018	VEMO 7.24809.29.0	V46-63-0011	VEMO 7.10334.06.0
V40-63-0019	VEMO 7.24809.27.0	V46-63-0013	VEMO 7.24809.90.0
V40-63-0020	VEMO 7.24809.28.0	V46-63-0018	VEMO 7.00368.16.0
V40-63-0021	VEMO 7.22414.04.0	V46-63-0019	VEMO 7.03435.05.0
V40-63-0024	VEMO 7.24809.24.0	V46-76-0001	VEMO 7.02604.10.0
V40-63-0025	VEMO 7.24809.25.0	V46-76-0004	VEMO 7.05270.45.0
V40-63-0026	VEMO 7.22414.07.0	V46-76-0006	VEMO 7.05270.48.0
V40-63-0029	VEMO 7.22772.12.0	V46-76-0008	VEMO 7.05270.51.0
V40-63-0030	VEMO 7.24809.78.0	V46-76-0009	VEMO 7.05270.49.0
V40-63-0031	VEMO 7.22772.11.0	V46-76-0011	VEMO 7.05270.56.0
V40-63-0032	VEMO 7.22818.63.0	V46-76-0013	VEMO 7.05270.54.0
V40-63-0036	VEMO 7.22630.28.0	V46-76-0015	VEMO 7.05270.47.0
V40-63-0037	VEMO 7.28384.13.0	V46-76-0015	VEMO 7.05270.51.0
V40-63-0045	VEMO 7.10334.03.0	V46-89-0001	VEMO 7.03571.16.0
V40-63-0048	VEMO 7.00020.50.0	V48-63-0002	VEMO 7.24809.95.0



NUMBERFINDER

REF-No.			REF-No.		
V48-63-0007	VEMO	7.24809.97.0	WG1015070	WILMINK	7.08369.30.0
V49-66-0001	VEMO	7.22427.03.0	WG1015073	WILMINK	7.08369.35.0
V49-76-0003	VEMO	7.05271.75.0	WG1015074	WILMINK	7.11020.04.0
V50-76-0002	VEMO	7.05270.36.0	WG1015076	WILMINK	7.11020.09.0
V51-63-0019	VEMO	7.05012.01.0	WG1015083	WILMINK	7.11020.08.0
V52-63-0004	VEMO	7.09002.05.0	WG1015212	WILMINK	7.22414.07.0
V52-63-0005	VEMO	7.09002.09.0	WG1015215	WILMINK	7.22785.17.0
V52-76-0004	VEMO	7.02604.73.0	WG1015225	WILMINK	7.22630.28.0
V52-76-0007	VEMO	7.02604.75.0	WG1015231	WILMINK	7.22414.08.0
V52-76-0008	VEMO	7.02604.79.0	WG1015242	WILMINK	7.24809.24.0
V52-76-0009	VEMO	7.02604.75.0	WG1015242	WILMINK	7.24809.27.0
V53-63-0003	VEMO	7.09002.12.0	WG1015249	WILMINK	7.24809.92.0
V53-76-0001	VEMO	7.02604.77.0	WG1015250	WILMINK	7.11237.01.0
V64-76-0004	VEMO	7.05271.54.0	WG1015251	WILMINK	7.24809.96.0
V70-76-0012	VEMO	7.05271.51.0	WG1015252	WILMINK	7.24809.91.0
V753526980	PSA	7.02604.41.0	WG1015257	WILMINK	7.00368.15.0
V754986080	PSA	7.02604.41.0	WG1015259	WILMINK	7.22946.38.0
V756095780	PSA	7.02604.41.0	WG1015261	WILMINK	7.10334.10.0
V759486080	PSA	7.02604.41.0	WG1015262	WILMINK	7.24809.77.0
V95-63-0003	VEMO	7.00555.06.0	WG1015266	WILMINK	7.22843.06.0
V95-63-0004	VEMO	7.02209.11.0	WG1015272	WILMINK	7.00075.07.0
V95-63-0005	VEMO	7.22996.11.0	WG1015273	WILMINK	7.24809.51.0
V95-63-0006	VEMO	7.21857.01.0	WG1015274	WILMINK	7.24809.68.0
V95-63-0007	VEMO	7.21857.59.0	WG1015281	WILMINK	7.09002.09.0
V95-63-0011	VEMO	7.02107.09.0	WG1015285	WILMINK	7.09002.05.0
V95-63-0013	VEMO	7.22996.12.0	WG1015297	WILMINK	7.28069.04.0
V95-63-0017	VEMO	7.01604.02.0	WG1015298	WILMINK	7.00578.12.0
V95-72-0071	VEMO	7.11020.14.0	WG1015299	WILMINK	7.28069.03.0
V95-72-0073	VEMO	7.11020.45.0	WG1015302	WILMINK	7.09002.00.0
V95-72-0074	VEMO	7.11020.13.0	WG1015304	WILMINK	7.24809.36.0
V95-72-0075	VEMO	7.11020.44.0	WG1015312	WILMINK	7.22477.10.0
V95-72-0096	VEMO	7.08369.55.0	WG1015315	WILMINK	7.09002.11.0
V95-72-0107	VEMO	7.08369.69.0	WG1015316	WILMINK	7.09002.12.0
V95-72-0127	VEMO	7.11020.43.0	WG1015319	WILMINK	7.24809.79.0
V95-76-0003	VEMO	7.05270.79.0	WG1015321	WILMINK	7.24809.80.0
V95-76-0004	VEMO	7.05270.72.0	WG1015322	WILMINK	7.00450.09.0
V95-76-0004	VEMO	7.05270.73.0	WG1015328	WILMINK	7.11237.00.0
V95-76-0006	VEMO	7.05270.67.0	WG1015332	WILMINK	7.11237.06.0
V95-76-0007	VEMO	7.05270.67.0	WG1015333	WILMINK	7.24809.99.0
V95-76-0009	VEMO	7.05270.71.0	WG1015335	WILMINK	7.24809.47.0
V95-76-0014	VEMO	7.05270.66.0	WG1015336	WILMINK	7.24809.53.0
V95-76-0015	VEMO	7.05270.66.0	WG1015343	WILMINK	7.00789.10.0
V95-76-0017	VEMO	7.05270.81.0	WG1015345	WILMINK	7.02156.24.0
V96-66-0002	VEMO	7.22299.03.0	WG1015345	WILMINK	7.02156.35.0
VX021131101AVX	FORD	7.22090.11.0	WG1015371	WILMINK	7.01493.07.0
WAV000040	LAND ROVER	7.28264.06.0	WG1015376	WILMINK	7.03784.34.0
WAV100380	LAND ROVER	7.22427.03.0	WG1015388	WILMINK	7.22414.08.0
WAV500210	LAND ROVER	7.11237.01.0	WG1015393	WILMINK	7.22818.58.0
WE01-20-300A	MAZDA	7.24809.75.0	WG1025532	WILMINK	7.00018.50.0
WG1012846	WILMINK	7.05271.22.0	WG1025533	WILMINK	7.00018.51.0
WG1013886	WILMINK	7.05271.22.0	WG1025534	WILMINK	7.00018.52.0
WG1014764	WILMINK	7.03446.01.0	WG1025536	WILMINK	7.00020.25.0
WG1015007	WILMINK	7.11190.08.0	WG1025538	WILMINK	7.00020.40.0
WG1015008	WILMINK	7.11190.00.0	WG1025541	WILMINK	7.00063.10.0
WG1015009	WILMINK	7.11190.02.0	WG1025542	WILMINK	7.00075.07.0
WG1015010	WILMINK	7.11190.09.0	WG1025556	WILMINK	7.00306.37.0
WG1015026	WILMINK	7.08369.03.0	WG1025559	WILMINK	7.00368.15.0
WG1015026	WILMINK	7.08369.04.0	WG1025567	WILMINK	7.00450.09.0
WG1015027	WILMINK	7.08369.09.0	WG1025611	WILMINK	7.05271.22.0
WG1015033	WILMINK	7.08369.01.0	WG1025662	WILMINK	7.00578.12.0
WG1015034	WILMINK	7.08369.41.0	WG1025720	WILMINK	7.01106.38.0
WG1015037	WILMINK	7.08369.02.0	WG1025730	WILMINK	7.01486.10.0
WG1015038	WILMINK	7.08369.08.0	WG1025734	WILMINK	7.01268.03.0
WG1015040	WILMINK	7.08369.14.0	WG1025736	WILMINK	7.01318.20.0
WG1015044	WILMINK	7.08369.05.0	WG1025740	WILMINK	7.01486.08.0
WG1015045	WILMINK	7.08369.32.0	WG1025742	WILMINK	7.01493.07.0
WG1015050	WILMINK	7.08369.38.0	WG1025743	WILMINK	7.01510.31.0
WG1015052	WILMINK	7.08369.17.0	WG1025744	WILMINK	7.01510.57.0
WG1015056	WILMINK	7.11020.38.0	WG1025796	WILMINK	7.02107.09.0



REF-No.	 PIERBURG	REF-No.	 PIERBURG
WG1025799	WILMINK 7.02156.24.0	WG1026848	WILMINK 7.22778.95.0
WG1025959	WILMINK 7.02604.07.0	WG1026849	WILMINK 7.22778.96.0
WG1025992	WILMINK 7.02604.41.0	WG1026850	WILMINK 7.22778.97.0
WG1026253	WILMINK 7.03446.01.0	WG1026851	WILMINK 7.22778.98.0
WG1026255	WILMINK 7.03635.12.0	WG1026852	WILMINK 7.22778.99.0
WG1026311	WILMINK 7.04389.00.0	WG1026853	WILMINK 7.22785.16.0
WG1026313	WILMINK 7.04389.02.0	WG1026854	WILMINK 7.22785.17.0
WG1026443	WILMINK 7.05271.22.0	WG1026855	WILMINK 7.22785.18.0
WG1026445	WILMINK 7.05271.24.0	WG1026856	WILMINK 7.22785.20.0
WG1026462	WILMINK 7.05574.00.0	WG1026860	WILMINK 7.22818.58.0
WG1026463	WILMINK 7.05574.01.0	WG1026861	WILMINK 7.22818.59.0
WG1026464	WILMINK 7.05574.02.0	WG1026862	WILMINK 7.22818.62.0
WG1026465	WILMINK 7.05574.03.0	WG1026865	WILMINK 7.22841.08.0
WG1026621	WILMINK 7.21851.31.0	WG1026866	WILMINK 7.22843.06.0
WG1026622	WILMINK 7.21851.32.0	WG1026879	WILMINK 7.22934.57.0
WG1026624	WILMINK 7.21852.24.0	WG1026882	WILMINK 7.22936.08.0
WG1026626	WILMINK 7.21852.78.0	WG1026883	WILMINK 7.22938.06.0
WG1026627	WILMINK 7.21852.79.0	WG1026884	WILMINK 7.22939.03.0
WG1026630	WILMINK 7.21852.85.0	WG1026887	WILMINK 7.22946.38.0
WG1026634	WILMINK 7.21857.01.0	WG1026965	WILMINK 7.24809.17.0
WG1026636	WILMINK 7.21857.59.0	WG1026974	WILMINK 7.24809.30.0
WG1026653	WILMINK 7.21949.51.0	WG1026977	WILMINK 7.24809.33.0
WG1026669	WILMINK 7.22090.11.0	WG1026979	WILMINK 7.24809.35.0
WG1026678	WILMINK 7.22166.02.0	WG1026980	WILMINK 7.24809.36.0
WG1026680	WILMINK 7.22166.38.0	WG1026984	WILMINK 7.01621.08.0
WG1026681	WILMINK 7.22166.39.0	WG1026991	WILMINK 7.24809.47.0
WG1026736	WILMINK 7.22286.26.0	WG1026995	WILMINK 7.24809.51.0
WG1026737	WILMINK 7.22286.41.0	WG1026996	WILMINK 7.24809.52.0
WG1026738	WILMINK 7.22286.51.0	WG1026997	WILMINK 7.24809.53.0
WG1026739	WILMINK 7.22286.52.0	WG1027001	WILMINK 7.24809.57.0
WG1026740	WILMINK 7.22286.53.0	WG1027014	WILMINK 7.28069.03.0
WG1026741	WILMINK 7.22286.54.0	WG1027015	WILMINK 7.28069.04.0
WG1026742	WILMINK 7.22286.55.0	WG1027019,	WILMINK 7.28124.19.0
WG1026743	WILMINK 7.22295.61.0	WG1027020	WILMINK 7.28124.20.0
WG1026744	WILMINK 7.22295.62.0	WG1027022	WILMINK 7.28124.30.0
WG1026745	WILMINK 7.22295.63.0	WG1027035	WILMINK 7.28238.55.0
WG1026746	WILMINK 7.22295.65.0	WG1027036	WILMINK 7.28238.56.0
WG1026747	WILMINK 7.22295.66.0	WG1027037	WILMINK 7.28238.57.0
WG1026748	WILMINK 7.22295.67.0	WG1027038	WILMINK 7.28238.58.0
WG1026749	WILMINK 7.22295.68.0	WG1027041	WILMINK 7.28238.61.0
WG1026750	WILMINK 7.22295.69.0	WG1027042	WILMINK 7.28238.62.0
WG1026751	WILMINK 7.22295.70.0	WG1027043	WILMINK 7.28238.63.0
WG1026752	WILMINK 7.22295.71.0	WG1027051	WILMINK 7.28290.11.0
WG1026753	WILMINK 7.22296.02.0	WG1027073	WILMINK 7.28415.09.0
WG1026754	WILMINK 7.22299.03.0	WG1029083	WILMINK 7.02604.07.0
WG1026769	WILMINK 7.22414.07.0	WG1029180	WILMINK 7.24809.68.0
WG1026770	WILMINK 7.22414.08.0	WG1029252	WILMINK 7.05271.24.0
WG1026771	WILMINK 7.22427.03.0	WG1032367	WILMINK 7.22843.06.0
WG1026790	WILMINK 7.22477.10.0	WG1032387	WILMINK 7.11237.05.0
WG1026791	WILMINK 7.22477.11.0	WG1091426	WILMINK 7.24809.61.0
WG1026796	WILMINK 7.22560.40.0	WG1091430	WILMINK 7.24809.35.0
WG1026797	WILMINK 7.22560.41.0	WG1091431	WILMINK 7.24809.52.0
WG1026798	WILMINK 7.22560.42.0	WG1091437	WILMINK 7.24809.30.0
WG1026799	WILMINK 7.22560.43.0	WG1091438	WILMINK 7.24809.17.0
WG1026800	WILMINK 7.22560.44.0	WG1091440	WILMINK 7.24809.57.0
WG1026801	WILMINK 7.22560.45.0	WG1091442	WILMINK 7.24809.53.0
WG1026807	WILMINK 7.22630.28.0	WG1091447	WILMINK 7.24809.36.0
WG1026831	WILMINK 7.22738.08.0	WG1091452	WILMINK 7.24809.33.0
WG1026833	WILMINK 7.22738.20.0	WG1091454	WILMINK 7.24809.47.0
WG1026836	WILMINK 7.22748.18.0	WG1091461	WILMINK 7.24809.51.0
WG1026837	WILMINK 7.22769.73.0	WG1151026	WILMINK 7.11020.07.0
WG1026838	WILMINK 7.22769.76.0	WG1268320	WILMINK 7.11020.14.0
WG1026839	WILMINK 7.22769.77.0	WG1268321	WILMINK 7.11020.13.0
WG1026840	WILMINK 7.22769.78.0	WG1268344	WILMINK 7.08369.34.0
WG1026841	WILMINK 7.22769.79.0	WG1268345	WILMINK 7.08369.37.0
WG1026842	WILMINK 7.22769.80.0	WG1268347	WILMINK 7.11020.02.0
WG1026845	WILMINK 7.22778.79.0	WG1268347	WILMINK 7.08369.43.0
WG1026846	WILMINK 7.22778.80.0	WG1268362	WILMINK 7.11020.10.0
WG1026847	WILMINK 7.22778.94.0	WG1268370	WILMINK 7.08369.27.0



NUMBERFINDER

REF-No.		REF-No.			
WG1268373	WILMINK	7.11020.45.0	WG1409022	WILMINK	7.21851.32.0
WG1268399	WILMINK	7.08369.82.0	WG1409023	WILMINK	7.22166.38.0
WG1268400	WILMINK	7.11020.19.0	WG1409024	WILMINK	7.22934.63.0
WG1268401	WILMINK	7.08369.93.0	WG1409025	WILMINK	7.21857.59.0
WG1268402	WILMINK	7.08369.92.0	WG1409026	WILMINK	7.22738.20.0
WG1268406	WILMINK	7.08369.83.0	WG1409030	WILMINK	7.21857.01.0
WG1268457	WILMINK	7.22778.96.0	WG1409032	WILMINK	7.21852.79.0
WG1281933	WILMINK	7.03435.05.0	WG1409034	WILMINK	7.28415.09.0
WG1284739	WILMINK	7.00020.50.0	WG1409962	WILMINK	7.22818.58.0
WG1344242	WILMINK	7.22818.58.0	WG1409962	WILMINK	7.22818.59.0
WG1353869	WILMINK	7.01317.10.0	WG1409970	WILMINK	7.22414.08.0
WG1353931	WILMINK	7.03051.04.0	WG1429151	WILMINK	7.22738.08.0
WG1353932	WILMINK	7.03083.20.0	WG1430054	WILMINK	7.22414.08.0
WG1353934	WILMINK	7.03295.03.0	WG1431280	WILMINK	7.22843.06.0
WG1353935	WILMINK	7.03571.16.0	WG1478396	WILMINK	7.03784.34.0
WG1353968	WILMINK	7.04038.08.0	WG1484252	WILMINK	7.08369.78.0
WG1353970	WILMINK	7.04256.35.0	WG1484254	WILMINK	7.08369.68.0
WG1353970	WILMINK	7.04256.36.0	WG1484284	WILMINK	7.08369.95.0
WG1353972	WILMINK	7.04257.19.0	WG1487683	WILMINK	7.08369.96.0
WG1353973	WILMINK	7.04257.20.0	WG1487684	WILMINK	7.08369.02.0
WG1353975	WILMINK	7.04402.02.0	WG1487686	WILMINK	7.08369.01.0
WG1354374	WILMINK	7.24809.66.0	WG1487687	WILMINK	7.08369.18.0
WG1354376	WILMINK	7.24809.68.0	WG1487691	WILMINK	7.08369.41.0
WG1407227	WILMINK	7.11020.37.0	WG1487692	WILMINK	7.08369.03.0
WG1407235	WILMINK	7.08369.15.0	WG1487693	WILMINK	7.08369.08.0
WG1407484	WILMINK	7.11492.03.0	WG1487694	WILMINK	7.08369.34.0
WG1408621	WILMINK	7.22414.08.0	WG1487697	WILMINK	7.08369.40.0
WG1408627	WILMINK	7.22818.59.0	WG1487704	WILMINK	7.08369.43.0
WG1408628	WILMINK	7.22818.59.0	WG1487707	WILMINK	7.08369.23.0
WG1408630	WILMINK	7.22818.58.0	WG1487711	WILMINK	7.11020.03.0
WG1408631	WILMINK	7.22818.58.0	WG1487715	WILMINK	7.08369.14.0
WG1408633	WILMINK	7.00063.10.0	WG1487718	WILMINK	7.08369.45.0
WG1408653	WILMINK	7.22785.16.0	WG1487720	WILMINK	7.08369.36.0
WG1408656	WILMINK	7.24809.17.0	WG1487721	WILMINK	7.08369.33.0
WG1408657	WILMINK	7.22477.11.0	WG1487726	WILMINK	7.08369.22.0
WG1408659	WILMINK	7.22818.62.0	WG1487734	WILMINK	7.08369.04.0
WG1408675	WILMINK	7.11237.04.0	WG1487735	WILMINK	7.08369.44.0
WG1408680	WILMINK	7.22785.18.0	WG1487746	WILMINK	7.08369.38.0
WG1408687	WILMINK	7.24809.57.0	WG1487747	WILMINK	7.08369.32.0
WG1408688	WILMINK	7.24809.52.0	WG1487748	WILMINK	7.08369.15.0
WG1408693	WILMINK	7.24809.68.0	WG1487750	WILMINK	7.08369.05.0
WG1408699	WILMINK	7.21949.51.0	WG1487751	WILMINK	7.08369.17.0
WG1408714	WILMINK	7.24809.35.0	WG1492208	WILMINK	7.00411.05.0
WG1408735	WILMINK	7.24809.90.0	WG1492210	WILMINK	7.00748.06.0
WG1408742	WILMINK	7.24809.93.0	WG1492213	WILMINK	7.01240.03.0
WG1408757	WILMINK	7.00999.08.0	WG1492215	WILMINK	7.01859.03.0
WG1408759	WILMINK	7.03435.05.0	WG1492219	WILMINK	7.02321.17.0
WG1408764	WILMINK	7.00020.50.0	WG1492233	WILMINK	7.03527.12.0
WG1408766	WILMINK	7.03295.03.0	WG1492234	WILMINK	7.03608.16.0
WG1408776	WILMINK	7.22785.18.0	WG1492235	WILMINK	7.04209.06.0
WG1408997	WILMINK	7.22738.08.0	WG1492236	WILMINK	7.04210.06.0
WG1408998	WILMINK	7.22934.57.0	WG1492239	WILMINK	7.04371.07.0
WG1408999	WILMINK	7.28124.19.0	WG1492241	WILMINK	7.04709.13.0
WG1409000	WILMINK	7.28124.20.0	WG1492316	WILMINK	7.07696.00.0
WG1409001	WILMINK	7.01486.10.0	WG1492317	WILMINK	7.21852.82.0
WG1409002	WILMINK	7.04389.00.0	WG1492323	WILMINK	7.22934.63.0
WG1409004	WILMINK	7.04389.02.0	WG1492388	WILMINK	7.22414.08.0
WG1409005	WILMINK	7.21851.31.0	WG1494043	WILMINK	7.08369.17.0
WG1409006	WILMINK	7.21852.24.0	WG1494110	WILMINK	7.08369.05.0
WG1409008	WILMINK	7.28238.55.0	WG1494111	WILMINK	7.08369.32.0
WG1409009	WILMINK	7.22296.02.0	WG1494115	WILMINK	7.08369.38.0
WG1409010	WILMINK	7.05574.00.0	WG1494172	WILMINK	7.08369.04.0
WG1409011	WILMINK	7.05574.01.0	WG1494196	WILMINK	7.08369.14.0
WG1409012	WILMINK	7.22778.97.0	WG1494223	WILMINK	7.08369.15.0
WG1409013	WILMINK	7.22769.77.0	WG1494231	WILMINK	7.11020.27.0
WG1409014	WILMINK	7.22769.78.0	WG1494313	WILMINK	7.08369.03.0
WG1409015	WILMINK	7.22769.73.0	WG1494314	WILMINK	7.08369.02.0
WG1409019	WILMINK	7.22166.02.0	WG1494315	WILMINK	7.08369.23.0
WG1409021	WILMINK	7.21852.85.0	WG1494317	WILMINK	7.08369.41.0



REF-No.	 PIERBURG	REF-No.	 PIERBURG
WG1494335	WILMINK 7.08369.09.0	WG1724411	WILMINK 7.22818.58.0
WG1494338	WILMINK 7.08369.01.0	WG1724425	WILMINK 7.22818.62.0
WG1494414	WILMINK 7.08369.35.0	WG1724484	WILMINK 7.00075.07.0
WG1494453	WILMINK 7.22843.06.0	WG1724515	WILMINK 7.00450.09.0
WG1494462	WILMINK 7.22630.28.0	WG1725634	WILMINK 7.04433.02.0
WG1494466	WILMINK 7.22785.17.0	WG1726484	WILMINK 7.02738.13.0
WG1494470	WILMINK 7.22414.08.0	WG1726503	WILMINK 7.04512.08.0
WG1494474	WILMINK 7.22818.59.0	WG1726505	WILMINK 7.05052.00.0
WG1494476	WILMINK 7.22818.58.0	WG1726568	WILMINK 7.24809.74.0
WG1494477	WILMINK 7.00063.10.0	WG1748749	WILMINK 7.08369.98.0
WG1494478	WILMINK 7.00063.10.0	WG1748750	WILMINK 7.08369.99.0
WG1494490	WILMINK 7.21949.51.0	WG1748756	WILMINK 7.11020.15.0
WG1494494	WILMINK 7.22785.18.0	WG1748764	WILMINK 7.08369.33.0
WG1494495	WILMINK 7.22785.16.0	WG1748767	WILMINK 7.08369.22.0
WG1494503	WILMINK 7.22946.38.0	WG1748768	WILMINK 7.08369.40.0
WG1494505	WILMINK 7.24809.17.0	WG1748793	WILMINK 7.08369.62.0
WG1494518	WILMINK 7.24809.24.0	WG1748797	WILMINK 7.08369.23.0
WG1494518	WILMINK 7.24809.27.0	WG1748803	WILMINK 7.08369.45.0
WG1494520	WILMINK 7.24809.28.0	WG1748806	WILMINK 7.08369.39.0
WG1494521	WILMINK 7.24809.52.0	WG1748807	WILMINK 7.08369.18.0
WG1494525	WILMINK 7.24809.30.0	WG1749279	WILMINK 7.22818.59.0
WG1494526	WILMINK 7.24809.57.0	WG1749282	WILMINK 7.22414.08.0
WG1494531	WILMINK 7.24809.33.0	WG1749283	WILMINK 7.22818.62.0
WG1494532	WILMINK 7.24809.51.0	WG1749293	WILMINK 7.02156.24.0
WG1494537	WILMINK 7.24809.36.0	WG1749306	WILMINK 7.24809.87.0
WG1494541	WILMINK 7.24809.97.0	WG1749318	WILMINK 7.24809.74.0
WG1494542	WILMINK 7.11237.03.0	WG1749345	WILMINK 7.01621.08.0
WG1494543	WILMINK 7.24809.95.0	WG1749379	WILMINK 7.07696.00.0
WG1494560	WILMINK 7.11237.08.0	WG1749380	WILMINK 7.03608.16.0
WG1494567	WILMINK 7.22414.07.0	WG1749381	WILMINK 7.04709.13.0
WG1494567	WILMINK 7.22818.62.0	WG1755857	WILMINK 7.08369.01.0
WG1494568	WILMINK 7.22477.11.0	WG1755859	WILMINK 7.08369.02.0
WG1494587	WILMINK 7.00368.15.0	WG1755862	WILMINK 7.08369.09.0
WG1494599	WILMINK 7.22818.62.0	WG1755863	WILMINK 7.08369.45.0
WG1494604	WILMINK 7.24809.68.0	WG1755870	WILMINK 7.08369.31.0
WG1494607	WILMINK 7.24809.79.0	WG1755871	WILMINK 7.08369.11.0
WG1494621	WILMINK 7.09002.00.0	WG1755873	WILMINK 7.08369.40.0
WG1494622	WILMINK 7.22843.06.0	WG1755883	WILMINK 7.08369.41.0
WG1494636	WILMINK 7.00020.40.0	WG1755885	WILMINK 7.08369.34.0
WG1494637	WILMINK 7.28069.03.0	WG1777576	WILMINK 7.03435.05.0
WG1494655	WILMINK 7.02156.24.0	WG1777581	WILMINK 7.22785.20.0
WG1494656	WILMINK 7.00578.12.0	WG1778567	WILMINK 7.05271.22.0
WG1494662	WILMINK 7.24809.53.0	WG1795106	WILMINK 7.00450.09.0
WG1494663	WILMINK 7.24809.47.0	WG1795508	WILMINK 7.24809.30.0
WG1494673	WILMINK 7.00020.50.0	WG1795850	WILMINK 7.22818.59.0
WG1494675	WILMINK 7.00450.09.0	WG1804892	WILMINK 7.01881.07.0
WG1494678	WILMINK 7.28069.04.0	WG1804894	WILMINK 7.03379.03.0
WG1494680	WILMINK 7.00789.10.0	WG1805538	WILMINK 7.22785.20.0
WG1494697	WILMINK 7.01621.08.0	WG1806735	WILMINK 7.00678.06.0
WG1494699	WILMINK 7.24809.74.0	WG1806736	WILMINK 7.02156.35.0
WG1494726	WILMINK 7.24809.61.0	WG1806738	WILMINK 7.04389.06.0
WG1494731	WILMINK 7.02156.24.0	WG1806739	WILMINK 7.04389.07.0
WG1494755	WILMINK 7.01493.07.0	WG1806743	WILMINK 7.05031.06.0
WG1494758	WILMINK 7.24809.94.0	WG1806744	WILMINK 7.05320.04.0
WG1494760	WILMINK 7.24809.87.0	WG1806771	WILMINK 7.22996.12.0
WG1494762	WILMINK 7.11237.07.0	WG1806772	WILMINK 7.24809.79.0
WG1494768	WILMINK 7.22477.10.0	WG1807137	WILMINK 7.00216.06.0
WG1498653	WILMINK 7.05271.22.0	WG1807138	WILMINK 7.01881.06.0
WG1500962	WILMINK 7.08369.04.0	WG1807139	WILMINK 7.02156.33.0
WG1500963	WILMINK 7.08369.17.0	WG1807140	WILMINK 7.02156.34.0
WG1500964	WILMINK 7.08369.03.0	WG1807141	WILMINK 7.03622.09.0
WG1500965	WILMINK 7.08369.14.0	WG1807453	WILMINK 7.11492.05.0
WG1500969	WILMINK 7.08369.08.0	WG1807792	WILMINK 7.08369.14.0
WG1500970	WILMINK 7.08369.05.0	WG1807793	WILMINK 7.08369.05.0
WG1500971	WILMINK 7.08369.32.0	WG1807800	WILMINK 7.08369.01.0
WG1500977	WILMINK 7.08369.46.0	WG1807802	WILMINK 7.08369.43.0
WG1700201	WILMINK 7.22477.10.0	WG1820259	WILMINK 7.11492.07.0
WG1700228	WILMINK 7.24809.17.0	WG1820328	WILMINK 7.01106.38.0
WG1700615	WILMINK 7.05662.07.0	WG1820329	WILMINK 7.01881.07.0

NUMBERFINDER

REF-No.		REF-No.			
WG1820346	WILMINK	7.04389.07.0	WG1897453	WILMINK	7.08369.40.0
WG1822308	WILMINK	7.09002.00.0	WG1897454	WILMINK	7.08369.41.0
WG1822334	WILMINK	7.03784.34.0	WG1897456	WILMINK	7.08369.43.0
WG1822343	WILMINK	7.03571.16.0	WG1897457	WILMINK	7.08369.44.0
WG1837542	WILMINK	7.05052.03.0	WG1897458	WILMINK	7.08369.45.0
WG1837633	WILMINK	7.01621.08.0	WG1897460	WILMINK	7.09002.08.0
WG1837868	WILMINK	7.00063.10.0	WG1897461	WILMINK	7.09002.09.0
WG1837871	WILMINK	7.22414.08.0	WG1897462	WILMINK	7.09002.12.0
WG1837873	WILMINK	7.22630.28.0	WG1898086	WILMINK	7.01621.08.0
WG1837996	WILMINK	7.01621.08.0	WG1899123	WILMINK	7.24809.28.0
WG1838016	WILMINK	7.24809.68.0	WG1899149	WILMINK	7.00075.07.0
WG1888861	WILMINK	7.00992.36.0	WG1899152	WILMINK	7.24809.68.0
WG1888862	WILMINK	7.01293.38.0	WG1899158	WILMINK	7.09002.00.0
WG1888863	WILMINK	7.01510.85.0	WG1899227	WILMINK	7.03051.04.0
WG1888864	WILMINK	7.01510.86.0	WG1899228	WILMINK	7.22939.03.0
WG1888865	WILMINK	7.01510.87.0	WG1899310	WILMINK	7.03571.16.0
WG1888871	WILMINK	7.02769.05.0	WG1901834	WILMINK	7.08369.09.0
WG1888872	WILMINK	7.03622.11.0	WG1901856	WILMINK	7.08369.05.0
WG1888873	WILMINK	7.03635.37.0	WG1901866	WILMINK	7.08369.17.0
WG1888874	WILMINK	7.03635.38.0	WG1903174	WILMINK	7.08369.22.0
WG1888875	WILMINK	7.03635.39.0	WG1903180	WILMINK	7.08369.81.0
WG1888876	WILMINK	7.03635.40.0	WG1903183	WILMINK	7.08369.23.0
WG1888877	WILMINK	7.03635.41.0	WG1903190	WILMINK	7.08369.43.0
WG1888880	WILMINK	7.04039.13.0	WG1903209	WILMINK	7.08369.27.0
WG1888885	WILMINK	7.04723.10.0	WG1903844	WILMINK	7.05320.04.0
WG1888887	WILMINK	7.04788.06.0	WG1906899	WILMINK	7.22560.43.0
WG1888888	WILMINK	7.05012.01.0	WG1909333	WILMINK	7.10992.00.0
WG1888899	WILMINK	7.06712.23.0	WG1924873	WILMINK	7.02751.02.0
WG1888927	WILMINK	7.08369.01.0	WG1924889	WILMINK	7.04382.09.0
WG1888928	WILMINK	7.08369.02.0	WG1924891	WILMINK	7.04739.09.0
WG1888929	WILMINK	7.08369.03.0	WG1924892	WILMINK	7.04784.06.0
WG1888930	WILMINK	7.08369.04.0	WG1924994	WILMINK	7.09002.05.0
WG1888931	WILMINK	7.08369.05.0	WG1937657	WILMINK	7.22785.18.0
WG1888934	WILMINK	7.08369.08.0	WG1937658	WILMINK	7.00020.25.0
WG1888935	WILMINK	7.08369.09.0	WG1938039	WILMINK	7.00020.25.0
WG1888937	WILMINK	7.08369.11.0	WG1938047	WILMINK	7.01621.08.0
WG1888940	WILMINK	7.08369.14.0	WG1938053	WILMINK	7.24809.28.0
WG1888941	WILMINK	7.08369.15.0	WG1938112	WILMINK	7.08369.38.0
WG1888943	WILMINK	7.08369.17.0	WG1938113	WILMINK	7.08369.32.0
WG1888944	WILMINK	7.08369.18.0	WG1938115	WILMINK	7.08369.17.0
WG1888945	WILMINK	7.08369.19.0	WG1938122	WILMINK	7.08369.34.0
WG1888948	WILMINK	7.08369.22.0	WG1938123	WILMINK	7.08369.40.0
WG1888949	WILMINK	7.08369.23.0	WG1938126	WILMINK	7.08369.08.0
WG1888952	WILMINK	7.08369.26.0	WG1938127	WILMINK	7.08369.02.0
WG1888953	WILMINK	7.08369.27.0	WG1946527	WILMINK	7.08369.09.0
WG1888956	WILMINK	7.08369.30.0	WG1946532	WILMINK	7.08369.41.0
WG1888959	WILMINK	7.09002.00.0	WG1964639	WILMINK	7.08369.04.0
WG1888964	WILMINK	7.24809.77.0	WG1964644	WILMINK	7.08369.01.0
WG1888965	WILMINK	7.24809.80.0	WG1964645	WILMINK	7.08369.41.0
WG1889426	WILMINK	7.22818.59.0	WG1964650	WILMINK	7.08369.02.0
WG1889427	WILMINK	7.22785.17.0	WG1964653	WILMINK	7.08369.14.0
WG1889665	WILMINK	7.08369.30.0	WG1964655	WILMINK	7.08369.38.0
WG1889788	WILMINK	7.08369.26.0	WG1964666	WILMINK	7.08369.35.0
WG1889796	WILMINK	7.08369.81.0	WG1964702	WILMINK	7.08369.15.0
WG1889798	WILMINK	7.08369.09.0	WG1964738	WILMINK	7.08369.40.0
WG1889800	WILMINK	7.11020.17.0	WG1964742	WILMINK	7.08369.23.0
WG1889805	WILMINK	7.11020.06.0	WG1964748	WILMINK	7.08369.39.0
WG1890049	WILMINK	7.08369.35.0	WG1964780	WILMINK	7.11020.26.0
WG1892944	WILMINK	7.05052.00.0	WG1964781	WILMINK	7.11020.31.0
WG1893397	WILMINK	7.00075.07.0	WG1964866	WILMINK	7.05271.22.0
WG1893404	WILMINK	7.03435.05.0	WG1965180	WILMINK	7.22630.28.0
WG1897433	WILMINK	7.01486.10.0	WG1965237	WILMINK	7.22996.12.0
WG1897445	WILMINK	7.08369.32.0	WG1965244	WILMINK	7.04923.18.0
WG1897446	WILMINK	7.08369.33.0	WG1966142	WILMINK	7.00020.40.0
WG1897447	WILMINK	7.08369.34.0	WG1966151	WILMINK	7.02107.09.0
WG1897448	WILMINK	7.08369.35.0	WG1966152	WILMINK	7.05031.06.0
WG1897449	WILMINK	7.08369.36.0	WG1966951	WILMINK	7.24809.30.0
WG1897451	WILMINK	7.08369.38.0	WG1966954	WILMINK	7.09002.00.0
WG1897452	WILMINK	7.08369.39.0	WG1977700	WILMINK	7.22785.17.0

REF-No.		 PIERBURG	REF-No.		 PIERBURG
WG1977714	WILMINK	7.22477.10.0	XEGR22	QUINTON HAZEL	7.24809.24.0
WG2015525	WILMINK	7.08369.17.0	XEGR22	QUINTON HAZEL	7.24809.27.0
WG2015538	WILMINK	7.08369.32.0	XEGR220	QUINTON HAZEL	7.22785.20.0
WG2015539	WILMINK	7.08369.38.0	XEGR23	QUINTON HAZEL	7.24809.34.0
WG2015549	WILMINK	7.08369.04.0	XEGR231	QUINTON HAZEL	7.24809.47.0
WG2015558	WILMINK	7.08369.14.0	XEGR236	QUINTON HAZEL	7.09720.01.0
WG2015565	WILMINK	7.08369.15.0	XEGR237	QUINTON HAZEL	7.09720.02.0
WG2015573	WILMINK	7.08369.41.0	XEGR24	QUINTON HAZEL	7.24809.30.0
WG2015582	WILMINK	7.08369.09.0	XEGR240	QUINTON HAZEL	7.24809.74.0
WG2015583	WILMINK	7.08369.01.0	XEGR247	QUINTON HAZEL	7.03435.05.0
WG2015592	WILMINK	7.08369.35.0	XEGR25	QUINTON HAZEL	7.24809.16.0
WG2015667	WILMINK	7.08369.84.0	XEGR26	QUINTON HAZEL	7.24809.25.0
WG2015671	WILMINK	7.08369.27.0	XEGR26	QUINTON HAZEL	7.24809.28.0
WG2015695	WILMINK	7.08369.22.0	XEGR27	QUINTON HAZEL	7.22818.57.0
WG2015696	WILMINK	7.08369.39.0	XEGR28	QUINTON HAZEL	7.00365.06.0
WG2015700	WILMINK	7.08369.40.0	XEGR29	QUINTON HAZEL	7.22875.16.0
WG2015725	WILMINK	7.22630.28.0	XEGR3	QUINTON HAZEL	7.24809.06.0
WG2042770	WILMINK	7.09002.12.0	XEGR31	QUINTON HAZEL	7.24809.39.0
WG2152412	WILMINK	7.08369.04.0	XEGR32	QUINTON HAZEL	7.24809.76.0
WG2152423	WILMINK	7.08369.27.0	XEGR41	QUINTON HAZEL	7.22843.07.0
WG2152424	WILMINK	7.08369.23.0	XEGR42	QUINTON HAZEL	7.00075.07.0
WG2152438	WILMINK	7.08369.33.0	XEGR43	QUINTON HAZEL	7.00907.03.0
WG2170487	WILMINK	7.08369.15.0	XEGR44	QUINTON HAZEL	7.22888.02.0
XC2F9F472BA	FORD	7.02604.60.0	XEGR45	QUINTON HAZEL	7.24809.56.0
XEG9014	ELTA	7.24809.68.0	XEGR46	QUINTON HAZEL	7.24809.38.0
XEG9017	ELTA	7.22818.58.0	XEGR47	QUINTON HAZEL	7.24809.33.0
XEG9024	ELTA	7.22843.06.0	XEGR48	QUINTON HAZEL	7.24809.63.0
XEG9028	ELTA	7.03784.34.0	XEGR49	QUINTON HAZEL	7.24809.57.0
XEG9042	ELTA	7.22818.59.0	XEGR50	QUINTON HAZEL	7.24809.52.0
XEG9043	ELTA	7.24809.36.0	XEGR51	QUINTON HAZEL	7.24809.49.0
XEG9046	ELTA	7.00368.15.0	XEGR54	QUINTON HAZEL	7.22477.11.0
XEG9071	ELTA	7.22818.62.0	XEGR55	QUINTON HAZEL	7.22477.10.0
XEG9078	ELTA	7.00450.09.0	XEGR56	QUINTON HAZEL	7.22818.59.0
XEG9102	ELTA	7.00075.07.0	XEGR57	QUINTON HAZEL	7.00020.25.0
XEG9171	ELTA	7.22738.08.0	XEGR6	QUINTON HAZEL	7.22414.08.0
XEG9204	ELTA	7.00578.12.0	XEGR60	QUINTON HAZEL	7.28069.03.0
XEG9225	ELTA	7.24809.47.0	XEGR61	QUINTON HAZEL	7.24809.36.0
XEG9261	ELTA	7.22414.08.0	XEGR62	QUINTON HAZEL	7.24809.37.0
XEG9273	ELTA	7.02156.24.0	XEGR63	QUINTON HAZEL	7.24809.55.0
XEG9323	ELTA	7.03435.05.0	XEGR64	QUINTON HAZEL	7.28069.04.0
XEGR1	QUINTON HAZEL	7.24809.29.0	XEGR65	QUINTON HAZEL	7.24809.32.0
XEGR107	QUINTON HAZEL	7.00578.12.0	XEGR66	QUINTON HAZEL	7.24809.51.0
XEGR11	QUINTON HAZEL	7.24809.07.0	XEGR68	QUINTON HAZEL	7.22785.17.0
XEGR118	QUINTON HAZEL	7.09002.05.0	XEGR69	QUINTON HAZEL	7.22843.06.0
XEGR121	QUINTON HAZEL	7.09002.00.0	XEGR7	QUINTON HAZEL	7.22414.04.0
XEGR124	QUINTON HAZEL	7.24809.59.0	XEGR73	QUINTON HAZEL	7.28070.03.0
XEGR127	QUINTON HAZEL	7.24809.77.0	XEGR74	QUINTON HAZEL	7.22946.34.0
XEGR13	QUINTON HAZEL	7.24809.10.0	XEGR75	QUINTON HAZEL	7.22946.33.0
XEGR135	QUINTON HAZEL	7.00450.09.0	XEGR75	QUINTON HAZEL	7.22946.34.0
XEGR140	QUINTON HAZEL	7.24809.78.0	XEGR76	QUINTON HAZEL	7.22818.62.0
XEGR144	QUINTON HAZEL	7.09002.08.0	XEGR77	QUINTON HAZEL	7.22785.18.0
XEGR145	QUINTON HAZEL	7.09002.09.0	XEGR78	QUINTON HAZEL	7.22785.16.0
XEGR150	QUINTON HAZEL	7.24809.35.0	XEGR79	QUINTON HAZEL	7.22574.12.0
XEGR158	QUINTON HAZEL	7.09002.11.0	XEGR8	QUINTON HAZEL	7.22875.13.0
XEGR159	QUINTON HAZEL	7.00512.03.0	XEGR80	QUINTON HAZEL	7.22136.50.0
XEGR16	QUINTON HAZEL	7.24809.17.0	XEGR81	QUINTON HAZEL	7.00020.24.0
XEGR17	QUINTON HAZEL	7.24809.26.0	XEGR82	QUINTON HAZEL	7.00368.15.0
XEGR18	QUINTON HAZEL	7.24809.31.0	XEGR83	QUINTON HAZEL	7.28248.17.0
XEGR181	QUINTON HAZEL	7.02156.24.0	XEGR85	QUINTON HAZEL	7.22818.59.0
XEGR182	QUINTON HAZEL	7.09002.12.0	XEGR85	QUINTON HAZEL	7.22818.63.0
XEGR184	QUINTON HAZEL	7.00450.10.0	XEGR86	QUINTON HAZEL	7.28384.13.0
XEGR191	QUINTON HAZEL	7.01621.08.0	XEGR87	QUINTON HAZEL	7.22946.38.0
XEGR193	QUINTON HAZEL	7.00020.50.0	XEGR88	QUINTON HAZEL	7.00063.10.0
XEGR198	QUINTON HAZEL	7.01604.02.0	XEGR89	QUINTON HAZEL	7.22818.58.0
XEGR2	QUINTON HAZEL	7.22630.28.0	XEGR907	QUINTON HAZEL	7.09730.01.0
XEGR20	QUINTON HAZEL	7.24809.19.0	XEGR908	QUINTON HAZEL	7.09730.00.0
XEGR200	QUINTON HAZEL	7.09720.00.0	XEGR91	QUINTON HAZEL	7.24809.68.0
XEGR21	QUINTON HAZEL	7.24809.20.0	XEGR98	QUINTON HAZEL	7.24809.69.0
XEGR217	QUINTON HAZEL	7.03196.09.0	XEGR99	QUINTON HAZEL	7.03784.34.0

NUMBERFINDER

REF-No.		REF-No.	
XELV29	QUINTON HAZEL	7.22738.08.0	
XF251432	FORD	7.02604.01.0	
XL3F9F472BA	FORD	7.02604.64.0	
XL3Z-9F472-BA	FORD	7.02604.64.0	
XL3Z9F472BA	FORD	7.02604.64.0	
XLOS1123	QUINTON HAZEL	7.05271.70.0	
XLOS1126	QUINTON HAZEL	7.05271.58.0	
XLOS1154	QUINTON HAZEL	7.05271.55.0	
XLOS1240	QUINTON HAZEL	7.05271.65.0	
XLOS1242	QUINTON HAZEL	7.05271.53.0	
XLOS1281	QUINTON HAZEL	7.05271.68.0	
XLOS1346	QUINTON HAZEL	7.05271.71.0	
XLOS1443	QUINTON HAZEL	7.05271.72.0	
XLOS1444	QUINTON HAZEL	7.05271.52.0	
XLOS1471	QUINTON HAZEL	7.05271.39.0	
XLOS1496	QUINTON HAZEL	7.05271.62.0	
XLOS1537	QUINTON HAZEL	7.05271.74.0	
XLOS1575	QUINTON HAZEL	7.05271.37.0	
XLOS1580	QUINTON HAZEL	7.05271.67.0	
XLOS1599	QUINTON HAZEL	7.05271.38.0	
XLOS1611	QUINTON HAZEL	7.05271.36.0	
XLOS164	QUINTON HAZEL	7.05271.46.0	
XLOS1649	QUINTON HAZEL	7.05271.61.0	
XLOS1699	QUINTON HAZEL	7.05271.69.0	
XLOS1710	QUINTON HAZEL	7.05271.54.0	
XLOS1738	QUINTON HAZEL	7.05271.24.0	
XLOS1770	QUINTON HAZEL	7.05271.22.0	
XLS1029	ELTA	7.05271.22.0	
XLS1714	ELTA	7.08369.34.0	
XLS1716	ELTA	7.08369.40.0	
XLS1720	ELTA	7.08369.08.0	
XLS1721	ELTA	7.08369.02.0	
XLS1730	ELTA	7.08369.03.0	
XLS1730	ELTA	7.08369.04.0	
XLS1742	ELTA	7.08369.41.0	
XLS1783	ELTA	7.08369.17.0	
XLS1789	ELTA	7.08369.05.0	
XM219D475AA	FORD	7.24809.19.0	
XR3F9G444BA	FORD	7.02604.60.0	
XR81557	JAGUAR	7.02604.60.0	
XR82007	JAGUAR	7.02604.60.0	
XR822998	JAGUAR	7.02604.60.0	
XR850044	JAGUAR	7.00224.13.0	
XS2A9G444AA	FORD	7.02604.60.0	
Y401-20-300	MAZDA	7.24809.06.0	
Y401-20-300A	MAZDA	7.24809.06.0	
Y425-20-300	MAZDA	7.24809.76.0	
Y605-20-300	MAZDA	7.24809.39.0	
Y605-20-300A	MAZDA	7.24809.39.0	
Y605-20-300B	MAZDA	7.24809.39.0	
Y605-20-300C	MAZDA	7.24809.39.0	
YL849F472BC	FORD	7.02604.60.0	
YM21-9A486-AA	FORD	7.22738.08.0	
YM21-9C491-AC	FORD	7.22286.55.0	
YM21-9F472-DA	FORD	7.05271.77.0	
YM21-9S495-AA	FORD	7.22738.08.0	
YS6A-9F472-AC	FORD	7.02604.60.0	
ZVKK072	ZZVF	7.21851.31.0	
v24-63-0017	VEMO	7.24809.88.0	
v24-63-0019	VEMO	7.05052.03.0	
v52-63-0014	VEMO	7.11237.07.0	
v53-63-0001	VEMO	7.11237.08.0	
wg1494608	WILMINK	7.24809.86.0	

D

ARTIKELNUMMER ALT - NEU

E

ARTICLE NUMBER OLD - NEW

PIERBURG-No. OLD → NEW

old	new	old	new
4.00157.02.0	7.00555.06.0	7.00450.00.0	7.00450.09.0
4.00158.03.0	7.00555.07.0	7.00450.02.0	7.00450.09.0
4.00237.00.0	7.22996.11.0	7.00450.07.0	7.00450.10.0
4.00268.00.0	7.01604.02.0	7.00450.08.0	7.00450.10.0
4.00511.01.0	7.05363.00.0	7.00512.00.0	7.00512.03.0
4.00512.00.0	7.02107.09.0	7.00578.05.0	7.00578.12.0
4.00555.00.0	7.02107.09.0	7.00632.05.0	7.00632.13.0
4.00561.00.0	7.02156.33.0	7.00632.10.0	7.00632.13.0
4.00561.01.0	7.02156.33.0	7.00678.00.0	7.00678.06.0
4.00561.02.0	7.02156.34.0	7.00678.01.0	7.00678.06.0
4.00692.00.0	7.03622.06.0	7.00678.03.0	7.00678.06.0
4.00720.00.0	7.03622.09.0	7.00678.04.0	7.00678.06.0
5.34114.62.0	7.22996.12.0	7.00684.08.0	7.00684.14.0
5.36359.03.0	7.01268.03.0	7.00684.10.0	7.00684.14.0
7.00018.00.0	7.00018.50.0	7.00684.12.0	7.00684.14.0
7.00018.01.0	7.00018.51.0	7.00748.01.0	7.00748.06.0
7.00018.09.0	7.00018.52.0	7.00748.02.0	7.00748.06.0
7.00018.21.0	7.00018.52.0	7.00748.04.0	7.00748.06.0
7.00018.40.0	7.00018.55.0	7.00789.03.0	7.00789.10.0
7.00018.41.0	7.00018.56.0	7.00789.04.0	7.00789.10.0
7.00020.14.0	7.00020.24.0	7.00789.05.0	7.00789.10.0
7.00020.15.0	7.00020.25.0	7.00789.07.0	7.00789.10.0
7.00020.17.0	7.00020.24.0	7.00789.08.0	7.00789.10.0
7.00020.18.0	7.00020.25.0	7.00823.03.0	7.00823.06.0
7.00020.19.0	7.00020.24.0	7.00823.04.0	7.00823.06.0
7.00020.21.0	7.00020.25.0	7.00837.00.0	7.00837.01.0
7.00020.22.0	7.00020.39.0	7.00907.00.0	7.00907.03.0
7.00020.23.0	7.00020.40.0	7.00907.01.0	7.00907.03.0
7.00020.26.0	7.00020.50.0	7.00907.02.0	7.00907.03.0
7.00020.29.0	7.00020.24.0	7.00992.29.0	7.00992.36.0
7.00020.31.0	7.00020.25.0	7.00992.33.0	7.00992.36.0
7.00020.32.0	7.00020.39.0	7.00999.07.0	7.00999.08.0
7.00020.33.0	7.00020.40.0	7.01106.09.0	7.01106.38.0
7.00020.36.0	7.00020.50.0	7.01106.14.0	7.01106.38.0
7.00063.02.0	7.00063.10.0	7.01106.16.0	7.01106.38.0
7.00063.04.0	7.00063.10.0	7.01106.19.0	7.01106.38.0
7.00063.05.0	7.00063.10.0	7.01106.26.0	7.01106.38.0
7.00063.06.0	7.00063.10.0	7.01106.30.0	7.01106.38.0
7.00063.07.0	7.00063.10.0	7.01106.33.0	7.01106.38.0
7.00063.09.0	7.00063.10.0	7.01106.37.0	7.01106.38.0
7.00063.11.0	7.00063.10.0	7.01240.00.0	7.01240.03.0
7.00063.13.0	7.00063.10.0	7.01240.01.0	7.01240.03.0
7.00075.04.0	7.00075.07.0	7.01267.00.0	7.01486.10.0
7.00075.05.0	7.00075.07.0	7.01267.04.0	7.01486.10.0
7.00075.06.0	7.00075.07.0	7.01267.10.0	7.01486.10.0
7.00128.00.0	7.01268.03.0	7.01268.01.0	7.01268.03.0
7.00128.01.0	7.01268.03.0	7.01293.32.0	7.01293.38.0
7.00128.19.0	7.01268.03.0	7.01300.00.0	7.01300.24.0
7.00216.01.0	7.00216.06.0	7.01300.16.0	7.01300.24.0
7.00216.04.0	7.00216.06.0	7.01300.17.0	7.01300.24.0
7.00224.06.0	7.00224.13.0	7.01300.21.0	7.01300.24.0
7.00306.27.0	7.00306.36.0	7.01300.22.0	7.01300.24.0
7.00306.31.0	7.00306.37.0	7.01300.25.0	7.01300.24.0
7.00306.32.0	7.00306.36.0	7.01317.07.0	7.01317.10.0
7.00309.04.0	7.00309.07.0	7.01318.01.0	7.01318.20.0
7.00365.00.0	7.00365.06.0	7.01318.12.0	7.01318.24.0
7.00365.03.0	7.00365.06.0	7.01436.00.0	7.22136.50.0
7.00365.04.0	7.00365.06.0	7.01486.00.0	7.01486.10.0
7.00365.05.0	7.00365.06.0	7.01486.01.0	7.01486.08.0
7.00368.01.0	7.00368.15.0	7.01486.02.0	7.01486.10.0
7.00368.04.0	7.00368.15.0	7.01486.03.0	7.01486.08.0
7.00368.05.0	7.00368.15.0	7.01493.05.0	7.01493.07.0
7.00368.06.0	7.00368.15.0	7.01493.06.0	7.01493.07.0
7.00368.14.0	7.00368.16.0	7.01510.11.0	7.01510.31.0
7.00368.17.0	7.00368.16.0	7.01510.13.0	7.01510.31.0
7.00411.00.0	7.00411.05.0	7.01510.34.0	7.01510.57.0
7.00411.01.0	7.00411.05.0	7.01510.51.0	7.01510.86.0
7.00411.03.0	7.00411.05.0	7.01510.58.0	7.01510.85.0

PIERBURG-No. OLD → NEW

PIERBURG-No. OLD → NEW

old	new	old	new
7.01510.66.0	7.01510.86.0	7.03435.02.0	7.03435.05.0
7.01510.71.0	7.01510.86.0	7.03435.03.0	7.03435.05.0
7.01510.74.0	7.01510.87.0	7.03446.00.0	7.03446.01.0
7.01510.77.0	7.01510.86.0	7.03446.02.0	7.03446.01.0
7.01510.79.0	7.01510.91.0	7.03446.02.1	7.03446.01.0
7.01510.81.0	7.01510.91.0	7.03487.02.0	7.03635.12.0
7.01510.82.0	7.01510.85.0	7.03487.04.0	7.03635.37.0
7.01510.83.0	7.01510.87.0	7.03487.07.0	7.03635.37.0
7.01510.84.0	7.01510.94.0	7.03487.09.0	7.03635.39.0
7.01510.88.0	7.01510.91.0	7.03487.11.0	7.03635.40.0
7.01599.04.0	7.01599.10.0	7.03487.12.0	7.03635.41.0
7.01599.12.0	7.01599.10.0	7.03487.13.0	7.03635.12.0
7.01599.17.0	7.01599.10.0	7.03487.14.0	7.03635.39.0
7.01621.04.0	7.24809.40.0	7.03487.16.0	7.03635.41.0
7.01782.02.0	7.01782.07.0	7.03527.07.0	7.03527.12.0
7.01782.03.0	7.01782.07.0	7.03571.07.0	7.03571.16.0
7.01782.06.0	7.01782.07.0	7.03571.08.0	7.03571.16.0
7.01859.00.0	7.01859.03.0	7.03571.09.0	7.03571.16.0
7.01859.01.0	7.01859.03.0	7.03571.10.0	7.03571.16.0
7.01881.04.0	7.01881.06.0	7.03571.11.0	7.03571.16.0
7.01881.05.0	7.01881.07.0	7.03571.13.0	7.03571.16.0
7.02014.05.0	7.02014.07.0	7.03608.03.0	7.03608.16.0
7.02107.06.0	7.02107.09.0	7.03608.04.0	7.03608.16.0
7.02132.02.0	7.02132.07.0	7.03608.05.0	7.03608.16.0
7.02132.08.0	7.02132.07.0	7.03608.06.0	7.03608.16.0
7.02156.15.0	7.02156.24.0	7.03608.08.0	7.03608.16.0
7.02156.21.0	7.02156.24.0	7.03608.09.0	7.03608.16.0
7.02156.29.0	7.02156.35.0	7.03608.10.0	7.03608.16.0
7.02156.32.0	7.02156.35.0	7.03608.11.0	7.03608.16.0
7.02187.10.0	7.02187.12.0	7.03608.12.0	7.03608.16.0
7.02209.04.0	7.02209.11.0	7.03608.14.0	7.03608.16.0
7.02209.08.0	7.02209.11.0	7.03608.15.0	7.03608.16.0
7.02209.14.0	7.02209.11.0	7.03622.03.0	7.03622.10.0
7.02209.15.0	7.02209.20.0	7.03622.04.0	7.03622.11.0
7.02209.21.0	7.02209.20.0	7.03622.07.0	7.03622.10.0
7.02321.08.0	7.02321.17.0	7.03635.05.0	7.03635.12.0
7.02321.12.0	7.02321.17.0	7.03635.09.0	7.03635.39.0
7.02321.13.0	7.02321.17.0	7.03635.10.0	7.03635.37.0
7.02321.14.0	7.02321.17.0	7.03635.13.0	7.03635.39.0
7.02321.18.0	7.02321.17.0	7.03635.14.0	7.03635.38.0
7.02604.06.0	7.02604.07.0	7.03635.15.0	7.03635.40.0
7.02604.40.0	7.02604.99.0	7.03635.16.0	7.03635.41.0
7.02738.09.0	7.02738.13.0	7.03635.17.3	7.03635.46.0
7.02751.01.0	7.02751.02.0	7.03635.19.0	7.03635.12.0
7.02756.01.0	7.02756.07.0	7.03635.20.0	7.03635.39.0
7.02756.04.0	7.02756.07.0	7.03635.21.0	7.03635.40.0
7.02756.09.0	7.02756.07.0	7.03635.22.0	7.03635.41.0
7.02756.09.2	7.02756.07.0	7.03635.35.0	7.03635.39.0
7.02756.11.0	7.02756.07.0	7.03647.00.0	7.03647.10.0
7.02769.00.0	7.02769.05.0	7.03647.02.0	7.03647.10.0
7.02769.01.0	7.02769.05.0	7.03647.05.0	7.03647.10.0
7.02769.02.0	7.02769.05.0	7.03647.06.0	7.03647.10.0
7.03051.01.0	7.03051.04.0	7.03647.08.0	7.03647.10.0
7.03083.07.0	7.03083.20.0	7.03692.10.0	7.03692.11.0
7.03083.08.0	7.03083.20.0	7.03693.09.0	7.03693.12.0
7.03083.09.0	7.03083.20.0	7.03693.10.0	7.03693.12.0
7.03083.11.0	7.03083.20.0	7.03693.11.0	7.03693.12.0
7.03083.12.0	7.03083.20.0	7.03761.06.0	7.03761.09.0
7.03196.01.0	7.03196.09.0	7.03761.08.0	7.03761.09.0
7.03196.02.0	7.03196.09.0	7.03762.08.0	7.03762.10.0
7.03196.04.0	7.03196.09.0	7.03762.09.0	7.03762.10.0
7.03196.10.0	7.03196.09.0	7.03784.00.0	7.03784.34.0
7.03295.01.0	7.03295.03.0	7.03784.05.0	7.03784.34.0
7.03379.00.0	7.03379.03.0	7.03784.09.0	7.03784.34.0
7.03390.06.0	7.03390.09.0	7.03784.10.0	7.03784.34.0
7.03390.08.0	7.03390.09.0	7.03784.18.0	7.03784.34.0
7.03391.09.0	7.03391.11.0	7.03784.20.0	7.03784.34.0
7.03391.10.0	7.03391.11.0	7.03784.23.0	7.03784.34.0

PIERBURG-No. OLD → NEW

PIERBURG-No. OLD → NEW

old	new	old	new
7.03784.24.0	7.03784.34.0	7.05194.22.0	7.05194.26.0
7.03784.27.0	7.03784.34.0	7.05194.24.0	7.05194.26.0
7.03784.29.0	7.03784.34.0	7.05243.02.0	7.05243.04.0
7.03784.30.0	7.03784.34.0	7.05243.03.0	7.05243.04.0
7.03784.35.0	7.03784.34.0	7.05264.02.0	7.05264.03.0
7.03803.00.0	7.03803.03.0	7.05315.01.0	7.05315.05.0
7.03991.10.0	7.03991.12.0	7.05315.02.0	7.05315.05.0
7.03991.10.1	7.03991.12.0	7.05315.04.0	7.05315.05.0
7.04038.04.0	7.04038.08.0	7.05320.01.0	7.05320.04.0
7.04038.05.0	7.04038.08.0	7.05320.02.0	7.05320.04.0
7.04039.04.0	7.04039.13.0	7.05343.10.0	7.05343.17.0
7.04039.10.0	7.04039.13.0	7.05343.16.0	7.05343.17.0
7.04039.11.0	7.04039.13.0	7.05343.16.1	7.05343.17.0
7.04239.00.0	7.04239.04.0	7.05446.06.0	7.05446.07.0
7.04239.01.0	7.04239.04.0	7.05447.06.0	7.05447.08.0
7.04239.05.0	7.04239.04.0	7.05447.07.0	7.05447.08.0
7.04256.26.0	7.04256.35.0	7.05448.06.0	7.05448.07.0
7.04256.27.0	7.04256.36.0	7.05449.06.0	7.08965.03.0
7.04257.12.0	7.04257.19.0	7.05454.05.0	7.05454.07.0
7.04257.13.0	7.04257.20.0	7.05454.06.0	7.05454.07.0
7.04275.06.0	7.04275.09.0	7.05483.00.0	7.05483.25.0
7.04275.08.0	7.04275.09.0	7.05483.12.0	7.05483.25.0
7.04371.03.0	7.04371.07.0	7.05483.14.0	7.05483.25.0
7.04382.00.0	7.04382.09.0	7.05483.23.0	7.05483.25.0
7.04382.05.0	7.04382.09.0	7.05483.24.0	7.05483.25.0
7.04382.10.0	7.04382.09.0	7.05499.02.0	7.05499.05.0
7.04402.01.0	7.04402.02.0	7.05500.01.0	7.05500.02.0
7.04433.01.0	7.04433.02.0	7.05501.01.0	7.05501.02.0
7.04448.00.0	7.04448.18.0	7.05502.01.0	7.05502.02.0
7.04448.14.0	7.04448.18.0	7.05506.13.0	7.05506.14.0
7.04448.17.0	7.04448.18.0	7.05578.13.0	7.05578.15.0
7.04493.11.0	7.04493.17.0	7.05590.01.0	7.05590.03.0
7.04511.27.0	7.04511.29.0	7.05632.01.0	7.05632.04.0
7.04589.05.0	7.04589.06.0	7.05720.14.0	7.07794.23.0
7.04723.00.0	7.04723.10.0	7.05720.15.0	7.07794.22.0
7.04723.05.0	7.04723.10.0	7.05720.19.0	7.07794.23.0
7.04739.06.0	7.04739.09.0	7.05720.20.0	7.07794.22.0
7.04739.07.0	7.04739.09.0	7.05720.21.0	7.07794.23.0
7.04739.08.0	7.04739.09.0	7.05720.22.0	7.07794.22.0
7.04784.00.0	7.04784.06.0	7.05720.23.0	7.07794.23.0
7.04784.05.0	7.04784.06.0	7.05720.24.0	7.07794.22.0
7.04787.00.0	7.04787.12.0	7.05720.25.0	7.07794.23.0
7.04787.05.0	7.04787.12.0	7.05742.07.0	7.05742.11.0
7.04787.09.0	7.04787.12.0	7.05742.08.0	7.05742.11.0
7.04787.11.0	7.04787.12.0	7.05742.10.0	7.05742.11.0
7.04788.00.0	7.04788.06.0	7.05838.03.0	7.05838.08.0
7.04788.09.0	7.04788.06.0	7.05838.07.0	7.05838.08.0
7.04788.11.0	7.04788.06.0	7.05838.07.1	7.05838.08.0
7.04799.05.0	7.04799.08.0	7.06026.01.0	7.05315.05.0
7.04923.00.0	7.04923.18.0	7.06036.00.0	7.06036.14.0
7.04923.09.0	7.04923.18.0	7.06036.10.0	7.06036.14.0
7.04923.12.0	7.04923.18.0	7.06036.12.0	7.06036.14.0
7.04923.13.0	7.04923.17.0	7.06036.13.0	7.06036.14.0
7.04924.12.0	7.04924.14.0	7.06712.02.0	7.22769.80.0
7.04924.13.0	7.04924.15.0	7.06712.03.0	7.06712.24.0
7.04930.04.0	7.04930.06.0	7.06712.05.0	7.06712.23.0
7.04931.03.0	7.04931.04.0	7.06712.10.0	7.22769.80.0
7.04999.05.0	7.04999.34.0	7.06712.11.0	7.06712.24.0
7.04999.20.0	7.04999.34.0	7.06713.00.0	7.22560.41.0
7.05012.00.0	7.05012.01.0	7.06713.01.0	7.22560.40.0
7.05031.02.0	7.05031.06.0	7.06713.03.0	7.06713.09.0
7.05031.03.0	7.05031.06.0	7.06713.04.0	7.06713.10.0
7.05107.00.0	7.05107.12.0	7.06713.07.0	7.22560.41.0
7.05107.05.0	7.05107.12.0	7.06713.08.0	7.22560.40.0
7.05107.09.0	7.05107.12.0	7.06714.00.0	7.06714.24.0
7.05107.11.0	7.05107.12.0	7.06714.01.0	7.06714.21.0
7.05194.03.0	7.05194.26.0	7.06714.02.0	7.06714.22.0
7.05194.04.0	7.05194.26.0	7.06714.03.0	7.06714.23.0

PIERBURG-No. OLD → NEW

PIERBURG-No. OLD → NEW

old	new	old	new
7.06714.04.0	7.22286.53.0	7.22166.28.0	7.22166.66.0
7.06714.05.0	7.22286.52.0	7.22166.32.0	7.22166.02.0
7.06714.11.0	7.22286.52.0	7.22166.35.0	7.22166.38.0
7.06714.12.0	7.22286.53.0	7.22166.36.0	7.22166.50.0
7.06714.13.0	7.06714.23.0	7.22166.40.0	7.22166.00.0
7.06714.14.0	7.06714.22.0	7.22166.46.0	7.21852.79.0
7.06714.15.0	7.06714.21.0	7.22166.62.0	7.21852.79.0
7.06714.16.0	7.06714.24.0	7.22166.76.0	7.22166.00.0
7.06967.00.0	7.22560.43.0	7.22166.78.0	7.21852.79.0
7.07044.10.0	7.07044.12.0	7.22169.00.0	7.22296.02.0
7.07141.00.0	7.07141.01.0	7.22286.00.0	7.22286.26.0
7.07417.01.0	7.04493.17.0	7.22286.01.0	7.22286.55.0
7.07417.37.0	7.07417.39.0	7.22286.02.0	7.22286.41.0
7.07419.02.0	7.07419.06.0	7.22286.06.0	7.22286.51.0
7.07420.02.0	7.07420.09.0	7.22286.07.0	7.22286.41.0
7.07420.05.0	7.07420.09.0	7.22286.11.0	7.22286.51.0
7.07549.06.0	7.07549.09.0	7.22286.11.5	7.22286.51.0
7.07549.07.0	7.07549.09.0	7.22286.12.0	7.22286.55.0
7.07549.08.0	7.07549.09.0	7.22286.13.0	7.22286.41.0
7.07654.00.0	7.04493.17.0	7.22286.16.0	7.22286.26.0
7.07654.01.0	7.04493.17.0	7.22286.17.0	7.22286.54.0
7.07794.18.0	7.07794.22.0	7.22286.18.0	7.22286.54.0
7.07794.19.0	7.07794.23.0	7.22286.28.0	7.22286.41.0
7.07969.03.0	7.07969.06.0	7.22286.29.0	7.22286.55.0
7.08965.00.0	7.08965.03.0	7.22286.32.0	7.22286.52.0
7.08965.02.0	7.08965.03.0	7.22286.33.0	7.22286.53.0
7.10197.00.0	7.10197.01.0	7.22286.36.0	7.06714.24.0
7.11433.00.0	7.04784.06.0	7.22286.37.0	7.22286.54.0
7.20820.02.0	7.21949.51.0	7.22286.38.0	7.22286.26.0
7.20820.52.0	7.21949.51.0	7.22286.50.0	7.22286.26.0
7.21464.01.0	7.21949.51.0	7.22286.56.0	7.06714.23.0
7.21819.00.0	7.21949.51.0	7.22286.57.0	7.06714.22.0
7.21819.10.0	7.21949.51.0	7.22286.58.0	7.06714.21.0
7.21819.50.0	7.21949.51.0	7.22295.00.0	7.22295.70.0
7.21819.60.0	7.21949.51.0	7.22295.01.0	7.22295.71.0
7.21851.12.0	7.21851.31.0	7.22295.06.0	7.22295.61.0
7.21851.19.0	7.21851.31.0	7.22295.08.0	7.22295.62.0
7.21851.20.0	7.21851.32.0	7.22295.09.0	7.22295.66.0
7.21851.27.0	7.21851.31.0	7.22295.09.5	7.22295.66.0
7.21851.29.0	7.21851.31.0	7.22295.10.0	7.22295.67.0
7.21852.02.0	7.21852.24.0	7.22295.11.0	7.22295.68.0
7.21852.08.0	7.21852.24.0	7.22295.11.5	7.22295.68.0
7.21852.10.0	7.21852.85.0	7.22295.12.0	7.22295.69.0
7.21852.25.0	7.21852.85.0	7.22295.12.5	7.22295.69.0
7.21852.25.5	7.21852.85.0	7.22295.13.0	7.22295.63.0
7.21852.39.0	7.21852.78.0	7.22295.16.0	7.22295.67.0
7.21852.43.0	7.21852.24.0	7.22295.19.0	7.22295.65.0
7.21852.46.0	7.21852.82.0	7.22295.24.0	7.22295.65.0
7.21852.48.0	7.22166.38.0	7.22295.27.0	7.22295.70.0
7.21852.58.0	7.22166.39.0	7.22295.28.0	7.22295.70.0
7.21857.09.0	7.21857.59.0	7.22295.28.5	7.22295.70.0
7.21857.10.0	7.21857.01.0	7.22295.29.0	7.22295.71.0
7.21920.00.0	7.21920.62.0	7.22295.29.5	7.22295.71.0
7.21920.10.0	7.21920.62.0	7.22295.30.0	7.22295.61.0
7.21920.10.1	7.21920.62.0	7.22295.31.0	7.22295.62.0
7.21920.11.0	7.21920.62.0	7.22295.33.0	7.22295.63.0
7.21920.12.0	7.21920.62.0	7.22295.34.0	7.22295.67.0
7.21920.50.0	7.21920.62.0	7.22295.34.5	7.22295.67.0
7.21920.60.0	7.21920.62.0	7.22295.35.0	7.22295.65.0
7.21920.61.0	7.21920.62.0	7.22295.38.0	7.22295.71.0
7.21949.01.0	7.21949.51.0	7.22295.39.0	7.22295.61.0
7.22052.28.0	7.22286.41.0	7.22295.40.0	7.22295.62.0
7.22090.03.0	7.22090.11.0	7.22295.41.0	7.22295.63.0
7.22090.53.0	7.22090.11.0	7.22295.55.0	7.22295.62.0
7.22136.00.0	7.22136.50.0	7.22295.64.0	7.22295.65.0
7.22160.00.0	7.22299.03.0	7.22296.00.0	7.22296.02.0
7.22166.01.0	7.22166.20.0	7.22296.00.5	7.22296.02.0
7.22166.27.0	7.22166.50.0	7.22296.50.0	7.22296.02.0

PIERBURG-No. OLD → NEW

PIERBURG-No. OLD → NEW

old	new	old	new
7.22299.00.0	7.22299.03.0	7.22769.06.0	7.22769.77.0
7.22299.02.0	7.22299.03.0	7.22769.10.0	7.22769.78.0
7.22414.00.0	7.22414.04.0	7.22769.27.0	7.22769.73.0
7.22414.01.0	7.22414.08.0	7.22769.48.0	7.22769.77.0
7.22414.02.0	7.22414.07.0	7.22769.49.0	7.22769.78.0
7.22414.05.0	7.22414.04.0	7.22769.49.5	7.22769.78.0
7.22414.50.0	7.22414.04.0	7.22769.51.0	7.22769.73.0
7.22414.51.0	7.22414.08.0	7.22769.63.0	7.22769.80.0
7.22414.52.0	7.22414.07.0	7.22769.65.0	7.22769.79.0
7.22423.02.0	7.21857.59.0	7.22769.66.0	7.22769.73.0
7.22427.00.0	7.22427.03.0	7.22769.67.0	7.06712.24.0
7.22472.04.0	7.22472.07.0	7.22769.68.0	7.22769.80.0
7.22477.00.0	7.22477.10.0	7.22769.72.0	7.06712.23.0
7.22477.01.0	7.22477.10.0	7.22772.03.0	7.22772.12.0
7.22477.02.0	7.22477.10.0	7.22772.04.0	7.22772.12.0
7.22477.03.0	7.22477.10.0	7.22772.09.0	7.22772.11.0
7.22477.04.0	7.22477.10.0	7.22772.10.0	7.22772.12.0
7.22477.05.0	7.22477.11.0	7.22778.02.0	7.22778.80.0
7.22477.08.0	7.22477.10.0	7.22778.03.0	7.22778.79.0
7.22477.09.0	7.22477.11.0	7.22778.05.0	7.22778.95.0
7.22515.00.0	7.22414.04.0	7.22778.06.0	7.22778.96.0
7.22515.01.0	7.22414.08.0	7.22778.09.0	7.22778.99.0
7.22560.00.0	7.22560.40.0	7.22778.10.0	7.22778.99.0
7.22560.01.0	7.22560.41.0	7.22778.14.0	7.22778.94.0
7.22560.02.0	7.22560.42.0	7.22778.16.0	7.22778.79.0
7.22560.05.0	7.22560.42.0	7.22778.17.0	7.22778.80.0
7.22560.06.0	7.22560.45.0	7.22778.19.0	7.22778.98.0
7.22560.07.0	7.22560.44.0	7.22778.21.0	7.22778.79.0
7.22560.08.0	7.22560.43.0	7.22778.32.0	7.22778.94.0
7.22560.11.0	7.22560.40.0	7.22778.34.0	7.22778.79.0
7.22560.12.0	7.22560.41.0	7.22778.38.0	7.22778.94.0
7.22560.13.0	7.22560.45.0	7.22778.40.0	7.22778.79.0
7.22560.20.0	7.22560.43.0	7.22778.43.0	7.22778.80.0
7.22560.23.0	7.22560.41.0	7.22778.44.0	7.22778.79.0
7.22560.24.0	7.22560.40.0	7.22778.45.0	7.22778.98.0
7.22560.24.5	7.22560.40.0	7.22778.48.0	7.22778.95.0
7.22560.25.0	7.22560.44.0	7.22778.49.0	7.22778.96.0
7.22560.26.0	7.22560.45.0	7.22778.50.0	7.22778.99.0
7.22560.27.0	7.22560.43.0	7.22778.50.5	7.22778.99.0
7.22560.34.0	7.22560.43.0	7.22778.62.0	7.22778.97.0
7.22560.35.0	7.22560.41.0	7.22778.64.0	7.05574.00.0
7.22560.38.0	7.06713.09.0	7.22778.65.0	7.05574.01.0
7.22560.39.0	7.06713.10.0	7.22778.68.0	7.22778.97.0
7.22574.02.0	7.22574.12.0	7.22778.81.0	7.05574.02.0
7.22574.11.0	7.22574.12.0	7.22778.81.5	7.05574.02.0
7.22574.14.0	7.22574.12.0	7.22778.82.0	7.05574.03.0
7.22630.13.0	7.22630.28.0	7.22778.82.5	7.05574.03.0
7.22630.17.0	7.22630.28.0	7.22785.03.0	7.22785.17.0
7.22630.20.0	7.22630.28.0	7.22785.04.0	7.22785.18.0
7.22630.23.0	7.22630.28.0	7.22785.05.0	7.22785.20.0
7.22738.01.0	7.22738.08.0	7.22785.06.0	7.28248.17.0
7.22738.03.0	7.22738.08.0	7.22785.07.0	7.22785.16.0
7.22738.04.0	7.22738.08.0	7.22785.11.0	7.28248.17.0
7.22738.07.0	7.22934.63.0	7.22785.12.0	7.22785.16.0
7.22738.09.0	7.22738.20.0	7.22785.13.0	7.22785.17.0
7.22738.13.0	7.22738.08.0	7.22785.14.0	7.22785.18.0
7.22738.14.0	7.22738.08.0	7.22785.15.0	7.28248.17.0
7.22738.15.0	7.22934.63.0	7.22785.19.0	7.22785.20.0
7.22738.16.0	7.22738.20.0	7.22818.01.0	7.22818.58.0
7.22738.17.0	7.22934.57.0	7.22818.02.0	7.22818.57.0
7.22738.19.0	7.22934.63.0	7.22818.03.0	7.22818.58.0
7.22738.21.0	7.22934.57.0	7.22818.06.0	7.22818.59.0
7.22748.08.0	7.22748.18.0	7.22818.16.0	7.22818.58.0
7.22748.15.0	7.22748.18.0	7.22818.17.0	7.22818.59.0
7.22769.00.0	7.22769.73.0	7.22818.18.0	7.22818.62.0
7.22769.03.0	7.22769.76.0	7.22818.23.0	7.22818.57.0
7.22769.04.0	7.22769.77.0	7.22818.26.0	7.22818.58.0
7.22769.05.0	7.22769.73.0	7.22818.29.0	7.22818.59.0

PIERBURG-No. OLD → NEW

PIERBURG-No. OLD → NEW

old	new	old	new
7.22818.30.0	7.22818.57.0	7.22946.29.0	7.22946.34.0
7.22818.32.0	7.22818.59.0	7.22946.31.0	7.22946.38.0
7.22818.33.0	7.22818.62.0	7.22946.33.0	7.22946.34.0
7.22818.34.0	7.22818.59.0	7.22946.39.0	7.22946.34.0
7.22818.35.0	7.22818.63.0	7.22946.40.0	7.22946.34.0
7.22818.36.0	7.22818.62.0	7.22946.41.0	7.22946.38.0
7.22818.37.0	7.22818.57.0	7.22946.43.0	7.22946.38.0
7.22818.38.0	7.22818.57.0	7.24809.00.0	7.24809.10.0
7.22818.39.0	7.22818.59.0	7.24809.05.0	7.24809.73.0
7.22818.41.0	7.22818.59.0	7.24809.18.0	7.22477.11.0
7.22818.42.0	7.22818.62.0	7.24809.82.5	7.24809.82.0
7.22818.43.0	7.22818.57.0	7.24809.83.5	7.24809.83.0
7.22818.45.0	7.22818.58.0	7.28069.01.0	7.28069.03.0
7.22818.49.0	7.22818.58.0	7.28069.02.0	7.28069.04.0
7.22818.50.0	7.22818.58.0	7.28070.00.0	7.28070.03.0
7.22818.51.0	7.22818.59.0	7.28070.02.0	7.28070.03.0
7.22818.52.0	7.22818.57.0	7.28070.04.0	7.28070.03.0
7.22818.53.0	7.22818.62.0	7.28090.00.0	7.22778.80.0
7.22818.54.0	7.22818.57.0	7.28124.00.0	7.28124.19.0
7.22818.55.0	7.22818.62.0	7.28124.02.0	7.28124.20.0
7.22818.55.5	7.22818.62.0	7.28124.03.0	7.28124.21.0
7.22818.56.0	7.22818.59.0	7.28124.13.0	7.28124.20.0
7.22818.61.0	7.22818.62.0	7.28124.14.0	7.28124.19.0
7.22841.00.0	7.22841.08.0	7.28124.22.0	7.28124.30.0
7.22841.03.0	7.22841.08.0	7.28124.23.0	7.28124.19.0
7.22843.00.0	7.22843.06.0	7.28124.24.0	7.28124.19.0
7.22843.02.0	7.22843.07.0	7.28124.25.0	7.28124.20.0
7.22875.00.0	7.22875.13.0	7.28124.26.0	7.28124.20.0
7.22875.12.0	7.22875.16.0	7.28124.27.0	7.28124.21.0
7.22875.15.0	7.28248.17.0	7.28238.00.0	7.28238.55.0
7.22888.01.0	7.22888.02.0	7.28238.01.0	7.28238.56.0
7.22934.32.0	7.22934.63.0	7.28238.02.0	7.28238.57.0
7.22934.53.0	7.22934.57.0	7.28238.03.0	7.28238.58.0
7.22934.54.0	7.22934.57.0	7.28238.06.0	7.28238.61.0
7.22934.59.0	7.22934.57.0	7.28238.27.0	7.28238.61.0
7.22934.60.0	7.22934.57.0	7.28238.28.0	7.28238.55.0
7.22934.62.0	7.22934.63.0	7.28238.29.0	7.28238.56.0
7.22934.64.0	7.22934.57.0	7.28238.30.0	7.28238.57.0
7.22934.65.0	7.22934.57.0	7.28238.31.0	7.28238.58.0
7.22934.65.1	7.22934.57.0	7.28238.32.0	7.28238.61.0
7.22936.02.0	7.22936.08.0	7.28238.44.0	7.28238.62.0
7.22938.00.0	7.22938.06.0	7.28238.45.0	7.28238.63.0
7.22938.02.0	7.22938.06.0	7.28247.07.0	7.28247.13.0
7.22938.05.0	7.22938.06.0	7.28248.04.0	7.28248.17.0
7.22938.08.0	7.22938.06.0	7.28248.04.5	7.28248.17.0
7.22938.09.0	7.22938.06.0	7.28248.16.0	7.28248.17.0
7.22939.00.0	7.22939.03.0	7.28264.00.0	7.28264.06.0
7.22946.00.0	7.22946.34.0	7.28264.02.0	7.28264.07.0
7.22946.01.0	7.22946.34.0	7.28270.02.0	7.28270.14.0
7.22946.02.0	7.22946.34.0	7.28290.05.0	7.28290.11.0
7.22946.03.0	7.22946.34.0	7.28290.09.0	7.28290.11.0
7.22946.04.0	7.22946.34.0	7.28384.00.0	7.28384.13.0
7.22946.10.0	7.22946.34.0	7.28384.00.5	7.28384.13.0
7.22946.11.0	7.22946.34.0	7.28384.12.0	7.28384.13.0
7.22946.14.0	7.22946.34.0	7.28415.00.0	7.28415.09.0
7.22946.15.0	7.22946.34.0	7.28415.02.0	7.28415.09.0
7.22946.16.0	7.22946.34.0	7.28415.04.0	7.28415.09.0
7.22946.17.0	7.22946.34.0	7.28415.08.0	7.28415.09.0
7.22946.18.0	7.22946.34.0	7.28415.08.1	7.28415.09.0
7.22946.19.0	7.22946.34.0		
7.22946.20.0	7.22946.34.0		
7.22946.22.0	7.22946.38.0		
7.22946.23.0	7.22946.34.0		
7.22946.24.0	7.22946.38.0		
7.22946.25.0	7.22946.34.0		
7.22946.26.0	7.22946.34.0		
7.22946.27.0	7.22946.38.0		
7.22946.28.0	7.22946.34.0		

Voraussetzungen für Kundenretouren (keine Reklamationen)

Lieber Geschäftspartner,

für Retouren von Waren gibt es vielerlei Gründe. Sollten Sie etwas zurückschicken, bitten wir Sie folgende Hinweise zu beachten.

Voraussetzungen für Retouren verkaufsfähiger Ware:

- Die Verpackung muss unbeschädigt, nicht beschrieben oder beklebt und sauber sein.
- Die Ware muss original verpackt sein.
- Bitte informieren Sie vor jeder Retoure Ihren Gebietsverkaufsleiter.
- Sie erhalten von Ihrem Gebietsverkaufsleiter eine Retourenauftragsnummer. Bitte geben Sie diese Nummer bei Ihrer Rücksendung an.
- Fügen Sie bei Ihrer Retoure pro Artikelposition eine Kopie der Rechnung bei.
- Das Rechnungsdatum darf nicht länger als 3 Jahre zurück liegen.

Die Abzüge vom Warenwert sind abhängig vom Rechnungsdatum und lauten wie folgt:

a) Rechnungsdatum nicht älter als	3 Monate	0%
b) Rechnungsdatum	3–12 Monate	20%
c) Rechnungsdatum	13–24 Monate	30%
d) Rechnungsdatum	25–36 Monate	40%

Wir behalten uns vor, durch ungeplante Kontrollprozesse oder sonstige Aufwände, die daraus entstandenen Kosten entsprechend in Abzug zu bringen. Nähere Informationen hierzu erhalten Sie von Ihrem Gebietsverkaufsleiter.

Grundsätzlich nicht zurückgenommen werden können:

- Waren aus Sonderverkäufen
- landesspezifische Waren
- Abverkaufsprodukte
- Produkte, die durch andere Artikel ersetzt wurden
- nicht mit uns abgestimmte Retouren
- Waren in unverkäuflichem Zustand (siehe oben)
- Kataloge und andere Drucksachen, CD/DVD, Werbematerial

Bitte stimmen Sie das weitere Vorgehen vor der Rücklieferung mit uns ab.

Vielen Dank.

Ihr Vertriebsteam

Requirements for customer returns (not claims)

Dear business partner,

There are many reasons why goods may need to be returned. Should you need to return goods to us where no claims apply, please observe the following instructions.

Requirements for returning saleable goods:

- The packaging must be clean and free from damage, writing and labels.
- The goods must be in their original packaging.
- Please inform your area sales manager before returning any goods.
- Your area sales manager will provide you with a returns order number.
Please include the number on your return.
- A copy of the invoice must be included with your return for each item position.
- The invoice must be dated within the last three years.

The deductions from the value of the goods depend on the invoice date and are as follows:

a) Invoice date not more than 3 months ago	0%
b) Invoice date 3-12 months	20%
c) Invoice date 13-24 months	30%
d) Invoice date 25-36 months	40%

We reserve the right to apply deductions for costs incurred as a result of inspections, re-storage processes and any other unplanned expenditure. Please contact your area sales manager for more information.

The following can not be returned:

- Goods from special sales
- Country-specific goods
- Sale products
- Products that have been replaced with other articles
- Returns that have not been agreed with us
- Goods in an unsaleable condition (see above)
- Catalogues and other printed items, CDs/DVDs, advertising material

Please agree the further procedure with us before returning the goods.

Thank you.

Your sales team

Vorgehensweise bei Reklamationen

Sehr geehrter Motorservice Partner,

für eine schnelle und reibungslose Reklamationsbearbeitung bitten wir um die Beachtung der nachfolgenden Punkte.

Voraussetzungen für Reklamationen

Der Motorservice Handelspartner garantiert gegenüber Motorservice, dass die Voraussetzungen für eine Reklamation erfüllt sind. Der Handelspartner von Motorservice hat im Vorfeld geprüft, ob das reklamierte Teil aus dem Motorservice Lieferprogramm stammt. Ferner ist anhand von Lieferscheinen oder Rechnungen zu prüfen und zu belegen, dass seit der Lieferung des Ersatzteils weniger als 12 Monate vergangen sind. Der Handelsweg muss eingehalten werden.

Einreichung von Reklamationen

Wenn die Teile über den Motorservice OnlineShop bestellt wurden, erfolgt die Einreichung der Reklamation direkt über den OnlineShop. Bitte wählen Sie hierzu im Menü „Mein Konto“ den Eintrag „Reklamationen“ und geben Sie die Daten in das bereitgestellte Webformular ein. Für alle übrigen Reklamationen benutzen Sie bitte das nachfolgende Formular. Bitte beachten Sie, dass die für die Bearbeitung notwendigen Pflichtdatenfelder vollständig ausgefüllt sind. Der Umfang der Reklamation (Schadenshöhe) muss stets vollständig angegeben werden. Darüber hinaus sind wir auch umgehend über ggf. entstandene Personenschäden zu informieren. Werden Reparatur- oder Folgekosten geltend gemacht, müssen die entsprechenden Rechnungen als Kopie beigefügt werden. Nachträglich eingereichte Kostenansprüche, die nach unserer Diagnose oder Ergebnismitteilung eingehen, können nicht mehr anerkannt werden.

Rücksendung von Reklamationsteilen

Senden Sie Reklamationsteile nur dann zurück, wenn diese explizit von Motorservice zurückgefordert werden. Ob und welche Teile zurückgesendet werden müssen, teilen wir Ihnen nach Eingang der Reklamationsmeldung mit. Produkte, die aus mehreren Teilen bestehen, müssen stets in dem Umfang zurückgesandt werden, wie diese bezogen wurden. Wir behalten uns vor, Teile die ebenfalls beschädigt wurden bzw. zur Schadensentstehung beigetragen haben, anzufordern oder nachzufordern, auch wenn diese nicht zum Lieferprogramm von Motorservice gehören.

Reklamationsteile sind für Motorservice kostenfrei einzusenden. Wenn in einer Lieferung Teile von unterschiedlichen Reklamationen enthalten sind, müssen diese jeweils separat verpackt und gekennzeichnet werden. Teile aus Reklamationen die über das Online Reklamationsmanagement eingereicht werden, müssen für den Rückversand mit dem von der Webanwendung bereit gestellten Rücksendetikett versehen werden. Bereits benutzte Teile müssen frei von Öl und sonstigen Verunreinigungen sein. Der Handelspartner muss sicherstellen, dass die Teile ordnungsgemäß verpackt sind und beim Transport nicht beschädigt werden können. Die Teile sind zweckmäßig in einer Originalverpackung unter Einhaltung größtmöglicher Sorgfalt einzusenden. Der Rücktransport erfolgt auf Risiko und Gefahr des Handelspartners. Bei einem Teilerückversand außerhalb der europäischen Union sind die zolltechnischen Bestimmungen (z. B. Mitsendung einer Proformarechnung, Mitteilung der ursprünglichen Handelsrechnungsnummer, Teiledeklaration) in jedem Fall einzuhalten.

Adressen für den Teilerückversand :

PIERBURG Schadensteile:
MS Motorservice International GmbH
Hamburger Straße 15
41540 Dormagen, Germany

Alle Neuteilreklamationen und alle sonstigen Schadensteile
MS Motorservice International GmbH
Wilhelm-Maybach-Straße 14-18
74196 Neuenstadt, Germany

Zerstörende Bauteilprüfungen

Im Rahmen der Reklamationsbearbeitung kann es nötig sein, Teile oder Baugruppen für eine Diagnose oder Werkstoffprüfung zu zerlegen oder einer zerstörenden Prüfung zu unterziehen. Sofern Sie sich bei der Einreichung der Reklamation schriftlich einverstanden erklärt haben, übernehmen wir für die bei der Analyse entstandenen Beschädigungen keine Haftung.

Sonstiges

Teile sind nur dann reklamationstauglich, wenn diese bestimmungsgemäß eingesetzt bzw. verwendet wurden. Modifizierte Teile, bereits zerlegte Komponenten und Teile, an denen Reparaturversuche unternommen wurden, sind nicht reklamationstauglich. Teile aus abgelehnten Reklamationen werden verschrottet, sofern diese nicht explizit zurückgefordert werden. Im Rahmen der Gewährleistung erstattete Teile gehen in das Eigentum von Motorservice über. Aus organisatorischen Gründen kann die Reklamationsabwicklung ausschließlich in den Sprachen Deutsch oder Englisch erfolgen.

Reklamationsformular

Adressangaben:

Ihre Schadensnummer (nicht Artikelnummer):

Motorservice Kundennummer:

Teilebezeichnung*:

Firmenname und Adresse*:

Artikelnummer*:

Anzahl Reklamationsteile*:

Kaufdatum*:

Rechnungsnummer:

Name Ihres Kunden (Werkstatt, Motoreninstandsetzer):

Neuteilerekklamation (nur ausfüllen bei unbenutzten Teilen):

 Beschädigung

 Produktfehler

 Einbauproblem

 Verpackungsfehler

 Transportschaden

 Falsche Spezifikation

 Korrosion/Schmutz

 Sonstiges

Schadensfall (nur ausfüllen, wenn die Teile im Betrieb beschädigt wurden):

Kraftstoffart*:

 Diesel

 Benzin

 Alkohol

 Gas (LPG, CNG, ...)

Applikation*:

 Straßenfahrzeug

 Industrieanwendung

 Marineanwendung

 Agrarfahrzeug

Motorenhersteller*:

Motorentyp/Motornummer*:

Schlüsselnummer (zu 2 und 3):

Baujahr/Erstzulassung*:

Teile-Einbaudatum*:

+

km-Stand/Betriebsstunden*:

Schadensdatum*:

+

km-Stand/Betriebsstunden*:

Schadensbeschreibung*: (fügen Sie ggf. eine Anlage bei, falls der Platz nicht ausreicht)

Schadensumfang/Forderung*:

 nur Teileersatz

Schadenssumme in Euro*:

 Teileersatz inklusive Reparaturkosten (bitte Reparaturrechnung beifügen)

 Bitte senden Sie die Teile im Fall einer Ablehnung wieder zurück.

 Ich bin damit einverstanden, dass die Teile im Zuge der Untersuchung bei Bedarf zerlegt, geöffnet oder einer zerstörenden Prüfung unterzogen werden werden.

Ort/Datum*:

Sachbearbeiter*:

Procedure in case of claims

Dear Motorservice Partner,

In order to ensure fast and trouble-free processing of claims, please observe the following points.

Prerequisites for claims

The Motorservice trading partner guarantees Motorservice that the prerequisites for a claim are met. The Motorservice trading partner has already verified whether the part subject to the claim is part of the Motorservice product range. Furthermore, it is to be checked and proven based on delivery notes or invoices that less than 12 months have passed since delivery of the spare part. The trade route must be adhered to.

Submitting claims

If the parts were ordered via the Motorservice OnlineShop, claims must be submitted directly via the OnlineShop. To do this, please select the "Claims" entry in the "My account" menu and enter the data in the web form provided. For all other claims, please use the following form. Please ensure that the compulsory fields required to process the claim are filled out completely. The scope of the claim (amount of loss) must always be fully specified. Furthermore, we need to be notified immediately about any resulting personal injury. If repair or follow-up costs are claimed, copies of the respective invoices must be enclosed. Claims for costs that were handed in after our diagnostics or communication of results cannot be accepted.

Returning claim parts

Claim parts should only be returned if explicitly requested by Motorservice. We will inform you whether and which parts have to be returned following receipt of your claim. Products made up of several parts must always be returned as a whole in the same scope as they were purchased. We reserve the right to request parts that were also damaged or that contributed to the damage being caused, even if they are not part of the Motorservice product range.

Claim parts must be sent in without incurring a charge for Motorservice. If a delivery includes parts relating to different claims, they must each be packaged and labelled separately. For parts from claims submitted via the online claims management, the returns label provided by the web application must be used for the return. Already used parts must be free from oil and other impurities. The trading partner must ensure that the parts are packaged properly and cannot be damaged during transport. The parts must be sent in appropriate original packaging with the greatest possible care. The items are returned at the trade partner's own risk and peril. When returning parts from outside the European Union, customs agreements (e.g. sending of a pro-forma invoice, communication of the original commercial invoice no., part declaration) must be adhered to at all times.

Destructive component testing

When processing claims, it may be necessary to dismantle parts or assembly groups for diagnostics or material inspection, or to subject them to destructive testing. If you gave your consent in writing when submitting the claim, we can accept no liability for any damage that may occur during the analysis.

Other

Parts can only be claimed if they were deployed or used for their intended purpose. Modified parts, components and parts already taken apart in the course of repair attempts cannot be claimed. Parts from rejected claims will be scrapped unless an explicit request has been made for them to be returned. Parts refunded within the scope of the warranty become the property of Motorservice. For organisational reasons, only German or English can be used when dealing with claims.

Addresses for returning parts:

PIERBURG damaged parts:

**MS Motorservice International GmbH
Hamburger Straße 15
41540 Dormagen, Germany**

All claims relating to new parts and all other damaged parts

**MS Motorservice International GmbH
Wilhelm-Maybach-Straße 14-18
74196 Neuenstadt, Germany**

Claims form

Address details:
Your claim number (not item number):

Motorservice customer number:

Part designation*:

Company name and address*:

Item number*:

Number of faulty parts*:

Date of purchase*:

Invoice number:

Name of your customer (repair shop, engine reconditioner):

 New part return (only to be completed for unused parts):
 Damage
 Product defect
 Installation problem
 Packaging fault
 Damage in transit
 Wrong specification
 Corrosion/dirt
 Other
 Event of damage (only to be completed if parts were damaged during operation):
Type of fuel*:
 Diesel
 Petrol
 Alcohol
 Gas (LPG, CNG, ...)
Application*:
 Road vehicle
 Industrial application
 Marine application
 Agricultural vehicle
Engine manufacturer*:

Engine type/engine number*:

Key number (for 2 and 3):

Model year/initial registration*:

Part date of installation*:

km status/hours of operation*:

+

Damage date*:

+

km status/hours of operation*:

Damage description*: (if required, add an attachment if not enough space is available)

Extent of damage/claim*:
 only part replacement
Total claim in Euro*:

 Part replacement incl. repair costs (please enclose repair invoice)
 In case of refusal, please return the parts.
 I agree the parts to be taken apart, opened or submitted to destructive testing within the scope of examination as required.
Place/date*:
Case handler*:

1. Geltungsbereich

1.1 Die Verkaufs- und Lieferbedingungen der MS Motorservice International GmbH (im Folgenden „Verkäufer“ genannt) gelten ausschließlich. Entgegenstehende oder von diesen Verkaufs- und Lieferbedingungen abweichende Bedingungen des Käufers werden nicht anerkannt, es sei denn, der Verkäufer hat ausdrücklich und schriftlich der Geltung abweichender Bedingungen zugestimmt. Diese Verkaufs- und Lieferbedingungen gelten auch dann, wenn der Verkäufer in Kenntnis entgegenstehender oder von den eigenen Verkaufs- und Lieferbedingungen abweichender Bedingungen des Käufers die Lieferung an den Käufer vorbehaltlos durchführt.

1.2 Von diesen Verkaufs- und Lieferbedingungen abweichende oder sie ergänzende separate Vereinbarungen zwischen den Parteien gelten vorrangig. Sie werden dort, sofern keine speziellen Regelungen getroffen sind, durch die vorliegenden Verkaufs- und Lieferbedingungen ergänzt. Für den Inhalt derartiger Vereinbarungen ist ein schriftlicher Vertrag bzw. die schriftliche Bestätigung des Verkäufers maßgebend.

1.3 Die Verkaufs- und Lieferbedingungen gelten auch für alle zukünftigen Geschäfte mit dem Käufer. Durch Bestellung des Käufers, spätestens aber durch Annahme der Ware, werden diese Verkaufs- und Lieferbedingungen vom Käufer anerkannt.

1.4 Diese Verkaufs- und Lieferbedingungen gelten nur gegenüber Unternehmern.

2. Angebot und Auftragsbestätigung

2.1 Angebote des Verkäufers sind stets unverbindlich. Ist eine Bestellung des Käufers, rechtlich als Angebot zu qualifizieren, gilt diese erst dann als angenommen, wenn sie vom Verkäufer innerhalb von vier Wochen schriftlich bestätigt wird. Spätestens kommt der Vertrag mit Versendung oder der Mitteilung über den Bereitstellungszeitpunkt der bestellten Ware, bei Teillieferung mit Absendung der ersten Lieferung, zustande.

2.2 Änderungen und sonstige Vereinbarungen sind nur dann verbindlich, wenn sie vom Verkäufer schriftlich bestätigt werden.

2.3 Die in den Angeboten enthaltenen Unterlagen, Zeichnungen, Gewichtszu- und Maßangaben, Muster etc. sind nur ungefähre Angaben und stellen keine Beschaffenheitsmerkmale dar. Der Verkäufer ist berechtigt, von den Beschreibungen im Angebot abzuweichen, sofern diese Abweichungen nicht grundlegender oder wesentlicher Art sind und der vertragsgemäße Zweck nicht wesentlich eingeschränkt wird.

2.4 Soweit Waren nach Käuferzeichnungen gefertigt werden, sind die vom Käufer erstellten und vom Verkäufer genehmigten Zeichnungen maßgeblich. Abweichungen von genehmigten Zeichnungen sind besonders zu vereinbaren und etwaige Mehrkosten hierfür sind dem Verkäufer zu vergüten.

3. Schutzrechte

3.1 Der Verkäufer behält sich an allen Abbildungen, Zeichnungen, Kalkulationen und sonstigen Unterlagen das Eigentums- und Urheberrecht vor; sie dürfen ohne vorherige schriftliche Zustimmung des Verkäufers weder für andere als die vom Verkäufer angegebenen Zwecke verwendet noch Dritten zugänglich gemacht werden. Dies gilt insbesondere für solche schriftlichen Unterlagen, die als „vertraulich“, „geheim“ oder ähnlich bezeichnet sind.

3.2 Der Verkäufer haftet nur für Ansprüche, die sich bei vertragsgemäßer Verwendung der Waren aus der Verletzung von Schutzrechten und Schutzrechtsanmeldungen (Schutzrechte) ergeben, von denen mindestens eines aus der Schutzrechtsfamilie entweder vom Europäischen Patentamt oder in einem der Staaten Bundesrepublik Deutschland, Frankreich, Großbritannien, Österreich, China, Japan oder USA veröffentlicht ist.

3.3 Erfolgen Lieferungen nach Zeichnungen oder sonstigen Angaben des Käufers und werden hierdurch Schutzrechte Dritter verletzt, stellt der Käufer den Verkäufer im Innenverhältnis von sämtlichen Ansprüchen frei.

4. Empfehlungen, Informationen und Auskünfte

Empfehlungen, Informationen und Auskünfte sind unverbindlich, soweit sie sich nicht auf die Ware selbst beziehen.

5. Preise

5.1 Alle Preise sind Nettopreise und gelten „ab Werk“ (Incoterms®2020, „EXW“) ausschließlich Verpackung, Fracht, Porto und Wertsicherung. Die gesetzliche Umsatzsteuer in der jeweils gültigen Höhe wird hinzugerechnet.

5.2 Etwaiger Mehraufwand, der durch Änderungswünsche entsteht, kann dem Käufer vom Verkäufer in Rechnung gestellt werden.

5.3 Treten nach Abschluss des Vertrages Ereignisse ein, die die Selbstkosten des Verkäufers beim Einkauf, der Herstellung und/oder dem Versand der Ware verteuern, so ist der Verkäufer zu entsprechender Preiserhöhung berechtigt.

6. Zahlungsbedingungen

6.1 Rechnungen sind innerhalb von 14 Tagen ab Rechnungsdatum ohne Abzug zur Zahlung fällig. Der Verkäufer ist, auch im Rahmen einer laufenden Geschäftsbeziehung, jederzeit berechtigt, eine Lieferung ganz oder teilweise nur gegen Vorkasse durchzuführen. Skonto gilt nur bei ausdrücklicher schriftlicher Vereinbarung.

6.2 Der Verkäufer ist berechtigt, selbst bei entgegenstehender Zweckbindung des Käufers eine Zahlung zunächst auf die jeweils älteste, nicht titulierte Schuld anzurechnen. Sind bereits Kosten oder Zinsen entstanden, ist der Verkäufer berechtigt, Zahlungen zunächst auf die Kosten, dann auf die Zinsen und zuletzt auf die Hauptleistung anzurechnen.

6.3 Das Recht zur Aufrechnung steht dem Käufer nur zu, wenn und soweit seine Gegenansprüche rechtskräftig festgestellt, unbestritten oder vom Verkäufer schriftlich anerkannt sind. Das Zurückbehaltungsrecht des Käufers ist auf Ansprüche aus dem Vertragsverhältnis beschränkt.

6.4 Der Verkäufer ist berechtigt, Verzugszinsen in Höhe des jeweils gültigen gesetzlichen Verzugszinssatzes zu verlangen. Das Recht, einen höheren Verzugschaden nachzuweisen, bleibt ausdrücklich vorbehalten.

7. Lieferung / Lieferzeit / Verzug

7.1 Lieferfristen und Liefertermine gelten nur dann als verbindlich vereinbart, wenn diese vom Verkäufer ausdrücklich schriftlich zugesagt werden. Der Verkäufer ist an den Liefertermin bzw. die Lieferfrist nicht gebunden, wenn der Käufer seinen Obliegenheiten (Zahlung von Abschlägen, Beibringung erforderlicher Unterlagen, Beistellungen zur Fertigung etc.) nicht rechtzeitig nachkommt. Die Einrede des nichterfüllten Vertrages bleibt vorbehalten.

7.2 Lieferfristen beginnen frühestens am dem Tag, an dem der Vertrag schriftlich geschlossen wurde und alle technischen Fragen geklärt sind.

7.3 Bei Änderungswünschen des Käufers ist der Verkäufer von der Einhaltung eines etwaig vereinbarten Liefertermins bzw. der Lieferfrist befreit. Die Parteien werden in diesem Fall einen neuen Liefertermin oder eine neue Lieferfrist vereinbaren.

7.4 Sofern nichts Abweichendes vereinbart wird, ist der Liefertermin bzw. die Lieferfrist eingehalten, wenn der Verkäufer die Ware an dem vereinbarten Ort bereitgestellt hat.

7.5 Wegen Lieferverzögerungen, die nicht auf Vorsatz oder grober Fahrlässigkeit des Verkäufers beruhen, kann der Käufer keine Ansprüche geltend machen. Dies gilt auch bei sonstigen Störungen, insbesondere für Lieferverzögerungen aufgrund von höherer Gewalt, Arbeitskämpfen, Unruhen, Epidemien und/oder Pandemien, Cyberattacken, behördlichen Maßnahmen, Ausbleiben von Zulieferern der Zulieferanten und sonstigen unvorhersehbaren, unabwendbaren und schwerwiegenden Ereignissen. Der vereinbarte Liefertermin bzw. die Lieferfrist verschiebt sich in diesen Fällen entsprechend der Dauer des Lieferhindernisses, der Verkäufer informiert den Käufer hierüber und wird, sofern möglich, einen neuen voraussichtlichen Liefertermin mitteilen. Der Ersatz von entgangenem Gewinn und Schäden aus Betriebsunterbrechung ist auf Vorsatz beschränkt.

7.6 Kommt der Käufer in Annahmeverzug oder verletzt er sonstige Mitwirkungspflichten, so ist der Verkäufer berechtigt, den insoweit entstandenen Schaden einschließlich etwaiger Mehraufwendungen ersetzt zu verlangen. Der Verkäufer ist darüber hinaus berechtigt, dem Käufer eine angemessene Annahmefrist zu setzen und nach deren fruchtlosem Verstreichen vom Vertrag zurückzutreten und Schadensersatz statt der Leistung zu verlangen.

7.7 Teillieferungen sind in zumutbarem Umfang zulässig. Insofern sind Ansprüche des Käufers wegen der Teillieferung oder einer verspäteten Lieferung der Restmenge ausgeschlossen.

8. Eigentumsvorbehalt

8.1 Der Verkäufer behält sich das Eigentum an sämtlichen gelieferten Waren bis zum Eingang aller Zahlungen aus der Lieferbeziehung, auch der zukünftig entstehenden Verbindlichkeiten, vor. Bei vertragswidrigem Verhalten, insbesondere bei Zahlungsverzug, ist der Verkäufer berechtigt, die Waren zurückzufordern.

8.2 Der Käufer ist verpflichtet, die gelieferten Waren pfleglich zu behandeln und während der Dauer des Eigentumsvorbehaltes auf eigene Kosten gegen jede Form des Untergangs zum Kaufpreis zu versichern. Der Verkäufer bleibt berechtigt, die Ware auf Kosten des Käufers selbst zu versichern.

8.3 Bei Pfändungen oder sonstigen Eingriffen Dritter hat der Käufer den Verkäufer unverzüglich schriftlich zu benachrichtigen, damit dieser Drittwiderspruchsklage oder andere Rechtsmittel erheben kann. Soweit der Dritte die hierdurch entstehenden gerichtlichen und außergerichtlichen Kosten nicht erstattet, haftet hierfür der Käufer.

8.4 Der Käufer ist berechtigt, die Ware im ordentlichen Geschäftsgang weiter zu verkaufen; er tritt dem Verkäufer jedoch bereits jetzt alle Forderungen in Höhe des Faktura-Endbetrages (einschließlich gesetzlicher Umsatzsteuer) der Forderung ab, die ihm aus der Weiterveräußerung gegen seine Abnehmer oder Dritte erwachsen, und zwar unabhängig davon, ob die Ware ohne oder nach Verarbeitung weiterverkauft wurde. Zur Einziehung dieser Forderung bleibt der Käufer auch nach Auslieferung berechtigt. Die Befugnis des Verkäufers, die Forderung selbst einzuziehen, bleibt davon unberührt.

8.5 Wird die gelieferte Ware mit anderen, nicht dem Verkäufer gehörenden Gegenständen untrennbar vermischt oder verbunden, so erwirbt der Verkäufer das Miteigentum an der neuen oder verbundenen Sache im Verhältnis des Wertes der gelieferten Ware (Faktura-Endbetrag, einschließlich gesetzlicher Mehrwertsteuer) zu der oder den anderen Gegenständen zum Zeitpunkt der Vermischung oder Verbindung. Der Käufer verwahrt das so entstandene Allein- oder Miteigentum für den Verkäufer.

8.6 Übersteigt der Wert der gegebenen Sicherheiten die Forderungen des Verkäufers insgesamt um mehr als 20 %, so ist der Verkäufer auf Verlangen des Käufers verpflichtet, die überschüssigen Sicherheiten nach Wahl des Verkäufers freizugeben.

8.7 Falls und soweit die maßgebliche Rechtsordnung keine Vereinbarung eines Eigentumsvorbehalts zulässt, wird der Käufer den Verkäufer bei Inanspruchnahme von Warenkredit angemessene andere Sicherheiten stellen.

9. Versand, Gefahrenübergang

9.1 Der Versand erfolgt auf Gefahr des Käufers. Die Gefahr geht stets spätestens mit Absendung der Ware, auch wenn weitere Leistungen von dem Verkäufer übernommen werden, auf den Käufer über.

9.2 Verzögert sich der Versand infolge von Umständen, die der Verkäufer nicht zu vertreten hat, so geht die Gefahr vom Tage der Anzeige der Versandbereitschaft auf den Käufer über. Auf schriftlichen Wunsch des Käufers wird die Sendung von dem Verkäufer gegen Bruch-, Transport-, Feuer- und Wasserschäden auf Kosten des Käufers versichert.

9.3 Transport- und alle sonstigen Verpackungen nach Maßgabe des Verpackungsgesetzes werden nicht zurückgenommen; ausgenommen sind Paletten. Der Käufer ist verpflichtet, die Entsorgung der Verpackung auf eigene Kosten zu besorgen.

10. Fertigungsmittel

10.1 Soweit der Käufer dem Verkäufer Fertigungsmittel (z.B. Werkzeuge, Formen) zur Verfügung stellt, sind diese dem Verkäufer kostenfrei zuzusenden. Für deren Untergang, Verschlechterung oder unvollständige Rücklieferung und daraus resultierende Schäden haftet der nur bei grober Fahrlässigkeit oder Vorsatz. Dies gilt nicht, soweit gesetzlich zwingend gehaftet wird.

10.2 Wenn Fertigungsmittel vom Verkäufer im Auftrag des Käufers angefertigt oder beschafft werden, stellt der Verkäufer dem Käufer hierfür die Kosten gesondert in Rechnung. Die Fertigungsmittel bleiben Eigentum des Verkäufers. Zur Herausgabe an den Käufer ist der Verkäufer nicht verpflichtet. Vorstehendes gilt auch für Folgewerkzeuge. Die nachfolgende Regelung in Ziffer 10.3 bleibt hiervon unberührt.

10.3 Im Falle der Amortisation der Kosten der Fertigungsmittel über den Teilepreis übernimmt der Käufer bei Nichtamortisation eines Werkzeuges die nicht gedeckten Kosten einschließlich der Kosten der sonstigen typengebundenen Einrichtungen. Kosten für Modelle gehen stets in vollem Umfang zu Lasten des Käufers.

10.4 Vom Verkäufer dem Käufer ausgehändigte Zeichnungen und Unterlagen sowie Vorschläge des Verkäufers für die Gestaltung und zur Herstellung der Ware dürfen an Dritte nicht weitergegeben und können vom Verkäufer jederzeit zurückverlangt werden.

11. Sachmängelhaftung / Haftung

11.1 Der Verkäufer haftet nicht für Schäden, die durch Verletzung von Bedienungs-, Wartungs- und Einbauvorschriften, ungeeignete, nicht bestimmungsgemäße oder unsachgemäße Verwendung, fehlerhafte oder nachlässige Behandlung, natürlicher Verschleiß, falsche Lagerung oder vom Käufer oder Dritten vorgenommene Veränderungen der Ware auftreten. Die Waren dürfen vom Käufer oder Dritten nur durch unterwiesenes Fachpersonal eingebaut werden.

11.2 Dem Verkäufer steht das Wahlrecht zwischen Nachbesserung und Neulieferung zu. Der Käufer hat dem Verkäufer die beanstandete Ware auf dessen Verlangen zu Untersuchungszwecken zu übergeben. Sofern dem Verkäufer aufgrund eines unberechtigten Mangelbeseitigungsvorlangens des Käufers Kosten entstehen (insbesondere Prüf- und Transportkosten), so kann der Verkäufer Erstattung dieser Kosten verlangen.

11.3 Die zum Zwecke der Nacherfüllung erforderlichen Aufwendungen werden nicht vom Verkäufer getragen, soweit die Aufwendungen sich dadurch erhöhen, dass die Ware nach der Lieferung an einen anderen Ort als den ursprünglichen Lieferort verbracht worden ist.

11.4 Erfolgt die Inanspruchnahme des Verkäufers durch den Käufer im Wege des Rückgriffs, nachdem der Käufer selbst wegen Mängel von seinem Kunden in Anspruch genommen worden ist, so gilt für die Rechtsdurchsetzung § 445a BGB.

11.5 Ansprüche aus Sachmängelhaftung verjähren in einem Jahr ab Übergabe der Ware, es sei denn, die Sachmängelhaftungsansprüche beruhen auf einer grob fahrlässigen oder vorsätzlichen Pflichtverletzung des Verkäufers oder seines Erfüllungsgehilfen oder auf einer Verletzung von Leben, Körper oder Gesundheit. Bei Mängelgewährleistungsansprüchen, die der Käufer im Wege des Rückgriffs gem. § 445a BGB gegen den Verkäufer geltend macht, gilt uneingeschränkt die Verjährungsregelung des § 445b BGB.

11.6 Der Käufer ist verpflichtet, seiner Untersuchungspflicht nach § 377 HGB auch bei Weiterveräußerung der Ware nachzukommen.

11.7 Das Rückgriffsrecht des Käufers gegen den Verkäufer wegen solcher Ansprüche aus Sachmängelhaftung, die dem Käufer von dessen Abnehmern entgegengesetzt werden, ist ausgeschlossen, wenn der Käufer seiner Untersuchungs- und Rügepflicht nicht nachgekommen ist oder die Ware durch Verarbeitung abgeändert wurde.

11.8 Die Haftung des Verkäufers nach den gesetzlichen Bestimmungen auf Schadensersatz ist uneingeschränkt gegeben, wenn eine dem Verkäufer zurechenbare Pflichtverletzung auf Vorsatz oder grober Fahrlässigkeit beruht. Soweit die dem Verkäufer zurechenbare Pflichtverletzung auf einfacher Fahrlässigkeit beruht und eine wesentliche Vertragspflicht schuldhaft verletzt ist, ist die Schadensersatzhaftung auf den vorhersehbaren Schaden beschränkt, der typischerweise in vergleichbaren Fällen eintritt. Im Übrigen ist die Haftung ausgeschlossen.

11.9 Der Ersatz von entgangenem Gewinn und Schäden aus Betriebsunterbrechung ist auf Vorsatz und grobe Fahrlässigkeit beschränkt.

11.10 Die Haftung nach den Bestimmungen des Produkthaftungsgesetzes oder vergleichbarer, unabdingbarer Rechte auch ausländischer Rechtsordnungen bleibt unberührt. Unberührt bleibt auch die Haftung wegen Verletzung von Leben, Körper und Gesundheit.

11.11 Soweit eine Haftung nach Tatbeständen der Ziffer 11.9 begründet wird, ist die Haftung des Verkäufers bei ausländischen Rechtsordnungen im Verhältnis zum Käufer insoweit beschränkt, als es nach dem jeweiligen ausländischen Recht zulässig wäre.

11.12 Soweit die Schadensersatzhaftung des Verkäufers ausgeschlossen oder eingeschränkt ist, gilt dies auch im Hinblick auf die persönliche Schadensersatzhaftung der Mitarbeiter, Vertreter und Erfüllungsgehilfen des Verkäufers.

12. Abtretungsverbot

12.1 Sämtliche Ansprüche des Käufers gegen den Verkäufer sind nicht abtretbar.

12.2 Der Verkäufer ist jederzeit auch ohne Zustimmung des Käufers dazu berechtigt, insbesondere mit ihm verbundene Unternehmen (im Sinne von § 15 AktG) als Erfüllungsgehilfen bei der Angebotserstellung und Vertragsabwicklung einzubinden.

13. Produkthaftung / Hinweispflichten

13.1 Der Käufer darf die Ware nur bestimmungsgemäß verwenden und muss dafür sorgen, dass diese Ware nur an mit den Produktgefahren und -risiken vertraute Personen weiterveräußert wird.

13.2 Der Käufer ist verpflichtet, bei Verwendung der Ware als Grundstoff und Teilprodukt von eigenen Produkten beim Inverkehrbringen des Endprodukts seiner Pflicht auch im Hinblick auf die von dem Verkäufer gelieferte Ware nachzukommen. Im Innenverhältnis stellt der Käufer den Verkäufer von der Geltendmachung von Ansprüchen bei Verletzung dieser Obliegenheit auf erstes Anfordern frei.

14. Geheimhaltung

Der Käufer muss alle geschäftlichen und technischen Informationen, die er vom Verkäufer erhalten hat, Dritten gegenüber wie Geschäfts- und Betriebsgeheimnisse behandeln, soweit diese nicht allgemein bekannt sind. Derartige Informationen dürfen ausschließlich zum vertragsgemäßen Zweck an Dritte, die über eine entsprechende Geheimhaltungsvereinbarung eingebunden sind, weitergegeben werden.

15. Datenschutz

Der Verkäufer erhebt, verarbeitet und nutzt personenbezogene Daten des Käufers nur unter Einhaltung der einschlägigen Datenschutzbestimmungen. Dementsprechend werden personenbezogene Daten des Käufers nur bei Vorliegen einer gesetzlichen Erlaubnis oder Vorliegen einer Einwilligung verwendet.

16. Sonstiges

16.1 Erfüllungsort ist der Ort des jeweiligen Verkäuferwerkes.

16.2 Gerichtsstand für sämtliche Streitigkeiten aus dem Vertrag ist Heilbronn. Der Verkäufer ist jedoch berechtigt, den Käufer auch an dessen allgemeinen Gerichtsstand zu verklagen.

16.3 Für die Abwicklung von Verträgen auf Grundlage dieser Verkaufs- und Lieferbedingungen gilt ausschließlich deutsches Recht unter Ausschluss des Kollisionsrechts und des UN-Kaufrechts (CISG).

16.4 Die Parteien sind verpflichtet, im Rahmen der Durchführung der Vertragsbeziehung sämtliche geltenden gesetzlichen Bestimmungen einzuhalten.

16.5 Soweit eine oder mehrere der vorstehenden Bestimmungen ganz oder teilweise unwirksam sein sollte, so bleibt die Gültigkeit der übrigen Bestimmungen hiervon unberührt. Die ungültige Bestimmung ist dann durch eine gesetzlich zulässige Bestimmung zu ersetzen, mit der Sinn und Zweck dieser Verkaufs- und Lieferbedingungen in möglichst gleicher Weise erreicht werden.

1. Scope of Application

- 1.1** The Terms and Conditions of Sale and Delivery of MS Motorservice International GmbH (hereinafter referred to as the "Seller") shall apply exclusively. Opposing terms of the Buyer or terms that deviate from these Terms and Conditions of Sale and Delivery shall not apply unless the Seller has expressly agreed to the validity of deviating terms in writing. These Terms and Conditions of Sale and Delivery shall also apply if the Seller effects delivery to the Buyer without reservation in full knowledge of opposing terms of the Buyer or terms that deviate from its own Terms and Conditions of Sale and Delivery.
- 1.2** Separate agreements between the parties deviating from or supplementing these Terms and Conditions of Sale and Delivery shall take precedence. They shall be supplemented by these Terms and Conditions of Sale and Delivery unless special provisions have been agreed. The content of such agreements is contingent on a written contract or the written confirmation of the Seller.
- 1.3** The Terms and Conditions of Sale and Delivery shall also apply to future business transactions with the Buyer. By placing a purchase order and at the latest upon acceptance of the goods, the Buyer accepts these Terms and Conditions of Sale and Delivery.
- 1.4** These Terms and Conditions of Sale and Delivery shall only apply in B2B relationships.

2. Offer and Order Confirmation

- 2.1** Offers by the Seller shall in all cases be non-binding. If a purchase order from the Buyer legally qualifies as an offer, it shall only be accepted once it has been confirmed in writing by the Seller within four weeks. The contract shall come into effect at the latest once the ordered goods have been dispatched or their delivery time has been communicated, and in case of partial delivery, once the first delivery has been dispatched.
- 2.2** Modifications and other agreements shall only be binding once they have been confirmed by the Seller in writing.
- 2.3** The documents, drawings, details relating to weight and dimensions, samples etc. contained in the offers are only approximate specifications and shall not constitute guaranteed qualities. The Seller shall be entitled to deviate from the descriptions in the offer to the extent that these deviations are not of a fundamental or significant nature and the purpose according to the contract is not substantially restricted.
- 2.4** Insofar as goods are manufactured according to Buyer's drawings, the drawings created by the Buyer and approved by the Seller shall be decisive. Deviations from approved drawings must be separately agreed and any additional costs in this regard shall be reimbursed to the Seller.

3. Industrial Property Rights

- 3.1** The Seller shall reserve industrial property rights and copyright to all illustrations, drawings, calculations, and other documents; these items may neither be used for purposes other than those stipulated by the Seller, nor made accessible to third parties without the prior written consent of the Seller. This shall apply in particular to written documents that are designated as "confidential", "secret" or similar.
- 3.2** The Seller shall only be liable for claims relating to violations of industrial property rights and applications for industrial property rights resulting from contractual use of the goods, if at least one property right from the family of industrial property rights has been published by the European Patents Office or in one of the following states: Federal Republic of Germany, France, United Kingdom, Austria, China, Japan or the USA.
- 3.3** Where deliveries are effected according to drawings or other specifications from the Buyer and where third-party property rights are breached as a result of this, the Buyer shall indemnify the Seller against any claims internally.

4. Recommendations and Information

Recommendations and information shall be non-binding insofar as they do not refer to the goods themselves.

5. Prices

- 5.1** All prices are net prices and shall be quoted ex works (Incoterms® 2020, "EXW") excluding packaging, freight, postage and insurance. Statutory VAT shall be added at the current applicable rate.
- 5.2** Any additional costs incurred as a result of modification requests may be charged to the Buyer by the Seller.
- 5.3** Where events occur after conclusion of the contract that result in increased costs for the Seller in terms of primary purchasing costs, manufacture and/or shipment of the goods, the Seller shall be entitled to increase its prices accordingly.

6. Conditions of Payment

- 6.1** Invoices shall be due for payment within 14 days of the invoice date without any deductions. Even as part of an active business relationship, the Seller is entitled, at any time, to only carry out a delivery, either fully or in part, in exchange for payment in advance. Discounts shall only apply where expressly agreed in writing.
- 6.2** The Seller shall be entitled to offset a payment against the oldest, not specifically titled debt, even where the Buyer has earmarked the payment for a different purpose. Where costs or interest have already been incurred, the Seller shall be entitled to offset payments, in the first instance, against the costs, then against the interest, and finally against the principal debt.
- 6.3** The Buyer shall only have the right to offset insofar as its counterclaims are legally binding, are uncontested or have been acknowledged in writing by the Seller. The right of retention on the part of the Buyer shall be limited to claims arising from the contractual relationship.
- 6.4** The Seller is entitled to charge default interest at the applicable statutory default interest rate. The right to prove a higher default damage shall be expressly reserved.

7. Delivery / Delivery Time / Delay

- 7.1** Delivery periods and delivery dates shall only be deemed to have been agreed with binding effect where these are expressly confirmed in writing by the Seller. The Seller shall not be bound to the delivery date or delivery period where the Buyer does not meet its obligations in due time (to make anticipated payments, to provide required documents, to supply materials for manufacture etc.). The plea for non-fulfilment of the contract shall remain reserved.
- 7.2** Delivery periods begin at the earliest on the day of written conclusion of the contract and once all technical issues have been clarified.
- 7.3** In the event of change requests from the Buyer, the Seller shall be exempt from compliance with any agreed delivery date or delivery period. In such cases, the parties shall agree a new delivery date or a new delivery period.
- 7.4** Unless otherwise agreed, the delivery date or delivery period shall be deemed to have been adhered to when the Seller has made the goods available at the location agreed.
- 7.5** The Buyer may not assert claims due to delivery delays that do not result from intent or gross negligence on the part of the Seller. In particular, including with regard to other disruptions, this shall apply to delivery delays caused by force majeure, labour disputes, unrest, epidemics and/or pandemics, cyber-attacks, official measures, failure to deliver by suppliers and any other unforeseeable, unavoidable and serious events. In such cases, the agreed delivery date or delivery period shall be extended according to the duration of the delivery impediment. The Seller shall notify the Buyer of this and, where possible, specify a new expected delivery date. Compensation for loss of profit and stop of production shall be limited to intent.
- 7.6** Where the Buyer delays acceptance or violates any other obligation to cooperate, the Seller shall be entitled to demand compensation for damage suffered in this respect, including any additional costs. Furthermore, the Seller shall have the right to set an appropriate acceptance period for the Buyer and to withdraw from the contract where this period has expired to no avail, and to demand compensation for damage instead of the performance.
- 7.7** Partial deliveries shall be permitted to a reasonable extent. In this regard, claims made by the Buyer due to partial delivery or delayed delivery of the remaining goods shall be excluded.

8. Retention of Title

- 8.1** The Seller shall reserve title of all goods delivered until all payments pertaining to the supplier relationship, including any dues as shall arise in the future, have been effected in full. In the event of conduct contrary to contract, in particular as regards payment default, the Seller shall be entitled to claim back the goods.
- 8.2** The Buyer shall be obliged to handle the delivered goods with care and to insure them at their purchase price against any kind of loss at its own expense during the period of retention of title. The Seller shall remain entitled to insure the goods itself at the expense of the Buyer.
- 8.3** In case of pledge or other third-party intervention, the Buyer shall immediately notify the Seller in writing so that the latter can initiate a third-party action or other legal remedies. Where the third party fails to reimburse the legal and extrajudicial costs arising from this, the Buyer shall be liable for such costs.
- 8.4** The Buyer shall be entitled to sell on the goods in the ordinary course of business; it hereby, however, assigns to the Seller all receivables arising from the resale to its customers or third parties to the value of the final invoice amount (including statutory VAT) of the receivables, irrespective of whether the goods were sold without or following further processing. The Buyer shall remain entitled to collect these receivables even after delivery. The Buyer's right to collect the receivables itself shall remain unaffected by this.

8.5 Where the goods delivered are inseparably mixed or combined with other items not belonging to the Seller, the Seller shall acquire joint ownership of the new or combined product in proportion to the value of the goods delivered (final invoice amount, including statutory VAT) in relation to the value of the other items at the time of combination or mixing. The Buyer shall safeguard the resulting sole ownership or joint ownership on behalf of the Seller.

8.6 Where the value of the securities granted exceeds the claims of the Seller by more than a total of 20%, the Seller shall be obliged to release the excess securities upon request of the Buyer, at the Seller's option.

8.7 If and to the extent that an agreement on the retention of title is not permitted under the relevant legal system, the Buyer shall provide the Seller with alternative appropriate securities on taking advantage of credit on goods.

9. Shipment, Transfer of Risk

- 9.1** Shipment shall be carried out at the risk of the Buyer. The risk shall transfer to the Buyer when the goods are dispatched at the very latest, even if the Seller has other services to perform.
- 9.2** Where shipment is delayed due to circumstances beyond the Seller's control, the risk shall pass to the Buyer from the day of notification of readiness for shipment. Upon written request of the Buyer and at the Buyer's expense, the Seller shall insure the shipment against breakage, damage in transit, as well as fire and water damage.
- 9.3** In accordance with the Packaging Act (Verpackungsgesetz), transport packaging and any other packaging shall not be taken back, with the exception of pallets. The Buyer shall be obliged to dispose of the packaging at its own expense.

10 Manufacturing Equipment

- 10.1** Insofar as the Buyer provides manufacturing equipment (e.g. tools, templates) to the Seller, these shall be sent to the Seller at no charge. The Seller can only be held liable for their loss, deterioration or incomplete return, including damage resulting from this, in cases of gross negligence or intent. This shall not apply in cases of legally mandatory liability.
- 10.2** Where manufacturing equipment is produced or procured by the Seller at the Buyer's request, the Seller shall invoice the Buyer for the costs for such equipment separately. The manufacturing equipment shall remain the property of the Seller. The Seller shall not be obliged to hand over said equipment to the Buyer. The above shall also apply in respect of follow-on tools. The following provision in Item 10.3 shall remain unaffected by this.
- 10.3** In the event of amortization of costs for the manufacturing equipment in excess of the part cost, the Buyer shall assume the costs not covered in case of non-amortization of a tool, including the costs for other type-specific equipment. Costs for models shall in all cases be for the account of the Buyer.
- 10.4** Drawings and documents provided to the Buyer by the Seller, as well as recommendations by the Seller in respect of design and production of the goods, may not be forwarded to third parties and can be claimed back by the Seller at any time.

11. Liability for Defects / Liability

- 11.1** The Seller shall not be liable for any damage caused by non-compliance with operating, maintenance and fitting instructions, inappropriate or improper use, faulty or negligent handling, natural wear and tear, incorrect storage or modification of the goods by the Buyer or third parties. Installation of the goods by the Buyer or a third party may only be carried out by trained and qualified personnel.
- 11.2** The Seller shall have the right to decide whether to remedy a defect or provide new goods. At the request of the Seller, the Buyer must hand the goods in question over to the Seller for examination. If the Seller incurs costs as a result of an unjustified request by the Buyer for the rectification of a defect (especially examination and transport costs), the Seller can demand compensation for these costs.
- 11.3** Expenses required for purposes of cure shall not be borne by the Seller in the event of increased expenses as a result of subsequent relocation of the goods to a location other than that of the original place of delivery.
- 11.4** If the Seller is sued by the Buyer by way of recourse after the Buyer itself has been sued by its customer due to defects, § 445a BGB (Bürgerliches Gesetzbuch - German Civil Code) shall apply to the enforcement of rights.
- 11.5** Claims based on liability for defects shall expire one year after handover of the goods unless the warranty claims are based on grossly negligent or wilful breach of obligation on the part of the Seller or one of its vicarious agents or on injury to life, limb, or health. Warranty claims for defects brought against the Seller by the Buyer by way of recourse in accordance with § 445a BGB are subject, without restriction, to the limitation period set out in § 445b BGB.
- 11.6** The Buyer shall also undertake to fulfil its obligation of examination pursuant to § 377 HGB (Handelsgesetzbuch - German Commercial Code) in the case of resale of the goods.
- 11.7** The Buyer's right of recourse against the Seller as a result of such claims based on liability for material defects made against the Buyer by its customers shall be excluded if the same has not fulfilled its obligation of examination and notification or if the goods have been modified by means of processing.
- 11.8** The Seller's liability for compensation according to statutory provisions shall apply without limitation if the same is responsible for breach of obligation based on intent or gross negligence. Insofar as a breach of obligation based on ordinary negligence is attributable to the Seller and an essential contractual obligation has been culpably violated, compensation for damages shall be limited to the amount of foreseeable damage that typically occurs in comparable cases. In all other cases, liability shall be excluded.
- 11.9** Compensation for loss of profit and damage resulting from business interruptions shall be limited to intent and gross negligence.
- 11.10** Liability according to the provisions of the Product Liability Law or similar, non-derogable rights of foreign jurisdiction shall remain unaffected. Liability resulting from injury to life, limb, and health shall also remain unaffected.
- 11.11** Insofar as liability arises according to the facts in Item 11.9, the liability of the Seller in case of foreign jurisdiction shall be limited in relation to the Buyer to the extent permissible according to the relevant foreign law.
- 11.12** Where the Seller's liability for compensation is excluded or limited, this shall also apply with regard to personal liability for compensation on the part of the Seller's employees, representatives, or vicarious agents.

12. Non-assignment Clause

- 12.1** All claims by the Buyer against the Seller shall be non-assignable.
- 12.2** The Seller is entitled at all times, even without the consent of the Buyer, to involve affiliated companies (in the sense of § 15 AktG (Aktengesetz - German Stock Corporation Act)) in particular in the generation of quotations and execution of contracts as vicarious agents.

13. Product Liability / Notification Obligation

- 13.1** The Buyer shall only use the goods according to their purpose and shall ensure that these goods are only resold to persons familiar with the hazards and risks associated with the goods.
- 13.2** The Buyer shall also undertake to fulfil its obligation to issue warnings in respect to the goods delivered by the Seller where the former uses these goods as base material or components for its own products when placing the final product on the market. The Buyer shall indemnify the Seller internally against assertion of claims arising from breach of this obligation upon first request.

14. Confidentiality

The Buyer shall treat as trade and company secret all business and technical information received from the Seller to the extent that this information is not public knowledge. Information of this nature may only be forwarded for the purposes of the contract to third parties who are bound by an appropriate non-disclosure agreement.

15. Data Protection

The Seller shall only collect, process and use personal data concerning the Buyer in accordance with the relevant data protection regulations. Consequently, personal data concerning the Buyer shall only be used on the basis of a legal ground or consent.

16. Other

- 16.1** The place of performance shall be the location of the relevant plant of the Seller.
- 16.2** The place of jurisdiction for all disputes arising from the contract shall be Heilbronn. The Seller shall, however, be entitled to file suit against the Buyer at its general place of jurisdiction as well.
- 16.3** Contracts based on these Terms and Conditions of Sale and Delivery shall be solely subject to German law excluding its conflict-of-laws provisions and the UN Convention on Contracts for the International Sale of Goods (CISG).
- 16.4** The parties shall be obliged to comply with all statutory provisions within the framework of the contractual relationship.
- 16.5** Should one or several of the above provisions be ineffective in whole or in part, the validity of the remaining provisions shall remain unaffected by this. The invalid provision shall in that case be replaced by a legally valid provision that most closely approximates the meaning and purpose of these Terms and Conditions of Sale and Delivery.

1. Domaine de validité

1.1 Les conditions générales de vente et de livraison de la société MS Motorservice International GmbH (ci-après dénommée le « Vendeur ») s'appliquent à l'exclusion de toutes autres. Aucune condition de l'Acheteur, contraire aux présentes conditions de vente et de livraison ou différentes, n'est admise, excepté si le Vendeur a donné son accord exprès et écrit à l'application de conditions différentes. Les présentes conditions de vente et de livraison s'appliquent également si le Vendeur, en connaissance de conditions de l'Acheteur contraires ou différentes des siennes propres, effectue sans réserve la livraison à l'Acheteur.

1.2 Toute convention distincte passée entre les parties et différente des présentes conditions de vente et de livraison ou les complétant, s'applique en priorité. Sauf réglementation spécifique applicable, les présentes conditions de vente et de livraison complètent lesdites conventions. Le contenu de ces dernières est déterminé par un contrat écrit ou une attestation écrite du Vendeur.

1.3 Les présentes conditions de vente et de livraison sont de même applicables à toutes les opérations commerciales futures avec l'Acheteur. L'Acheteur accepte ces conditions de vente et de livraison en passant commande, et au plus tard en réceptionnant la marchandise.

1.4 Les présentes conditions de vente et de livraison ne s'appliquent qu'aux entreprises.

2. Offre et confirmation de commande

2.1 Les offres du Vendeur s'entendent toujours sans engagement. Une commande de l'Acheteur qui pourra être juridiquement qualifiée d'offre, n'est réputée acceptée que dès lors que le Vendeur l'a confirmée par écrit dans un délai de quatre semaines. Le contrat est conclu au plus tard lors de l'expédition ou de la communication de la date de mise à disposition de la marchandise commandée, et pour les livraisons partielles, lors de l'envoi de la première livraison.

2.2 Les modifications et autres conventions ne présentent un caractère contraignant qu'une fois confirmées par écrit par le Vendeur.

2.3 Les documents, dessins, indications de poids et de mesure, modèles, etc. figurant dans les offres ne sont que des indications approximatives ne constituant pas des caractéristiques. Le Vendeur est autorisé à apporter des variantes aux descriptifs figurant dans l'offre pourvu que celles-ci ne soient pas de nature fondamentale ou essentielle et qu'elles ne constituent pas un obstacle substantiel à l'objet du contrat.

2.4 Si les marchandises sont fabriquées d'après des dessins de l'Acheteur, les dessins faits par celui-ci et approuvés par le Vendeur font foi. Les différences apportées aux dessins approuvés doivent être convenues séparément et les coûts supplémentaires éventuels en découlant donnent lieu à une rémunération du Vendeur.

3. Droits de protection

3.1 Le Vendeur demeure titulaire des droits d'auteur et de propriété intellectuelle sur l'ensemble des illustrations, dessins, calculs et autres documents ; cette documentation ne peut être utilisée, sans autorisation préalable du Vendeur, à d'autres fins que celles spécifiées par le Vendeur, ni être communiquée à des tiers. La présente clause s'applique notamment aux documents écrits portant la mention « confidentiel » ou « secret » ou une mention similaire.

3.2 La responsabilité du Vendeur est uniquement engagée en cas de recours exercé dans le cadre de l'utilisation contractuelle des marchandises suite à une violation de droits de protection et de demandes de droits de protection (droits de protection) dont un au moins appartenant à la famille des droits de protection est publié soit par l'Office européen des brevets soit dans l'un des États suivants : Allemagne, France, Grande-Bretagne, Chine, Japon ou USA.

3.3 Dans le cas où des livraisons effectuées sur la base de dessins ou autres indications de l'Acheteur violeraient les droits de protection de tiers, l'Acheteur dégage le Vendeur de tout recours dans le cadre de leurs relations internes.

4. Recommandations, informations et renseignements

Les recommandations, informations et renseignements sont sans engagement pour autant qu'ils ne se rapportent pas à la marchandise elle-même.

5. Prix

5.1 Tous nos prix sont nets et s'entendent « départ usine » (Incoterms® 2020, « EXW »), à l'exclusion de l'emballage, des frais, du port et de la garantie de valeur. La TVA est facturée en sus au taux légal en vigueur.

5.2 Le Vendeur peut facturer à l'Acheteur les éventuels coûts supplémentaires découlant de demandes de modifications.

5.3 En cas d'événements intervenant après la conclusion du contrat qui encheriraient le prix de revient du Vendeur pour ce qui est de l'achat, la production et/ou l'expédition de la marchandise, le Vendeur se réserve le droit d'appliquer une augmentation de prix correspondante.

6. Modalités de paiement

6.1 Les factures sont payables sans déduction aucune dans les 14 jours suivant la date de facture. Le Vendeur se réserve à tout moment le droit d'exiger un paiement anticipé avant tout ou partie d'une livraison, et ce même dans le cadre d'une relation commerciale établie. Aucune remise n'est consentie en l'absence d'accord exprès par écrit.

6.2 Le Vendeur se réserve le droit, même en cas d'affectation différente de la part de l'Acheteur, d'imputer un paiement en premier lieu sur la dette en souffrance la plus ancienne. En cas de frais ou d'intérêts déjà constatés, le Vendeur pourra imputer les paiements d'abord sur les frais, puis sur les intérêts et, en dernier lieu, sur la prestation principale.

6.3 L'Acheteur ne pourra prétendre à un règlement par compensation que si et pour autant que ses contre-prétentions ont un caractère exécutoire, qu'elles n'ont pas été contestées ou que le Vendeur les a reconnues par écrit. Le droit de rétention de l'Acheteur est limité aux créances découlant de la relation contractuelle.

6.4 Le Vendeur pourra exiger des intérêts de retard d'un montant correspondant au taux d'intérêt légal respectivement en vigueur. Il se réserve expressément le droit d'apporter la preuve d'un préjudice plus élevé résultant du retard.

7. Livraison / délai de livraison / retard

7.1 Les délais et dates de livraison ne sont réputés fermes que pour autant qu'ils ont été approuvés expressément par écrit par le Vendeur. Le Vendeur n'est pas tenu de respecter la date ou le délai de livraison si l'Acheteur ne remplit pas ses obligations (paiement d'acomptes, fourniture de documents nécessaires, fournitures requises pour la fabrication, etc.) dans les délais impartis. Le Vendeur se réserve le droit de faire valoir l'exception d'inexécution du contrat.

7.2 Les délais de livraison courent au plus tôt à compter de la date à laquelle le contrat est conclu par écrit et à laquelle l'ensemble des questions techniques est réglé.

7.3 Dans l'hypothèse où l'Acheteur demanderait des modifications, le Vendeur n'est plus tenu de respecter la date ou le délai de livraison éventuellement convenus. Dans ce cas, les parties conviendront d'une nouvelle date ou d'un nouveau délai de livraison.

7.4 Sauf convention contraire, la date ou le délai de livraison est réputé respecté dès lors que le Vendeur met la marchandise à disposition au lieu convenu.

7.5 L'Acheteur ne peut faire valoir aucun droit en cas de retard de livraison qui ne serait causé ni intentionnellement ni du fait d'une négligence grave du Vendeur. Ceci s'applique également en cas de perturbations de toute nature, notamment lorsque les retards de livraison résultent d'un cas de force majeure, de mouvements sociaux, d'épidémies et/ou de pandémies, de cyberattaques, de mesures administratives, d'un défaut de livraison par des fournisseurs ainsi que de tout événement grave, imprévisible et inévitabile. Dans ces cas, la date ou le délai de livraison convenu est reporté d'une durée égale à celle des circonstances faisant obstacle à la livraison. Le Vendeur en informe l'Acheteur et communique, dans la mesure du possible, une nouvelle date de livraison prévue. Il ne pourra être fait droit à une demande d'indemnisation pour manque à gagner et préjudices découlant d'une interruption d'exploitation qu'en cas de faute intentionnelle.

7.6 En cas de retard de l'Acheteur pour la réception ou de manquement de sa part à toute autre obligation de coopération, le Vendeur pourra exiger l'indemnisation du préjudice, y compris des coûts supplémentaires qui en résulteraient. Le Vendeur a en outre le droit de fixer à l'Acheteur un délai de réception raisonnable et, après expiration infructueuse de ce délai, de résilier le contrat et d'exiger une indemnisation en lieu et place de la prestation.

7.7 Les livraisons partielles sont autorisées dans une mesure raisonnable. Il s'ensuit que tout recours de la part l'Acheteur en cas de livraison partielle ou de retard de livraison des quantités restantes est exclu.

8. Réserve de propriété

8.1 Le Vendeur conserve la propriété de l'ensemble des marchandises livrées jusqu'à réception de l'ensemble des paiements, y compris les engagements à venir, résultant de la relation de fourniture. En cas de faute contractuelle, notamment de retard de paiement, le Vendeur se réserve le droit de réclamer la marchandise.

8.2 L'Acheteur est tenu de prendre soin de la marchandise livrée et de l'assurer à ses frais, pour son prix d'achat, contre toute forme de disparition pendant la durée de la réserve de propriété. Le Vendeur conserve le droit d'assurer lui-même la marchandise aux frais de l'Acheteur.

8.3 En cas de saisie ou autres interventions de tiers, l'Acheteur est tenu d'informer le Vendeur sans délai et par écrit, afin que ce dernier puisse faire valoir sa tierce opposition ou user d'autres voies de droit. Si le tiers ne rembourse pas les coûts judiciaires et extra judiciaires qui en résultent, la responsabilité de l'Acheteur est alors engagée.

8.4 L'Acheteur est autorisé à revendre la marchandise dans le cadre d'opérations commerciales régulières ; il cède toutefois d'ores et déjà au Vendeur l'ensemble des créances, résultant de la revente de la marchandise en question à ses clients ou à des tiers à hauteur du montant final de la facture (y compris la TVA applicable), et ce indépendamment du fait que la marchandise ait été revendue sans ou après transformation. L'Acheteur est autorisé à recouvrer cette créance même après la livraison. La faculté du Vendeur de recouvrer lui-même ladite créance n'en est pas affectée.

8.5 Si la marchandise livrée est mélangée ou alliée de manière indissociable à d'autres objets n'appartenant pas au Vendeur, ce dernier acquiert de ce fait une copropriété sur la chose nouvelle ou alliée au prorata de la valeur initiale de la marchandise livrée (montant final de la facture, TVA applicable comprise) par rapport à celle-ci ou aux autres éléments au moment du mélange ou de l'alliage. L'Acheteur sera le dépositaire pour le Vendeur de la propriété exclusive ou de la copropriété ainsi engendrée.

8.6 Si la valeur des sûretés qu'il ont été consenties excède les créances du Vendeur de plus de vingt pour cent (20 %), celui-ci s'engage à libérer les sûretés excédentaires selon son choix, sur demande de l'Acheteur.

8.7 Dans l'hypothèse où le système juridique en vigueur n'autoriserait pas de clause contractuelle de réserve de propriété, l'Acheteur faisant usage d'un crédit commercial s'engage à fournir au Vendeur d'autres garanties appropriées.

9. Expédition, transfert de risque

9.1 L'expédition s'effectue au risque de l'Acheteur. Le risque est toujours transféré à l'Acheteur au plus tard lors de l'envoi de la marchandise, même lorsque d'autres prestations sont acceptées par le Vendeur.

9.2 Si l'expédition subit un retard suite à des circonstances qui ne sont pas imputables au Vendeur, le risque est transféré à l'Acheteur à la date de l'avis d'expédition. Sur demande écrite de l'Acheteur, le Vendeur assurera l'envoi, aux frais de l'Acheteur, contre le bris, les dommages dus au transport, au feu et à l'eau.

9.3 Les emballages de transport et autres ne sont pas repris conformément à la législation sur les emballages, à l'exception des palettes. L'Acheteur est tenu de procéder à ses propres frais à l'élimination des emballages.

10. Moyens de fabrication

10.1 Dès lors que l'Acheteur met à la disposition du Vendeur des moyens de fabrication (p. ex. outillage/outils, moules), ces derniers doivent être envoyés gratuitement au Vendeur. La responsabilité du Vendeur ne pourra être engagée en ce qui concerne leur disparition, leur dégradation ou leur réexpédition incomplète et les dommages en résultant qu'en cas de négligence grave ou de faute intentionnelle. La présente clause ne s'applique pas si la responsabilité est obligatoire de par la loi.

10.2 Si l'Acheteur charge le Vendeur de fabriquer ou d'acheter des moyens de fabrication, les coûts afférents seront facturés à l'Acheteur séparément. Les moyens de fabrication restent la propriété du Vendeur. Celui-ci n'est pas tenu de les restituer à l'Acheteur. Il en ira de même des outillages complémentaires. La règle suivante énoncée au paragraphe 10.3 n'en est pas affectée.

10.3 En cas d'amortissement des coûts des moyens de fabrication supérieur au prix des pièces, l'Acheteur prendra à sa charge les coûts non couverts en cas de non amortissement d'un outil, y compris les coûts des divers équipements spécifiques. Les coûts des modèles sont toujours intégralement à la charge de l'Acheteur.

10.4 La transmission à des tiers des dessins (schémas) et des documents remis à l'Acheteur par le Vendeur, ainsi que les propositions de ce dernier visant à la conception et à la production de la marchandise, n'est pas autorisée ; le Vendeur peut à tout moment en exiger la restitution.

11. Responsabilité pour défaut de qualité / responsabilité

11.1 Le Vendeur décline toute responsabilité pour les dommages résultant d'un manquement aux consignes de manœuvre, de maintenance et de montage, de l'usage inapproprié ou non conforme ou incorrect de la marchandise, d'un traitement impropre ou négligent, de l'usure naturelle, d'un stockage inapproprié ou encore de modifications opérées sur la marchandise par l'Acheteur ou par des tiers. Le montage des marchandises par l'Acheteur ou par des tiers ne doit être effectué que par du personnel qualifié et compétent.

11.2 Le Vendeur a le choix entre réparations et remplacement. Sur demande, l'Acheteur est tenu de remettre au Vendeur la marchandise faisant l'objet de la réclamation à des fins de vérification. Dans le cas où une demande d'élimination de défaut injustifiée émise par l'Acheteur engendre des coûts pour le Vendeur (en particulier des frais de contrôle et de transport), le Vendeur peut exiger le remboursement desdits coûts.

11.3 Le Vendeur ne prend pas à sa charge les frais nécessaires à l'élimination du défaut s'ils sont augmentés du fait que la marchandise a été transportée ultérieurement à la livraison dans un autre endroit que le lieu initial de livraison.

11.4 Si le recours de l'Acheteur prend la forme d'une demande de reprise auprès du Vendeur après que l'Acheteur a lui-même fait l'objet d'un recours pour défaut déposé par son client, l'article 445a du Code civil allemand (BGB) s'applique.

11.5 Les droits issus de la responsabilité pour vice se prescrivent par 12 mois à compter de la remise de la marchandise, excepté si les droits de garantie en raison des défauts de la chose résultent d'un manquement intentionnel ou d'une négligence grave de la part du Vendeur ou de ses agents d'exécution ou d'une atteinte à la vie, à l'intégrité physique ou à la santé. Dans les cas où l'Acheteur fait valoir ses droits à la garantie des vices à l'encontre du Vendeur à des fins de reprise dans le cadre de l'article 445a du Code civil allemand (BGB), la réglementation sur la prescription de l'article 445b du Code civil allemand s'applique sans restriction aucune.

11.6 L'Acheteur est tenu de respecter son obligation d'examen de la marchandise conformément à l'article 377 du Code civil allemand (HGB), même en cas de revente de celle-ci.

11.7 En cas de réclamation pour défauts matériels déposée contre l'Acheteur par ses propres clients, tout droit de recours de l'Acheteur à l'encontre du Vendeur est exclu si l'Acheteur n'a pas respecté son obligation d'examiner les marchandises et d'aviser le Vendeur des défauts qu'il découvre ou si la marchandise a été soumise à un processus de modification.

11.8 La responsabilité légale du Vendeur en matière d'indemnisation est limitée en cas de manquement intentionnel à ses obligations ou de négligence grave de sa part. Dans le cas où le Vendeur manquerait à ses obligations par négligence de conduite et où il serait porté atteinte de manière fautive à une obligation contractuelle majeure, le droit aux dommages et intérêts sera limité au dommage prévisible, intervenant de manière caractéristique dans des cas comparables. Toute responsabilité est exclue dans les autres cas.

11.9 Il ne pourra être fait droit à une demande d'indemnisation pour manque à gagner et préjudices découlant d'une interruption d'exploitation qu'en cas de faute intentionnelle et de négligence grave.

11.10 La responsabilité en vertu des dispositions de la loi sur la responsabilité du fait des produits ou de normes comparables et impératives de législations étrangères subsiste. Demeure également inchangée la responsabilité en cas d'atteinte à la vie, à l'intégrité du corps et à la santé.

11.11 Dans le cas d'une responsabilité fondée, découlant de faits mentionnés au paragraphe 11.9, la responsabilité du Vendeur vis-à-vis de l'Acheteur, dans le cadre de législations étrangères, est limitée dans la même mesure qu'elle le serait par la législation étrangère en question.

11.12 Toute exclusion ou limitation de la responsabilité du Vendeur en matière d'indemnisation s'applique également à la responsabilité personnelle des employés, représentants et agents d'exécution du Vendeur.

12. Interdiction de cession

12.1 Tous les droits de l'Acheteur à l'encontre du Vendeur sont incessibles.

12.2 Le Vendeur se réserve le droit, à tout moment et sans l'accord de l'Acheteur, d'engager des entreprises, notamment celles qui lui sont liées (au sens de l'article 15 de la loi allemande sur les sociétés anonymes « Aktiengesetz ») en qualité d'agents d'exécution aux fins de l'élaboration des offres et de l'exécution du contrat.

13. Responsabilité du fait des produits défectueux / obligations d'information

13.1 L'Acheteur ne devra utiliser la marchandise que de manière conforme à sa destination et devra veiller à ce qu'elle ne soit revendue qu'à des personnes au fait des dangers et risques du produit.

13.2 Si l'Acheteur utilise le produit comme matériau de base ou comme sous-produit de ses propres produits, il est tenu, lors de la mise en circulation du produit final, de respecter son obligation d'avertissement, relative également à la marchandise qui lui a été fournie par le Vendeur. Dans le cadre de leurs relations internes, l'Acheteur libérera le Vendeur, à sa première demande, de tout recours exercé contre ce dernier pour manquement à ces obligations.

14. Confidentialité

Vis-à-vis des tiers, l'Acheteur est tenu de garder le secret en matière commerciale et industrielle sur toutes les informations commerciales et techniques qu'il a reçues de la part du Vendeur, dans la mesure où elles ne sont pas généralement connues. Les informations de cette nature ne pourront être communiquées qu'à des fins exclusivement contractuelles à des tiers liés par un accord de confidentialité approprié.

15. Protection des données

Le Vendeur collecte, traite et exploite les données à caractère personnel de l'Acheteur dans le cadre exclusif de la réglementation applicable sur la protection des données. En conséquence, l'utilisation des données à caractère personnel de l'Acheteur est soumise à autorisation légale ou au consentement de l'Acheteur.

16. Divers

16.1 Le lieu d'exécution est celui où se trouve l'usine du Vendeur concernée.

16.2 Le tribunal compétent pour tout litige découlant du contrat est Heilbronn. Toutefois, le Vendeur est autorisé à assigner l'Acheteur également devant le tribunal de droit commun compétent pour sa domiciliation.

16.3 L'exécution de contrats basée sur les présentes conditions de vente et de livraison est exclusivement régie par le droit allemand, à l'exclusion des règles de conflits de lois et de la Convention des Nations Unies sur les contrats de vente internationale de marchandises (CIVIM).

16.4 Les parties sont tenues, dans le cadre de l'exécution de la relation contractuelle, de respecter l'ensemble des dispositions légales en vigueur.

16.5 En cas d'invalidité totale ou partielle d'une ou plusieurs clauses ci-dessus, la validité des autres clauses n'en sera pas affectée. La clause invalide devra être remplacée par une clause légale s'approchant au plus près du sens et de l'objectif des présentes conditions de vente et de livraison.

1. 1. Ámbito de validez

- 1.1** Se aplicarán exclusivamente las condiciones de venta y entrega de MS Motorservice International GmbH (en adelante, «vendedor»). Las condiciones contrarias o que difieran de las presentes condiciones de venta y entrega del comprador se rechazarán, salvo que el vendedor haya aceptado expresamente por escrito la validez de las condiciones divergentes. Estas condiciones de venta y entrega también se aplicarán si el vendedor realiza la entrega al comprador sin reservas teniendo conocimiento de condiciones contrarias del comprador o que diverjan de las condiciones de venta y entrega propias.
- 1.2** Tienen prioridad los acuerdos separados entre las partes que se desvíen o complementen estos términos y condiciones de venta y entrega. Salvo que se hayan dictado disposiciones especiales, se completan con las presentes condiciones de venta y entrega. Para el contenido de semejantes acuerdos es decisivo un contrato escrito o una confirmación escrita del vendedor.
- 1.3** Las condiciones de venta y entrega también se aplicarán a todas las actividades futuras con el comprador. El comprador aceptará estas condiciones de venta y entrega con la realización del pedido, no obstante, a más tardar, al aceptar la mercancía.
- 1.4** Las presentes condiciones de venta y entrega solo aplican para empresas.

2. Oferta y confirmación del pedido

- 2.1** Las ofertas del vendedor no son obligatorias. Si un pedido efectuado por el comprador se considera legalmente una oferta, solo se considerará aceptado si el vendedor lo confirma por escrito en un plazo de cuatro semanas. A más tardar, el contrato se celebrará con el envío de la mercancía pedida o cuando se notifique que la mercancía solicitada está disponible; en caso de entregas parciales, cuando se envía la primera entrega.
- 2.2** Las modificaciones y otros acuerdos solo son vinculantes cuando el vendedor los confirme por escrito.
- 2.3** Los documentos, planos, pesos y dimensiones, muestras, etcétera, contenidos en las ofertas solo contienen datos aproximados y no constituyen características garantizadas. El vendedor tiene derecho a divergir de las descripciones de la oferta en tanto dichas divergencias no sean de carácter básico o fundamental, y no limiten en lo esencial la finalidad del contrato.
- 2.4** Cuando las mercancías se producen de acuerdo con los dibujos de los compradores, los planos elaborados por el comprador y aprobados por vendedor serán determinantes. Las divergencias de los planos autorizados deben acordarse por separado y cualquier coste añadido al respecto deberá remunerarse al vendedor.

3. Derechos protegidos

- 3.1** El vendedor se reserva los derechos de propiedad y de autor con respecto a todas las ilustraciones, planos, cálculos y demás documentos y no se podrán emplear para fines diferentes de los indicados por el vendedor ni relevarse a terceros, salvo que se disponga de una autorización previa por escrito del vendedor. Esto se aplica especialmente a la documentación escrita designada como «confidencial», «secreta» o de forma similar.
- 3.2** El vendedor solo es responsable de los daños ocasionados por el uso contractualmente correcto de las mercancías derivadas de la violación de los derechos protegidos y solicitudes de los derechos protegidos (derechos protegidos), de los cuales al menos uno de la familia de los derechos protegidos figurará en la lista de la Oficina Europea de Patentes o en uno de los estados de la República Federal de Alemania, Francia, Gran Bretaña, Austria, China, Japón o los EE. UU.
- 3.3** Si las entregas se realizan basándose en planos u otra información proporcionada por el comprador y con ello se violan los derechos de propiedad de terceros, el comprador deberá indemnizar internamente al vendedor por todas las reclamaciones.

4. Recomendaciones, información y declaraciones

Las recomendaciones, la información y las declaraciones no son vinculantes, siempre que no se refieran a la mercancía misma.

5. Precios

- 5.1** Todos los precios son precios netos y se entenderán «franco fábrica» («EXW» Incoterms®2020) sin el embalaje, transporte, franqueo y garantía de valor. Se agregará el impuesto legal sobre las ventas a la tasa aplicable.
- 5.2** El vendedor podrá facturarle al comprador cualquier gasto adicional resultante de solicitudes de modificación.
- 5.3** Si, tras celebrarse el contrato, se produjeran hechos que encarecieran los gastos directos del vendedor en la compra, la fabricación y/o el envío de la mercancía, el vendedor tendrá derecho a un incremento correspondiente del precio.

6. Condiciones de pago

- 6.1** Las facturas deberán abonarse sin descuento en un plazo de 14 días a partir de la fecha de la factura. El vendedor tiene derecho en cualquier momento, incluso durante una relación comercial en curso, a realizar una entrega total o parcial solo contra pago por adelantado. Los descuentos solo se aplicarán en caso de acuerdo expreso por escrito.
- 6.2** El vendedor tendrá derecho de facturar primero el pago de una deuda más antigua no titulada, incluso con la asignación obligatoria contraria del comprador. Si ya se han generado costes o intereses, el vendedor tendrá derecho a facturar primero el pago de los costes, a continuación, el de los intereses y, por último, el de la prestación principal.
- 6.3** El derecho a compensación corresponderá al comprador solo cuando sus contraprestaciones hayan adquirido firmeza legal, sean indiscutibles o hayan sido reconocidas por escrito por el vendedor. El derecho de retención del comprador estará limitado a los derechos de la relación contractual.
- 6.4** El vendedor tendrá derecho a exigir intereses de demora por el importe del tipo de interés de demora respectivo legalmente vigente. Queda reservado expresamente el derecho a acreditar mayores daños por demora.

7. Entrega/plazo de entrega/demora

- 7.1** Los plazos y fechas de entrega solo se aplicarán si el vendedor los acepta expresamente por escrito. El vendedor no estará obligado a cumplir con la fecha o plazo de entrega si el comprador incumple sus obligaciones (pago de los adelantos, aportación de los documentos necesarios, contribuciones a la producción, etcétera) en el tiempo previsto. Queda reservada la excepción por incumplimiento del contrato.
- 7.2** Los plazos de entrega comenzarán no antes del día en que se firme el contrato y todas las cuestiones técnicas hayan quedado resueltas.
- 7.3** Si el comprador solicita modificaciones, el vendedor quedará exento de cumplir con cualquier fecha o plazo de entrega acordado. En este caso, las partes acordarán una nueva fecha o un nuevo plazo de entrega.
- 7.4** Si no se acuerda nada distinto, la fecha o el plazo de entrega se cumplirá cuando el vendedor haya puesto a disposición la mercancía en el lugar acordado.
- 7.5** El cliente no podrá presentar ninguna reclamación debido a demoras en la entrega que no se deriven de una acción dolosa o negligencia grave del vendedor. Esto se aplica también para otros inconvenientes, especialmente, a las demoras en la entrega debidas a fuerza mayor, conflictos laborales, disturbios, epidemias y/o pandemias, ataques cibernéticos, medidas oficiales, carencia de suministros por parte de proveedores, así como a otros eventos imprevisibles, inevitables y de gravedad. En estos casos, la fecha o plazo de entrega acordado se aplazará en función de la duración del impedimento para la entrega, por lo que el vendedor informará al comprador y, si es posible, facilitará una nueva fecha prevista de entrega. La indemnización por pérdida de beneficios y daños resultante de la interrupción del servicio se limitará al dolo.
- 7.6** Si el comprador incurre en demora en la aceptación o infringe otros deberes de cooperación, el vendedor tendrá derecho a exigir una indemnización por los daños causados, que incluye los posibles gastos adicionales. Asimismo, el vendedor tendrá derecho a establecer un plazo de aceptación razonable para el comprador y, después de su vencimiento sin haber resultado, a rescindir el contrato y exigir una indemnización por daños en lugar de la prestación.
- 7.7** Se permitirán las entregas parciales de manera razonable. En este sentido, quedan excluidas las reclamaciones del comprador debido a la entrega parcial o una entrega con retraso de la cantidad restante.

8. Reserva de dominio

- 8.1** El vendedor conservará la propiedad de todas las mercancías entregadas hasta la recepción de todos los pagos correspondientes a la relación de suministro y futuras obligaciones correspondientes. En caso de incumplimiento del contrato, especialmente, en caso de demora del pago, el vendedor tendrá derecho a exigir la devolución de las mercancías.
- 8.2** El comprador estará obligado a tratar las mercancías entregadas con cuidado y a asegurarlas por cuenta propia contra cualquier forma de pérdida durante el período de reserva de dominio por el precio de compra. El vendedor seguirá teniendo derecho a asegurar el mismo la mercancía a cargo del comprador.
- 8.3** El comprador deberá comunicar sin dilación alguna y por escrito al vendedor cualquier caso de embargo o demás intervenciones de terceros, de modo que éste pueda ejercitar la reclamación por tercera u otros recursos. En tanto que la parte tercera no restituya los costes judiciales y extrajudiciales generados por ello, el comprador asumirá la responsabilidad al respecto.
- 8.4** El comprador tendrá derecho a revender la mercancía en el transcurso normal de su actividad comercial. No obstante, este cederá en ese momento al vendedor la totalidad de los cobros pendientes por el importe de la suma final de la factura (incluido el impuesto sobre el valor añadido) correspondiente al crédito que haya obtenido de la reventa frente a sus clientes o terceros, independientemente de si la mercancía fue vendida sin ser procesada o después de ello. El comprador conserva el derecho de cobrar esta deuda incluso después de la entrega. El derecho del vendedor a cobrar la deuda él mismo no será afectado.

- 8.5** Si las mercancías entregadas se mezclan o combinan inseparablemente con otras mercancías que no pertenecen al vendedor, el vendedor adquirirá la copropiedad del nuevo o combinado objeto en relación al valor de la mercancía entregada (importe de la suma final de la factura legal IVA incluido) para el otro u otros objetos en el momento de la mezcla o combinación. El comprador custodiará para el vendedor la propiedad o copropiedad así surgida.
- 8.6** En el caso de que el valor de las garantías entregadas exceda del valor de los créditos del vendedor en total en más de un 20 %, el vendedor tendrá la obligación de liberar, a elección del vendedor, el exceso de las garantías a solicitud del comprador.
- 8.7** Si y en tanto que el ordenamiento jurídico determinante no permita el acuerdo de una reserva de dominio, el comprador aportará otros avales razonables al vendedor si se utilizan créditos comerciales.

9. Envío, transmisión del riesgo

- 9.1** El envío se efectuará a riesgo del comprador. El riesgo se transmitirá al comprador, a más tardar, con el envío de la mercancía, también si el vendedor se hace cargo de otras prestaciones.
- 9.2** Si la entrega se retrasa debido a circunstancias de las que el vendedor no es responsable, el riesgo pasará al comprador en el momento en que se comunica al comprador que la mercancía está lista para el envío. Previa solicitud por escrito del comprador, el vendedor asegurará el envío contra daños por rotura, transporte, fuego y agua, y el comprador se hará cargo de los costes.
- 9.3** De conformidad con la ley de embalajes, no se aceptará la devolución de embalajes de transporte y demás embalajes; a excepción de las paletas. El comprador está obligado a eliminar el embalaje por cuenta propia.

10. Elementos de producción

- 10.1** En caso de que el comprador suministre elementos de producción (tales como herramientas y/o moldes), dichos elementos deberán enviarse sin coste alguno al vendedor. El vendedor asume la responsabilidad por su pérdida, deterioro o devolución incompleta y averías resultantes solo en casos de negligencia grave o dolo. Esto no se aplica si la responsabilidad es obligatoria por ley.
- 10.2** Si el vendedor fabrica o adquiere los elementos de producción en nombre del comprador, el vendedor facturará al comprador los costes por separado. El vendedor conservará la plena propiedad de los elementos de producción, sin que exista ninguna obligación de entregarlos al comprador. Lo anterior se aplica también a los útiles secuenciales. Esto no afecta a la regulación siguiente del apartado 10.3.
- 10.3** Si los costes de los elementos de producción se amortizan mediante el precio de las piezas, si una herramienta no se amortiza, el comprador asume los costes no cubiertos, incluidos los costes de otras instalaciones específicas del tipo. Los costes de los modelos siempre corren a cargo del comprador en su totalidad.
- 10.4** Los planos y la documentación entregados al comprador por el vendedor, así como las propuestas del vendedor para diseñar y fabricar la mercancía, no podrán entregarse a terceros y el vendedor podrá exigir su devolución en cualquier momento.

11. Responsabilidad por saneamiento de defectos/responsabilidad

- 11.1** El vendedor no asume responsabilidad por los daños causados por el incumplimiento de las instrucciones para el manejo, mantenimiento y montaje, la utilización inadecuada o indebida, el uso erróneo o negligente y el desgaste natural, el almacenamiento incorrecto o por las manipulaciones realizadas por el comprador o por terceros en la mercancía. El comprador o terceros solo podrán montar las mercancías empleando a personal especializado e instruido.
- 11.2** El vendedor tendrá derecho de elegir entre la reparación o sustitución del artículo defectuoso por uno nuevo. El comprador tiene que entregarle al vendedor la mercancía en cuestión a petición de éste para fines de inspección. Si el vendedor incurre en costes (en particular, costes de inspección y transporte) debido a la solicitud injustificada del comprador de rectificar un defecto, el vendedor puede exigir el reembolso de estos costes.
- 11.3** El vendedor no se hará cargo de los costes necesarios con fines de cumplimiento posterior si estos aumentan debido a que, tras la entrega, la mercancía hubiera sido llevada a otro lugar distinto al lugar de entrega original.
- 11.4** Si el comprador reclama al vendedor mediante recurso después de que el propio comprador haya sido demandado por su cliente por defectos, se aplicará el artículo 445a del Código Civil alemán (BGB, en sus siglas en alemán).
- 11.5** Las reclamaciones relacionadas con la responsabilidad por saneamiento de defectos caducarán después de un año desde la entrega de la mercancía, salvo que las reclamaciones de responsabilidad debida a defectos materiales se fundamenten en un incumplimiento doloso o gravemente negligente del contrato por parte del vendedor o sus auxiliares ejecutivos o en lo que concierne a daños personales que afecten a la integridad física y la salud. En caso de reclamaciones de garantía por defectos que el comprador ponga al vendedor mediante recurso de conformidad con el artículo 445a del Código Civil alemán (BGB, en sus siglas en alemán), se aplicará sin restricciones el plazo de prescripción del artículo 445b del Código Civil alemán (BGB).
- 11.6** El comprador estará obligado a cumplir con la obligación de realizar inspecciones de acuerdo con la legislación alemana, art. 377 del código de comercio alemán, incluso con la reventa de la mercancía.
- 11.7** El derecho de recurso del comprador contra el vendedor en cuanto a la responsabilidad por saneamiento de defectos, al que los clientes del comprador puedan oponerse, quedará excluido cuando el comprador no cumpla con la obligación de realizar pruebas y reclamaciones o cuando la mercancía haya sido sometida a una transformación.
- 11.8** La responsabilidad del vendedor en virtud de las disposiciones legales para la responsabilidad por daños y perjuicios se cumplirá íntegramente cuando un incumplimiento imputable de una obligación del vendedor se fundamenta en dolo o negligencia grave. En la medida en que el incumplimiento imputable de la obligación del vendedor se fundamenta en una negligencia simple y se viole una obligación esencial del contrato, la responsabilidad por daños y perjuicios se limitará al daño previsible que se produce normalmente en casos similares. Por lo demás, quedará excluida la responsabilidad.
- 11.9** La indemnización por pérdida de beneficios y daños resultante de la interrupción del servicio se limita al dolo y negligencia grave.
- 11.10** Esto no afectará a la responsabilidad según las disposiciones de la ley alemana de responsabilidad relativa a los productos defectuosos o también los derechos fundamentales comparables de otras legislaciones extranjeras. Tampoco se verá afectada la responsabilidad debida a lesiones a la vida, la integridad física y la salud.
- 11.11** Si se fundamenta una responsabilidad según los hechos del apartado 11.9, la responsabilidad del vendedor frente al comprador en el caso de ordenamientos jurídicos extranjeros se limitará en la medida en que estuviera permitido por la legislación extranjera correspondiente.
- 11.12** Siempre que la responsabilidad por daños y perjuicios del vendedor se excluya o esté limitada, esto también se aplicará respecto a la responsabilidad personal por daños y perjuicios de los empleados, representantes y auxiliares ejecutivos.

12. Prohibición de cesión

- 12.1** Todas las reclamaciones del comprador frente al vendedor no serán transferibles.
- 12.2** El vendedor tiene derecho en cualquier momento, incluso sin el consentimiento del comprador, a recurrir a empresas afiliadas a él (en el sentido del artículo 15 AktG (Ley de las sociedades anónimas alemanas)) como agentes auxiliares en la preparación de la oferta y la ejecución del contrato.

13. Responsabilidad relativa a los productos defectuosos/deber de advertencia

- 13.1** El comprador podrá utilizar la mercancía solo de la manera prevista y deberá asegurarse de que esta mercancía se revenda solo a las personas familiarizadas con los peligros y riesgos del producto.
- 13.2** Al usar los productos como producto primario y subproducto en propios productos, el comprador estará obligado a cumplir también con el deber de advertencia en cuanto a los productos entregados por el vendedor al comercializar el producto final. En las relaciones internas, el comprador renunciará a toda pretensión contra el vendedor en cuanto al incumplimiento de la presente obligación al primer requerimiento.

14. Obligación de confidencialidad

El comprador deberá tratar toda la información comercial y técnica que ha recibido del vendedor, en tanto esta no sea conocida con carácter general, como secreto comercial e industrial frente a terceros. Este tipo de información solo se podrá transmitir a terceras partes, que deberán comprometerse con el correspondiente acuerdo de confidencialidad, con fines contractuales.

15. Protección de datos

El vendedor recopila, procesa y utiliza los datos personales del comprador únicamente de conformidad con las normas de protección de datos pertinentes. En consecuencia, los datos personales del comprador solo se utilizarán si existe permiso o consentimiento legal.

16. Otros

- 16.1** El lugar de cumplimiento será el lugar en el que se encuentre la fábrica de venta correspondiente.
- 16.2** La jurisdicción para todos los litigios derivados del contrato será la de Heilbronn (Alemania). No obstante, el vendedor también tendrá derecho a demandar al comprador en su jurisdicción general.
- 16.3** Para la ejecución de los contratos sobre la base de las presentes condiciones de venta y entrega, se aplicará exclusivamente la ley alemana con exclusión del derecho de colisión y del derecho de adquisición de las Naciones Unidas (CISG).
- 16.4** En el contexto de la ejecución de la relación contractual, las partes están obligadas a cumplir todas las disposiciones legales aplicables.
- 16.5** Si una o varias de las disposiciones anteriores resultara total o parcialmente inválida, esto no afectará a la validez de las demás disposiciones. La disposición ineficaz deberá sustituirse por una disposición legal admisible con la que se obtengan el sentido y la finalidad de estas condiciones de venta y entrega en la medida de lo posible.

1. Ambito di validità

1.1 Valgono esclusivamente le Condizioni di vendita e di consegna di MS Motorservice International GmbH (di seguito denominata "Venditore"). Condizioni dell'Acquirente contrapposte o diverse dalle presenti Condizioni di vendita e di consegna non saranno riconosciute come valide a meno che il Venditore non ne abbia espressamente autorizzato per iscritto la validità. Le presenti Condizioni di vendita e di consegna sono valide anche qualora il Venditore esegua la consegna all'Acquirente senza riserve pur essendo a conoscenza di condizioni dell'Acquirente contrapposte o diverse dalle proprie Condizioni commerciali e di consegna.

1.2 Accordi tra le parti separati derogatori o integrativi rispetto alle presenti Condizioni di vendita e di consegna godono di priorità. In assenza di accordi specifici sono integrati dalle presenti Condizioni di vendita e di consegna. Il contenuto di tali accordi è soggetto a un contratto scritto oppure a una conferma scritta dell'Acquirente.

1.3 Le Condizioni di vendita e di consegna sono valide anche per tutte le operazioni commerciali future intrattenute con l'Acquirente. L'Acquirente riconosce e accetta le presenti Condizioni di vendita e di consegna inoltrando l'ordine, al più tardi con l'accettazione della merce.

1.4 Le presenti Condizioni di vendita e di consegna sono valide solo nei confronti di imprenditori.

2. Offerta e conferma d'ordine

2.1 L'offerta del Venditore sono sempre da considerarsi non vincolanti. Un ordine dell'Acquirente, classificabile come offerta in termini legali, viene considerato accettato solo nel momento in cui viene confermato per iscritto dal Venditore entro un periodo di quattro settimane. Il contratto sarà perfezionato al più tardi con l'invio o la comunicazione della data di fornitura della merce ordinata o dell'invio della prima fornitura in caso di consegne parziali.

2.2 Modifiche o altri accordi saranno vincolanti unicamente qualora vengano confermati per iscritto dal Venditore.

2.3 La documentazione, i disegni, i dati riguardanti pesi e dimensioni, i campioni ecc. contenuti nelle offerte sono informazioni approssimative e non rappresentano caratteristiche di configurazione. Il Venditore ha diritto a derogare alle descrizioni riportate nell'offerta purché dette deroghe non siano di natura fondamentale o essenziale e non limitino sostanzialmente lo scopo conforme al contratto.

2.4 Se le merci devono essere prodotte in base a disegni specifici dell'Acquirente, saranno determinanti i disegni approntati dall'Acquirente e approvati dal Venditore. Deroghe ai disegni approvati dovranno essere concordate separatamente e qualsiasi spesa aggiuntiva da esse derivante dovrà essere rimborsata al Venditore.

3. Diritti di protezione

3.1 Il Venditore si riserva i diritti di proprietà e d'autore su qualsiasi illustrazione, disegno, calcolo e altra documentazione che, quindi, non potranno essere utilizzati a scopi diversi da quelli indicati dal Venditore stesso né essere resi accessibili a terze persone senza previa autorizzazione scritta del Venditore. Ciò si applica soprattutto alla documentazione scritta definita dai termini "confidenziale", "segreta" o simili.

3.2 Il Venditore è unicamente responsabile di rivendicazioni derivanti, nonostante un utilizzo della merce conforme al contratto, dalla violazione di diritti di protezione e diritti di protezione depositati (diritti di protezione) di cui almeno uno appartenente alla famiglia di diritti di protezione sia stato pubblicato dall'Ufficio Brevetti Europeo o in uno degli Stati Repubblica Federale Tedesca, Francia, Gran Bretagna, Austria, Cina, Giappone o USA.

3.3 In caso di consegne eseguite sulla base di disegni o altri dati dell'Acquirente che ledono i diritti di protezione di terzi, nel rapporto interno l'Acquirente esonera il Venditore da qualsiasi rivendicazione.

4. Raccomandazioni, informazioni e precisazioni

Raccomandazioni, informazioni e precisazioni non sono vincolanti purché non si riferiscano alla merce stessa.

5. Prezzi

5.1 Tutti i prezzi si intendono al netto e sono validi "franco magazzino" (Incoterms®2020, "EXW") esclusi l'imballaggio, il trasporto, l'affrancatura e l'assicurazione del valore della merce. Ai prezzi si dovrà aggiungere l'imposta legale sul valore aggiunto di volta in volta valida.

5.2 Il Venditore può addebitare all'Acquirente qualsiasi eccedenza di spesa derivante da richieste di modifica.

5.3 In caso di eventi insorti dopo la stipula del contratto che causino l'aumento dei prezzi di costo del Venditore per l'acquisto, la produzione e/o la spedizione della merce, il Venditore avrà diritto ad aumentare i prezzi corrispondentemente.

6. Condizioni di pagamento

6.1 Le fatture devono essere pagate al netto entro 14 giorni dalla data della fattura. Il Venditore si riserva il diritto di effettuare, in qualsiasi momento anche nel contesto di un rapporto commerciale in corso, una consegna in toto o in parte solo dietro pagamento anticipato. Uno sconto vale unicamente previo esplicito accordo scritto.

6.2 Il Venditore ha diritto ad imputare un pagamento dapprima al debito più lontano non titolato, anche in caso di destinazione contrapposta allo scopo da parte dell'Acquirente. Se sono già insorti costi o interessi, il Venditore ha diritto ad imputare pagamenti dapprima ai costi, poi agli interessi e infine alla prestazione principale.

6.3 L'Acquirente detiene il diritto alla compensazione unicamente se e quando le sue controprese siano dichiarate aventi valore legale, incontestate o riconosciute per iscritto dal Venditore. Il diritto di ritenzione dell'Acquirente è limitato alle rivendicazioni derivanti dal rapporto contrattuale.

6.4 Il Venditore ha diritto ad esigere interessi di mora ad un tasso che è pari al tasso di interesse legale in vigore. Resta esplicitamente salvo il diritto a comprovare un danno di mora maggiore.

7. Consegna / periodo di consegna / ritardo

7.1 Le date e i periodi di consegna sono considerati vincolanti unicamente se sono stati espressamente promessi per iscritto dal Venditore. Il Venditore non è vincolato alla data o al periodo di consegna se l'Acquirente non ottempera tempestivamente ai suoi obblighi (pagamento di account, fornitura della necessaria documentazione, concessioni in comodato d'uso per fini produttivi, ecc.). Con riserva di eccezione di inadempimento.

7.2 I periodi di consegna hanno inizio non prima del giorno in cui è stato stipulato il contratto per iscritto e sono state chiarite tutte le questioni di carattere tecnico.

7.3 In caso di richieste di modifica da parte dell'Acquirente, il Venditore è esonerato dall'osservanza della data o del periodo di consegna eventualmente concordati. In questo caso, le parti dovranno concordare una nuova data o un nuovo periodo di consegna.

7.4 Se non diversamente concordato, la data o il periodo di consegna sono da considerarsi osservati quando il Venditore ha consegnato la merce nel luogo concordato.

7.5 L'Acquirente non ha diritto ad alcuna rivendicazione per ritardi della consegna che non siano dovuti a dolo o colpa grave del Venditore. Ciò si applica anche ad altri inconvenienti, soprattutto a ritardi della consegna dovuti a cause di forza maggiore, conflitti sindacali, agitazioni, epidemie e/o pandemie, attacchi informatici, provvedimenti delle autorità, mancate consegne da parte di subfornitori e altri eventi imprevedibili, inevitabili e gravi. In questi casi, la data o il periodo di consegna concordati saranno prorogati in misura corrispondente alla durata dell'ostacolo alla consegna; il Venditore informerà l'Acquirente in merito e, laddove possibile, comunicherà una nuova data di consegna prevista. Il rimborso di lucro cessante e danni derivanti dall'interruzione della produzione è limitato al dolo.

7.6 In caso di mora di accettazione da parte dell'Acquirente o qualora quest'ultimo violi altri obblighi di collaborazione, il Venditore avrà diritto a pretendere il rimborso del danno eventualmente insorto comprese tutte le spese supplementari. Il Venditore, inoltre, ha diritto ad imporre all'Acquirente un termine di accettazione ragionevole, scaduto il quale, senza esito, avrà diritto a recedere dal contratto nonché ad esigere il rimborso del danno invece della prestazione.

7.7 Forniture parziali sono ammesse in misura accettabile. Pertanto si escludono rivendicazioni dell'Acquirente per forniture parziali o forniture ritardate dell'ordinativo restante.

8. Diritto di riservato dominio

8.1 Il Venditore si riserva la proprietà di tutte le merci consegnate fino al percepimento di tutti i pagamenti derivanti dal rapporto di fornitura, anche degli obblighi futuri. In caso di comportamento contrario ai termini del contratto, in particolare in caso di ritardo dei pagamenti, il Venditore ha diritto a reclamare la restituzione della merce.

8.2 L'Acquirente è tenuto a trattare la merce consegnata con la dovuta cura e ad assicurarla a proprie spese per il valore a nuovo contro qualsiasi forma di perimento per tutta la durata del diritto di riservato dominio. Il Venditore resta autorizzato ad assicurare lui stesso la merce a spese dell'Acquirente.

8.3 In caso di pignoramenti o altri interventi di terze persone, l'Acquirente deve informarne immediatamente il Venditore per iscritto affinché quest'ultimo possa tentare opposizione di terzi o ricorrere ad altri mezzi legali. Se il terzo non rimborsa le spese giudiziali ed extragiudiziali da ciò derivanti, ne sarà responsabile l'Acquirente.

8.4 L'Acquirente ha diritto a rivendere la merce nell'andamento regolare degli affari; egli, tuttavia, cede già ora al Venditore tutti i crediti pari all'importo finale della fattura del credito (compresa l'imposta legale sul valore aggiunto) derivantigli dalla rivendita ai propri clienti o a terzi, indipendentemente da che la merce sia stata rivenduta prima o dopo una lavorazione. L'Acquirente continua ad avere diritto al recupero di questo credito anche dopo la consegna. Resta salva l'autorizzazione del Venditore a recuperare autonomamente il credito.

8.5 Se la merce consegnata viene indissolubilmente commista o unita ad altri oggetti non appartenenti al Venditore, quest'ultimo diventa comproprietario della cosa nuova o unita in rapporto del valore della merce consegnata (importo finale della fattura, compresa imposta legale sul valore aggiunto) al o agli altri oggetti al momento della commistione o dell'unione. L'Acquirente custodisce la proprietà esclusiva o la comproprietà così insorta per il Venditore.

8.6 Se il valore delle garanzie fornite supera i crediti del Venditore complessivamente di oltre il 20 % e l'Acquirente lo richiede, il Venditore sarà tenuto a svincolare le garanzie eccedenti a propria discrezione.

8.7 Se e nella misura in cui l'ordinamento giuridico determinante non ammette accordi sul diritto di riservato dominio, in caso di ricorso al credito su merci l'Acquirente fornirà al Venditore ulteriori garanzie ragionevoli.

9. Spedizione, trapasso di rischio

9.1 La spedizione avviene a rischio e pericolo dell'Acquirente. Il rischio passa sempre all'Acquirente anche se vengono assunte altre prestazioni dal Venditore, al più tardi con la spedizione della merce.

9.2 In caso di ritardi di spedizione non imputabili al Venditore, il rischio viene trasmesso all'Acquirente dal giorno in cui viene comunicata la disponibilità alla spedizione. Su richiesta scritta dell'Acquirente, il Venditore assicurerà la spedizione contro danni di rottura, di trasporto, causati da incendio e dall'acqua a spese dell'Acquirente.

9.3 Come previsto dalla normativa sugli imballaggi, gli imballaggi di trasporto e tutti gli altri imballaggi non saranno ripresi in consegna; fanno eccezione i pallet. L'Acquirente è tenuto a procedere a proprie spese allo smaltimento degli imballaggi.

10. Mezzi di produzione

10.1 Se l'Acquirente fornisce al Venditore mezzi di produzione (ad esempio attrezzi, stampi), questi dovranno essere spediti al Venditore gratuitamente. Il Venditore dovrà rispondere del loro perimento, del deterioramento o di una restituzione incompleta e dei danni che ne derivano solo in caso di colpa grave o dolo. Ciò non si applica qualora la responsabilità del Venditore sia prevista da disposizioni legali obbligatorie.

10.2 Se il Venditore produce o acquista mezzi di produzione su ordine dell'Acquirente, egli addebiterà all'Acquirente le spese pro quota con una fattura separata. I mezzi di produzione restano di proprietà del Venditore. Il Venditore non è tenuto a cedere detti mezzi all'Acquirente. Quanto summenzionato si applica anche alle attrezzature seguenti. Resta salva la seguente regola del punto 10.3.

10.3 Se è previsto l'ammortamento dei costi dei mezzi di produzione oltre il prezzo del pezzo, in caso di mancato ammortamento di un attrezzo l'Acquirente si accolla le spese scoperte, comprese le spese per ulteriori attrezzature specifiche. Le spese per i modelli sono sempre interamente a carico dell'Acquirente.

10.4 I disegni e la documentazione consegnati dal Venditore all'Acquirente nonché le proposte del Venditore circa il design e la produzione della merce non possono essere trasmessi a terzi e il Venditore ha diritto ad esigerne la restituzione in qualsiasi momento.

11. Garanzia per i vizi della cosa / responsabilità

11.1 Il Venditore non è responsabile per danni causati dall'inosservanza di istruzioni per l'uso, di manutenzione e specifiche di montaggio, utilizzo non appropriato, non secondo destinazione o non professionale, trattamento scorretto o negligente, usura naturale, scorretto stoccaggio o modifiche apportate alla merce dall'Acquirente o da terze persone. Le merci possono essere montate dall'Acquirente o da terzi esclusivamente ricorrendo a personale specializzato e addestrato.

11.2 Il Venditore ha diritto di scegliere tra una riparazione e una nuova consegna. L'Acquirente è tenuto a consegnare al Venditore la merce contestata qualora lo richieda a scopo di ispezione. Il Venditore potrà chiedere un risarcimento all'Acquirente per gli eventuali costi sostenuti in relazione all'eliminazione ingiustificata del difetto (in particolare costi di ispezione e trasporto)

11.3 Le spese necessarie all'adempimento successivo non sono a carico del Venditore se, dopo la consegna, aumentano a causa del trasporto della merce dopo la consegna in un altro luogo rispetto a quello originario.

11.4 Qualora l'Acquirente faccia valere il proprio diritto di regresso nei confronti del Venditore, dopo che l'Acquirente stesso è stato citato dal suo cliente per vizi, trova applicazione il § 445a del Codice Civile tedesco.

11.5 Le rivendicazioni derivanti dalla garanzia per i vizi della cosa cadono in prescrizione dopo un anno dal trasferimento della merce a meno che la responsabilità del danno non derivi da una prevaricazione per colpa grave o dolo del Venditore o del suo ausiliario o da delitti contro la vita, l'incolumità e la salute individuale. Qualora l'Acquirente faccia valere diritti di garanzia per vizi nei confronti del Venditore esercitando il regresso ai sensi del § 445a del Codice civile tedesco trovano applicazione, senza limitazione alcuna, le disposizioni sulla prescrizione di cui al § 445b del Codice civile tedesco.

11.6 L'Acquirente è tenuto ad ottemperare al proprio obbligo di controllo ai sensi del § 377 del Codice Commerciale tedesco anche in caso di rivendita della merce.

11.7 È escluso il diritto di regresso dell'Acquirente nei confronti del Venditore per diritti derivanti dalla garanzia per i vizi della cosa rivendicati nei confronti dell'Acquirente dai suoi clienti qualora l'Acquirente non ottemperi al suo obbligo di controllo e ricorso oppure la merce sia stata modificata tramite elaborazione successiva.

11.8 La responsabilità del Venditore conformemente alle disposizioni di legge riguardanti il risarcimento dei danni è illimitata se una prevaricazione imputabile al venditore è causata da dolo o colpa grave. Se la prevaricazione imputabile al Venditore è causata da semplice negligenza e sussiste la violazione colposa di un obbligo contrattuale fondamentale, la responsabilità del danno è limitata al danno prevedibile tipico che incorre in casi equiparabili. La responsabilità è esclusa nei casi restanti.

11.9 Il rimborso di lucro cessante e danni derivanti dall'interruzione della produzione è limitato ai casi di dolo o colpa grave.

11.10 Resta salva la responsabilità ai sensi delle disposizioni della legge sulla responsabilità del prodotto o leggi comparabili inalienabili di ordinamenti giuridici stranieri. Salva resta anche la responsabilità per delitti contro la vita, l'incolumità e la salute individuale.

11.11 In caso di responsabilità fondata ai sensi della fattispecie al punto 11.9, la responsabilità del Venditore prevista da ordinamenti giuridici stranieri in rapporto all'Acquirente è limitata all'entità che verrebbe ammessa dal rispettivo diritto straniero.

11.12 Se la responsabilità del danno del Venditore è esclusa o limitata, la colpa in eligendo si estende anche ai danni causati da collaboratori, rappresentanti ed ausiliari del Venditore.

12. Divieto di cessione

12.1 Tutti i diritti dell'Acquirente nei confronti del Venditore sono incedibili.

12.2 Il Venditore ha diritto a coinvolgere, in qualsiasi momento e senza il consenso dell'Acquirente, in particolare aziende correlate (ai sensi del § 15 AktG, Legge tedesca sulle società per azioni) in qualità di ausiliari per la stesura di offerte e l'evasione di contratti.

13. Responsabilità del prodotto / obblighi di avviso

13.1 L'Acquirente può utilizzare la merce solo secondo la sua destinazione e deve assicurarsi che detta merce venga rivenduta unicamente a persone a conoscenza dei pericoli e dei rischi connessi al prodotto.

13.2 Se utilizza la merce come prodotto base e parziale di prodotti propri, al momento della messa in circolazione del prodotto finale l'Acquirente è tenuto ad adempiere al proprio obbligo di avvertimento anche per quanto riguarda la merce fornita dal Venditore. Nel rapporto interno, l'Acquirente esonera il Venditore dall'esercizio di diritti in caso di violazione della suddetta obbligazione su prima richiesta.

14. Segretezza

Nei confronti di terzi, l'Acquirente è tenuto a trattare tutte le informazioni commerciali e tecniche ricevute dal Venditore come segreti commerciali e aziendali, purché non siano di dominio pubblico. Dette informazioni possono essere trasmesse a terzi, esclusivamente allo scopo previsto dal contratto, che siano vincolati da un corrispondente accordo di segretezza.

15. Tutela dei dati

Il Venditore raccoglie, tratta e utilizza i dati personali dell'Acquirente nel rispetto delle disposizioni relative alla tutela dei dati pertinenti. Pertanto i dati personali dell'Acquirente saranno utilizzati esclusivamente sulla base di una autorizzazione legale o di un consenso.

16. Altro

16.1 Luogo di adempimento è il luogo del corrispondente stabilimento del Venditore.

16.2 Foro competente per qualsiasi controversia derivante dal contratto è il Tribunale di Heilbronn. Tuttavia, il Venditore ha diritto a citare in giudizio l'Acquirente anche dinanzi al foro competente generale di quest'ultimo.

16.3 Per l'evasione di contratti basati sulle presenti Condizioni di vendita e di consegna si applica unicamente il Diritto tedesco con esclusione del Diritto dei conflitti di competenza e della Convenzione sulla Vendita Internazionale di Beni (CISG).

16.4 Le parti sono tenute ad ottemperare a tutte le disposizioni di legge vigenti nell'ambito dell'espletamento del rapporto contrattuale.

16.5 In caso di inefficacia totale o parziale di una o più di una delle clausole summenzionate, le restanti clausole restano tuttavia valide. La clausola invalida dovrà quindi essere sostituita da una clausola ammessa dalla legge che permetta di adempiere al senso e allo scopo delle presenti Condizioni di vendita e di consegna possibilmente nello stesso modo.

1. Сфера применения

1.1 Условия продажи и поставки MS Motorservice International GmbH (далее – «продавец») имеют исключительное действие. Противоположные или отличающиеся от настоящих условий продажи и поставки условия покупателя не признаются, за исключением случаев, когда продавец однозначно письменно признал их действительность. Настоящие условия продажи и поставки действительны и в том случае, если продавец, зная противоположные или отличающиеся от собственных условий продажи и поставки условия покупателя, осуществляет поставку для покупателя без предварительных договоренностей.

1.2 Отдельные соглашения между сторонами, отступающие от данных условий продажи и поставки, или дополняющие их, имеют преимущественное действие. В этой части, если не вычленили какие-либо специальные положения, эти соглашения дополняют настоящие условия продажи и поставки. Для вступления в силу содержания таких соглашений требуется письменный договор или письменное подтверждение продавца.

1.3 Условия продажи и поставки распространяются и на все будущие сделки с покупателем. Условия продажи и поставки признаются покупателем при размещении заказа, самое позднее – при приеме товара.

1.4 Настоящие условия продажи и поставки действуют только в отношении предпринимателей.

2. Предложение и подтверждение заказа

2.1 Предложения продавца всегда являются свободными. Если заказ покупателя квалифицируется с правовой точки зрения как предложение, он считается принятым только при его письменном подтверждении продавцом в течение четырех недель. Договор вступает в силу не позднее чем с момента отправки заказанного товара или уведомления о времени его готовности к отгрузке, при частичной поставке – с момента отправки первой партии.

2.2 Изменения и прочие соглашения являются обязательными только в случае их письменного подтверждения продавцом.

2.3 Содержащиеся в предложениях документы, чертежи, данные о весе и размерах, образцы и т. д., являются лишь приближительными данными, а не характеристиками качества. Продавец имеет право отклониться от описаний в предложениях, если такое отклонение не играет решающей или существенной роли, а цель договора при этом не будет существенно ограничена.

2.4 Если товары изготавливаются по чертежам покупателя, определяющими являются составленные покупателем и одобренные продавцом чертежи. Отклонения от уже одобренных чертежей согласовываются отдельно, а любые дополнительные расходы должны быть возмещены продавцу.

3. Патенты

3.1 Продавец сохраняет за собой право собственности и авторское право на все изображения, чертежи, расчеты и прочие документы; без предварительного письменного разрешения продавца они не могут быть использованы в целях, не указанных продавцом, либо переданы третьим лицам. В особенности это касается письменных документов с пометками «конфиденциально», «секретно» или подобными им.

3.2 Продавец несет ответственность только за претензии, возникшие при использовании товара в соответствии с договором, в связи с несоблюдением патентов и заявок на выдачу патентов (охраняемых прав), по меньшей мере, одним из семейства патентов был опубликован либо Европейским патентным ведомством, либо в одной из следующих стран: Федеративная Республика Германия, Франция, Великобритания, Австрия, Китай, Япония или США.

3.3 Если поставки осуществляются по чертежам или прочим данным покупателя, и при этом нарушаются патенты третьих лиц, покупатель, в рамках отношений партнеров по договору, снимает с продавца все претензии.

4. Рекомендации, информация и справки

Рекомендации, информация и справки являются необязательными, если они не относятся непосредственно к товару.

5. Цены

5.1 Все цены нетто и действуют на условиях франко-завод (Incoterms®2020, «EXW»), за исключением упаковки, фрахта, почтового сбора и индекса. Законодательно установленный налог с оборота в соответствующем размере начисляется дополнительно.

5.2 Возможные дополнительные затраты, возникшие в связи с пожеланиями покупателя по изменению, могут быть включены продавцом в счет покупателя.

5.3 В случае, если после заключения договора возникнут события, повышающие себестоимость товара продавца при его закупке, производстве и/или отправке, продавец имеет право на соответствующее повышение цены.

6. Условия оплаты

6.1 Счета подлежат полной оплате в течение 14 дней со дня выставления счета. Продавец вправе, в том числе в рамках текущих деловых отношений, в любое время осуществить поставку в полном объеме или частично только по предоплате. Скидки действуют только при наличии явного письменного соглашения.

6.2 Продавец имеет право, даже при противоположной целевой привязке покупателя, начислить оплату сначала в счет старого, не документированного долга. В случае возникновения расходов и процентов продавец имеет право зачесть платежи сначала на оплату расходов, затем процентов, и в последнюю очередь – на оплату основного продукта или услуги.

6.3 Право на взаимный зачет встречных требований покупатель имеет только в случае, если встречные требования определены имеющими законную силу, неоспоримыми или письменно признаны продавцом. Право покупателя отказаться от выполнения своих обязательств по договору ограничено претензиями, возникающими из договорных отношений.

6.4 Продавец имеет право требовать пеню за просрочку исполнения обязательства в размере действующей предусмотренной законодательством процентной ставки за просрочку платежа. Сохраняется право обоснования более высокого ущерба от просрочки.

7. Поставка / срок поставки / задержка

7.1 Договоренность о сроках и дате поставки считается обязательной только в случае, если они однозначно письменно одобрены продавцом. Продавец не обязан соблюдать дату и/или срок поставки, если покупатель не выполняет свои обязательства (выплата задатка, предоставление необходимых документов, размещение заказов на производство и т. д.) своевременно. Сохраняется право на возмещение стороны о неисполнении договора другой стороной.

7.2 Срок поставки начинается не ранее дня письменного заключения договора и разъяснения всех технических вопросов.

7.3 При наличии пожеланий покупателя по изменению, продавец освобождается от соблюдения любых согласованных даты и/или срока поставки. В данном случае стороны согласуют новую дату поставки или новые сроки поставки.

7.4 При отсутствии иных договоренностей, дата поставки или срок поставки считаются соблюденными, если товар доставлен продавцом в согласованное место.

7.5 Покупатель не имеет права предъявлять претензии по задержкам поставки, не вызванным умыслом или грубой халатностью продавца. В частности, в том числе при прочих нарушениях, это касается задержки поставки в связи с форс-мажорными обстоятельствами, заботками, беспорядками, эпидемиями и/или пандемиями, кибератаками, административными мерами, отсутствием поставок товаров субпоставщиками и прочими непредвиденными, неотвратимыми и существенными обстоятельствами. Согласованные сроки и даты поставки в этом случае продлеваются в соответствии с длительностью действия фактора задержки поставки. Продавец информирует об этом покупателя и, по возможности, сообщает новую предположительную дату поставки. Возмещаются только упущенная прибыль и ущерб в связи с простоем, которые вызваны умыслами действиями.

7.6 В случае просрочки в получении поставленного товара покупателем или нарушения им прочих обязательств по содействию продавец имеет право требовать возмещения понесенного ущерба, включая возможные дополнительные расходы. Кроме того, продавец имеет право устанавливать приемлемый срок приема товара покупателем, а по истечении срока выйти из договора и потребовать возмещения ущерба в виде выполнения договорных обязательств.

7.7 Частичные поставки допустимы в приемлемом объеме. В связи с этим претензии покупателя по частичной поставке или задержанной поставке остаточной партии исключаются.

8. Оговорка об условиях перехода права собственности на товар

8.1 Продавец сохраняет право собственности на все поставленные товары до поступления всех платежей в рамках отношений, возникающих при осуществлении поставок, а также будущих обязательств. При действиях, противоречащих условиям договора, в частности, при задержке оплаты, продавец имеет право потребовать вернуть товар.

8.2 Покупатель обязуется бережно обращаться с поставленными товарами, и в течение срока перехода права собственности на товар, за собственный счет застраховать его против любого вида уничтожения по купольной стоимости. За продавцом сохраняется право самостоятельно страховать товар за счет покупателя.

8.3 При наложении ареста на имущество или прочих вменяемых третьих лиц покупатель обязан незамедлительно письменно информировать продавца, чтобы он смог подать иск третьего лица о праве собственности на имущество или иную апелляцию. В случае, если третье лицо не возместит возникшие в связи с этим судебные и внесудебные расходы, ответственность за них несет покупатель.

8.4 Покупатель имеет право продать товар в рамках нормального делового процесса, однако он уже сейчас уступает продавцу все требования в размере итоговой суммы по счету-фактуре (включая установленный законом налог с оборота), которые у него возникают при перепродаже по отношению к клиенту или третьему лицу, независимо от того, был ли товар перепродан без переработки или после нее. Покупатель имеет право на предъявление этого требования к оплате и после передачи товара. Это не отменяет право продавца на самостоятельное возмещение этого требования.

8.5 При нераздельном смешении и соединении поставленного товара с предметами, не являющимися собственностью продавца, продавец приобретает право долевой собственности на новое или соединенное имущество в пропорции, равной отношению стоимости поставленного товара (итоговая сумма по счету-фактуре, включая установленный законом налог на добавленную стоимость) к стоимости других товаров на момент смешения или соединения. Покупатель хранит для продавца возникшую таким образом единичную или долевую собственность.

8.6 Если стоимость предоставленного залога превышает стоимость требований продавца в общем более чем на 20 %, продавец обязуется по требованию покупателя вернуть тому избыточный залог по выбору продавца.

8.7 Если совокупность действующих правовых норм не допускает договоренности об условиях перехода права собственности на товар, покупатель обязан предоставить продавцу другие соразмерные гарантии при получении товарного кредита.

9. Отправка, переход рисков

9.1 Отправка осуществляется на риск покупателя. Риск всегда переходит на покупателя не позднее чем с момента отправления товара, даже если прочие услуги берет на себя продавец.

9.2 Если отправка задерживается вследствие обстоятельств, не зависящих от продавца, риск переходит на покупателя в день уведомления о готовности к отправке. По письменной просьбе покупателя отправляемый товар страхуется продавцом за счет покупателя на случай ущерба при поломке, повреждении при транспортировке, пожаре и наводнении.

9.3 Транспортная и прочая упаковка, за исключением палет, не принимается назад в соответствии с Законом об упаковке. Покупатель обязан осуществить утилизацию упаковки за собственный счет.

10. Средства производства

10.1 Если покупатель предоставляет в распоряжение продавца средства производства (например, инструменты, формы), то они должны поставляться продавцу бесплатно. Продавец берет на себя ответственность за их поломку, удушение или неполный возврат и следующий из этого ущерб только в случае грубой халатности или умышленных действий. Данное положение не действует, если законом устанавливается обязательная ответственность.

10.2 Когда средства производства изготавливаются или приобретаются продавцом по поручению покупателя, продавец включает в счет соответствующие издержки. Эти средства производства остаются в собственности продавца. Продавец не обязан выдавать их покупателю. Это относится также и к последовательным штампам. Изложенное ниже положение под пунктом 10.3 при этом сохраняет свою силу.

10.3 В случае амортизации расходов на средства производства по цене детали, покупатель берет на себя не покрытые расходы при неамортизации инструмента, включая расходы на прочее типизированное оборудование. Затраты на модели всегда покрываются в полном объеме за счет покупателя.

10.4 Запрещено передавать третьим лицам данные, выданные покупателем продавцом чертежи и документы, а также сообщать о предложениях продавца о конструировании и изготовлении товара. Данные чертежи и документы могут быть истребованы назад продавцом в любое время.

11. Ответственность за обнаруженные в изделии дефекты / ответственность

11.1 Продавец не несет ответственности за ущерб, вызванный нарушением предписаний инструкций по эксплуатации, техническому обслуживанию и монтажу, использованию не по назначению или неквалифицированным использованием, неправильным или небрежным обращением, естественным износом, неправильным хранением, или изменением товара продавцом или третьими лицами. Монтаж товара по поручению покупателя или третьих лиц должен выполняться только обученными специалистами.

11.2 Выбор между устранением дефектов и поставкой нового товара делает продавец. По требованию продавца покупатель должен передать ему рекламизированный товар для анализа. В случае возникновения расходов вследствие непропорционального требования со стороны покупателя об устранении дефектов (в частности, расходом на испытания и транспортных расходов) продавец может потребовать возмещения этих расходов.

11.3 Продавец не покрывает издержки, необходимые для устранения дефекта, если повышение издержек связано с перевозкой товара после поставки в иное место, чем исходное место поставки.

11.4 Если требование к продавцу предъявляется покупателем в порядке регресса, после того как к самому покупателю были предъявлены претензии его клиентом за дефекты в изделии, то для реализации прав применяется § 445a Гражданского уложения Германии.

11.5 Срок действия требований по ответственности за обнаруженные в изделии дефекты истекает через год с момента передачи товара, кроме случаев, когда требование устранения недостатков, обнаруженных в товаре, основано на неисполнении обязательств продавцом или лицом, действующим по поручению продавца, по грубой халатности или умыслу, или в случае ущерба жизни и здоровью, а также телесных повреждений. В случае претензий по гарантии отсутствия дефектов, которые предъявляются к продавцу покупателем в порядке регресса согласно § 445a Гражданского уложения Германии, в неограниченном объеме действует положение об исковой давности согласно § 445b Гражданского уложения Германии.

11.6 Покупатель обязуется выполнить свою обязанность исследования товара при покупке согласно § 377 Торгового уложения, в том числе и в случае перепродажи товара.

11.7 Исключается применение покупателем права регресса по отношению к продавцу в связи с такими требованиями устранения недостатков, выданными покупателем клиентам, если покупатель не выполнил свою обязанность исследования товара при покупке и обязанность немедленно извещать о претензиях к качеству товара, или если товар был изменен при переработке.

11.8 Ответственность продавца за возмещение ущерба согласно положениям закона не ограничена, если вменяемое продавцу невыполнение обязанностей основано на умысле или грубой халатности. Если вменяемое продавцу невыполнение обязанностей основано на простой халатности, и виновно нарушены важные договорные обязательства, ответственность за возмещение ущерба ограничивается прогнозируемым ущербом, обычно возникающим в аналогичных случаях. В остальных случаях ответственность исключена.

11.9 Возмещаются только упущенная прибыль и ущерб в связи с простоем, которые вызваны умышленными действиями и грубой халатностью.

11.10 Это не затрагивает ответственность согласно Закону об ответственности за продукцию или аналогичным неотъемлемым правам зарубежных законодательств. Сохраняется ответственность за ущерб, нанесенный жизни и здоровью, а также при телесных повреждениях.

11.11 Если ответственность по фактам, указанным в пункте 11.9, обоснована, ответственность продавца по отношению к покупателю в рамках зарубежных законодательств ограничена пределами, допустимыми соответствующим зарубежным законодательством.

11.12 Если ответственность продавца за возмещение ущерба исключена или ограничена, это распространяется и на личную ответственность за возмещение ущерба сотрудников, представителей и лиц, действующих по поручению продавца.

12. Запрещение переуступки

12.1 Все требования покупателя по отношению к продавцу не подлежат переуступке.

12.2 Продавец вправе в любое время, в том числе без согласия покупателя, привлекать связанные с ним предприятия (согласно § 15 Закона об акционерных обществах) в качестве лиц, действующих по поручению продавца, к выставлению предложений и выполнению договоров.

13. Ответственность за продукцию / обязанность давать указания

13.1 Покупатель обязан использовать товар только по назначению и гарантировать перепродажу товара только лицам, ознакомленным с опасностями и рисками, связанными с продуктом.

13.2 Покупатель обязуется давать соответствующие указания в случае использования товара в качестве основного материала и компонента собственных продуктов при сырье конечного продукта, и относительно товара, поставленного продавцом. В рамках отношений партнеров по договору, покупатель освобождает продавца от предъявления претензий при нарушении этого обязательства по первому требованию.

14. Конфиденциальность

Покупатель обязан в отношении с третьими лицами обращаться со всей коммерческой и технической информацией, полученной от продавца, как с коммерческой и производственной тайной, кроме случаев, когда она общеизвестна. Подобная информация может быть передана третьим лицам, заключившим соглашение о конфиденциальности, только в целях, установленных договором.

15. Защита персональных данных

Продавец собирает, обрабатывает и использует персональные данные покупателя только при условии соблюдения действующих Положений о защите персональных данных. Согласно этим Положениям персональные данные покупателя используются только при наличии предусмотренного законом разрешения или согласия.

16. Прочие

16.1 Место исполнения является местонахождение соответствующего завода продавца.

16.2 Место судебного рассмотрения всех споров по данному договору является Хайльбронн. Однако продавец имеет право предъявить иск покупателю по месту его общей подсудности.

16.3 При исполнении договора по данным условиям продажи и поставки действует исключительно германское законодательство, за исключением случаев применения коллизионного права и Конвенции ООН о договорах международной купли-продажи товаров (CISG).

16.4 В рамках действия отношений по договору стороны обязуются выполнять все действующие положения закона.

16.5 Если одно или несколько изложенных выше положений окажется полностью или частично недействительным, остальные положения сохраняют силу. Недействительное положение должно быть заменено на законно допустимое положение, максимально приближенное к смыслу и цели данных условий продажи и поставки.

- ٥-٨ إذا كانت البضائع المسلمة مختلطة أو مدمجة بشكل مع أصناف أخرى لا تخص البائع لا يمكن فصله، فإن البائع يكتب ملكية مشتركة لهذه العناصر الجديدة أو المدمجة بنسبة قيمة البضائع المسلمة (مبلغ الفاتورة النهائية، بما في ذلك ضريبة القيمة المضافة) فيما يتعلق بكافة الأصناف التي جرى خلطها أو دمجها. ويحفظ المشتري بالملكية الزائدة أو المشتركة للبائع.
- ٦-٨ إذا تجاوزت قيمة الضمانات المقدمة لمطالبات البائع بأكثر من ٢٠٪، فإن البائع ملزم، بناءً على طلب المشتري، بتحرير الضمانات الزائدة وفقاً لتقدير البائع.
- ٧-٨ إذا لم يسمع النظم القانوني المعنى بالتوصل إلى اتفاق بشأن الاحتفاظ بحق الملكية، وإلى الحد الذي لا يسمح فيه بذلك، فإن المشتري يمدد البائع بالضمانات الأخرى المناسبة عند استخدام الائتمان التجاري.

٩- الشحن ونقل المخاطر

- ١-٩ الشحن يكون على مسؤولية المشتري. وتنتقل المخاطر إلى المشتري دائماً عند إرسال البضائع على أبعاد تقديري، حتى لو قَدِمَ البائع خدمات أخرى.
- ٢-٩ إذا تأخر الشحن بسبب ظروف لا يتحمل البائع مسؤوليتها، فإن المسؤولية تنتقل إلى المشتري من يوم الإبلاغ عن جاهزية الشحن. بناءً على طلب كتابي من المشتري، سيوفر البائع بالتأمين على الكسر والنقل والحرائق والأضرار الناجمة عن المياه على نفقة المشتري.
- ٣-٩ يتم إرجاع عوابع النقل وجميع العوابع الأخرى وفقاً لقانون التبعة، تستثنى من ذلك المنصات. يلتزم المشتري بالتخلص من العوابع على نفقته الخاصة.

١٠ معدات الإنتاج

- ١-١٠ إذا قام المشتري بإمداد البائع بمعدات الإنتاج (مثل الأدوات والقوالب)، فيجب إرسالها إلى البائع مجاناً. ولا يتحمل البائع مسؤولية خسارتها أو تدهور حالتها أو عدم اكتمال تسليمها والأضرار الناتجة عن ذلك إلا في حالات الإهمال الجسيم أو التعمد. ولا يطبق ذلك إذا كانت المسؤولية الزامية بموجب القانون.
- ٢-١٠ إذا قام البائع بتوصيل معدات الإنتاج أو شراؤها نيابة عن المشتري، فيقوم البائع بإرسال فاتورة إلى المشتري بالتكاليف بشكل منفصل. وتبقى معدات الإنتاج ملكاً للبائع. ولا يلتزم البائع بتسليمها للمشتري. وينطبق ما ورد أعلاه أيضاً على الأدوات اللائحة. ولا تتأثر اللائحة التالية الواردة في القسم ٣-١٠ بذلك.
- ٣-١٠ إذا تم تسديد نظير معدات الإنتاج من سعر قطع الغيار، ولم يتم تسديد سعر المعدات، فإن المشتري يتحمل التكاليف غير المغطاة، بما في ذلك مصروفات توفير المعدات الأخرى ذات الصلة بالبيع. يتحمل المشتري تكاليف النماذج دائماً بالكامل.
- ٤-١٠ يتم نقل الرسوم والمستندات التي يسلمها البائع إلى المشتري بالإضافة إلى اقتراحات البائع لتصميم وتصنيع البضائع إلى أطراف أخرى، ويجوز للبائع أن يطلب إعانتها في أي وقت.

١١ المسؤولية عن العيوب المادية / المسؤولية

- ١-١١ البائع غير مسؤول عن الأضرار التي تحدث نتيجة لانتهاك التعليمات التشغيل والصيانة والتزييب، أو الاستخدام غير المناسب أو غير السليم أو غير المطابق للتعليمات، أو التعامل غير الصحيح أو الإهمال، أو الهبلى الطبيعي، أو التخزين غير الصحيح أو التغييرات في البضائع التي أجراها المشتري في غيره من الأطراف. لا يُسمح للمشتري في الأطراف الأخرى بتركيب البضائع إلا بمعرفة موظفين متخصصين مدربين.
- ٢-١١ يحق للبائع الاختيار بين إصلاح المنتج أو تسليم المنتج جديد. ويجب على المشتري تسليم البضائع المعنية إلى البائع بناءً على طلبه لفحصها. إذا تكبد البائع تكاليف (لا سيما تكاليف الاختبار والنقل) بسبب طلب المشتري غير المبرر لتصحيح عيب ما، فيمكن للبائع أن يطالب بسداد هذه التكاليف

- ٣-١١ لن يتحمل البائع النفقات اللازمة للوفاء بالحق المعقد إذا زانت النفقات بسبب نقل البضائع إلى موقع آخر غير موقع التسليم الأصلي بعد التسليم.
- ٤-١١ إذا رفع المشتري دعوى ضد البائع باستخدام حق الرجوع بعد أن تم رفع دعوى قضائية ضد المشتري نفسه من أحد عملائه بسبب وجود عيب، فإن المادة 445a من القانون المدني الألماني (BGB) تطبق على الإنقاذ القانوني.
- ٥-١١ تنتهي المطالبات الناشئة عن المسؤولية عن العيوب المادية بعد علم من تسليم البضائع، ما لم تكن مطالبات المسؤولية عن العيوب المادية مبنية على إهمال جسيم أو خرق متعمد للواجب من البائع أو وكيله الذي يوجب عنه أو على تضرر الحياة، أو إصابة الجسم أو الصحة في حالة المطالبات الخاصة بضمان العيوب التي يوكدها المشتري ضد البائع عن طريق حق الرجوع وفقاً للمادة 445a من القانون المدني الألماني (BGB)، تنطبق فترة التقادم المنصوص عليها في المادة 445b من القانون المدني الألماني (BGB) دون قيود.
- ٦-١١ يلتزم المشتري بلوفاء بالتزامه بالتحقق وفقاً للمادة ٣٧٧ من القانون التجاري الألماني (HGB) حتى عند إعادة بيع البضائع.
- ٧-١١ يُستبعد حق المشتري في الرجوع على البائع بسبب المطالبات الناشئة عن المسؤولية عن العيوب المادية التي يتم توكيدها ضد المشتري من عدائه إذا لم يتم المشتري بلوفاء بالتزامه بالتحقق والإبلاغ عن العيوب أو إذا تم تعديل البضائع من خلال معالجتها.
- ٨-١١ عند استخدام البضائع كإحدى الأجزاء غير معدودة إذا كان الإخلال بالواجب المنسوب إلى البائع قائماً على التعمد أو الإهمال الجسيم. إذا كان خرق الواجب المنسوب إلى البائع يستند إلى إهمال بسيط وتم انتهاك التزام تعاقدي أساسي، فإن المسؤولية عن الأضرار تقتصر على الضرر المتوقع الذي يحدث عادة في الحالات المماثلة. علاوة على ذلك، تستبعد المسؤولية.
- ٩-١١ يقتصر التعويض عن الأرباح المفقودة والأضرار الناجمة عن انقطاع الأعمال الناجم عن التعمد والإهمال الجسيم.
- ١٠-١١ تبقى المسؤولية بموجب أحكام قانون مسؤولية المنتج أو الحقوق الشبيهة التي لا غنى عنها، بما في ذلك الأنظمة القانونية الأجنبية، دون مساس. كما تبقى المسؤولية عن الأضرار التي تلحق بالحياة والجسم والصحة دون مساس.
- ١١-١١ إلى الحد الذي يتم فيه تحديد المسؤولية بناءً على الواقع الواردة في القسم ٩-١١، تكون مسؤولية البائع المنصوص عليها في القوانين الأجنبية، فيما يتعلق بالمشتري، محدودة بالحد الذي ينص عليه القانون الأجنبي المعنى.
- ١٢-١١ إلى الحد الذي يتم فيه استبعاد أو تقييد مسؤولية البائع عن الأضرار، ينطبق ذلك أيضاً فيما يتعلق بالمسؤولية الشخصية عن الأضرار التي تلحق بموظفي البائع وممثليه وكلاءه الموقّنين.

١٢ حظر التنازل

- ١-١٢ لا يمكن التنازل عن جميع مطالبات المشتري ضد البائع.
- ٢-١٢ يحق للبائع في أي وقت، حتى دون موافقة المشتري، أن يُشرك الشركات التابعة له (بالمعنى المقصود في المادة ١٥ من قانون الشركات المساهمة) بوصفهم وكلاء يوثبون عنه في إعداد العرض وتنفيذ العقد.

١٣ التزامات المنتج/ واجب الإخطار

- ١-١٣ لا يُسمح للمشتري باستخدام البضائع إلا على النحو المطبق للتعليمات ويجب عليه التأكد من عدم إعادة بيع هذه البضائع إلا للأشخاص الذين لديهم دراية بمخاطر المنتج والأخطار الناجمة عنه.
- ٢-١٣ عند استخدام البضائع كمادة خام وكجزء من منتج ما، يلتزم المشتري بالامتثال لالتزامه بالتحذير عند طرح المنتج النهائي في السوق، بما في ذلك ما يتعلق بالبضائع التي يسلمها البائع. في العلاقة الداخلية، يعنى المشتري البائع من تأكيد المطالبات في حالة انتهاك هذا الالتزام عند الطلب الأول.

١٤- المسؤولية

يجب على المشتري التعامل مع كافة المعلومات التجارية والتقنية الواردة في البائع على أنها أسرار تجارية وأسرار تشغيلية تجاه أي أطراف أخرى، ما لم تكن معروفة بشكل عام. لا يُسمح بنقل هذه المعلومات إلا إلى أطراف أخرى ملزمة بتقافية حماية بيانات معينة ولغرض الوفاء بالعقد.

١٥- حماية البيانات

لا يقوم البائع بجمع ومعالجة واستخدام البيانات الشخصية للمشتري إلا بما يتوافق مع لوائح حماية البيانات ذات الصلة. وبناءً على ذلك، فإنه لن يستخدم البيانات الشخصية الخاصة بالمشتري إلا في حالة وجود تصريح أو موافقة قانونية.

١٦- نقاط أخرى

- ١-١٦ مكان التنفيذ هو موقع مصنع البائع المعنى.
- ٢-١٦ محل التقاضي لجميع النزاعات الناشئة عن العقد هو مدينة هيلبرون. ومع ذلك، يحق للبائع أيضاً مقاضاة المشتري في مقر محل التقاضي العام الخاص به.
- ٣-١٦ باستثناء لإبرام العقود بناءً على شروط البيع والتسليم هذه، ينطبق القانون الألماني حصرياً، باستثناء الأمور التي بها تنازع في القوانين واتفاقية الأمم المتحدة بشأن عقود البيع الدولي للبضائع (CISG).
- ٤-١٦ يلتزم الطرفان بالامتثال لجميع الأحكام القانونية المعمول بها عند تنفيذ العلاقة التعاقدية.
- ٥-١٦ إذا أصبح حكم أو أكثر من الأحكام المذكورة أعلاه غير فعال كلياً أو جزئياً، فإن صلاحية الأحكام المتبقية تبقى دون مساس. ويجب عندئذ استبدال الحكم غير الساري بأخر سار قانوناً ويحقق المعنى والغرض من شروط البيع والتسليم هذه بطريقة شبيهة بقدر الإمكان.

- ١- نطاق السريان**
- ١-١ تنطبق شروط البيع والتسليم الخاصة بشركة MS Motorservice International GmbH (المشار إليها فيما يلي "البائع") حصرياً. ومن ثم، إن يتم الاعتراف بشروط المشتري التي تتعارض أو تعيد عن شروط البيع والتسليم هذه إلا إذا وافق البائع كتابياً وبشكل واضح على صيغة هذه الشروط المخالفة. تنطبق شروط البيع والتسليم هذه أيضاً إذا قام البائع بالتوريد إلى المشتري دون أي تحفظ على الرغم من علمه بشروط المشتري التي تتعارض أو تعيد عن شروط البيع والتسليم الخاصة بالمشتري.
- ٢-١ تكون الأولوية للاتفاقيات المنفصلة بين الطرفين والتي تتخلف عن شروط البيع والتسليم هذه أو تستكملها. ما لم يتم وضع قواعد خاصة، سيتم استكمالها بشروط البيع والتسليم هذه. جديرٌ بالذكر أن العقد المكتوب أو التأكيد الكتابي من البائع يعتبر حاسماً بالنسبة لمحتوى هذه الاتفاقيات.
- ٣-١ تنطبق شروط البيع والتسليم أيضاً على كافة المعاملات المستقلة مع المشتري. بموجب تقديم المشتري لطلب، وحتى قبول البائع على أبعاد تقديري، يكون المشتري قد وافق على شروط البيع والتسليم هذه.
- ٤-١ تنطبق شروط البيع والتسليم هذه على الشركات فقط.

٢- العرض وتأكيد الطلب

- ١-٢ العروض التي يقدمها البائع غير ملزمة دائماً. فإذا كان طلب المشتري مؤهل قانوناً ليتمل عرضاً، فإنه لن يعتبر مقبولاً إلا إذا أكد البائع كتابياً في غضون أربعة أسابيع، يتم إبرام العقد عند إرسال البضائع المطلوبة أو عند توفير البضائع المطلوبة على أبعاد تقديري في حالة التسليم الجزئي، يكون العقد مُبرماً عند إرسال الفاتورة الأولى.
- ٢-٢ التغييرات والاتفاقيات الأخرى لا تكون ملزمة إلا إذا أكدها البائع كتابياً.
- ٣-٢ المستندات والرسومات ومعلومات الوزن والقياس والميزان وما إلى ذلك، الواردة في العروض تعتبر معلومات تقريبية فحسب ولا تمثل أي خصائص للحمولة. يحق للبائع الحيود عن الأوصاف الواردة في العرض، بشرط ألا تكون هذه الاختلافات جوهرية أو أساسية ولا تضر بالعرض التعاقدية بشكل كبير.
- ٤-٢ إذا تم تصنيع البضائع وفقاً لرسومات المشتري، فإن الرسومات التي أعدها المشتري ووافق عليها البائع تكون هي الحاسمة. يجب الاتفاق على وجه التحديد على الاختلافات عن الرسومات المعتمدة ويجب سداد أي مصروفات إضافية ناجمة عن ذلك إلى البائع.

٣- حقوق الملكية

- ١-٣ يحفظ البائع بحقوق الملكية وحقوق الطبع والنشر فيما يتعلق بكافة الرسومات التوضيحية والرسومات والحسابات وغيرها من المستندات؛ ولا يُسمح باستخدامها لأغراض أخرى غير تلك التي جدها البائع أو ابتناها لأي أطراف أخرى دون الحصول على موافقة كتابية مسبقة من البائع. وينطبق ذلك بشكل خاص على المستندات المكتوبة التي تم تصنيفها على أنها "سرية" أو "خاصة" أو ما شابه ذلك.
- ٢-٣ البائع غير مسؤول إلا عن المطالبات التي تنشأ عن انتهاك حقوق الملكية وتسجيلات حقوق الملكية (حقوق الملكية) عند استخدام البضائع وفقاً للعقد، والتي يندرج أحدها على الأقل في حقوق الملكية ما عن طريق النشر بمعرفة مكتب براءات الاختراع الأوروبي أو في إحدى جمهوريات ألمانيا الاتحادية أو فرنسا أو بريطانيا العظمى أو النمسا أو الصين أو اليابان أو الولايات المتحدة الأمريكية.
- ٣-٣ إذا تم تسليم بناءً على رسومات أو معلومات أخرى مقدمة من المشتري وترتب عن ذلك انتهاك حقوق ملكية طرف آخر، فيجب على المشتري تعويض البائع داخلياً عن جميع المطالبات.

٤- التوصيات والمعلومات والبيانات

التوصيات والمعلومات والبيانات لا تعتبر ملزمة إلا إذا كانت تتعلق بالبضائع نفسها.

٥- الأسعار

- ١-٥ جميع الأسعار تشير إلى الأسعار الصافية وتسري على "تسليم المصنع" (EXW - Incoterms@2020) باستثناء التعليف والشحن والبريد وتأمين القيمة. تصناف ضريبة المبيعات القانونية بقميتها السارية.
- ٢-٥ قد يُرسل البائع فاتورة بأي مصروفات إضافية ناجمة عن طلبات التغيير إلى المشتري.
- ٣-٥ إذا حدثت أي تغييرات بعد إبرام العقد أت إلى زيادة تكلفة شراء وإنتاج و/أو شحن البضائع للبائع، فيحق للبائع زيادة السعر المتفق عليه وفقاً لذلك.

٦- شروط الدفع

- ١-٦ تصيب الفواتير مستحقة الدفع دون أي خصومات خلال ١٤ يوماً من تاريخ الفاتورة. ويحق للبائع في أي وقت، حتى في إطار علاقة العمل المستمر، تنفيذ التتبعات كلياً أو جزئياً نظير الدفعة المقدمة فقط. ولا يطبق الخصم إلا إذا تم الاتفاق عليه صراحةً بصيغة كتابية.
- ٢-٦ يحق للبائع إجراء مقاصة مبدئية للمدفوعات نظير الديون القديمة غير المصنفة، حتى لو كان غرض المشتري مخالفاً لذلك. إذا تكبد البائع تكاليف أو فوائد بالفعل، فيحق له تعويض المدفوعات أو لا بقيمة هذه التكاليف، ثم نظير الفائدة وأخيراً نظير الخدمة الرئيسية.
- ٣-٦ لا يحق للمشتري التعويض إلا إذا كانت مطالباته المعنية قد تم إثباتها قانونياً أو كانت غير متنازع عليها أو إذا اعترف بها البائع كتابياً وإلى الحد الذي تكون فيه هذه المطالبات سارية قانوناً. يقتصر حق المشتري في الاحتفاظ بالحق في المطالبات الناشئة عن العلاقة التعاقدية.
- ٤-٦ يحق للبائع تحصيل الفائدة الافتراضية بمعدل الفرض القانوني المعمول به. ويبقى الحق في إثبات الأضرار الأعلى الناجمة عن التأخير محفوظاً.

٧- التوريد / وقت التسليم / التأخير

- ١-٧ لا تعتبر فترات التسليم وتواريخ التسليم ملزمة إلا إذا وافق عليها البائع صراحةً في صيغة كتابية. لا يلتزم البائع بتاريخ التسليم أو فترة التسليم إذا لم يف المشتري بالتمهات في الوقت المناسب (تحرير الدفعات المقدمة، وتوفير المستندات اللازمة، وإثابة الإنتاج، وما إلى ذلك). ويبقى الحق في معارضة العقد غير المكتمل محفوظاً.
- ٢-٧ تبدأ فترات التسليم في أقرب وقت من اليوم الذي تم فيه إبرام العقد كتابياً وتم توضيح جميع الأسئلة الفنية.
- ٣-٧ إذا طلب المشتري إجراء تغييرات، فيكون البائع معيّناً من الالتزام بأي تاريخ تسليم أو بفترة التسليم المتفق عليها. وفي هذه الحالة، يتفق الطرفان على مهلة أو موعد نهائي جديد للتسليم.
- ٤-٧ ما لم يتم الاتفاق على خلاف ذلك، يكون تاريخ التسليم أو مهلة التسليم مستوفاه إذا وُفّر البائع البضائع في الموقع المتفق عليه.
- ٥-٧ لا يمكن للمشتري تأكيد أي مطالبات بسبب التأخير في التسليم والتي لا تكون بسبب التعمد أو الإهمال الجسيم من طرف البائع. وينطبق ذلك أيضاً على الاختلالات الأخرى، ولا سيما تأخير التسليم بسبب القوة القاهرة، والنزاعات المالية، والإضرابات، والأوبئة و/أو الجوائح، والهجمات السيبرانية، والتدابير الحكومية، وعدم التسليم من الموردين وغيرها من الأحداث الخطيرة وغير المتوقعة والتي لا يمكن تجنبها. في هذه الحالات، سيتم تأجيل تاريخ التسليم أو مهلة التسليم المتفق عليها بحسب مدة وجود عائق التسليم، وسيقوم البائع بإبلاغ المشتري بذلك وسيقدم، إن أمكن، تاريخ تسليم متوقع جديد. يقتصر التعويض عن الأرباح المفقودة والأضرار الناجمة عن انقطاع الأعمال عمداً.
- ٦-٧ إذا أخفق المشتري في الفول أو انتهك التزامات التعاون الأخرى، فيحق للبائع المطالبة بالتعويض عن الضرر الناتج، بما في ذلك أي نفقات إضافية. ويحق للبائع أيضاً تحديد فترة قبول معقولة للمشتري، وإذا انتهت هذه الفترة، يحق له إلغاء العقد والمطالبة بالتعويض بدلاً من تنفيذ العقد.
- ٧-٧ يُسمح بالتسليم الجزئي إلى حد معقول. وفي ذلك الصدد، تستثنى مطالبات المشتري بسبب التسليم الجزئي أو التأخر في تسليم الكمية المتبقية.

٨- الاحتفاظ بالملكية

- ١-٨ يحفظ البائع بملكية كافة البضائع المسلمة حتى استلام كافة المدفوعات من علاقة التسليم، بما في ذلك الالتزامات المستقبلية. في حالة الإخلال بالعقد، وخاصة التأخر في السداد، يحق للبائع المطالبة بإعادة البضائع.
- ٢-٨ يلتزم المشتري بمعاملة البضائع المسلمة إليه بحرص وتأمينها على نفقته الخاصة ضد أي شكل من أشكال خسارة سعر الشراء طوال مدة الاحتفاظ بحق الملكية. ويبقى الحق مكتوباً للبائع في التأمين على البضائع بنفسه على نفقة المشتري.
- ٣-٨ في حالة مصادرة البضائع أو في حالة أي تدخلات أخرى من أطراف ثالثة، يجب على المشتري إخطار البائع كتابياً وعلى الفور حتى يتمكن البائع من تقديم مطالبات اعتراض تجاه الطرف الثالث أو يستخدم مبلغ الانصاف القانونية الأخرى. إذا لم يتم الطرف الثالث بسداد التكاليف القانونية وغير القضائية الناتجة، يكون المشتري مسؤولاً عن هذه التكاليف بنفسه.
- ٤-٨ يحق للمشتري إعادة بيع البضائع في سياق العمل العادي؛ ومع ذلك، فإنه يتنازل للبائع عندئذ عن جميع المطالبات بما يصل إلى مبلغ التكاليف القانونية وغير القضائية الناتجة، يكون المشتري مسؤولاً عن هذه التكاليف بنفسه.
- ٥-٨ الفاتورة النهائية (بما في ذلك ضريبة المبيعات القانونية) الخاص بالمطالبة التي تنشأ عن إعادة البيع إلى عملائه أو إلى أطراف ثالثة، بغض النظر عما إذا تمت إعادة بيع البضائع دون معالجتها أو بعد معالجتها. ويبقى الحق مكتوباً للمشتري في تحصيل هذه المطالبات حتى بعد التسليم. ولا تتأثر سلطة البائع في تحصيل هذه المطالبات بنفسه.

MS Motorservice International GmbH

Wilhelm-Maybach-Straße 14-18

74196 Neuenstadt, Germany

Telefon: +49 7139 9376-3333

Telefax: +49 7139 9376-2864

info@ms-motorservice.com

www.ms-motorservice.com



4 028977 497971

