



KNOWLEDGE **POOL**

PISTON DAMAGE – RECOGNISING AND RECTIFYING



MOTORSERVICE GROUP

QUALITY AND SERVICE FROM A SINGLE SOURCE

The Motorservice Group is the sales organisation for the worldwide aftermarket activities of Rheinmetall Automotive. It is a leading supplier of engine components for the independent aftermarket. With the premium brands Kolbenschmidt, Pierburg, TRW Engine Components and the BF brand, Motorservice offers its customers a wide and comprehensive range of top quality products from a single source. As a problem solver for trade and repair shops, the corporation also offers an extensive service package. Motorservice customers benefit from the combined technical know-how of a large international automotive supplier.

RHEINMETALL AUTOMOTIVE

RENOWNED SUPPLIER TO THE INTERNATIONAL AUTOMOTIVE INDUSTRY

Rheinmetall Automotive is the mobility division of the technology corporation Rheinmetall Group. With its premium brands Kolbenschmidt, Pierburg and Motorservice, Rheinmetall Automotive is a global leader in the relevant markets for air supply systems, emission control and pumps and in the development, manufacture and spare-parts supply of pistons, engine blocks and plain bearings. Low pollutant emissions, good fuel economy, reliability, quality and safety are the main driving forces behind the innovations of Rheinmetall Automotive.



KOLBENSCHMIDT



PIERBURG



TRW
EngineComponents

Edited by:

Motorservice, Technical Market Support

Layout and production:

Motorservice, Marketing

This document must not be reprinted, duplicated or translated in full or in part without our prior written consent or without reference to the source of the material.

All content including pictures and diagrams is subject to alteration. No liability accepted.

Published by:

© MS Motorservice International GmbH

Liability

All information in this brochure has been carefully researched and compiled. Nevertheless, it is possible that errors have occurred, information has been translated incorrectly, information is missing or the details provided have changed in the intervening time. As a result, we are unable to provide any guarantee nor to accept any legal liability for the accuracy, completeness, currency or quality of the information provided. We hereby waive all liability for any damages, whether direct or indirect in nature and whether tangible or intangible, resulting from the use or misuse of information or from incomplete or incorrect information in this brochure, unless proven to be the result of deliberate intent or negligence on our part. Likewise, we shall not be liable for damage arising because the engine reconitioner or mechanic does not have the necessary technical expertise, the required knowledge of, or experience in repairs. The extent to which the technical methods and repair information described here will apply to future engine generations cannot be predicted and must be verified in individual cases by the engineer servicing an engine or the workshop operator.



THE ISSUE

The aim of this brochure is to provide an overview of the different types of damage on pistons, cylinder sliding surfaces and cylinder liners. It can assist experts when running diagnostics and determining the cause of damage and provides laymen with basic information.

The process of assessing engine damage requires an all-encompassing approach to identify the causes, which may not always be clear. It is not at all a rare occurrence for engine repairs to be carried out and then for the same failures to occur again because, although the damaged components were replaced, nothing was done to eliminate the cause of the problem. When describing the events leading to the damage, experts are often only provided with a single, defective part, without any further data on the running time or extent of the damage. This only allows for general diagnostics and not an examination of the specific damage.

ADDITIONAL INFORMATION

Recognising damage is not always a straightforward task. In many cases the damage can be hard to make out, particularly in photographs. This is why you will also see damage pictograms for every damage pattern (Fig. 1). These will help you to identify the damage on the photographs more easily. These pictograms do not show the damage on a 1:1 scale. The pictograms are merely intended to serve as examples, in some cases with additional information. Damage that leaves characteristic traces on different points or parts is described with several pictograms.

A glossary containing key specialist terms has been included as an appendix to this brochure.



Fig. 1











TABLE OF CONTENTS		PAGE
1.	QUICK DIAGNOSIS	6
2.1	SEIZURE DUE TO INSUFFICIENT CLEARANCE	10
2.1.1	General information about seizures due to insufficient clearance	10
2.1.2	Seizure due to insufficient clearance on the piston skirt	11
2.1.3	45° seizure marks	12
2.1.4	Seizure due to insufficient clearance at the bottom skirt end	14
2.2	SEIZURE DUE TO LACK OF LUBRICATION	15
2.2.1	General information about seizures due to lack of lubrication	15
2.2.2	Seizure due to lack of lubrication on the piston skirt	16
2.2.3	Piston skirt seizure on one side only without matching wear marks on the counter-side	17
2.2.4	Dry running damage due to lack of lubrication caused by fuel flooding	18
2.2.5	Piston head seizure on a diesel piston	19
2.2.6	Seizure due to lack of lubrication caused by scuffed piston rings	20
2.3	SEIZURE DUE TO OVERHEATING	22
2.3.1	General information about seizure due to overheating	22
2.3.2	Seizure due to overheating centred around the piston head	23
2.3.3	Seizure due to overheating centred around the piston skirt	24

TABLE OF CONTENTS	PAGE
2.4 DAMAGE DUE TO ABNORMAL COMBUSTION	25
2.4.1 General information about piston damage due to abnormal combustion	25
2.4.2 Removal of material by melting from the piston head and piston skirt (petrol engines)	29
2.4.3 Material removal/fusion due to melting on the piston head (diesel engines)	30
2.4.4 Cracks in the piston crown and bowl (diesel engines)	32
2.4.5 Ring land fractures	34
2.4.6 Impact marks on the piston head (diesel engines)	36
2.4.7 Hole in the piston crown (petrol engines)	38
2.4.8 Piston head seizure due to the use of incorrect pistons (diesel engines)	40
2.4.9 Erosion on the piston top land and on the piston crown (petrol engines)	42
2.5 PISTON AND PISTON RING FRACTURES	44
2.5.1 General information about piston fractures	44
2.5.2 Piston fracture in the piston pin boss	45
2.5.3 Piston fracture due to the mechanical contact between piston crown and cylinder head	46
2.5.4 Material washout in the piston ring zone (piston ring fracture)	48
2.6 PISTON PIN FRACTURES	50
2.6.1 General information about piston pin fractures	50
2.6.2 Fractured piston pin	51
2.7 DAMAGE TO THE PISTON PIN CIRCLIPS	52
2.7.1 General information about damage to the piston pin circlips	52
2.7.2 Piston damage caused by broken piston pin circlips	53

TABLE OF CONTENTS	PAGE
2.8 SEIZURE IN THE PISTON PIN BOSSES	56
2.8.1 General information about seizure in the piston pin bosses	56
2.8.2 Seizure in the piston pin boss (floating-fit piston pin)	57
2.8.3 Seizure in the piston pin boss (shrink-fit connecting rod)	58
2.8.4 Seizure in the piston pin boss (with piston skirt seizure(s))	59
2.9 PISTON NOISES	60
2.9.1 General information about piston noises	60
2.9.2 Radial impact points on the piston top land	61
2.10 CYLINDERS AND CYLINDER LINERS	62
2.10.1 Longitudinal cylinder liner cracks	63
2.10.2 Torn-off flange on the cylinder liner	64
2.10.3 Cavitation on cylinder liners	66
2.10.4 Irregular sliding surface wear	68
2.10.5 Bright spots in upper sliding surface area	70
2.10.6 Cylinder liner crack due to hydraulic lock	72
2.11 INCREASED OIL CONSUMPTION	74
2.11.1 General information about increased oil consumption	74
2.11.2 Incorrectly installed oil control ring	75
2.11.3 Wear caused by the ingress of dirt	76
2.11.4 Wear caused by fuel flooding	78
2.11.5 Piston ring wear soon after engine reconditioning	80
2.11.6 Asymmetrical piston wear pattern	82
3. GLOSSARY	84

1. QUICK DIAGNOSIS

PISTON SKIRT DAMAGE

	Seizure due to insufficient clearance on the piston skirt	11		45° seizure marks	12
	Piston skirt seizure on one side only without matching wear marks on the counter-side	17		Seizure due to overheating centred around the piston skirt	24
	Seizure due to lack of lubrication on the piston skirt	16		Seizure due to insufficient clearance at the bottom skirt end	14
	Dry running damage due to lack of lubrication caused by fuel flooding	18		Wear on pistons, piston rings and cylinders caused by fuel flooding	78

PISTON HEAD SEIZURE

	Piston head seizure on a diesel piston	19		Piston head seizure due to the use of incorrect pistons (diesel engines)	40
	Seizure due to overheating centred around the piston head	23		Seizure due to lack of lubrication caused by scuffed piston rings	20

PISTON RING DAMAGE

Seizure due to lack of lubrication caused by scuffed piston rings

20



Wear on pistons, piston rings and cylinder running surfaces caused by the ingress of dirt

76



Incorrectly installed oil control ring

75



Wear on pistons, piston rings and cylinders caused by fuel flooding

78



Piston ring wear soon after engine reconditioning

80

**FURTHER DAMAGE IN THE RING AND SKIRT AREA**

Ring land fractures

34



Material washout in the piston ring zone (piston ring fracture)

48



Piston damage caused by broken piston pin circlips

53



Radial impact points on the piston top land

61



Asymmetrical piston wear pattern

82



Oil consumption-relevant damage

PISTON HEAD DAMAGE



Removal of material by melting from the piston head and piston skirt (petrol engines)

29



Material removal/fusion due to melting on the piston head (diesel engines)

30



Hole in the piston crown (petrol engines)

38



Erosion on the piston top land and on the piston crown (petrol engines)

42



Piston fracture due to the mechanical contact between piston crown and cylinder head

46



Impact marks on the piston head (diesel engines)

36



Cracks in the piston crown and bowl (diesel engines)

32



Piston fracture in the piston pin boss

45

PISTON PIN SEIZURE AND PISTON PIN FRACTURES



Seizure in the piston pin bosses (with piston skirt seizure)

59

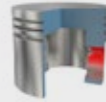

Seizure in the piston pin bosses (floating-fit piston pin)

57



Seizure in the piston pin bosses (shrink-fit connecting rod)

58



Fractured piston pin

51

DAMAGE TO CYLINDER LINERS AND CYLINDER BORES



Torn-off flange on the cylinder liner 64



Torn-off flange on the cylinder liner (preliminary stage) 64



Longitudinal cylinder liner cracks 63



Cylinder liner crack due to hydraulic lock 72



Cavitation on cylinder liners 66



Seizure due to insufficient clearance at the bottom skirt end 14



Irregular sliding surface wear 68 



Bright spots in upper sliding surface area 70 



Oil consumption-relevant damage

2.1 SEIZURE DUE TO INSUFFICIENT CLEARANCE

2.1.1 GENERAL INFORMATION ABOUT SEIZURES DUE TO INSUFFICIENT CLEARANCE

The clearance between the piston and the cylinder may become reduced beyond permissible limits or even completely decimated as a result of incorrect dimensioning of the two sides, after cylinder distortion or also after thermal overloads.

The piston reaches much higher temperatures when the engine is running. As a result, the thermal expansion of the piston is greater than the cylinder that encloses it. In addition, on account of the thermal expansion coefficient of aluminium, the expansion of the piston is approximately twice that of the grey cast iron commonly used in the cylinder. Both factors need to be taken into account accordingly at the design stage.

As the clearance between the piston and the cylinder decreases, mixed friction initially occurs: the expanding piston forces away the oil film on the cylinder wall. The result of this is that the loadbearing surfaces on the piston skirt are rubbed to a bright finish. The temperature of the components increases due to the mixed friction and the resulting frictional heat. The piston presses with increasing force against the cylinder wall and the oil film ultimately stops doing its job entirely. The piston then starts to run dry in the cylinder, resulting in initial rubbing marks, with a smooth surface with dark discolouration.

CHARACTERISTIC FEATURES OF SEIZURE DUE TO INSUFFICIENT CLEARANCE:

- Bright wear marks that change into smooth, darkly discoloured areas of wear due to rubbing.
- Seizure points on both the pressure side and the anti-thrust side.

2.1.2 SEIZURE DUE TO INSUFFICIENT CLEARANCE ON THE PISTON SKIRT



DESCRIPTION OF THE DAMAGE

- Several similar areas of seizure marks around the piston skirt.
- Seizure marks on both the pressure and anti-thrust sides of the piston skirt, i.e. seizure marks on opposite sides.
- Surface changes from bright wear marks to smooth, darkly discoloured areas of wear caused by rubbing.
- Undamaged ring zone.



DAMAGE ASSESSMENT

The clearance between the piston skirt and the cylinder running surface was either too narrow by design, or it was restricted by distortion that possibly did not occur until the engine was operating.

NOTE

In contrast to a seizure due to lack of lubrication, a seizure due to insufficient clearance always occurs after a brief running-in period following engine reconditioning.

POSSIBLE CAUSES FOR THE DAMAGE

- Cylinder bore too small.
- Cylinder head over-tightened or tightened unevenly (cylinder distortion).
- Uneven mating surfaces on the cylinder block or cylinder head.
- Dirty or damaged threaded bores or cylinder head bolts.
- Seized or insufficiently lubricated seating surfaces.
- Use of incorrect or unsuitable cylinder head gaskets.
- Cylinder distortion caused by uneven heating due to lime deposits, dirt or other malfunctions in the cooling system.

2.1.3 45° SEIZURE MARKS



DESCRIPTION OF THE DAMAGE

- Seizure marks on both the pressure and anti-thrust sides, offset at approximately 45° to the piston pin axis.
- The seizure areas change from bright wear marks to relatively smooth, darkly discoloured areas of wear caused by rubbing (Fig. 1).
- Piston pin displays blue tempering colour (Fig. 3). Reason: piston pin bed has become hot due to insufficient clearance or a lack of oil.



Fig. 1



Fig. 2



Fig. 3

DAMAGE ASSESSMENT

The piston pin boss has heated up excessively. The thin-walled and elastic piston skirt is able to compensate for the increased thermal expansion on the pressure and anti-thrust sides. The piston pin boss is stiffer and its expansion increases. The clearances are restricted and a piston seizure occurs. The piston seizure is centred around the transition between the piston pin boss and the piston skirt.

POSSIBLE CAUSES FOR THE DAMAGE

- Mechanical overload of the connecting rod bearing, e.g. due to abnormal combustion.
- Malfunction/fracture in the oil injection jet.
- Insufficient or no oil pump pressure.
- Insufficient lubrication when the engine was first taken into operation. The piston pin was not or was insufficiently lubricated when it was assembled.
- Failure of the connecting rod bush (piston pin seizure) due to insufficient clearance or lubrication.
- Installation fault during the process of shrinking the piston pin (shrink-fit connecting rod).

During the shrinking process, care must be taken to ensure that, immediately after the piston pin has been inserted, the piston pin bed is not checked for freedom of movement by tilting the piston back and forth. The temperatures are equalized between the two components immediately after the cool piston pin is inserted into the hot connecting rod. The heat introduction increases the thermal expansion of the piston pin as is the case during engine operation. If the bed is moved in this state, it can cause initial rubbing marks or seizure marks. This may cause stiffness or failure of the piston pin bed during engine operation. For this reason, allow the assembled components to cool down before checking the freedom of movement.

2.1.4 SEIZURE DUE TO INSUFFICIENT CLEARANCE AT THE BOTTOM SKIRT END



DESCRIPTION OF THE DAMAGE

- Seizure due to insufficient clearance at the bottom skirt ends, with wear marks and counter-wear marks.
- The marks change from bright wear marks to smooth, darkly discoloured areas of wear caused by rubbing (Fig. 1).
- There is nothing unusual about any of the remaining parts of the piston.
- Seizure marks in the cylinder liner in the area around the lower O-rings (Fig. 2).



Fig. 1



Fig. 2

DAMAGE ASSESSMENT

The piston seizure at the bottom edge of the piston skirt was caused by distortion/restricted clearances in the lower area of the cylinder liner.

POSSIBLE CAUSES FOR THE DAMAGE

- Incorrect sealing rings: excessively thick sealing rings can distort a cylinder liner and reduce the piston running clearance.
- Additional use of liquid sealants in the sealing ring groove. In order to seal the surfaces, the sealing rings must be able to deform elastically. The free space required for this in the groove must not be filled with additional sealant.
- Any sealing ring residue or dirt in the sealing ring grooves was not removed prior to installation.
- If the sealing rings twist when the cylinder liner is being inserted or slip out of the sealing ring groove, the cylinder liner will become constricted in this area. To prevent this, lubricant must always be used when installing the cylinder liner.

2.2 SEIZURE DUE TO LACK OF LUBRICATION

2.2.1 GENERAL INFORMATION ABOUT SEIZURES DUE TO LACK OF LUBRICATION

Seizures due to lack of lubrication can occur generally, i.e. even if there is sufficient clearance between the cylinder and the piston. In the process the oil film breaks down (often only locally) because of the high temperatures or because of fuel flooding. In these areas, the surfaces of the piston, piston rings and cylinder running surface then rub against each other without any lubrication, which soon causes seizure with a severely worn surface.

A similar situation arises if there is an insufficient lubricating film between the piston and the cylinder due to a lack of oil.

CHARACTERISTIC FEATURES OF A SEIZURE DUE TO LACK OF LUBRICATION:



If the oil film is destroyed altogether:

Seamless areas of narrow seizure marks, mainly on the piston skirt, showing a severely worn and darkly discoloured surface.



If there is a lack of oil:

Identical to those described above, apart from the discolouration of the surface. The surface of the seizure areas has an almost pure metallic finish, with no dark discolouration. As the lack of oil affects the entire surface of the cylinder, there are often seizure marks on both the pressure side and the anti-thrust side in the piston, in many cases even in the early stages.

2.2.2 SEIZURE DUE TO LACK OF LUBRICATION ON THE PISTON SKIRT



DESCRIPTION OF THE DAMAGE

- Seizure marks on the piston skirt on the pressure side, which in some cases extend into the piston ring zone.
- Slight seizure marks on the anti-thrust side.
- Surface of the seizure areas is light-coloured and has an almost pure metallic finish.



DAMAGE ASSESSMENT

There was an acute lack of lubricant between the piston and the cylinder bore. The fact that the surface of the seizure areas has an almost pure metallic finish indicates that the oil film was present but significantly weakened at the time of the seizure. Due to the limited extent of the damage, this concerns a temporary lack of oil or the early stages of damage. The damage would have been even more severe if engine had been operated further.



NOTE

With this type of seizure due to lack of lubrication, the damage area is always located in the area of the piston skirt where the normal wear pattern would have formed on an undamaged piston after running in.

POSSIBLE CAUSES FOR THE DAMAGE

Insufficient lubrication caused by:

- Insufficient engine oil.
- Oil pressure in the engine too low (oil pump, pressure relief valve, etc.): not enough oil emerges at the crankshaft bearings. This means that not enough lubricating oil is supplied to the cylinder running surface, which is lubricated with splash oil and centrifugal oil from the crankshaft.
- Failure of the oil injection jet for cooling the piston.

2.2.3 PISTON SKIRT SEIZURE ON ONE SIDE ONLY WITHOUT MATCHING WEAR MARKS ON THE COUNTER-SIDE



DESCRIPTION OF THE DAMAGE

- Severe, darkly discoloured seizure areas with a heavily worn surface on the pressure side of the piston.
- Opposite side of the piston skirt free of damage.
- Piston ring zone usually undamaged in the early stages.



DAMAGE ASSESSMENT

This is a typical example of seizure due to lack of lubrication. It usually occurs on the pressure side and is less common on the anti-thrust side. This damage is caused when the lubricating film breaks down on only one half of the cylinder. It is caused either by a lack of lubrication within a locally confined area or by the affected side of the cylinder overheating. Lack of clearance can be excluded as the potential cause here as, despite the severity of the seizure marks, there are no wear marks on the opposing counter-side.

POSSIBLE CAUSES FOR THE DAMAGE

- Partial collapse of the cooling mechanism due to lack of coolant, air bubbles, dirt deposits or other malfunctions in the cooling circuit.
- On ribbed cylinders, dirt deposits on the outside can lead to localised overheating and, consequently, a breakdown of the oil film.
- On air-cooled engines: defective, missing or incorrectly installed air baffles.
- Failure of the oil injection jet for cooling the piston.
- Insufficient oil pressure: insufficient lubrication on the cylinder pressure side for connecting rods with oil injection jets.
- Insufficient lubrication on the cylinder pressure side (which is subjected to greater loads) as a result of oil dilution or oil grades that are not suited to the intended purpose.

2.2.4 DRY RUNNING DAMAGE DUE TO LACK OF LUBRICATION CAUSED BY FUEL FLOODING



DESCRIPTION OF THE DAMAGE

- Narrow, sharply defined longitudinal friction marks on the piston skirt instead of the normal piston wear pattern.



DAMAGE ASSESSMENT

Unburned fuel has condensed at the cylinder running surface and diluted or washed off the load-bearing oil film. As a result, the interacting sliding parts (piston and cylinder bore) run dry against each other, which results in long, narrow friction marks. The piston ring zone usually remains undamaged.



NOTE

In the case of damage caused by unburned fuel, the damage occurs at the load-bearing areas on the piston skirt. These are the points at which the normal wear pattern would have formed on an undamaged piston.

POSSIBLE CAUSES FOR THE DAMAGE

- Overrich engine operation and abnormal combustion caused by faults in the mixture preparation or in the ignition system.
- Insufficient compression and, as a result, incomplete combustion.
- Coldstart device defective or operated for too long (carburettor engines).
- Oil dilution caused by frequent shortdistance driving or an overly rich mixture.

2.2.5 PISTON HEAD SEIZURE ON A DIESEL PISTON



DESCRIPTION OF THE DAMAGE

- Localised seizures that mainly occur on the piston top land.
- Surface of the seizure areas is rough and worn, in some cases larger pieces of material have been torn out.



DAMAGE ASSESSMENT

Due to a fault on the injection nozzle, non-atomised fuel was able to reach the cylinder wall, where it weakened the oil film to the point where the piston was running dry without any lubrication at all. As a result, the piston top land seized so severely that it was temporarily welded to the cylinder wall. This caused chunks to be torn from the piston head.

POSSIBLE CAUSES FOR THE DAMAGE

- Injection nozzles that are leaking, dripping after injection, clogged or the wrong type.
- Blocked injector nozzle needle due to bent injection nozzle body (incorrect tightening torque).
- Incorrect injection timing (start of delivery).

2.2.6 SEIZURE DUE TO LACK OF LUBRICATION CAUSED BY SCUFFED PISTON RINGS



DESCRIPTION OF THE DAMAGE

- Score marks and burned spots on the piston ring sliding surfaces (Fig. 1 and 2).
- Longitudinal scratches on the cylinder bores (not shown).
- In the early stages: initial rubbing marks can be seen on the piston top land (Fig. 3, top right).
- In a more advanced stage: the damaged areas have spread over the entire piston (Fig. 4).



Fig. 1



Fig. 2



Fig. 3



Fig. 4

DAMAGE ASSESSMENT

This type of damage primarily occurs during the running-in phase under heavy loads, when the piston rings are not yet run in and hence do not yet provide a full seal (mostly on diesel pistons). The combustion gases streaming past the piston rings heat up the rings and the cylinder wall excessively and cause the oil film to break down.

However, abnormal combustion and increased temperatures or insufficient cooling of the piston and cylinder wall can also affect or even destroy the lubricating film. Initially this causes the piston rings to run dry without lubrication, causing burn spots. The piston also has to slide over the non-lubricated parts of the cylinder, which causes initial rubbing marks on the piston top land and subsequently leads to seizures on the entire piston skirt (Fig. 4).

POSSIBLE CAUSES FOR THE DAMAGE

- Excessive engine loads during the running-in phase.
- The structure of the honed cylinder surface was not perfect for good adhesion of the engine oil (squashing of the graphite veins, peak folding formation, insufficient roughness and/or incorrect honing angle).
- Unsuitable lubricating oil (incorrect grade and viscosity).
- The temperature on the cylinder running surfaces was too high (malfunctions in the cooling system or deposits in the surrounding cooling ducts).
- Abnormal combustion and the resulting increased temperatures during combustion (lean mixture, glow ignition, injection nozzles leaking or dripping after injection).
- Insufficient oil supply to the cylinder running surfaces due to insufficient quantities of splash oil and centrifugal oil from the connecting rod bearings and crankshaft bearings.

2.3 SEIZURE DUE TO OVERHEATING

2.3.1 GENERAL INFORMATION ABOUT SEIZURE DUE TO OVERHEATING

In the case of seizures due to overheating, the oil film breaks down as a result of excessively high temperatures. Initially this causes mixed friction with individual friction marks. The material at the friction marks then heats up further and the piston loses all lubrication. The seizure areas have a dark discolouration and are badly broken up. Depending on the cause of the damage, the seizure due to overheating starts at either the piston skirt or the piston head.



2.3.2 SEIZURE DUE TO OVERHEATING CENTRED AROUND THE PISTON HEAD



DESCRIPTION OF THE DAMAGE

- Severe seizure starting from the piston head and lessening as it progresses towards the skirt end.
- Seizure marks are distributed around the entire circumference of the piston head.
- Surface of the seizure areas has a dark discolouration with severe scoring marks, and has broken up in places.
- Piston ring running surfaces show signs of seizure, which decrease in intensity towards the oil control ring.



DAMAGE ASSESSMENT

The piston head has been heated up so much as a result of extreme thermal overload that it has bridged the running clearance and destroyed the oil film. This caused a combination of seizure marks due to insufficient clearances and due to a lack of lubrication all around the piston head. A general lack of clearance due to insufficient piston installation clearance can be excluded as the possible cause, because in this case the damage would start in the skirt area (refer to the chapter entitled “Seizure due to insufficient clearance on the piston skirt”).

POSSIBLE CAUSES FOR THE DAMAGE

- Extended high loads during the running-in phase of the engine.
- Overheating due to faults in the combustion process.
- Malfunctions in the engine cooling system.
- Malfunctions in the oil supply (pistons with oil cooling or with oil cooling gallery).
- Bent or faulty oil injection nozzles, which insufficiently cool the piston with oil from underneath.
- Use of wrong sealing rings on the liner flange of wet cylinder liners (refer to the chapter entitled “Cavitation on cylinder liners”).

2.3.3 SEIZURE DUE TO OVERHEATING CENTRED AROUND THE PISTON SKIRT



DESCRIPTION OF THE DAMAGE

- The piston skirt has seized on both sides.
- The surface of the seizure marks has a dark discolouration and is rough and severely broken up.
- The piston ring zone is often only slightly damaged or not damaged at all.



DAMAGE ASSESSMENT

Severe overheating of the engine has caused the lubrication on the cylinder sliding surface to completely break down. This has caused a seizure due to lack of lubrication with a heavily broken up piston skirt. The damage is centred on the skirt area; there are no seizure marks around the piston head. It is thus possible to exclude engine-based oversteering caused by abnormal combustion.

POSSIBLE CAUSES FOR THE DAMAGE

- Overheating engine caused by the following malfunctions in the cooling system:
 - lack of coolant
 - dirt
 - defective water pump
 - faulty thermostat
 - torn or slipping V-belt
 - inadequately ventilated cooling systems.
- On air-cooled engines: overheating due to dirt deposits on the exterior of the cylinders, broken cooling ribs or failed or compromised cooling air ventilation.

2.4 DAMAGE DUE TO ABNORMAL COMBUSTION

2.4.1 GENERAL INFORMATION ABOUT PISTON DAMAGE DUE TO ABNORMAL COMBUSTION

ABNORMAL COMBUSTION IN PETROL ENGINES

The combustion of the air-fuel mixture in the cylinder follows a precisely defined process. It is started by the spark from the spark plug shortly before top dead centre (TDC). The flame spreads from the spark plug with a circular flame front and crosses the combustion chamber at a steadily increasing combustion speed of 5–30 m/s. The pressure in the combustion chamber rises steeply as a result and reaches its maximum value shortly after TDC. However, this normal combustion process can be disturbed by various factors, which can essentially be reduced to three different cases of combustion faults:

1. Glow ignition (pre-ignition):

Causes thermal overstressing of the piston.

2. Knocking combustion:

Causes erosion of material and mechanical overload on the piston and the crankshaft drive.

3. Fuel flooding:

Causes wear in conjunction with oil consumption as well as piston seizures.

Normal combustion



Knocking combustion



Glow ignition



Additional information for 1. Glow ignition (pre-ignition):

In the case of glow ignition, a part that is glowing in the combustion chamber triggers combustion before the actual ignition point. Potential candidates are the hot exhaust valve, the spark plug, sealing parts and deposits on these parts as well as the surfaces enclosing the combustion chamber. The flame acts uncontrolled on the components, causing the temperature in the piston crown to increase sharply and reach the melting point temperature of the piston material after just a few seconds of uninterrupted glow ignition.

On engines with a predominantly hemispherical combustion chamber this causes holes in the piston crown, which usually occur on an extension of the spark plug axis.

On combustion chambers with relatively large quenching areas between the piston crown and the cylinder head, the piston top land usually melts at the point in the quenching area (see glossary) subjected to the greatest load. This often continues down to the oil control ring and into the interior of the piston.

Knocking combustion, which causes high surface temperatures on individual parts of the combustion chamber, can also lead to glow ignition.

Additional information for 2. Knocking combustion:

When the combustion is knocking, the ignition is triggered in the normal manner via the spark from the spark plug. The flame front expanding from the spark plug generates pressure waves, which trigger critical reactions in the unburned gas. As a result, self-ignition takes place simultaneously at many points in the residual gas mixture. This in turn causes the combustion speed to increase by a factor of 10–15, and the pressure increase per degree of the crankshaft and the pressure peak also rise substantially. In addition, very high frequency pressure oscillations are formed in the expansion stroke. The temperature of the surfaces enclosing the combustion chamber also increases considerably. Combustion chambers that have been burned clean of any residue are an unmistakable indicator of combustion knocking.

On most engines, slight temporary knocking does not cause any damage, even over prolonged periods of time.

More severe and longer-lasting knocking causes piston material to be eroded from the piston top land and the piston crown. The cylinder head and the cylinder head gasket can also sustain damage in a similar way. Parts in the combustion chamber (e.g. the spark plug) can heat up so much in the process that glow ignition (pre-ignition) can take place in conjunction with overheating on the piston (i.e. material is melted on or removed by melting).

Severe continuous knocking will cause fractures in the ring land and the skirt after just a short time. This usually occurs without any material being melted on or removed by melting and without seizure marks.

Fig. 1 shows the pressure curve in the combustion chamber. The blue curve shows the pressure curve for normal combustion. The red curve shows the pressure curve for knocking combustion, and pressure peaks occur in this case.

Additional information for 3. Fuel flooding:

An excessively rich mixture, gradual loss of compression pressure and ignition malfunctions will generate incomplete combustion with concurrent fuel flooding. The lubrication of the pistons, piston rings and cylinder running surfaces becomes ineffective. The consequence is mixed friction with wear and increased oil consumption as well as seizure marks (refer to the chapters on oil consumption and piston seizure).

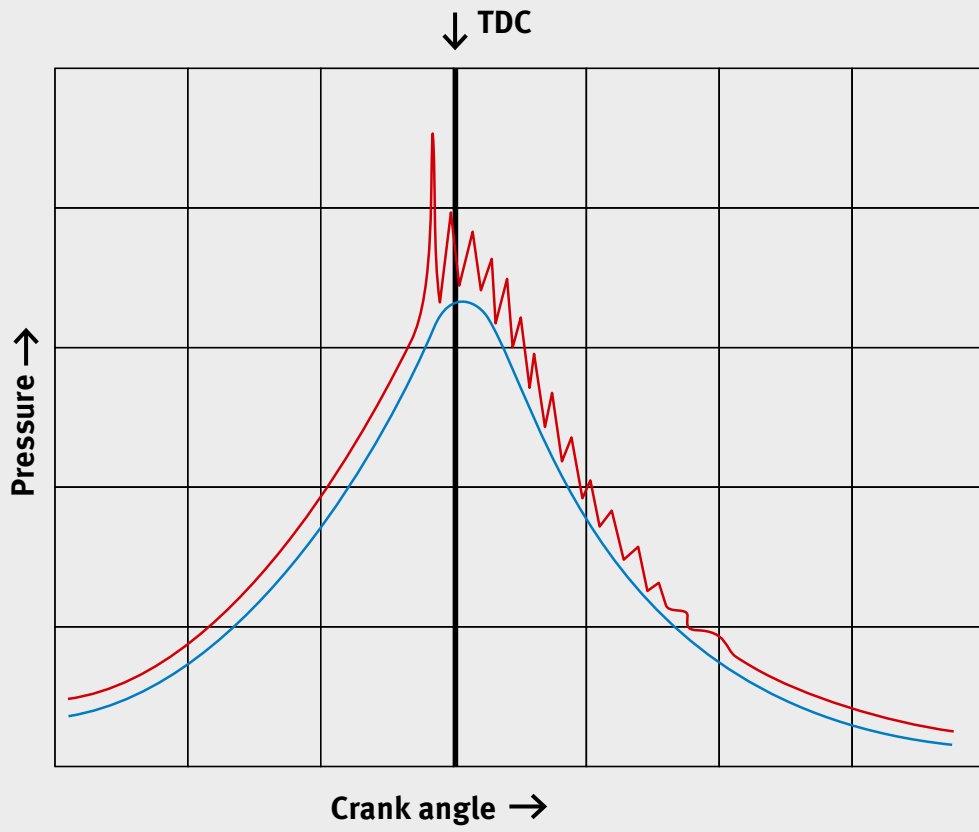

Fig. 1

ABNORMAL COMBUSTION ON DIESEL ENGINES

In order to ensure that the combustion process is optimised, use of an injection nozzle with extremely fine fuel atomisation and precise delivery and correct start of injection are also essential in addition to the basic requirement that the engine is mechanically in perfect working order. This is the only way to ensure that the injected fuel can ignite with a minimum ignition delay and, under normal pressure conditions, burn completely. Here too a distinction is made into three serious types of abnormal combustion:

1. Ignition delay

2. Incomplete combustion

3. Injection nozzles dripping after injection

Additional information for 1. Ignition delay:

The fuel will only ignite after a certain delay (ignition delay) if:

- it is not atomised finely enough,
- if it is injected into the cylinder at the wrong time,
- if the combustion temperature is not yet high enough at the start of injection.

The degree of atomisation depends only on the condition of the injection nozzle. An injection nozzle that works perfectly as tested with a nozzle tester can become jammed during installation or due to thermal stress such that it no longer atomises the fuel properly during operation.

The compression temperature depends on the compression pressure and therefore on the mechanical condition of the engine. On a cold engine there is always a certain ignition delay. During compression, the cold cylinder walls absorb a lot of heat from the (colder) intake air. As a result, the compression temperature present at the start of injection is not sufficient to immediately ignite the injected fuel. The required ignition temperature is not reached until the compression reaches a more advanced stage, at which point the fuel injected so far ignites suddenly. This causes a steep, explosive pressure increase that generates a noise and causes a sharp increase in the temperature of the piston crown. This can result in fractures, for example in the ring lands of the piston as well as heat stress cracks on the piston crown.

Additional information for 2. Incomplete combustion:

If the fuel does not reach the combustion chamber at the right time, or if it is not properly atomised, then the short period of time available is not enough to ensure complete combustion. The same happens if there is not enough oxygen (i.e. intake air) in the cylinder. The causes for this could be a blocked air filter, intake valves not opening correctly, turbocharger faults or wear on the piston rings and the valves. Unburned fuel partly condenses on the cylinder surfaces, where it adversely affects or destroys the lubricating film. Within a very short space of time this results in severe wear or seizure on the cylinder sliding surfaces, the piston ring running surfaces and ultimately also the piston skirt surfaces. This means that the engine will start to consume more oil and lose power (example damage symptoms are listed in the chapters “Seizure due to lack of lubrication” and “Increased oil consumption”).

Additional information for 3. Injection nozzles dripping after injection:

The injection nozzle may open again at the end of injection as a result of pressure fluctuations. These pressure fluctuations may come from the pressure valve of the fuel injection pump, the lines or the injection nozzles. To prevent this incorrect injection, the pressure in the system is reduced by a certain amount by the pressure valve of the fuel injection pump. If the injection pressure of the injection nozzles is set too low or if the pressure cannot be reliably maintained (mechanical injection nozzles), then it is possible that, despite this pressure reduction, the injection nozzles could still open several times in sequence after the end of injection. Injection nozzles that leak or drip after injection also cause an uncontrolled delivery of fuel into the combustion chamber. The uncontrolled injected fuel in both cases ends up unburned on the piston crown due to the lack of oxygen. There the fuel burns under quite high temperatures and heats local areas of the piston material so strongly that parts of the piston can be torn away from the surface under the effects of inertia force and erosion. This results in substantial amounts of material being carried away or washed away erosively on the piston crown.

2.4.2 REMOVAL OF MATERIAL BY MELTING FROM THE PISTON HEAD AND PISTON SKIRT (PETROL ENGINES)



DESCRIPTION OF THE DAMAGE

- The piston head has melted through behind the piston rings.
- The piston skirt has not seized; melted material has been worn away off the damaged area onto the piston skirt.



DAMAGE ASSESSMENT

The removal of material by melting from piston heads in petrol engines is the result of glow ignition on pistons with mostly flat crowns and relatively large quenching areas. Glow ignition is triggered by glowing parts in the combustion chamber that are hotter than the self-ignition temperature of the air-gas mixture. These are essentially the spark plug, the exhaust valves and any oil carbon deposits on the combustion chamber walls.

In the quenching area, the piston head is heated up significantly due to the glow ignition. The high temperatures cause the piston material to go soft. Material is carried away as far as the oil control ring due to the combined effects of inertia force and combustion gases entering the damage area.

POSSIBLE CAUSES FOR THE DAMAGE

- Heat value of the spark plugs too low.
- Mixture too lean, resulting in higher combustion temperatures.
- Damaged valves or insufficient valve clearance, causing the valves to not close correctly. The hot combustion gases streaming past cause the valves to start to glow. This primarily affects the exhaust valves, as the intake valves are cooled by the fresh gases.
- Glowing combustion residue on the piston crowns, the cylinder head, the valves and the spark plugs.
- Unsuitable fuel with an octane rating that is too low. The fuel quality must correspond to the compression ratio of the engine, i.e. the octane rating of the fuel must cover the octane requirements of the engine under all operating conditions.
- Petrol contaminated by diesel, which lowers the octane rating of the fuel.
- High engine or intake air temperature caused by inadequate ventilation of the engine compartment.
- General overheating of the engine.

2.4.3 MATERIAL REMOVAL/FUSION DUE TO MELTING ON THE PISTON HEAD (DIESEL ENGINES)



DESCRIPTION OF THE DAMAGE

Fig. 1:

- Piston head completely destroyed.
- Piston top land melted as far as the ring carrier.
- Seizure marks and damage on the piston skirt due to melted, worn down piston material.
- Ring carrier partially detached.
- Damage (impact marks) in all combustion chambers due to piston material and detached ring carrier parts.

Fig. 2:

- Erosive-type removal of material due to melting on the piston crown or the piston top land in the injection direction of the nozzle jets.
- No seizure marks on the piston skirt or the piston ring zone.



Fig. 1



Fig. 2

DAMAGE ASSESSMENT

This type of damage occurs particularly on diesel direct injection engines. Prechamber engines are only affected if the prechamber is damaged and the fuel is therefore also injected directly into the combustion chamber.

If, in a diesel direct injection engine, the injection nozzle of the affected cylinder cannot maintain its injection pressure, oscillations in the injection line can cause the injector nozzle needle to lift again. Fuel is injected into the combustion chamber again. If the oxygen has been used up, the fuel droplets stream through the combustion chamber and end up on the piston crown. There they burn away with a great deal of heat and the piston material becomes soft.

The inertia force and the erosion due to the combustion gases speeding past tear out individual particles from the surface (Fig. 2) or carry away the entire piston head (Fig. 1).

POSSIBLE CAUSES FOR THE DAMAGE

- Leaking injection nozzles or stiff/jammed injector nozzle needles.
- Broken or worn nozzle springs.
- Faulty pressure relief valves in the fuel injection pump.
- Injection quantity and injection timing not set in accordance with the engine manufacturer's specifications.
- On prechamber engines: Prechamber defect in conjunction with one of the above possible causes.
- Ignition delay due to insufficient compression caused by excessive gap dimensions, incorrect valve timing or leaking valves.
- Excessive ignition delay caused by diesel that is reluctant to ignite (cetane rating too low).
- Poor charging due to defective turbocharger.

2.4.4 CRACKS IN THE PISTON CROWN AND BOWL (DIESEL ENGINES)



DESCRIPTION OF THE DAMAGE

- Stress cracks on the edge of the bowl.
- Major crack extends to the piston pin boss.
- Channel burned from the bowl to below the oil control ring by combustion gases streaming through the major crack.



Fig. 1



Fig. 2

DAMAGE ASSESSMENT

The piston material is heated up significantly in localised areas – at the point where the prechamber jets make contact on prechamber engines (Fig. 3 and Fig. 4), and on the edge of the bowl on direct injection engines (Fig. 1). The material expands more than elsewhere in these areas. As the overheated areas are surrounded by colder materials, the material is plastically deformed here beyond its limit of elasticity. Exactly the opposite happens when it then cools down again: in the areas where before the material was previously buckled and forced away, there is now a shortage of material.

This results in tensile stresses, which ultimately cause stress cracks. If there are superimposed stresses caused by bending of the piston pin in addition to the thermal stresses, then the stress cracks turn into a much larger major crack, which causes complete breakage and failure of the piston.



Fig. 3

POSSIBLE CAUSES FOR THE DAMAGE

- Faults in mixture preparation caused by incorrect injection nozzles, malfunctions in the fuel injection pump or damage to the prechamber.
- High temperatures as a result of defects in the cooling system.
- Faults on the engine brake, or excessive use of the engine brake. This results in overheating.
- Insufficient piston cooling on pistons with a oil cooling gallery, caused for example by blocked or bent cooling oil nozzles.
- Temperature fluctuations in engines with frequently changing loads, such as city buses or earthmoving machines.
- Pistons with an incorrect specification, e.g. no oil cooling gallery despite the fact that a piston with oil gallery must be used.
- Pistons made by third-party manufacturers without fibre reinforcement of the edge of the bowl.
- Pistons with an unsuitable bowl shape for the engine (refer to the chapter entitled “Piston head seizure due to the use of incorrect pistons”).



Fig. 4

2.4.5 RING LAND FRACTURES



DESCRIPTION OF THE DAMAGE

- Ring land fracture on one side of the piston between the first and second compression ring (Fig. 1).
- Fracture, starting at the groove base at the top and running at a diagonal angle into the piston material, emerging at the groove base underneath (Fig. 2).
- Fracture is extended downwards.
- No piston seizure marks or signs of overheating.

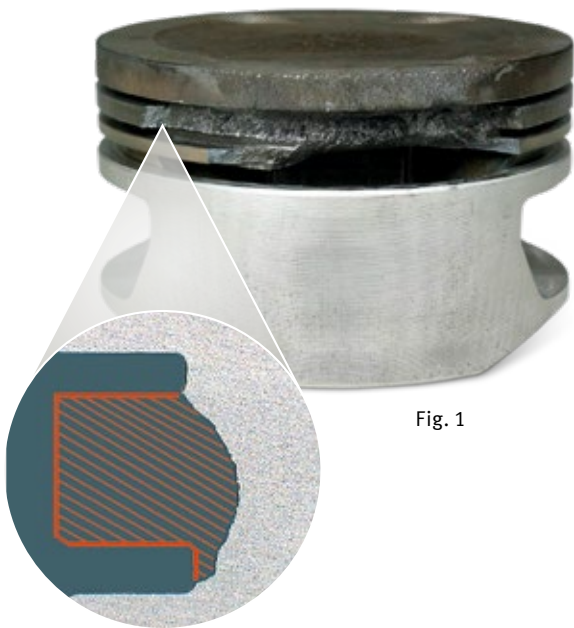

Fig. 1

Fig. 2: Cross section of fracture

DAMAGE ASSESSMENT

Land fractures are not caused by material faults, but by material overload. A distinction can be made between 3 different causes:

1. Knocking combustion:

The octane rating of the fuel was not capable of covering the engine's needs under all operating and load conditions (refer to the chapter entitled "General information about piston damage due to abnormal combustion in petrol engines").

Ring land fractures caused by knocking combustion usually occur on the pressure side. On a diesel engine, knocking combustion is caused by an ignition delay.

2. Hydraulic locks:

Liquid (water, coolant, oil or fuel) accidentally enters the combustion chamber when the engine is stopped or running. As the liquid is incompressible, the piston and crankshaft drive are subjected to enormous stresses during the compression cycle. This results in ring land fractures, boss fractures or connecting rod/crankshaft damage.

Fig. 3 shows the course of a fracture that occurs with knocking combustion and hydraulic locks: the force causing the fracture and acting from above on the ring land causes the fracture surfaces to extend downwards.

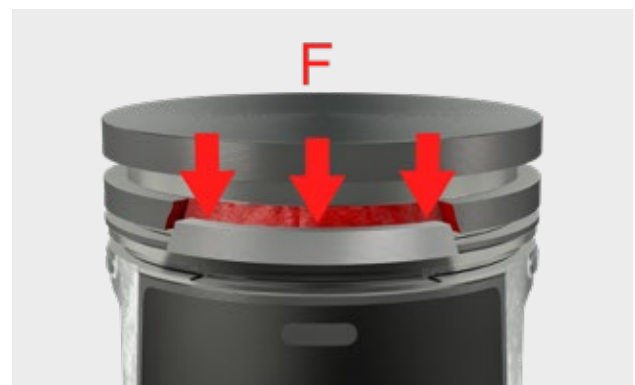

Fig. 3

3. Installation faults:

If the piston rings are incorrectly compressed, more force is required when installing the piston. Forcibly pressing in or knocking in the piston causes pre-damage to the ring lands in the form of fine hairline cracks. The ring lands fracture in the reverse direction as the pressure comes from below in this case (Fig. 4).



Fig. 4

POSSIBLE CAUSES FOR THE DAMAGE

Knocking combustion on petrol engines:

- Fuel without suitable anti-knock properties. The fuel quality must correspond to the compression ratio of the engine, i.e. the octane rating of the fuel must cover the octane requirements of the engine under all operating conditions.
- Petrol contaminated by diesel, which lowers the octane rating of the fuel.
- Excessively high compression ratio caused by excessive machining of the engine block surface and cylinder head mating surface, e.g. for engine reconditioning or tuning purposes.
- Ignition timing too advanced.
- Mixture too lean, resulting in higher combustion temperatures.
- Intake air temperatures too high, caused for example by inadequate ventilation of the engine compartment or incorrect switching of the intake air flap to summer operation (particularly on older carburettor engines).

Knocking combustion on diesel engines:

- Injection nozzles with poor atomisation or leaks.
- Injection pressure of the injection nozzles too low.
- Compression pressure too low due to incorrect cylinder head gaskets, insufficient piston protrusions, leaking valves or damaged/worn pistons.
- Defective cylinder head gaskets.
- Damage to the prechamber.
- Improper or excessive use of starting aids (e.g. starting spray) during cold starts.
- Defective turbocharger.

Hydraulic locks:

- Accidental intake of water while driving through water, or as a result of larger quantities of water being splashed up by passing vehicles or vehicles in front.
- While the engine is stopped, cylinder filling up with:
 - water, due to leaks in the cylinder head gasket or cracks in components.
 - fuel, due to leaking injection nozzles (only applies to petrol engines with a fuel injection system). The residual pressure in the fuel injection system is dissipated through the leaking nozzle into the cylinder.

In both cases, the damage will occur when the engine is started.

2.4.6 IMPACT MARKS ON THE PISTON HEAD (DIESEL ENGINES)



DESCRIPTION OF THE DAMAGE

- Severe impact marks on the piston head (Fig. 1). Nearly all oil carbon deposits removed.
- Scarring and oil carbon deposits pressed into the piston crown.
- Severe wear on the piston rings, particularly on the oil control ring.
- Imprint of the swirl chamber on the front edge of the piston crown (Fig. 2).
- Imprint of the valve on the right-hand side of the crown.
- First indicators of initial dry running damage due to lack of lubrication on the piston skirt (Fig. 4).



Fig. 1



Fig. 2



Fig. 3



Fig. 4

DAMAGE ASSESSMENT

The pistons have struck against the cylinder head/swirl chamber and one of the valves during operation. There have been no fractures yet as a result of these violent impacts. However, the nature of the wear on the piston rings and the piston skirt indicates that one consequence of these impacts has been abnormal combustion due to fuel flooding.

The striking of the piston results in vibrations on the cylinder head. This causes the injection nozzle to vibrate, and it is then unable to hold the pressure when closed and injects fuel into the cylinder in an uncontrolled manner. This causes fuel flooding, which damages the oil film. This damage leads to a higher level of mixed friction and therefore to wear on the piston rings and increased oil consumption. The characteristic damage caused by unburned fuel does not arise until the oil film is impaired by the fuel to such an extent that the piston is running with insufficient lubrication (refer to the chapter entitled “Dry running damage due to lack of lubrication caused by fuel flooding”).

In the initial stages the piston skirt is damaged to a lesser degree, as it is regularly supplied from the crankshaft drive with new oil that is still capable of providing lubrication. Once the abraded particles from the moving area of the pistons mix with the lubricating oil and the lubricating oil loses its load-bearing ability as a result of oil dilution, the wear will spread further.

POSSIBLE CAUSES FOR THE DAMAGE

- Incorrect piston protrusion dimension. The piston protrusion was not checked or corrected during engine reconditioning.
- Connecting rod bush bored eccentrically during replacement.
- Eccentric regrinding of the crankshaft.
- Eccentric reworking of the bearing counter bore (when resinking the crankshaft bearing caps).
- Installation of cylinder head gaskets with insufficient thickness.
- Oil carbon deposits on the piston head and resulting restriction or bridging of the gap dimension.
- Incorrect valve timing caused by incorrect adjustment, chain stretching or a slipped toothed belt.
- Differing connecting rod lengths.
- Excessive reworking of the cylinder head mating surface and the resulting shift in the valve timing. (The distance between the driving pinion/sprocket and the driven pinion/sprocket changes. Depending on the design of the chain or belt adjustment mechanism, it may not be possible to correct this.)
- New valve seat rings have been installed, but care was not taken to ensure that they are correctly positioned. If the valve seat surface is not positioned deeply enough in the cylinder head, the valves will not be recessed correctly in the cylinder head and will protrude too far as a result.
- Over-revving the engine. The valves do not close in time due to the increased inertia forces and strike against the piston.
- Excessive clearances in the connecting rod bearing or a worn-out connecting rod bearing, particularly in conjunction with over-revving when driving downhill.

2.4.7 HOLE IN THE PISTON CROWN (PETROL ENGINES)



DESCRIPTION OF THE DAMAGE

- Piston crown has a hole that penetrates all the way through, covered by the molten material.
- Skirt area displays seizure marks. Reason: the high temperatures and the piston material that has been ground down.



DAMAGE ASSESSMENT

This type of damage is caused by glow ignition. Glowing components exceed the self-ignition temperature of the air-gas mixture in the combustion chamber. These are essentially the spark plug, the exhaust valve and any combustion residue present in the combustion chamber. As a result, the mixture ignites before it is due to be ignited by the spark plug. This means that the flame acts for longer on the piston crown than in the normal combustion process.

Within a short space of time the piston crown heats up so much as a result of glow ignition that the material there becomes soft. The softened material is then carried away as a result of the inertia force on the reciprocal movements of the piston and the fast-streaming combustion gases. As such the combustion pressure forces a hole in through the remaining thickness of the piston crown wall. In many cases there will not be any seizure marks.



NOTE

Such rapid heating of a localised area on the piston crown is only possible as a result of glow ignition.

POSSIBLE CAUSES FOR THE DAMAGE

- Heat value of the spark plugs too low.
- Mixture too lean, resulting in higher combustion temperatures.
- Damaged or leaking valves, or insufficient valve clearance, causing the valves to not close correctly. The combustion gases streaming past significantly increase the temperature of the valves, and the valves start to glow. This primarily affects the exhaust valves, as the intake valves are cooled by the fresh gases.
- Glowing combustion residue and oil carbon deposits in the combustion chamber.
- Incorrect injector installation dimension (missing or duplicate sealing rings).
- Unsuitable fuel with an octane rating that is too low. The fuel quality must correspond to the compression ratio of the engine, i.e. the octane rating of the fuel must cover the octane requirements of the engine under all operating conditions.
- Petrol contaminated by diesel, which lowers the octane rating of the fuel.
- High engine or intake air temperature caused by inadequate ventilation of the engine compartment.
- General overheating of the engine.

2.4.8 PISTON HEAD SEIZURE DUE TO THE USE OF INCORRECT PISTONS (DIESEL ENGINES)



DESCRIPTION OF THE DAMAGE

- Localised score marks can be seen on the piston head, going all around the circumference of the piston.
- Score marks start at the piston crown and end at the second compression ring.
- Score marks are centred around the piston top land.



DAMAGE ASSESSMENT

This damage has been caused by abnormal combustion. However, the fault lies in the use of an incorrect piston, not with the fuel injection system. Engines are designed in accordance with the statutory prescribed emission standards. The pistons for the relevant emission standard are often barely any different to look at.

In this example, pistons with different bowl diameters were used on the same engine type to meet different emission standards. The piston for the Euro 1 emission standard (bowl diameter of 77 mm) was replaced during engine repair with a piston for the Euro 2 emission standard (bowl diameter of 75 mm).

Because of the smaller bowl diameter, the injection nozzle was also spraying onto the edge of the bowl rather than just into the bowl. The edge of the bowl and the piston material heated up at the points of contact and their thermal expansion therefore also increased. This led to the localised seizure marks.

If the pistons used are not intended for the engine type and emission standard, this can result in serious abnormal combustion with unforeseeable consequences. Other less severe effects would be failure to comply with exhaust gas values, lack of engine performance and increased fuel consumption.

POSSIBLE CAUSES FOR THE DAMAGE

- Pistons with an incorrectly shaped bowl or an incorrect bowl depth or diameter.
- Deviating piston dimensions (e.g. compression height).
- Incorrect piston design. For example, a piston without an oil cooling gallery must not be used if the engine manufacturer specifies an oil cooling gallery for the particular application.
- Use of incorrect components or components that are unsuitable for the intended purpose (injection nozzles, fuel injection pumps, cylinder head gaskets or other components that affect the mixture formation or combustion process).

2.4.9 EROSION ON THE PISTON TOP LAND AND ON THE PISTON CROWN (PETROL ENGINES)



DESCRIPTION OF THE DAMAGE

- Erosion-type removal of material from the piston top land (Fig. 2) or surface of the piston crown (Fig. 3).

DAMAGE ASSESSMENT

Erosion-type removal of material from the piston top land and from the piston crown always occurs as a result of extended periods of knocking combustion (medium severity). In the process, pressure waves spread in the cylinder and run down between the piston top land and the cylinder wall as far as the first compression ring. At the reversal point of the pressure wave, the kinetic energy tears out tiny particles from the surface of the piston.



Fig. 1

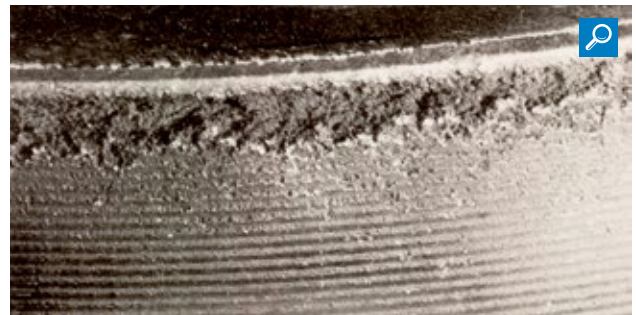

Fig. 2



Fig. 3

POSSIBLE CAUSES FOR THE DAMAGE

- Fuel without suitable anti-knock properties. The fuel quality must correspond to the compression ratio of the engine, i.e. the octane rating of the fuel must cover the octane requirements of the engine under all operating conditions.
- Petrol has been contaminated with diesel. Cause: accidental refuelling with the wrong type of fuel or shared use of tanks or canisters for both types of fuel. Even very small amounts of diesel are already enough to significantly lower the octane rating of the petrol.
- Large quantities of oil in the combustion chamber, caused for example by worn piston rings, valve guides or the exhaust gas turbocharger, will reduce the anti-knock properties of the fuel.
- Excessively high compression ratio. Cause: combustion residue on the piston crowns and cylinder head or excessive machining of the block surface and cylinder head surface for engine reconditioning or tuning purposes.
- Ignition timing too advanced.
- Mixture too lean, resulting in higher combustion temperatures.
- Intake air temperatures too high. Causes: inadequate ventilation of the engine compartment or exhaust gas back pressure, failure to switch the intake air flap to summer operation in a timely manner or a faulty automatic switchover mechanism (particularly on older carburettor engines).
- Failure of the knock control system.
- Modifications to the control unit software.

NOTE

Modern engines are equipped with systems designed to detect knocking combustion. This knock control system counteracts knocking combustion by adapting the ignition timing. However, the knock control system cannot intervene until knocking combustion has already occurred. Even if the knock control system is fully functional, the risk of damage cannot be ruled out if:

- the control range of the engine control unit is no longer sufficient, or
 - the knock limit is constantly reached.
-

2.5 PISTON AND PISTON RING FRACTURES

2.5.1 GENERAL INFORMATION ABOUT PISTON FRACTURES

During engine operation, pistons can break as a result of a forced fracture or can suffer a fatigue fracture.



Fig. 1

A forced fracture (Fig. 1) is always caused by a foreign body that collides with the piston while the engine is running. These foreign bodies could be parts of the connecting rod, crankshaft or valves, etc. that have been torn off. A forced fracture of the piston can also occur if water or fuel gets into the cylinder.

The fracture surfaces of a forced fracture appear grey. They are not worn down and display no line markings. The piston breaks suddenly without any fracture development.



Fig. 2

In the case of a fatigue fracture (Fig. 2), line markings form on the fracture surface that reveal the starting point and the gradual progress of the fracture. The fracture surfaces are often worn to the point of being shiny. The cause for a fatigue fracture is overstressing of the piston material.

Overstressing can occur due to:

- knocking combustion,
- severe vibrations of the piston, for example if the piston head has mechanical contact with the cylinder head,
- material defects,
- excessive skirt clearance.

Excessive deformation of the piston pin due to overstressing (bending and oval deformation) causes cracks in the boss or cracks in the support. Furthermore, fatigue fractures can also stem from heat stress cracks on the piston crowns.

2.5.2 PISTON FRACTURE IN THE PISTON PIN BOSS



DESCRIPTION OF THE DAMAGE

- Formation of a cleavage fracture that leads to the piston crown. This results in the piston being split into two parts (Fig. 1).
- Boss fatigue crack in the centre axis of the piston pin bore (Fig. 2 and 3).



Fig. 1



Fig. 2



Fig. 3: Cross section of a piston pin boss

DAMAGE ASSESSMENT

Boss fatigue fractures arise as a consequence of mechanical overstressing. The constant overstressing of the piston material increasingly results in alternating bending stresses and material fatigue. This process can be accelerated if there is no sufficient oil supply: an incipient crack in the piston pin boss will then spread even under normal loads, and will cause the piston to split.

POSSIBLE CAUSES FOR THE DAMAGE

- Abnormal combustion, in particular spontaneous combustion caused by ignition delay.
- Excessive or inappropriate use of starting aids during cold starts.
- The cylinder has filled up with water, fuel or oil whilst the engine is stopped (hydraulic lock).
- Performance enhancements (e.g. chip tuning) with use of the standard production piston.
- Incorrect or weight-reduced piston pins. The piston pin is deformed to an oval shape, placing excessive loads on the piston pin bed in the process.

2.5.3 PISTON FRACTURE DUE TO THE MECHANICAL CONTACT BETWEEN PISTON CROWN AND CYLINDER HEAD



DESCRIPTION OF THE DAMAGE

- Impact marks on the piston crown (Fig. 1), cylinder head mating surface and both valves (not shown).
- Fracture in the direction of the piston pin due to vibrations and the effects of violent impact.
- Piston skirt has broken off in the lower oil ring groove, fracture surfaces display the characteristics of a fatigue fracture (Fig. 2).

DAMAGE ASSESSMENT

The cause is an exceptionally fast sequence of hard impacts as the piston crown strikes the cylinder head, which subjects the piston to such violent shock vibrations that cracks are generated. The piston also no longer runs straight in the cylinder and subsequently strikes the cylinder wall with its skirt. On pistons with a lower oil control ring (Fig. 2) the skirt often breaks in the area of the lower oil ring groove.



Fig. 1



Fig. 2

POSSIBLE CAUSES FOR THE DAMAGE

- Excessive clearances in the connecting rod bearings or a worn-out connecting rod bearing, particularly in conjunction with over-revving when driving downhill.
- The gap dimension (the minimum distance between the piston crown and the cylinder head) was too small at TDC of the piston. The following scenarios may have caused this:
 - Pistons with an incorrect compression height. During engine reconditioning, the mating surface of the cylinder block is often reworked. If pistons with the original compression height are then refitted after machining, the piston protrusion may be too large. This is why pistons with a reduced compression height are available for repairs, enabling the piston protrusion to be kept within the tolerance range specified by the engine manufacturer.*
 - Insufficient thickness of the cylinder head gasket. Many manufacturers provide cylinder head gaskets with different thicknesses for the same engine. This is necessary to compensate for component tolerances during production, and it also allows adaptation of the piston protrusion during repairs. For this reason, when carrying out repairs ensure that only cylinder head gaskets with the prescribed material thickness are used. This ensures that the specified gap dimension will be achieved after the repair. If the cylinder block is reworked or replaced during repair work, the thickness of the gasket must be re-determined depending on the piston protrusion in accordance with the engine manufacturer's specifications.



CAUTION

Checking the freedom of movement by turning the engine by hand when it is cold does not guarantee that the piston will not strike the cylinder head when the operating temperature is reached. Reason: the piston and connecting rod increase in length as a result of thermal expansion, which reduces the gap between the piston crown and the cylinder head. Particularly on engines in commercial vehicles with large piston compression heights, the differences can be significant and reduce the freedom of movement of the piston at TDC by several tenths of a millimetre.

* Motorservice supply pistons with a reduced compression height (KH-) for many diesel engines. For details please refer to the "Pistons and Components" catalogue.

2.5.4 MATERIAL WASHOUT IN THE PISTON RING ZONE (PISTON RING FRACTURE)



DESCRIPTION OF THE DAMAGE

- Severe material washout reaching as far as the piston crown in the ring zone in the area of the first ring groove.
- Severe axial wear on the first ring groove.
- Severe mechanical damage on the piston crown.
- Running pattern of the piston skirt has a matt, buffed appearance.



DAMAGE ASSESSMENT

The damage is caused by the ingress of contamination into the combustion chamber. This is indicated by the severe axial wear on the grooves and on the first ring groove in particular. The contamination was then also deposited in the ring groove, where they caused abrasive wear on the piston ring and the ring groove. The axial clearance of the piston rings increased steadily as a result. In terms of its cross section, the piston ring was severely weakened, and it could no longer withstand the pressures of the combustion process and broke. Consequently, the broken-off part of the piston ring could move around practically unhindered in the rapidly enlarging groove. The washout shown in the picture was caused as a result of continuous “hammering” of this broken-off part. Once the washout reached the piston crown, the fragments of the piston ring entered the combustion chamber where they caused more damage.

POSSIBLE CAUSES FOR THE DAMAGE

- Severe axial wear on the ring groove and the piston rings caused by ingress of foreign bodies into the combustion chamber.
- If there is severe radial wear to the piston rings without any axial wear, then a likely cause is mixed friction wear as a result of fuel flooding.

Refer to the chapter entitled “Wear caused by fuel flooding”.

- If there is no wear on the ring grooves or piston rings and the engine has only been run a short time after reconditioning, the problem is often caused by incorrect installation of the piston. It is possible for the piston rings to be broken when the piston is inserted if the piston rings have not been pressed far enough into the ring groove. This happens if an incorrect or damaged insertion tool is used or if the piston ring scuff band is not fitted and tightened correctly around the piston.
- Ring flutter caused by excessive axial clearance of the piston rings. This is caused if only a new set of piston rings is installed during engine repairs, even though the ring grooves in the piston are already worn. The excessive clearance causes the piston rings to flutter and possibly break. Another reason may be the use of an incorrect set of piston rings: the height of the rings may be too small and the axial clearance in the groove therefore too great.
- A piston that is unsuitable for the intended purpose. Due to the greater loads and longer service life involved, pistons for diesel engines are equipped with a ring carrier made of cast iron alloyed with nickel. Pistons without a ring carrier are sometimes used on diesel engines for cost reasons, but only if the engines’ service life is expected to be shorter. This could be the case on e.g. agricultural machinery. If this type of piston without a ring carrier is used in engines that are intended to cover high mileage, there is a chance that the wear resistance of the ring grooves may not be sufficient.

2.6 PISTON PIN FRACTURES

2.6.1 GENERAL INFORMATION ABOUT PISTON PIN FRACTURES

Piston pin fractures can occur as a result of overstressing caused by abnormal combustion or by foreign bodies in the combustion chamber. Excessive or inappropriate use of starting aids (e.g. starting spray) should be viewed in the same way as the effects of extreme abnormal combustion.

The piston pin is deformed into an oval shape by the pressure exerted on the piston from the combustion gases. Under excessive loads a longitudinal crack can form at the ends of the piston pin, with its starting point either at the outer or inner diameter of the pin. The crack then spreads as a fatigue fracture towards the centre of the piston pin. In the area between the piston pin bore and the connecting rod eye that is subjected to the greatest shear stresses and bending stress, the crack then changes direction and becomes a lateral crack. This then ultimately causes the piston pin to break right through. In addition to the damage described here, fractures can also arise as a result of some other kind of damage.

2.6.2 FRACTURED PISTON PIN



DESCRIPTION OF THE DAMAGE

- Lateral fracture on the piston pin (Fig. 1) at the transition between the connecting rod and the piston pin boss.
- Shorter fragment split along its length.
- Fracture surfaces display the characteristics of a fatigue fracture.



Fig. 1

DAMAGE ASSESSMENT

Piston pin fractures are caused by excessive loads. Under overstressing conditions, the deformation of the piston pin into an oval shape in the piston pin bores initially causes a longitudinal crack at the ends of the piston pin. This crack can originate both in the exterior surface and on the interior of the bore. The crack then spreads towards the centre of the pin. In the area between the piston pin bore and the connecting rod eye that is subjected to the greatest shear stresses and bending stress, the crack then changes direction and becomes a lateral crack. This then ultimately causes the entire piston pin to break right through.

Fig. 2 shows that an incipient crack may not only be caused by overstressing, but also as a result of improper installation of the piston pin. The end face of the broken piston pin clearly shows that the incipient crack was caused by impact damage (hammer blow). An incipient crack can lead to breakage of the piston pin, even under normal load conditions.

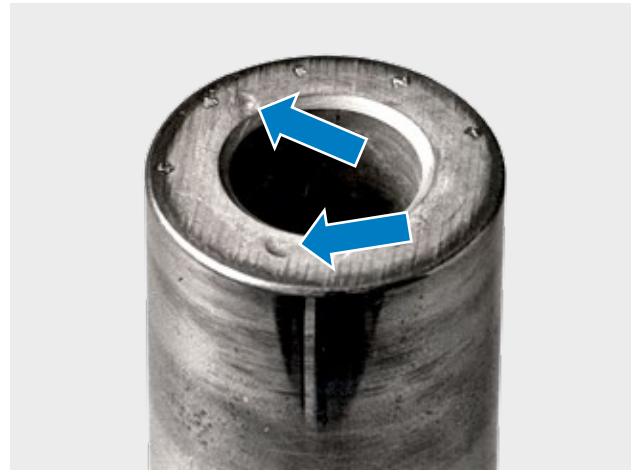

Fig. 2

POSSIBLE CAUSES FOR THE DAMAGE

- Abnormal combustion, often as a result of knocking combustion.
- Hydraulic locks.
- Improper handling of the piston pin during installation.
- Overloading of piston pin through improved engine performance.
- Weakening of piston pin through tuning measures (weight reduction).
- Incorrect piston pin.

2.7 DAMAGE TO THE PISTON PIN CIRCLIPS

2.7.1 GENERAL INFORMATION ABOUT DAMAGE TO THE PISTON PIN CIRCLIPS

Wire circlips or what are known as Seeger-type circlips are used as retainers for the piston pins. It is possible for both types to break, or jump or be knocked out of the groove in the piston.

If the circlips fracture or their ends break off, this is due to excessive loads or improper handling while inserting the circlips. The circlips are only subjected to axial loads if the piston pin has an axial movement forced upon it. This occurs if the connecting rod is misaligned or is oscillating in a mostly asymmetric fashion, which causes the piston pin axis and the crankshaft axis to no longer be parallel.

The piston pin then strikes in a very rapidly alternating sequence against the piston pin circlips and gradually forces them out of the groove. They are then forced on as far as the cylinder running surface, where they are worn away. Ultimately the circlips will break up. Some fragments become trapped between the piston and the cylinder, while other parts are thrown back and forth under inertia forces in the recess of the piston pin bosses, where they cause substantial material washout. It is also not uncommon for fragments to move through the inner bore in the piston pin right through to the other side of the piston, where they then also cause substantial damage.

2.7.2 PISTON DAMAGE CAUSED BY BROKEN PISTON PIN CIRCLIPS



DESCRIPTION OF THE DAMAGE I

- End of the piston pin bore on both sides of the piston suffered serious damage, in some places as far as the ring zone (Fig. 1).
- Circlip jumped out of the retaining groove and broke into fragments.
- Second circlip damaged.
- Due to the lack of retention, the piston pin has wandered outwards towards the cylinder running surface.
- Front face of the piston pin worn to a convex shape due to prolonged contact with the cylinder running surface (Fig. 2).
- Asymmetrical running pattern of the piston.



Fig. 1

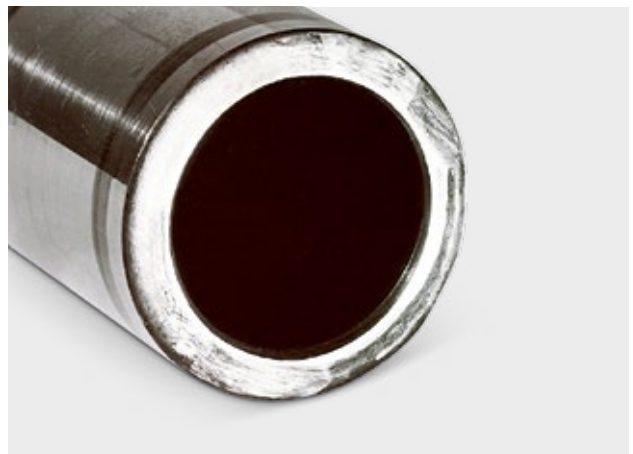

Fig. 2

DESCRIPTION OF THE DAMAGE II

- Asymmetrical piston wear pattern (Fig. 4).
- Piston pin boss and piston pin broken (Fig. 5 and 6).
- Pin bore hammered out in the area of the circlips.



Fig. 4



Fig. 5



Fig. 6

DAMAGE ASSESSMENT

Whether as wire circlips or Seeger-type circlips, the piston pin circlips are only forced out or hammered out in operation by means of axial thrust of the piston pin. This is based on the requirement that the circlip has been correctly inserted and has not been damaged.

Axial thrust in the piston pin always occurs when the piston pin axis is not parallel to the crankshaft axis. This is the case when a bent connecting rod leads to the piston running at a considerable angle. The reciprocating movements result in alternating axial thrust, which effectively hammers out the circlip. Once the circlip has jumped out, it is then clamped between the piston pin moving in an outwards direction, the piston and the cylinder running surface.

There, it is worn away and finally breaks into several fragments. Within a short space of time the fragment inertia forces hammer into the piston material as the piston moves up and down (Fig. 2). Individual fragments also move through the hollow piston pin and cause corresponding destruction on the opposite side of the piston.

POSSIBLE CAUSES FOR THE DAMAGE

- Axial thrust of the piston pin during engine operation caused by:
 - Bending or twisting of the connecting rod.
 - Connecting rod eye bored at an angle (axes not parallel).
 - Cylinder axis not perpendicular to crankshaft axis.
 - Excessive connecting rod bearing clearance, particularly in conjunction with asymmetrical connecting rods.
 - Connecting rod pins not parallel with crankshaft axis (machining fault).
- Use of old or damaged circlips.
- Improperly installed circlips.

2.8 SEIZURE IN THE PISTON PIN BOSSES

2.8.1 GENERAL INFORMATION ABOUT SEIZURE IN THE PISTON PIN BOSSES

The piston pin boss is not forcibly supplied with oil. Only splash oil or centrifugal oil is available. As a result, seizures on the piston pin bed are nearly always seizures due to lack of lubrication, with severely torn-up surfaces and fusion of materials.

On floating-fit piston pins, damage to the piston pin bores primarily arises:

- if the piston pin has insufficient clearance in the connecting rod bush.
- if the piston pin seizes or jams in the connecting rod bush.

This is indicated by piston pins with blue tempering colours around the connecting rod bush.

If the freedom of movement of the piston pin is restricted in the connecting rod bush, the pin is forced to rotate in the piston pin boss. However, the clearance of a floating-fit piston pin in the piston pin bores is too small for this. Extreme build-up of heat, the collapse of the lubrication system and seizures due to lack of lubrication in the piston pin boss will occur as a result.

Due to the high temperature increase, the piston also expands a great deal more on the skirt in the area of the piston pin bores. There, this can lead to a lack of clearances as well as seizures due to lack of lubrication in the cylinder bore (refer to the chapter entitled “45° seizure marks”).

For piston pins that are shrunk into the connecting rod, the clearance in the piston pin bore is sufficiently dimensioned to ensure that an adequate oil film can form there. When reusing used shrink-fit connecting rods it is important to ensure that the bore in the connecting rod has not become distorted or damaged in any other way. Otherwise, once the piston pin has been shrunk in place it could become deformed to such an extent that the clearance in the piston pin bores is no longer sufficient, as a result of which slight seizure marks could form.

Always lubricate the piston pin bed when installing the pistons to ensure that enough lubricant is provided for the first few revolutions.



NOTE

During the process of shrinking the piston pin into the connecting rod, the abovementioned lubrication of the piston pin is not the only aspect to consider. Immediately after the piston pin is inserted, the piston pin bed must not be checked for freedom of movement by tilting the piston back and forth! This is because the temperatures are equalized between the two components in this phase (cool piston pin, hot connecting rod). The piston pin can become very hot; it expands significantly and seizes in the piston pin boss. If the bed is moved in this state, it can cause initial rubbing marks or seizure marks. This may cause subsequent stiffness of the bed and thus increased friction and heat generation. For this reason always allow the assembled components to cool down first before checking the bed for freedom of movement.

2.8.2 SEIZURE IN THE PISTON PIN BOSSES (FLOATING-FIT PISTON PIN)



DESCRIPTION OF THE DAMAGE

- Piston pin has seized in the piston pin bores.
- Piston material has been welded onto the piston pin (Fig. 1).
- Piston pin displays a blue discolouration in the area of the connecting rod bush.



Fig. 1

DAMAGE ASSESSMENT

The blue discolouration of the piston pin in the area of the connecting rod bush indicates that the clearance there was insufficient, and that as a result the piston pin was only able to rotate in the connecting rod bush with difficulty or not at all. The only rotation of the piston pin took place in the piston pin bore. However, the clearance of a floating-fit piston pin is too small for this. The increased friction caused overheating in the bearing, as a result of which the oil film became ineffective and the piston pin seizure arose.

POSSIBLE CAUSES FOR THE DAMAGE

- The clearance between the connecting rod bush and the piston pin was not made large enough.
- The clearance in the connecting rod bush was bridged by a misalignment of the connecting rod and the piston pin became seized as a result.
- The piston pin bed was not lubricated when the pistons were installed.

NOTE

It is essential to generously lubricate the piston pin bed when installing the pistons to ensure that sufficient lubrication is present during the first few revolutions of the engine and to prevent initial rubbing marks from being formed when the engine is started.

2.8.3 SEIZURE IN THE PISTON PIN BOSSES (SHRINK-FIT CONNECTING ROD)



DESCRIPTION OF THE DAMAGE

- Piston has only run for a short length of time.
- No wear marks on the piston skirt.
- The piston pin bosses have seized on the upper side, i.e. the side under pressure load (Fig. 1).
- The surface at the seizures is clean bare metal; no traces of burned-in oil.



Fig. 1

DAMAGE ASSESSMENT

The piston has barely any wear marks and can therefore only have been run for a short time. The piston pin already seized during the first revolutions of the engine.

The clean bare metal seizures are a clear indication of a lack of oil in the piston pin bed.

POSSIBLE CAUSES FOR THE DAMAGE

- Piston pin bed was not lubricated before the piston was installed.
- When shrink-fitting the piston pin into the connecting rod, the freedom of movement of the piston pin bed was checked immediately after inserting the piston pin by tilting the piston back and forth. The bed can suffer at this point as a result of the unusual temperature differences between the components that do not occur in normal operation.

2.8.4 SEIZURE IN THE PISTON PIN BOSSES (WITH PISTON SKIRT SEIZURE)



DESCRIPTION OF THE DAMAGE

- Piston skirt has seized on both sides, starting at the piston head.
- Compression rings have become blocked in the ring grooves.
- Seizure marks are present in the piston pin bosses.



DAMAGE ASSESSMENT

The focus of the seizures on the piston head indicates that this is where the damage originated as a result of abnormal combustion. Subsequently the piston rings seized up, and the seizure marks spread increasingly down onto the skirt area.

The combustion gases streamed past the seized compression rings and heated up the piston to such a point that the oil film in the piston pin bed became ineffective, and seizures developed here as well.

POSSIBLE CAUSES FOR THE DAMAGE

Abnormal combustion leads to a seizure due to the combined effects of insufficient clearance and lack of lubrication on the piston head and piston skirt and subsequently also causes seizures in the piston pin bed.

2.9 PISTON NOISES

2.9.1 GENERAL INFORMATION ABOUT PISTON NOISES

Piston running noises can be caused by a wide variety of influences during engine operation.

- **Tilting of the pistons due to excessive running clearance:**

The piston can tilt if the dimensions of the cylinder bore are too large or as a result of wear or skirt collapse, stimulated by the pendulum motion of the connecting rod and the change of bearing surfaces of the piston in the cylinder. The piston head hits hard against the cylinder running surface as a result.

- **The correct installation direction of the piston was ignored:**

In order to smooth out the change of the bearing surfaces of the piston before TDC and before the power stroke, the piston pin axis is offset by some millimetres towards the piston pressure side. If the piston is inserted the wrong way round into the cylinder (i.e. rotated by 180°) and therefore the piston pin axis is offset to the wrong side, then the piston changes bearing surface at the wrong time. The piston tilting is then much heavier and much noisier.

- **Tilting of the piston caused by a stiff connecting rod bearing:**

The clearance between the piston pin and the connecting rod bush can either be too small by design, or it may have been eliminated by jamming or distortion. This can happen as a result of connecting rod misalignment (bending and twisting).

- **Piston striking in the direction of the piston pin:**

Any lateral striking of the cylinder bore by the piston mostly stems from misalignment of the connecting rod (bending or in particular twisting): the piston performs a pendulum movement during its upward/downward stroke in the longitudinal axis of the engine, as a result of which the piston strikes in an alternating sequence against the cylinder. Asymmetrical connecting rods or eccentric support for the piston by the connecting rod have the same effect.

- **Piston pin striking alternately against the piston pin circlips:**

Axial thrust in the piston pin is always the result of misalignment between the axis of the piston pin and the crankshaft axis. As described, bending or twisting of the connecting rod and asymmetry of the connecting rod are the most common causes. Excessive connecting rod bearing clearances (connecting rod bearing journal on the crankshaft) can cause a lateral pendulum movement of the connecting rod, particularly at lower engine speeds. The piston pin is skewed as a result in the connecting rod eye and is pushed back and forth in the piston pin bore due to the pendulum motion. The piston pin strikes against the piston pin circlips as a consequence.

2.9.2 RADIAL IMPACT POINTS ON THE PISTON TOP LAND



DESCRIPTION OF THE DAMAGE

- Piston top land has impact marks in the tilting direction (Fig. 1).
- The piston skirt displays a more pronounced running pattern to the top and bottom than in the middle of the skirt.



Fig. 1

DAMAGE ASSESSMENT

Piston noise that is clearly audible externally is caused by the piston head alternating striking the cylinder running surface.

Depending on the cause, the piston top land strikes either in the tilting direction or in the oval plane (piston pin direction) against the cylinder wall.

POSSIBLE DAMAGE REASONS FOR IMPACT POINTS IN THE TILTING DIRECTION

- Excessive installation clearances and hence poor guidance of the piston due to excessively large bored or honed cylinders.
- The installation direction was not observed for pistons with a piston pin axis offset.
- Tight connection of the piston pin bed: as a result, the piston head strikes against the cylinder running surface around the tilting axis of the piston pin. Reasons for this are:
 - Insufficient clearance in the connecting rod eye or in the piston pin bore.
 - Excessively narrow fit of the piston pin in the connecting rod bush (shrink-fit connecting rod). If the fit of the piston pin is too tight in the connecting rod eye when the piston pin is shrunk in, the connecting rod eye is deformed in the direction of the narrowest wall thickness. The connecting rod eye and the piston pin take on an oval form in the process. This results in restricted clearance between the piston pin and the piston.
 - Seized piston pin.

POSSIBLE DAMAGE REASONS FOR IMPACT POINTS IN THE PISTON PIN DIRECTION

- If the connecting rod is misaligned, particularly in the case of a twisted connecting rod or excessive connecting rod bearing clearances, the piston head moves in a pendulum motion in the piston pin direction and strikes against the cylinder.
- Connecting rod misalignment (distortion/twisting): this results in alternating axial thrust in the piston pin, as a result of which the piston pin strikes alternately against the circlips.

2.10 CYLINDERS AND CYLINDER LINERS



2.10.1 LONGITUDINAL CYLINDER LINER CRACKS



DESCRIPTION OF THE DAMAGE

- Vertical crack, extending from the liner flange.
- Dry cylinder liners can also be affected because of their relatively thin cylinder wall thickness.



DAMAGE ASSESSMENT

Cracks of this nature are frequently caused by careless handling of the cylinder liners (as a result of impacts or blows). Even if the cylinder liner does not suffer visible damage straight away, a microscopic crack or notch can generate a fracture during subsequent operation of the engine. Incorrect liner flange seat surfaces and dirt between the cylinder liner and the cylinder block can also cause this type of damage. In the case of longitudinal cracks caused by faulty liner flange seating surfaces, the longitudinal cracks often occur in conjunction with lateral cracks.

POSSIBLE CAUSES FOR THE DAMAGE

- Cracks or notches due to improper handling of the cylinder liners during transport or repairs.
- Hydraulic locks.
- Foreign bodies underneath contact or sealing surfaces.
- Faulty flange seat (refer to the chapter entitled “Torn-off flange on the cylinder liner”).
- Material erosion on edge of the cylinder liner through knocking combustion and consequent weakening of the cylinder liner.

2.10.2 TORN-OFF FLANGE ON THE CYLINDER LINER



DESCRIPTION OF THE DAMAGE

- Liner flange has been torn off.
- The flange crack starts at the base of the bottom edge of the liner flange and extends upwards at an angle of approx. 30°.



Fig. 1

DAMAGE ASSESSMENT

This type of damage is caused by bending moments that arise as a result of improper installation (dirt/form defects). In most cases, the cylinder liner flange is already pressed off when the cylinder head is tightened down. On the latest generations of engines for commercial vehicles with pump-nozzle unit or common rail fuel injection systems, the engine block is subjected to increasing loads as a result of the increasing combustion pressures. The use of very hard steel cylinder head gaskets on these engine types can cause distortion of the crankcase in the area of the liner flange seating surface after the engine has been in operation for a long time.

NOTE

The distortion of the seating surface cannot be detected by visual inspection alone unless the appropriate measuring aids are used. One simple way to check for this distortion is the use of bearing ink: thinly apply the ink around the seating surface of the liner flange on the engine block. Then insert the new liner without gaskets and press it onto the seat. Remove the cylinder liner again. The seating surface on the cylinder liner should now be evenly coated with ink around the entire circumference. If this is not the case, the liner seat needs to be reworked. This reworking is best performed on a stationary boring machine or with a mobile liner flange seat facing attachment. This ensures parallelism with respect to the housing surface (Fig. 2).

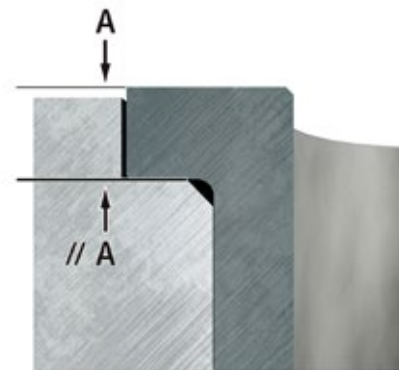

Fig. 2

POSSIBLE CAUSES FOR THE DAMAGE

- Worn liner flange seating surfaces on the engine after an extended running period.
- Dirty or corroded liner flange seating surfaces.
- Failure to ensure that the flange seat is perfectly rectangular and/or parallel (Fig. 2 and Fig. 5).
- Incorrect cylinder head gaskets.
- Non-compliance with the engine manufacturer's prescribed tightening torques and tightening angles when installing the cylinder head.
- Wrong number of sealing rings.

- Sealing rings jammed underneath the liner flange.
- Use of incorrectly dimensioned gaskets.
- Use of liquid sealants.
- In the case of dry press fit cylinder liners: installation fault through excessively high press-in force.
- Prescribed liner protrusion not complied with (Fig. 6):
 - If the protrusion of the cylinder liner is too great, then the liner flange is pressed off when the cylinder head bolts are tightened.
 - If the protrusion is too small, the cylinder liner is not pressed onto the liner seat with enough force and adopts a pendulum motion as a result of the piston movement. These forces cause the liner flange to be torn off.
- Reworking of the liner seat without due care for the proper form. The form of the liner seat must correspond to the form of the cylinder liner. The transition from the flange surface to the precision-fit seat diameter must have a chamfer of 0.5 – 1.0 mm x 45° to prevent the fillet on the liner flange from making contact with the edge. If this is not ensured then it is very easy for the liner flange to be pressed off when the cylinder head is tightened down (Fig. 3). Furthermore, the rounding radius of the liner seat ("D" in Fig. 4) must not be so large that it prevents the cylinder liner from bearing loads at the inner or outer edge on the liner flange.

NOTE

When reworking the liner flange seating surface during engine reconditioning, the necessary protrusion of the cylinder liner over the cylinder surface must be ensured, either by inserting steel washers underneath or by using a cylinder liner with an oversized flange* (recommended).



Fig. 3



Fig. 4



Fig. 5

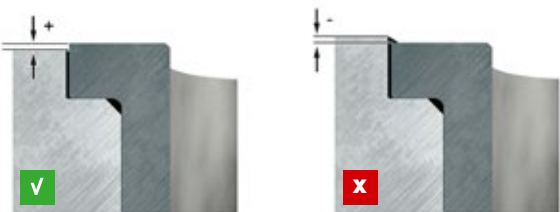

Fig. 6

* Motorservice supply cylinder liners with oversized flanges for most engines. For details please refer to the current "Pistons and Components" catalogue.

2.10.3 CAVITATION ON CYLINDER LINERS



DESCRIPTION OF THE DAMAGE

- Severe cavitation on the water jacket of the wet cylinder liner (Fig. 1 and 2).
- Coolant has penetrated through into the combustion chamber.



Fig. 1



Fig. 2



Fig. 3: Cross section of cylinder liner

DAMAGE ASSESSMENT

Cavitation is more likely to occur in the tilting plane of the piston (on the pressure or anti-thrust side) and is triggered by high-frequency vibrations of the cylinder wall. These vibrations are caused by the lateral forces exerted by the pistons, the combustion pressure and the change of bearing surfaces at TDC and BDC. If the coolant is no longer capable of following the vibrations of the cylinder wall, this results in the water film separating from the cylinder liner. Vapour bubbles form in the resulting area of low pressure, and when the cylinder wall vibrates back at exceptionally high speed, these bubbles implode. The water displaced by the bubbles hits the surface of the cylinder very suddenly. The impact energy generated in this way dissolves tiny particles. With time, complete holes are torn out (washed out).

A special feature of cavitation is the fact that the size of the holes increases further inside the material (Fig. 3), resulting in the cavities in the material.

Causes of cavitation

- Coolant temperature too high.
- Coolant pressure too low.
- Coolant boiling point too low.
- Combination of the above.

POSSIBLE CAUSES FOR THE DAMAGE

- Failure to comply with the correct piston clearance, e.g. re-installation of pistons that have already been used, or use of cylinders manufactured too large.
- Irregularity in liner flange seating surface – poor or inaccurate seating of the cylinder liner in the housing (refer to the chapter entitled “Torn-off flange on the cylinder liner”).
- The required permanent anti-freeze protection with corrosion protection or corresponding additives in the coolant are missing. The anti-corrosion agent contains inhibitors that prevent foaming. However, these inhibitors are used up with time. Therefore it is necessary to change the anti-corrosion agent every 2 years and to use the correct mixture ratio.
- Unsuitable coolants such as salt water (sea water), aggressive or acidic water or other liquids.
- Insufficient pre-pressure in the cooling system. Reason: unsuitable radiator cap (not enough pressure can be maintained due to a defective pressure relief valve) or because of a leak in the cooling system. If the pre-pressure in the cooling system is in accordance with the requirements, the boiling point of the coolant is higher than under atmospheric pressure. Although the pre-pressure does not eliminate the cause of the formation of the vapour bubbles, it can at least inhibit the formation of the bubbles.
- Incorrect sealing rings and/or sealing compound or silicone on the liner flange.
- Incorrect number of sealing rings.
- Engine operating temperature too low: if the engine does not reach its normal operating temperature due to particular operating conditions or thermostat defects, no overpressure can build up in the cooling system because of the reduced thermal expansion of the coolant. The low operating temperature also means that the pistons do not expand in the required manner. As a result they run with increased piston clearance. Both cases assist the formation of the bubbles and hence the cavitation.
- Installation of additional sealing rings in the undercut on the liner flange (Fig. 4): sealing rings may only be installed at this position if they are specifically required by the manufacturer.

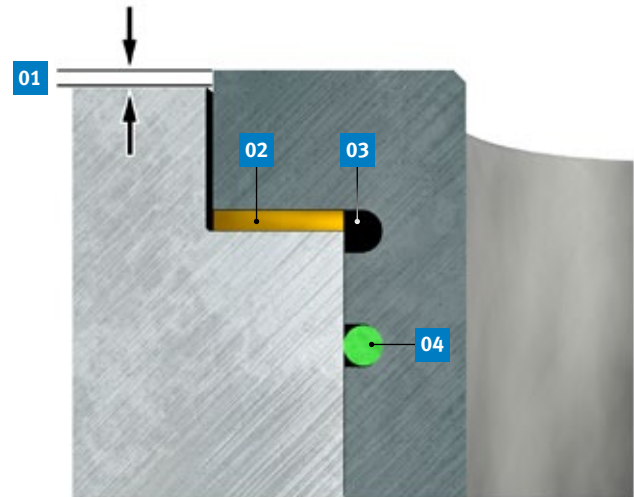

Fig. 4

- 01** Liner protrusion
- 02** Tombak shim
- 03** Undercut
- 04** O-ring

2.10.4 IRREGULAR SLIDING SURFACE WEAR



DESCRIPTION OF THE DAMAGE

- Corrosion on the outside diameter of the cylinder liner (Fig. 1).
- Uneven wear pattern with individual bright areas on the cylinder surface (Fig. 2).
- Piston undamaged.
- Oil loss at the sealing points, in particular the radial oil seals.



Fig. 1



Fig. 2

DAMAGE ASSESSMENT

Bright irregular running patterns on the sliding surfaces in the cylinders always indicate cylinder distortion. Wet or dry cylinder liners can be distorted immediately after installation. If the cylinder bores are distorted the piston rings cannot provide a perfectly tight seal against oil or combustion gases.

The oil escapes past the rings into the combustion chamber, where it is burned. The increasing quantities of combustion gases streaming past the piston cause the pressure in the crankcase to rise. This overpressure causes oil loss at sealing points around the engine, particularly at the radial oil seals. Furthermore, oil is forced through the valve guides into the intake and exhaust ducts, from where it is then burned by the engine or eliminated.

POSSIBLE CAUSES FOR THE DAMAGE

- With dry cylinder liners, significant unevenness is often caused by contact corrosion in the counter bores in the engine block (contact corrosion, Fig. 1). In this case the cylinder counter bore should be cleaned carefully. If this does not rectify the problem, then the cylinder counter bores should be reworked, and afterwards a cylinder liner with outside oversize* should be installed. The cylinder liners have thin walls and must be able to make contact across their full length and width. If this is not the case then the cylinder liners will already become deformed on installation in the counter bores. This deformation becomes more pronounced during operation. With dry cylinder liners, a distinction is made between press-fit and slip-fit types. Press-fit cylinder liners are pressed into the engine block and need to be bored and honed after being pressed in. Slip-fit cylinder liners are already finished off and only need to be slipped into the counter bore. Due to the clearance between the cylinder liner and the cylinder counter bore, this type of liner has a greater tendency to problems with distortion and corrosion than press-fit cylinder liners.
- Uneven or incorrect tightening of the cylinder head bolts.
- Uneven engine block and cylinder head mating surfaces.
- Dirty or distorted threads on the cylinder head bolts.
- Unsuitable or incorrect cylinder head gaskets.
- Substantial cylinder distortion due to faulty liner flange contact in the housing, incorrect liner protrusion and distorted and/or a worn-out lower liner guide.
- Liner seat too loose or too tight in the housing (on dry cylinder liners).

For ribbed cylinders in particular:

- Misalignment of the ribbed cylinders.
Individual ribbed cylinders must lie exactly plane-parallel to the crankcase and the cylinder head and must be at the same height.
- Incorrectly installed or missing air baffles.
- Attachment bolts touch the cylinder housing in the bores.

- Mechanical contact with the adjacent cylinder.
- Misaligned sealing surfaces at the intake and exhaust manifolds. The intake and exhaust manifolds must be pre-installed before the cylinder heads are tightened. Reason: all sealing surfaces must be aligned; ribbed cylinders and cylinder heads must not be distorted when the manifold is tightened.

For engines without cylinder liners in particular:

- Distorted cylinder bores. Certain engines tend to become distorted when the cylinder head is installed. If these engines are bored and honed as normal, problems with distortion may arise later on during operation.

Recommendation:

On engine blocks without cylinder liners where the cylinders are bored directly into the engine block, we recommend bolting a torque plate (also referred to as a honing mask) onto the mating surface of the cylinder before machining the cylinder. This torque plate has the same openings as the engine block (apart from the water ducts) and is several centimetres thick. The act of bolting on the torque plate and tightening it to the specified tightening torque creates the same tension conditions as if the cylinder head were installed. Any distortion in the cylinder bores that could arise when tightening the cylinder head bolts is therefore deliberately simulated and is therefore taken into account during machining. This ensures that the cylinder bore is (to a great extent) round and cylindrical during subsequent operation of the engine (provided that the machining is carried out properly).

* Motorservice supply cylinder liners with outside oversize for many engines. For details please refer to the "Pistons and Components" catalogue.

2.10.5 BRIGHT SPOTS IN UPPER SLIDING SURFACE AREA



DESCRIPTION OF THE DAMAGE

- Bright, bare areas with no honing structure on cylinder sliding surface (Fig. 1 and 2).
- No signs of wear on the piston.
- Oil carbon deposits on the piston top land.
- Increased oil consumption.

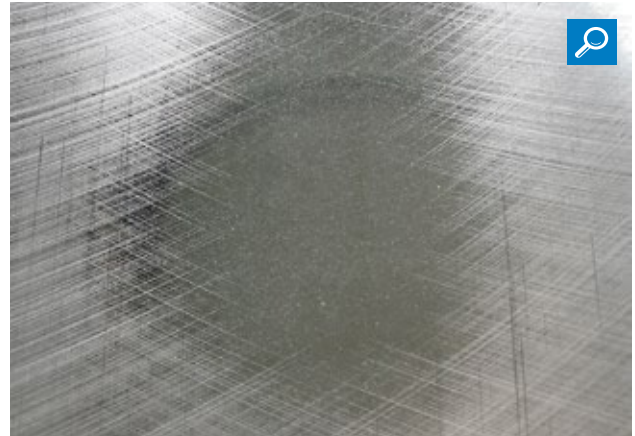

Fig. 2



Fig. 1



Fig. 3

DAMAGE ASSESSMENT

This type of damage pattern occurs when a hard oil carbon coating forms in operation on the piston top land as a result of burned oil and combustion residue (Fig. 3). This coating has abrasive properties, which lead to increased wear in the upper part of the cylinder in operation due to the reciprocal motion and the change of bearing surfaces of the piston. The increased oil consumption is not caused by the bright spots themselves, as the polished areas do not cause noticeable out-of-roundness of the cylinder, and the piston rings can still continue to perform their sealing duties. The lubrication of the cylinder is also unaffected, as it is still possible to retain enough oil in the open graphite veins of the cylinder surface despite the loss of the honing structure. When assessing this type of damage, it is important to note that, in this case, the bright spots all coincide with points in the cylinder that come into contact with the carbonised piston top land. If the bright spots are also present at other points, then the cause for the damage is more likely to be found:

- in distortion of the cylinder (refer to the chapter entitled “Irregular sliding surface wear”),
- fuel flooding (refer to the chapter entitled “Wear on pistons, piston rings and cylinders caused by fuel flooding”),
- or ingress of dirt or contaminants (refer to the chapter entitled “Wear on pistons, piston rings and cylinder running surfaces caused by the ingress of dirt”).

POSSIBLE CAUSES FOR THE DAMAGE

- Excessively high ingress of engine oil into the combustion chamber due to a defective turbocharger, inadequate oil separation in the engine ventilation system, defective valve stem seals, etc.
- Overpressure in the crankcase due to increased emissions of blow-by gases or due to a defective crankcase ventilation valve.
- Inadequate cylinder finishing, resulting in increased ingress of oil into the combustion chamber (refer to the chapter entitled “Piston ring wear soon after engine reconditioning”).
- Use of non-approved engine oils or engine oils of a lower quality.

2.10.6 CYLINDER LINER CRACK DUE TO HYDRAULIC LOCK



DESCRIPTION OF THE DAMAGE

- Upper area of cylinder liner displays severe damage due to a crack and seizure marks on the sliding surface (Fig. 2 and 3).
- Piston displays seizure marks on the pressure and anti-thrust sides.
- In the piston crown: bowl-shaped recess in the area of the seizure marks (Fig. 4).



Fig. 1



Fig. 2



Fig. 3



Fig. 4

DAMAGE ASSESSMENT

The cylinder liner was damaged by a hydraulic lock, which burst the cylinder liner and pressed in a dent in the piston crown.

The piston material has been squashed outwards, causing a significant restriction of the piston clearance in the cylinder bore. It is not possible to identify whether the hydraulic lock occurred while the engine was running or while it was being started.

POSSIBLE CAUSES FOR THE DAMAGE

- Accidental intake of water while driving through water, or as a result of larger quantities of water being splashed up by passing vehicles or vehicles in front.
- While the engine is stopped, cylinder filling up with:
 - coolant due to leaks in the cylinder head gasket or cracks in components.
 - fuel due to leaking injection nozzles. The residual pressure in the fuel injection system is dissipated through the leaking nozzle into the cylinder. The damage occurs when the engine is started.

2.11 INCREASED OIL CONSUMPTION

2.11.1 GENERAL INFORMATION ABOUT INCREASED OIL CONSUMPTION

The total amount of oil used by an engine is primarily made up of oil consumption (oil burned in the combustion chamber) and oil loss (leaks). The amount of oil that passes the piston rings and cylinder wall into the combustion chamber and is used there is negligible today. As a result of the continuous further development of engine components, material compositions and production processes, the wear on cylinders, pistons and piston rings has been reduced and in turn, oil consumption has also decreased. This is underlined by the high mileages and the reduction of incidents of damage to the crankshaft drive. Although the oil consumption in the combustion chamber cannot be eliminated entirely, it can be minimised: the interacting sliding parts (piston, piston rings and cylinder running surface) require continuous lubrication to ensure smooth operation. During combustion the oil film on the cylinder wall is subjected to the hot combustion. The quantity of engine oil that evaporates or burns here depends on the engine output, engine load, engine oil grade and temperature.

In the majority of cases, wear on pistons, piston rings and cylinders and the resulting increased oil consumption is not caused by the components themselves. Instead, wear on these components can nearly always be explained as the result of an external event: abnormal combustion due to incorrect mixture preparation, dirt entering the engine from outside, inadequate engine cooling, lack of oil, use of incorrect oil grades or faults made during installation. The following pages contain detailed descriptions of different types of damage that affect pistons and cylinders.

 **NOTE**

A separate brochure entitled “Oil consumption and oil loss” has been published on this topic.

2.11.2 INCORRECTLY INSTALLED OIL CONTROL RING



DESCRIPTION OF THE DAMAGE

- No signs of wear on piston rings or piston (Fig. 1).
- End of the expander spring of the 3-piece oil control ring broken off.
- Scratches in the groove base of the oil control ring.



Fig. 1

DAMAGE ASSESSMENT

Due to the overlapping of the expander spring during installation, its circumferential length is shortened. This results in a fracture in the expander spring and/or loss of tension for the 3-piece oil control rings. The blades are no longer pressed tightly against the cylinder wall and no longer scrape off the oil. Oil enters the combustion chamber, where it is burned. This results in excessive oil consumption.

POSSIBLE CAUSES FOR THE DAMAGE

- Incorrect oil control rings.
- Installation faults.

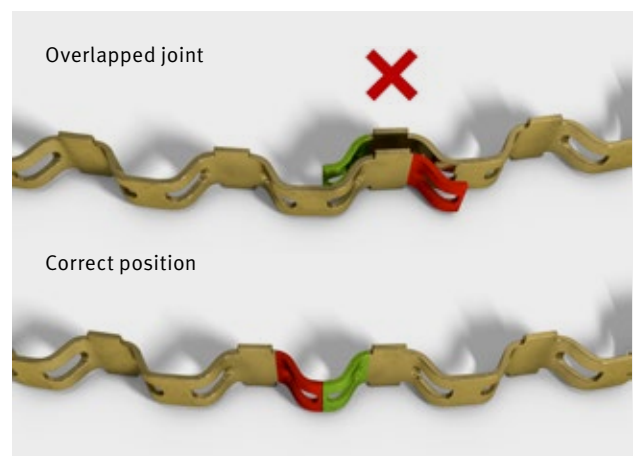

Fig. 2

CAUTION

Both coloured parts of the expander spring must be visible after installation of the 3-piece oil control rings. These colour-coded marks should therefore always be checked (even on pre-installed piston rings) before installation of the pistons (Fig. 2).

2.11.3 WEAR ON PISTONS, PISTON RINGS AND CYLINDER RUNNING SURFACES CAUSED BY THE INGRESS OF DIRT



DESCRIPTION OF THE DAMAGE

- Piston: matt, ground wear pattern on the skirt with fine, small longitudinal scratches on the piston top land and the piston skirt.
- Tool marks created during machining worn away.
- Worn compression ring edges, on the first piston ring in particular as well as ring groove edges (Fig. 2).
- Axial clearance of the compression rings substantially increased, in particular on the first piston ring.

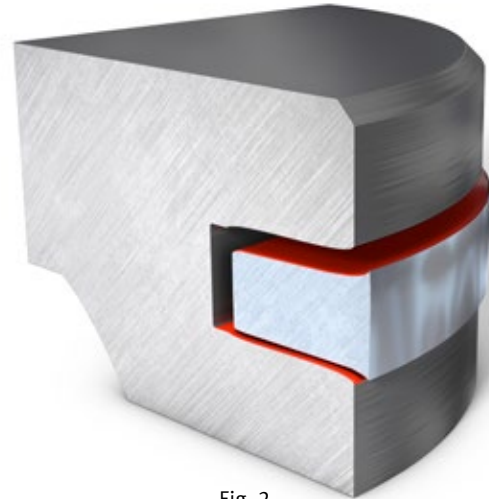

Fig. 2



Fig. 1

Fig. 3

DAMAGE ASSESSMENT

Abrasive foreign bodies in the oil circuit cause scratches on the piston and piston rings, a matt wear pattern on the piston skirt and roll marks on the ring flanks (Fig. 4 and 5). As the piston rings are worn on the running surfaces and edges, they can no longer seal the cylinder against oil passing into the combustion chamber. At the same time, the pressure in the crankcase increases as a result of combustion gases streaming past the cylinder. This may cause oil to escape at radial oil seals, valve stem seals and other sealing points. Roll marks on the piston rings are caused by dirt particles that become lodged in the ring groove. As the piston ring rotates in the groove it keeps running over the dirt particles, which creates the characteristic roll marks.

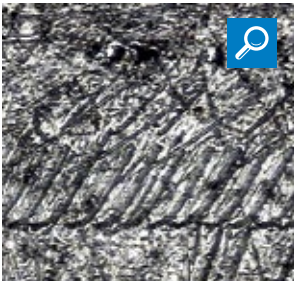

Fig. 4

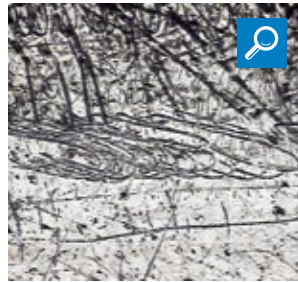

Fig. 5

POSSIBLE CAUSES FOR THE DAMAGE

- Abrasive dirt particles that enter the engine with the intake air due to inadequate filtration, including:
 - Missing, defective, deformed or poorly maintained air filters.
 - Leaking points in the intake system, such as distorted flanges, missing gaskets or defective or porous hoses.
- Residual particles of dirt from engine reconditioning. Parts of the engine are often blasted with sand or glass beads during reconditioning work in order to remove persistent deposits or combustion residue from the surfaces. If the blasting material becomes deposited in the material and is not cleaned out properly, it may work its way loose when the engine is running, thus causing abrasive wear. Fig. 6 and 7 show microscopic images of damage caused by dirt, under polarised light. Fragments of the glass blasting material and entire beads of the glass can clearly be seen.
- If the first oil change is performed too late, the abraded particles generated when the engine is run in are spread through the oil circuit to the other interacting sliding parts where they cause more damage. The sharp oil-scraping edges of the piston rings are particularly prone to damage.

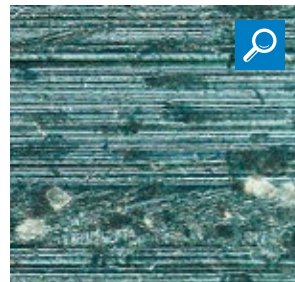

Fig. 6

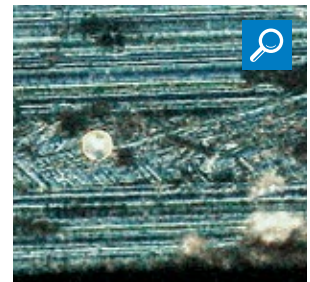

Fig. 7

2.11.4 WEAR ON PISTONS, PISTON RINGS AND CYLINDERS CAUSED BY FUEL FLOODING



DESCRIPTION OF THE DAMAGE

- Severe signs of wear on the piston top land and piston skirt.
- Friction marks on the piston skirt, characteristic of dry running due to fuel flooding.
- Piston rings display severe radial wear (Fig. 1). Both webs (support surfaces) on the oil control ring have been worn down (Fig. 2). By way of comparison in Fig. 3: profile of a new and worn oil control ring (double-bevelled spiral expander ring).
- Increased oil consumption.



Fig. 1

Fig. 2



Fig. 3

DAMAGE ASSESSMENT

Fuel flooding due to abnormal combustion always damages the oil film. This leads to a higher level of mixed friction and increased radial wear on the piston rings within a short period. The characteristic fuel friction only occurs after the oil film has been so badly impaired by the fuel that lubrication is then insufficient (refer to the chapter entitled “Dry running damage due to lack of lubrication caused by fuel flooding”). The increasingly ineffective lubrication results in high levels of wear on the piston rings, piston ring grooves and cylinder sliding surfaces.

In the initial stages the piston skirt is damaged to a lesser degree, as it is regularly supplied with new oil that is still capable of providing lubrication from the crankshaft drive. Once the abraded particles from the moving area become mixed with the lubricating oil and the lubricating oil loses its load-bearing ability as a result of increasing oil dilution, the wear will spread to all bearing points in the engine. This affects the piston pins and crankshaft journals in particular.

POSSIBLE CAUSES FOR THE DAMAGE

- Frequent operation over short distances and resulting oil dilution with fuel.
- Coolant admixture in engine oil.
- Poor engine oil grade.
- Fuel flooding due to incomplete combustion as a result of malfunctions in the mixture preparation.
- Malfunctions in ignition system (misfiring).
- Insufficient compression pressure or poor filling through worn or fractured piston rings.
- Incorrect piston protrusion dimension: the piston strikes against the cylinder head. On diesel engines with direct injection, the resulting vibrations cause uncontrolled injection of fuel from the injection nozzles and thus fuel flooding in the cylinder (refer to the chapter entitled “Impact marks on the piston head”).
- Poor filling through clogged-up air filter.
- Faulty and leaking injection nozzles.
- Faulty or incorrectly set fuel injection pump.
- Incorrectly routed injection lines (vibrations).
- Poor charging through faulty or worn turbocharger.
- Poor fuel quality (poor self-ignition and incomplete combustion).

2.11.5 PISTON RING WEAR SOON AFTER ENGINE RECONDITIONING



DESCRIPTION OF THE DAMAGE

- No damage or wear on piston.
- Superficial inspection of piston rings reveals no wear marks, however, closer inspection reveals abnormal wear on the oil-scraping ring edges, mostly on the bottom ring edges (see magnified image).
- Tangible burr on the bottom edge of the piston ring running surface.



Fig. 1

DAMAGE ASSESSMENT

The worn piston ring edges lead to high hydrodynamic forces (Fig. 2) between the running surfaces of the piston rings and the cylinder running surface as a result of the formation of an oil wedge.

The piston rings float on the oil film during the upward/downward motion of the piston and are lifted off slightly from the cylinder running surface. In this way, an increased quantity of lubricating oil reaches the combustion chamber where it is burned.

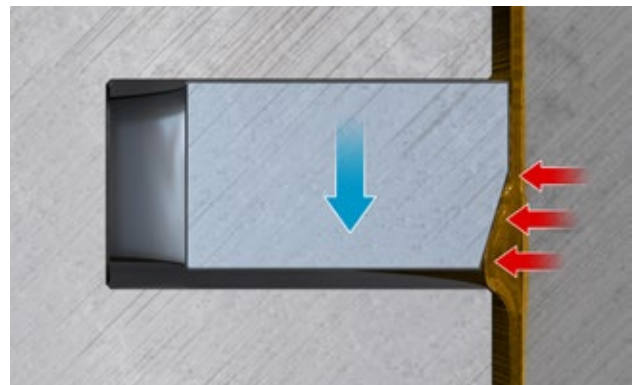

Fig. 2

POSSIBLE CAUSES FOR THE DAMAGE

The burring is caused if the piston rings are refitted in less than ideal conditions after the engine reconditioning. The main reasons are insufficient or inappropriate cylinder finishing. If blunt honing stones are used for finish honing or excessive pressure is applied during honing, burrs and elevations form on the cylinder wall. These metal edges are folded over in the direction of machining (Fig. 3). This is referred to as the “peak folding formation” and causes increased friction during the running-in phase, preventing engine oil from becoming deposited in the fine graphite veins.

If these burrs are not removed in a final machining process referred to as plateau honing, this will result in premature wear at the piston ring edges during the running-in phase. The piston rings then take on the undesired duty of wearing away the folded peaks and cleaning the graphite veins. However, this leads to wear on the piston ring edges and the formation of burrs. From experience, burrs created in this way on the piston ring edge can only be run off with great difficulty. The damaged piston rings need to be replaced.

A second set of piston rings installed as replacement rings will encounter much better, virtually normal operating conditions. This is because the first set of piston rings will have removed most of the disadvantageous edge layer on the cylinder running surface (the “peak folding formation”) through wear. The oil consumption will return to normal levels after replacing the piston rings. In many cases this is incorrectly attributed to poor-quality materials in the first piston rings that were installed.

The microscopic enlargement in Fig. 4 shows the bent-over peaks through a section of the cylinder surface after the disadvantageous honing of the cylinder running surface (peak folding). Fig. 5 shows the surface after plateau honing. The burrs and peaks have been mostly removed, and the graphite veins have been exposed. The piston rings will encounter good conditions for running-in and should therefore provide a long service life. Hone-brushing the surface to create the plateau finish delivers particularly good results.



Fig. 3



Fig. 4



Fig. 5

2.11.6 ASYMMETRICAL PISTON WEAR PATTERN



DESCRIPTION OF THE DAMAGE

Fig. 1:

- Asymmetrical wear pattern on piston over its entire height.
- Top land on left of piston above the piston pin bore and on opposite side at lower edge of piston rubbed bare.
- Uneven wear pattern on compression ring.

Fig. 2:

- Piston running skew, with the wear mainly on the lower, right-hand edge of the piston at the recess for the cooling-oil nozzle and under the piston pin bore.



Fig. 1



Fig. 2

DAMAGE ASSESSMENT

This type of asymmetrical wear pattern indicates that the piston has not been running perfectly straight in the cylinder bore and that the piston pin axis and the crankshaft axis are not parallel to each other. The piston rings cannot perform their sealing function properly due to the lack of proper contact with the cylinder. The hot combustion gases blow through and heat up the piston rings and the cylinder wall excessively. This weakens the oil film, which may result in a seizure due to lack of lubrication. As the piston is running skew in the cylinder, its reciprocating movement creates a pumping effect at the piston rings, which pumps oil into the combustion chamber and thus increases oil consumption. Under certain conditions an axial thrust can be applied to the piston pin, which can lead to wear or fracturing of the piston pin circlips (refer to the chapter entitled “Piston damage caused by broken piston pin circlips”).

POSSIBLE CAUSES FOR THE DAMAGE

- Bent or twisted connecting rods.
- Connecting rod eyes bored at an angle.
- Cylinder bore not perpendicular to crankshaft axis.
- Individual cylinders not installed straight (distorted during installation).
- Connecting rod pins not parallel with crankshaft axis.
- Connecting rod eye bored at an angle (axes not parallel).
- Excessive connecting rod bearing clearance, particularly in conjunction with asymmetrical connecting rods (centre offset between connecting rod eye and the large connecting rod bearing).

3. GLOSSARY

TECHNICAL TERMS AND PISTON DESIGNATIONS

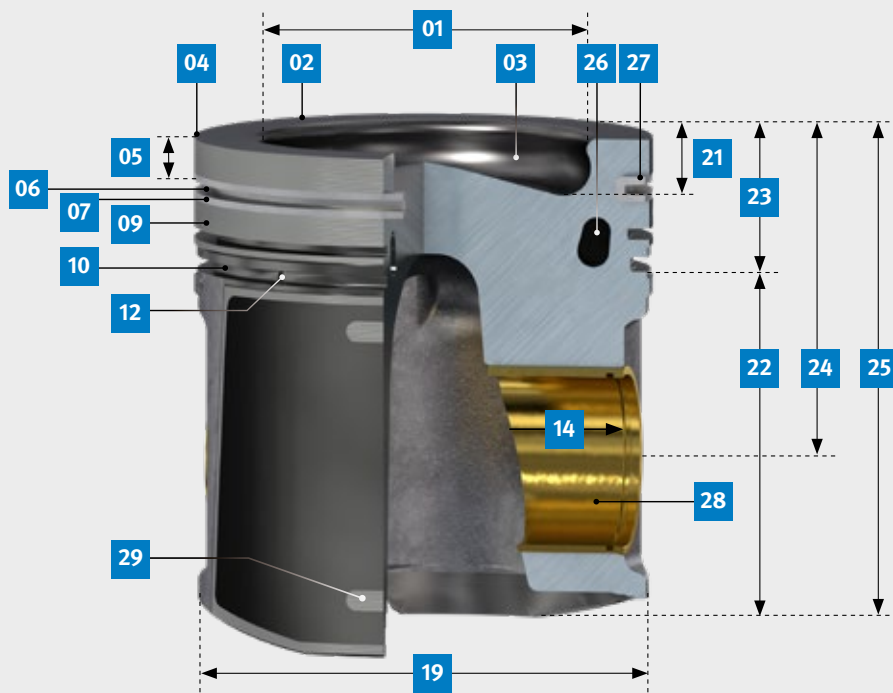

- 01 \varnothing of bowl
- 02 Piston crown
- 03 Bowl
- 04 Piston crown edge
- 05 Piston top land (fire land)
- 06 Compression ring groove
- 07 Ring land
- 08 Groove base
- 09 Recessed ring land
- 10 Groove walls
- 11 Oil control ring groove
- 12 Oil return bore
- 13 Piston pin boss
- 14 Retention for groove distance
- 15 Circlip groove
- 16 Distance between bosses
- 17 Register diameter
- 18 Bottom edge of piston skirt
- 19 Piston diameter 90 ° against piston pin bore
- 20 Piston pin bore
- 21 Bowl depth
- 22 Skirt zone
- 23 Ring zone
- 24 Compression height
- 25 Piston length
- 26 Oil cooling gallery
- 27 Ring carrier
- 28 Piston pin bush
- 29 \varnothing of measuring window
- 30 Crown elevation

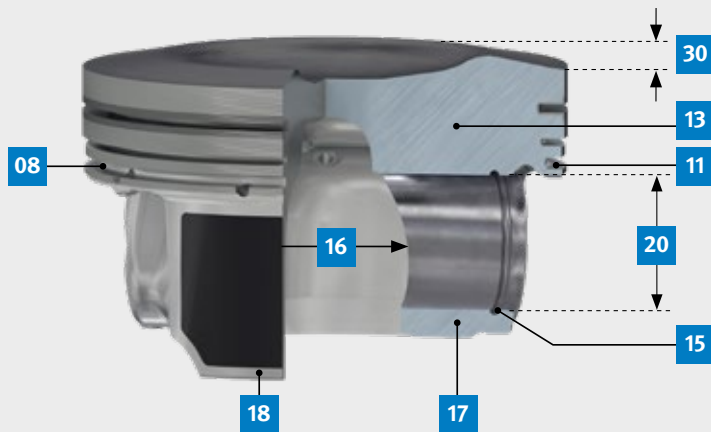

EXPLANATION OF THE TECHNICAL TERMS USED IN THIS DOCUMENT

abrasive

Rubbing/grinding.

anti-knock properties

Capability of the petrol fuel to resist selfignition.

anti-thrust side

The side of the piston or cylinder that is opposite the pressure side.

assembly

Repair kit containing the cylinder liner and piston.

asymmetric

Not symmetric.

axis offset

By design the piston pin axis is offset by some tenths of a millimetre towards the piston pressure side. As a result, the piston changes bearing surfaces at TDC before the actual combustion takes place. This makes the change of bearing surface quieter and less harsh than if the change of bearing surface took place due to the starting combustion under far greater loads. On diesel engines the offset of the piston pin axis may also be towards the anti-thrust side as a result of the high temperatures.

blow-by

Quantity of leakage gases that flows past the piston rings into the crankcase during combustion. The worse the sealing on the piston in the cylinder, the more blow-by gases can flow past. Blow-by gas emission is on average 1% of the air quantity taken in.

cavitation

Hollowing-out of material that is situated in water or other liquids. If a vacuum is formed and a high temperature is present at the surface, vapour bubbles are formed (analogously to the process of boiling), which then collapse again immediately. As the bubbles collapse, the water column bounces back with high kinetic energy onto the material and tears out tiny particles from the surface of the material. The formation of these bubbles is triggered by vibrations or a strong vacuum.

centrifugal oil

Oil that emerges from the bearings of the crankshaft in a planned manner and serves to coat and lubricate the cylinder sliding surfaces with oil from underneath.

change of bearing surfaces

The changing of the piston from the anti-thrust side to the pressure side in the cylinder or vice versa. During the upwards stroke the piston bears against the anti-thrust side of the cylinder and then changes to the pressure side around TDC.

cetane rating

Index that indicates the ignition qualities of diesel fuel. The higher the cetane rating, the higher the ignition quality.

chip tuning

Modifications to the software of an engine control unit in order to increase the power output of the engine.

common rail

Name for the latest generation of diesel direct injection systems. The electrically actuated injection valves are supplied with highly pressurised fuel from a shared injection rail.

connecting rod misalignment

Lack of parallelism between the crankshaft axis and the piston pin axis.

continuous knocking

Knocking combustion that persists continuously while the engine is running.

convexity

Slight barrel-shaped form of the piston in the skirt area.

course of fracture

Direction of fracture.

dead centre

The point at which the reciprocating movement of the piston reverses direction in the cylinder. A distinction is made between top dead centre (TDC) and bottom dead centre (BDC).

direct injection engine

Engine in which the fuel is injected directly into the combustion chamber.

downward piston stroke

Movement of the piston towards the crankshaft during the intake and power strokes (4-stroke engine).

erosion

The removal of material as a result of the effects of the kinetic energy of solids, liquids or gases acting on the surface.

exhaust emissions regulations

National or international legislation governing the limits for exhaust emissions from motor vehicles.

expansion stroke

Combustion stroke/power stroke.

fatigue fracture

A fracture that develops slowly, as opposed to occurring suddenly due to material overload. The speed at which the fracture spreads can range from a few seconds to several hours or even days. The fracture starts from an incipient crack, a point of damage or as a result of vibrations. The fracture surfaces are not irregularly grey and matt, but instead have line markings that document the gradual progress of the fracture.

fibre reinforcement

Fibre reinforcement of the edge of the bowl for pistons in diesel direct injection engines. Before casting, a fibre ring made of aluminium oxide is laid into the piston mould. This ring is then penetrated by liquid aluminium during casting. As a result, the edge of the bowl is more resistant to the formation of cracks. Fibre reinforcements are only possible for the process of squeeze casting, in which the aluminium is forced into the mould under high pressure (approx. 1000 bar).

forced fracture

A fracture that occurs within a fraction of a second as a result of overloading a material, with no incipient crack beforehand. The fracture surfaces are matt, granular and not smeared.

fuel flooding

Excessive ingress of fuel into the combustion chamber. Fuel is deposited on the components as a result of poor atomisation or an overly rich mixture, from where it can dilute or wash off the oil film on the cylinder sliding surface. This results in insufficient lubrication, which may cause rubbing marks or seizures.

gap/dimension width

Remaining space between the piston crown and the cylinder head at TDC of the piston. When reconditioning an engine, the manufacturer's specifications for the dimensions of this gap must be observed (see "piston protrusion").

The gap dimension is also referred to as the lead dimension as it can be measured with lead wire. The lead wire is inserted in the cylinder during assembly, and the engine is then turned over once.

The lead wire is squashed flat as a result and can then be remeasured. The size measured from the squashed wire is the lead gap.

glow ignition

Self-ignition of the air-fuel mixture before the actual ignition by means of the spark plug. The glow ignition takes place due to components that have started to glow (cylinder head gasket, spark plug, exhaust valve, oil carbon deposits, etc.).

graphite veins

Graphite deposits in the base material during lamellar graphite casting (grey cast iron). If the veins that become exposed during the cylinder finishing are cleaned with honing brushes, then oil can be deposited there for lubrication of the piston.

graphite exposure rate

The number of graphite veins exposed during hone brushing. The benchmark is $\geq 20\%$.

hone brushing

The last stage of the honing process. The peaks and burrs are removed from the surface of the cylinder, and the graphite veins are exposed and cleaned. With hone brushing a graphite exposure rate up to 50% is possible.

honing

Cylinder finishing by means of cross grinding.

honing structure

Characteristic grinding pattern created during cross grinding (honing).

initial rubbing marks

Pre-seizure stage occurring due to lack of lubricating oil or a starting restriction of clearances.

insufficient lubrication/lack of lubrication

Insufficient lubrication arises if the oil film is weakened and its function impaired as a result. Causes: not enough oil present, oil film diluted by fuel or oil film breaking up. It initially results in mixed friction and ultimately in rubbing marks or seizure of the components.

lambda control

Closed-loop control device on petrol engines for controlling the ratio of the added air and fuel.

line markings

Lines that can be found on the fracture surfaces of fatigue fractures and that are caused by the relatively fast spreading of the fracture. The fracture occurs step-by-step. A new line is

created every time a new piece becomes fractured. The fracture starts from the centre of the line markings.

material collapse

Microstructural changes and resulting changes in shape to the piston skirt on a used piston (see “piston installation clearance”).

mixed friction

Where two interacting sliding parts are mechanically separated from one another by an oil film, mixed friction arises when this oil film is weakened. Individual material elevations on one of the sliding parts then come into contact with the material peaks of the other, causing metallic friction. Mixed friction is also referred to as semi-liquid friction.

octane rating

The octane rating of a fuel (RON = Research Octane Number) indicates the anti-knock properties of petrol fuel. The higher the octane rating, the better the anti-knock properties of the fuel.

octane requirement

The octane requirement of an engine results from its design characteristics. It increases with increasing compression ratio, engine temperature, advanced ignition, charge, engine load and disadvantageous combustion chamber design. The octane rating request of an engine (MON = Motor Octane Number) should always be a few points below the octane rating of the available fuel to prevent engine knocking in all operating conditions.

oil dilution

Oil dilution describes the thinning of oil with fuel. Causes: if the vehicle is frequently driven for short journeys, if there are malfunctions during mixture preparation or in the ignition system or there is insufficient compression due to mechanical engine problems. Unburned fuel is then deposited on the cylinder wall, where it is mixed with the oil and thus also reaches the oil pan. The viscosity and lubricating capacity of the oil are reduced, leading to increased wear and oil consumption.

peak folding

Torn-out and squashed material that covers the cylinder running surface if cylinder finishing is incorrect or incomplete (honing/cross grinding).

peak folding formation

Squashing of material at the cylinder sliding surface caused by blunt honing stones or excessive grinding from the honing stones.

piston installation clearance

The clearance between the piston and the cylinder that ensures the freedom of movement of the new piston in the cylinder during installation and operation.

During the first hours of operation the new piston is still subject to deformation (i.e. collapse). This is caused on the one hand by the temperature rise and the resulting microstructural changes that still take place, and on the other hand by the mechanical loads. The maximum piston size (which always lies in the skirt area) is therefore subject to a certain amount of variation during the running-in phase. This variation will vary according to the design, material composition and specific load. This is a completely normal response for aluminium pistons in operation and does not represent a cause for concern. The piston skirt will also be subject to plastic deformation in the event of piston damage caused by insufficient lubrication, overheating or mechanical overload, which can result in even greater deformation and dimensional changes.

In the event of damage, the piston installation clearance is often used to assess the wear, or installation clearances are incorrectly calculated afterwards, even though this is not possible as the used piston no longer has the original shape or dimensions that it had when it was new. In many cases the maximum piston size on the skirt is deemed to be too small, and wear is attributed to the piston even though the fine machining marks or the coating on the piston skirt are completely intact.

These piston dimensions measured on a used piston and the installation clearances calculated from them cannot be used to assess either the quality of the engine repair work carried out, or the quality of materials and the dimensional accuracy of the piston when new.

If the installation clearance is too small then a seizure due to insufficient clearance may occur (refer to the chapter entitled “Seizure due to insufficient clearance”). If the installation clearance is too large then the engine will generate more noise when cold as a result of piston tilting. Piston seizures, increased oil consumption or other forms of damage cannot occur as a result.

The installation clearance must not be confused with the running clearance of the piston. The running clearance is not established until the thermal expansion of the piston is complete, and cannot be measured.

piston protrusion

Protrusion of the diesel piston beyond the cylinder block sealing face at TDC. The protrusion is an important measurement that must be accurately checked and observed when reconditioning an engine to ensure that the compression ratio remains correct and the piston does not strike against the cylinder head.

piston running clearance

The piston running clearance settles during operation once the thermal expansion of the components is complete. Due to their different design characteristics and wall thicknesses, the piston changes shape as it is heated up. The piston expands more in areas where the wall thickness is greater, which is taken into account accordingly in the design.

piston running skew

A piston running skewed in the cylinder due to a twisted or bent connecting rod. Upon removal it reveals an asymmetrical wear pattern.

piston tilting

The changing of the piston bearing surface in the cylinder from the pressure side to the anti-thrust side and vice versa. The tilting of the pistons is the second loudest noise on a reciprocating internal combustion engine after the combustion noise itself.

piston wear pattern

The wear pattern on the piston skirt where the skirt lies against the cylinder.

piston with an oil cooling gallery

Pistons subject to greater thermal loads are designed with a oil cooling gallery in the piston crown. When the engine is running, oil is sprayed into this cast oil cooling gallery.

plateau honing

The finishing process when machining cylinders, during which the peaks on the material surface are cut away to create a plateau. This process smooths out the surface, improves the running-in behaviour and reduces wear.

prechamber

Part of the combustion chamber on indirect injection diesel engines. Fuel is injected into the prechamber where it then ignites. The overpressure generated in the prechamber forces the piston down.

press-fit

Type of dry cylinder liner that is pressed into the cylinder counter bore using a specially designated lubricant. These liners are almost always semi-finished liners, i.e. the cylinder bore then needs to be finished by boring and honing. The advantage of this is that the liner fits tightly within the cylinder counter bore.

pressure side

The side of the piston or cylinder upon which the piston rests during combustion. The pressure side is opposite to the direction of rotation of the crankshaft.

pump-nozzle unit

A special design used on diesel direct injection engines whereby the injection nozzle and pressure generator (pump) form a single unit that is installed directly in the cylinder head. The injection pressure is generated by a pump piston that is actuated directly by the engine's camshaft (in contrast to a distributor injection pump or an inline injection pump). The injection nozzles are actuated electrically. The injection time and quantity are controlled electronically by a control unit.

quenching area

The part of the piston crown that gets very close to the cylinder head. At the end of the compression cycle the mixture is squashed ever more tightly from the edge area into the middle of the combustion chamber. This causes the gases to swirl and improves combustion.

ribbed cylinder

Cylinders on engines cooled primarily by air cooling. The cylinders have cooling ribs on the outside for cooling the engine.

ring carrier

A cast iron ring with a high nickel content that is cast into the aluminium piston. The first ring groove is cut into the ring carrier. As a result, the first (and sometimes the second) compression ring sits in a wearresistant groove, allowing for higher operating pressures and therefore higher loads. Ring carriers are used on diesel pistons in accordance with the Al-Fin method.

roll marks

Wear marks on the piston ring flanks caused by the ingress of dust or dirt into the engine. The dirt particles trapped in the piston ring groove cause wear marks on the grooves and the piston ring flanks. They are caused due to the rotation of the piston ring, which causes the dirt to scratch a regular pattern into the surface.

rubbing marks

The initial contact between two interacting sliding parts made when the lubricating film becomes damaged. In contrast to a seizure, rubbing changes the microstructure of the surface but does not particularly change its dimensions.

shrink-fit connecting rod

Connecting rod with a rigid link between the piston pin and the connecting rod. When the piston and connecting rod are assembled, the connecting rod eye is heated up and the piston pin is significantly cooled down. As a result of the shrinking of the piston pin and the expansion of the connecting rod bore, an air gap is generated that makes it possible to slide in the piston pin by hand.

As the components then cool down/heat up again, the clearance is eliminated and the piston pin is firmly clamped in the connecting rod. The piston does not need to be heated up when the piston pin is shrunk into the connecting rod eye.

slag line

Slag residue that is embedded in the material during hot deformation of engine parts during manufacture (valves, piston pins, etc.). During subsequent operation of the engine it may weaken the material, thereby causing a fracture.

slip-fit

A type of dry cylinder liner that can be inserted into the cylinder block by hand. Usually, this type of liner is already endfinished, so the cylinder bore does not need to be bored and honed afterwards. The disadvantage is the clearance that remains between the cylinder liner and the counter bore.

swirl chamber

Part of the combustion chamber on indirect injection diesel engines. The difference to a prechamber is that the outlet opening of the chamber is larger and opens tangentially into the combustion chamber. During compression, the shape of the chamber imparts a substantial swirl on the air streaming into the chamber, which helps to improve the combustion process.

tangential tension

Force that presses the installed piston ring against the cylinder wall.

tilting direction

Direction of rotation around the piston pin axis. As the piston does not rotate around this axis and instead only tips back and forth in the cylinder, this is also referred to as the tilting direction.

upward piston stroke

Movement of the piston away from the crankshaft towards the cylinder head (during the compression and exhaust strokes, on a 4-stroke engine).

KNOW-HOW TRANSFER

PROFESSIONAL KNOWLEDGE FROM THE EXPERTS

WORLDWIDE TRAINING

Direct from the manufacturer

Each year, around 4,500 mechanics and engineers benefit from our training courses and seminars, which we hold on-site in locations across the world or in our training centres in Neuenstadt, Dormagen and Tamm (Germany).

TECHNICAL INFORMATION

From practical experience for practical use

Our Product Information and Service Information publications, technical brochures and posters keep you at the forefront of the latest technological developments.

TECHNICAL VIDEOS

Knowledge transfer via video

Our videos provide you with useful information on our products, such as hands-on fitting instructions and system descriptions.



PRODUCTS IN FOCUS ONLINE

Our solutions explained clearly

Interactive elements, animations and video clips provide interesting information about our products in and around the engine.

ONLINESHOP

Your direct access to our products

Order at any time. Quick availability check. Extensive product search by engine, vehicle, dimensions etc.

NEWS

Regular information via e-mail

Subscribe online to our free newsletter now and receive regular information about additions to the product range, technical publications and much more.

INDIVIDUAL INFORMATION

Especially for our customers

We provide extensive information and services relating to our wide range of services: e.g. personalised sales-promoting materials, sales support, technical support and much more.



TECHNIPEDIA

Technical information on all aspects of the engine

We share our know-how with you in our Technipedia. You can get professional knowledge direct from experts here.

MOTORSERVICE APP

Access technical know-how on the move

Here, you will find the latest information and services relating to our products quickly and easily.

SOCIAL MEDIA

Always up to date





HEADQUARTERS:

MS Motorservice International GmbH

Wilhelm-Maybach-Straße 14-18

74196 Neuenstadt, Germany

www.ms-motorservice.com



4 028977 480423

www.ms-motorservice.com

© MS Motorservice International GmbH – 50 003 973-02 – EN – 07/15 (012020)