



PIERBURG



PRODUCT CATALOG ELECTRIC VALVES

TAKING RESPONSIBILITY IN A CHANGING WORLD



RHEINMETALL

	DE	EN	FR	ES	IT	RU	AR
	Elektrische Ventile	Electric valves	Clapets électriques	Válvulas eléctricas	Valvole elettriche	Электрические клапаны	الصمامات الكهربائية
AKF	AKF-Ventil	ACF valve	Valve de filtre à charbon actif	Válvula AKF	Valvola FCA	Клапан фильтра из активированного угля	صمام فلتر الفحم النشط (ACF)
DW-AGR	Druckwandler (AGR)	Pressure transducer (EGR)	Convertisseur de pression (EGR)	Convertidor de presión (EGR)	Convertitore di pressione (EGR)	Преобразователь давления (EGR)	صمام الضغط (EGR)
DW-RK	Druckwandler Regelklappe (AGR)	Pressure transducer regulating throttle (EGR)	Convertisseur de pression (valve de réglage – EGR)	Convertidor de presión mariposa de regulación (EGR)	Convertitore di pressione farfalla di regolazione (EGR)	Преобразователь авления, регулирующая заслонка (EGR)	صمام التحكم في محول الضغط (EGR)
DW-SR	Druckwandler (Saugrohr)	Pressure transducer (intake manifold)	Convertisseur de pression (tubulure d'aspiration)	Convertidor de presión (tubo de aspiración)	Convertitore di pressione (tubo d'aspirazione)	Преобразователь давления (впускная труба)	محول الضغط (التيوب السحب)
DW-TL	Druckwandler (Turbolader)	Pressure transducer (turbocharger)	Convertisseur de pression (turbocompresseur)	Convertidor de presión (turbocargador)	Convertitore di pressione (turbocompressore)	Преобразователь давления (турбоагнетатель)	محول الضغط (شاحن توربيني)
EOV	Öldruckventil	Oil pressure valve	Valve de pression d'huile	Válvula de presión de aceite	Valvola di pressione dell'olio	Давление масла клапан	صمام ضغط الزيت
EUV-AGK	Umschaltventil (Abgasklappe)	Electric switchover valve (exhaust gas flap)	Valve d'inversion (volet de gaz d'échappement)	Válvula de inversión (mariposa del escape)	Valvola di commutazione (valvola dei gas di scarico)	Переключающий клапан (клапан выхлопных газов)	صمام تحويل (غطاء العادم)
EUV-AGR	Umschaltventil (AGR)	Electric switchover valve (EGR)	Valve d'inversion (EGR)	Válvula de inversión (EGR)	Valvola di commutazione (EGR)	Переключающий клапан (EGR)	صمام تحويل (EGR)
EUV-BKV	Umschaltventil (Bremskraftverstärker)	Electric switchover valve (brake booster)	Valve d'inversion (frein assisté)	Válvula de inversión (reforzador de frenado)	Valvola di commutazione (amplificatore della forza frenante)	Переключающий клапан (усилитель тормозного привода)	صمام تحويل (مُعزز قوة الفراملية)
EUV-DS	Umschaltventil (Differentialsperre)	Electric switchover valve (differential lock)	Valve d'inversion (blocage du différentiel)	Válvula de inversión (cierre diferencial)	Valvola di commutazione (bloccaggio del differenziale)	Переключающий клапан (дифференциальная блокировка)	صمام تحويل (قفل تفاضلي)
EUV-KA	Umschaltventil (Klimaanlage)	Electric switchover valve (air conditioning)	Valve d'inversion (climatisation)	Válvula de inversión (aire acondicionado)	Valvola di commutazione (aire condizionata)	Переключающий клапан (система кондиционирования воздуха)	صمام تحويل (مكيف الهواء)
EUV-KK	Umschaltventil (Kühlmittelkreislauf)	Electric switchover valve (coolant circuit)	Valve d'inversion (circuit de liquide de refroidissement)	Válvula de inversión (circuito de líquido refrigerante)	Valvola di commutazione (circuit del liquido di raffreddamento)	Переключающий клапан (контур циркуляции охлаждающего средства)	صمام تحويل (دورة مادة التبريد)
EUV-LS	Umschaltventil (Luftsteuerung)	Electric switchover valve (air control)	Valve d'inversion (commande de ventilation)	Válvula de inversión (control del aire)	Valvola di commutazione (controllo aria)	Переключающий клапан (управление воздухом)	صمام تحويل (التحكم في الهواء)
EUV-ML	Umschaltventil (Motorlagerung)	Electric switchover valve (engine mounting)	Valve d'inversion (support de moteur)	Válvula de inversión (soporte de motor)	Valvola di commutazione (sospensione del motore)	Переключающий клапан (подшипники двигателя)	صمام تحويل (التحكم في المحرك)
EUV-RK	Umschaltventil (Regelklappe)	Electric switchover valve (regulating throttle)	Valve d'inversion (valve de réglage)	Válvula de inversión (mariposa de regulación)	Valvola di commutazione (farfalla di regolazione)	Переключающий клапан (регулирующая заслонка)	صمام تحويل (صمام الضغط)
EUV-SL	Umschaltventil (Sekundärluft)	Electric switchover valve (secondary air)	Valve d'inversion (air secondaire)	Válvula de inversión (aire secundario)	Valvola di commutazione (aria secondaria)	Переключающий клапан (вторичный воздух)	صمام تحويل (الهواء الثانوي)
EUV-SR	Umschaltventil (Saugrohr)	Electric switchover valve (intake manifold)	Valve d'inversion (tubulure d'aspiration)	Válvula de inversión (tubo de aspiración)	Valvola di commutazione (tubo d'aspirazione)	Переключающий клапан (впускная труба)	صمام تحويل (التيوب السحب)
EUV-VB	Umschaltventil (Verdichter-Bypassklappe)	Electric switchover valve (compressor bypass)	Valve d'inversion (clapet bypass du compresseur)	Válvula de inversión (mariposa by-pass del compresor)	Valvola di commutazione (farfalla di bypass del compressore)	Переключающий клапан (байпасный клапан компрессора)	صمام تحويل (صمام تحويل الكمبريسور)
EUV-WP	Umschaltventil (Wasserpumpe)	Electric switchover valve (water pump)	Vanne d'inversion (pompe à eau)	Válvula de inversión (bomba de agua)	Valvola di commutazione (pompa dell'acqua)	Переключающий клапан (водяной насос)	صمام تحويل (مضخة المياه)
LDRV	Ladedruckregelventil	Boost pressure control valve	Clapet de commande de pression d'admission	Válvula reguladora presión de admisión	Valvola di regolazione della pressione di sovralimentazione	Клапан регулирования давления наддува	صمام التحكم في ضغط الشحن
LLR	Leerlaufregler	Idle controller	Régulateur de ralenti	Regulador de ralentí	Regolatore del funzionamento al minimo	Регулятор холостого хода	منظم للدوران الحمايد
OEL-HV	Öldruckhalteventil (Automatikgetriebe)	Oil pressure support valve (automatic transmission unit)	Clapet de maintien de la pression d'huile (boite de vitesses automatique)	Válvula de retención de aceite (transmisión automática)	Valvola di tenuta pressione dell'olio (transmissione automatica)	Удерживающий давление масла клапан (автоматическая коробка передач)	صمام الحفاظ على ضغط الزيت (ناقل الحركة الأوتوماتيكي)
SM	Schrittmotor	Stepper motor	Moteur pas-à-pas	Motor paso a paso	Motorino passo-passo	Шаговый двигатель	محرك خطوي
STE	Steuereinheit	Control unit	Unité de commande	Unidad de regulación	Unità di comando	Внешний привод	وحدة تحكم
SUV	Schubumluftventil	Recirculating air valve	Clapet d'air de recirculation	Válvula de aire circulante en régimen de retención	Valvola di ricircolo dell'aria in fase di rilascio	Рециркуляционный воздушный клапан	سوپاپ گردش هوا
SV-HYAT	Steuerventil (Hydraulikaggregat, Automatikgetriebe)	Control valve (hydraulic unit, automatic transmission)	Clapet de commande (groupe hydraulique, transmission automatique)	Válvula de mando (grupo hidráulico, transmisión automática)	Valvola di comando (gruppo idraulico, cambio automatico)	Управляющий клапан (гидравлический агрегат, автоматическая коробка передач)	صمام تحكم (وحدة الطاقة الهيدروليكية، صندوق التروس الأوتوماتي)
SV-KK	Steuerventil (Kühlmittelkreislauf)	Control valve (coolant circuit)	Clapet de commande (circuit de liquide de refroidissement)	Válvula de mando (circuit refrigerante)	Valvola di comando (circuit del liquido di raffreddamento)	Управляющий клапан (контур циркуляции охлаждающего средства)	صمام تحكم (دورة سائل التبريد)
SV-NWV	Steuerventil (Nockenwellensteuerung)	Control valve (camshaft adjustment)	Clapet de commande (réglage de l'arbre à cames)	Válvula de mando (ajuste del árbol de levas)	Valvola di comando (regolazione albero a camme)	Управляющий клапан (механизм изменения фаз газораспределения)	صمام التحكم (التحكم في عمود الكامات)
SV-PDA	Steuerventil, Kanalabschaltung	Control valve, channel shut-off	Clapet de commande, coupure de canalisation	Válvula de mando, interrupción de canal	Valvola di comando, disinserimento canale	Управляющий клапан, отключение канала	صمام التحكم (فصل القنوات)
ZM-NWV	Zentralmagnet, Nockenwellenverstellung	Central magnet, camshaft adjustment	Aimant central, réglage de l'arbre à cames	Imán central, ajuste del árbol de levas	Magnete centrale, regolazione albero a camme	Центральный магнит, механизм изменения фаз газораспределения	مغناطيس مركزي، ضبط عمود الكامات



NO FAKES!

LABEL AND SECURITY SEAL

1 SECURITY SEAL

ORIGINAL CLOSURE



DAMAGED CLOSURE



ATTENTION
Label and Security Seal must always be undamaged.

2 SECURITY CODE



TESA® HOLOSPOT SECURITYCODE (FOUR-DIGIT) WITH 2D MATRIX CODE

On the label the logo and Security-Code shine in rainbow colours when under direct light. The four digits match the last four digits of the complete 2D matrix code.

3 ONLINE CHECK



01)04052938000016(21)J2VPF2P400440D



MOTORSERVICE APP YOUR MOBILE FAKE CHECK

www.ms-motorservice.com/app



ELEKTRISCHE VENTILE

ELECTRIC VALVES

CLAPETS ÉLECTRIQUES

VÁLVULAS ELÉCTRICAS

VALVOLE ELETTRICHE

ЭЛЕКТРИЧЕСКИЕ КЛАПАНЫ

الصمامات الكهربائية

INDEX

Page

DE	Grundlagen	2
	Hinweise zur Benutzung des Katalogs	10
EN	Basic information	14
	Instructions for using the catalogue	22
FR	Généralités	26
	Précisions sur l'utilisation du catalogue	34
ES	Fundamentos	38
	Indicaciones para la utilización del catálogo	46
IT	Nozioni basilari	50
	Avvertenze sull'utilizzo del catalogo	58
RU	Основы	62
	Примечания по пользованию каталогом	70
AR	نقاط أساسية	83
	إرشادات استخدام الكatalog	75

Disclaimer

Namen, Beschreibungen, Nummern von Motoren, Fahrzeugen, Produkten, Herstellern etc. sind nur zu Vergleichszwecken aufgeführt. Die im Katalog enthaltenen Teile sind Ersatzteile für die aufgeführten Applikationen.

Names, descriptions and numbers of engines, vehicles, products, manufacturers, etc. are mentioned solely for the purpose of comparison. The parts contained in the catalogue are spare parts for the applications listed.

Les noms, les descriptions, les numéros de moteurs, les véhicules, les produits, les constructeurs, etc., ne sont donnés qu'à des fins de comparaison. Les articles mentionnés dans le catalogue sont des pièces de rechange destinées aux applications stipulées.

Los nombres, las designaciones y los números de motores, vehículos, productos o de fabricantes, etc., se indican sólo a modo de comparación. Las piezas incluidas en el catálogo son repuestos para las aplicaciones indicadas.

Nomi, descrizioni, numeri di motori, veicoli, prodotti, produttori, eccetera sono riportati solo per poter fare confronti. I componenti contenuti nel catalogo sono ricambi per le applicazioni citate.

Названия, описания и номера двигателей, транспортных средств, продуктов, изготовителей и т. п. приводятся только для сравнения. Содержащиеся в каталоге части представляют собой запасные части для приведенных продуктов.

أسماء وشروح وأرقام المحركات والسيارات والمنتجات والشركات المنتجة وغيرها مذكورة فقط بهدف المقارنة والأجزاء المذكورة في الكatalog عبارة عن قطع غيار للتطبيقات المذكورة.

WICHTIGE HINWEISE

Alle Angaben in diesem Katalog sind unverbindlich. Für deren Richtigkeit und Vollständigkeit können wir keine Haftung übernehmen. Informationen über eventuelle Fehler im Katalog sind uns stets willkommen und werden in den zukünftigen Ausgaben korrigiert.

Namen, Beschreibungen und Nummernangaben von Fahrzeugen oder Herstellern u. ä. sind ebenso wie die Original-Teilnummern der Fahrzeug- und Motorenhersteller nur zu Vergleichszwecken aufgeführt. Entsprechende Angaben sind keine Herkunftsbezeichnungen und dürfen gegenüber Dritten nicht verwendet werden. Bitte beachten Sie zudem, dass Änderungen der Ausrüstung durch die Fahrzeug- oder Motorenhersteller bzw. Änderungen der Bezeichnungen nicht ausgeschlossen werden können. Für die Anwendung der Vergleichslisten können wir daher keine Haftung übernehmen.

Wir behalten uns ausdrücklich vor, die Produktspezifikationen, die Werkstoffe, das Aussehen und den Lieferumfang unserer Produkte jederzeit zu ändern. Die Abbildungen im Katalog sind daher unverbindlich.

Vor dem Einbau ist stets zu prüfen, ob das erworbene Produkt für den beabsichtigten Verwendungszweck geeignet ist. Eine Aussage über eine bestimmte Beschaffenheit oder eine Eignung für einen bestimmten Einsatzzweck kann aus unseren Angaben nicht abgeleitet werden. Insbesondere gilt es zu beachten, dass die im Katalog angebotenen Produkte nicht für den Einsatz in Luft- und Raumfahrzeugen bestimmt sind. Bei der Verwendung in Off-Highway Motoren (z. B. Marine-, Stationär- oder Bahn-Motoren) ist darauf zu achten, dass bei gleicher Motorbezeichnung unterschiedliche Motorenteile (z. B. Kolben) zum Einsatz kommen können. Ggf. ist vor dem Einbau der Produkte daher der fachkundige Rat des Herstellers oder dessen autorisierter Vertragswerkstatt einzuholen. Wir weisen zudem darauf hin, dass der Einbau stets durch unterwiesenes Fachpersonal zu erfolgen hat. Abbildungen, Schemazeichnungen und andere Angaben dienen der Erläuterung und Darstellung und können nicht als Grundlage für den Einbau verwendet werden.

Jegliche Vervielfältigung, Nachahmung, Verbreitung oder öffentliche Wiedergabe dieses Kataloges, auch auszugsweise, ist nur mit unserer vorherigen schriftlichen Zustimmung und einer entsprechenden Quellenangabe gestattet. Mit Erscheinen dieses Kataloges verlieren alle früheren Ausgaben ihre Gültigkeit.

ZERTIFIZIERUNGEN

MS Motorservice International GmbH verfügt über ein nach ISO 9001 zertifiziertes Qualitätsmanagementsystem und ein nach ISO 14001 zertifiziertes Umweltmanagementsystem.





DIE INHALTE DES KATALOGS SIND AUCH IN UNSEREM ONLINE KATALOG, IN UNSERER APP SOWIE AUF TECALLIANCE ENTHALTEN.

Weitere Informationen:
catalog.ms-motorservice.com
motorservice.app

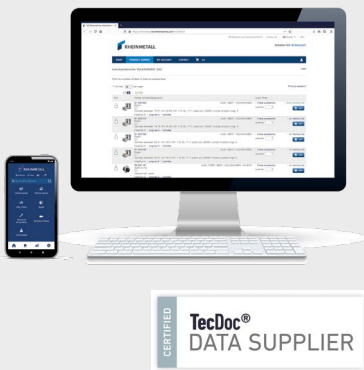

INHALT	SEITE
Wichtige Hinweise	2
Qualitätsmanagement	2
Know-how Transfer – Fachwissen vom Experten	4
1. Elektrische Ventile	7
2. HINWEISE ZUR BENUTZUNG DES KATALOGS	10
3. Hauptanwendungen / Produktabbildungen	85
4. Programmergänzung	179
5. Herstellerverzeichnis	191
6. PRODUKTPROGRAMM	195
7. Referenzliste	1321
8. Vorgehensweise bei Reklamation / Reklamationsformular	

MOTORSERVICE GRUPPE

QUALITÄT UND SERVICE AUS EINER HAND

Die Motorservice Gruppe ist die Vertriebsorganisation für die weltweiten Aftermarket-Aktivitäten von Rheinmetall. Sie ist ein führender Anbieter von Motorkomponenten für den freien Ersatzteilmarkt. Mit den Premiummarken Kolbenschmidt, Pierburg, TRW Engine Components sowie den Marken BF und turbo by Intec bietet Motorservice seinen Kunden aus Handel und Werkstatt ein breites und tiefes Sortiment in Spitzenqualität.

RHEINMETALL

TECHNOLOGIEN FÜR DIE MOBILITÄT DER ZUKUNFT

Als weltweiter Automobilzulieferer nimmt Rheinmetall mit seiner Kompetenz in den Bereichen Luftversorgung, Schadstoffreduzierung und Pumpen sowie bei der Entwicklung, Fertigung und Ersatzteillieferung von Kolben, Motorblöcken und Gleitlagern Spitzenpositionen auf den jeweiligen Märkten ein. Die Produktentwicklung erfolgt in enger Kooperation mit renommierten Automobilherstellern.

KNOW-HOW TRANSFER FACHWISSEN VOM EXPERTEN

WELTWEITE SCHULUNGEN

Direkt vom Hersteller

Jährlich profitieren rund 4.500 Mechaniker und Techniker von unseren Schulungen und Seminaren, die wir weltweit vor Ort oder auch in unseren Schulungszentren in Neuenstadt, Dormagen und Tamm (Deutschland) durchführen.

TECHNISCHE INFORMATIONEN

Aus der Praxis für die Praxis

Mit unseren Produkt Informationen, Service Informationen, technischen Broschüren und Postern sind Sie immer auf dem neuesten Stand der Technik.

TECHNISCHE VIDEOS

Wissensvermittlung per Video

In unseren Videos finden Sie praxisbezogene Einbauhinweise und Systemerklärungen rund um unsere Produkte.



PRODUKTE IM FOKUS ONLINE

Unsere Lösungen anschaulich erklärt

Erfahren Sie durch interaktive Elemente, Animationen und Videoclips Wissenswertes über unsere Produkte im und um den Motor.

ONLINESHOP

Ihr direkter Zugang zu unseren Produkten

Bestellen rund um die Uhr. Schnelles Prüfen der Verfügbarkeit. Umfangreiche Produktsuche über Motor, Fahrzeug, Abmessungen usw..

NEWS

Regelmäßige Informationen per E-Mail

Melden Sie sich jetzt online zu unserem kostenlosen Newsletter an und Sie erhalten regelmäßige Informationen über Produktneuaufnahmen, technische Publikationen und vieles mehr.

INDIVIDUELLE INFORMATIONEN

Speziell für unsere Kunden

Von uns erhalten Sie umfangreiche Informationen und Services zu unserem breiten Leistungsspektrum: wie z. B. personalisierte Verkaufsförderungsmaterialien, Verkaufunterstützungen, technischen Support und vieles mehr.



TECHNIPEDIA

Technische Informationen rund um den Motor

In unserer Technipedia teilen wir unser Know-how mit Ihnen. Hier finden Sie Fachwissen direkt vom Experten.

MOTORSERVICE APP

Mobiler Zugang zu technischem Know-how

Hier erhalten Sie schnell und einfach die aktuellsten Informationen und Services rund um unsere Produkte.

SOCIAL MEDIA

Immer aktuell

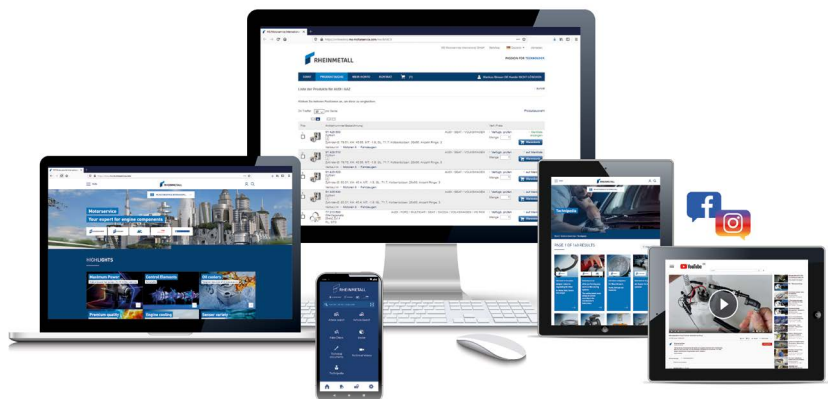

www.ms-motorservice.com





1. ELEKTRISCHE VENTILE

KLEINE BAUTEILE MIT GROSSER WIRKUNG

Elektrische Ventile sind wichtige Bauteile zum Schalten und Steuern sowie bei der Realisierung von Komfort- und Sicherheitsfunktionen. Sie werden für das Betätigen von pneumatischen Stellern eingesetzt oder dienen zum Umschalten zwischen zwei oder mehreren Zuständen.

Ventile bieten ein großes Potential für den freien Ersatzteilhandel, da diese direkt oder indirekt vom OBD-System überwacht werden. Beim Ausfall der Ventile ist ein Austausch unerlässlich. Vertrauen Sie auf die OE-Qualität des Marktführers Pierburg mit einer OE-Produktion von mehr als 125.000 Ventilen pro Tag und mehr als 350 Ventilen in Serie.

PRODUKTPROGRAMM

- 01** Umschaltventil
- 02** Steuerventile und Zentralmagnete zur Nockenwellenverstellung
- 03** Druckwandler
- 04** AKF-Absperrventil (Aktivkohlefilterventil)
- 05** AKF-Regenerierventil (Aktivkohlefilterventil)
- 06** Schubumluftventil

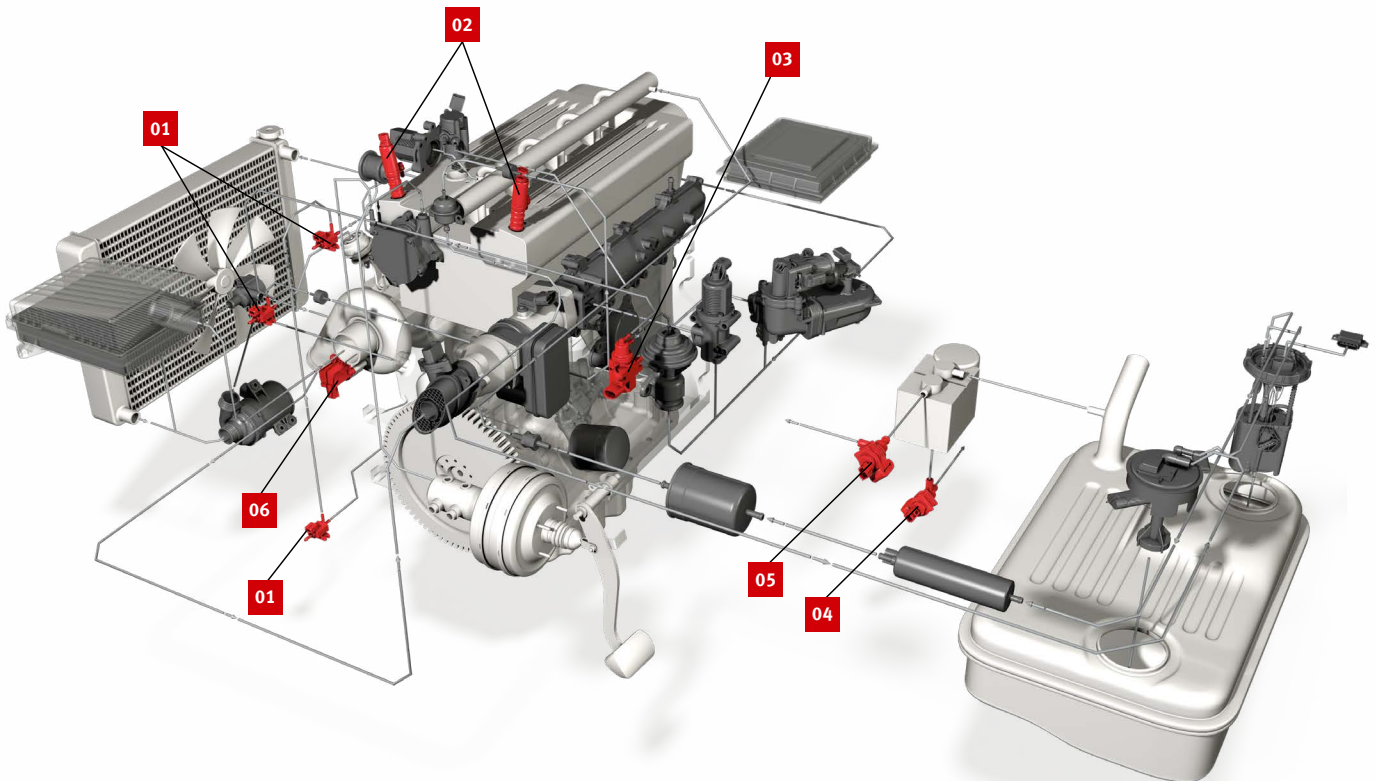

DRUCKWANDLER

Zur stufenlosen Ansteuerung von pneumatischen AGR-Ventilen, VTG-Turboladern und Umschaltung Bypass-AGR-Kühler.



UMSCHALTVENTILE

Umschaltventile werden dort eingesetzt, wo eine einfach Auf-Zu-Funktion von pneumatischen Stellern erforderlich ist, z. B. zur Ansteuerung von Ladedruckventilen (Wastegate), Sekundärluftventilen, Saugrohrklappen und Bypassklappen an AGR-Kühlern.



AKTIVKOHLEFILTERVENTILE (AKF-VENTILE)

AKF-Ventile sind wichtige Bauteile im Tankentlüftungssystem sowie in der Tankleckdiagnose. Das Tankentlüftungssystem verhindert, dass Kraftstoffdämpfe mit schädlichen Kohlenwasserstoffen in die Umwelt entweichen. Es belüftet außerdem den Kraftstofftank, wenn z. B. durch den entnommenen Kraftstoff oder durch niedrige Außentemperaturen Unterdruck im Kraftstofftank entsteht.



SCHUBUMLUFTVENTILE

Das Schubumluftventil zur Ladedruckregelung verhindert ein unnötiges Abbremsen des Turboladers beim plötzlichen Schließen der Drosselklappe. Dies verringert den Effekt des Turbolochs deutlich.



STEUERVENTILE UND ZENTRAL-MAGNETE ZUR NOCKENWELLENVERSTELLUNG

Abhängig von der Motordrehzahl leiten die Steuerventile den Ölfluss durch unterschiedliche Ölkanäle zu den jeweiligen Kammern im hydraulischen Nockenwellenversteller. Dadurch wird die Nockenwelle relativ zum Nockenwellenrad verdreht und die Steuerzeiten verändert. Auf diese Weise wird das Betriebsverhalten bei Teillast und Vollast verbessert und der Verbrauch reduziert.



Fahrzeug- und Ventilhersteller verwenden zum Teil unterschiedliche Bezeichnungen für diese Bauteile. Hier eine Auswahl alternativer Bezeichnungen für die jeweiligen Benennungen:

- **Druckwandler:** elektropneumatischer Wandler, EPW, elektrischer Druckwandler
- **Umschaltventil:** Elektroumschaltventil, EUV, Magnetventil Ladedruckbegrenzung N75 (VW), Magnetumschaltventil (VW), Elektroventil (BMW)
- **Elektrischer Druckwandler:** Druckwandler, Ventil (VW), Elektroventil (BMW), EDW, DW



2. HINWEISE ZUR BENUTZUNG DES KATALOGS

AT	Automatikgetriebe	MT	Schaltgetriebe		Ab / bis Motornummer
EH	elektrisch-hydraulisch		Mit Dichtung		Ab / bis Fahrgestellnummer
EL	Elektrisch		Ohne Dichtung		Länderausführung
EP	Elektrisch-pneumatisch				

01	02	03	04	05	06	07	
							VOLVO
S40 I (644)							8
1.8 85-90 kW (116-122 PS) B 4184 S2	06.2001→08.2003		7.07400.06.0* ↳ 7.02087.05.0	STE EUV-VB	EP EP	 Without deposit return for used part. No return of the solenoid valve. Intake side	
			7.22517.04.0 7.22240.15.0 7.22240.13.0 7.06117.16.0	AKF EUV-LS LDRV SV-NWV	EL EL EL EH		
			09	08			

01 Fahrzeug / Motor	06 Antriebsart / Ausführung
02 Baujahr von → bis	07 Info / Kriterien
03 Produktgruppe	08 Artikel-Kürzel*
04 7.xxxxx.xx.x ↳ 7.xxxxx.xx.x**	09 Pierburg Nr.
05 Artikel-Code*	

* siehe Abkürzungsverzeichnis
** nicht mehr lieferbar

PIERBURG NR.

			02			03			
						PIERBURG No.		123	
01	4.02003.62.0	LLR	43	7.02256.00.0	EUV-LS	28	7.02901.05.0	SUV	50
	7.00017.02.0	EUV-LS	28	7.02256.00.0	EUV-RK	31	7.02909.07.0	SUV	50
	7.00017.03.0	LDRV	39	7.02256.00.0	EUV-SL	31	7.02968.02.0	DW-TL	18

01 Pierburg Nr.
02 Artikel-Code
03 Abbildung/Seite

HAUPTANWENDUNGEN

		01		03	
		electric valves			
EUV-SL	7.22880.01.0	EUV-SL	7.28098.15.0	EUV-SR	7.01039.03.0
		→SI 0087 →SI 0096 →SI 0106		→SI 0096 04	
05		AUDI ALLROAD (4BH, C5) A4 Avant (8ED, B7) A4 Avant (8E5, B6) A4 Convertible (8H7, B6, 8HE, B7) A4 (8EC, B7) A4 (8E2, B6) A6 Avant (4F5, C6) A6 (4F2, C6)		OPEL ASTRA G Convertible (T98) ASTRA G Coupe (T98) ASTRA G Estate (T98) ASTRA G Hatchback (T98) ASTRA H (A04) ASTRA H GTC (A04) SPEEDSTER (E01) ZAFIRA A MPV (T98)	

01 Pierburg Nr.
02 Artikel-Code
03 Produktgruppe
04 Produkt- / Service Information
05 Fahrzeug

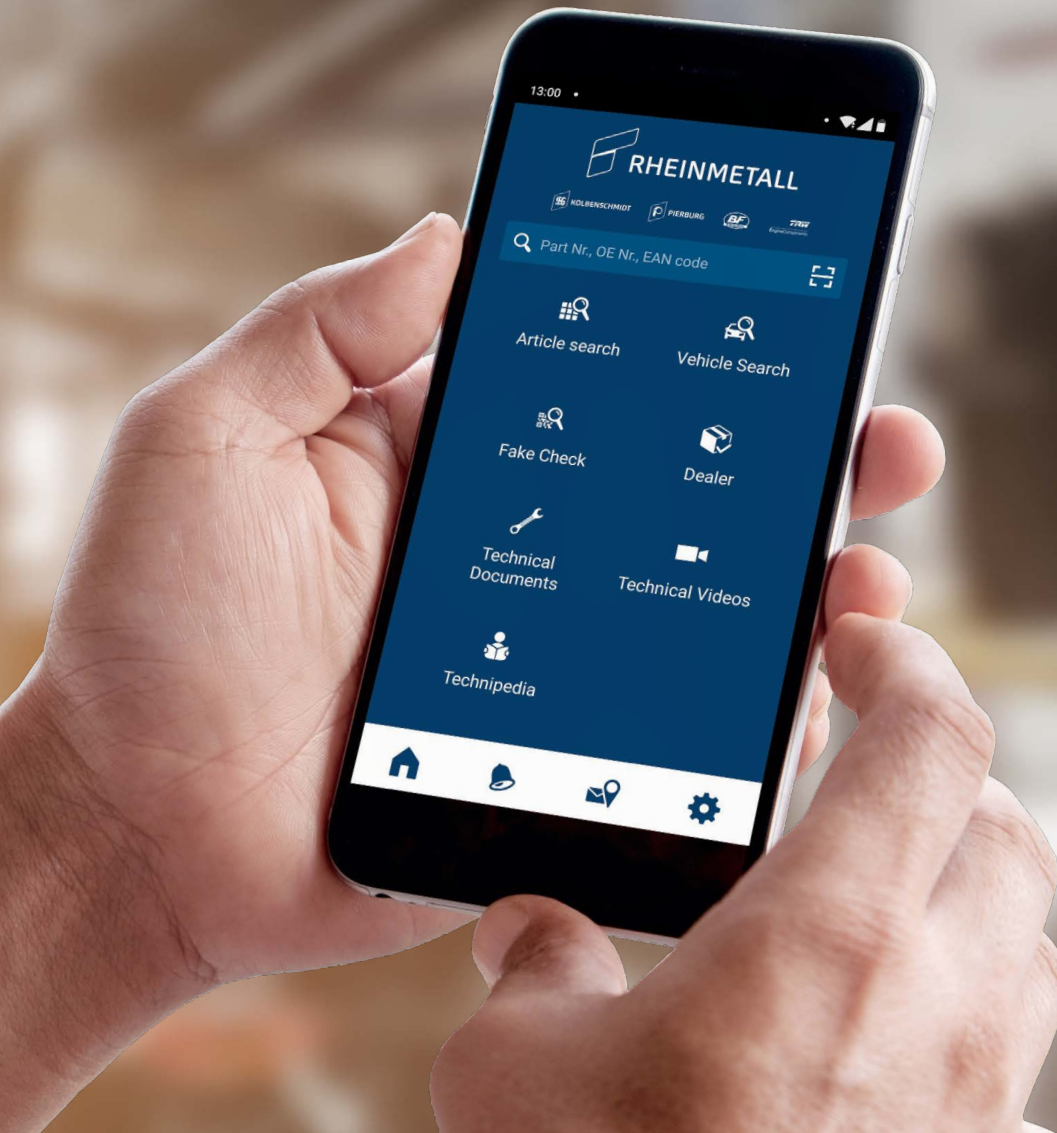

MOTORSERVICE APP

MOBILER ZUGANG ZU TECHNISCHEM KNOW-HOW



Mehr erfahren
www.ms-motorservice.com/app

EN

Basic information ►

IMPORTANT INFORMATION

All information in this catalogue is non-binding. We cannot accept any liability for correctness and completeness. We always welcome feedback about any errors in the catalogue and will correct them in future editions.

Names, descriptions and numbers of vehicles or manufacturers etc. are listed for comparison purposes only, as are the original part numbers of vehicle and engine manufacturers. These are not designations of origin and may not be used for third parties. Please also note that changes may be made to the equipment or to designations by the vehicle or engine manufacturers. We therefore cannot accept any liability for the use of the comparison lists.

We expressly reserve the right to change the product specifications, materials, appearance and scope of supply of our products at any time. The images in the catalogue are therefore non-binding.

Before installation, always check whether the product purchased is suitable for the intended use. Our information cannot be used to make a claim about a specific quality or suitability for a specific intended purpose. In particular, it should be noted that the products offered in the catalogue are not intended for use in aircraft and spacecraft. When used in off-highway engines (e.g. marine, stationary or train engines), please note that the same engine designation may be used for different engine parts (e.g. pistons). Therefore, before installing the products, it may be necessary to seek expert advice from the manufacturer or an authorised repair shop. We would also like to point out that the installation must always be carried out by trained, qualified personnel. Images, schematic diagrams and other information are for explanation and illustration purposes and must not be used as a basis for installation.

Any duplication, imitation, distribution or public reproduction of this catalogue, even in part, is permitted only with our prior written consent and a corresponding reference to the source. The publication of this catalogue renders all previous editions invalid.

CERTIFICATIONS

MS Motorservice International GmbH has an ISO 9001 certified quality management system and an ISO 14001 certified environmental management system.



THE CONTENTS OF THE CATALOGUE ARE ALSO AVAILABLE IN OUR ONLINE CATALOGUE, IN OUR APP AND ON TECALLIANCE.

Further information:
catalog.ms-motorservice.com
motorservice.app



CONTENTS	PAGE
Important information	14
Quality management	14
Know-how transfer – professional knowledge from the expert	16
1. Emission control	19
2. INSTRUCTIONS FOR USING THE CATALOGUE	22
3. Main applications / product images	85
4. Addition to the range	179
5. Directory of manufacturers	191
6. PRODUCT RANGE	195
7. Reference list	1321
8. Procedure for claims / claims form	

MOTORSERVICE GROUP

QUALITY AND SERVICE FROM A SINGLE SOURCE

The Motorservice Group is the sales organisation for the global aftermarket activities of Rheinmetall. It is a leading supplier of engine components for the independent aftermarket. With the premium brands Kolbenschmidt, Pierburg, TRW Engine Components and the brands BF and turbo by Intec, Motorservice offers its trade and repair shop customers a wide and comprehensive range of top-quality products.

RHEINMETALL

TECHNOLOGY FOR FUTURE MOBILITY

As a global supplier to the automotive industry, Rheinmetall’s expertise in air supply systems, emission control and pumps and in the development, manufacture and spare parts supply of pistons, engine blocks and engine bearings puts it right at the top of the markets. Product development is carried out in close cooperation with well-known automotive manufacturers.

KNOW-HOW TRANSFER

PROFESSIONAL KNOWLEDGE FROM THE EXPERTS

WORLDWIDE TRAININGS

Direct from the manufacturer

Each year, around 4,500 mechanics and engineers benefit from our training courses and seminars, which we hold on-site in locations across the world or in our training centres in Neuenstadt, Dormagen and Tamm (Germany).

TECHNICAL INFORMATION

From practical experience for practical use

Our Product Information and Service Information publications, technical brochures and posters keep you at the forefront of the latest technological developments.

TECHNICAL VIDEOS

Knowledge transfer via video

Our videos provide you with useful information on our products, such as hands-on fitting instructions and system descriptions.



PRODUCTS IN FOCUS ONLINE

Our solutions explained clearly

Interactive elements, animations and video clips provide interesting information about our products in and around the engine.

ONLINESHOP

Your direct access to our products

Order at any time. Quick availability check. Extensive product search by engine, vehicle, dimensions etc.

NEWS

Regular information via e-mail

Subscribe online to our free newsletter now and receive regular information about additions to the product range, technical publications and much more.

INDIVIDUAL INFORMATION

Especially for our customers

We provide extensive information and services relating to our wide range of services: e.g. personalised sales-promoting materials, sales support, technical support and much more.



TECHNIPEDIA

Technical information on all aspects of the engine

We share our know-how with you in our Technipedia. You can get professional knowledge direct from experts here.

MOTORSERVICE APP

Access technical know-how on the move

Here, you will find the latest information and services relating to our products quickly and easily.

SOCIAL MEDIA

Always up to date



www.ms-motorservice.com





1. ELECTRIC VALVES

SMALL COMPONENTS WITH A BIG IMPACT

Electric valves are important components for switching and controlling as well as for implementing comfort and safety functions. They are used for the purposes of operating pneumatic actuators or for switching between two or more states.

Valves offer great potential for the independent spare parts trade, since they can be monitored by the OBD system either directly or indirectly. If these valves fail, replacement is essential. Trust the OE quality of Pierburg, the market leader with an OE production of over 125,000 valves a day and more than 350 valves in series production.

PRODUCT RANGE

- 01** Switchover valve
- 02** Control valves and central magnets for camshaft adjustment
- 03** Pressure transducer
- 04** ACF shut-off valve (activated carbon filter valve)
- 05** ACF regeneration valve (activated carbon filter valve)
- 06** Recirculating air valve

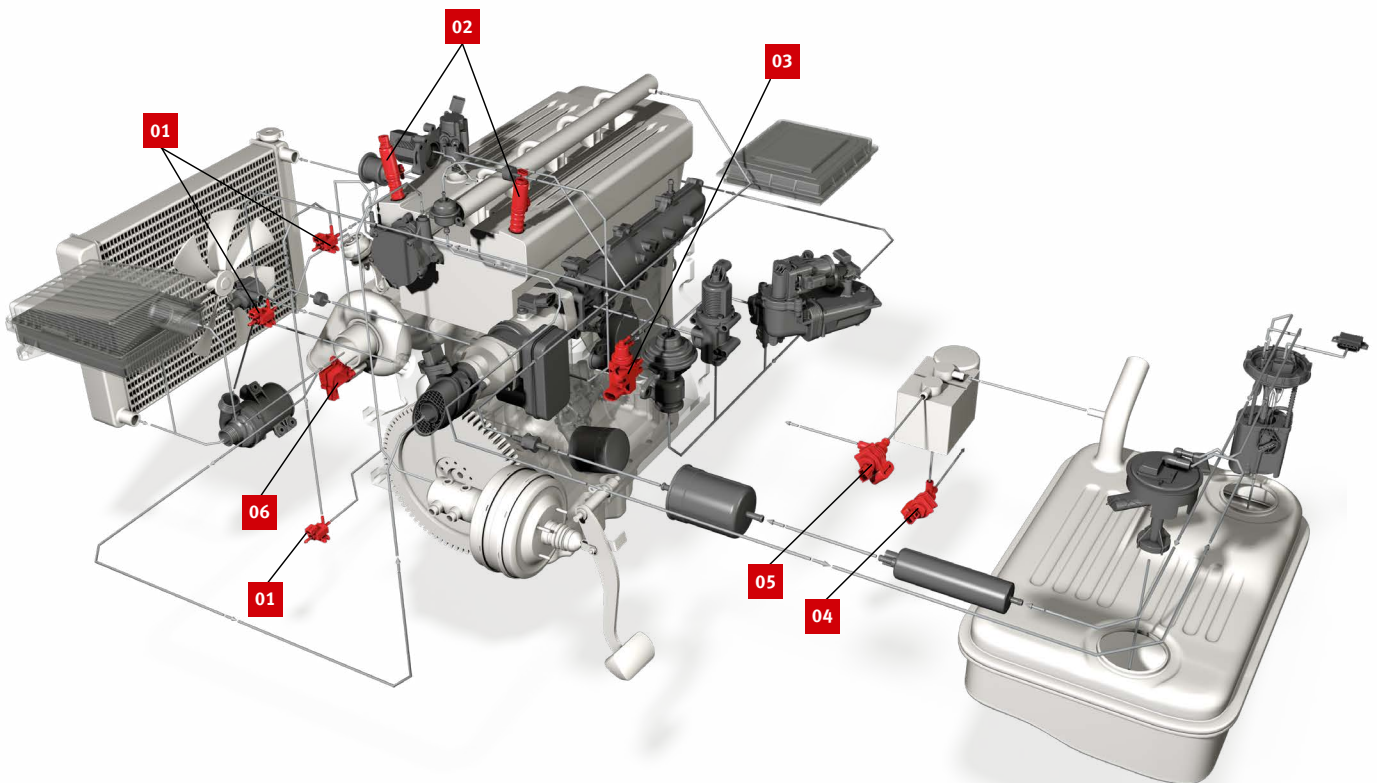

PRESSURE TRANSDUCERS

For continuous control of pneumatic EGR valves, VTG turbochargers and bypass EGR cooler switching.



SWITCHOVER VALVES

Switchover valves are used wherever a simple open-close function of the pneumatic actuators is needed, for e.g. for controlling boost pressure valves (wastegate), secondary air valves, intake manifold flaps and bypass flaps on EGR coolers.



ACTIVATED CARBON FILTER VALVES (ACF VALVES)

ACF valves are important components in the fuel tank ventilation system as well as the fuel tank leakage diagnosis. The fuel tank ventilation system stops fuel vapours containing harmful hydrocarbons from escaping into the atmosphere. It also provides air to the fuel tank, for example if a vacuum forms in the tank when fuel levels fall or the ambient temperature is low.



RECIRCULATING AIR VALVES

The recirculating air valve for boost pressure control prevents the turbocharger from slowing down unnecessarily when the throttle valve closes suddenly. This reduces the turbo lag effect significantly.



CONTROL VALVES AND CENTRAL MAGNETS FOR CAMSHAFT ADJUSTMENT

Depending on the engine speed, the control valves guide the oil flow through various oil channels to the respective chambers in the hydraulic camshaft adjuster. As a result, the camshaft is turned relative to the camshaft gear and the control times are altered. This improves operating behaviour under full load and part load, and reduces fuel consumption.



Vehicle and valve manufacturers sometimes use different designations for these components.

Here is a selection of alternative designations for the respective names:

- **Pressure transducer:** Electropneumatic pressure transducers (EPW), electric pressure transducer
- **Switchover valve:** Electric switchover valve (EUV), solenoid valve boost pressure limitation N75 (VW), solenoid switchover valve (VW), electric valve (BMW)
- **Electric pressure transducer:** Pressure transducer, valve (VW), electric valve (BMW), EDW, DW



2. INSTRUCTIONS FOR USING THE CATALOGUE

AT	Automatic transmission unit	MT	Manual transmissions		From / to engine number
EH	electro-hydraulic		With gasket		From / to chassis number
EL	Electric		Without gasket		Country version
EP	Electric-pneumatic				

ENGLISH

01	02	03	04	05	06	07	
							8
S40 I (644)							
1.8 85-90 kW (116-122 PS) B 4184 S2	06.2001→08.2003		7.07400.06.0* ↳ 7.02087.05.0	STE EUV-VB	EP EP		Without deposit return for used part. No return of the solenoid valve. Intake side
			7.22517.04.0 7.22240.15.0 7.22240.13.0 7.06117.16.0	AKF EUV-LS LDRV SV-NWV	EL EL EL EH		
			09	08			

01 Vehicle / engine

02 Model year from → to

03 Product group

04 7.xxxxx.xx.x
↳ 7.xxxxx.xx.x**

05 Article code*

06 Type of drive / version

07 Info / criteria

08 Article abbreviation*

09 Pierburg no.

* see list of abbreviations
** no longer available

PIERBURG NO.

			02			03			
						PIERBURG No.		123	
01	4.02003.62.0	LLR	43	7.02256.00.0	EUV-LS	28	7.02901.05.0	SUV	50
	7.00017.02.0	EUV-LS	28	7.02256.00.0	EUV-RK	31	7.02909.07.0	SUV	50
	7.00017.03.0	LDRV	39	7.02256.00.0	EUV-SL	31	7.02968.02.0	DW-TL	18

01 Pierburg no.
02 Article code
03 Figure / page

MAIN APPLICATIONS

		01			03
		02		04	
		electric valves			
EUV-SL	7.22880.01.0	EUV-SL	7.28098.15.0	EUV-SR	7.01039.03.0
→SI 0087 →SI 0096 →SI 0106		→SI 0096		→SI 0096	
AUDI A4 Avant (8ED, B7) A4 Avant (8K5, B8) A4 Convertible (8H7, B6, 8HE, B7) A4 (8EC, B7) A4 (8K2, B8) A5 Convertible (8F7)		AUDI ALLROAD (4BH, C5) A4 Avant (8ED, B7) A4 Avant (8E5, B6) A4 Convertible (8H7, B6, 8HE, B7) A4 (8EC, B7) A4 (8E2, B6) A6 Avant (4F5, C6) A6 (4F2, C6)		OPEL ASTRA G Convertible (T98) ASTRA G Coupe (T98) ASTRA G Estate (T98) ASTRA G Hatchback (T98) ASTRA H (A04) ASTRA H GTC (A04) SPEEDSTER (E01) ZAFIRA A MPV (T98)	
05					04

01 Pierburg no.
02 Article code
03 Product group
04 Product / Service Information
05 Vehicle

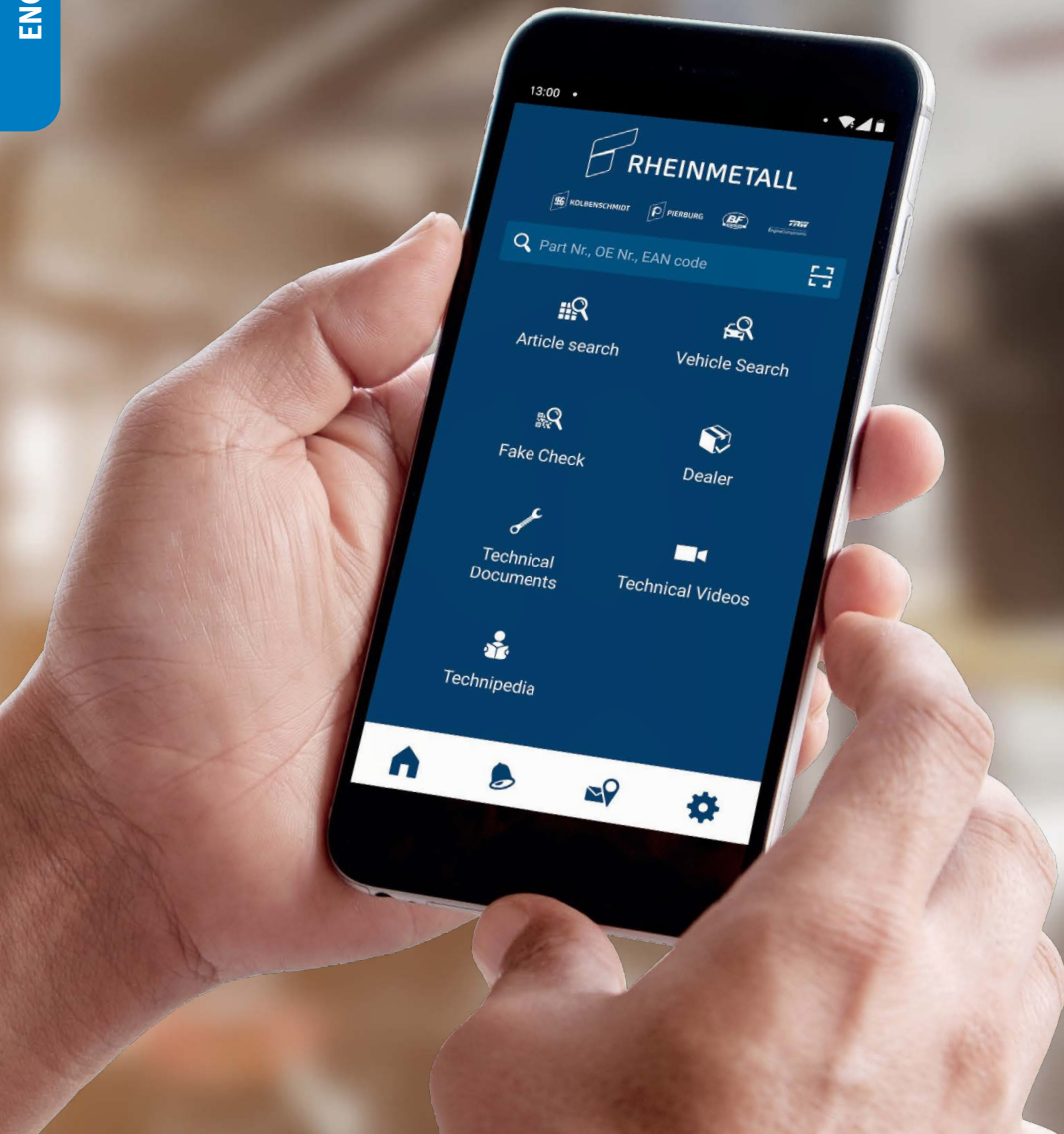

MOTORSERVICE APP

MOBILE ACCESS TO TECHNICAL KNOW-HOW



Find out more
www.ms-motorservice.com/app

REMARQUES IMPORTANTES

Toutes les informations figurant dans ce catalogue sont fournies sans engagement de notre part. Nous déclinons toute responsabilité quant à l'exactitude et l'exhaustivité des contenus. Si vous relevez des erreurs dans ce catalogue, n'hésitez pas à nous les communiquer : nous veillerons à les corriger dans les futures éditions.

Les noms, descriptions, numéros de véhicule ou de constructeur, etc. ne sont donnés qu'à titre de comparaison, tout comme les références des pièces d'origine des constructeurs automobiles ou de moteurs. Ces informations ne doivent pas être utilisées dans le cadre de communications externes car ce ne sont pas les désignations d'origine. Il est de plus impossible d'exclure que les constructeurs automobiles ou de moteurs n'apportent des modifications aux équipements et aux désignations. Nous déclinons donc toute responsabilité pour l'utilisation des listes de correspondances.

Nous nous réservons explicitement le droit d'apporter à tout moment des modifications aux spécifications de nos produits, aux matériaux utilisés, à leur aspect et à la composition des lots. Les illustrations du catalogue n'ont donc qu'une valeur indicative.

Avant le montage, vérifiez toujours que le produit acheté est adapté à l'usage prévu. Une quelconque qualité ou aptitude à un usage particulier ne peut être déduite de nos indications. Il convient notamment de noter que les produits proposés dans le catalogue ne sont pas destinés aux applications aérospatiales. Dans le cas de l'utilisation sur des moteurs off-highway (par ex. moteurs de marine, moteurs stationnaires ou moteurs de traction), tenir compte du fait que des pièces de moteur différentes (par ex. des pistons) peuvent être utilisées pour une même désignation du moteur. Le cas échéant, demandez conseil au constructeur ou à un concessionnaire agréé avant de monter les produits. Nous rappelons que le montage doit toujours être confié à des techniciens qualifiés et formés. Les illustrations, dessins schématiques et autres indications sont destinés à expliquer et à représenter nos produits ; ils ne peuvent en aucun cas servir de base au montage des pièces.

Toute duplication, imitation, diffusion ou reproduction, même partielle, du présent catalogue sans notre consentement écrit préalable et sans indication de la source est illicite. La présente édition remplace et annule toutes les éditions précédentes du catalogue.

CERTIFICATIONS

MS Motorservice International GmbH bénéficie d'un système de gestion de la qualité certifié conforme à ISO 9001 et d'un système de gestion de l'environnement certifié conforme à ISO 14001.





VOUS TROUVEREZ LES
INFORMATIONS DE CE
CATALOGUE DANS NOTRE
CATALOGUE EN LIGNE,
SUR NOTRE APPLICATION
ET SUR TECALLIANE.

Plus d'informations :
catalog.ms-motorservice.com
motorservice.app



CONTENU	PAGE
Remarques importantes	26
Gestion de la qualité	26
Transfert de savoir-faire – Compétence des experts	28
1. Réduction des émissions nocives	31
2. PRÉCISIONS SUR L'UTILISATION DU CATALOGUE	34
3. Principales applications / Illustrations	85
4. Complément de gamme	179
5. Liste de constructeurs	191
6. GAMME DE PRODUITS	195
7. Liste de références	1321
8. Marche à suivre en cas de réclamation / Formulaire de réclamation	

GRUPE MOTORSERVICE

QUALITÉ ET SERVICE AUPRÈS D'UN UNIQUE FOURNISSEUR

Le groupe Motorservice est l'organisation commerciale en charge des activités internationales Aftermarket de Rheinmetall. C'est l'un des premiers fournisseurs de composants de moteurs pour le marché indépendant des pièces de rechange. Avec les marques haut de gamme Kolbenschmidt, Pierburg, TRW Engine Components ainsi que les marques BF et turbo by Intec, Motorservice propose à ses clients commerçants et garagistes une gamme étendue et variée de très grande qualité.

RHEINMETALL

DES TECHNOLOGIES AU SERVICE DE LA MOBILITÉ DE DEMAIN

Équipementier automobile présent dans le monde entier, Rheinmetall se place, grâce à son savoir-faire dans les domaines de l'alimentation en air, de la réduction des émissions nocives et des pompes ainsi que dans le développement, la fabrication et la fourniture de pistons, de blocs-moteurs et de coussinets, en tête de ces marchés respectifs. Le développement des produits se déroule en étroite coopération avec des constructeurs automobiles renommés.

TRANSFERT DE SAVOIR-FAIRE LA COMPÉTENCE D'UN EXPERT

FORMATIONS DANS LE MONDE ENTIER

En direct du fabricant

Tous les ans, environ 4 500 mécaniciens et techniciens profitent de nos formations et des séminaires que nous organisons sur place, dans le monde entier, ou dans nos centres de formation de Neuenstadt, Dormagen et Tamm (Allemagne).

INFORMATIONS TECHNIQUES

Des informations issues de la pratique pour la pratique

Avec nos Product Information, Service Information, brochures techniques et posters, vous êtes à chaque instant à la pointe de la technique.

VIDÉOS TECHNIQUES

Transmission des connaissances par vidéo

Dans nos vidéos, vous trouverez des instructions de montage pratiques et des explications système concernant nos produits.



PLEINS FEUX SUR LES PRODUITS EN LIGNE

Nos solutions clairement expliquées

Au travers d'éléments interactifs, d'animations et de clips vidéo, apprenez tout ce qu'il faut savoir sur nos produits pour le moteur.

BOUTIQUE EN LIGNE

Votre accès direct à nos produits

Commande 24 h sur 24. Contrôle rapide de la disponibilité. Recherche produits exhaustive par moteur, véhicule, dimensions, etc.

NEWS

Informations régulières par e-mail

Inscrivez-vous vite en ligne à notre newsletter gratuite pour recevoir régulièrement des informations sur les nouveaux produits, les publications techniques et de nombreux autres sujets.

INFORMATIONS PERSONNALISÉES

Spécialement pour nos clients

Par notre intermédiaire, vous profitez d'informations et de services complets sur notre large gamme de prestations tels que du matériel de promotion des ventes personnalisé, des aides à la vente, un support technique et bien d'autres choses encore.



TECHNIPEDIA

Informations techniques concernant le moteur

Avec Technipedia, nous vous offrons un accès à notre savoir-faire. Vous y trouverez les connaissances techniques de nos experts directement.

L'APPLI MOTORSERVICE

Un accès mobile à notre savoir-faire technique

Vous y trouverez rapidement et facilement les informations et les services les plus à jour relatifs à nos produits.

MÉDIAS SOCIAUX

Toujours à jour

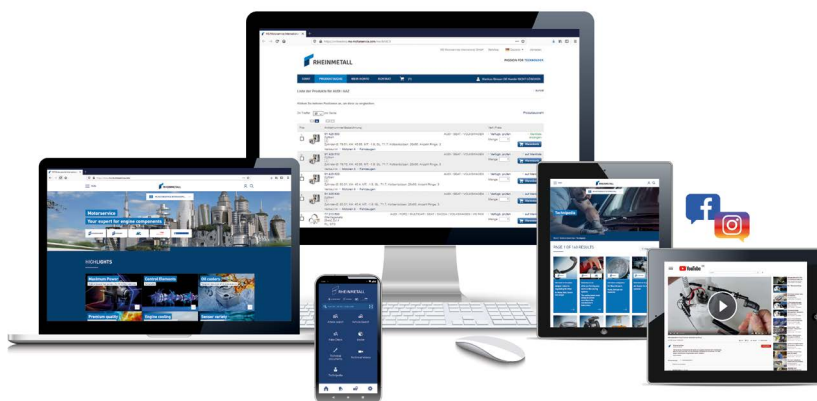

www.ms-motorservice.com





1. CLAPETS ÉLECTRIQUES

DE PETITS COMPOSANTS AUX EFFETS DÉMULTIPLIÉS

Les clapets électriques sont d'importants composants de commutation et de commande, indispensables aux fonctions de confort et de sécurité. Ils servent à actionner les actionneurs pneumatiques et à basculer entre deux états ou plus.

Dans la mesure où ils dépendent directement ou indirectement du système OBD, les clapets constituent un énorme potentiel pour le commerce des pièces de rechange. Lorsqu'ils tombent en panne, le remplacement est inévitable. Faites donc confiance à la qualité première monte de Pierburg, leader du marché, avec sa production de plus de 125 000 clapets de première monte par jour et de plus de 350 modèles de série.

GAMME DE PRODUITS

- 01** Vanne d'inversion
- 02** Clapets de commande et aimants centraux pour le réglage de l'arbre à cames
- 03** Convertisseur de pression
- 04** Clapet de coupure AKF (à filtre à charbon actif)
- 05** Valve de régénération AKF (à filtre à charbon actif)
- 06** Clapet d'air de recirculation

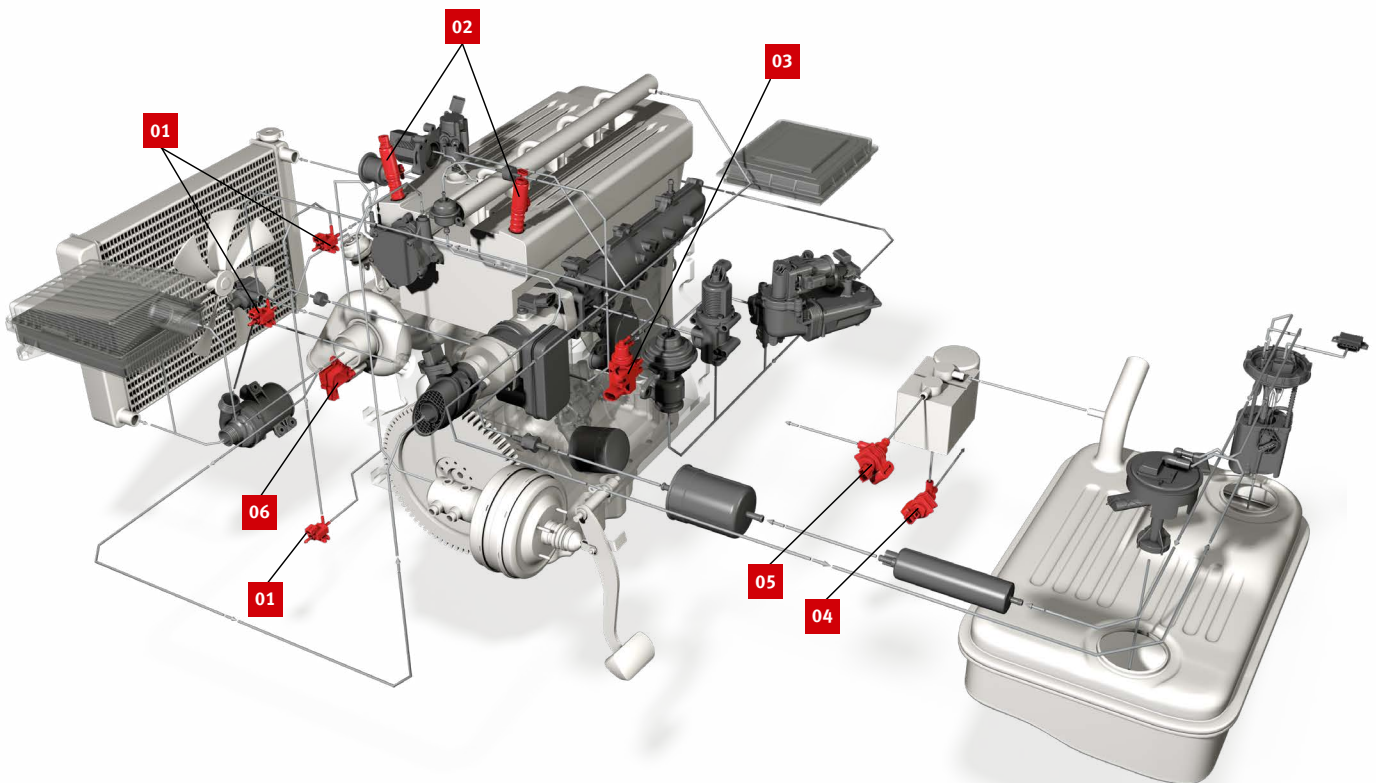

CONVERTISSEUR DE PRESSION

Pour la commande progressive des vannes EGR pneumatiques, des turbocompresseurs à géométrie variable et la commutation du bypass des refroidisseurs EGR.



VANNES D'INVERSION

Les vannes d'inversion sont généralement utilisées lorsqu'on souhaite une fonction d'ouverture-fermeture simple d'actionneurs pneumatiques, notamment pour la commande des soupapes de régulation de la suralimentation (wastegate), des valves d'air secondaire, des clapets du collecteur d'admission et des clapets bypass des refroidisseurs EGR.



CLAPETS DE COUPURE AKF (VALVES DE FILTRE À CHARBON ACTIVÉ)

Les clapets de coupure AKF sont des composants essentiels du système de ventilation du réservoir et du diagnostic de fuite du réservoir. Le système de ventilation du réservoir empêche le rejet dans l'environnement des vapeurs de carburant contenant des hydrocarbures nocifs. Il aère également le réservoir de carburant, si par exemple une dépression s'y produit, suite au prélèvement de carburant ou lorsque les températures extérieures sont basses.



CLAPETS D'AIR DE RECIRCULATION

Le clapet d'air de recirculation régule la pression de suralimentation pour éviter un freinage inutile du turbocompresseur en cas de fermeture soudaine du papillon. Ce qui réduit sensiblement l'effet de « trou du turbo ».



CLAPETS DE COMMANDE ET AIMANTS CENTRAUX POUR LE RÉGLAGE DE L'ARBRE À CAMES

Les clapets de commande dirigent le débit d'huile en fonction de la vitesse du moteur à travers les différents canaux d'huile des chambres du régulateur hydraulique de l'arbre à cames. Il s'ensuit une rotation de l'arbre à cames par rapport à la poulie d'arbre à cames qui modifie l'épure de distribution. De cette façon, le fonctionnement en pleine charge ou en charge partielle est amélioré, et la consommation réduite.



Les constructeurs automobiles et les fabricants de clapets utilisent des appellations parfois assez différentes pour leurs composants.

Voici une sélection d'appellations autres que les désignations utilisées :

- **Convertisseur de pression** : Convertisseur électropneumatique, EPW, convertisseur de pression électrique
- **Vanne d'inversion** : clapet d'inversion électrique, EUV, électrovanne de limitation de pression d'admission N75 (VW), électrovanne d'inversion (VW), électrovanne (BMW)
- **Convertisseur de pression électrique** : Convertisseur de pression, vanne (VW), électrovanne (BMW), EDW, DW



2. PRÉCISIONS SUR L'UTILISATION DU CATALOGUE

AT	Boîte de vitesses automatique	MT	Boîte de vitesses		A partir du / jusqu'au numéro de moteur
EH	électro-hydraulique		Avec joint		A partir du / jusqu'au numéro de châssis
EL	Electrique		Sans joint		Version pays
EP	Electropneumatique				

FRANÇAIS

PIERBURG		VOLVO					
S40 I (644)							8
1.8 85-90 kW (116-122 PS) B 4184 S2	06.2001→08.2003		7.07400.06.0* ↳ 7.02087.05.0	STE EUV-VB	EP EP		Without deposit return for used part. No return of the solenoid valve. Intake side
			7.22517.04.0 7.22240.15.0 7.22240.13.0 7.06117.16.0	AKF EUV-LS LDRV SV-NWV	EL EL EL EH		
			09	08			

01 Véhicule / Moteur	06 Mode d'entraînement / Modèle
02 Année de construction de → à	07 Infos / Critères
03 Groupe de produits	08 Sigles des articles*
04 7.xxxxx.xx.x ↳ 7.xxxxx.xx.x**	09 N° Pierburg
05 Code d'article*	





* voir liste des abréviations
** plus disponible

N° PIERBURG

PIERBURG			PIERBURG			PIERBURG			
			02			PIERBURG No. 123			
01	PIERBURG	i	PIERBURG	i	PIERBURG	PIERBURG	i	PIERBURG	
	4.02003.62.0	LLR	43	7.02256.00.0	EUV-LS	28	7.02901.05.0	SUV	50
	7.00017.02.0	EUV-LS	28	7.02256.00.0	EUV-RK	31	7.02909.07.0	SUV	50
	7.00017.03.0	LDRV	39	7.02256.00.0	EUV-SL	31	7.02968.02.0	DW-TL	18

01 N° Pierburg
02 Code d'article
03 Illustration / Page

APPLICATIONS PRINCIPALES

PIERBURG		01	PIERBURG		03	electric valves	
EUV-SL	7.22880.01.0	EUV-SL	7.28098.15.0	EUV-SR	7.01039.03.0		
							
→SI 0087 →SI 0096 →SI 0106		→SI 0096		→SI 0096		04	
05	AUDI	AUDI		OPEL			
	A4 Avant (8ED, B7) A4 Avant (8K5, B8) A4 Convertible (8H7, B6, 8HE, B7) A4 (8EC, B7) A4 (8K2, B8) A5 Convertible (8F7)	ALLROAD (4BH, C5) A4 Avant (8ED, B7) A4 Avant (8E5, B6) A4 Convertible (8H7, B6, 8HE, B7) A4 (8EC, B7) A4 (8E2, B6) A6 Avant (4F5, C6) A6 (4F2, C6)		ASTRA G Convertible (T98) ASTRA G Coupe (T98) ASTRA G Estate (T98) ASTRA G Hatchback (T98) ASTRA H (A04) ASTRA H GTC (A04) SPEEDSTER (E01) ZAFIRA A MPV (T98)			
01 N° Pierburg		04 Product / Service Information		02 Code d'article		05 Véhicule	
03 Groupe de produits							

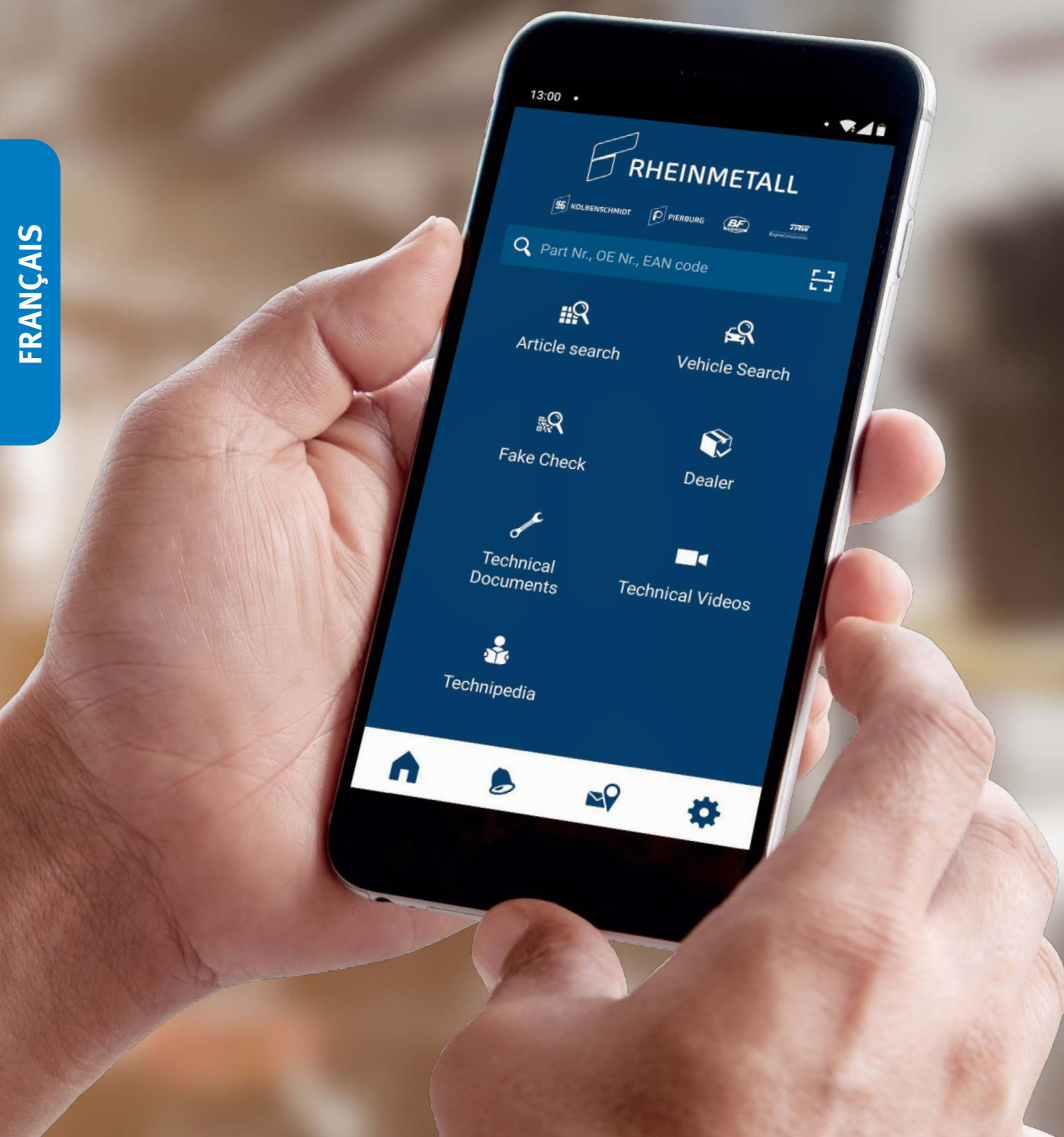

APPLICATION MOTORSERVICE ACCÈS MOBILE AU SAVOIR-FAIRE TECHNIQUE



Pour plus d'informations
www.ms-motorservice.com/app

INDICACIONES IMPORTANTES

Todos los datos de este catálogo no son vinculantes. No podemos asumir ninguna responsabilidad por su exactitud e integridad. La información sobre posibles errores en el catálogo es siempre bienvenida y será corregida en futuras ediciones.

Los nombres, descripciones y números de vehículos o fabricantes, entre otros, así como los números de pieza originales de los fabricantes de vehículos y motores, solo se indican con fines comparativos. Las indicaciones correspondientes no son denominaciones de origen y no pueden utilizarse con terceros. Tenga también en cuenta que no se pueden descartar modificaciones en el equipamiento por parte de los fabricantes de vehículos o motores, ni cambios en las denominaciones. Por lo tanto, no podemos asumir ninguna responsabilidad por el uso de las listas comparativas.

Nos reservamos expresamente el derecho de modificar en cualquier momento las especificaciones del producto, los materiales, el aspecto y el volumen de suministro de nuestros productos. Por lo tanto, las ilustraciones del catálogo no son vinculantes.

Antes del montaje, se debe comprobar siempre si el producto adquirido es adecuado para el uso previsto. De nuestra información no se puede derivar una afirmación sobre una determinada naturaleza o idoneidad para un uso determinado. En particular, hay que tener en cuenta que los productos ofrecidos en el catálogo no están destinados a ser utilizados en aeronaves o naves espaciales. Cuando se utilizan en motores fuera de carretera (p. ej. motores marinos, estacionarios o subterráneos) se debe tener en cuenta que, con la misma denominación del motor, pueden utilizarse diferentes piezas del motor (p. ej. pistones). En caso necesario, se debe solicitar el asesoramiento del fabricante o del taller autorizado antes de instalar los productos. Además, le informamos de que el montaje debe ser realizado siempre por personal técnico con formación. Las ilustraciones, los esquemas y demás indicaciones se muestran con fines explicativos e ilustrativos y no pueden utilizarse como base para la instalación.

Cualquier duplicación, imitación, distribución o reproducción pública de este catálogo, incluso parcial, solo está permitida con nuestro consentimiento previo por escrito y la correspondiente referencia a la fuente. Con la publicación de este catálogo, todas las ediciones anteriores pierden su validez.

CERTIFICACIONES

MS Motorservice International GmbH cuenta con un sistema de gestión de calidad certificado según ISO 9001 y un sistema de gestión medioambiental certificado según ISO 14001.





LOS CONTENIDOS DEL CATÁLOGO TAMBIÉN SE RECOGEN EN NUESTRO CATÁLOGO ONLINE, EN NUESTRA APLICACIÓN, ASÍ COMO EN TECALLIANCE.

Más información:
catalog.ms-motorservice.com
motorservice.app



CONTENIDO	PÁGINA
Indicaciones importantes	38
Gestión de calidad	38
Transferencia de conocimientos especiales: conocimientos técnicos del experto	40
1. Reducción de contaminantes	43
2. INDICACIONES PARA LA UTILIZACIÓN DEL CATÁLOGO	46
3. Aplicaciones principales / figuras de productos	85
4. Adición al programa	179
5. Índice de fabricantes	191
6. PROGRAMA DE PRODUCTOS	195
7. Lista de referencias	1321
8. Manera de proceder en caso de reclamación / formulario de reclamación	

GRUPO MOTORSERVICE

CALIDAD Y SERVICIO EN UN SOLO PROVEEDOR

El Grupo Motorservice es la organización de ventas y distribución para las actividades de servicio posventa de Rheinmetall en todo el mundo. Se trata de uno de los principales proveedores de componentes del motor en el mercado libre de piezas de repuesto. Gracias a las marcas de primera calidad Kolbenschmidt, Pierburg y TRW Engine Components, así como a las marcas BF y turbo by Intec, Motorservice ofrece a sus clientes comerciales y de talleres un amplio y completo surtido de máxima calidad.

RHEINMETALL

TECNOLOGÍAS PARA LA MOVILIDAD DEL FUTURO

Como proveedor automotriz internacional, Rheinmetall está a la cabeza en los mercados correspondientes gracias a su gran competencia en los sectores de alimentación de aire, reducción de contaminantes y bombas, así como en el desarrollo, producción y suministro de piezas de repuesto para pistones, bloques de motor y cojinetes de fricción. El desarrollo de productos se efectúa en estrecha colaboración con fabricantes de automóviles de renombre.

TRANSFERENCIA DE EXPERIENCIAS CONOCIMIENTOS TÉCNICOS DEL EXPERTO

CURSOS FORMATIVOS EN TODO EL MUNDO

Directamente del fabricante

Aualmente, alrededor de 4.500 mecánicos y técnicos se benefician de nuestros cursos formativos y seminarios, que realizamos a escala mundial in situ o también en nuestros centros de formación en Neuenstadt y Dormagen y Tamm (Alemania).

INFORMACIONES TÉCNICAS

De la práctica para la práctica

Con las Product Information, las Service Information, los folletos técnicos y los pósters, estará usted siempre a la vanguardia de la técnica.

VÍDEOS TÉCNICOS

Difusión de conocimientos por vídeo

En nuestros vídeos encontrará indicaciones prácticas para el montaje y aclaraciones sistemáticas sobre nuestros productos.



PRODUCTOS EN EL PUNTO DE MIRA ONLINE

Nuestras soluciones explicadas de forma gráfica

Conozca, gracias a los elementos interactivos, las animaciones y los clips de vídeo, aspectos curiosos de nuestros productos para y acerca del motor.

TIENDA ONLINE

Su acceso directo a nuestros productos

Realice pedidos las 24 horas. Rápida comprobación de la disponibilidad. Amplia búsqueda de productos del motor, el vehículo, las dimensiones, etc.

NOVEDADES

Informaciones regulares por e-mail

Suscríbase de forma online a nuestro Newsletter gratuito y recibirá periódicamente informaciones sobre productos recién incluidos, publicaciones técnicas y mucho más.

INFORMACIONES INDIVIDUALES

Especialmente para nuestros clientes

Le ofrecemos numerosas informaciones y servicios sobre nuestro amplio espectro de prestaciones: como por ejemplo, materiales de promoción de ventas personalizados, asistencias de ventas, soporte técnico y mucho más.



TECNIPEDIA

Informaciones técnicas en torno al motor

En nuestra Tecnipedia compartimos con usted nuestra experiencia. Aquí podrá encontrar conocimientos técnicos directamente del experto.

APLICACIÓN DE MOTORSERVICE

Acceso móvil a la experiencia técnica

Aquí podrá obtener de forma rápida y sencilla las informaciones y los servicios más actuales acerca de nuestros productos.

MEDIOS SOCIALES

Siempre actual



www.ms-motorservice.com





1. VÁLVULAS ELÉCTRICAS

PEQUEÑOS COMPONENTES CON GRAN EFECTO

Las válvulas eléctricas son componentes importantes para cambiar y controlar, así como en la realización de funciones para la comodidad y la seguridad. Se emplean para el accionamiento de actuadores neumáticos o sirven para conmutar entre dos o más estados.

Las válvulas ofrecen un gran potencial para el comercio de piezas de repuesto, porque las supervisa directa o indirectamente el sistema OBD. En caso del fallo de las válvulas se hace indispensable una sustitución. Confíe en la calidad de repuestos originales del líder del mercado Pierburg con una producción de recambios originales de más de 125 000 válvulas diarias y más de 350 válvulas en serie.

PROGRAMA DE PRODUCTOS

- 01** Válvula de inversión
- 02** Válvulas de mando y los imanes centrales para el ajuste del árbol de levas
- 03** Convertidor de presión
- 04** Válvula de cierre con filtro de carbón activo
- 05** Válvula de regeneración AKF (filtro de carbón activo)
- 06** Válvula de aire circulante en régimen de retención

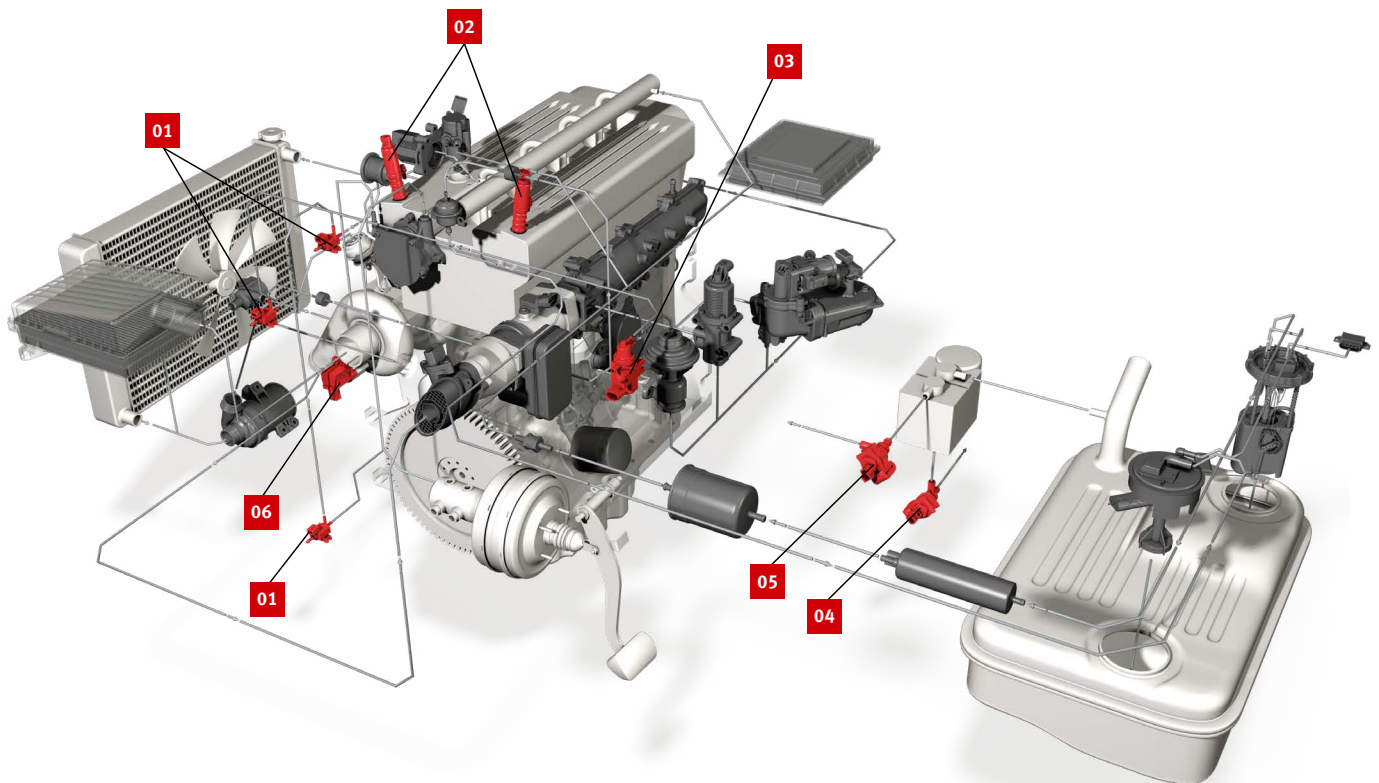

CONVERTIDOR DE PRESIÓN

Para el control en progresión continua de válvulas neumáticas EGR, turbocargadores VTG, la conmutación bypass del radiador EGR.



VÁLVULAS DE INVERSIÓN

Las válvulas de inversión se emplean donde sea necesaria una función sencilla de abrir-cerrar de los actuadores neumáticos, p. ej., para el control de válvulas de presión de sobrealimentación (wastegate), válvulas de aire secundario, colectores de admisión y válvulas mariposa by-pass en radiadores EGR.



VÁLVULAS DEL FILTRO DE CARBÓN ACTIVO (VÁLVULA AKF)

Las válvulas AKF son componentes importantes en el sistema de ventilación del depósito, así como en el diagnóstico de fugas del depósito. El sistema de ventilación del depósito impide que los vapores del combustible con hidrocarburos nocivos afecten al medio ambiente. También ventila el depósito de combustible cuando se genera, por ejemplo, un vacío en el depósito, debido al combustible extraído o a las bajas temperaturas exteriores.



VÁLVULAS DE AIRE CIRCULANTE EN RÉGIMEN DE RETENCIÓN

La válvula de aire circulante en régimen de retención para la regulación de presión de carga impide el frenado innecesario del turbocargador si se cierra repentinamente la válvula de mariposa. Esto disminuye claramente el efecto de caída en la sobrealimentación.



VÁLVULAS DE MANDO (REGULACIÓN DE LA PRESIÓN DE ADMISIÓN) E IMANES CENTRALES PARA EL AJUSTE DEL ÁRBOL DE LEVAS

En función del régimen del motor, las válvulas de mando conducen el caudal de aceite a través de los diferentes canales de aceite hacia las cámaras correspondientes en el ajustador hidráulico del árbol de levas. Con esto, el árbol de levas se gira relativamente respecto a la rueda de árbol de levas y modifica las fases de distribución. De este modo se mejora el comportamiento de la marcha con carga parcial y plena carga, y se reduce el consumo.



Los fabricantes de vehículos y válvulas emplean en parte designaciones diferentes para estos componentes. A continuación, presentamos una selección de designaciones alternativas para las correspondientes denominaciones:

- **Convertidor de presión:** Transductor electroneumático, EPW, transductor eléctrico de presión
- **Válvula de inversión:** Válvula electromagnética de conmutación, EUV, válvula electromagnética de limitación de presión de sobrealimentación N75 (VW), válvula electromagnética de conmutación (VW), válvula eléctrica (BMW)
- **Transductor eléctrico de presión:** Convertidor de presión, válvula (VW), válvula eléctrica (BMW), EDW, DW



2. INDICACIONES PARA LA UTILIZACIÓN DEL CATÁLOGO

AT	Transmisión automática
EH	electro-hidráulico
EL	Eléctrico
EP	Electroneumático

MT	Caja de cambios
	Con junta
	Sin junta

	Desde / hasta número del motor
	Desde / hasta número del chasis
	Ejecución para diferentes países

01

02

03

04

05

06

07

VOLVO

S40 I (644)							8
<p>1.8 85-90 kW (116-122 PS) B 4184 S2</p>	<p>06.2001→08.2003</p>	<p> 7.22517.04.0 AKF</p> <p>7.22240.15.0 EUV-LS</p> <p>7.22240.13.0 LDRV</p> <p>7.06117.16.0 SV-NWV</p>	<p>7.07400.06.0* STE</p> <p>↳ 7.02087.05.0 EUV-VB</p>	<p>EP</p> <p>EP</p> <p>EL</p> <p>EL</p> <p>EL</p> <p>EH</p>	<p></p> <p>Without deposit return for used part. No return of the solenoid valve. Intake side</p>		

01 Vehículo / motor

02 Año de construcción desde → hasta

03 Grupo de productos

04 7.xxxxx.xx.x
↳ 7.xxxxx.xx.x**

05 Código de artículo*

06 Modo de accionamiento / versión

07 Inform. / criterios

08 Abreviatura de artículo*

09 N.º Pierburg

* Véase la lista de abreviaturas

** Ya no está disponible

ESPAÑOL

N.º PIERBURG

			02						
						PIERBURG No.		123	
01	4.02003.62.0	LLR	43	7.02256.00.0	EUV-LS	28	7.02901.05.0	SUV	50
	7.00017.02.0	EUV-LS	28	7.02256.00.0	EUV-RK	31	7.02909.07.0	SUV	50
	7.00017.03.0	LDRV	39	7.02256.00.0	EUV-SL	31	7.02968.02.0	DW-TL	18

01 N.º Pierburg
02 Código de artículo
03 Figura / página

APLICACIONES PRINCIPALES

		01				03	
		electric valves					
EUV-SL	7.22880.01.0	EUV-SL	7.28098.15.0	EUV-SR	7.01039.03.0		
		02					
		05				04	
AUDI A4 Avant (8ED, B7) A4 Avant (8K5, B8) A4 Convertible (8H7, B6, 8HE, B7) A4 (8EC, B7) A4 (8K2, B8) A5 Convertible (8F7)		→SI 0087 →SI 0096 →SI 0106		AUDI ALLROAD (4BH, C5) A4 Avant (8ED, B7) A4 Avant (8E5, B6) A4 Convertible (8H7, B6, 8HE, B7) A4 (8EC, B7) A4 (8E2, B6) A6 Avant (4F5, C6) A6 (4F2, C6)		OPEL ASTRA G Convertible (T98) ASTRA G Coupe (T98) ASTRA G Estate (T98) ASTRA G Hatchback (T98) ASTRA H (A04) ASTRA H GTC (A04) SPEEDSTER (E01) ZAFIRA A MPV (T98)	
		04					

01 N.º Pierburg
02 Código de artículo
03 Grupo de productos
04 Product Information / Service Information
05 Vehículo



APLICACIÓN MOTORSERVICE ACCESO MÓVIL A LA EXPERIENCIA TÉCNICA



Saber más
www.ms-motorservice.com/app

INFORMAZIONI IMPORTANTI

Tutte le informazioni contenute in questo catalogo sono non vincolanti. Decliniamo ogni responsabilità quanto alla loro correttezza e completezza. Le segnalazioni di eventuali errori presenti nel catalogo sono sempre benvenute e verranno utilizzate a fini di rettifica delle edizioni future.

I nomi, le descrizioni e i numeri dei veicoli o dei costruttori ecc., nonché i numeri delle parti originali dei costruttori di veicoli e motori, sono indicati solo a scopo di confronto. Tali indicazioni non costituiscono denominazioni di origine e non possono essere utilizzate nei confronti di terzi. Si noti, inoltre, che non si possono escludere modifiche all'attrezzatura da parte dei costruttori di veicoli o motori né modifiche alle denominazioni. Pertanto, non ci assumiamo nessuna responsabilità riguardo all'uso delle liste di comparazione.

Ci riserviamo espressamente di modificare in qualsiasi momento le specifiche, i materiali, l'aspetto e l'ambito di consegna dei nostri prodotti. Le illustrazioni del catalogo non sono quindi vincolanti.

Prima dell'installazione, verificare sempre che il prodotto acquistato sia idoneo all'uso che se ne intende fare. Dalle nostre informazioni non è lecito desumere affermazioni su una particolare natura o sull'idoneità a uno scopo particolare. Si noti, in particolare, che i prodotti presentati nel catalogo non sono destinati all'uso in automobili e veicoli spaziali. In caso di utilizzo in motori Off-Highway (ad es. marini, stazionari o ferroviari), tenere presente che per la stessa denominazione di motore possono trovare impiego componenti del motore differenti (ad es. pistoni). Pertanto, prima dell'installazione dei prodotti potrebbe essere necessario il parere di un esperto del produttore o della sua officina autorizzata. Si ricorda, inoltre, che l'installazione deve sempre essere eseguita da personale specializzato e qualificato. Le illustrazioni, i disegni schematici e le altre informazioni hanno uno scopo illustrativo e esplicativo e non possono essere utilizzate come base per l'installazione.

Qualsiasi riproduzione, imitazione, distribuzione o comunicazione pubblica di questo catalogo, anche in estratti, è consentita solo con il nostro preventivo consenso scritto, e citando correttamente la fonte. Con la pubblicazione di questo catalogo tutte le precedenti edizioni perdono di validità.

CERTIFICAZIONI

MS Motorservice International GmbH dispone di un sistema di gestione della qualità certificato ISO 9001 e di un sistema di gestione ambientale certificato ISO 14001.





I CONTENUTI DEL CATALOGO SONO CONSULTABILI ANCHE NEL NOSTRO CATALOGO ONLINE, NELLA NOSTRA APP E IN TECALLIANCE.

Maggiori informazioni:
catalog.ms-motorservice.com
motorservice.app



CONTENUTO	PAGINA
Avvertenze importanti	50
Gestione della qualità	50
Trasferimento di know-how – competenza tecnica di esperti	52
1. Riduzione delle sostanze nocive	55
2. AVVERTENZE SULL'UTILIZZO DEL CATALOGO	58
3. Applicazioni principali / illustrazioni prodotti	85
4. Integrazione programma	179
5. Elenco dei produttori	191
6. APPLICAZIONI PRODOTTI	195
7. Liste corrispondenze	1321
8. Modo di procedere in caso di reclamo / modulo reclami	

GRUPPO MOTORSERVICE

QUALITÀ E ASSISTENZA DA UN UNICO FORNITORE

Il gruppo Motorservice è l'organizzazione di distribuzione per le attività aftermarket di Rheinmetall a livello globale. L'azienda rappresenta uno dei fornitori leader per componenti del motore nel mercato libero dei ricambi. Con i marchi premium Kolbenschmidt, Pierburg, TRW Engine Components e i marchi BF e turbo by Intec, Motorservice offre ai suoi rivenditori e alle officine un ampio e vario assortimento di elevata qualità.

RHEINMETALL

TECNOLOGIE PER LA MOBILITÀ DEL FUTURO

In qualità di partner privilegiato dell'industria automobilistica, Rheinmetall è leader a livello mondiale nei settori dell'alimentazione dell'aria, della riduzione delle sostanze nocive e delle pompe nonché nello sviluppo, nella produzione e nella fornitura di ricambi di pistoni, blocchi motore e cuscinetti a strisciamento. Lo sviluppo dei prodotti avviene in stretta collaborazione con i principali costruttori automobilistici.

TRASFERIMENTO DI KNOW-HOW CONSULENZA DI ESPERTI

FORMAZIONE A LIVELLO GLOBALE

Direttamente dal produttore

Ogni anno circa 4.500 meccanici e tecnici colgono l'opportunità e partecipano ai nostri corsi di formazione e seminari che organizziamo in loco in tutto il mondo o anche nei nostri centri di formazione a Dormagen e Tamm (Germania).

INFORMAZIONI TECNICHE

Consigli pratici per il lavoro quotidiano

Con le Product Information, le Service Information, le brochure e i poster tecnici lo stato attuale della tecnica non è più un mistero.

VIDEO TECNICI

La comunicazione scientifica tramite video

Nei nostri video tecnici potrete trovare avvertenze per il montaggio orientate alla pratica e spiegazioni sul sistema relative ai nostri prodotti.



PRODOTTI IN PRIMO PIANO ONLINE

Le nostre soluzioni spiegate dettagliatamente

Tramite gli elementi interattivi, le animazioni e i videoclip imparerete tutto quello che è utile sapere sui prodotti e sul motore.

ONLINESHOP

Accesso diretto ai nostri prodotti

Ordini 24 ore su 24. Verifica rapida della disponibilità. Ampia ricerca prodotti in base a motore, a veicolo, dimensioni, etc.

NOTIZIE

Informazioni regolari per e-mail

Iscrivetevi ora online alla nostra newsletter gratuita. Riceverete regolarmente informazioni sui nuovi prodotti, sulle pubblicazioni tecniche e tanto altro ancora.

INFORMAZIONI PERSONALIZZATE

Appositamente per i nostri clienti

Vi forniremo informazioni dettagliate e assistenza sul nostro ampio spettro di servizi: come ad es. materiale di promozione delle vendite, supporto alle vendite, assistenza tecnica e tanto altro ancora.



TECHNIPEDIA

Informazioni tecniche sul motore

Nella nostra Technipedia condividiamo con voi il nostro vasto know-how. Avrete accesso diretto alle conoscenze tecniche dei nostri esperti.

MOTORSERVICE APP

Accesso mobile al know-how tecnico

Qui troverete in modo semplice e rapido informazioni aggiornate e assistenza sui nostri prodotti.

SOCIAL MEDIA

Aggiornamento costante



www.ms-motorservice.com





ITALIANO

1. VALVOLE ELETTRICHE

PICCOLI COMPONENTI CON GRANDE EFFICACIA

Le valvole elettriche sono componenti importanti per il comando e il controllo, nonché nell'ambito della realizzazione di funzionalità comfort e di sicurezza. Sono responsabili dell'azionamento degli attuatori pneumatici oppure si occupano della commutazione tra due o più stati.

Le valvole offrono un grande potenziale per il mercato libero dei ricambi, poiché possono essere controllate direttamente o indirettamente dal sistema OBD. In caso di avaria delle valvole la sostituzione è indispensabile. Affidatevi alla qualità OE del leader di mercato Pierburg, il quale vanta una produzione OE di oltre 125.000 valvole al giorno e oltre 350 valvole di serie.

GAMMA DI PRODOTTI

- 01** Valvola di commutazione
- 02** Valvole di comando e magneti centrali per la regolazione dell'albero a camme
- 03** Convertitore di pressione
- 04** Valvola di intercettazione FCA (valvola filtro a carbone attivo)
- 05** Valvola di rigenerazione FCA (valvola filtro a carbone attivo)
- 06** Valvola di ricircolo dell'aria in fase di rilascio

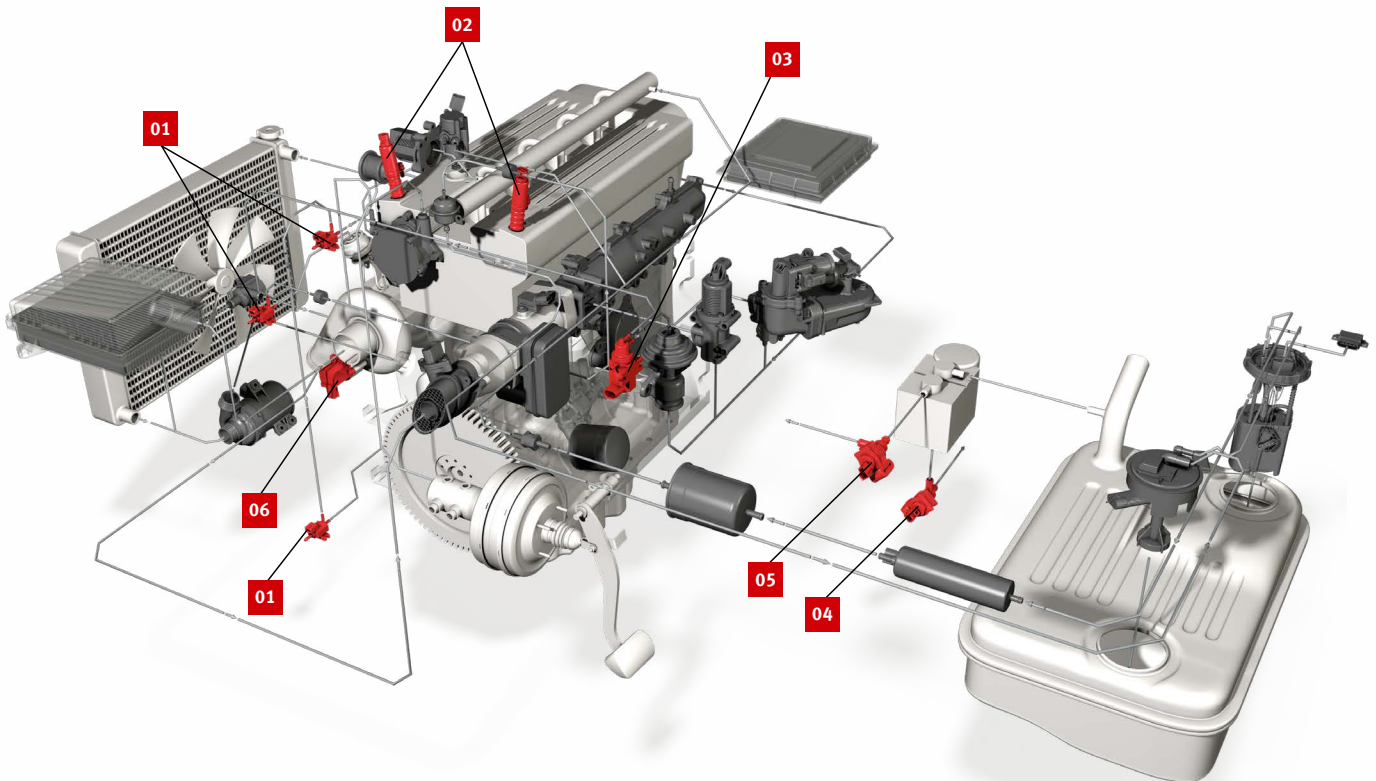

CONVERTITORE DI PRESSIONE

Per il comando in continuo di valvole EGR pneumatiche, turbocompressori VTG e commutazione del bypass del radiatore EGR.



VALVOLE DI COMMUTAZIONE

Le valvole di commutazione sono principalmente utilizzate per la semplice funzione di apertura / chiusura degli attuatori pneumatici, ad es. per il comando di valvole pressione di sovralimentazione (waste-gate), valvole aria secondaria, valvole sul collettore di aspirazione e farfalle di bypass dei radiatori EGR.



VALVOLE FILTRO A CARBONE ATTIVO (VALVOLE FCA)

Le valvole FCA sono componenti importanti nel sistema di sfiato serbatoio nonché nella diagnosi di perdite nel serbatoio. Il sistema di sfiato serbatoio impedisce che i vapori di carburante con gli idrocarburi inquinanti vengano rilasciati nell'ambiente. Il sistema di sfiato serbatoio sfiata inoltre il serbatoio del carburante, ad es. quando a seguito del prelievo di carburante o delle basse temperature esterne nel serbatoio del carburante si crea una depressione.



VALVOLE DI RICIRCOLO DELL'ARIA IN FASE DI RILASCIO

La valvola di ricircolo dell'aria in fase di rilascio per la regolazione della pressione di sovralimentazione impedisce una decelerazione non necessaria del turbocompressore alla chiusura improvvisa della valvola a farfalla. Ciò minimizza in misura notevole l'effetto "turbo-lag".



VALVOLE DI COMANDO E MAGNETI CENTRALI PER LA REGOLAZIONE DELL'ALBERO A CAMME

In base al numero di giri del motore le valvole di comando conducono il flusso dell'olio attraverso i vari canali dell'olio alle rispettive camere del regolatore idraulico dell'albero a camme. In questo modo l'albero a camme viene fatto ruotare rispetto al suo ingranaggio, modificando i tempi di attuazione. La regolazione dell'albero riduce i consumi e migliora il comportamento d'esercizio a carico ridotto e pieno carico.



I costruttori automobilistici e i produttori di valvole in parte usano denominazioni diverse per i loro componenti. Riportiamo qui un elenco selezionato di denominazioni alternative alla nomenclatura adottata:

- **Convertitore di pressione:** Convertitore elettropneumatico, EPW, convertitori di pressione elettrico
- **Valvola di commutazione:** Elettrovalvola di commutazione, EUV, valvola elettromagnetica, pressione di sovralimentazione N75 (VW), valvola elettromagnetica di commutazione (VW), elettrovalvola (BMW)
- **Convertitore di pressione elettrico:** Convertitore di pressione, valvola (VW), elettrovalvola (BMW), EDW, DW



2° AVVERTENZE SULL'UTILIZZO DEL CATALOGO

AT	Cambio automatico
EH	elettro-idraulica
EL	Elettrico
EP	Elettropneumatico

MT	Cambio
	Con guarnizione
	Senza guarnizione

	A partire dal / fino al numero del motore
	A partire dal / fino al numero di telaio
	Versione nazionale

01

02

03

04

05

06

07

VOLVO

S40 I (644)						8
<p>1.8 85-90 kW (116-122 PS) B 4184 S2</p>	<p>06.2001→08.2003</p>	<p> 7.22517.04.0 AKF</p> <p>7.22240.15.0 EUV-LS</p> <p>7.22240.13.0 LDRV</p> <p>7.06117.16.0 SV-NWV</p>	<p>7.07400.06.0* STE</p> <p>↳ 7.02087.05.0 EUV-VB</p>	<p>EL</p> <p>EL</p> <p>EL</p> <p>EH</p>	<p>EP</p> <p>EP</p>	<p> Without deposit return for used part. No return of the solenoid valve. Intake side</p>

09

08

<p>01 Veicolo / motore</p> <p>02 Anno di costruzione da → a</p> <p>03 Gruppo prodotti</p> <p>04 7.xxxxx.xx.x ↳ 7.xxxxx.xx.x**</p> <p>05 Codice articolo*</p>	<p>06 Tipo di azionamento / versione</p> <p>07 Info / criteri</p> <p>08 Abbreviazione articolo*</p> <p>09 N. Pierburg</p>
---	---

* vedere indice abbreviazioni
** non più disponibile

N. PIERBURG

			02						
						PIERBURG No.		03 123	
01	4.02003.62.0	LLR	43	7.02256.00.0	EUV-LS	28	7.02901.05.0	SUV	50
	7.00017.02.0	EUV-LS	28	7.02256.00.0	EUV-RK	31	7.02909.07.0	SUV	50
	7.00017.03.0	LDRV	39	7.02256.00.0	EUV-SL	31	7.02968.02.0	DW-TL	18

01 N. Pierburg
02 Codice articolo
03 Figura / pagina

APPLICAZIONI PRINCIPALI

		01				03	
		electric valves					
EUV-SL	7.22880.01.0	EUV-SL	7.28098.15.0	EUV-SR	7.01039.03.0		
		02					
		05					
		04					
AUDI A4 Avant (8ED, B7) A4 Avant (8K5, B8) A4 Convertible (8H7, B6, 8HE, B7) A4 (8EC, B7) A4 (8K2, B8) A5 Convertible (8F7)		→SI 0087 →SI 0096 →SI 0106 AUDI ALLROAD (4BH, C5) A4 Avant (8ED, B7) A4 Avant (8E5, B6) A4 Convertible (8H7, B6, 8HE, B7) A4 (8EC, B7) A4 (8E2, B6) A6 Avant (4F5, C6) A6 (4F2, C6)		OPEL ASTRA G Convertible (T98) ASTRA G Coupe (T98) ASTRA G Estate (T98) ASTRA G Hatchback (T98) ASTRA H (A04) ASTRA H GTC (A04) SPEEDSTER (E01) ZAFIRA A MPV (T98)		→SI 0096 04	
01 N. Pierburg 02 Codice articolo 03 Gruppo prodotti		04 Product / Service Information 05 Veicolo					



MOTORSERVICE APP ACCESSO MOBILE AL NOSTRO KNOW-HOW TECNICO



Per maggiori informazioni
www.ms-motorservice.com/app

ВАЖНЫЕ УКАЗАНИЯ

Все приведенные в этом каталоге данные не являются обязательными. Мы не можем принять на себя ответственность за их правильность и полноту. Мы всегда рады получить информацию о возможных допущенных в каталоге ошибках, которые мы исправляем в следующих изданиях.

Названия, описания и номера автомобилей, производителей и т. п., а также оригинальные артикулы производителей автомобилей и двигателей приводятся только для сравнения. Соответствующие данные не являются данными о происхождении и не могут быть использованы против третьих лиц. Просим вас также учитывать, что не исключаются изменения в оснащении, внесенные производителями автомобилей или двигателей, а также изменения обозначений. По этой причине мы не можем принять на себя ответственность за использование списков сравнения.

Мы оставляем за собой право в любое время изменять спецификации, материалы, внешний вид и комплекты поставки наших компонентов. Поэтому приведенные в каталоге рисунки не являются обязательными.

Перед установкой всегда необходимо проверять пригодность приобретенного компонента к использованию в намеченных целях. На основании предоставленных нами данных нельзя делать заключения о наличии определенных характеристик или о пригодности к использованию в какой-либо области применения. В частности, следует учесть, что предлагаемые в каталоге компоненты не предназначены для использования в воздушных и космических транспортных средствах. В случае применения в двигателях, не предназначенных для дорожного транспорта (напр., судовых и стационарных двигателях, а также тяговых двигателях рельсового транспорта) необходимо учитывать, что при одном и том же обозначении двигателей в них могут использоваться разные компоненты (например, поршни). По этой причине перед установкой компонентов может потребоваться компетентная консультация производителя или авторизованной СТО. Мы также обращаем ваше внимание на то, что установку компонентов всегда должны выполнять квалифицированные специалисты. Рисунки, схематические чертежи и прочие данные используются для пояснения и иллюстрации; они не могут служить основой для установки.

Любое копирование, повторение, распространение или публичная демонстрация настоящего каталога или его частей возможны только с нашего предварительного письменного согласия с соответствующим указанием источника. С момента выпуска данного каталога все предыдущие издания теряют свою силу.

СЕРТИФИКАТЫ

Компания MS Motorservice International GmbH успешно прошла сертификацию системы менеджмента качества по ISO 9001 и системы экологического менеджмента по ISO 14001.





ИНФОРМАЦИЯ КАТАЛОГА СОДЕРЖИТСЯ ТАКЖЕ В НАШЕМ ОНЛАЙН-КАТАЛОГЕ, В НАШЕМ ПРИЛОЖЕНИИ И НА TDCALLIANCE.

Дополнительная информация:
catalog.ms-motorservice.com
[motorservice.app](#)

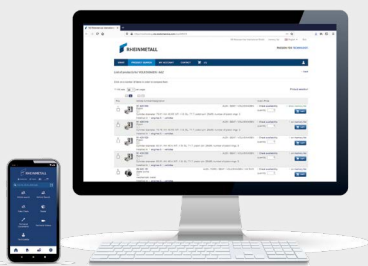

СОДЕРЖАНИЕ

СТР.

Важные указания	62
Менеджмент качества	62
Передача ноу-хау: специальные знания от эксперта	64
1. Уменьшение содержания вредных веществ	67
2. УКАЗАНИЯ ПО ПОЛЬЗОВАНИЮ КАТАЛОГОМ	70
3. Основные области применения / изображения компонентов	85
4. Дополнение к программе	179
5. Перечень производителей	191
6. ПРОИЗВОДСТВЕННЫЙ АССОРТИМЕНТ	195
7. Список сравнения	1321
8. Процедура рассмотрения рекламаций / формуляр для рекламаций	

ГРУППА MOTORSERVICE

КАЧЕСТВО И СЕРВИС ИЗ ОДНИХ РУК

Группа Motorservice — это организация по сбыту продукции концерна Rheinmetall, активно действующая на мировом рынке послепродажного обслуживания автомобилей. Она является ведущей фирмой, предлагающей компоненты двигателей для свободного рынка запасных частей. Клиенты Motorservice получают из магазинов и СТО широкий и глубокий ассортимент продукции высочайшего качества, охватывающий премиум-марки Kolbenschmidt, Pierburg, TRW Engine Components, а также марки VF и turbo by Intec.

RHEINMETALL

ТЕХНОЛОГИИ В СФЕРЕ МОБИЛЬНОСТИ БУДУЩЕГО

В качестве поставщика автомобильной промышленности в мировом масштабе Rheinmetall, благодаря своему профессионализму, занимает на соответствующих рынках ведущие в мире позиции в таких областях, как снабжение воздухом, уменьшение содержания вредных веществ и насосы, а также по разработке и производству поршней, блоков цилиндров двигателей и подшипников скольжения, включая поставку запасных частей к ним. Разработка продуктов осуществляется в тесном сотрудничестве с известными компаниями-производителями транспортных средств.

ПЕРЕДАЧА НОУ-ХАУ СПЕЦИАЛЬНЫЕ ЗНАНИЯ ОТ ЭКСПЕРТА

КУРСЫ ОБУЧЕНИЯ ПО ВСЕМУ МИРУ

Напрямую от изготовителя

Ежегодно около 4 500 механиков и техников приобретают новые знания на наших курсах обучения и семинарах, которые мы проводим как на местах, в различных странах мира, так и в наших учебных центрах, расположенных в Нойенштадте, Дормагене и Тамме (Германия).

ТЕХНИЧЕСКАЯ ИНФОРМАЦИЯ

Практические навыки для практического применения

Благодаря нашим Product Information, Service Information, техническим брошюрам и плакатам Вы всегда будете идти в ногу со временем.

ТЕХНИЧЕСКИЕ ВИДЕОФИЛЬМЫ

Передача знаний по видео

Наши видеофильмы содержат проверенные на практике инструкции по монтажу и системные пояснения к нашим продуктам.



ПРОДУКТЫ В ФОКУСЕ ВНИМАНИЯ ОНЛАЙН

Наглядное описание наших решений

Вы узнаете много интересного о наших продуктах, установленных внутри двигателя и вокруг него, благодаря интерактивным элементам, анимации и видеороликам.

ВИРТУАЛЬНЫЙ МАГАЗИН

Ваш прямой доступ к нашим продуктам

Оформление заказов круглосуточно. Быстрый контроль наличия. Обширный поиск продуктов по двигателю, транспортному средству, размерам и т. д.

НОВОСТИ

Регулярно рассылаемая по e-mail информация

Подпишитесь онлайн на наш бюллетень, и Вы будете регулярно и бесплатно получать информацию о новых продуктах в программе, технические издания и многое другое.

ИНДИВИДУАЛЬНАЯ ИНФОРМАЦИЯ

Специально для наших заказчиков

Подробная информация и сервис из нашего обширного спектра услуг, например: индивидуализированные материалы для содействия сбыту, поддержка сбыта, техническая поддержка и многое другое.



ТЕХНИПЕДИЯ

Техническая информация, связанная с двигателями

В нашей технпедии мы поделимся с Вами своими ноу-хау. Здесь Вы найдете специальные знания напрямую от эксперта.

ПРИЛОЖЕНИЕ MOTORSERVICE

Мобильный доступ к техническому ноу-хау

Здесь Вы быстро и просто получите самую актуальную информацию и услуги по нашим продуктам.

СОЦИАЛЬНЫЕ СЕТИ

Всегда в курсе



www.ms-motorservice.com





РУССКИЙ

1. ЭЛЕКТРИЧЕСКИЕ КЛАПАНЫ

МАЛЕНЬКИЕ КОМПОНЕНТЫ БОЛЬШОЙ ВАЖНОСТИ

Электрические клапаны являются важными компонентами для переключения и управления, а также для реализаций функций комфорта и безопасности. Они применяются для управления пневматическими исполнительными элементами или служат для переключения между двумя или несколькими состояниями.

Поставка клапанов на независимый рынок запасных частей имеет большой потенциал, поскольку они непосредственно или косвенно контролируются системой бортовой диагностики (OBD). Если клапаны выходят из строя, требуется их замена. Положитесь на конвейерное качество компании Pierburg – ведущего производителя для сборочных линий OEM, выпускающего свыше 125 000 клапанов в день и более 350 типов клапанов для серийного производства автомобилей.

ПРОИЗВОДСТВЕННЫЙ АССОРТИМЕНТ

- 01** Переключающий клапан
- 02** Управляющие клапаны и центральные магниты для механизмов изменения фаз газораспределения
- 03** Преобразователь давления
- 04** Запорный клапан адсорбера (клапан системы поглощения топливных испарений)
- 05** Клапан продувки адсорбера (клапан системы поглощения топливных испарений)
- 06** Рециркуляционный воздушный клапан

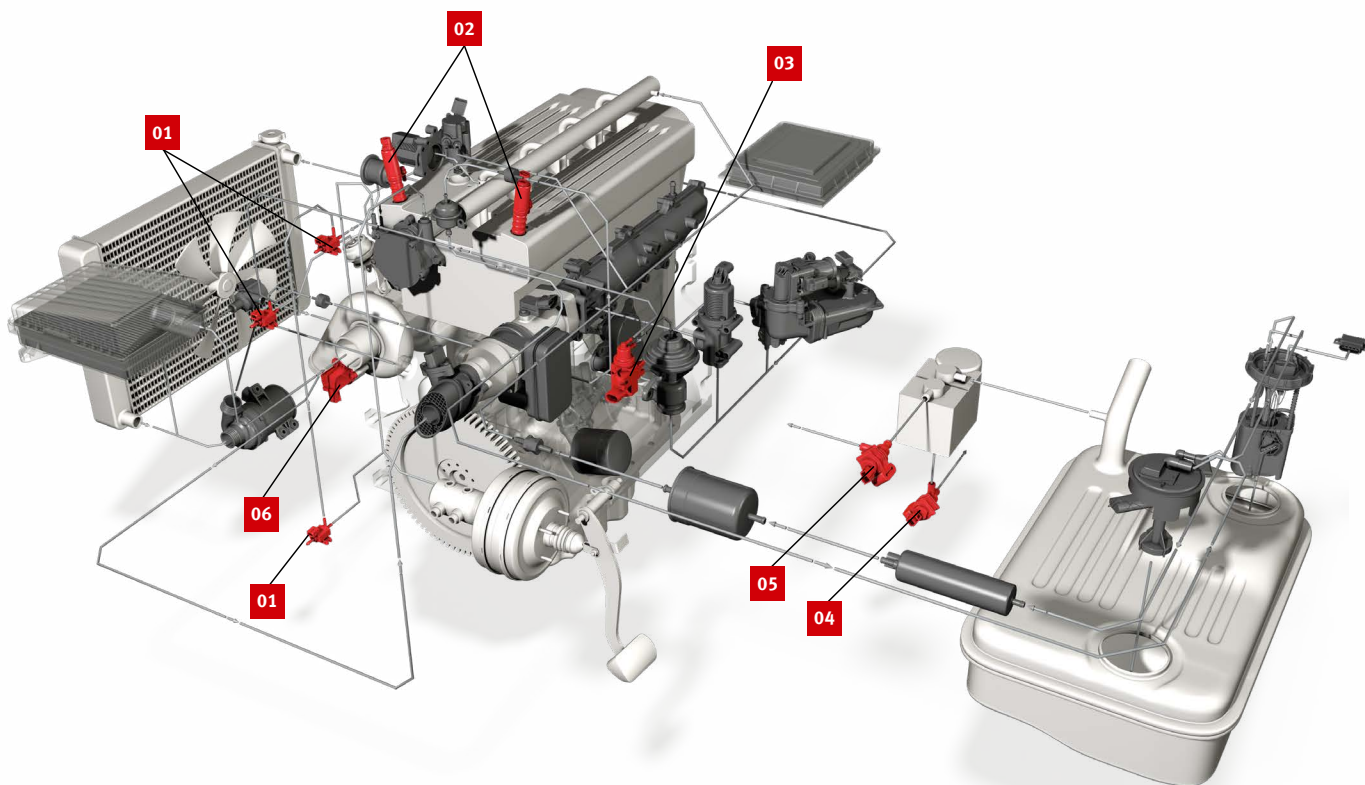

ПРЕОБРАЗОВАТЕЛИ ДАВЛЕНИЯ

Используются для плавного управления пневматическими клапанами EGR, турбонагнетателями VTG, а также для переключения байпасного канала охладителя системы EGR.



ПЕРЕКЛЮЧАЮЩИЕ КЛАПАНЫ

Переключающие клапаны используются там, где требуется простая функция открытия и закрытия пневматических исполнительных элементов, например, для управления перепускными клапанами турбины (wastegate), клапанами вторичного воздуха, заслонками впускного коллектора и байпасными клапанами охладителей системы EGR.



КЛАПАНЫ СИСТЕМЫ ПОГЛОЩЕНИЯ ТОПЛИВНЫХ ИСПАРЕНИЙ (КЛАПАНЫ УГОЛЬНОГО АДСОРБЕРА)

Клапаны угольного адсорбера играют важную роль в работе системы поглощения топливных испарений, также как и при диагностике её негерметичности. Система поглощения топливных испарений предотвращает утечку в атмосферу топливных паров с содержанием вредных углеводородов. Кроме того, она обеспечивает поступление воздуха в топливный бак, если, например, из-за снижения уровня топлива или понижения наружной температуры, в топливном баке возникает разрежение.



РЕЦИРКУЛЯЦИОННЫЕ ВОЗДУШНЫЕ КЛАПАНЫ

Рециркуляционный воздушный клапан системы турбонаддува предотвращает нежелательное замедление турбонагнетателя при резком закрытии дроссельной заслонки. Это позволяет значительно снизить эффект турбоямы.



УПРАВЛЯЮЩИЕ КЛАПАНЫ И ЦЕНТРАЛЬНЫЕ МАГНИТЫ ДЛЯ МЕХАНИЗМА ИЗМЕНЕНИЯ ФАЗ ГАЗОРАСПРЕДЕЛЕНИЯ

В зависимости от оборотов и нагрузки двигателя, управляющие клапаны обеспечивают прохождение потока масла по различным масляным каналам к соответствующим камерам в гидравлической муфте изменения фаз газораспределения. За счет этого происходит смещение распределительного вала относительно своей приводной шестерни и изменение фаз газораспределения. Это позволяет улучшить рабочие характеристики двигателя при частичной и полной нагрузке и снизить расход топлива.



Производители клапанов и производители автомобилей в ряде случаев используют различающиеся названия для этих компонентов.

Ниже представлен частичный обзор альтернативных вариантов названий:

- **Преобразователь давления:** электропневматический преобразователь, EPW, электрический преобразователь давления
- **Переключающий клапан:** электрический клапан двойного действия, EUV, электромагнитный клапан ограничения давления наддува N75 (VW), электромагнитный переключающий клапан (VW), электроклапан (BMW)
- **Электрический преобразователь давления:** преобразователь давления, клапан (VW), электроклапан (BMW), EDW, DW



2. УКАЗАНИЯ ПО ПОЛЬЗОВАНИЮ КАТАЛОГОМ

AT	Автоматическая коробка передач	MT	Ступенчатая коробка передач		Начиная с / до номера двигателя
EH	электрический-гидравлический		С уплотнением		Начиная с / до номера шасси
EL	Электрический		Без уплотнения		Экспортное исполнение
EP	Электропневматический				

VOLVO

S40 I (644)			8
1.8 85-90 kW (116-122 PS) B 4184 S2	06.2001→08.2003	7.07400.06.0* STE ↳ 7.02087.05.0 EUV-VB 7.22517.04.0 AKF 7.22240.15.0 EUV-LS 7.22240.13.0 LDRV 7.06117.16.0 SV-NWV	EP Without deposit return for used part. EP No return of the solenoid valve. Intake side EL EL EL EH

01 Автомобиль / двигатель

02 Год выпуска с → по

03 Группа компонентов

04 7.xxxxx.xx.x
↳ 7.xxxxx.xx.x**

05 Код изделия*

06 Вид привода / исполнение

07 Информация / критерии

08 Сокращенное обозначение изделия*

MOTORSERVICE مجموعة الجودة والخدمة من مصدر واحد

تعد مجموعة Motorservice شركة مبالاء سويديا نشطة ما بعدة بصتمخا عوزيتلا مؤسسها Rheinmetall شركة قدمت مع ساولا بارغلا عطة قسوي محركات فلما وفير مكونات في فدانارلا شركاتلا إحدى في هو Motorservice تميزتلا جاريتملا حل اماتلا هم ايلوذج قجود في اعلة بلصوا قة كبير لشكيت شورلاو تجارتلا نها منعمل Kolbenschmidt و Pierburg و TRW Engine Components لاضجارية فلما حل اماتلا ن BF و turbo by Intec.

RHEINMETALL

تقنيات للتقل في المستقبل

بصفتها مورد سيارات على مستوى العالم، تتمتع شركة Rheinmetall بالكفاءة العليا في الأسواق المعنية في مجالات إمداد الهواء، وخفض الانبعاثات الضارة والمضخات وكذلك في تطوير وتصنيع وتوريد قطع غيار المكابيس وكتل المحركات والمحامل الانزلاقية. يتم تطوير المنتجات بالتعاون الوثيق مع مُصنعي السيارات المعروفين.

PIERBURG №

			PIERBURG No.			123			
01	4.02003.62.0	LLR	43	7.02256.00.0	EUV-LS	28	7.02901.05.0	SUV	50
	7.00017.02.0	EUV-LS	28	7.02256.00.0	EUV-RK	31	7.02909.07.0	SUV	50
	7.00017.03.0	LDRV	39	7.02256.00.0	EUV-SL	31	7.02968.02.0	DW-TL	18

01 Pierburg №
02 Код изделия
03 Рисунок / страница

ОСНОВНЫЕ ОБЛАСТИ ПРИМЕНЕНИЯ

				electric valves	
EUV-SL	7.22880.01.0	EUV-SL	7.28098.15.0	EUV-SR	7.01039.03.0
→SI 0087 →SI 0096 →SI 0106		→SI 0096		→SI 0096	
AUDI A4 Avant (8ED, B7) A4 Avant (8K5, B8) A4 Convertible (8H7, B6, 8HE, B7) A4 (8EC, B7) A4 (8E2, B6) A6 Avant (4F5, C6) A6 (4F2, C6)		AUDI ALLROAD (4BH, C5) A4 Avant (8ED, B7) A4 Avant (8E5, B6) A4 Convertible (8H7, B6, 8HE, B7) A4 (8EC, B7) A4 (8E2, B6) A6 Avant (4F5, C6) A6 (4F2, C6)		OPEL ASTRA G Convertible (T98) ASTRA G Coupe (T98) ASTRA G Estate (T98) ASTRA G Hatchback (T98) ASTRA H (A04) ASTRA H GTC (A04) SPEEDSTER (E01) ZAFIRA A MPV (T98)	
05	AUDI	04		Product / Service Information	
01 Pierburg № 02 Код изделия 03 Группа компонентов		05 Автомобиль			

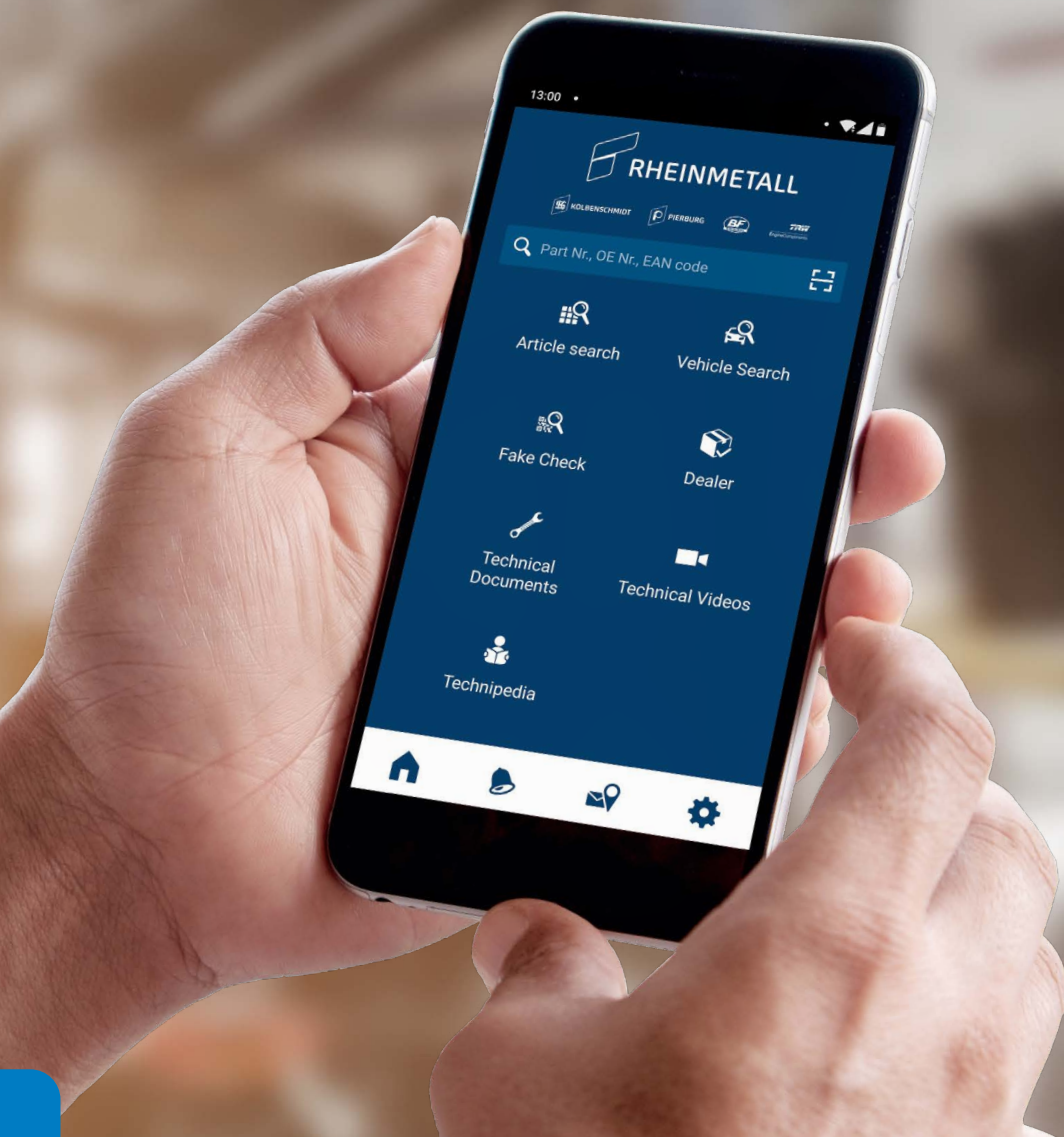

ПРИЛОЖЕНИЕ MOTORSERVICE МОБИЛЬНЫЙ ДОСТУП К ТЕХНИЧЕСКОМУ НОУ-ХАУ



Узнать больше
www.ms-motorservice.com/app

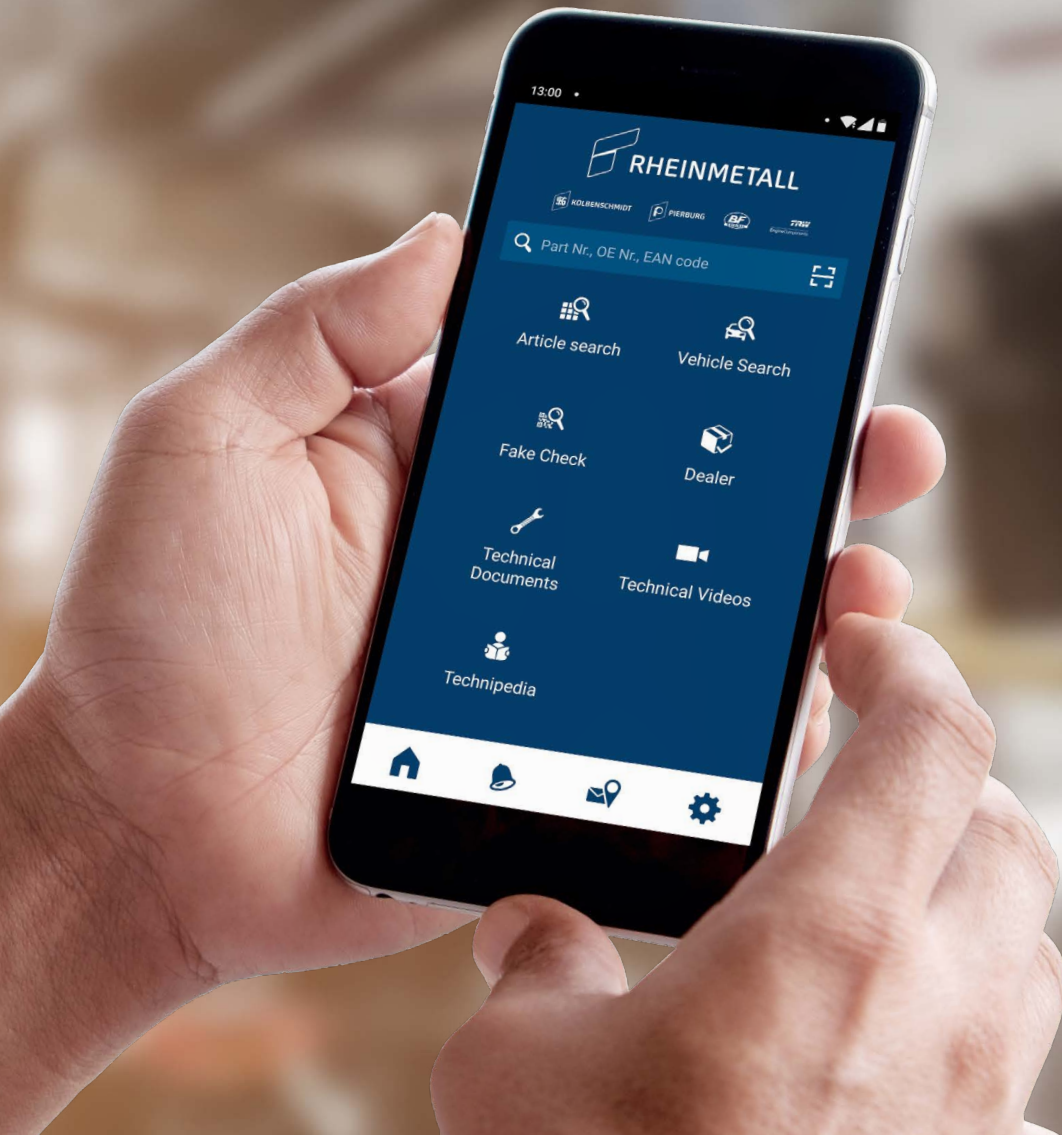

MOTORSERVICE تطبيق مدخل متحرك إلى المعارف الفنية

تعرف على المزيد
www.ms-motorservice.com/app
باللغة الإنجليزية





PIERBURG رقم

PIERBURG			PIERBURG			PIERBURG No. 123		
PIERBURG	i		PIERBURG	i		PIERBURG	i	
4.02003.62.0	LLR	43	7.02256.00.0	EUV-LS	28	7.02901.05.0	SUV	50
7.00017.02.0	EUV-LS	28	7.02256.00.0	EUV-RK	31	7.02909.07.0	SUV	50
7.00017.03.0	LDRV	39	7.02256.00.0	EUV-SL	31	7.02968.02.0	DW-TL	18

01 Pierburg رقم
02 كود المنتج
03 الصورة/ الصفحة

التطبيقات الرئيسية

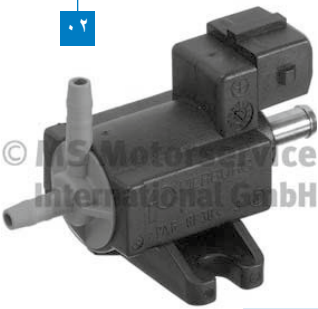
PIERBURG		PIERBURG		electric valves	
EUV-SL	7.22880.01.0	EUV-SL	7.28098.15.0	EUV-SR	7.01039.03.0
	→SI 0087 →SI 0096 →SI 0106		→SI 0096		→SI 0096
AUDI	A4 Avant (8ED, B7) A4 Avant (8K5, B8) A4 Convertible (8H7, B6, 8HE, B7) A4 (8EC, B7) A4 (8K2, B8) A5 Convertible (8F7)	AUDI	ALLROAD (4BH, C5) A4 Avant (8ED, B7) A4 Avant (8E5, B6) A4 Convertible (8H7, B6, 8HE, B7) A4 (8EC, B7) A4 (8E2, B6) A6 Avant (4F5, C6) A6 (4F2, C6)	OPEL	ASTRA G Convertible (T98) ASTRA G Coupe (T98) ASTRA G Estate (T98) ASTRA G Hatchback (T98) ASTRA H (A04) ASTRA H GTC (A04) SPEEDSTER (E01) ZAFIRA A MPV (T98)

04 معلومات عن المنتج / الخدمة
05 سيارة
01 Pierburg رقم
02 كود المنتج
03 مجموعة المنتجات

٢- إرشادات حول استخدام الكتالوج

بدا من/حتى رقم المحرك		ناقل الحركة اليدوي	MT	ناقل الحركة الأوتوماتيكي	AT
بدا من/حتى رقم الشاشة		مع جوان			EH
تصميم لبلدان معينة		بدون جوان			EL
					EP

8					
S40 I (644)					
1.8 85-90 kW (116-122 PS) B 4184 S2		06.2001→08.2003	7.07400.06.0* → 7.02087.05.0	STE EUV-VB	EP EP Without deposit return for used part. No return of the solenoid valve. Intake side
			7.22517.04.0 7.22240.15.0 7.22240.13.0 7.06117.16.0	AKF EUV-LS LDRV SV-NWV	EL EL EL EH

٠٥ كود المنتج*

٠٦ طريقة الإدارة / التصميم

٠٧ معلومات / معايير

٠٨ مختصر المنتج*

٠٩ رقم Pierburg

٠١ السيارة / المحرك

٠٢ سنة الصنع من ← حتى

٠٣ مجموعة المنتجات

٠٤ 7.XXXXX.XX.X ←

7.XXXXX.XX.X ←

* انظر فهرس الاختصاصات
** لم يعد متوفراً



محول الضغط

للتحكم المباشر في الصمامات البنيوماتيكية لإعادة تدوير العادم والشاحن التوربيني VTG ولتحويل تفرقة مبرد نظام إعادة تدوير العادم.



صمامات التحويل

تستخدم صمامات التحويل في المواضع التي يكون فيها من الضروري استخدام وظيفة الفتح والغلق للضوابط البنيوماتيكية، مثلاً لغرض التحكم في صمامات ضغط الشحن وصمامات الهواء الثانوي وصمامات أنبوب السحب وصمامات التفرقة بمبردات إعادة تدوير العادم.



صمامات فلتر الكربون النشط

صمامات فلتر الكربون النشط هي أجزاء تركيبية هامة في نظام تصريف الهواء عن خزان الوقود وفي نظام تشخيص مواضع التسريب بالخزان. يحول نظام تصريف الهواء عن الخزان دون وصول أبخرة الوقود المحملة بمواد هيدروكربونية إلى البيئة. وهو بالإضافة إلى ذلك يقوم بتهوية خزان الوقود عندما ينشأ على سبيل المثال ضغط منخفض في خزان الوقود جراء الوقود المتصرف أو درجات الحرارة الخارجية المنخفضة.

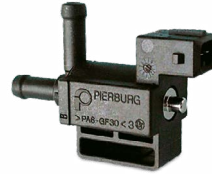

صمامات تدوير الهواء بالدفع

يمنع صمام تدوير الهواء بالدفع الخاص بالتحكم في ضغط الشحن الكبج غير الاضطرابي للشاحن التوربيني عند الغلق المفاجئ للصمام الخانق، الأمر الذي يمنع تأثير الثقب التوربيني بوضوح.



صمامات التحكم والمغناطيسات المركزية لتعديل ضبط عمود الكامات

ارتباطاً بعدد لفات المحرك فإن صمامات التحكم تقوم بتوجيه تدفق الزيت عبر قنوات الزيت المختلفة إلى الغرف ذات الصلة في ضابض عمود الكامات الهيدروليكي. وبالتالي يتم تدوير عمود الكامات بشكل نسبي إلى ترس عمود الكامات وتغيير أوقات التحكم. وبهذه الطريقة يتم تحسين سلوك التشغيل في وضع الحمل الجزئي والكامل ويتم تقليل الاستهلاك.



شركات تصنيع السيارات والصمامات تستخدم مسميات مختلفة نوعاً ما للمكونات التي تعمل بها. وفيما يلي عرض لمسميات بديلة للمسميات المعنية:

- **محول الضغط:**
كهربائي محول كهربائي بنيوماتيكي، نظام EPW، محول ضغط
- **صمام تحويل:**
صمام مغناطيسي صمام تحويل كهربائي، صمام التحويل الكهربائي، لتحديد ضغط الشحن N75 (فولكس فاجن)،
الكهربائي (بي إم دبليو) صمام التحويل المغناطيسي (فولكس فاجن)، الصمام
- **محول ضغط كهربائي:**
محول ضغط، صمام (فولكس فاجن)، صمام كهربائي
(بي إم دبليو)، EDW، DW

مجموعة المنتجات

١. صمام تحويل
٢. صمامات التحكم ومغناطيسات مركزية لتعديل ضبط عمود الكامات
٣. محول الضغط
٤. صمام إغلاق فلتر الكربون الفعال
٥. صمام إعادة توليد فلتر الكربون الفعال
٦. صمام تدوير هواء بالدفع

١. الصمامات الكهربائية

أجزاء تركيبية صغيرة بفعالية كبيرة

الصمامات الكهربائية هي أجزاء تركيبية هامة تقوم بالتوصيل والتحكم ولها دور أيضا في تحقيق وظائف الراحة والأمان. ويتم استخدامها لتشغيل عناصر الضبط البيوميكانيكية أو أنها تقوم بالتحويل بين حالتين أو أكثر.

الصمامات توفر إمكانية كبيرة لسوق قطع الغيار الحر، حيث يتم مراقبتها بشكل مباشر أو غير مباشر من قبل نظام OBD. عند تعطل الصمامات فيجب تغييرها على الفور. ضع ثقتك في جودة التجهيزات الأصلية لشركة Pierburg، رائدة السوق التي تتجاوز طاقتها الإنتاجية للتجهيزات الأصلية ١٢٥,٠٠٠ صمام في اليوم وأكثر من ٣٥٠ صمام قياسيا.

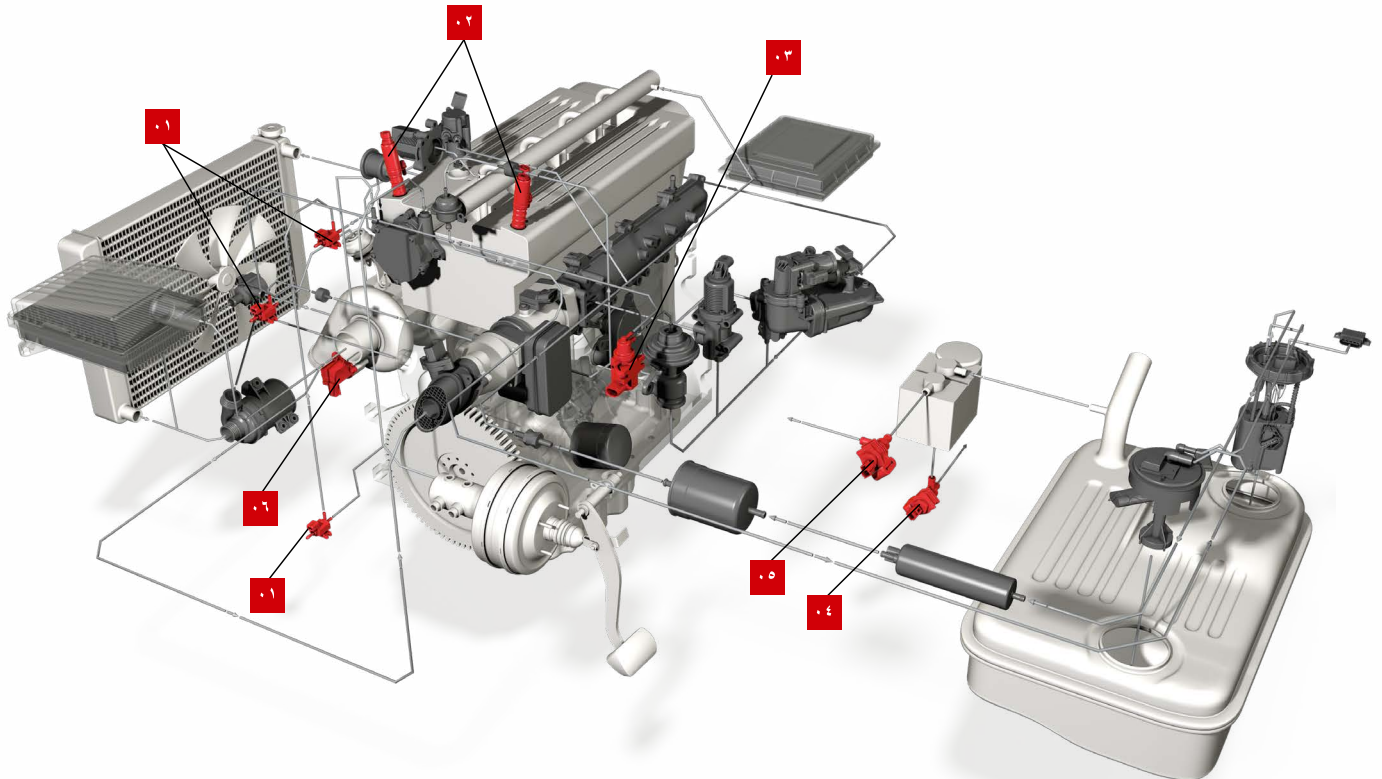





نقل المعرفة الفنية المتخصصة المعرفة الفنية المتخصصة للخبير

دورات تدريب في جميع أنحاء العالم

من الجهة الصانعة مباشرة

يوجد حوالي ٤٥٠٠ ميكانيكي وفي يستفيدون سنويًا من الدورات التدريبية والسيمنارات التي نعددها في موقعك في جميع أنحاء العالم أو في مراكزنا التدريبية في نوينشتاد ودورماجن وتام (ألمانيا).

معلومات فنية

من ربح التدريب العملي لواقع التدريب العملي

من خلال ما نوفره من معلومات للمنتج ومعلومات الخدمة والكتيبات والملصقات الفنية فسوف تكون دائمًا مواكبًا لأحدث مستوى معرفي في المجال التقني.

مقاطع فيديو فنية

نقل المعرفة عن طريق الفيديو

ستجد في مقاطع الفيديو التي نقدمها إرشادات تركيبية عملية وشروحات خاصة بنظم منتجاتنا.

YouTube

البويرة مسلطة على المنتجات أونلاين

حولنا موضحة بشكل مرئي

من خلال العناصر التفاعلية والصور المتحركة ومقاطع الفيديو يمكنك الاستعلام عن منتجاتنا سواء التي في المحرك أو في نطاقه.

متجر أونلاين

طريقك المباشر لمنتجاتنا

يمكنك الطلب على مدار الساعة. الفحص السريع للتوفرية. البحث الشامل عن المنتجات من خلال المحرك والمركبة والأبعاد وما إلى ذلك.

أخبار

معلومات دورية عن طريق البريد الإلكتروني

قم الآن بتسجيل اشتراكك أونلاين في صحيفتنا المجانية وستحصل على معلومات دورية خاصة بمستجدات المنتجات والمنشورات الفنية وغيرها الكثير.

معلومات فردية

مخصصة لعملائنا

سوف نقدم لك معلومات وخدمات شاملة متعلقة بنطاق معدلات أداننا العريض: مثلاً خامات تعزيز البيع المتوائمة مع المتطلبات الشخصية ووسائل دعم البيع والدعم الفني وغيرها الكثير.



الموسوعة الفنية

معلومات فنية خاصة بالمحرك

في موسوعتنا الفنية سوف نتشارك معك معرفتنا الفنية المتخصصة. سوف تجد هنا المعرفة الفنية المتخصصة مباشرة من الخبراء.

تطبيق خدمة المحرك

إمكانية وصول جواله للمعرفة الفنية المتخصصة

سوف تحصل هنا بسرعة وسهولة على أحدث مستوى للمعلومات والخدمات بشأن منتجاتنا.

الوسائط الاجتماعية

دائمًا محدثة



www.ms-motorservice.com

صفحة	المحتوى
٨٣	إرشادات مهمة
٨٣	إدارة الجودة
٨١	نقل الخبرة الفنية - الدراية الفنية للخبراء
٦٠	١- خفض الانبعاثات الضارة
٧٥	٢- إرشادات حول استخدام الكتالوج
٨٥	٣- التطبيقات الرئيسية / صور المنتجات
١٧٩	٤- استكمال البرنامج
١٩١	٥- فهرس الشركات الصانعة
١٩٥	٦- تطبيقات المنتج
١٣٢١	٧- قوائم المراجع
	٨- طريقة التصرف في حالة وجود شكوى / صيغة الشكوى

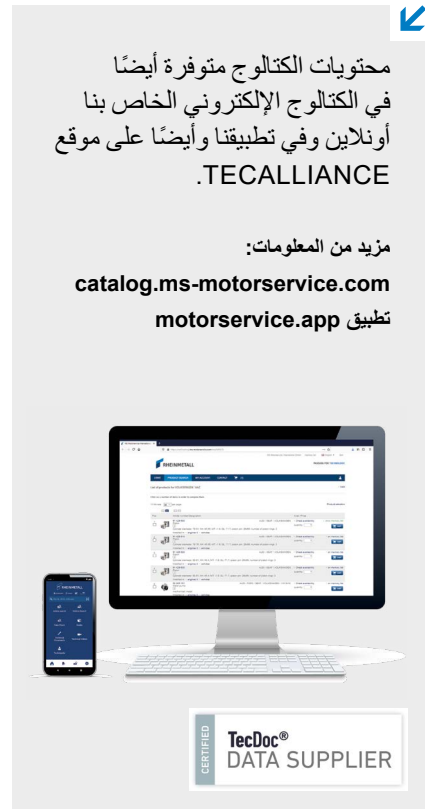

محتويات الكتالوج متوفرة أيضًا في الكتالوج الإلكتروني الخاص بنا أونلاين وفي تطبيقنا أيضًا على موقع .TECALLIANCE

مزيد من المعلومات:
catalog.ms-motorservice.com
 تطبيق motorservice.app

TecDoc®
 CERTIFIED DATA SUPPLIER

مجموعة MOTORSERVICE الجودة والخدمة من مصدر واحد

تعد مجموعة Motorservice شركة مبالاء وسويتلا نشطة ما بعدة بصتمخا معوزيتلا مؤسسة Rheinmetall. شركة مكدت معساوولا يارغلا عطة قسو ومحركات فلا وفير مكونات في فدنارلا شركاتلا إحدى ي هو Motorservice تميزتلا جاريتلا علماماتلا مع لفلود قجود لعاة بليصوا قة كبير لشكيت شورلاو تجارنتلا نها منعمل Kolbenschmidt و Pierburg و TRW Engine Components لاضجارية فتلا علماملا نBF و turbo by Intec.

RHEINMETALL تقنيات للتقل في المستقبل

بصفتها مورد سيارات على مستوى العالم، تتمتع شركة Rheinmetall بالكفاءة العليا في الأسواق المعنية في مجالات إمداد الهواء، وخفض الانبعاثات الضارة والمضخات وكذلك في تطوير وتصنيع وتوريد قطع غيار المكابيس وكتل المحركات والمحامل الانزلاقية. يتم تطوير المنتجات بالتعاون الوثيق مع مصنعي السيارات المعروفين.

إرشادات مهمة

يتعين دائماً قبل التركيب القيام بالفحص للتحقق مما إذا كان المنتج المعني مناسباً لغرض الاستخدام المقصود. لا يمكن الاطلاع على بياناتنا ومعرفة أي معلومات عن طبيعة معينة أو التحقق من ملاءمة لغرض معين. وبصفة خاصة يرجى مراعاة أن المنتجات المطروحة في الكتالوج ليست مناسبة للاستخدام في المركبات الهوائية أو الفضائية. عند الاستخدام في محركات الطرق الوعرة (مثل المحركات البحرية أو الثابتة أو محركات القطارات) يجب مراعاة أنه حتى في حالة تشابه مسمى المحرك فهناك أجزاء أخرى مختلفة من المحرك (المكابح مثلاً). ولذلك فقد يتعين أيضاً قبل تركيب المنتجات طلب المشورة الفنية المتخصصة من الجهة الصانعة أو الورشة الفنية المعتمدة. وفي هذا الصدد فإننا نشير إلى ضرورة إجراء أعمال التركيب دائماً على يد عمالة فنية متخصصة ومدربة. الصور والرسوم التوضيحية وغيرها من البيانات الأخرى تستخدم للشرح والإيضاح ولا يمكن استخدامها كأساس للتركيب.

لا يُسمح بأي نسخ أو محاكاة أو توزيع أو استنساخ عام لهذا الكتالوج، حتى ولو بشكل جزئي دون الحصول على تصريح كتابي مسبق وأن يكون هناك بيان مصدر يحمل هذا المضمون. إصدار هذا الكتالوج يُفقد الإصدارات السابقة صلاحيتها.

كل البيانات الواردة في هذا الكتالوج غير ملزمة. ولا يمكننا تحمل أية مسؤولية عن سلامتها واكتمالها. ويسعدنا دائماً تلقي إخطاراتكم بخصوص أية أخطاء قد ترد في الكتالوج على أن نصحها في الطبعة القادمة.

السماء والتوصيفات وبيانات الأرقام الخاصة بالمركبات أو الجهات المصنعة وما شابه واردة فقط لأغراض المقارنة، تماماً مثل أرقام القطع الأصلية للجهات المصنعة للمركبات والمحركات. مثل هذه البيانات ليست رسوماً أساسية ولا يجوز استخدامها ضد أطراف أخرى. يرجى في هذا الإطار مراعاة أنه يمكن إدخال تغييرات على التجهيزات من قبل الشركات الصانعة للسيارات والمحركات أو قد تطرأ تغييرات على المسميات. ولذلك فلا يمكننا تحمل أية مسؤولية عن استخدام قوائم المقارنة.

نحن نحفظ صراحة بحق إدخال تغييرات على مواصفات المنتجات والخامات والمظهر الخارجي ونطاق توريد منتجاتنا في أي وقت. ولذلك فإن الأشكال الواردة في الكتالوج ليست ملزمة.

شهادات الاعتماد





شركة MS Motorservice International GmbH مزودة بنظام إدارة الجودة معتمد طبقاً للمواصفة ISO 9001 ونظام إدارة البيئة معتمد وفقاً للمواصفة ISO 14001.









AR









◀ أساسيات

		Page
123	PIERBURG NO.	86
	ELECTRIC VALVES	89



 PIERBURG			 PIERBURG			 PIERBURG		
4.02003.62.0	LLR	150	7.01633.06.0	DW-TL	104	7.02256.29.0	EUV-KA	126
5.02549.03.0*	EUV-VB	140	7.01738.01.0	LDRV	145	7.02256.30.0	SV-PDA	174
7.00017.02.0	EUV-LS	127	7.01762.04.0	SUV	157	7.02256.31.0	SV-PDA	174
7.00017.03.0	LDRV	143	7.01771.01.0	DW-AGR	92	7.02256.37.0	EUV-AGK	117
7.00036.03.0	LDRV	143	7.01771.01.0	DW-RK	97	7.02256.37.0	EUV-AGR	120
7.00045.00.0*	LDRV	143	7.01771.01.0	DW-TL	104	7.02256.37.0	EUV-AT	124
7.00175.04.0	SUV	156	7.01777.17.0	DW-TL	104	7.02256.37.0	EUV-DS	125
7.00262.02.0	DW-TL	98	7.01777.18.0	DW-TL	104	7.02256.37.0	EUV-KK	126
7.00265.02.0	DW-AGR	91	7.01777.19.0	DW-TL	105	7.02256.37.0	EUV-SL	132
7.00265.02.0	DW-TL	98	7.01805.01.0	EUV-AGR	118	7.02256.37.0	EUV-SR	136
7.00272.03.0	DW-AGR	91	7.01805.01.0	EUV-LS	127	7.02256.37.0	EUV-VB	141
7.00326.03.0	EUV-VB	140	7.01805.01.0	EUV-SL	132	7.02256.37.0	EUV-WP	143
7.00380.04.0	LDRV	144	7.01805.01.0	EUV-SR	135	7.02256.38.0	AKF	89
7.00380.11.0	LDRV	144	7.01814.12.0	DW-TL	105	7.02256.39.0	AKF	89
7.00415.07.0	SUV	156	7.01814.22.0	DW-TL	105	7.02256.40.0	SV-KK	164
7.00470.07.0	LDRV	144	7.01830.13.0	SUV	157	7.02256.41.0	SV-KK	164
7.00513.10.0	DW-TL	98	7.01835.06.0	SUV	158	7.02256.42.0	SV-KK	165
7.00513.19.0	DW-TL	98	7.01870.06.0	SUV	158	7.02256.43.0	EUV-SR	136
7.00515.04.0	EUV-AGR	118	7.01904.03.0	LDRV	146	7.02256.44.0	EUV-AGR	121
7.00515.05.0	EUV-AGR	118	7.01981.07.0	SV-AGR-K	162	7.02256.45.0	EUV-SR	136
7.00580.01.0	DW-AGR	91	7.02063.02.0	DW-AGR	92	7.02256.46.0	EUV-AGR	121
7.00607.02.0	DW-TL	98	7.02087.05.0	EUV-VB	141	7.02256.47.0	EUV-AGR	122
7.00607.04.0	DW-TL	99	7.02183.01.0	DW-AGR	92	7.02256.48.0	STE	155
7.00612.01.0	DW-AGR	91	7.02184.01.0	DW-TL	106	7.02256.49.0	LDRV	146
7.00612.01.0	DW-TL	99	7.02207.05.0	SUV	158	7.02256.50.0	EUV-RK	131
7.00756.05.0	DW-AGR	91	7.02212.02.0	DW-TL	106	7.02256.51.0	EUV-SR	136
7.00782.04.0	DW-TL	99	7.02221.01.0	LDRV	146	7.02256.53.0	DW-TL	108
7.00782.11.0	DW-TL	99	7.02256.00.0	EUV-AGK	116	7.02288.01.0	EUV-SR	137
7.00782.12.0	DW-TL	100	7.02256.00.0	EUV-AGR	118	7.02318.01.0	EUV-AGK	117
7.00782.16.0	DW-TL	100	7.02256.00.0	EUV-KK	126	7.02318.01.0	EUV-AGR	122
7.00784.01.0	EUV-SL	132	7.02256.00.0	EUV-LS	128	7.02318.01.0	EUV-KL	127
7.00868.02.0	DW-TL	100	7.02256.00.0	EUV-RK	131	7.02318.01.0	EUV-LS	128
7.00887.19.0	DW-TL	101	7.02256.00.0	EUV-SL	132	7.02318.01.0	EUV-ML	130
7.00887.20.0	DW-TL	101	7.02256.00.0	EUV-SR	135	7.02318.01.0	EUV-SL	133
7.00887.21.0	DW-TL	101	7.02256.03.0	DW-AGR	93	7.02318.01.0	EUV-SR	137
7.00887.22.0	DW-TL	102	7.02256.04.0	DW-AGR	93	7.02318.01.0	LDRV	146
7.00964.03.0	DW-AGR	91	7.02256.04.0	DW-TL	106	7.02325.04.0	DW-TL	108
7.00964.03.0	DW-RK	97	7.02256.05.0	OEL-HV	153	7.02325.05.0	DW-TL	108
7.00964.03.0	DW-TL	102	7.02256.06.0	SV-KK	164	7.02325.06.0	DW-TL	109
7.00968.04.0	DW-TL	102	7.02256.07.0	EUV-AGR	119	7.02328.08.0	SUV	158
7.01003.01.0	LDRV	144	7.02256.14.0	EUV-RK	131	7.02428.02.0	EUV-LS	128
7.01010.03.0	DW-AGR	92	7.02256.15.0	DW-TL	106	7.02436.02.0	EUV-AGR	122
7.01019.01.0	DW-AGR	92	7.02256.16.0	EUV-AGR	120	7.02461.01.0	EUV-AGR	122
7.01024.02.0	LDRV	144	7.02256.17.0	DW-TL	106	7.02461.01.0	EUV-LS	128
7.01037.02.0	EUV-SL	132	7.02256.18.0	EUV-SR	135	7.02461.01.0	EUV-SL	133
7.01037.02.0	LDRV	145	7.02256.19.0	EUV-AGR	120	7.02461.01.0	EUV-SR	137
7.01039.03.0	EUV-SR	134	7.02256.19.0	EUV-LS	128	7.02461.03.0	EUV-AGR	122
7.01039.03.0	EUV-VB	141	7.02256.19.0	EUV-SR	136	7.02476.09.0	SUV	159
7.01039.03.0	LDRV	145	7.02256.19.0	LDRV	146	7.02534.01.0	DW-TL	109
7.01044.03.0	EUV-SR	135	7.02256.20.0	DW-AGR	93	7.02588.04.0	LDRV	147
7.01115.08.0	SUV	157	7.02256.21.0	DW-TL	107	7.02613.02.0	EUV-AGR	123
7.01121.02.0*	DW-AGR	92	7.02256.22.0	AKF	89	7.02721.06.0*	EUV-VB	142
7.01122.03.0*	DW-AGR	92	7.02256.23.0	DW-AGR	93	7.02901.05.0	SUV	159
7.01152.02.0	DW-TL	102	7.02256.23.0	DW-RK	97	7.02909.07.0	SUV	160
7.01282.02.0	LDRV	145	7.02256.23.0	DW-TL	107	7.02909.12.0	SUV	160
7.01343.04.0	LDRV	145	7.02256.24.0	DW-AGR	94	7.02968.02.0	DW-TL	109
7.01349.01.0*	DW-AGR	92	7.02256.24.0	DW-RK	97	7.03003.01.0	DW-TL	109
7.01420.02.0	DW-TL	103	7.02256.24.0	DW-TL	107	7.03003.12.0	DW-TL	109
7.01421.01.0	DW-TL	103	7.02256.25.0	DW-AGR	94	7.03073.01.0	DW-TL	109
7.01441.04.0	EUV-VB	141	7.02256.25.0	DW-TL	107	7.03075.02.0	EUV-LS	129
7.01569.04.0*	DW-AGR	92	7.02256.26.0	DW-TL	108	7.03085.02.0	DW-AGR	94
7.01569.05.0*	DW-AGR	92	7.02256.27.0	DW-AGR	94	7.03085.02.0	DW-TL	110
7.01632.02.0	DW-RK	97	7.02256.27.0	DW-TL	108	7.03088.01.0	DW-TL	110
7.01632.02.0	DW-TL	103	7.02256.28.0	SV-PDA	173	7.03162.09.0	LDRV	147
7.01633.04.0	DW-TL	103	7.02256.29.0	EUV-AGR	120	7.03280.04.0	EUV-AGR	123

 PIERBURG			 PIERBURG			 PIERBURG		
7.03280.04.0	EUV-KK	126	7.06117.18.0	SV-NWV	168	7.08681.00.0	EOV	114
7.03280.04.0	EUV-SL	133	7.06117.20.0	ZM-NWV	175	7.08681.01.0	EOV	115
7.03280.04.0	EUV-SR	137	7.06117.21.0	ZM-NWV	175	7.08681.02.0	EOV	115
7.03294.02.0	EUV-AGR	123	7.06117.24.0	ZM-NWV	175	7.08681.03.0	SV-HYAT	163
7.03294.02.0	EUV-RK	132	7.06117.26.0	ZM-NWV	175	7.08681.04.0	SV-HYAT	163
7.03294.02.0	LDRV	147	7.06117.33.0	SV-NWV	168	7.08681.05.0	SV-HYAT	163
7.03306.16.0	LDRV	147	7.06117.34.0	SV-NWV	168	7.08681.06.0	SV-HYAT	163
7.03351.12.0	LDRV	147	7.06117.35.0	SV-NWV	169	7.08681.07.0	SV-HYAT	164
7.03357.04.0	LDRV	148	7.06117.36.0	SV-NWV	169	7.08681.08.0	EOV	115
7.03381.14.0	SUV	160	7.06117.37.0	SV-NWV	169	7.08681.09.0	EOV	116
7.03381.15.0	SUV	160	7.06117.38.0	SV-NWV	169	7.08681.13.0	SV-HYAT	164
7.03460.02.0*	STE	155	7.06117.39.0	SV-NWV	170	7.08681.14.0	SV-HYAT	164
7.03554.10.0	DW-TL	110	7.06117.41.0	ZM-NWV	176	7.08681.15.0	EOV	116
7.03584.01.0	EUV-AGR	123	7.06117.42.0	SV-NWV	170	7.09000.03.0	SV-KK	165
7.03652.01.0	DW-TL	110	7.06117.43.0	SV-NWV	170	7.10014.00.0	AKF	89
7.03653.01.0	DW-TL	111	7.06117.44.0	SV-NWV	170	7.21042.01.0	EUV-DS	125
7.03833.02.0	EUV-VB	142	7.06117.45.0	SV-NWV	170	7.21071.50.0	AKF	90
7.03833.02.0	LDRV	148	7.06117.46.0	SV-NWV	171	7.21071.50.0	EUV-AGK	117
7.03855.00.0*	STE	155	7.06117.47.0	SV-NWV	171	7.21071.50.0	EUV-AGR	123
7.03855.02.0*	STE	155	7.06117.48.0	SV-NWV	171	7.21071.50.0	EUV-AT	125
7.03856.02.0*	STE	156	7.06117.52.0	SV-NWV	172	7.21071.50.0	EUV-DS	125
7.03964.01.0	DW-TL	111	7.06117.53.0	SV-NWV	172	7.21071.50.0	EUV-KA	126
7.03978.01.0	DW-TL	111	7.06117.54.0	SV-NWV	172	7.21071.50.0	EUV-LS	129
7.04011.05.0	DW-TL	111	7.06117.55.0	SV-NWV	173	7.21071.50.0	EUV-SL	133
7.04216.05.0	SUV	160	7.06117.56.0	SV-NWV	173	7.21071.50.0	EUV-SR	138
7.04247.02.0	SUV	161	7.06117.57.0	SV-NWV	173	7.21071.50.0	UAV	174
7.04269.04.0	SUV	161	7.06117.58.0	SV-NWV	173	7.21483.54.0	EUV-AGR	123
7.04423.01.0	DW-TL	111	7.06117.60.0	ZM-NWV	176	7.21895.55.0	EUV-LS	129
7.04492.07.0	LDRV	148	7.06269.00.0	LLR	150	7.21895.55.0	EUV-SL	134
7.04615.03.0	SUV	161	7.06269.01.0	LLR	151	7.21895.55.0	LDRV	149
7.04638.01.0	DW-TL	111	7.06269.02.0	LLR	151	7.21903.44.0	DW-AGR	95
7.04654.10.0	SUV	161	7.06269.03.0	LLR	151	7.21903.48.0	DW-TL	113
7.04663.14.0	DW-TL	112	7.06269.04.0	LLR	151	7.21903.49.0	DW-TL	113
7.04664.02.0	DW-TL	112	7.06269.05.0	LLR	151	7.21903.63.0	DW-TL	113
7.04779.00.0	DW-TL	112	7.06269.06.0	LLR	151	7.21903.70.0	DW-AGR	95
7.04818.04.0	SUV	161	7.06269.07.0	LLR	151	7.21903.70.0	DW-TL	113
7.04881.08.0*	SUV	162	7.06269.09.0	LLR	152	7.21903.73.0	DW-AGR	95
7.04927.08.0	SUV	162	7.06269.10.0	LLR	152	7.21903.73.0	DW-TL	113
7.05314.02.0	DW-TL	112	7.06269.11.0	LLR	152	7.21903.75.0	DW-AGR	95
7.05367.05.0	SUV	162	7.06269.20.0	LLR	152	7.21903.75.0	DW-RK	98
7.05432.00.0	SM	153	7.06269.21.0	LLR	152	7.21903.75.0	DW-TL	113
7.05432.01.0	SM	154	7.06269.22.0	LLR	152	7.22098.04.0	AKF	90
7.05432.02.0	SM	154	7.06269.23.0	LLR	152	7.22138.50.0	EUV-AGR	124
7.05432.03.0	SM	154	7.06269.24.0	LLR	152	7.22138.50.0	EUV-LS	129
7.05432.04.0	SM	154	7.06269.26.0	LLR	152	7.22138.50.0	EUV-SR	138
7.05432.06.0	SM	154	7.06269.27.0	LLR	153	7.22240.09.0	LDRV	149
7.05432.09.0	SM	155	7.06269.28.0	LLR	153	7.22240.13.0	LDRV	149
7.05432.11.0	SM	155	7.07400.00.0*	STE	156	7.22240.15.0	EUV-LS	129
7.05432.12.0	SM	155	7.07400.01.0*	STE	156	7.22240.15.0	EUV-SL	134
7.05432.13.0	SM	155	7.07400.02.0*	STE	156	7.22280.02.0	EUV-AGK	117
7.06117.00.0	SV-NWV	165	7.07400.03.0*	STE	156	7.22280.02.0	EUV-LS	129
7.06117.01.0	SV-NWV	165	7.07400.04.0*	STE	156	7.22280.02.0	EUV-SL	134
7.06117.02.0	SV-NWV	166	7.07400.05.0*	STE	156	7.22280.02.0	EUV-SR	138
7.06117.03.0	SV-NWV	166	7.07400.06.0*	STE	156	7.22355.01.0	EUV-SR	138
7.06117.04.0	SV-NWV	166	7.07400.09.0*	STE	156	7.22402.03.0	EUV-SR	139
7.06117.05.0	SV-NWV	166	7.07400.10.0*	STE	156	7.22510.03.0	AKF	90
7.06117.06.0	SV-NWV	167	7.07400.11.0*	LDRV	148	7.22517.04.0	AKF	90
7.06117.07.0	ZM-NWV	174	7.07400.12.0*	STE	156	7.22517.06.0	AKF	90
7.06117.08.0	SV-NWV	167	7.07400.13.0*	DW-TL	112	7.22572.01.0	EUV-VB	142
7.06117.10.0	SV-NWV	167	7.07400.14.0*	DW-TL	112	7.22593.03.0	AKF	90
7.06117.12.0	ZM-NWV	175	7.07400.15.0*	DW-TL	112	7.22687.15.0*	EUV-LS	129
7.06117.14.0	SV-NWV	168	7.07400.16.0*	DW-TL	112	7.22687.16.0*	EUV-LS	130
7.06117.15.0	SV-NWV	168	7.07400.17.0*	DW-TL	112	7.22687.39.0	EUV-LS	130
7.06117.16.0	SV-NWV	168	7.07400.18.0*	DW-TL	112	7.22687.44.0	EUV-AGK	117
7.06117.17.0	SV-NWV	168	7.07400.19.0*	EUV-VB	142	7.22687.44.0	EUV-SR	139

PIERBURG No. 123	 PIERBURG  			 PIERBURG  			 PIERBURG  		
		7.22687.44.0	EUV-VB	142					
	7.22687.46.0	LDRV	149						
	7.22687.49.0	EUV-DR	125						
	7.22687.49.0	EUV-LS	130						
	7.22687.49.0	EUV-VB	143						
	7.22687.50.0	EUV-SR	139						
	7.22687.51.0	LDRV	150						
	7.22796.01.0	DW-AGR	96						
	7.22796.01.0	DW-TL	114						
	7.22880.01.0	EUV-AGK	117						
	7.22880.01.0	EUV-AGR	124						
	7.22880.01.0	EUV-KK	127						
	7.22880.01.0	EUV-LS	130						
	7.22880.01.0	EUV-ML	131						
	7.22880.01.0	EUV-SL	134						
	7.22880.01.0	EUV-SR	139						
	7.22892.02.0	AKF	90						
	7.22903.16.0	DW-TL	114						
	7.22903.17.0	DW-AGR	96						
	7.22903.18.0	DW-AGR	96						
	7.22903.19.0	DW-TL	114						
	7.22903.28.0	DW-AGR	96						
	7.22903.28.0	DW-TL	114						
	7.22903.34.0	DW-AGR	96						
	7.22903.36.0	DW-AGR	96						
	7.22903.37.0	DW-AGR	96						
	7.22908.03.0	LDRV	150						
	7.28098.04.0	EUV-AGK	118						
	7.28098.04.0	EUV-AGR	124						
	7.28098.04.0	EUV-DS	125						
	7.28098.04.0	EUV-KA	126						
	7.28098.04.0	EUV-ML	131						
	7.28098.04.0	EUV-SR	140						
	7.28098.15.0	EUV-LS	130						
	7.28098.15.0	EUV-SL	134						
	7.28098.15.0	EUV-SR	140						
	7.28098.16.0	EUV-BKV	125						
	7.28170.03.0	EUV-RK	132						
	7.28194.01.0	AKF	90						
	7.28197.16.0	LDRV	150						
	7.28286.13.0	EUV-AGK	118						
	7.28286.13.0	EUV-SL	134						
	7.28311.04.0	LDRV	150						
	7.28328.07.0	DW-RK	98						
	7.28328.07.0	DW-TL	114						



AKF 7.02256.22.0	AKF 7.02256.38.0	AKF 7.02256.39.0
 <p>OPEL ASTRA G Convertible (T98) ASTRA G Coupe (T98) ASTRA G Estate (T98) ASTRA G Estate Van (F70) ASTRA G Hatchback (T98) ASTRA G Saloon (T98) ASTRA H (A04) ASTRA H Estate (A04) ASTRA H Estate Van (L70) ASTRA H GTC (A04) ASTRA H Saloon (A04) ASTRA H TwinTop (A04) ASTRA J (P10) ASTRA J Saloon ASTRA J Sports Tourer (P10) INSIGNIA A (G09) INSIGNIA A Saloon (G09) INSIGNIA A Sports Tourer (G09) MERIVA A MPV (X03) MOKKA / MOKKA X (J13) VECTRA C (Z02) VECTRA C Estate (Z02) VECTRA C GTS (Z02) ZAFIRA / ZAFIRA FAMILY B (A05)</p> <p>VAUXHALL ASTRA Mk III (F) Convertible (T92) ASTRA Mk IV (G) Convertible (T98) ASTRA Mk IV (G) Estate (T98) ASTRA Mk IV (G) Hatchback (T98) ASTRA Mk IV (G) Saloon (T98) COMBO Mk II (C) Box Body/MPV (F25) COMBO TOUR Mk II (C) (F25) CORSA Mk II (C) (X01) MERIVA A (X03) VECTRA Mk II (C) (Z02) VECTRA Mk II (C) GTS (Z02)</p> <p>→SI 0096</p>	<p>OPEL ASTRA G Convertible (T98) ASTRA G Coupe (T98) ASTRA G Estate (T98) ASTRA G Estate Van (F70) ASTRA G Hatchback (T98) ASTRA G Saloon (T98) ASTRA H (A04) ASTRA H Estate (A04) ASTRA H Estate Van (L70) ASTRA H GTC (A04) ASTRA H Saloon (A04) ASTRA H TwinTop (A04) ASTRA J (P10) ASTRA J Saloon ASTRA J Sports Tourer (P10) INSIGNIA A (G09) INSIGNIA A Saloon (G09) INSIGNIA A Sports Tourer (G09) MERIVA A MPV (X03) MOKKA / MOKKA X (J13) VECTRA C (Z02) VECTRA C Estate (Z02) VECTRA C GTS (Z02) ZAFIRA / ZAFIRA FAMILY B (A05)</p> <p>VAUXHALL ASTRA Mk III (F) Convertible (T92) ASTRA Mk IV (G) Convertible (T98) ASTRA Mk IV (G) Estate (T98) ASTRA Mk IV (G) Hatchback (T98) ASTRA Mk IV (G) Saloon (T98) ASTRA Mk V (H) (A04) ASTRA Mk V (H) Estate (A04) ASTRA Mk V (H) Sport Hatch (A04) ASTRA Mk V (H) TwinTop (A04) ASTRA Mk VI (J) (P10) ASTRA Mk VI (J) Estate (P10) ASTRA Mk VI (J) Saloon (P10) ASTRAVAN Mk IV (G) Estate Van (T98) ASTRAVAN Mk V (H) Estate Van (A04) MERIVA A (X03) MOKKA / MOKKA X (J13) ZAFIRA Mk II (B) (A05)</p>	<p>S-MAX (WA6) VOLVO S60 II (134) S80 II (124) V60 I (155, 157) V70 III (135) XC60 I SUV (156) XC70 II (136) XC90 I (275)</p>
<p>AKF 7.02256.38.0</p>  <p>BUICK SGM EXCELLE GT (CP2) EXCELLE XT (CP2) CHEVROLET CRUZE (J300) CRUZE Station Wagon (J308) TRAX CHEVROLET (SGM) AVEO Hatchback (SJ1) AVEO Saloon (SJ1) CRUZE Hatchback (CP1) CRUZE Saloon (CP1)</p>	<p>AKF 7.02256.39.0</p>  <p>FORD FOCUS II (DA_, HCP, DP) KUGA I MONDEO IV (BA7) MONDEO IV Saloon (BA7) MONDEO IV Turnier (BA7)</p>	<p>AKF 7.10014.00.0 New</p>  <p>AUDI A2 (8Z0) A3 (8P1) A3 Convertible (8P7) A3 Sportback (8PA) A4 B5 (8D2) A4 B5 Avant (8D5) A4 B6 (8E2) A4 B6 Avant (8E5) A4 B6 Convertible (8H7) A4 B7 (8EC) A4 B7 Avant (8ED) A6 C5 (4B2) A6 C5 Avant (4B5) TT (8J3) TT Roadster (8J9)</p> <p>SEAT ALTEA (5P1) ALTEA XL (5P5, 5P8) EXEO (3R2) EXEO ST (3R5) LEON (1P1) TOLEDO III (5P2)</p> <p>SKODA OCTAVIA II (1Z3) OCTAVIA II Combi (1Z5)</p> <p>VOLKSWAGEN BORA I (1J2) BORA Variant (1J6) CADDY III Box Body/MPV (2KA, 2KH, 2CA, 2CH) CADDY III MPV (2KB, 2KJ, 2CB, 2CJ) EOS (1F7, 1F8) GOLF IV (1J1) GOLF IV Variant (1J5) GOLF PLUS V (5M1, 521) GOLF V (1K1) GOLF V Variant (1K5) GOLF VI (5K1) GOLF VI Variant (AJ5)</p>

ELECTRIC VALVES





ELECTRIC VALVES



AKF 7.10014.00.0 New
 JETTA III (1K2)
 MULTIVAN V (7HM, 7HN, 7HF, 7EF, 7EM, 7EN)
 PASSAT B5.5 (3B3)
 PASSAT B5.5 Variant (3B6)
 PASSAT B6 (3C2)
 PASSAT B6 Variant (3C5)
 POLO (9N_)
 TOURAN (1T1, 1T2)
 TRANSPORTER V Bus (7HB, 7HJ, 7EB, 7EJ, 7EF, 7EG, 7HF, 7EC)
 TRANSPORTER V Platform/Chassis (7JD, 7JE, 7JL, 7JY, 7JZ, 7FD)
 TRANSPORTER V Van (7HA, 7HH, 7EA, 7EH)
VW FAW
 CADDY (9HB)
 SAGITAR (9L2)

AKF 7.22510.03.0

VOLVO
 S60 I (384)
 V70 II (285)
 XC70 CROSS COUNTRY I (295)

AKF 7.22517.06.0
 S80 I (184)
 V40 Estate (645)
 V70 I (875, 876)

AKF 7.22593.03.0

AKF 7.21071.50.0

 →SI 0087
 →SI 0096
 →SI 0100
MERCEDES-BENZ
 /8 (W114)

AKF 7.22517.04.0

 →SI 0087
VOLVO
 C70 I Convertible (873)
 C70 I Coupe (872)
 S40 I (644)
 S60 I (384)
 S70 (874)
 S80 I (184)
 V40 Estate (645)
 V70 I (875, 876)
 V70 II (285)
 XC70 CROSS COUNTRY I (295)

SAAB
 9-3 (YS3D)
 9-3 Cabriolet (YS3D)
 9-5 (YS3E)
 9-5 Estate (YS3E)

AKF 7.22892.02.0

AKF 7.22098.04.0

PORSCHE
 911 (996)
 911 Convertible (996)
 911 Targa (996)
 BOXSTER (986)

AKF 7.22517.06.0

PORSCHE
 911 (996)
 911 Convertible (996)

AKF 7.28194.01.0

 →SI 0096
VOLVO
 C70 I Convertible (873)
 C70 I Coupe (872)
 S70 (874)
 V70 I (875, 876)
 V70 II (285)



DW-AGR	7.00265.02.0	DW-AGR	7.00272.03.0	DW-AGR	7.00612.01.0
 <p>NISSAN ALMERA TINO (V10)</p>		<p>i40 I (VF) i40 I CW (VF) ix20 (JC) ix35 (LM, EL, ELH) KIA CARENS III MPV (UN) CARENS IV CARNIVAL / GRAND CARNIVAL III (VQ) CARNIVAL II (GQ) CEE'D (JD) CEE'D Hatchback (ED) CEE'D SW (ED) CEE'D Sportswagon (JD) CERATO I Hatchback (LD) CERATO I Saloon (LD) MAGENTIS (MG) OPTIMA (FSGDS6B) PICANTO (SA) PRO CEE'D (ED) PRO CEE'D (JD) RIO II (JB) RIO II Saloon (JB) RIO III (UB) RIO IV (YB, SC, FB) SORENTO I (JC) SOUL I (AM) SOUL II (PS) SPORTAGE II (JE_, KM) STONIC (YB) VENGA (YN)</p>		 <p>→SI 0096 →SI 0100</p> <p>CITROEN C4 Coupe (LA_) C4 I (LC_) C4 I Hatchback Van (LR_) C5 Estate Van (DE_, RE_) C5 II (RC_) C5 II Break (RE_)</p>	
DW-AGR	7.00272.03.0			DW-AGR	7.00756.05.0
 <p>→SI 0096</p> <p>HYUNDAI ACCENT II (LC) ACCENT II Saloon (LC) ACCENT III (MC) ACCENT III Saloon (MC) ACCENT IV (RB) ACCENT IV Saloon (RB) ELANTRA IV Saloon (HD) ELANTRA V Saloon (MD, UD) GRANDEUR (TG) H-1 / STAREX Bus (A1) H-1 Cargo (TQ) H-1 Travel (TQ) H-1 Van (A1) H100 Platform/Chassis (HR) LAVITA MATRIX (FC) SANTA FÉ II (CM) SONATA V (NF) TERRACAN (HP) TRAJET (FO) TUCSON (JM) VERNA i10 I (PA) i20 ACTIVE (IB, GB) i20 I (PB, PBT) i20 II (GB, IB) i20 II Coupe (GB) i30 (FD) i30 (GD) i30 Coupe i30 Estate (FD) i30 Estate (GD)</p>		<p>DW-AGR 7.00580.01.0</p>  <p>→SI 0096</p> <p>VOLKSWAGEN CADDY III Box Body/MPV (2KA, 2KH, 2CA, 2CH) CADDY III MPV (2KB, 2KJ, 2CB, 2CJ) GOLF V (1K1) MULTIVAN V (7HM, 7HN, 7HF, 7EF, 7EM, 7EN) PHAETON (3D1, 3D2, 3D3, 3D4, 3D6, 3D7, 3D8, 3D9) TOUAREG (7LA, 7L6, 7L7) TRANSPORTER V Bus (7HB, 7HJ, 7EB, 7EJ, 7EF, 7EG, 7HF, 7EC) TRANSPORTER V Platform/Chassis (7JD, 7JE, 7JL, 7JY, 7JZ, 7FD) TRANSPORTER V Van (7HA, 7HH, 7EA, 7EH) ENGINE</p>		 <p>FORD MONDEO III (B5Y) MONDEO III Saloon (B4Y) MONDEO III Turnier (BWY) JAGUAR X-TYPE I (X400) X-TYPE I Estate (X400)</p>	
DW-AGR	7.00964.03.0				
 <p>→SI 0087 →SI 0096 →SI 0100</p> <p>CITROEN C2 (JM_)</p>					

ELECTRIC VALVES





ELECTRIC VALVES



DW-AGR	7.00964.03.0
C2 ENTERPRISE (JG_) C3 I (FC_, FN_) C3 II (SC_) C3 Pluriel (HB_) XSARA (N1) XSARA Break (N2) XSARA Coupe (N0) PEUGEOT 1007 (KM_) 206 Hatchback (2A/C) 206 SW (2E/K) 206 Van 307 (3A/C) 307 Break (3E) 307 SW (3H) 307 SW Estate Van (3E_, 3H_) 307 Saloon	
DW-AGR	7.01010.03.0



→SI 0096

VM MOTORI
DUMMY

DW-AGR	7.01019.01.0
---------------	---------------------



→SI 0096

AUDI
A4 B7 (8EC)
A4 B7 Avant (8ED)
A4 B7 Convertible (8HE)
A6 Allroad C6 (4FH)
A6 C6 (4F2)
A6 C6 Avant (4F5)
A8 D3 (4E2, 4E8)
Q7 (4LB)
VOLKSWAGEN
PHAETON (3D1, 3D2, 3D3, 3D4, 3D6, 3D7, 3D8, 3D9)
TOUAREG (7LA, 7L6, 7L7)

DW-AGR	7.01121.02.0*
→7.00756.05.0 DW-AGR JAGUAR X-TYPE I (X400) X-TYPE I Estate (X400)	
DW-AGR	7.01122.03.0*
→7.00756.05.0 DW-AGR FORD MONDEO III (B5Y) MONDEO III Saloon (B4Y) MONDEO III Turnier (BWY)	
DW-AGR	7.01349.01.0*
→7.00756.05.0 DW-AGR FORD MONDEO III (B5Y) MONDEO III Saloon (B4Y) MONDEO III Turnier (BWY)	

DW-AGR	7.01569.04.0*
→7.00756.05.0 DW-AGR JAGUAR X-TYPE I (X400) X-TYPE I Estate (X400)	
DW-AGR	7.01569.05.0*
→7.00756.05.0 DW-AGR JAGUAR X-TYPE I (X400) X-TYPE I Estate (X400)	

DW-AGR	7.01771.01.0
---------------	---------------------



→SI 0096

FORD
FOCUS III
FOCUS III Estate Van
FOCUS III Hatchback Van
FOCUS III Saloon
GALAXY II (WA6)
KUGA I
MONDEO IV (BA7)
MONDEO IV Saloon (BA7)
MONDEO IV Turnier (BA7)
S-MAX (WA6)
VOLVO
V50 (545)

DW-AGR	7.02063.02.0
	
→SI 0096 BMW 1 (E81) 1 (E87) 1 Convertible (E88) 1 Coupe (E82) 3 (E90) 3 Convertible (E93) 3 Coupe (E92) 3 Touring (E91) 5 (E60) 5 Touring (E61) X3 (E83) X5 (E70)	

DW-AGR	7.02183.01.0
---------------	---------------------



→SI 0096

AUDI
A3 (8L1)
A4 B5 (8D2)
A4 B5 Avant (8D5)
SEAT
ALHAMBRA (7V8, 7V9)
CORDOBA (6L2)
IBIZA III (6L1)
LEON (1M1)
TOLEDO II (1M2)
SKODA
FABIA I (6Y2)
FABIA I Combi (6Y5)
FABIA I Praktik (6Y5)
FABIA I Saloon (6Y3)
OCTAVIA I (1U2)
OCTAVIA I Combi (1U5)
OCTAVIA I Estate Van (1U5)
SUPERB I (3U4)
SUPERB II (3T4)
SUPERB II Estate (3T5)



DW-AGR	7.02183.01.0	DW-AGR	7.02256.03.0	DW-AGR	7.02256.04.0
VOLKSWAGEN BORA I (1J2) BORA Variant (1J6) FOX Hatchback (5Z1, 5Z3, 5Z4) GOLF IV (1J1) GOLF IV Van (1J1) GOLF IV Variant (1J5) GOLF VAN IV Variant (1J5) LT 28-35 II Bus (2DB, 2DE, 2DK) LT 28-46 II Platform/Chassis (2DC, 2DF, 2DG, 2DL, 2DM) LT 28-46 II Van (2DA, 2DD, 2DH) NEW BEETLE (9C1, 1C1) NEW BEETLE Convertible (1Y7) PASSAT B5.5 (3B3) PASSAT B5.5 Variant (3B6) POLO (9N_) POLO IV Saloon (9A4, 9A2, 9N2, 9A6) SHARAN (7M8, 7M9, 7M6) SURAN (5Z) TOUAREG (7LA, 7L6, 7L7) ENGINE		DUCATO Van (230_) DUCATO Van (244_) FIORINO Box Body/MPV (146_) FIORINO Pick up (146_) MAREA (185_) MAREA Weekend (185_) MULTIPLA (186_) PALIO (178_) PALIO Weekend (178_, 173_, 373_, 374_, 171_) PUNTO (176_) PUNTO Van (176_) SIENA (178_, 172_) STRADA Pickup (178_) LANCIA KAPPA (838_) KAPPA Coupe (838_) KAPPA SW (838_) LYBRA (839_) LYBRA SW (839_) PEUGEOT BOXER Bus BOXER Bus (230P) BOXER Bus (244, Z_) BOXER Platform/Chassis BOXER Platform/Chassis (244) BOXER Platform/Chassis (ZCT_) BOXER Van BOXER Van (230L) BOXER Van (244)		MASTER II Bus (JD) MASTER II Van (FD) MEGANE I (BA0/1_) MEGANE I Classic (LA0/1_) MEGANE I Coach (DA0/1_) MEGANE I Grandtour (KA0/1_) MEGANE Scenic (JA0/1_) SCÉNIC I MPV (JA0/1_, FA0_) VAUXHALL VIVARO A Bus (X83) VIVARO A Platform/Chassis (X83) VIVARO A Van (X83)	
DW-AGR	7.02256.03.0			DW-AGR	7.02256.20.0
					
	→SI 0096 →SI 0100				→SI 0096
ALFA ROMEO 145 (930_) 146 (930_) 156 (932_) 156 Sportwagon (932_) 166 (936_)				FIAT DUCATO Bus (250_) DUCATO Platform/Chassis (250_) DUCATO Van (250_)	
CITROEN JUMPER Bus JUMPER Bus (230P) JUMPER Bus (244, Z_) JUMPER Platform/Chassis JUMPER Platform/Chassis (230) JUMPER Platform/Chassis (244) JUMPER Van JUMPER Van (230L) JUMPER Van (244)		DW-AGR	7.02256.04.0	DW-AGR	7.02256.23.0
FIAT BRAVA (182_) BRAVO I (182_) DUCATO Bus (230_) DUCATO Bus (244_) DUCATO II (244) DUCATO Platform/Chassis (230_) DUCATO Platform/Chassis (244_)					
			→SI 0096		→SI 0096
NISSAN INTERSTAR Bus (X70) INTERSTAR Van (X70)		OPEL MOVANO Bus (X70) MOVANO Van (X70) VIVARO A Bus (X83) VIVARO A Platform/Chassis (X83) VIVARO A Van (X83)		CITROEN JUMPER Bus (244, Z_) JUMPER Platform/Chassis (244) JUMPER Van (230L) JUMPER Van (244) XANTIA (X1_, X2_) XANTIA Break (X1_, X2_) XSARA (N1) XSARA Break (N2) XSARA Coupe (N0) XSARA Estate Van XSARA Hatchback Van (N3_)	
RENAULT AVANTIME (DE0_) CLIO II (BB_, CB_) CLIO II Hatchback Van (SB0/1/2_) ESPACE III (JE0_) KANGOO (KC0/1_) KANGOO Express (FC0/1_) LAGUNA I (B56_, 556_) LAGUNA I Grandtour (K56_)				FIAT DUCATO Bus (230_) DUCATO Bus (244_) DUCATO Platform/Chassis (230_)	



DW-AGR 7.02256.23.0

DUCATO Platform/Chassis (244_)
 DUCATO Van (230_)
 DUCATO Van (244_)
PEUGEOT
 307 SW Estate Van (3E_, 3H_)
 307 Saloon
 406 (8B)
 406 Break (8E/F)
 607 (9D, 9U)
 BOXER Bus (244, Z_)
 BOXER Platform/Chassis (244)
 BOXER Van (230L)
 BOXER Van (244)



→SI 0096

CITROEN

BERLINGO / BERLINGO FIRST Box Body/MPV (M_)
 BERLINGO / BERLINGO FIRST MPV (MF_, GJK_, GFK_)
 C3 I (FC_, FN_)
 C4 I (LC_)
 C4 I Saloon
 C5 Estate Van (DE_, RE_)
 C5 I (DC_)
 C5 I Break (DE_)
 C5 II (RC_)
 C5 II Break (RE_)
 C8 (EA_, EB_)
 EVASION MPV (22, U6)
 JUMPER Van (230L)
 JUMPY (U6U_)
 JUMPY Platform/Chassis (BU_, BV_, BW_, BX_)
 JUMPY Van (BS_, BT_, BY_, BZ_)
 XANTIA (X1_, X2_)
 XANTIA Break (X1_, X2_)
 XANTIA Estate Van (X2_)
 XSARA (N1)
 XSARA Break (N2)
 XSARA Coupe (N0)
 XSARA Estate Van
 XSARA Hatchback Van (N3_)
 XSARA PICASSO (N68)
FIAT
 SCUDO Bus (220_)
 SCUDO Platform/Chassis (220_)
 SCUDO Van (220_)
 ULYSSE (179_)
 ULYSSE (220_)

DW-AGR 7.02256.24.0

LANCIA
 PHEDRA (179_)
 ZETA (22_)
PEUGEOT
 206 Hatchback (2A/C)
 206 SW (2E/K)
 306 (7B, N3, N5)
 306 Break (7E, N3, N5)
 306 Estate Van (N_, 7_)
 306 Hatchback (7A, 7C, N3, N5)
 307 SW Estate Van (3E_, 3H_)
 307 Saloon
 406 (8B)
 406 Break (8E/F)
 607 (9D, 9U)
 806 (221)
 807 (EB_)
 BOXER Bus (244, Z_)
 BOXER Platform/Chassis (244)
 BOXER Van (244)
 EXPERT (224_)
 EXPERT Platform/Chassis (223)
 EXPERT Van (222)
 PARTNER Box Body/MPV (5_, G_)
 PARTNER MPV (5_, G_)
SUZUKI
 LIANA (ER, RH_)
 LIANA Hatchback



→SI 0096

DW-AGR 7.02256.25.0

FORD
 ENDEAVOUR
 EVEREST
 RANGER (ET)
MAZDA
 BT-50 Pickup (CD, UN)
 BT-50 Platform/Chassis (CD, UN)

DW-AGR 7.02256.27.0



→SI 0096

MINI (BMW)

MINI (R56)
 MINI COUNTRYMAN (R60)
 MINI Coupe (R58)
 MINI PACEMAN (R61)
 MINI Roadster (R59)

DW-AGR 7.03085.02.0



HYUNDAI

ACCENT II (LC)
 ACCENT II Saloon (LC)
 ELANTRA III (XD)
 ELANTRA III Saloon (XD)
 GETZ (TB)
 H-1 / STAREX Bus (A1)
 MATRIX (FC)
 SANTA FÉ I (SM)
 TRAJET (FO)
 ix35 (LM, EL, ELH)

OPEL

ASTRA G Estate (T98)
 ASTRA G Estate Van (F70)
 ASTRA G Hatchback (T98)
 ASTRA G Saloon (T98)
 CORSA C (X01)
 CORSA C Hatchback Van (X01)

VAUXHALL

ASTRA Mk IV (G) Estate (T98)
 ASTRA Mk IV (G) Hatchback (T98)
 ASTRA Mk IV (G) Saloon (T98)
 ASTRAVAN Mk IV (G) Estate Van (T98)
 CORSA Mk II (C) (X01)
 CORSAVAN Mk II (C) Hatchback Van (X01)



DW-AGR	7.21903.44.0	DW-AGR	7.21903.70.0	DW-AGR	7.21903.73.0
	 <p>→SI 0065 →SI 0076 →SI 0087 →SI 0096 →SI 0100</p> <p>VOLVO S40 I (644) V40 Estate (645)</p>	<p>CORDOBA Vario (6K5) IBIZA II (6K1) INCA (6K9) LEON (1M1) TOLEDO I (1L2) TOLEDO II (1M2) SKODA OCTAVIA I (1U2) OCTAVIA I Combi (1U5) VOLKSWAGEN BORA I (1J2) BORA Variant (1J6) CADDY II Box Body/MPV (9K9A) CADDY II MPV (9K9B) GOLF III (1H1) GOLF III Cabriolet (1E7) GOLF III Van (1H1) GOLF III Variant (1H5) GOLF IV (1J1) GOLF IV Cabriolet (1E7) GOLF IV Van (1J1) GOLF IV Variant (1J5) GOLF VAN IV Variant (1J5) GOLF Van III Variant (1H5) JETTA IV (1J5) LT 28-35 II Bus (2DB, 2DE, 2DK) LT 28-46 II Platform/Chassis (2DC, 2DF, 2DG, 2DL, 2DM) LT 28-46 II Van (2DA, 2DD, 2DH) LUPO I (6X1, 6E1) NEW BEETLE (9C1, 1C1) PASSAT B3/B4 (3A2, 35I) PASSAT B3/B4 Variant (3A5, 35I) PASSAT B5 (3B2) PASSAT B5 Variant (3B5) PASSAT B5.5 (3B3) PASSAT B5.5 Variant (3B6) POLO (6N2) POLO (9N_) POLO III CLASSIC (6V2) POLO Variant (6V5) SHARAN (7M8, 7M9, 7M6) SHARAN VAN (7M_) TRANSPORTER IV Bus (70B, 70C, 7DB, 7DK, 70J, 70K, 7DC, 7DJ) TRANSPORTER IV Platform/Chassis (70E, 70L, 70M, 7DE, 7DL, 7D) TRANSPORTER IV Van (70A, 70H, 7DA, 7DH) VENTO (1H2) ENGINE</p>	 <p>→SI 0065 →SI 0076 →SI 0087 →SI 0089 →SI 0096</p> <p>BMW 3 (E36) 3 Touring (E36) 5 (E39) 5 Touring (E39) 7 (E38) LAND ROVER RANGE ROVER II (P38A) RANGE ROVER III (L322) OPEL OMEGA B (V94) OMEGA B Estate (V94) VAUXHALL OMEGA (B) Estate (V94) OMEGA (B) Saloon (V94)</p>		
DW-AGR	7.21903.70.0			DW-AGR	7.21903.75.0
	 <p>→SI 0065 →SI 0076 →SI 0087 →SI 0096 →SI 0100</p> <p>AUDI 100 C4 Avant (4A5) 100 C4 Saloon (4A2) 80 B4 Avant (8C5) 80 B4 Saloon (8C2) A2 (8Z0) A3 (8L1) A4 B5 (8D2) A4 B5 Avant (8D5) A6 C4 (4A2) A6 C4 Avant (4A5) A6 C5 (4B2) A6 C5 Avant (4B5) CABRIOLET B3 (8G7) FORD GALAXY I (WGR) SEAT ALHAMBRA (7V8, 7V9) ALHAMBRA VAN (7V8, 7V9) AROSA (6H1) CORDOBA (6K1, 6K2) CORDOBA VARIO Estate Van (6K5)</p>			 <p>→SI 0065 →SI 0076 →SI 0087 →SI 0096 →SI 0100</p> <p>SEAT CORDOBA (6K1, 6K2) CORDOBA Vario (6K5) IBIZA II (6K1) VOLKSWAGEN CADDY II Box Body/MPV (9K9A) CADDY II MPV (9K9B) POLO III CLASSIC (6V2) POLO Variant (6V5)</p>	





<p>DW-AGR 7.22796.01.0</p>	<p>DW-AGR 7.22903.17.0</p>	<p>DW-AGR 7.22903.34.0</p>
 <p>→SI 0065 →SI 0076 →SI 0087 →SI 0096 →SI 0100</p> <p>BMW 1 (E87) 3 (E46) 3 (E90) 3 Compact (E46) 3 Convertible (E46) 3 Convertible (E93) 3 Coupe (E46) 3 Coupe (E92) 3 Touring (E46) 3 Touring (E91) 5 (E39) 5 (E60) 5 Touring (E39) 5 Touring (E61) 6 (E63) 6 Convertible (E64) 7 (E38) 7 (E65, E66, E67) X3 (E83) X5 (E53) X5 (E70) X6 (E71, E72)</p>	 <p>→SI 0065 →SI 0076 →SI 0087</p> <p>AUDI A4 B6 (8E2) A4 B6 Avant (8E5) A6 C5 (4B2) A6 C5 Avant (4B5)</p>	 <p>SKODA SUPERB I (3U4)</p> <p>VOLKSWAGEN PASSAT B5.5 (3B3) PASSAT B5.5 Variant (3B6)</p> <p>AUDI A4 B6 (8E2) A4 B6 Avant (8E5) A4 B6 Convertible (8H7) A4 B7 (8EC) A4 B7 Avant (8ED) A8 D3 (4E2, 4E8)</p>
<p>DW-AGR 7.22903.17.0</p>	<p>DW-AGR 7.22903.28.0</p>	<p>DW-AGR 7.22903.37.0 New</p>
 <p>→SI 0065 →SI 0076 →SI 0087 →SI 0096 →SI 0100</p> <p>AUDI A6 C5 (4B2)</p>	 <p>→SI 0096 →SI 0100</p> <p>AUDI A4 B7 (8EC) A4 B7 Avant (8ED) A6 C6 (4F2) A6 C6 Avant (4F5)</p>	 <p>AUDI A4 B6 (8E2) A4 B6 Avant (8E5) A6 C5 (4B2) A6 C5 Avant (4B5)</p>
<p>DW-AGR 7.22903.34.0</p>	<p>DW-AGR 7.22903.34.0</p>	
 <p>AUDI A4 B6 (8E2)</p>		



DW-RK	7.00964.03.0	DW-RK	7.01771.01.0	DW-RK	7.02256.24.0
 <p>→SI 0087 →SI 0096 →SI 0100</p> <p>PEUGEOT 307 (3A/C) 307 Break (3E) 307 SW (3H) 307 SW Estate Van (3E_, 3H_) 307 Saloon</p>		 <p>→SI 0096</p> <p>FORD C-MAX (DM2) FOCUS C-MAX (DM2) FOCUS II (DA_, HCP, DP) FOCUS II Convertible FOCUS II Saloon (DB_, FCH, DH) FOCUS II Turnier (DA_, FFS, DS) GALAXY II (WA6) KUGA I MONDEO IV (BA7) MONDEO IV Saloon (BA7) MONDEO IV Turnier (BA7) S-MAX (WA6)</p> <p>VOLVO C30 (533) C70 II Convertible (542) S40 II (544) S80 II (124) V50 (545) V70 III (135)</p>		 <p>→SI 0096</p> <p>CITROEN BERLINGO / BERLINGO FIRST Box Body/MPV (M_) BERLINGO / BERLINGO FIRST MPV (MF_, GJK_, GFK_) C15 Box Body/MPV (VD_) C5 Estate Van (DE_, RE_) C5 I (DC_) C5 I Break (DE_) EVASION MPV (22, U6) JUMPER Bus (244, Z_) JUMPER Platform/Chassis (244) JUMPER Van (230L) JUMPER Van (244) JUMPY (U6U_) JUMPY Platform/Chassis (BU_, BV_, BW_, BX_) JUMPY Van (BS_, BT_, BY_, BZ_) XANTIA (X1_, X2_) XANTIA Break (X1_, X2_) XANTIA Estate Van (X2_) XSARA (N1) XSARA Break (N2) XSARA Coupe (N0) XSARA Estate Van XSARA Hatchback Van (N3_) XSARA PICASSO (N68)</p> <p>FIAT SCUDO Van (220_)</p> <p>LANCIA PHEDRA (179_) ZETA (22_)</p> <p>PEUGEOT 206 Hatchback (2A/C) 206 SW (2E/K) 306 (7B, N3, N5) 306 Break (7E, N3, N5) 306 Estate Van (N_, 7_) 306 Hatchback (7A, 7C, N3, N5) 306 Hatchback Van 406 (8B) 406 Break (8E/F) 406 Coupe (8C) 607 (9D, 9U) 806 (221) BOXER Bus (244, Z_) BOXER Platform/Chassis (244) BOXER Van (244) EXPERT Platform/Chassis (223) EXPERT Van (222) PARTNER Box Body/MPV (5_, G_)</p>	
 <p>CITROEN C4 Coupe (LA_) C4 I (LC_) C4 I Hatchback Van (LR_) C5 Estate Van (DE_, RE_) C5 II (RC_) C5 II Break (RE_) C5 III Break (RW_) C8 (EA_, EB_)</p> <p>FIAT ULYSSE (179_)</p> <p>LANCIA PHEDRA (179_)</p> <p>PEUGEOT 307 (3A/C) 307 Break (3E) 307 CC (3B) 307 SW (3H) 407 (6D_) 407 Coupe (6C_) 407 SW (6E_) 407 SW Estate Van (6E_) 807 (EB_)</p>		 <p>→SI 0096</p> <p>CITROEN C8 (EA_, EB_) JUMPY (U6U_) JUMPY Platform/Chassis (BU_, BV_, BW_, BX_) JUMPY Van (BS_, BT_, BY_, BZ_) XSARA (N1) XSARA Break (N2) XSARA Coupe (N0)</p> <p>PEUGEOT 807 (EB_) EXPERT (224_) EXPERT Platform/Chassis (223) EXPERT Van (222)</p>		<p>ELECTRIC VALVES</p> 	



ELECTRIC VALVES



DW-RK 7.02256.24.0
PARTNER MPV (5_, G_)
PARTNER Platform/Chassis (5_, G_)

DW-RK 7.21903.75.0



→SI 0065
→SI 0076
→SI 0087
→SI 0096
→SI 0100

AUDI
A2 (8Z0)

DW-RK 7.28328.07.0



→SI 0087
→SI 0096
→SI 0100

FORD
FOCUS C-MAX (DM2)
FOCUS II (DA_, HCP, DP)
FOCUS II Estate Van
FOCUS II Saloon (DB_, FCH, DH)
FOCUS II Turnier (DA_, FFS, DS)

DW-TL 7.00262.02.0



→SI 0096

DW-TL 7.00262.02.0
MERCEDES-BENZ
VIANO (W639)
VITO / MIXTO Van (W639)
VITO Bus (W639)

DW-TL 7.00265.02.0



NISSAN
ALMERA II (N16)
ALMERA II Hatchback (N16)
ALMERA TINO (V10)
PRIMERA (P12)
PRIMERA Estate (WP12)
PRIMERA Hatchback (P12)
X-TRAIL (T30)

DW-TL 7.00513.10.0



→SI 0096

LEXUS
IS II (_E2_)
TOYOTA
AURIS (_E15_)
AVENSIS (_T25_)
AVENSIS Estate (_T25_)
AVENSIS Estate (_T27_)
AVENSIS Saloon (_T25_)
AVENSIS Saloon (_T27_)
COROLLA Saloon (_E15_)
COROLLA Verso (ZER_, ZZE12_, R1_)
RAV 4 III (_A3_)

DW-TL 7.00513.19.0 New



LEXUS
GS (_L1_)
IS III (_E3_)
NX (_Z1_)
RC (_C1_)
RX (_L2_)
TOYOTA
AURIS (_E18_)
AURIS Estate (_E18_)
C-HR (_X1_)
CROWN (_S21_)
CROWN (_S22_)
HARRIER (_U6_)
TOYOTA FAW
CROWN ROYAL (_S21_)
TOYOTA GAC
HIGHLANDER (_U5_)

DW-TL 7.00607.02.0



→SI 0096

ALFA ROMEO
147 (937_)
156 (932_)
156 Sportwagon (932_)
159 (939_)
159 Sportwagon (939_)
166 (936_)
BRERA (939_)
GT (937_)
MITO (955_)
SPIDER (939_)
FIAT
500 (312_)
500L (351_, 352_)
BRAVO II (198_)
CROMA (194_)
DOBLO Box Body/MPV (223_)
DOBLO MPV (119_, 223_)



DW-TL	7.00607.02.0	DW-TL	7.00612.01.0	DW-TL	7.00782.11.0
<p>DUCATO Bus (230_) DUCATO Bus (244_) DUCATO Platform/Chassis (230_) DUCATO Platform/Chassis (244_) DUCATO Van (230_) DUCATO Van (244_) GRANDE PUNTO (199_) GRANDE PUNTO Van (199_) IDEA (350_) LINEA (323_, 110_) MAREA (185_) MAREA Weekend (185_) MULTIPLA (186_) PANDA (169_) PANDA (312_, 319_) PANDA Hatchback Van (169_) PUNTO (199_) PUNTO EVO (199_) PUNTO EVO Hatchback Van (199_) PUNTO Hatchback Van (199_) STILO (192_) STILO Multi Wagon (192_) STILO VAN (192_) STRADA Pickup (178_)</p> <p>FORD KA (RU8)</p> <p>LANCIA DELTA III (844_) LYBRA (839_) LYBRA SW (839_) MUSA (350_) THESIS (841_) YPSILON (312_) YPSILON (843_)</p>		 <p>→SI 0096 →SI 0100</p> <p>CITROEN C5 Estate Van (DE_, RE_) C5 II (RC_) C5 II Break (RE_)</p> <p>PEUGEOT 307 (3A/C) 307 Break (3E) 307 CC (3B) 307 SW (3H) 307 SW Estate Van (3E_, 3H_) 407 (6D_) 407 Coupe (6C_) 407 SW (6E_) 407 SW Estate Van (6E_)</p>	 <p>BRABUS 40S (W221) 50S (W221)</p> <p>MERCEDES-BENZ A-CLASS (W176) C-CLASS (W205) C-CLASS Convertible (A205) C-CLASS Coupe (C205) C-CLASS T-Model (S205) CLA Coupe (C117) CLA Shooting Brake (X117) CLS (C218) CLS Shooting Brake (X218) E-CLASS (W212) E-CLASS (W213) E-CLASS Convertible (A207) E-CLASS Convertible (A238) E-CLASS Coupe (C207) E-CLASS Coupe (C238) E-CLASS T-Model (S212) E-CLASS T-Model (S213) G-CLASS (W463) GL-CLASS (X166) GLA-CLASS (X156) GLC (X253) GLC Coupe (C253) GLE (W166) GLE Coupe (C292) GLS (X166) M-CLASS (W166) R-CLASS (W251, V251) S-CLASS (W221) S-CLASS (W222, V222, X222) S-CLASS Convertible (A217) S-CLASS Coupe (C216) S-CLASS Coupe (C217) SL (R231) SLC (R172)</p> <p>MERCEDES-BENZ (BBDC) E-CLASS (W212) E-CLASS (W213)</p>		
		DW-TL	7.00782.04.0		
		 <p>→SI 0096 →SI 0100</p> <p>MERCEDES-BENZ A-CLASS (W169) B-CLASS Sports Tourer (W245) SPRINTER 3,5-t Bus (B906) SPRINTER 3,5-t Platform/Chassis (B906) SPRINTER 3,5-t Van (B906) SPRINTER 3-t Bus (B906) SPRINTER 3-t Platform/Chassis (B906) SPRINTER 3-t Van (B906) SPRINTER 4,6-t Platform/Chassis (B906) SPRINTER 4,6-t Van (B906) SPRINTER 5-t Platform/Chassis (B906) SPRINTER 5-t Van (B906)</p> <p>SMART FORFOUR (454) FORTWO Cabrio (451) FORTWO Coupe (451)</p>			
DW-TL	7.00607.04.0 New				
 <p>IVECO DAILY V Platform/Chassis DAILY V Van DAILY VI Platform/Chassis DAILY VI Van</p>					

ELECTRIC VALVES





DW-TL	7.00782.12.0	DW-TL	7.00782.12.0	DW-TL	7.00782.16.0
		<p>SPRINTER 5-t Platform/Chassis (B907) SPRINTER 5-t Tourer Bus (B907) SPRINTER 5-t Van (B906) SPRINTER 5-t Van (B907) V-CLASS (W447) VITO Mixto (Double Cabin) (W447) VITO Tourer (W447) VITO Van (W447) MERCEDES-BENZ (FJDA) SPRINTER (B906)</p>		<p>VITO Van (W447) MERCEDES-BENZ (BBDC) C-CLASS (W205) E-CLASS (W212) E-CLASS (W213) GLA (X156) GLC (X253) GLK-CLASS (X204)</p>	
		<p>DW-TL</p> <p>7.00782.16.0</p> 		<p>DW-TL</p> <p>7.00868.02.0</p> 	
<p>FREIGHTLINER SPRINTER 2500 Extended Cargo Van SPRINTER 2500 Standard Cargo Van SPRINTER 2500 Standard Passenger Van SPRINTER 3500 Cab & Chassis SPRINTER 3500 Extended Cargo Van SPRINTER 3500 Standard Cargo Van SPRINTER 3500 Standard Passenger Van</p> <p>MERCEDES-BENZ C-CLASS (W204) C-CLASS (W205) C-CLASS Convertible (A205) C-CLASS Coupe (C204) C-CLASS Coupe (C205) C-CLASS T-Model (S204) C-CLASS T-Model (S205) CLS (C218) CLS Shooting Brake (X218) E-CLASS (W212) E-CLASS Convertible (A207) E-CLASS Coupe (C207) E-CLASS T-Model (S212) GLC (X253) GLC Coupe (C253) GLE (W166) GLK-CLASS (X204) M-CLASS (W166) MARCO POLO Camper (W447) S-CLASS (W221) S-CLASS (W222, V222, X222) SLC (R172) SLK (R172) SPRINTER 3,5-t Bus (B906) SPRINTER 3,5-t Platform/Chassis (B906) SPRINTER 3,5-t Platform/Chassis (B907, B910) SPRINTER 3,5-t Tourer Bus (B907) SPRINTER 3,5-t Van (B906) SPRINTER 3,5-t Van (B907, B910) SPRINTER 3-t Bus (B906) SPRINTER 3-t Platform/Chassis (B906) SPRINTER 3-t Platform/Chassis (B910, B907) SPRINTER 3-t Van (B906) SPRINTER 3-t Van (B910) SPRINTER 4,6-t Bus (B906) SPRINTER 4,6-t Platform/Chassis (B906) SPRINTER 4,6-t Van (B906) SPRINTER 4-t Platform/Chassis (B907, B910) SPRINTER 4-t Tourer Bus (B907) SPRINTER 4-t Van (B907, B910) SPRINTER 5-t Bus (B906) SPRINTER 5-t Platform/Chassis (B906)</p>		<p>MERCEDES-BENZ A-CLASS (W176) AMG GT (C190) AMG GT (X290) AMG GT Roadster (R190) B-CLASS Sports Tourer (W246, W242) C-CLASS (W204) C-CLASS (W205) C-CLASS Convertible (A205) C-CLASS Coupe (C204) C-CLASS Coupe (C205) C-CLASS T-Model (S204) C-CLASS T-Model (S205) CLA Coupe (C117) CLA Shooting Brake (X117) CLS (C218) E-CLASS (W212) E-CLASS (W213) E-CLASS Convertible (A207) E-CLASS Convertible (A238) E-CLASS Coupe (C207) E-CLASS Coupe (C238) E-CLASS T-Model (S212) E-CLASS T-Model (S213) G-CLASS (W463) GLA-CLASS (X156) GLC (X253) GLC Coupe (C253) GLE (V167) GLE Coupe (C167) GLK-CLASS (X204) GLS (X167) S-CLASS (W222, V222, X222) S-CLASS Convertible (A217) S-CLASS Coupe (C217) SLC (R172) SLK (R172) V-CLASS (W447) VITO Tourer (W447)</p>		<p>AUDI A3 (8L1) A3 (8P1) A3 Convertible (8P7) A3 Sportback (8PA) A4 B5 (8D2) A4 B5 Avant (8D5) A4 B6 (8E2) A4 B6 Avant (8E5) A4 B6 Convertible (8H7) A4 B7 (8EC) A4 B7 Avant (8ED) TT (8J3) TT Roadster (8J9)</p> <p>SEAT ALHAMBRA (710, 711) ALHAMBRA (7V8, 7V9) ALTEA (5P1) ALTEA XL (5P5, 5P8) CORDOBA (6L2) IBIZA III (6L1) IBIZA IV (6J5, 6P1) IBIZA IV SC (6J1, 6P5) LEON (1M1) LEON (1P1) TOLEDO II (1M2) TOLEDO III (5P2)</p> <p>SKODA FABIA II (542) FABIA II Combi (545) OCTAVIA I (1U2) OCTAVIA I Combi (1U5) OCTAVIA II (1Z3) OCTAVIA II Combi (1Z5) ROOMSTER (5J7) ROOMSTER Praktik (5J) SUPERB I (3U4) SUPERB II (3T4) SUPERB II Estate (3T5) YETI (5L)</p>	



DW-TL	7.00868.02.0	DW-TL	7.00887.19.0	DW-TL	7.00887.21.0
VOLKSWAGEN BEETLE (5C1, 5C2) BEETLE Convertible (5C7, 5C8) BORA I (1J2) BORA Variant (1J6) CADDY III Box Body/MPV (2KA, 2KH, 2CA, 2CH) CADDY III MPV (2KB, 2KJ, 2CB, 2CJ) CRAFTER 30-35 Bus (2E_) CRAFTER 30-50 Platform/Chassis (2F_) CRAFTER 30-50 Van (2E_) EOS (1F7, 1F8) GOLF IV (1J1) GOLF IV Van (1J1) GOLF IV Variant (1J5) GOLF PLUS V (5M1, 521) GOLF V (1K1) GOLF V Variant (1K5) GOLF VAN IV Variant (1J5) GOLF VAN VI Variant (AJ5) GOLF VI (5K1) GOLF VI Van (5K1_) GOLF VI Variant (AJ5) JETTA III (1K2) JETTA IV (162, 163, AV3, AV2) MULTIVAN V (7HM, 7HN, 7HF, 7EF, 7EM, 7EN) MULTIVAN VI (SGF, SGM, SGN, SHM, SHN) NEW BEETLE (9C1, 1C1) NEW BEETLE Convertible (1Y7) PASSAT ALLTRACK B7 (365) PASSAT B5 (3B2) PASSAT B5 GP (3BG) PASSAT B5 Variant (3B5) PASSAT B5.5 (3B3) PASSAT B5.5 Variant (3B6) PASSAT B6 (3C2) PASSAT B6 Variant (3C5) PASSAT B7 (362) PASSAT B7 Variant (365) PASSAT CC B6 (357) POLO (9N_) SCIROCCO III (137, 138) SCIROCCO Van (137) SHARAN (7M8, 7M9, 7M6) TIGUAN (5N_) TOURAN (1T1, 1T2) TRANSPORTER / CARAVELLE VI Bus (SGB, SGG, SGJ, SGC, SHB, SHJ) TRANSPORTER V Bus (7HB, 7HJ, 7EB, 7EJ, 7EF, 7EG, 7HF, 7EC) TRANSPORTER V Platform/Chassis (7JD, 7JE, 7JL, 7JY, 7JZ, 7FD) TRANSPORTER V Van (7HA, 7HH, 7EA, 7EH) TRANSPORTER VI Platform/Chassis (SFD, SFE, SFL, SFZ, SJD, SJ) TRANSPORTER VI Van (SGA, SGH, SHA, SHH) ENGINE		 BMW 1 Convertible (E88) 1 Coupe (E82) 3 (E90) 3 Convertible (E93) 3 Coupe (E92) 3 Touring (E91) 5 (E60) 5 (F10) 5 Gran Turismo (F07) 5 Touring (E61) 5 Touring (F11) 6 Convertible (F12) 6 Coupe (F13) 7 (F01, F02, F03, F04) X5 (E70) X6 (E71, E72) Z4 Roadster (E89)		 BMW 1 (F20) 1 (F21) 1 Convertible (E88) 1 Coupe (E82) 2 Coupe (F22, F87) 3 (E90) 3 (F30, F80) 3 Convertible (E93) 3 Coupe (E92) 3 Gran Turismo (F34) 3 Touring (E91) 3 Touring (F31) 4 Convertible (F33, F83) 4 Coupe (F32, F82) 4 Gran Coupe (F36) 5 (F10) 5 Gran Turismo (F07) 5 Touring (F11) 6 Convertible (F12) 6 Coupe (F13) 6 Gran Coupe (F06) 7 (F01, F02, F03, F04) X1 (E84) X3 (F25) X4 (F26) X5 (E70) X5 (F15, F85) X6 (E71, E72) X6 (F16, F86) Z4 Roadster (E89)	
		DW-TL		7.00887.20.0	
		 BMW 7 (F01, F02, F03, F04) X6 (E71, E72)		→SI 0096 BMW (BRILLIANCE) 3 SERIES (F30, F35) 5 SERIES (F10, F18) X1 (E84)	
				ROLLS-ROYCE DAWN (RR6) GHOST I (RR4) WRAITH (RR5)	



DW-TL 7.00887.22.0



ALPINA

B3 (F30)

BMW

1 (F20)

1 (F21)

1 Convertible (E88)

1 Coupe (E82)

2 Coupe (F22, F87)

3 (F30, F80)

3 Convertible (E93)

3 Coupe (E92)

3 Touring (E91)

5 (F10)

5 Gran Turismo (F07)

5 Touring (F11)

6 Convertible (F12)

6 Coupe (F13)

6 Gran Coupe (F06)

7 (F01, F02, F03, F04)

X1 (E84)

X3 (F25)

X4 (F26)

X5 (E70)

X6 (E71, E72)

BMW (BRILLIANCE)

3 SERIES (F30, F35)

5 SERIES (F10, F18)

DW-TL 7.00964.03.0



PEUGEOT

307 (3A/C)

307 Break (3E)

307 SW (3H)

→SI 0087

→SI 0096

→SI 0100

DW-TL 7.00968.04.0



→SI 0089

→SI 0096

CITROEN

BERLINGO / BERLINGO FIRST Box Body/MPV (M_)

BERLINGO / BERLINGO FIRST MPV (MF_, GJK_, GFK_)

BERLINGO Box Body/MPV (B9)

BERLINGO MULTISPACE (B9)

BERLINGO Platform/Chassis (B9)

C2 (JM_)

C3 I (FC_, FN_)

C3 II (SC_)

C3 PICASSO (SH_)

C4 Coupe (LA_)

C4 GRAND PICASSO I (UA_)

C4 I (LC_)

C4 I Saloon

C4 PICASSO I MPV (UD_)

C5 II (RC_)

C5 II Break (RE_)

C5 III (RD_)

C5 III Break (RW_)

XSARA PICASSO (N68)

FORD

C-MAX (DM2)

FIESTA V (JH_, JD_)

FIESTA V Van

FIESTA VI (CB1, CCN)

FIESTA VI Van

FOCUS C-MAX (DM2)

FOCUS II (DA_, HCP, DP)

FOCUS II Saloon (DB_, FCH, DH)

FOCUS II Turnier (DA_, FFS, DS)

FUSION (JU_)

MAZDA

3 (BK)

3 (BL)

3 Saloon (BK)

PEUGEOT

1007 (KM_)

206 Hatchback (2A/C)

206 SW (2E/K)

207 (WA_, WC_)

207 CC (WD_)

207 Hatchback Van (WA_, WC_)

207 SW (WK_)

307 (3A/C)

307 Break (3E)

307 SW (3H)

308 CC (4B_)

DW-TL 7.00968.04.0

308 I (4A_, 4C_)

308 SW I (4E_, 4H_)

407 (6D_)

407 SW (6E_)

607 (9D, 9U)

PARTNER Box Body/MPV

PARTNER Box Body/MPV (5_, G_)

PARTNER MPV (5_, G_)

PARTNER Platform/Chassis

PARTNER TEPEE

VOLVO

C30 (533)

S40 II (544)

S80 II (124)

V50 (545)

V70 III (135)

DW-TL 7.01152.02.0



→SI 0096

NISSAN

INTERSTAR Bus (X70)

INTERSTAR Platform/Chassis

INTERSTAR Van (X70)

PRIMASTAR Bus (X83)

PRIMASTAR Platform/Chassis (X83)

PRIMASTAR Van (X83)

OPEL

MOVANO Bus (X70)

MOVANO Platform/Chassis (X70)

MOVANO Van (X70)

VIVARO A Bus (X83)

VIVARO A Platform/Chassis (X83)

VIVARO A Van (X83)

RENAULT

ESPACE IV (JK0/1_)

GRAND SCÉNIC II (JM0/1_)

LAGUNA II (BG0/1_)

LAGUNA II Grandtour (KG0/1_)

MASTER II Bus (JD)

MASTER II Platform/Chassis (ED/HD/UD)

MASTER II Van (FD)

MEGANE II (BM0/1_, CM0/1_)

MEGANE II Coupé-Cabriolet (EM0/1_)

MEGANE II Estate (KM0/1_)

MEGANE II Saloon (LM0/1_)

SCÉNIC II (JM0/1_)

TRAFIC II Bus (JL)

TRAFIC II Platform/Chassis (EL)

TRAFIC II Van (FL)

VEL SATIS (BJ0_)



DW-TL	7.01152.02.0
VAUXHALL	
MOVANO Mk I (A) Chassis/Cab (X70)	
MOVANO Mk I (A) Combi (X70)	
MOVANO Mk I (A) Van (X70)	
VIVARO A Bus (X83)	
VIVARO A Platform/Chassis (X83)	
VIVARO A Van (X83)	

DW-TL	7.01420.02.0
-------	--------------



→SI 0096

CHEVROLET

MALIBU (V300)

OPEL

- ASTRA H (A04)
- ASTRA H Estate (A04)
- ASTRA H Estate Van (L70)
- ASTRA H GTC (A04)
- ASTRA H Saloon (A04)
- ASTRA H TwinTop (A04)
- CASCADA (W13)
- CORSA D (S07)
- CORSA D Hatchback Van (S07)
- MERIVA A MPV (X03)
- MERIVA B MPV (S10)
- ZAFIRA / ZAFIRA FAMILY B (A05)

VAUXHALL

- ASTRA Mk V (H) (A04)
- ASTRA Mk V (H) Estate (A04)
- ASTRA Mk V (H) Sport Hatch (A04)
- ASTRA Mk V (H) TwinTop (A04)
- ASTRAVAN Mk V (H) Estate Van (A04)
- CASCADA Convertible (W13)
- CORSA Mk III (D) (S07)
- CORSAVAN Mk III (D) Hatchback Van (S07)
- MERIVA A (X03)
- MERIVA Mk II (B) (S10)
- ZAFIRA Mk II (B) (A05)

DW-TL	7.01421.01.0
-------	--------------



→SI 0096

OPEL

- COMBO Box Body/MPV
- COMBO Tour
- INSIGNIA A (G09)
- INSIGNIA A Country Tourer (G09)
- INSIGNIA A Saloon (G09)
- INSIGNIA A Sports Tourer (G09)
- SIGNUM Hatchback (Z03)
- VECTRA C (Z02)
- VECTRA C Estate (Z02)
- VECTRA C GTS (Z02)

VAUXHALL

- COMBO Mk II (C) Box Body/MPV (F25)
- COMBO TOUR Mk II (C) (F25)
- INSIGNIA Mk I (A) Country Tourer (G09)
- INSIGNIA Mk I (A) Hatchback (G09)
- INSIGNIA Mk I (A) Saloon (G09)
- INSIGNIA Mk I (A) Sports Tourer (G09)
- SIGNUM (Z03)
- VECTRA Mk II (C) (Z02)
- VECTRA Mk II (C) Estate (Z02)
- VECTRA Mk II (C) GTS (Z02)

DW-TL	7.01632.02.0
-------	--------------



CITROEN

- C4 Coupe (LA_)
- C4 I (LC_)
- C4 I Hatchback Van (LR_)

PEUGEOT

- 307 (3A/C)
- 307 Break (3E)
- 307 CC (3B)
- 307 SW (3H)

DW-TL	7.01633.04.0
-------	--------------



→SI 0096

CITROEN

- C4 Coupe (LA_)
- C4 I (LC_)
- C4 I Hatchback Van (LR_)
- C4 PICASSO I MPV (UD_)
- C5 II (RC_)
- C5 II Break (RE_)
- C5 III (RD_)
- C5 III Break (RW_)
- C6 (TD_)
- C8 (EA_, EB_)
- JUMPY (VF7)
- JUMPY Van

FIAT

- SCUDO Bus (270_, 272_)
- SCUDO Platform/Chassis (270_, 272_)
- SCUDO Van (270_, 272_)
- ULYSSE (179_)

LANCIA

- PHEDRA (179_)

PEUGEOT

- 307 (3A/C)
- 307 Break (3E)
- 307 CC (3B)
- 307 SW (3H)
- 307 SW Estate Van (3E_, 3H_)
- 308 CC (4B_)
- 308 I (4A_, 4C_)
- 308 SW I (4E_, 4H_)
- 407 (6D_)
- 407 Coupe (6C_)
- 407 SW (6E_)
- 407 SW Estate Van (6E_)
- 607 (9D, 9U)
- 807 (EB_)
- EXPERT Platform/Chassis
- EXPERT Van (VF3A_, VF3U_, VF3X_)

ELECTRIC VALVES





ELECTRIC VALVES



DW-TL 7.01633.06.0



CITROEN

- BERLINGO Box Body/MPV (B9)
- BERLINGO MULTISPACE (B9)
- C3 II (SC_)
- C3 PICASSO (SH_)
- C4 AIRCROSS
- C4 GRAND PICASSO I (UA_)
- C4 GRAND PICASSO II (DA_, DE_)
- C4 II (B7)
- C4 II Hatchback Van (NC_)
- C4 II Saloon (NC_)
- C4 PICASSO I MPV (UD_)
- C4 PICASSO II
- C5 III (RD_)
- C5 III Break (RW_)
- DS3
- DS4 (NX_)
- DS5
- GRAND C4 SPACETOURER (3A_, 3E_)

DS

- DS 4 / DS 4 CROSSBACK (NX_)

FORD

- C-MAX II (DXA/CB7, DXA/CEU)
- FOCUS III
- FOCUS III Saloon
- FOCUS III Turnier
- GALAXY II (WA6)
- GRAND C-MAX (DXA/CB7, DXA/CEU)
- MONDEO IV (BA7)
- MONDEO IV Saloon (BA7)
- MONDEO IV Turnier (BA7)
- MONDEO IV Van
- S-MAX (WA6)
- TRANSIT CONNECT MPV
- TRANSIT CONNECT V408 Box Body/MPV
- TRANSIT COURIER B460 Box Body/MPV
- TRANSIT COURIER B460 MPV

MINI (BMW)

- ASX (GA_W_)

PEUGEOT

- 2008 I (CU_)
- 207 (WA_, WC_)
- 207 CC (WD_)
- 207 SW (WK_)
- 208 I (CA_, CC_)
- 3008 MPV (OU_)
- 308 CC (4B_)
- 308 Hatchback Van (LB_)
- 308 I (4A_, 4C_)
- 308 II (LB_, LP_, LW_, LH_, L3_)

DW-TL 7.01633.06.0

- 308 SW I (4E_, 4H_)
- 308 SW II (LC_, LJ_, LR_, LX_, L4_)
- 4008
- 5008 (OU_, OE_)
- 508 I (8D_)
- 508 SW Estate Van (8E_)
- 508 SW I (8E_)
- PARTNER Box Body/MPV
- PARTNER TEPEE
- VOLVO**
- C30 (533)
- S40 II (544)
- S60 II (134)
- S80 II (124)
- V40 Hatchback (525, 526)
- V40 Hatchback Van (525, 526)
- V50 (545)
- V60 I (155, 157)
- V60 I Estate Van (155)
- V70 III (135)

DW-TL 7.01771.01.0



→SI 0096

FORD

- C-MAX (DM2)
- C-MAX II (DXA/CB7, DXA/CEU)
- C-MAX II Van
- FOCUS C-MAX (DM2)
- FOCUS II (DA_, HCP, DP)
- FOCUS II Convertible
- FOCUS II Saloon (DB_, FCH, DH)
- FOCUS II Turnier (DA_, FFS, DS)
- FOCUS III
- FOCUS III Estate Van
- FOCUS III Hatchback Van
- FOCUS III Saloon
- GALAXY II (WA6)
- KUGA I
- MONDEO IV (BA7)
- MONDEO IV Saloon (BA7)
- MONDEO IV Turnier (BA7)
- S-MAX (WA6)
- VOLVO**
- C30 (533)
- C70 II Convertible (542)
- S40 II (544)
- S80 II (124)
- V50 (545)
- V70 III (135)

DW-TL 7.01777.17.0



→SI 0096

BMW

- 1 (F20)
- 1 (F21)
- 3 (F30, F80)
- 3 Touring (F31)

BMW (BRILLIANCE)

- 3 SERIES (F30, F35)

MINI (BMW)

- MINI (R56)
- MINI CLUBMAN (R55)
- MINI COUNTRYMAN (R60)
- MINI Convertible (R57)
- MINI Coupe (R58)
- MINI PACEMAN (R61)
- MINI Roadster (R59)

DW-TL 7.01777.18.0



CITROEN

- C4 Coupe (LA_)
- C4 GRAND PICASSO I (UA_)
- C4 GRAND PICASSO II (DA_, DE_)
- C4 I (LC_)
- C4 II (B7)
- C4 II Saloon (NC_)
- C4 PICASSO I MPV (UD_)
- C4 PICASSO II
- C5 III (RD_)
- C5 III Break (RW_)
- DS3
- DS3 Convertible
- DS4 (NX_)
- DS5
- DS**
- DS 3 (SA_)
- DS 4 / DS 4 CROSSBACK (NX_)
- DS 5 (KF_)



DW-TL	7.01777.18.0
PEUGEOT	
207 (WA_, WC_)	
207 CC (WD_)	
207 SW (WK_)	
208 I (CA_, CC_)	
3008 MPV (OU_)	
3008 SUV (MC_, MR_, MJ_, M4_)	
308 CC (4B_)	
308 I (4A_, 4C_)	
308 II (LB_, LP_, LW_, LH_, L3_)	
308 SW I (4E_, 4H_)	
308 SW II (LC_, LJ_, LR_, LX_, L4_)	
5008 (OU_, 0E_)	
5008 II (MC_, MJ_, MR_, M4_)	
508 I (8D_)	
508 SW I (8E_)	
RCZ	

DW-TL	7.01814.12.0
DACIA	
DOKKER Express Box Body/MPV	
DOKKER MPV (KE_)	
DUSTER (HS_)	
DUSTER SUV Van	
LODGY (JS_)	
LOGAN II	
LOGAN MCV II	
SANDERO II	
FIAT	
TALENTO Bus (296_)	
TALENTO Platform/Chassis (296_)	
TALENTO Van (296_)	
MERCEDES-BENZ	
C-CLASS (W205)	
C-CLASS T-Model (S205)	
NISSAN	
JUKE (F15)	
MICRA V (K14)	
NOTE (E12)	
NV200 / EVALIA Bus	
NV200 Van	
NV300 Kombi (X82)	
NV300 Platform/Chassis (X82)	
NV300 Van (X82)	
NV400 Platform/Chassis (X62, X62B)	
NV400 Van (X62, X62B)	
QASHQAI II SUV (J11, J11_)	
OPEL	
MOVANO B Bus (X62)	
MOVANO B Platform/Chassis (X62)	
MOVANO B Van (X62)	
VIVARO B Bus (X82)	
VIVARO B Platform/Chassis (X82)	
VIVARO B Van (X82)	
RENAULT	
CAPTUR I (J5_, H5_)	
CLIO IV (BH_)	
CLIO IV Grandtour (KH_)	
CLIO IV Hatchback Van (BH_)	
DOKKER	
SPACE V (JR_)	
FLUENCE (L3_)	
GRAND SCÉNIC III (JZ0/1_)	
GRAND SCÉNIC IV (R9_)	
KADJAR (HA_, HL_)	
KANGOO / GRAND KANGOO (KW0/1_)	
KANGOO Express (FW0/1_)	
KOLEOS II (HC_)	



→SI 0096

DW-TL	7.01777.19.0
CITROEN	
C4 Coupe (LA_)	
C4 GRAND PICASSO II (DA_, DE_)	
C4 I (LC_)	
C4 PICASSO II	
C4 SPACETOURER (3D_)	
DS3	
DS3 Convertible	
DS4 (NX_)	
DS5	
DS	
DS 3 (SA_)	
DS 3 Convertible (SB_)	
DS 4 / DS 4 CROSSBACK (NX_)	
DS 5 (KF_)	
OPEL	
GRANDLAND X (A18)	
PEUGEOT	
208 I (CA_, CC_)	
3008 MPV (OU_)	
3008 SUV (MC_, MR_, MJ_, M4_)	
308 CC (4B_)	
308 I (4A_, 4C_)	
308 II (LB_, LP_, LW_, LH_, L3_)	
308 SW II (LC_, LJ_, LR_, LX_, L4_)	
5008 (OU_, 0E_)	
5008 II (MC_, MJ_, MR_, M4_)	
508 I (8D_)	
508 II (FB_, FH_, F3_)	
508 SW I (8E_)	
RCZ	



DW-TL	7.01814.12.0
LAGUNA Coupe (DT0/1)	
LAGUNA III Grandtour (KT0/1)	
LODGY (JS_)	
MASTER III Bus (JV)	
MASTER III Platform/Chassis (EV, HV, UV)	
MASTER III Van (FV)	
MEGANE CC (EZ0/1_)	
MEGANE III Coupe (DZ0/1_)	
MEGANE III Grandtour (KZ0/1)	
MEGANE III Hatchback (BZ0/1_, B3_)	
MEGANE III Hatchback Van (BZ_)	
MEGANE IV GRAND COUPE	
MEGANE IV Grandtour (K9A/M/N_)	
MEGANE IV Hatchback (B9A/M/N_)	
SANDERO/STEPWAY II (B8_)	
SCÉNIC III (JZ0/1_)	
SCÉNIC IV (J9_)	
TALISMAN (LP_)	
TALISMAN Grandtour (KP_)	
TRAFIC III Bus (JG_)	
TRAFIC III Platform/Chassis (EG_)	
TRAFIC III Van (FG_)	
VAUXHALL	
MOVANO Mk II (B) Chassis/Cab (X62)	
MOVANO Mk II (B) Combi (X62)	
MOVANO Mk II (B) VAN (X62)	
VIVARO B Bus (X82)	
VIVARO B Platform/Chassis (X82)	
VIVARO B Van (X82)	

DW-TL	7.01814.22.0
FIAT	
TALENTO Bus (296_)	
TALENTO Platform/Chassis (296_)	
TALENTO Van (296_)	
MERCEDES-BENZ	
X-CLASS (470)	
X-CLASS Platform/Chassis (470)	
NISSAN	
NAVARA Platform/Chassis (D23)	
NP300 NAVARA Pickup (D23)	
NV300 Kombi (X82)	
NV300 Platform/Chassis (X82)	
NV300 Van (X82)	
OPEL	
VIVARO B Bus (X82)	
VIVARO B Platform/Chassis (X82)	
VIVARO B Van (X82)	
RENAULT	
ALASKAN	





ELECTRIC VALVES



DW-TL	7.01814.22.0
ESPACE V (JR_) GRAND SCÉNIC IV (R9_) MEGANE IV Grandtour (K9A/M/N_) MEGANE IV Hatchback (B9A/M/N_) SCÉNIC IV (J9_) TALISMAN (LP_) TALISMAN Grandtour (KP_) TRAFIC III Bus (JG_) TRAFIC III Platform/Chassis (EG_) TRAFIC III Van (FG_) VAUXHALL VIVARO B Bus (X82) VIVARO B Platform/Chassis (X82) VIVARO B Van (X82)	



→SI 0096

- AUDI**
 A3 (8L1)
 A4 B5 (8D2)
 A4 B5 Avant (8D5)
- SEAT**
 ALHAMBRA (7V8, 7V9)
 LEON (1M1)
 TOLEDO II (1M2)
- SKODA**
 FABIA I (6Y2)
 FABIA I Combi (6Y5)
 FABIA I Praktik (6Y5)
 FABIA I Saloon (6Y3)
 OCTAVIA I (1U2)
 OCTAVIA I Combi (1U5)
 OCTAVIA I Estate Van (1U5)
 SUPERB I (3U4)
- VOLKSWAGEN**
 BORA I (1J2)
 BORA Variant (1J6)
 GOLF IV (1J1)
 GOLF IV Variant (1J5)
 GOLF VAN IV Variant (1J5)
 LT 28-35 II Bus (2DB, 2DE, 2DK)
 LT 28-46 II Platform/Chassis (2DC, 2DF, 2DG, 2DL, 2DM)
 LT 28-46 II Van (2DA, 2DD, 2DH)
 MULTIVAN VI (SGF, SGM, SGN, SHM, SHN)
 NEW BEETLE (9C1, 1C1)
 NEW BEETLE Convertible (1Y7)
 PASSAT B5 (3B2)
 PASSAT B5 Variant (3B5)
 PASSAT B5.5 (3B3)

DW-TL	7.02184.01.0
PASSAT B5.5 Variant (3B6) SHARAN (7M8, 7M9, 7M6) TOUAREG (7LA, 7L6, 7L7) TRANSPORTER / CARAVELLE VI Bus (SGB, SGG, SGJ, SGC, SHB, SHJ) TRANSPORTER VI Platform/Chassis (SFD, SFE, SFL, SFZ, SJD, SJ) TRANSPORTER VI Van (SGA, SGH, SHA, SHH) ENGINE	



→SI 0096

- NISSAN**
 NP300 NAVARA (D40)
 NP300 NAVARA Platform/Chassis (D40)
 PATHFINDER III (R51)



→SI 0096

- NISSAN**
 INTERSTAR Bus (X70)
 INTERSTAR Van (X70)
 PRIMASTAR Bus (X83)
 PRIMASTAR Van (X83)
- OPEL**
 MOVANO Bus (X70)
 MOVANO Van (X70)
 VIVARO A Bus (X83)
 VIVARO A Platform/Chassis (X83)
 VIVARO A Van (X83)
- RENAULT**
 ESPACE III (JE0_)
 LAGUNA I (B56_, 556_)
 LAGUNA I Grandtour (K56_)
 LAGUNA II (BG0/1_)
 LAGUNA II Grandtour (KG0/1_)
 MEGANE I (BA0/1_)
 MEGANE I Classic (LA0/1_)

DW-TL	7.02256.04.0
MEGANE I Coach (DA0/1_) SCÉNIC I MPV (JA0/1_, FA0_) TRAFIC II Bus (JL) TRAFIC II Platform/Chassis (EL) TRAFIC II Van (FL) VAUXHALL VIVARO A Bus (X83) VIVARO A Platform/Chassis (X83) VIVARO A Van (X83)	



→SI 0096

- RENAULT**
 ESPACE IV (JK0/1_)
 GRAND SCÉNIC II (JM0/1_)
 GRAND SCÉNIC III (JZ0/1_)
 KOLEOS I (HY_)
 LAGUNA Coupe (DT0/1)
 LAGUNA II (BG0/1_)
 LAGUNA II Grandtour (KG0/1_)
 LAGUNA III (BT0/1)
 LAGUNA III Grandtour (KT0/1)
 MASTER III Van (FV)
 MEGANE CC (EZ0/1_)
 MEGANE II (BM0/1_, CM0/1_)
 MEGANE II Coupé-Cabriolet (EM0/1_)
 MEGANE II Estate (KM0/1_)
 MEGANE II Saloon (LM0/1_)
 MEGANE III Coupe (DZ0/1_)
 MEGANE III Grandtour (KZ0/1)
 MEGANE III Hatchback (BZ0/1_, B3_)
 SCÉNIC II (JM0/1_)
 SCÉNIC III (JZ0/1_)
 VEL SATIS (BJ0_)



→SI 0096



DW-TL	7.02256.17.0	DW-TL	7.02256.21.0	DW-TL	7.02256.24.0
<p>NISSAN QASHQAI / QASHQAI +2 I (J10, NJ10, JJ10E) X-TRAIL (T31)</p> <p>RENAULT KOLEOS I (HY_)</p>		<p>MEGANE III Grandtour (KZ0/1) MEGANE III Hatchback (BZ0/1_, B3_) MEGANE III Hatchback Van (BZ_) MODUS / GRAND MODUS (F/JP0_) SCÉNIC II (JM0/1_) SCÉNIC III (JZ0/1_) THALIA I (LB_) THALIA II (LU_) TWINGO II (CN0_)</p>		<p>EVASION MPV (22, U6) JUMPY (U6U_) JUMPY Platform/Chassis (BU_, BV_, BW_, BX_) JUMPY Van (BS_, BT_, BY_, BZ_) XANTIA (X1_, X2_) XANTIA Break (X1_, X2_)</p> <p>FIAT SCUDO Bus (220_) SCUDO Platform/Chassis (220_) SCUDO Van (220_) ULYSSE (179_) ULYSSE (220_)</p> <p>LANCIA PHEDRA (179_) ZETA (22_)</p> <p>PEUGEOT 307 SW Estate Van (3E_, 3H_) 307 Saloon 406 (8B) 406 Break (8E/F) 607 (9D, 9U) 806 (221) 807 (EB_) BOXER Bus (244, Z_) BOXER Platform/Chassis (244) BOXER Van (244) EXPERT (224_) EXPERT Platform/Chassis (223) EXPERT Van (222)</p> <p>SUZUKI LIANA (ER, RH_) LIANA Hatchback</p>	
<p>DW-TL 7.02256.21.0</p>  <p>→SI 0096</p> <p>DACIA LOGAN (LS_) LOGAN EXPRESS (FS_) LOGAN MCV (KS_) LOGAN Pickup (US_) SANDERO</p> <p>NISSAN CUBE (Z12) JUKE (F15) KUBISTAR Van (X76) MICRA III (K12) NOTE (E11, NE11) NV200 / EVALIA Bus NV200 Van QASHQAI / QASHQAI +2 I (J10, NJ10, JJ10E) TIIDA Hatchback (C11) TIIDA Saloon (SC11)</p> <p>RENAULT CLIO II (BB_, CB_) CLIO III (BR0/1, CR0/1) CLIO III Grandtour (KR0/1_) CLIO III Hatchback Van (SB_, SR_) FLUENCE (L3_) GRAND SCÉNIC II (JM0/1_) GRAND SCÉNIC III (JZ0/1_) KANGOO (KC0/1_) KANGOO / GRAND KANGOO (KW0/1_) KANGOO BE BOP (KW0/1_) KANGOO Express (FC0/1_) KANGOO Express (FW0/1_) LAGUNA III (BT0/1) LAGUNA III Grandtour (KT0/1) LOGAN I (LS_) LOGAN I Estate (KS_) MEGANE II (BM0/1_, CM0/1_) MEGANE II Coupé-Cabriolet (EM0/1_) MEGANE II Estate (KM0/1_) MEGANE II Estate Van (KM_) MEGANE II Hatchback Van (KM0/2_) MEGANE II Saloon (LM0/1_) MEGANE III Combi Van (KZ0/1) MEGANE III Coupe (DZ0/1_)</p>		<p>DW-TL 7.02256.23.0</p>  <p>→SI 0096</p> <p>CITROEN C5 I (DC_) C5 I Break (DE_) C8 (EA_, EB_) XSARA (N1) XSARA Break (N2) XSARA Coupe (N0) XSARA Estate Van XSARA Hatchback Van (N3_)</p> <p>PEUGEOT 406 (8B) 406 Break (8E/F) 406 Coupe (8C) 607 (9D, 9U) 807 (EB_)</p>		<p>DW-TL 7.02256.25.0</p>  <p>→SI 0096</p> <p>FORD ENDEAVOUR EVEREST RANGER (ET)</p> <p>MAZDA BT-50 Pickup (CD, UN) BT-50 Platform/Chassis (CD, UN)</p>	
<p>DW-TL 7.02256.24.0</p>  <p>→SI 0096</p> <p>CITROEN C3 I (FC_, FN_) C4 I (LC_) C4 I Saloon C5 Estate Van (DE_, RE_) C5 I (DC_) C5 I Break (DE_) C8 (EA_, EB_)</p>					



ELECTRIC VALVES



DW-TL 7.02256.26.0



→SI 0096

OPEL
 SIGNUM Hatchback (Z03)
 VECTRA C (Z02)
 VECTRA C Estate (Z02)
 VECTRA C GTS (Z02)

VAUXHALL
 SIGNUM (Z03)
 VECTRA Mk II (C) (Z02)
 VECTRA Mk II (C) Estate (Z02)
 VECTRA Mk II (C) GTS (Z02)

DW-TL 7.02256.27.0

5 Touring (G31)
 6 (E63)
 6 Convertible (E64)
 6 Convertible (F12)
 6 Coupe (F13)
 6 Gran Coupe (F06)
 6 Gran Turismo (G32)
 7 (F01, F02, F03, F04)
 7 (G11, G12)
 8 Convertible (G14, F91)
 8 Coupe (G15, F92)
 8 Gran Coupe (G16, F93)
 X1 (E84)
 X1 (F48)
 X2 (F39)
 X3 (E83)
 X3 (F25)
 X3 (G01, F97)
 X4 (F26)
 X4 (G02, F98)
 X5 (E70)
 X5 (F15, F85)
 X5 (G05, F95)
 X6 (E71, E72)
 X6 (F16, F86)
 X7 (G07)

MINI (BMW)
 MINI COUNTRYMAN (R60)
 MINI PACEMAN (R61)

DW-TL 7.02325.04.0



→SI 0096

VOLVO
 S80 II (124)
 V70 III (135)
 XC60 I SUV (156)
 XC70 II (136)

DW-TL 7.02256.27.0



→SI 0096

DW-TL 7.02256.53.0



FORD
 KUGA II (DM2)
 MONDEO V Saloon (CD)

FORD USA
 EDGE

LINCOLN
 CONTINENTAL
 MKC
 MKX
 MKZ

DW-TL 7.02325.05.0 New



VOLVO
 C30 (533)
 C70 II Convertible (542)
 S40 II (544)
 S60 II (134)
 S80 II (124)
 V40 Hatchback (525, 526)
 V40 Hatchback Van (525, 526)
 V50 (545)
 V60 I (155, 157)
 V60 I Estate Van (155)
 V70 III (135)
 V70 III Estate Van (135)
 XC60 I SUV (156)
 XC70 II (136)



DW-TL 7.02325.06.0

→SI 0096

VOLVO
S60 II (134)
S80 II (124)
V40 Hatchback (525, 526)
V60 I (155, 157)
V70 III (135)
XC60 I SUV (156)
XC70 II (136)

VOLVO ASIA
S60L

DW-TL 7.02968.02.0 New

FUSO
CANTER

MITSUBISHI
Canter (FE5, FE6) VI

DW-TL 7.03003.01.0

FREEMONT (345_)
GRANDE PUNTO (199_)
LINEA (323_, 110_)
PANDA (169_)
PANDA (312_, 319_)
PANDA VAN (312_, 519_)
PUNTO (199_)
PUNTO EVO (199_)
QUBO (225_)
STRADA Pickup (178_)
TIPO Estate (356_)
TIPO Hatchback (356_)
TIPO Saloon (356_)

LANCIA
DELTA III (844_)
MUSA (350_)
YPSILON (312_)
YPSILON (843_)

PEUGEOT
BIPPER (AA_)
BIPPER TEPEE

DW-TL 7.02534.01.0

DW-TL 7.03003.01.0

ALFA ROMEO
159 (939_)
159 Sportwagon (939_)
BRERA (939_)
GIULIA (952_)
GIULIETTA (940_)
GIULIETTA Hatchback Van (940_)
MITO (955_)
SPIDER (939_)
STELVIO (949_)

DW-TL 7.03003.12.0

FERRARI
CALIFORNIA

MASERATI
GHIBLI III (M157)
LEVANTE SUV (M161)
QUATTROPORTE VI

FIAT
SEDICI (189_)

MARUTI SUZUKI
RITZ
S-CROSS
SWIFT

OPEL
AGILA (B) (H08)

SUZUKI
SPLASH (EX)
SWIFT III (MZ, EZ)
SWIFT IV (FZ, NZ)
SX4 (EY, GY)
SX4 S-CROSS (JY)

VAUXHALL
AGILA Mk II (B) (H08)

CHRYSLER
DELTA
YPSILON

CITROEN
NEMO Box Body/MPV (AA_)
NEMO MPV

DODGE
JOURNEY

FIAT
500 (312_)
500 C (312_)
500L (351_, 352_)
500X (334_)
BRAVO II (198_)
BRAVO Van (198_)
DOBLO Bus (263_)
DOBLO Cargo (263_)
DOBLO Platform/Chassis (263_)
DUCATO Bus (250_)
DUCATO Platform/Chassis (250_)
DUCATO Van (250_)
FIORINO Box Body/MPV (225_)

DW-TL 7.03073.01.0

CHEVROLET
AVEO Hatchback (T300)
AVEO Saloon (T300)
CRUZE (J300)
CRUZE Hatchback (J305)
CRUZE Station Wagon (J308)
TRAX



ELECTRIC VALVES



DW-TL	7.03073.01.0
OPEL	
ASTRA J (P10)	
ASTRA J Estate Van (P10)	
ASTRA J GTC	
ASTRA J Hatchback Van (P10)	
ASTRA J Saloon	
ASTRA J Sports Tourer (P10)	
CASCADA (W13)	
CORSA D (S07)	
CORSA D Hatchback Van (S07)	
MERIVA B MPV (S10)	
MOKKA / MOKKA X (J13)	
ZAFIRA TOURER C (P12)	
VAUXHALL	
ASTRA Mk VI (J) (P10)	
ASTRA Mk VI (J) Estate (P10)	
ASTRA Mk VI (J) GTC (P10)	
ASTRA Mk VI (J) Saloon (P10)	
CASCADA Convertible (W13)	
CORSA Mk III (D) (S07)	
MERIVA Mk II (B) (S10)	
MOKKA / MOKKA X (J13)	
ZAFIRA Mk III (P12)	

DW-TL	7.03085.02.0
ZAFIRA / ZAFIRA FAMILY B (A05)	
ZAFIRA B Box Body/MPV (A05)	
VAUXHALL	
ASTRA Mk V (H) (A04)	
ASTRA Mk V (H) Estate (A04)	
ASTRA Mk V (H) Sport Hatch (A04)	
ASTRA Mk VI (J) (P10)	
ASTRA Mk VI (J) Estate (P10)	
ASTRA Mk VI (J) GTC (P10)	
ASTRA Mk VI (J) Saloon (P10)	
CORSA Mk III (D) (S07)	
MERIVA Mk II (B) (S10)	
ZAFIRA Mk II (B) (A05)	

DW-TL	7.03554.10.0 New
MAZDA	
3 (BM, BN)	
3 Saloon (BM_, BN_)	
6 Estate (GJ, GL)	
6 Estate Van (GJ)	
6 Saloon (GJ, GL)	
CX-5 (KE, GH)	
CX-5 (KF)	



DW-TL	7.03085.02.0
HYUNDAI	
ACCENT II (LC)	
ACCENT II Saloon (LC)	
ELANTRA III (XD)	
ELANTRA III Saloon (XD)	
GETZ (TB)	
H-1 / STAREX Bus (A1)	
MATRIX (FC)	
SANTA FÉ I (SM)	
OPEL	
ASTRA H (A04)	
ASTRA H CLASSIC Estate (A04)	
ASTRA H CLASSIC Hatchback (A04)	
ASTRA H CLASSIC Saloon (A04)	
ASTRA H Estate (A04)	
ASTRA H Estate Van (L70)	
ASTRA H GTC (A04)	
ASTRA H Saloon (A04)	
ASTRA J (P10)	
ASTRA J GTC	
ASTRA J Saloon	
ASTRA J Sports Tourer (P10)	
CORSA D (S07)	
CORSA D Hatchback Van (S07)	
MERIVA A MPV (X03)	
MERIVA B MPV (S10)	

DW-TL	7.03088.01.0
OPEL	
ASTRA G CLASSIC (T98)	
ASTRA G Estate (T98)	
ASTRA G Estate Van (F70)	
ASTRA G Hatchback (T98)	
ASTRA G Saloon (T98)	
ASTRA H (A04)	
ASTRA H Estate (A04)	
ASTRA H Estate Van (L70)	
ASTRA H GTC (A04)	
ASTRA H Saloon (A04)	
CORSA C (X01)	
CORSA C Hatchback Van (X01)	
CORSA C Saloon (X01)	
MERIVA A MPV (X03)	
VAUXHALL	
ASTRA Mk IV (G) Estate (T98)	
ASTRA Mk IV (G) Hatchback (T98)	
ASTRA Mk IV (G) Saloon (T98)	
ASTRA Mk V (H) (A04)	
ASTRA Mk V (H) Estate (A04)	
ASTRA Mk V (H) Sport Hatch (A04)	
ASTRAVAN Mk IV (G) Estate Van (T98)	
ASTRAVAN Mk V (H) Estate Van (A04)	
CORSA Mk II (C) (X01)	
CORSAVAN Mk II (C) Hatchback Van (X01)	
MERIVA A (X03)	



DW-TL	7.03652.01.0
OPEL	
INSIGNIA A (G09)	
INSIGNIA A Country Tourer (G09)	
INSIGNIA A Saloon (G09)	
INSIGNIA A Sports Tourer (G09)	
SAAB	
9-3 (YS3F, E79, D79, D75)	
9-3 Convertible (YS3F)	
9-3 Estate (E50)	
9-3X (YS3)	
VAUXHALL	
INSIGNIA Mk I (A) Country Tourer (G09)	
INSIGNIA Mk I (A) Hatchback (G09)	
INSIGNIA Mk I (A) Saloon (G09)	
INSIGNIA Mk I (A) Sports Tourer (G09)	





DW-TL 7.03653.01.0



OPEL

CORSA D (S07)
CORSA D Hatchback Van (S07)

VAUXHALL

CORSA Mk III (D) (S07)
CORSAVAN Mk III (D) Hatchback Van (S07)

DW-TL 7.03978.01.0

ASTRA J (P10)
ASTRA J GTC
ASTRA J Sports Tourer (P10)
CASCADA (W13)
INSIGNIA A (G09)
INSIGNIA A Country Tourer (G09)
INSIGNIA A Saloon (G09)
INSIGNIA A Sports Tourer (G09)
ZAFIRA TOURER C (P12)
VAUXHALL
ASTRA Mk V (H) (A04)
ASTRA Mk V (H) Estate (A04)
ASTRA Mk V (H) Sport Hatch (A04)
ASTRA Mk VI (J) (P10)
ASTRA Mk VI (J) Estate (P10)
ASTRA Mk VI (J) GTC (P10)
CASCADA Convertible (W13)
INSIGNIA Mk I (A) Country Tourer (G09)
INSIGNIA Mk I (A) Hatchback (G09)
INSIGNIA Mk I (A) Saloon (G09)
INSIGNIA Mk I (A) Sports Tourer (G09)
ZAFIRA Mk III (P12)

DW-TL 7.04423.01.0



OPEL

ASTRA H (A04)
ASTRA H CLASSIC Hatchback (A04)
ASTRA H Estate (A04)
ASTRA H Estate Van (L70)
ASTRA H GTC (A04)
ASTRA H Saloon (A04)
MERIVA B MPV (S10)

VAUXHALL

ASTRA Mk V (H) (A04)
ASTRA Mk V (H) Estate (A04)
ASTRA Mk V (H) Sport Hatch (A04)
ASTRAVAN Mk V (H) Estate Van (A04)
MERIVA Mk II (B) (S10)

DW-TL 7.03964.01.0



CHEVROLET

COLORADO
S10 BLAZER

NISSAN

NAVARA (D22)
NP300 NAVARA (D40)
XTERRA (WD22_)

DW-TL 7.04011.05.0



FORD

B-MAX (JK)
B-MAX Van (JK)
C-MAX II (DXA/CB7, DXA/CEU)
C-MAX II Van
FOCUS III
FOCUS III Estate Van
FOCUS III Hatchback Van
FOCUS III Saloon
FOCUS III Turnier
FUSION (USA)
GALAXY III (CK)
GRAND C-MAX (DXA/CB7, DXA/CEU)
GRAND C-MAX Van
KUGA II (DM2)
KUGA II VAN
MONDEO V Hatchback (CE)
MONDEO V Saloon (CD)
MONDEO V Turnier (CF)
S-MAX (CJ, WA6)

DW-TL 7.04638.01.0 New



PORSCHE

718 BOXSTER (982)
718 CAYMAN (982)
CAYENNE (92A)
MACAN (95B)
PANAMERA (970)

DW-TL 7.03978.01.0



CHEVROLET

CRUZE (J300)
MALIBU (V300)

OPEL

ASTRA H (A04)
ASTRA H Estate (A04)
ASTRA H GTC (A04)
ASTRA H Saloon (A04)

ELECTRIC VALVES





ELECTRIC VALVES



DW-TL 7.04663.14.0 New



FORD USA

- EDGE (U387)
- EXPLORER
- F-150 Crew Cab Pickup
- F-150 Extended Cab Pickup
- F-150 Standard Cab Pickup

LAND ROVER

- DISCOVERY SPORT (L550)
- RANGE ROVER EVOQUE (L538)
- RANGE ROVER EVOQUE Convertible (L538)

DW-TL 7.04664.02.0



VOLVO

- S60 II (134)
- S80 II (124)
- S90 II (234)
- V40 Hatchback (525, 526)
- V60 I (155, 157)
- V60 II (225, 227)
- V70 III (135)
- V90 II Estate (235, 236)
- XC40 (536)
- XC60 I SUV (156)
- XC60 II (246)
- XC70 II (136)
- XC90 II (256)

DW-TL 7.04779.00.0



OPEL

- MOVANO Bus (X70)
 - MOVANO Platform/Chassis (X70)
 - MOVANO Van (X70)
 - VIVARO A Bus (X83)
 - VIVARO A Platform/Chassis (X83)
 - VIVARO A Van (X83)
- VAUXHALL**
- VIVARO A Van (X83)

DW-TL 7.05314.02.0 New



MAZDA

- 2 (DL, DJ)
- 2 Saloon (DL)
- 3 Saloon (BP_)
- CX-3 (DK)

DW-TL 7.07400.13.0*

→7.04011.05.0 DW-TL

FORD

- C-MAX II (DXA/CB7, DXA/CEU)
- C-MAX II Van
- FOCUS III
- FOCUS III Estate Van
- FOCUS III Hatchback Van
- FOCUS III Saloon
- FOCUS III Turnier
- GRAND C-MAX (DXA/CB7, DXA/CEU)
- GRAND C-MAX Van
- KUGA II (DM2)
- KUGA II VAN

DW-TL 7.07400.14.0*

→7.04011.05.0 DW-TL

FORD

- C-MAX II (DXA/CB7, DXA/CEU)
- C-MAX II Van
- FOCUS III

DW-TL 7.07400.14.0*

- FOCUS III Estate Van
- FOCUS III Hatchback Van
- FOCUS III Saloon
- FOCUS III Turnier
- GRAND C-MAX (DXA/CB7, DXA/CEU)
- GRAND C-MAX Van
- KUGA II (DM2)

DW-TL 7.07400.15.0*

→7.04011.05.0 DW-TL

FORD

- C-MAX II (DXA/CB7, DXA/CEU)
- C-MAX II Van
- FOCUS III
- FOCUS III Estate Van
- FOCUS III Hatchback Van
- FOCUS III Saloon
- FOCUS III Turnier
- GRAND C-MAX (DXA/CB7, DXA/CEU)
- GRAND C-MAX Van
- KUGA II (DM2)

DW-TL 7.07400.16.0*

→7.04011.05.0 DW-TL

FORD

- GALAXY III (CK)
- MONDEO V Hatchback (CE)
- MONDEO V Saloon (CD)
- MONDEO V Turnier (CF)
- S-MAX (CJ, WA6)

DW-TL 7.07400.17.0*

→7.04011.05.0 DW-TL

FORD

- FUSION (USA)

DW-TL 7.07400.18.0*

→7.04011.05.0 DW-TL

FORD

- GALAXY III (CK)
- MONDEO V Hatchback (CE)
- MONDEO V Saloon (CD)
- MONDEO V Turnier (CF)
- S-MAX (CJ, WA6)



DW-TL 7.21903.48.0



- SI 0065
- SI 0076
- SI 0087
- SI 0089
- SI 0096

ALFA ROMEO

- 156 (932_)
- 156 Sportwagon (932_)
- 166 (936_)

FIAT

- MAREA (185_)
- MAREA Weekend (185_)
- STILO (192_)
- STILO Multi Wagon (192_)

LANCIA

- LYBRA (839_)
- LYBRA SW (839_)

DW-TL 7.21903.63.0



- SI 0096

VOLVO

- S60 I (384)
- S80 I (184)
- V70 II (285)
- XC70 CROSS COUNTRY I (295)
- XC90 I (275)

DW-TL 7.21903.73.0



- SI 0065
- SI 0076
- SI 0087
- SI 0089
- SI 0096

LAND ROVER

- FREELANDER I (L314)

DW-TL 7.21903.49.0



- SI 0087
- SI 0089
- SI 0096

AUDI

- A6 C5 (4B2)
- A6 C5 Avant (4B5)
- A8 D2 (4D2, 4D8)
- ALLROAD C5 (4BH)

DW-TL 7.21903.70.0



- SI 0065
- SI 0076
- SI 0087
- SI 0096
- SI 0100

AUDI

- A4 B5 (8D2)
- A4 B5 Avant (8D5)
- A6 C5 (4B2)
- A6 C5 Avant (4B5)

SKODA

- SUPERB I (3U4)

VOLKSWAGEN

- CADDY II Box Body/MPV (9K9A)
- CADDY II MPV (9K9B)
- PASSAT B3/B4 (3A2, 35I)
- PASSAT B3/B4 Variant (3A5, 35I)
- PASSAT B5 (3B2)
- PASSAT B5 Variant (3B5)
- PASSAT B5.5 (3B3)
- PASSAT B5.5 Variant (3B6)

DW-TL 7.21903.75.0



- SI 0065
- SI 0076
- SI 0087
- SI 0096
- SI 0100

AUDI

- A3 (8L1)
- A4 B5 (8D2)
- A4 B5 Avant (8D5)
- A6 C5 (4B2)
- A6 C5 Avant (4B5)

FORD

- GALAXY I (WGR)

SEAT

- ALHAMBRA (7V8, 7V9)
- AROSA (6H1)
- LEON (1M1)
- TOLEDO I (1L2)
- TOLEDO II (1M2)

SKODA

- OCTAVIA I (1U2)
- OCTAVIA I Combi (1U5)

VOLKSWAGEN

- BORA I (1J2)
- BORA Variant (1J6)
- GOLF III (1H1)
- GOLF III Cabriolet (1E7)
- GOLF III Variant (1H5)

ELECTRIC VALVES





ELECTRIC VALVES



DW-TL	7.21903.75.0
GOLF IV (1J1)	
GOLF IV Cabriolet (1E7)	
GOLF IV Van (1J1)	
GOLF IV Variant (1J5)	
GOLF VAN IV Variant (1J5)	
GOLF Van III Variant (1H5)	
LT 28-35 II Bus (2DB, 2DE, 2DK)	
LT 28-46 II Platform/Chassis (2DC, 2DF, 2DG, 2DL, 2DM)	
LT 28-46 II Van (2DA, 2DD, 2DH)	
LUPO I (6X1, 6E1)	
NEW BEETLE (9C1, 1C1)	
PASSAT B3/B4 (3A2, 35I)	
PASSAT B3/B4 Variant (3A5, 35I)	
PASSAT B5 (3B2)	
PASSAT B5 Variant (3B5)	
PASSAT B5.5 (3B3)	
PASSAT B5.5 Variant (3B6)	
POLO (6N2)	
POLO III (6N1)	
SHARAN (7M8, 7M9, 7M6)	
TRANSPORTER IV Bus (70B, 70C, 7DB, 7DK, 70J, 70K, 7DC, 7DJ)	
TRANSPORTER IV Platform/Chassis (70E, 70L, 70M, 7DE, 7DL, 7D)	
TRANSPORTER IV Van (70A, 70H, 7DA, 7DH)	
VENTO (1H2)	

DW-TL	7.22796.01.0
	

- SI 0065
- SI 0076
- SI 0087
- SI 0096
- SI 0100

BMW

- 3 (E46)
- 3 Compact (E46)
- 3 Convertible (E46)
- 3 Coupe (E46)
- 3 Touring (E46)
- 5 (E39)
- 5 (E60)
- 5 Touring (E39)
- 5 Touring (E61)
- 7 (E38)
- 7 (E65, E66, E67)
- X3 (E83)
- X5 (E53)

DW-TL	7.22903.16.0
→SI 0065	
→SI 0076	
→SI 0087	
→SI 0089	
→SI 0096	

- AUDI**
- A6 C4 (4A2)
 - A6 C4 Avant (4A5)
 - A6 C5 (4B2)
 - A6 C5 Avant (4B5)
 - ALLROAD C5 (4BH)

DW-TL	7.22903.19.0
	

- SI 0065
- SI 0076
- SI 0087
- SI 0089
- SI 0096

- AUDI**
- A4 B6 (8E2)
 - A4 B6 Avant (8E5)
 - A6 C5 (4B2)
 - A6 C5 Avant (4B5)

DW-TL	7.22903.28.0
	

- SI 0096
- SI 0100

- AUDI**
- A4 B6 (8E2)
 - A4 B6 Avant (8E5)
 - A4 B7 (8EC)
 - A4 B7 Avant (8ED)
 - A4 B7 Convertible (8HE)
 - A6 C5 (4B2)
 - A6 C5 Avant (4B5)
- SKODA**
- SUPERB I (3U4)

DW-TL	7.22903.28.0
VW SVW	PASSAT B5 (9F8)

DW-TL	7.28328.07.0
	
→SI 0087	
→SI 0096	
→SI 0100	

- FORD**
- FOCUS C-MAX (DM2)
 - FOCUS II (DA_, HCP, DP)
 - FOCUS II Estate Van
 - FOCUS II Saloon (DB_, FCH, DH)
 - FOCUS II Turnier (DA_, FFS, DS)

EOV	7.08681.00.0	New
		

- CITROEN**
- BERLINGO (ER_, EC_)
 - BERLINGO Box Body/MPV (B9)
 - BERLINGO Box Body/MPV (K9)
 - BERLINGO MULTISPACE (B9)
 - BERLINGO Platform/Chassis (B9)
 - C-ELYSEE (DD_)
 - C3 AIRCROSS II (2R_, 2C_)
 - C3 II (SC_)
 - C3 III (SX)
 - C3 PICASSO (SH_)
 - C4 CACTUS
 - C4 II (B7)
 - C4 SPACETOUREUR (3D_)
 - C5 AIRCROSS
 - DS3
 - DS3 Convertible
 - DS4 (NX_)
 - DS5
 - GRAND C4 SPACETOUREUR (3A_, 3E_)
 - JUMPY Bus (V_)
 - JUMPY Van (V_)
 - SPACETOUREUR Bus (V_)



EOV 7.08681.00.0 New	EOV 7.08681.00.0 New	EOV 7.08681.01.0 New
<p>DS DS 3 (SA_) DS 3 CROSSBACK (UR_, UC_, UJ_) DS 3 Convertible (SB_) DS 4 / DS 4 CROSSBACK (NX_) DS 5 (KF_) DS 7 Crossback (J_)</p> <p>FORD B-MAX (JK) B-MAX Van (JK) C-MAX II (DXA/CB7, DXA/CEU) C-MAX II Van ECOSPORT FIESTA VI (CB1, CCN) FIESTA VI Van FIESTA VII (HJ, HF) FIESTA VII Van FOCUS III FOCUS III Estate Van FOCUS III Hatchback Van FOCUS III Saloon FOCUS III Turnier FOCUS IV (HN) FOCUS IV Saloon (HM) FOCUS IV Turnier (HP) GRAND C-MAX (DXA/CB7, DXA/CEU) GRAND C-MAX Van KA+ III (UK, FK) KUGA II (DM2) MONDEO V Hatchback (CE) MONDEO V Saloon (CD) MONDEO V Turnier (CF) TOURNEO CONNECT / GRAND TOURNEO CONNECT V408 MPV TOURNEO COURIER B460 MPV TRANSIT CONNECT MPV TRANSIT CONNECT V408 Box Body/MPV TRANSIT COURIER B460 Box Body/MPV TRANSIT COURIER B460 MPV</p> <p>OPEL COMBO Box Body/MPV (X19) COMBO E Tour / Life (X19) CORSA F CROSSLAND X / CROSSLAND (P17, P2QO) GRANDLAND X (A18) VIVARO C Bus (K0) VIVARO C Van (K0) ZAFIRA LIFE Bus (K0)</p> <p>PEUGEOT 2008 I (CU_) 2008 II (UD_, US_, UY_, UK_) 208 I (CA_, CC_) 208 II (UB_, UP_, UW_, UJ_) 3008 MPV (OU_) 3008 SUV (MC_, MR_, MJ_, M4_) 301 308 II (LB_, LP_, LW_, LH_, L3_) 308 SW II (LC_, LJ_, LR_, LX_, L4_) 5008 (OU_, OE_) 5008 II (MC_, MJ_, MR_, M4_) 508 I (8D_) 508 II (FB_, FH_, F3_) 508 SW I (8E_)</p>	<p>508 SW II (FC_, FJ_, F4_) EXPERT Bus (V_) EXPERT Van (V_) PARTNER Box Body/MPV PARTNER Box Body/MPV (K9) PARTNER TEPEE RIFTER TRAVELLER Bus (V_)</p> <p>TOYOTA PROACE Bus (MDZ_) PROACE CITY Box Body/MPV PROACE CITY VERSO MPV PROACE VERSO Bus (MPY_) PROACE Van (MDZ_)</p> <p>VAUXHALL COMBO Mk IV (E) Box Body/MPV COMBO Mk IV (E) Life (X19) CORSA Mk V (F) CROSSLAND X (P17) GRANDLAND X (A18) VIVARO C Van (K0) VIVARO LIFE Bus (K0)</p>	<p>INSIGNIA Mk I (A) Saloon (G09) INSIGNIA Mk I (A) Sports Tourer (G09) INSIGNIA Mk II (B) Hatchback (Z18) INSIGNIA Mk II (B) Sports Tourer (Z18) MERIVA Mk II (B) (S10) MOKKA / MOKKA X (J13) ZAFIRA Mk III (P12)</p>
		<p>EOV 7.08681.02.0 New</p> <div style="text-align: center;">  <p>© MS Motorservice International GmbH</p> </div> <p>OPEL ANTARA A (L07) CASCADA (W13) INSIGNIA A (G09) INSIGNIA A Country Tourer (G09) INSIGNIA A Saloon (G09) INSIGNIA A Sports Tourer (G09) INSIGNIA B Country Tourer (Z18) INSIGNIA B Grand Sport (Z18) INSIGNIA B Sports Tourer (Z18) ZAFIRA TOURER C (P12)</p> <p>VAUXHALL CASCADA Convertible (W13) INSIGNIA Mk I (A) Country Tourer (G09) INSIGNIA Mk I (A) Hatchback (G09) INSIGNIA Mk I (A) Saloon (G09) INSIGNIA Mk I (A) Sports Tourer (G09) INSIGNIA Mk II (B) Country Tourer (Z18) INSIGNIA Mk II (B) Hatchback (Z18) INSIGNIA Mk II (B) Sports Tourer (Z18) ZAFIRA Mk III (P12)</p>
	<p>EOV 7.08681.01.0 New</p> <div style="text-align: center;">  <p>© MS Motorservice International GmbH</p> </div> <p>CHEVROLET CRUZE Saloon</p> <p>OPEL ASTRA J (P10) ASTRA J GTC ASTRA J Saloon ASTRA J Sports Tourer (P10) ASTRA K (B16) ASTRA K Sports Tourer (B16) INSIGNIA A (G09) INSIGNIA A Country Tourer (G09) INSIGNIA A Saloon (G09) INSIGNIA A Sports Tourer (G09) INSIGNIA B Grand Sport (Z18) INSIGNIA B Sports Tourer (Z18) MERIVA B MPV (S10) MOKKA / MOKKA X (J13) ZAFIRA TOURER C (P12)</p> <p>VAUXHALL ASTRA Mk VI (J) (P10) ASTRA Mk VI (J) Estate (P10) ASTRA Mk VI (J) GTC (P10) ASTRA Mk VII (K) (B16) ASTRA Mk VII (K) Estate (B16) INSIGNIA Mk I (A) Country Tourer (G09) INSIGNIA Mk I (A) Hatchback (G09)</p>	
		<p>EOV 7.08681.08.0</p> <div style="text-align: center;">  <p>© MS Motorservice International GmbH</p> </div> <p>FORD FOCUS IV (HN) FOCUS IV Turnier (HP) GALAXY III (CK) GALAXY MK III VAN (CK) KUGA III (DFK)</p>





ELECTRIC VALVES



EOV	7.08681.08.0	EOV	7.08681.09.0	EOV	7.08681.15.0 New
MONDEO V Hatchback (CE) MONDEO V Saloon (CD) MONDEO V Turnier (CF) S-MAX (CJ, WA6) TOURNEO CUSTOM V362 Bus (F3) TRANSIT CUSTOM V362 Bus (F3) TRANSIT CUSTOM V362 Van (FY, FZ) TRANSIT V363 Bus (FAD, FBD) TRANSIT V363 Platform/Chassis (FED, FFD) TRANSIT V363 Van (FCD, FDD) FORD AUSTRALIA ENDURA (CA) FOCUS Estate (SA) FORD USA EDGE		2008 II (UD_, US_, UY_, UK_) 208 I (CA_, CC_) 208 II (UB_, UP_, UW_, UJ_) 3008 MPV (OU_) 3008 SUV (MC_, MR_, MJ_, M4_) 308 II (LB_, LP_, LW_, LH_, L3_) 308 SW II (LC_, LJ_, LR_, LX_, L4_) 5008 (OU_, OE_) 5008 II (MC_, MJ_, MR_, M4_) 508 II (FB_, FH_, F3_) 508 SW II (FC_, FJ_, F4_) PARTNER Box Body/MPV PARTNER Box Body/MPV (K9) PARTNER TEPEE RIFTER TOYOTA PROACE CITY Box Body/MPV PROACE CITY VERSO MPV VAUXHALL COMBO Mk IV (E) Box Body/MPV COMBO Mk IV (E) Life (X19) CORSA Mk V (F) CROSSLAND X (P17) GRANDLAND X (A18)	CLIO IV Hatchback Van (BH_) GRAND SCÉNIC III (JZ0/1_) GRAND SCÉNIC IV (R9_) KADJAR (HA_, HL_) KANGOO / GRAND KANGOO (KW0/1_) KANGOO Express (FW0/1_) MEGANE CC (EZ0/1_) MEGANE III Coupe (DZ0/1_) MEGANE III Grandtour (KZ0/1) MEGANE III Hatchback (BZ0/1_, B3_) MEGANE IV GRAND COUPE MEGANE IV Grandtour (K9A/M/N_) MEGANE IV Hatchback (B9A/M/N_) SCÉNIC III (JZ0/1_) SCÉNIC IV (J9_) TWINGO III (BCM_) SMART FORFOUR Hatchback (453) FORTWO Convertible (453) FORTWO Coupe (453)		
	EOV 7.08681.09.0		EOV 7.08681.15.0 New		EUV-AGK 7.02256.00.0
					
CITROEN BERLINGO (ER_, EC_) BERLINGO Box Body/MPV (B9) BERLINGO Box Body/MPV (K9) BERLINGO MULTISPACE (B9) C3 AIRCROSS II (2R_, 2C_) C3 II (SC_) C3 III (SX) C3 PICASSO (SH_) C4 CACTUS C4 GRAND PICASSO II (DA_, DE_) C4 II (B7) C4 PICASSO II C4 SPACETOURER (3D_) C5 AIRCROSS DS3 DS3 Convertible DS4 (NX_) GRAND C4 SPACETOURER (3A_, 3E_) DS DS 3 (SA_) DS 3 CROSSBACK (UR_, UC_, UJ_) DS 3 Convertible (SB_) DS 4 / DS 4 CROSSBACK (NX_) DS 7 Crossback (J_) OPEL COMBO Box Body/MPV (X19) COMBO E Tour / Life (X19) CORSA F CROSSLAND X / CROSSLAND (P17, P200) GRANDLAND X (A18) PEUGEOT 2008 I (CU_)		DACIA DOKKER Express Box Body/MPV DOKKER MPV (KE_) DUSTER (HM_) DUSTER (HS_) DUSTER SUV Van LODGY (JS_) LOGAN II LOGAN MCV II SANDERO II MERCEDES-BENZ A-CLASS (W177) A-CLASS Saloon (V177) CITAN Box Body/MPV (W415) CITAN MPV (415) NISSAN JUKE (F15) MICRA V (K14) PULSAR Hatchback (C13) QASHQAI II SUV (J11, J11_) RENAULT CAPTUR I (J5_, H5_) CLIO IV (BH_) CLIO IV Grandtour (KH_)	AUDI A3 (8P1) A3 Sportback (8PA) Q5 (FYB, FYG) R8 (4S3, 4SP) R8 Spyder (427, 429) R8 Spyder (4S9, 4SR) TT (8J3) TT (8N3) TT Roadster (8J9) TT Roadster (8N9) LAMBORGHINI HURACÁN HURACÁN EVO HURACÁN EVO SPYDER HURACÁN SPYDER VOLKSWAGEN EOS (1F7, 1F8) GOLF IV (1J1) NEW BEETLE (9C1, 1C1) SCIROCCO III (137, 138)		



EUV-AGK 7.02256.37.0



→SI 0096

BRABUS

40S (W221)

DODGE

CALIBER

MERCEDES-BENZ

S-CLASS (W221)

S-CLASS (W222, V222, X222)

S-CLASS Coupe (C217)

SPRINTER 3-t Bus (B903)

MERCEDES-BENZ (BBDC)

C-CLASS (W204)

E-CLASS (W211)

E-CLASS (W212)

GLK-CLASS (X204)

MERCEDES-BENZ (FJDA)

VIANO

VITO (V639)

EUV-AGK 7.02318.01.0

- 5 Touring (E61)
 - 5 Touring (F11)
 - 6 Convertible (F12)
 - 6 Coupe (F13)
 - 6 Gran Coupe (F06)
 - 7 (E65, E66, E67)
 - 7 (F01, F02, F03, F04)
 - X1 (E84)
 - X3 (E83)
 - X3 (F25)
 - X4 (F26)
 - X5 (E70)
 - X6 (E71, E72)
 - Z3 Roadster (E36)
 - Z4 Roadster (E89)
- ROLLS-ROYCE**
- DAWN (RR6)
 - GHOST I (RR4)
 - WRAITH (RR5)

EUV-AGK 7.21071.50.0



→SI 0087
→SI 0096
→SI 0100

MERCEDES-BENZ

T1 Platform/Chassis (B602)

T1 Van (B602)

EUV-AGK 7.02318.01.0

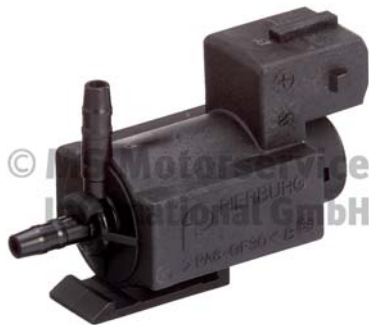

→SI 0096
→SI 0100

BMW

1 (E81)

1 (E87)

1 Convertible (E88)

1 Coupe (E82)

3 (E36)

3 (E46)

3 Compact (E36)

3 Convertible (E36)

3 Coupe (E36)

3 Touring (E36)

3 Touring (E46)

5 (E60)

5 (F10)

5 Gran Turismo (F07)

EUV-AGK 7.22280.02.0



→SI 0087
→SI 0100

PORSCHE

911 (997)

911 Convertible (997)

BOXSTER (981)

CAYMAN (981)

EUV-AGK 7.22687.44.0



FERRARI

360 (F131)

360 Spider (F131)

458

458 Spider

812 GTS Spider (F152)

812 SUPERFAST (F152M)

CALIFORNIA

ENZO FERRARI

F12 Berlinetta (F152)

F430

F430 Spider

GTC4 Lusso / Lusso T

LaFERRARI (F150)

EUV-AGK 7.22880.01.0



→SI 0087
→SI 0096
→SI 0106

AUDI

A4 B6 Avant (8E5)

R8 (422, 423)

AUDI FAW

Q3 (84B, 84G)

SKODA SVW

OCTAVIA Hatchback (913)

SUPERB (374)

YETI (0Y6, 0Y7)

VOLKSWAGEN

POLO Variant (6V5)

VW FAW

CC Saloon (990, 991)

MAGOTAN (B7L, 942)

SAGITAR (BK2)

VW SVW

PASSAT B7 (A42, A43)

TIGUAN (591, 592)





ELECTRIC VALVES



EUV-AGK 7.28098.04.0



→SI 0087
→SI 0096

AUDI

- A3 (8P1)
- A3 Sportback (8PA)
- A4 B8 Avant (8K5)
- A5 (8T3)
- A5 Convertible (8F7)
- A8 D3 (4E2, 4E8)
- A8 D4 (4H2, 4H8, 4HC, 4HL)
- Q5 (8RB)

BENTLEY

- CONTINENTAL Convertible (3S_)
- CONTINENTAL Convertible (3W_, 394)
- CONTINENTAL Coupe (3S3)
- CONTINENTAL Coupe (3W_, 393)
- CONTINENTAL FLYING SPUR (3W_)
- FLYING SPUR (4W_)
- FLYING SPUR (ZG2_)
- MULSANNE (3Y_)

VOLKSWAGEN

- GOLF V (1K1)
- GOLF VI (5K1)
- GOLF VI Van (5K1_)

EUV-AGK 7.28286.13.0



MASERATI

- GHIBLI III (M157)
- LEVANTE SUV (M161)
- QUATTROPORTE VI

EUV-AGR 7.00515.04.0

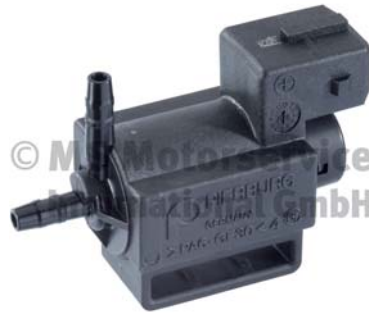

VOLVO

- C30 (533)
- C70 II Convertible (542)
- S40 II (544)
- S60 I (384)
- S80 II (124)
- V50 (545)
- V70 II (285)
- V70 III (135)
- XC60 I SUV (156)
- XC70 CROSS COUNTRY I (295)
- XC70 II (136)
- XC90 I (275)

EUV-AGR 7.00515.05.0



VOLVO

- S60 II (134)
- S80 II (124)
- S90 II (234)
- V40 Hatchback (525, 526)
- V60 I (155, 157)
- V60 II (225, 227)
- V70 III (135)
- V90 II Estate (235, 236)
- XC40 (536)
- XC60 I SUV (156)
- XC60 II (246)
- XC70 II (136)
- XC90 II (256)

EUV-AGR 7.01805.01.0



→SI 0096

ALFA ROMEO

- 164 (164_)

EUV-AGR 7.02256.00.0



AUDI

- A1 (8X1, 8XK)
- A1 Sportback (8XA, 8XF)
- A3 (8L1)
- A3 (8P1)
- A3 (8V1, 8VK)
- A3 Convertible (8P7)
- A3 Limousine (8VS, 8VM)
- A3 Sportback (8PA)
- A3 Sportback (8VA, 8VF)
- A4 Allroad B8 (8KH)
- A4 Allroad B9 (8WH, 8WJ)
- A4 B6 (8E2)
- A4 B6 Avant (8E5)
- A4 B7 (8EC)
- A4 B7 Avant (8ED)
- A4 B7 Convertible (8HE)
- A4 B8 (8K2)
- A4 B8 Avant (8K5)
- A4 B9 (8W2, 8WC)
- A4 B9 Avant (8W5, 8WD)
- A5 (8T3)
- A5 (F53, F5P)
- A5 Convertible (8F7)
- A5 Convertible (F57, F5E)
- A5 Sportback (8TA)
- A5 Sportback (F5A, F5F)
- A6 Allroad C6 (4FH)
- A6 Allroad C7 (4GH, 4GJ)
- A6 C5 (4B2)
- A6 C5 Avant (4B5)
- A6 C6 (4F2)
- A6 C6 Avant (4F5)



EUV-AGR	7.02256.00.0	EUV-AGR	7.02256.00.0	EUV-AGR	7.02256.00.0
A6 C7 (4G2, 4GC)		FABIA II Combi (545)		MULTIVAN V (7HM, 7HN, 7HF, 7EF, 7EM, 7EN)	
A6 C7 Avant (4G5, 4GD)		KAROQ (NU7)		MULTIVAN VI (SGF, SGM, SGN, SHM, SHN)	
A6 C8 (4A2)		OCTAVIA I (1U2)		NEW BEETLE (9C1, 1C1)	
A6 C8 Avant (4A5)		OCTAVIA I Combi (1U5)		NEW BEETLE Convertible (1Y7)	
A7 Sportback (4GA, 4GF)		OCTAVIA II (1Z3)		PASSAT B6 (3C2)	
A7 Sportback (4KA)		OCTAVIA II Combi (1Z5)		PASSAT B6 Variant (3C5)	
A8 D3 (4E2, 4E8)		OCTAVIA III (5E3, NL3, NR3)		PASSAT B7 (362)	
A8 D4 (4H2, 4H8, 4HC, 4HL)		OCTAVIA III Combi (5E5, 5E6)		PASSAT B7 (A32, A33)	
A8 D5 (4N2, 4N8)		OCTAVIA IV (NX3)		PASSAT B7 Estate Van (365)	
Q2 (GAB, GAG)		OCTAVIA IV Combi (NX5)		PASSAT B7 Variant (365)	
Q3 (8UB, 8UG)		RAPID (NA2)		PASSAT CC B6 (357)	
Q5 (8RB)		RAPID (NH3)		PHAETON (3D1, 3D2, 3D3, 3D4, 3D6, 3D7, 3D8, 3D9)	
Q5 Van (FYB, FYG)		RAPID Spaceback (NH1)		POLO (9N_)	
Q7 (4LB)		ROOMSTER (5J7)		POLO III CLASSIC (6V2)	
Q7 (4MB, 4MG)		ROOMSTER Praktik (5J)		POLO V (6R1, 6C1)	
Q7 Van (4LB)		SUPERB II (3T4)		POLO Van (6R)	
Q7 Van (4MB, 4MG)		SUPERB II Estate (3T5)		POLO Variant (6V5)	
Q8 (4MN)		YETI (5L)		SCIROCCO III (137, 138)	
TT (8J3)		VOLKSWAGEN		SCIROCCO Van (137)	
TT Roadster (8J9)		AMAROK (2HA, 2HB, S1B, S6B, S7A, S7B)		SHARAN (7M8, 7M9, 7M6)	
BENTLEY		AMAROK Platform/Chassis (S1B, S6B, S7B)		SHARAN (7N1, 7N2)	
BENTAYGA (4V1)		AMEO (631)		SHARAN VAN (7M_)	
FORD		ARTEON (3H7, 3H8)		SHARAN VAN (7N1, 7N2)	
GALAXY I (WGR)		BEETLE (5C1, 5C2)		TIGUAN (5N_)	
MAN		BEETLE Convertible (5C7, 5C8)		TIGUAN (AD1, AX1)	
TGE Bus		BORA I (1J2)		TIGUAN ALLSPACE (BW2)	
TGE Platform/Chassis (UZ_)		BORA Variant (1J6)		TIGUAN VAN (5N_)	
TGE Van		CADDY ALLTRACK Box Body/MPV (SAA)		TOUAREG (7LA, 7L6, 7L7)	
PORSCHE		CADDY ALLTRACK MPV (SAB)		TOUAREG (7P5, 7P6)	
CAYENNE (92A)		CADDY III Box Body/MPV (2KA, 2KH, 2CA, 2CH)		TOUAREG (CR7)	
CAYENNE (9PA)		CADDY III MPV (2KB, 2KJ, 2CB, 2CJ)		TOUAREG VAN (7P5)	
MACAN (95B)		CADDY IV Box Body/MPV (SAA, SAH)		TOURAN (1T1, 1T2)	
PANAMERA (970)		CADDY IV MPV (SAB, SAJ)		TOURAN (1T3)	
PANAMERA (971)		CC B7 (358)		TOURAN (5T1)	
PANAMERA Sport Turismo (971)		CRAFTER 30-35 Bus (2E_)		TOURAN VAN (1T1, 1T2)	
SEAT		CRAFTER 30-50 Platform/Chassis (2F_)		TOURAN VAN (1T3)	
ALHAMBRA (710, 711)		CRAFTER 30-50 Van (2E_)		TRANSPORTER / CARAVELLE VI Bus (SGB, SGG, SGJ, SGC, SHB, SHJ)	
ALHAMBRA (7V8, 7V9)		CRAFTER Bus (SY1, SYJ)		TRANSPORTER V Bus (7HB, 7HJ, 7EB, 7EJ, 7EF, 7EG, 7HF, 7EC)	
ALTEA (5P1)		CRAFTER Platform/Chassis (SZ_)		TRANSPORTER V Platform/Chassis (7JD, 7JE, 7JL, 7JY, 7JZ, 7FD)	
ALTEA XL (5P5, 5P8)		CRAFTER Van (SY_, SX_)		TRANSPORTER V Van (7HA, 7HH, 7EA, 7EH)	
ATECA (KH7, KHP)		EOS (1F7, 1F8)		TRANSPORTER VI Platform/Chassis (SFD, SFE, SFL, SFZ, SJD, SJ)	
CORDOBA (6K1, 6K2)		GOLF IV (1J1)		TRANSPORTER VI Van (SGA, SGH, SHA, SHH)	
CORDOBA (6L2)		GOLF IV Van (1J1)			
CORDOBA Vario (6K5)		GOLF IV Variant (1J5)			
EXEO (3R2)		GOLF PLUS V (5M1, 521)			
EXEO ST (3R5)		GOLF PLUS Van (521)			
IBIZA II (6K1)		GOLF SPORTSVAN VII (AM1, AN1)			
IBIZA IV (6J5, 6P1)		GOLF V (1K1)			
IBIZA IV SC (6J1, 6P5)		GOLF V Variant (1K5)			
IBIZA IV ST (6J8, 6P8)		GOLF VAN IV Variant (1J5)			
LEON (1M1)		GOLF VAN VI Variant (AJ5)			
LEON (1P1)		GOLF VI (5K1)			
LEON (5F1)		GOLF VI Convertible (517)			
LEON SC (5F5)		GOLF VI Van (5K1_)			
LEON ST (5F8)		GOLF VI Variant (AJ5)			
TOLEDO II (1M2)		GOLF VII (5G1, BQ1, BE1, BE2)			
TOLEDO III (5P2)		GOLF VII Variant (BA5, BV5)			
TOLEDO IV (KG3)		GRAND CALIFORNIA Camper (SCB, SCC)			
SKODA		JETTA III (1K2)			
FABIA I (6Y2)		JETTA IV (162, 163, AV3, AV2)			
FABIA I Combi (6Y5)		LT 28-35 II Bus (2DB, 2DE, 2DK)			
FABIA I Saloon (6Y3)		LT 28-46 II Platform/Chassis (2DC, 2DF, 2DG, 2DL, 2DM)			
FABIA II (542)		LT 28-46 II Van (2DA, 2DD, 2DH)			

EUV-AGR 7.02256.07.0

→SI 0096



ELECTRIC VALVES



EUV-AGR 7.02256.07.0

FORD

- FIESTA Box Body/MPV (J5_, J3_)
- FIESTA Box Body/MPV (JV_)
- FIESTA IV (JA_, JB_)
- FOCUS I (DAW, DBW)
- FOCUS I Estate Van (DNW)
- FOCUS I Saloon (DFW)
- FOCUS I Turnier (DNW)
- TOURNEO CONNECT
- TRANSIT CONNECT (P65_, P70_, P80_)



→SI 0096

OPEL

- ANTARA A (L07)

EUV-AGR 7.02256.19.0



→SI 0096

NISSAN

- PRIMASTAR Bus (X83)
- PRIMASTAR Van (X83)

OPEL

- ARENA Combi (A97)
- ARENA Van (TB, TF)
- MOVANO B Bus (X62)
- MOVANO B Platform/Chassis (X62)
- MOVANO B Van (X62)
- MOVANO Bus (X70)
- MOVANO Platform/Chassis (X70)
- MOVANO Van (X70)
- VIVARO A Bus (X83)
- VIVARO A Platform/Chassis (X83)
- VIVARO A Van (X83)

RENAULT

- CLIO II (BB_, CB_)
- CLIO II Hatchback Van (SB0/1/2_)
- ESPACE IV (JK0/1_)
- GRAND SCÉNIC II (JM0/1_)

EUV-AGR 7.02256.19.0

- GRAND SCÉNIC III (JZ0/1_)
- KANGOO (KC0/1_)
- KANGOO Express (FC0/1_)
- KOLEOS I (HY_)
- LAGUNA Coupe (DT0/1)
- LAGUNA II (BG0/1_)
- LAGUNA II Grandtour (KG0/1_)
- LAGUNA III (BT0/1)
- LAGUNA III Grandtour (KT0/1)
- MASTER III Van (FV)
- MEGANE CC (EZ0/1_)
- MEGANE II (BM0/1_, CM0/1_)
- MEGANE II Coupé-Cabriolet (EM0/1_)
- MEGANE II Estate (KM0/1_)
- MEGANE II Saloon (LM0/1_)
- MEGANE III Coupe (DZ0/1_)
- MEGANE III Grandtour (KZ0/1)
- MEGANE III Hatchback (BZ0/1_, B3_)
- SCÉNIC II (JM0/1_)
- SCÉNIC III (JZ0/1_)
- TRAFIC II Bus (JL)
- TRAFIC II Platform/Chassis (EL)
- TRAFIC II Van (FL)
- TRAFIC Platform/Chassis (PXX)
- VEL SATIS (BJ0_)

VAUXHALL

- ARENA Combi (A97)
- ARENA Van (A97)
- MOVANO Mk II (B) Chassis/Cab (X62)
- MOVANO Mk II (B) Combi (X62)
- MOVANO Mk II (B) VAN (X62)
- VIVARO A Bus (X83)
- VIVARO A Platform/Chassis (X83)
- VIVARO A Van (X83)

EUV-AGR 7.02256.29.0



→SI 0096

FORD

- ESCORT Coupe
- ESCORT VI (GAL, AAL, ABL)
- ESCORT VI Convertible (ALL)
- ESCORT VI Saloon (GAL, AFL)
- ESCORT VI Turnier (GAL, ANL)
- FIESTA III (GFJ)
- MONDEO I (GBP)
- MONDEO I Saloon (GBP)
- MONDEO I Turnier (BNP)
- MONDEO II (BAP)
- MONDEO II Saloon (BFP)
- MONDEO II Turnier (BNP)

EUV-AGR 7.02256.37.0



→SI 0096

DODGE

- CALIBER

FREIGHTLINER

- SPRINTER 2500 Extended Cargo Van
- SPRINTER 2500 Standard Cargo Van
- SPRINTER 2500 Standard Passenger Van
- SPRINTER 3500 Cab & Chassis
- SPRINTER 3500 Extended Cargo Van
- SPRINTER 3500 Standard Cargo Van
- SPRINTER 3500 Standard Passenger Van

JEEP

- COMPASS (MK49)
- PATRIOT (MK74)

MERCEDES-BENZ

- A-CLASS (W177)
- A-CLASS Saloon (V177)
- B-CLASS Sports Tourer (W247)
- C-CLASS (W202)
- C-CLASS (W205)
- C-CLASS Convertible (A205)
- C-CLASS Coupe (C205)
- C-CLASS T-Model (S202)
- C-CLASS T-Model (S205)
- CLA (C118)
- CLA Shooting Brake (X118)
- CLS (C257)
- E-CLASS (W210)
- E-CLASS (W213)
- E-CLASS All-Terrain (S213)
- E-CLASS Convertible (A238)
- E-CLASS Coupe (C238)
- E-CLASS T-Model (S210)
- E-CLASS T-Model (S213)
- G-CLASS (W461)
- G-CLASS (W463)
- GLA (H247)
- GLB (X247)
- GLC (X253)
- GLC Coupe (C253)
- GLE (V167)
- GLE Coupe (C167)
- GLS (X167)
- MARCO POLO Camper (W447)
- S-CLASS (W222, V222, X222)
- S-CLASS (W223)
- SPRINTER 3,5-t Platform/Chassis (B907, B910)
- SPRINTER 3,5-t Van (B907, B910)
- SPRINTER 3-t Bus (B903)
- SPRINTER 3-t Platform/Chassis (B910, B907)



EUV-AGR 7.02256.37.0	EUV-AGR 7.02256.44.0 New	EUV-AGR 7.02256.46.0
<p>SPRINTER 4-t Van (B907, B910) UNIMOG V-CLASS (W447) VITO Mixto (Double Cabin) (W447) VITO Tourer (W447) VITO Van (W447)</p> <p>MERCEDES-BENZ (BBDC) C-CLASS (W204) E-CLASS (W211) E-CLASS (W212) GLK-CLASS (X204)</p> <p>MERCEDES-BENZ (FJDA) VIANO VITO (V639)</p> <p>PUCH G-MODELL (W461) G-MODELL Van (W461)</p>	<p>INSIGNIA A Country Tourer (G09) INSIGNIA A Saloon (G09) INSIGNIA A Sports Tourer (G09) INSIGNIA B Country Tourer (Z18) INSIGNIA B Grand Sport (Z18) INSIGNIA B Sports Tourer (Z18) MERIVA B MPV (S10) MOKKA / MOKKA X (J13) ZAFIRA TOURER C (P12)</p> <p>VAUXHALL ASTRA Mk VI (J) (P10) ASTRA Mk VI (J) Estate (P10) ASTRA Mk VI (J) GTC (P10) ASTRA Mk VII (K) (B16) ASTRA Mk VII (K) Estate (B16) CASCADA Convertible (W13) INSIGNIA Mk I (A) Country Tourer (G09) INSIGNIA Mk I (A) Hatchback (G09) INSIGNIA Mk I (A) Saloon (G09) INSIGNIA Mk I (A) Sports Tourer (G09) INSIGNIA Mk II (B) Country Tourer (Z18) INSIGNIA Mk II (B) Hatchback (Z18) INSIGNIA Mk II (B) Sports Tourer (Z18) MERIVA Mk II (B) (S10) MOKKA / MOKKA X (J13) ZAFIRA Mk III (P12)</p>	<p>E-350 Extended Passenger Van E-350 SUPER DUTY Cutaway Van E-350 SUPER DUTY Extended Cargo Van E-350 SUPER DUTY Standard Cargo Van E-350 SUPER DUTY Stripped Chassis E-350 Standard Cargo Van E-350 Standard Passenger Van E-350 Stripped Chassis E-450 SUPER DUTY Cab & Chassis E-450 SUPER DUTY Cutaway Van E-450 SUPER DUTY Stripped Chassis ESCAPE EXPEDITION EXPLORER EXPLORER (U2, U_) EXPLORER (U251) EXPLORER SPORT TRAC Pickup F-150 Crew Cab Pickup F-150 Extended Cab Pickup F-150 Standard Cab Pickup F-250 SUPER DUTY Crew Cab Pickup F-250 SUPER DUTY Extended Cab Pickup F-250 SUPER DUTY Standard Cab Pickup F-350 SUPER DUTY Crew Cab Pickup F-350 SUPER DUTY Extended Cab Pickup F-350 SUPER DUTY Standard Cab Pickup FOCUS</p>
<p>EUV-AGR 7.02256.44.0 New</p>	<p>EUV-AGR 7.02256.46.0</p>	<p>FOCUS Estate FOCUS Hatchback MUSTANG Convertible (C) MUSTANG Coupe (C) RANGER Standard Cab Pickup TAURUS Estate TAURUS Saloon THUNDERBIRD Convertible WINDSTAR WINDSTAR (A3)</p>
		<p>LINCOLN BLACKWOOD LS NAVIGATOR (U228)</p> <p>MAZDA TRIBUTE (EP)</p> <p>MERCURY COUGAR Coupe GRAND MARQUIS GRAND MARQUIS Saloon MARINER MOUNTAINEER MYSTIQUE SABLE SABLE Estate</p>
<p>CHEVROLET COLORADO Crew Cab Pickup COLORADO Extended Cab Pickup CRUZE Saloon EXPRESS 2500 Extended Cargo Van EXPRESS 2500 Standard Cargo Van EXPRESS 2500 Standard Passenger Van EXPRESS 3500 Cutaway Van EXPRESS 3500 Extended Cargo Van EXPRESS 3500 Standard Cargo Van EXPRESS 3500 Standard Passenger Van TRAX</p> <p>GMC CANYON Crew Cab Pickup CANYON Extended Cab Pickup SAVANA 2500 Standard Cargo Van SAVANA 2500 Standard Passenger Van SAVANA 3500 Cutaway Van SAVANA 3500 Extended Cargo Van SAVANA 3500 Extended Passenger Van SAVANA 3500 Standard Cargo Van</p> <p>OPEL ANTARA A (L07) ASTRA J (P10) ASTRA J GTC ASTRA J Saloon ASTRA J Sports Tourer (P10) ASTRA K (B16) ASTRA K Sports Tourer (B16) CASCADA (W13) INSIGNIA A (G09)</p>	<p>FORD COUGAR (EC_) MAVERICK MONDEO I (GBP) MONDEO I Saloon (GBP) MONDEO I Turnier (BNP) MONDEO II (BAP) MONDEO II Saloon (BFP) MONDEO II Turnier (BNP) TRANSIT Bus (FD_, FB_, FS_, FZ_, FC_) TRANSIT Platform/Chassis (FM_, FN_) TRANSIT Van (FA_)</p> <p>FORD USA CONTOUR CROWN VICTORIA E-150 Extended Cargo Van E-150 Standard Cargo Van E-150 Standard Passenger Van E-250 Extended Cargo Van E-250 Standard Cargo Van E-250 Stripped Chassis E-350 Cutaway Van E-350 Extended Cargo Van</p>	



ELECTRIC VALVES



EUV-AGR 7.02256.47.0



FORD

- COURIER Pickup
- ESCORT CLASSIC (AAL, ABL)
- ESCORT CLASSIC Turnier (ANL)
- ESCORT VI (GAL, AAL, ABL)
- ESCORT VI Convertible (ALL)
- ESCORT VI Estate Van (AVL)
- ESCORT VI Saloon (GAL, AFL)
- ESCORT VI Turnier (GAL, ANL)
- FIESTA Box Body/MPV (J5_, J3_)
- FIESTA Box Body/MPV (JV_)
- FIESTA IV (JA_, JB_)
- MONDEO I (GBP)
- MONDEO I Saloon (GBP)
- MONDEO I Turnier (BNP)
- MONDEO II (BAP)
- MONDEO II Saloon (BFP)
- MONDEO II Turnier (BNP)
- TRANSIT Bus (E_)
- TRANSIT Platform/Chassis (E_)
- TRANSIT TOURNEO Bus
- TRANSIT Van (E_)
- FORD AUSTRALIA**
- TRANSIT Bus (VF, VG)
- TRANSIT Platform/Chassis (VF, VG)
- MAZDA**
- 121 III (JASM, JBSM)

EUV-AGR 7.02318.01.0

- 2 Coupe (F22, F87)
- 3 (E46)
- 3 (E90)
- 3 (F30, F80)
- 3 Compact (E46)
- 3 Convertible (E93)
- 3 Coupe (E92)
- 3 Gran Turismo (F34)
- 3 Touring (E46)
- 3 Touring (E91)
- 3 Touring (F31)
- 4 Convertible (F33, F83)
- 4 Coupe (F32, F82)
- 4 Gran Coupe (F36)
- 5 (E60)
- 5 (F10)
- 5 Gran Turismo (F07)
- 5 Touring (E61)
- 5 Touring (F11)
- 6 Convertible (F12)
- 6 Coupe (F13)
- 6 Gran Coupe (F06)
- 7 (F01, F02, F03, F04)
- X1 (E84)
- X3 (E83)
- X3 (F25)
- X4 (F26)
- X5 (E70)
- X5 (F15, F85)
- X6 (E71, E72)
- X6 (F16, F86)
- MINI (BMW)**
- MINI (R56)
- MINI CLUBMAN (R55)
- MINI CLUBVAN (R55)
- MINI COUNTRYMAN (R60)
- MINI Convertible (R57)
- MINI Coupe (R58)
- MINI PACEMAN (R61)
- MINI Roadster (R59)

EUV-AGR 7.02436.02.0 New

- DISCOVERY V (L462)
- RANGE ROVER IV (L405)
- RANGE ROVER SPORT I (L320)
- RANGE ROVER SPORT II (L494)
- RANGE ROVER VELAR (L560)

EUV-AGR 7.02461.01.0



→SI 0096

OPEL

- ASTRA G CLASSIC (T98)
- ASTRA G CLASSIC Caravan (F35)
- ASTRA G Estate (T98)
- ASTRA G Estate Van (F70)
- ASTRA G Hatchback (T98)
- ASTRA G Saloon (T98)
- COMBO Box Body/MPV
- COMBO Tour
- CORSA C (X01)
- CORSA C Hatchback Van (X01)
- CORSA C Saloon (X01)
- MERIVA A MPV (X03)
- MERIVA B MPV (S10)

VAUXHALL

- ASTRA Mk IV (G) Estate (T98)
- ASTRA Mk IV (G) Hatchback (T98)
- ASTRA Mk IV (G) Saloon (T98)
- ASTRAVAN Mk IV (G) Estate Van (T98)
- COMBO Mk II (C) Box Body/MPV (F25)
- COMBO TOUR Mk II (C) (F25)
- CORSA Mk II (C) (X01)
- MERIVA A (X03)
- MERIVA Mk II (B) (S10)

EUV-AGR 7.02318.01.0

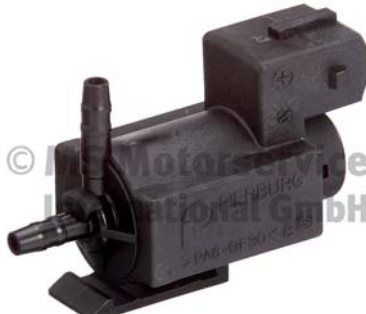

→SI 0096
→SI 0100

BMW

- 1 (E81)
- 1 (E87)
- 1 (F20)
- 1 (F21)
- 1 Convertible (E88)
- 1 Coupe (E82)

EUV-AGR 7.02436.02.0 New



JAGUAR

- F-PACE (X761)
- XF I (X250)
- XF II (X260)
- XF SPORTBRAKE (X250)
- XF SPORTBRAKE (X260)
- XJ (X351)

LAND ROVER

- DISCOVERY IV (L319)

EUV-AGR 7.02461.03.0



CHEVROLET

- TRAX
- OPEL**
- MOKKA / MOKKA X (J13)



EUV-AGR 7.02461.03.0

VAUXHALL
MOKKA / MOKKA X (J13)

EUV-AGR 7.02613.02.0 New



VOLVO
C30 (533)
C70 II Convertible (542)
S40 II (544)
S60 II (134)
S80 II (124)
V40 Hatchback (525, 526)
V50 (545)
V60 I (155, 157)
V70 III (135)
XC60 I SUV (156)
XC70 II (136)

EUV-AGR 7.03280.04.0



→PI 1961

AUDI
A4 Allroad B9 (8WH, 8WJ)
A4 B9 (8W2, 8WC)
A4 B9 Avant (8W5, 8WD)
A5 (F53, F5P)
A5 Sportback (F5A, F5F)
A6 Allroad C8 (4AH)
A7 Sportback (4KA)
A8 D4 (4H2, 4H8, 4HC, 4HL)
Q5 (FYB, FYG)
Q7 (4MB, 4MG)
Q8 (4MN)
VOLKSWAGEN
AMAROK (2HA, 2HB, S1B, S6B, S7A, S7B)
TOUAREG (CR7)

EUV-AGR 7.03294.02.0



HYUNDAI
H-1 Cargo (TQ)
H-1 Travel (TQ)
i30 (FD)
i30 Estate (FD)
i40 I (VF)
i40 I CW (VF)
ix35 (LM, EL, ELH)
ix35 Van

KIA
CEE'D Hatchback (ED)
CEE'D SW (ED)
PRO CEE'D (ED)

EUV-AGR 7.03584.01.0 New



LEXUS
IS II (_E2_)
TOYOTA
AURIS (_E15_)
AURIS (_E18_)
AURIS Estate (_E18_)
AVENSIS (_T25_)
AVENSIS Estate (_T25_)
AVENSIS Estate (_T27_)
AVENSIS Saloon (_T25_)
AVENSIS Saloon (_T27_)
COROLLA Saloon (_E15_)
COROLLA Verso (ZER_, ZZE12_, R1_)
RAV 4 III (_A3_)
RAV 4 IV (_A4_)
VERSO (_R2_)

EUV-AGR 7.21071.50.0



→SI 0087
→SI 0096
→SI 0100

MERCEDES-BENZ
124 Saloon (W124)
124 T-Model (S124)
G-CLASS (W461)
SL (R129)
SPRINTER 2-t Bus (B901, B902)
SPRINTER 2-t Platform/Chassis (B901, B902)
SPRINTER 2-t Van (B901, B902)
SPRINTER 3-t Bus (B903)
SPRINTER 3-t Platform/Chassis (B903)
SPRINTER 3-t Van (B903)

SSANGYONG
KORANDO (KJ)
KORANDO Cabrio (KJ)
MUSSO (FJ)

EUV-AGR 7.21483.54.0



→SI 0065
→SI 0076
→SI 0087
→SI 0096
→SI 0100

AUDI
100 C4 Avant (4A5)
100 C4 Saloon (4A2)
80 B4 Avant (8C5)
80 B4 Saloon (8C2)
A4 B5 (8D2)
A4 B5 Avant (8D5)
A6 C4 (4A2)
A6 C4 Avant (4A5)
CABRIOLET B3 (8G7)
COUPE B3 (89, 8B3)

ELECTRIC VALVES





ELECTRIC VALVES



EUV-AGR 7.21483.54.0

FORD
 GALAXY I (WGR)
 GALAXY MK I VAN (WGR)

SEAT
 ALHAMBRA (7V8, 7V9)
 ALHAMBRA VAN (7V8, 7V9)
 CORDOBA (6K1, 6K2)
 IBIZA II (6K1)
 LEON (1M1)
 TOLEDO II (1M2)

VOLKSWAGEN
 BORA I (1J2)
 BORA Variant (1J6)
 GOLF III (1H1)
 GOLF III Cabriolet (1E7)
 GOLF III Variant (1H5)
 GOLF IV (1J1)
 GOLF IV Variant (1J5)
 LUPO I (6X1, 6E1)
 PASSAT B3/B4 (3A2, 35I)
 PASSAT B3/B4 Variant (3A5, 35I)
 POLO (6N2)
 POLO III (6N1)
 SHARAN (7M8, 7M9, 7M6)
 SHARAN VAN (7M_)
 TRANSPORTER IV Bus (70B, 70C, 7DB, 7DK, 70J, 70K, 7DC, 7DJ)
 TRANSPORTER IV Platform/Chassis (70E, 70L, 70M, 7DE, 7DL, 7D)
 TRANSPORTER IV Van (70A, 70H, 7DA, 7DH)

EUV-AGR 7.22138.50.0

AUDI
 A4 B6 Avant (8E5)
 A6 C8 (4A2)
 A7 Sportback (4KA)
 A8 D5 (4N2, 4N8)
 Q5 (FYB, FYG)

AUDI FAW
 Q3 (84B, 84G)

SEAT
 IBIZA IV (6J5, 6P1)
 IBIZA IV Hatchback Van (6J1)
 IBIZA IV SC (6J1, 6P5)
 IBIZA IV ST (6J8, 6P8)

SKODA
 FABIA II (542)
 FABIA II Combi (545)
 ROOMSTER (5J7)
 ROOMSTER Praktik (5J)

SKODA SVW
 OCTAVIA Hatchback (913)
 SUPERB (374)
 YETI (0Y6, 0Y7)

VOLKSWAGEN
 POLO V (6R1, 6C1)
 POLO Van (6R)
 POLO Variant (6V5)

VW FAW
 CC Saloon (990, 991)
 MAGOTAN (B7L, 942)
 SAGITAR (BK2)

VW SVW
 PASSAT B7 (A42, A43)
 TIGUAN (591, 592)

OPEL
 ASTRA G Convertible (T98)
 ASTRA G Coupe (T98)
 ASTRA G Estate (T98)
 ASTRA G Hatchback (T98)
 ASTRA G Saloon (T98)
 CORSA B (S93)
 CORSA B Hatchback Van (S93)
 SIGNUM Hatchback (Z03)
 VECTRA C (Z02)
 VECTRA C Estate (Z02)
 VECTRA C GTS (Z02)
 ZAFIRA A MPV (T98)

VAUXHALL
 ASTRA Mk IV (G) Estate (T98)

EUV-AGR 7.22138.50.0

ASTRA Mk IV (G) Hatchback (T98)
 ASTRA Mk IV (G) Saloon (T98)
 ASTRAVAN Mk IV (G) Estate Van (T98)
 SIGNUM (Z03)
 VECTRA Mk II (C) (Z02)
 VECTRA Mk II (C) Estate (Z02)
 VECTRA Mk II (C) GTS (Z02)
 ZAFIRA A (T98)

EUV-AGR 7.22880.01.0



→SI 0087
 →SI 0096
 →SI 0106

AUDI
 A4 B6 Avant (8E5)
 A6 C8 (4A2)
 A7 Sportback (4KA)
 A8 D5 (4N2, 4N8)
 Q5 (FYB, FYG)

AUDI FAW
 Q3 (84B, 84G)

SEAT
 IBIZA IV (6J5, 6P1)
 IBIZA IV Hatchback Van (6J1)
 IBIZA IV SC (6J1, 6P5)
 IBIZA IV ST (6J8, 6P8)

SKODA
 FABIA II (542)
 FABIA II Combi (545)
 ROOMSTER (5J7)
 ROOMSTER Praktik (5J)

SKODA SVW
 OCTAVIA Hatchback (913)
 SUPERB (374)
 YETI (0Y6, 0Y7)

VOLKSWAGEN
 POLO V (6R1, 6C1)
 POLO Van (6R)
 POLO Variant (6V5)

VW FAW
 CC Saloon (990, 991)
 MAGOTAN (B7L, 942)
 SAGITAR (BK2)

VW SVW
 PASSAT B7 (A42, A43)
 TIGUAN (591, 592)

EUV-AGR 7.28098.04.0



→SI 0087
 →SI 0096

VOLKSWAGEN
 NEW BEETLE (9C1, 1C1)
 NEW BEETLE Convertible (1Y7)
 PASSAT B6 (3C2)
 PASSAT B6 Variant (3C5)

EUV-AT 7.02256.37.0



→SI 0096

DODGE
 CALIBER

MERCEDES-BENZ
 E-CLASS (W210)
 SPRINTER 3-t Bus (B903)

MERCEDES-BENZ (BBDC)
 C-CLASS (W204)
 E-CLASS (W211)
 E-CLASS (W212)
 GLK-CLASS (X204)

MERCEDES-BENZ (FJDA)
 VIANO
 VITO (V639)



EUV-AT 7.21071.50.0



→SI 0087
→SI 0096
→SI 0100

MERCEDES-BENZ

124 Convertible (A124)
124 Coupe (C124)
124 T-Model (S124)
E-CLASS Convertible (A124)
E-CLASS Coupe (C124)
E-CLASS T-Model (S124)

EUV-BKV 7.28098.16.0



→SI 0096

PORSCHE

PANAMERA (970)

EUV-DR 7.22687.49.0



AUDI

A3 (8L1)
A4 B5 (8D2)
A4 B5 Avant (8D5)
A6 C5 (4B2)
A6 C5 Avant (4B5)
ALLROAD C5 (4BH)
TT (8N3)

EUV-DR 7.22687.49.0

TT Roadster (8N9)
SEAT
LEON (1M1)
TOLEDO II (1M2)
SKODA
OCTAVIA I (1U2)
OCTAVIA I Combi (1U5)
VOLKSWAGEN
BORA I (1J2)
BORA Variant (1J6)
GOLF IV (1J1)
GOLF IV Variant (1J5)

EUV-DS 7.02256.37.0



→SI 0096

DODGE

CALIBER
MERCEDES-BENZ
G-CLASS (W461)
G-CLASS (W463)
G-CLASS Cabrio (W463)
SPRINTER 3-t Bus (B903)
MERCEDES-BENZ (BBDC)
C-CLASS (W204)
E-CLASS (W211)
E-CLASS (W212)
GLK-CLASS (X204)
MERCEDES-BENZ (FJDA)
VIANO
VITO (V639)

EUV-DS 7.21042.01.0 New



MERCEDES-BENZ

T2/LN1 Dump Truck
T2/LN1 Platform/Chassis
T2/LN1 Van

EUV-DS 7.21042.01.0 New

VARIO Cab with engine
VARIO Van (B667, B670, B668)

EUV-DS 7.21071.50.0



→SI 0087
→SI 0096
→SI 0100

MERCEDES-BENZ

G-CLASS (W463)
G-CLASS Cabrio (W463)
SPRINTER 2-t Bus (B901, B902)
SPRINTER 2-t Platform/Chassis (B901, B902)
SPRINTER 2-t Van (B901, B902)
SPRINTER 3-t Bus (B903)
SPRINTER 3-t Platform/Chassis (B903)
SPRINTER 3-t Van (B903)
SPRINTER 4-t Platform/Chassis (B904)
SPRINTER 4-t Van (B904)
T2/LN1 Dump Truck
T2/LN1 Platform/Chassis
T2/LN1 Van
VOLKSWAGEN
LT 28-35 II Bus (2DB, 2DE, 2DK)
LT 28-46 II Platform/Chassis (2DC, 2DF, 2DG, 2DL, 2DM)
LT 28-46 II Van (2DA, 2DD, 2DH)

EUV-DS 7.28098.04.0



→SI 0087
→SI 0096

VOLKSWAGEN

MULTIVAN V (7HM, 7HN, 7HF, 7EF, 7EM, 7EN)
MULTIVAN VI (SGF, SGM, SGN, SHM, SHN)
TRANSPORTER / CARAVELLE VI Bus (SGB, SGG, SGJ, SGC, SHB, SHJ)
TRANSPORTER V Bus (7HB, 7HJ, 7EB, 7EJ, 7EF, 7EG, 7HF, 7EC)

ELECTRIC VALVES





ELECTRIC VALVES



EUV-DS 7.28098.04.0
 TRANSPORTER V Platform/Chassis (7JD, 7JE, 7JL, 7JY, 7JZ, 7FD)
 TRANSPORTER V Van (7HA, 7HH, 7EA, 7EH)
 TRANSPORTER VI Platform/Chassis (SFD, SFE, SFL, SFZ, SJD, SJ)
 TRANSPORTER VI Van (SGA, SGH, SHA, SHH)

EUV-KA 7.02256.29.0



→SI 0096

FORD

TRANSIT Bus (FD_, FB_, FS_, FZ_, FC_)
 TRANSIT Platform/Chassis (FM_, FN_, FF_)
 TRANSIT TOURNEO Bus
 TRANSIT Van (FA_)

EUV-KA 7.21071.50.0



→SI 0087
 →SI 0096
 →SI 0100

MERCEDES-BENZ

123 Coupe (C123)
 123 Saloon (W123)
 123 T-Model (S123)
 G-CLASS (W460)
 G-CLASS Cabrio (W460)
 S-CLASS (W116)

EUV-KA 7.28098.04.0



→SI 0087
 →SI 0096

FORD

GALAXY I (WGR)
 GALAXY MK I VAN (WGR)

SEAT

ALHAMBRA (7V8, 7V9)
 ALHAMBRA VAN (7V8, 7V9)

VOLKSWAGEN

SHARAN (7M8, 7M9, 7M6)
 SHARAN VAN (7M_)

EUV-KK 7.02256.00.0



AUDI

A4 Allroad B8 (8KH)
 A4 B8 (8K2)
 A4 B8 Avant (8K5)
 A5 (8T3)
 A5 Convertible (8F7)
 A5 Sportback (8TA)
 Q5 (8RB)
 Q7 (4MB, 4MG)
 Q7 Van (4MB, 4MG)

VOLKSWAGEN

AMAROK (2HA, 2HB, S1B, S6B, S7A, S7B)
 AMAROK Platform/Chassis (S1B, S6B, S7B)
 TOUAREG (7P5, 7P6)

EUV-KK 7.02256.37.0



→SI 0096

DODGE

CALIBER

MERCEDES-BENZ

A-CLASS (W176)
 B-CLASS Sports Tourer (W246, W242)
 CLA Coupe (C117)
 CLA Shooting Brake (X117)
 GLA-CLASS (X156)
 SPRINTER 3-t Bus (B903)

MERCEDES-BENZ (BBDC)

C-CLASS (W204)
 E-CLASS (W211)
 E-CLASS (W212)
 GLK-CLASS (X204)

MERCEDES-BENZ (FJDA)

VIANO
 VITO (V639)

EUV-KK 7.03280.04.0



→PI 1961

AUDI

A5 Convertible (8F7)





PORSCHE

PANAMERA (970)
 PANAMERA (971)
 PANAMERA Sport Turismo (971)

VOLKSWAGEN

ATLAS (CA1)
 ATLAS CROSS SPORT (CMC)
 TOUAREG (7P5, 7P6)

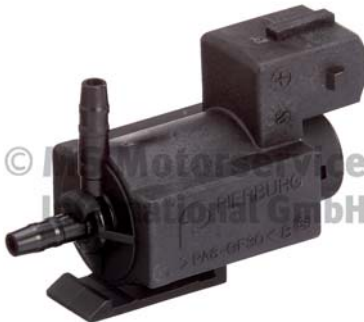

EUV-KK 7.22880.01.0	EUV-KK 7.22880.01.0	EUV-LS 7.01805.01.0
 <p>→SI 0087 →SI 0096 →SI 0106</p> <p>AUDI A1 (8X1, 8XK) A1 Sportback (8XA, 8XF) A3 (8P1) A3 Convertible (8P7) A3 Sportback (8PA) A4 B6 Avant (8E5) A6 C8 (4A2) A7 Sportback (4KA) A8 D4 (4H2, 4H8, 4HC, 4HL) A8 D5 (4N2, 4N8) Q7 (4MB, 4MG)</p> <p>AUDI FAW Q3 (84B, 84G)</p> <p>SEAT ALTEA (5P1) ALTEA XL (5P5, 5P8) IBIZA IV (6J5, 6P1) IBIZA IV SC (6J1, 6P5) IBIZA IV ST (6J8, 6P8) LEON (1P1) TOLEDO IV (KG3)</p> <p>SKODA FABIA II (542) FABIA II Combi (545) OCTAVIA II (1Z3) OCTAVIA II Combi (1Z5) RAPID (NH3) RAPID Spaceback (NH1) ROOMSTER (5J7) ROOMSTER Praktik (5J) YETI (5L)</p> <p>SKODA SVW OCTAVIA Hatchback (913) SUPERB (374) YETI (0Y6, 0Y7)</p> <p>VOLKSWAGEN BEETLE (5C1, 5C2) BEETLE Convertible (5C7, 5C8) CADDY III Box Body/MPV (2KA, 2KH, 2CA, 2CH) CADDY III MPV (2KB, 2KJ, 2CB, 2CJ) GOLF PLUS V (5M1, 521) GOLF PLUS Van (521) GOLF VAN VI Variant (AJ5) GOLF VI (5K1) GOLF VI Convertible (517) GOLF VI Van (5K1_)</p>	<p>GOLF VI Variant (AJ5) JETTA IV (162, 163, AV3, AV2) POLO V (6R1, 6C1) POLO Van (6R) POLO Variant (6V5) TOUAREG (7P5, 7P6) TOUAREG (CR7) TOURAN (1T3)</p> <p>VW FAW CC Saloon (990, 991) MAGOTAN (B7L, 942) SAGITAR (BK2)</p> <p>VW SVW PASSAT B7 (A42, A43) TIGUAN (591, 592)</p>	 <p>→SI 0096</p> <p>AUDI A3 (8L1) A4 B5 (8D2) A4 B5 Avant (8D5) A4 B6 (8E2) A4 B6 Avant (8E5) A4 B6 Convertible (8H7) A4 B7 (8EC) A4 B7 Avant (8ED) A4 B7 Convertible (8HE) A6 C5 (4B2) A6 C5 Avant (4B5) A6 C6 (4F2) A6 C6 Avant (4F5)</p> <p>AUDI FAW A4 B6 (8E2) A6L C6 (4Z8)</p> <p>SEAT TOLEDO I (1L2)</p> <p>VOLKSWAGEN CITI GOLF GOLF II (19E, 1G1) GOLF II Van (19E, 1G1) JETTA II (19E, 1G2, 165) PASSAT B2 (32B) PASSAT B2 Saloon (32B) PASSAT B2 Variant (33B) PASSAT B3/B4 (3A2, 35I) PASSAT B3/B4 Variant (3A5, 35I) PASSAT B5 (3B2) PASSAT B5 Variant (3B5) PASSAT B5.5 (3B3) PASSAT B5.5 Variant (3B6)</p> <p>VW SVW SANTANA Estate (331, 334)</p>
	<p>EUV-KL 7.02318.01.0</p>  <p>→SI 0096 →SI 0100</p> <p>BMW 3 (E46) 3 Compact (E46) 3 Convertible (E46) 3 Coupe (E46) 5 (E39) 5 Touring (E39) 7 (E38)</p>	
	<p>EUV-LS 7.00017.02.0</p>  <p>MAYBACH 57 (W240)</p> <p>MERCEDES-BENZ S-CLASS (W220) S-CLASS (W221) S-CLASS Coupe (C215) S-CLASS Coupe (C216) SL (R230)</p>	



EUV-LS 7.02256.00.0



AUDI
A6 C6 (4F2)
A6 C6 Avant (4F5)

EUV-LS 7.02318.01.0

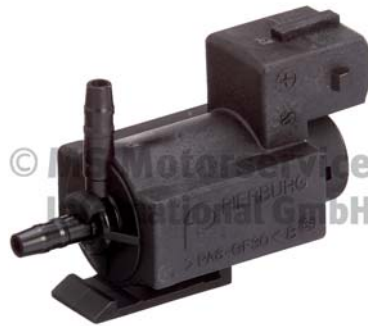

BMW
5 (F10)
7 (E65, E66, E67)
7 (F01, F02, F03, F04)
X5 (F15, F85)
MINI (BMW)
MINI (R50, R53)
MINI Convertible (R52)

→SI 0096
→SI 0100

EUV-LS 7.02461.01.0



CHEVROLET
CRUZE (J300)
CRUZE Hatchback (J305)
CRUZE Station Wagon (J308)
OPEL
ASTRA H (A04)
ASTRA H CLASSIC Estate (A04)
ASTRA H CLASSIC Hatchback (A04)
ASTRA H CLASSIC Saloon (A04)
ASTRA H Estate (A04)
ASTRA H Estate Van (L70)
ASTRA H GTC (A04)
ASTRA H Saloon (A04)
ASTRA J (P10)
ASTRA J Estate Van (P10)
ASTRA J GTC
ASTRA J Hatchback Van (P10)
ASTRA J Saloon
ASTRA J Sports Tourer (P10)
CORSA D (S07)
MERIVA A MPV (X03)
MERIVA B MPV (S10)
ZAFIRA / ZAFIRA FAMILY B (A05)
ZAFIRA B Box Body/MPV (A05)

→SI 0096

EUV-LS 7.02256.19.0



→SI 0096

OPEL
ARENA Combi (A97)
ARENA Van (TB, TF)
MOVANO B Platform/Chassis (X62)
MOVANO Bus (X70)
MOVANO Platform/Chassis (X70)
MOVANO Van (X70)
RENAULT
AVANTIME (DE0_)
ESPACE III (JE0_)
LAGUNA II (BG0/1_)
LAGUNA II Grandtour (KG0/1_)
MASTER II Bus (JD)
MASTER II Platform/Chassis (ED/HD/UD)
MASTER II Van (FD)
MEGANE I Grandtour (KA0/1_)
MEGANE II (BM0/1_, CM0/1_)
MEGANE II Coupé-Cabriolet (EM0/1_)
MEGANE II Estate (KM0/1_)
MEGANE II Saloon (LM0/1_)
MEGANE Scenic (JA0/1_)
SCÉNIC I MPV (JA0/1_, FA0_)
TRAFIC Bus (TXW)
TRAFIC Van (TXX)
VEL SATIS (BJ0_)
VAUXHALL
ARENA Combi (A97)
ARENA Van (A97)
MOVANO Mk I (A) Chassis/Cab (X70)
MOVANO Mk I (A) Combi (X70)
MOVANO Mk I (A) Van (X70)

EUV-LS 7.02428.02.0 New



JAGUAR
F-PACE (X761)
XF I (X250)
XF II (X260)
XF SPORTBRAKE (X250)
XF SPORTBRAKE (X260)
XJ (X351)
LAND ROVER
DISCOVERY IV (L319)
DISCOVERY V (L462)
RANGE ROVER IV (L405)
RANGE ROVER SPORT I (L320)
RANGE ROVER SPORT II (L494)
RANGE ROVER VELAR (L560)

VAUXHALL
ASTRA Mk V (H) (A04)
ASTRA Mk V (H) Estate (A04)
ASTRA Mk V (H) Sport Hatch (A04)
ASTRA Mk VI (J) (P10)
ASTRA Mk VI (J) Estate (P10)
ASTRA Mk VI (J) GTC (P10)
ASTRA Mk VI (J) Saloon (P10)
ASTRAVAN Mk V (H) Estate Van (A04)
CORSA Mk III (D) (S07)
MERIVA Mk II (B) (S10)
ZAFIRA Mk II (B) (A05)

ELECTRIC VALVES



EUV-LS 7.03075.02.0 New



BMW
7 (F01, F02, F03, F04)
X6 (E71, E72)

EUV-LS 7.21071.50.0



→SI 0087
→SI 0096
→SI 0100

MERCEDES-BENZ
124 Coupe (C124)
124 Saloon (W124)
124 T-Model (S124)
190 (W201)
300
C-CLASS (W202)
C-CLASS T-Model (S202)
E-CLASS (W124)
E-CLASS (W210)
E-CLASS Convertible (A124)
E-CLASS Coupe (C124)
E-CLASS T-Model (S124)
E-CLASS T-Model (S210)
G-CLASS (W460)
G-CLASS (W463)
G-CLASS Cabrio (W463)
S-CLASS (W116)
S-CLASS (W126)
S-CLASS (W140)
S-CLASS Coupe (C140)
SL (R107)
SL (R129)
SL Coupe (C107)
T1 Bus (B601)
T1 Platform/Chassis (601)
T1 Van (601, 611)
VARIO
VARIO Bus (B670)
VARIO Dump Truck

EUV-LS 7.21071.50.0

VARIO Platform/Chassis (B670, B668, B667)
VARIO Van (B667, B670, B668)
SSANGYONG
KORANDO (KJ)
KORANDO Cabrio (KJ)
MUSSO (FJ)

EUV-LS 7.21895.55.0



→SI 0087
→SI 0089
→SI 0106

VOLKSWAGEN
CADDY II Box Body/MPV (9K9A)
CADDY II MPV (9K9B)

EUV-LS 7.22138.50.0



→SI 0087
→SI 0096
→SI 0100

OPEL
VECTRA B (J96)
VECTRA B Estate (J96)
VECTRA B Hatchback (J96)
VAUXHALL
VECTRA (B) Hatchback (J96)

EUV-LS 7.22240.15.0



→SI 0096

VOLVO
S40 I (644)
S60 I (384)
S80 I (184)
S80 II (124)
V40 Estate (645)
V70 I (875, 876)
V70 II (285)
V70 III (135)
XC70 CROSS COUNTRY I (295)
XC70 II (136)
XC90 I (275)
XC90 I VAN (275)

EUV-LS 7.22280.02.0



→SI 0087
→SI 0100

PORSCHE
911 (996)
911 (997)
911 Convertible (996)
911 Convertible (997)
911 Targa (996)
911 Targa (997)
BOXSTER (987)
CAYENNE (92A)
CAYMAN (981)
CAYMAN (987)
PANAMERA (970)

EUV-LS 7.22687.15.0*

→7.22687.49.0 EUV-VB

BENTLEY
CONTINENTAL Coupe (3W_, 393)
CONTINENTAL FLYING SPUR (3W_)

ELECTRIC VALVES





ELECTRIC VALVES



EUV-LS 7.22687.16.0*
 →7.22687.49.0 EUV-VB
BENTLEY
 CONTINENTAL Coupe (3W_, 393)
 CONTINENTAL FLYING SPUR (3W_)

EUV-LS 7.22687.39.0



EUV-LS 7.22687.49.0

BENTLEY
 CONTINENTAL Convertible (3W_, 394)
 CONTINENTAL Coupe (3W_, 393)
 CONTINENTAL FLYING SPUR (3W_)
 FLYING SPUR (4W_)



EUV-LS 7.28098.15.0

AUDI
 R8 (422, 423)
 R8 Spyder (427, 429)

→SI 0096



AUDI
 A3 (8L1)
 A4 B5 (8D2)
 A4 B5 Avant (8D5)
 A6 C5 (4B2)
 A6 C5 Avant (4B5)
 ALLROAD C5 (4BH)
 TT (8N3)
 TT Roadster (8N9)

FERRARI
 F430 Spider

PORSCHE
 911 (996)
 911 (997)
 911 Convertible (996)
 911 Convertible (997)
 PANAMERA (970)

SEAT
 LEON (1M1)
 TOLEDO II (1M2)

SKODA
 OCTAVIA I (1U2)
 OCTAVIA I Combi (1U5)

VOLKSWAGEN
 BORA I (1J2)
 BORA Variant (1J6)
 GOLF IV (1J1)
 GOLF IV Variant (1J5)

EUV-LS 7.22880.01.0

AUDI
 A4 B6 Avant (8E5)
 A6 Allroad C6 (4FH)
 A6 C6 (4F2)
 A6 C6 Avant (4F5)
 A6 C8 (4A2)
 A7 Sportback (4KA)
 A8 D3 (4E2, 4E8)
 Q7 (4MB, 4MG)
 Q8 (4MN)

AUDI FAW
 Q3 (84B, 84G)

SKODA SVW
 OCTAVIA Hatchback (913)
 SUPERB (374)
 YETI (0Y6, 0Y7)

VOLKSWAGEN
 POLO Variant (6V5)
 TOUAREG (CR7)

VW FAW
 CC Saloon (990, 991)
 MAGOTAN (B7L, 942)
 SAGITAR (BK2)

VW SVW
 PASSAT B7 (A42, A43)
 TIGUAN (591, 592)

→SI 0087
 →SI 0096
 →SI 0106



EUV-ML 7.02318.01.0

BMW
 1 (E81)
 1 (E87)
 1 Convertible (E88)
 1 Coupe (E82)
 3 (E46)
 3 (E90)
 3 (F30, F80)
 3 Convertible (E93)
 3 Coupe (E46)
 3 Coupe (E92)
 3 Gran Turismo (F34)
 3 Touring (E46)
 3 Touring (E91)
 3 Touring (F31)
 4 Convertible (F33, F83)
 4 Coupe (F32, F82)
 4 Gran Coupe (F36)
 5 (E39)
 5 (E60)
 5 (F10)
 5 Gran Turismo (F07)
 5 Touring (E39)
 5 Touring (E61)
 5 Touring (F11)
 6 (E63)
 6 Convertible (E64)
 6 Convertible (F12)
 6 Coupe (F13)
 6 Gran Coupe (F06)

→SI 0096
 →SI 0100

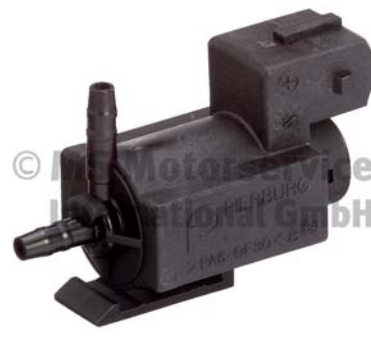



EUV-ML	7.02318.01.0
7 (E38) 7 (E65, E66, E67) 7 (F01, F02, F03, F04) X1 (E84) X3 (E83) X3 (F25) X4 (F26) X5 (E53) X5 (E70) X5 (F15, F85) X6 (E71, E72) X6 (F16, F86)	

EUV-ML	7.28098.04.0
	

EUV-RK	7.02256.14.0
	

EUV-ML	7.22880.01.0
	

	→SI 0087 →SI 0096
AUDI	Q7 (4LB) Q7 Van (4LB)
PORSCHE	CAYENNE (92A)
VOLKSWAGEN	PHAETON (3D1, 3D2, 3D3, 3D4, 3D6, 3D7, 3D8, 3D9) TOUAREG (7P5, 7P6) TOUAREG VAN (7P5)

FIAT	DOBLO MPV (119_, 223_)
-------------	------------------------

EUV-RK	7.02256.50.0	New
		

	→SI 0087 →SI 0096 →SI 0106
AUDI	A4 B6 Avant (8E5)
AUDI FAW	Q3 (84B, 84G)
SKODA SVW	OCTAVIA Hatchback (913) SUPERB (374) YETI (0Y6, 0Y7)
VOLKSWAGEN	PASSAT B5.5 (3B3) PASSAT B5.5 Variant (3B6) POLO Variant (6V5)
VW FAW	CC Saloon (990, 991) MAGOTAN (B7L, 942) SAGITAR (BK2)
VW SVW	PASSAT B7 (A42, A43) TIGUAN (591, 592)

EUV-RK	7.02256.00.0
	





ALFA ROMEO	147 (937_) 156 (932_) 156 Sportwagon (932_) 166 (936_) GT (937_)
FIAT	BRAVA (182_) BRAVO I (182_) BRAVO II (198_) DOBLO Box Body/MPV (223_) DOBLO MPV (119_, 223_) MAREA (185_) MAREA Weekend (185_) MULTIPLA (186_) STILO (192_) STILO Multi Wagon (192_) STILO VAN (192_)
LANCIA	LYBRA (839_) LYBRA SW (839_) THESIS (841_)

AUDI	A6 C5 (4B2) A6 C5 Avant (4B5) A6 C6 (4F2) A6 C6 Avant (4F5)
BENTLEY	BENTAYGA (4V1)
PORSCHE	CAYENNE (92A)
VOLKSWAGEN	TOUAREG (7P5, 7P6)



ELECTRIC VALVES





EUV-RK 7.03294.02.0	EUV-SL 7.00784.01.0	EUV-SL 7.02256.00.0
 <p>HYUNDAI H-1 Cargo (TQ) KIA SORENTO I (JC) SORENTO I VAN (JC)</p>	<p>7 (E38) X5 (E53) Z3 Coupe (E36) Z3 Roadster (E36)</p> <hr/> <p>EUV-SL 7.01037.02.0</p>  <p>→SI 0096</p> <p>SEAT IBIZA III (6L1) VOLKSWAGEN NEW BEETLE (9C1, 1C1) NEW BEETLE Convertible (1Y7) POLO (9N_)</p>	<p>A3 Sportback (8PA) TT (8J3) TT (8N3) TT Roadster (8J9) TT Roadster (8N9)</p> <p>SEAT ALHAMBRA (7V8, 7V9) LEON (1M1) TOLEDO II (1M2)</p> <p>SKODA OCTAVIA I (1U2) OCTAVIA I Combi (1U5)</p>
<p>EUV-RK 7.28170.03.0</p>  <p>→SI 0096</p> <p>FIAT DOBLO Box Body/MPV (223_) DOBLO MPV (119_, 223_) IDEA (350_) IDEA Van (350_) PALIO (178_) PALIO Weekend (178_, 173_, 373_, 374_, 171_) PUNTO (188_) PUNTO Hatchback Van (188_) STRADA Pickup (178_)</p> <p>LANCIA MUSA (350_)</p>	<p>EUV-SL 7.01805.01.0</p>  <p>→SI 0096</p> <p>AUDI A4 B5 Avant (8D5) A6 C5 (4B2) A6 C5 Avant (4B5)</p>	<p>EUV-SL 7.02256.37.0</p>  <p>→SI 0096</p> <p>BRABUS 60S (W221)</p> <p>CHRYSLER CROSSFIRE CROSSFIRE Roadster</p> <p>DODGE CALIBER SPRINTER 2500 Cab & Chassis SPRINTER 2500 Standard Cargo Van SPRINTER 2500 Standard Passenger Van SPRINTER 3500 Cab & Chassis SPRINTER 3500 Standard Cargo Van SPRINTER 3500 Standard Passenger Van</p> <p>FREIGHTLINER SPRINTER 2500 Cab & Chassis SPRINTER 2500 Standard Cargo Van SPRINTER 2500 Standard Passenger Van SPRINTER 3500 Cab & Chassis SPRINTER 3500 Standard Cargo Van SPRINTER 3500 Standard Passenger Van</p>
<p>EUV-SL 7.00784.01.0</p> <p>→SI 0087 →SI 0106</p> <p>BMW 3 (E36) 3 (E46) 3 Compact (E36) 3 Compact (E46) 3 Convertible (E36) 3 Convertible (E46) 3 Coupe (E36) 3 Coupe (E46) 3 Touring (E36) 3 Touring (E46) 5 (E39) 5 (E60) 5 Touring (E39)</p>	<p>EUV-SL 7.02256.00.0</p>  <p>AUDI A3 (8L1) A3 (8P1)</p>	<p>SPRINTER 3500 Standard Passenger Van</p> <p>MAYBACH 57 (W240) 62 (V240)</p> <p>MERCEDES-BENZ A-CLASS (W168) A-CLASS (W169) B-CLASS Sports Tourer (W245) C-CLASS (W202) C-CLASS (W203) C-CLASS (W204) C-CLASS Coupe (C204) C-CLASS Coupe (CL203) C-CLASS T-Model (S202) C-CLASS T-Model (S203) C-CLASS T-Model (S204)</p>

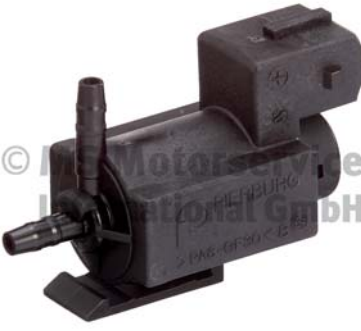

EUV-SL 7.02256.37.0	EUV-SL 7.02318.01.0	EUV-SL 7.03280.04.0
<p>CLK (C208) CLK (C209) CLK Convertible (A208) CLK Convertible (A209) CLS (C219) E-CLASS (W210) E-CLASS (W211) E-CLASS (W212) E-CLASS Platform/Chassis (VF210) E-CLASS T-Model (S210) E-CLASS T-Model (S211) E-CLASS T-Model (S212) G-CLASS (W463) G-CLASS Cabrio (W463) M-CLASS (W163) M-CLASS (W164) R-CLASS (W251, V251) S-CLASS (W220) S-CLASS (W221) S-CLASS (W222, V222, X222) S-CLASS Convertible (A217) S-CLASS Coupe (C215) S-CLASS Coupe (C216) S-CLASS Coupe (C217) SL (R129) SL (R230) SL (R231) SLK (R170) SLK (R171) SLR (R199) SLR Roadster (R199) SLS AMG (C197) SLS AMG Roadster (R197) SPRINTER 2-t Van (B901, B902) SPRINTER 3-t Bus (B903) SPRINTER 3-t Platform/Chassis (B903) SPRINTER 3-t Van (B903) SPRINTER 4-t Platform/Chassis (B904) SPRINTER 4-t Van (B904) V-CLASS (638/2) Vaneo (414) VIANO (W639) VITO / MIXTO Van (W639) VITO Bus (W638) VITO Bus (W639) VITO Van (W638)</p> <p>MERCEDES-BENZ (BBDC) C-CLASS (W204) E-CLASS (W211) E-CLASS (W212) GLK-CLASS (X204)</p> <p>MERCEDES-BENZ (FJDA) VIANO VITO (V639)</p> <p>PUCH G-MODELL (W463) G-MODELL Cabrio (W463)</p> <p>SMART FORTWO Cabrio (451) FORTWO Convertible (453) FORTWO Coupe (451) FORTWO Coupe (453)</p>	 <p>→SI 0096 →SI 0100</p> <p>BMW 3 (E36) 3 (E46) 3 Compact (E36) 3 Convertible (E36) 3 Coupe (E36) 3 Coupe (E46) 3 Touring (E36) 3 Touring (E46) 5 (E39) 5 (E60) 5 Touring (E39) 5 Touring (E61) 7 (E38) 8 (E31) X5 (E53) Z3 Coupe (E36) Z3 Roadster (E36) Z8 Roadster (E52)</p> <p>LAND ROVER DISCOVERY II (L318) RANGE ROVER II (P38A)</p>	 <p>→PI 1961</p> <p>AUDI A6 C7 (4G2, 4GC) A6 C7 Avant (4G5, 4GD) A7 Sportback (4GA, 4GF) A8 D4 (4H2, 4H8, 4HC, 4HL)</p>
	<p>EUV-SL 7.02461.01.0</p>  <p>→SI 0096</p> <p>AUDI TT (8N3) TT Roadster (8N9)</p>	<p>EUV-SL 7.21071.50.0</p>  <p>→SI 0087 →SI 0096 →SI 0100</p> <p>MERCEDES-BENZ 124 Convertible (A124) 124 Coupe (C124) 124 Saloon (W124) 124 T-Model (S124) C-CLASS (W202) E-CLASS (W124) E-CLASS (W210) E-CLASS Convertible (A124) E-CLASS Coupe (C124) E-CLASS T-Model (S124) G-CLASS (W463) G-CLASS Cabrio (W463) S-CLASS (W140) SL (R129)</p>





ELECTRIC VALVES



EUV-SL 7.21895.55.0



→SI 0087
→SI 0089
→SI 0106

VOLKSWAGEN

NEW BEETLE (9C1, 1C1)
NEW BEETLE Convertible (1Y7)

EUV-SL 7.22280.02.0

CARRERA GT (980)
CAYMAN (987)

EUV-SL 7.22880.01.0



→SI 0087
→SI 0096
→SI 0106

EUV-SL 7.28098.15.0



→SI 0096

AUDI

A4 B6 (8E2)
A4 B6 Avant (8E5)
A4 B6 Convertible (8H7)
A4 B7 (8EC)
A4 B7 Avant (8ED)
A4 B7 Convertible (8HE)
A6 C6 (4F2)
A6 C6 Avant (4F5)

EUV-SL 7.22240.15.0



→SI 0096

VOLVO

960 (964)
S40 I (644)
S90 I (964)
V40 Estate (645)
V90 I Estate (965)

AUDI

A4 B6 Avant (8E5)
A4 B7 (8EC)
A4 B7 Avant (8ED)
A4 B7 Convertible (8HE)
A4 B8 (8K2)
A4 B8 Avant (8K5)
A5 (8T3)
A5 Convertible (8F7)
A5 Sportback (8TA)
A6 Allroad C7 (4GH, 4GJ)
A6 C6 (4F2)
A6 C6 Avant (4F5)
A6 C7 (4G2, 4GC)
A6 C7 Avant (4G5, 4GD)
A7 Sportback (4GA, 4GF)
A8 D3 (4E2, 4E8)
A8 D4 (4H2, 4H8, 4HC, 4HL)
Q7 (4LB)
Q7 (4MB, 4MG)
R8 (422, 423)
R8 (4S3, 4SP)
R8 Spyder (427, 429)
R8 Spyder (4S9, 4SR)

AUDI FAW

Q3 (84B, 84G)

SKODA SVW

OCTAVIA Hatchback (913)
SUPERB (374)
YETI (0Y6, 0Y7)

VOLKSWAGEN

PHAETON (3D1, 3D2, 3D3, 3D4, 3D6, 3D7, 3D8, 3D9)
POLO Variant (6V5)
TOUAREG (7LA, 7L6, 7L7)
TOUAREG (7P5, 7P6)

VW FAW

CC Saloon (990, 991)
MAGOTAN (B7L, 942)
SAGITAR (BK2)

VW SVW

PASSAT B7 (A42, A43)
TIGUAN (591, 592)

EUV-SL 7.22280.02.0



→SI 0087
→SI 0100

PORSCHE

911 (993)
911 (996)
911 Convertible (996)
BOXSTER (986)
BOXSTER (987)

EUV-SL 7.28286.13.0



MASERATI

QUATTROPORTE VI

EUV-SR 7.01039.03.0



→SI 0096

OPEL

ASTRA G Convertible (T98)
ASTRA G Coupe (T98)
ASTRA G Estate (T98)
ASTRA G Hatchback (T98)
ASTRA H (A04)
ASTRA H GTC (A04)
SPEEDSTER (E01)



EUV-SR 7.01039.03.0	EUV-SR 7.01805.01.0	EUV-SR 7.02256.18.0
<p>ZAFIRA A MPV (T98) VAUXHALL ASTRA Mk IV (G) Convertible (T98) ASTRA Mk IV (G) Coupe (T98) ASTRA Mk IV (G) Hatchback (T98) VX220 Convertible (E01) ZAFIRA A (T98)</p>	<p>A8 D2 (4D2, 4D8) CABRIOLET B3 (8G7) COUPE B3 (89, 8B3) TT (8N3) TT Roadster (8N9) AUDI FAW A6 C5 (4Y8) SEAT EXEO (3R2) EXEO ST (3R5) LEON (1M1) TOLEDO I (1L2) TOLEDO II (1M2) SKODA OCTAVIA I (1U2) OCTAVIA I Combi (1U5) SUPERB I (3U4) VOLKSWAGEN BORA I (1J2) BORA Variant (1J6) GOLF IV (1J1) GOLF IV Variant (1J5) PASSAT B5 (3B2) PASSAT B5 Variant (3B5) PASSAT B5.5 (3B3) PASSAT B5.5 Variant (3B6) VW SVW PASSAT B5 (9F8)</p>	
<p>EUV-SR 7.01044.03.0</p>  <p>→SI 0096</p> <p>VOLKSWAGEN GOLF PLUS V (5M1, 521) GOLF V (1K1) GOLF V Variant (1K5) JETTA III (1K2) TIGUAN (5N_) TOURAN (1T1, 1T2)</p>	<p>EUV-SR 7.02256.00.0</p>  <p>AUDI A1 (8X1, 8XK) A1 Sportback (8XA, 8XF) A3 (8V1, 8VK) A3 Convertible (8V7, 8VE) A3 Limousine (8VS, 8VM) A3 Sportback (8VA, 8VF) A4 B8 (8K2) A4 B8 Avant (8K5) A4 B9 (8W2, 8WC) A4 B9 Avant (8W5, 8WD) A5 (F53, F5P) A5 Convertible (F57, F5E) A5 Sportback (F5A, F5F) A6 C7 (4G2, 4GC) A6 C7 Avant (4G5, 4GD) A7 Sportback (4GA, 4GF) A8 D4 (4H2, 4H8, 4HC, 4HL) Q3 (8UB, 8UG) Q7 (4MB, 4MG) TT (FV3, FVP) TT Roadster (FV9, FVR) SEAT ALHAMBRA (710, 711) IBIZA IV SC (6J1, 6P5) LEON (5F1) LEON SC (5F5) LEON ST (5F8) SKODA KODIAQ (NS7, NV7) VOLKSWAGEN BEETLE (5C1, 5C2) BEETLE Convertible (5C7, 5C8) GOLF VI Convertible (517) GOLF VII (5G1, BQ1, BE1, BE2) GOLF VII Variant (BA5, BV5) JETTA IV (162, 163, AV3, AV2) PASSAT ALLTRACK B8 Variant (3G5, CB5) PASSAT B8 (3G2, CB2) PASSAT B8 Variant (3G5, CB5) POLO V (6R1, 6C1) SCIROCCO III (137, 138) SHARAN (7N1, 7N2) TIGUAN (AD1, AX1)</p>	<p>AUDI A1 (8X1, 8XK) A1 Sportback (8XA, 8XF) A3 (8V1, 8VK) A3 Convertible (8V7, 8VE) A3 Limousine (8VS, 8VM) A3 Sportback (8VA, 8VF) A4 B8 (8K2) A4 B8 Avant (8K5) A4 B9 (8W2, 8WC) A4 B9 Avant (8W5, 8WD) A5 (F53, F5P) A5 Convertible (F57, F5E) A5 Sportback (F5A, F5F) A6 C7 (4G2, 4GC) A6 C7 Avant (4G5, 4GD) A7 Sportback (4GA, 4GF) A8 D4 (4H2, 4H8, 4HC, 4HL) Q3 (8UB, 8UG) Q7 (4MB, 4MG) TT (FV3, FVP) TT Roadster (FV9, FVR) SEAT ALHAMBRA (710, 711) IBIZA IV SC (6J1, 6P5) LEON (5F1) LEON SC (5F5) LEON ST (5F8) SKODA KODIAQ (NS7, NV7) VOLKSWAGEN BEETLE (5C1, 5C2) BEETLE Convertible (5C7, 5C8) GOLF VI Convertible (517) GOLF VII (5G1, BQ1, BE1, BE2) GOLF VII Variant (BA5, BV5) JETTA IV (162, 163, AV3, AV2) PASSAT ALLTRACK B8 Variant (3G5, CB5) PASSAT B8 (3G2, CB2) PASSAT B8 Variant (3G5, CB5) POLO V (6R1, 6C1) SCIROCCO III (137, 138) SHARAN (7N1, 7N2) TIGUAN (AD1, AX1)</p>
<p>EUV-SR 7.01805.01.0</p>  <p>→SI 0096</p> <p>AUDI 100 C3 Avant (445, 446) 100 C3 Saloon (443, 444) 100 C4 Avant (4A5) 100 C4 Saloon (4A2) 80 B4 Avant (8C5) 80 B4 Saloon (8C2) A3 (8L1) A4 B5 (8D2) A4 B5 Avant (8D5) A4 B6 (8E2) A4 B6 Avant (8E5) A4 B6 Convertible (8H7) A4 B7 (8EC) A6 C4 (4A2) A6 C4 Avant (4A5) A6 C5 (4B2) A6 C5 Avant (4B5)</p>	<p>AUDI A3 (8P1) A3 Sportback (8PA) A6 C6 (4F2) A6 C6 Avant (4F5) Q7 (4LB) TT (8J3) TT (8N3) TT Roadster (8J9) TT Roadster (8N9) PORSCHE CAYENNE (92A) CAYENNE (9PA) SEAT ALHAMBRA (7V8, 7V9) LEON (1M1) TOLEDO II (1M2) VOLKSWAGEN TOUAREG (7P5, 7P6)</p>	



EUV-SR 7.02256.19.0



→SI 0096

RENAULT

LAGUNA II (BG0/1_)
LAGUNA II Grandtour (KG0/1_)

EUV-SR 7.02256.37.0



→SI 0096

DODGE

CALIBER

MERCEDES-BENZ

S-CLASS (W222, V222, X222)
SPRINTER 2-t Bus (B901, B902)
SPRINTER 2-t Platform/Chassis (B901, B902)
SPRINTER 2-t Van (B901, B902)
SPRINTER 3-t Bus (B903)
SPRINTER 3-t Platform/Chassis (B903)
SPRINTER 3-t Van (B903)
SPRINTER 4-t Bus (B904)
SPRINTER 4-t Platform/Chassis (B904)
SPRINTER 4-t Van (B904)
V-CLASS (638/2)
VIANO (W639)
VITO / MIXTO Van (W639)
VITO Bus (W638)
VITO Bus (W639)
VITO Van (W638)

MERCEDES-BENZ (BBDC)

C-CLASS (W204)
E-CLASS (W211)
E-CLASS (W212)
GLK-CLASS (X204)

MERCEDES-BENZ (FJDA)

VIANO
VITO (V639)

EUV-SR 7.02256.43.0 New



CHEVROLET

AVEO Hatchback (T300)
AVEO Saloon (T300)
CRUZE (J300)
CRUZE Hatchback (J305)
CRUZE Station Wagon (J308)
ORLANDO (J309)
TRAX

OPEL

ASTRA H (A04)
ASTRA H Estate (A04)
ASTRA H GTC (A04)
ASTRA H Saloon (A04)
ASTRA H TwinTop (A04)
ASTRA J (P10)
ASTRA J GTC
ASTRA J Saloon
ASTRA J Sports Tourer (P10)
CORSA D (S07)
INSIGNIA A (G09)
INSIGNIA A Saloon (G09)
INSIGNIA A Sports Tourer (G09)
MERIVA B MPV (S10)
MOKKA / MOKKA X (J13)
SIGNUM Hatchback (Z03)
VECTRA C (Z02)
VECTRA C Estate (Z02)
VECTRA C GTS (Z02)
ZAFIRA / ZAFIRA FAMILY B (A05)
ZAFIRA TOURER C (P12)

VAUXHALL

ASTRA Mk V (H) (A04)
ASTRA Mk V (H) Estate (A04)
ASTRA Mk V (H) Sport Hatch (A04)
ASTRA Mk V (H) TwinTop (A04)
ASTRA Mk VI (J) (P10)
ASTRA Mk VI (J) Estate (P10)
ASTRA Mk VI (J) GTC (P10)
ASTRA Mk VI (J) Saloon (P10)
CORSA Mk III (D) (S07)
INSIGNIA Mk I (A) Hatchback (G09)
INSIGNIA Mk I (A) Saloon (G09)
INSIGNIA Mk I (A) Sports Tourer (G09)
MERIVA Mk II (B) (S10)
MOKKA / MOKKA X (J13)
SIGNUM (Z03)
VECTRA Mk II (C) (Z02)
VECTRA Mk II (C) Estate (Z02)
VECTRA Mk II (C) GTS (Z02)
ZAFIRA Mk II (B) (A05)
ZAFIRA Mk III (P12)

EUV-SR 7.02256.45.0 New



CHEVROLET

AVEO Hatchback (T300)
AVEO Saloon (T300)
CRUZE (J300)
CRUZE Hatchback (J305)
CRUZE Station Wagon (J308)
ORLANDO (J309)
TRAX

EUV-SR 7.02256.51.0



FORD

FIESTA V (JH_, JD_)
GALAXY II (WA6)
MONDEO III (B5Y)
MONDEO III Saloon (B4Y)
MONDEO III Turnier (BWY)
MONDEO IV (BA7)
MONDEO IV Saloon (BA7)
MONDEO IV Turnier (BA7)
S-MAX (WA6)

MAZDA

3 (BK)
3 (BL)
3 Saloon (BK)
3 Saloon (BL)
5 (CW)
6 Estate (GH)
6 Hatchback (GG)
6 Hatchback (GH)
6 Saloon (GG)
6 Saloon (GH)
6 Station Wagon (GY)
MPV II (LW)
MX-5 III (NC)
TRIBUTE (EP)

ELECTRIC VALVES







ELECTRIC VALVES



EUV-SR 7.21071.50.0



→SI 0087
→SI 0096
→SI 0100

MERCEDES-BENZ

- /8 (W114)
- /8 (W115)
- /8 Coupe (W114)
- 2T-SERIES
- CABRIOLET (W111, W112)
- COUPE (W111, W112)
- PAGODE (W113)
- S-CLASS (W116)
- S-CLASS Saloon (W108, W109)
- T1 Bus (B601)
- T1 Platform/Chassis (601)
- T1 Van (601, 611)

EUV-SR 7.22138.50.0



→SI 0087
→SI 0096
→SI 0100

SAAB

- 9-3 (YS3D)
- 9-3 (YS3F, E79, D79, D75)

EUV-SR 7.22280.02.0



→SI 0087
→SI 0100

PORSCHE

- 911 (993)
- 911 (997)
- 911 Convertible (993)
- CAYENNE (92A)
- CAYENNE (9PA)
- PANAMERA (970)

EUV-SR 7.22355.01.0



→SI 0087
→SI 0096
→SI 0100

DODGE

- SPRINTER 2500 Cab & Chassis
- SPRINTER 2500 Standard Cargo Van
- SPRINTER 2500 Standard Passenger Van
- SPRINTER 3500 Cab & Chassis
- SPRINTER 3500 Standard Cargo Van
- SPRINTER 3500 Standard Passenger Van

FREIGHTLINER

- SPRINTER 2500 Standard Cargo Van
- SPRINTER 2500 Standard Passenger Van
- SPRINTER 3500 Standard Cargo Van
- SPRINTER 3500 Standard Passenger Van

MERCEDES-BENZ

- C-CLASS (W202)
- C-CLASS (W203)
- C-CLASS (W204)
- C-CLASS Coupe (C204)
- C-CLASS Coupe (CL203)
- C-CLASS T-Model (S202)
- C-CLASS T-Model (S203)
- C-CLASS T-Model (S204)
- CLC-CLASS (CL203)
- CLK (C208)

EUV-SR 7.22355.01.0

- CLK (C209)
- CLK Convertible (A208)
- CLK Convertible (A209)
- CLS (C219)
- E-CLASS (W210)
- E-CLASS (W211)
- E-CLASS (W212)
- E-CLASS Convertible (A207)
- E-CLASS Coupe (C207)
- E-CLASS Platform/Chassis (VF210)
- E-CLASS T-Model (S210)
- E-CLASS T-Model (S211)
- E-CLASS T-Model (S212)
- G-CLASS (W463)
- G-CLASS Cabrio (W463)
- GL-CLASS (X164)
- GLK-CLASS (X204)
- M-CLASS (W163)
- M-CLASS (W164)
- R-CLASS (W251, V251)
- S-CLASS (W220)
- S-CLASS (W221)
- S-CLASS Coupe (C215)
- S-CLASS Coupe (C216)

- SL (R129)
- SL (R230)
- SLK (R170)
- SLK (R171)
- SPRINTER 3,5-t Bus (B906)
- SPRINTER 3,5-t Platform/Chassis (B906)
- SPRINTER 3,5-t Van (B906)
- SPRINTER 3-t Bus (B906)
- SPRINTER 3-t Platform/Chassis (B906)
- SPRINTER 3-t Van (B906)
- SPRINTER 4,6-t Platform/Chassis (B906)
- SPRINTER 4,6-t Van (B906)
- SPRINTER 5-t Platform/Chassis (B906)
- SPRINTER 5-t Van (B906)
- VIANO (W639)
- VITO / MIXTO Van (W639)
- VITO Bus (W639)

MERCEDES-BENZ (BBDC)

- C-CLASS (W204)
- E-CLASS (W211)

MERCEDES-BENZ (FJDA)

- VIANO
- VITO (V639)

PUCH

- G-MODELL (W463)
- G-MODELL Cabrio (W463)





ELECTRIC VALVES



EUV-SR	7.22880.01.0
<p>OCTAVIA II (1Z3) OCTAVIA II Combi (1Z5) SUPERB I (3U4) SUPERB II (3T4) SUPERB II Estate (3T5) YETI (5L) SKODA SVW OCTAVIA Hatchback (913) SUPERB (374) YETI (0Y6, 0Y7) VOLKSWAGEN AMAROK (2HA, 2HB, S1B, S6B, S7A, S7B) BEETLE (5C1, 5C2) BEETLE Convertible (5C7, 5C8) BORA I (1J2) BORA Variant (1J6) CADDY III Box Body/MPV (2KA, 2KH, 2CA, 2CH) CADDY III MPV (2KB, 2KJ, 2CB, 2CJ) CC B7 (358) EOS (1F7, 1F8) GOLF IV (1J1) GOLF IV Variant (1J5) GOLF PLUS V (5M1, 521) GOLF V (1K1) GOLF V Variant (1K5) GOLF VI (5K1) GOLF VI Convertible (517) GOLF VI Van (5K1_) GOLF VI Variant (AJ5) JETTA III (1K2) JETTA IV (162, 163, AV3, AV2) NEW BEETLE (9C1, 1C1) NEW BEETLE Convertible (1Y7) PASSAT ALLTRACK B7 (365) PASSAT B5.5 (3B3) PASSAT B5.5 Variant (3B6) PASSAT B6 (3C2) PASSAT B6 Variant (3C5) PASSAT B7 (362) PASSAT B7 Estate Van (365) PASSAT B7 Variant (365) PASSAT CC B6 (357) POLO (9N_) POLO III CLASSIC (6V2) POLO IV Saloon (9N4) POLO Variant (6V5) SCIROCCO III (137, 138) SCIROCCO Van (137) SHARAN (7N1, 7N2) SHARAN VAN (7N1, 7N2) TIGUAN (5N_) TIGUAN VAN (5N_) TOUAREG (7P5, 7P6) TOURAN (1T1, 1T2) TOURAN VAN (1T1, 1T2) VW FAW CC Saloon (990, 991) MAGOTAN (B7L, 942) SAGITAR (BK2) VW SVW PASSAT B7 (A42, A43) TIGUAN (591, 592)</p>	

EUV-SR	7.28098.04.0
 <p>→SI 0087 →SI 0096</p> <p>AUDI A2 (8Z0) A3 (8L1) SEAT LEON (1M1) TOLEDO II (1M2) VOLKSWAGEN BORA I (1J2) BORA Variant (1J6) GOLF IV (1J1) GOLF IV Variant (1J5) LUPO I (6X1, 6E1) TRANSPORTER IV Bus (70B, 70C, 7DB, 7DK, 70J, 70K, 7DC, 7DJ) TRANSPORTER IV Platform/Chassis (70E, 70L, 70M, 7DE, 7DL, 7D) TRANSPORTER IV Van (70A, 70H, 7DA, 7DH)</p>	

EUV-SR	7.28098.15.0
 <p>→SI 0096</p> <p>AUDI A4 B8 (8K2) A4 B8 Avant (8K5) A5 (8T3) A5 Convertible (8F7) A5 Sportback (8TA) A6 Allroad C6 (4FH) A6 Allroad C7 (4GH, 4GJ) A6 C6 (4F2) A6 C6 Avant (4F5) A6 C7 (4G2, 4GC) A6 C7 Avant (4G5, 4GD) A7 Sportback (4GA, 4GF) A8 D4 (4H2, 4H8, 4HC, 4HL) Q5 (8RB) Q7 (4LB)</p>	

EUV-SR	7.28098.15.0
<p>Q7 Van (4LB) VOLKSWAGEN TOUAREG (7P5, 7P6)</p>	

EUV-VB	5.02549.03.0*
<p>→7.01441.04.0 EUV-VB</p> <p>BUICK REGAL Saloon VERANO Saloon CHEVROLET COBALT COBALT Coupe HHR OPEL GT Convertible (M07) INSIGNIA A (G09) INSIGNIA A Saloon (G09) INSIGNIA A Sports Tourer (G09) PONTIAC SOLSTICE Convertible SOLSTICE Coupe VAUXHALL INSIGNIA Mk I (A) Hatchback (G09) INSIGNIA Mk I (A) Saloon (G09) INSIGNIA Mk I (A) Sports Tourer (G09)</p>	

EUV-VB	7.00326.03.0
 <p>→SI 0096</p> <p>CADILLAC BLS BLS Wagon OPEL SIGNUM Hatchback (Z03) VECTRA C (Z02) VECTRA C Estate (Z02) VECTRA C GTS (Z02) SAAB 9-3 (YS3F, E79, D79, D75) 9-3 Convertible (YS3F) 9-3 Estate (E50) 9-3X (YS3) VAUXHALL SIGNUM (Z03) VECTRA Mk II (C) (Z02) VECTRA Mk II (C) Estate (Z02) VECTRA Mk II (C) GTS (Z02)</p>	

EUV-VB 7.01039.03.0

→SI 0096

BUICK SGM

REGAL II (EG1)

CHEVROLET (SGM)

MALIBU (EG3)

OPEL

ASTRA H (A04)

ASTRA H Estate (A04)

ASTRA H GTC (A04)

ASTRA H TwinTop (A04)

ASTRA J (P10)

ASTRA J GTC

ASTRA J Saloon

ASTRA J Sports Tourer (P10)

CORSA D (S07)

CORSA D Hatchback Van (S07)

CORSA E (X15)

INSIGNIA A (G09)

INSIGNIA A Saloon (G09)

INSIGNIA A Sports Tourer (G09)

MERIVA A MPV (X03)

ZAFIRA TOURER C (P12)

SAAB

9-5 (YS3G)

VAUXHALL

ASTRA Mk V (H) Estate (A04)

ASTRA Mk V (H) Sport Hatch (A04)

ASTRA Mk VI (J) (P10)

ASTRA Mk VI (J) Estate (P10)

ASTRA Mk VI (J) GTC (P10)

ASTRA Mk VI (J) Saloon (P10)

CORSA Mk III (D) (S07)

CORSA Mk IV (E) (X15)

INSIGNIA Mk I (A) Hatchback (G09)

INSIGNIA Mk I (A) Saloon (G09)

INSIGNIA Mk I (A) Sports Tourer (G09)

MERIVA A (X03)

ZAFIRA Mk III (P12)

EUV-VB 7.01441.04.0 New

BUICK

REGAL Saloon

VERANO Saloon

CHEVROLET

COBALT

COBALT Coupe

HHR

OPEL

ASTRA J GTC

GT Convertible (M07)

INSIGNIA A (G09)

INSIGNIA A Saloon (G09)

INSIGNIA A Sports Tourer (G09)

PONTIAC

SOLSTICE Convertible

SOLSTICE Coupe

VAUXHALL

ASTRA Mk VI (J) GTC (P10)

INSIGNIA Mk I (A) Hatchback (G09)

INSIGNIA Mk I (A) Saloon (G09)

INSIGNIA Mk I (A) Sports Tourer (G09)

EUV-VB 7.02087.05.0

FORD

FOCUS III

FOCUS III Turnier

GALAXY III (CK)

KUGA II (DM2)

MONDEO V Hatchback (CE)

MONDEO V Saloon (CD)

MONDEO V Turnier (CF)

S-MAX (CJ, WA6)

FORD (CHANGAN)

EDGE

KUGA

MONDEO

MONDEO / ZHISHENG

TAURUS

EUV-VB 7.02087.05.0
FORD JMC

EVEREST

EUV-VB 7.02256.37.0

→SI 0096

DODGE

CALIBER

JEEP

COMPASS (MK49)

MERCEDES-BENZ

C-CLASS (W204)

C-CLASS (W205)

C-CLASS Convertible (A205)

C-CLASS Coupe (C204)

C-CLASS Coupe (C205)

C-CLASS T-Model (S204)

C-CLASS T-Model (S205)

CLS (C218)

CLS Shooting Brake (X218)

E-CLASS (W212)

E-CLASS Convertible (A207)

E-CLASS Coupe (C207)

E-CLASS T-Model (S212)

GLC (X253)

GLC Coupe (C253)

GLE (W166)

GLK-CLASS (X204)

M-CLASS (W166)

S-CLASS (W221)

S-CLASS (W222, V222, X222)

SLC (R172)

SLK (R172)

SPRINTER 3,5-t Bus (B906)

SPRINTER 3,5-t Platform/Chassis (B906)

SPRINTER 3,5-t Platform/Chassis (B907, B910)

SPRINTER 3,5-t Tourer Bus (B907)

SPRINTER 3,5-t Van (B906)

SPRINTER 3,5-t Van (B907, B910)

SPRINTER 3-t Bus (B903)

SPRINTER 3-t Platform/Chassis (B906)

SPRINTER 3-t Platform/Chassis (B910, B907)

SPRINTER 3-t Van (B906)

SPRINTER 4-t Platform/Chassis (B907, B910)

SPRINTER 4-t Van (B907, B910)

SPRINTER 5-t Bus (B906)

SPRINTER 5-t Platform/Chassis (B906)

SPRINTER 5-t Platform/Chassis (B907)

SPRINTER 5-t Van (B906)

SPRINTER 5-t Van (B907)





ELECTRIC VALVES



EUV-VB 7.02256.37.0
MERCEDES-BENZ (BBDC)
 C-CLASS (W204)
 E-CLASS (W211)
 E-CLASS (W212)
 GLK-CLASS (X204)
MERCEDES-BENZ (FJDA)
 VIANO
 VITO (V639)

EUV-VB 7.02721.06.0*
 →7.01441.04.0 **EUV-VB**
BUICK
 REGAL Saloon
 VERANO Saloon
CHEVROLET
 COBALT
 COBALT Coupe
 HHR
OPEL
 ASTRA J GTC
 INSIGNIA A (G09)
 INSIGNIA A Saloon (G09)
 INSIGNIA A Sports Tourer (G09)
VAUXHALL
 ASTRA Mk VI (J) GTC (P10)
 INSIGNIA Mk I (A) Hatchback (G09)
 INSIGNIA Mk I (A) Saloon (G09)
 INSIGNIA Mk I (A) Sports Tourer (G09)



EUV-VB 7.03833.02.0
BUICK SGM
 ENCORE (SJ2)
CHEVROLET
 AVEO Hatchback (T300)
 CRUZE (J300)
 CRUZE Hatchback (J305)
 CRUZE Station Wagon (J308)
 ORLANDO (J309)
 TRAX
GM HOLDEN LTD
 CRUZE Hatchback (JH)
 CRUZE Saloon (JH)
 TRAX (TJ)
OPEL
 ADAM (M13)
 ASTRA J (P10)
 ASTRA J GTC
 ASTRA J Saloon
 ASTRA J Sports Tourer (P10)
 CASCADA (W13)

EUV-VB 7.03833.02.0
 CORSA D (S07)
 CORSA D Hatchback Van (S07)
 CORSA E (X15)
 INSIGNIA A (G09)
 INSIGNIA A Saloon (G09)
 INSIGNIA A Sports Tourer (G09)
 MERIVA B MPV (S10)
 MOKKA / MOKKA X (J13)
 ZAFIRA / ZAFIRA FAMILY B (A05)
 ZAFIRA B Box Body/MPV (A05)
 ZAFIRA TOURER C (P12)
VAUXHALL
 ADAM (M13)
 ASTRA Mk VI (J) (P10)
 ASTRA Mk VI (J) Estate (P10)
 ASTRA Mk VI (J) GTC (P10)
 ASTRA Mk VI (J) Saloon (P10)
 CASCADA Convertible (W13)
 CORSA Mk III (D) (S07)
 CORSA Mk IV (E) (X15)
 INSIGNIA Mk I (A) Hatchback (G09)
 INSIGNIA Mk I (A) Saloon (G09)
 INSIGNIA Mk I (A) Sports Tourer (G09)
 MERIVA Mk II (B) (S10)
 MOKKA / MOKKA X (J13)
 ZAFIRA Mk III (P12)

EUV-VB 7.07400.19.0*
 →7.22687.44.0 **EUV-AGK,**
EUV-SR, EUV-VB
FORD
 C-MAX II (DXA/CB7, DXA/CEU)
 C-MAX II Van
 FOCUS III
 FOCUS III Hatchback Van
 FOCUS III Saloon
 FOCUS III Turnier
 GALAXY II (WA6)
 GALAXY MK II VAN (WA6)
 GRAND C-MAX (DXA/CB7, DXA/CEU)
 GRAND C-MAX Van
 MONDEO IV (BA7)
 MONDEO IV Saloon (BA7)
 MONDEO IV Turnier (BA7)
 MONDEO IV Van
 S-MAX (WA6)
 S-MAX VAN (WA6)
VOLVO
 S60 II (134)
 S80 II (124)
 V40 Hatchback (525, 526)
 V60 I (155, 157)
 V70 III (135)

EUV-VB 7.22572.01.0

LAND ROVER
 DEFENDER Cabrio (L316)
 DEFENDER Pick Up (L316)
 DEFENDER Station Wagon (L316)
 DISCOVERY II (L318)

EUV-VB 7.22687.44.0

FORD
 B-MAX (JK)
 B-MAX Van (JK)
 C-MAX II (DXA/CB7, DXA/CEU)
 C-MAX II Van
 FOCUS III
 FOCUS III Estate Van
 FOCUS III Hatchback Van
 FOCUS III Saloon
 FOCUS III Turnier
 GALAXY II (WA6)
 GALAXY MK II VAN (WA6)
 GRAND C-MAX (DXA/CB7, DXA/CEU)
 GRAND C-MAX Van
 MONDEO IV (BA7)
 MONDEO IV Saloon (BA7)
 MONDEO IV Turnier (BA7)
 MONDEO IV Van
 MONDEO V Hatchback (CE)
 MONDEO V Saloon (CD)
 MONDEO V Turnier (CF)
 S-MAX (WA6)
 S-MAX VAN (WA6)
VOLVO
 S60 II (134)
 S80 II (124)
 V40 Hatchback (525, 526)
 V60 I (155, 157)
 V70 III (135)



EUV-VB 7.22687.49.0	EUV-WP 7.02256.37.0	EUV-WP 7.02256.37.0
 <p>AUDI A6 C5 (4B2) A6 C5 Avant (4B5)</p>	<p>E-CLASS Convertible (A238) E-CLASS Coupe (C207) E-CLASS Coupe (C238) E-CLASS T-Model (S212) E-CLASS T-Model (S213) G-CLASS (W463) GLA-CLASS (X156) GLC (X253) GLC Coupe (C253) GLE (V167) GLE (W166) GLE Coupe (C167) GLK-CLASS (X204) GLS (X167) M-CLASS (W166) MARCO POLO Camper (W447) S-CLASS (W221) S-CLASS (W222, V222, X222) S-CLASS (W223) SLC (R172) SLK (R172) SPRINTER 3,5-t Bus (B906) SPRINTER 3,5-t Platform/Chassis (B906) SPRINTER 3,5-t Platform/Chassis (B907, B910) SPRINTER 3,5-t Tourer Bus (B907) SPRINTER 3,5-t Van (B906) SPRINTER 3,5-t Van (B907, B910) SPRINTER 3-t Bus (B903) SPRINTER 3-t Bus (B906) SPRINTER 3-t Platform/Chassis (B906) SPRINTER 3-t Platform/Chassis (B910, B907) SPRINTER 3-t Van (B906) SPRINTER 3-t Van (B910) SPRINTER 4,6-t Bus (B906) SPRINTER 4,6-t Platform/Chassis (B906) SPRINTER 4,6-t Van (B906) SPRINTER 4-t Platform/Chassis (B907, B910) SPRINTER 4-t Tourer Bus (B907) SPRINTER 4-t Van (B907, B910) SPRINTER 5-t Bus (B906) SPRINTER 5-t Platform/Chassis (B906) SPRINTER 5-t Platform/Chassis (B907) SPRINTER 5-t Tourer Bus (B907) SPRINTER 5-t Van (B906) SPRINTER 5-t Van (B907) V-CLASS (W447) VIANO (W639) VITO / MIXTO Van (W639) VITO Bus (W639) VITO Mixto (Double Cabin) (W447) VITO Tourer (W447) VITO Van (W447)</p>	<p>VIANO VITO (V639)</p>
<p>EUV-WP 7.02256.37.0</p>  <p>→SI 0096</p> <p>DODGE CALIBER</p> <p>FREIGHTLINER SPRINTER 2500 Extended Cargo Van SPRINTER 2500 Standard Cargo Van SPRINTER 2500 Standard Passenger Van SPRINTER 3500 Cab & Chassis SPRINTER 3500 Extended Cargo Van SPRINTER 3500 Standard Cargo Van SPRINTER 3500 Standard Passenger Van</p> <p>JEEP COMPASS (MK49)</p> <p>MERCEDES-BENZ A-CLASS (W176) B-CLASS Sports Tourer (W246, W242) C-CLASS (W204) C-CLASS (W205) C-CLASS Convertible (A205) C-CLASS Coupe (C204) C-CLASS Coupe (C205) C-CLASS T-Model (S204) C-CLASS T-Model (S205) CLA Coupe (C117) CLA Shooting Brake (X117) CLS (C218) CLS (C257) CLS Shooting Brake (X218) E-CLASS (W210) E-CLASS (W212) E-CLASS (W213) E-CLASS All-Terrain (S213) E-CLASS Convertible (A207)</p>	<p>→SI 0096</p> <p>MERCEDES-BENZ (BBDC) C-CLASS (W204) E-CLASS (W212) GLC (X253) GLK-CLASS (X204)</p> <p>MERCEDES-BENZ (FJDA) SPRINTER (B906)</p>	<p>LDRV 7.00017.03.0</p>  <p>MERCEDES-BENZ A-CLASS (W169) B-CLASS Sports Tourer (W245) C-CLASS (W204) C-CLASS Coupe (C204) C-CLASS T-Model (S204) E-CLASS (W212) E-CLASS Convertible (A207) E-CLASS Coupe (C207) E-CLASS T-Model (S212) SLK (R172)</p> <p>MERCEDES-BENZ (BBDC) C-CLASS (W204) E-CLASS (W212)</p>
<p>EUV-WP 7.02256.37.0</p>  <p>→SI 0096</p> <p>DODGE CALIBER</p> <p>FREIGHTLINER SPRINTER 2500 Extended Cargo Van SPRINTER 2500 Standard Cargo Van SPRINTER 2500 Standard Passenger Van SPRINTER 3500 Cab & Chassis SPRINTER 3500 Extended Cargo Van SPRINTER 3500 Standard Cargo Van SPRINTER 3500 Standard Passenger Van</p> <p>JEEP COMPASS (MK49)</p> <p>MERCEDES-BENZ A-CLASS (W176) B-CLASS Sports Tourer (W246, W242) C-CLASS (W204) C-CLASS (W205) C-CLASS Convertible (A205) C-CLASS Coupe (C204) C-CLASS Coupe (C205) C-CLASS T-Model (S204) C-CLASS T-Model (S205) CLA Coupe (C117) CLA Shooting Brake (X117) CLS (C218) CLS (C257) CLS Shooting Brake (X218) E-CLASS (W210) E-CLASS (W212) E-CLASS (W213) E-CLASS All-Terrain (S213) E-CLASS Convertible (A207)</p>	<p>→SI 0096</p> <p>MERCEDES-BENZ (BBDC) C-CLASS (W204) E-CLASS (W212) GLC (X253) GLK-CLASS (X204)</p> <p>MERCEDES-BENZ (FJDA) SPRINTER (B906)</p>	<p>LDRV 7.00036.03.0</p>  <p>→SI 0096</p> <p>FORD FOCUS I (DAW, DBW)</p>
<p>EUV-WP 7.02256.37.0</p>  <p>→SI 0096</p> <p>DODGE CALIBER</p> <p>FREIGHTLINER SPRINTER 2500 Extended Cargo Van SPRINTER 2500 Standard Cargo Van SPRINTER 2500 Standard Passenger Van SPRINTER 3500 Cab & Chassis SPRINTER 3500 Extended Cargo Van SPRINTER 3500 Standard Cargo Van SPRINTER 3500 Standard Passenger Van</p> <p>JEEP COMPASS (MK49)</p> <p>MERCEDES-BENZ A-CLASS (W176) B-CLASS Sports Tourer (W246, W242) C-CLASS (W204) C-CLASS (W205) C-CLASS Convertible (A205) C-CLASS Coupe (C204) C-CLASS Coupe (C205) C-CLASS T-Model (S204) C-CLASS T-Model (S205) CLA Coupe (C117) CLA Shooting Brake (X117) CLS (C218) CLS (C257) CLS Shooting Brake (X218) E-CLASS (W210) E-CLASS (W212) E-CLASS (W213) E-CLASS All-Terrain (S213) E-CLASS Convertible (A207)</p>	<p>→SI 0096</p> <p>MERCEDES-BENZ (BBDC) C-CLASS (W204) E-CLASS (W212) GLC (X253) GLK-CLASS (X204)</p> <p>MERCEDES-BENZ (FJDA) SPRINTER (B906)</p>	<p>LDRV 7.00045.00.0* →7.28311.04.0 LDRV</p> <p>OPEL SIGNUM Hatchback (Z03) VECTRA C (Z02) VECTRA C Estate (Z02) VECTRA C GTS (Z02)</p> <p>VAUXHALL SIGNUM (Z03) VECTRA Mk II (C) (Z02) VECTRA Mk II (C) Estate (Z02) VECTRA Mk II (C) GTS (Z02)</p>

ELECTRIC VALVES



LDRV 7.00380.04.0



→PI 1769
→SI 0087
→SI 0089
→SI 0096

MAN
LION'S CITY
TGL
ENGINE

LDRV 7.00380.11.0



→PI 1769

MAN
TGL
TGM
TGX
ENGINE
NEOPLAN Bus GmbH
Centroliner
Cityliner
Skyliner
Starliner
Tourliner

LDRV 7.00470.07.0



AUDI

- A1 (8X1, 8XK)
- A3 (8P1)
- A3 Convertible (8P7)
- A3 Sportback (8PA)
- A3 Sportback (8VA, 8VF)
- A4 Allroad B8 (8KH)
- A4 B7 (8EC)
- A4 B7 Avant (8ED)
- A4 B7 Convertible (8HE)
- A4 B8 (8K2)
- A4 B8 Avant (8K5)
- A5 (8T3)
- A5 Convertible (8F7)
- A5 Sportback (8TA)
- A6 C6 (4F2)
- A6 C6 Avant (4F5)
- A6 C7 (4G2, 4GC)
- A6 C7 Avant (4G5, 4GD)
- A8 D4 (4H2, 4H8, 4HC, 4HL)
- Q3 (8UB, 8UG)
- Q5 (8RB)
- TT (8J3)
- TT Roadster (8J9)

SEAT

- ALHAMBRA (710, 711)
- ALTEA (5P1)
- ALTEA XL (5P5, 5P8)
- EXEO (3R2)
- EXEO ST (3R5)
- LEON (1P1)
- TOLEDO III (5P2)

SKODA

- OCTAVIA II (1Z3)
- OCTAVIA II Combi (1Z5)
- RAPID (NH3)
- RAPID Spaceback (NH1)
- SUPERB II (3T4)
- SUPERB II Estate (3T5)
- YETI (5L)

VOLKSWAGEN

- AMAROK (2HA, 2HB, S1B, S6B, S7A, S7B)
- AMAROK Platform/Chassis (S1B, S6B, S7B)
- BEETLE (5C1, 5C2)
- BEETLE Convertible (5C7, 5C8)
- CC B7 (358)
- CRAFTER 30-35 Bus (2E_)
- CRAFTER 30-50 Platform/Chassis (2F_)
- CRAFTER 30-50 Van (2E_)
- EOS (1F7, 1F8)

LDRV 7.00470.07.0

- GOLF PLUS V (5M1, 521)
- GOLF V (1K1)
- GOLF V Variant (1K5)
- GOLF VI (5K1)
- GOLF VI Convertible (517)
- GOLF VI Van (5K1_)
- GOLF VI Variant (AJ5)
- JETTA III (1K2)
- JETTA IV (162, 163, AV3, AV2)
- PASSAT ALLTRACK B7 (365)
- PASSAT B6 (3C2)
- PASSAT B6 Variant (3C5)
- PASSAT B7 (362)
- PASSAT B7 Variant (365)
- PASSAT CC B6 (357)
- POLO V (6R1, 6C1)
- SCIROCCO III (137, 138)
- SCIROCCO Van (137)
- SHARAN (7N1, 7N2)
- TIGUAN (5N_)
- TOURAN (1T1, 1T2)

LDRV 7.01003.01.0



→SI 0096

MERCEDES-BENZ

- S-CLASS (W220)
- S-CLASS (W221)
- S-CLASS Coupe (C215)
- S-CLASS Coupe (C216)
- SL (R230)

LDRV 7.01024.02.0



→SI 0087
→SI 0089
→SI 0096

OPEL

- ASTRA G Convertible (T98)
- ASTRA G Coupe (T98)



LDRV 7.01024.02.0

ASTRA G Estate (T98)
 ASTRA G Hatchback (T98)
 ASTRA H (A04)
 ASTRA H Estate (A04)
 ASTRA H GTC (A04)
 ASTRA H TwinTop (A04)
 SPEEDSTER (E01)
 ZAFIRA / ZAFIRA FAMILY B (A05)
 ZAFIRA A MPV (T98)
 ZAFIRA B Box Body/MPV (A05)
VAUXHALL
 ASTRA Mk IV (G) Convertible (T98)
 ASTRA Mk IV (G) Coupe (T98)
 ASTRA Mk IV (G) Hatchback (T98)
 ASTRA Mk V (H) (A04)
 ASTRA Mk V (H) Estate (A04)
 ASTRA Mk V (H) Sport Hatch (A04)
 ASTRA Mk V (H) TwinTop (A04)
 VX220 Convertible (E01)
 ZAFIRA A (T98)
 ZAFIRA Mk II
 ZAFIRA Mk II (B) (A05)

LDRV 7.01039.03.0



→SI 0096

OPEL
 ASTRA H (A04)
 ASTRA H Estate (A04)
 ASTRA H GTC (A04)
 ASTRA H TwinTop (A04)
 ZAFIRA / ZAFIRA FAMILY B (A05)
 ZAFIRA B Box Body/MPV (A05)
VAUXHALL
 ASTRA Mk V (H) (A04)
 ASTRA Mk V (H) Estate (A04)
 ASTRA Mk V (H) Sport Hatch (A04)
 ASTRA Mk V (H) TwinTop (A04)
 ZAFIRA Mk II (B) (A05)

LDRV 7.01343.04.0

DUSTER SUV Van
 LODGY (JS_)
 LOGAN II
 LOGAN MCV II
 SANDERO II
MERCEDES-BENZ
 CITAN Box Body/MPV (W415)
 CITAN MPV (415)
NISSAN
 JUKE (F15)
 MICRA V (K14)
 PULSAR Hatchback (C13)
 QASHQAI II SUV (J11, J11_)
RENAULT
 CAPTUR I (J5_, H5_)
 CLIO IV (BH_)
 CLIO IV Grandtour (KH_)
 CLIO IV Hatchback Van (BH_)
 FLUENCE (L3_)
 GRAND SCÉNIC III (JZ0/1_)
 GRAND SCÉNIC IV (R9_)
 KADJAR (HA_, HL_)
 KANGOO / GRAND KANGOO (KW0/1_)
 KANGOO Express (FW0/1_)
 MEGANE CC (EZ0/1_)
 MEGANE III Coupe (DZ0/1_)
 MEGANE III Grandtour (KZ0/1)
 MEGANE III Hatchback (BZ0/1_, B3_)
 MEGANE IV GRAND COUPE
 MEGANE IV Grandtour (K9A/M/N_)
 MEGANE IV Hatchback (B9A/M/N_)
 SCÉNIC III (JZ0/1_)
 SCÉNIC IV (J9_)

LDRV 7.01037.02.0



→SI 0096

AUDI
 A3 (8L1)
FORD
 GALAXY I (WGR)
SEAT
 ALHAMBRA (7V8, 7V9)
 LEON (1M1)
 TOLEDO II (1M2)
SKODA
 OCTAVIA I (1U2)
 OCTAVIA I Combi (1U5)
VOLKSWAGEN
 BORA I (1J2)
 BORA Variant (1J6)
 GOLF IV (1J1)
 GOLF IV Van (1J1)
 GOLF IV Variant (1J5)
 GOLF VAN IV Variant (1J5)
 NEW BEETLE (9C1, 1C1)
 NEW BEETLE Convertible (1Y7)
 SHARAN (7M8, 7M9, 7M6)

LDRV 7.01282.02.0 New



VOLVO
 ENGINE

LDRV 7.01738.01.0



NISSAN
 GT-R (R35)

LDRV 7.01343.04.0



DACIA
 DOKKER Express Box Body/MPV
 DOKKER MPV (KE_)
 DUSTER (HM_)
 DUSTER (HS_)





LDRV 7.01904.03.0



MAN
ENGINE

→PI 1769

LDRV 7.02221.01.0



VOLVO

- S60 II (134)
- S80 II (124)
- V60 I (155, 157)
- V60 I Estate Van (155)
- V70 III (135)
- V70 III Estate Van (135)
- XC60 I SUV (156)
- XC60 I VAN (156)
- XC70 II (136)
- XC70 II VAN (136)

→SI 0096

LDRV 7.02256.19.0



NISSAN

- INTERSTAR Bus (X70)
- INTERSTAR Platform/Chassis
- INTERSTAR Van (X70)
- PRIMASTAR Bus (X83)

→SI 0096

LDRV 7.02256.19.0

- PRIMASTAR Platform/Chassis (X83)
- PRIMASTAR Van (X83)
- RENAULT**
- ESPACE IV (JK0/1_)
- GRAND SCÉNIC II (JM0/1_)
- MASTER II Bus (JD)
- MASTER II Platform/Chassis (ED/HD/UD)
- MASTER II Van (FD)
- SCÉNIC II (JM0/1_)
- TRAFIC II Bus (JL)
- TRAFIC II Platform/Chassis (EL)
- TRAFIC II Van (FL)

LDRV 7.02256.49.0 New



ABARTH

- 500 / 595 / 695
- GRANDE PUNTO
- ALFA ROMEO**
- 147 (937_)
- GIULIETTA (940_)
- MITO (955_)

FIAT

- BRAVO II (198_)
- DOBLO Box Body/MPV (223_)
- DOBLO Bus (263_)
- DOBLO Cargo (263_)
- DOBLO MPV (119_, 223_)
- DOBLO Platform/Chassis (263_)
- GRANDE PUNTO (199_)
- IDEA (350_)
- PALIO (178_)
- PALIO Weekend (178_, 173_, 373_, 374_, 171_)
- PUNTO (188_)
- PUNTO Hatchback Van (188_)
- SIENA (178_, 172_)
- STILO (192_)
- STRADA Pickup (178_)

LANCIA

- DELTA III (844_)
- MUSA (350_)
- THESIS (841_)

LDRV 7.02318.01.0

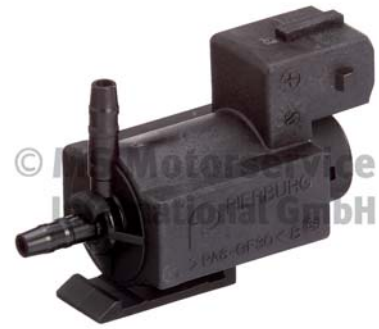

→SI 0096

→SI 0100

BMW

- 1 (E81)
- 1 (E87)
- 1 (F20)
- 1 (F21)
- 1 Convertible (E88)
- 1 Coupe (E82)
- 2 Coupe (F22, F87)
- 3 (E90)
- 3 (F30, F80)
- 3 Coupe (E92)
- 3 Gran Turismo (F34)
- 3 Touring (E91)
- 3 Touring (F31)
- 4 Convertible (F33, F83)
- 4 Coupe (F32, F82)
- 4 Gran Coupe (F36)
- 5 (E60)
- 5 (F10)
- 5 Gran Turismo (F07)
- 5 Touring (E61)
- 5 Touring (F11)
- 6 (E63)
- 6 Convertible (E64)
- 6 Convertible (F12)
- 6 Coupe (F13)
- 6 Gran Coupe (F06)
- 7 (F01, F02, F03, F04)
- X1 (E84)
- X3 (E83)
- X3 (F25)
- X4 (F26)
- X5 (E70)
- X5 (F15, F85)
- X6 (E71, E72)
- X6 (F16, F86)



LDRV	7.02588.04.0	LDRV	7.03162.09.0 New	LDRV	7.03294.02.0
 <p>→SI 0096</p>					
<p>AUDI A1 (8X1, 8XK) A1 Sportback (8XA, 8XF)</p> <p>SEAT ALHAMBRA (710, 711) IBIZA IV (6J5, 6P1) IBIZA IV SC (6J1, 6P5) IBIZA IV ST (6J8, 6P8)</p> <p>SKODA FABIA II (542) FABIA II Combi (545)</p> <p>VOLKSWAGEN BEETLE (5C1, 5C2) BEETLE Convertible (5C7, 5C8) CC B7 (358) EOS (1F7, 1F8) GOLF PLUS V (5M1, 521) GOLF PLUS Van (521) GOLF V (1K1) GOLF V Variant (1K5) GOLF VI (5K1) GOLF VI Convertible (517) GOLF VI Van (5K1_) GOLF VI Variant (AJ5) JETTA III (1K2) JETTA IV (162, 163, AV3, AV2) PASSAT B6 (3C2) PASSAT B6 Variant (3C5) PASSAT B7 (362) PASSAT B7 Variant (365) PASSAT CC B6 (357) POLO V (6R1, 6C1) POLO Van (6R) SCIROCCO III (137, 138) SCIROCCO Van (137) SHARAN (7N1, 7N2) TIGUAN (5N_) TOURAN (1T1, 1T2) TOURAN (1T3)</p>		<p>FORD C-MAX II (DXA/CB7, DXA/CEU) C-MAX II Van FOCUS III FOCUS III Hatchback Van FOCUS III Saloon FOCUS III Turnier GALAXY II (WA6) GRAND C-MAX (DXA/CB7, DXA/CEU) GRAND C-MAX Van MONDEO IV (BA7) MONDEO IV Saloon (BA7) MONDEO IV Turnier (BA7) S-MAX (WA6)</p> <p>VOLVO S60 II (134) S80 II (124) V60 I (155, 157) V70 III (135)</p>		<p>RIO II Saloon (JB) SPORTAGE III (SL)</p>	
				LDRV	7.03306.16.0 New
					
				<p>FORD FOCUS III FOCUS III Turnier KUGA II (DM2) MONDEO V Hatchback (CE) MONDEO V Saloon (CD) MONDEO V Turnier (CF)</p> <p>FORD USA TAURUS</p> <p>LINCOLN MKC MKT MKZ</p>	
				LDRV	7.03294.02.0
					
					
		<p>HYUNDAI ACCENT III (MC) ACCENT III Saloon (MC) ELANTRA IV Saloon (HD) H-1 Cargo (TQ) MATRIX (FC) i30 (FD) i30 Estate (FD) i40 I (VF) i40 I CW (VF) ix35 (LM, EL, ELH) ix35 Van</p> <p>KIA CEE'D Hatchback (ED) CEE'D SW (ED) PRO CEE'D (ED) RIO II (JB)</p>		<p>BUICK ENCORE SUV</p> <p>BUICK SGM ENVISION (CP4) VERANO Saloon (CP5)</p> <p>CADILLAC ATS ATS Coupe</p> <p>CHEVROLET CRUZE Hatchback CRUZE Saloon TRAX</p> <p>CHEVROLET (SGM) CRUZE Saloon (CP3)</p> <p>MG SAIC GT</p> <p>OPEL ADAM (M13)</p>	

ELECTRIC VALVES





ELECTRIC VALVES



LDRV 7.03351.12.0
 ASTRA J (P10)
 ASTRA K (B16)
 ASTRA K Estate Van
 ASTRA K Sports Tourer (B16)
 CASCADA (W13)
 CORSA E (X15)
 INSIGNIA A (G09)
 INSIGNIA A Country Tourer (G09)
 INSIGNIA A Saloon (G09)
 INSIGNIA A Sports Tourer (G09)
 INSIGNIA B Country Tourer (Z18)
 INSIGNIA B Grand Sport (Z18)
 INSIGNIA B Sports Tourer (Z18)
 MOKKA / MOKKA X (J13)
 ZAFIRA TOURER C (P12)
VAUXHALL
 ADAM (M13)
 ASTRA Mk VII (K) (B16)
 ASTRA Mk VII (K) Estate (B16)
 CASCADA Convertible (W13)
 CORSA Mk IV (E) (X15)
 INSIGNIA Mk II (B) Hatchback (Z18)
 INSIGNIA Mk II (B) Sports Tourer (Z18)
 MOKKA / MOKKA X (J13)

LDRV 7.03357.04.0



BUICK

ENVISION
 REGAL Regal TourX
 REGAL Saloon
 REGAL Sportback
BUICK SGM
 ENVISION (CP4)
 REGAL GS (EG7)
 REGAL III (EG7)

CADILLAC

ATS
 ATS Coupe
 CT6
 CTS
 CTS Coupe
 CTS Sport Wagon

CADILLAC (SGM)

ATS-L (SA1)
 CT6 (CK1)
 XTS (EG4)

CHEVROLET

CAMARO
 CAMARO Convertible
 EQUINOX

LDRV 7.03357.04.0
 MALIBU
 MALIBU (V300)
 TRAVERSE
CHEVROLET (SGM)
 EQUINOX (CP8)
GM HOLDEN LTD
 CALAIS Hatchback (ZB)
 COMMODORE Estate (ZB)
 COMMODORE Hatchback (ZB)
 EQUINOX (EQ)
GMC
 TERRAIN
OPEL
 INSIGNIA A (G09)
 INSIGNIA A Country Tourer (G09)
 INSIGNIA A Saloon (G09)
 INSIGNIA A Sports Tourer (G09)
 INSIGNIA B Country Tourer (Z18)
 INSIGNIA B Grand Sport (Z18)
 INSIGNIA B Sports Tourer (Z18)
VAUXHALL
 INSIGNIA Mk I (A) Hatchback (G09)
 INSIGNIA Mk I (A) Saloon (G09)
 INSIGNIA Mk I (A) Sports Tourer (G09)
 INSIGNIA Mk II (B) Hatchback (Z18)
 INSIGNIA Mk II (B) Sports Tourer (Z18)

LDRV 7.03833.02.0



OPEL

ASTRA H (A04)
 ASTRA H Estate (A04)
 ASTRA H GTC (A04)
 ASTRA H TwinTop (A04)
 ASTRA J (P10)
 ASTRA J GTC
 ASTRA J Saloon
 ASTRA J Sports Tourer (P10)
 CORSA D (S07)
 CORSA D Hatchback Van (S07)
 CORSA E (X15)
 INSIGNIA A (G09)
 INSIGNIA A Saloon (G09)
 INSIGNIA A Sports Tourer (G09)
 MERIVA A MPV (X03)
 ZAFIRA TOURER C (P12)

VAUXHALL

ASTRA Mk V (H) (A04)
 ASTRA Mk V (H) Estate (A04)
 ASTRA Mk V (H) Sport Hatch (A04)
 ASTRA Mk VI (J) (P10)

LDRV 7.03833.02.0
 CORSA Mk III (D) (S07)
 CORSA Mk IV (E) (X15)
 INSIGNIA Mk I (A) Hatchback (G09)
 INSIGNIA Mk I (A) Saloon (G09)
 INSIGNIA Mk I (A) Sports Tourer (G09)
 MERIVA A (X03)

LDRV 7.04492.07.0 New



FORD

C-MAX II (DXA/CB7, DXA/CEU)
 C-MAX II Van
 FIESTA VI (CB1, CCN)
 FIESTA VI Van
 FOCUS III
 FOCUS III Hatchback Van
 FOCUS III Saloon
 FOCUS III Turnier
 GALAXY II (WA6)
 GALAXY III (CK)
 GALAXY MK II VAN (WA6)
 GRAND C-MAX (DXA/CB7, DXA/CEU)
 GRAND C-MAX Van
 KUGA II (DM2)
 MONDEO IV (BA7)
 MONDEO IV Saloon (BA7)
 MONDEO IV Turnier (BA7)
 MONDEO IV Van
 S-MAX (CJ, WA6)
 S-MAX (WA6)
 S-MAX VAN (WA6)
 TOURNEO CONNECT / GRAND TOURNEO
 CONNECT V408 MPV
 TRANSIT CONNECT V408 Box Body/MPV

FORD AUSTRALIA

FIESTA Hatchback (WZ)
 KUGA (TF)

VOLVO

S60 II (134)
 S80 II (124)
 V40 Hatchback (525, 526)
 V60 I (155, 157)
 V70 III (135)

LDRV 7.07400.11.0*

→7.22687.46.0 LDRV

JAGUAR

F-PACE (X761)
 XF II (X260)
 XF SPORTBRAKE (X260)

LAND ROVER

DISCOVERY IV (L319)



LDRV 7.07400.11.0*	LDRV 7.21895.55.0	LDRV 7.22240.13.0
<p>DISCOVERY V (L462) RANGE ROVER IV (L405) RANGE ROVER SPORT I (L320) RANGE ROVER SPORT II (L494) RANGE ROVER VELAR (L560)</p>	<p>GOLF IV Variant (1J5) GOLF VAN IV Variant (1J5) GOLF Van III Variant (1H5) LT 28-35 II Bus (2DB, 2DE, 2DK) LT 28-46 II Platform/Chassis (2DC, 2DF, 2DG, 2DL, 2DM) LT 28-46 II Van (2DA, 2DD, 2DH) LUPO I (6X1, 6E1) PASSAT B3/B4 (3A2, 35I) PASSAT B3/B4 Variant (3A5, 35I) PASSAT B5 (3B2) PASSAT B5 Variant (3B5) POLO (6N2) POLO (9N_) POLO III CLASSIC (6V2) POLO IV Saloon (9N4) POLO Van Estate Van (6V5) POLO Variant (6V5) SHARAN (7M8, 7M9, 7M6) SHARAN VAN (7M_) VENTO (1H2)</p>	 <p>→SI 0087 →SI 0089 →SI 0096</p>
<p>LDRV 7.21895.55.0</p>  <p>→SI 0087 →SI 0089 →SI 0106</p> <p>AUDI A2 (8Z0) A3 (8L1) A4 B5 (8D2) A4 B5 Avant (8D5) A6 C4 (4A2) A6 C4 Avant (4A5) A6 C5 (4B2) A6 C5 Avant (4B5) A6 C6 (4F2) A6 C6 Avant (4F5)</p> <p>FORD GALAXY I (WGR) GALAXY MK I VAN (WGR)</p> <p>SEAT ALHAMBRA (7V8, 7V9) ALHAMBRA VAN (7V8, 7V9) AROSA (6H1) CORDOBA (6K1, 6K2) CORDOBA Vario (6K5) IBIZA II (6K1) INCA (6K9) LEON (1M1) TOLEDO I (1L2) TOLEDO II (1M2)</p> <p>SKODA OCTAVIA I (1U2) OCTAVIA I Combi (1U5) SUPERB I (3U4)</p> <p>VOLKSWAGEN BORA I (1J2) BORA Variant (1J6) CADDY II Box Body/MPV (9K9A) CADDY II MPV (9K9B) GOLF III (1H1) GOLF III Cabriolet (1E7) GOLF III Van (1H1) GOLF III Variant (1H5) GOLF IV (1J1) GOLF IV Van (1J1)</p>	<p>LDRV 7.22240.09.0</p>  <p>→SI 0087 →SI 0096 →SI 0100</p> <p>VOLVO C70 I Convertible (873) C70 I Coupe (872) S40 I (644) S70 (874) S80 I (184) V40 Estate (645) V70 I (875, 876) XC70 CROSS COUNTRY I (295)</p>	<p>LDRV 7.22687.46.0 New</p>  <p>JAGUAR F-PACE (X761) XF II (X260) XF SPORTBRAKE (X260)</p> <p>LAND ROVER DISCOVERY IV (L319) DISCOVERY V (L462) RANGE ROVER IV (L405) RANGE ROVER SPORT I (L320) RANGE ROVER SPORT II (L494) RANGE ROVER VELAR (L560)</p>





LDRV 7.22687.51.0 New



PORSCHE
CAYENNE (92A)
MACAN (95B)
PANAMERA (970)

LDRV 7.22908.03.0



MG
MG 6 Hatchback
MG 6 Saloon
MG ZT
MG ZT- T
PORSCHE
911 (996)
911 Convertible (996)
CAYENNE (92A)
CAYENNE (9PA)
PANAMERA (970)

ROVER
75 (RJ)
75 I Tourer (RJ)

LDRV 7.28197.16.0



FORD
FOCUS II (DA_, HCP, DP)

→SI 0096

LDRV 7.28197.16.0

KUGA I
MONDEO IV (BA7)
MONDEO IV Saloon (BA7)
MONDEO IV Turnier (BA7)
S-MAX (WA6)
VOLVO
C30 (533)
C70 II Convertible (542)
S40 II (544)
S60 I (384)
S60 II (134)
S80 II (124)
V40 Hatchback (525, 526)
V50 (545)
V60 I (155, 157)
V70 II (285)
V70 III (135)
XC60 I SUV (156)
XC70 II (136)
VOLVO (CHANGAN)
S80L

LDRV 7.28311.04.0



→SI 0096

CADILLAC
BLS
BLS Wagon
SRX
OPEL
INSIGNIA A (G09)
INSIGNIA A Saloon (G09)
INSIGNIA A Sports Tourer (G09)
SIGNUM Hatchback (Z03)
VECTRA C (Z02)
VECTRA C Estate (Z02)
VECTRA C GTS (Z02)
VAUXHALL
INSIGNIA Mk I (A) Hatchback (G09)
INSIGNIA Mk I (A) Saloon (G09)
INSIGNIA Mk I (A) Sports Tourer (G09)
SIGNUM (Z03)
VECTRA Mk II (C) (Z02)
VECTRA Mk II (C) Estate (Z02)
VECTRA Mk II (C) GTS (Z02)

LLR 4.02003.62.0



FORD
ESCORT V (AAL, ABL)
ESCORT VI (GAL, AAL, ABL)
GALAXY I (WGR)
SCORPIO I (GAE, GGE)
SCORPIO I Saloon (GGE)
SCORPIO I Turnier (GGE)
SCORPIO II (GFR, GGR)
SCORPIO II Turnier (GNR, GGR)
SIERRA I Hatchback (GBC)
SIERRA II (GBG, GB4)
SIERRA II Hatchback (GBC, GBG)
SIERRA II Turnier (BNG)
TRANSIT Bus (E_)
TRANSIT Platform/Chassis (E_)
TRANSIT TOURNEO Bus
TRANSIT Van (E_)
FORD AUSTRALIA
TRANSIT Platform/Chassis (VF, VG)

LLR 7.06269.00.0



FORD
GALAXY I (WGR)



LLR 7.06269.01.0



OPEL

- ASTRA F (T92)
- ASTRA F Convertible (T92)
- ASTRA F Estate (T92)
- ASTRA F Hatchback (T92)
- ASTRA G Estate (T98)
- ASTRA G Hatchback (T98)
- ASTRA G Saloon (T98)
- CALIBRA A (C89)
- OMEGA B (V94)
- OMEGA B Estate (V94)
- VECTRA A (J89)
- VECTRA A Hatchback (J89)
- VECTRA B (J96)
- VECTRA B Estate (J96)
- VECTRA B Hatchback (J96)

VAUXHALL

- ASTRA Mk III (F) Convertible (T92)
- ASTRA Mk III (F) Estate (T92)
- ASTRA Mk III (F) Hatchback (T92)
- ASTRA Mk III (F) Saloon (T92)
- ASTRA Mk IV (G) Hatchback (T98)
- ASTRA Mk IV (G) Saloon (T98)
- CALIBRA (C89)
- CAVALIER Mk III Hatchback (J89)
- CAVALIER Mk III Saloon (J89)
- OMEGA (B) Estate (V94)
- OMEGA (B) Saloon (V94)
- VECTRA (B) Estate (J96)
- VECTRA (B) Hatchback (J96)
- VECTRA (B) Saloon (J96)

LLR 7.06269.02.0



FORD

- ESCORT CLASSIC (AAL, ABL)
- ESCORT CLASSIC Turnier (ANL)
- ESCORT VI (GAL, AAL, ABL)
- ESCORT VI Convertible (ALL)

LLR 7.06269.02.0

- ESCORT VI Saloon (GAL, AFL)
- ESCORT VI Turnier (GAL, ANL)
- FIESTA Box Body/MPV (J5_, J3_)
- FIESTA III (GFJ)
- FIESTA IV (JA_, JB_)
- KA (RB_)
- MONDEO II (BAP)
- MONDEO II Saloon (BFP)
- MONDEO II Turnier (BNP)
- SCORPIO II (GFR, GGR)
- SCORPIO II Turnier (GNR, GGR)

LLR 7.06269.03.0



FORD

- ESCORT VI (GAL, AAL, ABL)
- ESCORT VI Saloon (GAL, AFL)
- ESCORT VI Turnier (GAL, ANL)
- FIESTA Box Body/MPV (J5_, J3_)
- FIESTA IV (JA_, JB_)
- FOCUS I (DAW, DBW)
- FOCUS I Estate Van (DNW)
- FOCUS I Saloon (DFW)
- FOCUS I Turnier (DNW)
- KA (RB_)
- KA Van (RB)
- TOURNEO CONNECT
- TRANSIT CONNECT (P65_, P70_, P80_)

LLR 7.06269.04.0



FORD

- FIESTA IV (JA_, JB_)
- FOCUS I (DAW, DBW)
- FOCUS I Saloon (DFW)
- FOCUS I Turnier (DNW)
- PUMA (EC_)

LLR 7.06269.05.0



FORD

- GALAXY I (WGR)
- TRANSIT Bus (FD_, FB_, FS_, FZ_, FC_)
- TRANSIT Platform/Chassis (FM_, FN_)
- TRANSIT Van (FA_)

LLR 7.06269.06.0



FIAT

- BARCETTA (183_)
- BRAVA (182_)
- BRAVO I (182_)
- COUPE (175_)
- MAREA (185_)
- MAREA Weekend (185_)

LANCIA

- DEDRA (835_)
- DEDRA SW (835_)
- DELTA II (836_)

LLR 7.06269.07.0



RENAULT

- ESPACE III (JE0_)
- LAGUNA I (B56_, 556_)
- LAGUNA I Grandtour (K56_)
- MEGANE I (BA0/1_)

ELECTRIC VALVES





ELECTRIC VALVES



LLR 7.06269.07.0
 MEGANE I Cabriolet (EA0/1_)
 MEGANE I Classic (LA0/1_)
 MEGANE I Coach (DA0/1_)
 MEGANE Scenic (JA0/1_)

LLR 7.06269.09.0



RENAULT
 LAGUNA I (B56_, 556_)
 LAGUNA I Grandtour (K56_)
 SAFRANE I (B54_)
 SAFRANE II (B54_)
VOLVO
 S40 I (644)
 V40 Estate (645)

LLR 7.06269.10.0



FORD
 COUGAR (EC_)
 MONDEO III (B5Y)
 MONDEO III Saloon (B4Y)
 MONDEO III Turnier (BWY)

LLR 7.06269.11.0



FORD
 MONDEO I (GBP)

LLR 7.06269.11.0
 MONDEO I Saloon (GBP)
 MONDEO I Turnier (BNP)

LLR 7.06269.20.0



FORD USA
 EXPLORER (U2, U_)

LLR 7.06269.21.0



FORD
 COUGAR (EC_)
 MONDEO II (BAP)
 MONDEO II Saloon (BFP)
 MONDEO II Turnier (BNP)

LLR 7.06269.22.0



FORD
 MONDEO III (B5Y)
 MONDEO III Saloon (B4Y)
 MONDEO III Turnier (BWY)
FORD (CHANGAN)
 MONDEO

LLR 7.06269.23.0



FORD
 FOCUS I (DAW, DBW)
 FOCUS I Saloon (DFW)
 FOCUS I Turnier (DNW)

LLR 7.06269.24.0



FORD
 COUGAR (EC_)
 MONDEO II (BAP)
 MONDEO II Saloon (BFP)
 MONDEO II Turnier (BNP)

LLR 7.06269.26.0



FORD
 ESCORT V (AAL, ABL)
 ESCORT VI (GAL, AAL, ABL)
 P 100 II
 SCORPIO I (GAE, GGE)
 SCORPIO I Saloon (GGE)
 SCORPIO I Turnier (GGE)
 SCORPIO II (GFR, GGR)
 SCORPIO II Turnier (GNR, GGR)
 SIERRA I Hatchback (GBC)
 SIERRA II (GBG, GB4)
 SIERRA II Hatchback (GBC, GBG)



LLR 7.06269.26.0

SIERRA II Turnier (BNG)
SIERRA Turnier (BNC)
TRANSIT Bus (E_)
TRANSIT TOURNEO Bus
TRANSIT Van (E_)

LLR 7.06269.27.0



FORD
FIESTA IV (JA_ , JB_)
PUMA (EC_)
MAZDA
121 III (JASM, JBSM)

LLR 7.06269.28.0



FORD
FIESTA Box Body/MPV (J5_ , J3_)
FIESTA IV (JA_ , JB_)
MONDEO I (GBP)
MONDEO I Saloon (GBP)
MONDEO I Turnier (BNP)
MAZDA
121 III (JASM, JBSM)

OEL-HV 7.02256.05.0



→SI 0096

OEL-HV 7.02256.05.0

CITROEN
EVASION MPV (22, U6)
JUMPY (U6U_)
JUMPY (VF7)
JUMPY Platform/Chassis (BU_ , BV_ , BW_ , BX_)
JUMPY Van
JUMPY Van (BS_ , BT_ , BY_ , BZ_)
XANTIA (X1_ , X2_)
XANTIA Break (X1_ , X2_)
XSARA (N1)
XSARA Break (N2)
XSARA Coupe (N0)
XSARA PICASSO (N68)
FIAT
SCUDO Bus (220_)
SCUDO Van (220_)
ULYSSE (179_)
ULYSSE (220_)
LANCIA
ZETA (22_)
PEUGEOT
206 CC (2D)
206 Hatchback (2A/C)
206 SW (2E/K)
206 Saloon
306 (7B, N3, N5)
306 Break (7E, N3, N5)
306 Convertible (7D, N3, N5)
306 Hatchback (7A, 7C, N3, N5)
406 (8B)
406 Break (8E/F)
406 Coupe (8C)
407 (6D_)
407 Coupe (6C_)
407 SW (6E_)
806 (221)
EXPERT (224_)
EXPERT Platform/Chassis (223)
EXPERT Van (222)
EXPERT Van (VF3A_ , VF3U_ , VF3X_)
RENAULT
CLIO II (BB_ , CB_)
CLIO III (BR0/1, CR0/1)
CLIO III Grandtour (KR0/1_)
GRAND SCÉNIC II (JM0/1_)
KANGOO (KC0/1_)
KANGOO Express (FC0/1_)
LAGUNA I (B56_ , 556_)
LAGUNA I Grandtour (K56_)
LAGUNA II (BG0/1_)
MEGANE GRANDTOUR
MEGANE I (BA0/1_)
MEGANE I Cabriolet (EA0/1_)
MEGANE I Classic (LA0/1_)
MEGANE I Coach (DA0/1_)
MEGANE I Grandtour (KA0/1_)
MEGANE II (BM0/1_ , CM0/1_)
MEGANE II Coupé-Cabriolet (EM0/1_)
MEGANE II Estate (KM0/1_)
MEGANE II Saloon (LM0/1_)
MEGANE Scenic (JA0/1_)
SCÉNIC I MPV (JA0/1_ , FA0_)
SCÉNIC II (JM0/1_)

SM 7.05432.00.0



OPEL
ASCONA C (J82)
ASTRA F (T92)
ASTRA F Convertible (T92)
ASTRA F Estate (T92)
ASTRA F Estate Van (T92)
ASTRA F Hatchback (T92)
ASTRA G Estate (T98)
ASTRA G Estate Van (F70)
ASTRA G Hatchback (T98)
ASTRA G Saloon (T98)
COMBO Box Body/MPV (71_)
CORSA A Hatchback (S83)
CORSA B (S93)
CORSA B Hatchback Van (S93)
KADETT E (T85)
KADETT E Combo (T85)
KADETT E Convertible (T85)
KADETT E Estate (T85)
KADETT E Estate Van (T85)
KADETT E Hatchback (T85)
VECTRA A (J89)
VECTRA A Hatchback (J89)
VECTRA B (J96)
VECTRA B Estate (J96)
VECTRA B Hatchback (J96)
VAUXHALL
ASTRA Mk III (F) Convertible (T92)
ASTRA Mk III (F) Estate (T92)
ASTRA Mk III (F) Hatchback (T92)
ASTRA Mk III (F) Saloon (T92)
ASTRA Mk IV (G) Estate (T98)
ASTRA Mk IV (G) Hatchback (T98)
ASTRA Mk IV (G) Saloon (T98)
ASTRAVAN Mk III (F) Estate Van (T92)
ASTRAVAN Mk IV (G) Estate Van (T98)
CAVALIER Mk II Saloon (J82)
CAVALIER Mk III Hatchback (J89)
CAVALIER Mk III Saloon (J89)
COMBO Mk I (B) (S93)
CORSA Mk I (B) (S93)
CORSAVAN Mk I (B) Hatchback Van (S93)
VECTRA (B) Hatchback (J96)
VECTRA (B) Saloon (J96)

ELECTRIC VALVES





SM 7.05432.01.0



GM HOLDEN LTD

BARINA Hatchback (SB)
COMBO Van (SB)

OPEL

ASTRA F (T92)
ASTRA F Estate (T92)
ASTRA F Estate Van (T92)
ASTRA F Hatchback (T92)
COMBO Box Body/MPV (71_)
CORSA A Hatchback (S83)
CORSA A Hatchback Van (S83)
CORSA A TR (S83)
CORSA B (S93)
CORSA B Hatchback Van (S93)
KADETT E (T85)
KADETT E Combo (T85)
KADETT E Convertible (T85)
KADETT E Estate (T85)
KADETT E Estate Van (T85)
KADETT E Hatchback (T85)

VAUXHALL

ASTRA Mk II Hatchback (T85)
ASTRA Mk III (F) Estate (T92)
ASTRA Mk III (F) Hatchback (T92)
ASTRA Mk III (F) Saloon (T92)
ASTRAVAN Mk III (F) Estate Van (T92)
COMBO Mk I (B) (S93)
CORSA Mk I (B) (S93)
CORSAVAN Mk I (B) Hatchback Van (S93)
NOVA Hatchback (S83)
NOVA Saloon (S83)

SM 7.05432.02.0



CITROEN

BERLINGO / BERLINGO FIRST Box Body/MPV (M_)
BX (XB_)
BX Break (XB_)

SM 7.05432.02.0

EVASION MPV (22, U6)
JUMPER Bus (230P)
JUMPER Platform/Chassis (230)
JUMPER Van (230L)
XANTIA (X1_, X2_)
XANTIA Break (X1_, X2_)
XSARA (N1)
XSARA Break (N2)
XSARA Coupe (N0)
ZX (N2)
ZX Break (N2)

FIAT

DUCATO Platform/Chassis (230_)
DUCATO Van (230_)
ULYSSE (220_)

PEUGEOT

205 I Convertible (741B, 20D)
205 II (20A/C)
306 (7B, N3, N5)
306 Break (7E, N3, N5)
306 Convertible (7D, N3, N5)
306 Hatchback (7A, 7C, N3, N5)
309 II (3C, 3A)
405 I (15B)
405 I Break (15E)
405 II (4B)
405 II Break (4E)
406 (8B)
406 Break (8E/F)
806 (221)
BOXER Bus (230P)
BOXER Platform/Chassis (ZCT_)
BOXER Van (230L)
EXPERT (224_)
EXPERT Van (222)

SM 7.05432.03.0



FORD

FIESTA IV (JA_, JB_)

MAZDA

121 III (JASM, JBMS)

SM 7.05432.04.0



CITROEN

ZX (N2)
ZX Break (N2)

PEUGEOT

306 (7B, N3, N5)
306 Hatchback (7A, 7C, N3, N5)

SM 7.05432.06.0



CITROEN

BERLINGO / BERLINGO FIRST Box Body/MPV (M_)
BERLINGO / BERLINGO FIRST MPV (MF_, GJK_, GFK_)
XANTIA (X1_, X2_)
XANTIA Break (X1_, X2_)
XSARA (N1)
XSARA Break (N2)
XSARA Coupe (N0)

IRAN KHODRO (IKCO)

PEUGEOT 405 Saloon (15B)

PEUGEOT

306 (7B, N3, N5)
306 Break (7E, N3, N5)
306 Convertible (7D, N3, N5)
306 Hatchback (7A, 7C, N3, N5)
406 (8B)
406 Break (8E/F)
PARTNER Box Body/MPV (5_, G_)
PARTNER MPV (5_, G_)



SM 7.05432.09.0



ALFA ROMEO

- 145 (930_)
- 146 (930_)

FIAT

- BRAVA (182_)
- BRAVO I (182_)
- MAREA (185_)
- MAREA Weekend (185_)
- PALIO (178_)
- PALIO Weekend (178_, 173_, 373_, 374_, 171_)
- SIENA (178_, 172_)
- TEMPRA (159_)
- TEMPRA S.W. (159_)
- TIPO (160_)

LANCIA

- DEDRA (835_)
- DEDRA SW (835_)
- DELTA II (836_)

SM 7.05432.11.0



OPEL

- ASTRA F (T92)
- ASTRA F CLASSIC Estate (T92)
- ASTRA F CLASSIC Saloon (T92)
- ASTRA F Convertible (T92)
- ASTRA F Estate (T92)
- ASTRA F Estate Van (T92)
- ASTRA F Hatchback (T92)
- ASTRA G Estate (T98)
- ASTRA G Hatchback (T98)
- ASTRA G Saloon (T98)
- CORSA A Hatchback (S83)
- CORSA B (S93)
- CORSA B Estate (S93)
- TIGRA (S93)
- VECTRA B (J96)
- VECTRA B Estate (J96)
- VECTRA B Hatchback (J96)

SM 7.05432.11.0

- ZAFIRA A MPV (T98)
- VAUXHALL**
- ASTRA Mk III (F) Estate (T92)
- ASTRA Mk III (F) Hatchback (T92)
- ASTRA Mk III (F) Saloon (T92)
- ASTRA Mk IV (G) Estate (T98)
- ASTRA Mk IV (G) Hatchback (T98)
- ASTRA Mk IV (G) Saloon (T98)
- CORSA Mk I (B) (S93)
- NOVA Hatchback (S83)
- NOVA Saloon (S83)
- TIGRA Mk I (S93)
- VECTRA (B) Hatchback (J96)
- VECTRA (B) Saloon (J96)
- ZAFIRA A (T98)

SM 7.05432.12.0



AUDI

- 80 B4 Avant (8C5)
- 80 B4 Saloon (8C2)
- A4 B5 (8D2)
- A4 B5 Avant (8D5)
- A6 C4 (4A2)
- A6 C4 Avant (4A5)
- CABRIOLET B3 (8G7)
- COUPE B3 (89, 8B3)

SM 7.05432.13.0 New



FORD

- FIESTA V (JH_, JD_)
- FIESTA V Van
- FUSION (JU_)
- KA (RB_)
- STREET KA (RL2)

STE 7.02256.48.0

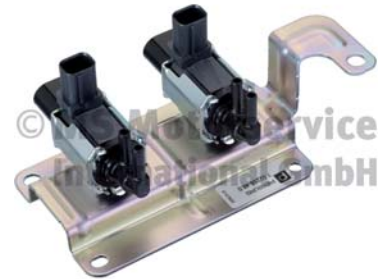

FORD

- C-MAX (DM2)
- FOCUS C-MAX (DM2)
- FOCUS II (DA_, HCP, DP)
- FOCUS II Convertible
- FOCUS II Saloon (DB_, FCH, DH)
- FOCUS II Turnier (DA_, FFS, DS)
- GALAXY II (WA6)
- MONDEO IV (BA7)
- MONDEO IV Saloon (BA7)
- MONDEO IV Turnier (BA7)
- S-MAX (WA6)

FORD AUSTRALIA

- FOCUS Hatchback (LT)
- FOCUS Hatchback (LV)
- FOCUS Saloon (LS, LT)
- FOCUS Saloon (LV)

VOLVO

- C30 (533)
- S40 II (544)
- S80 II (124)
- V50 (545)
- V70 III (135)

STE 7.03460.02.0*

- 7.01420.02.0 DW-TL
- 7.03073.01.0 DW-TL

OPEL

- ASTRA J (P10)
- ASTRA J GTC
- ASTRA J Sports Tourer (P10)
- CASCADA (W13)

VAUXHALL

- ASTRA Mk VI (J) (P10)
- ASTRA Mk VI (J) Estate (P10)
- ASTRA Mk VI (J) GTC (P10)
- CASCADA Convertible (W13)

STE 7.03855.00.0*

- 7.03073.01.0 DW-TL

OPEL

- ZAFIRA TOURER C (P12)

VAUXHALL

- ZAFIRA Mk III (P12)

STE 7.03855.02.0*

- 7.03073.01.0 DW-TL

OPEL

- ZAFIRA TOURER C (P12)



ELECTRIC VALVES



SUV	7.01830.13.0
GOLF V Variant (1K5) GOLF VI (5K1) GOLF VI Convertible (517) GOLF VI Variant (AJ5) JETTA III (1K2) JETTA IV (162, 163, AV3, AV2) MAGOTAN (3C) (VRC) PASSAT ALLTRACK B7 (365) PASSAT B6 (3C2) PASSAT B6 Variant (3C5) PASSAT B7 (362) PASSAT B7 Variant (365) PASSAT CC B6 (357) POLO V (6R1, 6C1) SAGITAR (VRC) SCIROCCO III (137, 138) SHARAN (7N1, 7N2) TIGUAN (5N_)	

SUV	7.01870.06.0
	

SUV	7.02207.05.0 New
	

SUV	7.01835.06.0
	

<p>BRABUS 40S (W221)</p> <p>MERCEDES-BENZ A-CLASS (W176) B-CLASS Sports Tourer (W246, W242) C-CLASS (W204) C-CLASS (W205) C-CLASS Convertible (A205) C-CLASS Coupe (C204) C-CLASS Coupe (C205) C-CLASS T-Model (S204) C-CLASS T-Model (S205) CLA Coupe (C117) CLA Shooting Brake (X117) CLS (C218) CLS Shooting Brake (X218) E-CLASS (W212) E-CLASS (W213) E-CLASS Convertible (A207) E-CLASS Convertible (A238) E-CLASS Coupe (C207) E-CLASS Coupe (C238) E-CLASS T-Model (S212) E-CLASS T-Model (S213) GL-CLASS (X166) GLA-CLASS (X156) GLC (X253) GLC Coupe (C253) GLE (W166) GLE Coupe (C292) GLS (X166) M-CLASS (W166) R-CLASS (W251, V251) S-CLASS (W222, V222, X222) S-CLASS Coupe (C217) SL (R231) SLC (R172) SLK (R172)</p>	<p>JAGUAR F-PACE (X761) XF I (X250) XF II (X260) XF SPORTBRAKE (X250) XF SPORTBRAKE (X260) XJ (X351)</p> <p>LAND ROVER DISCOVERY IV (L319) DISCOVERY V (L462) RANGE ROVER III (L322) RANGE ROVER IV (L405) RANGE ROVER SPORT I (L320) RANGE ROVER SPORT II (L494) RANGE ROVER VELAR (L560)</p>
--	--

SUV	7.02328.08.0
	

<p>ABARTH 500 / 595 / 695 500C / 595C / 695C GRANDE PUNTO</p> <p>ALFA ROMEO GIULIETTA (940_) MITO (955_)</p> <p>FIAT 500L (351_, 352_) 500X (334_) BRAVO II (198_) DOBLO Bus (263_) DOBLO Cargo (263_) DOBLO Platform/Chassis (263_) GRANDE PUNTO (199_) LINEA (323_, 110_) TIPO Estate (356_) TIPO Hatchback (356_) TIPO Saloon (356_)</p> <p>LANCIA DELTA III (844_)</p> <p>OPEL COMBO Box Body/MPV (X12) COMBO Tour (X12)</p>	<p>MERCEDES-BENZ (BBDC) C-CLASS (W204) E-CLASS (W212) E-CLASS (W213) GLA (X156)</p>
---	--

<p>FORD EXPLORER (U502) F-150 FLEX TAURUS VI</p> <p>→SI 0096</p>



SUV	7.02476.09.0 New	SUV	7.02901.05.0	SUV	7.02901.05.0
 <p>DACIA DOKKER Express Box Body/MPV DOKKER MPV (KE_) DUSTER (HM_) DUSTER (HS_) LODGY (JS_) RENAULT CAPTUR I (J5_, H5_) CLIO IV (BH_) CLIO IV Grandtour (KH_) GRAND SCÉNIC III (JZ0/1_) GRAND SCÉNIC IV (R9_) KADJAR (HA_, HL_) KANGOO / GRAND KANGOO (KW0/1_) KANGOO Express (FW0/1_) MEGANE III Coupe (DZ0/1_) MEGANE IV GRAND COUPE MEGANE IV Grandtour (K9A/M/N_) MEGANE IV Hatchback (B9A/M/N_)</p>		<p>A5 (8T3) A5 (F53, F5P) A5 Convertible (8F7) A5 Convertible (F57, F5E) A5 Sportback (8TA) A5 Sportback (F5A, F5F) A6 C7 (4G2, 4GC) A6 C7 Avant (4G5, 4GD) A6 C8 (4A2) A6 C8 Avant (4A5) A7 Sportback (4GA, 4GF) A7 Sportback (4KA) A8 D4 (4H2, 4H8, 4HC, 4HL) Q2 (GAB, GAG) Q3 (8UB, 8UG) Q3 (F3B) Q3 Sportback (F3N) Q5 (8RB) Q5 (FYB, FYG) Q7 (4MB, 4MG) Q8 (4MN) TT (8J3) TT (FV3, FVP) TT Roadster (8J9) TT Roadster (FV9, FVR) AUDI FAW A3 Limousine (85S, 85M) A3 Sportback (85A, 85F) A4L B8 (828) A6L C7 (4X8, 4XL) Q3 (84B, 84G) Q5 B8 (83B) SEAT ALHAMBRA (710, 711) ATECA (KH7, KHP) EXEO (3R2) EXEO ST (3R5) IBIZA IV SC (6J1, 6P5) LEON (5F1) LEON Hatchback Van (5F1) LEON SC (5F5) LEON ST (5F8) LEON ST Estate Van (5F8) TARRACO (KN2) SKODA KAROQ (NU7) KODIAQ (NS7, NV7) OCTAVIA II (1Z3) OCTAVIA II Combi (1Z5) OCTAVIA III (5E3, NL3, NR3) OCTAVIA III Combi (5E5, 5E6) SUPERB II (3T4) SUPERB II Estate (3T5) SUPERB III (3V3) SUPERB III Estate (3V5) SKODA SVW OCTAVIA Hatchback (913) SUPERB (374) YETI (0Y6, 0Y7) VOLKSWAGEN AMAROK (2HA, 2HB, S1B, S6B, S7A, S7B) AMAROK Platform/Chassis (S1B, S6B, S7B) ARTEON (3H7, 3H8)</p>		<p>ATLAS (CA1) BEETLE (5C1, 5C2) BEETLE Convertible (5C7, 5C8) CC B7 (358) EOS (1F7, 1F8) GOLF V (1K1) GOLF V Variant (1K5) GOLF VI (5K1) GOLF VI Convertible (517) GOLF VI Van (5K1_) GOLF VII (5G1, BQ1, BE1, BE2) GOLF VII Van (5G1) GOLF VII Variant (BA5, BV5) JETTA III (1K2) JETTA IV (162, 163, AV3, AV2) MULTIVAN V (7HM, 7HN, 7HF, 7EF, 7EM, 7EN) MULTIVAN VI (SGF, SGM, SGN, SHM, SHN) PASSAT ALLTRACK B7 (365) PASSAT B6 (3C2) PASSAT B6 Variant (3C5) PASSAT B7 (362) PASSAT B7 (A32, A33) PASSAT B7 Variant (365) PASSAT B8 (3G2, CB2) PASSAT B8 Variant (3G5, CB5) PASSAT CC B6 (357) POLO V (6R1, 6C1) SCIROCCO III (137, 138) SHARAN (7N1, 7N2) T-ROC (A11) TIGUAN (5N_) TIGUAN (AD1, AX1) TIGUAN ALLSPACE (BW2) TOUAREG (CR7) TOURAN (5T1) TRANSPORTER / CARAVELLE VI Bus (SGB, SGG, SGJ, SGC, SHB, SHJ) TRANSPORTER V Bus (7HB, 7HJ, 7EB, 7EJ, 7EF, 7EG, 7HF, 7EC) TRANSPORTER V Platform/Chassis (7JD, 7JE, 7JL, 7JY, 7JZ, 7FD) TRANSPORTER V Van (7HA, 7HH, 7EA, 7EH) TRANSPORTER VI Platform/Chassis (SFD, SFE, SFL, SFZ, SJD, SJ) TRANSPORTER VI Van (SGA, SGH, SHA, SHH) VW FAW BORA (152) CC Saloon (990, 991) MAGOTAN (B6, 9X2) MAGOTAN (B7L, 942) SAGITAR (9L2) SAGITAR (BK2) VW SVW LAMANDO (BM1, BM2) LAVIDA (181) LAVIDA (182, 184) PASSAT B7 (A42, A43) POLO Hatchback (621) TIGUAN (591, 592) TOURAN (9R1, 9R3)</p>	
 <p>→SI 0096</p> <p>AUDI A1 (8X1, 8XK) A1 Sportback (8XA, 8XF) A1 Sportback (GBA) A3 (8P1) A3 (8V1, 8VK) A3 Convertible (8P7) A3 Convertible (8V7, 8VE) A3 Limousine (8VS, 8VM) A3 Sportback (8PA) A3 Sportback (8VA, 8VF) A4 Allroad B8 (8KH) A4 B8 (8K2) A4 B8 Avant (8K5) A4 B9 (8W2, 8WC) A4 B9 Avant (8W5, 8WD)</p>					





SUV 7.02909.07.0



ABARTH

124 Spider

PUNTO

PUNTO EVO

ALFA ROMEO

GIULIETTA (940_)

MITO (955_)

CHRYSLER

DELTA

YPSILON

FIAT

124 Spider (348_)

500 (312_)

500 C (312_)

500L (351_, 352_)

500X (334_)

BRAVO II (198_)

PANDA (312_, 319_)

PANDA VAN (312_, 519_)

PUNTO (199_)

PUNTO EVO (199_)

JEEP

RENEGADE SUV (BU, B1)

LANCIA

DELTA III (844_)

YPSILON (312_)

SUV 7.02909.12.0



ALFA ROMEO

GIULIA (952_)

STELVIO (949_)

FERRARI

488 GTB (F142M)

488 Spider

CALIFORNIA

F8 Spider

F8 Tributo Coupe

GTC4 Lusso / Lusso T

SUV 7.02909.12.0

PORTOFINO

FIAT

DUCATO Bus (250_)

DUCATO Platform/Chassis (250_)

DUCATO Van (250_)

JEEP

CHEROKEE (KL)

WRANGLER IV (JL)

SUV 7.03381.14.0



BUICK SGM

ENVISION (CP4)

CHEVROLET (SGM)

CRUZE Saloon (CP3)

OPEL

ADAM (M13)

ASTRA K (B16)

ASTRA K Sports Tourer (B16)

CORSA E (X15)

INSIGNIA B Country Tourer (Z18)

INSIGNIA B Grand Sport (Z18)

INSIGNIA B Sports Tourer (Z18)

MOKKA / MOKKA X (J13)

VAUXHALL

ADAM (M13)

ASTRA Mk VII (K) (B16)

ASTRA Mk VII (K) Estate (B16)

CORSA Mk IV (E) (X15)

INSIGNIA Mk II (B) Hatchback (Z18)

INSIGNIA Mk II (B) Sports Tourer (Z18)

MOKKA / MOKKA X (J13)

SUV 7.03381.15.0



BUICK SGM

ENVISION (CP4)

CADILLAC

ATS

CTS

SUV 7.03381.15.0

CADILLAC (SGM)

ATS-L (SA1)

XTS (EG4)

CHEVROLET

CAMARO

MALIBU IV

OPEL

INSIGNIA A (G09)

INSIGNIA A Country Tourer (G09)

INSIGNIA A Saloon (G09)

INSIGNIA A Sports Tourer (G09)

VAUXHALL

INSIGNIA Mk I (A) Hatchback (G09)

INSIGNIA Mk I (A) Saloon (G09)

INSIGNIA Mk I (A) Sports Tourer (G09)

SUV 7.04216.05.0



BMW

1 (F20)

1 (F21)

2 Convertible (F23)

2 Coupe (F22, F87)

3 (F30, F80)

3 Gran Turismo (F34)

3 Touring (F31)

4 Convertible (F33, F83)

4 Coupe (F32, F82)

4 Gran Coupe (F36)

5 (F10)

5 Gran Turismo (F07)

5 Touring (F11)

7 (G11, G12)

X1 (E84)

X3 (F25)

X4 (F26)

X5 (F15, F85)

X6 (F16, F86)

Z4 Roadster (E89)

BMW (BRILLIANCE)

3 SERIES (F30, F35)

5 SERIES (F10, F18)

X1 (E84)

ROLLS-ROYCE

CULLINAN (RR31)

GHOST II (RR21)

GHOST II Extended Wheelbase (RR22)

PHANTOM VIII (RR11, RR12)



SUV	7.04247.02.0	SUV	7.04269.04.0	SUV	7.04615.03.0
-----	--------------	-----	--------------	-----	--------------



AUDI

A1 (8X1, 8XK)
A1 Sportback (8XA, 8XF)

SEAT

ALHAMBRA (710, 711)
IBIZA IV (6J5, 6P1)
IBIZA IV SC (6J1, 6P5)
IBIZA IV ST (6J8, 6P8)

SKODA

FABIA II (542)
FABIA II Combi (545)

VOLKSWAGEN

BEETLE (5C1, 5C2)
BEETLE Convertible (5C7, 5C8)
CC B7 (358)
EOS (1F7, 1F8)
GOLF PLUS V (5M1, 521)
GOLF PLUS Van (521)
GOLF V (1K1)
GOLF V Variant (1K5)
GOLF VAN VI Variant (AJ5)
GOLF VI (5K1)
GOLF VI Convertible (517)
GOLF VI Van (5K1_)
GOLF VI Variant (AJ5)
JETTA III (1K2)
JETTA IV (162, 163, AV3, AV2)
PASSAT B6 (3C2)
PASSAT B6 Variant (3C5)
PASSAT B7 (362)
PASSAT B7 Variant (365)
PASSAT CC B6 (357)
POLO V (6R1, 6C1)
POLO Van (6R)
SCIROCCO III (137, 138)
SCIROCCO Van (137)
SHARAN (7N1, 7N2)
TIGUAN (5N_)
TOURAN (1T1, 1T2)
TOURAN (1T3)



FORD

C-MAX II (DXA/CB7, DXA/CEU)
C-MAX II Van
FIESTA VI (CB1, CCN)
FIESTA VI Van
FOCUS III
FOCUS III Hatchback Van
FOCUS III Saloon
FOCUS III Turnier
GALAXY II (WA6)
GALAXY MK II VAN (WA6)
GRAND C-MAX (DXA/CB7, DXA/CEU)
GRAND C-MAX Van
KUGA II (DM2)
MONDEO IV (BA7)
MONDEO IV Saloon (BA7)
MONDEO IV Turnier (BA7)
S-MAX (WA6)
TOURNEO CONNECT / GRAND TOURNEO
CONNECT V408 MPV
TRANSIT CONNECT V408 Box Body/MPV

FORD AUSTRALIA

FIESTA Hatchback (WZ)
KUGA (TF)

GT
KUGA II (DM2)
MONDEO V Hatchback (CE)
MONDEO V Turnier (CF)
PUMA
S-MAX (CJ, WA6)
TOURNEO CONNECT / GRAND TOURNEO
CONNECT V408 MPV
TRANSIT CONNECT V408 Box Body/MPV

FORD USA

MUSTANG Convertible
MUSTANG Coupe

VOLVO

S60 II (134)
S80 II (124)
V40 Hatchback (525, 526)
V60 I (155, 157)
V70 III (135)

SUV	7.04654.10.0	New
-----	--------------	-----



LEXUS

GS (_L1_)
IS III (_E3_)
NX (_Z1_)
RC (_C1_)
RX (_L2_)

TOYOTA

CROWN (_S21_)
CROWN (_S22_)
HARRIER (_U6_)
TOYOTA FAW
CROWN ROYAL (_S21_)
TOYOTA GAC
HIGHLANDER (_U5_)

SUV	7.04615.03.0
-----	--------------



FORD

C-MAX II (DXA/CB7, DXA/CEU)
C-MAX II Van
FOCUS III
FOCUS III Estate Van
FOCUS III Saloon
FOCUS III Turnier
FOCUS IV (HN)
FOCUS IV Saloon (HM)
FOCUS IV Turnier (HP)
FUSION (USA)
GALAXY III (CK)

SUV	7.04818.04.0	New
-----	--------------	-----



DACIA

DOKKER Express Box Body/MPV





SUV	7.04818.04.0	New
<p>DOKKER MPV (KE_) LODGY (JS_) MERCEDES-BENZ A-CLASS (W176) A-CLASS (W177) A-CLASS Saloon (V177) B-CLASS Sports Tourer (W246, W242) B-CLASS Sports Tourer (W247) C-CLASS (W204) C-CLASS (W205) C-CLASS Convertible (A205) C-CLASS Coupe (C204) C-CLASS Coupe (C205) C-CLASS T-Model (S204) C-CLASS T-Model (S205) CLA (C118) CLA Coupe (C117) CLA Shooting Brake (X117) CLA Shooting Brake (X118) CLS (C218) E-CLASS (W212) E-CLASS (W213) E-CLASS Convertible (A207) E-CLASS Convertible (A238) E-CLASS Coupe (C207) E-CLASS Coupe (C238) E-CLASS T-Model (S212) E-CLASS T-Model (S213) GLA (H247) GLA-CLASS (X156) GLB (X247) GLC (X253) GLC Coupe (C253) GLE (V167) GLE Coupe (C167) GLK-CLASS (X204) SLC (R172) SLK (R172) V-CLASS (W447) VITO Tourer (W447) VITO Van (W447) MERCEDES-BENZ (BBDC) A-CLASS (W177) C-CLASS (W205) E-CLASS (W212) E-CLASS (W213) GLA (H247) GLA (X156) GLB (X247) GLC (X253) GLK-CLASS (X204) MERCEDES-BENZ (FJDA) V-CLASS (W448) VITO (W448) NISSAN QASHQAI II SUV (J11, J11_) X-TRAIL (T32_) RENAULT CAPTUR I (J5_, H5_) CAPTUR II GRAND SCÉNIC IV (R9_) KADJAR (HA_, HL_) KOLEOS II (HC_)</p>		

SUV	7.04818.04.0	New
<p>MEGANE IV GRAND COUPE MEGANE IV Grandtour (K9A/M/N_) MEGANE IV Hatchback (B9A/M/N_) SCÉNIC IV (J9_) TALISMAN (LP_) TALISMAN Grandtour (KP_)</p>		

SUV	7.04881.08.0*	
	→7.02909.12.0	SUV
<p>FIAT DUCATO Bus (250_) DUCATO Platform/Chassis (250_) DUCATO Van (250_)</p>		

SUV	7.04927.08.0	New
-----	--------------	-----



<p>MERCEDES-BENZ A-CLASS (W177) A-CLASS Saloon (V177) AMG GT (X290) C-CLASS (W205) C-CLASS Convertible (A205) C-CLASS Coupe (C205) C-CLASS T-Model (S205) CLS (C257) E-CLASS (W213) E-CLASS Convertible (A238) E-CLASS Coupe (C238) E-CLASS T-Model (S213) G-CLASS (W463) GLC (X253) GLC Coupe (C253) S-CLASS (W222, V222, X222) S-CLASS Convertible (A217) S-CLASS Coupe (C217)</p>		
---	--	--

SUV	7.05367.05.0	New
-----	--------------	-----



<p>MINI (BMW) MINI (R56)</p>		
--	--	--

SUV	7.05367.05.0	New
<p>MINI CLUBMAN (R55) MINI COUNTRYMAN (R60) MINI Convertible (R57) MINI PACEMAN (R61) MINI Roadster (R59) POLESTAR POLESTAR 1 (P) VOLVO S60 II (134) S60 III (224) S90 II (234) V40 Hatchback (525, 526) V60 I (155, 157) V60 II (225, 227) V70 III (135) V90 II Estate (235, 236) XC60 I SUV (156) XC60 II (246) XC90 II (256) VOLVO ASIA S60 S60L S90 XC60 II</p>		

SV-AGR-K	7.01981.07.0
----------	--------------



<p>ALFA ROMEO MITO (955_)</p>	
<p>CHEVROLET AVEO Hatchback (T300) AVEO Saloon (T300)</p>	
<p>CITROEN NEMO Box Body/MPV (AA_) NEMO MPV</p>	
<p>FIAT 500 (312_) 500 C (312_) 500L (351_, 352_) DOBLO Bus (263_) DOBLO Cargo (263_) DOBLO Platform/Chassis (263_) FIORINO Box Body/MPV (225_) FIORINO MPV (225_) GRANDE PUNTO (199_) IDEA (350_) LINEA (323_, 110_) PANDA (169_) PANDA (312_, 319_) PANDA VAN (312_, 519_) PUNTO (199_)</p>	





SV-AGR-K	7.01981.07.0
PUNTO EVO (199_)	
PUNTO EVO Hatchback Van (199_)	
PUNTO Hatchback Van (199_)	
QUBO (225_)	
STRADA Pickup (178_)	
TIPO Estate (356_)	
TIPO Hatchback (356_)	
TIPO Saloon (356_)	
FORD	
KA (RU8)	
LANCIA	
MUSA (350_)	
YPSILON (312_)	
YPSILON (843_)	
OPEL	
ASTRA J (P10)	
ASTRA J Estate Van (P10)	
ASTRA J Hatchback Van (P10)	
ASTRA J Saloon	
ASTRA J Sports Tourer (P10)	
COMBO Box Body/MPV (X12)	
COMBO Tour (X12)	
CORSA D (S07)	
CORSA D Hatchback Van (S07)	
MERIVA B MPV (S10)	
MERIVA B VAN (S10)	
PEUGEOT	
BIPPER (AA_)	
BIPPER TEPEE	
SUZUKI	
SWIFT IV (FZ, NZ)	
VAUXHALL	
ASTRA Mk VI (J) (P10)	
ASTRA Mk VI (J) Estate (P10)	
ASTRA Mk VI (J) Saloon (P10)	
CORSA Mk III (D) (S07)	
CORSAVAN Mk III (D) Hatchback Van (S07)	
MERIVA Mk II (B) (S10)	

SV-HYAT	7.08681.03.0 New
	
→PI 1862	
ALFA ROMEO	
147 (937_)	
156 (932_)	
156 Sportwagon (932_)	
GT (937_)	
CITROEN	
NEMO Box Body/MPV (AA_)	
NEMO MPV	

SV-HYAT	7.08681.03.0 New
FIAT	
DOBLO Bus (263_)	
DOBLO Cargo (263_)	
DOBLO Platform/Chassis (263_)	
FIORINO Box Body/MPV (225_)	
IDEA (350_)	
PUNTO (188_)	
QUBO (225_)	
LANCIA	
MUSA (350_)	
YPSILON (843_)	
OPEL	
COMBO Box Body/MPV (X12)	
COMBO Tour (X12)	
PEUGEOT	
BIPPER (AA_)	
BIPPER TEPEE	
VAUXHALL	
COMBO Mk III (D) Box Body/MPV (X12)	

SV-HYAT	7.08681.04.0 New
	
→PI 1862	
ALFA ROMEO	
147 (937_)	
156 (932_)	
156 Sportwagon (932_)	
GT (937_)	
CITROEN	
NEMO Box Body/MPV (AA_)	
NEMO MPV	
FIAT	
DOBLO Bus (263_)	
DOBLO Cargo (263_)	
DOBLO Platform/Chassis (263_)	
FIORINO Box Body/MPV (225_)	
IDEA (350_)	
PUNTO (188_)	
QUBO (225_)	
LANCIA	
MUSA (350_)	
YPSILON (843_)	
OPEL	
COMBO Box Body/MPV (X12)	
COMBO Tour (X12)	
PEUGEOT	
BIPPER (AA_)	
BIPPER TEPEE	
VAUXHALL	
COMBO Mk III (D) Box Body/MPV (X12)	

SV-HYAT	7.08681.06.0 New
	
→PI 1862	
ALFA ROMEO	
147 (937_)	
156 (932_)	
156 Sportwagon (932_)	
GT (937_)	

SV-HYAT	7.08681.05.0 New
	
→PI 1862	
ALFA ROMEO	
147 (937_)	
156 (932_)	
156 Sportwagon (932_)	
GT (937_)	
CITROEN	
NEMO Box Body/MPV (AA_)	
NEMO MPV	
FIAT	
DOBLO Bus (263_)	
DOBLO Cargo (263_)	
DOBLO Platform/Chassis (263_)	
FIORINO Box Body/MPV (225_)	
IDEA (350_)	
PUNTO (188_)	
QUBO (225_)	
LANCIA	
MUSA (350_)	
YPSILON (843_)	
OPEL	
COMBO Box Body/MPV (X12)	
COMBO Tour (X12)	
PEUGEOT	
BIPPER (AA_)	
BIPPER TEPEE	
VAUXHALL	
COMBO Mk III (D) Box Body/MPV (X12)	

SV-HYAT	7.08681.06.0 New
	
→PI 1862	
ALFA ROMEO	
147 (937_)	
156 (932_)	
156 Sportwagon (932_)	
GT (937_)	



ELECTRIC VALVES



SV-HYAT 7.08681.06.0 New

CITROEN
NEMO Box Body/MPV (AA_)
NEMO MPV

FIAT
DOBLO Bus (263_)
DOBLO Cargo (263_)
DOBLO Platform/Chassis (263_)
FIORINO Box Body/MPV (225_)
IDEA (350_)
PUNTO (188_)
QUBO (225_)

LANCIA
MUSA (350_)
YPSILON (843_)

OPEL
COMBO Box Body/MPV (X12)
COMBO Tour (X12)

PEUGEOT
BIPPER (AA_)
BIPPER TEPEE

VAUXHALL
COMBO Mk III (D) Box Body/MPV (X12)

SV-HYAT 7.08681.07.0 New



→PI 1862

FIAT
DUCATO Bus (250_)
DUCATO Platform/Chassis (250_)
DUCATO Van (250_)

SV-HYAT 7.08681.13.0 New



→PI 1862

FIAT
DUCATO Bus (250_)
DUCATO Platform/Chassis (250_)
DUCATO Van (250_)

SV-HYAT 7.08681.14.0 New



→PI 1862

FIAT
DUCATO Bus (250_)
DUCATO Platform/Chassis (250_)
DUCATO Van (250_)

SV-KK 7.02256.06.0



→SI 0096

VOLKSWAGEN
TRANSPORTER IV Bus (70B, 70C, 7DB, 7DK, 70J, 70K, 7DC, 7DJ)
TRANSPORTER IV Platform/Chassis (70E, 70L, 70M, 7DE, 7DL, 7D)
TRANSPORTER IV Van (70A, 70H, 7DA, 7DH)

SV-KK 7.02256.40.0



→SI 0096

AUDI
A3 (8P1)
A3 Convertible (8P7)
A3 Sportback (8PA)

AUDI FAW
A3 Limousine (85S, 85M)
A3 Sportback (85A, 85F)

SV-KK 7.02256.40.0

SEAT
ALHAMBRA (710, 711)

SKODA
OCTAVIA II (1Z3)
OCTAVIA II Combi (1Z5)
SUPERB II (3T4)
SUPERB II Estate (3T5)
YETI (5L)

VOLKSWAGEN
CADDY III Box Body/MPV (2KA, 2KH, 2CA, 2CH)
CADDY III MPV (2KB, 2KJ, 2CB, 2CJ)
CC B7 (358)
EOS (1F7, 1F8)
GOLF PLUS V (5M1, 521)
GOLF V (1K1)
GOLF V Variant (1K5)
GOLF VI (5K1)
GOLF VI Convertible (517)
GOLF VI Variant (AJ5)
JETTA III (1K2)
PASSAT ALLTRACK B7 (365)
PASSAT B6 (3C2)
PASSAT B6 Variant (3C5)
PASSAT B7 (362)
PASSAT B7 Variant (365)
PASSAT CC B6 (357)
SHARAN (7N1, 7N2)
TOURAN (1T1, 1T2)
TOURAN (1T3)

SV-KK 7.02256.41.0



AUDI
A3 Sportback (8VA, 8VF)
A6 C8 (4A2)
A6 C8 Avant (4A5)
A8 D5 (4N2, 4N8)
Q5 (8RB)
Q7 (4LB)

MAN
TGE Bus
TGE Platform/Chassis (UZ_)
TGE Van

PORSCHE
CAYENNE (92A)
CAYENNE (9PA)
MACAN (95B)

SEAT
ALHAMBRA (710, 711)

VOLKSWAGEN
AMAROK (2HA, 2HB, S1B, S6B, S7A, S7B)



SV-KK	7.02256.41.0
<p>AMAROK Platform/Chassis (S1B, S6B, S7B) ATLAS (CA1) CADDY III Box Body/MPV (2KA, 2KH, 2CA, 2CH) CADDY III MPV (2KB, 2KJ, 2CB, 2CJ) CRAFTER Bus (SYI, SYJ) CRAFTER Platform/Chassis (SZ_) CRAFTER Van (SY_, SX_) GOLF VII (5G1, BQ1, BE1, BE2) MULTIVAN V (7HM, 7HN, 7HF, 7EF, 7EM, 7EN) MULTIVAN VI (SGF, SGM, SGN, SHM, SHN) PASSAT B8 (3G2, CB2) PASSAT B8 Variant (3G5, CB5) SHARAN (7N1, 7N2) TOUAREG (7LA, 7L6, 7L7) TOUAREG (7P5, 7P6) TOURAN (1T1, 1T2) TOURAN (1T3) TRANSPORTER / CARAVELLE VI Bus (SGB, SGG, SGJ, SGC, SHB, SHJ) TRANSPORTER V Bus (7HB, 7HJ, 7EB, 7EJ, 7EF, 7EG, 7HF, 7EC) TRANSPORTER V Platform/Chassis (7JD, 7JE, 7JL, 7JY, 7JZ, 7FD) TRANSPORTER V Van (7HA, 7HH, 7EA, 7EH) TRANSPORTER VI Platform/Chassis (SFD, SFE, SFL, SFZ, SJD, SJ) TRANSPORTER VI Van (SGA, SGH, SHA, SHH)</p>	

SV-KK	7.09000.03.0
 <p>MAZDA 3 Hatchback (BP) 3 Saloon (BP_) CX-30 (DM)</p>	

SV-NWV	7.06117.00.0	New
<p>5 SERIES (E60) X1 (E84) ROLLS-ROYCE PHANTOM VII (RR1) PHANTOM VII Coupe (RR3) PHANTOM VII Drophead Coupe (RR2)</p>		

SV-KK	7.02256.42.0
 <p>PORSCHE CAYENNE (9PA) VOLKSWAGEN MULTIVAN V (7HM, 7HN, 7HF, 7EF, 7EM, 7EN) TOUAREG (7LA, 7L6, 7L7) TRANSPORTER V Bus (7HB, 7HJ, 7EB, 7EJ, 7EF, 7EG, 7HF, 7EC) TRANSPORTER V Platform/Chassis (7JD, 7JE, 7JL, 7JY, 7JZ, 7FD) TRANSPORTER V Van (7HA, 7HH, 7EA, 7EH)</p>	

SV-NWV	7.06117.00.0	New
 <p>ALPINA B5 (E60) B5 Estate (E61) B6 Convertible (E64) B7 (E65) BMW 1 (E81) 1 (E87) 1 Convertible (E88) 1 Coupe (E82) 3 (E46) 3 (E90) 3 Compact (E46) 3 Convertible (E46) 3 Convertible (E93) 3 Coupe (E46) 3 Coupe (E92) 3 Touring (E46) 3 Touring (E91) 5 (E60) 5 Touring (E61) 6 (E63) 6 Convertible (E64) 7 (E65, E66, E67) X1 (E84) X3 (E83) X5 (E53) X5 (E70) Z4 Roadster (E85) BMW (BRILLIANCE) 3 SERIES (E46) 3 SERIES (E90)</p>		

SV-NWV	7.06117.01.0	New
 <p>BMW 1 (E81) 1 (E87) 1 Convertible (E88) 1 Coupe (E82) 3 (E90) 3 Convertible (E93) 3 Coupe (E92) 3 Touring (E91) 5 (E60) 5 (F10) 5 Touring (E61) 5 Touring (F11) 6 (E63) 6 Convertible (E64) 7 (E65, E66, E67) 7 (F01, F02, F03, F04) X1 (E84) X3 (E83) X3 (F25) X5 (E70) X6 (E71, E72) Z4 Coupe (E86) Z4 Roadster (E85) Z4 Roadster (E89) BMW (BRILLIANCE) 3 SERIES (E90) 5 SERIES (E60) 5 SERIES (F10, F18)</p>		

ELECTRIC VALVES





SV-NWV 7.06117.02.0 **New**



© MS Motorservice International GmbH

- BMW**
- 1 (F20)
- 1 (F21)
- 3 (F30, F80)
- 3 Touring (F31)
- BMW (BRILLIANCE)**
- 3 SERIES (F30, F35)
- MINI (BMW)**
- MINI (R56)
- MINI CLUBMAN (R55)
- MINI CLUBVAN (R55)
- MINI COUNTRYMAN (R60)
- MINI Convertible (R57)
- MINI Coupe (R58)
- MINI PACEMAN (R61)
- MINI Roadster (R59)

SV-NWV 7.06117.03.0 **New**



© MS Motorservice International GmbH

- CHEVROLET**
- COLORADO Cab & Chassis
- COLORADO Crew Cab Pickup
- COLORADO Extended Cab Pickup
- COLORADO Standard Cab Pickup
- GMC**
- CANYON Cab & Chassis
- CANYON Crew Cab Pickup
- CANYON Extended Cab Pickup
- CANYON Standard Cab Pickup
- HUMMER**
- HUMMER H3
- HUMMER H3T

SV-NWV 7.06117.04.0 **New**



© MS Motorservice International GmbH

- BUICK**
- ALLURE Saloon
- ENCLAVE
- LA CROSSE Saloon
- RENDEZVOUZ
- BUICK SGM**
- GL8 S II (CU3)
- LACROSSE (EG2)
- PARK AVENUE (S8E)
- ROYAUM (S8W)
- CADILLAC**
- ATS
- ATS Coupe
- CTS
- CTS Coupe
- CTS Sport Wagon
- SRX
- STS
- XTS (1P5)
- CADILLAC (SGM)**
- SLS (S6D)
- XTS (EG4)
- CHEVROLET**
- CAMARO
- CAMARO Convertible
- CAPTIVA (C100, C140)
- CAPTIVA SPORT
- COLORADO Crew Cab Pickup
- COLORADO Extended Cab Pickup
- EQUINOX
- IMPALA Saloon
- MALIBU
- MALIBU (V300)
- TRAVERSE
- GMC**
- ACADIA
- TERRAIN
- OPEL**
- ANTARA A (L07)
- INSIGNIA A (G09)
- INSIGNIA A Saloon (G09)
- INSIGNIA A Sports Tourer (G09)
- SIGNUM Hatchback (Z03)
- VECTRA C (Z02)
- VECTRA C Estate (Z02)
- VECTRA C GTS (Z02)
- PONTIAC**
- G6
- G6 Coupe
- G8 Saloon

SV-NWV 7.06117.04.0 **New**

- TORRENT
- ROEWE SAIC**
- 950
- SAAB**
- 9-3 (YS3F, E79, D79, D75)
- 9-3 Convertible (YS3F)
- 9-3 Estate (E50)
- 9-5 (YS3G)
- VAUXHALL**
- INSIGNIA Mk I (A) Hatchback (G09)
- INSIGNIA Mk I (A) Saloon (G09)
- INSIGNIA Mk I (A) Sports Tourer (G09)
- SIGNUM (Z03)
- VECTRA Mk II (C) Estate (Z02)
- VECTRA Mk II (C) GTS (Z02)

SV-NWV 7.06117.05.0



- BUICK**
- LA CROSSE Saloon
- REGAL Saloon
- VERANO Saloon
- BUICK SGM**
- GL8 S II (CU3)
- LACROSSE (CW2, CW3)
- LACROSSE (EG2)
- REGAL II (EG1)
- CADILLAC (SGM)**
- SLS (S6D)
- CHEVROLET**
- CAPTIVA (C100, C140)
- CAPTIVA SPORT
- COBALT
- COBALT Coupe
- EQUINOX
- HHR
- MALIBU
- MALIBU (V300)
- CHEVROLET (SGM)**
- CAPTIVA (S7L)
- MALIBU (EG3)
- GMC**
- TERRAIN
- OPEL**
- ANTARA A (L07)
- ASTRA J GTC
- GT Convertible (M07)
- INSIGNIA A (G09)
- INSIGNIA A Saloon (G09)
- INSIGNIA A Sports Tourer (G09)





ELECTRIC VALVES



SV-NWV 7.06117.10.0 New
LAND ROVER
 RANGE ROVER III (L322)

SV-NWV 7.06117.14.0



NISSAN
 MICRA C+C III (K12)
 MICRA III (K12)
 NOTE (E11, NE11)

SV-NWV 7.06117.15.0



RENAULT
 DUSTER (HS_)
 FLUENCE (L3_)
 MEGANE CC (EZ0/1_)
 MEGANE III Coupe (DZ0/1_)
 MEGANE III Grandtour (KZ0/1)
 MEGANE III Hatchback (BZ0/1_, B3_)

SV-NWV 7.06117.16.0 New



VOLVO
 S40 I (644)
 V40 Estate (645)

SV-NWV 7.06117.17.0 New



VOLVO
 S40 I (644)
 V40 Estate (645)

SV-NWV 7.06117.18.0



LAND ROVER
 FREELANDER 2 (L359)
VOLVO
 S60 II (134)
 S80 II (124)
 V60 I (155, 157)
 V70 III (135)
 XC60 I SUV (156)
 XC70 II (136)
 XC90 I (275)
VOLVO (CHANGAN)
 S80L

SV-NWV 7.06117.33.0 New



FORD
 C-MAX II (DXA/CB7, DXA/CEU)
 FOCUS III
 FOCUS III Turnier
 FUSION Saloon
 GALAXY III (CK)

SV-NWV 7.06117.33.0 New

KUGA II (DM2)
 MONDEO V Hatchback (CE)
 MONDEO V Saloon (CD)
 MONDEO V Turnier (CF)
 RANGER (TKE)
 S-MAX (CJ, WA6)
 TRANSIT CONNECT MPV
 TRANSIT CONNECT V408 Box Body/MPV

FORD USA
 EDGE
 EDGE (U387)
 EXPLORER
 MUSTANG Convertible
 MUSTANG Coupe
 TAURUS

LINCOLN
 MKC
 MKT
 MKX
 MKZ
MERCURY
 MILAN Saloon

SV-NWV 7.06117.34.0 New



CITROEN
 C2 (JM_)
 C3 I (FC_, FN_)
 C4 Coupe (LA_)
 C4 I (LC_)
 C4 I Saloon
 C5 II (RC_)
 C5 II Break (RE_)
 C8 (EA_, EB_)
 C8 Van (EA_, EB_)
PEUGEOT
 1007 (KM_)
 206 Hatchback (2A/C)
 206 SW (2E/K)
 207 (WA_, WC_)
 307 (3A/C)
 307 Break (3E)
 307 CC (3B)
 307 SW (3H)
 307 Saloon
 407 (6D_)
 407 SW (6E_)
 807 (EB_)



SV-NWV 7.06117.35.0 New	SV-NWV 7.06117.36.0 New	SV-NWV 7.06117.37.0 New
 <p>© MS Motorservice International GmbH</p> <p>ALFA ROMEO MITO (955_)</p> <p>FIAT 500 (312_) 500 C (312_) DOBLO Box Body/MPV (223_) DOBLO MPV (119_, 223_) GRANDE PUNTO (199_) IDEA (350_) LINEA (323_, 110_) PALIO (178_) SIENA (178_, 172_)</p> <p>LANCIA MUSA (350_) YPSILON (843_)</p>	<p>5 Gran Turismo (F07) 5 Touring (F11) 6 Convertible (F12) 6 Coupe (F13) 6 Gran Coupe (F06) 7 (F01, F02, F03, F04) 7 (G11, G12) X1 (E84) X3 (F25) X4 (F26) X5 (E70) X5 (F15, F85) X6 (E71, E72) X6 (F16, F86)</p> <p>BMW (BRILLIANCE) 3 SERIES (F30, F35) 5 SERIES (F10, F18)</p> <p>ROLLS-ROYCE CULLINAN (RR31) DAWN (RR6) GHOST I (RR4) GHOST II (RR21) GHOST II Extended Wheelbase (RR22) PHANTOM VIII (RR11, RR12) WRAITH (RR5)</p>	<p>GOLF PLUS V (5M1, 521) GOLF V (1K1) JETTA III (1K2) PASSAT B6 (3C2) PASSAT B6 Variant (3C5) PASSAT B7 (362) PASSAT B7 (A32, A33) PASSAT B7 Estate Van (365) PASSAT B7 Variant (365) PASSAT CC B6 (357) PHAETON (3D1, 3D2, 3D3, 3D4, 3D6, 3D7, 3D8, 3D9) TOUAREG (7LA, 7L6, 7L7) TOUAREG (7P5, 7P6) TOURAN (1T1, 1T2) TOURAN VAN (1T1, 1T2)</p>
<p>SV-NWV 7.06117.36.0 New</p>  <p>© MS Motorservice International GmbH</p> <p>ALPINA B6 Gran Coupe (F06) B7 (F01, F02)</p> <p>BMW 1 (F20) 1 (F21) 1 Convertible (E88) 1 Coupe (E82) 2 Convertible (F23) 2 Coupe (F22, F87) 3 (E90) 3 (F30, F80) 3 Convertible (E93) 3 Coupe (E92) 3 Gran Turismo (F34) 3 Touring (E91) 3 Touring (F31) 4 Convertible (F33, F83) 4 Coupe (F32, F82) 4 Gran Coupe (F36) 5 (F10)</p>	<p>SV-NWV 7.06117.37.0 New</p>  <p>© MS Motorservice International GmbH</p> <p>AUDI A3 (8P1) A3 Sportback (8PA) A6 C6 (4F2) Q7 (4LB) Q7 Van (4LB) TT (8J3) TT Roadster (8J9)</p> <p>SEAT ALTEA (5P1) ALTEA XL (5P5, 5P8) LEON (1P1) TOLEDO III (5P2)</p> <p>SKODA OCTAVIA II (1Z3) OCTAVIA II Combi (1Z5) SUPERB II (3T4) SUPERB II Estate (3T5)</p> <p>VOLKSWAGEN ATLAS (CA1) ATLAS CROSS SPORT (CMC) CC B7 (358) EOS (1F7, 1F8)</p>	<p>SV-NWV 7.06117.38.0 New</p>  <p>© MS Motorservice International GmbH</p> <p>ALFA ROMEO 159 (939_) 159 Sportwagon (939_) 4C (960_) 4C SPIDER (960_) BRERA (939_) GIULIETTA (940_) GIULIETTA Hatchback Van (940_) MITO (955_) SPIDER (939_)</p> <p>CHRYSLER YPSILON</p> <p>DODGE FORZA</p> <p>FIAT 500 (312_) 500 C (312_) DOBLO Box Body/MPV (223_) DOBLO MPV (119_, 223_) FIORINO Box Body/MPV (225_) FIORINO Box Body/MPV (265_) FIORINO MPV (225_) GRANDE PUNTO (199_) GRANDE PUNTO Van (199_) IDEA (350_) LINEA (323_, 110_) PALIO (178_) PANDA (169_) PANDA (312_, 319_) PANDA Hatchback Van (169_) PANDA VAN (312_, 519_) PUNTO (199_) PUNTO EVO (199_)</p>

ELECTRIC VALVES



ELECTRIC VALVES



SV-NWV 7.06117.38.0 New
 QUBO (225_)
 SIENA (178_, 172_)
FORD
 KA (RU8)
LANCIA
 DELTA III (844_)
 MUSA (350_)
 YPSILON (312_)
 YPSILON (843_)

SV-NWV 7.06117.42.0 New
 A4 B8 Avant (8K5)
 A5 (8T3)
 A5 Convertible (8F7)
 A5 Sportback (8TA)
 A6 Allroad C6 (4FH)
 A6 C6 (4F2)
 A6 C6 Avant (4F5)
 A8 D3 (4E2, 4E8)
 Q5 (8RB)

SV-NWV 7.06117.44.0 New
 Q7 (4LB)
 TT (8J3)
 TT (8N3)
 TT Roadster (8J9)
 TT Roadster (8N9)
SEAT
 ALHAMBRA (7V8, 7V9)
VOLKSWAGEN
 BORA I (1J2)
 BORA Variant (1J6)
 EOS (1F7, 1F8)
 GOLF IV (1J1)
 GOLF IV Variant (1J5)
 GOLF V (1K1)
 MULTIVAN V (7HM, 7HN, 7HF, 7EF, 7EM, 7EN)
 PASSAT B5.5 (3B3)
 PASSAT B5.5 Variant (3B6)
 PASSAT B6 (3C2)
 PASSAT B6 Variant (3C5)
 SHARAN (7M8, 7M9, 7M6)
 TOUAREG (7LA, 7L6, 7L7)
 TRANSPORTER IV Bus (70B, 70C, 7DB, 7DK, 70J, 70K, 7DC, 7DJ)
 TRANSPORTER IV Platform/Chassis (70E, 70L, 70M, 7DE, 7DL, 7D)
 TRANSPORTER IV Van (70A, 70H, 7DA, 7DH)
 TRANSPORTER V Bus (7HB, 7HJ, 7EB, 7EJ, 7EF, 7EG, 7HF, 7EC)
 TRANSPORTER V Platform/Chassis (7JD, 7JE, 7JL, 7JY, 7JZ, 7FD)
 TRANSPORTER V Van (7HA, 7HH, 7EA, 7EH)
 ENGINE



RENAULT
 CLIO III (BR0/1, CR0/1)
 CLIO III Grandtour (KR0/1_)
 FLUENCE (L3_)
 GRAND SCÉNIC II (JM0/1_)
 GRAND SCÉNIC III (JZ0/1_)
 LAGUNA II (BG0/1_)
 LAGUNA II Grandtour (KG0/1_)
 LAGUNA III (BT0/1)
 LAGUNA III Grandtour (KT0/1)
 MEGANE CC (EZ0/1_)
 MEGANE II (BM0/1_, CM0/1_)
 MEGANE II Coupé-Cabriolet (EM0/1_)
 MEGANE II Estate (KM0/1_)
 MEGANE II Saloon (LM0/1_)
 MEGANE III Coupe (DZ0/1_)
 MEGANE III Grandtour (KZ0/1)
 MEGANE III Hatchback (BZ0/1_, B3_)
 MODUS / GRAND MODUS (F/JPO_)
 SCÉNIC II (JM0/1_)
 SCÉNIC III (JZ0/1_)
 TWINGO II (CN0_)
 WIND (E4M_)

AUDI
 A3 (8P1)
 A3 Sportback (8PA)
 Q7 (4LB)
 TT (8J3)
 TT (8N3)
 TT Roadster (8J9)
 TT Roadster (8N9)
VOLKSWAGEN
 EOS (1F7, 1F8)
 GOLF IV (1J1)
 GOLF V (1K1)
 MULTIVAN V (7HM, 7HN, 7HF, 7EF, 7EM, 7EN)
 PASSAT B6 (3C2)
 PASSAT B6 Variant (3C5)
 TOUAREG (7LA, 7L6, 7L7)
 TRANSPORTER V Bus (7HB, 7HJ, 7EB, 7EJ, 7EF, 7EG, 7HF, 7EC)
 TRANSPORTER V Platform/Chassis (7JD, 7JE, 7JL, 7JY, 7JZ, 7FD)
 TRANSPORTER V Van (7HA, 7HH, 7EA, 7EH)
 ENGINE



SV-NWV 7.06117.42.0 New



AUDI
 A4 B8 (8K2)

SV-NWV 7.06117.44.0 New

AUDI
 A3 (8P1)
 A3 Sportback (8PA)

CITROEN
 BERLINGO Box Body/MPV (B9)
 BERLINGO MULTISPACE (B9)
 C-ELYSEE (DD_)
 C3 AIRCROSS II (2R_, 2C_)
 C3 II (SC_)
 C3 III (SX)
 C3 PICASSO (SH_)
 C4 CACTUS
 C4 Coupe (LA_)
 C4 GRAND PICASSO I (UA_)
 C4 GRAND PICASSO II (DA_, DE_)
 C4 I (LC_)
 C4 II (B7)
 C4 PICASSO I MPV (UD_)
 C4 PICASSO II
 C4 SPACETOUREUR (3D_)



SV-NWV 7.06117.45.0 New	SV-NWV 7.06117.46.0	SV-NWV 7.06117.47.0
<p>C5 AIRCROSS C5 III (RD_) C5 III Break (RW_) DS3 DS3 Convertible DS4 (NX_) DS5 GRAND C4 SPACETOURER (3A_, 3E_) DS DS 3 (SA_) DS 3 Convertible (SB_) DS 4 / DS 4 CROSSBACK (NX_) DS 5 (KF_) DS 7 Crossback (J_) OPEL CROSSLAND X / CROSSLAND (P17, P2QO) GRANDLAND X (A18) PEUGEOT 2008 I (CU_) 207 (WA_, WC_) 207 CC (WD_) 207 SW (WK_) 208 I (CA_, CC_) 3008 MPV (OU_) 3008 SUV (MC_, MR_, MJ_, M4_) 301 308 CC (4B_) 308 I (4A_, 4C_) 308 II (LB_, LP_, LW_, LH_, L3_) 308 SW I (4E_, 4H_) 308 SW II (LC_, LJ_, LR_, LX_, L4_) 5008 (OU_, 0E_) 5008 II (MC_, MJ_, MR_, M4_) 508 I (8D_) 508 II (FB_, FH_, F3_) 508 SW I (8E_) 508 SW II (FC_, FJ_, F4_) PARTNER Box Body/MPV PARTNER TEPEE RCZ VAUXHALL CROSSLAND X (P17) GRANDLAND X (A18)</p>	<p>A4 B7 Convertible (8HE) A6 C6 (4F2) A6 C6 Avant (4F5) TT (8J3) TT Roadster (8J9) SEAT ALTEA (5P1) ALTEA XL (5P5, 5P8) EXEO (3R2) EXEO ST (3R5) LEON (1P1) TOLEDO III (5P2) SKODA OCTAVIA II (1Z3) OCTAVIA II Combi (1Z5) VOLKSWAGEN EOS (1F7, 1F8) GOLF V (1K1) GOLF V Variant (1K5) GOLF VI (5K1) GOLF VI Convertible (517) JETTA III (1K2) PASSAT B6 (3C2) PASSAT B6 Variant (3C5) SCIROCCO III (137, 138)</p>	<p>VOLKSWAGEN TOUAREG (7P5, 7P6)</p>
		SV-NWV 7.06117.48.0
		 <p>AUDI A1 (8X1, 8XK) A1 CITY CARVER (GBH) A1 Sportback (8XA, 8XF) A1 Sportback (GBA) A3 (8V1, 8VK) A3 Convertible (8V7, 8VE) A3 Limousine (8VS, 8VM) A3 Sportback (8VA, 8VF) A4 B9 (8W2, 8WC) A4 B9 Avant (8W5, 8WD) A5 (F53, F5P) A5 Sportback (F5A, F5F) Q2 (GAB, GAG) Q3 (8UB, 8UG) Q3 (F3B) Q3 Sportback (F3N) SEAT ALHAMBRA (710, 711) ARONA (KJ7) ATECA (KH7, KHP) IBIZA IV (6J5, 6P1) IBIZA IV SC (6J1, 6P5) IBIZA IV ST (6J8, 6P8) IBIZA V (KJ1) LEON (5F1) LEON SC (5F5) LEON ST (5F8) Mii (KF1, KE1) TARRACO (KN2) TOLEDO IV (KG3) SKODA CITIGO (NF1) FABIA III (NJ3) FABIA III Estate (NJ5) KAMIQ (NW4) KAROQ (NU7) KODIAQ (NS7, NV7) OCTAVIA III (5E3, NL3, NR3) OCTAVIA III Combi (5E5, 5E6) RAPID (NH3) RAPID Spaceback (NH1) SCALA (NW1) SUPERB III (3V3) SUPERB III Estate (3V5) YETI (5L)</p>
	SV-NWV 7.06117.47.0	
	 <p>AUDI A3 Limousine (8VS, 8VM) A3 Sportback (8VA, 8VF) A4 B8 (8K2) A4 B8 Avant (8K5) A5 (8T3) A5 Convertible (8F7) A5 Sportback (8TA) A6 Allroad C7 (4GH, 4GJ) A6 C7 (4G2, 4GC) A6 C7 Avant (4G5, 4GD) A7 Sportback (4GA, 4GF) A8 D4 (4H2, 4H8, 4HC, 4HL) Q3 (F3B) Q3 Sportback (F3N) Q5 (8RB) Q7 (4LB) Q7 (4MB, 4MG) TT (FV3, FVP) TT Roadster (FV9, FVR) PORSCHE CAYENNE (92A) PANAMERA (970)</p>	
SV-NWV 7.06117.46.0		
 <p>AUDI A3 (8P1) A3 Sportback (8PA) A4 B7 (8EC) A4 B7 Avant (8ED)</p>		

ELECTRIC VALVES





ELECTRIC VALVES



SV-NWV	7.06117.48.0
VOLKSWAGEN	
AMEO (631)	
BEETLE (5C1, 5C2)	
BEETLE Convertible (5C7, 5C8)	
CADDY ALLTRACK Box Body/MPV (SAA)	
CADDY ALLTRACK MPV (SAB)	
CADDY IV Box Body/MPV (SAA, SAH)	
CADDY IV MPV (SAB, SAJ)	
GOLF SPORTSVAN VII (AM1, AN1)	
GOLF VI Convertible (517)	
GOLF VII (5G1, BQ1, BE1, BE2)	
GOLF VII Variant (BA5, BV5)	
JETTA IV (162, 163, AV3, AV2)	
JETTA VII Saloon (BU3)	
LOAD UP (121, 122, BL1, BL2)	
PASSAT ALLTRACK B8 Variant (3G5, CB5)	
PASSAT B8 (3G2, CB2)	
PASSAT B8 Variant (3G5, CB5)	
POLO V (6R1, 6C1)	
POLO V Saloon (602, 604, 612, 614)	
POLO VI (AW1, BZ1)	
SCIROCCO III (137, 138)	
SHARAN (7N1, 7N2)	
T-CROSS (C11)	
T-ROC (A11)	
T-ROC Convertible (AC7)	
TIGUAN (5N_)	
TIGUAN (AD1, AX1)	
TIGUAN ALLSPACE (BW2)	
TOURAN (5T1)	
UPI! (121, 122, BL1, BL2, BL3, 123)	

SV-NWV	7.06117.52.0
FORD	
GALAXY II (WA6)	
MONDEO IV (BA7)	
MONDEO IV Saloon (BA7)	
MONDEO IV Turnier (BA7)	
MONDEO IV Van	
S-MAX (WA6)	
FORD AUSTRALIA	
MONDEO Hatchback (MA, MB, MC)	
JAGUAR	
F-PACE (X761)	
XE (X760)	
XF I (X250)	
XF II (X260)	
XF SPORTBRAKE (X250)	
XJ (X351)	
LAND ROVER	
DISCOVERY SPORT (L550)	
FREELANDER 2 (L359)	
RANGE ROVER EVOQUE (L538)	
RANGE ROVER EVOQUE Convertible (L538)	
RANGE ROVER SPORT II (L494)	
VOLVO	
S60 II (134)	
S80 II (124)	
V60 I (155, 157)	
V70 III (135)	
XC60 I SUV (156)	
VOLVO (CHANGAN)	
S80L	



SV-NWV	7.06117.52.0
LAND ROVER	
DISCOVERY SPORT (L550)	
FREELANDER 2 (L359)	
RANGE ROVER EVOQUE (L538)	
RANGE ROVER EVOQUE Convertible (L538)	
RANGE ROVER SPORT II (L494)	
VOLVO	
S60 II (134)	
S80 II (124)	
V60 I (155, 157)	
V70 III (135)	
XC60 I SUV (156)	
VOLVO (CHANGAN)	
S80L	

SV-NWV	7.06117.53.0
FORD	
GALAXY II (WA6)	
MONDEO IV (BA7)	
MONDEO IV Saloon (BA7)	
MONDEO IV Turnier (BA7)	
MONDEO IV Van	
S-MAX (WA6)	
FORD AUSTRALIA	
MONDEO Hatchback (MA, MB, MC)	
JAGUAR	
F-PACE (X761)	
XE (X760)	
XF I (X250)	
XF II (X260)	
XF SPORTBRAKE (X250)	
XJ (X351)	
LAND ROVER	
DISCOVERY SPORT (L550)	
FREELANDER 2 (L359)	
RANGE ROVER EVOQUE (L538)	
RANGE ROVER EVOQUE Convertible (L538)	
RANGE ROVER SPORT II (L494)	
VOLVO	
S60 II (134)	
S80 II (124)	
V60 I (155, 157)	
V70 III (135)	
XC60 I SUV (156)	
VOLVO (CHANGAN)	
S80L	



SV-NWV	7.06117.54.0
AUDI	
A1 (8X1, 8XK)	
A1 Sportback (8XA, 8XF)	
A3 (8P1)	
A3 Sportback (8PA)	
SEAT	
ALHAMBRA (710, 711)	
ALTEA (5P1)	
ALTEA XL (5P5, 5P8)	
CORDOBA (6L2)	
IBIZA III (6L1)	
IBIZA IV (6J5, 6P1)	
IBIZA IV SC (6J1, 6P5)	
IBIZA IV ST (6J8, 6P8)	
LEON (1P1)	
TOLEDO III (5P2)	
TOLEDO IV (KG3)	
SKODA	
FABIA II (542)	
FABIA II Combi (545)	
OCTAVIA II (1Z3)	
OCTAVIA II Combi (1Z5)	
RAPID (NH3)	
RAPID Spaceback (NH1)	
ROOMSTER (5J7)	
YETI (5L)	
VOLKSWAGEN	
BEETLE (5C1, 5C2)	
BEETLE Convertible (5C7, 5C8)	
CC B7 (358)	
EOS (1F7, 1F8)	
GOLF PLUS V (5M1, 521)	
GOLF V (1K1)	
GOLF V Variant (1K5)	
GOLF VI (5K1)	
GOLF VI Convertible (517)	
GOLF VI Variant (AJ5)	
JETTA III (1K2)	
JETTA IV (162, 163, AV3, AV2)	
PASSAT B6 (3C2)	
PASSAT B6 Variant (3C5)	
PASSAT B7 (362)	
PASSAT B7 Variant (365)	
POLO (9N_)	
POLO IV Saloon (9N4)	
POLO V (6R1, 6C1)	
SCIROCCO III (137, 138)	
SHARAN (7N1, 7N2)	
TIGUAN (5N_)	
TOURAN (1T1, 1T2)	





SV-NWV 7.06117.54.0

TOURAN (1T3)
VW SVW
 POLO JINQING (9J3)
 POLO JINQU (9J4)

SV-NWV 7.06117.55.0



FORD

FUSION Saloon
 GALAXY II (WA6)
 MONDEO IV (BA7)
 MONDEO IV Saloon (BA7)
 MONDEO IV Turnier (BA7)
 MONDEO IV Van
 RANGER (TKE)
 S-MAX (WA6)

FORD ASIA / OZEANIA

RANGER (PX)

FORD AUSTRALIA

MONDEO Estate (MB, MC)
 MONDEO Hatchback (MA, MB, MC)
 MONDEO Saloon (MA, MB)

FORD USA

FUSION

MAZDA

3 (BK)
 3 (BL)
 3 Saloon (BK)
 3 Saloon (BL)
 5 (CR19)
 5 (CW)
 6 Estate (GH)
 6 Hatchback (GG)
 6 Hatchback (GH)
 6 Saloon (GG)
 6 Saloon (GH)
 6 Station Wagon (GY)
 BT-50 II Pickup (B22, B32, UP, UR)
 CX-7 (ER)
 MX-5 III (NC)

MERCURY

MILAN Saloon

VOLVO

S60 II (134)
 S80 II (124)
 V60 I (155, 157)
 V70 III (135)
 XC60 I SUV (156)

VOLVO (CHANGAN)

S80L

SV-NWV 7.06117.56.0



BUICK

REGAL Saloon

CADILLAC

ATS
 ATS Coupe
 CT6
 CTS

CHEVROLET

CAMARO
 CAMARO Convertible
 COLORADO Crew Cab Pickup
 COLORADO Extended Cab Pickup
 IMPALA Saloon
 MALIBU
 MALIBU (V300)

GMC

ACADIA

OPEL

INSIGNIA A (G09)
 INSIGNIA A Country Tourer (G09)
 INSIGNIA A Saloon (G09)
 INSIGNIA A Sports Tourer (G09)
 INSIGNIA B Country Tourer (Z18)
 INSIGNIA B Grand Sport (Z18)
 INSIGNIA B Sports Tourer (Z18)

VAUXHALL

INSIGNIA Mk I (A) Hatchback (G09)
 INSIGNIA Mk I (A) Saloon (G09)
 INSIGNIA Mk I (A) Sports Tourer (G09)
 INSIGNIA Mk II (B) Hatchback (Z18)
 INSIGNIA Mk II (B) Sports Tourer (Z18)

SV-NWV 7.06117.57.0



BUICK

REGAL Saloon

CADILLAC

ATS
 ATS Coupe

SV-NWV 7.06117.57.0

CT6
 CTS
CHEVROLET
 CAMARO
 CAMARO Convertible
 COLORADO Crew Cab Pickup
 COLORADO Extended Cab Pickup
 IMPALA Saloon
 MALIBU
 MALIBU (V300)

GMC

ACADIA

OPEL

INSIGNIA A (G09)
 INSIGNIA A Country Tourer (G09)
 INSIGNIA A Saloon (G09)
 INSIGNIA A Sports Tourer (G09)
 INSIGNIA B Country Tourer (Z18)
 INSIGNIA B Grand Sport (Z18)
 INSIGNIA B Sports Tourer (Z18)

VAUXHALL

INSIGNIA Mk I (A) Hatchback (G09)
 INSIGNIA Mk I (A) Saloon (G09)
 INSIGNIA Mk I (A) Sports Tourer (G09)
 INSIGNIA Mk II (B) Hatchback (Z18)
 INSIGNIA Mk II (B) Sports Tourer (Z18)

SV-NWV 7.06117.58.0



BMW

3 (E90)
 3 Convertible (E93)
 3 Coupe (E92)

SV-PDA 7.02256.28.0



GM HOLDEN LTD

BARINA Hatchback (XC)
 COMBO Van (XC)

→SI 0096

ELECTRIC VALVES





ELECTRIC VALVES



SV-PDA 7.02256.28.0

OPEL

- AGILA (A) (H00)
- ASTRA G CLASSIC Caravan (F35)
- ASTRA G Hatchback (T98)
- ASTRA G Saloon (T98)
- ASTRA H (A04)
- ASTRA H CLASSIC Estate (A04)
- ASTRA H CLASSIC Hatchback (A04)
- ASTRA H Estate (A04)
- ASTRA H Estate Van (L70)
- ASTRA H GTC (A04)
- ASTRA H Saloon (A04)
- ASTRA H TwinTop (A04)
- COMBO Box Body/MPV
- COMBO Tour
- CORSA C (X01)
- CORSA C Hatchback Van (X01)
- CORSA CLASSIC Saloon
- CORSA D (S07)
- CORSA D Hatchback Van (S07)
- MERIVA A MPV (X03)
- TIGRA TwinTop (X04)

SUZUKI

- WAGON R Hatchback
- WAGON R+ Hatchback (MM)

VAUXHALL

- AGILA Mk I (A) (H00)
- ASTRA Mk V (H) (A04)
- ASTRA Mk V (H) Estate (A04)
- ASTRA Mk V (H) Sport Hatch (A04)
- ASTRAVAN Mk V (H) Estate Van (A04)
- COMBO Mk II (C) Box Body/MPV (F25)
- COMBO TOUR Mk II (C) (F25)
- CORSA Mk II (C) (X01)
- CORSA Mk III (D) (S07)
- CORSAVAN Mk II (C) Hatchback Van (X01)
- CORSAVAN Mk III (D) Hatchback Van (S07)
- MERIVA A (X03)
- TIGRA TwinTop (X04)

SV-PDA 7.02256.30.0



→SI 0096

ALFA ROMEO

- MITO (955_)

FIAT

- GRANDE PUNTO (199_)

SV-PDA 7.02256.31.0



→SI 0096

OPEL

- ASTRA G CLASSIC (T98)
- ASTRA G CLASSIC Caravan (F35)
- ASTRA G Convertible (T98)
- ASTRA G Coupe (T98)
- ASTRA G Estate (T98)
- ASTRA G Estate Van (F70)
- ASTRA G Hatchback (T98)
- ASTRA H (A04)
- ASTRA H Estate (A04)
- ASTRA H Estate Van (L70)
- ASTRA H GTC (A04)
- ASTRA H Saloon (A04)
- ASTRA H TwinTop (A04)
- MERIVA A MPV (X03)
- VECTRA C (Z02)
- VECTRA C Estate (Z02)
- VECTRA C GTS (Z02)
- ZAFIRA / ZAFIRA FAMILY B (A05)

VAUXHALL

- ASTRA Mk IV (G) Convertible (T98)
- ASTRA Mk IV (G) Coupe (T98)
- ASTRA Mk IV (G) Estate (T98)
- ASTRA Mk IV (G) Hatchback (T98)
- ASTRA Mk V (H) (A04)
- ASTRA Mk V (H) Estate (A04)
- ASTRA Mk V (H) Sport Hatch (A04)
- ASTRA Mk V (H) TwinTop (A04)
- ASTRAVAN Mk V (H) Estate Van (A04)
- MERIVA A (X03)
- ZAFIRA Mk II (B) (A05)

UAV 7.21071.50.0



→SI 0087

→SI 0096

→SI 0100

UAV 7.21071.50.0

MERCEDES-BENZ

- /8 (W114)
- /8 Coupe (W114)
- 123 Coupe (C123)
- 123 Saloon (W123)
- S-CLASS (W116)
- SL (R107)
- SL Coupe (C107)

ZM-NWV 7.06117.07.0



BUICK

- ENCORE SUV

BUICK SGM

- ENCORE (SJ2)

CADILLAC

- ELR

CHEVROLET

- AVEO Saloon (T300)
- CRUZE (J300)
- CRUZE Hatchback (J305)
- CRUZE Station Wagon (J308)
- VOLT

OPEL

- ADAM (M13)
- AMPERA (R12)
- ASTRA J (P10)
- ASTRA J GTC
- ASTRA J Saloon
- ASTRA J Sports Tourer (P10)
- CASCADA (W13)
- CORSA D (S07)
- CORSA D Hatchback Van (S07)
- CORSA E (X15)
- CORSA E Hatchback Van (X15)
- INSIGNIA A (G09)
- INSIGNIA A Saloon (G09)
- INSIGNIA A Sports Tourer (G09)
- MERIVA B MPV (S10)
- MERIVA B VAN (S10)
- MOKKA / MOKKA X (J13)
- ZAFIRA TOURER C (P12)

VAUXHALL

- ADAM (M13)
- AMPERA (R12)
- ASTRA Mk VI (J) (P10)
- ASTRA Mk VI (J) Estate (P10)
- ASTRA Mk VI (J) GTC (P10)
- ASTRA Mk VI (J) Saloon (P10)
- CASCADA Convertible (W13)
- CORSA Mk III (D) (S07)



ZM-NWV	7.06117.07.0
<p>CORSA Mk IV (E) (X15) CORSAVAN Mk III (D) Hatchback Van (S07) CORSAVAN Mk IV (E) Hatchback Van (X15) INSIGNIA Mk I (A) Hatchback (G09) INSIGNIA Mk I (A) Saloon (G09) INSIGNIA Mk I (A) Sports Tourer (G09) MERIVA Mk II (B) (S10) MOKKA / MOKKA X (J13) ZAFIRA Mk III (P12)</p>	



ZM-NWV	7.06117.21.0
<p>C-CLASS Coupe (CL203) C-CLASS T-Model (S202) C-CLASS T-Model (S203) CLK (C208) CLK Convertible (A208) E-CLASS (W210) E-CLASS T-Model (S210) SLK (R170)</p>	



- FORD**
- B-MAX (JK)
 - B-MAX Van (JK)
 - C-MAX II (DXA/CB7, DXA/CEU)
 - C-MAX II Van
 - ECOSPORT
 - FIESTA Saloon
 - FIESTA VI (CB1, CCN)
 - FIESTA VI Van
 - FIESTA VII (HJ, HF)
 - FIESTA VII Van
 - FOCUS III
 - FOCUS III Estate Van
 - FOCUS III Hatchback Van
 - FOCUS III Saloon
 - FOCUS III Turnier
 - FOCUS IV (HN)
 - FOCUS IV Saloon (HM)
 - FOCUS IV Turnier (HP)
 - GRAND C-MAX (DXA/CB7, DXA/CEU)
 - GRAND C-MAX Van
 - MONDEO V Hatchback (CE)
 - MONDEO V Saloon (CD)
 - MONDEO V Turnier (CF)
 - TOURNEO CONNECT / GRAND TOURNEO CONNECT V408 MPV
 - TOURNEO COURIER B460 MPV
 - TRANSIT CONNECT V408 Box Body/MPV
 - TRANSIT COURIER B460 Box Body/MPV
 - TRANSIT COURIER B460 MPV
- FORD AUSTRALIA**
- ECOSPORT (BK, BL)
 - FIESTA Hatchback (WZ)

- MERCEDES-BENZ**
- 124 Convertible (A124)
 - 124 Coupe (C124)
 - 124 Saloon (W124)
 - 124 T-Model (S124)
 - C-CLASS (W202)
 - C-CLASS T-Model (S202)
 - CLK (C208)
 - CLK Convertible (A208)
 - E-CLASS (W124)
 - E-CLASS (W210)
 - E-CLASS Convertible (A124)
 - E-CLASS Coupe (C124)
 - E-CLASS T-Model (S124)
 - E-CLASS T-Model (S210)
 - G-CLASS (W463)
 - G-CLASS Cabrio (W463)
 - M-CLASS (W163)
 - S-CLASS (W140)
 - S-CLASS Coupe (C140)
 - SL (R129)
 - SLK (R170)
 - SPRINTER 2-t Bus (B901, B902)
 - SPRINTER 2-t Platform/Chassis (B901, B902)
 - SPRINTER 2-t Van (B901, B902)
 - SPRINTER 3-t Bus (B903)
 - SPRINTER 3-t Platform/Chassis (B903)
 - SPRINTER 3-t Van (B903)
 - SPRINTER 4-t Bus (B904)
 - SPRINTER 4-t Platform/Chassis (B904)
 - SPRINTER 4-t Van (B904)
 - V-CLASS (638/2)
 - VITO Bus (W638)
 - VITO Van (W638)



- MERCEDES-BENZ**
- C-CLASS (W203)
 - C-CLASS (W204)
 - C-CLASS Coupe (CL203)
 - C-CLASS T-Model (S203)
 - C-CLASS T-Model (S204)
 - CLC-CLASS (CL203)
 - CLK (C209)
 - CLK Convertible (A209)
 - E-CLASS (W211)
 - E-CLASS (W212)
 - E-CLASS T-Model (S211)
 - SLK (R171)
 - SPRINTER 3,5-t Bus (B906)
 - SPRINTER 3,5-t Platform/Chassis (B906)
 - SPRINTER 3,5-t Van (B906)
 - SPRINTER 3-t Bus (B906)
 - SPRINTER 3-t Platform/Chassis (B906)
 - SPRINTER 3-t Van (B906)
 - SPRINTER 5-t Platform/Chassis (B906)
- MERCEDES-BENZ (BBDC)**
- C-CLASS (W204)
 - E-CLASS (W211)
 - E-CLASS (W212)



MERCEDES-BENZ
C-CLASS (W203)



AUDI
A1 (8X1, 8XK)

ELECTRIC VALVES





ELECTRIC VALVES



ZM-NWV 7.06117.26.0 New	ZM-NWV 7.06117.26.0 New	ZM-NWV 7.06117.26.0 New
<p>A1 Sportback (8XA, 8XF) A3 (8P1) A3 (8V1, 8VK) A3 Convertible (8P7) A3 Convertible (8V7, 8VE) A3 Limousine (8VS, 8VM) A3 Sportback (8PA) A3 Sportback (8VA, 8VF) A4 Allroad B8 (8KH) A4 Allroad B9 (8WH, 8WJ) A4 B8 (8K2) A4 B8 Avant (8K5) A4 B9 (8W2, 8WC) A4 B9 Avant (8W5, 8WD) A5 (8T3) A5 (F53, F5P) A5 Convertible (8F7) A5 Convertible (F57, F5E) A5 Sportback (8TA) A5 Sportback (F5A, F5F) A6 C7 (4G2, 4GC) A6 C7 Avant (4G5, 4GD) A6 C8 (4A2) A6 C8 Avant (4A5) A7 Sportback (4GA, 4GF) A7 Sportback (4KA) A8 D4 (4H2, 4H8, 4HC, 4HL) Q2 (GAB, GAG) Q3 (8UB, 8UG) Q3 Sportback (F3N) Q5 (8RB) Q5 (FYB, FYG) Q5 Van (8RB) Q7 (4MB, 4MG) Q8 (4MN) TT (8J3) TT (FV3, FVP) TT Roadster (8J9) TT Roadster (FV9, FVR)</p> <p>PORSCHE MACAN (95B)</p> <p>SEAT ALHAMBRA (710, 711) ALTEA (5P1) ALTEA XL (5P5, 5P8) EXEO (3R2) EXEO ST (3R5) IBIZA IV SC (6J1, 6P5) LEON (1P1) LEON (5F1) LEON Hatchback Van (5F1) LEON SC (5F5) LEON ST (5F8) LEON ST Estate Van (5F8) TOLEDO III (5P2)</p> <p>SKODA OCTAVIA II (1Z3) OCTAVIA II Combi (1Z5) OCTAVIA III (5E3, NL3, NR3) OCTAVIA III Combi (5E5, 5E6) OCTAVIA IV (NX3) OCTAVIA IV Combi (NX5) SUPERB II (3T4)</p>	<p>SUPERB II Estate (3T5) SUPERB III (3V3) SUPERB III Estate (3V5) YETI (5L)</p> <p>SKODA SVW OCTAVIA Hatchback (913)</p> <p>VOLKSWAGEN AMAROK (2HA, 2HB, S1B, S6B, S7A, S7B) AMAROK Platform/Chassis (S1B, S6B, S7B) ARTEON (3H7, 3H8) ARTEON SHOOTING BRAKE (3H9) ATLAS (CA1) ATLAS CROSS SPORT (CMC) BEETLE (5C1, 5C2) BEETLE Convertible (5C7, 5C8) CC B7 (358) EOS (1F7, 1F8) GOLF ALLTRACK VII Variant (BA5, BV5) GOLF V (1K1) GOLF V Variant (1K5) GOLF VI (5K1) GOLF VI Convertible (517) GOLF VI Van (5K1_) GOLF VI Variant (AJ5) GOLF VII (5G1, BQ1, BE1, BE2) GOLF VII Van (5G1) GOLF VII Variant (BA5, BV5) JETTA III (1K2) JETTA IV (162, 163, AV3, AV2) JETTA VII Saloon (BU3) MULTIVAN V (7HM, 7HN, 7HF, 7EF, 7EM, 7EN) MULTIVAN VI (SGF, SGM, SGN, SHM, SHN) PASSAT ALLTRACK B7 (365) PASSAT ALLTRACK B8 Variant (3G5, CB5) PASSAT B6 (3C2) PASSAT B6 Variant (3C5) PASSAT B7 (362) PASSAT B7 (A32, A33) PASSAT B7 Estate Van (365) PASSAT B7 Variant (365) PASSAT B8 (3G2, CB2) PASSAT B8 Variant (3G5, CB5) PASSAT CC B6 (357) POLO V (6R1, 6C1) SCIROCCO III (137, 138) SCIROCCO Van (137) SHARAN (7N1, 7N2) SHARAN VAN (7N1, 7N2) T-ROC (A11) TIGUAN (5N_) TIGUAN (AD1, AX1) TIGUAN ALLSPACE (BW2) TIGUAN VAN (5N_) TOUAREG (CR7) TOURAN (5T1) TRANSPORTER / CARAVELLE VI Bus (SGB, SGG, SGG, SHB, SHJ) TRANSPORTER V Bus (7HB, 7HJ, 7EB, 7EJ, 7EF, 7EG, 7HF, 7EC) TRANSPORTER V Platform/Chassis (7JD, 7JE, 7JL, 7JY, 7JZ, 7FD) TRANSPORTER V Van (7HA, 7HH, 7EA, 7EH)</p>	<p>TRANSPORTER VI Platform/Chassis (SFD, SFE, SFL, SFZ, SJD, SJ) TRANSPORTER VI Van (SGA, SGH, SHA, SHH)</p> <hr/> <p>ZM-NWV 7.06117.41.0 New</p> <div data-bbox="1037 448 1420 694" data-label="Image"> </div> <p>SCION FR-S Coupe</p> <p>SUBARU BRZ FORESTER (SJ_) IMPREZA Hatchback (GP_) IMPREZA Hatchback (GT_) IMPREZA Saloon (GJ_) LEGACY V (BM) LEGACY V Estate (BR) LEGACY VI (BN, BS) LEVORG OUTBACK (BR) OUTBACK (BS) WRX Saloon (GJ) XV (GT) XV (_GP_)</p> <p>TOYOTA GT 86 Coupe (ZN6_)</p> <hr/> <p>ZM-NWV 7.06117.60.0</p> <div data-bbox="1037 1388 1420 1747" data-label="Image"> </div> <p>MERCEDES-BENZ C-CLASS (W203) C-CLASS (W204) C-CLASS Coupe (CL203) C-CLASS T-Model (S203) C-CLASS T-Model (S204) CLC-CLASS (CL203) CLK (C209) CLK Convertible (A209) CLS (C219) E-CLASS (W211) E-CLASS (W212)</p>



ZM-NWV	7.06117.60.0
--------	--------------

- E-CLASS Convertible (A207)
- E-CLASS Coupe (C207)
- E-CLASS T-Model (S211)
- E-CLASS T-Model (S212)
- G-CLASS (W463)
- G-CLASS Cabrio (W463)
- GL-CLASS (X164)
- GLK-CLASS (X204)
- M-CLASS (W164)
- R-CLASS (W251, V251)
- S-CLASS (W221)
- S-CLASS Coupe (C216)
- SL (R230)
- SLK (R171)
- SPRINTER 3,5-t Bus (B906)
- SPRINTER 3,5-t Platform/Chassis (B906)
- SPRINTER 3,5-t Van (B906)
- SPRINTER 3-t Bus (B906)
- SPRINTER 3-t Platform/Chassis (B906)
- SPRINTER 3-t Van (B906)
- SPRINTER 4,6-t Platform/Chassis (B906)
- SPRINTER 4,6-t Van (B906)
- SPRINTER 5-t Platform/Chassis (B906)
- SPRINTER 5-t Van (B906)
- VIANO (W639)
- VITO / MIXTO Van (W639)
- VITO Bus (W639)
- MERCEDES-BENZ (BBDC)**
- C-CLASS (W204)
- E-CLASS (W211)
- E-CLASS (W212)
- GLK-CLASS (X204)
- MERCEDES-BENZ (FJDA)**
- VIANO
- VITO (V639)



D

PROGRAMMERGÄNZUNGEN

E

ADDITIONS TO THE RANGE

ADDITIONS TO THE RANGE

ADDITIONS TO THE RANGE

DW-TL 7.00513.19.0 New	SUV 7.02207.05.0 New	EUV-AGR 7.02256.44.0 New
LEXUS GS (_L1_) IS III (_E3_) NX (_Z1_) RC (_C1_) RX (_L2_) TOYOTA AURIS (_E18_) AURIS Estate (_E18_) C-HR (_X1_) CROWN (_S21_) CROWN (_S22_) HARRIER (_U6_) TOYOTA FAW CROWN ROYAL (_S21_) TOYOTA GAC HIGHLANDER (_U5_)	DISCOVERY V (L462) RANGE ROVER III (L322) RANGE ROVER IV (L405) RANGE ROVER SPORT I (L320) RANGE ROVER SPORT II (L494) RANGE ROVER VELAR (L560) EUV-SR 7.02256.43.0 New CHEVROLET AVEO Hatchback (T300) AVEO Saloon (T300) CRUZE (J300) CRUZE Hatchback (J305) CRUZE Station Wagon (J308) ORLANDO (J309) TRAX OPEL ASTRA H (A04) ASTRA H Estate (A04) ASTRA H GTC (A04) ASTRA H Saloon (A04) ASTRA H TwinTop (A04) ASTRA J (P10) ASTRA J GTC ASTRA J Saloon ASTRA J Sports Tourer (P10) CORSA D (S07) INSIGNIA A (G09) INSIGNIA A Saloon (G09) INSIGNIA A Sports Tourer (G09) MERIVA B MPV (S10) MOKKA / MOKKA X (J13) SIGNUM Hatchback (Z03) VECTRA C (Z02) VECTRA C Estate (Z02) VECTRA C GTS (Z02) ZAFIRA / ZAFIRA FAMILY B (A05) ZAFIRA TOURER C (P12) VAUXHALL ASTRA Mk V (H) (A04) ASTRA Mk V (H) Estate (A04) ASTRA Mk V (H) Sport Hatch (A04) ASTRA Mk V (H) TwinTop (A04) ASTRA Mk VI (J) (P10) ASTRA Mk VI (J) Estate (P10) ASTRA Mk VI (J) GTC (P10) ASTRA Mk VI (J) Saloon (P10) CORSA Mk III (D) (S07) INSIGNIA Mk I (A) Hatchback (G09) INSIGNIA Mk I (A) Saloon (G09) INSIGNIA Mk I (A) Sports Tourer (G09) MERIVA Mk II (B) (S10) MOKKA / MOKKA X (J13) SIGNUM (Z03) VECTRA Mk II (C) (Z02) VECTRA Mk II (C) Estate (Z02) VECTRA Mk II (C) GTS (Z02) ZAFIRA Mk II (B) (A05) ZAFIRA Mk III (P12)	COLORADO Extended Cab Pickup CRUZE Saloon EXPRESS 2500 Extended Cargo Van EXPRESS 2500 Standard Cargo Van EXPRESS 2500 Standard Passenger Van EXPRESS 3500 Cutaway Van EXPRESS 3500 Extended Cargo Van EXPRESS 3500 Standard Cargo Van EXPRESS 3500 Standard Passenger Van TRAX GMC CANYON Crew Cab Pickup CANYON Extended Cab Pickup SAVANA 2500 Standard Cargo Van SAVANA 2500 Standard Passenger Van SAVANA 3500 Cutaway Van SAVANA 3500 Extended Cargo Van SAVANA 3500 Extended Passenger Van SAVANA 3500 Standard Cargo Van OPEL ANTARA A (L07) ASTRA J (P10) ASTRA J GTC ASTRA J Saloon ASTRA J Sports Tourer (P10) ASTRA K (B16) ASTRA K Sports Tourer (B16) CASCADA (W13) INSIGNIA A (G09) INSIGNIA A Country Tourer (G09) INSIGNIA A Saloon (G09) INSIGNIA A Sports Tourer (G09) INSIGNIA B Country Tourer (Z18) INSIGNIA B Grand Sport (Z18) INSIGNIA B Sports Tourer (Z18) MERIVA B MPV (S10) MOKKA / MOKKA X (J13) ZAFIRA TOURER C (P12) VAUXHALL ASTRA Mk VI (J) (P10) ASTRA Mk VI (J) Estate (P10) ASTRA Mk VI (J) GTC (P10) ASTRA Mk VII (K) (B16) ASTRA Mk VII (K) Estate (B16) CASCADA Convertible (W13) INSIGNIA Mk I (A) Country Tourer (G09) INSIGNIA Mk I (A) Hatchback (G09) INSIGNIA Mk I (A) Saloon (G09) INSIGNIA Mk I (A) Sports Tourer (G09) INSIGNIA Mk II (B) Country Tourer (Z18) INSIGNIA Mk II (B) Hatchback (Z18) INSIGNIA Mk II (B) Sports Tourer (Z18) MERIVA Mk II (B) (S10) MOKKA / MOKKA X (J13) ZAFIRA Mk III (P12)
DW-TL 7.00607.04.0 New		
IVECO DAILY V Platform/Chassis DAILY V Van DAILY VI Platform/Chassis DAILY VI Van		
LDRV 7.01282.02.0 New		
VOLVO ENGINE		
EUV-VB 7.01441.04.0 New		
BUICK REGAL Saloon VERANO Saloon CHEVROLET COBALT COBALT Coupe HHR OPEL ASTRA J GTC GT Convertible (M07) INSIGNIA A (G09) INSIGNIA A Saloon (G09) INSIGNIA A Sports Tourer (G09) PONTIAC SOLSTICE Convertible SOLSTICE Coupe VAUXHALL ASTRA Mk VI (J) GTC (P10) INSIGNIA Mk I (A) Hatchback (G09) INSIGNIA Mk I (A) Saloon (G09) INSIGNIA Mk I (A) Sports Tourer (G09)		
SUV 7.02207.05.0 New		
JAGUAR F-PACE (X761) XF I (X250) XF II (X260) XF SPORTBRAKE (X250) XF SPORTBRAKE (X260) XJ (X351) LAND ROVER DISCOVERY IV (L319)		
	EUV-AGR 7.02256.44.0 New	
	CHEVROLET COLORADO Crew Cab Pickup	
		EUV-SR 7.02256.45.0 New
		CHEVROLET AVEO Hatchback (T300) AVEO Saloon (T300) CRUZE (J300) CRUZE Hatchback (J305) CRUZE Station Wagon (J308)

ADDITIONS TO THE RANGE

EUV-SR 7.02256.45.0 New ORLANDO (J309) TRAX	DW-TL 7.02325.05.0 New V40 Hatchback (525, 526) V40 Hatchback Van (525, 526) V50 (545) V60 I (155, 157) V60 I Estate Van (155) V70 III (135) V70 III Estate Van (135) XC60 I SUV (156) XC70 II (136)	EUV-AGR 7.02613.02.0 New VOLVO C30 (533) C70 II Convertible (542) S40 II (544) S60 II (134) S80 II (124) V40 Hatchback (525, 526) V50 (545) V60 I (155, 157) V70 III (135) XC60 I SUV (156) XC70 II (136)
LDRV 7.02256.49.0 New ABARTH 500 / 595 / 695 GRANDE PUNTO ALFA ROMEO 147 (937_) GIULIETTA (940_) MITO (955_) FIAT BRAVO II (198_) DOBLO Box Body/MPV (223_) DOBLO Bus (263_) DOBLO Cargo (263_) DOBLO MPV (119_, 223_) DOBLO Platform/Chassis (263_) GRANDE PUNTO (199_) IDEA (350_) PALIO (178_) PALIO Weekend (178_, 173_, 373_, 374_, 171_) PUNTO (188_) PUNTO Hatchback Van (188_) SIENA (178_, 172_) STILO (192_) STRADA Pickup (178_) LANCIA DELTA III (844_) MUSA (350_) THESIS (841_)	EUV-LS 7.02428.02.0 New JAGUAR F-PACE (X761) XF I (X250) XF II (X260) XF SPORTBRAKE (X250) XF SPORTBRAKE (X260) XJ (X351) LAND ROVER DISCOVERY IV (L319) DISCOVERY V (L462) RANGE ROVER IV (L405) RANGE ROVER SPORT I (L320) RANGE ROVER SPORT II (L494) RANGE ROVER VELAR (L560)	DW-TL 7.02968.02.0 New FUSO CANTER MITSUBISHI Canter (FE5, FE6) VI
EUV-RK 7.02256.50.0 New ALFA ROMEO 147 (937_) 156 (932_) 156 Sportwagon (932_) 166 (936_) GT (937_) FIAT BRAVA (182_) BRAVO I (182_) BRAVO II (198_) DOBLO Box Body/MPV (223_) DOBLO MPV (119_, 223_) MAREA (185_) MAREA Weekend (185_) MULTIPLA (186_) STILO (192_) STILO Multi Wagon (192_) STILO VAN (192_) LANCIA LYBRA (839_) LYBRA SW (839_) THESIS (841_)	EUV-AGR 7.02436.02.0 New JAGUAR F-PACE (X761) XF I (X250) XF II (X260) XF SPORTBRAKE (X250) XF SPORTBRAKE (X260) XJ (X351) LAND ROVER DISCOVERY IV (L319) DISCOVERY V (L462) RANGE ROVER IV (L405) RANGE ROVER SPORT I (L320) RANGE ROVER SPORT II (L494) RANGE ROVER VELAR (L560)	EUV-LS 7.03075.02.0 New BMW 7 (F01, F02, F03, F04) X6 (E71, E72)
DW-TL 7.02325.05.0 New VOLVO C30 (533) C70 II Convertible (542) S40 II (544) S60 II (134) S80 II (124)	SUV 7.02476.09.0 New DACIA DOKKER Express Box Body/MPV DOKKER MPV (KE_) DUSTER (HM_) DUSTER (HS_) LODGY (JS_) RENAULT CAPTUR I (J5_, H5_) CLIO IV (BH_) CLIO IV Grandtour (KH_) GRAND SCÉNIC III (JZ0/1_) GRAND SCÉNIC IV (R9_) KADJAR (HA_, HL_) KANGOO / GRAND KANGOO (KW0/1_) KANGOO Express (FW0/1_) MEGANE III Coupe (DZ0/1_) MEGANE IV GRAND COUPE MEGANE IV Grandtour (K9A/M/N_) MEGANE IV Hatchback (B9A/M/N_)	LDRV 7.03162.09.0 New FORD C-MAX II (DXA/CB7, DXA/CEU) C-MAX II Van FOCUS III FOCUS III Hatchback Van FOCUS III Saloon FOCUS III Turnier GALAXY II (WA6) GRAND C-MAX (DXA/CB7, DXA/CEU) GRAND C-MAX Van MONDEO IV (BA7) MONDEO IV Saloon (BA7) MONDEO IV Turnier (BA7) S-MAX (WA6) VOLVO S60 II (134) S80 II (124) V60 I (155, 157) V70 III (135)
		LDRV 7.03306.16.0 New FORD FOCUS III FOCUS III Turnier KUGA II (DM2) MONDEO V Hatchback (CE) MONDEO V Saloon (CD) MONDEO V Turnier (CF) FORD USA TAURUS LINCOLN MKC MKT MKZ
		DW-TL 7.03554.10.0 New MAZDA 3 (BM, BN)

DW-TL	7.03554.10.0 New	DW-TL	7.04638.01.0 New	SUV	7.04818.04.0 New
3 Saloon (BM_, BN_) 6 Estate (GJ, GL) 6 Estate Van (GJ) 6 Saloon (GJ, GL) CX-5 (KE, GH) CX-5 (KF)		PORSCHE 718 BOXSTER (982) 718 CAYMAN (982) CAYENNE (92A) MACAN (95B) PANAMERA (970)		E-CLASS Coupe (C238) E-CLASS T-Model (S212) E-CLASS T-Model (S213) GLA (H247) GLA-CLASS (X156) GLB (X247) GLC (X253) GLC Coupe (C253) GLE (V167) GLE Coupe (C167) GLK-CLASS (X204) SLC (R172) SLK (R172) V-CLASS (W447) VITO Tourer (W447) VITO Van (W447)	
EUV-AGR	7.03584.01.0 New	SUV	7.04654.10.0 New		
LEXUS IS II (_E2_) TOYOTA AURIS (_E15_) AURIS (_E18_) AURIS Estate (_E18_) AVENSIS (_T25_) AVENSIS Estate (_T25_) AVENSIS Estate (_T27_) AVENSIS Saloon (_T25_) AVENSIS Saloon (_T27_) COROLLA Saloon (_E15_) COROLLA Verso (ZER_, ZZE12_, R1_) RAV 4 III (_A3_) RAV 4 IV (_A4_) VERSO (_R2_)		LEXUS GS (_L1_) IS III (_E3_) NX (_Z1_) RC (_C1_) RX (_L2_) TOYOTA CROWN (_S21_) CROWN (_S22_) HARRIER (_U6_) TOYOTA FAW CROWN ROYAL (_S21_) TOYOTA GAC HIGHLANDER (_U5_)		MERCEDES-BENZ (BBDC) A-CLASS (W177) C-CLASS (W205) E-CLASS (W212) E-CLASS (W213) GLA (H247) GLA (X156) GLB (X247) GLC (X253) GLK-CLASS (X204) MERCEDES-BENZ (FJDA) V-CLASS (W448) VITO (W448) NISSAN QASHQAI II SUV (J11, J11_) X-TRAIL (T32_) RENAULT CAPTUR I (J5_, H5_) CAPTUR II GRAND SCÉNIC IV (R9_) KADJAR (HA_, HL_) KOLEOS II (HC_) MEGANE IV GRAND COUPE MEGANE IV Grandtour (K9A/M/N_) MEGANE IV Hatchback (B9A/M/N_) SCÉNIC IV (J9_) TALISMAN (LP_) TALISMAN Grandtour (KP_)	
LDRV	7.04492.07.0 New	DW-TL	7.04663.14.0 New		
FORD C-MAX II (DXA/CB7, DXA/CEU) C-MAX II Van FIESTA VI (CB1, CCN) FIESTA VI Van FOCUS III FOCUS III Hatchback Van FOCUS III Saloon FOCUS III Turnier GALAXY II (WA6) GALAXY III (CK) GALAXY MK II VAN (WA6) GRAND C-MAX (DXA/CB7, DXA/CEU) GRAND C-MAX Van KUGA II (DM2) MONDEO IV (BA7) MONDEO IV Saloon (BA7) MONDEO IV Turnier (BA7) MONDEO IV Van S-MAX (CJ, WA6) S-MAX (WA6) S-MAX VAN (WA6) TOURNEO CONNECT / GRAND TOURNEO CONNECT V408 MPV TRANSIT CONNECT V408 Box Body/MPV		FORD USA EDGE (U387) EXPLORER F-150 Crew Cab Pickup F-150 Extended Cab Pickup F-150 Standard Cab Pickup LAND ROVER DISCOVERY SPORT (L550) RANGE ROVER EVOQUE (L538) RANGE ROVER EVOQUE Convertible (L538)			
		SUV	7.04818.04.0 New		
FORD AUSTRALIA FIESTA Hatchback (WZ) KUGA (TF) VOLVO S60 II (134) S80 II (124) V40 Hatchback (525, 526) V60 I (155, 157) V70 III (135)		DACIA DOKKER Express Box Body/MPV DOKKER MPV (KE_) LODGY (JS_) MERCEDES-BENZ A-CLASS (W176) A-CLASS (W177) A-CLASS Saloon (V177) B-CLASS Sports Tourer (W246, W242) B-CLASS Sports Tourer (W247) C-CLASS (W204) C-CLASS (W205) C-CLASS Convertible (A205) C-CLASS Coupe (C204) C-CLASS Coupe (C205) C-CLASS T-Model (S204) C-CLASS T-Model (S205) CLA (C118) CLA Coupe (C117) CLA Shooting Brake (X117) CLA Shooting Brake (X118) CLS (C218) E-CLASS (W212) E-CLASS (W213) E-CLASS Convertible (A207) E-CLASS Convertible (A238) E-CLASS Coupe (C207)		SUV	7.04927.08.0 New
				MERCEDES-BENZ A-CLASS (W177) A-CLASS Saloon (V177) AMG GT (X290) C-CLASS (W205) C-CLASS Convertible (A205) C-CLASS Coupe (C205) C-CLASS T-Model (S205) CLS (C257) E-CLASS (W213) E-CLASS Convertible (A238) E-CLASS Coupe (C238) E-CLASS T-Model (S213) G-CLASS (W463) GLC (X253) GLC Coupe (C253) S-CLASS (W222, V222, X222)	

ADDITIONS TO THE RANGE

<p>SUV 7.04927.08.0 New</p> <p>S-CLASS Convertible (A217) S-CLASS Coupe (C217)</p>	<p>SV-NWV 7.06117.00.0 New</p> <p>3 Coupe (E92) 3 Touring (E46) 3 Touring (E91) 5 (E60) 5 Touring (E61) 6 (E63) 6 Convertible (E64) 7 (E65, E66, E67) X1 (E84) X3 (E83) X5 (E53) X5 (E70) Z4 Roadster (E85)</p>	<p>SV-NWV 7.06117.02.0 New</p> <p>MINI (BMW) MINI (R56) MINI CLUBMAN (R55) MINI CLUBVAN (R55) MINI COUNTRYMAN (R60) MINI Convertible (R57) MINI Coupe (R58) MINI PACEMAN (R61) MINI Roadster (R59)</p>
<p>DW-TL 7.05314.02.0 New</p> <p>MAZDA 2 (DL, DJ) 2 Saloon (DL) 3 Saloon (BP_) CX-3 (DK)</p>	<p>5 (E60) 5 Touring (E61) 6 (E63) 6 Convertible (E64) 7 (E65, E66, E67) X1 (E84) X3 (E83) X5 (E53) X5 (E70) Z4 Roadster (E85)</p>	<p>MINI (BMW) MINI (R56) MINI CLUBMAN (R55) MINI COUNTRYMAN (R60) MINI Convertible (R57) MINI PACEMAN (R61) MINI Roadster (R59)</p>
<p>SUV 7.05367.05.0 New</p> <p>MINI (BMW) MINI (R56) MINI CLUBMAN (R55) MINI COUNTRYMAN (R60) MINI Convertible (R57) MINI PACEMAN (R61) MINI Roadster (R59)</p> <p>POLESTAR POLESTAR 1 (P)</p> <p>VOLVO S60 II (134) S60 III (224) S90 II (234) V40 Hatchback (525, 526) V60 I (155, 157) V60 II (225, 227) V70 III (135) V90 II Estate (235, 236) XC60 I SUV (156) XC60 II (246) XC90 II (256)</p> <p>VOLVO ASIA S60 S60L S90 XC60 II</p>	<p>BMW (BRILLIANCE) 3 SERIES (E46) 3 SERIES (E90) 5 SERIES (E60) X1 (E84)</p> <p>ROLLS-ROYCE PHANTOM VII (RR1) PHANTOM VII Coupe (RR3) PHANTOM VII Drophead Coupe (RR2)</p>	<p>SV-NWV 7.06117.03.0 New</p> <p>CHEVROLET COLORADO Cab & Chassis COLORADO Crew Cab Pickup COLORADO Extended Cab Pickup COLORADO Standard Cab Pickup</p> <p>GMC CANYON Cab & Chassis CANYON Crew Cab Pickup CANYON Extended Cab Pickup CANYON Standard Cab Pickup</p> <p>HUMMER HUMMER H3 HUMMER H3T</p>
<p>SM 7.05432.13.0 New</p> <p>FORD FIESTA V (JH_, JD_) FIESTA V Van FUSION (JU_) KA (RB_) STREET KA (RL2)</p>	<p>SV-NWV 7.06117.01.0 New</p> <p>BMW 1 (E81) 1 (E87) 1 Convertible (E88) 1 Coupe (E82) 3 (E90) 3 Convertible (E93) 3 Coupe (E92) 3 Touring (E91) 5 (E60) 5 (F10) 5 Touring (E61) 5 Touring (F11) 6 (E63) 6 Convertible (E64) 7 (E65, E66, E67) 7 (F01, F02, F03, F04) X1 (E84) X3 (E83) X3 (F25) X5 (E70) X6 (E71, E72) Z4 Coupe (E86) Z4 Roadster (E85) Z4 Roadster (E89)</p>	<p>SV-NWV 7.06117.04.0 New</p> <p>BUICK ALLURE Saloon ENCLAVE LA CROSSE Saloon RENDEZVOUZ</p> <p>BUICK SGM GL8 S II (CU3) LACROSSE (EG2) PARK AVENUE (S8E) ROYAUM (S8W)</p> <p>CADILLAC ATS ATS Coupe CTS CTS Coupe CTS Sport Wagon SRX STS XTS (1P5)</p>
<p>SV-NWV 7.06117.00.0 New</p> <p>ALPINA B5 (E60) B5 Estate (E61) B6 Convertible (E64) B7 (E65)</p> <p>BMW 1 (E81) 1 (E87) 1 Convertible (E88) 1 Coupe (E82) 3 (E46) 3 (E90) 3 Compact (E46) 3 Convertible (E46) 3 Convertible (E93) 3 Coupe (E46)</p>	<p>SV-NWV 7.06117.02.0 New</p> <p>BMW 1 (F20) 1 (F21) 3 (F30, F80) 3 Touring (F31)</p> <p>BMW (BRILLIANCE) 3 SERIES (E90) 5 SERIES (E60) 5 SERIES (F10, F18)</p>	<p>CADILLAC (SGM) SLS (S6D) XTS (EG4)</p> <p>CHEVROLET CAMARO CAMARO Convertible CAPTIVA (C100, C140) CAPTIVA SPORT COLORADO Crew Cab Pickup COLORADO Extended Cab Pickup EQUINOX IMPALA Saloon MALIBU MALIBU (V300) TRAVERSE</p> <p>GMC ACADIA TERRAIN</p>

SV-NWV	7.06117.04.0 New	ZM-NWV	7.06117.12.0 New	ZM-NWV	7.06117.26.0 New
OPEL ANTARA A (L07) INSIGNIA A (G09) INSIGNIA A Saloon (G09) INSIGNIA A Sports Tourer (G09) SIGNUM Hatchback (Z03) VECTRA C (Z02) VECTRA C Estate (Z02) VECTRA C GTS (Z02)		MONDEO V Saloon (CD) MONDEO V Turnier (CF) TOURNEO CONNECT / GRAND TOURNEO CONNECT V408 MPV TOURNEO COURIER B460 MPV TRANSIT CONNECT V408 Box Body/MPV TRANSIT COURIER B460 Box Body/MPV TRANSIT COURIER B460 MPV FORD AUSTRALIA ECOSPORT (BK, BL) FIESTA Hatchback (WZ)		A4 B9 (8W2, 8WC) A4 B9 Avant (8W5, 8WD) A5 (8T3) A5 (F53, F5P) A5 Convertible (8F7) A5 Convertible (F57, F5E) A5 Sportback (8TA) A5 Sportback (F5A, F5F) A6 C7 (4G2, 4GC) A6 C7 Avant (4G5, 4GD) A6 C8 (4A2) A6 C8 Avant (4A5) A7 Sportback (4GA, 4GF) A7 Sportback (4KA) A8 D4 (4H2, 4H8, 4HC, 4HL) Q2 (GAB, GAG) Q3 (8UB, 8UG) Q3 Sportback (F3N) Q5 (8RB) Q5 (FYB, FYG) Q5 Van (8RB) Q7 (4MB, 4MG) Q8 (4MN) TT (8J3) TT (FV3, FVP) TT Roadster (8J9) TT Roadster (FV9, FVR)	
		SV-NWV	7.06117.16.0 New		
		VOLVO S40 I (644) V40 Estate (645)			
		SV-NWV	7.06117.17.0 New		
		VOLVO S40 I (644) V40 Estate (645)			
		ZM-NWV	7.06117.24.0 New		
		MERCEDES-BENZ C-CLASS (W203) C-CLASS (W204) C-CLASS Coupe (CL203) C-CLASS T-Model (S203) C-CLASS T-Model (S204) CLC-CLASS (CL203) CLK (C209) CLK Convertible (A209) E-CLASS (W211) E-CLASS (W212) E-CLASS T-Model (S211) SLK (R171) SPRINTER 3,5-t Bus (B906) SPRINTER 3,5-t Platform/Chassis (B906) SPRINTER 3,5-t Van (B906) SPRINTER 3-t Bus (B906) SPRINTER 3-t Platform/Chassis (B906) SPRINTER 3-t Van (B906) SPRINTER 5-t Platform/Chassis (B906)			
		SV-NWV	7.06117.10.0 New		
ALPINA ROADSTER V8 (E52)					
BMW 5 (E39) 5 Touring (E39) 7 (E38) X5 (E53)					
LAND ROVER RANGE ROVER III (L322)					
ZM-NWV	7.06117.12.0 New	ZM-NWV	7.06117.26.0 New		
FORD B-MAX (JK) B-MAX Van (JK) C-MAX II (DXA/CB7, DXA/CEU) C-MAX II Van ECOSPORT FIESTA Saloon FIESTA VI (CB1, CCN) FIESTA VI Van FIESTA VII (HJ, HF) FIESTA VII Van FOCUS III FOCUS III Estate Van FOCUS III Hatchback Van FOCUS III Saloon FOCUS III Turnier FOCUS IV (HN) FOCUS IV Saloon (HM) FOCUS IV Turnier (HP) GRAND C-MAX (DXA/CB7, DXA/CEU) GRAND C-MAX Van MONDEO V Hatchback (CE)		MERCEDES-BENZ (BBDC) C-CLASS (W204) E-CLASS (W211) E-CLASS (W212)			
		ZM-NWV	7.06117.26.0 New		
		AUDI A1 (8X1, 8XK) A1 Sportback (8XA, 8XF) A3 (8P1) A3 (8V1, 8VK) A3 Convertible (8P7) A3 Convertible (8V7, 8VE) A3 Limousine (8VS, 8VM) A3 Sportback (8PA) A3 Sportback (8VA, 8VF) A4 Allroad B8 (8KH) A4 Allroad B9 (8WH, 8WJ) A4 B8 (8K2) A4 B8 Avant (8K5)			
				PORSCHE MACAN (95B)	
				SEAT ALHAMBRA (710, 711) ALTEA (5P1) ALTEA XL (5P5, 5P8) EXEO (3R2) EXEO ST (3R5) IBIZA IV SC (6J1, 6P5) LEON (1P1) LEON (5F1) LEON Hatchback Van (5F1) LEON SC (5F5) LEON ST (5F8) LEON ST Estate Van (5F8) TOLEDO III (5P2)	
				SKODA OCTAVIA II (1Z3) OCTAVIA II Combi (1Z5) OCTAVIA III (5E3, NL3, NR3) OCTAVIA III Combi (5E5, 5E6) OCTAVIA IV (NX3) OCTAVIA IV Combi (NX5) SUPERB II (3T4) SUPERB II Estate (3T5) SUPERB III (3V3) SUPERB III Estate (3V5) YETI (5L)	
				SKODA SVW OCTAVIA Hatchback (913)	
				VOLKSWAGEN AMAROK (2HA, 2HB, S1B, S6B, S7A, S7B) AMAROK Platform/Chassis (S1B, S6B, S7B) ARTEON (3H7, 3H8) ARTEON SHOOTING BRAKE (3H9) ATLAS (CA1)	

ZM-NWV 7.06117.26.0 New	SV-NWV 7.06117.33.0 New	SV-NWV 7.06117.36.0 New
ATLAS CROSS SPORT (CMC) BEETLE (5C1, 5C2) BEETLE Convertible (5C7, 5C8) CC B7 (358) EOS (1F7, 1F8) GOLF ALLTRACK VII Variant (BA5, BV5) GOLF V (1K1) GOLF V Variant (1K5) GOLF VI (5K1) GOLF VI Convertible (517) GOLF VI Van (5K1_) GOLF VI Variant (AJ5) GOLF VII (5G1, BQ1, BE1, BE2) GOLF VII Van (5G1) GOLF VII Variant (BA5, BV5) JETTA III (1K2) JETTA IV (162, 163, AV3, AV2) JETTA VII Saloon (BU3) MULTIVAN V (7HM, 7HN, 7HF, 7EF, 7EM, 7EN) MULTIVAN VI (SGF, SGM, SGN, SHM, SHN) PASSAT ALLTRACK B7 (365) PASSAT ALLTRACK B8 Variant (3G5, CB5) PASSAT B6 (3C2) PASSAT B6 Variant (3C5) PASSAT B7 (362) PASSAT B7 (A32, A33) PASSAT B7 Estate Van (365) PASSAT B7 Variant (365) PASSAT B8 (3G2, CB2) PASSAT B8 Variant (3G5, CB5) PASSAT CC B6 (357) POLO V (6R1, 6C1) SCIROCCO III (137, 138) SCIROCCO Van (137) SHARAN (7N1, 7N2) SHARAN VAN (7N1, 7N2) T-ROC (A11) TIGUAN (5N_) TIGUAN (AD1, AX1) TIGUAN ALLSPACE (BW2) TIGUAN VAN (5N_) TOUAREG (CR7) TOURAN (5T1) TRANSPORTER / CARAVELLE VI Bus (SGB, SGG, SGJ, SGC, SHB, SHJ) TRANSPORTER V Bus (7HB, 7HJ, 7EB, 7EJ, 7EF, 7EG, 7HF, 7EC) TRANSPORTER V Platform/Chassis (7JD, 7JE, 7JL, 7JY, 7JZ, 7FD) TRANSPORTER V Van (7HA, 7HH, 7EA, 7EH) TRANSPORTER VI Platform/Chassis (SFD, SFE, SFL, SFZ, SJD, SJ) TRANSPORTER VI Van (SGA, SGH, SHA, SHH)	MONDEO V Turnier (CF) RANGER (TKE) S-MAX (CJ, WA6) TRANSIT CONNECT MPV TRANSIT CONNECT V408 Box Body/MPV FORD USA EDGE EDGE (U387) EXPLORER MUSTANG Convertible MUSTANG Coupe TAURUS LINCOLN MKC MKT MKX MKZ MERCURY MILAN Saloon	ALPINA B6 Gran Coupe (F06) B7 (F01, F02) BMW 1 (F20) 1 (F21) 1 Convertible (E88) 1 Coupe (E82) 2 Convertible (F23) 2 Coupe (F22, F87) 3 (E90) 3 (F30, F80) 3 Convertible (E93) 3 Coupe (E92) 3 Gran Turismo (F34) 3 Touring (E91) 3 Touring (F31) 4 Convertible (F33, F83) 4 Coupe (F32, F82) 4 Gran Coupe (F36) 5 (F10) 5 Gran Turismo (F07) 5 Touring (F11) 6 Convertible (F12) 6 Coupe (F13) 6 Gran Coupe (F06) 7 (F01, F02, F03, F04) 7 (G11, G12) X1 (E84) X3 (F25) X4 (F26) X5 (E70) X5 (F15, F85) X6 (E71, E72) X6 (F16, F86) BMW (BRILLIANCE) 3 SERIES (F30, F35) 5 SERIES (F10, F18) ROLLS-ROYCE CULLINAN (RR31) DAWN (RR6) GHOST I (RR4) GHOST II (RR21) GHOST II Extended Wheelbase (RR22) PHANTOM VIII (RR11, RR12) WRAITH (RR5)
	SV-NWV 7.06117.34.0 New CITROEN C2 (JM_) C3 I (FC_, FN_) C4 Coupe (LA_) C4 I (LC_) C4 I Saloon C5 II (RC_) C5 II Break (RE_) C8 (EA_, EB_) C8 Van (EA_, EB_) PEUGEOT 1007 (KM_) 206 Hatchback (2A/C) 206 SW (2E/K) 207 (WA_, WC_) 307 (3A/C) 307 Break (3E) 307 CC (3B) 307 SW (3H) 307 Saloon 407 (6D_) 407 SW (6E_) 807 (EB_)	
	SV-NWV 7.06117.35.0 New ALFA ROMEO MITO (955_) FIAT 500 (312_) 500 C (312_) DOBLO Box Body/MPV (223_) DOBLO MPV (119_, 223_) GRANDE PUNTO (199_) IDEA (350_) LINEA (323_, 110_) PALIO (178_) SIENA (178_, 172_) LANCIA MUSA (350_) YPSILON (843_)	SV-NWV 7.06117.37.0 New AUDI A3 (8P1) A3 Sportback (8PA) A6 C6 (4F2) Q7 (4LB) Q7 Van (4LB) TT (8J3) TT Roadster (8J9) SEAT ALTEA (5P1) ALTEA XL (5P5, 5P8) LEON (1P1) TOLEDO III (5P2) SKODA OCTAVIA II (1Z3)
SV-NWV 7.06117.33.0 New FORD C-MAX II (DXA/CB7, DXA/CEU) FOCUS III FOCUS III Turnier FUSION Saloon GALAXY III (CK) KUGA II (DM2) MONDEO V Hatchback (CE) MONDEO V Saloon (CD)		

ADDITIONS TO THE RANGE

ADDITIONS TO THE RANGE

SV-NWV 7.06117.37.0 New	SV-NWV 7.06117.38.0 New	SV-NWV 7.06117.42.0 New
OCTAVIA II Combi (1Z5) SUPERB II (3T4) SUPERB II Estate (3T5) VOLKSWAGEN ATLAS (CA1) ATLAS CROSS SPORT (CMC) CC B7 (358) EOS (1F7, 1F8) GOLF PLUS V (5M1, 521) GOLF V (1K1) JETTA III (1K2) PASSAT B6 (3C2) PASSAT B6 Variant (3C5) PASSAT B7 (362) PASSAT B7 (A32, A33) PASSAT B7 Estate Van (365) PASSAT B7 Variant (365) PASSAT CC B6 (357) PHAETON (3D1, 3D2, 3D3, 3D4, 3D6, 3D7, 3D8, 3D9) TOUAREG (7LA, 7L6, 7L7) TOUAREG (7P5, 7P6) TOURAN (1T1, 1T2) TOURAN VAN (1T1, 1T2)	LANCIA DELTA III (844_) MUSA (350_) YPSILON (312_) YPSILON (843_) SV-NWV 7.06117.39.0 New RENAULT CLIO III (BR0/1, CR0/1) CLIO III Grandtour (KR0/1_) FLUENCE (L3_) GRAND SCÉNIC II (JM0/1_) GRAND SCÉNIC III (JZ0/1_) LAGUNA II (BG0/1_) LAGUNA II Grandtour (KG0/1_) LAGUNA III (BT0/1) LAGUNA III Grandtour (KT0/1) MEGANE CC (EZ0/1_) MEGANE II (BM0/1_, CM0/1_) MEGANE II Coupé-Cabriolet (EM0/1_) MEGANE II Estate (KM0/1_) MEGANE II Saloon (LM0/1_) MEGANE III Coupe (DZ0/1_) MEGANE III Grandtour (KZ0/1) MEGANE III Hatchback (BZ0/1_, B3_) MODUS / GRAND MODUS (FJP0_) SCÉNIC II (JM0/1_) SCÉNIC III (JZ0/1_) TWINGO II (CN0_) WIND (E4M_)	A8 D3 (4E2, 4E8) Q5 (8RB) SV-NWV 7.06117.43.0 New AUDI A3 (8P1) A3 Sportback (8PA) Q7 (4LB) TT (8J3) TT (8N3) TT Roadster (8J9) TT Roadster (8N9) VOLKSWAGEN EOS (1F7, 1F8) GOLF IV (1J1) GOLF V (1K1) MULTIVAN V (7HM, 7HN, 7HF, 7EF, 7EM, 7EN) PASSAT B6 (3C2) PASSAT B6 Variant (3C5) TOUAREG (7LA, 7L6, 7L7) TRANSPORTER V Bus (7HB, 7HJ, 7EB, 7EJ, 7EF, 7EG, 7HF, 7EC) TRANSPORTER V Platform/Chassis (7JD, 7JE, 7JL, 7JY, 7JZ, 7FD) TRANSPORTER V Van (7HA, 7HH, 7EA, 7EH) ENGINE
SV-NWV 7.06117.38.0 New	ZM-NWV 7.06117.41.0 New	SV-NWV 7.06117.44.0 New
ALFA ROMEO 159 (939_) 159 Sportwagon (939_) 4C (960_) 4C SPIDER (960_) BRERA (939_) GIULIETTA (940_) GIULIETTA Hatchback Van (940_) MITO (955_) SPIDER (939_) CHRYSLER YPSILON DODGE FORZA FIAT 500 (312_) 500 C (312_) DOBLO Box Body/MPV (223_) DOBLO MPV (119_, 223_) FIORINO Box Body/MPV (225_) FIORINO Box Body/MPV (265_) FIORINO MPV (225_) GRANDE PUNTO (199_) GRANDE PUNTO Van (199_) IDEA (350_) LINEA (323_, 110_) PALIO (178_) PANDA (169_) PANDA (312_, 319_) PANDA Hatchback Van (169_) PANDA VAN (312_, 519_) PUNTO (199_) PUNTO EVO (199_) QUBO (225_) SIENA (178_, 172_) FORD KA (RU8)	SCION FR-S Coupe SUBARU BRZ FORESTER (SJ_) IMPREZA Hatchback (GP_) IMPREZA Hatchback (GT_) IMPREZA Saloon (GJ_) LEGACY V (BM) LEGACY V Estate (BR) LEGACY VI (BN, BS) LEVORG OUTBACK (BR) OUTBACK (BS) WRX Saloon (GJ) XV (GT) XV (_GP_) TOYOTA GT 86 Coupe (ZN6_)	SV-NWV 7.06117.44.0 New AUDI A3 (8P1) A3 Sportback (8PA) Q7 (4LB) TT (8J3) TT (8N3) TT Roadster (8J9) TT Roadster (8N9) SEAT ALHAMBRA (7V8, 7V9) VOLKSWAGEN BORA I (1J2) BORA Variant (1J6) EOS (1F7, 1F8) GOLF IV (1J1) GOLF IV Variant (1J5) GOLF V (1K1) MULTIVAN V (7HM, 7HN, 7HF, 7EF, 7EM, 7EN) PASSAT B5.5 (3B3) PASSAT B5.5 Variant (3B6) PASSAT B6 (3C2) PASSAT B6 Variant (3C5) SHARAN (7M8, 7M9, 7M6) TOUAREG (7LA, 7L6, 7L7) TRANSPORTER IV Bus (70B, 70C, 7DB, 7DK, 70J, 70K, 7DC, 7DJ) TRANSPORTER IV Platform/Chassis (70E, 70L, 70M, 7DE, 7DL, 7D) TRANSPORTER IV Van (70A, 70H, 7DA, 7DH) TRANSPORTER V Bus (7HB, 7HJ, 7EB, 7EJ, 7EF, 7EG, 7HF, 7EC) TRANSPORTER V Platform/Chassis (7JD, 7JE, 7JL, 7JY, 7JZ, 7FD) TRANSPORTER V Van (7HA, 7HH, 7EA, 7EH) ENGINE
SV-NWV 7.06117.42.0 New		
AUDI A4 B8 (8K2) A4 B8 Avant (8K5) A5 (8T3) A5 Convertible (8F7) A5 Sportback (8TA) A6 Allroad C6 (4FH) A6 C6 (4F2) A6 C6 Avant (4F5)		

SV-NWV 7.06117.45.0 New	EOV 7.08681.00.0 New	EOV 7.08681.00.0 New
CITROEN BERLINGO Box Body/MPV (B9) BERLINGO MULTISPACE (B9) C-ELYSEE (DD_) C3 AIRCROSS II (2R_, 2C_) C3 II (SC_) C3 III (SX) C3 PICASSO (SH_) C4 CACTUS C4 Coupe (LA_) C4 GRAND PICASSO I (UA_) C4 GRAND PICASSO II (DA_, DE_) C4 I (LC_) C4 II (B7) C4 PICASSO I MPV (UD_) C4 PICASSO II C4 SPACETOURER (3D_) C5 AIRCROSS C5 III (RD_) C5 III Break (RW_) DS3 DS3 Convertible DS4 (NX_) DS5 GRAND C4 SPACETOURER (3A_, 3E_) DS DS 3 (SA_) DS 3 Convertible (SB_) DS 4 / DS 4 CROSSBACK (NX_) DS 5 (KF_) DS 7 Crossback (J_) OPEL CROSSLAND X / CROSSLAND (P17, P2QO) GRANDLAND X (A18) PEUGEOT 2008 I (CU_) 207 (WA_, WC_) 207 CC (WD_) 207 SW (WK_) 208 I (CA_, CC_) 3008 MPV (0U_) 3008 SUV (MC_, MR_, MJ_, M4_) 301 308 CC (4B_) 308 I (4A_, 4C_) 308 II (LB_, LP_, LW_, LH_, L3_) 308 SW I (4E_, 4H_) 308 SW II (LC_, LJ_, LR_, LX_, L4_) 5008 (0U_, 0E_) 5008 II (MC_, MJ_, MR_, M4_) 508 I (8D_) 508 II (FB_, FH_, F3_) 508 SW I (8E_) 508 SW II (FC_, FJ_, F4_) PARTNER Box Body/MPV PARTNER TEPEE RCZ VAUXHALL CROSSLAND X (P17) GRANDLAND X (A18)	CITROEN BERLINGO (ER_, EC_) BERLINGO Box Body/MPV (B9) BERLINGO Box Body/MPV (K9) BERLINGO MULTISPACE (B9) BERLINGO Platform/Chassis (B9) C-ELYSEE (DD_) C3 AIRCROSS II (2R_, 2C_) C3 II (SC_) C3 III (SX) C3 PICASSO (SH_) C4 CACTUS C4 II (B7) C4 SPACETOURER (3D_) C5 AIRCROSS DS3 DS3 Convertible DS4 (NX_) DS5 GRAND C4 SPACETOURER (3A_, 3E_) JUMPY Bus (V_) JUMPY Van (V_) SPACETOURER Bus (V_) DS DS 3 (SA_) DS 3 CROSSBACK (UR_, UC_, UJ_) DS 3 Convertible (SB_) DS 4 / DS 4 CROSSBACK (NX_) DS 5 (KF_) DS 7 Crossback (J_) FORD B-MAX (JK) B-MAX Van (JK) C-MAX II (DXA/CB7, DXA/CEU) C-MAX II Van ECOSPORT FIESTA VI (CB1, CCN) FIESTA VI Van FIESTA VII (HJ, HF) FIESTA VII Van FOCUS III FOCUS III Estate Van FOCUS III Hatchback Van FOCUS III Saloon FOCUS III Turnier FOCUS IV (HN) FOCUS IV Saloon (HM) FOCUS IV Turnier (HP) GRAND C-MAX (DXA/CB7, DXA/CEU) GRAND C-MAX Van KA+ III (UK, FK) KUGA II (DM2) MONDEO V Hatchback (CE) MONDEO V Saloon (CD) MONDEO V Turnier (CF) TOURNEO CONNECT / GRAND TOURNEO CONNECT V408 MPV TOURNEO COURIER B460 MPV TRANSIT CONNECT MPV TRANSIT CONNECT V408 Box Body/MPV TRANSIT COURIER B460 Box Body/MPV TRANSIT COURIER B460 MPV	OPEL COMBO Box Body/MPV (X19) COMBO E Tour / Life (X19) CORSA F CROSSLAND X / CROSSLAND (P17, P2QO) GRANDLAND X (A18) VIVARO C Bus (K0) VIVARO C Van (K0) ZAFIRA LIFE Bus (K0) PEUGEOT 2008 I (CU_) 2008 II (UD_, US_, UY_, UK_) 208 I (CA_, CC_) 208 II (UB_, UP_, UW_, UJ_) 3008 MPV (0U_) 3008 SUV (MC_, MR_, MJ_, M4_) 301 308 II (LB_, LP_, LW_, LH_, L3_) 308 SW II (LC_, LJ_, LR_, LX_, L4_) 5008 (0U_, 0E_) 5008 II (MC_, MJ_, MR_, M4_) 508 I (8D_) 508 II (FB_, FH_, F3_) 508 SW I (8E_) 508 SW II (FC_, FJ_, F4_) EXPERT Bus (V_) EXPERT Van (V_) PARTNER Box Body/MPV PARTNER Box Body/MPV (K9) PARTNER TEPEE RIFTER TRAVELLER Bus (V_) TOYOTA PROACE Bus (MDZ_) PROACE CITY Box Body/MPV PROACE CITY VERSO MPV PROACE VERSO Bus (MPY_) PROACE Van (MDZ_) VAUXHALL COMBO Mk IV (E) Box Body/MPV COMBO Mk IV (E) Life (X19) CORSA Mk V (F) CROSSLAND X (P17) GRANDLAND X (A18) VIVARO C Van (K0) VIVARO LIFE Bus (K0)
		EOV 7.08681.01.0 New CHEVROLET CRUZE Saloon OPEL ASTRA J (P10) ASTRA J GTC ASTRA J Saloon ASTRA J Sports Tourer (P10) ASTRA K (B16) ASTRA K Sports Tourer (B16) INSIGNIA A (G09) INSIGNIA A Country Tourer (G09) INSIGNIA A Saloon (G09) INSIGNIA A Sports Tourer (G09) INSIGNIA B Grand Sport (Z18) INSIGNIA B Sports Tourer (Z18)

ADDITIONS TO THE RANGE

ADDITIONS TO THE RANGE

EOV 7.08681.01.0 New	SV-HYAT 7.08681.03.0 New	SV-HYAT 7.08681.05.0 New
MERIVA B MPV (S10) MOKKA / MOKKA X (J13) ZAFIRA TOURER C (P12) VAUXHALL ASTRA Mk VI (J) (P10) ASTRA Mk VI (J) Estate (P10) ASTRA Mk VI (J) GTC (P10) ASTRA Mk VII (K) (B16) ASTRA Mk VII (K) Estate (B16) INSIGNIA Mk I (A) Country Tourer (G09) INSIGNIA Mk I (A) Hatchback (G09) INSIGNIA Mk I (A) Saloon (G09) INSIGNIA Mk I (A) Sports Tourer (G09) INSIGNIA Mk II (B) Hatchback (Z18) INSIGNIA Mk II (B) Sports Tourer (Z18) MERIVA Mk II (B) (S10) MOKKA / MOKKA X (J13) ZAFIRA Mk III (P12)	OPEL COMBO Box Body/MPV (X12) COMBO Tour (X12) PEUGEOT BIPPER (AA_) BIPPER TEPEE VAUXHALL COMBO Mk III (D) Box Body/MPV (X12)	PEUGEOT BIPPER (AA_) BIPPER TEPEE VAUXHALL COMBO Mk III (D) Box Body/MPV (X12)
EOV 7.08681.02.0 New	SV-HYAT 7.08681.04.0 New	SV-HYAT 7.08681.06.0 New
OPEL ANTARA A (L07) CASCADA (W13) INSIGNIA A (G09) INSIGNIA A Country Tourer (G09) INSIGNIA A Saloon (G09) INSIGNIA A Sports Tourer (G09) INSIGNIA B Country Tourer (Z18) INSIGNIA B Grand Sport (Z18) INSIGNIA B Sports Tourer (Z18) ZAFIRA TOURER C (P12) VAUXHALL CASCADA Convertible (W13) INSIGNIA Mk I (A) Country Tourer (G09) INSIGNIA Mk I (A) Hatchback (G09) INSIGNIA Mk I (A) Saloon (G09) INSIGNIA Mk I (A) Sports Tourer (G09) INSIGNIA Mk II (B) Country Tourer (Z18) INSIGNIA Mk II (B) Hatchback (Z18) INSIGNIA Mk II (B) Sports Tourer (Z18) ZAFIRA Mk III (P12)	ALFA ROMEO 147 (937_) 156 (932_) 156 Sportwagon (932_) GT (937_) CITROEN NEMO Box Body/MPV (AA_) NEMO MPV FIAT DOBLO Bus (263_) DOBLO Cargo (263_) DOBLO Platform/Chassis (263_) FIORINO Box Body/MPV (225_) IDEA (350_) PUNTO (188_) QUBO (225_) LANCIA MUSA (350_) YPSILON (843_) OPEL COMBO Box Body/MPV (X12) COMBO Tour (X12) PEUGEOT BIPPER (AA_) BIPPER TEPEE VAUXHALL COMBO Mk III (D) Box Body/MPV (X12)	ALFA ROMEO 147 (937_) 156 (932_) 156 Sportwagon (932_) GT (937_) CITROEN NEMO Box Body/MPV (AA_) NEMO MPV FIAT DOBLO Bus (263_) DOBLO Cargo (263_) DOBLO Platform/Chassis (263_) FIORINO Box Body/MPV (225_) IDEA (350_) PUNTO (188_) QUBO (225_) LANCIA MUSA (350_) YPSILON (843_) OPEL COMBO Box Body/MPV (X12) COMBO Tour (X12) PEUGEOT BIPPER (AA_) BIPPER TEPEE VAUXHALL COMBO Mk III (D) Box Body/MPV (X12)
SV-HYAT 7.08681.03.0 New	SV-HYAT 7.08681.05.0 New	SV-HYAT 7.08681.07.0 New
ALFA ROMEO 147 (937_) 156 (932_) 156 Sportwagon (932_) GT (937_) CITROEN NEMO Box Body/MPV (AA_) NEMO MPV FIAT DOBLO Bus (263_) DOBLO Cargo (263_) DOBLO Platform/Chassis (263_) FIORINO Box Body/MPV (225_) IDEA (350_) PUNTO (188_) QUBO (225_) LANCIA MUSA (350_) YPSILON (843_) OPEL COMBO Box Body/MPV (X12) COMBO Tour (X12)	ALFA ROMEO 147 (937_) 156 (932_) 156 Sportwagon (932_) GT (937_) CITROEN NEMO Box Body/MPV (AA_) NEMO MPV FIAT DOBLO Bus (263_) DOBLO Cargo (263_) DOBLO Platform/Chassis (263_) FIORINO Box Body/MPV (225_) IDEA (350_) PUNTO (188_) QUBO (225_) LANCIA MUSA (350_) YPSILON (843_) OPEL COMBO Box Body/MPV (X12) COMBO Tour (X12)	FIAT DUCATO Bus (250_) DUCATO Platform/Chassis (250_) DUCATO Van (250_)
SV-HYAT 7.08681.13.0 New	SV-HYAT 7.08681.14.0 New	EOV 7.08681.15.0 New
FIAT DUCATO Bus (250_) DUCATO Platform/Chassis (250_) DUCATO Van (250_)	FIAT DUCATO Bus (250_) DUCATO Platform/Chassis (250_) DUCATO Van (250_)	DACIA DOKKER Express Box Body/MPV DOKKER MPV (KE_) DUSTER (HM_) DUSTER (HS_) DUSTER SUV Van LODGY (JS_) LOGAN II

ADDITIONS TO THE RANGE

EOV 7.08681.15.0 New	AKF 7.10014.00.0 New	DW-AGR 7.22903.36.0 New
LOGAN MCV II SANDERO II MERCEDES-BENZ A-CLASS (W177) A-CLASS Saloon (V177) CITAN Box Body/MPV (W415) CITAN MPV (415) NISSAN JUKE (F15) MICRA V (K14) PULSAR Hatchback (C13) QASHQAI II SUV (J11, J11_) RENAULT CAPTUR I (J5_, H5_) CLIO IV (BH_) CLIO IV Grandtour (KH_) CLIO IV Hatchback Van (BH_) GRAND SCÉNIC III (JZ0/1_) GRAND SCÉNIC IV (R9_) KADJAR (HA_, HL_) KANGOO / GRAND KANGOO (KW0/1_) KANGOO Express (FW0/1_) MEGANE CC (EZ0/1_) MEGANE III Coupe (DZ0/1_) MEGANE III Grandtour (KZ0/1) MEGANE III Hatchback (BZ0/1_, B3_) MEGANE IV GRAND COUPE MEGANE IV Grandtour (K9A/M/N_) MEGANE IV Hatchback (B9A/M/N_) SCÉNIC III (JZ0/1_) SCÉNIC IV (J9_) TWINGO III (BCM_) SMART FORFOUR Hatchback (453) FORTWO Convertible (453) FORTWO Coupe (453)	OCTAVIA II Combi (1Z5) VOLKSWAGEN BORA I (1J2) BORA Variant (1J6) CADDY III Box Body/MPV (2KA, 2KH, 2CA, 2CH) CADDY III MPV (2KB, 2KJ, 2CB, 2CJ) EOS (1F7, 1F8) GOLF IV (1J1) GOLF IV Variant (1J5) GOLF PLUS V (5M1, 521) GOLF V (1K1) GOLF V Variant (1K5) GOLF VI (5K1) GOLF VI Variant (AJ5) JETTA III (1K2) MULTIVAN V (7HM, 7HN, 7HF, 7EF, 7EM, 7EN) PASSAT B5.5 (3B3) PASSAT B5.5 Variant (3B6) PASSAT B6 (3C2) PASSAT B6 Variant (3C5) POLO (9N_) TOURAN (1T1, 1T2) TRANSPORTER V Bus (7HB, 7HJ, 7EB, 7EJ, 7EF, 7EG, 7HF, 7EC) TRANSPORTER V Platform/Chassis (7JD, 7JE, 7JL, 7JY, 7JZ, 7FD) TRANSPORTER V Van (7HA, 7HH, 7EA, 7EH) VW FAW CADDY (9HB) SAGITAR (9L2)	A4 B7 (8EC) A4 B7 Avant (8ED) A8 D3 (4E2, 4E8)
		DW-AGR 7.22903.37.0 New
		AUDI A4 B6 (8E2) A4 B6 Avant (8E5) A6 C5 (4B2) A6 C5 Avant (4B5)
	EUV-DS 7.21042.01.0 New	
	MERCEDES-BENZ T2/LN1 Dump Truck T2/LN1 Platform/Chassis T2/LN1 Van VARIO Cab with engine VARIO Van (B667, B670, B668)	
AKF 7.10014.00.0 New	LDRV 7.22687.46.0 New	
AUDI A2 (8Z0) A3 (8P1) A3 Convertible (8P7) A3 Sportback (8PA) A4 B5 (8D2) A4 B5 Avant (8D5) A4 B6 (8E2) A4 B6 Avant (8E5) A4 B6 Convertible (8H7) A4 B7 (8EC) A4 B7 Avant (8ED) A6 C5 (4B2) A6 C5 Avant (4B5) TT (8J3) TT Roadster (8J9)	JAGUAR F-PACE (X761) XF II (X260) XF SPORTBRAKE (X260) LAND ROVER DISCOVERY IV (L319) DISCOVERY V (L462) RANGE ROVER IV (L405) RANGE ROVER SPORT I (L320) RANGE ROVER SPORT II (L494) RANGE ROVER VELAR (L560)	
	LDRV 7.22687.51.0 New	
	PORSCHE CAYENNE (92A) MACAN (95B) PANAMERA (970)	
	DW-AGR 7.22903.36.0 New	
	AUDI A4 B6 (8E2) A4 B6 Avant (8E5) A4 B6 Convertible (8H7)	

D

HERSTELLERVERZEICHNIS

E

LIST OF MANUFACTURERS

	Page		Page
A		F	
ABARTH	196	FAHR	526
AGRIA	974 → FORD	526
ALFA ROMEO	198 → MERCEDES-BENZ	675
ALPINA	209 → VOLKSWAGEN	1127
..... → BMW	325	FAUN	526
AUDI	210	FENDT	660
AUDI FAW	320	FERRARI	490
AUSTIN (BLMC)	1012	FIAT	492
AUTOBIANCHI	637	FIATALLIS	675
		FORD	526
		FORD (CHANGAN)	595
		FORD ASIA / OZEANIA	592
		FORD AUSTRALIA	593
		FORD JMC	596
		FORD USA	597
		FORDSON	526
		FREIGHTLINER	607
		FUSO	609
B		G	
BENTLEY	321	GM HOLDEN LTD	614
BMW	325	GMC	610
BMW (BRILLIANCE)	406		
BRABUS	408	H	
BUICK	409	HUMMER	615
BUICK SGM	415	HYUNDAI	616
		I	
		IHC-CASE (CNH)	675
		INFINITI	853
		IRAN KHODRO (IKCO)	624
		IVECO	625
	 → FIAT	492
C		J	
CADILLAC	418	JAGUAR	627
CADILLAC (SGM)	430	JEEP	630
CASE	675		
CHEVROLET	431	K	
CHEVROLET (SGM)	450	KIA	631
CHRYSLER	451	KOMATSU	675
..... → JEEP	630	KÄSSBOHRER	660
CITROEN	452 → MERCEDES-BENZ	675
CITROEN (DF-PSA)	481		
CLAAS	526	L	
..... → FORD	675	LAMBORGHINI	637
..... → MERCEDES-BENZ	1127	LANCIA	643
..... → VOLKSWAGEN		LAND ROVER	1012
	 → ROVER	652
		LEXUS	675
		LIEBHERR	658
		LINCOLN	658
D			
DACIA	482		
..... → RENAULT	974		
DETROIT DIESEL	675		
DODGE	485		
DS	486		
DS(CAPSA)	489		

	Page		Page
M		S	
MAN	660	SAAB	1013
..... → NEOPLAN Bus GmbH	852	SAVIEM	→ MAN 660
MARUTI SUZUKI	663	SCION	1019
MASERATI	664	SEAT	1020
MAYBACH	665	SKODA	1044
MAZDA	666	SKODA SVW	1069
MERCEDES-BENZ	675 → SKODA	1044
MERCEDES-BENZ (BBDC)	828	SMART	1070
MERCEDES-BENZ (FJDA)	836	SSANGYONG	1072
MERCURY	838	STEYR	→ MAN 660
MG	840 → MERCEDES-BENZ	675
MG SAIC	841	SUBARU	1073
MINI (BMW)	842	SUZUKI	1075
MITSUBISHI	851		
MWB	→ MERCEDES-BENZ 675	T	
N		TOYOTA	1076
NEOPLAN Bus GmbH	852	TOYOTA FAW	1082
..... → MAN	660	TOYOTA GAC	1083
NEW HOLLAND	→ FIAT 492	U	
..... → FORD	526	UNIC	→ FIAT 492
..... → MERCEDES-BENZ	675	UTB	→ FIAT 492
NISSAN	853	V	
O		VAUXHALL	1084
OM	→ FIAT 492	VM MOTORI	1126
OPEL	862	VOLKSWAGEN	1127
P		VOLVO	1265
PEUGEOT	923	VOLVO (CHANGAN)	1315
PEUGEOT (DF-PSA)	957	VOLVO ASIA	1314
POLESTAR	958	VOLVO-BM	→ VOLVO 1265
POLSKI-FIAT	→ FIAT 492	VW FAW	1316
PONTIAC	959 → VOLKSWAGEN	1127
PORSCHE	961	VW SVW	1318
PUCH	973 → VOLKSWAGEN	1127
R			
RABA	→ MAN 660		
RENAULT	974		
ROEWE SAIC	1009		
ROLLS-ROYCE	1010		
ROMAN-DIESEL	→ MAN 660		
ROVER	1012		

D

PRODUKTPROGRAMM

E

PRODUCT RANGE

A



124 Spider

1

1.4 (348) 125 kW (170 PS)
552 53 268

03.2016→



7.02909.07.0

SUV

EL

500 / 595 / 695

2

1.4 (312.AXD1A) 99-140 kW
(135-190 PS)
312 A1.000

08.2008→



7.02256.49.0

LDRV

EP

1.4 (312.AXF11, 312.AXF1A)
103-132 kW (140-180 PS)
312 A3.000

08.2008→



7.02256.49.0

LDRV

EP

für OE-Nummer: 46813571
for OE number: 46813571

1.4 (312.AXF11, 312.AXF1A,
312.AXD1A) 99-140 kW
(135-190 PS)
312 A1.000, 312 A3.000

08.2008→



7.02256.49.0

LDRV

EP

1.4 (312.AXF1A, 312.AXD1A)
103-132 kW (140-180 PS)
312 A3.000

05.2010→



7.01835.06.0

SUV

EL

1.4 (312.AXT1A) 140 kW (190 PS)
312 A9.000

08.2008→



7.01835.06.0

SUV

EL

1.4 (312.AXY11, 312.AXY1A)
107 kW (145 PS)
312 B4.000

05.2016→



7.01835.06.0

SUV

EL

1.4 (312.AXZ11) 121 kW (165 PS)
312 B3.000

05.2016→



7.01835.06.0

SUV

EL

1.4 (312.AYB11, 312.AYB1A)
120 kW (163 PS)
312 B6.000

06.2016→



7.01835.06.0

SUV

EL

500C / 595C / 695C

3

1.4 (312.AXD1A) 99-140 kW
(135-190 PS)
312 A1.000

05.2008→



7.01835.06.0

SUV

EL

1.4 (312.AXF11, 312.AXF1A)
103-132 kW (140-180 PS)
312 A3.000

06.2010→



7.01835.06.0

SUV

EL

1.4 (312.AXF1A, 312.AXF11,
312.AXD1A) 99-140 kW
(135-190 PS)
312 A1.000, 312 A3.000

09.2009→



7.01835.06.0

SUV

EL

1.4 (312.AXY1A, 312.AXY11)
107 kW (145 PS)
312 B4.000

05.2016→



7.01835.06.0

SUV

EL

1.4 (312.AXZ1A) 121 kW (165 PS)
312 B3.000

05.2016→



7.01835.06.0

SUV

EL

GRANDE PUNTO

4

1.4 (199.AXN1B) 114-132 kW
(155-180 PS)
199 A8.000

07.2007→06.2010



7.02256.49.0

LDRV

EP

für OE-Nummer: 46813571
for OE number: 46813571

7.01835.06.0

SUV

EL

1.4 ESSEESSE / SUPERSPORT
(199.AXX1B) 114-132 kW
(155-180 PS)
199 A8.000

05.2008→06.2010



7.02256.49.0

LDRV

EP

für OE-Nummer: 46813571
for OE number: 46813571

7.01835.06.0

SUV

EL



PUNTO	5
--------------	----------



1.4 (199.AXX1B) 120-132 kW (163-180 PS) 955 A8.000	03.2012→		7.02909.07.0	SUV	EL	
1.4 SUPERSPORT (199.AXX1B) 120-132 kW (163-180 PS) 955 A8.000	03.2012→		7.02909.07.0	SUV	EL	

PUNTO EVO	6
------------------	----------



1.4 (199.AXX1B) 120-132 kW (163-180 PS) 955 A8.000	07.2008→02.2012		7.02909.07.0	SUV	EL	
1.4 (199.AXX1B) 120-132 kW (163-180 PS) 955 A8.000	10.2009→02.2012		7.02909.07.0	SUV	EL	

A









145 (930_)
1



















1.4 i.e. (930.A3) 66 kW (90 PS) AR 33501	07.1994→12.1996	 7.05432.09.0	SM	EL	mit Dichtring with O-ring
1.6 i.e. (930.A2) 76 kW (103 PS) AR 33201	10.1994→12.1996	 7.05432.09.0	SM	EL	mit Dichtring with O-ring Vett No. 3014142→
1.9 TD (930.A4) 66-68 kW (90-92 PS) AR 33601	10.1994→02.1999	 7.02256.03.0	DW-AGR	EP	01.1997→

146 (930_)
2

1.4 i.e. (930.B3) 66 kW (90 PS) AR 33501	12.1994→12.1996	 7.05432.09.0	SM	EL	mit Dichtring with O-ring
1.6 i.e. (930.B2) 76 kW (103 PS) AR 33201	12.1994→12.1996	 7.05432.09.0	SM	EL	mit Dichtring with O-ring
1.9 TD (930.B4A) 66-68 kW (90-92 PS) AR 33601	12.1994→02.1999	 7.02256.03.0	DW-AGR	EP	01.1997→

147 (937_)
3

1.9 JTD (937.AXD1A, 937.BXD1A) 81-88 kW (110-120 PS) 937 A2.000	04.2001→03.2010	 7.00607.02.0	DW-TL	EP	
		7.02256.50.0	EUV-RK	EL	
1.9 JTD (937.AXF1A, 937.BXF1A) 74-77 kW (101-105 PS) 182 B9.000	06.2003→03.2010	 7.02256.50.0	EUV-RK	EL	
		7.02256.49.0	LDRV	EP	
1.9 JTD 16V (937.AXG1B, 937.BXG1B) 103 kW (140 PS) 192 A5.000	11.2002→03.2010	 7.00607.02.0	DW-TL	EP	
		7.02256.50.0	EUV-RK	EL	
1.9 JTD 16V (937.AXG1B, 937.BXG1B) 93-103 kW (126-140 PS) 937 A4.000	09.2003→09.2004	 7.00607.02.0	DW-TL	EP	
		7.02256.50.0	EUV-RK	EL	
1.9 JTD 16V (937.AXM1B, 937.AXS1B) 100 kW (136 PS) 192 B1.000	10.2004→03.2010	 7.00607.02.0	DW-TL	EP	
		7.02256.50.0	EUV-RK	EL	
1.9 JTDM (937.AXD1A, 937.AXV1A, 937.BXB1A) 85 kW (115 PS) 939 A7.000	10.2004→03.2010	 7.00607.02.0	DW-TL	EP	
		7.02256.50.0	EUV-RK	EL	
1.9 JTDM 16V (937.AXN1B, 937.AXZ1B) 125 kW (170 PS) 937 A6.000	06.2008→03.2010	 7.00607.02.0	DW-TL	EP	
		7.02256.50.0	EUV-RK	EL	
1.9 JTDM 16V (937.AXN1B, 937.BXN1B) 110 kW (150 PS) 937 A5.000	09.2004→03.2010	 7.00607.02.0	DW-TL	EP	
		7.02256.50.0	EUV-RK	EL	
1.9 JTDM 8V (937.AXD1A, 937.AXU1A, 937.BXU1A) 88 kW (120 PS) 937 A3.000	07.2005→03.2010	 7.00607.02.0	DW-TL	EP	
		7.02256.50.0	EUV-RK	EL	









							
147 (937_)						3	
2.0 16V T.SPARK (937.AXA1, 937.AXC1, 937.BXC1) 110-114 kW (150-155 PS) AR 32310	01.2001→03.2010		7.08681.03.0	SV-HYAT	EH	für OE-Nummer: 71737621, 71753780 for OE number: 71737621, 71753780	
			7.08681.04.0	SV-HYAT	EH		
			7.08681.05.0	SV-HYAT	EH	für OE-Nummer: 71737623, 71753782 for OE number: 71737623, 71753782	
3.2 GTA (937.AXL1) 184 kW (250 PS) 932 A.000	02.2003→03.2010		7.08681.03.0	SV-HYAT	EH	für OE-Nummer: 71737621, 71753780 for OE number: 71737621, 71753780	
			7.08681.04.0	SV-HYAT	EH		
			7.08681.05.0	SV-HYAT	EH	für OE-Nummer: 71737623, 71753782 for OE number: 71737623, 71753782	
7.08681.06.0			SV-HYAT	EH			
	156 (932_)						4
	1.9 JTD (932.A2B00) 81 kW (110 PS) AR 37101	01.2001→05.2001		7.02256.03.0	DW-AGR	EP	
7.00607.02.0				DW-TL	EP		
7.21903.48.0				DW-TL	EP		
7.02256.50.0				EUV-RK	EL		
1.9 JTD (932.A2B00, 932.A2C00) 81-88 kW (110-120 PS) 937 A2.000	05.2001→09.2005		7.21903.48.0	DW-TL	EP		
			7.00607.02.0	DW-TL	EP		
			7.02256.50.0	EUV-RK	EL		
1.9 JTD (932.A2B00, 932.A2C00) 81-88 kW (110-120 PS) 937 A2.000	05.2001→09.2005		7.00607.02.0	DW-TL	EP		
			7.02256.50.0	EUV-RK	EL		
1.9 JTD (932.AXN00, 932.BXE00) 110 kW (150 PS) 937 A5.000	07.2004→09.2005		7.00607.02.0	DW-TL	EP		
			7.02256.50.0	EUV-RK	EL		
1.9 JTD (932.AXE00) 100 kW (136 PS) 192 B1.000	11.2002→11.2004		7.00607.02.0	DW-TL	EP		
			7.02256.50.0	EUV-RK	EL		
1.9 JTD (932.AXE00) 93-103 kW (126-140 PS) 937 A4.000	11.2003→09.2005		7.00607.02.0	DW-TL	EP		
			7.02256.50.0	EUV-RK	EL		
1.9 JTD (932B2) 77 kW (105 PS) AR 32302	09.1997→10.2000		7.02256.03.0	DW-AGR	EP		
			7.21903.48.0	DW-TL	EP		
1.9 JTD 16V (932.AXE00) 103 kW (140 PS) 192 A5.000	11.2002→09.2005		7.02256.50.0	EUV-RK	EL		
2.0 16V T.SPARK (932A2) 110-114 kW (150-155 PS) AR 32301, AR 32310	09.1997→06.2002		7.08681.03.0	SV-HYAT	EH	 AR 32301, AR 32310: für OE-Nummer: 71737621, 71753780 for OE number: 71737621, 71753780	
			7.08681.04.0	SV-HYAT	EH		
			7.08681.05.0	SV-HYAT	EH	 AR 32301, AR 32310: für OE-Nummer: 71737623, 71753782 for OE number: 71737623, 71753782	
7.08681.06.0			SV-HYAT	EH			
	2.0 16V T.SPARK (932A21_) 110-114 kW (150-155 PS) AR 32310	10.2000→03.2002		7.08681.03.0	SV-HYAT	EH	für OE-Nummer: 71737621, 71753780 for OE number: 71737621, 71753780
				7.08681.04.0	SV-HYAT	EH	
7.08681.05.0	SV-HYAT	EH	für OE-Nummer: 71737623, 71753782 for OE number: 71737623, 71753782				

A







156 (932_)

4

2.0 JTS (932AXA) 119-122 kW (162-166 PS) 937 A1.000	03.2002→09.2005		7.08681.06.0	SV-HYAT	EH	für OE-Nummer: 71737621, 71753780 for OE number: 71737621, 71753780
			7.08681.03.0	SV-HYAT	EH	
			7.08681.04.0	SV-HYAT	EH	
			7.08681.05.0	SV-HYAT	EH	
2.4 JTD (932A1B_) 103 kW (140 PS) 839 A6.000	10.2000→09.2005		7.08681.06.0	SV-HYAT	EH	für OE-Nummer: 71737623, 71753782 for OE number: 71737623, 71753782
			7.08681.05.0	SV-HYAT	EH	
2.4 JTD (932AXC) 110 kW (150 PS) 841 C000	03.2002→09.2005		7.08681.06.0	SV-HYAT	EH	
			7.21903.48.0	DW-TL	EP	
2.4 JTD (932AXF00) 120-147 kW (163-200 PS) 841 M.000, 841 N.000	06.2003→09.2005		7.02256.50.0	EUV-RK	EL	
			7.00607.02.0	DW-TL	EP	
2.4 JTD (932AXF00) 129 kW (175 PS) 841 G.000	10.2003→09.2005		7.02256.50.0	EUV-RK	EL	
			7.00607.02.0	DW-TL	EP	
2.4 JTD (932B1) 99-100 kW (135-136 PS) AR 32501	09.1997→09.2003		7.00607.02.0	DW-TL	EP	
			7.02256.50.0	EUV-RK	EL	
3.2 GTA (932AXB) 184 kW (250 PS) 932 A.000	03.2002→09.2005		7.02256.03.0	DW-AGR	EP	für OE-Nummer: 71737621, 71753780 for OE number: 71737621, 71753780
			7.08681.03.0	SV-HYAT	EH	
			7.08681.04.0	SV-HYAT	EH	
			7.08681.05.0	SV-HYAT	EH	
3.2 GTA (932AXB) 184 kW (250 PS) 932 A.000	03.2002→09.2005		7.08681.06.0	SV-HYAT	EH	für OE-Nummer: 71737623, 71753782 for OE number: 71737623, 71753782
			7.08681.05.0	SV-HYAT	EH	

156 Sportwagon (932_)

5

1.9 JTD (932.B2B00) 81 kW (110 PS) AR 37101	01.2001→05.2001		7.02256.03.0	DW-AGR	EP	
			7.00607.02.0	DW-TL	EP	
			7.21903.48.0	DW-TL	EP	
			7.02256.50.0	EUV-RK	EL	
1.9 JTD (932B2) 77 kW (105 PS) AR 32302	05.2000→10.2000		7.02256.03.0	DW-AGR	EP	
			7.21903.48.0	DW-TL	EP	
1.9 JTD (932B2B, 932B2C) 81-88 kW (110-120 PS) 937 A2.000	05.2001→05.2006		7.21903.48.0	DW-TL	EP	
			7.00607.02.0	DW-TL	EP	
1.9 JTD (932BXE00) 100 kW (136 PS) 192 B1.000	11.2002→11.2004		7.02256.50.0	EUV-RK	EL	
			7.00607.02.0	DW-TL	EP	
1.9 JTD (932BXE00) 93-103 kW (126-140 PS) 937 A4.000	11.2003→05.2006		7.00607.02.0	DW-TL	EP	
			7.02256.50.0	EUV-RK	EL	





						
156 Sportwagon (932_)						5
1.9 JTD (932BXE00, 932BXN00) 110 kW (150 PS) 937 A5.000	03.2005→05.2006		7.00607.02.0	DW-TL	EP	
			7.02256.50.0	EUV-RK	EL	
1.9 JTD 16V (932BXE00) 103 kW (140 PS) 192 A5.000	11.2002→05.2006		7.02256.50.0	EUV-RK	EL	
			7.02256.50.0	EUV-RK	EL	
1.9 JTD 16V Q4 (932BXN20) 110 kW (150 PS) 937 A5.000	07.2004→05.2006		7.00607.02.0	DW-TL	EP	
			7.02256.50.0	EUV-RK	EL	
2.0 16V T.SPARK (932A2) 110-114 kW (150-155 PS) AR 32301, AR 32310	05.2000→06.2002		7.08681.03.0	SV-HYAT	EH	 AR 32301, AR 32310: für OE-Nummer: 71737621, 71753780 for OE number: 71737621, 71753780
			7.08681.04.0	SV-HYAT	EH	
			7.08681.05.0	SV-HYAT	EH	 AR 32301, AR 32310: für OE-Nummer: 71737623, 71753782 for OE number: 71737623, 71753782
2.0 16V T.SPARK (932B21_) 110-114 kW (150-155 PS) AR 32310	10.2000→03.2002		7.08681.03.0	SV-HYAT	EH	für OE-Nummer: 71737621, 71753780 for OE number: 71737621, 71753780
			7.08681.04.0	SV-HYAT	EH	
			7.08681.05.0	SV-HYAT	EH	für OE-Nummer: 71737623, 71753782 for OE number: 71737623, 71753782
2.0 JTS (932BXA) 119-122 kW (162-166 PS) 937 A1.000	03.2002→05.2006		7.08681.03.0	SV-HYAT	EH	für OE-Nummer: 71737621, 71753780 for OE number: 71737621, 71753780
			7.08681.04.0	SV-HYAT	EH	
			7.08681.05.0	SV-HYAT	EH	für OE-Nummer: 71737623, 71753782 for OE number: 71737623, 71753782
2.4 JTD (932.B1B00) 103 kW (140 PS) 839 A6.000	10.2000→05.2006		7.21903.48.0	DW-TL	EP	
			7.02256.50.0	EUV-RK	EL	
			7.02256.50.0	EUV-RK	EL	
2.4 JTD (932.BXC00) 110 kW (150 PS) 841 C000	03.2002→05.2006		7.00607.02.0	DW-TL	EP	
			7.02256.50.0	EUV-RK	EL	
			7.02256.50.0	EUV-RK	EL	
2.4 JTD (932BXF00) 120-147 kW (163-200 PS) 841 M.000, 841 N.000	06.2003→05.2006		7.00607.02.0	DW-TL	EP	
			7.02256.50.0	EUV-RK	EL	
			7.02256.50.0	EUV-RK	EL	
2.4 JTD (932BXF00) 129 kW (175 PS) 841 G.000	10.2003→05.2006		7.00607.02.0	DW-TL	EP	
			7.02256.50.0	EUV-RK	EL	
			7.02256.50.0	EUV-RK	EL	
3.2 GTA (932.BXB00) 184 kW (250 PS) 932 A.000	03.2002→05.2006		7.08681.03.0	SV-HYAT	EH	für OE-Nummer: 71737621, 71753780 for OE number: 71737621, 71753780
			7.08681.04.0	SV-HYAT	EH	
			7.08681.05.0	SV-HYAT	EH	für OE-Nummer: 71737623, 71753782 for OE number: 71737623, 71753782
			7.08681.06.0	SV-HYAT	EH	

A





159 (939_)

6

1.8 MPI (939AXL1A) 96-103 kW (131-140 PS) 939 A4.000	06.2005→11.2011		7.06117.08.0	SV-NWV	EH	mit Dichtring with O-ring
1.8 TBi (939.AXN1B) 147 kW (200 PS) 939 B1.000	05.2009→12.2012		7.06117.38.0	SV-NWV	EL	mit Dichtring with O-ring
1.9 JTDM 16V (939AXC1B, 939AXC12) 110 kW (150 PS) 939 A2.000	09.2005→11.2011		7.00607.02.0	DW-TL	EP	
			7.03003.01.0	DW-TL	EP	
1.9 JTDM 16V (939AXF1B, 939AXC1B) 100 kW (136 PS) 937 A8.000	09.2005→11.2011		7.03003.01.0	DW-TL	EP	
1.9 JTDM 16V (939AXF1B, 939AXC1B) 100 kW (136 PS) 939 A8.000	09.2005→11.2011		7.00607.02.0	DW-TL	EP	
			7.03003.01.0	DW-TL	EP	
1.9 JTDM 8V (939AXE1B) 88 kW (120 PS) 939 A1.000	09.2005→11.2011		7.00607.02.0	DW-TL	EP	
			7.03003.01.0	DW-TL	EP	
1.9 JTDM 8V (939AXE1B, 939BXE1B, 939BXH1B) 85 kW (115 PS) 937 A7.000, 939 A7.000	09.2005→11.2011		7.00607.02.0	DW-TL	EP	
			7.03003.01.0	DW-TL	EP	
2.0 JTDM (939AXP1B) 125 kW (170 PS) 939 B3.000	05.2009→11.2011		7.03003.01.0	DW-TL	EP	
2.0 JTDM (939AXQ1B) 120 kW (163 PS) 844 A2.000	05.2009→11.2011		7.03003.01.0	DW-TL	EP	
2.0 JTDM (939AXR1B) 100 kW (136 PS) 939 B4.000	06.2010→11.2011		7.03003.01.0	DW-TL	EP	
2.4 JTDM (939AXD) 154 kW (210 PS) 939 A9.000	07.2007→11.2011		7.00607.02.0	DW-TL	EP	
			7.03003.01.0	DW-TL	EP	für OE-Nummer: 51884840, 55228986 for OE number: 51884840, 55228986
2.4 JTDM (939AXD12, 939AXD1B) 147-154 kW (200-209 PS) 939 A3.000	09.2005→11.2011		7.00607.02.0	DW-TL	EP	
			7.03003.01.0	DW-TL	EP	für OE-Nummer: 51884840, 55228986 for OE number: 51884840, 55228986
2.4 JTDM Q4 (939AXMB2) 154 kW (210 PS) 939 A9.000	05.2007→11.2011		7.00607.02.0	DW-TL	EP	
			7.03003.01.0	DW-TL	EP	für OE-Nummer: 51884840, 55228986 for OE number: 51884840, 55228986

159 Sportwagon (939_)















7























1.8 MPI (939BXL1A) 96-103 kW (131-140 PS) 939 A4.000	06.2005→11.2011		7.06117.08.0	SV-NWV	EH	mit Dichtring with O-ring
1.8 TBi (939BXN1B) 147 kW (200 PS) 939 B1.000	07.2009→11.2011		7.06117.38.0	SV-NWV	EL	mit Dichtring with O-ring
1.9 JTDM 16V (939BXC1B) 100 kW (136 PS) 937 A8.000	03.2006→11.2011		7.00607.02.0	DW-TL	EP	

						
159 Sportwagon (939_)						7
						
1.9 JTDM 16V (939BXC1B, 939BXC12) 110 kW (150 PS) 939 A2.000	03.2006→11.2011		7.03003.01.0 7.00607.02.0	DW-TL DW-TL	EP EP	
			7.03003.01.0	DW-TL	EP	
1.9 JTDM 8V (939AXH1B, 939BXH1B) 85 kW (115 PS) 937 A7.000	03.2006→11.2011		7.03003.01.0 7.00607.02.0	DW-TL DW-TL	EP EP	
			7.03003.01.0	DW-TL	EP	
1.9 JTDM 8V (939BXE1B) 88 kW (120 PS) 939 A1.000	03.2006→11.2011		7.03003.01.0 7.00607.02.0	DW-TL DW-TL	EP EP	
			7.03003.01.0	DW-TL	EP	
2.0 JTDM (939BXP1B) 125 kW (170 PS) 939 B3.000	07.2009→11.2011		7.03003.01.0	DW-TL	EP	
2.0 JTDM (939BXQ1B) 120 kW (163 PS) 844 A2.000	05.2009→11.2011		7.03003.01.0	DW-TL	EP	
2.0 JTDM (939BXR1B) 100 kW (136 PS) 939 B4.000	06.2010→11.2011		7.03003.01.0	DW-TL	EP	
2.4 JTDM (939.BXM1B) 154 kW (210 PS) 939 A9.000	05.2007→12.2012		7.00607.02.0 7.03003.01.0	DW-TL DW-TL	EP EP	für OE-Nummer: 55188059, 55203202 für OE number: 55188059, 55203202 für OE-Nummer: 51884840, 55228986 für OE number: 51884840, 55228986
2.4 JTDM (939BXD1B, 939BXD12) 147-154 kW (200-209 PS) 939 A3.000	03.2006→11.2011		7.00607.02.0 7.03003.01.0	DW-TL DW-TL	EP EP	für OE-Nummer: 51884840, 55228986 für OE number: 51884840, 55228986
2.4 JTDM Q4 (939BXM2B) 154 kW (210 PS) 939 A9.000	05.2007→11.2011		7.00607.02.0 7.03003.01.0	DW-TL DW-TL	EP EP	für OE-Nummer: 51884840, 55228986 für OE number: 51884840, 55228986
164 (164_)						8
2.5 TD (164.A1A) 84 kW (114 PS) VM 84 A	06.1987→09.1992		7.01805.01.0	EUV-AGR	EL	
2.5 TD (164.K2A, 164.K2B) 92 kW (125 PS) VM 08 B, VM 32 B	09.1992→09.1998		7.01805.01.0	EUV-AGR	EL	
166 (936_)						9
2.4 JTD (936A2A_) 100 kW (136 PS) AR 34202	09.1998→10.2000		7.02256.03.0	DW-AGR	EP	
2.4 JTD (936A2B_) 103 kW (140 PS) 839 A6.000	10.2000→06.2007		7.02256.03.0 7.00607.02.0 7.02256.50.0	DW-AGR DW-TL EUV-RK	EP EP EL	
2.4 JTD (936AXA00, 936A3B00) 110 kW (150 PS) 841 C000	04.2002→06.2007		7.00607.02.0 7.21903.48.0 7.02256.50.0	DW-TL DW-TL EUV-RK	EP EP EL	

A



166 (936_)						9
2.4 JTD (936AXC00) 120-147 kW (163-200 PS) 841 M.000	07.2006→06.2007		7.00607.02.0	DW-TL	EP	
2.4 JTD (936AXC00, 936AXD01) 129 kW (175 PS) 841 G.000, 841 H.000	10.2003→06.2007		7.00607.02.0	DW-TL	EP	
			7.21903.48.0	DW-TL	EP	
			7.02256.50.0	EUV-RK	EL	
2.4 JTD (936AXD01, 936AXC00) 120-147 kW (163-200 PS) 841 M.000, 841 N.000	10.2003→06.2007		7.00607.02.0	DW-TL	EP	
			7.21903.48.0	DW-TL	EP	
			7.02256.50.0	EUV-RK	EL	
4C (960_)						10
1.8 (960.CXB1A) 177 kW (241 PS) 960 A1.000	03.2013→		7.06117.38.0	SV-NWV	EL	mit Dichtring with O-ring
4C SPIDER (960_)						11
1.8 (960.DXB1A, 960CXB1A) 177 kW (241 PS) 960 A1.000	10.2014→		7.06117.38.0	SV-NWV	EL	mit Dichtring with O-ring
BRERA (939_)						12
1.8 TBi (939DXN1B) 147 kW (200 PS) 939 B1.000	05.2009→06.2010		7.06117.38.0	SV-NWV	EL	mit Dichtring with O-ring
2.0 JTDM (939DXP1B) 125 kW (170 PS) 939 B3.000	05.2009→06.2010		7.03003.01.0	DW-TL	EP	
2.0 JTDM (939DXQ1B) 120 kW (163 PS) 844 A2.000	03.2008→06.2010		7.03003.01.0	DW-TL	EP	
2.4 JTDM 20V (939DXD1B, 939DXD12) 147-154 kW (200-209 PS) 939 A3.000	01.2006→03.2011		7.00607.02.0	DW-TL	EP	
			7.03003.01.0	DW-TL	EP	
2.4 JTDM 20V (939DXD1B, 939DXM1B) 154 kW (210 PS) 939 A9.000	05.2007→03.2011		7.00607.02.0	DW-TL	EP	
			7.03003.01.0	DW-TL	EP	
GIULIA (952_)						13
2.0 Q4 (952ACA45) 147-257 kW (200-350 PS) 552 73 835	08.2016→		7.02909.12.0	SUV	EL	
2.0 Super (952ABA25B) 147-257 kW (200-350 PS) 552 73 835	08.2016→		7.02909.12.0	SUV	EL	
2.0 Veloce (952ACA25) 147-257 kW (200-350 PS) 552 73 835	08.2016→		7.02909.12.0	SUV	EL	
2.9 (952AAM24) 375-397 kW (510-540 PS) 670 05 0436	11.2019→		7.03003.01.0	DW-TL	EP	
2.9 GTA (952AAM24) 375-397 kW (510-540 PS) 670 05 0436	05.2020→		7.03003.01.0	DW-TL	EP	



						
GIULIA (952_)						13
2.9 Quadrifoglio (952AAM24) 375-397 kW (510-540 PS) 670 05 0436, 670 05 2721	10.2015→		7.03003.01.0	DW-TL	EP	
			7.02909.12.0	SUV	EL	
GIULIETTA (940_)						14
1.4 BiFuel (940FXA1A, 940FXT1A) 88 kW (120 PS) 198 A4.000	12.2011→02.2017		7.02256.49.0	LDRV	EP	
			7.01835.06.0	SUV	EL	
1.4 TB (940.FYA1A) 110 kW (150 PS) 940 C2.000	09.2014→		7.02909.07.0	SUV	EL	
1.4 TB (940FXA1A) 88 kW (120 PS) 198 A4.000	04.2010→		7.02256.49.0	LDRV	EP	
			7.01835.06.0	SUV	EL	
1.4 TB (940FXA1A) 88 kW (120 PS) 940 B7.000	04.2010→		7.02256.49.0	LDRV	EP	
1.4 TB (940FXB1A) 110-125 kW (150-170 PS) 940 A2.000	04.2010→		7.02909.07.0	SUV	EL	
1.4 TB (940FXN1A, 940FXU1A) 77 kW (105 PS) 940 B1.000, 940 B8.000	04.2011→		7.02256.49.0	LDRV	EP	
			7.01835.06.0	SUV	EL	
1.6 JTDM (940.FYB1_) 84-88 kW (114-120 PS) 552 80 444, 940 C1.000, 940 C5.000	02.2015→		7.03003.01.0	DW-TL	EP	
1.6 JTDM (940.FYE1_) 85-88 kW (116-120 PS) 940 C5.000	09.2015→		7.03003.01.0	DW-TL	EP	
1.6 JTDM (940FXD1A) 77 kW (105 PS) 940 A3.000	04.2010→		7.03003.01.0	DW-TL	EP	
1.8 TBI (940FXR11) 177 kW (241 PS) 940 B2.000	09.2013→01.2020		7.06117.38.0	SV-NWV	EL	mit Dichtring with O-ring
1.8 TBi (940FXC1A) 169-177 kW (230-241 PS) 940 A1.000	04.2010→02.2016		7.06117.38.0	SV-NWV	EL	mit Dichtring with O-ring
1.8 TBi (940FXC1A) 169-177 kW (230-241 PS) 940 A1.000	04.2010→09.2013		7.06117.38.0	SV-NWV	EL	mit Dichtring with O-ring
1.8 TBi (940FXR11) 177 kW (241 PS) 940 B2.000, 960 A1.000	09.2013→		7.03003.01.0	DW-TL	EP	
			7.06117.38.0	SV-NWV	EL	mit Dichtring with O-ring
2.0 JTDM (940.FXL1A) 103 kW (140 PS) 940 A5.000	04.2010→		7.03003.01.0	DW-TL	EP	
2.0 JTDM (940.FXQ1A) 103-150 kW (140-204 PS) 940 B5.000, 940 C3.000	08.2013→		7.03003.01.0	DW-TL	EP	
2.0 JTDM (940.FXV11) 125-129 kW (170-175 PS) 940 B4.000	11.2013→		7.03003.01.0	DW-TL	EP	

A



GIULIETTA (940_)

14

2.0 JTDM (940FXE1A) 110-125 kW (150-170 PS) 552 83 099, 940 A4.000	04.2010→		7.03003.01.0	DW-TL	EP	
2.0 JTDM (940FXH1A, 940FXH11, 940.FXZ11, 940.FXZ1A) 120 kW (163 PS) 940 A7.000, 940 B9.000	04.2010→		7.03003.01.0	DW-TL	EP	
2.0 JTDM (940FXM1A, 940FXS1A, 940FYD1A) 100 kW (136 PS) 940 A8.000, 940 B6.000, 940 C4.000	04.2010→02.2016		7.03003.01.0	DW-TL	EP	







GT (937_)

15











1.9 JTD (937CXN1B) 110 kW (150 PS) 937 A5.000	11.2003→09.2010		7.00607.02.0	DW-TL	EP	
			7.02256.50.0	EUV-RK	EL	
1.9 JTD (937CXN1B, 937CXZ1B) 125 kW (170 PS) 937 A6.000	05.2008→09.2010		7.00607.02.0	DW-TL	EP	
			7.02256.50.0	EUV-RK	EL	
2.0 JTS (937CXH1A, 937CXH11) 119-122 kW (162-166 PS) 937 A1.000	11.2003→09.2010		7.08681.03.0	SV-HYAT	EH	für OE-Nummer: 71737621, 71753780 for OE number: 71737621, 71753780
			7.08681.04.0	SV-HYAT	EH	
			7.08681.05.0	SV-HYAT	EH	für OE-Nummer: 71737623, 71753782 for OE number: 71737623, 71753782
			7.08681.06.0	SV-HYAT	EH	

MITO (955_)



16

0.9 (955AXY1B, 955AXZ1B) 74-77 kW (101-105 PS) 199 B6.000	12.2013→		7.03003.01.0	DW-TL	EP	
0.9 TwinAir (955.AXW1B) 63 kW (86 PS) 312 A2.000	07.2011→		7.00607.02.0	DW-TL	EP	
			7.03003.01.0	DW-TL	EP	
			7.02909.07.0	SUV	EL	
0.9 TwinAir (955AXY1B) 74-77 kW (101-105 PS) 199 B6.000	04.2013→		7.03003.01.0	DW-TL	EP	
			7.02909.07.0	SUV	EL	
1.3 MultiJet (955AXH1B, 955AXT1A) 66 kW (90 PS) 199 A3.000, 955 B2.000	08.2008→08.2010		7.00607.02.0	DW-TL	EP	
			7.03003.01.0	DW-TL	EP	
1.3 MultiJet (955AXP1A, 955AYC1A) 70 kW (95 PS) 199 B1.000	09.2009→12.2018		7.00607.02.0	DW-TL	EP	
			7.03003.01.0	DW-TL	EP	
			7.01981.07.0	SV-AGR-K	EP	
1.3 MultiJet (955AXP1A, 955AYC1A) 70 kW (95 PS) 330 A1.000	09.2009→12.2018		7.00607.02.0	DW-TL	EP	
			7.03003.01.0	DW-TL	EP	
1.3 MultiJet (955AXT1A) 62 kW (84 PS) 199 B4.000	01.2011→		7.03003.01.0	DW-TL	EP	
			7.01981.07.0	SV-AGR-K	EP	

MITO (955_)
16

1.3 MultiJet (955AXT1A, 955AYA1A) 59 kW (80 PS) 199 B8.000	12.2013→		7.03003.01.0	DW-TL	EP	
1.4 (955.AXB1B, 955.AXU1A) 57 kW (78 PS) 350 A1.000	03.2011→		7.06117.38.0	SV-NWV	EL	mit Dichtring with O-ring
1.4 (955AXB1B) 57-58 kW (78-79 PS) 955 A1.000	08.2008→08.2013		7.06117.35.0	SV-NWV	EL	
1.4 (955AXB1B, 955.AXF1B) 70 kW (95 PS) 199 A6.000	09.2008→08.2013		7.02256.30.0	SV-PDA	EP	
1.4 (955AXV1A) 51 kW (69 PS) 955 A9.000	05.2011→		7.06117.38.0	SV-NWV	EL	mit Dichtring with O-ring
1.4 Bifuel (955.AXG1A) 88 kW (120 PS) 198 A4.000	04.2016→		7.02256.49.0	LDRV	EP	
			7.01835.06.0	SUV	EL	
1.4 Bifuel (955AXG1A) 88 kW (120 PS) 198 A4.000	01.2009→		7.02256.49.0	LDRV	EP	
			7.01835.06.0	SUV	EL	
1.4 MultiAir (955AXN1B) 110-125 kW (150-170 PS) 940 A2.000	09.2009→		7.02909.07.0	SUV	EL	
1.4 TB (955.AYB11, 955.AXB1B) 103 kW (140 PS) 955 B1.000	12.2013→		7.02909.07.0	SUV	EL	
1.4 TJet (955AXA1B) 114 kW (155 PS) 199 A8.000	08.2008→06.2011		7.02256.49.0	LDRV	EP	
			7.01835.06.0	SUV	EL	
1.4 TJet (955AXD1B) 110 kW (150 PS) 198 A1.000	09.2008→06.2011		7.02256.49.0	LDRV	EP	
			7.01835.06.0	SUV	EL	
1.4 TJet (955AXG1A) 88 kW (120 PS) 198 A4.000	08.2008→		7.02256.49.0	LDRV	EP	
			7.01835.06.0	SUV	EL	
1.4 Turbo MultiAir (955AXM1A, 955AXR11) 99 kW (135 PS) 955 A2.000, 955 A7.000	10.2009→		7.02909.07.0	SUV	EL	
1.4 Turbo MultiAir (955AXS1B, 955AXS11) 120 kW (163 PS) 955 A8.000	10.2009→		7.02909.07.0	SUV	EL	

SPIDER (939_)
17



1.8 TBi (939DXN1B) 147 kW (200 PS) 939 B1.000	05.2009→03.2011		7.06117.38.0	SV-NWV	EL	mit Dichtring with O-ring
2.0 JTDM (939DXP1B, 939EXP1B) 125 kW (170 PS) 939 B3.000	05.2009→06.2010		7.03003.01.0	DW-TL	EP	
2.0 JTDM (939DXQ1B) 120 kW (163 PS) 844 A2.000	04.2009→03.2011		7.03003.01.0	DW-TL	EP	

A





SPIDER (939_)

17

2.4 JTDM (939DXM1B, 939EXM1B) 147-154 kW (200-209 PS) 939 A3.000	03.2008→03.2011		7.00607.02.0	DW-TL	EP
			7.03003.01.0	DW-TL	EP
2.4 JTDM (939EXD1B, 939EXD12) 147-154 kW (200-209 PS) 939 A3.000	03.2006→03.2011		7.00607.02.0	DW-TL	EP
			7.03003.01.0	DW-TL	EP





STELVIO (949_)



18

2.0 Q4 (949.AXA2A) 147-257 kW (200-350 PS) 552 73 835	12.2016→		7.02909.12.0	SUV	EL
			7.02909.12.0	SUV	EL
2.0 Q4 (949.AXF2A) 147-257 kW (200-350 PS) 552 73 835	12.2016→		7.02909.12.0	SUV	EL
			7.02909.12.0	SUV	EL
2.9 Q4 (949.AXG2A) 376 kW (511 PS) EED	07.2017→		7.03003.01.0	DW-TL	EP
			7.03003.01.0	DW-TL	EP
2.9 Q4 (949.AXG2A, 949.AXH2A, 949.AXS2A) 375-397 kW (510-540 PS) 670 05 0436	11.2017→		7.03003.01.0	DW-TL	EP
			7.03003.01.0	DW-TL	EP
2.9 Q4 (949.AXH2A) 375-397 kW (510-540 PS) 670 05 0436	11.2019→		7.03003.01.0	DW-TL	EP
			7.03003.01.0	DW-TL	EP

GIULIETTA Hatchback Van (940_)

19

1.6 JTDM (940FXD1A) 77 kW (105 PS) 940 A3.000	04.2011→02.2016		7.03003.01.0	DW-TL	EP
			7.03003.01.0	DW-TL	EP
1.8 (940FXC1A) 169-177 kW (230-241 PS) 940 A1.000	04.2011→02.2016		7.03003.01.0	DW-TL	EP
			7.06117.38.0	SV-NWV	EL mit Dichtring with O-ring
2.0 JTDM (940FXE1A) 125 kW (170 PS) 940 A4.000	04.2011→02.2016		7.03003.01.0	DW-TL	EP
			7.03003.01.0	DW-TL	EP
2.0 JTDM (940FXL1A) 103 kW (140 PS) 940 A5.000	07.2013→02.2016		7.03003.01.0	DW-TL	EP
			7.03003.01.0	DW-TL	EP
2.0 JTDM (940FXQ1A) 103-150 kW (140-204 PS) 940 B5.000	08.2013→02.2016		7.03003.01.0	DW-TL	EP
			7.03003.01.0	DW-TL	EP
2.0 JTDM (940FXV11) 125-129 kW (170-175 PS) 940 B4.000	05.2015→		7.03003.01.0	DW-TL	EP
			7.03003.01.0	DW-TL	EP







						
B3 (F30)						1
BITURBO 301-332 kW (409-452 PS) N55 B30 A	03.2013→02.2017		7.00887.22.0	DW-TL	EP	
BITURBO All-wheel Drive 301-332 kW (409-452 PS) N55 B30 A	03.2013→02.2017		7.00887.22.0	DW-TL	EP	
S BITURBO 301-332 kW (409-452 PS) N55 B30 A	03.2017→08.2018		7.00887.22.0	DW-TL	EP	
S BITURBO All-wheel Drive 301-332 kW (409-452 PS) N55 B30 A	03.2017→08.2018		7.00887.22.0	DW-TL	EP	
B5 (E60)						2
4.4 368 kW (500 PS) N62B44A19	03.2005→09.2010		7.06117.00.0	SV-NWV	EL	mit Dichtring with O-ring
B5 Estate (E61)						3
4.4 368 kW (500 PS) N62B44A19	03.2005→09.2010		7.06117.00.0	SV-NWV	EL	mit Dichtring with O-ring
B6 Convertible (E64)						4
4.4 368-390 kW (500-530 PS) N62 B44 A	08.2007→08.2010		7.06117.00.0	SV-NWV	EL	mit Dichtring with O-ring
B6 Gran Coupe (F06)						5
BITURBO All-wheel Drive 373-441 kW (507-600 PS) N63 B44 A	04.2014→12.2014		7.06117.36.0	SV-NWV	EL	mit Dichtring with O-ring
BITURBO All-wheel Drive 397-441 kW (540-600 PS) N63 B44 B	01.2015→03.2016		7.06117.36.0	SV-NWV	EL	mit Dichtring with O-ring
B7 (E65)						6
4.4 368 kW (500 PS) N62B44A19	12.2003→06.2008		7.06117.00.0	SV-NWV	EL	mit Dichtring with O-ring
B7 (F01, F02)						7
4.4 All-wheel Drive 403 kW (548 PS) N63 M20 A	09.2012→01.2016		7.06117.36.0	SV-NWV	EL	mit Dichtring with O-ring
BITURBO 373-441 kW (507-600 PS) N63 B44 A	03.2009→06.2012		7.06117.36.0	SV-NWV	EL	mit Dichtring with O-ring
BITURBO 397-441 kW (540-600 PS) N63 B44 B	07.2012→07.2015		7.06117.36.0	SV-NWV	EL	mit Dichtring with O-ring
BITURBO 403 kW (548 PS) N63 M20 A	09.2012→01.2016		7.06117.36.0	SV-NWV	EL	mit Dichtring with O-ring
BITURBO All-wheel Drive 373-441 kW (507-600 PS) N63 B44 A	09.2010→06.2012		7.06117.36.0	SV-NWV	EL	mit Dichtring with O-ring
BITURBO All-wheel Drive 397-441 kW (540-600 PS) N63 B44 B	07.2012→07.2015		7.06117.36.0	SV-NWV	EL	mit Dichtring with O-ring
ROADSTER V8 (E52)						8
4.8 V8 280 kW (381 PS) M62 B48 (488S2)	06.2002→10.2003		7.06117.10.0	SV-NWV	EL	

A









100 C3 Avant (445, 446)

1

1.8 55 kW (75 PS) RS	08.1982→12.1987		7.01805.01.0	EUV-SR	EL	
1.8 66 kW (90 PS) JW, NP	08.1983→07.1989		7.01805.01.0	EUV-SR	EL	
1.8 65-66 kW (88-90 PS) SH	08.1986→07.1990		7.01805.01.0	EUV-SR	EL	
1.8 quattro 66 kW (90 PS) JW, NP	10.1984→07.1988		7.01805.01.0	EUV-SR	EL	
1.8 quattro 65-66 kW (88-90 PS) SH	08.1986→07.1990		7.01805.01.0	EUV-SR	EL	
2.0 TD 74 kW (100 PS) NC	03.1988→11.1990		7.01805.01.0	EUV-SR	EL	





100 C3 Saloon (443, 444)

2

1.8 55 kW (75 PS) RS	08.1982→12.1987		7.01805.01.0	EUV-SR	EL	
1.8 66 kW (90 PS) JW, NP	08.1983→07.1989		7.01805.01.0	EUV-SR	EL	
1.8 65-66 kW (88-90 PS) SH	08.1986→07.1988		7.01805.01.0	EUV-SR	EL	
1.8 quattro 66 kW (90 PS) JW, NP	10.1984→07.1988		7.01805.01.0	EUV-SR	EL	
1.8 quattro 65-66 kW (88-90 PS) SH	08.1986→07.1990		7.01805.01.0	EUV-SR	EL	
2.0 D Turbo 74 kW (100 PS) NC	03.1988→11.1990		7.01805.01.0	EUV-SR	EL	





100 C4 Avant (4A5)

3

2.5 TDI 85 kW (116 PS) AAT	09.1991→06.1994		7.21903.70.0	DW-AGR	EP	Fahrgestellnummer ab: 4A-R-097 001 Vehicle Identification Number from: 4A-R-097 001
2.8 E 128 kW (174 PS) AAH	09.1991→07.1994		7.21483.54.0	EUV-AGR	EL	Fahrgestellnummer ab: 4A-M-000 001 Vehicle Identification Number from: 4A-M-000 001
			7.01805.01.0	EUV-SR	EL	 ch. 4A-M-000 001→
2.8 E quattro 128 kW (174 PS) AAH	09.1991→07.1994		7.21483.54.0	EUV-AGR	EL	Fahrgestellnummer ab: 4A-M-000 001 Vehicle Identification Number from: 4A-M-000 001
			7.01805.01.0	EUV-SR	EL	 ch. 4A-M-000 001→





100 C4 Saloon (4A2)

































4

2.5 TDI 85 kW (116 PS) AAT	07.1991→06.1994		7.21903.70.0	DW-AGR	EP	Fahrgestellnummer ab: 4A-R-097 001 Vehicle Identification Number from: 4A-R-097 001
2.8 E 128 kW (174 PS) AAH	12.1990→07.1994		7.21483.54.0	EUV-AGR	EL	Fahrgestellnummer ab: 4A-M-000 001 Vehicle Identification Number from: 4A-M-000 001
			7.01805.01.0	EUV-SR	EL	 ch. 4A-M-000 001→
2.8 E quattro 128 kW (174 PS) AAH	09.1991→07.1994		7.21483.54.0	EUV-AGR	EL	Fahrgestellnummer ab: 4A-M-000 001 Vehicle Identification Number from: 4A-M-000 001
			7.01805.01.0	EUV-SR	EL	 ch. 4A-M-000 001→

80 B4 Avant (8C5)

5

1.9 TDI 66 kW (90 PS) 1Z	07.1992→01.1996		7.21903.70.0	DW-AGR	EP	Fahrgestellnummer ab: 8C-R-136 878 Vehicle Identification Number from: 8C-R-136 878
2.6 110 kW (150 PS) ABC	07.1992→01.1996		7.05432.12.0	SM	EL	mit Dichtring with O-ring  ch. 8C-S-025 821→
			7.05432.12.0	SM	EL	mit Dichtring with O-ring  ch. 8C-S-025 821→

						
80 B4 Avant (8C5)						5
2.8 128 kW (174 PS) AAH	09.1991→01.1996		7.21483.54.0	EUV-AGR	EL	 ch. 8C-N-000 001→ch. 8C-N-300 000
			7.01805.01.0	EUV-SR	EL	
2.8 quattro 128 kW (174 PS) AAH	08.1992→07.1995		7.21483.54.0	EUV-AGR	EL	 ch. 8C-N-000 001→ch. 8C-N-300 000
			7.01805.01.0	EUV-SR	EL	
80 B4 Saloon (8C2)						6
1.9 TDI 66 kW (90 PS) 1Z	09.1991→12.1994		7.21903.70.0	DW-AGR	EP	Fahrgestellnummer ab: 8C-R-136 878 Vehicle Identification Number from: 8C-R-136 878
2.6 110 kW (150 PS) ABC	07.1992→12.1994		7.05432.12.0	SM	EL	mit Dichtring with O-ring  ch. 8C-S-025 821→
2.6 quattro 110 kW (150 PS) ABC	06.1992→12.1994		7.05432.12.0	SM	EL	mit Dichtring with O-ring  ch. 8C-S-025 821→
2.8 128 kW (174 PS) AAH	09.1991→12.1994		7.21483.54.0	EUV-AGR	EL	 ch. 8C-N-000 001→ch. 8C-N-300 000
			7.01805.01.0	EUV-SR	EL	
2.8 quattro 128 kW (174 PS) AAH	09.1991→12.1994		7.21483.54.0	EUV-AGR	EL	 ch. 8C-N-000 001→ch. 8C-N-300 000
			7.01805.01.0	EUV-SR	EL	
A1 (8X1, 8XK)						7
1.0 TFSI 70 kW (95 PS) CHZB	03.2015→10.2018		7.06117.48.0	SV-NWV	EL	
1.0 TFSI 60 kW (82 PS) CHZE	01.2016→10.2018		7.06117.48.0	SV-NWV	EL	
1.2 TFSI 63 kW (86 PS) CBZA	05.2010→04.2015		7.22880.01.0	EUV-KK	EL	
1.4 TFSI 90 kW (122 PS) CAXA, CNVA	05.2010→04.2015		7.01830.13.0	SUV	EL	
			7.06117.54.0	SV-NWV	EL	
1.4 TFSI 136 kW (185 PS) CAVG, CTHG	01.2011→04.2015		7.02588.04.0	LDRV	EL	
			7.04247.02.0	SUV	EL	
			7.06117.54.0	SV-NWV	EL	
1.4 TFSI 103 kW (140 PS) CPTA	04.2012→04.2015		7.06117.48.0	SV-NWV	EL	
1.4 TFSI 92 kW (125 PS) CZCA, CZDD	11.2014→10.2018		7.06117.48.0	SV-NWV	EL	
1.4 TSI 110 kW (150 PS) CZEA	11.2014→10.2018		7.06117.48.0	SV-NWV	EL	
1.6 TDI 77 kW (105 PS) CAYC	05.2010→04.2015		7.02256.00.0	EUV-AGR	EP	
1.6 TDI 66 kW (90 PS) CAYB	03.2011→04.2015		7.02256.00.0	EUV-AGR	EP	
1.8 TFSI 141 kW (192 PS) DAJB	02.2015→10.2018		7.02256.18.0	EUV-SR	EP	
			7.02901.05.0	SUV	EL	
			7.06117.26.0	ZM-NWV	EL	
2.0 TDI 105 kW (143 PS) CFHD	09.2011→04.2015		7.02256.00.0	EUV-AGR	EP	
2.0 TDI 100 kW (136 PS) CFHB	05.2012→04.2015		7.02256.00.0	EUV-AGR	EP	

A



A1 (8X1, 8XK)

7

2.0 TFSI quattro 188 kW (256 PS) CDLH	03.2012→11.2012		7.00470.07.0	LDRV	EL
			7.01830.13.0	SUV	EL
S1 quattro 170 kW (231 PS) CWZA	03.2014→10.2018		7.02901.05.0	SUV	EL
			7.06117.26.0	ZM-NWV	EL











A1 CITY CARVER (GBH)

8

25 TFSI 70 kW (95 PS) DKLA	07.2019→		7.06117.48.0	SV-NWV	EL
30 TFSI 85 kW (116 PS) DKJA, DKRF	07.2019→		7.06117.48.0	SV-NWV	EL

A1 Sportback (8XA, 8XF)

























9

1.0 TFSI 70 kW (95 PS) CHZB	03.2015→10.2018		7.06117.48.0	SV-NWV	EL
1.0 TFSI 60 kW (82 PS) CHZE	01.2016→10.2018		7.06117.48.0	SV-NWV	EL
1.2 TFSI 63 kW (86 PS) CBZA	01.2012→04.2015		7.22880.01.0	EUV-KK	EL
1.4 TFSI 90 kW (122 PS) CAXA, CNVA	11.2011→04.2015		7.01830.13.0	SUV	EL
			7.06117.54.0	SV-NWV	EL
1.4 TFSI 136 kW (185 PS) CAVG, CTHG	11.2011→04.2015		7.02588.04.0	LDRV	EL
			7.04247.02.0	SUV	EL
			7.06117.54.0	SV-NWV	EL
1.4 TFSI 103 kW (140 PS) CPTA	04.2012→04.2015		7.06117.48.0	SV-NWV	EL
1.4 TFSI 92 kW (125 PS) CZCA, CZDD	11.2014→10.2018		7.06117.48.0	SV-NWV	EL
1.4 TSI 110 kW (150 PS) CZEA	11.2014→10.2018		7.06117.48.0	SV-NWV	EL
1.6 TDI 66 kW (90 PS) CAYB	11.2011→04.2015		7.02256.00.0	EUV-AGR	EP
1.6 TDI 77 kW (105 PS) CAYC	11.2011→04.2015		7.02256.00.0	EUV-AGR	EP
1.8 TFSI 141 kW (192 PS) DAJB	02.2015→10.2018		7.02256.18.0	EUV-SR	EP
			7.02901.05.0	SUV	EL
			7.06117.26.0	ZM-NWV	EL
2.0 TDI 105 kW (143 PS) CFHD	09.2011→04.2015		7.02256.00.0	EUV-AGR	EP
2.0 TDI 100 kW (136 PS) CFHB	05.2012→04.2015		7.02256.00.0	EUV-AGR	EP
S1 quattro 170 kW (231 PS) CWZA	03.2014→10.2018		7.02901.05.0	SUV	EL
			7.06117.26.0	ZM-NWV	EL

A1 Sportback (GBA)

10

25 TFSI 70 kW (95 PS) DKLA	11.2018→		7.06117.48.0	SV-NWV	EL
30 TFSI 85 kW (116 PS) DKJA, DKRF	07.2018→		7.06117.48.0	SV-NWV	EL
40 TFSI 147 kW (200 PS) CZPC, DKZC	09.2018→		7.02901.05.0	SUV	EL

						
A2 (8Z0)						11
1.2 TDI 45 kW (61 PS) ANY	03.2001→08.2005		7.21903.70.0	DW-AGR	EP	
			7.21903.75.0	DW-RK	EP	
1.4 TDI 55 kW (75 PS) AMF	02.2000→08.2005		7.21903.70.0	DW-AGR	EP	
			7.21895.55.0	LDRV	EL	
1.6 FSI 81 kW (110 PS) BAD	05.2002→08.2005		7.10014.00.0	AKF	EL	
			7.28098.04.0	EUV-SR	EL	
A3 (8L1)						12
1.6 74 kW (101 PS) AEH, AKL	09.1996→05.2003		7.22402.03.0	EUV-SR	EL	 AEH, AKL: Fahrgestellnummer bis: 8L-Y-150 000 Vehicle Identification Number to: 8L-Y-150 000
			7.22880.01.0	EUV-SR	EL	 AEH, AKL: Fahrgestellnummer ab: 8L-1-000 001 Vehicle Identification Number from: 8L-1-000 001
1.6 74 kW (101 PS) APF	08.1998→05.2003		7.02256.00.0	EUV-AGR	EP	
			7.22402.03.0	EUV-SR	EL	Fahrgestellnummer bis: 8L-Y-150 000 Vehicle Identification Number to: 8L-Y-150 000
			7.22880.01.0	EUV-SR	EL	Fahrgestellnummer ab: 8L-1-000 001 Vehicle Identification Number from: 8L-1-000 001
1.6 75 kW (102 PS) AVU	08.2000→05.2003		7.22402.03.0	EUV-SR	EL	 →ch. 8L-Y-150 000
			7.22880.01.0	EUV-SR	EL	
1.6 75 kW (102 PS) BFQ	08.2000→05.2003		7.22880.01.0	EUV-SR	EL	
1.8 92 kW (125 PS) AGN	09.1996→05.2003		7.02461.01.0	EUV-SR	EL	 ch. 8L-W-000 001→
			7.28098.04.0	EUV-SR	EL	
1.8 92 kW (125 PS) APG	08.1998→05.2003		7.02256.00.0	EUV-SL	EP	
			7.02461.01.0	EUV-SR	EL	
			7.28098.04.0	EUV-SR	EL	
1.8 T 110 kW (150 PS) ARZ, AUM	12.1996→05.2003		7.22687.49.0	EUV-DR	EP	
			7.22687.39.0	EUV-LS	EL	
			7.01805.01.0	EUV-SR	EL	
1.8 T 110 kW (150 PS) AQA	08.1998→05.2003		7.22687.49.0	EUV-DR	EP	
			7.22687.39.0	EUV-LS	EL	
1.8 T 132 kW (180 PS) AJQ	12.1998→05.2003		7.22687.49.0	EUV-DR	EP	
			7.22687.39.0	EUV-LS	EL	
1.8 T 132 kW (180 PS) APP, ARY, AUQ	12.1998→05.2003		7.22687.49.0	EUV-DR	EP	
			7.22687.39.0	EUV-LS	EL	
			7.01805.01.0	EUV-SR	EL	
1.8 T quattro 110 kW (150 PS) ARX	12.1996→05.2003		7.22687.49.0	EUV-DR	EP	
			7.22687.39.0	EUV-LS	EL	
			7.01805.01.0	EUV-SR	EL	
1.8 T quattro 110 kW (150 PS) AQA	08.1998→05.2003		7.22687.49.0	EUV-DR	EP	
			7.22687.39.0	EUV-LS	EL	

A



A3 (8L1)

12

1.8 T quattro 132 kW (180 PS) AJQ	10.1998→05.2003		7.22687.49.0	EUV-DR	EP	
			7.22687.39.0	EUV-LS	EL	
1.8 T quattro 132 kW (180 PS) ARY	10.1998→05.2003		7.22687.49.0	EUV-DR	EP	
			7.22687.39.0	EUV-LS	EL	
			7.01805.01.0	EUV-SR	EL	
1.9 TDI 66 kW (90 PS) AGR	09.1996→07.2001		7.02183.01.0	DW-AGR	EP	ch. 8L-Y-000 001→
			7.21903.70.0	DW-AGR	EP	Fahrgestellnummer bis: 8L-X-200 000 Vehicle Identification Number to: 8L-X-200 000
			7.02256.00.0	EUV-AGR	EP	ch. 8L-Y-000 001→
			7.01037.02.0	LDRV	EL	ch. 8L-Y-000 001→
			7.21895.55.0	LDRV	EL	Fahrgestellnummer bis: 8L-X-200 000 Vehicle Identification Number to: 8L-X-200 000
1.9 TDI 66 kW (90 PS) ALH	08.1997→07.1998		7.02183.01.0	DW-AGR	EP	ch. 8L-Y-000 001→
			7.21903.70.0	DW-AGR	EP	Fahrgestellnummer bis: 8L-X-200 000 Vehicle Identification Number to: 8L-X-200 000
			7.02184.01.0	DW-TL	EP	ch. 8L-Y-000 001→
			7.21903.75.0	DW-TL	EP	→ch. 8L-X-200 000
			7.02256.00.0	EUV-AGR	EP	ch. 8L-Y-000 001→
1.9 TDI 81 kW (110 PS) AHF, ASV	08.1997→07.2001		7.02183.01.0	DW-AGR	EP	AHF, ASV: ch. 8L-Y-000 001→
			7.21903.70.0	DW-AGR	EP	AHF, ASV: Fahrgestellnummer bis: 8L-X-200 000 Vehicle Identification Number to: 8L-X-200 000
			7.02184.01.0	DW-TL	EP	AHF, ASV: ch. 8L-Y-000 001→
			7.21903.75.0	DW-TL	EP	AHF, ASV: →ch. 8L-X-200 000
			7.02256.00.0	EUV-AGR	EP	AHF, ASV: ch. 8L-Y-000 001→
1.9 TDI 96 kW (130 PS) ASZ	08.2000→05.2003		7.02183.01.0	DW-AGR	EP	
			7.00868.02.0	DW-TL	EP	
			7.02256.00.0	EUV-AGR	EP	
1.9 TDI 74 kW (101 PS) ATD	10.2000→05.2003		7.02183.01.0	DW-AGR	EP	
			7.02184.01.0	DW-TL	EP	
			7.02256.00.0	EUV-AGR	EP	
1.9 TDI 74 kW (100 PS) AXR	11.2001→05.2003		7.02183.01.0	DW-AGR	EP	
			7.00868.02.0	DW-TL	EP	
			7.02256.00.0	EUV-AGR	EP	
1.9 TDI quattro 96 kW (130 PS) ASZ	08.2000→05.2003		7.02183.01.0	DW-AGR	EP	
			7.00868.02.0	DW-TL	EP	
			7.02256.00.0	EUV-AGR	EP	
S3 quattro 154 kW (209 PS) AMK	03.1999→04.2002		7.22687.49.0	EUV-DR	EP	
			7.22687.39.0	EUV-LS	EL	
S3 quattro 154 kW (209 PS) APY, AUL	03.1999→04.2002		7.22687.49.0	EUV-DR	EP	
			7.01805.01.0	EUV-LS	EL	
			7.22687.39.0	EUV-LS	EL	













A3 (8L1)						12
S3 quattro 165 kW (224 PS) BAM	10.2001→05.2003		7.22687.49.0	EUV-DR	EP	
			7.22687.39.0	EUV-LS	EL	
A3 (8P1)						13
1.2 TSI 77 kW (105 PS) CBZB	04.2010→08.2012		7.22880.01.0	EUV-KK	EL	
			7.02256.40.0	SV-KK	EL	für Fahrzeuge mit Standheizung for vehicles with parking heater
1.4 TFSI 92 kW (125 PS) CAXC	09.2007→08.2012		7.00415.07.0	SUV	EL	Produktionsdatum bis: 28.04.2008 Production date to: 28.04.2008
			7.02256.40.0	SV-KK	EL	für Fahrzeuge mit Standheizung for vehicles with parking heater
			7.06117.54.0	SV-NWV	EL	
1.4 TFSI 92 kW (125 PS) CMSA	09.2007→08.2012		7.01830.13.0	SUV	EL	
			7.02256.40.0	SV-KK	EL	für Fahrzeuge mit Standheizung for vehicles with parking heater
1.6 75 kW (102 PS) BGU, BSE, BSF	05.2003→08.2012		7.10014.00.0	AKF	EL	
			7.22880.01.0	EUV-SR	EL	
			7.02256.40.0	SV-KK	EL	BGU, BSE, BSF: für Fahrzeuge mit Standheizung for vehicles with parking heater
1.6 E-Power 75 kW (102 PS) CCSA, CMXA	01.2011→08.2012		7.10014.00.0	AKF	EL	
1.6 FSI 85 kW (115 PS) BAG, BLF, BLP	08.2003→09.2007		7.10014.00.0	AKF	EL	
			7.22880.01.0	EUV-SR	EL	
			7.02256.40.0	SV-KK	EL	BAG, BLF, BLP: für Fahrzeuge mit Standheizung for vehicles with parking heater
			7.06117.54.0	SV-NWV	EL	
1.6 TDI 66 kW (90 PS) CAYB	05.2009→08.2012		7.02256.00.0	EUV-AGR	EP	
			7.02256.40.0	SV-KK	EL	für Fahrzeuge mit Standheizung for vehicles with parking heater
1.6 TDI 77 kW (105 PS) CAYC	05.2009→08.2012		7.02256.00.0	EUV-AGR	EP	
			7.02256.40.0	SV-KK	EL	für Fahrzeuge mit Standheizung for vehicles with parking heater
1.8 TFSI 118 kW (160 PS) BYT, BZB	11.2006→08.2012		7.00470.07.0	LDRV	EL	
			7.01830.13.0	SUV	EL	
			7.02256.40.0	SV-KK	EL	BYT, BZB: für Fahrzeuge mit Standheizung for vehicles with parking heater
			7.06117.26.0	ZM-NWV	EL	
1.8 TFSI 118 kW (160 PS) CDA A	11.2006→08.2012		7.03280.04.0	EUV-SR	EL	Baujahr ab: 01.2009 Construction year from: 01.2009 nur in Verbindung mit: Fahrzeug umgerüstet only in connection with: Fahrzeug umgerüstet
			7.22880.01.0	EUV-SR	EL	
			7.00470.07.0	LDRV	EL	
			7.01830.13.0	SUV	EL	
			7.02256.40.0	SV-KK	EL	für Fahrzeuge mit Standheizung for vehicles with parking heater
			7.06117.26.0	ZM-NWV	EL	

















A



A3 (8P1)

13

1.8 TFSI quattro 118 kW (160 PS) CDAА	07.2008→08.2012		7.03280.04.0	EUV-SR	EL	nur in Verbindung mit: Fahrzeug umgerüstet only in connection with: Fahrzeug umgerüstet
			7.22880.01.0	EUV-SR	EL	
			7.00470.07.0	LDRV	EL	
			7.01830.13.0	SUV	EL	
			7.02256.40.0	SV-KK	EL	
7.06117.26.0	ZM-NWV	EL				
1.9 TDI 77 kW (105 PS) BKC, BXE	05.2003→05.2010		7.02256.40.0	SV-KK	EL	 BKC, BXE: für Fahrzeuge mit Standheizung for vehicles with parking heater
1.9 TDI 77 kW (105 PS) BLS	05.2003→05.2010		7.00868.02.0	DW-TL	EP	für Fahrzeuge mit Standheizung for vehicles with parking heater
			7.02256.00.0	EUV-AGR	EP	
			7.02256.40.0	SV-KK	EL	
2.0 FSI 110 kW (150 PS) AXW, BLR, BLX, BLY, BMB, BVY	05.2003→06.2008		7.22880.01.0	EUV-SR	EL	 AXW, BLR, BLX, BLY, BMB, BVY: für Fahrzeuge mit Standheizung for vehicles with parking heater
			7.02256.40.0	SV-KK	EL	
			7.06117.37.0	SV-NWV	EL	
2.0 FSI 110 kW (150 PS) BVZ	05.2003→06.2008		7.22880.01.0	EUV-SR	EL	für Fahrzeuge mit Standheizung for vehicles with parking heater
			7.02256.40.0	SV-KK	EL	
			7.06117.37.0	SV-NWV	EL	
			7.06117.46.0	SV-NWV	EH	
2.0 TDI 100 kW (136 PS) AZV	05.2003→08.2012		7.02256.40.0	SV-KK	EL	für Fahrzeuge mit Standheizung for vehicles with parking heater
2.0 TDI 100 kW (136 PS) CBAA	05.2003→08.2012		7.00868.02.0	DW-TL	EP	für Fahrzeuge mit Standheizung for vehicles with parking heater
			7.02256.00.0	EUV-AGR	EP	
			7.02256.40.0	SV-KK	EL	
2.0 TDI 100 kW (136 PS) CFFA	05.2003→08.2012		7.02256.00.0	EUV-AGR	EP	für Fahrzeuge mit Standheizung for vehicles with parking heater
			7.02256.40.0	SV-KK	EL	
2.0 TDI 103 kW (140 PS) BMM	06.2005→06.2008		7.00868.02.0	DW-TL	EP	für Fahrzeuge mit Standheizung for vehicles with parking heater
			7.02256.40.0	SV-KK	EL	
2.0 TDI 125 kW (170 PS) BMN, CBBB	03.2006→08.2012		7.00868.02.0	DW-TL	EP	 BMN, CBBB: für Fahrzeuge mit Standheizung for vehicles with parking heater
			7.02256.00.0	EUV-AGR	EP	
			7.02256.00.0	EUV-SR	EP	
			7.02256.40.0	SV-KK	EL	
2.0 TDI 125 kW (170 PS) CFGB	03.2006→08.2012		7.02256.00.0	EUV-AGR	EP	für Fahrzeuge mit Standheizung for vehicles with parking heater
			7.02256.40.0	SV-KK	EL	









						
A3 (8P1)						13
2.0 TDI 120 kW (163 PS) BUY	06.2006→06.2008		7.00868.02.0	DW-TL	EP	für Fahrzeuge mit Standheizung for vehicles with parking heater
			7.02256.00.0	EUV-AGR	EP	
			7.02256.00.0	EUV-SR	EP	
			7.02256.40.0	SV-KK	EL	
2.0 TDI 16V 103 kW (140 PS) BKD	05.2003→08.2012		7.02256.40.0	SV-KK	EL	für Fahrzeuge mit Standheizung for vehicles with parking heater
2.0 TDI 16V 103 kW (140 PS) CBAB	05.2003→08.2012		7.00868.02.0	DW-TL	EP	für Fahrzeuge mit Standheizung for vehicles with parking heater
			7.02256.00.0	EUV-AGR	EP	
			7.02256.40.0	SV-KK	EL	
			7.02256.40.0	SV-KK	EL	
2.0 TDI 16V 103 kW (140 PS) CFFB, CLJA	05.2003→08.2012		7.02256.00.0	EUV-AGR	EP	für Fahrzeuge mit Standheizung for vehicles with parking heater
			7.02256.40.0	SV-KK	EL	
2.0 TDI 16V quattro 103 kW (140 PS) BKD	08.2004→08.2012		7.02256.40.0	SV-KK	EL	für Fahrzeuge mit Standheizung for vehicles with parking heater
2.0 TDI 16V quattro 103 kW (140 PS) CBAB	08.2004→08.2012		7.00868.02.0	DW-TL	EP	für Fahrzeuge mit Standheizung for vehicles with parking heater
			7.02256.00.0	EUV-AGR	EP	
			7.02256.40.0	SV-KK	EL	
			7.02256.40.0	SV-KK	EL	
2.0 TDI 16V quattro 103 kW (140 PS) CFFB	08.2004→08.2012		7.02256.00.0	EUV-AGR	EP	für Fahrzeuge mit Standheizung for vehicles with parking heater
			7.02256.40.0	SV-KK	EL	
2.0 TDI quattro 100 kW (136 PS) AZV	05.2003→06.2008		7.02256.40.0	SV-KK	EL	für Fahrzeuge mit Standheizung for vehicles with parking heater
2.0 TDI quattro 103 kW (140 PS) BMM	01.2006→06.2008		7.00868.02.0	DW-TL	EP	für Fahrzeuge mit Standheizung for vehicles with parking heater
			7.02256.40.0	SV-KK	EL	
2.0 TDI quattro 125 kW (170 PS) BMN, CBBB	03.2006→08.2012		7.00868.02.0	DW-TL	EP	für Fahrzeuge mit Standheizung for vehicles with parking heater
			7.02256.00.0	EUV-AGR	EP	
			7.02256.00.0	EUV-SR	EP	
			7.02256.40.0	SV-KK	EL	
2.0 TDI quattro 125 kW (170 PS) CFGB	03.2006→08.2012		7.02256.00.0	EUV-AGR	EP	für Fahrzeuge mit Standheizung for vehicles with parking heater
			7.02256.40.0	SV-KK	EL	
2.0 TFSI 147 kW (200 PS) AXX	09.2004→08.2012		7.00470.07.0	LDRV	EL	mit Dichtring with O-ring
			7.01830.13.0	SUV	EL	
			7.06117.46.0	SV-NWV	EH	
2.0 TFSI 147 kW (200 PS) BWA	09.2004→08.2012		7.00470.07.0	LDRV	EL	für Fahrzeuge mit Standheizung for vehicles with parking heater mit Dichtring with O-ring
			7.01830.13.0	SUV	EL	
			7.02256.40.0	SV-KK	EL	
			7.06117.46.0	SV-NWV	EH	

A



A3 (8P1)

13

2.0 TFSI 147 kW (200 PS) CAWB	09.2004→08.2012		7.03280.04.0	EUV-SR	EL	Baujahr ab: 01.2008 Construction year from: 01.2008 nur in Verbindung mit: Fahrzeug umgerüstet only in connection with: Fahrzeug umgerüstet	
			7.22880.01.0	EUV-SR	EL		
			7.00470.07.0	LDRV	EL		 ch. 01.2009→
			7.02901.05.0	SUV	EL		für OE-Nummer: 06H 145 710 C, 06J 145 713 F for OE number: 06H 145 710 C, 06J 145 713 F
			7.02256.40.0	SV-KK	EL		für Fahrzeuge mit Standheizung for vehicles with parking heater
2.0 TFSI 147 kW (200 PS) CCZA	09.2004→08.2012		7.03280.04.0	EUV-SR	EL	Baujahr ab: 01.2009 Construction year from: 01.2009 nur in Verbindung mit: Fahrzeug umgerüstet only in connection with: Fahrzeug umgerüstet	
			7.00470.07.0	LDRV	EL		01.2009→
			7.02901.05.0	SUV	EL		für OE-Nummer: 06J 145 713 F, 06J 145 713 K for OE number: 06J 145 713 F, 06J 145 713 K
			7.02256.40.0	SV-KK	EL		für Fahrzeuge mit Standheizung for vehicles with parking heater
2.0 TFSI quattro 147 kW (200 PS) AXX	09.2004→08.2012		7.00470.07.0	LDRV	EL		
			7.01830.13.0	SUV	EL		
			7.06117.46.0	SV-NWV	EH		mit Dichtring with O-ring
2.0 TFSI quattro 147 kW (200 PS) BWA	09.2004→08.2012		7.00470.07.0	LDRV	EL		
			7.01830.13.0	SUV	EL		
			7.02256.40.0	SV-KK	EL		für Fahrzeuge mit Standheizung for vehicles with parking heater
			7.06117.46.0	SV-NWV	EH		mit Dichtring with O-ring
2.0 TFSI quattro 147 kW (200 PS) CBFA	09.2004→08.2012		7.03280.04.0	EUV-SR	EL	Baujahr ab: 01.2009 Construction year from: 01.2009 nur in Verbindung mit: Fahrzeug umgerüstet only in connection with: Fahrzeug umgerüstet	
			7.06117.26.0	ZM-NWV	EL		
2.0 TFSI quattro 147-149 kW (200-203 PS) CCTA	09.2004→08.2012		7.03280.04.0	EUV-SR	EL	Baujahr ab: 01.2009 Construction year from: 01.2009 nur in Verbindung mit: Fahrzeug umgerüstet only in connection with: Fahrzeug umgerüstet	
2.0 TFSI quattro 147 kW (200 PS) CCZA	09.2004→08.2012		7.03280.04.0	EUV-SR	EL	Baujahr ab: 01.2009 Construction year from: 01.2009 nur in Verbindung mit: Fahrzeug umgerüstet only in connection with: Fahrzeug umgerüstet	
			7.00470.07.0	LDRV	EL		01.2009→
			7.02901.05.0	SUV	EL		für OE-Nummer: 06J 145 713 F, 06J 145 713 K for OE number: 06J 145 713 F, 06J 145 713 K

						A
A3 (8P1)						13
3.2 V6 quattro 184-186 kW (250-253 PS) BDB, BMJ, BUB	07.2003→05.2009		7.02256.40.0	SV-KK	EL	für Fahrzeuge mit Standheizung for vehicles with parking heater
			7.06117.26.0	ZM-NWV	EL	
			7.10014.00.0	AKF	EL	
			7.28098.04.0	EUV-AGK	EL	BDB, BMJ: Fahrgestellnummer ab: 8P-5A013 001, 8P-5B000 001 Vehicle Identification Number from: 8P-5A013 001, 8P-5B000 001 BUB: Fahrgestellnummer ab: 8P-5A013 001, 8P-5B000 001 Vehicle Identification Number from: 8P-5A013 001, 8P-5B000 001 2007 2007
			7.02256.00.0	EUV-AGK	EP	BDB, BMJ: →ch. 8P-5A013 000 BUB: →12.2007, →ch. 8P-5A013 000 BUB: 01.2008→
			7.02256.00.0	EUV-SL	EP	
			7.02256.00.0	EUV-SR	EP	
			7.02256.40.0	SV-KK	EL	BDB, BMJ, BUB: für Fahrzeuge mit Standheizung for vehicles with parking heater
S3 quattro 195 kW (265 PS) BHZ, CDLA	11.2006→08.2012		7.02256.00.0	EUV-AGK	EP	BHZ: →ch. 8P-5A013 000 2007 2007 CDLA: Produktionsdatum ab: 10.05.2010 Production date from: 10.05.2010
			7.28098.04.0	EUV-AGK	EL	BHZ: Fahrgestellnummer ab: 8P-5A013 001, 8P-5B000 001 Vehicle Identification Number from: 8P-5A013 001, 8P-5B000 001 2007 2007 BHZ: 2008 2008 CDLA: Produktionsdatum bis: 10.05.2010 Production date to: 10.05.2010
			7.00470.07.0	LDRV	EL	01.2009→
			7.00415.07.0	SUV	EL	Produktionsdatum bis: 11.11.2008 Production date to: 11.11.2008
			7.01830.13.0	SUV	EL	
			7.02256.40.0	SV-KK	EL	BHZ, CDLA: für Fahrzeuge mit Standheizung for vehicles with parking heater
			7.06117.46.0	SV-NWV	EH	mit Dichtring with O-ring
			S3 quattro 188 kW (256 PS) BZC, CDLC	02.2007→08.2012		7.02256.00.0

A



A3 (8P1)

13

		7.28098.04.0	EUV-AGK	EL	BZC: Fahrgestellnummer ab: 8P-5A013 001, 8P-5B000 001 Vehicle Identification Number from: 8P-5A013 001, 8P-5B000 001 CDLC: Produktionsdatum bis: 10.05.2010 Production date to: 10.05.2010
		7.00470.07.0	LDRV	EL	01.2009→
		7.00415.07.0	SUV	EL	Produktionsdatum bis: 11.11.2008 Production date to: 11.11.2008
		7.01830.13.0	SUV	EL	
		7.02256.40.0	SV-KK	EL	BZC, CDLC: für Fahrzeuge mit Standheizung for vehicles with parking heater
		7.06117.46.0	SV-NWV	EH	mit Dichtring with O-ring

A3 (8V1, 8VK)

14

1.0 TFSI 85 kW (115 PS) CHZD	07.2016→12.2017	7.06117.48.0	SV-NWV	EL	Fahrgestellnummer ab: 8V-L-000 001 Vehicle Identification Number from: 8V-L-000 001	
1.2 TFSI 77 kW (105 PS) CJZA	02.2013→05.2015	7.06117.48.0	SV-NWV	EL	Fahrgestellnummer ab: 8V-D-000 001 Vehicle Identification Number from: 8V-D-000 001 Produktionsdatum bis: 10.02.2014 Production date to: 10.02.2014	
1.2 TFSI 81 kW (110 PS) CYVB	05.2014→08.2016	7.06117.48.0	SV-NWV	EL	Fahrgestellnummer ab: 8V-D-000 001 Vehicle Identification Number from: 8V-D-000 001 Produktionsdatum bis: 10.02.2014 Production date to: 10.02.2014	
1.4 TFSI 90 kW (122 PS) CMBA, CXSA	04.2012→05.2014	7.06117.48.0	SV-NWV	EL	CMBA, CXSA: Fahrgestellnummer ab: 8V-D-000 001 Vehicle Identification Number from: 8V-D-000 001	
1.4 TFSI 103 kW (140 PS) CPTA	03.2013→08.2016	7.06117.48.0	SV-NWV	EL	Fahrgestellnummer ab: 8V-D-000 001 Vehicle Identification Number from: 8V-D-000 001	
1.4 TFSI 92 kW (125 PS) CXSB, CZCA	05.2014→08.2016	7.06117.48.0	SV-NWV	EL	CXSB, CZCA: Fahrgestellnummer ab: 8V-D-000 001 Vehicle Identification Number from: 8V-D-000 001	
1.4 TSI 110 kW (150 PS) CZEA	05.2014→12.2017	7.06117.48.0	SV-NWV	EL	Fahrgestellnummer ab: 8V-D-000 001 Vehicle Identification Number from: 8V-D-000 001	
1.8 TFSI 132 kW (180 PS) CJSA			7.03280.04.0	EUV-SR	EL	Fahrgestellnummer ab: 8V-D-000 001 Vehicle Identification Number from: 8V-D-000 001
			7.02901.05.0	SUV	EL	
			7.06117.26.0	ZM-NWV	EL	Fahrgestellnummer ab: 8V-D-000 001 Vehicle Identification Number from: 8V-D-000 001
1.8 TFSI quattro 132 kW (180 PS) CJSB			7.03280.04.0	EUV-SR	EL	Fahrgestellnummer ab: 8V-D-000 001 Vehicle Identification Number from: 8V-D-000 001
			7.02901.05.0	SUV	EL	
			7.06117.26.0	ZM-NWV	EL	Fahrgestellnummer ab: 8V-D-000 001 Vehicle Identification Number from: 8V-D-000 001
2.0 TDI 105 kW (143 PS) CRFC	09.2012→10.2020	7.02256.00.0	EUV-AGR	EP	ch. 8V-D-000 001→	
2.0 TDI 81 kW (110 PS) CRFA	01.2013→08.2016	7.02256.00.0	EUV-AGR	EP	ch. 8V-D-000 001→	
2.0 TFSI 140 kW (190 PS) CZPB	05.2016→12.2017		7.02256.18.0	EUV-SR	EP	
			7.02901.05.0	SUV	EL	

A3 (8V1, 8VK)						14
2.0 TFSI quattro 140 kW (190 PS) CZPB	05.2016→12.2017		7.02256.18.0	EUV-SR	EP	
			7.02901.05.0	SUV	EL	
S3 quattro 221 kW (300 PS) CJXC	11.2012→08.2016		7.02901.05.0	SUV	EL	
			7.06117.26.0	ZM-NWV	EL	Fahrgestellnummer ab: 8V-D-000 001 Vehicle Identification Number from: 8V-D-000 001
S3 quattro 206 kW (280 PS) CJXB	02.2013→07.2014		7.06117.26.0	ZM-NWV	EL	Fahrgestellnummer ab: 8V-D-000 001 Vehicle Identification Number from: 8V-D-000 001
S3 quattro 210 kW (286 PS) CJXF	05.2014→08.2016		7.02901.05.0	SUV	EL	
			7.06117.26.0	ZM-NWV	EL	Fahrgestellnummer ab: 8V-D-000 001 Vehicle Identification Number from: 8V-D-000 001
S3 quattro 228 kW (310 PS) CJXG, DJHA	06.2016→12.2017		7.02256.18.0	EUV-SR	EP	
			7.06117.26.0	ZM-NWV	EL	
S3 quattro 213 kW (290 PS) CJXD, DJHB	07.2016→12.2017		7.02256.18.0	EUV-SR	EP	
			7.06117.26.0	ZM-NWV	EL	CJXD, DJHB: Fahrgestellnummer ab: 8V-L-000 001 Vehicle Identification Number from: 8V-L-000 001
A3 Convertible (8P7)						15
1.2 TFSI 77 kW (105 PS) CBZB	03.2010→05.2013		7.22880.01.0	EUV-KK	EL	
			7.02256.40.0	SV-KK	EL	für Fahrzeuge mit Standheizung for vehicles with parking heater
1.4 TFSI 92 kW (125 PS) CAXC	02.2011→05.2013		7.01830.13.0	SUV	EL	
			7.02256.40.0	SV-KK	EL	für Fahrzeuge mit Standheizung for vehicles with parking heater
1.6 75 kW (102 PS) BSE	09.2008→05.2010		7.10014.00.0	AKF	EL	
			7.22880.01.0	EUV-SR	EL	
			7.02256.40.0	SV-KK	EL	für Fahrzeuge mit Standheizung for vehicles with parking heater
1.6 TDI 77 kW (105 PS) CAYC	05.2009→05.2013		7.02256.00.0	EUV-AGR	EP	
			7.02256.40.0	SV-KK	EL	für Fahrzeuge mit Standheizung for vehicles with parking heater
1.8 TFSI 118 kW (160 PS) BZB	04.2008→05.2013		7.03280.04.0	EUV-SR	EL	nur in Verbindung mit: Fahrzeug umgerüstet only in connection with: Fahrzeug umgerüstet
			7.00470.07.0	LDRV	EL	
			7.01830.13.0	SUV	EL	
			7.02256.40.0	SV-KK	EL	für Fahrzeuge mit Standheizung for vehicles with parking heater
			7.06117.26.0	ZM-NWV	EL	
1.8 TFSI 118 kW (160 PS) CDAA	04.2008→05.2013		7.03280.04.0	EUV-SR	EL	nur in Verbindung mit: Fahrzeug umgerüstet only in connection with: Fahrzeug umgerüstet
			7.22880.01.0	EUV-SR	EL	
			7.00470.07.0	LDRV	EL	
			7.01830.13.0	SUV	EL	
			7.02256.40.0	SV-KK	EL	für Fahrzeuge mit Standheizung for vehicles with parking heater

A



A3 Convertible (8P7)

15













			7.06117.26.0	ZM-NWV	EL	
1.9 TDI 77 kW (105 PS) BLS	04.2008→10.2009		7.00868.02.0	DW-TL	EP	
			7.02256.00.0	EUV-AGR	EP	für Fahrzeuge mit Standheizung for vehicles with parking heater
			7.02256.40.0	SV-KK	EL	
2.0 TDI 103 kW (140 PS) CBAB	04.2008→05.2013		7.00868.02.0	DW-TL	EP	
			7.02256.00.0	EUV-AGR	EP	für Fahrzeuge mit Standheizung for vehicles with parking heater
			7.02256.40.0	SV-KK	EL	
2.0 TDI 103 kW (140 PS) CFFB	04.2008→05.2013		7.02256.00.0	EUV-AGR	EP	
			7.02256.40.0	SV-KK	EL	für Fahrzeuge mit Standheizung for vehicles with parking heater
2.0 TDI 100 kW (136 PS) CBAA	04.2008→05.2013		7.00868.02.0	DW-TL	EP	
			7.02256.00.0	EUV-AGR	EP	für Fahrzeuge mit Standheizung for vehicles with parking heater
			7.02256.40.0	SV-KK	EL	
2.0 TDI 100 kW (136 PS) CFFA	04.2008→05.2013		7.02256.00.0	EUV-AGR	EP	
			7.02256.40.0	SV-KK	EL	für Fahrzeuge mit Standheizung for vehicles with parking heater
2.0 TFSI 147 kW (200 PS) CAWB	04.2008→05.2013		7.03280.04.0	EUV-SR	EL	nur in Verbindung mit: Fahrzeug umgerüstet only in connection with: Fahrzeug umgerüstet
			7.22880.01.0	EUV-SR	EL	
			7.00470.07.0	LDRV	EL	
			7.00415.07.0	SUV	EL	
			7.01830.13.0	SUV	EL	
			7.02901.05.0	SUV	EL	für OE-Nummer: 06H 145 710 C, 06J 145 713 F for OE number: 06H 145 710 C, 06J 145 713 F
			7.02256.40.0	SV-KK	EL	für Fahrzeuge mit Standheizung for vehicles with parking heater
7.06117.26.0	ZM-NWV	EL				
2.0 TFSI 147 kW (200 PS) CCZA	04.2008→05.2013		7.03280.04.0	EUV-SR	EL	nur in Verbindung mit: Fahrzeug umgerüstet only in connection with: Fahrzeug umgerüstet
			7.00470.07.0	LDRV	EL	
			7.00415.07.0	SUV	EL	
			7.02256.40.0	SV-KK	EL	für Fahrzeuge mit Standheizung for vehicles with parking heater
			7.06117.26.0	ZM-NWV	EL	

A3 Convertible (8V7, 8VE)





16

1.4 TFSI 103 kW (140 PS) CPTA	10.2013→		7.06117.48.0	SV-NWV	EL	
1.4 TFSI 92 kW (125 PS) CXSB, CZCA	02.2014→		7.06117.48.0	SV-NWV	EL	
			7.06117.48.0	SV-NWV	EL	
1.4 TFSI 85 kW (115 PS) CZCC	02.2016→10.2020		7.06117.48.0	SV-NWV	EL	
1.4 TSI 110 kW (150 PS) CZEA	05.2014→10.2020		7.06117.48.0	SV-NWV	EL	
1.8 TFSI 132 kW (180 PS) CJSA, CJSB	10.2013→07.2016		7.03280.04.0	EUV-SR	EL	
			7.02901.05.0	SUV	EL	

A3 Convertible (8V7, 8VE)
16

		7.06117.26.0	ZM-NWV	EL	
1.8 TFSI 125 kW (170 PS) CNSB	05.2014→10.2020	 7.02256.18.0	EUV-SR	EP	Produktionsdatum ab: 03.08.2015 Production date from: 03.08.2015
		7.02901.05.0	SUV	EL	
		7.06117.26.0	ZM-NWV	EL	
1.8 TFSI quattro 132 kW (180 PS) CJSB	03.2014→	 7.03280.04.0	EUV-SR	EL	
		7.02901.05.0	SUV	EL	
		7.06117.26.0	ZM-NWV	EL	
2.0 TFSI 140 kW (190 PS) CZPB	05.2016→10.2020	 7.02256.18.0	EUV-SR	EP	Produktionsdatum bis: 26.12.2016 Production date to: 26.12.2016
		7.02901.05.0	SUV	EL	
2.0 TFSI 137 kW (186 PS) CZRA	09.2016→10.2020	 7.02256.18.0	EUV-SR	EP	Produktionsdatum bis: 26.12.2016 Production date to: 26.12.2016
		7.02901.05.0	SUV	EL	
2.0 TFSI quattro 162 kW (220 PS) CNTC	05.2014→10.2020	 7.02901.05.0	SUV	EL	
		7.06117.26.0	ZM-NWV	EL	
2.0 TFSI quattro 140 kW (190 PS) CZPB	05.2016→10.2020	 7.02256.18.0	EUV-SR	EP	Produktionsdatum bis: 26.12.2016 Production date to: 26.12.2016
		7.02901.05.0	SUV	EL	
2.0 TFSI quattro 170 kW (231 PS) DHHA	07.2018→10.2020	 7.06117.26.0	ZM-NWV	EL	
40 TFSI 140 kW (190 PS) DKZA	11.2018→10.2020	 7.02901.05.0	SUV	EL	
S3 quattro 210 kW (286 PS) CJXF	03.2014→	 7.02901.05.0	SUV	EL	
		7.06117.26.0	ZM-NWV	EL	
S3 quattro 221 kW (300 PS) CJXC	04.2014→10.2020	 7.02901.05.0	SUV	EL	
		7.06117.26.0	ZM-NWV	EL	
S3 quattro 228 kW (310 PS) DJHA	07.2016→10.2020	 7.02256.18.0	EUV-SR	EP	
		7.06117.26.0	ZM-NWV	EL	
S3 quattro 213 kW (290 PS) DJHB	07.2016→10.2020	 7.02256.18.0	EUV-SR	EP	
		7.06117.26.0	ZM-NWV	EL	
S3 quattro 221 kW (300 PS) DNUE	09.2018→10.2020	 7.06117.26.0	ZM-NWV	EL	

A3 Limousine (8VS, 8VM)
17



















1.0 TFSI 85 kW (115 PS) CHZD	07.2016→10.2020	 7.06117.48.0	SV-NWV	EL	Fahrgestellnummer ab: 8V-L-000 001 Vehicle Identification Number from: 8V-L-000 001
1.2 TFSI 77 kW (105 PS) CJZA	10.2013→	 7.06117.48.0	SV-NWV	EL	Fahrgestellnummer ab: 8V-D-000 001 Vehicle Identification Number from: 8V-D-000 001 Produktionsdatum bis: 10.02.2014 Production date to: 10.02.2014
1.2 TFSI 81 kW (110 PS) CYVB	05.2014→	 7.06117.48.0	SV-NWV	EL	Fahrgestellnummer ab: 8V-D-000 001 Vehicle Identification Number from: 8V-D-000 001 Produktionsdatum bis: 10.02.2014 Production date to: 10.02.2014
1.4 TFSI 103 kW (140 PS) CPTA	05.2013→	 7.06117.48.0	SV-NWV	EL	Fahrgestellnummer ab: 8V-D-000 001 Vehicle Identification Number from: 8V-D-000 001
1.4 TFSI 90 kW (122 PS) CXSA	09.2013→10.2020	 7.06117.48.0	SV-NWV	EL	Fahrgestellnummer ab: 8V-D-000 001 Vehicle Identification Number from: 8V-D-000 001

A















A3 Limousine (8VS, 8VM)







17

1.4 TFSI 92 kW (125 PS) CXSB, CZCA	09.2013→	 7.06117.48.0	SV-NWV	EL	 CXSB, CZCA: Fahrgestellnummer ab: 8V-D-000 001 Vehicle Identification Number from: 8V-D-000 001
1.4 TSI 110 kW (150 PS) CZEA	05.2014→10.2020	 7.06117.48.0	SV-NWV	EL	Fahrgestellnummer ab: 8V-D-000 001 Vehicle Identification Number from: 8V-D-000 001
1.8 TFSI 132 kW (180 PS) CJSA, CJSB	05.2013→	 7.03280.04.0	EUV-SR	EL	 CJSA, CJSB: Fahrgestellnummer ab: 8V-D-000 001 Vehicle Identification Number from: 8V-D-000 001
			SUV ZM-NWV	EL	 CJSA, CJSB: Fahrgestellnummer ab: 8V-D-000 001 Vehicle Identification Number from: 8V-D-000 001
1.8 TFSI 125 kW (170 PS) CNSB	11.2013→10.2020	 7.02256.18.0	EUV-SR	EP	Fahrgestellnummer ab: 8V-D-000 001 Vehicle Identification Number from: 8V-D-000 001 Produktionsdatum ab: 03.08.2015 Production date from: 03.08.2015
			SUV ZM-NWV	EL	Fahrgestellnummer ab: 8V-D-000 001 Vehicle Identification Number from: 8V-D-000 001
1.8 TFSI quattro 132 kW (180 PS) CJSB	11.2013→	 7.03280.04.0	EUV-SR	EL	Fahrgestellnummer ab: 8V-D-000 001 Vehicle Identification Number from: 8V-D-000 001
			SUV ZM-NWV	EL	Fahrgestellnummer ab: 8V-D-000 001 Vehicle Identification Number from: 8V-D-000 001
2.0 TDI 81 kW (110 PS) CRFA	05.2013→10.2020	 7.02256.00.0	EUV-AGR	EP	 ch. 8V-D-000 001→
2.0 TDI 105 kW (143 PS) CRFC	10.2013→10.2020	 7.02256.00.0	EUV-AGR	EP	 ch. 8V-D-000 001→
2.0 TFSI 162 kW (220 PS) CHHB	11.2015→10.2020	 7.02256.18.0	EUV-SR	EP	Fahrgestellnummer ab: 8V-D-000 001 Vehicle Identification Number from: 8V-D-000 001
			SUV ZM-NWV	EL	Fahrgestellnummer ab: 8V-D-000 001 Vehicle Identification Number from: 8V-D-000 001
2.0 TFSI 162 kW (220 PS) CNTC	11.2015→10.2020	 7.06117.26.0	ZM-NWV	EL	Fahrgestellnummer ab: 8V-D-000 001 Vehicle Identification Number from: 8V-D-000 001
2.0 TFSI 140 kW (190 PS) CZPB, DKZA	05.2016→10.2020	 7.02256.18.0	EUV-SR	EP	
			SUV	EL	
2.0 TFSI 137 kW (186 PS) CZRA	09.2016→10.2020	 7.02256.18.0	EUV-SR	EP	Produktionsdatum bis: 26.12.2016 Production date to: 26.12.2016
			SUV	EL	
2.0 TFSI quattro 162 kW (220 PS) CNTC	11.2013→10.2020	 7.02901.05.0	SUV	EL	
			7.06117.26.0 ZM-NWV	EL	Fahrgestellnummer ab: 8V-D-000 001 Vehicle Identification Number from: 8V-D-000 001
2.0 TFSI quattro 140 kW (190 PS) CZPB, DKZA	05.2016→10.2020	 7.02256.18.0	EUV-SR	EP	
			SUV	EL	
2.0 TFSI quattro 170 kW (231 PS) DHHA	07.2018→10.2020	 7.06117.26.0	ZM-NWV	EL	

A3 Limousine (8VS, 8VM)
17

30 TFSI 85 kW (116 PS) DKRF	07.2018→10.2020	 7.06117.48.0	SV-NWV	EL	Fahrgestellnummer ab: 8V-L-000 001 Vehicle Identification Number from: 8V-L-000 001
40 TFSI 140 kW (190 PS) DKZA	07.2018→10.2020	 7.02256.18.0 7.02901.05.0	EUV-SR SUV	EP EL	
40 TFSI quattro 140 kW (190 PS) DKZA	07.2018→10.2020	 7.02901.05.0	SUV	EL	
RS3 quattro 294 kW (400 PS) DAZA, DNWA	04.2017→10.2020	 7.22880.01.0 7.06117.47.0	EUV-SR SV-NWV	EL EH	mit Dichtring with O-ring
S3 quattro 221 kW (300 PS) CJXC	10.2013→10.2020	 7.02901.05.0 7.06117.26.0	SUV ZM-NWV	EL EL	Fahrgestellnummer ab: 8V-D-000 001 Vehicle Identification Number from: 8V-D-000 001
S3 quattro 206 kW (280 PS) CJXB	10.2013→	 7.06117.26.0	ZM-NWV	EL	Fahrgestellnummer ab: 8V-D-000 001 Vehicle Identification Number from: 8V-D-000 001
S3 quattro 215 kW (292 PS) CYFB	05.2014→10.2020	 7.06117.26.0	ZM-NWV	EL	Fahrgestellnummer ab: 8V-D-000 001 Vehicle Identification Number from: 8V-D-000 001
S3 quattro 210 kW (286 PS) CJXF	05.2014→	 7.02901.05.0 7.06117.26.0	SUV ZM-NWV	EL EL	Fahrgestellnummer ab: 8V-D-000 001 Vehicle Identification Number from: 8V-D-000 001
S3 quattro 228 kW (310 PS) CJXG, DJHA	06.2016→10.2020	 7.02256.18.0 7.06117.26.0	EUV-SR ZM-NWV	EP EL	
S3 quattro 213 kW (290 PS) CJXD, DJHB	08.2016→10.2020	 7.02256.18.0 7.06117.26.0	EUV-SR ZM-NWV	EP EL	 CJXD, DJHB: Fahrgestellnummer ab: 8V-L-000 001 Vehicle Identification Number from: 8V-L-000 001
S3 quattro 221 kW (300 PS) DNUE	09.2018→10.2020	 7.06117.26.0	ZM-NWV	EL	Fahrgestellnummer ab: 8V-L-000 001 Vehicle Identification Number from: 8V-L-000 001

A3 Sportback (8PA)
18

1.2 TSI 77 kW (105 PS) CBZB	04.2010→03.2013	 7.22880.01.0 7.02256.40.0	EUV-KK SV-KK	EL EL	für Fahrzeuge mit Standheizung for vehicles with parking heater
1.4 TFSI 92 kW (125 PS) CAXC	09.2007→03.2013	 7.00415.07.0 7.02256.40.0 7.06117.54.0	SUV SV-KK SV-NWV	EL EL EL	Produktionsdatum bis: 28.04.2008 Production date to: 28.04.2008 für Fahrzeuge mit Standheizung for vehicles with parking heater
1.4 TFSI 92 kW (125 PS) CMSA	09.2007→03.2013	 7.01830.13.0 7.02256.40.0	SUV SV-KK	EL EL	für Fahrzeuge mit Standheizung for vehicles with parking heater
1.6 75 kW (102 PS) BGU, BSE, BSF	09.2004→03.2013	 7.10014.00.0 7.22880.01.0 7.02256.40.0	AKF EUV-SR SV-KK	EL EL EL	 BGU, BSE, BSF: für Fahrzeuge mit Standheizung for vehicles with parking heater
1.6 E-Power 75 kW (102 PS) CCSA, CMXA	01.2011→03.2013	 7.10014.00.0	AKF	EL	

A





A3 Sportback (8PA)

18

1.6 FSI 85 kW (115 PS) BLF, BLP	09.2004→09.2007		7.10014.00.0	AKF	EL	BLF, BLP: für Fahrzeuge mit Standheizung for vehicles with parking heater
			7.22880.01.0	EUV-SR	EL	
			7.02256.40.0	SV-KK	EL	
1.6 TDI 66 kW (90 PS) CAYB	05.2009→03.2013		7.06117.54.0	SV-NWV	EL	
			7.02256.00.0	EUV-AGR	EP	
			7.02256.40.0	SV-KK	EL	
1.6 TDI 77 kW (105 PS) CAYC	05.2009→03.2013		7.02256.00.0	EUV-AGR	EP	
			7.02256.40.0	SV-KK	EL	
1.8 TFSI 118 kW (160 PS) BYT, BZB	11.2006→03.2013		7.00470.07.0	LDRV	EL	BYT, BZB: für Fahrzeuge mit Standheizung for vehicles with parking heater
			7.01830.13.0	SUV	EL	
			7.02256.40.0	SV-KK	EL	
			7.06117.26.0	ZM-NWV	EL	
1.8 TFSI 118 kW (160 PS) CDA A	11.2006→03.2013		7.03280.04.0	EUV-SR	EL	Baujahr ab: 01.2009 Construction year from: 01.2009 nur in Verbindung mit: Fahrzeug umgerüstet only in connection with: Fahrzeug umgerüstet
			7.22880.01.0	EUV-SR	EL	
			7.00470.07.0	LDRV	EL	
			7.01830.13.0	SUV	EL	
			7.02256.40.0	SV-KK	EL	
			7.06117.26.0	ZM-NWV	EL	
1.8 TFSI quattro 118 kW (160 PS) CDA A	07.2008→03.2013		7.03280.04.0	EUV-SR	EL	nur in Verbindung mit: Fahrzeug umgerüstet only in connection with: Fahrzeug umgerüstet
			7.22880.01.0	EUV-SR	EL	
			7.00470.07.0	LDRV	EL	
			7.01830.13.0	SUV	EL	
			7.02256.40.0	SV-KK	EL	
			7.06117.26.0	ZM-NWV	EL	
1.9 TDI 77 kW (105 PS) BKC, BXE	09.2004→05.2010		7.02256.40.0	SV-KK	EL	BKC, BXE: für Fahrzeuge mit Standheizung for vehicles with parking heater
1.9 TDI 77 kW (105 PS) BLS	09.2004→05.2010		7.00868.02.0	DW-TL	EP	
			7.02256.00.0	EUV-AGR	EP	
			7.02256.40.0	SV-KK	EL	
2.0 FSI 110 kW (150 PS) AXW, BLR, BLX, BLY, BMB, BVY	09.2004→06.2008		7.22880.01.0	EUV-SR	EL	AXW, BLR, BLX, BLY, BMB, BVY: für Fahrzeuge mit Standheizung for vehicles with parking heater
			7.02256.40.0	SV-KK	EL	
			7.06117.37.0	SV-NWV	EL	
2.0 FSI 110 kW (150 PS) BVZ	09.2004→06.2008		7.22880.01.0	EUV-SR	EL	
			7.02256.40.0	SV-KK	EL	

A3 Sportback (8PA)
18

















			7.06117.37.0 7.06117.46.0	SV-NWV SV-NWV	EL EH	mit Dichtring with O-ring Fahrgestellnummer ab: 8P-8A190 001, 8P-8B024 001 Vehicle Identification Number from: 8P-8A190 001, 8P-8B024 001
2.0 TDI 100 kW (136 PS) AZV	09.2004→03.2013		7.02256.40.0	SV-KK	EL	für Fahrzeuge mit Standheizung for vehicles with parking heater
2.0 TDI 100 kW (136 PS) CBAA	09.2004→03.2013		7.00868.02.0 7.02256.00.0 7.02256.40.0	DW-TL EUV-AGR SV-KK	EP EP EL	für Fahrzeuge mit Standheizung for vehicles with parking heater
2.0 TDI 100 kW (136 PS) CFFA	09.2004→03.2013		7.02256.00.0 7.02256.40.0	EUV-AGR SV-KK	EP EL	für Fahrzeuge mit Standheizung for vehicles with parking heater
2.0 TDI 103 kW (140 PS) BMM	06.2005→06.2008		7.00868.02.0 7.02256.40.0	DW-TL SV-KK	EP EL	für Fahrzeuge mit Standheizung for vehicles with parking heater
2.0 TDI 125 kW (170 PS) BMN, CBBB	03.2006→03.2013		7.00868.02.0 7.02256.00.0 7.02256.00.0 7.02256.40.0	DW-TL EUV-AGR EUV-SR SV-KK	EP EP EP EL	 BMN, CBBB: für Fahrzeuge mit Standheizung for vehicles with parking heater
2.0 TDI 125 kW (170 PS) CFGB	03.2006→03.2013		7.02256.00.0 7.02256.40.0	EUV-AGR SV-KK	EP EL	für Fahrzeuge mit Standheizung for vehicles with parking heater
2.0 TDI 120 kW (163 PS) BUY	06.2006→06.2008		7.00868.02.0 7.02256.00.0 7.02256.00.0 7.02256.40.0	DW-TL EUV-AGR EUV-SR SV-KK	EP EP EP EL	für Fahrzeuge mit Standheizung for vehicles with parking heater
2.0 TDI 16V 103 kW (140 PS) BKD	09.2004→03.2013		7.02256.40.0	SV-KK	EL	für Fahrzeuge mit Standheizung for vehicles with parking heater
2.0 TDI 16V 103 kW (140 PS) CBAB	09.2004→03.2013		7.00868.02.0 7.02256.00.0 7.02256.40.0	DW-TL EUV-AGR SV-KK	EP EP EL	für Fahrzeuge mit Standheizung for vehicles with parking heater
2.0 TDI 16V 103 kW (140 PS) CFFB, CLJA	09.2004→03.2013		7.02256.00.0 7.02256.40.0	EUV-AGR SV-KK	EP EL	 CFFB, CLJA: für Fahrzeuge mit Standheizung for vehicles with parking heater
2.0 TDI 16V quattro 103 kW (140 PS) BKD	11.2005→03.2013		7.02256.40.0	SV-KK	EL	für Fahrzeuge mit Standheizung for vehicles with parking heater
2.0 TDI 16V quattro 103 kW (140 PS) CBAB	11.2005→03.2013		7.00868.02.0 7.02256.00.0 7.02256.40.0	DW-TL EUV-AGR SV-KK	EP EP EL	für Fahrzeuge mit Standheizung for vehicles with parking heater















A



A3 Sportback (8PA)

18

2.0 TDI 16V quattro 103 kW (140 PS) CFFB	11.2005→03.2013		7.02256.00.0	EUV-AGR	EP	
			7.02256.40.0	SV-KK	EL	für Fahrzeuge mit Standheizung for vehicles with parking heater
2.0 TDI quattro 103 kW (140 PS) BMM	01.2006→06.2008		7.00868.02.0	DW-TL	EP	
			7.02256.40.0	SV-KK	EL	für Fahrzeuge mit Standheizung for vehicles with parking heater
2.0 TDI quattro 125 kW (170 PS) BMN, CBBB	03.2006→03.2013		7.00868.02.0	DW-TL	EP	
			7.02256.00.0	EUV-AGR	EP	
			7.02256.00.0	EUV-SR	EP	
			7.02256.40.0	SV-KK	EL	 BMN, CBBB: für Fahrzeuge mit Standheizung for vehicles with parking heater
2.0 TDI quattro 125 kW (170 PS) CFGB	03.2006→03.2013		7.02256.00.0	EUV-AGR	EP	
			7.02256.40.0	SV-KK	EL	für Fahrzeuge mit Standheizung for vehicles with parking heater
2.0 TFSI 147 kW (200 PS) AXX	09.2004→03.2013		7.00470.07.0	LDRV	EL	
			7.01830.13.0	SUV	EL	
			7.06117.46.0	SV-NWV	EH	mit Dichtring with O-ring
2.0 TFSI 147 kW (200 PS) BPY, BWA	09.2004→03.2013		7.00470.07.0	LDRV	EL	
			7.01830.13.0	SUV	EL	
			7.02256.40.0	SV-KK	EL	 BPY, BWA: für Fahrzeuge mit Standheizung for vehicles with parking heater
			7.06117.46.0	SV-NWV	EH	mit Dichtring with O-ring
2.0 TFSI 147 kW (200 PS) CAWB, CBFA	09.2004→03.2013		7.03280.04.0	EUV-SR	EL	 CAWB: Baujahr ab: 01.2008 Construction year from: 01.2008 nur in Verbindung mit: Fahrzeug umgerüstet only in connection with: Fahrzeug umgerüstet
						 CBFA: Baujahr ab: 01.2009 Construction year from: 01.2009 nur in Verbindung mit: Fahrzeug umgerüstet only in connection with: Fahrzeug umgerüstet
			7.22880.01.0	EUV-SR	EL	
			7.00470.07.0	LDRV	EL	 CAWB:  ch. 01.2009→  CBFA: 01.2009→
			7.02901.05.0	SUV	EL	 CAWB: für OE-Nummer: 06H 145 710 C, 06J 145 713 F for OE number: 06H 145 710 C, 06J 145 713 F  CBFA: für OE-Nummer: 06H 145 710 C, 06J 145 713 F, 06J 145 713 k for OE number: 06H 145 710 C, 06J 145 713 F, 06J 145 713 k
			7.02256.40.0	SV-KK	EL	 CAWB, CBFA: für Fahrzeuge mit Standheizung for vehicles with parking heater
7.06117.26.0	ZM-NWV	EL				





















						
A3 Sportback (8PA)						18
2.0 TFSI 147-149 kW (200-203 PS) CCTA	09.2004→03.2013		7.03280.04.0	EUV-SR	EL	Baujahr ab: 01.2009 Construction year from: 01.2009 nur in Verbindung mit: Fahrzeug umgerüstet only in connection with: Fahrzeug umgerüstet
2.0 TFSI 147 kW (200 PS) CCZA	09.2004→03.2013		7.03280.04.0	EUV-SR	EL	Baujahr ab: 01.2009 Construction year from: 01.2009 nur in Verbindung mit: Fahrzeug umgerüstet only in connection with: Fahrzeug umgerüstet
			7.00470.07.0	LDRV	EL	01.2009→
			7.02901.05.0	SUV	EL	
			7.02256.40.0	SV-KK	EL	für Fahrzeuge mit Standheizung for vehicles with parking heater
			7.06117.26.0	ZM-NWV	EL	
2.0 TFSI quattro 147 kW (200 PS) AXX	09.2004→03.2013		7.00470.07.0	LDRV	EL	
			7.01830.13.0	SUV	EL	
			7.06117.46.0	SV-NWV	EH	mit Dichtring with O-ring
2.0 TFSI quattro 147 kW (200 PS) BPY, BWA	09.2004→03.2013		7.00470.07.0	LDRV	EL	
			7.01830.13.0	SUV	EL	
			7.02256.40.0	SV-KK	EL	 BPY, BWA: für Fahrzeuge mit Standheizung for vehicles with parking heater
			7.06117.46.0	SV-NWV	EH	mit Dichtring with O-ring
2.0 TFSI quattro 147 kW (200 PS) CBFA	09.2004→03.2013		7.03280.04.0	EUV-SR	EL	Baujahr ab: 01.2009 Construction year from: 01.2009 nur in Verbindung mit: Fahrzeug umgerüstet only in connection with: Fahrzeug umgerüstet
			7.00470.07.0	LDRV	EL	01.2009→
			7.02901.05.0	SUV	EL	für OE-Nummer: 06J 145 713 F, 06J 145 713 K for OE number: 06J 145 713 F, 06J 145 713 K
			7.06117.26.0	ZM-NWV	EL	
2.0 TFSI quattro 147-149 kW (200-203 PS) CCTA	09.2004→03.2013		7.03280.04.0	EUV-SR	EL	Baujahr ab: 01.2009 Construction year from: 01.2009 nur in Verbindung mit: Fahrzeug umgerüstet only in connection with: Fahrzeug umgerüstet
			7.00470.07.0	LDRV	EL	01.2009→
2.0 TFSI quattro 147 kW (200 PS) CCZA	09.2004→03.2013		7.03280.04.0	EUV-SR	EL	Baujahr ab: 01.2009 Construction year from: 01.2009 nur in Verbindung mit: Fahrzeug umgerüstet only in connection with: Fahrzeug umgerüstet
			7.00470.07.0	LDRV	EL	01.2009→
			7.02901.05.0	SUV	EL	für OE-Nummer: 06J 145 713 F, 06J 145 713 K for OE number: 06J 145 713 F, 06J 145 713 K
			7.02256.40.0	SV-KK	EL	für Fahrzeuge mit Standheizung for vehicles with parking heater
			7.06117.26.0	ZM-NWV	EL	

A



A3 Sportback (8PA)

18























<p>3.2 V6 quattro 184 kW (250 PS) BDB</p>	<p>09.2004→05.2009</p>	<p> 7.10014.00.0 7.02256.00.0 7.28098.04.0 7.06117.43.0 7.06117.44.0</p>	<p>AKF EUV-AGK EUV-AGK SV-NWV SV-NWV</p>	<p>EL EP  →ch. 8P-5A013 000 EL Fahrgestellnummer ab: 8P-5A013 001, 8P-5B000 001 Vehicle Identification Number from: 8P-5A013 001, 8P-5B000 001 EL mit Dichtring with O-ring Auslassseite Exhaust Side EL mit Dichtring with O-ring Einlassseite Intake Side</p>
<p>3.2 V6 quattro 184-186 kW (250-253 PS) BMJ, BUB</p>	<p>09.2004→05.2009</p>	<p> 7.10014.00.0 7.28098.04.0 7.02256.00.0 7.02256.00.0 7.02256.00.0 7.02256.40.0 7.06117.43.0 7.06117.44.0</p>	<p>AKF EUV-AGK EUV-AGK EUV-SL EUV-SR SV-KK SV-NWV SV-NWV</p>	<p>EL EL  BMJ: Fahrgestellnummer ab: 8P-5A013 001, 8P-5B000 001 Vehicle Identification Number from: 8P-5A013 001, 8P-5B000 001  BUB: Fahrgestellnummer ab: 8P-5A013 001, 8P-5B000 001 Vehicle Identification Number from: 8P-5A013 001, 8P-5B000 001 2007 EP  BMJ:  →ch. 8P-5A013 000  BUB:  →ch. 8P-5A013 000 2007  BUB: 2008 2008 EL  BMJ, BUB: für Fahrzeuge mit Standheizung for vehicles with parking heater EL mit Dichtring with O-ring  BMJ, BUB: Auslassseite Exhaust Side EL mit Dichtring with O-ring  BMJ, BUB: Einlassseite Intake Side</p>
<p>RS3 quattro 250 kW (340 PS) CEPA</p>	<p>01.2011→12.2012</p>	<p> 7.02256.00.0 7.22880.01.0 7.00470.07.0 7.01830.13.0</p>	<p>EUV-AGK EUV-SR LDRV SUV</p>	<p>EP EL EL EL</p>
<p>S3 quattro 195 kW (265 PS) BHZ, CDLA</p>	<p>06.2008→03.2013</p>	<p> 7.02256.00.0 7.28098.04.0</p>	<p>EUV-AGK EUV-AGK</p>	<p>EP  BHZ:  →ch. 8P-5A013 000 2007 2007  CDLA: Produktionsdatum ab: 10.05.2010 Production date from: 10.05.2010 EL  BHZ: Fahrgestellnummer ab: 8P-5A013 001, 8P-5B000 001 Vehicle Identification Number from: 8P-5A013 001, 8P-5B000 001  CDLA: Produktionsdatum bis: 10.05.2010 Production date to: 10.05.2010</p>

A3 Sportback (8PA)					18	
			7.00470.07.0 7.00415.07.0 7.01830.13.0 7.02256.40.0 7.06117.46.0	LDRV SUV SUV SV-KK SV-NWV	EL EL EL EL EH	01.2009→ Produktionsdatum bis: 11.11.2008 Production date to: 11.11.2008 BHZ, CDLA: für Fahrzeuge mit Standheizung for vehicles with parking heater mit Dichtring with O-ring
S3 quattro 188 kW (256 PS) CDLC	07.2008→03.2013		7.02256.00.0 7.28098.04.0 7.00415.07.0 7.01830.13.0 7.02256.40.0 7.06117.46.0	EUV-AGK EUV-AGK SUV SUV SV-KK SV-NWV	EP EL EL EL EH	Produktionsdatum ab: 10.05.2010 Production date from: 10.05.2010 Produktionsdatum bis: 10.05.2010 Production date to: 10.05.2010 Produktionsdatum bis: 11.11.2008 Production date to: 11.11.2008 für Fahrzeuge mit Standheizung for vehicles with parking heater mit Dichtring with O-ring
A3 Sportback (8VA, 8VF)					19	
1.0 TFSI 85 kW (115-116 PS) CHZD, DKRF	07.2016→10.2020		7.06117.48.0	SV-NWV	EL CHZD, DKRF: Fahrgestellnummer ab: 8V-L-000 001 Vehicle Identification Number from: 8V-L-000 001	
1.2 TFSI 77 kW (105 PS) CJZA	05.2013→		7.06117.48.0	SV-NWV	EL Fahrgestellnummer ab: 8V-D-000 001 Vehicle Identification Number from: 8V-D-000 001 Produktionsdatum bis: 10.02.2014 Production date to: 10.02.2014	
1.2 TFSI 81 kW (110 PS) CYVB	05.2014→08.2016		7.06117.48.0	SV-NWV	EL Fahrgestellnummer ab: 8V-D-000 001 Vehicle Identification Number from: 8V-D-000 001 Produktionsdatum bis: 10.02.2014 Production date to: 10.02.2014	
1.4 TFSI 90 kW (122 PS) CMBA, CXSA	09.2012→10.2020		7.06117.48.0	SV-NWV	EL CMBA, CXSA: Fahrgestellnummer ab: 8V-D-000 001 Vehicle Identification Number from: 8V-D-000 001	
1.4 TFSI 103 kW (140 PS) CPTA	03.2013→		7.06117.48.0	SV-NWV	EL Fahrgestellnummer ab: 8V-D-000 001 Vehicle Identification Number from: 8V-D-000 001	
1.4 TFSI 92 kW (125 PS) CXSB, CZCA	05.2014→08.2016		7.06117.48.0	SV-NWV	EL CXSB, CZCA: Fahrgestellnummer ab: 8V-D-000 001 Vehicle Identification Number from: 8V-D-000 001	
1.4 TFSI e-tron 110 kW (150 PS) CUKB, CXUA	05.2014→10.2020		7.02256.41.0	SV-KK	EL CUKB, CXUA: ch. 8V-D-000 001→	
			7.06117.48.0	SV-NWV	EL CUKB, CXUA: Fahrgestellnummer ab: 8V-D-000 001 Vehicle Identification Number from: 8V-D-000 001	
1.4 TFSI e-tron 110 kW (150 PS) CXUA	05.2014→10.2020		7.02256.41.0	SV-KK	EL ch. 8V-D-000 001→	
			7.06117.48.0	SV-NWV	EL Fahrgestellnummer ab: 8V-D-000 001 Vehicle Identification Number from: 8V-D-000 001	
1.4 TFSI g-tron 81 kW (110 PS) CPWA	11.2013→10.2020		7.06117.48.0	SV-NWV	EL Fahrgestellnummer ab: 8V-D-000 001 Vehicle Identification Number from: 8V-D-000 001	
1.4 TSI 110 kW (150 PS) CZEA	05.2014→10.2020		7.06117.48.0	SV-NWV	EL Fahrgestellnummer ab: 8V-D-000 001 Vehicle Identification Number from: 8V-D-000 001	

A

A3 Sportback (8VA, 8VF)
19

1.8 TFSI 132 kW (180 PS) CJSA, CJSB	09.2012→		7.03280.04.0	EUV-SR	EL	CJSA, CJSB: Fahrgestellnummer ab: 8V-D-000 001 Vehicle Identification Number from: 8V-D-000 001
			7.02901.05.0 7.06117.26.0	SUV ZM-NWV	EL	
1.8 TFSI quattro 132 kW (180 PS) CJSB	05.2013→		7.03280.04.0	EUV-SR	EL	CJSA, CJSB: Fahrgestellnummer ab: 8V-D-000 001 Vehicle Identification Number from: 8V-D-000 001
			7.02901.05.0 7.06117.26.0	SUV ZM-NWV	EL	
2.0 45 TFSI 162 kW (220 PS) CHHB	02.2015→08.2016		7.02256.18.0	EUV-SR	EP	Fahrgestellnummer ab: 8V-D-000 001 Vehicle Identification Number from: 8V-D-000 001
			7.02901.05.0 7.06117.26.0	SUV ZM-NWV	EL	
2.0 TDI 105 kW (143 PS) CRFC	03.2013→10.2020		7.02256.00.0	EUV-AGR	EP	ch. 8V-D-000 001→
			7.02901.05.0	SUV	EL	
2.0 TDI 81 kW (110 PS) CRFA	05.2013→10.2020		7.02256.00.0	EUV-AGR	EP	ch. 8V-D-000 001→
			7.02901.05.0	SUV	EL	
2.0 TFSI 140 kW (190 PS) CZPB, DKZA	05.2016→10.2020		7.02256.18.0	EUV-SR	EP	
			7.02901.05.0	SUV	EL	
2.0 TFSI quattro 140 kW (190 PS) CZPB, DKZA	05.2016→10.2020		7.02256.18.0	EUV-SR	EP	
			7.02901.05.0	SUV	EL	
30 TFSI 85 kW (116 PS) DKRF	07.2018→10.2020		7.06117.48.0	SV-NWV	EL	Fahrgestellnummer ab: 8V-L-000 001 Vehicle Identification Number from: 8V-L-000 001
			7.02256.18.0	EUV-SR	EP	
40 TFSI 140 kW (190 PS) DKZA	07.2018→10.2020		7.02256.18.0	EUV-SR	EP	
			7.02901.05.0	SUV	EL	
40 TFSI quattro 140 kW (190 PS) DKZA	07.2018→10.2020		7.02901.05.0	SUV	EL	
			7.02901.05.0	SUV	EL	
RS3 quattro 270 kW (367 PS) CZGB	03.2015→		7.22880.01.0	EUV-SR	EL	
			7.00470.07.0	LDRV	EL	
			7.02901.05.0	SUV	EL	
RS3 quattro 294 kW (400 PS) DAZA, DNWA	04.2017→10.2020		7.22880.01.0	EUV-SR	EL	
			7.02901.05.0	SUV	EL	
			7.06117.47.0	SV-NWV	EH	
S3 quattro 221 kW (300 PS) CJXC	11.2012→10.2020		7.02901.05.0	SUV	EL	
			7.06117.26.0	ZM-NWV	EL	
S3 quattro 206 kW (280 PS) CJXB	05.2013→		7.06117.26.0	ZM-NWV	EL	Fahrgestellnummer ab: 8V-D-000 001 Vehicle Identification Number from: 8V-D-000 001
			7.02901.05.0	SUV	EL	
S3 quattro 210 kW (286 PS) CJXF	05.2014→08.2016		7.02901.05.0	SUV	EL	

						A
A3 Sportback (8VA, 8VF)						19
			7.06117.26.0	ZM-NWV	EL	Fahrgestellnummer ab: 8V-D-000 001 Vehicle Identification Number from: 8V-D-000 001
S3 quattro 228 kW (310 PS) CJXG, DJHA	06.2016→10.2020		7.02256.18.0	EUV-SR	EP	
			7.06117.26.0	ZM-NWV	EL	
S3 quattro 213 kW (290 PS) CJXD, DJHB	07.2016→10.2020		7.02256.18.0	EUV-SR	EP	
			7.06117.26.0	ZM-NWV	EL	 CJXD, DJHB: Fahrgestellnummer ab: 8V-L-000 001 Vehicle Identification Number from: 8V-L-000 001
S3 quattro 221 kW (300 PS) DNUE	09.2018→10.2020		7.06117.26.0	ZM-NWV	EL	Fahrgestellnummer ab: 8V-L-000 001 Vehicle Identification Number from: 8V-L-000 001
A4 Allroad B8 (8KH)						20
2.0 TDI quattro 125 kW (170 PS) CAHA	04.2009→05.2016		7.02256.00.0	EUV-AGR	EP	
			7.02256.00.0	EUV-KK	EP	2012 2012 Produktionsdatum ab: 31.08.2009 Production date from: 31.08.2009
2.0 TDI quattro 120 kW (163 PS) CAHB, CGLD	04.2009→05.2016		7.02256.00.0	EUV-AGR	EP	
			7.02256.00.0	EUV-KK	EP	 CAHB, CGLD: 2012 2012 Produktionsdatum ab: 31.08.2009 Production date from: 31.08.2009
2.0 TDI quattro 105 kW (143 PS) CAGA, CJCA	09.2009→05.2016		7.02256.00.0	EUV-AGR	EP	
			7.02256.00.0	EUV-KK	EP	 CAGA, CJCA: 2012 2012 Produktionsdatum ab: 31.08.2009 Production date from: 31.08.2009
2.0 TDI quattro 100 kW (136 PS) CAGB, CJCB	09.2009→05.2016		7.02256.00.0	EUV-AGR	EP	
			7.02256.00.0	EUV-KK	EP	 CAGB, CJCB: 2012 2012 Produktionsdatum ab: 31.08.2009 Production date from: 31.08.2009
2.0 TDI quattro 130 kW (177 PS) CGLC	11.2011→05.2016		7.02256.00.0	EUV-AGR	EP	
			7.02256.00.0	EUV-KK	EP	2012 2012 Produktionsdatum ab: 31.08.2009 Production date from: 31.08.2009
2.0 TDI quattro 110 kW (150 PS) CJCD	05.2013→05.2016		7.02256.00.0	EUV-AGR	EP	
2.0 TFSI Flexfuel quattro 155 kW (211 PS) CPMA	09.2012→12.2013		7.03280.04.0	EUV-SR	EL	
			7.02901.05.0	SUV	EL	
			7.06117.26.0	ZM-NWV	EL	
2.0 TFSI Flexfuel quattro 162 kW (220 PS) CPMB	05.2013→05.2016		7.03280.04.0	EUV-SR	EL	
			7.02901.05.0	SUV	EL	
			7.06117.26.0	ZM-NWV	EL	
2.0 TFSI quattro 155 kW (211 PS) CDNC	04.2009→05.2016		7.03280.04.0	EUV-SR	EL	nur in Verbindung mit: Fahrzeug umgerüstet only in connection with: Fahrzeug umgerüstet

A



A4 Allroad B8 (8KH)

20

			7.22880.01.0	EUV-SR	EL	
			7.00470.07.0	LDRV	EL	
			7.01830.13.0	SUV	EL	
			7.06117.26.0	ZM-NWV	EL	
2.0 TFSI quattro 155 kW (211 PS) CPMA	04.2009→05.2016		7.03280.04.0	EUV-SR	EL	
			7.02901.05.0	SUV	EL	
			7.06117.26.0	ZM-NWV	EL	
2.0 TFSI quattro 162 kW (220 PS) CPMB	05.2013→05.2016		7.03280.04.0	EUV-SR	EL	
			7.00470.07.0	LDRV	EL	
			7.02901.05.0	SUV	EL	
			7.06117.26.0	ZM-NWV	EL	
2.0 TFSI quattro 165 kW (224 PS) CNCD	05.2013→05.2016		7.02901.05.0	SUV	EL	
			7.06117.26.0	ZM-NWV	EL	
3.0 TDI quattro 176 kW (240 PS) CCWA	04.2009→01.2012		7.02256.00.0	EUV-AGR	EP	
3.0 TDI quattro 180 kW (245 PS) CDUC, CKVB, CKVC	01.2012→05.2016		7.02256.00.0	EUV-AGR	EP	

A4 Allroad B9 (8WH, 8WJ)

















21

2.0 TFSI Mild Hybrid quattro 183-185 kW (249-252 PS) DDWA	11.2018→10.2019		7.06117.26.0	ZM-NWV	EL	
2.0 TFSI quattro 185 kW (252 PS) CYMC, CYRB	01.2016→		7.06117.26.0	ZM-NWV	EL	
2.0 TFSI quattro 183 kW (249 PS) CYRC	05.2016→10.2019		7.06117.26.0	ZM-NWV	EL	
3.0 TDI quattro 160 kW (218 PS) CSWB	01.2016→08.2018		7.02256.00.0	EUV-AGR	EP	
			7.03280.04.0	EUV-AGR	EL	
3.0 TDI quattro 200 kW (272 PS) CRTC	01.2016→08.2018		7.02256.00.0	EUV-AGR	EP	
3.0 TDI quattro 210 kW (286 PS) DCPC	07.2018→10.2019		7.02256.00.0	EUV-AGR	EP	
			7.03280.04.0	EUV-AGR	EL	
45 TDI quattro 170 kW (231 PS) DCPE	07.2018→		7.02256.00.0	EUV-AGR	EP	
			7.03280.04.0	EUV-AGR	EL	
45 TFSI Mild Hybrid quattro 180 kW (245 PS) DKNA	07.2018→		7.06117.26.0	ZM-NWV	EL	
45 TFSI Mild Hybrid quattro 183-185 kW (249-252 PS) DDWA	02.2020→		7.06117.26.0	ZM-NWV	EL	
50 TDI quattro 210 kW (286 PS) DCPC	11.2019→		7.02256.00.0	EUV-AGR	EP	
			7.03280.04.0	EUV-AGR	EL	

A4 B5 (8D2)

22

1.6 74 kW (100 PS) AHL, ANA, ARM	10.1996→10.2000		7.22402.03.0	EUV-SR	EL	AHL, ANA, ARM: Fahrgestellnummer ab: 8D-X-200 001 Vehicle Identification Number from: 8D-X-200 001
1.6 75 kW (102 PS) ALZ	07.2000→11.2000		7.10014.00.0	AKF	EL	ch. 8D-X-200 001→
			7.22880.01.0	EUV-SR	EL	Fahrgestellnummer ab: 8D-X-200 001 Vehicle Identification Number from: 8D-X-200 001











































						
A4 B5 (8D2)						22
1.8 92-95 kW (125-129 PS) ADR	11.1994→11.2000		7.01805.01.0	EUV-SR	EL	
			7.22402.03.0	EUV-SR	EL	Fahrgestellnummer ab: 8D-X-200 001 Vehicle Identification Number from: 8D-X-200 001
1.8 92 kW (125 PS) APT, ARG, AVV	11.1994→11.2000		7.22402.03.0	EUV-SR	EL	 APT, ARG, AVV: Fahrgestellnummer ab: 8D-X-200 001 Vehicle Identification Number from: 8D-X-200 001
1.8 T 110 kW (150 PS) ANB, APU, AWT	01.1995→11.2000		7.01805.01.0	EUV-LS	EL	 ANB, APU, AWT:  ch. 8D-X-200 001→
1.8 T 125-127 kW (170-173 PS) AMB	05.2000→09.2000		7.01805.01.0	EUV-SR	EL	
1.8 T quattro 110 kW (150 PS) ANB, APU, AWT	01.1995→11.2000		7.01805.01.0	EUV-LS	EL	 ANB, APU, AWT:  ch. 8D-X-200 001→
1.8 quattro 92-95 kW (125-129 PS) ADR	12.1995→11.2000		7.01805.01.0	EUV-SR	EL	
			7.22402.03.0	EUV-SR	EL	Fahrgestellnummer ab: 8D-X-200 001 Vehicle Identification Number from: 8D-X-200 001
1.8 quattro 92 kW (125 PS) APT, ARG	07.1998→11.2000		7.22402.03.0	EUV-SR	EL	 APT, ARG: Fahrgestellnummer ab: 8D-X-200 001 Vehicle Identification Number from: 8D-X-200 001
1.9 TDI 66 kW (90 PS) 1Z, AHU	01.1995→11.2000		7.21903.70.0	DW-AGR	EP	
			7.21903.70.0	DW-TL	EP	für OE-Nummer: 1H0 906 627 for OE number: 1H0 906 627
			7.21895.55.0	LDRV	EL	
1.9 TDI 66 kW (90 PS) AHH	01.1995→11.2000		7.21903.70.0	DW-AGR	EP	
			7.21903.70.0	DW-TL	EP	für OE-Nummer: 1H0 906 627 for OE number: 1H0 906 627
			7.21903.75.0	DW-TL	EP	
1.9 TDI 81 kW (110 PS) AFN, AVG	10.1995→11.2000		7.21903.75.0	DW-TL	EP	 AFN, AVG:  ch. 8D-X-200 001→
			7.21903.70.0	DW-AGR	EP	
			7.21903.70.0	DW-TL	EP	 AFN, AVG: für OE-Nummer: 1H0 906 627 for OE number: 1H0 906 627
1.9 TDI 55 kW (75 PS) AFF	12.1995→11.2000		7.21903.70.0	DW-AGR	EP	
			7.21903.70.0	DW-TL	EP	für OE-Nummer: 1H0 906 627 for OE number: 1H0 906 627
			7.21895.55.0	LDRV	EL	
1.9 TDI 85 kW (115 PS) AJM	03.2000→11.2000		7.02183.01.0	DW-AGR	EP	 ch. 8D-1-000 001→
			7.02184.01.0	DW-TL	EP	 ch. 8D-1-000 001→
			7.21903.75.0	DW-TL	EP	 ch. 8D-X-200 001→ch. 8D-Y-300 0 00
			7.21903.70.0	DW-AGR	EP	Fahrgestellnummer bis: 8D-Y-300 000 Vehicle Identification Number to: 8D-Y-300 000
			7.21903.70.0	DW-TL	EP	für OE-Nummer: 1H0 906 627 for OE number: 1H0 906 627
1.9 TDI quattro 81 kW (110 PS) AFN, AVG	09.1996→11.2000		7.21903.75.0	DW-TL	EP	 AFN, AVG:  ch. 8D-X-200 001→
			7.21903.70.0	DW-AGR	EP	
			7.21903.70.0	DW-TL	EP	 AFN, AVG: für OE-Nummer: 1H0 906 627 for OE number: 1H0 906 627

A



A4 B5 (8D2)

22

1.9 TDI quattro 85 kW (115 PS) AJM, ATJ	03.2000→11.2000	 7.02183.01.0	DW-AGR	EP	 AJM, ATJ:  ch. 8D-1-000 001→
		7.02184.01.0	DW-TL	EP	 AJM, ATJ:  ch. 8D-1-000 001→
		7.21903.75.0	DW-TL	EP	 AJM, ATJ:  ch. 8D-X-200 001→ch. 8D-Y-300 000
		7.21903.70.0	DW-AGR	EP	 AJM, ATJ: Fahrgestellnummer bis: 8D-Y-300 000 Vehicle Identification Number to: 8D-Y-300 000
2.4 110 kW (150 PS) AFM	07.1995→07.1997	 7.01805.01.0	EUV-SR	EL	mit Dichtring with O-ring Thailand Thailand
		7.05432.12.0	SM	EL	
2.4 121 kW (165 PS) AGA, ALF, APS, ARJ	03.1997→11.2000	 7.01805.01.0	EUV-SR	EL	 APS, ARJ:  ch. 8D-X-200 001→
2.4 120 kW (163 PS) AJG, AMM, APZ	08.1997→11.2000	 7.01805.01.0	EUV-SR	EL	 AMM:  ch. 8E-1-000 001→ch. 8E-5-400 000  APZ:  ch. 8D-X-200 001→
2.4 quattro 121 kW (165 PS) AGA, ALF, APS, ARJ	03.1997→11.2000	 7.01805.01.0	EUV-SR	EL	 APS, ARJ:  ch. 8D-X-200 001→
2.4 quattro 120 kW (163 PS) APZ	08.1997→11.2000	 7.01805.01.0	EUV-SR	EL	 ch. 8D-X-200 001→
2.5 TDI 110 kW (150 PS) AFB, AKN	09.1997→11.2000	 7.00868.02.0	DW-TL	EP	
2.5 TDI quattro 110 kW (150 PS) AFB, AKN	09.1997→11.2000	 7.00868.02.0	DW-TL	EP	
2.6 110 kW (150 PS) ABC	01.1995→11.2000	 7.05432.12.0	SM	EL	mit Dichtring with O-ring
2.6 quattro 110 kW (150 PS) ABC	01.1995→11.2000	 7.05432.12.0	SM	EL	mit Dichtring with O-ring
2.7 Turbo quattro 169 kW (230 PS) AJK	02.1999→09.2000	 7.22687.39.0	EUV-LS	EL	
2.8 128 kW (174 PS) AAH	09.1995→07.1997	 7.21483.54.0	EUV-AGR	EL	
		7.01805.01.0	EUV-SR	EL	
2.8 142 kW (193 PS) ACK, ALG, APR, AQD	10.1996→11.2000	 7.01805.01.0	EUV-SR	EL	 APR, AQD:  ch. 8D-X-200 001→
2.8 140 kW (190 PS) ATX	09.1999→10.2000	 7.01805.01.0	EUV-SR	EL	 ch. 8D-X-200 001→
2.8 quattro 128 kW (174 PS) AAH	01.1995→07.1997	 7.21483.54.0	EUV-AGR	EL	
		7.01805.01.0	EUV-SR	EL	
2.8 quattro 142 kW (193 PS) ACK, ALG, APR, AQD	10.1996→08.2001	 7.01805.01.0	EUV-SR	EL	 APR, AQD:  ch. 8D-X-200 001→
2.8 quattro 140 kW (190 PS) ATX	09.1999→10.2000	 7.01805.01.0	EUV-SR	EL	 ch. 8D-X-200 001→
S4 quattro 195 kW (265 PS) AGB, AZB	09.1997→09.2001	 7.22687.49.0	EUV-DR	EP	Fahrgestellnummer ab: 8D-X-200 001 Vehicle Identification Number from: 8D-X-200 001
		7.22687.39.0	EUV-LS	EL	 AGB, AZB:  ch. 8D-X-200 001→

						
A4 B5 Avant (8D5)						23
1.6 74 kW (100 PS) AHL, ANA, ARM	11.1994→09.2001		7.22402.03.0	EUV-SR	EL  AHL, ANA, ARM: Fahrgestellnummer ab: 8D-X-200 001 Vehicle Identification Number from: 8D-X-200 001	
1.6 75 kW (102 PS) ALZ	07.2000→09.2001		7.10014.00.0	AKF	EL  ch. 8D-X-200 001→	
			7.22880.01.0	EUV-SR	EL Fahrgestellnummer ab: 8D-X-200 001 Vehicle Identification Number from: 8D-X-200 001	
1.8 92-95 kW (125-129 PS) ADR	02.1996→09.2001		7.01805.01.0	EUV-SR	EL	
			7.22402.03.0	EUV-SR	EL Fahrgestellnummer ab: 8D-X-200 001 Vehicle Identification Number from: 8D-X-200 001	
1.8 92 kW (125 PS) APT, ARG, AVV	02.1996→09.2001		7.22402.03.0	EUV-SR	EL  APT, ARG, AVV: Fahrgestellnummer ab: 8D-X-200 001 Vehicle Identification Number from: 8D-X-200 001	
1.8 T 110 kW (150 PS) ANB, APU, AWT	03.1996→09.2001		7.01805.01.0	EUV-LS	EL  ANB, APU, AWT:  ch. 8D-X-200 001→	
1.8 T quattro 110 kW (150 PS) ANB, APU, AWT	01.1996→09.2001		7.01805.01.0	EUV-LS	EL  ANB, APU, AWT:  ch. 8D-X-200 001→	
1.8 quattro 92-95 kW (125-129 PS) ADR	01.1996→09.2001		7.01805.01.0	EUV-SR	EL	
			7.22402.03.0	EUV-SR	EL Fahrgestellnummer ab: 8D-X-200 001 Vehicle Identification Number from: 8D-X-200 001	
1.8 quattro 92 kW (125 PS) APT, ARG	07.1998→09.2001		7.22402.03.0	EUV-SR	EL  APT, ARG: Fahrgestellnummer ab: 8D-X-200 001 Vehicle Identification Number from: 8D-X-200 001	
1.9 Hybrid 66 kW (90 PS) AHU	03.1998→06.2000		7.21903.70.0	DW-AGR	EP	
			7.21903.70.0	DW-TL	EP für OE-Nummer: 1H0 906 627 for OE number: 1H0 906 627	
			7.21895.55.0	LDRV	EL	
1.9 TDI 66 kW (90 PS) 1Z, AHU	02.1996→09.2001		7.21903.70.0	DW-AGR	EP	
			7.21903.70.0	DW-TL	EP für OE-Nummer: 1H0 906 627 for OE number: 1H0 906 627	
			7.21895.55.0	LDRV	EL	
1.9 TDI 66 kW (90 PS) AHH	02.1996→09.2001		7.21903.70.0	DW-AGR	EP	
			7.21903.70.0	DW-TL	EP für OE-Nummer: 1H0 906 627 for OE number: 1H0 906 627	
			7.21903.75.0	DW-TL	EP	
1.9 TDI 81 kW (110 PS) AFN, AVG	02.1996→09.2001		7.21903.75.0	DW-TL	EP  AFN, AVG:  ch. 8D-X-200 001→	
			7.21903.70.0	DW-AGR	EP	
			7.21903.70.0	DW-TL	EP  AFN, AVG: für OE-Nummer: 1H0 906 627 for OE number: 1H0 906 627	
1.9 TDI 55 kW (75 PS) AFF	03.1996→09.2001		7.21903.70.0	DW-AGR	EP	
			7.21903.70.0	DW-TL	EP für OE-Nummer: 1H0 906 627 for OE number: 1H0 906 627	
			7.21895.55.0	LDRV	EL	
1.9 TDI 85 kW (115 PS) AJM	03.2000→09.2001		7.02183.01.0	DW-AGR	EP  ch. 8D-1-000 001→	
			7.02184.01.0	DW-TL	EP  ch. 8D-1-000 001→	
			7.21903.75.0	DW-TL	EP  ch. 8D-X-200 001→ch. 8D-Y-300 000	

A



A4 B5 Avant (8D5)

23

		7.21903.70.0	DW-AGR	EP	Fahrgestellnummer bis: 8D-Y-300 000 Vehicle Identification Number to: 8D-Y-300 000
		7.21903.70.0	DW-TL	EP	für OE-Nummer: 1H0 906 627 for OE number: 1H0 906 627
1.9 TDI 85 kW (115 PS) ATJ	03.2000→09.2001	 7.21903.70.0	DW-AGR	EP	Fahrgestellnummer bis: 8D-Y-300 000 Vehicle Identification Number to: 8D-Y-300 000
		7.21903.70.0	DW-TL	EP	für OE-Nummer: 1H0 906 627 for OE number: 1H0 906 627
1.9 TDI quattro 81 kW (110 PS) AFN, AVG	09.1996→09.2001	 7.21903.75.0	DW-TL	EP	 AFN, AVG:  ch. 8D-X-200 001→
		7.21903.70.0	DW-AGR	EP	
		7.21903.70.0	DW-TL	EP	 AFN, AVG: für OE-Nummer: 1H0 906 627 for OE number: 1H0 906 627
1.9 TDI quattro 85 kW (115 PS) ATJ	03.2000→09.2001	 7.02183.01.0	DW-AGR	EP	 ch. 8D-1-000 001→
		7.02184.01.0	DW-TL	EP	 ch. 8D-1-000 001→
		7.21903.75.0	DW-TL	EP	 ch. 8D-X-200 001→ch. 8D-Y-300 000
		7.21903.70.0	DW-AGR	EP	Fahrgestellnummer bis: 8D-Y-300 000 Vehicle Identification Number to: 8D-Y-300 000
		7.21903.70.0	DW-TL	EP	für OE-Nummer: 1H0 906 627 for OE number: 1H0 906 627
2.4 110 kW (150 PS) AFM	07.1995→07.1997	 7.01805.01.0	EUV-SR	EL	
		7.05432.12.0	SM	EL	mit Dichtring with O-ring  Thailand  Thailand
2.4 121 kW (165 PS) AGA, ALF, APS, ARJ	03.1997→09.2001	 7.01805.01.0	EUV-SR	EL	 APS, ARJ:  ch. 8D-X-200 001→
2.4 120 kW (163 PS) AJG, AMM, APZ	08.1997→09.2001	 7.01805.01.0	EUV-SR	EL	 AMM:  ch. 8E-1-000 001→ch. 8E-5-400 000  APZ:  ch. 8D-X-200 001→
2.4 quattro 121 kW (165 PS) AGA, ALF, APS, ARJ	03.1997→09.2001	 7.01805.01.0	EUV-SR	EL	 APS, ARJ:  ch. 8D-X-200 001→
2.4 quattro 120 kW (163 PS) APZ	08.1997→09.2001	 7.01805.01.0	EUV-SR	EL	 ch. 8D-X-200 001→
2.5 TDI 110 kW (150 PS) AFB, AKN	09.1997→09.2001	 7.00868.02.0	DW-TL	EP	
2.5 TDI quattro 110 kW (150 PS) AFB, AKN	09.1997→09.2001	 7.00868.02.0	DW-TL	EP	
2.6 110 kW (150 PS) ABC	02.1996→09.2001	 7.05432.12.0	SM	EL	mit Dichtring with O-ring
2.6 quattro 110 kW (150 PS) ABC	01.1996→09.2001	 7.05432.12.0	SM	EL	mit Dichtring with O-ring
2.8 128 kW (174 PS) AAH	03.1996→09.1996	 7.21483.54.0	EUV-AGR	EL	
		7.01805.01.0	EUV-SR	EL	
2.8 142 kW (193 PS) ACK, ALG, APR, AQD	10.1996→09.2001	 7.01805.01.0	EUV-SR	EL	 APR, AQD:  ch. 8D-X-200 001→
2.8 140 kW (190 PS) ATX	03.1999→09.2000	 7.01805.01.0	EUV-SR	EL	 ch. 8D-X-200 001→
2.8 quattro 128 kW (174 PS) AAH	01.1996→09.1996	 7.21483.54.0	EUV-AGR	EL	
		7.01805.01.0	EUV-SR	EL	
2.8 quattro 142 kW (193 PS) ACK, ALG, APR, AQD	10.1996→09.2001	 7.01805.01.0	EUV-SR	EL	 APR, AQD:  ch. 8D-X-200 001→





















A4 B5 Avant (8D5)						23
2.8 quattro 140 kW (190 PS) ATX	03.1999→09.2000		7.01805.01.0	EUV-SR	EL	ch. 8D-X-200 001→
RS4 quattro 280 kW (380 PS) ASJ, AZR	05.2000→09.2001		7.22687.49.0	EUV-DR	EP	
			7.22687.39.0	EUV-LS	EL	
			7.01805.01.0	EUV-SL	EL	
S4 quattro 195 kW (265 PS) AGB, AZB	09.1997→09.2001		7.22687.49.0	EUV-DR	EP	Fahrgestellnummer ab: 8D-X-200 001 Vehicle Identification Number from: 8D-X-200 001
			7.22687.39.0	EUV-LS	EL	AGB, AZB: ch. 8D-X-200 001→
A4 B6 (8E2)						24
1.6 75 kW (102 PS) ALZ	11.2000→12.2004		7.22880.01.0	EUV-SR	EL	Fahrgestellnummer ab: 8D-X-200 001 Vehicle Identification Number from: 8D-X-200 001
1.8 T 110 kW (150 PS) AVJ	11.2000→07.2002		7.01805.01.0	EUV-LS	EL	ch. 8E-1-000 001→ch. 8E-5-400 000
1.8 T 125-127 kW (170-173 PS) AMB	07.2001→12.2004		7.01805.01.0	EUV-SR	EL	
1.8 T 120 kW (163 PS) BFB	07.2002→12.2004		7.01805.01.0	EUV-LS	EL	ch. 8E-1-000 001→
1.8 T 140 kW (190 PS) BEX	11.2002→12.2004		7.01805.01.0	EUV-LS	EL	ch. 8E-1-000 001→ch. 8E-5-400 000
1.8 T quattro 110 kW (150 PS) AVJ	11.2000→07.2002		7.01805.01.0	EUV-LS	EL	ch. 8E-1-000 001→ch. 8E-5-400 000
1.8 T quattro 125-127 kW (170-173 PS) AMB	07.2001→12.2004		7.01805.01.0	EUV-SR	EL	
1.8 T quattro 120 kW (163 PS) BFB	07.2002→12.2004		7.01805.01.0	EUV-LS	EL	ch. 8E-1-000 001→
1.8 T quattro 140 kW (190 PS) BEX	11.2002→12.2004		7.01805.01.0	EUV-LS	EL	ch. 8E-1-000 001→ch. 8E-5-400 000
			7.22903.18.0	DW-AGR	EP	AVF, AWX: ch. 8E-1-000 001→ch. 8E-2-450 000
			7.22903.37.0	DW-AGR	EP	AVF, AWX: ch. 8E-3-000 001→ch. 8E-5-400 000
			7.22903.28.0	DW-TL	EP	AVF, AWX: ch. 8E-2-450 000→
			7.22903.19.0	DW-TL	EP	AVF, AWX: →ch. 8E-2-450 000
7.02256.00.0	EUV-AGR	EP	AVF, AWX: ch. 8E-1-000 001→ch. 8E-5-400 000			
1.9 TDI 96 kW (130 PS) AVF, AWX	11.2000→12.2004		7.22903.18.0	DW-AGR	EP	ch. 8E-1-000 001→ch. 8E-2-450 000
			7.22903.37.0	DW-AGR	EP	ch. 8E-3-000 001→ch. 8E-5-400 000
			7.22903.28.0	DW-TL	EP	ch. 8E-2-450 000→
			7.22903.19.0	DW-TL	EP	→ch. 8E-2-450 000
			7.02256.00.0	EUV-AGR	EP	ch. 8E-1-000 001→ch. 8E-5-400 000
1.9 TDI 74 kW (101 PS) AVB	05.2001→12.2004		7.22903.18.0	DW-AGR	EP	ch. 8E-1-000 001→ch. 8E-2-450 000
			7.22903.37.0	DW-AGR	EP	ch. 8E-3-000 001→ch. 8E-5-400 000
			7.22903.28.0	DW-TL	EP	ch. 8E-2-450 000→
			7.22903.19.0	DW-TL	EP	→ch. 8E-2-450 000
			7.02256.00.0	EUV-AGR	EP	ch. 8E-1-000 001→ch. 8E-5-400 000
1.9 TDI 85 kW (116 PS) BKE	06.2004→12.2004		7.22903.28.0	DW-TL	EP	ch. 8E-2-450 000→
1.9 TDI quattro 96 kW (130 PS) AVF	11.2001→12.2004		7.22903.18.0	DW-AGR	EP	ch. 8E-1-000 001→ch. 8E-2-450 000
			7.22903.37.0	DW-AGR	EP	ch. 8E-3-000 001→ch. 8E-5-400 000
			7.22903.28.0	DW-TL	EP	ch. 8E-2-450 000→
			7.22903.19.0	DW-TL	EP	→ch. 8E-2-450 000
			7.02256.00.0	EUV-AGR	EP	ch. 8E-1-000 001→ch. 8E-5-400 000

A



A4 B6 (8E2)

24

2.0 96 kW (130 PS) ALT	11.2000→12.2004		7.10014.00.0	AKF	EL	 ch. 89E-1-000 001→
			7.22880.01.0	EUV-SR	EL	Fahrgestellnummer ab: 8E-1-000 001 Vehicle Identification Number from: 8E-1-000 001
2.0 FSI 110 kW (150 PS) AWA	07.2002→12.2004		7.22880.01.0	EUV-SR	EL	Fahrgestellnummer ab: 8E-1-000 001 Vehicle Identification Number from: 8E-1-000 001 Fahrgestellnummer bis: 8E-5-400 000 Vehicle Identification Number to: 8E-5-400 000
2.4 125 kW (170 PS) BDV	09.2001→12.2004		7.01805.01.0	EUV-SR	EL	 ch. 8E-1-000 001→ch. 8E-5-400 000
2.4 120 kW (163 PS) AMM	09.2001→12.2004		7.01805.01.0	EUV-SR	EL	 ch. 8E-1-000 001→ch. 8E-5-400 000
2.5 TDI 114 kW (155 PS) AYM	08.2001→07.2002		7.22903.34.0	DW-AGR	EP	Fahrgestellnummer ab: 8E-1-000 001 Vehicle Identification Number from: 8E-1-000 001 Fahrgestellnummer bis: 8E-5-400 000 Vehicle Identification Number to: 8E-5-400 000
			7.00868.02.0	DW-TL	EP	
2.5 TDI 120 kW (163 PS) BCZ, BFC	07.2002→12.2004		7.22903.34.0	DW-AGR	EP	 BCZ, BFC: Fahrgestellnummer ab: 8E-1-000 001 Vehicle Identification Number from: 8E-1-000 001 Fahrgestellnummer bis: 8E-5-400 000 Vehicle Identification Number to: 8E-5-400 000
			7.00868.02.0	DW-TL	EP	
2.5 TDI 120 kW (163 PS) BDG	06.2003→12.2004		7.22903.36.0	DW-AGR	EP	 ch. 8E-1-000 001→ch. 8E-5-400 000
			7.00868.02.0	DW-TL	EP	
2.5 TDI quattro 132 kW (180 PS) AKE, BAU	11.2000→12.2004		7.22903.34.0	DW-AGR	EP	 AKE: Fahrgestellnummer ab: 8E-1-000-001 Vehicle Identification Number from: 8E-1-000-001 Fahrgestellnummer bis: 8E-5-400 000 Vehicle Identification Number to: 8E-5-400 000  BAU: Fahrgestellnummer ab: 8E-1-000 001 Vehicle Identification Number from: 8E-1-000 001 Fahrgestellnummer bis: 8E-5-400 000 Vehicle Identification Number to: 8E-5-400 000
			7.00868.02.0	DW-TL	EP	
2.5 TDI quattro 132 kW (180 PS) BDH	11.2000→12.2004		7.22903.36.0	DW-AGR	EP	 ch. 8E-1-000 001→ch. 8E-5-400 000
			7.00868.02.0	DW-TL	EP	
3.0 162-164 kW (220-223 PS) ASN, AVK	11.2000→12.2004		7.22880.01.0	EUV-SR	EL	 ASN, AVK: Fahrgestellnummer ab: 8E-1-000 001 Vehicle Identification Number from: 8E-1-000 001 Fahrgestellnummer bis: 8E-5-400 000 Vehicle Identification Number to: 8E-5-400 000
3.0 160-162 kW (218-220 PS) BBJ	04.2001→12.2004		7.22880.01.0	EUV-SR	EL	Fahrgestellnummer ab: 8E-1-000 001 Vehicle Identification Number from: 8E-1-000 001

A4 B6 (8E2)						24
3.0 quattro 162-164 kW (220-223 PS) ASN, AVK	11.2000→12.2004		7.22880.01.0	EUV-SR	EL	ASN, AVK: Fahrgestellnummer ab: 8E-1-000 001 Vehicle Identification Number from: 8E-1-000 001 Fahrgestellnummer bis: 8E-5-400 000 Vehicle Identification Number to: 8E-5-400 000
3.0 quattro 160-162 kW (218-220 PS) BBJ	04.2001→12.2004		7.22880.01.0	EUV-SR	EL	Fahrgestellnummer ab: 8E-1-000 001 Vehicle Identification Number from: 8E-1-000 001
S4 quattro 253 kW (344 PS) BBK	03.2003→12.2004		7.01805.01.0	EUV-LS	EL	ch. 8E-1-000 001→
			7.28098.15.0	EUV-SL	EL	Fahrgestellnummer ab: 8E-1-000 001 Vehicle Identification Number from: 8E-1-000 001
A4 B6 Avant (8E5)						25
1.6 75 kW (102 PS) ALZ	09.2001→12.2004		7.10014.00.0	AKF	EL	ch. 8E-1-000 001→
			7.22880.01.0	EUV-SR	EL	Fahrgestellnummer ab: 8D-X-200 001 Vehicle Identification Number from: 8D-X-200 001
1.8 T 110 kW (150 PS) AVJ	09.2001→07.2002		7.01805.01.0	EUV-LS	EL	ch. 8E-1-000 001→ch. 8E-5-400 000
1.8 T 120 kW (163 PS) BFB	07.2002→12.2004		7.01805.01.0	EUV-LS	EL	ch. 8E-1-000 001→
1.8 T 140 kW (190 PS) BEX	11.2002→12.2004		7.01805.01.0	EUV-LS	EL	ch. 8E-1-000 001→ch. 8E-5-400 000
1.8 T quattro 110 kW (150 PS) AVJ	09.2001→07.2002		7.01805.01.0	EUV-LS	EL	ch. 8E-1-000 001→ch. 8E-5-400 000
1.8 T quattro 125-127 kW (170-173 PS) AMB	09.2001→12.2004		7.01805.01.0	EUV-SR	EL	
1.8 T quattro 120 kW (163 PS) BFB	07.2002→12.2004		7.01805.01.0	EUV-LS	EL	ch. 8E-1-000 001→
1.8 T quattro 140 kW (190 PS) BEX	11.2002→12.2004		7.01805.01.0	EUV-LS	EL	ch. 8E-1-000 001→ch. 8E-5-400 000
1.9 TDI 96 kW (130 PS) AVF, AWX	09.2001→12.2004		7.22903.18.0	DW-AGR	EP	AVF, AWX: ch. 8E-1-000 001→ch. 8E-2-450 000
			7.22903.37.0	DW-AGR	EP	AVF, AWX: ch. 8E-3-000 001→ch. 8E-5-400 000
			7.22903.28.0	DW-TL	EP	AVF, AWX: ch. 8E-2-450 000→
			7.22903.19.0	DW-TL	EP	AVF, AWX: →ch. 8E-2-450 000
7.02256.00.0	EUV-AGR	EP	AVF, AWX: ch. 8E-1-000 001→ch. 8E-5-400 000			
1.9 TDI 74 kW (101 PS) AVB	11.2001→12.2004		7.22903.18.0	DW-AGR	EP	ch. 8E-1-000 001→ch. 8E-2-450 000
			7.22903.37.0	DW-AGR	EP	ch. 8E-3-000 001→ch. 8E-5-400 000
			7.22903.28.0	DW-TL	EP	ch. 8E-2-450 000→
			7.22903.19.0	DW-TL	EP	→ch. 8E-2-450 000
7.02256.00.0	EUV-AGR	EP	ch. 8E-1-000 001→ch. 8E-5-400 000			
1.9 TDI 85 kW (116 PS) BKE	06.2004→12.2004		7.22903.28.0	DW-TL	EP	ch. 8E-2-450 000→
1.9 TDI quattro 96 kW (130 PS) AVF	11.2001→12.2004		7.22903.18.0	DW-AGR	EP	ch. 8E-1-000 001→ch. 8E-2-450 000
			7.22903.37.0	DW-AGR	EP	ch. 8E-3-000 001→ch. 8E-5-400 000

A



A4 B6 Avant (8E5)

25

			7.22903.28.0	DW-TL	EP	ch. 8E-2-450 000→
			7.22903.19.0	DW-TL	EP	→ch. 8E-2-450 000
			7.02256.00.0	EUV-AGR	EP	ch. 8E-1-000 001→ch. 8E-5-400 000
2.0 96 kW (130 PS) ALT	09.2001→12.2004		7.10014.00.0	AKF	EL	ch. 8E-1-000 001→
			7.22880.01.0	EUV-SR	EL	Fahrgestellnummer ab: 8E-1-000 001 Vehicle Identification Number from: 8E-1-000 001
2.0 FSI 110 kW (150 PS) AWA	06.2003→12.2004		7.22880.01.0	EUV-SR	EL	Fahrgestellnummer ab: 8E-1-000 001 Vehicle Identification Number from: 8E-1-000 001 Fahrgestellnummer bis: 8E-5-400 000 Vehicle Identification Number to: 8E-5-400 000
2.4 125 kW (170 PS) BDV	09.2001→12.2004		7.01805.01.0	EUV-SR	EL	ch. 8E-1-000 001→ch. 8E-5-400 000
2.4 120 kW (163 PS) AMM	09.2001→12.2004		7.01805.01.0	EUV-SR	EL	ch. 8E-1-000 001→ch. 8E-5-400 000
2.5 TDI 114 kW (155 PS) AYM	09.2001→07.2002		7.22903.34.0	DW-AGR	EP	Fahrgestellnummer ab: 8E-1-000 001 Vehicle Identification Number from: 8E-1-000 001 Fahrgestellnummer bis: 8E-5-400 000 Vehicle Identification Number to: 8E-5-400 000
			7.00868.02.0	DW-TL	EP	
2.5 TDI 120 kW (163 PS) BCZ, BFC	07.2002→12.2004		7.22903.34.0	DW-AGR	EP	BCZ, BFC: Fahrgestellnummer ab: 8E-1-000 001 Vehicle Identification Number from: 8E-1-000 001 Fahrgestellnummer bis: 8E-5-400 000 Vehicle Identification Number to: 8E-5-400 000
			7.00868.02.0	DW-TL	EP	
2.5 TDI 120 kW (163 PS) BDG	06.2003→12.2004		7.22903.36.0	DW-AGR	EP	ch. 8E-1-000 001→ch. 8E-5-400 000
			7.00868.02.0	DW-TL	EP	
2.5 TDI quattro 132 kW (180 PS) AKE, BAU	09.2001→12.2004		7.22903.34.0	DW-AGR	EP	AKE, BAU: Fahrgestellnummer ab: 8E-1-000 001 Vehicle Identification Number from: 8E-1-000 001 Fahrgestellnummer bis: 8E-5-400 000 Vehicle Identification Number to: 8E-5-400 000
			7.00868.02.0	DW-TL	EP	
2.5 TDI quattro 132 kW (180 PS) BDH	06.2003→12.2004		7.22903.36.0	DW-AGR	EP	ch. 8E-1-000 001→ch. 8E-5-400 000
			7.00868.02.0	DW-TL	EP	
3.0 160-162 kW (218-220 PS) BBJ	04.2001→12.2004		7.22880.01.0	EUV-SR	EL	Fahrgestellnummer ab: 8E-1-000 001 Vehicle Identification Number from: 8E-1-000 001
3.0 162 kW (220 PS) ASN	09.2001→12.2004		7.22880.01.0	EUV-SR	EL	Fahrgestellnummer ab: 8E-1-000 001 Vehicle Identification Number from: 8E-1-000 001 Fahrgestellnummer bis: 8E-5-400 000 Vehicle Identification Number to: 8E-5-400 000
3.0 quattro 160-162 kW (218-220 PS) BBJ	04.2001→12.2004		7.22880.01.0	EUV-SR	EL	Fahrgestellnummer ab: 8E-1-000 001 Vehicle Identification Number from: 8E-1-000 001
3.0 quattro 162-164 kW (220-223 PS) ASN, AVK	09.2001→12.2004		7.22880.01.0	EUV-AGK	EL	
			7.22880.01.0	EUV-AGR	EL	





A4 B6 Avant (8E5)						25
			7.22880.01.0 7.22880.01.0 7.22880.01.0 7.22880.01.0 7.22880.01.0	EUV-KK EUV-LS EUV-ML EUV-SL EUV-SR	EL EL EL EL EL	ASN, AVK: Fahrgestellnummer ab: 8E-1-000 001 Vehicle Identification Number from: 8E-1-000 001 Fahrgestellnummer bis: 8E-5-400 000 Vehicle Identification Number to: 8E-5-400 000
3.0 quattro 162-164 kW (220-223 PS) AVK	09.2001→12.2004		7.22880.01.0	EUV-SR	EL	Fahrgestellnummer ab: 8E-1-000 001 Vehicle Identification Number from: 8E-1-000 001 Fahrgestellnummer bis: 8E-5-400 000 Vehicle Identification Number to: 8E-5-400 000
S4 quattro 253 kW (344 PS) BBK	03.2003→12.2004		7.01805.01.0 7.28098.15.0	EUV-LS EUV-SL	EL EL	ch. 8E-1-000 001→ Fahrgestellnummer ab: 8E-1-000 001 Vehicle Identification Number from: 8E-1-000 001
A4 B6 Convertible (8H7)						26
1.8 T 120 kW (163 PS) BFB	07.2002→12.2005		7.01805.01.0	EUV-LS	EL	ch. 8E-1-000 001→
1.8 T 125-127 kW (170-173 PS) AMB	10.2002→10.2005		7.01805.01.0	EUV-SR	EL	
1.8 T quattro 120 kW (163 PS) BFB	05.2003→12.2005		7.01805.01.0	EUV-LS	EL	ch. 8E-1-000 001→
1.8 T quattro 125-127 kW (170-173 PS) AMB	09.2003→12.2004		7.01805.01.0	EUV-SR	EL	
2.0 96 kW (130 PS) ALT	09.2004→12.2005		7.10014.00.0 7.22880.01.0	AKF EUV-SR	EL EL	Fahrgestellnummer ab: 8E-1-000 001 Vehicle Identification Number from: 8E-1-000 001
2.4 125 kW (170 PS) BDV	04.2002→12.2005		7.01805.01.0	EUV-SR	EL	ch. 8E-1-000 001→ch. 8E-5-400 000
2.4 120 kW (163 PS) AMM	04.2002→12.2005		7.01805.01.0	EUV-SR	EL	ch. 8E-1-000 001→ch. 8E-5-400 000
2.5 TDI 120 kW (163 PS) BCZ, BFC	08.2002→12.2005		7.22903.34.0 7.00868.02.0	DW-AGR DW-TL	EP EP	
2.5 TDI 120 kW (163 PS) BDG	08.2002→12.2005		7.22903.36.0 7.00868.02.0	DW-AGR DW-TL	EP EP	
3.0 162 kW (220 PS) ASN	04.2002→12.2005		7.22880.01.0	EUV-SR	EL	ASN: Fahrgestellnummer ab: 8E-1-000 001 Vehicle Identification Number from: 8E-1-000 001 Fahrgestellnummer bis: 8E-5-400 000 Vehicle Identification Number to: 8E-5-400 000 ASN: Fahrgestellnummer ab: 8E-1-000 001 Vehicle Identification Number from: 8E-1-000 001 Fahrgestellnummer bis: 8E-5-400 000 Vehicle Identification Number to: 8E-5-400 000

A



A4 B6 Convertible (8H7)





































26

3.0 160-162 kW (218-220 PS) BBJ	04.2002→12.2005	 7.22880.01.0	EUV-SR	EL	Fahrgestellnummer ab: 8E-1-000 001 Vehicle Identification Number from: 8E-1-000 001
3.0 quattro 162 kW (220 PS) ASN	05.2003→12.2005	 7.22880.01.0	EUV-SR	EL	Fahrgestellnummer ab: 8E-1-000 001 Vehicle Identification Number from: 8E-1-000 001 Fahrgestellnummer bis: 8E-5-400 000 Vehicle Identification Number to: 8E-5-400 000
S4 quattro 253 kW (344 PS) BBK	03.2004→12.2005	 7.01805.01.0	EUV-LS	EL	 ch. 8E-1-000 001→
		7.28098.15.0	EUV-SL	EL	

A4 B7 (8EC)

27

1.6 75 kW (102 PS) ALZ	11.2004→06.2008	 7.10014.00.0	AKF	EL	 ch. 8E-5-400 001→
		7.22880.01.0	EUV-SR	EL	Fahrgestellnummer ab: 8D-X-200 001 Vehicle Identification Number from: 8D-X-200 001
1.8 T 120 kW (163 PS) BFB	11.2004→06.2008	 7.01805.01.0	EUV-LS	EL	 ch. 8E-1-000 001→
1.8 T 125-127 kW (170-173 PS) AMB	01.2005→12.2005	 7.01805.01.0	EUV-SR	EL	
1.8 T quattro 120 kW (163 PS) BFB	11.2004→06.2008	 7.01805.01.0	EUV-LS	EL	 ch. 8E-1-000 001→
1.9 TDI 85 kW (116 PS) BKE, BRB	11.2004→06.2008	 7.22903.28.0	DW-TL	EP	 BKE, BRB:  ch. 8E-2-450 000→
2.0 96 kW (130 PS) ALT	11.2004→06.2008	 7.10014.00.0	AKF	EL	 ch. 8E-5-400 001→
		7.22880.01.0	EUV-SR	EL	Fahrgestellnummer ab: 8E-1-000 001 Vehicle Identification Number from: 8E-1-000 001
2.0 FSI 110 kW (150 PS) AWA	01.2005→07.2005	 7.22880.01.0	EUV-SR	EL	Fahrgestellnummer ab: 8E-1-000 001 Vehicle Identification Number from: 8E-1-000 001 Fahrgestellnummer bis: 8E-5-400 000 Vehicle Identification Number to: 8E-5-400 000
2.0 TDI 100 kW (136 PS) BNA, BRF	11.2004→06.2008	 7.22903.28.0	DW-AGR	EP	 BNA, BRF:  ch. 8E-5-400 001→
		7.02256.00.0	EUV-AGR	EP	 BNA, BRF:  ch. 8E-5-400 001→
2.0 TDI 103 kW (140 PS) BPW	11.2004→06.2008	 7.22903.28.0	DW-TL	EP	 ch. 8E-5-400 001→
2.0 TDI 89 kW (121 PS) BVG	09.2005→09.2006	 7.22903.28.0	DW-TL	EP	 ch. 8E-5-400 001→
		7.02256.00.0	EUV-AGR	EP	 ch. 8E-5-400 001→
2.0 TDI 93 kW (126 PS) BVF	11.2005→11.2006	 7.22903.28.0	DW-TL	EP	 ch. 8E-5-400 001→
		7.02256.00.0	EUV-AGR	EP	 ch. 8E-5-400 001→
2.0 TDI 125 kW (170 PS) BRD	06.2006→06.2008	 7.22903.28.0	DW-TL	EP	 ch. 8E-5-400 001→
		7.02256.00.0	EUV-AGR	EP	 ch. 8E-5-400 001→
2.0 TDI 120 kW (163 PS) BVA	06.2006→06.2008	 7.22903.28.0	DW-TL	EP	 ch. 8E-5-400 001→
		7.02256.00.0	EUV-AGR	EP	 ch. 8E-5-400 001→
2.0 TDI 16V 103 kW (140 PS) BLB, BRE	11.2004→06.2008	 7.22903.28.0	DW-AGR	EP	 BLB, BRE:  ch. 8E-5-400 001→
		7.02256.00.0	EUV-AGR	EP	 BLB, BRE:  ch. 8E-5-400 001→
2.0 TDI quattro 103 kW (140 PS) BPW	01.2006→06.2008	 7.22903.28.0	DW-TL	EP	 ch. 8E-5-400 001→

						
A4 B7 (8EC)						27
2.0 TDI quattro 125 kW (170 PS) BRD	06.2006→06.2008		7.22903.28.0	DW-TL	EP	 ch. 8E-5-400 001→
			7.02256.00.0	EUV-AGR	EP	 ch. 8E-5-400 001→
2.0 TDI quattro 120 kW (163 PS) BVA	06.2006→06.2008		7.22903.28.0	DW-TL	EP	 ch. 8E-5-400 001→
			7.02256.00.0	EUV-AGR	EP	 ch. 8E-5-400 001→
2.0 TFSI 147-149 kW (200-203 PS) BGB, BPG, BWE, BWT	11.2004→06.2008		7.00470.07.0	LDRV	EL	 BGB, BPG, BWE, BWT:  ch. 8E-5-400 001→
			7.01830.13.0	SUV	EL	
			7.06117.46.0	SV-NWV	EH	mit Dichtring with O-ring  BGB, BPG, BWE, BWT: Fahrgestellnummer ab: 8E-5-400 001 Vehicle Identification Number from: 8E-5-400 001
2.0 TFSI 162 kW (220 PS) BUL	06.2005→06.2008		7.00470.07.0	LDRV	EL	 ch. 8E-5-400 001→
			7.01830.13.0	SUV	EL	
			7.06117.46.0	SV-NWV	EH	mit Dichtring with O-ring Fahrgestellnummer ab: 8E-5-400 001 Vehicle Identification Number from: 8E-5-400 001
2.0 TFSI 147-149 kW (200-203 PS) BWT	09.2006→06.2008		7.01830.13.0	SUV	EL	
2.0 TFSI 125 kW (170 PS) BPJ, BYK	10.2006→06.2008		7.00470.07.0	LDRV	EL	 BPJ, BYK:  ch. 8E-5-400 001→
			7.01830.13.0	SUV	EL	
			7.06117.46.0	SV-NWV	EH	mit Dichtring with O-ring  BPJ, BYK: Fahrgestellnummer ab: 8E-5-400 001 Vehicle Identification Number from: 8E-5-400 001
2.0 TFSI quattro 147-149 kW (200-203 PS) BGB, BPG, BWE, BWT	11.2004→06.2008		7.00470.07.0	LDRV	EL	 BGB, BPG, BWE, BWT:  ch. 8E-5-400 001→
			7.01830.13.0	SUV	EL	
			7.06117.46.0	SV-NWV	EH	mit Dichtring with O-ring  BGB, BPG, BWE, BWT: Fahrgestellnummer ab: 8E-5-400 001 Vehicle Identification Number from: 8E-5-400 001
2.0 TFSI quattro 162 kW (220 PS) BUL	06.2005→06.2008		7.00470.07.0	LDRV	EL	 ch. 8E-5-400 001→
			7.01830.13.0	SUV	EL	
			7.06117.46.0	SV-NWV	EH	mit Dichtring with O-ring Fahrgestellnummer ab: 8E-5-400 001 Vehicle Identification Number from: 8E-5-400 001
2.5 TDI 120 kW (163 PS) BDG	11.2004→05.2006		7.22903.36.0	DW-AGR	EP	 ch. 8E-5-400 001→
2.7 TDI 120 kW (163 PS) BSG	11.2005→06.2008		7.00868.02.0	DW-TL	EP	
			7.01019.01.0	DW-AGR	EP	 ch. 8E-5-400 001→
2.7 TDI 132 kW (180 PS) BPP	01.2006→06.2008		7.02256.00.0	EUV-AGR	EP	 ch. 8E-5-400 001→
			7.01019.01.0	DW-AGR	EP	 ch. 8E-5-400 001→

A



A4 B7 (8EC)







































27

			7.02256.00.0	EUV-AGR	EP	Fahrgestellnummer ab: 8E-5-400 001 Vehicle Identification Number from: 8E-5-400 001
3.0 160-162 kW (218-220 PS) BBJ	11.2004→05.2006		7.22880.01.0	EUV-SR	EL	Fahrgestellnummer ab: 8E-1-000 001 Vehicle Identification Number from: 8E-1-000 001
3.0 TDI quattro 150 kW (204 PS) BKN	11.2004→06.2008		7.01019.01.0	DW-AGR	EP	ch. 8E-5-400 001→
			7.02256.00.0	EUV-AGR	EP	ch. 8E-5-400 001→
3.0 TDI quattro 171 kW (233 PS) ASB	01.2006→06.2008		7.01019.01.0	DW-AGR	EP	ch. 8E-5-400 001→
			7.02256.00.0	EUV-AGR	EP	ch. 8E-5-400 001→
3.0 quattro 160-162 kW (218-220 PS) BBJ	11.2004→07.2006		7.22880.01.0	EUV-SR	EL	Fahrgestellnummer ab: 8E-1-000 001 Vehicle Identification Number from: 8E-1-000 001
3.2 FSI 188 kW (255 PS) AUK	01.2005→06.2008		7.22880.01.0	EUV-SR	EL	Fahrgestellnummer ab: 8E-5-400 001 Vehicle Identification Number from: 8E-5-400 001
3.2 FSI quattro 188-190 kW (255-258 PS) AUK, BKH	01.2005→06.2008		7.22880.01.0	EUV-SR	EL	AUK, BKH: Fahrgestellnummer ab: 8E-5-400 001 Vehicle Identification Number from: 8E-5-400 001
RS4 quattro 309 kW (420 PS) BNS	09.2005→06.2008		7.01805.01.0	EUV-LS	EL	
			7.22880.01.0	EUV-SL	EL	
S4 quattro 253 kW (344 PS) BBK	11.2004→06.2008		7.01805.01.0	EUV-LS	EL	ch. 8E-1-000 001→
			7.28098.15.0	EUV-SL	EL	
S4 quattro 253 kW (344 PS) BHF	11.2004→06.2008		7.01805.01.0	EUV-LS	EL	ch. 8E-1-000 001→

A4 B7 Avant (8ED)

28

1.6 75 kW (102 PS) ALZ	11.2004→06.2008		7.10014.00.0	AKF	EL	ch. 8E-5-400 001→
			7.22880.01.0	EUV-SR	EL	Fahrgestellnummer ab: 8D-X-200 001 Vehicle Identification Number from: 8D-X-200 001
1.8 T 120 kW (163 PS) BFB	11.2004→06.2008		7.01805.01.0	EUV-LS	EL	ch. 8E-1-000 001→
1.8 T quattro 120 kW (163 PS) BFB	11.2004→06.2008		7.01805.01.0	EUV-LS	EL	ch. 8E-1-000 001→
1.9 TDI 85 kW (116 PS) BKE, BRB	11.2004→06.2008		7.22903.28.0	DW-TL	EP	BKE, BRB: ch. 8E-2-450 000→
2.0 96 kW (130 PS) ALT	11.2004→06.2008		7.22880.01.0	EUV-SR	EL	Fahrgestellnummer ab: 8E-1-000 001 Vehicle Identification Number from: 8E-1-000 001
2.0 TDI 100 kW (136 PS) BNA, BRF	11.2004→06.2008		7.22903.28.0	DW-AGR	EP	BNA, BRF: ch. 8E-5-400 001→
			7.02256.00.0	EUV-AGR	EP	BNA, BRF: ch. 8E-5-400 001→
2.0 TDI 103 kW (140 PS) BPW	11.2004→06.2008		7.22903.28.0	DW-TL	EP	ch. 8E-5-400 001→
2.0 TDI 89 kW (121 PS) BVG	09.2005→09.2006		7.22903.28.0	DW-TL	EP	ch. 8E-5-400 001→
			7.02256.00.0	EUV-AGR	EP	ch. 8E-5-400 001→
2.0 TDI 93 kW (126 PS) BVF	11.2005→11.2006		7.22903.28.0	DW-TL	EP	ch. 8E-5-400 001→
			7.02256.00.0	EUV-AGR	EP	ch. 8E-5-400 001→
2.0 TDI 125 kW (170 PS) BRD	06.2006→06.2008		7.22903.28.0	DW-TL	EP	ch. 8E-5-400 001→
			7.02256.00.0	EUV-AGR	EP	ch. 8E-5-400 001→























						
A4 B7 Avant (8ED)						28
2.0 TDI 120 kW (163 PS) BVA	06.2006→06.2008		7.22903.28.0	DW-TL	EP	 ch. 8E-5-400 001→
			7.02256.00.0	EUV-AGR	EP	 ch. 8E-5-400 001→
2.0 TDI 16V 103 kW (140 PS) BLB, BRE	11.2004→06.2008		7.22903.28.0	DW-AGR	EP	 BLB, BRE:  ch. 8E-5-400 001→
			7.02256.00.0	EUV-AGR	EP	 BLB, BRE:  ch. 8E-5-400 001→
2.0 TDI quattro 103 kW (140 PS) BPW	01.2006→06.2008		7.22903.28.0	DW-TL	EP	 ch. 8E-5-400 001→
2.0 TDI quattro 125 kW (170 PS) BRD	06.2006→06.2008		7.22903.28.0	DW-TL	EP	 ch. 8E-5-400 001→
			7.02256.00.0	EUV-AGR	EP	 ch. 8E-5-400 001→
2.0 TDI quattro 120 kW (163 PS) BVA	06.2006→06.2008		7.22903.28.0	DW-TL	EP	 ch. 8E-5-400 001→
			7.02256.00.0	EUV-AGR	EP	 ch. 8E-5-400 001→
2.0 TFSI 147 kW (200 PS) BGB, BPG, BWE	11.2004→06.2008		7.00470.07.0	LDRV	EL	 BGB, BPG, BWE:  ch. 8E-5-400 001→
			7.01830.13.0	SUV	EL	
			7.06117.46.0	SV-NWV	EH	mit Dichtring with O-ring  BGB, BPG, BWE: Fahrgestellnummer ab: 8E-5-400 001 Vehicle Identification Number from: 8E-5-400 001
2.0 TFSI 162 kW (220 PS) BUL	06.2005→06.2008		7.00470.07.0	LDRV	EL	 ch. 8E-5-400 001→
			7.01830.13.0	SUV	EL	
			7.06117.46.0	SV-NWV	EH	mit Dichtring with O-ring Fahrgestellnummer ab: 8E-5-400 001 Vehicle Identification Number from: 8E-5-400 001
2.0 TFSI 125 kW (170 PS) BPJ, BYK	10.2006→06.2008		7.00470.07.0	LDRV	EL	 BPJ, BYK:  ch. 8E-5-400 001→
			7.01830.13.0	SUV	EL	
			7.06117.46.0	SV-NWV	EH	mit Dichtring with O-ring  BPJ, BYK: Fahrgestellnummer ab: 8E-5-400 001 Vehicle Identification Number from: 8E-5-400 001
2.0 TFSI quattro 147-149 kW (200-203 PS) BGB, BWE, BWT	11.2004→06.2008		7.00470.07.0	LDRV	EL	 BGB, BWE, BWT:  ch. 8E-5-400 001→
			7.01830.13.0	SUV	EL	
			7.06117.46.0	SV-NWV	EH	mit Dichtring with O-ring  BGB, BWE, BWT: Fahrgestellnummer ab: 8E-5-400 001 Vehicle Identification Number from: 8E-5-400 001
2.0 TFSI quattro 147 kW (200 PS) BPG	11.2004→06.2008		7.01830.13.0	SUV	EL	
			7.06117.46.0	SV-NWV	EH	mit Dichtring with O-ring Fahrgestellnummer ab: 8E-5-400 001 Vehicle Identification Number from: 8E-5-400 001
2.0 TFSI quattro 162 kW (220 PS) BUL	06.2005→06.2008		7.00470.07.0	LDRV	EL	 ch. 8E-5-400 001→
			7.01830.13.0	SUV	EL	

A













A4 B7 Avant (8ED)

28

			7.06117.46.0	SV-NWV	EH	mit Dichtring with O-ring Fahrgestellnummer ab: 8E-5-400 001 Vehicle Identification Number from: 8E-5-400 001
2.5 TDI 120 kW (163 PS) BDG	11.2004→05.2006		7.22903.36.0	DW-AGR	EP	 ch. 8E-5-400 001→
			7.00868.02.0	DW-TL	EP	
2.7 TDI 132 kW (180 PS) BPP	01.2006→06.2008		7.01019.01.0	DW-AGR	EP	 ch. 8E-5-400 001→
			7.02256.00.0	EUV-AGR	EP	 ch. 8E-5-400 001→
2.7 TDi 120 kW (163 PS) BSG	11.2005→03.2008		7.01019.01.0	DW-AGR	EP	 ch. 8E-5-400 001→
			7.02256.00.0	EUV-AGR	EP	 ch. 8E-5-400 001→
3.0 160-162 kW (218-220 PS) BBJ	11.2004→05.2006		7.22880.01.0	EUV-SR	EL	Fahrgestellnummer ab: 8E-1-000 001 Vehicle Identification Number from: 8E-1-000 001
3.0 TDI quattro 150 kW (204 PS) BKN	11.2004→06.2008		7.01019.01.0	DW-AGR	EP	 ch. 8E-5-400 001→
			7.02256.00.0	EUV-AGR	EP	 ch. 8E-5-400 001→
3.0 TDI quattro 171 kW (233 PS) ASB	01.2006→06.2008		7.01019.01.0	DW-AGR	EP	 ch. 8E-5-400 001→
			7.02256.00.0	EUV-AGR	EP	 ch. 8E-5-400 001→
3.0 quattro 160-162 kW (218-220 PS) BBJ	11.2004→07.2006		7.22880.01.0	EUV-SR	EL	Fahrgestellnummer ab: 8E-1-000 001 Vehicle Identification Number from: 8E-1-000 001
3.2 FSI 188 kW (255 PS) AUK	01.2005→06.2008		7.22880.01.0	EUV-SR	EL	Fahrgestellnummer ab: 8E-5-400 001 Vehicle Identification Number from: 8E-5-400 001
3.2 FSI quattro 188-190 kW (255-258 PS) AUK, BKH	01.2005→06.2008		7.22880.01.0	EUV-SR	EL	 AUK, BKH: Fahrgestellnummer ab: 8E-5-400 001 Vehicle Identification Number from: 8E-5-400 001
RS4 quattro 309 kW (420 PS) BNS	09.2005→06.2008		7.01805.01.0	EUV-LS	EL	
			7.22880.01.0	EUV-SL	EL	
S4 quattro 253 kW (344 PS) BBK	11.2004→06.2008		7.01805.01.0	EUV-LS	EL	 ch. 8E-1-000 001→
			7.28098.15.0	EUV-SL	EL	

A4 B7 Convertible (8HE)

29

1.8 T 120 kW (163 PS) BFB	01.2006→03.2009		7.01805.01.0	EUV-LS	EL	
2.0 TDI 103 kW (140 PS) BPW	01.2006→03.2009		7.22903.28.0	DW-TL	EP	 ch. 8E-5-400 001→
2.0 TDI 100 kW (136 PS) BRC	01.2006→03.2009		7.22903.28.0	DW-TL	EP	 ch. 8E-5-400 001→
2.0 TFSI 16V 147-149 kW (200-203 PS) BWE, BWT	01.2006→03.2009		7.00470.07.0	LDRV	EL	 BWE, BWT:  ch. 8E-5-400 001→
			7.01830.13.0	SUV	EL	
			7.06117.46.0	SV-NWV	EH	mit Dichtring with O-ring
2.0 TFSI quattro 147-149 kW (200-203 PS) BWT	11.2005→03.2009		7.00470.07.0	LDRV	EL	 ch. 8E-5-400 001→
			7.01830.13.0	SUV	EL	
			7.06117.46.0	SV-NWV	EH	mit Dichtring with O-ring Fahrgestellnummer ab: 8E-5-400 001 Vehicle Identification Number from: 8E-5-400 001











A4 B7 Convertible (8HE)						29
2.7 TDI 132 kW (180 PS) BPP	06.2006→03.2009		7.01019.01.0	DW-AGR	EP	ch. 8E-5-400 001→
			7.02256.00.0	EUV-AGR	EP	
3.0 TDI quattro 171 kW (233 PS) ASB	01.2006→03.2009		7.01019.01.0	DW-AGR	EP	ch. 8E-5-400 001→
			7.02256.00.0	EUV-AGR	EP	
3.0 TDI quattro 150 kW (204 PS) BKN	01.2006→03.2009		7.01019.01.0	DW-AGR	EP	ch. 8E-5-400 001→
			7.02256.00.0	EUV-AGR	EP	
3.2 FSI 188 kW (255 PS) AUK	01.2006→03.2009		7.22880.01.0	EUV-SR	EL	Fahrgestellnummer ab: 8E-5-400 001 Vehicle Identification Number from: 8E-5-400 001
3.2 FSI quattro 188-190 kW (255-258 PS) AUK, BKH	01.2006→03.2009		7.22880.01.0	EUV-SR	EL	AUK, BKH: Fahrgestellnummer ab: 8E-5-400 001 Vehicle Identification Number from: 8E-5-400 001
RS4 quattro 309 kW (420 PS) BNS	02.2006→12.2008		7.01805.01.0	EUV-LS	EL	
			7.22880.01.0	EUV-SL	EL	
S4 quattro 253 kW (344 PS) BBK	11.2005→03.2009		7.01805.01.0	EUV-LS	EL	
			7.28098.15.0	EUV-SL	EL	
S4 quattro 253 kW (344 PS) BHF	11.2005→03.2009		7.01805.01.0	EUV-LS	EL	
A4 B8 (8K2)						30
1.8 TFSI 118 kW (160 PS) CABB	11.2007→03.2012		7.00470.07.0	LDRV	EL	ch. 8K-8-000 001→
			7.00415.07.0	SUV	EL	Fahrgestellnummer ab: 8K-8-000 001 Vehicle Identification Number from: 8K-8-000 001
			7.01830.13.0	SUV	EL	
			7.06117.26.0	ZM-NWV	EL	Fahrgestellnummer ab: 8K-8-000 001 Vehicle Identification Number from: 8K-8-000 001
1.8 TFSI 118 kW (160 PS) CDHB	11.2007→03.2012		7.03280.04.0	EUV-SR	EL	Fahrgestellnummer ab: 8K-8-000 001 Vehicle Identification Number from: 8K-8-000 001 nur in Verbindung mit: Fahrzeug umgerüstet only in connection with: Fahrzeug umgerüstet
			7.22880.01.0	EUV-SR	EL	Fahrgestellnummer ab: 8K-8-000 001 Vehicle Identification Number from: 8K-8-000 001
			7.00470.07.0	LDRV	EL	ch. 8K-8-000 001→
			7.01830.13.0	SUV	EL	
1.8 TFSI 88 kW (120 PS) CABA	01.2008→12.2015		7.00470.07.0	LDRV	EL	ch. 8K-8-000 001→
			7.00415.07.0	SUV	EL	Fahrgestellnummer ab: 8K-8-000 001 Vehicle Identification Number from: 8K-8-000 001
			7.01830.13.0	SUV	EL	
			7.06117.26.0	ZM-NWV	EL	Fahrgestellnummer ab: 8K-8-000 001 Vehicle Identification Number from: 8K-8-000 001

































A



A4 B8 (8K2)

30

1.8 TFSI 88 kW (120 PS) CDHA	01.2008→12.2015		7.03280.04.0	EUV-SR	EL	Fahrgestellnummer ab: 8K-8-000 001 Vehicle Identification Number from: 8K-8-000 001 nur in Verbindung mit: Fahrzeug umgerüstet only in connection with: Fahrzeug umgerüstet
			7.22880.01.0	EUV-SR	EL	Fahrgestellnummer ab: 8K-8-000 001 Vehicle Identification Number from: 8K-8-000 001
			7.00470.07.0 7.01830.13.0 7.06117.26.0	LDRV SUV ZM-NWV	EL EL EL	 ch. 8K-8-000 001→
					EL	Fahrgestellnummer ab: 8K-8-000 001 Vehicle Identification Number from: 8K-8-000 001
1.8 TFSI 125 kW (170 PS) CJEB	11.2011→12.2015		7.03280.04.0	EUV-SR	EL	
			7.01830.13.0 7.02901.05.0 7.06117.26.0	SUV SUV ZM-NWV	EL EL EL	
1.8 TFSI quattro 118 kW (160 PS) CDHB	09.2008→03.2012		7.03280.04.0	EUV-SR	EL	Fahrgestellnummer ab: 8K-8-000 001 Vehicle Identification Number from: 8K-8-000 001 nur in Verbindung mit: Fahrzeug umgerüstet only in connection with: Fahrzeug umgerüstet
			7.22880.01.0	EUV-SR	EL	Fahrgestellnummer ab: 8K-8-000 001 Vehicle Identification Number from: 8K-8-000 001
			7.00470.07.0 7.01830.13.0 7.06117.26.0	LDRV SUV ZM-NWV	EL EL EL	 ch. 8K-8-000 001→
					EL	 ch. 8K-8-000 001→
1.8 TFSI quattro 125 kW (170 PS) CJEB	11.2011→12.2015		7.03280.04.0	EUV-SR	EL	
			7.01830.13.0 7.02901.05.0 7.06117.26.0	SUV SUV ZM-NWV	EL EL EL	
2.0 TDI 105 kW (143 PS) CAGA, CJCA, CMEA, CMFA	11.2007→12.2015		7.02256.00.0	EUV-AGR	EP	 CAGA, CMEA:  ch. 8K-8-000 001→
			7.02256.00.0	EUV-KK	EP	 CAGA, CMEA:  ch. 8K-8-000 001→ Produktionsdatum ab: 31.08.2009 Production date from: 31.08.2009
2.0 TDI 100 kW (136 PS) CAGB, CJCB	11.2007→12.2015		7.02256.00.0	EUV-AGR	EP	 CAGB, CJCB:  ch. 8K-8-000 001→
			7.02256.00.0	EUV-KK	EP	 CAGB, CJCB:  ch. 8K-8-000 001→ Produktionsdatum ab: 31.08.2009 Production date from: 31.08.2009
2.0 TDI 125 kW (170 PS) CAHA	01.2008→03.2012		7.02256.00.0	EUV-AGR	EP	 ch. 8K-8-000 001→
			7.02256.00.0	EUV-KK	EP	 ch. 8K-8-000 001→ Produktionsdatum ab: 31.08.2009 Production date from: 31.08.2009
2.0 TDI 88 kW (120 PS) CAGC, CJCC	06.2008→12.2015		7.02256.00.0	EUV-AGR	EP	 ch. 8K-8-000 001→
			7.02256.00.0	EUV-KK	EP	 ch. 8K-8-000 001→ Produktionsdatum ab: 31.08.2009 Production date from: 31.08.2009
2.0 TDI 120 kW (163 PS) CAHB, CGLD	08.2008→12.2015		7.02256.00.0	EUV-AGR	EP	 ch. 8K-8-000 001→

						A
A4 B8 (8K2)						30
			7.02256.00.0	EUV-KK	EP	 ch. 8K-8-000 001→ Produktionsdatum ab: 31.08.2009 Production date from: 31.08.2009
2.0 TDI 130 kW (177 PS) CGLC, CMGB	11.2011→12.2015		7.02256.00.0	EUV-AGR	EP	
2.0 TDI 110 kW (150 PS) CJCD, CMFB	05.2013→12.2015		7.02256.00.0	EUV-AGR	EP	
2.0 TDI quattro 125 kW (170 PS) CAHA	01.2008→03.2012		7.02256.00.0	EUV-AGR	EP	 ch. 8K-8-000 001→
			7.02256.00.0	EUV-KK	EP	 ch. 8K-8-000 001→ Produktionsdatum ab: 31.08.2009 Production date from: 31.08.2009
2.0 TDI quattro 105 kW (143 PS) CAGA, CJCA	11.2008→12.2015		7.02256.00.0	EUV-AGR	EP	 ch. 8K-8-000 001→
			7.02256.00.0	EUV-KK	EP	 ch. 8K-8-000 001→ Produktionsdatum ab: 31.08.2009 Production date from: 31.08.2009
2.0 TDI quattro 130 kW (177 PS) CGLC	11.2011→12.2015		7.02256.00.0	EUV-AGR	EP	
2.0 TDI quattro 110 kW (150 PS) CJCD	05.2013→12.2015		7.02256.00.0	EUV-AGR	EP	
2.0 TFSI 132 kW (180 PS) CAEA, CDNB	06.2008→12.2015		7.03280.04.0	EUV-SR	EL	 CAEA, CDNB: nur in Verbindung mit: Fahrzeug umgerüstet only in connection with: Fahrzeug umgerüstet
			7.22880.01.0	EUV-SR	EL	 CAEA, CDNB: Fahrgestellnummer ab: 8K-8-000 001 Vehicle Identification Number from: 8K-8-000 001
			7.00470.07.0	LDRV	EL	 CAEA, CDNB:  ch. 8K-8-000 001→
			7.02901.05.0	SUV	EL	 CAEA, CDNB:  ch. 8K-8-000 001→ für OE-Nummer: 06H 145 702 R, 06H 145 710 C for OE number: 06H 145 702 R, 06H 145 710 C
			7.01830.13.0	SUV	EL	
			7.06117.26.0	ZM-NWV	EL	 CAEA, CDNB: Fahrgestellnummer ab: 8K-8-000 001 Vehicle Identification Number from: 8K-8-000 001
2.0 TFSI 132 kW (180 PS) CFKA	06.2008→12.2015		7.03280.04.0	EUV-SR	EL	Baujahr ab: 01.2013 Construction year from: 01.2013
			7.22880.01.0	EUV-SR	EL	Fahrgestellnummer ab: 8K-8-000 001 Vehicle Identification Number from: 8K-8-000 001
			7.00470.07.0	LDRV	EL	 ch. 8K-8-000 001→
			7.01830.13.0	SUV	EL	
			7.06117.26.0	ZM-NWV	EL	Fahrgestellnummer ab: 8K-8-000 001 Vehicle Identification Number from: 8K-8-000 001
2.0 TFSI 155-164 kW (211-223 PS) CAEB, CDNC	06.2008→05.2013		7.03280.04.0	EUV-SR	EL	 CAEB, CDNC: nur in Verbindung mit: Fahrzeug umgerüstet only in connection with: Fahrzeug umgerüstet
			7.22880.01.0	EUV-SR	EL	 CAEB, CDNC: Fahrgestellnummer ab: 8K-8-000 001 Vehicle Identification Number from: 8K-8-000 001
			7.00470.07.0	LDRV	EL	 CAEB, CDNC:  ch. 8K-8-000 001→





























A



A4 B8 (8K2)

30

			7.02901.05.0	SUV	EL	CAEB, CDNC: ch. 8K-8-000 001→ für OE-Nummer: 06H 145 702 R, 06H 145 710 C for OE number: 06H 145 702 R, 06H 145 710 C
			7.01830.13.0	SUV	EL	
			7.06117.26.0	ZM-NWV	EL	CAEB, CDNC: Fahrgestellnummer ab: 8K-8-000 001 Vehicle Identification Number from: 8K-8-000 001
2.0 TFSI 165 kW (224 PS) CNCD	05.2013→12.2015		7.02256.18.0	EUV-SR	EP	Produktionsdatum ab: 26.05.2014 Production date from: 26.05.2014
			7.06117.26.0	ZM-NWV	EL	
2.0 TFSI 162 kW (220 PS) CAED	05.2013→12.2015		7.03280.04.0	EUV-SR	EL	nur in Verbindung mit: Fahrzeug umgerüstet only in connection with: Fahrzeug umgerüstet
			7.22880.01.0	EUV-SR	EL	
			7.06117.26.0	ZM-NWV	EL	
2.0 TFSI Flexfuel quattro 155 kW (211 PS) CPMA	09.2012→12.2013		7.03280.04.0	EUV-SR	EL	
			7.02901.05.0	SUV	EL	
			7.06117.26.0	ZM-NWV	EL	
2.0 TFSI Flexfuel quattro 162 kW (220 PS) CPMB	05.2013→12.2015		7.03280.04.0	EUV-SR	EL	
			7.06117.26.0	ZM-NWV	EL	
2.0 TFSI flexible fuel 132 kW (180 PS) CFKA	11.2009→12.2015		7.03280.04.0	EUV-SR	EL	Baujahr ab: 01.2013 Construction year from: 01.2013
			7.22880.01.0	EUV-SR	EL	Fahrgestellnummer ab: 8K-8-000 001 Vehicle Identification Number from: 8K-8-000 001
			7.00470.07.0	LDRV	EL	ch. 8K-8-000 001→
			7.06117.26.0	ZM-NWV	EL	Fahrgestellnummer ab: 8K-8-000 001 Vehicle Identification Number from: 8K-8-000 001
2.0 TFSI flexible fuel quattro 132 kW (180 PS) CFKA	11.2009→12.2015		7.03280.04.0	EUV-SR	EL	Baujahr ab: 01.2013 Construction year from: 01.2013
			7.22880.01.0	EUV-SR	EL	Fahrgestellnummer ab: 8K-8-000 001 Vehicle Identification Number from: 8K-8-000 001
			7.00470.07.0	LDRV	EL	ch. 8K-8-000 001→
			7.06117.26.0	ZM-NWV	EL	Fahrgestellnummer ab: 8K-8-000 001 Vehicle Identification Number from: 8K-8-000 001
2.0 TFSI quattro 155-164 kW (211-223 PS) CAEB, CDNC	06.2008→12.2015		7.03280.04.0	EUV-SR	EL	CAEB, CDNC: nur in Verbindung mit: Fahrzeug umgerüstet only in connection with: Fahrzeug umgerüstet
			7.22880.01.0	EUV-SR	EL	CAEB, CDNC: Fahrgestellnummer ab: 8K-8-000 001 Vehicle Identification Number from: 8K-8-000 001
			7.00470.07.0	LDRV	EL	CAEB, CDNC: ch. 8K-8-000 001→







						A
A4 B8 (8K2)						30
			7.02901.05.0	SUV	EL	 CAEB, CDNC:  ch. 8K-8-000 001→ für OE-Nummer: 06H 145 702 R, 06H 145 710 C for OE number: 06H 145 702 R, 06H 145 710 C
			7.01830.13.0	SUV	EL	
			7.06117.26.0	ZM-NWV	EL	 CAEB, CDNC: Fahrgestellnummer ab: 8K-8-000 001 Vehicle Identification Number from: 8K-8-000 001
2.0 TFSI quattro 155 kW (211 PS) CPMA	06.2008→12.2015		7.03280.04.0	EUV-SR	EL	
			7.02901.05.0	SUV	EL	
			7.06117.26.0	ZM-NWV	EL	
2.0 TFSI quattro 132 kW (180 PS) CFKA	11.2009→03.2012		7.03280.04.0	EUV-SR	EL	
			7.22880.01.0	EUV-SR	EL	Fahrgestellnummer ab: 8K-8-000 001 Vehicle Identification Number from: 8K-8-000 001
			7.06117.26.0	ZM-NWV	EL	Fahrgestellnummer ab: 8K-8-000 001 Vehicle Identification Number from: 8K-8-000 001
2.0 TFSI quattro 165 kW (224 PS) CNCD	05.2013→12.2015		7.02256.18.0	EUV-SR	EP	Produktionsdatum ab: 26.05.2014 Production date from: 26.05.2014
			7.06117.26.0	ZM-NWV	EL	
2.0 TFSI quattro 162 kW (220 PS) CAED	05.2013→12.2015		7.03280.04.0	EUV-SR	EL	nur in Verbindung mit: Fahrzeug umgerüstet only in connection with: Fahrzeug umgerüstet
			7.22880.01.0	EUV-SR	EL	
			7.00470.07.0	LDRV	EL	
			7.06117.26.0	ZM-NWV	EL	
2.0 TFSI quattro 162 kW (220 PS) CPMB	05.2013→12.2015		7.03280.04.0	EUV-SR	EL	
			7.00470.07.0	LDRV	EL	
			7.06117.26.0	ZM-NWV	EL	
2.7 TDI 140 kW (190 PS) CAMA, CGKA	11.2007→03.2012		7.02256.00.0	EUV-AGR	EP	 CAMA, CGKA:  ch. 8K-8-000 001→
2.7 TDI 120 kW (163 PS) CAMB, CGKB	11.2007→03.2012		7.02256.00.0	EUV-AGR	EP	 CAMB, CGKB: Fahrgestellnummer ab: 8K-8-000 001 Vehicle Identification Number from: 8K-8-000 001
3.0 TDI 150 kW (204 PS) CLAB	11.2011→12.2015		7.02256.00.0	EUV-AGR	EP	
3.0 TDI quattro 176 kW (240 PS) CAPA, CCLA, CCWA	11.2007→03.2012		7.02256.00.0	EUV-AGR	EP	 CAPA, CCLA, CCWA:  ch. 8K-8-000 001→
3.0 TDI quattro 155 kW (211 PS) CCWB	06.2008→05.2010		7.02256.00.0	EUV-AGR	EP	 ch. 8K-8-000 001→
3.0 TDI quattro 180 kW (245 PS) CDUC, CKVB, CKVC	11.2011→12.2015		7.02256.00.0	EUV-AGR	EP	
3.0 TFSI quattro 200 kW (272 PS) CMUA	02.2012→12.2015		7.22880.01.0	EUV-SR	EL	
			7.28098.15.0	EUV-SR	EL	
			7.06117.47.0	SV-NWV	EH	mit Dichtring with O-ring
3.0 TFSI quattro 200 kW (272 PS) CRED	02.2012→12.2015		7.22880.01.0	EUV-SL	EL	
			7.22880.01.0	EUV-SR	EL	
			7.06117.47.0	SV-NWV	EH	mit Dichtring with O-ring

A







A4 B8 (8K2)

30























3.2 FSI 190-195 kW (258-265 PS) CALA	09.2008→03.2012		7.22880.01.0	EUV-SR	EL	Fahrgestellnummer ab: 8K-8-000 001 Vehicle Identification Number from: 8K-8-000 001
			7.06117.42.0	SV-NWV	EL	mit Dichtring with O-ring  ch. 8K-8-000 001→
3.2 FSI quattro 190-195 kW (258-265 PS) CALA	11.2007→03.2012		7.22880.01.0	EUV-SR	EL	Fahrgestellnummer ab: 8K-8-000 001 Vehicle Identification Number from: 8K-8-000 001
			7.06117.42.0	SV-NWV	EL	mit Dichtring with O-ring  ch. 8K-8-000 001→
S4 quattro 245 kW (333 PS) CAKA	11.2008→12.2015		7.22880.01.0	EUV-SR	EL	Fahrgestellnummer ab: 8K-8-000 001 Vehicle Identification Number from: 8K-8-000 001
			7.28098.15.0	EUV-SR	EL	Fahrgestellnummer ab: 8K-8-000 001 Vehicle Identification Number from: 8K-8-000 001
			7.06117.42.0	SV-NWV	EL	mit Dichtring with O-ring  ch. 8K-8-000 001→
S4 quattro 245 kW (333 PS) CCBA	11.2008→12.2015		7.06117.42.0	SV-NWV	EL	mit Dichtring with O-ring  ch. 8K-8-000 001→
S4 quattro 245-249 kW (333-339 PS) CGWC, CGXC	11.2008→12.2015		7.22880.01.0	EUV-SR	EL	
			7.28098.15.0	EUV-SR	EL	
			7.06117.47.0	SV-NWV	EH	mit Dichtring with O-ring
S4 quattro 245 kW (333 PS) CREC	11.2008→12.2015		7.22880.01.0	EUV-SL	EL	
			7.22880.01.0	EUV-SR	EL	
			7.06117.47.0	SV-NWV	EH	mit Dichtring with O-ring
S4 quattro 245 kW (333 PS) CTUB	11.2008→12.2015		7.28098.15.0	EUV-SR	EL	
			7.06117.47.0	SV-NWV	EH	mit Dichtring with O-ring

A4 B8 Avant (8K5)

31

1.8 TFSI 118 kW (160 PS) CABB	11.2007→03.2012		7.00470.07.0	LDRV	EL	 ch. 8K-8-000 001→
			7.00415.07.0	SUV	EL	Fahrgestellnummer ab: 8K-8-000 001 Vehicle Identification Number from: 8K-8-000 001
			7.01830.13.0	SUV	EL	
			7.06117.26.0	ZM-NWV	EL	Fahrgestellnummer ab: 8K-8-000 001 Vehicle Identification Number from: 8K-8-000 001
1.8 TFSI 118 kW (160 PS) CDHB	11.2007→03.2012		7.03280.04.0	EUV-SR	EL	Fahrgestellnummer ab: 8K-8-000 001 Vehicle Identification Number from: 8K-8-000 001 nur in Verbindung mit: Fahrzeug umgerüstet only in connection with: Fahrzeug umgerüstet
			7.22880.01.0	EUV-SR	EL	Fahrgestellnummer ab: 8K-8-000 001 Vehicle Identification Number from: 8K-8-000 001
			7.00470.07.0	LDRV	EL	 ch. 8K-8-000 001→
			7.01830.13.0	SUV	EL	

A4 B8 Avant (8K5)
31

























		7.06117.26.0	ZM-NWV	EL	Fahrgestellnummer ab: 8K-8-000 001 Vehicle Identification Number from: 8K-8-000 001
1.8 TFSI 88 kW (120 PS) CDHA	04.2008→12.2015		7.03280.04.0	EUV-SR	EL Fahrgestellnummer ab: 8K-8-000 001 Vehicle Identification Number from: 8K-8-000 001 nur in Verbindung mit: Fahrzeug umgerüstet only in connection with: Fahrzeug umgerüstet
			7.22880.01.0	EUV-SR	EL Fahrgestellnummer ab: 8K-8-000 001 Vehicle Identification Number from: 8K-8-000 001
			7.00470.07.0	LDRV	EL  ch. 8K-8-000 001→
			7.01830.13.0 7.06117.26.0	SUV ZM-NWV	EL EL Fahrgestellnummer ab: 8K-8-000 001 Vehicle Identification Number from: 8K-8-000 001
1.8 TFSI 125 kW (170 PS) CJEB	11.2011→12.2015		7.03280.04.0	EUV-SR	EL
			7.01830.13.0	SUV	EL
			7.02901.05.0	SUV	EL
			7.06117.26.0	ZM-NWV	EL
1.8 TFSI quattro 118 kW (160 PS) CDHB	09.2008→03.2012		7.03280.04.0	EUV-SR	EL Fahrgestellnummer ab: 8K-8-000 001 Vehicle Identification Number from: 8K-8-000 001 nur in Verbindung mit: Fahrzeug umgerüstet only in connection with: Fahrzeug umgerüstet
			7.22880.01.0	EUV-SR	EL Fahrgestellnummer ab: 8K-8-000 001 Vehicle Identification Number from: 8K-8-000 001
			7.00470.07.0	LDRV	EL  ch. 8K-8-000 001→
			7.01830.13.0 7.06117.26.0	SUV ZM-NWV	EL EL  ch. 8K-8-000 001→
1.8 TFSI quattro 125 kW (170 PS) CJEB	11.2011→12.2015		7.03280.04.0	EUV-SR	EL
			7.01830.13.0	SUV	EL
			7.02901.05.0	SUV	EL
			7.06117.26.0	ZM-NWV	EL
2.0 TDI 105 kW (143 PS) CAGA, CJCA, CMEA, CMFA	04.2008→12.2015		7.02256.00.0	EUV-AGR	EP  CAGA, CMEA:  ch. 8K-8-000 001→
			7.02256.00.0	EUV-KK	EP  CAGA, CMEA:  ch. 8K-8-000 001→ Produktionsdatum ab: 31.08.2009 Production date from: 31.08.2009
2.0 TDI 125 kW (170 PS) CAHA	04.2008→03.2012		7.02256.00.0	EUV-AGR	EP  ch. 8K-8-000 001→
			7.02256.00.0	EUV-KK	EP  ch. 8K-8-000 001→ Produktionsdatum ab: 31.08.2009 Production date from: 31.08.2009
2.0 TDI 100 kW (136 PS) CAGB, CJCB	04.2008→12.2015		7.02256.00.0	EUV-AGR	EP  CAGB, CJCB:  ch. 8K-8-000 001→
			7.02256.00.0	EUV-KK	EP  CAGB, CJCB:  ch. 8K-8-000 001→ Produktionsdatum ab: 31.08.2009 Production date from: 31.08.2009
2.0 TDI 88 kW (120 PS) CAGC, CJCC	06.2008→12.2015		7.02256.00.0	EUV-AGR	EP  ch. 8K-8-000 001→
			7.02256.00.0	EUV-KK	EP  ch. 8K-8-000 001→ Produktionsdatum ab: 31.08.2009 Production date from: 31.08.2009

A



A4 B8 Avant (8K5)

31

2.0 TDI 120 kW (163 PS) CAHB, CGLD	08.2008→12.2015	 7.02256.00.0	EUV-AGR	EP	 ch. 8K-8-000 001→
		7.02256.00.0	EUV-KK	EP	 ch. 8K-8-000 001→ Produktionsdatum ab: 31.08.2009 Production date from: 31.08.2009
2.0 TDI 130 kW (177 PS) CGLC	11.2011→12.2015	 7.02256.00.0	EUV-AGR	EP	
2.0 TDI 110 kW (150 PS) CJCD, CMFB	05.2013→12.2015	 7.02256.00.0	EUV-AGR	EP	
2.0 TDI quattro 105 kW (143 PS) CAGA, CJCA	04.2008→12.2015	 7.02256.00.0	EUV-AGR	EP	 ch. 8K-8-000 001→
		7.02256.00.0	EUV-KK	EP	 ch. 8K-8-000 001→ Produktionsdatum ab: 31.08.2009 Production date from: 31.08.2009
2.0 TDI quattro 125 kW (170 PS) CAHA	08.2008→03.2012	 7.02256.00.0	EUV-AGR	EP	 ch. 8K-8-000 001→
		7.02256.00.0	EUV-KK	EP	 ch. 8K-8-000 001→ Produktionsdatum ab: 31.08.2009 Production date from: 31.08.2009
2.0 TDI quattro 130 kW (177 PS) CGLC	11.2011→12.2015	 7.02256.00.0	EUV-AGR	EP	
2.0 TDI quattro 110 kW (150 PS) CJCD	05.2013→12.2015	 7.02256.00.0	EUV-AGR	EP	
2.0 TFSI 155-164 kW (211-223 PS) CAEB, CDNC	06.2008→05.2013	 7.03280.04.0	EUV-SR	EL	 CAEB, CDNC: nur in Verbindung mit: Fahrzeug umgerüstet only in connection with: Fahrzeug umgerüstet
		7.22880.01.0	EUV-SR	EL	 CAEB, CDNC: Fahrgestellnummer ab: 8K-8-000 001 Vehicle Identification Number from: 8K-8-000 001
		7.00470.07.0	LDRV	EL	 CAEB, CDNC:  ch. 8K-8-000 001→
		7.02901.05.0	SUV	EL	 CAEB, CDNC:  ch. 8K-8-000 001→ für OE-Nummer: 06H 145 702 R, 06H 145 710 C for OE number: 06H 145 702 R, 06H 145 710 C
		7.01830.13.0	SUV	EL	
		7.06117.26.0	ZM-NWV	EL	 CAEB, CDNC: Fahrgestellnummer ab: 8K-8-000 001 Vehicle Identification Number from: 8K-8-000 001
2.0 TFSI 132 kW (180 PS) CDNB	06.2008→12.2015	 7.03280.04.0	EUV-SR	EL	nur in Verbindung mit: Fahrzeug umgerüstet only in connection with: Fahrzeug umgerüstet
		7.22880.01.0	EUV-SR	EL	Fahrgestellnummer ab: 8K-8-000 001 Vehicle Identification Number from: 8K-8-000 001
		7.00470.07.0	LDRV	EL	 ch. 8K-8-000 001→
		7.02901.05.0	SUV	EL	 ch. 8K-8-000 001→ für OE-Nummer: 06H 145 702 R, 06H 145 710 C for OE number: 06H 145 702 R, 06H 145 710 C
		7.01830.13.0	SUV	EL	
		7.06117.26.0	ZM-NWV	EL	Fahrgestellnummer ab: 8K-8-000 001 Vehicle Identification Number from: 8K-8-000 001
2.0 TFSI 132 kW (180 PS) CFKA	06.2008→12.2015	 7.03280.04.0	EUV-SR	EL	Baujahr ab: 01.2013 Construction year from: 01.2013















						A
A4 B8 Avant (8K5)						31
			7.22880.01.0 7.00470.07.0 7.01830.13.0 7.06117.26.0	EUV-SR LDRV SUV ZM-NWV	EL EL ch. 8K-8-000 001→ EL EL Fahrgestellnummer ab: 8K-8-000 001 Vehicle Identification Number from: 8K-8-000 001	
2.0 TFSI 165 kW (224 PS) CNCD	05.2013→12.2015		7.02256.18.0 7.06117.26.0	EUV-SR ZM-NWV	EP EL	Produktionsdatum ab: 26.05.2014 Production date from: 26.05.2014
2.0 TFSI flexible fuel 132 kW (180 PS) CFKA	11.2009→12.2015		7.03280.04.0 7.22880.01.0 7.00470.07.0 7.06117.26.0	EUV-SR EUV-SR LDRV ZM-NWV	EL EL EL EL	Baujahr ab: 01.2013 Construction year from: 01.2013 Fahrgestellnummer ab: 8K-8-000 001 Vehicle Identification Number from: 8K-8-000 001 ch. 8K-8-000 001→ Fahrgestellnummer ab: 8K-8-000 001 Vehicle Identification Number from: 8K-8-000 001
2.0 TFSI flexible fuel quattro 132 kW (180 PS) CFKA	11.2009→12.2015		7.03280.04.0 7.22880.01.0 7.06117.26.0	EUV-SR EUV-SR ZM-NWV	EL EL EL	Baujahr ab: 01.2013 Construction year from: 01.2013 Fahrgestellnummer ab: 8K-8-000 001 Vehicle Identification Number from: 8K-8-000 001 Fahrgestellnummer ab: 8K-8-000 001 Vehicle Identification Number from: 8K-8-000 001
2.0 TFSI quattro 155-164 kW (211-223 PS) CAEB, CDNC	06.2008→12.2015		7.03280.04.0 7.22880.01.0 7.00470.07.0 7.02901.05.0 7.01830.13.0 7.06117.26.0	EUV-SR EUV-SR LDRV SUV SUV ZM-NWV	EL EL EL EL EL EL	CAEB, CDNC: nur in Verbindung mit: Fahrzeug umgerüstet only in connection with: Fahrzeug umgerüstet CAEB, CDNC: Fahrgestellnummer ab: 8K-8-000 001 Vehicle Identification Number from: 8K-8-000 001 CAEB, CDNC: ch. 8K-8-000 001→ CAEB, CDNC: ch. 8K-8-000 001→ für OE-Nummer: 06H 145 702 R, 06H 145 710 C for OE number: 06H 145 702 R, 06H 145 710 C CAEB, CDNC: Fahrgestellnummer ab: 8K-8-000 001 Vehicle Identification Number from: 8K-8-000 001
2.0 TFSI quattro 165 kW (224 PS) CNCD	05.2013→12.2015		7.02256.18.0 7.06117.26.0	EUV-SR ZM-NWV	EP EL	Produktionsdatum ab: 26.05.2014 Production date from: 26.05.2014
2.7 TDI 140 kW (190 PS) CAMA, CGKA	04.2008→03.2012		7.02256.00.0	EUV-AGR	EP	CAMA, CGKA: ch. 8K-8-000 001→
2.7 TDI 120 kW (163 PS) CAMB, CGKB	06.2008→03.2012		7.02256.00.0	EUV-AGR	EP	CAMB, CGKB: ch. 8K-8-000 001→
3.0 TDI 150 kW (204 PS) CLAB	11.2011→12.2015		7.02256.00.0	EUV-AGR	EP	
3.0 TDI quattro 176 kW (240 PS) CAPA, CCLA, CCWA	04.2008→03.2012		7.02256.00.0	EUV-AGR	EP	CAPA, CCLA, CCWA: ch. 8K-8-000 001→

A







A4 B8 Avant (8K5)

31







3.0 TDI quattro 155 kW (211 PS) CCWB	06.2008→05.2010	 7.02256.00.0	EUV-AGR	EP	 ch. 8K-8-000 001→
3.0 TDI quattro 180 kW (245 PS) CDUC, CKVB, CKVC	11.2011→12.2015	 7.02256.00.0	EUV-AGR	EP	
3.0 TFSI quattro 200 kW (272 PS) CMUA	02.2012→12.2015	 7.22880.01.0	EUV-SR	EL	
		7.28098.15.0	EUV-SR	EL	
		7.06117.47.0	SV-NWV	EH	mit Dichtring with O-ring
3.0 TFSI quattro 200 kW (272 PS) CRED	02.2012→12.2015	 7.22880.01.0	EUV-SL	EL	
		7.22880.01.0	EUV-SR	EL	
		7.06117.47.0	SV-NWV	EH	mit Dichtring with O-ring
3.2 FSI 190-195 kW (258-265 PS) CALA	09.2008→03.2012	 7.22880.01.0	EUV-SR	EL	Fahrgestellnummer ab: 8K-8-000 001 Vehicle Identification Number from: 8K-8-000 001
		7.06117.42.0	SV-NWV	EL	mit Dichtring with O-ring  ch. 8K-8-000 001→
3.2 FSI quattro 190-195 kW (258-265 PS) CALA	04.2008→03.2012	 7.22880.01.0	EUV-SR	EL	Fahrgestellnummer ab: 8K-8-000 001 Vehicle Identification Number from: 8K-8-000 001
		7.06117.42.0	SV-NWV	EL	mit Dichtring with O-ring  ch. 8K-8-000 001→
RS4 quattro 331 kW (450 PS) CFSA	05.2012→08.2015	 7.28098.04.0	EUV-AGK	EL	
		7.22880.01.0	EUV-SR	EL	
S4 quattro 245 kW (333 PS) CAKA	11.2008→12.2015	 7.22880.01.0	EUV-SR	EL	Fahrgestellnummer ab: 8K-8-000 001 Vehicle Identification Number from: 8K-8-000 001
		7.28098.15.0	EUV-SR	EL	Fahrgestellnummer ab: 8K-8-000 001 Vehicle Identification Number from: 8K-8-000 001
		7.06117.42.0	SV-NWV	EL	mit Dichtring with O-ring  ch. 8K-8-000 001→
S4 quattro 245 kW (333 PS) CCBA	11.2008→12.2015	 7.06117.42.0	SV-NWV	EL	mit Dichtring with O-ring  ch. 8K-8-000 001→
S4 quattro 245-249 kW (333-339 PS) CGWC, CGXC, CTUB	11.2008→12.2015	 7.22880.01.0	EUV-SR	EL	
		7.28098.15.0	EUV-SR	EL	
		7.06117.47.0	SV-NWV	EH	mit Dichtring with O-ring
S4 quattro 245 kW (333 PS) CREC	11.2008→12.2015	 7.06117.47.0	SV-NWV	EH	mit Dichtring with O-ring

A4 B9 (8W2, 8WC)

32

1.4 TFSI 110 kW (150 PS) CVNA	08.2015→11.2019	 7.06117.48.0	SV-NWV	EL	
2.0 TFSI 140 kW (190 PS) CVKB, DBPA	05.2015→	 7.02256.18.0	EUV-SR	EP	 CVKB: Produktionsdatum bis: 26.12.2016 Production date to: 26.12.2016
		7.02901.05.0	SUV	EL	 DBPA: Produktionsdatum bis: 01.02.2017 Production date to: 01.02.2017
2.0 TFSI 185 kW (252 PS) CYMC	05.2015→11.2019	 7.02901.05.0	SUV	EL	

A4 B9 (8W2, 8WC)
32





		7.06117.26.0	ZM-NWV	EL	
2.0 TFSI 185 kW (252 PS) CYRB	05.2015→11.2019	 7.02256.18.0	EUV-SR	EP	
		7.02901.05.0	SUV	EL	
		7.06117.26.0	ZM-NWV	EL	
2.0 TFSI 183 kW (249 PS) CYRC	11.2015→11.2019	 7.02256.18.0	EUV-SR	EP	
		7.02901.05.0	SUV	EL	
		7.06117.26.0	ZM-NWV	EL	
2.0 TFSI Mild Hybrid 183-185 kW (249-252 PS) DDWA	05.2017→11.2019	 7.02901.05.0	SUV	EL	
		7.06117.26.0	ZM-NWV	EL	
2.0 TFSI Mild Hybrid quattro 183-185 kW (249-252 PS) DDWA	05.2017→11.2019	 7.02901.05.0	SUV	EL	
		7.06117.26.0	ZM-NWV	EL	
		7.02901.05.0	SUV	EL	
2.0 TFSI quattro 185 kW (252 PS) CYMC	05.2015→	 7.02901.05.0	SUV	EL	
		7.06117.26.0	ZM-NWV	EL	
2.0 TFSI quattro 185 kW (252 PS) CYRB	05.2015→	 7.02256.18.0	EUV-SR	EP	
		7.02901.05.0	SUV	EL	
		7.06117.26.0	ZM-NWV	EL	
2.0 TFSI quattro 183 kW (249 PS) CYRC	11.2015→11.2019	 7.02256.18.0	EUV-SR	EP	
		7.02901.05.0	SUV	EL	
		7.06117.26.0	ZM-NWV	EL	
3.0 TDI 160 kW (218 PS) CSWB	09.2015→08.2018	 7.02256.00.0	EUV-AGR	EP	
		7.03280.04.0	EUV-AGR	EL	
3.0 TDI quattro 200 kW (272 PS) CRTC	05.2015→08.2018	 7.02256.00.0	EUV-AGR	EP	
		7.03280.04.0	EUV-AGR	EL	
3.0 TDI quattro 160 kW (218 PS) CSWB	09.2015→08.2018	 7.02256.00.0	EUV-AGR	EP	
		7.02901.05.0	SUV	EL	
35 TFSI Mild Hybrid 110 kW (150 PS) DLVB	12.2018→11.2019	 7.02901.05.0	SUV	EL	
		7.06117.26.0	ZM-NWV	EL	
40 TFSI Mild Hybrid 140 kW (190 PS) DEMA, DKYA	05.2017→11.2019	 7.02256.18.0	EUV-SR	EP	 DEMA, DKYA: Produktionsdatum bis: 26.12.2016 Production date to: 26.12.2016
		7.02901.05.0	SUV	EL	
		7.06117.26.0	ZM-NWV	EL	
40 TFSI Mild Hybrid 140 kW (190 PS) DLVA	05.2017→11.2019	 7.02901.05.0	SUV	EL	
		7.06117.26.0	ZM-NWV	EL	
45 TDI quattro 170 kW (231 PS) DCPE	07.2018→11.2019	 7.02256.00.0	EUV-AGR	EP	
		7.03280.04.0	EUV-AGR	EL	
45 TFSI Mild Hybrid 180 kW (245 PS) DKNA	07.2018→11.2019	 7.02901.05.0	SUV	EL	
		7.06117.26.0	ZM-NWV	EL	

A

















A4 B9 (8W2, 8WC)

32









45 TFSI Mild Hybrid quattro 180 kW (245 PS) DKNA	07.2018→11.2019		7.06117.26.0	ZM-NWV	EL	
45 TFSI Mild Hybrid quattro 183-185 kW (249-252 PS) DDWA	02.2020→		7.06117.26.0	ZM-NWV	EL	
50 TDI quattro 210 kW (286 PS) DCPC	07.2018→11.2019		7.02256.00.0	EUV-AGR	EP	
			7.03280.04.0	EUV-AGR	EL	
S4 quattro 260 kW (354 PS) CWGD	05.2016→11.2019		7.22880.01.0	EUV-SR	EL	

A4 B9 Avant (8W5, 8WD)







33

1.4 TFSI 110 kW (150 PS) CVNA	02.2016→10.2019		7.06117.48.0	SV-NWV	EL	
2.0 TFSI 140 kW (190 PS) CVKB	08.2015→		7.02256.18.0	EUV-SR	EP	Produktionsdatum bis: 26.12.2016 Production date to: 26.12.2016
			7.02901.05.0	SUV	EL	
			7.06117.26.0	ZM-NWV	EL	
2.0 TFSI 185 kW (252 PS) CYRB	05.2016→10.2019		7.02256.18.0	EUV-SR	EP	
			7.02901.05.0	SUV	EL	
			7.06117.26.0	ZM-NWV	EL	
2.0 TFSI 183 kW (249 PS) CYRC	05.2016→10.2019		7.02256.18.0	EUV-SR	EP	
			7.02901.05.0	SUV	EL	
			7.06117.26.0	ZM-NWV	EL	
2.0 TFSI Mild Hybrid 183-185 kW (249-252 PS) DDWA	05.2017→10.2019		7.02901.05.0	SUV	EL	
			7.06117.26.0	ZM-NWV	EL	
2.0 TFSI Mild Hybrid quattro 183-185 kW (249-252 PS) DDWA	11.2018→		7.02901.05.0	SUV	EL	
			7.06117.26.0	ZM-NWV	EL	
2.0 TFSI g-tron 125 kW (170 PS) CVLA	11.2016→10.2019		7.02901.05.0	SUV	EL	
			7.06117.26.0	ZM-NWV	EL	
2.0 TFSI quattro 185 kW (252 PS) CYRB	08.2015→10.2019		7.02256.18.0	EUV-SR	EP	
			7.02901.05.0	SUV	EL	
			7.06117.26.0	ZM-NWV	EL	
2.0 TFSI quattro 183 kW (249 PS) CYRC	11.2015→10.2019		7.02256.18.0	EUV-SR	EP	
			7.02901.05.0	SUV	EL	
			7.06117.26.0	ZM-NWV	EL	
3.0 TDI 160 kW (218 PS) CSWB	10.2015→08.2018		7.02256.00.0	EUV-AGR	EP	
3.0 TDI quattro 200 kW (272 PS) CRTC	08.2015→08.2018		7.02256.00.0	EUV-AGR	EP	
3.0 TDI quattro 160 kW (218 PS) CSWB	11.2015→08.2018		7.02256.00.0	EUV-AGR	EP	
35 TFSI Mild Hybrid 110 kW (150 PS) DLVB	12.2018→10.2019		7.02901.05.0	SUV	EL	
			7.06117.26.0	ZM-NWV	EL	
40 TFSI Mild Hybrid 140 kW (190 PS) DEMA, DKYA	05.2017→10.2019		7.02256.18.0	EUV-SR	EP	 DEMA, DKYA: Produktionsdatum bis: 26.12.2016 Production date to: 26.12.2016

A4 B9 Avant (8W5, 8WD)
33

			7.02901.05.0	SUV	EL	
			7.06117.26.0	ZM-NWV	EL	
40 TFSI Mild Hybrid 140 kW (190 PS) DLVA	05.2017→10.2019		7.02901.05.0	SUV	EL	
			7.06117.26.0	ZM-NWV	EL	
40 TFSI g-tron 125 kW (170 PS) CVLA	11.2016→10.2019		7.02901.05.0	SUV	EL	
			7.06117.26.0	ZM-NWV	EL	
45 TDI quattro 170 kW (231 PS) DCPE	07.2018→10.2019		7.02256.00.0	EUV-AGR	EP	
			7.03280.04.0	EUV-AGR	EL	
45 TFSI Mild Hybrid 180 kW (245 PS) DKNA	07.2018→10.2019		7.02901.05.0	SUV	EL	
			7.06117.26.0	ZM-NWV	EL	
45 TFSI Mild Hybrid quattro 180 kW (245 PS) DKNA	07.2018→10.2019		7.06117.26.0	ZM-NWV	EL	
45 TFSI Mild Hybrid quattro 183-185 kW (249-252 PS) DDWA	02.2020→		7.06117.26.0	ZM-NWV	EL	
50 TDI quattro 210 kW (286 PS) DCPC	07.2018→10.2019		7.02256.00.0	EUV-AGR	EP	
			7.03280.04.0	EUV-AGR	EL	
S4 quattro 260 kW (354 PS) CWGD	05.2016→10.2019		7.22880.01.0	EUV-SR	EL	

A5 (8T3)
34

1.8 TFSI 125 kW (170 PS) CABD	10.2007→07.2011		7.00470.07.0	LDRV	EL	
			7.00415.07.0	SUV	EL	
			7.01830.13.0	SUV	EL	
			7.06117.26.0	ZM-NWV	EL	
1.8 TFSI 118 kW (160 PS) CDHB	05.2009→09.2011		7.03280.04.0	EUV-SR	EL	nur in Verbindung mit: Fahrzeug umgerüstet only in connection with: Fahrzeug umgerüstet
			7.22880.01.0	EUV-SR	EL	
			7.00470.07.0	LDRV	EL	
			7.01830.13.0	SUV	EL	
			7.06117.26.0	ZM-NWV	EL	
1.8 TFSI 125 kW (170 PS) CJEB	08.2011→01.2017		7.03280.04.0	EUV-SR	EL	
			7.02901.05.0	SUV	EL	
			7.06117.26.0	ZM-NWV	EL	
1.8 TFSI 130 kW (177 PS) CJEE	05.2015→01.2017		7.03280.04.0	EUV-SR	EL	
			7.06117.26.0	ZM-NWV	EL	
2.0 TDI 125 kW (170 PS) CAHA	08.2008→03.2012		7.02256.00.0	EUV-AGR	EP	
			7.02256.00.0	EUV-KK	EP	für Fahrzeuge ohne Standheizung for vehicles without parking heater Produktionsdatum ab: 31.08.2009 Production date from: 31.08.2009
2.0 TDI 120 kW (163 PS) CAHB, CGLD	08.2008→01.2017		7.02256.00.0	EUV-AGR	EP	

























A



A5 (8T3)

34

			7.02256.00.0	EUV-KK	EP	für Fahrzeuge ohne Standheizung for vehicles without parking heater Produktionsdatum ab: 31.08.2009 Production date from: 31.08.2009
2.0 TDI 130 kW (177 PS) CGLC	10.2011→01.2017		7.02256.00.0	EUV-AGR	EP	
2.0 TDI quattro 125 kW (170 PS) CAHA	08.2008→03.2012		7.02256.00.0	EUV-AGR	EP	
			7.02256.00.0	EUV-KK	EP	für Fahrzeuge ohne Standheizung for vehicles without parking heater Produktionsdatum ab: 31.08.2009 Production date from: 31.08.2009
2.0 TDI quattro 130 kW (177 PS) CGLC	12.2011→01.2017		7.02256.00.0	EUV-AGR	EP	
2.0 TFSI 155 kW (211 PS) CDNC	06.2008→11.2013		7.03280.04.0	EUV-SR	EL	nur in Verbindung mit: Fahrzeug umgerüstet only in connection with: Fahrzeug umgerüstet
			7.22880.01.0	EUV-SR	EL	
			7.00470.07.0	LDRV	EL	
			7.01830.13.0	SUV	EL	
			7.02901.05.0	SUV	EL	
			7.06117.26.0	ZM-NWV	EL	
2.0 TFSI 132 kW (180 PS) CDNB	11.2008→03.2012		7.03280.04.0	EUV-SR	EL	nur in Verbindung mit: Fahrzeug umgerüstet only in connection with: Fahrzeug umgerüstet
			7.22880.01.0	EUV-SR	EL	
			7.00470.07.0	LDRV	EL	
			7.01830.13.0	SUV	EL	
			7.02901.05.0	SUV	EL	PKW, Coupe/ Passenger car, coupé
			7.06117.26.0	ZM-NWV	EL	
2.0 TFSI 165 kW (224 PS) CNCD	05.2013→05.2016		7.06117.26.0	ZM-NWV	EL	
2.0 TFSI 169 kW (230 PS) CNCE	08.2015→01.2017		7.06117.26.0	ZM-NWV	EL	
2.0 TFSI Flexfuel quattro 162 kW (220 PS) CPMB	03.2012→01.2017		7.03280.04.0	EUV-SR	EL	
			7.00470.07.0	LDRV	EL	
			7.06117.26.0	ZM-NWV	EL	
2.0 TFSI Flexfuel quattro 155 kW (211 PS) CPMA	01.2013→12.2013		7.03280.04.0	EUV-SR	EL	
			7.00470.07.0	LDRV	EL	
			7.06117.26.0	ZM-NWV	EL	
2.0 TFSI quattro 155-164 kW (211-223 PS) CAEB, CDNC	06.2008→01.2017		7.03280.04.0	EUV-SR	EL	CAEB, CDNC: nur in Verbindung mit: Fahrzeug umgerüstet only in connection with: Fahrzeug umgerüstet
			7.22880.01.0	EUV-SR	EL	
			7.00470.07.0	LDRV	EL	
			7.01830.13.0	SUV	EL	
			7.02901.05.0	SUV	EL	
			7.06117.26.0	ZM-NWV	EL	
2.0 TFSI quattro 155 kW (211 PS) CPMA	06.2008→01.2017		7.03280.04.0	EUV-SR	EL	
			7.00470.07.0	LDRV	EL	01.2012→
			7.01830.13.0	SUV	EL	
			7.02901.05.0	SUV	EL	

						
A5 (8T3)						34
2.0 TFSI quattro 162 kW (220 PS) CAED	03.2012→01.2017		7.06117.26.0	ZM-NWV	EL	nur in Verbindung mit: Fahrzeug umgerüstet only in connection with: Fahrzeug umgerüstet
			7.03280.04.0	EUV-SR	EL	
			7.22880.01.0	EUV-SR	EL	
			7.00470.07.0	LDRV	EL	
2.0 TFSI quattro 162 kW (220 PS) CPMB	03.2012→01.2017		7.06117.26.0	ZM-NWV	EL	
			7.03280.04.0	EUV-SR	EL	
			7.00470.07.0	LDRV	EL	
2.0 TFSI quattro 165 kW (224 PS) CNCD	05.2013→05.2016		7.06117.26.0	ZM-NWV	EL	
			7.03280.04.0	EUV-SR	EL	
2.0 TFSI quattro 169 kW (230 PS) CNCE	08.2015→01.2017		7.06117.26.0	ZM-NWV	EL	
2.7 TDI 140 kW (190 PS) CAMA, CGKA	06.2007→03.2012		7.02256.00.0	EUV-AGR	EP	
2.7 TDI 120 kW (163 PS) CAMB, CGKB	09.2007→03.2012		7.02256.00.0	EUV-AGR	EP	
3.0 TDI 150 kW (204 PS) CLAB	10.2011→01.2017		7.02256.00.0	EUV-AGR	EP	
3.0 TDI quattro 176 kW (240 PS) CAPA, CCWA	06.2007→03.2012		7.02256.00.0	EUV-AGR	EP	
3.0 TDI quattro 155 kW (211 PS) CCWB	03.2008→05.2010		7.02256.00.0	EUV-AGR	EP	
3.0 TDI quattro 180 kW (245 PS) CDUC, CKVB, CKVC	10.2011→01.2017		7.02256.00.0	EUV-AGR	EP	
3.0 TDI quattro 160 kW (218 PS) CKVD	05.2015→01.2017		7.02256.00.0	EUV-AGR	EP	
3.0 TFSI quattro 200 kW (272 PS) CHMB	12.2011→01.2017		7.28098.15.0	EUV-SR	EL	mit Dichtring with O-ring
			7.06117.47.0	SV-NWV	EH	
3.0 TFSI quattro 200 kW (272 PS) CMUA	12.2011→01.2017		7.22880.01.0	EUV-SL	EL	mit Dichtring with O-ring
			7.28098.15.0	EUV-SR	EL	
			7.06117.47.0	SV-NWV	EH	
3.0 TFSI quattro 200 kW (272 PS) CRED	12.2011→01.2017		7.22880.01.0	EUV-SL	EL	mit Dichtring with O-ring
			7.22880.01.0	EUV-SR	EL	
			7.06117.47.0	SV-NWV	EH	
3.2 FSI 190-195 kW (258-265 PS) CALA	06.2007→03.2012		7.22880.01.0	EUV-SR	EL	mit Dichtring with O-ring
			7.06117.42.0	SV-NWV	EL	
3.2 FSI quattro 190-195 kW (258-265 PS) CALA	06.2007→03.2012		7.22880.01.0	EUV-SR	EL	mit Dichtring with O-ring
			7.06117.42.0	SV-NWV	EL	
RS5 quattro 331 kW (450 PS) CFSA	03.2010→01.2017		7.28098.04.0	EUV-AGK	EL	
			7.22880.01.0	EUV-SR	EL	
S5 quattro 253-260 kW (344-354 PS) CAUA	06.2007→03.2012		7.22880.01.0	EUV-SR	EL	11.2008→, PKW, Coupe/ Passenger car, coupé

A











A5 (8T3)























34

S5 quattro 245 kW (333 PS) CAKA	10.2011→01.2017		7.22880.01.0	EUV-SL	EL	mit Dichtring with O-ring
			7.28098.15.0	EUV-SR	EL	
			7.06117.42.0	SV-NWV	EL	
S5 quattro 245 kW (333 PS) CGWC	10.2011→01.2017		7.22880.01.0	EUV-SL	EL	mit Dichtring with O-ring
			7.28098.15.0	EUV-SR	EL	
			7.06117.42.0	SV-NWV	EL	
S5 quattro 245-249 kW (333-339 PS) CGXC	10.2011→01.2017		7.22880.01.0	EUV-SL	EL	mit Dichtring with O-ring
			7.28098.15.0	EUV-SR	EL	
			7.06117.47.0	SV-NWV	EH	
S5 quattro 245 kW (333 PS) CREC, CTDA	10.2011→01.2017		7.22880.01.0	EUV-SL	EL	mit Dichtring with O-ring
			7.22880.01.0	EUV-SR	EL	
			7.06117.47.0	SV-NWV	EH	
S5 quattro 245 kW (333 PS) CTUB	10.2011→01.2017		7.28098.15.0	EUV-SR	EL	mit Dichtring with O-ring
			7.06117.47.0	SV-NWV	EH	
S5 quattro 245-249 kW (333-339 PS) CGXC	01.2013→01.2017		7.28098.15.0	EUV-SR	EL	

A5 (F53, F5P)

35

1.4 TFSI 110 kW (150 PS) CVNA	11.2016→02.2020		7.06117.48.0	SV-NWV	EL	
2.0 TFSI 140 kW (190 PS) CVKB	09.2016→		7.02256.18.0	EUV-SR	EP	Produktionsdatum bis: 26.12.2016 Production date to: 26.12.2016
			7.02901.05.0	SUV	EL	
			7.06117.26.0	ZM-NWV	EL	
2.0 TFSI 185 kW (252 PS) CYRB	11.2016→02.2020		7.02256.18.0	EUV-SR	EP	
			7.02901.05.0	SUV	EL	
			7.06117.26.0	ZM-NWV	EL	
2.0 TFSI Mild Hybrid 183-185 kW (249-252 PS) DDWA	05.2017→02.2020		7.02901.05.0	SUV	EL	
			7.06117.26.0	ZM-NWV	EL	
2.0 TFSI Mild Hybrid quattro 183-185 kW (249-252 PS) DDWA, DLHB	05.2017→02.2020		7.02901.05.0	SUV	EL	
			7.06117.26.0	ZM-NWV	EL	
			7.06117.26.0	ZM-NWV	EL	
2.0 TFSI quattro 185 kW (252 PS) CYMC	06.2016→		7.02901.05.0	SUV	EL	
			7.06117.26.0	ZM-NWV	EL	
2.0 TFSI quattro 185 kW (252 PS) CYRB	06.2016→		7.02256.18.0	EUV-SR	EP	
			7.02901.05.0	SUV	EL	
			7.06117.26.0	ZM-NWV	EL	
			7.06117.26.0	ZM-NWV	EL	
2.0 TFSI quattro 183 kW (249 PS) CYRC	06.2016→02.2020		7.02256.18.0	EUV-SR	EP	
			7.06117.26.0	ZM-NWV	EL	











						
A5 (F53, F5P)						35
2.0 TFSI quattro 185 kW (252 PS) DLHB	11.2019→		7.06117.26.0	ZM-NWV	EL	
3.0 TDI 160 kW (218 PS) CSWB	11.2016→08.2018		7.02256.00.0	EUV-AGR	EP	
			7.03280.04.0	EUV-AGR	EL	
3.0 TDI quattro 160 kW (218 PS) CSWB	07.2016→08.2018		7.02256.00.0	EUV-AGR	EP	
			7.03280.04.0	EUV-AGR	EL	
3.0 TDI quattro 210 kW (286 PS) DCPC	01.2017→02.2020		7.02256.00.0	EUV-AGR	EP	
			7.03280.04.0	EUV-AGR	EL	
3.0 TDI quattro 200 kW (272 PS) CRTC	02.2017→12.2017		7.02256.00.0	EUV-AGR	EP	
			7.03280.04.0	EUV-AGR	EL	
35 TFSI Mild Hybrid 110 kW (150 PS) DLVB	02.2019→02.2020		7.06117.26.0	ZM-NWV	EL	
40 TFSI Mild Hybrid 140 kW (190 PS) DEMA, DHDA, DKYA, DLVA	05.2017→		7.02901.05.0	SUV	EL	
			7.06117.26.0	ZM-NWV	EL	
45 TDI quattro 170 kW (231 PS) DCPE	07.2018→02.2020		7.02256.00.0	EUV-AGR	EP	
			7.03280.04.0	EUV-AGR	EL	
45 TFSI Mild Hybrid 180 kW (245 PS) DKNA	07.2018→02.2020		7.02901.05.0	SUV	EL	
			7.06117.26.0	ZM-NWV	EL	
45 TFSI Mild Hybrid quattro 180 kW (245 PS) DKNA	07.2018→02.2020		7.06117.26.0	ZM-NWV	EL	
50 TDI quattro 210 kW (286 PS) DCPC	01.2017→02.2020		7.02256.00.0	EUV-AGR	EP	
			7.03280.04.0	EUV-AGR	EL	
RS5 quattro 331 kW (450 PS) DECA	04.2017→		7.22880.01.0	EUV-SR	EL	Produktionsdatum bis: 17.08.2020 Production date to: 17.08.2020
S5 quattro 260 kW (354 PS) CWGD	07.2016→		7.22880.01.0	EUV-SR	EL	Produktionsdatum bis: 27.07.2020 Production date to: 27.07.2020
A5 Convertible (8F7)						36
1.8 TFSI 118 kW (160 PS) CDHB	09.2009→03.2012		7.03280.04.0	EUV-SR	EL	nur in Verbindung mit: Fahrzeug umgerüstet only in connection with: Fahrzeug umgerüstet
			7.22880.01.0	EUV-SR	EL	
			7.00470.07.0	LDRV	EL	
			7.01830.13.0	SUV	EL	
			7.06117.26.0	ZM-NWV	EL	
1.8 TFSI 125 kW (170 PS) CJEB	09.2011→03.2016		7.03280.04.0	EUV-SR	EL	
			7.02901.05.0	SUV	EL	
			7.06117.26.0	ZM-NWV	EL	
1.8 TFSI 130 kW (177 PS) CJEE	05.2015→01.2017		7.03280.04.0	EUV-SR	EL	
			7.06117.26.0	ZM-NWV	EL	
2.0 TDI 125 kW (170 PS) CAHA	05.2009→03.2012		7.02256.00.0	EUV-AGR	EP	























A



A5 Convertible (8F7)

36

			7.02256.00.0	EUV-KK	EP	für Fahrzeuge ohne Standheizung for vehicles without parking heater Produktionsdatum ab: 31.08.2009 Production date from: 31.08.2009
2.0 TDI 120 kW (163 PS) CAHB, CGLD	05.2009→06.2014		7.02256.00.0	EUV-AGR	EP	für Fahrzeuge ohne Standheizung for vehicles without parking heater Produktionsdatum ab: 31.08.2009 Production date from: 31.08.2009
			7.02256.00.0	EUV-KK	EP	
2.0 TDI 130 kW (177 PS) CGLC	10.2011→01.2017		7.02256.00.0	EUV-AGR	EP	
2.0 TDI 105 kW (143 PS) CJCA	10.2011→05.2015		7.02256.00.0	EUV-AGR	EP	
2.0 TDI 110 kW (150 PS) CJCD	05.2013→01.2017		7.02256.00.0	EUV-AGR	EP	
2.0 TDI quattro 130 kW (177 PS) CGLC	01.2012→05.2015		7.02256.00.0	EUV-AGR	EP	
2.0 TFSI 132 kW (180 PS) CAEA	03.2009→03.2012		7.03280.04.0	EUV-SR	EL	nur in Verbindung mit: Fahrzeug umgerüstet only in connection with: Fahrzeug umgerüstet
			7.22880.01.0	EUV-SR	EL	PKW, Cabriolet/ Passenger car, cabriolet
			7.00470.07.0	LDRV	EL	
			7.01830.13.0	SUV	EL	
			7.06117.26.0	ZM-NWV	EL	
2.0 TFSI 132 kW (180 PS) CDNB	03.2009→03.2012		7.03280.04.0	EUV-SR	EL	nur in Verbindung mit: Fahrzeug umgerüstet only in connection with: Fahrzeug umgerüstet
			7.22880.01.0	EUV-SR	EL	PKW, Coupe/ Passenger car, coupé
			7.00470.07.0	LDRV	EL	
			7.01830.13.0	SUV	EL	
			7.02901.05.0	SUV	EL	
			7.06117.26.0	ZM-NWV	EL	
2.0 TFSI 155-164 kW (211-223 PS) CAEB, CDNC	03.2009→06.2014		7.03280.04.0	EUV-KK	EL	nur in Verbindung mit: Fahrzeug umgerüstet only in connection with: Fahrzeug umgerüstet
			7.03280.04.0	EUV-SR	EL	nur in Verbindung mit: Fahrzeug umgerüstet only in connection with: Fahrzeug umgerüstet
			7.22880.01.0	EUV-SR	EL	PKW, Coupe/ Passenger car, coupé
			7.00470.07.0	LDRV	EL	
			7.01830.13.0	SUV	EL	
			7.02901.05.0	SUV	EL	
			7.06117.26.0	ZM-NWV	EL	
			7.06117.26.0	ZM-NWV	EL	
2.0 TFSI 165 kW (224 PS) CNCD	05.2013→05.2016		7.06117.26.0	ZM-NWV	EL	
2.0 TFSI 162 kW (220 PS) CAED	05.2013→12.2014		7.03280.04.0	EUV-SR	EL	nur in Verbindung mit: Fahrzeug umgerüstet only in connection with: Fahrzeug umgerüstet
			7.22880.01.0	EUV-SR	EL	PKW, Coupe/ Passenger car, coupé
			7.00470.07.0	LDRV	EL	
			7.06117.26.0	ZM-NWV	EL	
2.0 TFSI 169 kW (230 PS) CNCE	08.2015→01.2017		7.06117.26.0	ZM-NWV	EL	

						
A5 Convertible (8F7)						36
2.0 TFSI Flexfuel quattro 162 kW (220 PS) CPMB	03.2012→01.2017		7.03280.04.0	EUV-SR	EL	
			7.00470.07.0 7.06117.26.0	LDRV ZM-NWV	EL EL	
2.0 TFSI Flexfuel quattro 155 kW (211 PS) CPMA	01.2013→12.2013		7.03280.04.0	EUV-SR	EL	
			7.00470.07.0 7.06117.26.0	LDRV ZM-NWV	EL EL	
2.0 TFSI quattro 155-164 kW (211-223 PS) CAEB, CDNC	03.2009→01.2017		7.03280.04.0	EUV-SR	EL	 CAEB, CDNC: nur in Verbindung mit Fahrzeug umgerüstet only in connection with: Fahrzeug umgerüstet
			7.22880.01.0	EUV-SR	EL	
			7.00470.07.0	LDRV	EL	
			7.01830.13.0	SUV	EL	
			7.02901.05.0 7.06117.26.0	SUV ZM-NWV	EL EL	
2.0 TFSI quattro 155 kW (211 PS) CPMA	03.2009→01.2017		7.03280.04.0	EUV-SR	EL	01.2012→
			7.00470.07.0	LDRV	EL	
			7.02901.05.0 7.06117.26.0	SUV ZM-NWV	EL EL	
2.0 TFSI quattro 162 kW (220 PS) CPMB	03.2012→01.2017		7.03280.04.0	EUV-SR	EL	
			7.00470.07.0 7.06117.26.0	LDRV ZM-NWV	EL EL	
2.0 TFSI quattro 165 kW (224 PS) CNCD	05.2013→05.2016		7.06117.26.0	ZM-NWV	EL	
2.0 TFSI quattro 162 kW (220 PS) CAED	09.2013→01.2017		7.03280.04.0	EUV-SR	EL	nur in Verbindung mit: Fahrzeug umgerüstet only in connection with: Fahrzeug umgerüstet
			7.22880.01.0	EUV-SR	EL	
			7.00470.07.0 7.06117.26.0	LDRV ZM-NWV	EL EL	
2.0 TFSI quattro 169 kW (230 PS) CNCE	08.2015→01.2017		7.06117.26.0	ZM-NWV	EL	
2.7 TDI 140 kW (190 PS) CGKA	03.2009→03.2012		7.02256.00.0	EUV-AGR	EP	
2.7 TDI 120 kW (163 PS) CGKB	05.2009→03.2012		7.02256.00.0	EUV-AGR	EP	
3.0 TDI 150 kW (204 PS) CLAB	10.2011→01.2017		7.02256.00.0	EUV-AGR	EP	
3.0 TDI quattro 176 kW (240 PS) CCWA	03.2009→03.2012		7.02256.00.0	EUV-AGR	EP	
3.0 TDI quattro 180 kW (245 PS) CDUC, CKVC	10.2011→01.2017		7.02256.00.0	EUV-AGR	EP	
3.0 TDI quattro 160 kW (218 PS) CKVD	05.2015→01.2017		7.02256.00.0	EUV-AGR	EP	
3.0 TFSI quattro 200 kW (272 PS) CMUA	11.2011→01.2017		7.22880.01.0	EUV-SL	EL	mit Dichtring with O-ring
			7.28098.15.0	EUV-SR	EL	
			7.06117.47.0	SV-NWV	EH	
3.0 TFSI quattro 200 kW (272 PS) CRED	11.2011→01.2017		7.22880.01.0	EUV-SL	EL	
			7.22880.01.0	EUV-SR	EL	

A



A5 Convertible (8F7)

36

			7.06117.47.0	SV-NWV	EH	mit Dichtring with O-ring
3.2 FSI 190-195 kW (258-265 PS) CALA	03.2009→03.2012		7.22880.01.0	EUV-SR	EL	
			7.06117.42.0	SV-NWV	EL	mit Dichtring with O-ring
3.2 FSI quattro 190-195 kW (258-265 PS) CALA	03.2009→03.2012		7.22880.01.0	EUV-SR	EL	
			7.06117.42.0	SV-NWV	EL	mit Dichtring with O-ring
RS5 quattro 331 kW (450 PS) CFSA	11.2012→08.2015		7.28098.04.0	EUV-AGK	EL	
			7.22880.01.0	EUV-SR	EL	
S5 quattro 245 kW (333 PS) CAKA, CCBA	06.2009→01.2017		7.22880.01.0	EUV-SL	EL	PKW, Cabriolet/ Passenger car, cabriolet
			7.28098.15.0	EUV-SR	EL	PKW, Cabriolet/ Passenger car, cabriolet
			7.06117.42.0	SV-NWV	EL	mit Dichtring with O-ring
S5 quattro 245-249 kW (333-339 PS) CGWC, CGXC	06.2009→01.2017		7.22880.01.0	EUV-SL	EL	
			7.28098.15.0	EUV-SR	EL	
			7.06117.47.0	SV-NWV	EH	mit Dichtring with O-ring
S5 quattro 245 kW (333 PS) CREC, CTDA	06.2009→01.2017		7.22880.01.0	EUV-SL	EL	
			7.22880.01.0	EUV-SR	EL	
			7.06117.47.0	SV-NWV	EH	mit Dichtring with O-ring
S5 quattro 245 kW (333 PS) CTUB	06.2009→01.2017		7.28098.15.0	EUV-SR	EL	
			7.06117.47.0	SV-NWV	EH	mit Dichtring with O-ring

A5 Convertible (F57, F5E)

37

2.0 TFSI 185 kW (252 PS) CYRB	03.2017→12.2019		7.02256.18.0	EUV-SR	EP	Fahrgestellnummer ab: F5-H-000 001 Vehicle Identification Number from: F5-H-000 001
			7.02901.05.0	SUV	EL	
			7.06117.26.0	ZM-NWV	EL	Fahrgestellnummer ab: F5-H-000 001 Vehicle Identification Number from: F5-H-000 001
2.0 TFSI 140 kW (190 PS) CVKB	03.2017→12.2019		7.02901.05.0	SUV	EL	
			7.06117.26.0	ZM-NWV	EL	ch. F5-H-000 001→
2.0 TFSI Mild Hybrid 183-185 kW (249-252 PS) DDWA	05.2017→12.2019		7.02901.05.0	SUV	EL	
			7.06117.26.0	ZM-NWV	EL	
2.0 TFSI Mild Hybrid quattro 183-185 kW (249-252 PS) DDWA	05.2017→12.2019		7.02901.05.0	SUV	EL	
			7.06117.26.0	ZM-NWV	EL	
2.0 TFSI Mild Hybrid quattro 185 kW (252 PS) DLHB	05.2017→12.2019		7.02901.05.0	SUV	EL	
			7.06117.26.0	ZM-NWV	EL	
2.0 TFSI quattro 185 kW (252 PS) CYMC, DLHB	11.2016→12.2019		7.06117.26.0	ZM-NWV	EL	CYMC, DLHB: Fahrgestellnummer ab: F5-H-000 001 Vehicle Identification Number from: F5-H-000 001

A5 Convertible (F57, F5E) 37

2.0 TFSI quattro 185 kW (252 PS) CYRB	11.2016→12.2019	7.02256.18.0	EUV-SR	EP	Fahrgestellnummer ab: F5-H-000 001 Vehicle Identification Number from: F5-H-000 001
		7.06117.26.0	ZM-NWV	EL	Fahrgestellnummer ab: F5-H-000 001 Vehicle Identification Number from: F5-H-000 001
3.0 TDI 160 kW (218 PS) CSWB	03.2017→08.2018	7.02256.00.0	EUV-AGR	EP	ch. F5-H-000 001→
3.0 TDI quattro 210 kW (286 PS) DCPC	11.2016→12.2019	7.02256.00.0	EUV-AGR	EP	ch. F5-H-000 001→
3.0 TDI quattro 160 kW (218 PS) CSWB	12.2016→08.2018	7.02256.00.0	EUV-AGR	EP	ch. F5-H-000 001→
40 TFSI Mild Hybrid 140 kW (190 PS) DEMA, DKYA, DLVA	05.2017→	7.02901.05.0	SUV	EL	
		7.06117.26.0	ZM-NWV	EL	DEMA, DKYA, DLVA: Fahrgestellnummer ab: F5-H-000 001 Vehicle Identification Number from: F5-H-000 001
45 TFSI Mild Hybrid 180 kW (245 PS) DKNA	07.2018→12.2019	7.02901.05.0	SUV	EL	
		7.06117.26.0	ZM-NWV	EL	
45 TFSI Mild Hybrid quattro 180 kW (245 PS) DKNA	07.2018→12.2019	7.06117.26.0	ZM-NWV	EL	
50 TDI quattro 210 kW (286 PS) DCPC	11.2016→12.2019	7.02256.00.0	EUV-AGR	EP	ch. F5-H-000 001→
S5 quattro 260 kW (354 PS) CWGD	03.2017→	7.22880.01.0	EUV-SR	EL	Fahrgestellnummer ab: F5-H-000 001 Vehicle Identification Number from: F5-H-000 001 Produktionsdatum bis: 27.07.2020 Production date to: 27.07.2020

A5 Sportback (8TA) 38













1.8 TFSI 118 kW (160 PS) CDHB	11.2009→09.2011	7.03280.04.0	EUV-SR	EL	nur in Verbindung mit: Fahrzeug umgerüstet only in connection with: Fahrzeug umgerüstet
		7.22880.01.0	EUV-SR	EL	
		7.00470.07.0	LDRV	EL	
		7.01830.13.0	SUV	EL	
		7.06117.26.0	ZM-NWV	EL	
1.8 TFSI 125 kW (170 PS) CJEB	08.2011→01.2017	7.03280.04.0	EUV-SR	EL	
		7.01830.13.0	SUV	EL	
		7.02901.05.0	SUV	EL	
		7.06117.26.0	ZM-NWV	EL	
1.8 TFSI 106 kW (144 PS) CJED	09.2014→01.2017	7.03280.04.0	EUV-SR	EL	
		7.01830.13.0	SUV	EL	
		7.06117.26.0	ZM-NWV	EL	
1.8 TFSI 130 kW (177 PS) CJEE	05.2015→01.2017	7.03280.04.0	EUV-SR	EL	
		7.06117.26.0	ZM-NWV	EL	
2.0 TDI 125 kW (170 PS) CAHA	09.2009→03.2012	7.02256.00.0	EUV-AGR	EP	
		7.02256.00.0	EUV-KK	EP	für Fahrzeuge ohne Standheizung for vehicles without parking heater Produktionsdatum ab: 31.08.2009 Production date from: 31.08.2009

A



















A5 Sportback (8TA)

38

2.0 TDI 120 kW (163 PS) CAHB, CGLD	09.2009→01.2017		7.02256.00.0	EUV-AGR	EP	für Fahrzeuge ohne Standheizung for vehicles without parking heater Produktionsdatum ab: 31.08.2009 Production date from: 31.08.2009
			7.02256.00.0	EUV-KK	EP	
2.0 TDI 100 kW (136 PS) CAGB, CJCB	09.2009→01.2017		7.02256.00.0	EUV-AGR	EP	für Fahrzeuge ohne Standheizung for vehicles without parking heater Produktionsdatum ab: 31.08.2009 Production date from: 31.08.2009
			7.02256.00.0	EUV-KK	EP	
2.0 TDI 105 kW (143 PS) CAGA, CJCA, CMEA, CMFA	09.2009→01.2017		7.02256.00.0	EUV-AGR	EP	CAGA, CMEA: für Fahrzeuge ohne Standheizung for vehicles without parking heater Produktionsdatum ab: 31.08.2009 Production date from: 31.08.2009
			7.02256.00.0	EUV-KK	EP	
2.0 TDI 130 kW (177 PS) CGLC	10.2011→01.2017		7.02256.00.0	EUV-AGR	EP	
2.0 TDI 110 kW (150 PS) CJCD, CMFB	05.2013→01.2017		7.02256.00.0	EUV-AGR	EP	
2.0 TDI quattro 125 kW (170 PS) CAHA	09.2009→03.2012		7.02256.00.0	EUV-AGR	EP	für Fahrzeuge ohne Standheizung for vehicles without parking heater Produktionsdatum ab: 31.08.2009 Production date from: 31.08.2009
			7.02256.00.0	EUV-KK	EP	
2.0 TDI quattro 130 kW (177 PS) CGLC	12.2011→01.2017		7.02256.00.0	EUV-AGR	EP	
2.0 TFSI 132 kW (180 PS) CDNB	09.2009→06.2014		7.03280.04.0	EUV-SR	EL	nur in Verbindung mit: Fahrzeug umgerüstet only in connection with: Fahrzeug umgerüstet PKW, Coupe/ Passenger car, coupé
			7.22880.01.0	EUV-SR	EL	
			7.00470.07.0	LDRV	EL	
			7.01830.13.0	SUV	EL	
			7.02901.05.0	SUV	EL	
			7.06117.26.0	ZM-NWV	EL	
2.0 TFSI 155 kW (211 PS) CDNC	09.2009→11.2013		7.03280.04.0	EUV-SR	EL	nur in Verbindung mit: Fahrzeug umgerüstet only in connection with: Fahrzeug umgerüstet
			7.22880.01.0	EUV-SR	EL	
			7.00470.07.0	LDRV	EL	
			7.01830.13.0	SUV	EL	
			7.02901.05.0	SUV	EL	
			7.06117.26.0	ZM-NWV	EL	
2.0 TFSI 165 kW (224 PS) CNCD	05.2013→05.2016		7.06117.26.0	ZM-NWV	EL	
2.0 TFSI 169 kW (230 PS) CNCE	08.2015→01.2017		7.06117.26.0	ZM-NWV	EL	
2.0 TFSI quattro 155 kW (211 PS) CDNC	09.2009→01.2017		7.03280.04.0	EUV-SR	EL	nur in Verbindung mit: Fahrzeug umgerüstet only in connection with: Fahrzeug umgerüstet
			7.22880.01.0	EUV-SR	EL	
			7.00470.07.0	LDRV	EL	
			7.01830.13.0	SUV	EL	
			7.02901.05.0	SUV	EL	

A5 Sportback (8TA)
38

			7.06117.26.0	ZM-NWV	EL	
2.0 TFSI quattro 165 kW (224 PS) CNCD	05.2013→05.2016		7.06117.26.0	ZM-NWV	EL	
2.0 TFSI quattro 169 kW (230 PS) CNCE	08.2015→01.2017		7.06117.26.0	ZM-NWV	EL	
2.7 TDI 140 kW (190 PS) CAMA, CGKA	09.2009→03.2012		7.02256.00.0	EUV-AGR	EP	
2.7 TDI 120 kW (163 PS) CGKB	09.2009→03.2012		7.02256.00.0	EUV-AGR	EP	
3.0 TDI 150 kW (204 PS) CLAB	10.2011→01.2017		7.02256.00.0	EUV-AGR	EP	
3.0 TDI quattro 176 kW (240 PS) CCWA	09.2009→03.2012		7.02256.00.0	EUV-AGR	EP	
3.0 TDI quattro 180 kW (245 PS) CDUC, CKVB, CKVC	10.2011→01.2017		7.02256.00.0	EUV-AGR	EP	
3.0 TDI quattro 160 kW (218 PS) CKVD	05.2015→01.2017		7.02256.00.0	EUV-AGR	EP	
3.0 TFSI quattro 200 kW (272 PS) CHMB	12.2011→01.2017		7.28098.15.0	EUV-SR	EL	
			7.06117.47.0	SV-NWV	EH	mit Dichtring with O-ring
3.0 TFSI quattro 200 kW (272 PS) CMUA	12.2011→01.2017		7.22880.01.0	EUV-SL	EL	
			7.28098.15.0	EUV-SR	EL	
			7.06117.47.0	SV-NWV	EH	mit Dichtring with O-ring
3.0 TFSI quattro 200 kW (272 PS) CRED	12.2011→01.2017		7.22880.01.0	EUV-SL	EL	
			7.22880.01.0	EUV-SR	EL	
			7.06117.47.0	SV-NWV	EH	mit Dichtring with O-ring
3.2 FSI quattro 190-195 kW (258-265 PS) CALA	09.2009→03.2012		7.22880.01.0	EUV-SR	EL	
			7.06117.42.0	SV-NWV	EL	mit Dichtring with O-ring
S5 quattro 245 kW (333 PS) CAKA	01.2010→01.2017		7.22880.01.0	EUV-SL	EL	
			7.28098.15.0	EUV-SR	EL	
			7.06117.42.0	SV-NWV	EL	mit Dichtring with O-ring
S5 quattro 245 kW (333 PS) CGWC	01.2010→01.2017		7.22880.01.0	EUV-SL	EL	
			7.28098.15.0	EUV-SR	EL	mit Dichtring with O-ring
			7.06117.42.0	SV-NWV	EL	mit Dichtring with O-ring
S5 quattro 245 kW (333 PS) CREC, CTDA	01.2010→01.2017		7.22880.01.0	EUV-SL	EL	
			7.22880.01.0	EUV-SR	EL	
			7.06117.47.0	SV-NWV	EH	mit Dichtring with O-ring

























A5 Sportback (F5A, F5F)
39

1.4 TFSI 110 kW (150 PS) CVNA	01.2017→02.2020		7.06117.48.0	SV-NWV	EL	
2.0 TFSI 185 kW (252 PS) CYRB	11.2016→02.2020		7.02256.18.0	EUV-SR	EP	
			7.02901.05.0	SUV	EL	

A

A5 Sportback (F5A, F5F)
39

		7.06117.26.0	ZM-NWV	EL	
2.0 TFSI 140 kW (190 PS) CVKB	01.2017→	7.02256.18.0	EUV-SR	EP	Produktionsdatum bis: 26.12.2016 Production date to: 26.12.2016
		7.06117.26.0	ZM-NWV	EL	
2.0 TFSI Mild Hybrid 183-185 kW (249-252 PS) DDWA	05.2017→02.2020	7.02901.05.0	SUV	EL	
		7.06117.26.0	ZM-NWV	EL	
2.0 TFSI Mild Hybrid quattro 183-185 kW (249-252 PS) DDWA, DLHB	05.2017→02.2020	7.02901.05.0	SUV	EL	
		7.06117.26.0	ZM-NWV	EL	
2.0 TFSI g-tron 125 kW (170 PS) CVLA	02.2017→02.2020	7.06117.26.0	ZM-NWV	EL	
2.0 TFSI quattro 185 kW (252 PS) CYMC	09.2016→	7.06117.26.0	ZM-NWV	EL	
2.0 TFSI quattro 185 kW (252 PS) CYRB	09.2016→	7.02256.18.0	EUV-SR	EP	
		7.06117.26.0	ZM-NWV	EL	
2.0 TFSI quattro 183 kW (249 PS) CYRC	09.2016→02.2020	7.02256.18.0	EUV-SR	EP	
		7.06117.26.0	ZM-NWV	EL	
3.0 TDI 160 kW (218 PS) CSWB	03.2017→08.2018	7.02256.00.0	EUV-AGR	EP	
		7.03280.04.0	EUV-AGR	EL	
3.0 TDI quattro 160 kW (218 PS) CSWB	09.2016→	7.02256.00.0	EUV-AGR	EP	
		7.03280.04.0	EUV-AGR	EL	
3.0 TDI quattro 210 kW (286 PS) DCPC	01.2017→02.2020	7.02256.00.0	EUV-AGR	EP	
		7.03280.04.0	EUV-AGR	EL	
3.0 TDI quattro 200 kW (272 PS) CRTC	02.2017→12.2017	7.02256.00.0	EUV-AGR	EP	
		7.03280.04.0	EUV-AGR	EL	
35 TFSI Mild Hybrid 110 kW (150 PS) DLVB	08.2018→02.2020	7.06117.26.0	ZM-NWV	EL	
40 TFSI Mild Hybrid 140 kW (190 PS) DEMA, DHDA, DKYA, DLVA	05.2017→	7.02901.05.0	SUV	EL	
		7.06117.26.0	ZM-NWV	EL	
40 TFSI g-tron 125 kW (170 PS) CVLA	02.2017→	7.06117.26.0	ZM-NWV	EL	
45 TDI quattro 170 kW (231 PS) DCPE	07.2018→02.2020	7.02256.00.0	EUV-AGR	EP	
		7.03280.04.0	EUV-AGR	EL	
45 TFSI Mild Hybrid 180 kW (245 PS) DKNA	07.2018→02.2020	7.02901.05.0	SUV	EL	
		7.06117.26.0	ZM-NWV	EL	
45 TFSI Mild Hybrid quattro 180 kW (245 PS) DKNA	02.2019→02.2020	7.02901.05.0	SUV	EL	
		7.06117.26.0	ZM-NWV	EL	
50 TDI quattro 210 kW (286 PS) DCPC	01.2017→02.2020	7.02256.00.0	EUV-AGR	EP	
		7.03280.04.0	EUV-AGR	EL	





						
A5 Sportback (F5A, F5F)						39
RS5 quattro 331 kW (450 PS) DECA	06.2018→		7.22880.01.0	EUV-SR	EL	Produktionsdatum bis: 17.08.2020 Production date to: 17.08.2020
S5 quattro 260 kW (354 PS) CWGD	09.2016→		7.22880.01.0	EUV-SR	EL	Produktionsdatum bis: 27.07.2020 Production date to: 27.07.2020
A6 Allroad C6 (4FH)						40
2.7 TDI quattro 132 kW (180 PS) BPP	03.2006→10.2008		7.01019.01.0	DW-AGR	EP	
			7.02256.00.0	EUV-AGR	EP	
2.7 TDI quattro 120 kW (163 PS) BSG	05.2006→08.2011		7.01019.01.0	DW-AGR	EP	
			7.02256.00.0	EUV-AGR	EP	
2.7 TDI quattro 120 kW (163 PS) CAND	05.2006→08.2011		7.02256.00.0	EUV-AGR	EP	
			7.02256.00.0	EUV-AGR	EP	
2.7 TDI quattro 140 kW (190 PS) CANC	10.2008→08.2011		7.02256.00.0	EUV-AGR	EP	
			7.22880.01.0	EUV-LS	EL	
3.0 TDI quattro 171 kW (233 PS) ASB	05.2006→10.2008		7.01019.01.0	DW-AGR	EP	
			7.02256.00.0	EUV-AGR	EP	
			7.22880.01.0	EUV-LS	EL	
3.0 TDI quattro 155 kW (211 PS) BNG	05.2006→08.2011		7.01019.01.0	DW-AGR	EP	
			7.02256.00.0	EUV-AGR	EP	
			7.22880.01.0	EUV-LS	EL	
3.0 TDI quattro 155 kW (211 PS) CDYB	05.2006→08.2011		7.02256.00.0	EUV-AGR	EP	
			7.22880.01.0	EUV-AGR	EP	
			7.22880.01.0	EUV-LS	EL	
3.0 TDI quattro 176 kW (240 PS) CDYA, CDYC	10.2008→08.2011		7.02256.00.0	EUV-AGR	EP	
			7.22880.01.0	EUV-LS	EL	
			7.22880.01.0	EUV-AGR	EP	
3.0 TFSI quattro 213 kW (290 PS) CAJA	10.2008→08.2011		7.22880.01.0	EUV-SR	EL	
			7.28098.15.0	EUV-SR	EL	mit Dichtring with O-ring
			7.06117.42.0	SV-NWV	EL	
			7.22880.01.0	EUV-LS	EL	
3.2 FSI quattro 188 kW (255 PS) AUK	05.2006→10.2008		7.22880.01.0	EUV-LS	EL	
			7.22880.01.0	EUV-SR	EL	
4.2 FSI quattro 250-257 kW (340-350 PS) BVJ	05.2006→12.2010		7.22880.01.0	EUV-LS	EL	Fahrgestellnummer ab: 4F-9-019 351 Vehicle Identification Number from: 4F-9-019 351
			7.22880.01.0	EUV-SR	EL	Fahrgestellnummer ab: 4F-9-019 351 Vehicle Identification Number from: 4F-9-019 351
A6 Allroad C7 (4GH, 4GJ)						41
3.0 TDI quattro 150 kW (204 PS) CLAA	01.2012→12.2014		7.02256.00.0	EUV-AGR	EP	
3.0 TDI quattro 180 kW (245 PS) CDUD, CKVC	01.2012→06.2016		7.02256.00.0	EUV-AGR	EP	
3.0 TDI quattro 230 kW (313 PS) CGQB	01.2012→12.2014		7.02256.00.0	EUV-AGR	EP	
3.0 TDI quattro 235 kW (320 PS) CVUA	01.2012→09.2018		7.02256.00.0	EUV-AGR	EP	
3.0 TDI quattro 155 kW (211 PS) CRTF, CZVC	09.2014→09.2018		7.02256.00.0	EUV-AGR	EP	
3.0 TDI quattro 160 kW (218 PS) CRTE, CZVA	09.2014→09.2018		7.02256.00.0	EUV-AGR	EP	

A



A6 Allroad C7 (4GH, 4GJ)

41

3.0 TDI quattro 200 kW (272 PS) CRTD	09.2014→09.2018		7.02256.00.0	EUV-AGR	EP	
3.0 TDI quattro 140 kW (190 PS) CZVF	11.2015→09.2018		7.02256.00.0	EUV-AGR	EP	
3.0 TFSI quattro 228 kW (310 PS) CGWD	01.2012→12.2014		7.22880.01.0	EUV-SR	EL	mit Dichtring with O-ring
			7.28098.15.0	EUV-SR	EL	
			7.06117.47.0	SV-NWV	EH	
3.0 TFSI quattro 245 kW (333 PS) CREC	09.2014→09.2018		7.22880.01.0	EUV-SL	EL	mit Dichtring with O-ring
			7.22880.01.0	EUV-SR	EL	
			7.06117.47.0	SV-NWV	EH	















A6 Allroad C8 (4AH)

42

45 TDI quattro 183 kW (249 PS) CVMD	08.2019→		7.03280.04.0	EUV-AGR	EL	
55 TDI Mild Hybrid 253 kW (345 PS) DMKD	11.2020→		7.03280.04.0	EUV-AGR	EL	

A6 C4 (4A2)

43

1.8 92-95 kW (125-129 PS) ADR	12.1995→10.1997		7.01805.01.0	EUV-SR	EL	
1.8 quattro 92-95 kW (125-129 PS) ADR	12.1995→10.1997		7.01805.01.0	EUV-SR	EL	
1.9 TDI 66 kW (90 PS) 1Z, AHU	06.1994→10.1997		7.21903.70.0	DW-AGR	EP	
			7.21895.55.0	LDRV	EL	
2.4 110 kW (150 PS) AFM	07.1995→06.1996		7.01805.01.0	EUV-SR	EL	mit Dichtring with O-ring ■■ Thailand ■■ Thailand
			7.05432.12.0	SM	EL	
2.5 TDI 85 kW (116 PS) AAT	06.1994→10.1997		7.21903.70.0	DW-AGR	EP	
			7.22903.16.0	DW-TL	EP	
2.5 TDI 103 kW (140 PS) AEL	08.1994→10.1997		7.21903.70.0	DW-AGR	EP	
			7.22903.16.0	DW-TL	EP	
2.5 TDI quattro 103 kW (140 PS) AEL	10.1995→10.1997		7.21903.70.0	DW-AGR	EP	
			7.22903.16.0	DW-TL	EP	
2.6 110 kW (150 PS) ABC	06.1994→10.1997		7.05432.12.0	SM	EL	mit Dichtring with O-ring  ch. 4A-S-026 715→
2.6 102 kW (139 PS) ACZ	06.1994→10.1997		7.05432.12.0	SM	EL	mit Dichtring with O-ring  ch. 4A-S-026 715→ ■■ China, Gemeinschaft Unabhängiger Staaten ■■ China, Community of Independent States
2.6 quattro 110 kW (150 PS) ABC	06.1994→10.1997		7.05432.12.0	SM	EL	mit Dichtring with O-ring  ch. 4A-S-026 715→
2.8 120-128 kW (163-174 PS) AFC	06.1994→10.1997		7.01805.01.0	EUV-SR	EL	
2.8 128 kW (174 PS) AAH	06.1994→10.1997		7.21483.54.0	EUV-AGR	EL	

A6 C4 (4A2)						43
2.8 120-128 kW (163-174 PS) AEJ	08.1995→07.1996		7.01805.01.0 7.21483.54.0	EUV-SR EUV-AGR	EL EL	 Gemeinschaft Unabhängiger Staaten, Schweiz Community of Independent States, Switzerland
2.8 142 kW (193 PS) ACK	12.1995→10.1997		7.01805.01.0 7.01805.01.0	EUV-SR EUV-SR	EL EL	
2.8 quattro 128 kW (174 PS) AAH	06.1994→10.1997		7.21483.54.0 7.01805.01.0	EUV-AGR EUV-SR	EL EL	
2.8 quattro 142 kW (193 PS) ACK	12.1995→10.1997		7.01805.01.0	EUV-SR	EL	
S6 Plus quattro 240 kW (326 PS) AHK	04.1996→10.1997		7.01805.01.0	EUV-SR	EL	
A6 C4 Avant (4A5)						44
1.8 92-95 kW (125-129 PS) ADR	12.1995→12.1997		7.01805.01.0	EUV-SR	EL	
1.8 quattro 92-95 kW (125-129 PS) ADR	12.1995→12.1997		7.01805.01.0	EUV-SR	EL	
1.9 TDI 66 kW (90 PS) 1Z, AHU	06.1994→12.1997		7.21903.70.0 7.21895.55.0	DW-AGR LDRV	EP EL	
2.4 110 kW (150 PS) AFM	07.1996→12.1997		7.01805.01.0 7.05432.12.0	EUV-SR SM	EL EL	mit Dichtring with O-ring Thailand Thailand
2.5 TDI 85 kW (116 PS) AAT	06.1994→12.1997		7.21903.70.0 7.22903.16.0	DW-AGR DW-TL	EP EP	
2.5 TDI 103 kW (140 PS) AEL	08.1994→12.1997		7.21903.70.0 7.22903.16.0	DW-AGR DW-TL	EP EP	
2.5 TDI quattro 103 kW (140 PS) AEL	07.1995→12.1997		7.21903.70.0 7.22903.16.0	DW-AGR DW-TL	EP EP	
2.6 110 kW (150 PS) ABC	06.1994→12.1997		7.05432.12.0	SM	EL	mit Dichtring with O-ring ch. 4A-S-026 715→
2.6 102 kW (139 PS) ACZ	06.1994→02.1997		7.05432.12.0	SM	EL	mit Dichtring with O-ring ch. 4A-S-026 715→ China, Gemeinschaft Unabhängiger Staaten China, Community of Independent States
2.6 quattro 110 kW (150 PS) ABC	06.1994→12.1997		7.05432.12.0	SM	EL	mit Dichtring with O-ring ch. 4A-S-026 715→
2.8 120-128 kW (163-174 PS) AFC	06.1994→12.1997		7.01805.01.0	EUV-SR	EL	
2.8 128 kW (174 PS) AAH	06.1994→12.1997		7.21483.54.0 7.01805.01.0	EUV-AGR EUV-SR	EL EL	
2.8 120-128 kW (163-174 PS) AEJ	06.1994→07.1995		7.21483.54.0 7.01805.01.0	EUV-AGR EUV-SR	EL EL	 Gemeinschaft Unabhängiger Staaten, Schweiz Community of Independent States, Switzerland

A





























A6 C4 Avant (4A5)

44

2.8 142 kW (193 PS) ACK	12.1995→12.1997	 7.01805.01.0	EUV-SR	EL	
2.8 quattro 128 kW (174 PS) AAH	06.1994→12.1997	 7.21483.54.0	EUV-AGR	EL	
		7.01805.01.0	EUV-SR	EL	
2.8 quattro 142 kW (193 PS) ACK	12.1995→12.1997	 7.01805.01.0	EUV-SR	EL	
S6 Plus quattro 240 kW (326 PS) AHK	04.1996→12.1997	 7.01805.01.0	EUV-SR	EL	

A6 C5 (4B2)

45

1.8 92 kW (125 PS) AJP	07.1997→01.2005	 7.01805.01.0	EUV-SR	EL	
1.8 92 kW (125 PS) AQE, ARH	07.1997→01.2005	 7.22402.03.0	EUV-SR	EL	
1.8 T 110 kW (150 PS) ANB, APU, ARK, AWT	01.1997→01.2005	 7.01805.01.0	EUV-LS	EL	
1.8 T quattro 110 kW (150 PS) ANB, APU, ARK, AWT	02.1997→01.2005	 7.01805.01.0	EUV-LS	EL	
1.9 TDI 81 kW (110 PS) AFN, AVG	04.1997→10.2000	 7.21903.70.0	DW-AGR	EP	 AFN, AVG: für OE-Nummer: 1H0 906 627 for OE number: 1H0 906 627
		7.21903.70.0	DW-TL	EP	
		7.21903.75.0	DW-TL	EP	
1.9 TDI 85 kW (115 PS) AJM	07.2000→01.2005	 7.21903.70.0	DW-AGR	EP	für OE-Nummer: 1H0 906 627 for OE number: 1H0 906 627
		7.21903.70.0	DW-TL	EP	
		7.21903.75.0	DW-TL	EP	
1.9 TDI 96 kW (130 PS) AVF, AWX	08.2001→01.2005	 7.22903.37.0	DW-AGR	EP	 AVF, AWX:  ch. 4B-3-000 001→
		7.22903.18.0	DW-AGR	EP	 AVF, AWX:  →ch. 4B-2-200 000
		7.22903.28.0	DW-TL	EP	 AVF, AWX:  ch. 4B-3-000 001→
		7.22903.19.0	DW-TL	EP	 AVF, AWX:  →ch. 4B-2-200 000
		7.02256.00.0	EUV-AGR	EP	
2.0 96 kW (130 PS) ALT	08.2001→01.2005	 7.10014.00.0	AKF	EL	
		7.22880.01.0	EUV-SR	EL	
2.4 121 kW (165 PS) AGA, ALF, AML, APS, ARJ	02.1997→01.2005	 7.01805.01.0	EUV-SR	EL	
2.4 115 kW (156 PS) APC	02.1997→01.2005	 7.01805.01.0	EUV-SR	EL	
2.4 120 kW (163 PS) AJG, AMM, APZ	02.1997→01.2005	 7.01805.01.0	EUV-SR	EL	
2.4 100 kW (136 PS) ALW, ASM	07.1998→01.2005	 7.01805.01.0	EUV-SR	EL	
2.4 125 kW (170 PS) BDV	08.2001→01.2005	 7.01805.01.0	EUV-SR	EL	
2.4 quattro 121 kW (165 PS) AGA, ALF, AML, APS, ARJ	02.1997→01.2005	 7.01805.01.0	EUV-SR	EL	
2.4 quattro 120 kW (163 PS) AJG, APZ	02.1997→01.2005	 7.01805.01.0	EUV-SR	EL	
2.4 quattro 115 kW (156 PS) APC	08.1998→07.1999	 7.01805.01.0	EUV-SR	EL	
2.4 quattro 125 kW (170 PS) BDV	08.2001→01.2005	 7.01805.01.0	EUV-SR	EL	
2.5 TDI 110 kW (150 PS) AFB, AKN	07.1997→01.2005	 7.21903.49.0	DW-TL	EP	→12.2001











						
A6 C5 (4B2)						45
2.5 TDI 132 kW (180 PS) AKE	02.2000→01.2005		7.22903.17.0	DW-AGR	EP	Baujahr ab: 01.2002 Construction year from: 01.2002 →12.2001
			7.21903.49.0	DW-TL	EP	
			7.02256.00.0	EUV-RK	EP	
2.5 TDI 114 kW (155 PS) AYM	08.2001→01.2005		7.22903.17.0	DW-AGR	EP	
			7.02256.00.0	EUV-RK	EP	
2.5 TDI 120 kW (163 PS) BCZ	07.2002→01.2005		7.22903.17.0	DW-AGR	EP	
			7.22903.16.0	DW-TL	EP	 ch. 4B-1-150 501→
2.5 TDI 120 kW (163 PS) BDG	07.2002→01.2005		7.22903.17.0	DW-AGR	EP	
			7.22903.16.0	DW-TL	EP	 ch. 4B-1-150 501→
2.5 TDI 120 kW (163 PS) BFC	07.2002→01.2005		7.22903.17.0	DW-AGR	EP	
			7.02256.00.0	EUV-RK	EP	
2.5 TDI 132 kW (180 PS) BAU	02.2003→01.2005		7.22903.17.0	DW-AGR	EP	
			7.22903.16.0	DW-TL	EP	 ch. 4B-1-150 501→
			7.02256.00.0	EUV-RK	EP	
2.5 TDI 132 kW (180 PS) BDH	02.2003→01.2005		7.22903.17.0	DW-AGR	EP	
2.5 TDI quattro 110 kW (150 PS) AFB, AKN	07.1997→01.2005		7.21903.49.0	DW-TL	EP	→12.2001
2.5 TDI quattro 132 kW (180 PS) AKE	02.2000→01.2005		7.22903.17.0	DW-AGR	EP	Baujahr ab: 01.2002 Construction year from: 01.2002 →12.2001  ch. 4B-1-150 501→
			7.21903.49.0	DW-TL	EP	
			7.22903.16.0	DW-TL	EP	
			7.02256.00.0	EUV-RK	EP	
2.5 TDI quattro 132 kW (180 PS) BAU	02.2003→01.2005		7.22903.17.0	DW-AGR	EP	
			7.22903.16.0	DW-TL	EP	 ch. 4B-1-150 501→
			7.02256.00.0	EUV-RK	EP	
2.5 TDI quattro 132 kW (180 PS) BDH	02.2003→01.2005		7.22903.17.0	DW-AGR	EP	
			7.22903.16.0	DW-TL	EP	 ch. 4B-1-150 501→
2.7 T 169 kW (230 PS) AJK	02.1999→01.2005		7.22687.49.0	EUV-DR	EP	
			7.22687.39.0	EUV-LS	EL	
2.7 T quattro 169 kW (230 PS) AZA	12.1997→01.2005		7.22687.49.0	EUV-DR	EP	
			7.22687.39.0	EUV-LS	EL	
			7.01805.01.0	EUV-SL	EL	
2.7 T quattro 169 kW (230 PS) AJK	02.1999→01.2005		7.22687.49.0	EUV-DR	EP	
			7.22687.39.0	EUV-LS	EL	
2.7 T quattro 184 kW (250 PS) ARE, BES	08.2001→01.2005		7.22687.49.0	EUV-DR	EP	
			7.22687.39.0	EUV-LS	EL	
			7.01805.01.0	EUV-SL	EL	
2.8 142 kW (193 PS) ACK, ALG, AMX, APR, AQD	02.1997→01.2005		7.01805.01.0	EUV-SR	EL	
2.8 132 kW (180 PS) AGE	10.1997→05.2000		7.01805.01.0	EUV-SR	EL	
2.8 140 kW (190 PS) ATX	07.1999→01.2005		7.01805.01.0	EUV-SR	EL	

A



















A6 C5 (4B2)































45

2.8 quattro 142 kW (193 PS) ACK, ALG, AMX, APR, AQD	02.1997→01.2005	 7.01805.01.0	EUV-SR	EL	
2.8 quattro 132 kW (180 PS) AGE	01.1998→07.1998	 7.01805.01.0	EUV-SR	EL	
2.8 quattro 140 kW (190 PS) ATX	07.1999→05.2001	 7.01805.01.0	EUV-SR	EL	
3.0 160-162 kW (218-220 PS) BBJ	06.2001→01.2005	 7.01805.01.0	EUV-LS	EL	
		7.22880.01.0	EUV-SR	EL	
		7.21895.55.0	LDRV	EL	
3.0 162 kW (220 PS) ASN	08.2001→01.2005	 7.01805.01.0	EUV-LS	EL	
		7.22880.01.0	EUV-SR	EL	
		7.21895.55.0	LDRV	EL	
3.0 quattro 160-162 kW (218-220 PS) BBJ	06.2001→07.2004	 7.01805.01.0	EUV-LS	EL	
		7.22880.01.0	EUV-SR	EL	
		7.21895.55.0	LDRV	EL	
3.0 quattro 162 kW (220 PS) ASN	08.2001→01.2005	 7.01805.01.0	EUV-LS	EL	
		7.22880.01.0	EUV-SR	EL	
		7.21895.55.0	LDRV	EL	
RS6 quattro 331 kW (450 PS) BCY	07.2002→01.2005	 7.22687.39.0	EUV-LS	EL	
		7.22687.49.0	EUV-VB	EP	
S6 quattro 250 kW (340 PS) ANK, AQJ	09.1999→01.2005	 7.22687.50.0	EUV-SR	EP	 ANK, AQJ: für OE-Nummer: 077 906 283 B, 077 906 283 D for OE number: 077 906 283 B, 077 906 283 D

A6 C5 Avant (4B5)

46

1.8 92 kW (125 PS) AJP	12.1997→01.2005	 7.01805.01.0	EUV-SR	EL	
1.8 92 kW (125 PS) AQE, ARH	12.1997→01.2005	 7.22402.03.0	EUV-SR	EL	
1.8 T 110 kW (150 PS) ANB, APU, ARK, AWT	12.1997→01.2005	 7.01805.01.0	EUV-LS	EL	
1.8 T quattro 110 kW (150 PS) ANB, APU, ARK, AWT	12.1997→01.2005	 7.01805.01.0	EUV-LS	EL	
1.9 TDI 81 kW (110 PS) AFN, AVG	02.1998→04.2001	 7.21903.70.0	DW-AGR	EP	
		7.21903.70.0	DW-TL	EP	 AFN, AVG: für OE-Nummer: 1H0 906 627 for OE number: 1H0 906 627
		7.21903.75.0	DW-TL	EP	
1.9 TDI 85 kW (115 PS) AJM	07.2000→01.2005	 7.21903.70.0	DW-AGR	EP	
		7.21903.70.0	DW-TL	EP	für OE-Nummer: 1H0 906 627 for OE number: 1H0 906 627
		7.21903.75.0	DW-TL	EP	
1.9 TDI 96 kW (130 PS) AVF, AWX	08.2001→01.2005	 7.22903.37.0	DW-AGR	EP	 AVF, AWX:  ch. 4B-3-000 001→
		7.22903.18.0	DW-AGR	EP	 AVF, AWX:  →ch. 4B-2-200 000
		7.22903.28.0	DW-TL	EP	 AVF, AWX:  ch. 4B-3-000 001→
		7.22903.19.0	DW-TL	EP	 AVF, AWX:  →ch. 4B-2-200 000
		7.02256.00.0	EUV-AGR	EP	
2.0 96 kW (130 PS) ALT	08.2001→01.2005	 7.10014.00.0	AKF	EL	





					
A6 C5 Avant (4B5)					46
			7.22880.01.0	EUV-SR	EL
2.4 121 kW (165 PS) AGA, ALF, AML, APS, ARJ	12.1997→01.2005		7.01805.01.0	EUV-SR	EL
2.4 115 kW (156 PS) APC	12.1997→01.2005		7.01805.01.0	EUV-SR	EL
2.4 120 kW (163 PS) AJG, AMM, APZ	12.1997→01.2005		7.01805.01.0	EUV-SR	EL
2.4 100 kW (136 PS) ALW, ASM	07.1998→01.2005		7.01805.01.0	EUV-SR	EL
2.4 125 kW (170 PS) BDV	08.2001→01.2005		7.01805.01.0	EUV-SR	EL
2.4 quattro 121 kW (165 PS) AGA, ALF, AML, APS, ARJ	12.1997→01.2005		7.01805.01.0	EUV-SR	EL
2.4 quattro 120 kW (163 PS) AJG, APZ	12.1997→01.2005		7.01805.01.0	EUV-SR	EL
2.4 quattro 115 kW (156 PS) APC	08.1998→05.2001		7.01805.01.0	EUV-SR	EL
2.4 quattro 125 kW (170 PS) BDV	08.2001→01.2005		7.01805.01.0	EUV-SR	EL
2.5 TDI 110 kW (150 PS) AFB, AKN	12.1997→01.2005		7.21903.49.0	DW-TL	EP  AFB, AKN: →12.2001
2.5 TDI 132 kW (180 PS) AKE	02.2000→01.2005		7.22903.17.0	DW-AGR	EP Baujahr ab: 01.2002 Construction year from: 01.2002
			7.21903.49.0	DW-TL	EP →12.2001
			7.22903.16.0	DW-TL	EP  ch. 4B-1-150 501→
			7.02256.00.0	EUV-RK	EP
2.5 TDI 114 kW (155 PS) AYM	08.2001→01.2005		7.22903.17.0	DW-AGR	EP
			7.02256.00.0	EUV-RK	EP
2.5 TDI 120 kW (163 PS) BCZ	07.2002→01.2005		7.22903.17.0	DW-AGR	EP
			7.22903.16.0	DW-TL	EP  ch. 4B-1-150 501→
			7.02256.00.0	EUV-RK	EP
2.5 TDI 120 kW (163 PS) BDG	07.2002→01.2005		7.22903.17.0	DW-AGR	EP
			7.22903.16.0	DW-TL	EP  ch. 4B-1-150 501→
2.5 TDI 120 kW (163 PS) BFC	07.2002→01.2005		7.22903.17.0	DW-AGR	EP
			7.02256.00.0	EUV-RK	EP
			7.22903.17.0	DW-AGR	EP
2.5 TDI 132 kW (180 PS) BAU	02.2003→01.2005		7.22903.17.0	DW-AGR	EP
			7.22903.16.0	DW-TL	EP  ch. 4B-1-150 501→
			7.02256.00.0	EUV-RK	EP
2.5 TDI 132 kW (180 PS) BDH	02.2003→01.2005		7.22903.17.0	DW-AGR	EP
			7.22903.16.0	DW-TL	EP  ch. 4B-1-150 501→
2.5 TDI quattro 110 kW (150 PS) AFB, AKN	02.1998→01.2005		7.21903.49.0	DW-TL	EP  AFB, AKN: →12.2001
2.5 TDI quattro 132 kW (180 PS) AKE	02.2000→01.2005		7.22903.17.0	DW-AGR	EP Baujahr ab: 01.2002 Construction year from: 01.2002
			7.21903.49.0	DW-TL	EP →12.2001
			7.22903.16.0	DW-TL	EP  ch. 4B-1-150 501→
			7.02256.00.0	EUV-RK	EP
2.5 TDI quattro 132 kW (180 PS) BAU	02.2003→01.2005		7.22903.17.0	DW-AGR	EP
			7.22903.16.0	DW-TL	EP  ch. 4B-1-150 501→
			7.02256.00.0	EUV-RK	EP

A









A6 C5 Avant (4B5)

46

2.5 TDI quattro 132 kW (180 PS) BDH	02.2003→01.2005		7.22903.17.0	DW-AGR	EP	
			7.22903.16.0	DW-TL	EP	
2.7 T 169 kW (230 PS) AJK	02.1999→01.2005		7.22687.49.0	EUV-DR	EP	 ch. 4B-1-150 501→
			7.22687.39.0	EUV-LS	EL	
2.7 T quattro 169 kW (230 PS) AZA	12.1997→01.2005		7.22687.49.0	EUV-DR	EP	
			7.22687.39.0	EUV-LS	EL	
			7.01805.01.0	EUV-SL	EL	
2.7 T quattro 169 kW (230 PS) AJK	02.1999→01.2005		7.22687.49.0	EUV-DR	EP	
			7.22687.39.0	EUV-LS	EL	
2.7 T quattro 184 kW (250 PS) ARE, BES	08.2001→01.2005		7.22687.49.0	EUV-DR	EP	
			7.22687.39.0	EUV-LS	EL	
			7.01805.01.0	EUV-SL	EL	
2.8 142 kW (193 PS) ACK, ALG, AMX, APR, AQD	12.1997→01.2005		7.01805.01.0	EUV-SR	EL	
2.8 132 kW (180 PS) AGE	12.1997→05.2000		7.01805.01.0	EUV-SR	EL	
2.8 140 kW (190 PS) ATX	07.1999→01.2005		7.01805.01.0	EUV-SR	EL	
2.8 quattro 142 kW (193 PS) ACK, ALG, AMX, APR, AQD	12.1997→01.2005		7.01805.01.0	EUV-SR	EL	
3.0 160-162 kW (218-220 PS) BBJ	06.2001→01.2005		7.01805.01.0	EUV-LS	EL	
			7.22880.01.0	EUV-SR	EL	
			7.21895.55.0	LDRV	EL	
3.0 162 kW (220 PS) ASN	08.2001→01.2005		7.01805.01.0	EUV-LS	EL	
			7.22880.01.0	EUV-SR	EL	
			7.21895.55.0	LDRV	EL	
3.0 quattro 160-162 kW (218-220 PS) BBJ	06.2001→01.2005		7.01805.01.0	EUV-LS	EL	
			7.22880.01.0	EUV-SR	EL	
			7.21895.55.0	LDRV	EL	
3.0 quattro 162 kW (220 PS) ASN	08.2001→01.2005		7.01805.01.0	EUV-LS	EL	
			7.22880.01.0	EUV-SR	EL	
			7.21895.55.0	LDRV	EL	
RS6 plus quattro 353 kW (480 PS) BRV	04.2004→01.2005		7.22687.39.0	EUV-LS	EL	
			7.22687.49.0	EUV-VB	EP	
RS6 quattro 331 kW (450 PS) BCY	07.2002→01.2005		7.22687.39.0	EUV-LS	EL	
			7.22687.49.0	EUV-VB	EP	
S6 quattro 250 kW (340 PS) ANK, AQJ	09.1999→01.2005		7.22687.50.0	EUV-SR	EP	 ANK, AQJ: für OE-Nummer: 077 906 283 B, 077 906 283 D for OE number: 077 906 283 B, 077 906 283 D

A6 C6 (4F2)

47

2.0 TDI 103 kW (140 PS) BLB, BRE	07.2004→10.2008		7.22903.28.0	DW-AGR	EP	 BLB, BRE:  ch. 4F-5-000 001→
			7.02256.00.0	EUV-AGR	EP	 BLB, BRE:  ch. 4F-5-000 001→
			7.02256.00.0	EUV-RK	EP	 BLB, BRE:  ch. 4F-5-000 001→

























A6 C6 (4F2)					47
2.0 TDI 100 kW (136 PS) BNA, BRF	07.2004→03.2011		7.02256.00.0	EUV-SR	EP BLB, BRE: ch. 4F-5-000 001→
			7.22903.28.0	DW-AGR	EP BNA, BRF: ch. 4F-5-000 001→
			7.02256.00.0	EUV-AGR	EP BNA, BRF: ch. 4F-5-000 001→
			7.02256.00.0	EUV-RK	EP BNA, BRF: ch. 4F-5-000 001→
2.0 TDI 100 kW (136 PS) CAGB	07.2004→03.2011		7.02256.00.0	EUV-SR	EP BNA, BRF: ch. 4F-5-000 001→
			7.02256.00.0	EUV-AGR	EP
2.0 TDI 125 kW (170 PS) CAHA	11.2008→03.2011		7.02256.00.0	EUV-LS	EP
			7.02256.00.0	EUV-AGR	EP
2.0 TDI 120 kW (163 PS) CAHB	04.2009→03.2011		7.02256.00.0	EUV-LS	EP
			7.02256.00.0	EUV-AGR	EP
2.0 TFSI 125 kW (170 PS) BPJ, BYK	06.2005→03.2011		7.00470.07.0	LDRV	EL BPJ, BYK: ch. 4F-5-000 001→
			7.01830.13.0	SUV	EL
			7.06117.37.0	SV-NWV	EL BPJ, BYK: Fahrgestellnummer ab: 4F-5-000 001 Vehicle Identification Number from: 4F-5-000 001
			7.06117.46.0	SV-NWV	EH mit Dichtring with O-ring BPJ, BYK: Fahrgestellnummer ab: 4F-5-000 001 Vehicle Identification Number from: 4F-5-000 001
2.4 130 kW (177 PS) BDW	05.2004→10.2008		7.22880.01.0	EUV-SR	EL Fahrgestellnummer ab: 4F-5-000 001 Vehicle Identification Number from: 4F-5-000 001
2.4 quattro 130 kW (177 PS) BDW	01.2005→10.2008		7.22880.01.0	EUV-SR	EL Fahrgestellnummer ab: 4F-5-000 001 Vehicle Identification Number from: 4F-5-000 001
2.7 TDI 132 kW (180 PS) BPP	11.2004→10.2008		7.01019.01.0	DW-AGR	EP ch. 4F-5-000 001→
			7.02256.00.0	EUV-AGR	EP ch. 4F-5-000 001→
			7.02256.00.0	EUV-LS	EP ch. 4F-5-000 001→
2.7 TDI 120 kW (163 PS) BSG	11.2004→03.2011		7.01019.01.0	DW-AGR	EP ch. 4F-5-000 001→
			7.02256.00.0	EUV-AGR	EP ch. 4F-5-000 001→
			7.02256.00.0	EUV-LS	EP ch. 4F-5-000 001→
2.7 TDI 120 kW (163 PS) CANB	11.2004→03.2011		7.02256.00.0	EUV-AGR	EP
			7.22880.01.0	EUV-LS	EL
2.7 TDI 140 kW (190 PS) CANA	10.2008→03.2011		7.02256.00.0	EUV-AGR	EP
			7.22880.01.0	EUV-LS	EL
2.7 TDI quattro 132 kW (180 PS) BPP	11.2004→10.2008		7.01019.01.0	DW-AGR	EP ch. 4F-5-000 001→
			7.02256.00.0	EUV-AGR	EP ch. 4F-5-000 001→
			7.02256.00.0	EUV-LS	EP ch. 4F-5-000 001→
2.7 TDI quattro 120 kW (163 PS) BSG	06.2005→03.2011		7.01019.01.0	DW-AGR	EP ch. 4F-5-000 001→
			7.02256.00.0	EUV-AGR	EP ch. 4F-5-000 001→
			7.02256.00.0	EUV-LS	EP ch. 4F-5-000 001→
2.7 TDI quattro 120 kW (163 PS) CAND	06.2005→03.2011		7.02256.00.0	EUV-AGR	EP
			7.22880.01.0	EUV-LS	EL

























A



A6 C6 (4F2)

47

2.7 TDI quattro 140 kW (190 PS) CANC	10.2008→03.2011		7.02256.00.0	EUV-AGR	EP	
			7.22880.01.0	EUV-LS	EL	
2.8 FSI 154 kW (210 PS) BDX	11.2006→10.2008		7.22880.01.0	EUV-LS	EL	Fahrgestellnummer ab: 4F-5-000 001 Vehicle Identification Number from: 4F-5-000 001
			7.22880.01.0	EUV-SR	EL	Fahrgestellnummer ab: 4F-5-000 001 Vehicle Identification Number from: 4F-5-000 001
			7.06117.42.0	SV-NWV	EL	mit Dichtring with O-ring  ch. 4F-5-000 001→
2.8 FSI 140 kW (190 PS) CCDA	10.2008→03.2011		7.22880.01.0	EUV-LS	EL	
			7.22880.01.0	EUV-SR	EL	
			7.06117.42.0	SV-NWV	EL	mit Dichtring with O-ring
2.8 FSI 162 kW (220 PS) CCEA	10.2008→03.2011		7.22880.01.0	EUV-LS	EL	
			7.22880.01.0	EUV-SR	EL	
			7.06117.42.0	SV-NWV	EL	mit Dichtring with O-ring
2.8 FSI quattro 154 kW (210 PS) BDX	06.2007→10.2008		7.22880.01.0	EUV-LS	EL	Fahrgestellnummer ab: 4F-5-000 001 Vehicle Identification Number from: 4F-5-000 001
			7.22880.01.0	EUV-SR	EL	Fahrgestellnummer ab: 4F-5-000 001 Vehicle Identification Number from: 4F-5-000 001
			7.06117.42.0	SV-NWV	EL	mit Dichtring with O-ring  ch. 4F-5-000 001→
2.8 FSI quattro 140 kW (190 PS) CCDA	10.2008→03.2011		7.22880.01.0	EUV-LS	EL	
			7.22880.01.0	EUV-SR	EL	
			7.06117.42.0	SV-NWV	EL	mit Dichtring with O-ring
2.8 FSI quattro 162 kW (220 PS) CCEA	10.2008→03.2011		7.22880.01.0	EUV-LS	EL	
			7.22880.01.0	EUV-SR	EL	
			7.06117.42.0	SV-NWV	EL	mit Dichtring with O-ring
3.0 160-162 kW (218-220 PS) BBJ	08.2004→05.2006		7.01805.01.0	EUV-LS	EL	
			7.21895.55.0	LDRV	EL	
3.0 TDI quattro 165 kW (225 PS) BMK	05.2004→05.2006		7.01019.01.0	DW-AGR	EP	 ch. 4F-5-000 001→
			7.02256.00.0	EUV-AGR	EP	 ch. 4F-5-000 001→
			7.02256.00.0	EUV-LS	EP	 ch. 4F-5-000 001→
3.0 TDI quattro 155 kW (211 PS) BNG	05.2004→03.2011		7.01019.01.0	DW-AGR	EP	 ch. 4F-5-000 001→
			7.02256.00.0	EUV-AGR	EP	 ch. 4F-5-000 001→
			7.02256.00.0	EUV-LS	EP	 ch. 4F-5-000 001→
3.0 TDI quattro 155 kW (211 PS) CDYB	05.2004→03.2011		7.02256.00.0	EUV-AGR	EP	
			7.22880.01.0	EUV-LS	EL	
3.0 TDI quattro 171 kW (233 PS) ASB	06.2006→10.2008		7.01019.01.0	DW-AGR	EP	 ch. 4F-5-000 001→
			7.02256.00.0	EUV-AGR	EP	 ch. 4F-5-000 001→
			7.02256.00.0	EUV-LS	EP	 ch. 4F-5-000 001→
3.0 TDI quattro 176 kW (240 PS) CDYA, CDYC	10.2008→03.2011		7.02256.00.0	EUV-AGR	EP	

					
A6 C6 (4F2)					47
3.0 TFSI quattro 220 kW (299 PS) CCAA	10.2008→03.2011		7.22880.01.0	EUV-LS	EL
			7.22880.01.0	EUV-SR	EL
			7.28098.15.0 7.06117.42.0	EUV-SR SV-NWV	EL EL
3.0 TFSI quattro 213 kW (290 PS) CAJA	10.2008→03.2011		7.22880.01.0	EUV-SR	EL
			7.28098.15.0	EUV-SR	EL
			7.06117.42.0	SV-NWV	EL
3.0 quattro 160-162 kW (218-220 PS) BBJ	05.2004→05.2006		7.01805.01.0	EUV-LS	EL
			7.22880.01.0	EUV-SR	EL
			7.21895.55.0	LDRV	EL
3.2 FSI 188-190 kW (255-258 PS) AUK, BKH	05.2004→05.2009		7.22880.01.0	EUV-LS	EL  AUK, BKH: Fahrgestellnummer ab: 4F-5-000 001 Vehicle Identification Number from: 4F-5-000 001
			7.22880.01.0	EUV-SR	EL  AUK: Fahrgestellnummer ab: 4F-5-000 001 Vehicle Identification Number from: 4F-5-000 001  BKH: Fahrgestellnummer ab: 4F-5-000 001 Vehicle Identification Number from: 4F-5-000 001  Korea (Republik)  Korea (Republic)
3.2 FSI 190-195 kW (258-265 PS) CALA	05.2009→03.2011		7.22880.01.0	EUV-SR	EL Fahrgestellnummer ab: 4F-5-000 001 Vehicle Identification Number from: 4F-5-000 001
			7.06117.42.0	SV-NWV	EL mit Dichtring with O-ring
3.2 FSI quattro 188-190 kW (255-258 PS) AUK, BKH	05.2004→10.2008		7.22880.01.0	EUV-LS	EL Fahrgestellnummer ab: 4F-5-000 001 Vehicle Identification Number from: 4F-5-000 001
			7.22880.01.0	EUV-SR	EL  AUK: Fahrgestellnummer ab: 4F-5-000 001 Vehicle Identification Number from: 4F-5-000 001  BKH: Fahrgestellnummer ab: 4F-5-000 001 Vehicle Identification Number from: 4F-5-000 001  Korea (Republik)  Korea (Republic)
3.2 FSI quattro 183 kW (249 PS) BYU	09.2006→10.2008		7.22880.01.0	EUV-LS	EL Fahrgestellnummer ab: 4F-5-000 001 Vehicle Identification Number from: 4F-5-000 001
			7.22880.01.0	EUV-SR	EL Fahrgestellnummer ab: 4F-5-000 001 Vehicle Identification Number from: 4F-5-000 001
4.2 FSI quattro 250-257 kW (340-350 PS) BVJ	06.2006→03.2011		7.22880.01.0	EUV-LS	EL Fahrgestellnummer ab: 4F-5-000 001 Vehicle Identification Number from: 4F-5-000 001
			7.22880.01.0	EUV-SR	EL Fahrgestellnummer ab: 4F-5-000 001 Vehicle Identification Number from: 4F-5-000 001
4.2 quattro 246 kW (335 PS) BAT	05.2004→05.2006		7.22880.01.0	EUV-LS	EL Fahrgestellnummer ab: 4F-5-000 001 Vehicle Identification Number from: 4F-5-000 001

A



A6 C6 (4F2)































47

			7.28098.15.0	EUV-SL	EL	Fahrgestellnummer ab: 4F-5-000 001 Vehicle Identification Number from: 4F-5-000 001
RS6 quattro 426 kW (580 PS) BUH	09.2008→08.2010		7.22880.01.0	EUV-SR	EL	
S6 quattro 320 kW (435 PS) BXA	03.2006→03.2011		7.22880.01.0	EUV-SL	EL	Fahrgestellnummer ab: 4F-5-000 001 Vehicle Identification Number from: 4F-5-000 001

A6 C6 Avant (4F5)

48

2.0 TDI 103 kW (140 PS) BLB, BRE	06.2005→10.2008		7.22903.28.0	DW-AGR	EP	BLB, BRE: ch. 4F-5-000 001→
			7.02256.00.0	EUV-AGR	EP	BLB, BRE: ch. 4F-5-000 001→
			7.02256.00.0	EUV-RK	EP	BLB, BRE: ch. 4F-5-000 001→
			7.02256.00.0	EUV-SR	EP	BLB, BRE: ch. 4F-5-000 001→
2.0 TDI 100 kW (136 PS) BNA, BRP	06.2005→08.2011		7.22903.28.0	DW-AGR	EP	BNA, BRP: ch. 4F-5-000 001→
			7.02256.00.0	EUV-AGR	EP	BNA, BRP: ch. 4F-5-000 001→
			7.02256.00.0	EUV-RK	EP	BNA, BRP: ch. 4F-5-000 001→
			7.02256.00.0	EUV-SR	EP	BNA, BRP: ch. 4F-5-000 001→
2.0 TDI 100 kW (136 PS) CAGB	06.2005→08.2011		7.02256.00.0	EUV-AGR	EP	ch. 4F-5-000 001→
			7.02256.00.0	EUV-LS	EP	ch. 4F-5-000 001→
2.0 TDI 125 kW (170 PS) CAHA	10.2008→08.2011		7.02256.00.0	EUV-AGR	EP	
			7.02256.00.0	EUV-LS	EP	
2.0 TDI 120 kW (163 PS) CAHB	04.2009→08.2011		7.02256.00.0	EUV-AGR	EP	
			7.02256.00.0	EUV-LS	EP	
2.0 TFSI 125 kW (170 PS) BPJ	06.2005→08.2011		7.00470.07.0	LDRV	EL	ch. 4F-5-000 001→
			7.01830.13.0	SUV	EL	
			7.06117.46.0	SV-NWV	EH	mit Dichtring with O-ring Fahrgestellnummer ab: 4F-5-000 001 Vehicle Identification Number from: 4F-5-000 001
2.4 130 kW (177 PS) BDW	03.2005→10.2008		7.22880.01.0	EUV-SR	EL	Fahrgestellnummer ab: 4F-5-000 001 Vehicle Identification Number from: 4F-5-000 001
2.4 quattro 130 kW (177 PS) BDW	03.2005→10.2008		7.22880.01.0	EUV-SR	EL	Fahrgestellnummer ab: 4F-5-000 001 Vehicle Identification Number from: 4F-5-000 001
2.7 TDI 120 kW (163 PS) BSG	03.2005→08.2011		7.01019.01.0	DW-AGR	EP	ch. 4F-5-000 001→
			7.02256.00.0	EUV-AGR	EP	ch. 4F-5-000 001→
			7.02256.00.0	EUV-LS	EP	ch. 4F-5-000 001→
2.7 TDI 120 kW (163 PS) CANB	03.2005→08.2011		7.02256.00.0	EUV-AGR	EP	
			7.22880.01.0	EUV-LS	EL	
2.7 TDI 132 kW (180 PS) BPP	03.2005→10.2008		7.01019.01.0	DW-AGR	EP	ch. 4F-5-000 001→
			7.02256.00.0	EUV-AGR	EP	ch. 4F-5-000 001→
			7.02256.00.0	EUV-LS	EP	ch. 4F-5-000 001→
2.7 TDI 140 kW (190 PS) CANA	10.2008→08.2011		7.02256.00.0	EUV-AGR	EP	
			7.22880.01.0	EUV-LS	EL	
2.7 TDI quattro 132 kW (180 PS) BPP	11.2004→10.2008		7.01019.01.0	DW-AGR	EP	ch. 4F-5-000 001→
			7.02256.00.0	EUV-AGR	EP	ch. 4F-5-000 001→

						
A6 C6 Avant (4F5)						48
2.7 TDI quattro 120 kW (163 PS) BSG	06.2005→08.2011		7.02256.00.0	EUV-LS	EP	 ch. 4F-5-000 001→
			7.01019.01.0	DW-AGR	EP	 ch. 4F-5-000 001→
			7.02256.00.0	EUV-AGR	EP	 ch. 4F-5-000 001→
			7.02256.00.0	EUV-LS	EP	 ch. 4F-5-000 001→
2.7 TDI quattro 120 kW (163 PS) CAND	06.2005→08.2011		7.02256.00.0	EUV-AGR	EP	
			7.22880.01.0	EUV-LS	EL	
2.7 TDI quattro 140 kW (190 PS) CANC	10.2008→08.2011		7.02256.00.0	EUV-AGR	EP	
			7.22880.01.0	EUV-LS	EL	
2.8 FSI 154 kW (210 PS) BDX	11.2006→10.2008		7.22880.01.0	EUV-LS	EL	Fahrgestellnummer ab: 4F-5-000 001 Vehicle Identification Number from: 4F-5-000 001
			7.22880.01.0	EUV-SR	EL	Fahrgestellnummer ab: 4F-5-000 001 Vehicle Identification Number from: 4F-5-000 001
			7.06117.42.0	SV-NWV	EL	mit Dichtring with O-ring  ch. 4F-5-000 001→
2.8 FSI 140 kW (190 PS) CCDA	10.2008→08.2011		7.22880.01.0	EUV-LS	EL	
			7.22880.01.0	EUV-SR	EL	
			7.06117.42.0	SV-NWV	EL	mit Dichtring with O-ring
2.8 FSI 162 kW (220 PS) CCEA	10.2008→08.2011		7.22880.01.0	EUV-LS	EL	
			7.22880.01.0	EUV-SR	EL	
			7.06117.42.0	SV-NWV	EL	mit Dichtring with O-ring
2.8 FSI quattro 154 kW (210 PS) BDX	06.2007→10.2008		7.22880.01.0	EUV-LS	EL	Fahrgestellnummer ab: 4F-5-000 001 Vehicle Identification Number from: 4F-5-000 001
			7.22880.01.0	EUV-SR	EL	Fahrgestellnummer ab: 4F-5-000 001 Vehicle Identification Number from: 4F-5-000 001
			7.06117.42.0	SV-NWV	EL	mit Dichtring with O-ring  ch. 4F-5-000 001→
2.8 FSI quattro 140 kW (190 PS) CCDA	10.2008→08.2011		7.22880.01.0	EUV-LS	EL	
			7.22880.01.0	EUV-SR	EL	
			7.06117.42.0	SV-NWV	EL	mit Dichtring with O-ring
2.8 FSI quattro 162 kW (220 PS) CCEA	10.2008→08.2011		7.22880.01.0	EUV-LS	EL	
			7.22880.01.0	EUV-SR	EL	
			7.06117.42.0	SV-NWV	EL	mit Dichtring with O-ring
3.0 160-162 kW (218-220 PS) BBJ	03.2005→05.2006		7.01805.01.0	EUV-LS	EL	
			7.21895.55.0	LDRV	EL	
3.0 TDI quattro 165 kW (225 PS) BMK	03.2005→05.2006		7.01019.01.0	DW-AGR	EP	 ch. 4F-5-000 001→
			7.02256.00.0	EUV-AGR	EP	 ch. 4F-5-000 001→
			7.02256.00.0	EUV-LS	EP	 ch. 4F-5-000 001→
3.0 TDI quattro 155 kW (211 PS) BNG	03.2005→08.2011		7.01019.01.0	DW-AGR	EP	 ch. 4F-5-000 001→
			7.02256.00.0	EUV-AGR	EP	 ch. 4F-5-000 001→
			7.02256.00.0	EUV-LS	EP	 ch. 4F-5-000 001→

A



A6 C6 Avant (4F5)



























48

3.0 TDI quattro 155 kW (211 PS) CDYB	03.2005→08.2011		7.02256.00.0	EUV-AGR	EP	
			7.22880.01.0	EUV-LS	EL	
3.0 TDI quattro 171 kW (233 PS) ASB	06.2006→10.2008		7.01019.01.0	DW-AGR	EP	ch. 4F-5-000 001→
			7.02256.00.0	EUV-AGR	EP	ch. 4F-5-000 001→
			7.02256.00.0	EUV-LS	EP	ch. 4F-5-000 001→
3.0 TDI quattro 176 kW (240 PS) CDYA, CDYC	10.2008→08.2011		7.02256.00.0	EUV-AGR	EP	
			7.22880.01.0	EUV-LS	EL	
3.0 TFSI quattro 220 kW (299 PS) CCAA	10.2008→08.2011		7.22880.01.0	EUV-SR	EL	
			7.28098.15.0	EUV-SR	EL	
			7.06117.42.0	SV-NWV	EL	mit Dichtring with O-ring
3.0 TFSI quattro 213 kW (290 PS) CAJA	10.2008→08.2011		7.22880.01.0	EUV-SR	EL	
			7.28098.15.0	EUV-SR	EL	
			7.06117.42.0	SV-NWV	EL	mit Dichtring with O-ring
3.0 quattro 160-162 kW (218-220 PS) BBJ	03.2005→05.2006		7.21895.55.0	LDRV	EL	
3.2 FSI 188 kW (255 PS) AUK	03.2005→10.2008		7.22880.01.0	EUV-LS	EL	Fahrgestellnummer ab: 4F-5-000 001 Vehicle Identification Number from: 4F-5-000 001
			7.22880.01.0	EUV-SR	EL	Fahrgestellnummer ab: 4F-5-000 001 Vehicle Identification Number from: 4F-5-000 001
3.2 FSI quattro 188-190 kW (255-258 PS) AUK, BKH	03.2005→10.2008		7.22880.01.0	EUV-LS	EL	AUK, BKH: Fahrgestellnummer ab: 4F-5-000 001 Vehicle Identification Number from: 4F-5-000 001
			7.22880.01.0	EUV-SR	EL	AUK: Fahrgestellnummer ab: 4F-5-000 001 Vehicle Identification Number from: 4F-5-000 001 BKH: Korea (Republik) Korea (Republic)
4.2 FSI quattro 250-257 kW (340-350 PS) BVJ	06.2006→08.2011		7.22880.01.0	EUV-LS	EL	Fahrgestellnummer ab: 4F-5-000 001 Vehicle Identification Number from: 4F-5-000 001
			7.22880.01.0	EUV-SR	EL	Fahrgestellnummer ab: 4F-5-000 001 Vehicle Identification Number from: 4F-5-000 001
4.2 quattro 246 kW (335 PS) BAT	03.2005→05.2006		7.22880.01.0	EUV-LS	EL	Fahrgestellnummer ab: 4F-5-000 001 Vehicle Identification Number from: 4F-5-000 001
			7.28098.15.0	EUV-SL	EL	Fahrgestellnummer ab: 4F-5-000 001 Vehicle Identification Number from: 4F-5-000 001
RS6 quattro 426 kW (580 PS) BUH	04.2008→08.2010		7.22880.01.0	EUV-SR	EL	
S6 quattro 320 kW (435 PS) BXA	03.2006→08.2011		7.22880.01.0	EUV-SL	EL	Fahrgestellnummer ab: 4F-5-000 001 Vehicle Identification Number from: 4F-5-000 001

A6 C7 (4G2, 4GC)

49

1.8 TFSI 140 kW (190 PS) CYGA	09.2014→09.2018		7.02256.18.0	EUV-SR	EP	
			7.02901.05.0	SUV	EL	
			7.06117.26.0	ZM-NWV	EL	











 					
A6 C7 (4G2, 4GC)					49
2.0 TDI 130 kW (177 PS) CGLC, CMGB	03.2011→09.2018	 7.02256.00.0	EUV-AGR	EP	 CGLC, CMGB:  ch. 4G-B-000 001→
2.0 TDI 120 kW (163 PS) CGLD	03.2011→09.2018	 7.02256.00.0	EUV-AGR	EP	 ch. 4G-B-000 001→
2.0 TDI 100 kW (136 PS) CGLE	01.2012→09.2018	 7.02256.00.0	EUV-AGR	EP	 ch. 4G-B-000 001→
2.0 TFSI 155-164 kW (211-223 PS) CAEB	03.2011→05.2013	 7.03280.04.0	EUV-SR	EL	Fahrgestellnummer ab: 4G-B-000 001 Vehicle Identification Number from: 4G-B-000 001 nur in Verbindung mit: Fahrzeug umgerüstet only in connection with: Fahrzeug umgerüstet
		7.22880.01.0	EUV-SR	EL	Fahrgestellnummer ab: 4G-B-000 001 Vehicle Identification Number from: 4G-B-000 001
		7.00470.07.0	LDRV	EL	 ch. 4G-B-000 001→
		7.02901.05.0	SUV	EL	 ch. 4G-B-000 001→
		7.01830.13.0	SUV	EL	
		7.06117.26.0	ZM-NWV	EL	Fahrgestellnummer ab: 4G-B-000 001 Vehicle Identification Number from: 4G-B-000 001
2.0 TFSI 132 kW (180 PS) CDNB	05.2011→09.2018	 7.03280.04.0	EUV-SR	EL	Fahrgestellnummer ab: 4G-B-000 001 Vehicle Identification Number from: 4G-B-000 001 nur in Verbindung mit: Fahrzeug umgerüstet only in connection with: Fahrzeug umgerüstet
		7.22880.01.0	EUV-SR	EL	Fahrgestellnummer ab: 4G-B-000 001 Vehicle Identification Number from: 4G-B-000 001
		7.00470.07.0	LDRV	EL	 ch. 4G-B-000 001→
		7.02901.05.0	SUV	EL	 ch. 4G-B-000 001→
		7.06117.26.0	ZM-NWV	EL	Fahrgestellnummer ab: 4G-B-000 001 Vehicle Identification Number from: 4G-B-000 001
2.0 TFSI 162 kW (220 PS) CAED	05.2013→09.2018	 7.03280.04.0	EUV-SR	EL	Fahrgestellnummer ab: 4G-B-000 001 Vehicle Identification Number from: 4G-B-000 001 nur in Verbindung mit: Fahrzeug umgerüstet only in connection with: Fahrzeug umgerüstet
		7.00470.07.0	LDRV	EL	 ch. 4G-B-000 001→
		7.01830.13.0	SUV	EL	
		7.02901.05.0	SUV	EL	
		7.06117.26.0	ZM-NWV	EL	Fahrgestellnummer ab: 4G-B-000 001 Vehicle Identification Number from: 4G-B-000 001
2.0 TFSI 185 kW (252 PS) CYNB	09.2014→09.2018	 7.01830.13.0	SUV	EL	
		7.06117.26.0	ZM-NWV	EL	
2.0 TFSI 185 kW (252 PS) CYPA	09.2014→09.2018	 7.02256.18.0	EUV-SR	EP	
		7.01830.13.0	SUV	EL	
		7.06117.26.0	ZM-NWV	EL	
2.0 TFSI hybrid 155 kW (211 PS) CHJA	11.2011→09.2018	 7.22880.01.0	EUV-SR	EL	Fahrgestellnummer ab: 4G-B-000 001 Vehicle Identification Number from: 4G-B-000 001
		7.00470.07.0	LDRV	EL	 ch. 4G-B-000 001→
		7.02901.05.0	SUV	EL	 ch. 4G-B-000 001→































A



A6 C7 (4G2, 4GC)

49

		7.06117.26.0	ZM-NWV	EL	Fahrgestellnummer ab: 4G-B-000 001 Vehicle Identification Number from: 4G-B-000 001	
2.0 TFSI quattro 155-164 kW (211-223 PS) CAEB	05.2012→05.2013		7.03280.04.0	EUV-SR	EL	Fahrgestellnummer ab: 4G-B-000 001 Vehicle Identification Number from: 4G-B-000 001 nur in Verbindung mit: Fahrzeug umgerüstet only in connection with: Fahrzeug umgerüstet
			7.22880.01.0	EUV-SR	EL	Fahrgestellnummer ab: 4G-B-000 001 Vehicle Identification Number from: 4G-B-000 001
			7.00470.07.0	LDRV	EL	 ch. 4G-B-000 001→
			7.02901.05.0	SUV	EL	 ch. 4G-B-000 001→
			7.01830.13.0	SUV	EL	
		7.06117.26.0	ZM-NWV	EL	Fahrgestellnummer ab: 4G-B-000 001 Vehicle Identification Number from: 4G-B-000 001	
2.0 TFSI quattro 155-164 kW (211-223 PS) CAEB	01.2013→09.2018		7.03280.04.0	EUV-SR	EL	Fahrgestellnummer ab: 4G-B-000 001 Vehicle Identification Number from: 4G-B-000 001 nur in Verbindung mit: Fahrzeug umgerüstet only in connection with: Fahrzeug umgerüstet
			7.22880.01.0	EUV-SR	EL	Fahrgestellnummer ab: 4G-B-000 001 Vehicle Identification Number from: 4G-B-000 001
2.0 TFSI quattro 162 kW (220 PS) CAED	05.2013→09.2018		7.03280.04.0	EUV-SR	EL	Fahrgestellnummer ab: 4G-B-000 001 Vehicle Identification Number from: 4G-B-000 001 nur in Verbindung mit: Fahrzeug umgerüstet only in connection with: Fahrzeug umgerüstet
			7.01830.13.0	SUV	EL	
			7.02901.05.0	SUV	EL	
			7.06117.26.0	ZM-NWV	EL	Fahrgestellnummer ab: 4G-B-000 001 Vehicle Identification Number from: 4G-B-000 001
2.0 TFSI quattro 185 kW (252 PS) CYNB	05.2014→09.2018		7.01830.13.0	SUV	EL	
			7.02901.05.0	SUV	EL	
			7.06117.26.0	ZM-NWV	EL	
2.0 TFSI quattro 185 kW (252 PS) CYPA	05.2014→09.2018		7.02256.18.0	EUV-SR	EP	
			7.01830.13.0	SUV	EL	
			7.02901.05.0	SUV	EL	
			7.06117.26.0	ZM-NWV	EL	
2.0 TFSI quattro 183 kW (249 PS) CYPB	05.2015→09.2018		7.02256.18.0	EUV-SR	EP	
			7.02901.05.0	SUV	EL	
			7.06117.26.0	ZM-NWV	EL	
2.8 FSI 150 kW (204 PS) CHVA	11.2010→04.2015		7.22880.01.0	EUV-SR	EL	Fahrgestellnummer ab: 4G-B-000 001 Vehicle Identification Number from: 4G-B-000 001
			7.06117.47.0	SV-NWV	EH	mit Dichtring with O-ring Fahrgestellnummer ab: 4G-B-000 001 Vehicle Identification Number from: 4G-B-000 001
2.8 FSI quattro 150 kW (204 PS) CHVA	11.2010→04.2015		7.22880.01.0	EUV-SR	EL	 ch. 4G-B-000 001→







					
A6 C7 (4G2, 4GC)					49
			7.06117.47.0	SV-NWV	EH mit Dichtring with O-ring Fahrgestellnummer ab: 4G-B-000 001 Vehicle Identification Number from: 4G-B-000 001
2.8 FSI quattro 162 kW (220 PS) CVPA	09.2014→09.2018		7.22880.01.0	EUV-SR	EL
			7.06117.47.0	SV-NWV	EH mit Dichtring with O-ring
3.0 TDI 150 kW (204 PS) CLAB	11.2010→09.2018		7.02256.00.0	EUV-AGR	EP  ch. 4G-B-000 001→
3.0 TDI 155 kW (211 PS) CTCB	09.2014→09.2018		7.02256.00.0	EUV-AGR	EP
3.0 TDI 160 kW (218 PS) CTCC	09.2014→09.2018		7.02256.00.0	EUV-AGR	EP
3.0 TDI quattro 150 kW (204 PS) CLAA	03.2011→09.2018		7.02256.00.0	EUV-AGR	EP  ch. 4G-B-000 001→
3.0 TDI quattro 180 kW (245 PS) CDUC, CDUD, CKVB, CKVC	03.2011→09.2018		7.02256.00.0	EUV-AGR	EP  CDUC, CDUD, CKVB, CKVC:  ch. 4G-B-000 001→
3.0 TDI quattro 230 kW (313 PS) CGQB	11.2011→09.2018		7.02256.00.0	EUV-AGR	EP  ch. 4G-B-000 001→
3.0 TDI quattro 176 kW (239 PS) CPNB	05.2013→09.2018		7.02256.00.0	EUV-AGR	EP  ch. 4G-B-000 001→
3.0 TDI quattro 155 kW (211 PS) CRTF	09.2014→09.2018		7.02256.00.0	EUV-AGR	EP
3.0 TDI quattro 160 kW (218 PS) CRTE, CZVA	09.2014→09.2018		7.02256.00.0	EUV-AGR	EP
3.0 TDI quattro 200 kW (272 PS) CRTD	09.2014→09.2018		7.02256.00.0	EUV-AGR	EP
3.0 TDI quattro 235 kW (320 PS) CVUA	09.2014→09.2018		7.02256.00.0	EUV-AGR	EP
3.0 TDI quattro 240 kW (326 PS) CVUB	09.2014→09.2018		7.02256.00.0	EUV-AGR	EP
3.0 TFSI quattro 220 kW (299 PS) CCAA	11.2010→05.2012		7.28098.15.0	EUV-SR	EL
3.0 TFSI quattro 220 kW (300 PS) CGWB	11.2010→05.2012		7.22880.01.0	EUV-SL	EL Fahrgestellnummer ab: 4G-B-000 001 Vehicle Identification Number from: 4G-B-000 001
			7.22880.01.0	EUV-SR	EL Fahrgestellnummer ab: 4G-B-000 001 Vehicle Identification Number from: 4G-B-000 001
			7.28098.15.0	EUV-SR	EL Fahrgestellnummer ab: 4G-B-000 001 Vehicle Identification Number from: 4G-B-000 001
			7.06117.47.0	SV-NWV	EH mit Dichtring with O-ring Fahrgestellnummer ab: 4G-B-000 001 Vehicle Identification Number from: 4G-B-000 001
3.0 TFSI quattro 228-231 kW (310-314 PS) CGWD, CGXB, CTUA	03.2011→09.2018		7.22880.01.0	EUV-SL	EL  ch. 4G-B-000 001→
			7.22880.01.0	EUV-SR	EL  CGWD, CGXB, CTUA: Fahrgestellnummer ab: 4G-B-000 001 Vehicle Identification Number from: 4G-B-000 001
			7.28098.15.0	EUV-SR	EL  CGWD, CGXB, CTUA: Fahrgestellnummer ab: 4G-B-000 001 Vehicle Identification Number from: 4G-B-000 001

A













A6 C7 (4G2, 4GC)





























49

			7.06117.47.0	SV-NWV	EH	mit Dichtring with O-ring  CGWD, CGXB, CTUA: Fahrgestellnummer ab: 4G-B-000 001 Vehicle Identification Number from: 4G-B-000 001
3.0 TFSI quattro 228-231 kW (310-314 PS) CTUA	01.2013→09.2018		7.22880.01.0	EUV-SR	EL	Fahrgestellnummer ab: 4G-B-000 001 Vehicle Identification Number from: 4G-B-000 001
			7.28098.15.0	EUV-SR	EL	Fahrgestellnummer ab: 4G-B-000 001 Vehicle Identification Number from: 4G-B-000 001
3.0 TFSI quattro 245 kW (333 PS) CREC	09.2014→09.2018		7.22880.01.0	EUV-SL	EL	
			7.22880.01.0	EUV-SR	EL	
			7.06117.47.0	SV-NWV	EH	mit Dichtring with O-ring
3.0 TFSI quattro 250 kW (340 PS) CREH	09.2016→09.2018		7.22880.01.0	EUV-SL	EL	
			7.22880.01.0	EUV-SR	EL	
			7.06117.47.0	SV-NWV	EH	mit Dichtring with O-ring
S6 quattro 309 kW (420 PS) CEUC	02.2012→09.2018		7.03280.04.0	EUV-SL	EL	Fahrgestellnummer ab: 4G-B-000 001 Vehicle Identification Number from: 4G-B-000 001
			7.03280.04.0	EUV-SR	EL	Fahrgestellnummer ab: 4G-B-000 001 Vehicle Identification Number from: 4G-B-000 001
			7.01830.13.0	SUV	EL	
			7.06117.47.0	SV-NWV	EH	mit Dichtring with O-ring Fahrgestellnummer ab: 4G-B-000 001 Vehicle Identification Number from: 4G-B-000 001
S6 quattro 331 kW (450 PS) CTGE	10.2014→09.2018		7.03280.04.0	EUV-SL	EL	
			7.03280.04.0	EUV-SR	EL	
			7.01830.13.0	SUV	EL	
			7.06117.47.0	SV-NWV	EH	mit Dichtring with O-ring

A6 C7 Avant (4G5, 4GD)

50

1.8 TFSI 140 kW (190 PS) CYGA	09.2014→09.2018		7.02256.18.0	EUV-SR	EP	
			7.02901.05.0	SUV	EL	
			7.06117.26.0	ZM-NWV	EL	
2.0 TDI 130 kW (177 PS) CGLC, CMGB	05.2011→09.2018		7.02256.00.0	EUV-AGR	EP	 CGLC, CMGB:  ch. 4G-B-000 001→
2.0 TDI 120 kW (163 PS) CGLD	05.2011→09.2018		7.02256.00.0	EUV-AGR	EP	 ch. 4G-B-000 001→
2.0 TDI 100 kW (136 PS) CGLE	01.2012→09.2018		7.02256.00.0	EUV-AGR	EP	 ch. 4G-B-000 001→
2.0 TFSI 132 kW (180 PS) CDNB	06.2011→09.2018		7.03280.04.0	EUV-SR	EL	Fahrgestellnummer ab: 4G-BV-000 001 Vehicle Identification Number from: 4G-BV-000 001 nur in Verbindung mit: Fahrzeug umgerüstet only in connection with: Fahrzeug umgerüstet
			7.22880.01.0	EUV-SR	EL	Fahrgestellnummer ab: 4G-B-000 001 Vehicle Identification Number from: 4G-B-000 001
			7.00470.07.0	LDRV	EL	 ch. 4G-B-000 001→









					
A6 C7 Avant (4G5, 4GD)					50
			7.02901.05.0 7.06117.26.0	SUV ZM-NWV	EL  ch. 4G-B-000 001→ EL Fahrgestellnummer ab: 4G-B-000 001 Vehicle Identification Number from: 4G-B-000 001
2.0 TFSI 185 kW (252 PS) CYNB	09.2014→09.2018		7.01830.13.0 7.02901.05.0 7.06117.26.0	SUV SUV ZM-NWV	EL EL EL
2.0 TFSI 185 kW (252 PS) CYPA	09.2014→09.2018		7.02256.18.0 7.01830.13.0 7.02901.05.0 7.06117.26.0	EUV-SR SUV SUV ZM-NWV	EP EL EL EL
2.0 TFSI quattro 183 kW (249 PS) CYPB	05.2015→09.2018		7.02256.18.0 7.02901.05.0 7.06117.26.0	EUV-SR SUV ZM-NWV	EP EL EL
2.0 TFSI quattro 185 kW (252 PS) CYPA	05.2015→09.2018		7.02256.18.0 7.01830.13.0 7.02901.05.0 7.06117.26.0	EUV-SR SUV SUV ZM-NWV	EP EL EL EL
2.8 FSI 150 kW (204 PS) CHVA	05.2011→04.2015		7.22880.01.0 7.06117.47.0	EUV-SR SV-NWV	EL Fahrgestellnummer ab: 4G-B-000 001 Vehicle Identification Number from: 4G-B-000 001 EH mit Dichtring with O-ring Fahrgestellnummer ab: 4G-B-000 001 Vehicle Identification Number from: 4G-B-000 001
2.8 FSI quattro 150 kW (204 PS) CHVA	05.2011→04.2015		7.22880.01.0 7.06117.47.0	EUV-SR SV-NWV	EL Fahrgestellnummer ab: 4G-B-000 001 Vehicle Identification Number from: 4G-B-000 001 EH mit Dichtring with O-ring Fahrgestellnummer ab: 4G-B-000 001 Vehicle Identification Number from: 4G-B-000 001
2.8 FSI quattro 162 kW (220 PS) CVPA	09.2014→09.2018		7.22880.01.0 7.06117.47.0	EUV-SR SV-NWV	EL EH mit Dichtring with O-ring
3.0 TDI 150 kW (204 PS) CLAB	05.2011→09.2018		7.02256.00.0	EUV-AGR	EP  ch. 4G-B-000 001→
3.0 TDI 155 kW (211 PS) CTCB	09.2014→09.2018		7.02256.00.0	EUV-AGR	EP
3.0 TDI 160 kW (218 PS) CTCC	09.2014→09.2018		7.02256.00.0	EUV-AGR	EP
3.0 TDI quattro 150 kW (204 PS) CLAA	05.2011→09.2018		7.02256.00.0	EUV-AGR	EP  ch. 4G-B-000 001→
3.0 TDI quattro 180 kW (245 PS) CDUC, CDUD, CKVB, CKVC	05.2011→09.2018		7.02256.00.0	EUV-AGR	EP  CDUC, CDUD, CKVB, CKVC:  ch. 4G-B-000 001→
3.0 TDI quattro 230 kW (313 PS) CGQB	11.2011→09.2018		7.02256.00.0	EUV-AGR	EP  ch. 4G-B-000 001→
3.0 TDI quattro 155 kW (211 PS) CRTF	09.2014→09.2018		7.02256.00.0	EUV-AGR	EP
3.0 TDI quattro 160 kW (218 PS) CRTE, CZVA	09.2014→09.2018		7.02256.00.0	EUV-AGR	EP
3.0 TDI quattro 200 kW (272 PS) CRTD	09.2014→09.2018		7.02256.00.0	EUV-AGR	EP

A



A6 C7 Avant (4G5, 4GD)

50





















3.0 TDI quattro 235 kW (320 PS) CVUA	09.2014→09.2018	 7.02256.00.0	EUV-AGR	EP	
3.0 TDI quattro 240 kW (326 PS) CVUB	09.2014→09.2018	 7.02256.00.0	EUV-AGR	EP	
3.0 TFSI quattro 220 kW (300 PS) CGWB	05.2011→05.2012	 7.22880.01.0	EUV-SL	EL	Fahrgestellnummer ab: 4G-B-000 001 Vehicle Identification Number from: 4G-B-000 001
		7.22880.01.0	EUV-SR	EL	Fahrgestellnummer ab: 4G-B-000 001 Vehicle Identification Number from: 4G-B-000 001
		7.28098.15.0	EUV-SR	EL	Fahrgestellnummer ab: 4G-B-000 001 Vehicle Identification Number from: 4G-B-000 001
		7.06117.47.0	SV-NWV	EH	mit Dichtring with O-ring Fahrgestellnummer ab: 4G-B-000 001 Vehicle Identification Number from: 4G-B-000 001
3.0 TFSI quattro 228 kW (310 PS) CGWD	11.2011→09.2018	 7.22880.01.0	EUV-SR	EL	Fahrgestellnummer ab: 4G-B-000 001 Vehicle Identification Number from: 4G-B-000 001
		7.28098.15.0	EUV-SR	EL	Fahrgestellnummer ab: 4G-B-000 001 Vehicle Identification Number from: 4G-B-000 001
		7.06117.47.0	SV-NWV	EH	mit Dichtring with O-ring Fahrgestellnummer ab: 4G-B-000 001 Vehicle Identification Number from: 4G-B-000 001
3.0 TFSI quattro 245 kW (333 PS) CREC	09.2014→09.2018	 7.22880.01.0	EUV-SL	EL	
		7.22880.01.0	EUV-SR	EL	
		7.06117.47.0	SV-NWV	EH	mit Dichtring with O-ring
RS6 performance quattro 445 kW (605 PS) CWUC	11.2015→09.2018	 7.03280.04.0	EUV-SL	EL	
		7.03280.04.0	EUV-SR	EL	
		7.06117.47.0	SV-NWV	EH	mit Dichtring with O-ring
RS6 quattro 412 kW (560 PS) CRDB, CWUB	01.2013→09.2018	 7.03280.04.0	EUV-SL	EL	
		7.03280.04.0	EUV-SR	EL	
		7.01830.13.0	SUV	EL	
		7.06117.47.0	SV-NWV	EH	mit Dichtring with O-ring
S6 quattro 309 kW (420 PS) CEUC	02.2012→09.2018	 7.03280.04.0	EUV-SL	EL	Fahrgestellnummer ab: 4G-B-000 001 Vehicle Identification Number from: 4G-B-000 001
		7.03280.04.0	EUV-SR	EL	Fahrgestellnummer ab: 4G-B-000 001 Vehicle Identification Number from: 4G-B-000 001
		7.01830.13.0	SUV	EL	
		7.06117.47.0	SV-NWV	EH	mit Dichtring with O-ring Fahrgestellnummer ab: 4G-B-000 001 Vehicle Identification Number from: 4G-B-000 001
S6 quattro 331 kW (450 PS) CTGE	10.2014→09.2018	 7.03280.04.0	EUV-SL	EL	
		7.03280.04.0	EUV-SR	EL	
		7.01830.13.0	SUV	EL	
		7.06117.47.0	SV-NWV	EH	mit Dichtring with O-ring

A6 C8 (4A2)						51
45 TDI Mild Hybrid quattro 170 kW (231 PS) DDVE	07.2018→		7.02256.00.0	EUV-AGR	EP	
45 TFSI Mild Hybrid 180 kW (245 PS) DKNA, DLHA	08.2018→		7.02901.05.0	SUV	EL	
45 TFSI Mild Hybrid quattro 180 kW (245 PS) DKNA, DLHA	08.2018→		7.02901.05.0	SUV	EL	
45 TFSI quattro 185 kW (252 PS) DLHB	11.2019→		7.22880.01.0	EUV-KK	EL	Produktionsdatum bis: 17.08.2020 Production date to: 17.08.2020
50 TDI Mild Hybrid quattro 210 kW (286 PS) DDVB	02.2018→		7.02256.00.0	EUV-AGR	EP	
			7.22880.01.0	EUV-AGR	EL	
50 TFSI e quattro 185 kW (252 PS) DLGA	11.2019→		7.02901.05.0	SUV	EL	
			7.02256.41.0	SV-KK	EL	
			7.06117.26.0	ZM-NWV	EL	
55 TFSI e quattro 185 kW (252 PS) DLGA	11.2019→		7.02901.05.0	SUV	EL	
			7.02256.41.0	SV-KK	EL	
			7.06117.26.0	ZM-NWV	EL	
S6 TDI Mild Hybrid quattro 257 kW (349 PS) DEWA	03.2019→		7.22880.01.0	EUV-AGR	EL	
S6 TFSI Mild Hybrid quattro 331 kW (450 PS) DKMB	01.2020→		7.22880.01.0	EUV-KK	EL	Produktionsdatum bis: 17.08.2020 Production date to: 17.08.2020
			7.22880.01.0	EUV-LS	EL	
A6 C8 Avant (4A5)						52
45 TDI Mild Hybrid quattro 170 kW (231 PS) DDVE	05.2018→		7.02256.00.0	EUV-AGR	EP	
45 TFSI Mild Hybrid 180 kW (245 PS) DKNA, DLHA	08.2018→		7.02901.05.0	SUV	EL	
45 TFSI Mild Hybrid quattro 180 kW (245 PS) DKNA, DLHA	08.2018→		7.02901.05.0	SUV	EL	
50 TDI Mild Hybrid quattro 210 kW (286 PS) DDVB	05.2018→		7.02256.00.0	EUV-AGR	EP	
55 TFSI e quattro 185 kW (252 PS) DLGA	04.2020→		7.02256.41.0	SV-KK	EL	
			7.06117.26.0	ZM-NWV	EL	
A7 Sportback (4GA, 4GF)						53
1.8 TFSI 140 kW (190 PS) CYGA	04.2015→05.2018		7.02256.18.0	EUV-SR	EP	
			7.02901.05.0	SUV	EL	
			7.06117.26.0	ZM-NWV	EL	
2.0 TFSI 185 kW (252 PS) CYPA	09.2014→05.2018		7.02256.18.0	EUV-SR	EP	
			7.02901.05.0	SUV	EL	
			7.06117.26.0	ZM-NWV	EL	
2.0 TFSI quattro 183 kW (249 PS) CYPB	05.2015→05.2018		7.02256.18.0	EUV-SR	EP	
			7.02901.05.0	SUV	EL	







A7 Sportback (4GA, 4GF)









53

			7.06117.26.0	ZM-NWV	EL	
2.0 TFSI quattro 185 kW (252 PS) CYNB	05.2015→05.2018		7.02901.05.0	SUV	EL	
			7.06117.26.0	ZM-NWV	EL	
2.0 TFSI quattro 185 kW (252 PS) CYPA	05.2015→05.2018		7.02256.18.0	EUV-SR	EP	
			7.02901.05.0	SUV	EL	
			7.06117.26.0	ZM-NWV	EL	
2.5 FSI 150 kW (204 PS) CLXB	09.2012→03.2015		7.22880.01.0	EUV-SR	EL	
			7.06117.47.0	SV-NWV	EH	mit Dichtring with O-ring
2.8 FSI 150 kW (204 PS) CHVA	02.2011→03.2015		7.22880.01.0	EUV-SR	EL	
			7.06117.47.0	SV-NWV	EH	mit Dichtring with O-ring
2.8 FSI quattro 150 kW (204 PS) CHVA, CNYA	10.2010→03.2015		7.22880.01.0	EUV-SR	EL	
			7.06117.47.0	SV-NWV	EH	mit Dichtring with O-ring
2.8 FSI quattro 162 kW (220 PS) CVPA	09.2014→05.2018		7.22880.01.0	EUV-SR	EL	
			7.06117.47.0	SV-NWV	EH	mit Dichtring with O-ring
3.0 TDI 150 kW (204 PS) CLAB	11.2010→03.2015		7.02256.00.0	EUV-AGR	EP	
3.0 TDI 160 kW (218 PS) CTCC, CZVB	07.2014→05.2018		7.02256.00.0	EUV-AGR	EP	
3.0 TDI 140 kW (190 PS) CZVE	11.2015→05.2018		7.02256.00.0	EUV-AGR	EP	
3.0 TDI 155 kW (211 PS) CZVD	11.2015→05.2018		7.02256.00.0	EUV-AGR	EP	
3.0 TDI quattro 180 kW (245 PS) CDUC, CDUD, CKVB, CKVC	10.2010→06.2016		7.02256.00.0	EUV-AGR	EP	
3.0 TDI quattro 150 kW (204 PS) CLAA	12.2010→03.2015		7.02256.00.0	EUV-AGR	EP	
3.0 TDI quattro 230 kW (313 PS) CGQB	11.2011→03.2015		7.02256.00.0	EUV-AGR	EP	
3.0 TDI quattro 176 kW (239 PS) CPNB	05.2013→06.2017		7.02256.00.0	EUV-AGR	EP	
3.0 TDI quattro 235 kW (320 PS) CVUA	05.2014→05.2018		7.02256.00.0	EUV-AGR	EP	
3.0 TDI quattro 160 kW (218 PS) CRTE, CZVA	07.2014→05.2018		7.02256.00.0	EUV-AGR	EP	
3.0 TDI quattro 155 kW (211 PS) CRTF, CTCB	07.2014→05.2018		7.02256.00.0	EUV-AGR	EP	
3.0 TDI quattro 240 kW (326 PS) CVUB	09.2014→05.2018		7.02256.00.0	EUV-AGR	EP	
3.0 TDI quattro 140 kW (190 PS) CZVF	11.2015→05.2018		7.02256.00.0	EUV-AGR	EP	
3.0 TFSI quattro 220 kW (300 PS) CGWB, CHMA	10.2010→05.2012		7.22880.01.0	EUV-SL	EL	
			7.28098.15.0	EUV-SR	EL	
			7.06117.47.0	SV-NWV	EH	mit Dichtring with O-ring
3.0 TFSI quattro 228-231 kW (310-314 PS) CGWD, CGXB, CTTA, CTUA	01.2011→03.2015		7.22880.01.0	EUV-SL	EL	
			7.22880.01.0	EUV-SR	EL	

A7 Sportback (4GA, 4GF)
53

			7.28098.15.0 7.06117.47.0	EUV-SR SV-NWV	EL EH	mit Dichtring with O-ring
3.0 TFSI quattro 245 kW (333 PS) CREC	05.2014→05.2018		7.22880.01.0 7.22880.01.0 7.06117.47.0	EUV-SL EUV-SR SV-NWV	EL EL EH	mit Dichtring with O-ring
RS7 performance quattro 445 kW (605 PS) CWUC	11.2015→04.2018		7.03280.04.0 7.03280.04.0 7.06117.47.0	EUV-SL EUV-SR SV-NWV	EL EL EH	mit Dichtring with O-ring
RS7 quattro 412 kW (560 PS) CRDB, CWUB	10.2013→04.2018		7.03280.04.0 7.03280.04.0 7.01830.13.0 7.06117.47.0	EUV-SL EUV-SR SUV SV-NWV	EL EL EL EH	mit Dichtring with O-ring
S7 quattro 309 kW (420 PS) CEUC	02.2012→03.2015		7.03280.04.0 7.03280.04.0 7.01830.13.0 7.06117.47.0	EUV-SL EUV-SR SUV SV-NWV	EL EL EL EH	mit Dichtring with O-ring
S7 quattro 331 kW (450 PS) CTGE	07.2014→05.2018		7.03280.04.0 7.03280.04.0 7.01830.13.0 7.06117.47.0	EUV-SL EUV-SR SUV SV-NWV	EL EL EL EH	mit Dichtring with O-ring

A7 Sportback (4KA)
54

40 TFSI 140 kW (190 PS) DKYA	11.2019→		7.06117.26.0	ZM-NWV	EL	
45 TDI Mild Hybrid quattro 155 kW (211 PS) DDVF	04.2018→		7.02256.00.0	EUV-AGR	EP	
45 TDI Mild Hybrid quattro 170 kW (231 PS) DDVE	06.2018→		7.02256.00.0	EUV-AGR	EP	
45 TFSI Mild Hybrid 180 kW (245 PS) DKNA	07.2018→		7.02901.05.0 7.06117.26.0	SUV ZM-NWV	EL EL	
45 TFSI Mild Hybrid 180 kW (245 PS) DLHA	07.2018→		7.02901.05.0	SUV	EL	
45 TFSI Mild hybrid quattro 180 kW (245 PS) DKNA	07.2018→		7.06117.26.0	ZM-NWV	EL	
50 TDI Mild Hybrid quattro 210 kW (286 PS) DDVB	10.2017→		7.22880.01.0	EUV-AGR	EL	
50 TFSI e quattro 185 kW (252 PS) DLGA	11.2019→		7.06117.26.0	ZM-NWV	EL	
55 TFSI Mild Hybrid quattro 250 kW (340 PS) DLZA	10.2017→		7.22880.01.0	EUV-KK	EL	Produktionsdatum bis: 17.08.2020 Production date to: 17.08.2020

A























A7 Sportback (4KA)





























54

55 TFSI e quattro 185 kW (252 PS) DLGA	07.2019→		7.06117.26.0	ZM-NWV	EL	
55 TFSI e quattro 185 kW (252 PS) DLGA	07.2019→		7.06117.26.0	ZM-NWV	EL	
S7 TDI Mild Hybrid quattro 257 kW (349 PS) DEWA	03.2019→		7.22880.01.0	EUV-AGR	EL	
S7 TDI Mild Hybrid quattro	12.2020→		7.03280.04.0	EUV-AGR	EL	
S7 TFSI Mild Hybrid quattro 331 kW (450 PS) DKMB	01.2020→		7.22880.01.0	EUV-KK	EL	Produktionsdatum bis: 17.08.2020 Production date to: 17.08.2020
			7.22880.01.0	EUV-LS	EL	

A8 D2 (4D2, 4D8)

55

2.5 TDI 110 kW (150 PS) AFB, AKN	01.1997→04.2000		7.21903.49.0	DW-TL	EP	
2.5 TDI 132 kW (180 PS) AKE	09.2000→09.2002		7.21903.49.0	DW-TL	EP	
2.5 TDI quattro 110 kW (150 PS) AFB, AKN	07.1997→04.2000		7.21903.49.0	DW-TL	EP	
2.5 TDI quattro 132 kW (180 PS) AKE	09.2000→09.2002		7.21903.49.0	DW-TL	EP	
2.8 128 kW (174 PS) AAH	03.1994→03.1996		7.01805.01.0	EUV-SR	EL	
2.8 120-128 kW (163-174 PS) AEJ	07.1995→03.1996		7.01805.01.0	EUV-SR	EL	
2.8 142 kW (193 PS) ACK, ALG, AMX, APR, AQD	04.1996→09.2002		7.01805.01.0	EUV-SR	EL	 AMX, APR, AQD: ch. 4D-X-005 001→
2.8 quattro 128 kW (174 PS) AAH	03.1994→03.1996		7.01805.01.0	EUV-SR	EL	
2.8 quattro 120-128 kW (163-174 PS) AEJ	07.1995→03.1996		7.01805.01.0	EUV-SR	EL	
2.8 quattro 142 kW (193 PS) ACK, AMX, APR, AQD	04.1996→09.2002		7.01805.01.0	EUV-SR	EL	 AMX, APR, AQD: ch. 4D-X-005 001→
3.7 169 kW (230 PS) AEW	07.1995→12.1998		7.01805.01.0	EUV-SR	EL	
3.7 quattro 169 kW (230 PS) AEW, AKJ	07.1995→11.1998		7.01805.01.0	EUV-SR	EL	
4.2 quattro 220-224 kW (299-305 PS) ABZ, AKG	03.1994→11.1998		7.01805.01.0	EUV-SR	EL	
4.2 quattro 180 kW (245 PS) AEM	03.1994→07.1996		7.01805.01.0	EUV-SR	EL	
4.2 quattro 210 kW (285 PS) AGH	07.1995→09.1998		7.01805.01.0	EUV-SR	EL	
S8 quattro 250 kW (340 PS) AHC, AKH	07.1996→06.1999		7.01805.01.0	EUV-SR	EL	
S8 quattro 265-268 kW (360-364 PS) AQH, AVP, AYS, BCS	06.1999→09.2002		7.22687.50.0	EUV-SR	EP	 AQH, AVP, AYS, BCS: Fahrgestellnummer ab: 4D-X-005 001 Vehicle Identification Number from: 4D-X-005 001 für OE-Nummer: 077 906 283 B, 077 906 283 D for OE number: 077 906 283 B, 077 906 283 D





















						
A8 D3 (4E2, 4E8)						56
2.8 FSI 154 kW (210 PS) BDX	08.2007→07.2010		7.22880.01.0	EUV-SR	EL	mit Dichtring with O-ring
			7.06117.42.0	SV-NWV	EL	
2.8 FSI 170 kW (231 PS) CJBA	01.2009→07.2010		7.22880.01.0	EUV-SR	EL	mit Dichtring with O-ring
			7.06117.42.0	SV-NWV	EL	
3.0 160-162 kW (218-220 PS) BBJ	07.2003→05.2006		7.22880.01.0	EUV-SL	EL	
3.0 162 kW (220 PS) ASN	08.2003→05.2005		7.22880.01.0	EUV-SL	EL	
3.0 TDI quattro 171 kW (233 PS) ASB	08.2003→07.2010		7.01019.01.0	DW-AGR	EP	 ch. 4E-3-000 001→
			7.02256.00.0	EUV-AGR	EP	
3.0 TDI quattro 155 kW (211 PS) BNG	11.2003→07.2010		7.01019.01.0	DW-AGR	EP	 ch. 4E-3-000 001→
			7.02256.00.0	EUV-AGR	EP	
3.0 quattro 162 kW (220 PS) ASN	07.2003→05.2005		7.22880.01.0	EUV-SL	EL	
3.0 quattro 160-162 kW (218-220 PS) BBJ	11.2003→05.2004		7.22880.01.0	EUV-SL	EL	
3.2 FSI 191 kW (260 PS) BPK	06.2005→07.2010		7.22880.01.0	EUV-LS	EL	
			7.22880.01.0	EUV-SR	EL	
3.2 FSI quattro 191 kW (260 PS) BPK	06.2005→07.2010		7.22880.01.0	EUV-LS	EL	
			7.22880.01.0	EUV-SR	EL	
4.0 TDI quattro 202 kW (275 PS) ASE	05.2003→07.2005		7.22903.36.0	DW-AGR	EP	 ch. 4E-3-000 001→
			7.22880.01.0	EUV-LS	EL	
4.2 FSI quattro 250-257 kW (340-350 PS) BVJ	06.2006→07.2010		7.22880.01.0	EUV-SL	EL	
4.2 TDI quattro 235 kW (320 PS) BMC	01.2005→06.2005		7.02256.00.0	EUV-AGR	EP	 ch. 4E-3-000 001→
			7.22880.01.0	EUV-LS	EL	
4.2 TDI quattro 240 kW (326 PS) BVN	07.2005→07.2010		7.02256.00.0	EUV-AGR	EP	 ch. 4E-3-000 001→
			7.22880.01.0	EUV-LS	EL	
4.2 quattro 246 kW (335 PS) BFM	10.2002→07.2010		7.22687.50.0	EUV-SR	EP	Fahrgestellnummer ab: 4E-3-000 001 Vehicle Identification Number from: 4E-3-000 001 rechts oben Upper Right
6.0 W12 quattro 331-335 kW (450-456 PS) BHT, BSB, BTE	12.2003→07.2010		7.28098.04.0	EUV-AGK	EL	BHT, BSB, BTE: Fahrgestellnummer ab: 4E-3-000 001 Vehicle Identification Number from: 4E-3-000 001
			7.22880.01.0	EUV-SL	EL	
S8 quattro 324-331 kW (441-450 PS) BSM	06.2006→07.2010		7.28098.04.0	EUV-AGK	EL	Fahrgestellnummer ab: 4E-3-000 001 Vehicle Identification Number from: 4E-3-000 001
			7.22880.01.0	EUV-SL	EL	
S8 quattro 324-331 kW (441-450 PS) BSM	09.2006→07.2010		7.28098.04.0	EUV-AGK	EL	Fahrgestellnummer ab: 4E-3-000 001 Vehicle Identification Number from: 4E-3-000 001
			7.22880.01.0	EUV-LS	EL	
			7.22880.01.0	EUV-SL	EL	
			7.22880.01.0	EUV-SR	EL	

A







A8 D4 (4H2, 4H8, 4HC, 4HL)

57

2.0 TFSI hybrid 155 kW (211 PS) CHJA	02.2012→11.2015	 7.22880.01.0	EUV-SR	EL	 ch. 4H-A-000 001→ch. 4H-A-010 000 Fahrgestellnummer ab: 4H-A-000 001 Vehicle Identification Number from: 4H-A-000 001
		7.00470.07.0	LDRV	EL	
		7.02901.05.0	SUV	EL	
		7.06117.26.0	ZM-NWV	EL	
2.0 TFSI quattro 185 kW (252 PS) CYPA	09.2016→01.2018	 7.02256.18.0	EUV-SR	EP	
		7.02901.05.0	SUV	EL	
		7.06117.26.0	ZM-NWV	EL	
2.5 TFSI 150 kW (204 PS) CPAA, CVBA	07.2012→06.2016	 7.22880.01.0	EUV-SL	EL	mit Dichtring with O-ring Fahrgestellnummer ab: 4H-A-000 001 Vehicle Identification Number from: 4H-A-000 001 Fahrgestellnummer bis: 4H-A-010 000 Vehicle Identification Number to: 4H-A-010 000
		7.22880.01.0	EUV-SR	EL	
		7.06117.47.0	SV-NWV	EH	
3.0 TDI 150 kW (204 PS) CLAB	09.2011→09.2013	 7.02256.00.0	EUV-AGR	EP	 ch. 4H-A-000 001→ch. 4H-A-010 000
3.0 TDI quattro 184 kW (250 PS) CDTA, CDTC, CMHA	07.2010→01.2018	 7.02256.00.0	EUV-AGR	EP	 CDTA, CMHA:  ch. 4H-A-000 001→ch. 4H-A-010 000
3.0 TDI quattro 155 kW (211 PS) CDTB, CTBB	08.2010→11.2015	 7.02256.00.0	EUV-AGR	EP	 ch. 4H-A-000 001→ch. 4H-A-010 000
3.0 TDI quattro 176 kW (239 PS) CPNA	11.2012→06.2016	 7.02256.00.0	EUV-AGR	EP	 ch. 4H-A-000 001→ch. 4H-A-010 000
3.0 TDI quattro 190 kW (258 PS) CTBA	10.2013→01.2018	 7.02256.00.0	EUV-AGR	EP	
3.0 TDI quattro 193 kW (262 PS) CTBD	05.2015→01.2018	 7.02256.00.0	EUV-AGR	EP	
3.0 TFSI quattro 245-249 kW (333-339 PS) CGXC, CMDA, CTUB	06.2010→01.2018	 7.28098.04.0	EUV-AGK	EL	 CGXC, CMDA, CTUB: Fahrgestellnummer ab: 4H-A-000 001 Vehicle Identification Number from: 4H-A-000 001 Fahrgestellnummer bis: 4H-A-010 000 Vehicle Identification Number to: 4H-A-010 000
		7.22880.01.0	EUV-SL	EL	 CGXC, CMDA, CTUB: Fahrgestellnummer ab: 4H-A-000 001 Vehicle Identification Number from: 4H-A-000 001 Fahrgestellnummer bis: 4H-A-010 000 Vehicle Identification Number to: 4H-A-010 000
		7.28098.15.0	EUV-SR	EL	
		7.06117.47.0	SV-NWV	EH	mit Dichtring with O-ring  CGXC, CMDA, CTUB: Fahrgestellnummer ab: 4H-A-000 001 Vehicle Identification Number from: 4H-A-000 001 Fahrgestellnummer bis: 4H-A-010 000 Vehicle Identification Number to: 4H-A-010 000
3.0 TFSI quattro 245 kW (333 PS) CREC, CTDA	06.2010→01.2018	 7.22880.01.0	EUV-SL	EL	
		7.06117.47.0	SV-NWV	EH	

A8 D4 (4H2, 4H8, 4HC, 4HL)
57









3.0 TFSI quattro 213 kW (290 PS) CGWA	07.2010→04.2014		7.28098.04.0	EUV-AGK	EL	Fahrgestellnummer ab: 4H-A-000 001 Vehicle Identification Number from: 4H-A-000 001 Fahrgestellnummer bis: 4H-A-010 000 Vehicle Identification Number to: 4H-A-010 000
			7.22880.01.0	EUV-SL	EL	
			7.28098.15.0	EUV-SR	EL	Fahrgestellnummer ab: 4H-A-000 001 Vehicle Identification Number from: 4H-A-000 001 Fahrgestellnummer bis: 4H-A-010 001 Vehicle Identification Number to: 4H-A-010 001
3.0 TFSI quattro 213 kW (290 PS) CREG	07.2010→04.2014		7.22880.01.0	EUV-SL	EL	
			7.22880.01.0	EUV-SR	EL	
			7.06117.47.0	SV-NWV	EH	mit Dichtring with O-ring
3.0 TFSI quattro 228 kW (310 PS) CGWD	11.2011→01.2018		7.22880.01.0	EUV-SL	EL	
			7.22880.01.0	EUV-SR	EL	
			7.28098.15.0	EUV-SR	EL	Fahrgestellnummer ab: 4H-A-000 001 Vehicle Identification Number from: 4H-A-000 001 Fahrgestellnummer bis: 4H-A-010 001 Vehicle Identification Number to: 4H-A-010 001
3.0 TFSI quattro 228 kW (310 PS) CREA	11.2011→01.2018		7.22880.01.0	EUV-SL	EL	
			7.22880.01.0	EUV-SR	EL	
			7.06117.47.0	SV-NWV	EH	mit Dichtring with O-ring
4.0 TFSI quattro 309 kW (420 PS) CEUA	03.2012→12.2014		7.28098.04.0	EUV-AGK	EL	Fahrgestellnummer ab: 4H-A-000 001 Vehicle Identification Number from: 4H-A-000 001 Fahrgestellnummer bis: 4H-A-010 000 Vehicle Identification Number to: 4H-A-010 000
			7.03280.04.0	EUV-AGR	EL	Fahrgestellnummer ab: 4H-A-000 001 Vehicle Identification Number from: 4H-A-000 001 Fahrgestellnummer bis: 4H-A-010 000 Vehicle Identification Number to: 4H-A-010 000
			7.03280.04.0	EUV-SR	EL	Fahrgestellnummer ab: 4H-A-000 001 Vehicle Identification Number from: 4H-A-000 001 Fahrgestellnummer bis: 4H-A-010 000 Vehicle Identification Number to: 4H-A-010 000

A



A8 D4 (4H2, 4H8, 4HC, 4HL)

57

			<p>7.01830.13.0 SUV EL 7.06117.47.0 SV-NWV EH</p>	<p>mit Dichtring with O-ring Fahrgestellnummer ab: 4H-A-000 001 Vehicle Identification Number from: 4H-A-000 001 Fahrgestellnummer bis: 4H-A-010 000 Vehicle Identification Number to: 4H-A-010 000</p>
<p>4.0 TFSI quattro 320 kW (435 PS) CTGA</p>	10.2013→12.2015	 <p>7.03280.04.0</p>	<p>EUV-SR EL SUV EL SV-NWV EH</p>	<p>mit Dichtring with O-ring</p>
<p>4.0 TFSI quattro 331 kW (450 PS) CTGF</p>	07.2015→01.2018	 <p>7.03280.04.0</p>	<p>EUV-SL EL SUV EL SV-NWV EH</p>	<p>mit Dichtring with O-ring</p>
<p>4.2 FSI quattro 273 kW (371 PS) CDRA</p>	11.2009→12.2012	 <p>7.22880.01.0</p>	<p>EUV-KK EL EUV-SL EL</p>	
<p>4.2 TDI quattro 258 kW (351 PS) CDSB</p>	11.2009→04.2014	 <p>7.02256.00.0</p>	<p>EUV-AGR EP</p>	<p> ch. 4H-A-000 001→ch. 4H-A-010 000</p>
<p>4.2 TDI quattro 283 kW (385 PS) CTEC</p>	10.2013→01.2018	 <p>7.02256.00.0</p>	<p>EUV-AGR EP</p>	
<p>6.3 W12 quattro 368 kW (500 PS) CEJA</p>	01.2011→01.2018	 <p>7.28098.04.0</p>	<p>EUV-AGK EL</p>	<p>Fahrgestellnummer ab: 4H-A-000 001 Vehicle Identification Number from: 4H-A-000 001 Fahrgestellnummer bis: 4H-A-010 000 Vehicle Identification Number to: 4H-A-010 000</p>
<p>S8 plus quattro 445 kW (605 PS) DDTA</p>	11.2015→01.2018	 <p>7.03280.04.0</p>	<p>EUV-SL EL EUV-SR EL SUV EL SV-NWV EH</p>	<p>mit Dichtring with O-ring</p>
<p>S8 quattro 382-388 kW (520-528 PS) CGTA</p>	04.2012→01.2018	 <p>7.28098.04.0</p>	<p>EUV-AGK EL</p>	<p>Fahrgestellnummer ab: 4H-A-000 001 Vehicle Identification Number from: 4H-A-000 001 Fahrgestellnummer bis: 4H-A-010 000 Vehicle Identification Number to: 4H-A-010 000</p>
		<p>7.03280.04.0</p>	<p>EUV-SL EL</p>	<p>Fahrgestellnummer ab: 4H-A-000 001 Vehicle Identification Number from: 4H-A-000 001 Fahrgestellnummer bis: 4H-A-010 000 Vehicle Identification Number to: 4H-A-010 000</p>
		<p>7.03280.04.0</p>	<p>EUV-SR EL</p>	<p>Fahrgestellnummer ab: 4H-A-000 001 Vehicle Identification Number from: 4H-A-000 001 Fahrgestellnummer bis: 4H-A-010 000 Vehicle Identification Number to: 4H-A-010 000</p>
		<p>7.01830.13.0</p>	<p>SUV EL</p>	

--	--	--	--	--	--

A8 D4 (4H2, 4H8, 4HC, 4HL) 57

			7.06117.47.0	SV-NWV	EH	mit Dichtring with O-ring Fahrgestellnummer ab: 4H-A-000 001 Vehicle Identification Number from: 4H-A-000 001 Fahrgestellnummer bis: 4H-A-010 000 Vehicle Identification Number to: 4H-A-010 000
S8 quattro 382 kW (520 PS) CTFA	04.2012→01.2018		7.03280.04.0	EUV-SL	EL	
			7.03280.04.0	EUV-SR	EL	
			7.01830.13.0	SUV	EL	
			7.06117.47.0	SV-NWV	EH	mit Dichtring with O-ring

A8 D5 (4N2, 4N8) 58

45 TDI quattro (4N2, 4N8) 183 kW (249 PS) CVMD	01.2019→		7.02256.00.0	EUV-AGR	EP	
50 TDI Mild Hybrid quattro 210 kW (286 PS) DDVC	06.2017→		7.02256.00.0	EUV-AGR	EP	
			7.22880.01.0	EUV-AGR	EL	
50 TFSI Mild Hybrid quattro (4N8) 210 kW (286 PS) CZSA	07.2018→		7.22880.01.0	EUV-KK	EL	Produktionsdatum bis: 27.07.2020 Production date to: 27.07.2020
55 TFSI Mild Hybrid quattro 250 kW (340 PS) CZSE	06.2017→		7.22880.01.0	EUV-KK	EL	Produktionsdatum bis: 27.07.2020 Production date to: 27.07.2020
			7.02256.41.0	SV-KK	EL	
60 TFSI Mild Hybrid quattro 338 kW (460 PS) CXYA	05.2018→		7.02256.00.0	EUV-AGR	EP	
60 TFSI e quattro 250 kW (340 PS) CZSE	10.2019→		7.22880.01.0	EUV-KK	EL	Produktionsdatum bis: 27.07.2020 Production date to: 27.07.2020
60 TFSI e quattro 250 kW (340 PS) CZSE	10.2019→		7.22880.01.0	EUV-KK	EL	Produktionsdatum bis: 27.07.2020 Production date to: 27.07.2020
			7.02256.41.0	SV-KK	EL	

ALLROAD C5 (4BH) 59

2.5 TDI quattro 132 kW (180 PS) AKE	05.2000→08.2005		7.22903.17.0	DW-AGR	EP	Fahrgestellnummer ab: 4B-1-150 501 Vehicle Identification Number from: 4B-1-150 501
			7.22903.16.0	DW-TL	EP	ch. 4B-1-150 501→
			7.21903.49.0	DW-TL	EP	→ch. 4B-1-150 500
2.5 TDI quattro 120 kW (163 PS) BCZ	05.2003→08.2005		7.22903.17.0	DW-AGR	EP	Fahrgestellnummer ab: 4B-1-150 501 Vehicle Identification Number from: 4B-1-150 501
			7.22903.16.0	DW-TL	EP	ch. 4B-1-150 501→
2.5 TDI quattro 132 kW (180 PS) BAU	06.2003→08.2005		7.22903.17.0	DW-AGR	EP	Fahrgestellnummer ab: 4B-1-150 501 Vehicle Identification Number from: 4B-1-150 501
			7.22903.16.0	DW-TL	EP	ch. 4B-1-150 501→
2.7 T quattro 184 kW (250 PS) ARE, BES	05.2000→08.2005		7.22687.49.0	EUV-DR	EP	
			7.22687.39.0	EUV-LS	EL	

CABRIOLET B3 (8G7) 60

1.8 92-95 kW (125-129 PS) ADR	01.1997→08.2000		7.01805.01.0	EUV-SR	EL	
1.9 TDI 66 kW (90 PS) 1Z, AHU	06.1995→08.2000		7.21903.70.0	DW-AGR	EP	

A

CABRIOLET B3 (8G7)
60

2.6 110 kW (150 PS) ABC	06.1993→08.2000	7.05432.12.0	SM	EL	mit Dichtring with O-ring ch. 8G-S-001 303→
2.8 128 kW (174 PS) AAH	11.1992→08.2000	7.21483.54.0	EUV-AGR	EL	
		7.01805.01.0	EUV-SR	EL	

COUPE B3 (89, 8B3)
61





















2.6 110 kW (150 PS) ABC	08.1992→12.1996	7.05432.12.0	SM	EL	mit Dichtring with O-ring ch. 8B-S-000 554→
2.6 quattro 110 kW (150 PS) ABC	08.1992→12.1996	7.05432.12.0	SM	EL	mit Dichtring with O-ring ch. 8B-S-000 545→
2.8 128 kW (174 PS) AAH	09.1991→12.1996	7.21483.54.0	EUV-AGR	EL	
		7.01805.01.0	EUV-SR	EL	
2.8 quattro 128 kW (174 PS) AAH	09.1991→12.1996	7.21483.54.0	EUV-AGR	EL	
		7.01805.01.0	EUV-SR	EL	

Q2 (GAB, GAG)
62

1.0 TFSI 85 kW (115 PS) CHZJ	10.2016→	7.06117.48.0	SV-NWV	EL	
1.4 TFSI 110 kW (150 PS) CZEA	06.2016→	7.06117.48.0	SV-NWV	EL	
2.0 TDI 105 kW (143 PS) CRFC	11.2016→	7.02256.00.0	EUV-AGR	EP	
2.0 TFSI quattro 140 kW (190 PS) CZPB, DKZA	05.2017→	7.02901.05.0	SUV	EL	
		7.06117.26.0	ZM-NWV	EL	
3.0 TFSI 85 kW (116 PS) DKRF	07.2018→	7.06117.48.0	SV-NWV	EL	
SQ2 TFSI quattro 221 kW (300 PS) DNUE	08.2018→	7.06117.26.0	ZM-NWV	EL	

Q3 (8UB, 8UG)
63

1.4 TFSI 92 kW (125 PS) CZDB	07.2016→10.2018	7.06117.48.0	SV-NWV	EL	
1.4 TFSi Flex 110 kW (150 PS) CZDA	02.2016→10.2018	7.06117.48.0	SV-NWV	EL	
1.4 TSI 110 kW (150 PS) CHPB, CZDA, CZEA	10.2013→10.2018	7.06117.48.0	SV-NWV	EL	
2.0 TDI 130 kW (177 PS) CFGC	06.2011→04.2015	7.02256.00.0	EUV-AGR	EP	
2.0 TDI 103 kW (140 PS) CFFB, CLJA	09.2011→10.2018	7.02256.00.0	EUV-AGR	EP	
2.0 TDI 100 kW (136 PS) CFFA	09.2011→10.2018	7.02256.00.0	EUV-AGR	EP	
2.0 TDI quattro 130 kW (177 PS) CFGC, CLLB	06.2011→10.2018	7.02256.00.0	EUV-AGR	EP	
2.0 TDI quattro 120 kW (163 PS) CFGD	06.2011→04.2015	7.02256.00.0	EUV-AGR	EP	
2.0 TDI quattro 103 kW (140 PS) CFFB	01.2012→10.2018	7.02256.00.0	EUV-AGR	EP	
2.0 TFSI 147-149 kW (200-203 PS) CCTA	09.2014→10.2018	7.03280.04.0	EUV-SR	EL	
		7.00470.07.0	LDRV	EL	
		7.02901.05.0	SUV	EL	
		7.06117.26.0	ZM-NWV	EL	

						
Q3 (8UB, 8UG)						63
2.0 TFSI 132 kW (180 PS) CULB	05.2015→10.2018		7.02256.18.0	EUV-SR	EP	
			7.02901.05.0	SUV	EL	
			7.06117.26.0	ZM-NWV	EL	
2.0 TFSI quattro 155 kW (211 PS) CPSA	06.2011→04.2015		7.03280.04.0	EUV-SR	EL	
			7.00470.07.0	LDRV	EL	
			7.02901.05.0	SUV	EL	
2.0 TFSI quattro 125 kW (170 PS) CCZC	06.2011→04.2015		7.03280.04.0	EUV-SR	EL	
			7.00470.07.0	LDRV	EL	
			7.02901.05.0	SUV	EL	
2.0 TFSI quattro 147-149 kW (200-203 PS) CCTA	09.2014→10.2018		7.03280.04.0	EUV-SR	EL	
			7.00470.07.0	LDRV	EL	
			7.06117.26.0	ZM-NWV	EL	
2.0 TFSI quattro 162 kW (220 PS) CULC	11.2014→10.2018		7.02256.18.0	EUV-SR	EP	
			7.02901.05.0	SUV	EL	
			7.06117.26.0	ZM-NWV	EL	
2.0 TFSI quattro 132 kW (180 PS) CULB	11.2014→10.2018		7.02256.18.0	EUV-SR	EP	
			7.02901.05.0	SUV	EL	
			7.06117.26.0	ZM-NWV	EL	
RS 2.5 quattro 250 kW (340 PS) CZGA	05.2013→10.2018		7.22880.01.0	EUV-SR	EL	
			7.00470.07.0	LDRV	EL	
RS 2.5 quattro 228 kW (310 PS) CTSA	10.2013→10.2018		7.22880.01.0	EUV-SR	EL	
			7.00470.07.0	LDRV	EL	
			7.01830.13.0	SUV	EL	
RS performance 2.5 quattro 270 kW (367 PS) CZGB	01.2015→10.2018		7.22880.01.0	EUV-SR	EL	
Q3 (F3B)						64
2.5 RS quattro 294 kW (400 PS) DAZA, DNWA	10.2019→		7.22880.01.0	EUV-SR	EL	
			7.06117.47.0	SV-NWV	EH	
35 TFSI 110 kW (150 PS) CZDA	11.2018→		7.06117.48.0	SV-NWV	EL	
45 TFSI quattro 169 kW (230 PS) DKTA	07.2018→		7.02901.05.0	SUV	EL	
Q3 Sportback (F3N)						65
2.5 RS quattro 294 kW (400 PS) DAZA	10.2019→		7.22880.01.0	EUV-SR	EL	
			7.06117.47.0	SV-NWV	EH	
2.5 RS quattro 294 kW (400 PS) DNWA	10.2019→		7.22880.01.0	EUV-SR	EL	
			7.02901.05.0	SUV	EL	
			7.06117.47.0	SV-NWV	EH	

A

















Q3 Sportback (F3N)





















65

35 TFSI 110 kW (150 PS) CZDA	10.2019→	 7.06117.48.0	SV-NWV	EL	
45 TFSI quattro 169 kW (230 PS) DKTA	06.2019→	 7.06117.26.0	ZM-NWV	EL	

Q5 (8RB)

66

2.0 Hybrid quattro 155 kW (211 PS) CHJA	09.2012→05.2016	 7.28098.04.0	EUV-AGK	EL	
		7.03280.04.0	EUV-SR	EL	nur in Verbindung mit: Fahrzeug umgerüstet only in connection with: Fahrzeug umgerüstet
		7.22880.01.0	EUV-SR	EL	
		7.00470.07.0	LDRV	EL	
		7.02901.05.0	SUV	EL	
2.0 TDI 100 kW (136 PS) CJCB	11.2010→05.2017	 7.02256.00.0	EUV-AGR	EP	
		7.02256.00.0	EUV-KK	EP	für Fahrzeuge ohne Standheizung for vehicles without parking heater Produktionsdatum ab: 31.08.2009 Production date from: 31.08.2009
		7.02256.41.0	SV-KK	EL	für Fahrzeuge mit Standheizung for vehicles with parking heater
2.0 TDI 100 kW (136 PS) CSUB	11.2010→05.2017	 7.02256.41.0	SV-KK	EL	für Fahrzeuge mit Standheizung for vehicles with parking heater
2.0 TDI 105 kW (143 PS) CJCA	11.2010→05.2013	 7.02256.00.0	EUV-AGR	EP	
		7.02256.00.0	EUV-KK	EP	für Fahrzeuge ohne Standheizung for vehicles without parking heater Produktionsdatum ab: 31.08.2009 Production date from: 31.08.2009
		7.02256.41.0	SV-KK	EL	für Fahrzeuge mit Standheizung for vehicles with parking heater
2.0 TDI 110 kW (150 PS) CJCD, CSUA	05.2013→05.2017	 7.02256.41.0	SV-KK	EL	 CJCD, CSUA: für Fahrzeuge mit Standheizung for vehicles with parking heater
2.0 TDI 140 kW (190 PS) CNHA	09.2015→05.2017	 7.02256.41.0	SV-KK	EL	für Fahrzeuge mit Standheizung for vehicles with parking heater
2.0 TDI quattro 125 kW (170 PS) CAHA, CGLB, CMGA	11.2008→09.2012	 7.02256.00.0	EUV-AGR	EP	
		7.02256.00.0	EUV-KK	EP	 CAHA, CGLB, CMGA: für Fahrzeuge ohne Standheizung for vehicles without parking heater Produktionsdatum ab: 31.08.2009 Production date from: 31.08.2009
		7.02256.41.0	SV-KK	EL	 CAHA, CGLB, CMGA: für Fahrzeuge mit Standheizung for vehicles with parking heater
2.0 TDI quattro 120 kW (163 PS) CAHB, CGLA, CGLD	11.2008→05.2017	 7.02256.00.0	EUV-AGR	EP	
		7.02256.00.0	EUV-KK	EP	 CAHB, CGLA: für Fahrzeuge ohne Standheizung for vehicles without parking heater Produktionsdatum ab: 31.08.2009 Production date from: 31.08.2009
		7.02256.41.0	SV-KK	EL	 CAHB, CGLA, CGLD: für Fahrzeuge mit Standheizung for vehicles with parking heater
2.0 TDI quattro 120 kW (163 PS) CNHC	11.2008→05.2017	 7.02256.41.0	SV-KK	EL	für Fahrzeuge mit Standheizung for vehicles with parking heater













						A
Q5 (8RB)						66
2.0 TDI quattro 105 kW (143 PS) CAGA, CJCA	08.2009→05.2013		7.02256.00.0	EUV-AGR	EP	 CAGA, CJCA: für Fahrzeuge ohne Standheizung for vehicles without parking heater Produktionsdatum ab: 31.08.2009 Production date from: 31.08.2009  CAGA, CJCA: für Fahrzeuge mit Standheizung for vehicles with parking heater
			7.02256.00.0	EUV-KK	EP	
			7.02256.41.0	SV-KK	EL	
2.0 TDI quattro 100 kW (136 PS) CAGB, CJCB	08.2009→05.2017		7.02256.00.0	EUV-AGR	EP	 CAGB, CJCB: für Fahrzeuge ohne Standheizung for vehicles without parking heater Produktionsdatum ab: 31.08.2009 Production date from: 31.08.2009  CAGB, CJCB: für Fahrzeuge mit Standheizung for vehicles with parking heater
			7.02256.00.0	EUV-KK	EP	
			7.02256.41.0	SV-KK	EL	
2.0 TDI quattro 100 kW (136 PS) CSUB	08.2009→05.2017		7.02256.41.0	SV-KK	EL	für Fahrzeuge mit Standheizung for vehicles with parking heater
2.0 TDI quattro 130 kW (177 PS) CGLC, CMGB	06.2012→05.2017		7.02256.00.0	EUV-AGR	EP	 CGLC, CMGB: für Fahrzeuge mit Standheizung for vehicles with parking heater
			7.02256.41.0	SV-KK	EL	
2.0 TDI quattro 110 kW (150 PS) CJCD	05.2013→05.2017		7.02256.00.0	EUV-AGR	EP	für Fahrzeuge mit Standheizung for vehicles with parking heater
			7.02256.41.0	SV-KK	EL	
2.0 TDI quattro 110 kW (150 PS) CSUA	05.2013→05.2017		7.02256.41.0	SV-KK	EL	für Fahrzeuge mit Standheizung for vehicles with parking heater
2.0 TDI quattro 140 kW (190 PS) CNHA	11.2013→05.2017		7.02256.41.0	SV-KK	EL	für Fahrzeuge mit Standheizung for vehicles with parking heater
2.0 TFSI Flexfuel quattro 155 kW (211 PS) CPMA	09.2012→12.2013		7.03280.04.0	EUV-SR	EL	für Fahrzeuge mit Standheizung for vehicles with parking heater
			7.00470.07.0	LDRV	EL	
			7.02256.41.0	SV-KK	EL	
			7.06117.26.0	ZM-NWV	EL	
2.0 TFSI Flexfuel quattro 162 kW (220 PS) CPMB	09.2013→05.2017		7.03280.04.0	EUV-SR	EL	für Fahrzeuge mit Standheizung for vehicles with parking heater
			7.00470.07.0	LDRV	EL	
			7.02256.41.0	SV-KK	EL	
			7.06117.26.0	ZM-NWV	EL	
2.0 TFSI Hybrid quattro 155 kW (211 PS) CHJA	06.2011→06.2016		7.28098.04.0	EUV-AGK	EL	nur in Verbindung mit: Fahrzeug umgerüstet only in connection with: Fahrzeug umgerüstet für Fahrzeuge mit Standheizung for vehicles with parking heater
			7.03280.04.0	EUV-SR	EL	
			7.22880.01.0	EUV-SR	EL	
			7.00470.07.0	LDRV	EL	
			7.02901.05.0	SUV	EL	
			7.02256.41.0	SV-KK	EL	
7.06117.26.0	ZM-NWV	EL				

A













Q5 (8RB)

66

2.0 TFSI quattro 155-164 kW (211-223 PS) CAEB, CDNC	11.2008→09.2012		7.03280.04.0	EUV-SR	EL	 CAEB, CDNC: nur in Verbindung mit: Fahrzeug umgerüstet only in connection with: Fahrzeug umgerüstet
			7.22880.01.0	EUV-SR	EL	
			7.00470.07.0	LDRV	EL	
			7.01830.13.0	SUV	EL	
			7.02256.41.0	SV-KK	EL	
7.06117.26.0	ZM-NWV	EL				
2.0 TFSI quattro 132 kW (180 PS) CDNB	08.2009→10.2012		7.03280.04.0	EUV-SR	EL	nur in Verbindung mit: Fahrzeug umgerüstet only in connection with: Fahrzeug umgerüstet
			7.22880.01.0	EUV-SR	EL	
			7.00470.07.0	LDRV	EL	
			7.01830.13.0	SUV	EL	
			7.02256.41.0	SV-KK	EL	
7.06117.26.0	ZM-NWV	EL				
2.0 TFSI quattro 165 kW (224 PS) CNCD	06.2012→05.2016		7.02901.05.0	SUV	EL	für Fahrzeuge mit Standheizung for vehicles with parking heater
			7.02256.41.0	SV-KK	EL	
			7.06117.26.0	ZM-NWV	EL	
2.0 TFSI quattro 132 kW (180 PS) CNCB	11.2012→05.2017		7.01830.13.0	SUV	EL	für Fahrzeuge mit Standheizung for vehicles with parking heater
			7.02901.05.0	SUV	EL	
			7.02256.41.0	SV-KK	EL	
			7.06117.26.0	ZM-NWV	EL	
2.0 TFSI quattro 162 kW (220 PS) CPMB	05.2013→05.2017		7.03280.04.0	EUV-SR	EL	für Fahrzeuge mit Standheizung for vehicles with parking heater
			7.00470.07.0	LDRV	EL	
			7.02901.05.0	SUV	EL	
			7.02256.41.0	SV-KK	EL	
			7.06117.26.0	ZM-NWV	EL	
2.0 TFSI quattro 169 kW (230 PS) CNCE	08.2015→05.2017		7.02901.05.0	SUV	EL	für Fahrzeuge mit Standheizung for vehicles with parking heater
			7.02256.41.0	SV-KK	EL	
			7.06117.26.0	ZM-NWV	EL	
3.0 TDI quattro 176 kW (239-240 PS) CCWA, CPNB	11.2008→05.2017		7.02256.00.0	EUV-AGR	EP	 CCWA, CPNB: für Fahrzeuge mit Standheizung for vehicles with parking heater
			7.02256.41.0	SV-KK	EL	
3.0 TDI quattro 155 kW (211 PS) CCWB	11.2008→09.2012		7.02256.00.0	EUV-AGR	EP	für Fahrzeuge mit Standheizung for vehicles with parking heater
			7.02256.41.0	SV-KK	EL	
3.0 TDI quattro 180 kW (245 PS) CDUD	06.2012→05.2017		7.02256.00.0	EUV-AGR	EP	für Fahrzeuge mit Standheizung for vehicles with parking heater
			7.02256.41.0	SV-KK	EL	
3.0 TDI quattro 184 kW (250 PS) CTBC	06.2012→05.2017		7.02256.00.0	EUV-AGR	EP	

Q5 (8RB)
66

			7.02256.41.0	SV-KK	EL	für Fahrzeuge mit Standheizung for vehicles with parking heater
3.0 TDI quattro 190 kW (258 PS) CTBA	11.2013→05.2017		7.02256.00.0	EUV-AGR	EP	
			7.02256.41.0	SV-KK	EL	für Fahrzeuge mit Standheizung for vehicles with parking heater
3.0 TFSI quattro 200 kW (272 PS) CTUC, CTVA	06.2012→05.2017		7.22880.01.0	EUV-SR	EL	
			7.28098.15.0	EUV-SR	EL	
			7.02256.41.0	SV-KK	EL	 CTUC, CTVA: für Fahrzeuge mit Standheizung for vehicles with parking heater
			7.06117.47.0	SV-NWV	EH	mit Dichtring with O-ring
3.2 FSI quattro 199 kW (270 PS) CALB	11.2008→12.2012		7.22880.01.0	EUV-SR	EL	
			7.02256.41.0	SV-KK	EL	für Fahrzeuge mit Standheizung for vehicles with parking heater
			7.06117.42.0	SV-NWV	EL	mit Dichtring with O-ring
SQ5 TDI quattro 230 kW (313 PS) CGQB, CVUC	12.2012→11.2015		7.02256.00.0	EUV-AGR	EP	
			7.02256.41.0	SV-KK	EL	 CGQB, CVUC: für Fahrzeuge mit Standheizung for vehicles with parking heater
SQ5 TDI quattro 240 kW (326 PS) CVUB	04.2015→05.2017		7.02256.00.0	EUV-AGR	EP	
			7.02256.41.0	SV-KK	EL	für Fahrzeuge mit Standheizung for vehicles with parking heater
SQ5 TDI quattro 250 kW (340 PS) DEHA	11.2015→05.2017		7.02256.00.0	EUV-AGR	EP	
			7.02256.41.0	SV-KK	EL	für Fahrzeuge mit Standheizung for vehicles with parking heater
SQ5 TFSI quattro 260 kW (354 PS) CTUD, CTXA	05.2013→05.2017		7.22880.01.0	EUV-SR	EL	
			7.28098.15.0	EUV-SR	EL	
			7.02256.41.0	SV-KK	EL	 CTUD, CTXA: für Fahrzeuge mit Standheizung for vehicles with parking heater
			7.06117.47.0	SV-NWV	EH	mit Dichtring with O-ring

Q5 (FYB, FYG)
67









2.0 TFSI quattro 185 kW (252 PS) DAXB, DAYB	06.2016→		7.02901.05.0	SUV	EL	
			7.06117.26.0	ZM-NWV	EL	 DAXB, DAYB: Fahrgestellnummer ab: FY-H-000 001 Vehicle Identification Number from: FY-H-000 001
2.0 TFSI quattro 183 kW (249 PS) DAXC	01.2017→11.2020		7.02901.05.0	SUV	EL	
			7.06117.26.0	ZM-NWV	EL	Fahrgestellnummer ab: FY-H-000 001 Vehicle Identification Number from: FY-H-000 001
3.0 TDI quattro 210 kW (286 PS) DCPC	07.2017→11.2020		7.02256.00.0	EUV-AGK	EP	
			7.03280.04.0	EUV-AGR	EL	
			7.22880.01.0	EUV-AGR	EL	Fahrgestellnummer ab: FY-H-000 001 Vehicle Identification Number from: FY-H-000 001
45 TDI quattro 170 kW (231 PS) DCPE	08.2018→11.2020		7.03280.04.0	EUV-AGR	EL	

A















Q5 (FYB, FYG)

67

45 TFSI Mild Hybrid quattro 180 kW (245 PS) DGKB, DNTA	12.2018→	 7.06117.26.0	ZM-NWV	EL	 DGKB, DNTA: Fahrgestellnummer ab: FY-H-000 001 Vehicle Identification Number from: FY-H-000 001
50 TDI quattro 210 kW (286 PS) DCPC	03.2019→11.2020	 7.02256.00.0 7.03280.04.0	EUV-AGK EUV-AGR	EP EL	
50 TFSI e quattro 185 kW (252 PS) DLGA	04.2019→	 7.06117.26.0	ZM-NWV	EL	
50 TFSI e quattro 185 kW (252 PS) DLGA	04.2019→11.2020	 7.06117.26.0	ZM-NWV	EL	
55 TFSI e quattro 185 kW (252 PS) DLGA	08.2019→	 7.06117.26.0	ZM-NWV	EL	
55 TFSI e quattro 185 kW (252 PS) DLGA	08.2019→11.2020	 7.06117.26.0	ZM-NWV	EL	
SQ5 TDI Mild Hybrid quattro 255 kW (347 PS) DEWB	02.2019→11.2020	 7.22880.01.0	EUV-AGR	EL	
SQ5 TFSI quattro 260 kW (354 PS) CWGD	11.2016→	 7.22880.01.0	EUV-SR	EL	Fahrgestellnummer ab: FY-H-000 001 Vehicle Identification Number from: FY-H-000 001

Q7 (4LB)

68

3.0 TDI quattro 171 kW (233 PS) BUG	03.2006→05.2008	 7.01019.01.0 7.02256.00.0 7.02256.41.0	DW-AGR EUV-AGR SV-KK	EP EP EL	für Fahrzeuge mit Standheizung for vehicles with parking heater
3.0 TDI quattro 155 kW (211 PS) BUN	03.2006→05.2010	 7.01019.01.0 7.02256.00.0 7.02256.41.0	DW-AGR EUV-AGR SV-KK	EP EP EL	für Fahrzeuge mit Standheizung for vehicles with parking heater
3.0 TDI quattro 155 kW (211 PS) CASB	03.2006→05.2010	 7.02256.00.0 7.02256.41.0	EUV-AGR SV-KK	EP EL	für Fahrzeuge mit Standheizung for vehicles with parking heater
3.0 TDI quattro 176 kW (240 PS) CASA, CCMA	11.2007→08.2015	 7.02256.00.0 7.02256.41.0	EUV-AGR SV-KK	EP EL	 CASA, CCMA: für Fahrzeuge mit Standheizung for vehicles with parking heater
3.0 TDI quattro 176 kW (240 PS) CJGA, CNRB	11.2007→08.2015	 7.02256.00.0 7.28098.04.0 7.02256.41.0	EUV-AGR EUV-ML SV-KK	EP EL EL	 CJGA, CNRB: für Fahrzeuge mit Standheizung for vehicles with parking heater
3.0 TDI quattro 165 kW (224 PS) CATA	06.2009→05.2012	 7.02256.00.0 7.02256.41.0	EUV-AGR SV-KK	EP EL	für Fahrzeuge mit Standheizung for vehicles with parking heater
3.0 TDI quattro 150 kW (204 PS) CJGC, CJMA	05.2010→08.2015	 7.02256.00.0 7.28098.04.0 7.02256.41.0	EUV-AGR EUV-ML SV-KK	EP EL EL	 CJGC, CJMA: für Fahrzeuge mit Standheizung for vehicles with parking heater
3.0 TDI quattro 180 kW (245 PS) CJGD	05.2011→08.2015	 7.02256.41.0	SV-KK	EL	für Fahrzeuge mit Standheizung for vehicles with parking heater
3.0 TDI quattro 180 kW (245 PS) CLZB, CRCA	05.2011→08.2015	 7.02256.00.0	EUV-AGR	EP	

Q7 (4LB)						68
			7.28098.04.0 7.02256.41.0	EUV-ML SV-KK	EL EL	CLZB, CRCA: für Fahrzeuge mit Standheizung for vehicles with parking heater
3.0 TFSI quattro 200 kW (272 PS) CJTC, CJWC	05.2010→08.2015		7.22880.01.0	EUV-SL	EL	
			7.28098.15.0 7.02256.41.0	EUV-SR SV-KK	EL EL	CJTC, CJWC: für Fahrzeuge mit Standheizung for vehicles with parking heater
			7.06117.47.0	SV-NWV	EH	mit Dichtring with O-ring
3.0 TFSI quattro 245 kW (333 PS) CJTB, CJWB, CNAА, CTWA	05.2010→08.2015		7.22880.01.0	EUV-SL	EL	
			7.28098.15.0 7.02256.41.0	EUV-SR SV-KK	EL EL	CJTB, CJWB, CNAА, CTWA: für Fahrzeuge mit Standheizung for vehicles with parking heater
			7.06117.47.0	SV-NWV	EH	mit Dichtring with O-ring
3.0 TFSI quattro 206 kW (280 PS) CJWE, CTWB	05.2011→08.2015		7.22880.01.0	EUV-SL	EL	
			7.28098.15.0 7.02256.41.0	EUV-SR SV-KK	EL EL	CJWE, CTWB: für Fahrzeuge mit Standheizung for vehicles with parking heater
			7.06117.47.0	SV-NWV	EH	mit Dichtring with O-ring
3.6 FSI quattro 206 kW (280 PS) BHK	08.2006→05.2010		7.02256.00.0	EUV-SR	EP	
			7.02256.41.0	SV-KK	EL	für Fahrzeuge mit Standheizung for vehicles with parking heater
			7.06117.37.0	SV-NWV	EL	Fahrgestellnummer ab: 4L-7-062 001 Vehicle Identification Number from: 4L-7-062 001 Fahrgestellnummer bis: 4L-8-150 000 Vehicle Identification Number to: 4L-8-150 000
			7.06117.43.0	SV-NWV	EL	mit Dichtring with O-ring →ch. 4L-7-062 000 Auslasseite Exhaust Side nur in Verbindung mit: 066 109 210 AB, 066 109 210 R only in connection with: 066 109 210 AB, 066 109 210 R
			7.06117.44.0	SV-NWV	EL	mit Dichtring with O-ring →ch. 4L-7-062 000 Einlassseite Intake Side nur in Verbindung mit: 066 109 210 AB, 066 109 210 R only in connection with: 066 109 210 AB, 066 109 210 R
4.2 FSI quattro 231-257 kW (314-350 PS) BAR	03.2006→05.2010		7.22880.01.0	EUV-SR	EL	Fahrgestellnummer ab: 4L-9-029 261 Vehicle Identification Number from: 4L-9-029 261
			7.02256.41.0	SV-KK	EL	für Fahrzeuge mit Standheizung for vehicles with parking heater
4.2 TDI quattro 240 kW (326 PS) BTR	03.2007→06.2009		7.02256.00.0	EUV-AGR	EP	
			7.02256.41.0	SV-KK	EL	für Fahrzeuge mit Standheizung for vehicles with parking heater

A



Q7 (4LB)























68

4.2 TDI quattro 250 kW (340 PS) CCFA, CCFC	05.2009→08.2015		7.02256.00.0	EUV-AGR	EP	CCFA, CCFC: für Fahrzeuge mit Standheizung for vehicles with parking heater
			7.02256.41.0	SV-KK	EL	
4.2 quattro 231-257 kW (314-350 PS) BAR	03.2006→12.2010		7.22880.01.0	EUV-SR	EL	für Fahrzeuge mit Standheizung for vehicles with parking heater
			7.02256.41.0	SV-KK	EL	
6.0 TDI quattro 368 kW (500 PS) CCGA	09.2008→05.2014		7.02256.00.0	EUV-AGR	EP	für Fahrzeuge mit Standheizung for vehicles with parking heater
			7.02256.41.0	SV-KK	EL	

Q7 (4MB, 4MG)

69

2.0 TFSI e-tron quattro 185 kW (252 PS) CVJA	02.2016→12.2019		7.22880.01.0	EUV-LS	EL	Produktionsdatum ab: 08.01.2018 Production date from: 08.01.2018
			7.02256.18.0	EUV-SR	EP	
			7.06117.26.0	ZM-NWV	EL	
2.0 TFSI quattro 185 kW (252 PS) CYMC	08.2015→		7.22880.01.0	EUV-LS	EL	
			7.02901.05.0	SUV	EL	
			7.06117.26.0	ZM-NWV	EL	
2.0 TFSI quattro 185 kW (252 PS) CYRB	08.2015→		7.02256.18.0	EUV-SR	EP	
			7.02901.05.0	SUV	EL	
			7.06117.26.0	ZM-NWV	EL	
3.0 TDI e-tron quattro 190 kW (258 PS) CVZA	08.2015→12.2019		7.02256.00.0	EUV-AGR	EP	
3.0 TDI quattro 200 kW (272 PS) CRTC	01.2015→12.2019		7.02256.00.0	EUV-AGR	EP	
			7.03280.04.0	EUV-AGR	EL	
3.0 TDI quattro 160 kW (218 PS) CRTE	05.2015→12.2019		7.02256.00.0	EUV-AGR	EP	
			7.03280.04.0	EUV-AGR	EL	
3.0 TDI quattro 160 kW (218 PS) CZZA	05.2015→12.2019		7.02256.00.0	EUV-AGR	EP	
3.0 TDI quattro 183 kW (249 PS) CVMD	06.2015→12.2019		7.02256.00.0	EUV-AGR	EP	
			7.03280.04.0	EUV-SR	EL	
3.0 TDI quattro 190 kW (258 PS) CUEA	08.2015→12.2019		7.02256.00.0	EUV-AGR	EP	
3.0 TDI quattro 155 kW (211 PS) CZZB	08.2015→12.2019		7.02256.00.0	EUV-AGR	EP	
3.0 TFSI quattro 245 kW (333 PS) CREC	01.2015→12.2019		7.22880.01.0	EUV-KK	EL	mit Dichtring with O-ring
			7.22880.01.0	EUV-LS	EL	
			7.22880.01.0	EUV-SL	EL	
			7.06117.47.0	SV-NWV	EH	
45 TFSI quattro 180 kW (245 PS) DMFA, DNEA	03.2020→		7.06117.26.0	ZM-NWV	EL	
55 TFSI Mild Hybrid quattro 250 kW (340 PS) DCBD	07.2019→		7.22880.01.0	EUV-KK	EL	Produktionsdatum bis: 20.07.2020 Production date to: 20.07.2020

						
Q7 (4MB, 4MG)						69
60 TFSI e quattro 250 kW (340 PS) DCBE	11.2019→		7.22880.01.0	EUV-KK	EL	Produktionsdatum bis: 27.07.2020 Production date to: 27.07.2020
60 TFSI e quattro 250 kW (340 PS) DCBE	11.2019→		7.22880.01.0	EUV-KK	EL	Produktionsdatum bis: 27.07.2020 Production date to: 27.07.2020
SQ7 TDI quattro 320 kW (435 PS) CZAC	04.2016→12.2019		7.02256.00.0	EUV-AGR	EP	
			7.02256.00.0	EUV-KK	EP	
Q8 (4MN)						70
45 TDI Mild Hybrid quattro 170 kW (231 PS) DHXC, DPXB	07.2018→		7.02256.00.0	EUV-AGR	EP	
45 TDI quattro 183 kW (249 PS) CVMD	02.2018→		7.02256.00.0	EUV-AGR	EP	
			7.03280.04.0	EUV-AGR	EL	
45 TFSI quattro 180 kW (245 PS) DMFA	10.2019→		7.22880.01.0	EUV-LS	EL	
			7.02901.05.0	SUV	EL	
			7.06117.26.0	ZM-NWV	EL	
50 TDI Mild Hybrid quattro 210 kW (286 PS) DHXA, DPXA	07.2018→		7.02256.00.0	EUV-AGR	EP	
SQ8 TDI Mild Hybrid quattro 320 kW (435 PS) DHVA	05.2018→		7.02256.00.0	EUV-AGR	EP	
R8 (422, 423)						71
4.2 FSI quattro 309 kW (420 PS) BYH	04.2007→09.2010		7.22880.01.0	EUV-AGK	EL	
			7.22880.01.0	EUV-SL	EL	
4.2 FSI quattro 316 kW (430 PS) CNDA	07.2010→07.2015		7.22880.01.0	EUV-SL	EL	
			7.22880.01.0	EUV-SR	EL	
5.2 FSI quattro 386 kW (525 PS) BUJ, CTYA	04.2009→07.2015		7.28098.15.0	EUV-LS	EL	
			7.22880.01.0	EUV-SL	EL	
			7.22880.01.0	EUV-SR	EL	
5.2 FSI quattro 412 kW (560 PS) CMPA	11.2010→07.2015		7.28098.15.0	EUV-LS	EL	
			7.22880.01.0	EUV-SL	EL	
5.2 FSI quattro 404 kW (549 PS) CTPA	05.2012→07.2015		7.28098.15.0	EUV-LS	EL	
			7.22880.01.0	EUV-SL	EL	
			7.22880.01.0	EUV-SR	EL	
5.2 FSI quattro 419 kW (570 PS) CTPB	07.2014→07.2015		7.22880.01.0	EUV-SR	EL	
R8 (4S3, 4SP)						72
5.2 FSI RWS 397 kW (540 PS) DKAB	09.2017→		7.02256.00.0	EUV-AGK	EP	
			7.22880.01.0	EUV-SR	EL	
5.2 FSI quattro 449 kW (610 PS) CSPA, DKAA	07.2015→		7.02256.00.0	EUV-AGK	EP	
			7.22880.01.0	EUV-SL	EL	
			7.22880.01.0	EUV-SR	EL	
5.2 FSI quattro 397 kW (540 PS) CSPB	07.2015→		7.02256.00.0	EUV-AGK	EP	
			7.22880.01.0	EUV-SL	EL	

A



R8 (4S3, 4SP)

72

5.2 FSI quattro 456 kW (620 PS) DMWA	09.2018→		7.02256.00.0	EUV-AGK	EP
			7.22880.01.0	EUV-SL	EL
5.2 FSI quattro 419 kW (570 PS) DKAC	09.2018→		7.02256.00.0	EUV-AGK	EP
			7.22880.01.0	EUV-SR	EL

R8 Spyder (427, 429)

73

4.2 FSI quattro 316 kW (430 PS) CNDA	09.2010→07.2015		7.22880.01.0	EUV-SL	EL
			7.22880.01.0	EUV-SR	EL
5.2 FSI 404 kW (549 PS) CTPA	07.2012→07.2015		7.28098.15.0	EUV-LS	EL
5.2 FSI quattro 386 kW (525 PS) BUJ	02.2010→07.2015		7.02256.00.0	EUV-AGK	EP
			7.28098.15.0	EUV-LS	EL
			7.22880.01.0	EUV-SL	EL
5.2 FSI quattro 386 kW (525 PS) CTYA	02.2010→07.2015		7.28098.15.0	EUV-LS	EL
			7.22880.01.0	EUV-SL	EL
5.2 FSI quattro 412 kW (560 PS) CMPA	11.2011→07.2015		7.28098.15.0	EUV-LS	EL
			7.22880.01.0	EUV-SL	EL

R8 Spyder (4S9, 4SR)

74











5.2 FSI RWS 397 kW (540 PS) DKAB	09.2017→		7.02256.00.0	EUV-AGK	EP
			7.22880.01.0	EUV-SR	EL
5.2 FSI quattro 397 kW (540 PS) CSPB, DKAB	05.2016→		7.02256.00.0	EUV-AGK	EP
			7.22880.01.0	EUV-SL	EL
5.2 FSI quattro 449 kW (610 PS) CSPA, DKAA	05.2017→		7.02256.00.0	EUV-AGK	EP
			7.22880.01.0	EUV-SL	EL
5.2 FSI quattro 456 kW (620 PS) DMWA	09.2018→		7.02256.00.0	EUV-AGK	EP
			7.22880.01.0	EUV-SL	EL
5.2 FSI quattro 419 kW (570 PS) DKAC	09.2018→		7.02256.00.0	EUV-AGK	EP
			7.22880.01.0	EUV-SR	EL

TT (8J3)

75

1.8 TFSI 118 kW (160 PS) CDA A	06.2008→06.2014		7.03280.04.0	EUV-SR	EL	nur in Verbindung mit: Fahrzeug umgerüstet only in connection with: Fahrzeug umgerüstet
			7.22880.01.0	EUV-SR	EL	
			7.00470.07.0	LDRV	EL	
			7.01830.13.0	SUV	EL	
2.0 TDI quattro 125 kW (170 PS) CBBB	06.2008→06.2014		7.00868.02.0	DW-TL	EP	
			7.02256.00.0	EUV-AGR	EP	
2.0 TDI quattro 125 kW (170 PS) CFGB	06.2008→06.2014		7.02256.00.0	EUV-AGR	EP	

TT (8J3)
75





2.0 TFSI 147 kW (200 PS) BPY, BWA	08.2006→06.2010		7.00470.07.0	LDRV	EL	mit Dichtring with O-ring
			7.01830.13.0	SUV	EL	
			7.06117.46.0	SV-NWV	EH	
2.0 TFSI 147-149 kW (200-203 PS) CCTA	08.2006→06.2010		7.03280.04.0	EUV-SR	EL	nur in Verbindung mit: Fahrzeug umgerüstet only in connection with: Fahrzeug umgerüstet
			7.22880.01.0	EUV-SR	EL	
			7.00470.07.0	LDRV	EL	
			7.00415.07.0	SUV	EL	
			7.06117.26.0	ZM-NWV	EL	
2.0 TFSI 147-149 kW (200-203 PS) CCTA	01.2008→06.2010		7.03280.04.0	EUV-SR	EL	nur in Verbindung mit: Fahrzeug umgerüstet only in connection with: Fahrzeug umgerüstet
			7.22880.01.0	EUV-SR	EL	
2.0 TFSI 155 kW (211 PS) CESA	05.2010→06.2014		7.03280.04.0	EUV-SR	EL	nur in Verbindung mit: Fahrzeug umgerüstet only in connection with: Fahrzeug umgerüstet
			7.22880.01.0	EUV-SR	EL	
			7.00470.07.0	LDRV	EL	
			7.02901.05.0	SUV	EL	
			7.06117.26.0	ZM-NWV	EL	
2.0 TFSI quattro 147-149 kW (200-203 PS) CCTA	06.2008→06.2010		7.03280.04.0	EUV-SR	EL	nur in Verbindung mit: Fahrzeug umgerüstet only in connection with: Fahrzeug umgerüstet
			7.22880.01.0	EUV-SR	EL	
			7.00415.07.0	SUV	EL	
			7.06117.26.0	ZM-NWV	EL	
2.0 TFSI quattro 147 kW (200 PS) CCZA	06.2008→06.2010		7.03280.04.0	EUV-SR	EL	nur in Verbindung mit: Fahrzeug umgerüstet only in connection with: Fahrzeug umgerüstet
			7.22880.01.0	EUV-SR	EL	
			7.00470.07.0	LDRV	EL	
			7.00415.07.0	SUV	EL	
			7.06117.26.0	ZM-NWV	EL	
2.0 TFSI quattro 155 kW (211 PS) CESA, CETA	05.2010→06.2014		7.03280.04.0	EUV-SR	EL	 CESA, CETA: nur in Verbindung mit: Fahrzeug umgerüstet only in connection with: Fahrzeug umgerüstet
			7.22880.01.0	EUV-SR	EL	
			7.00470.07.0	LDRV	EL	
			7.02901.05.0	SUV	EL	
			7.06117.26.0	ZM-NWV	EL	
2.0 TTS quattro 200 kW (272 PS) CDLB	05.2008→06.2014		7.02256.00.0	EUV-AGK	EP	Produktionsdatum bis: 11.11.2008 Production date to: 11.11.2008
			7.00470.07.0	LDRV	EL	
			7.00415.07.0	SUV	EL	
			7.01830.13.0	SUV	EL	
			7.06117.46.0	SV-NWV	EH	
2.0 TTS quattro 195 kW (265 PS) CDLA, CDMA	05.2008→06.2014		7.02256.00.0	EUV-AGK	EP	
			7.00470.07.0	LDRV	EL	

A









TT (8J3)























75

			7.00415.07.0	SUV	EL	 CDLA, CDMA: Produktionsdatum bis: 11.11.2008 Production date to: 11.11.2008
			7.01830.13.0	SUV	EL	
			7.06117.46.0	SV-NWV	EH	
2.5 RS quattro 250 kW (340 PS) CEPA	07.2009→06.2014		7.02256.00.0	EUV-AGK	EP	
			7.22880.01.0	EUV-SR	EL	
			7.00470.07.0	LDRV	EL	
			7.01830.13.0	SUV	EL	
2.5 RS quattro 265 kW (360 PS) CEPB	05.2011→06.2014		7.02256.00.0	EUV-AGK	EP	
			7.22880.01.0	EUV-SR	EL	
			7.00470.07.0	LDRV	EL	
			7.01830.13.0	SUV	EL	
3.2 V6 quattro 184-186 kW (250-253 PS) BUB	08.2006→06.2010		7.10014.00.0	AKF	EL	
			7.02256.00.0	EUV-AGK	EP	
			7.02256.00.0	EUV-SL	EP	
			7.02256.00.0	EUV-SR	EP	
			7.06117.37.0	SV-NWV	EL	Produktionsdatum ab: 18.12.2006 Production date from: 18.12.2006
			7.06117.43.0	SV-NWV	EL	mit Dichtring with O-ring Auslassseite Exhaust Side Produktionsdatum bis: 18.12.2006 Production date to: 18.12.2006
			7.06117.44.0	SV-NWV	EL	mit Dichtring with O-ring Einlassseite Intake Side Produktionsdatum bis: 18.12.2006 Production date to: 18.12.2006

TT (8N3)

76

1.8 T 132 kW (180 PS) AJQ	10.1998→06.2006		7.22687.49.0	EUV-DR	EP	
			7.22687.39.0	EUV-LS	EL	
1.8 T 132 kW (180 PS) APP, AUQ	10.1998→06.2006		7.22687.49.0	EUV-DR	EP	
			7.22687.39.0	EUV-LS	EL	
			7.01805.01.0	EUV-SR	EL	
1.8 T 110 kW (150 PS) AUM	09.2002→06.2006		7.22687.49.0	EUV-DR	EP	
			7.22687.39.0	EUV-LS	EL	
			7.01805.01.0	EUV-SR	EL	
1.8 T 120 kW (163 PS) BVP	09.2005→06.2006		7.22687.49.0	EUV-DR	EP	
			7.22687.39.0	EUV-LS	EL	
			7.01805.01.0	EUV-SR	EL	
1.8 T 140 kW (190 PS) BVR	09.2005→06.2006		7.22687.49.0	EUV-DR	EP	
			7.22687.39.0	EUV-LS	EL	
			7.01805.01.0	EUV-SR	EL	
1.8 T quattro 132 kW (180 PS) AJQ	10.1998→06.2006		7.22687.49.0	EUV-DR	EP	
			7.22687.39.0	EUV-LS	EL	

						
TT (8N3)						76
1.8 T quattro 132 kW (180 PS) ARY, AUQ	10.1998→06.2006		7.22687.49.0	EUV-DR	EP	
			7.22687.39.0	EUV-LS	EL	
			7.01805.01.0	EUV-SR	EL	
1.8 T quattro 165 kW (224 PS) APX	10.1998→06.2006		7.22687.49.0	EUV-DR	EP	
			7.22687.39.0	EUV-LS	EL	
			7.02461.01.0	EUV-SL	EL	
1.8 T quattro 165 kW (224 PS) BAM	10.1998→06.2006		7.22687.49.0	EUV-DR	EP	
			7.22687.39.0	EUV-LS	EL	
1.8 T quattro 180 kW (245 PS) BFV	03.2005→06.2006		7.22687.49.0	EUV-DR	EP	
			7.22687.39.0	EUV-LS	EL	
1.8 T quattro 140 kW (190 PS) BVR	09.2005→06.2006		7.22687.49.0	EUV-DR	EP	
			7.22687.39.0	EUV-LS	EL	
			7.01805.01.0	EUV-SR	EL	
3.2 VR6 quattro 184 kW (250 PS) BHE, BPF	07.2003→06.2006		7.02256.00.0	EUV-AGK	EP	mit Dichtring with O-ring  BHE, BPF: Auslassseite Exhaust Side mit Dichtring with O-ring  BHE, BPF: Einlassseite Intake Side
			7.02256.00.0	EUV-SL	EP	
			7.02256.00.0	EUV-SR	EP	
			7.06117.43.0	SV-NWV	EL	
			7.06117.44.0	SV-NWV	EL	
TT (FV3, FVP)						77
1.8 TFSI 132 kW (180 PS) CJSA, CJSB	07.2015→08.2018		7.03280.04.0	EUV-SR	EL	
			7.02901.05.0	SUV	EL	
			7.06117.26.0	ZM-NWV	EL	
2.0 TFSI 169 kW (230 PS) CHHC	07.2014→		7.02256.18.0	EUV-SR	EP	
			7.06117.26.0	ZM-NWV	EL	
2.0 TFSI quattro 169 kW (230 PS) CHHC	07.2014→		7.02256.18.0	EUV-SR	EP	
			7.06117.26.0	ZM-NWV	EL	
2.0 TFSI quattro 162 kW (220 PS) CNTC	04.2015→		7.02901.05.0	SUV	EL	
			7.06117.26.0	ZM-NWV	EL	
2.0 TTS quattro 228 kW (310 PS) CJXG	11.2014→		7.02256.18.0	EUV-SR	EP	
			7.02901.05.0	SUV	EL	
			7.06117.26.0	ZM-NWV	EL	
2.0 TTS quattro 210 kW (286 PS) CJXF	02.2015→		7.02256.18.0	EUV-SR	EP	
			7.02901.05.0	SUV	EL	
			7.06117.26.0	ZM-NWV	EL	
2.0 TTS quattro 215 kW (292 PS) CYFB	07.2015→		7.02901.05.0	SUV	EL	
			7.06117.26.0	ZM-NWV	EL	
2.0 TTS quattro 225 kW (306 PS) DNUF	08.2018→		7.02901.05.0	SUV	EL	

A













TT (FV3, FVP)

77

2.5 RS quattro 294 kW (400 PS) DAZA, DNWA	10.2016→	 7.22880.01.0	EUV-SR	EL	mit Dichtring with O-ring
		7.02901.05.0	SUV	EL	
		7.06117.47.0	SV-NWV	EH	

TT Roadster (8J9)

78

1.8 TFSI 118 kW (160 PS) CDA A	06.2008→06.2014	 7.03280.04.0	EUV-SR	EL	nur in Verbindung mit: Fahrzeug umgerüstet only in connection with: Fahrzeug umgerüstet
		7.22880.01.0	EUV-SR	EL	
		7.00470.07.0	LDRV	EL	
		7.01830.13.0	SUV	EL	
		7.06117.26.0	ZM-NWV	EL	
2.0 TDI quattro 125 kW (170 PS) CBBB	06.2008→06.2014	 7.00868.02.0	DW-TL	EP	
		7.02256.00.0	EUV-AGR	EP	
2.0 TDI quattro 125 kW (170 PS) CFGB	06.2008→06.2014	 7.02256.00.0	EUV-AGR	EP	
2.0 TFSI 147 kW (200 PS) BPY, BWA	03.2007→06.2010	 7.00470.07.0	LDRV	EL	mit Dichtring with O-ring
		7.01830.13.0	SUV	EL	
		7.06117.46.0	SV-NWV	EH	
2.0 TFSI 147-149 kW (200-203 PS) CCTA	03.2007→06.2010	 7.03280.04.0	EUV-SR	EL	nur in Verbindung mit: Fahrzeug umgerüstet only in connection with: Fahrzeug umgerüstet
		7.22880.01.0	EUV-SR	EL	
		7.00470.07.0	LDRV	EL	
		7.00415.07.0	SUV	EL	
		7.06117.26.0	ZM-NWV	EL	
2.0 TFSI 155 kW (211 PS) CESA	05.2010→06.2014	 7.03280.04.0	EUV-SR	EL	nur in Verbindung mit: Fahrzeug umgerüstet only in connection with: Fahrzeug umgerüstet
		7.22880.01.0	EUV-SR	EL	
		7.00470.07.0	LDRV	EL	
		7.02901.05.0	SUV	EL	
		7.06117.26.0	ZM-NWV	EL	
2.0 TFSI quattro 147-149 kW (200-203 PS) CCTA, CCZA	06.2008→06.2010	 7.03280.04.0	EUV-SR	EL	 CCTA, CCZA: nur in Verbindung mit: Fahrzeug umgerüstet only in connection with: Fahrzeug umgerüstet
		7.22880.01.0	EUV-SR	EL	
		7.00470.07.0	LDRV	EL	
		7.00415.07.0	SUV	EL	
		7.06117.26.0	ZM-NWV	EL	
2.0 TFSI quattro 155 kW (211 PS) CESA, CETA	05.2010→06.2014	 7.03280.04.0	EUV-SR	EL	 CESA, CETA: nur in Verbindung mit: Fahrzeug umgerüstet only in connection with: Fahrzeug umgerüstet
		7.22880.01.0	EUV-SR	EL	
		7.00470.07.0	LDRV	EL	
		7.02901.05.0	SUV	EL	
		7.06117.26.0	ZM-NWV	EL	
2.0 TTS quattro 200 kW (272 PS) CDLB	05.2008→06.2014	 7.02256.00.0	EUV-AGK	EP	
		7.00470.07.0	LDRV	EL	

TT Roadster (8J9)
78

			7.00415.07.0	SUV	EL	Produktionsdatum bis: 11.11.2008 Production date to: 11.11.2008
			7.01830.13.0	SUV	EL	
			7.06117.46.0	SV-NWV	EH	mit Dichtring with O-ring
2.0 TTS quattro 195 kW (265 PS) CDLA, CDMA	05.2008→06.2014		7.02256.00.0	EUV-AGK	EP	
			7.00470.07.0	LDRV	EL	
			7.00415.07.0	SUV	EL	CDLA, CDMA: Produktionsdatum bis: 11.11.2008 Production date to: 11.11.2008
			7.01830.13.0	SUV	EL	
			7.06117.46.0	SV-NWV	EH	mit Dichtring with O-ring
2.5 RS quattro 250 kW (340 PS) CEPA	07.2009→06.2014		7.02256.00.0	EUV-AGK	EP	
			7.22880.01.0	EUV-SR	EL	
			7.00470.07.0	LDRV	EL	
			7.01830.13.0	SUV	EL	
2.5 RS quattro 265 kW (360 PS) CEPB	03.2012→06.2014		7.02256.00.0	EUV-AGK	EP	
			7.22880.01.0	EUV-SR	EL	
			7.00470.07.0	LDRV	EL	
			7.01830.13.0	SUV	EL	
3.2 V6 quattro 184-186 kW (250-253 PS) BUB	03.2007→06.2010		7.10014.00.0	AKF	EL	
			7.02256.00.0	EUV-AGK	EP	
			7.02256.00.0	EUV-SL	EP	
			7.02256.00.0	EUV-SR	EP	
			7.06117.37.0	SV-NWV	EL	Produktionsdatum ab: 18.12.2006 Production date from: 18.12.2006
			7.06117.43.0	SV-NWV	EL	mit Dichtring with O-ring Auslassseite Exhaust Side Produktionsdatum bis: 18.12.2006 Production date to: 18.12.2006
			7.06117.44.0	SV-NWV	EL	mit Dichtring with O-ring Einlassseite Intake Side Produktionsdatum bis: 18.12.2006 Production date to: 18.12.2006

TT Roadster (8N9)
79

1.8 T 132 kW (180 PS) AJQ	10.1999→06.2006		7.22687.49.0	EUV-DR	EP	
			7.22687.39.0	EUV-LS	EL	
1.8 T 132 kW (180 PS) APP, AUQ	10.1999→06.2006		7.22687.49.0	EUV-DR	EP	
			7.22687.39.0	EUV-LS	EL	
			7.01805.01.0	EUV-SR	EL	
1.8 T 110 kW (150 PS) AUM	01.2001→06.2006		7.22687.49.0	EUV-DR	EP	
			7.22687.39.0	EUV-LS	EL	
			7.01805.01.0	EUV-SR	EL	
1.8 T 140 kW (190 PS) BVR	09.2005→06.2006		7.22687.49.0	EUV-DR	EP	
			7.22687.39.0	EUV-LS	EL	
			7.01805.01.0	EUV-SR	EL	

A



TT Roadster (8N9)

79





















1.8 T 120 kW (163 PS) BVP	09.2005→06.2006		7.22687.49.0	EUV-DR	EP	
			7.22687.39.0	EUV-LS	EL	
			7.01805.01.0	EUV-SR	EL	
1.8 T quattro 165 kW (224 PS) APX	10.1999→06.2006		7.22687.49.0	EUV-DR	EP	
			7.22687.39.0	EUV-LS	EL	
			7.02461.01.0	EUV-SL	EL	
1.8 T quattro 165 kW (224 PS) BAM	10.1999→06.2006		7.22687.49.0	EUV-DR	EP	
			7.22687.39.0	EUV-LS	EL	
1.8 T quattro 132 kW (180 PS) AJQ	02.2000→06.2006		7.22687.49.0	EUV-DR	EP	
			7.22687.39.0	EUV-LS	EL	
1.8 T quattro 132 kW (180 PS) ARY, AUQ	02.2000→06.2006		7.22687.49.0	EUV-DR	EP	
			7.22687.39.0	EUV-LS	EL	
			7.01805.01.0	EUV-SR	EL	
1.8 T quattro 140 kW (190 PS) BVR	09.2005→06.2006		7.22687.49.0	EUV-DR	EP	
			7.22687.39.0	EUV-LS	EL	
			7.01805.01.0	EUV-SR	EL	
3.2 VR6 quattro 184 kW (250 PS) BHE, BPF	07.2003→06.2006		7.02256.00.0	EUV-AGK	EP	
			7.02256.00.0	EUV-SL	EP	
			7.02256.00.0	EUV-SR	EP	
			7.06117.43.0	SV-NWV	EL	
			7.06117.44.0	SV-NWV	EL	

mit Dichtring
with O-ring
 BHE, BPF: Auslassseite
Exhaust Side
mit Dichtring
with O-ring
 BHE, BPF: Einlassseite
Intake Side

TT Roadster (FV9, FVR)



80

1.8 TFSI 132 kW (180 PS) CJSA, CJSB	07.2015→08.2018		7.03280.04.0	EUV-SR	EL	
			7.02901.05.0	SUV	EL	
			7.06117.26.0	ZM-NWV	EL	
2.0 TFSI 169 kW (230 PS) CHHC	11.2014→		7.02256.18.0	EUV-SR	EP	
			7.06117.26.0	ZM-NWV	EL	
2.0 TFSI quattro 169 kW (230 PS) CHHC	11.2014→		7.02256.18.0	EUV-SR	EP	
			7.06117.26.0	ZM-NWV	EL	
2.0 TFSI quattro 162 kW (220 PS) CNTC	04.2015→		7.02901.05.0	SUV	EL	
			7.06117.26.0	ZM-NWV	EL	
2.0 TTS quattro 228 kW (310 PS) CJXG	11.2014→		7.02256.18.0	EUV-SR	EP	
			7.02901.05.0	SUV	EL	
			7.06117.26.0	ZM-NWV	EL	
2.0 TTS quattro 210 kW (286 PS) CJXF	02.2015→		7.02256.18.0	EUV-SR	EP	
			7.02901.05.0	SUV	EL	
			7.06117.26.0	ZM-NWV	EL	
2.0 TTS quattro 225 kW (306 PS) DNUF	08.2018→		7.02901.05.0	SUV	EL	

						
TT Roadster (FV9, FVR)						80
2.5 RS quattro 294 kW (400 PS) DAZA, DNWA	10.2016→		7.22880.01.0 7.02901.05.0 7.06117.47.0	EUV-SR SUV SV-NWV	EL EL EH	mit Dichtring with O-ring
Q5 Van (8RB)						81
2.0 TFSI quattro 155 kW (211 PS) CDNC	11.2008→09.2012		7.03280.04.0 7.22880.01.0 7.06117.26.0	EUV-SR EUV-SR ZM-NWV	EL EL EL	nur in Verbindung mit: Fahrzeug umgerüstet only in connection with: Fahrzeug umgerüstet
3.2 FSI quattro 199 kW (270 PS) CALB	11.2008→09.2012		7.22880.01.0	EUV-SR	EL	
Q5 Van (FYB, FYG)						82
3.0 TDI quattro 210 kW (286 PS) DCPC	07.2017→11.2020		7.02256.00.0	EUV-AGR	EP	
Q7 Van (4LB)						83
3.0 TDI quattro 176 kW (240 PS) CJGA	11.2007→05.2012		7.28098.04.0	EUV-ML	EL	
3.0 TDI quattro 150 kW (204 PS) CJMA	11.2010→08.2015		7.28098.04.0	EUV-ML	EL	
3.0 TDI quattro 180 kW (245 PS) CLZB, CRCA	05.2011→08.2015		7.28098.04.0	EUV-ML	EL	
3.0 TFSI quattro 245 kW (333 PS) CJTB	05.2010→08.2015		7.28098.15.0	EUV-SR	EL	
3.6 FSI quattro 206 kW (280 PS) BHK	08.2006→05.2010		7.06117.37.0	SV-NWV	EL	Fahrgestellnummer ab: 4L-7-062 001 Vehicle Identification Number from: 4L-7-062 001 Fahrgestellnummer bis: 4L-8-150 000 Vehicle Identification Number to: 4L-8-150 000
4.2 FSI quattro 231-257 kW (314-350 PS) BAR	08.2006→05.2010		7.22880.01.0	EUV-SR	EL	Fahrgestellnummer ab: 4L-9-029 261 Vehicle Identification Number from: 4L-9-029 261
4.2 TDI quattro 250 kW (340 PS) CCFA, CCFC	03.2007→08.2015		7.02256.00.0	EUV-AGR	EP	
Q7 Van (4MB, 4MG)						84
3.0 TDI quattro 200 kW (272 PS) CRTC	01.2015→12.2019		7.02256.00.0	EUV-AGR	EP	
3.0 TDI quattro 155-160 kW (211-218 PS) CZZA, CZZB	08.2015→12.2019		7.02256.00.0	EUV-AGR	EP	
4.0 SQ7 TDI quattro 320 kW (435 PS) CZAC	04.2016→		7.02256.00.0 7.02256.00.0	EUV-AGR EUV-KK	EP EP	

A

A3 Limousine (85S, 85M)
1

35 TFSI 110 kW (150 PS) CSSA, DJSA	03.2014→	 7.02256.40.0	SV-KK	EL
40 TFSI 132 kW (180 PS) CUFA	01.2015→	 7.02901.05.0	SUV	EL
		7.02256.40.0	SV-KK	EL



A3 Sportback (85A, 85F)
2

40 TFSI 132 kW (180 PS) CUFA	01.2015→	 7.02901.05.0	SUV	EL
		7.02256.40.0	SV-KK	EL





A4 B6 (8E2)
3

1.8 T 120 kW (163 PS) BFB	02.2003→07.2005	 7.01805.01.0	EUV-LS	EL
-------------------------------------	-----------------	---	--------	----

A4L B8 (828)
4

1.8 30 TFSI 118 kW (160 PS) CCUA	08.2009→	 7.02901.05.0	SUV	EL
2.0 35 TFSI 132 kW (179-180 PS) CDZA, CUJA	11.2008→12.2016	 7.02901.05.0	SUV	EL
45 TFSI quattro 165-169 kW (224-230 PS) CUHA	06.2014→	 7.02901.05.0	SUV	EL

A6 C5 (4Y8)
5

1.8 92 kW (125 PS) ADR	01.2000→12.2005	 7.01805.01.0	EUV-SR	EL
2.4 121 kW (165 PS) APS	09.1999→12.2005	 7.01805.01.0	EUV-SR	EL
2.4 125 kW (170 PS) BDV	06.2002→12.2005	 7.01805.01.0	EUV-SR	EL
2.8 140 kW (190 PS) ATX	09.2000→07.2005	 7.01805.01.0	EUV-SR	EL

A6L C6 (4Z8)
6

3.0 160 kW (218 PS) BBJ	03.2005→12.2006	 7.01805.01.0	EUV-LS	EL
-----------------------------------	-----------------	---	--------	----



A6L C7 (4X8, 4XL)
7



























2.0 TFSI 132 kW (179-180 PS) CDNB, CDZA	01.2012→12.2016	 7.02901.05.0	SUV	EL
---	-----------------	---	-----	----

Q3 (84B, 84G)
8

40 TFSI quattro 147 kW (200 PS) CGMA	04.2013→12.2016	 7.22880.01.0	EUV-AGK	EL
		7.22880.01.0	EUV-AGR	EL
		7.22880.01.0	EUV-KK	EL
		7.22880.01.0	EUV-LS	EL
		7.22880.01.0	EUV-ML	EL
		7.22880.01.0	EUV-SL	EL
		7.22880.01.0	EUV-SR	EL
		7.02901.05.0	SUV	EL

Q5 B8 (83B)
9

2.0 TFSI quattro 155 kW (211 PS) CADA	03.2010→12.2015	 7.02901.05.0	SUV	EL
35 TFSI quattro 132 kW (180 PS) CDZA	04.2013→12.2015	 7.02901.05.0	SUV	EL
40 TFSI quattro 165-169 kW (224-230 PS) CUHA	11.2014→	 7.02901.05.0	SUV	EL









						
BENTAYGA (4V1)						1
4.0 D 320 kW (435 PS) CZAC	01.2017→		7.02256.00.0	EUV-AGR	EP	
			7.02256.00.0	EUV-RK	EP	
4.0 TDI 310 kW (421 PS) CZAA	11.2016→		7.02256.00.0	EUV-AGR	EP	
			7.02256.00.0	EUV-RK	EP	
CONTINENTAL Convertible (3S_)						2
6.0 AWD 467 kW (635 PS) DDBD	12.2018→		7.28098.04.0	EUV-AGK	EL	
CONTINENTAL Convertible (3W_, 394)						3
4.0 AWD 388-389 kW (528-529 PS) CMMD, CYCA	09.2014→		7.28098.04.0	EUV-AGK	EL	
4.0 FLEX AWD 373 kW (507 PS) CMMC, CYCB	04.2012→		7.28098.04.0	EUV-AGK	EL	
4.0 FLEX AWD 388-389 kW (528-529 PS) CMMD, CYCA	12.2013→		7.28098.04.0	EUV-AGK	EL	
4.0 GTC AWD 373 kW (507 PS) CMMC, CYCB	04.2012→01.2019		7.28098.04.0	EUV-AGK	EL	
6.0 AWD 412 kW (560 PS) BEB	06.2006→04.2011		7.28098.04.0	EUV-AGK	EL	
			7.22687.49.0	EUV-LS	EP	2010 2010
6.0 AWD 412 kW (560 PS) BWR, CKHD	06.2006→04.2011		7.22687.49.0	EUV-LS	EP	 BWR, CKHD: 2010 2010
6.0 AWD 423 kW (575 PS) CKHB, CVAB	11.2011→		7.28098.04.0	EUV-AGK	EL	
			7.22687.49.0	EUV-LS	EP	 CKHB, CVAB: 2015 2015
6.0 AWD 434 kW (590 PS) DBDA	11.2017→07.2018		7.28098.04.0	EUV-AGK	EL	
			7.22687.49.0	EUV-LS	EP	2016 2016
6.0 AWD 472 kW (642 PS) DBDD	11.2017→07.2018		7.28098.04.0	EUV-AGK	EL	
			7.22687.49.0	EUV-LS	EP	2016 2016
6.0 AWD 522 kW (710 PS) DJLA	11.2017→05.2018		7.28098.04.0	EUV-AGK	EL	
			7.22687.49.0	EUV-LS	EP	
6.0 CS ISR 467-472 kW (635-642 PS) CVAC	03.2011→		7.28098.04.0	EUV-AGK	EL	
6.0 CS ISR 471 kW (641 PS) CKHE	03.2011→		7.28098.04.0	EUV-AGK	EL	
			7.22687.49.0	EUV-LS	EP	2011 2011
6.0 FLEX AWD 463 kW (630 PS) CKHA	03.2010→12.2013		7.22687.49.0	EUV-LS	EP	2011 2011
6.0 FLEX AWD 423 kW (575 PS) CKHB	09.2011→12.2015		7.28098.04.0	EUV-AGK	EL	
			7.22687.49.0	EUV-LS	EP	2015 2015
6.0 FLEX AWD 453-460 kW (616-626 PS) CVAA	09.2012→		7.28098.04.0	EUV-AGK	EL	
			7.22687.49.0	EUV-LS	EP	2015 2015



B

CONTINENTAL Convertible (3W_, 394)

3

6.0 FLEX AWD 467-472 kW (635-642 PS) CVAC	05.2014→		7.28098.04.0	EUV-AGK	EL	
			7.22687.49.0	EUV-LS	EP	2015 2015
6.0 FLEX AWD 434 kW (590 PS) DBDA	05.2015→		7.28098.04.0	EUV-AGK	EL	
			7.22687.49.0	EUV-LS	EP	2016 2016
6.0 FLEX AWD 472 kW (642 PS) DBDD	01.2016→		7.28098.04.0	EUV-AGK	EL	
			7.22687.49.0	EUV-LS	EP	2016 2016
6.0 GTC Speed AWD 453-460 kW (616-626 PS) CVAA	03.2013→01.2019		7.28098.04.0	EUV-AGK	EL	
			7.22687.49.0	EUV-LS	EP	2015 2015
6.0 GTC Speed AWD 467-472 kW (635-642 PS) CVAC, DBDE	05.2014→05.2016		7.28098.04.0	EUV-AGK	EL	
			7.22687.49.0	EUV-LS	EP	 CVAC: 2015 2015  DBDE: 2016 2016
6.0 GTC Speed All-wheel Drive 448-449 kW (609-610 PS) BWRA, CKHC	08.2007→04.2011		7.22687.49.0	EUV-LS	EP	 BWRA, CKHC: 2010 2010











CONTINENTAL Coupe (3S3)























4

6.0 W12 AWD 467 kW (635 PS) DDBD	09.2017→		7.28098.04.0	EUV-AGK	EL	
--	----------	---	---------------------	---------	----	--

CONTINENTAL Coupe (3W_, 393)

5

4.0 373 kW (507 PS) CMMC, CYCB	09.2011→		7.28098.04.0	EUV-AGK	EL	
4.0 388-389 kW (528-529 PS) CMMD, CYCA	01.2014→		7.28098.04.0	EUV-AGK	EL	
4.0 FLEX 373 kW (507 PS) CMMC	09.2011→		7.28098.04.0	EUV-AGK	EL	
4.0 FLEX 388-389 kW (528-529 PS) CMMD, CYCA	12.2013→		7.28098.04.0	EUV-AGK	EL	
4.0 FLEX 426 kW (579 PS) DCCA	10.2014→		7.28098.04.0	EUV-AGK	EL	
4.0 GT 373 kW (507 PS) CMMC, CYCB	04.2012→		7.28098.04.0	EUV-AGK	EL	
6.0 423 kW (575 PS) CKHB, CVAB	01.2011→05.2015		7.28098.04.0	EUV-AGK	EL	
			7.22687.49.0	EUV-LS	EP	 CKHB, CVAB: 2015 2015
6.0 AWD 434 kW (590 PS) DBDA	08.2015→		7.28098.04.0	EUV-AGK	EL	
			7.22687.49.0	EUV-LS	EP	2016 2016
6.0 FLEX 463 kW (630 PS) BWRB, CKHA	02.2008→		7.28098.04.0	EUV-AGK	EL	
			7.22687.49.0	EUV-LS	EP	
6.0 FLEX 423 kW (575 PS) CKHB	11.2010→12.2013		7.28098.04.0	EUV-AGK	EL	
			7.22687.49.0	EUV-LS	EP	2015 2015



					
CONTINENTAL Coupe (3W_, 393)					
6.0 FLEX 453-460 kW (616-626 PS) CVAA	09.2012→		7.28098.04.0 EUV-AGK EL		
			7.22687.49.0 EUV-LS EP	2015	2015
6.0 FLEX 453-460 kW (616-626 PS) CVAA	09.2012→		7.28098.04.0 EUV-AGK EL		
6.0 FLEX 467-472 kW (635-642 PS) CVAC	05.2014→		7.28098.04.0 EUV-AGK EL		
			7.22687.49.0 EUV-LS EP	2015	2015
6.0 FLEX 434 kW (590 PS) DBDA	05.2015→		7.28098.04.0 EUV-AGK EL		
			7.22687.49.0 EUV-LS EP	2016	2016
6.0 FLEX 472 kW (642 PS) DBDD	09.2016→		7.28098.04.0 EUV-AGK EL		
			7.22687.49.0 EUV-LS EP	2016	2016
6.0 GT 412 kW (560 PS) BEB, BWR	06.2003→12.2011		7.28098.04.0 EUV-AGK EL		BEB, BWR: 2006 2006
			7.22687.15.0* EUV-LS EP		mit Halter with holder
			↳ 7.22687.49.0 EUV-LS EP		BEB, BWR: 2005 2005
			7.22687.16.0* EUV-LS EP		mit Halter with holder
6.0 GT Speed 449 kW (610 PS) BWRA	09.2007→12.2011		7.22687.49.0 EUV-LS EP		
			7.28098.04.0 EUV-AGK EL		
6.0 GT Speed 467-472 kW (635-642 PS) CVAC, DBDE	05.2014→05.2016		7.28098.04.0 EUV-AGK EL		
			7.22687.49.0 EUV-LS EP		CVAC: 2015 2015 DBDE: 2016 2016
6.0 GT Speed 472 kW (642 PS) DBDD	05.2016→		7.28098.04.0 EUV-AGK EL		
			7.22687.49.0 EUV-LS EP	2016	2016
6.0 Supersports 463 kW (630 PS) BWRB, CKHA	10.2009→12.2011		7.22687.49.0 EUV-LS EP		
6.0 Supersports AWD 522 kW (710 PS) DJLA	09.2017→05.2018		7.28098.04.0 EUV-AGK EL		
CONTINENTAL FLYING SPUR (3W_)					
6.0 412 kW (560 PS) BEB, BWR	03.2005→12.2010		7.28098.04.0 EUV-AGK EL		BEB, BWR: 2006 2006
			7.22687.15.0* EUV-LS EP		mit Halter with holder
			↳ 7.22687.49.0 EUV-LS EP		BEB, BWR: 2005 2005
			7.22687.16.0* EUV-LS EP		mit Halter with holder
			↳ 7.22687.49.0 EUV-LS EP		



B











CONTINENTAL FLYING SPUR (3W_)

6

6.0 FLEX 448-449 kW (609-610 PS) BWRA, CKHC	09.2008→02.2013		7.22687.49.0	EUV-LS	EP
6.0 FLEX 412 kW (560 PS) CKHD	06.2010→12.2013		7.22687.49.0	EUV-LS	EP
6.0 Speed 449 kW (610 PS) BWRA	09.2008→12.2010		7.22687.49.0	EUV-LS	EP

FLYING SPUR (4W_)

7

4.0 388-389 kW (528-529 PS) CMMD, CYCA	09.2014→		7.28098.04.0	EUV-AGK	EL
4.0 FLEX 373 kW (507 PS) CMMC, CYCB	03.2013→		7.28098.04.0	EUV-AGK	EL
4.0 FLEX 388-389 kW (528-529 PS) CYCA	06.2016→		7.28098.04.0	EUV-AGK	EL
4.0 V8 373 kW (507 PS) CMMC, CYCB	03.2013→10.2020		7.28098.04.0	EUV-AGK	EL
6.0 453-460 kW (616-626 PS) CVAA	03.2014→		7.28098.04.0	EUV-AGK	EL
6.0 FLEX 453-460 kW (616-626 PS) CVAA	03.2013→		7.28098.04.0	EUV-AGK	EL
6.0 FLEX 453-460 kW (616-626 PS) CVAA	01.2014→		7.28098.04.0	EUV-AGK	EL
			7.22687.49.0	EUV-LS	EP
6.0 W12 453-460 kW (616-626 PS) CVAA, DBDB	03.2013→10.2020		7.28098.04.0	EUV-AGK	EL
			7.22687.49.0	EUV-LS	EP
V8 S 4.0 388-389 kW (528-529 PS) CYCA	05.2016→		7.28098.04.0	EUV-AGK	EL
W12 S 6.0 467 kW (635 PS) DBDE	11.2016→		7.28098.04.0	EUV-AGK	EL
			7.22687.49.0	EUV-LS	EP



FLYING SPUR (ZG2_)

8

6.0 W12 TSI 4WD (ZG21BB) 467 kW (635 PS) DDBD	04.2019→		7.28098.04.0	EUV-AGK	EL
--	----------	---	---------------------	---------	----

MULSANNE (3Y_)

9

6.8 377 kW (513 PS) CKBB, CZMB	09.2009→11.2014		7.28098.04.0	EUV-AGK	EL
6.8 Speed 395 kW (537 PS) CZMA	09.2014→12.2020		7.28098.04.0	EUV-AGK	EL

							
1 (E81)						1	B
116 d 66-150 kW (90-204 PS) N47 D20 A, N47 D20 C	11.2008→12.2011		7.02063.02.0	DW-AGR	EP		
116 d 66-145 kW (90-197 PS) N47 D20 A	01.2011→12.2011		7.02063.02.0	DW-AGR	EP		
			7.02318.01.0	EUV-AGR	EL		
116 d 66-150 kW (90-204 PS) N47 D20 C	01.2011→12.2011		7.02063.02.0	DW-AGR	EP		
116 i 89-90 kW (121-122 PS) N43 B16 AA	03.2007→12.2011		7.02318.01.0	EUV-ML	EL		
			7.02318.01.0	EUV-SR	EL		
116 i 85 kW (115 PS) N45 B16 A	09.2007→12.2011		7.02318.01.0	EUV-ML	EL		
			7.02318.01.0	EUV-SR	EL		
			7.06117.00.0	SV-NWV	EL	mit Dichtring with O-ring	
116 i 90-125 kW (122-170 PS) N43 B20 A	11.2008→12.2011		7.02318.01.0	EUV-ML	EL		
			7.02318.01.0	EUV-SR	EL		
118 d 66-145 kW (90-197 PS) N47 D20 A	09.2006→12.2011		7.02063.02.0	DW-AGR	EP		
			7.02318.01.0	EUV-AGR	EL	Produktionsdatum ab: 01.09.2008 Production date from: 01.09.2008	
118 d 66-150 kW (90-204 PS) N47 D20 C	09.2006→12.2011		7.02063.02.0	DW-AGR	EP		
118 d 66-145 kW (90-197 PS) N47 D20 A	09.2006→12.2011		7.02063.02.0	DW-AGR	EP		
			7.02318.01.0	EUV-AGR	EL	Produktionsdatum ab: 01.09.2008 Production date from: 01.09.2008	
118 d 66-150 kW (90-204 PS) N47 D20 C	09.2006→12.2011		7.02063.02.0	DW-AGR	EP		
118 i 90-125 kW (122-170 PS) N43 B20 A	09.2006→12.2011		7.02318.01.0	EUV-ML	EL		
			7.02318.01.0	EUV-SR	EL		
118 i 95-125 kW (129-170 PS) N46 B20 B	09.2006→12.2011		7.06117.00.0	SV-NWV	EL	mit Dichtring with O-ring	
118 i 95-125 kW (129-170 PS) N46 B20 B	09.2006→02.2008		7.06117.00.0	SV-NWV	EL	mit Dichtring with O-ring	
120 d 66-150 kW (90-204 PS) N47 D20 A, N47 D20 C	03.2007→12.2011		7.02063.02.0	DW-AGR	EP		
			7.02318.01.0	EUV-AGR	EL	 N47 D20 A, N47 D20 C: Produktionsdatum ab: 01.09.2008 Production date from: 01.09.2008	
120 d 66-150 kW (90-204 PS) N47 D20 A, N47 D20 C	03.2007→12.2011		7.02063.02.0	DW-AGR	EP		
			7.02318.01.0	EUV-AGR	EL	 N47 D20 A, N47 D20 C: Produktionsdatum ab: 01.09.2008 Production date from: 01.09.2008	
120 d 66-150 kW (90-204 PS) N47 D20 A, N47 D20 C	03.2007→12.2011		7.02063.02.0	DW-AGR	EP		
			7.02318.01.0	EUV-AGR	EL	 N47 D20 A, N47 D20 C: Produktionsdatum ab: 01.09.2008 Production date from: 01.09.2008	
120 i 90-125 kW (122-170 PS) N43 B20 A	03.2007→09.2012		7.02318.01.0	EUV-ML	EL		
			7.02318.01.0	EUV-SR	EL		
120 i 95-125 kW (129-170 PS) N46 B20 B, N46 B20 C	03.2007→12.2011		7.06117.00.0	SV-NWV	EL	mit Dichtring with O-ring	
120 i 90-125 kW (122-170 PS) N43 B20 A	03.2007→12.2011		7.02318.01.0	EUV-ML	EL		
			7.02318.01.0	EUV-SR	EL		











































B

1 (E81) **1**

123 d 150-160 kW (204-218 PS) N47 D20 B, N47 D20 D	03.2007→12.2011		7.02063.02.0	DW-AGR	EP	 N47 D20 B, N47 D20 D: Produktionsdatum ab: 01.03.2009 Production date from: 01.03.2009
			7.02256.27.0	DW-TL	EP	
			7.02318.01.0	EUV-AGR	EL	
7.02318.01.0	LDRV	EL				
130 i 155-200 kW (211-272 PS) N52 B30 A, N52 B30 B, N52 B30 BF	09.2006→12.2011		7.02318.01.0	EUV-AGK	EL	
			7.06117.01.0	SV-NWV	EL	
130 i 155-200 kW (211-272 PS) N52 B30 A, N52 B30 B, N52 B30 BF	09.2006→12.2011		7.06117.01.0	SV-NWV	EL	mit Dichtring with O-ring

1 (E87) **2**

116 d 66-150 kW (90-204 PS) N47 D20 A, N47 D20 C	03.2009→06.2011		7.02063.02.0	DW-AGR	EP	
			7.02318.01.0	EUV-AGR	EL	
116 d 66-150 kW (90-204 PS) N47 D20 C	01.2011→12.2011		7.02063.02.0	DW-AGR	EP	
			7.02318.01.0	EUV-AGR	EL	
116 i 85 kW (115 PS) N45 B16 A	06.2004→06.2011		7.06117.00.0	SV-NWV	EL	mit Dichtring with O-ring
116 i 89-90 kW (121-122 PS) N43 B16 AA	09.2007→06.2011		7.02318.01.0	EUV-ML	EL	
			7.02318.01.0	EUV-SR	EL	
116 i 90-125 kW (122-170 PS) N43 B20 A	01.2009→06.2011		7.02318.01.0	EUV-ML	EL	
			7.02318.01.0	EUV-SR	EL	
118 d 85-120 kW (116-163 PS) M47 D20 (204D4)	06.2004→02.2007		7.22796.01.0	DW-AGR	EP	
118 d 66-150 kW (90-204 PS) N47 D20 A, N47 D20 C	03.2007→06.2011		7.02063.02.0	DW-AGR	EP	
			7.02318.01.0	EUV-AGR	EL	 N47 D20 A, N47 D20 C: Produktionsdatum ab: 01.09.2008 Production date from: 01.09.2008
118 d 66-150 kW (90-204 PS) N47 D20 A, N47 D20 C	03.2007→06.2011		7.02063.02.0	DW-AGR	EP	
			7.02318.01.0	EUV-AGR	EL	 N47 D20 A, N47 D20 C: Produktionsdatum ab: 01.09.2008 Production date from: 01.09.2008
118 i 95-125 kW (129-170 PS) N46 B20 B	07.2004→02.2007		7.06117.00.0	SV-NWV	EL	mit Dichtring with O-ring
118 i 90-125 kW (122-170 PS) N43 B20 A	09.2006→06.2011		7.02318.01.0	EUV-ML	EL	
			7.02318.01.0	EUV-SR	EL	
118 i 95-125 kW (129-170 PS) N46 B20 B	10.2006→06.2011		7.06117.00.0	SV-NWV	EL	mit Dichtring with O-ring
118 i 90-125 kW (122-170 PS) N43 B20 A	03.2007→12.2007		7.02318.01.0	EUV-ML	EL	
			7.02318.01.0	EUV-SR	EL	
120 d 85-120 kW (116-163 PS) M47 D20 (204D4)	06.2004→02.2007		7.22796.01.0	DW-AGR	EP	→01.2007
			7.02318.01.0	EUV-SR	EL	
120 d 85-120 kW (116-163 PS) M47 D20 (204D4)	06.2004→02.2007		7.22796.01.0	DW-AGR	EP	
			7.02318.01.0	EUV-SR	EL	

							
1 (E87)						2	B
120 d 85-120 kW (116-163 PS) M47 D20 (204D4)	05.2006→02.2007		7.02318.01.0	EUV-SR	EL		
120 d 66-145 kW (90-197 PS) N47 D20 A	03.2007→06.2011		7.02063.02.0	DW-AGR	EP		
			7.02318.01.0	EUV-AGR	EL	Produktionsdatum ab: 01.09.2008 Production date from: 01.09.2008	
120 d 66-150 kW (90-204 PS) N47 D20 A, N47 D20 C	03.2007→06.2011		7.02063.02.0	DW-AGR	EP		
			7.02318.01.0	EUV-AGR	EL	 N47 D20 A, N47 D20 C: Produktionsdatum ab: 01.09.2008 Production date from: 01.09.2008	
120 d 66-145 kW (90-197 PS) N47 D20 A	03.2007→10.2010		7.02318.01.0	EUV-AGR	EL	Produktionsdatum ab: 01.09.2008 Production date from: 01.09.2008	
120 i 95-125 kW (129-170 PS) N46 B20 B, N46 B20 BD, N46 B20 C, N46 B20 CC	06.2004→02.2007		7.06117.00.0	SV-NWV	EL	mit Dichtring with O-ring	
			7.06117.00.0	SV-NWV	EL	mit Dichtring with O-ring	
120 i 95-125 kW (129-170 PS) N46 B20 B, N46 B20 BD, N46 B20 C, N46 B20 CC	03.2007→06.2011		7.02318.01.0	EUV-ML	EL		
			7.02318.01.0	EUV-SR	EL		
120 i 90-125 kW (122-170 PS) N43 B20 A	03.2007→06.2011		7.02318.01.0	EUV-ML	EL		
			7.02318.01.0	EUV-SR	EL		
			7.02318.01.0	EUV-SR	EL		
123 d 150-160 kW (204-218 PS) N47 D20 B, N47 D20 D	03.2007→06.2011		7.02063.02.0	DW-AGR	EP	 N47 D20 B, N47 D20 D: →03.2009	
			7.02256.27.0	DW-TL	EP		
			7.02318.01.0	EUV-AGR	EL		
			7.02318.01.0	LDRV	EL		
130 i 155-200 kW (211-272 PS) N52 B30 A, N52 B30 AF, N52 B30 BF	09.2005→02.2007		7.06117.01.0	SV-NWV	EL	mit Dichtring with O-ring	
			7.06117.01.0	SV-NWV	EL	mit Dichtring with O-ring	
130 i 155-200 kW (211-272 PS) N52 B30 A, N52 B30 AF, N52 B30 BF	03.2007→06.2011		7.02318.01.0	EUV-AGK	EL		
			7.06117.01.0	SV-NWV	EL	mit Dichtring with O-ring	
130 i 160-200 kW (218-272 PS) N52 B30 B	03.2007→06.2011		7.02318.01.0	EUV-AGK	EL		
118d 2.0 16V 90-105 kW (122-143 PS) M47 D20 TU2 UL, N47 D20UL	09.2004→05.2011		7.02318.01.0	EUV-AGR	EL		
1 (F20)						3	
114 d 70-85 kW (95-116 PS) N47 D16 A	11.2012→06.2015		7.02318.01.0	EUV-AGR	EL		
114 i 75-130 kW (102-177 PS) N13 B16 A	07.2012→02.2015		7.01777.17.0	DW-TL	EP		
			7.01762.04.0	SUV	EL		
			7.06117.02.0	SV-NWV	EL		
116 d 66-150 kW (90-204 PS) N47 D20 C	07.2011→02.2015		7.02318.01.0	EUV-AGR	EL		
116 d 70-85 kW (95-116 PS) N47 D16 A	03.2012→02.2015		7.02318.01.0	EUV-AGR	EL		
			7.01777.17.0	DW-TL	EP		
			7.01762.04.0	SUV	EL		
116 i 75-130 kW (102-177 PS) N13 B16 A	07.2011→02.2015		7.01777.17.0	DW-TL	EP		
			7.01762.04.0	SUV	EL		
			7.06117.02.0	SV-NWV	EL		



























B

1 (F20)

3

116 i 80-100 kW (109-136 PS) B38 B15 A	03.2015→06.2019		7.06117.02.0	SV-NWV	EL
118 d 66-150 kW (90-204 PS) N47 D20 C	07.2011→02.2015		7.02318.01.0	EUV-AGR	EL
118 d 66-150 kW (90-204 PS) N47 D20 C	07.2011→02.2015		7.02318.01.0	EUV-AGR	EL
118 d xDrive 66-150 kW (90-204 PS) N47 D20 C	07.2013→02.2015		7.02318.01.0	EUV-AGR	EL
118 i 75-130 kW (102-177 PS) N13 B16 A	07.2011→02.2015		7.01777.17.0	DW-TL	EP
			7.01762.04.0	SUV	EL
			7.06117.02.0	SV-NWV	EL
118 i 75-130 kW (102-177 PS) N13 B16 A	03.2015→06.2015		7.01777.17.0	DW-TL	EP
			7.01762.04.0	SUV	EL
			7.06117.02.0	SV-NWV	EL
118 i 80-100 kW (109-136 PS) B38 B15 A	07.2015→06.2019		7.06117.02.0	SV-NWV	EL
120 d 66-150 kW (90-204 PS) N47 D20 C	07.2011→06.2019		7.02318.01.0	EUV-AGR	EL
120 d 66-150 kW (90-204 PS) N47 D20 C	07.2011→02.2015		7.02318.01.0	EUV-AGR	EL
120 d 66-150 kW (90-204 PS) N47 D20 C	07.2011→02.2015		7.02318.01.0	EUV-AGR	EL
120 d xDrive 66-150 kW (90-204 PS) N47 D20 C	11.2012→02.2015		7.02318.01.0	EUV-AGR	EL
120 d xDrive 66-150 kW (90-204 PS) N47 D20 C	11.2012→02.2015		7.02318.01.0	EUV-AGR	EL
120 i 75-130 kW (102-177 PS) N13 B16 A	03.2015→06.2016		7.01777.17.0	DW-TL	EP
			7.01762.04.0	SUV	EL
			7.06117.02.0	SV-NWV	EL
120 i 115-190 kW (156-258 PS) B48 B20 A	07.2016→06.2019		7.06117.02.0	SV-NWV	EL
125 d 150-160 kW (204-218 PS) N47 D20 D	03.2012→06.2019		7.02256.27.0	DW-TL	EP
			7.02318.01.0	EUV-AGR	EL
			7.02318.01.0	LDRV	EL
125 d 150-160 kW (204-218 PS) N47 D20 D	03.2012→02.2015		7.02256.27.0	DW-TL	EP
			7.02318.01.0	EUV-AGR	EL
			7.02318.01.0	LDRV	EL
125 d 85-170 kW (116-231 PS) B47 D20 B	03.2015→06.2019		7.02256.27.0	DW-TL	EP
125 i 110-205 kW (150-279 PS) N20 B20 A	03.2012→11.2017		7.00887.21.0	DW-TL	EP
			7.04216.05.0	SUV	EL
125 i 110-205 kW (150-279 PS) N20 B20 A	03.2012→11.2017		7.00887.21.0	DW-TL	EP
			7.04216.05.0	SUV	EL
125 i Active Flex 110-205 kW (150-279 PS) N20 B20 A	11.2014→11.2017		7.04216.05.0	SUV	EL
M 135 i 200-272 kW (272-370 PS) N55 B30 A	07.2012→02.2015		7.00887.22.0	DW-TL	EP











						
1 (F20)					3	B
			7.06117.36.0	SV-NWV	EL	mit Dichtring with O-ring
M 135 i 200-272 kW (272-370 PS) N55 B30 A	03.2015→06.2016		7.00887.22.0	DW-TL	EP	
			7.06117.36.0	SV-NWV	EL	mit Dichtring with O-ring
M 135 i xDrive 200-272 kW (272-370 PS) N55 B30 A	11.2012→02.2015		7.00887.22.0	DW-TL	EP	
			7.06117.36.0	SV-NWV	EL	mit Dichtring with O-ring
M 135 i xDrive 200-272 kW (272-370 PS) N55 B30 A	03.2015→06.2016		7.00887.22.0	DW-TL	EP	
			7.06117.36.0	SV-NWV	EL	mit Dichtring with O-ring
1 (F21)					4	
114 d 70-85 kW (95-116 PS) N47 D16 A	07.2012→		7.02318.01.0	EUV-AGR	EL	
114 i 75-130 kW (102-177 PS) N13 B16 A	12.2011→		7.01777.17.0	DW-TL	EP	
			7.01762.04.0	SUV	EL	
			7.06117.02.0	SV-NWV	EL	
116 d 70-85 kW (95-116 PS) N47 D16 A	12.2011→		7.02318.01.0	EUV-AGR	EL	
116 d 66-150 kW (90-204 PS) N47 D20 C	01.2012→		7.02318.01.0	EUV-AGR	EL	
116 i 75-130 kW (102-177 PS) N13 B16 A	12.2011→		7.01777.17.0	DW-TL	EP	
			7.01762.04.0	SUV	EL	
			7.06117.02.0	SV-NWV	EL	
118 d 66-150 kW (90-204 PS) N47 D20 C	12.2011→02.2015		7.02318.01.0	EUV-AGR	EL	
118 d 66-150 kW (90-204 PS) N47 D20 C	12.2011→		7.02318.01.0	EUV-AGR	EL	
			7.02318.01.0	EUV-AGR	EL	
			7.02318.01.0	EUV-AGR	EL	
118 d xDrive 66-150 kW (90-204 PS) N47 D20 C	05.2013→		7.02318.01.0	EUV-AGR	EL	
			7.02318.01.0	EUV-AGR	EL	
			7.02318.01.0	EUV-AGR	EL	
118 i 75-130 kW (102-177 PS) N13 B16 A	07.2012→		7.01777.17.0	DW-TL	EP	
			7.01762.04.0	SUV	EL	
			7.06117.02.0	SV-NWV	EL	
118 i 75-130 kW (102-177 PS) N13 B16 A	03.2015→		7.01777.17.0	DW-TL	EP	
			7.01762.04.0	SUV	EL	
			7.06117.02.0	SV-NWV	EL	
120 d 66-150 kW (90-204 PS) N47 D20 C	07.2012→		7.02318.01.0	EUV-AGR	EL	
120 d 66-150 kW (90-204 PS) N47 D20 C	07.2012→		7.02318.01.0	EUV-AGR	EL	
			7.02318.01.0	EUV-AGR	EL	
			7.02318.01.0	EUV-AGR	EL	
120 d xDrive 66-150 kW (90-204 PS) N47 D20 C	01.2012→		7.02318.01.0	EUV-AGR	EL	
			7.02318.01.0	EUV-AGR	EL	
			7.02318.01.0	EUV-AGR	EL	
120 d xDrive 66-150 kW (90-204 PS) N47 D20 C	02.2012→02.2015		7.02318.01.0	EUV-AGR	EL	
			7.02318.01.0	EUV-AGR	EL	
			7.02318.01.0	EUV-AGR	EL	
120 i 75-130 kW (102-177 PS) N13 B16 A	03.2015→		7.01777.17.0	DW-TL	EP	
			7.01762.04.0	SUV	EL	



B







1 (F21)





















4

			7.06117.02.0	SV-NWV	EL	
125 d 150-160 kW (204-218 PS) N47 D20 D	12.2011→02.2015		7.02256.27.0	DW-TL	EP	
			7.02318.01.0	EUV-AGR	EL	
125 d 150-160 kW (204-218 PS) N47 D20 D	12.2011→		7.02256.27.0	DW-TL	EP	
			7.02318.01.0	EUV-AGR	EL	
125 d 85-170 kW (116-231 PS) B47 D20 B	03.2015→		7.02256.27.0	DW-TL	EP	
			7.02318.01.0	EUV-AGR	EL	
125 i 110-205 kW (150-279 PS) N20 B20 A	12.2011→12.2019		7.00887.21.0	DW-TL	EP	
			7.04216.05.0	SUV	EL	
125 i 110-205 kW (150-279 PS) N20 B20 A	03.2013→		7.00887.21.0	DW-TL	EP	
			7.04216.05.0	SUV	EL	
125 i Active Flex 110-205 kW (150-279 PS) N20 B20 A	08.2014→		7.04216.05.0	SUV	EL	
M 135 i 200-272 kW (272-370 PS) N55 B30 A	12.2011→		7.00887.21.0	DW-TL	EP	Produktionsdatum bis: 31.05.2012 Production date to: 31.05.2012
			7.00887.22.0	DW-TL	EP	Produktionsdatum ab: 01.06.2012 Production date from: 01.06.2012
			7.06117.36.0	SV-NWV	EL	mit Dichtring with O-ring
M 135 i 200-272 kW (272-370 PS) N55 B30 A	03.2015→		7.00887.22.0	DW-TL	EP	
			7.06117.36.0	SV-NWV	EL	mit Dichtring with O-ring
M 135 i xDrive 200-272 kW (272-370 PS) N55 B30 A	02.2012→		7.00887.21.0	DW-TL	EP	Produktionsdatum bis: 31.05.2012 Production date to: 31.05.2012
			7.00887.22.0	DW-TL	EP	Produktionsdatum ab: 01.06.2012 Production date from: 01.06.2012
			7.06117.36.0	SV-NWV	EL	mit Dichtring with O-ring
M 135 i xDrive 200-272 kW (272-370 PS) N55 B30 A	03.2015→		7.00887.22.0	DW-TL	EP	
			7.06117.36.0	SV-NWV	EL	mit Dichtring with O-ring

1 Convertible (E88)

5

118 d 66-150 kW (90-204 PS) N47 D20 A, N47 D20 C	09.2008→12.2013		7.02063.02.0	DW-AGR	EP	
			7.02318.01.0	EUV-AGR	EL	
118 d 66-150 kW (90-204 PS) N47 D20 A, N47 D20 C	09.2008→12.2013		7.02063.02.0	DW-AGR	EP	
			7.02318.01.0	EUV-AGR	EL	
118 i 90-125 kW (122-170 PS) N43 B20 A	03.2008→12.2013		7.02318.01.0	EUV-ML	EL	
			7.02318.01.0	EUV-SR	EL	
118 i 95-125 kW (129-170 PS) N46 B20 B	09.2008→12.2013		7.06117.00.0	SV-NWV	EL	mit Dichtring with O-ring
120 d 66-150 kW (90-204 PS) N47 D20 A, N47 D20 C	03.2008→12.2013		7.02063.02.0	DW-AGR	EP	
			7.02318.01.0	EUV-AGR	EL	 N47 D20 A, N47 D20 C: Produktionsdatum ab: 01.09.2008 Production date from: 01.09.2008





































 						
1 Convertible (E88)					5	B
120 d 66-150 kW (90-204 PS) N47 D20 A, N47 D20 C	03.2008→12.2013		7.02063.02.0	DW-AGR	EP	 N47 D20 A, N47 D20 C: Produktionsdatum ab: 01.09.2008 Production date from: 01.09.2008
			7.02318.01.0	EUV-AGR	EL	
120 d 66-150 kW (90-204 PS) N47 D20 C	03.2008→12.2013		7.02063.02.0	DW-AGR	EP	Produktionsdatum ab: 01.09.2008 Production date from: 01.09.2008
			7.02318.01.0	EUV-AGR	EL	
120 i 90-125 kW (122-170 PS) N43 B20 A	12.2007→10.2013		7.02318.01.0	EUV-ML	EL	
			7.02318.01.0	EUV-SR	EL	
120 i 90-125 kW (122-170 PS) N43 B20 A	03.2008→12.2013		7.02318.01.0	EUV-ML	EL	
			7.02318.01.0	EUV-SR	EL	
120 i 95-125 kW (129-170 PS) N46 B20 B, N46 B20 C, N46 B20 E	03.2008→12.2013		7.06117.00.0	SV-NWV	EL	mit Dichtring with O-ring
			7.02063.02.0	DW-AGR	EP	 N47 D20 B, N47 D20 D: Produktionsdatum ab: 01.03.2009 Production date from: 01.03.2009
7.02256.27.0	DW-TL	EP				
7.02318.01.0	EUV-AGR	EL				
123 d 150-160 kW (204-218 PS) N47 D20 B, N47 D20 D	09.2008→12.2013		7.02318.01.0	LDRV	EL	
			7.02318.01.0	EUV-AGK	EL	
125 i 155-200 kW (211-272 PS) N52 B30 A, N52 B30 B, N52 B30 BF	12.2007→10.2013		7.06117.01.0	SV-NWV	EL	mit Dichtring with O-ring
			7.02318.01.0	EUV-AGK	EL	
128 i 155-200 kW (211-272 PS) N51 B30 A, N52 B30 A	12.2007→10.2013		7.02318.01.0	EUV-AGK	EL	mit Dichtring with O-ring
			7.06117.01.0	SV-NWV	EL	
135 i 200-264 kW (272-359 PS) N54 B30 A	03.2008→10.2013		7.00887.19.0	DW-TL	EP	mit Dichtring with O-ring
			7.02318.01.0	EUV-AGK	EL	
			7.06117.01.0	SV-NWV	EL	
135 i 200-272 kW (272-370 PS) N55 B30 A	03.2008→10.2013		7.00887.21.0	DW-TL	EP	Produktionsdatum bis: 31.05.2012 Production date to: 31.05.2012
			7.00887.22.0	DW-TL	EP	Produktionsdatum ab: 01.06.2012 Production date from: 01.06.2012
			7.02318.01.0	EUV-AGK	EL	mit Dichtring with O-ring
			7.06117.36.0	SV-NWV	EL	
135 i 200-272 kW (272-370 PS) N55 B30 A	03.2008→12.2013		7.00887.21.0	DW-TL	EP	Produktionsdatum bis: 31.05.2012 Production date to: 31.05.2012
			7.00887.22.0	DW-TL	EP	Produktionsdatum ab: 01.06.2012 Production date from: 01.06.2012
			7.02318.01.0	EUV-AGK	EL	mit Dichtring with O-ring
			7.06117.36.0	SV-NWV	EL	
1 Coupe (E82)					6	
118 d 66-150 kW (90-204 PS) N47 D20 C	09.2009→10.2013		7.02318.01.0	EUV-AGR	EL	
			7.02318.01.0	EUV-AGR	EL	
120 d 66-150 kW (90-204 PS) N47 D20 A, N47 D20 C	09.2007→10.2013		7.02063.02.0	DW-AGR	EP	
			7.02318.01.0	EUV-AGR	EL	

B
1 Coupe (E82)
6

120 d 66-150 kW (90-204 PS) N47 D20 A, N47 D20 C	09.2007→10.2013		7.02063.02.0	DW-AGR	EP	
			7.02318.01.0	EUV-AGR	EL	
120 d 66-150 kW (90-204 PS) N47 D20 A, N47 D20 C	09.2007→10.2013		7.02063.02.0	DW-AGR	EP	
			7.02318.01.0	EUV-AGR	EL	
120 i 90-125 kW (122-170 PS) N43 B20 A	10.2007→10.2013		7.02318.01.0	EUV-ML	EL	
			7.02318.01.0	EUV-SR	EL	
120 i 95-125 kW (129-170 PS) N46 B20 B, N46 B20 C, N46 B20 E	09.2009→10.2013		7.06117.00.0	SV-NWV	EL	mit Dichtring with O-ring
123 d 150-160 kW (204-218 PS) N47 D20 B, N47 D20 D	10.2007→10.2013		7.02063.02.0	DW-AGR	EP	
			7.02256.27.0	DW-TL	EP	
			7.02318.01.0	EUV-AGR	EL	
125 i 155-200 kW (211-272 PS) N52 B30 A	03.2008→10.2013		7.02318.01.0	EUV-AGK	EL	
			7.06117.01.0	SV-NWV	EL	mit Dichtring with O-ring
125 i 160-200 kW (218-272 PS) N52 B30 B, N52 B30 BF	03.2008→10.2013		7.06117.01.0	SV-NWV	EL	mit Dichtring with O-ring
128 i 155-200 kW (211-272 PS) N51 B30 A, N52 B30 A	10.2007→10.2013		7.02318.01.0	EUV-AGK	EL	
			7.06117.01.0	SV-NWV	EL	mit Dichtring with O-ring
135 i 200-264 kW (272-359 PS) N54 B30 A	10.2007→10.2013		7.00887.19.0	DW-TL	EP	
			7.02318.01.0	EUV-AGK	EL	
			7.06117.01.0	SV-NWV	EL	mit Dichtring with O-ring
135 i 200-272 kW (272-370 PS) N55 B30 A	10.2007→10.2013		7.00887.21.0	DW-TL	EP	Produktionsdatum bis: 31.05.2012 Production date to: 31.05.2012
			7.00887.22.0	DW-TL	EP	Produktionsdatum ab: 01.06.2012 Production date from: 01.06.2012
			7.06117.36.0	SV-NWV	EL	mit Dichtring with O-ring
135 i 200-264 kW (272-359 PS) N54 B30 A	10.2007→10.2013		7.00887.19.0	DW-TL	EP	
			7.02318.01.0	EUV-AGK	EL	
			7.06117.01.0	SV-NWV	EL	mit Dichtring with O-ring
135 i 200-272 kW (272-370 PS) N55 B30 A	10.2007→10.2013		7.00887.21.0	DW-TL	EP	Produktionsdatum bis: 31.05.2012 Production date to: 31.05.2012
			7.00887.22.0	DW-TL	EP	Produktionsdatum ab: 01.06.2012 Production date from: 01.06.2012
			7.06117.36.0	SV-NWV	EL	mit Dichtring with O-ring
M 200-264 kW (272-359 PS) N54 B30 A	03.2011→06.2012		7.00887.19.0	DW-TL	EP	
			7.06117.01.0	SV-NWV	EL	mit Dichtring with O-ring

2 Convertible (F23)
7

220 i 110-205 kW (150-279 PS) N20 B20 A, N20 B20 B	04.2014→07.2016		7.04216.05.0	SUV	EL	
225 d 85-170 kW (116-231 PS) B47 D20 B	07.2015→		7.02256.27.0	DW-TL	EP	
228 i 110-205 kW (150-279 PS) N20 B20 A	11.2014→		7.04216.05.0	SUV	EL	

					
2 Convertible (F23)					
7					
228 i xDrive 110-205 kW (150-279 PS) N20 B20 A	09.2015→		7.04216.05.0	SUV	EL  USA  USA
M 235 i 200-272 kW (272-370 PS) N55 B30 A	11.2014→		7.06117.36.0	SV-NWV	EL mit Dichtring with O-ring
M 235 i xDrive 200-272 kW (272-370 PS) N55 B30 A	07.2015→		7.06117.36.0	SV-NWV	EL mit Dichtring with O-ring
2 Coupe (F22, F87)					
8					
218 d 66-150 kW (90-204 PS) N47 D20 C	03.2014→06.2015		7.02318.01.0	EUV-AGR	EL
218 d 66-150 kW (90-204 PS) N47 D20 C	03.2014→06.2015		7.02318.01.0	EUV-AGR	EL
220 d 66-150 kW (90-204 PS) N47 D20 C	10.2012→11.2014		7.02318.01.0	EUV-AGR	EL
220 d 66-150 kW (90-204 PS) N47 D20 C	10.2012→11.2014		7.02318.01.0	EUV-AGR	EL
220 d 66-150 kW (90-204 PS) N47 D20 C	11.2014→		7.02318.01.0	EUV-AGR	EL
220 i 110-205 kW (150-279 PS) N20 B20 A, N20 B20 B	10.2013→		7.04216.05.0	SUV	EL
225 d 150-160 kW (204-218 PS) N47 D20 D	01.2014→		7.02256.27.0	DW-TL	EP
			7.02318.01.0	EUV-AGR	EL
			7.02318.01.0	LDRV	EL
225 d 85-170 kW (116-231 PS) B47 D20 B	07.2015→		7.02256.27.0	DW-TL	EP
228 i 110-205 kW (150-279 PS) N20 B20 A	01.2014→		7.00887.21.0	DW-TL	EP  USA  USA
			7.04216.05.0	SUV	EL
228 i 110-205 kW (150-279 PS) N20 B20 A	07.2014→		7.00887.21.0	DW-TL	EP  USA  USA
			7.04216.05.0	SUV	EL
228 i 179-180 kW (243-245 PS) N26 B20 A	07.2014→		7.04216.05.0	SUV	EL  USA  USA
228 i xDrive 110-205 kW (150-279 PS) N20 B20 A, N26 B20 A	07.2014→		7.04216.05.0	SUV	EL  N20 B20 A, N26 B20 A:  USA  USA
M 235 i 200-272 kW (272-370 PS) N55 B30 A	10.2013→		7.00887.22.0	DW-TL	EP
			7.06117.36.0	SV-NWV	EL mit Dichtring with O-ring
M 235 i 200-272 kW (272-370 PS) N55 B30 A	03.2014→		7.00887.22.0	DW-TL	EP
			7.06117.36.0	SV-NWV	EL mit Dichtring with O-ring
M 235 i xDrive 200-272 kW (272-370 PS) N55 B30 A	07.2014→		7.00887.22.0	DW-TL	EP
			7.06117.36.0	SV-NWV	EL mit Dichtring with O-ring
M2 200-272 kW (272-370 PS) N55 B30 A	11.2015→06.2018		7.00887.22.0	DW-TL	EP
			7.04216.05.0	SUV	EL
			7.06117.36.0	SV-NWV	EL mit Dichtring with O-ring

B
2 Coupe (F22, F87)
8



























M2 CS 272-368 kW (370-500 PS) S55 B30 A	11.2019→	7.06117.36.0	SV-NWV	EL	mit Dichtring with O-ring
M2 Competition 272-368 kW (370-500 PS) S55 B30 A	06.2018→	7.06117.36.0	SV-NWV	EL	mit Dichtring with O-ring

3 (E36)
9

316 i 75-77 kW (102-105 PS) M43 B16 (164E2)	09.1993→05.1998	7.02318.01.0	EUV-SL	EL	
323 i 120-141 kW (163-192 PS) M52 B25 (256S3)	05.1995→11.1998	7.02318.01.0	EUV-AGK	EL	
		7.00784.01.0	EUV-SL	EP	
325 td 85-105 kW (115-143 PS) M51 D25 (256T1)	09.1991→02.1998	7.21903.73.0	DW-AGR	EP	01.1996→
325 tds 85-105 kW (115-143 PS) M51 D25 (256T1)	05.1993→02.1998	7.21903.73.0	DW-AGR	EP	01.1996→
328 i 141-143 kW (192-194 PS) M52 B28 (286S1)	01.1995→04.1998	7.00784.01.0	EUV-SL	EP	
		7.02318.01.0	EUV-AGK	EL	
		7.02318.01.0	EUV-SL	EL	
M3 3.2 236 kW (321 PS) S50 B32 (326S1)	10.1995→01.1998	7.00784.01.0	EUV-SL	EP	
M3 3.2 176-179 kW (239-243 PS) S52 B32 (326S2)	09.1996→05.1998	7.02318.01.0	EUV-SL	EL	

3 (E46)
10

316 i 77 kW (105 PS) M43 B16 (164E3)	04.2000→02.2005	7.02318.01.0	EUV-SL	EL	
316 i 85 kW (115 PS) N42 B18 A, N46 B18 A	02.2002→02.2005	7.06117.00.0	SV-NWV	EL	mit Dichtring with O-ring
316 i 77-85 kW (105-115 PS) N40 B16 A, N45 B16 A	06.2002→02.2005	7.06117.00.0	SV-NWV	EL	mit Dichtring with O-ring
318 d 85-100 kW (116-136 PS) M47 D20 (204D1)	09.2001→03.2003	7.22796.01.0	DW-AGR	EP	
		7.22796.01.0	DW-TL	EP	
		7.02318.01.0	EUV-AGR	EL	
318 d 85-120 kW (116-163 PS) M47 D20 (204D4)	03.2003→02.2005	7.22796.01.0	DW-AGR	EP	
		7.22796.01.0	DW-TL	EP	
		7.02318.01.0	EUV-AGR	EL	
318 i 77-87 kW (105-118 PS) M43 B19 (194E1)	12.1997→09.2001	7.02318.01.0	EUV-SL	EL	
318 i 95-125 kW (129-170 PS) N42 B20 A, N46 B20 A, N46 B20 C	09.2001→02.2005	7.06117.00.0	SV-NWV	EL	mit Dichtring with O-ring
318 i 100-110 kW (136-150 PS) N42 B20 A	09.2001→02.2005	7.06117.00.0	SV-NWV	EL	mit Dichtring with O-ring
320 d 85-100 kW (116-136 PS) M47 D20 (204D1)	02.1998→08.2001	7.22796.01.0	DW-AGR	EP	
		7.22796.01.0	DW-TL	EP	
		7.02318.01.0	EUV-KL	EL	
320 d 85-100 kW (116-136 PS) M47 D20 (204D1)	04.1998→09.2001	7.22796.01.0	DW-AGR	EP	
		7.22796.01.0	DW-TL	EP	
		7.02318.01.0	EUV-KL	EL	
320 d 85-120 kW (116-163 PS) M47 D20 (204D4)	09.2001→05.2005	7.22796.01.0	DW-AGR	EP	
		7.22796.01.0	DW-TL	EP	
		7.02318.01.0	EUV-KL	EL	

					
3 (E46)					
320 i 100-110 kW (136-150 PS) M52 B20 (206S4)	03.1998→09.2000		7.00784.01.0	EUV-SL	EP
320 i 120-125 kW (163-170 PS) M54 B22 (226S1)	09.2000→02.2005		7.00784.01.0	EUV-SL	EP
			7.02318.01.0	EUV-SL	EL
320 i 120-125 kW (163-170 PS) M54 B22 (226S1)	09.2000→02.2005		7.02318.01.0	EUV-SL	EL
323 i 120-141 kW (163-192 PS) M52 B25 (256S4)	03.1998→09.2000		7.00784.01.0	EUV-SL	EP
325 i 137-141 kW (186-192 PS) M54 B25 (256S5)	09.2000→04.2005		7.02318.01.0	EUV-SL	EL
325 i 137-141 kW (186-192 PS) M54 B25 (256S5)	09.2000→02.2005		7.00784.01.0	EUV-SL	EP
			7.02318.01.0	EUV-SL	EL
325 xi 137-141 kW (186-192 PS) M54 B25 (256S5)	09.2000→04.2005		7.02318.01.0	EUV-AGK	EL
325 xi 137-141 kW (186-192 PS) M54 B25 (256S5)	09.2000→02.2005		7.02318.01.0	EUV-AGK	EL
			7.00784.01.0	EUV-SL	EP
328 i 141-144 kW (192-196 PS) M52 B28 (286S2)	02.1998→06.2000		7.00784.01.0	EUV-SL	EP
			7.02318.01.0	EUV-SL	EL
328 i 141-144 kW (192-196 PS) M52 B28 (286S2)	09.1998→12.2000		7.02318.01.0	EUV-SL	EL
330 d 135-142 kW (184-193 PS) M57 D30 (306D1)	10.1999→02.2005		7.22796.01.0	DW-AGR	EP
			7.22796.01.0	DW-TL	EP
			7.02318.01.0	EUV-AGR	EL
330 d 150-160 kW (204-218 PS) M57 D30 (306D2)	03.2003→02.2005		7.22796.01.0	DW-AGR	EP
			7.22796.01.0	DW-TL	EP
			7.02318.01.0	EUV-SR	EL
330 i 163-170 kW (222-231 PS) M54 B30 (306S3)	06.2000→02.2005		7.00784.01.0	EUV-SL	EP
330 xd 135-142 kW (184-193 PS) M57 D30 (306D1)	01.2000→02.2003		7.22796.01.0	DW-AGR	EP
			7.22796.01.0	DW-TL	EP
330 xd 150-160 kW (204-218 PS) M57 D30 (306D2)	09.2002→12.2004		7.22796.01.0	DW-AGR	EP
			7.22796.01.0	DW-TL	EP
			7.02318.01.0	EUV-ML	EL
330 xi 163-170 kW (222-231 PS) M54 B30 (306S3)	06.2000→02.2005		7.00784.01.0	EUV-SL	EP
3 (E90)					
316 d 66-150 kW (90-204 PS) N47 D20 C	07.2009→12.2011		7.02318.01.0	EUV-AGR	EL
316 i 85 kW (115 PS) N45 B16 A	09.2005→10.2011		7.06117.00.0	SV-NWV	EL
				mit Dichtring with O-ring	
316 i 85-90 kW (115-122 PS) N43 B16 A, N43 B16 AA	09.2007→10.2011		7.02318.01.0	EUV-ML	EL
			7.02318.01.0	EUV-SR	EL
318 d 85-120 kW (116-163 PS) M47 D20 (204D4)	03.2005→08.2007		7.22796.01.0	DW-AGR	EP
			7.02318.01.0	EUV-AGR	EL
318 d 66-150 kW (90-204 PS) N47 D20 A, N47 D20 C	02.2007→10.2011		7.02063.02.0	DW-AGR	EP
			7.02318.01.0	EUV-AGR	EL

10
B
11



B

3 (E90)

11

			7.02318.01.0	EUV-ML	EL	
318 d 66-150 kW (90-204 PS) N47 D20 A, N47 D20 C	09.2007→10.2011		7.02063.02.0	DW-AGR	EP	
318 i 95-125 kW (129-170 PS) N46 B20 B	09.2005→08.2007		7.06117.00.0	SV-NWV	EL	mit Dichtring with O-ring
318 i 90-125 kW (122-170 PS) N43 B20 A	09.2007→10.2011		7.02318.01.0	EUV-ML	EL	
			7.02318.01.0	EUV-SR	EL	
318 i 95-125 kW (129-170 PS) N46 B20 B, N46 B20 C, N46 B20 CC, N46 B20 CD, N46 B20 E	09.2007→10.2011		7.06117.00.0	SV-NWV	EL	mit Dichtring with O-ring
320 d 85-120 kW (116-163 PS) M47 D20 (204D4)	12.2004→08.2007		7.22796.01.0	DW-AGR	EP	
			7.02318.01.0	EUV-AGR	EL	
320 d 85-120 kW (116-163 PS) M47 D20 (204D4)	12.2004→09.2007		7.22796.01.0	DW-AGR	EP	
			7.02318.01.0	EUV-SR	EL	
320 d 85-120 kW (116-163 PS) M47 D20 (204D4)	12.2004→09.2007		7.22796.01.0	DW-AGR	EP	
			7.02318.01.0	EUV-SR	EL	
320 d 66-145 kW (90-197 PS) N47 D20 A	09.2007→08.2008		7.02318.01.0	EUV-AGR	EL	
			7.02318.01.0	EUV-ML	EL	
320 d 66-150 kW (90-204 PS) N47 D20 A, N47 D20 C	09.2007→02.2010		7.02063.02.0	DW-AGR	EP	
			7.02318.01.0	EUV-AGR	EL	
320 d 66-150 kW (90-204 PS) N47 D20 C	09.2008→10.2011		7.02063.02.0	DW-AGR	EP	Euro 3 (D3) Euro 3 (D3)
			7.02318.01.0	EUV-AGR	EL	
			7.02318.01.0	EUV-ML	EL	
320 d 66-150 kW (90-204 PS) N47 D20 C	03.2010→10.2011		7.02063.02.0	DW-AGR	EP	
320 d xDrive 66-150 kW (90-204 PS) N47 D20 C	09.2008→10.2011		7.02318.01.0	EUV-AGR	EL	
320 d xDrive 66-150 kW (90-204 PS) N47 D20 A, N47 D20 C	09.2008→02.2010		7.02318.01.0	EUV-AGR	EL	
320 d xDrive 66-150 kW (90-204 PS) N47 D20 C	03.2010→10.2011		7.02318.01.0	EUV-AGR	EL	
320 i 95-125 kW (129-170 PS) N46 B20 B, N46 B20 BD, N46 B20 C, N46 B20 CB	12.2004→08.2007		7.06117.00.0	SV-NWV	EL	mit Dichtring with O-ring
320 i 95-125 kW (129-170 PS) N46 B20 B, N46 B20 C, N46 B20 CC, N46 B20 CD, N46 B20 E	02.2007→12.2011		7.06117.00.0	SV-NWV	EL	mit Dichtring with O-ring
320 i 90-125 kW (122-170 PS) N43 B20 A	03.2007→12.2011		7.02318.01.0	EUV-ML	EL	
			7.02318.01.0	EUV-SR	EL	
320 i 90-125 kW (122-170 PS) N43 B20 A	09.2007→10.2011		7.02318.01.0	EUV-ML	EL	
			7.02318.01.0	EUV-SR	EL	
320 si 127 kW (173 PS) N45 B20 A	09.2005→08.2006		7.06117.00.0	SV-NWV	EL	mit Dichtring with O-ring
323 i 130-160 kW (177-218 PS) N52 B25 A, N52 B25 B, N52 B25 BE, N52 B25 BF	09.2005→02.2007		7.06117.01.0	SV-NWV	EL	mit Dichtring with O-ring

















					
3 (E90)					
323 i 130-160 kW (177-218 PS) N52 B25 A, N52 B25 BF	03.2007→12.2011		7.06117.01.0	SV-NWV	EL mit Dichtring with O-ring
325 d 135-173 kW (184-235 PS) M57 D30 (306D3)	09.2006→02.2010		7.22796.01.0	DW-AGR	EP
			7.02318.01.0	EUV-ML	EL
325 d 150-210 kW (204-286 PS) N57 D30 A	03.2010→10.2011		7.02318.01.0	EUV-AGR	EL
			7.02318.01.0	EUV-ML	EL
325 i 130-160 kW (177-218 PS) N52 B25 A, N52 B25 B, N52 B25 BF	12.2004→12.2011		7.06117.01.0	SV-NWV	EL mit Dichtring with O-ring
325 i 130-160 kW (177-218 PS) N52 B25 A	01.2006→12.2011		7.06117.01.0	SV-NWV	EL mit Dichtring with O-ring
325 i 150-200 kW (204-272 PS) N53 B30 A	03.2007→12.2011		7.06117.01.0	SV-NWV	EL mit Dichtring with O-ring
325 i 150-200 kW (204-272 PS) N53 B30 A	03.2007→12.2011		7.06117.01.0	SV-NWV	EL mit Dichtring with O-ring
325 i 130-163 kW (177-222 PS) N52 B25	09.2008→12.2009		7.06117.01.0	SV-NWV	EL mit Dichtring with O-ring
325 i xDrive 150-200 kW (204-272 PS) N53 B30 A	09.2008→10.2011		7.06117.01.0	SV-NWV	EL mit Dichtring with O-ring
325 i xDrive 150-200 kW (204-272 PS) N53 B30 A	09.2008→10.2011		7.06117.01.0	SV-NWV	EL mit Dichtring with O-ring
325 xi 130-160 kW (177-218 PS) N52 B25 A	09.2005→08.2008		7.06117.01.0	SV-NWV	EL mit Dichtring with O-ring
325 xi 155-200 kW (211-272 PS) N52 B30 A	09.2005→08.2006		7.06117.01.0	SV-NWV	EL mit Dichtring with O-ring
325 xi 150-200 kW (204-272 PS) N53 B30 A	09.2007→08.2008		7.06117.01.0	SV-NWV	EL mit Dichtring with O-ring
328 i 160-172 kW (218-234 PS) N51 B30 A	09.2006→12.2011		7.06117.01.0	SV-NWV	EL mit Dichtring with O-ring
328 i xDrive 155-200 kW (211-272 PS) N51 B30 A, N52 B30 A	09.2008→12.2010		7.06117.01.0	SV-NWV	EL mit Dichtring with O-ring
328 xi 155-200 kW (211-272 PS) N51 B30 A, N52 B30 A	09.2006→12.2008		7.06117.01.0	SV-NWV	EL mit Dichtring with O-ring
			7.22796.01.0	DW-AGR	EP
			7.02318.01.0	EUV-ML	EL
330 d 135-173 kW (184-235 PS) M57 D30 (306D3)	09.2005→12.2011		7.22796.01.0	DW-AGR	EP →08.2008
			7.02318.01.0	EUV-ML	EL
			7.02318.01.0	EUV-SR	EL
330 d 150-210 kW (204-286 PS) N57 D30 A	09.2005→12.2011		7.02318.01.0	EUV-AGR	EL
			7.02318.01.0	EUV-ML	EL
330 d 150-210 kW (204-286 PS) N57 D30 A	09.2008→10.2011		7.02318.01.0	EUV-AGR	EL
			7.02318.01.0	EUV-ML	EL
330 d xDrive 150-210 kW (204-286 PS) N57 D30 A	09.2008→10.2011		7.02318.01.0	EUV-AGR	EL
			7.02318.01.0	EUV-ML	EL
			7.02318.01.0	EUV-SR	EL











B

3 (E90)











11

330 i 155-200 kW (211-272 PS) N52 B30 A, N52 B30 BF	12.2004→10.2011	 7.06117.01.0	SV-NWV	EL	mit Dichtring with O-ring
330 i 155-200 kW (211-272 PS) N52 B30 A, N52 B30 BF	03.2007→12.2011	 7.06117.01.0	SV-NWV	EL	mit Dichtring with O-ring
330 i 150-200 kW (204-272 PS) N53 B30 A	09.2007→10.2011	 7.06117.01.0	SV-NWV	EL	mit Dichtring with O-ring
330 i xDrive 150-200 kW (204-272 PS) N53 B30 A	09.2008→10.2011	 7.06117.01.0	SV-NWV	EL	mit Dichtring with O-ring
330 xd 135-173 kW (184-235 PS) M57 D30 (306D3)	09.2005→08.2008	 7.22796.01.0	DW-AGR	EP	
		7.02318.01.0	EUV-ML	EL	
330 xi 155-200 kW (211-272 PS) N52 B30 A	09.2005→08.2007	 7.06117.01.0	SV-NWV	EL	mit Dichtring with O-ring
330 xi 150-200 kW (204-272 PS) N53 B30 A	09.2007→08.2008	 7.06117.01.0	SV-NWV	EL	mit Dichtring with O-ring
335 d 198-221 kW (269-301 PS) M57 D30 (306D5)	09.2006→12.2011	 7.22796.01.0	DW-AGR	EP	
		7.02256.27.0	DW-TL	EP	
		7.02318.01.0	EUV-AGR	EL	
		7.02318.01.0	EUV-ML	EL	
		7.02318.01.0	EUV-SR	EL	
335 i 200-264 kW (272-359 PS) N54 B30 A	03.2006→12.2011	 7.00887.19.0	DW-TL	EP	
		7.06117.01.0	SV-NWV	EL	mit Dichtring with O-ring
335 i 200-264 kW (272-359 PS) N54 B30 A	03.2006→12.2011	 7.00887.19.0	DW-TL	EP	
		7.06117.01.0	SV-NWV	EL	mit Dichtring with O-ring
335 i 200-272 kW (272-370 PS) N55 B30 A	03.2006→12.2011	 7.00887.21.0	DW-TL	EP	
		7.06117.36.0	SV-NWV	EL	mit Dichtring with O-ring
335 i 200-264 kW (272-359 PS) N54 B30 A	03.2006→12.2011	 7.00887.19.0	DW-TL	EP	
		7.06117.01.0	SV-NWV	EL	mit Dichtring with O-ring
335 i 200-272 kW (272-370 PS) N55 B30 A	03.2006→12.2011	 7.00887.21.0	DW-TL	EP	
		7.06117.36.0	SV-NWV	EL	mit Dichtring with O-ring
335 i 200-264 kW (272-359 PS) N54 B30 A	09.2006→02.2010	 7.00887.19.0	DW-TL	EP	
		7.06117.01.0	SV-NWV	EL	mit Dichtring with O-ring
335 i 200-272 kW (272-370 PS) N55 B30 A	03.2010→12.2011	 7.00887.21.0	DW-TL	EP	
		7.06117.36.0	SV-NWV	EL	mit Dichtring with O-ring
335 i xDrive 200-264 kW (272-359 PS) N54 B30 A	05.2008→10.2011	 7.06117.01.0	SV-NWV	EL	mit Dichtring with O-ring
335 i xDrive 200-264 kW (272-359 PS) N54 B30 A	05.2008→10.2011	 7.00887.19.0	DW-TL	EP	
		7.06117.01.0	SV-NWV	EL	mit Dichtring with O-ring

3 (E90)
11
B

335 i xDrive 200-272 kW (272-370 PS) N55 B30 A	05.2008→10.2011		7.00887.21.0	DW-TL	EP	
			7.06117.36.0	SV-NWV	EL	mit Dichtring with O-ring
335 i xDrive 200-264 kW (272-359 PS) N54 B30 A	09.2008→02.2010		7.00887.19.0	DW-TL	EP	
			7.06117.01.0	SV-NWV	EL	mit Dichtring with O-ring
335 i xDrive 200-272 kW (272-370 PS) N55 B30 A	03.2010→10.2011		7.00887.21.0	DW-TL	EP	
			7.06117.36.0	SV-NWV	EL	mit Dichtring with O-ring
335 xi 200-264 kW (272-359 PS) N54 B30 A	09.2006→06.2008		7.06117.01.0	SV-NWV	EL	mit Dichtring with O-ring
335 xi 200-264 kW (272-359 PS) N54 B30 A	09.2006→06.2008		7.00887.19.0	DW-TL	EP	
			7.06117.01.0	SV-NWV	EL	mit Dichtring with O-ring
335 xi 200-264 kW (272-359 PS) N54 B30 A	03.2007→08.2008		7.00887.19.0	DW-TL	EP	
			7.06117.01.0	SV-NWV	EL	mit Dichtring with O-ring
M3 309 kW (420 PS) S65 B40 A	12.2007→10.2011		7.06117.58.0	SV-NWV	EH	mit Dichtring with O-ring
M3 CRT 331 kW (450 PS) S65 B44 A	03.2011→12.2011		7.06117.58.0	SV-NWV	EH	mit Dichtring with O-ring

3 (F30, F80)
12

316 d 66-150 kW (90-204 PS) N47 D20 C	03.2012→10.2018		7.02318.01.0	EUV-AGR	EL	
316 i 75-130 kW (102-177 PS) N13 B16 A	07.2012→08.2016		7.01777.17.0	DW-TL	EP	
			7.01762.04.0	SUV	EL	
			7.06117.02.0	SV-NWV	EL	
318 d 66-150 kW (90-204 PS) N47 D20 C	03.2012→06.2015		7.02318.01.0	EUV-AGR	EL	
318 d 66-150 kW (90-204 PS) N47 D20 C	03.2012→10.2018		7.02318.01.0	EUV-AGR	EL	
318 d xDrive 66-150 kW (90-204 PS) N47 D20 C	07.2013→06.2015		7.02318.01.0	EUV-AGR	EL	
320 d 66-150 kW (90-204 PS) N47 D20 C	11.2011→03.2016		7.02318.01.0	EUV-AGR	EL	
320 d 66-150 kW (90-204 PS) N47 D20 C	11.2011→10.2018		7.02318.01.0	EUV-AGR	EL	
320 d 66-150 kW (90-204 PS) N47 D20 C	11.2011→03.2016		7.02318.01.0	EUV-AGR	EL	
320 d xDrive 66-150 kW (90-204 PS) N47 D20 C	08.2012→06.2015		7.02318.01.0	EUV-AGR	EL	
320 d xDrive 66-150 kW (90-204 PS) N47 D20 C	08.2012→06.2015		7.02318.01.0	EUV-AGR	EL	
320 i 110-205 kW (150-279 PS) N20 B20 A, N20 B20 B	03.2012→10.2018		7.00887.21.0	DW-TL	EP	
			7.04216.05.0	SUV	EL	



















B

3 (F30, F80)

12





320 i 110-205 kW (150-279 PS) N20 B20 A	03.2012→10.2018		7.00887.21.0	DW-TL	EP
			7.04216.05.0	SUV	EL
320 i 120-135 kW (163-184 PS) N20 B20 B, N20 B20 D	03.2012→10.2018		7.04216.05.0	SUV	EL
320 i 75-130 kW (102-177 PS) N13 B16 A	11.2012→06.2016		7.01777.17.0	DW-TL	EP
			7.01762.04.0	SUV	EL
			7.06117.02.0	SV-NWV	EL
320 i ActiveFlex 110-205 kW (150-279 PS) N20 B20 A	12.2013→10.2018		7.00887.21.0	DW-TL	EP
			7.04216.05.0	SUV	EL
320 i xDrive 110-205 kW (150-279 PS) N20 B20 A, N20 B20 B	07.2012→10.2018		7.00887.21.0	DW-TL	EP
			7.04216.05.0	SUV	EL
320 i xDrive 110-205 kW (150-279 PS) N20 B20 A, N20 B20 B	07.2012→10.2018		7.00887.21.0	DW-TL	EP
			7.04216.05.0	SUV	EL
325 d 150-160 kW (204-218 PS) N47 D20 D	03.2013→02.2016		7.02256.27.0	DW-TL	EP
			7.02318.01.0	EUV-AGR	EL
			7.02318.01.0	LDRV	EL
325 d 150-160 kW (204-218 PS) N47 D20 D	03.2013→02.2016		7.02256.27.0	DW-TL	EP
325 d 85-170 kW (116-231 PS) B47 D20 B	03.2016→02.2018		7.02256.27.0	DW-TL	EP
328 i 110-205 kW (150-279 PS) N20 B20 A	11.2011→10.2018		7.00887.21.0	DW-TL	EP
			7.04216.05.0	SUV	EL
328 i 179-180 kW (243-245 PS) N26 B20 A	03.2012→06.2016		7.04216.05.0	SUV	EL
328 i ActiveFlex 110-205 kW (150-279 PS) N20 B20 A	02.2014→10.2018		7.00887.21.0	DW-TL	EP
			7.04216.05.0	SUV	EL
328 i xDrive 110-205 kW (150-279 PS) N20 B20 A	07.2012→08.2016		7.00887.21.0	DW-TL	EP
			7.04216.05.0	SUV	EL
328 i xDrive 179-180 kW (243-245 PS) N26 B20 A	07.2012→08.2016		7.04216.05.0	SUV	EL
328 i xDrive 110-205 kW (150-279 PS) N20 B20 A	07.2012→07.2016		7.00887.21.0	DW-TL	EP
			7.04216.05.0	SUV	EL
328 i xDrive 179-180 kW (243-245 PS) N26 B20 A	07.2012→07.2016		7.04216.05.0	SUV	EL
328i 110-205 kW (150-279 PS) N20 B20 A	11.2011→06.2015		7.00887.21.0	DW-TL	EP
			7.04216.05.0	SUV	EL
330 d 150-210 kW (204-286 PS) N57 D30 A	07.2012→10.2018		7.02318.01.0	EUV-AGR	EL
			7.02318.01.0	EUV-ML	EL

							
3 (F30, F80)						12	B
330 d 150-210 kW (204-286 PS) N57 D30 A	07.2012→10.2018		7.02318.01.0	EUV-AGR	EL		
			7.02318.01.0	EUV-ML	EL		
330 d xDrive 150-210 kW (204-286 PS) N57 D30 A	03.2013→10.2018		7.02318.01.0	EUV-AGR	EL		
			7.02318.01.0	EUV-ML	EL		
330 d xDrive 150-210 kW (204-286 PS) N57 D30 A	03.2013→10.2018		7.02318.01.0	EUV-AGR	EL		
			7.02318.01.0	EUV-ML	EL		
335 d xDrive 220-230 kW (299-313 PS) N57 D30 B	07.2013→10.2018		7.02256.27.0	DW-TL	EP		
			7.02318.01.0	EUV-AGR	EL		
			7.02318.01.0	EUV-ML	EL		
335 i 200-272 kW (272-370 PS) N55 B30 A	11.2011→07.2015		7.00887.21.0	DW-TL	EP	Produktionsdatum bis: 31.05.2012 Production date to: 31.05.2012 Produktionsdatum ab: 01.06.2012 Production date from: 01.06.2012	
			7.00887.22.0	DW-TL	EP		
			7.01762.04.0	SUV	EL		
			7.06117.36.0	SV-NWV	EL		
335 i 200-272 kW (272-370 PS) N55 B30 A	11.2011→06.2013		7.00887.21.0	DW-TL	EP	Produktionsdatum bis: 31.05.2012 Production date to: 31.05.2012 Produktionsdatum ab: 01.06.2012 Production date from: 01.06.2012	
			7.00887.22.0	DW-TL	EP		
			7.01762.04.0	SUV	EL		
			7.06117.36.0	SV-NWV	EL		
335 i 200-272 kW (272-370 PS) N55 B30 A	01.2013→12.2013		7.00887.22.0	DW-TL	EP	mit Dichtring with O-ring	
			7.01762.04.0	SUV	EL		
			7.06117.36.0	SV-NWV	EL		
335 i 200-272 kW (272-370 PS) N55 B30 A	07.2013→07.2015		7.00887.22.0	DW-TL	EP	mit Dichtring with O-ring	
			7.01762.04.0	SUV	EL		
			7.06117.36.0	SV-NWV	EL		
335 i xDrive 200-272 kW (272-370 PS) N55 B30 A	07.2012→07.2015		7.00887.22.0	DW-TL	EP	mit Dichtring with O-ring	
			7.01762.04.0	SUV	EL		
			7.06117.36.0	SV-NWV	EL		
335 i xDrive 200-272 kW (272-370 PS) N55 B30 A	07.2012→06.2013		7.00887.22.0	DW-TL	EP	mit Dichtring with O-ring	
			7.01762.04.0	SUV	EL		
			7.06117.36.0	SV-NWV	EL		
335 i xDrive 200-272 kW (272-370 PS) N55 B30 A	07.2013→07.2015		7.00887.22.0	DW-TL	EP	mit Dichtring with O-ring	
			7.01762.04.0	SUV	EL		
			7.06117.36.0	SV-NWV	EL		



B









3 (F30, F80) 12

























ActiveHybrid 200-272 kW (272-370 PS) N55 B30 A	07.2012→06.2015		7.00887.22.0	DW-TL	EP	mit Dichtring with O-ring
			7.01762.04.0 7.06117.36.0	SUV SV-NWV	EL EL	
ActiveHybrid 200-272 kW (272-370 PS) N55 B30 A	07.2012→06.2015		7.00887.22.0	DW-TL	EP	mit Dichtring with O-ring
			7.01762.04.0 7.06117.36.0	SUV SV-NWV	EL EL	
M3 272-368 kW (370-500 PS) S55 B30 A	03.2014→10.2018		7.06117.36.0	SV-NWV	EL	mit Dichtring with O-ring
M3 CS 272-368 kW (370-500 PS) S55 B30 A	01.2018→10.2018		7.06117.36.0	SV-NWV	EL	mit Dichtring with O-ring
M3 Competition 272-368 kW (370-500 PS) S55 B30 A	03.2016→10.2018		7.06117.36.0	SV-NWV	EL	mit Dichtring with O-ring

3 Compact (E36) 13

316 i 75-77 kW (102-105 PS) M43 B16 (164E2)	01.1994→08.2000		7.02318.01.0	EUV-SL	EL	
323 ti 120-141 kW (163-192 PS) M52 B25 (256S3)	09.1997→08.2000		7.00784.01.0	EUV-SL	EP	
			7.02318.01.0	EUV-AGK	EL	
			7.02318.01.0	EUV-SL	EL	
323 ti 120-141 kW (163-192 PS) M52 B25 (256S3)	01.1999→08.2000		7.02318.01.0	EUV-AGK	EL	
			7.02318.01.0	EUV-SL	EL	

3 Compact (E46) 14

316 ti 85 kW (115 PS) N42 B18 A, N46 B18 A	06.2001→02.2005		7.06117.00.0	SV-NWV	EL	mit Dichtring with O-ring
316 ti 77-85 kW (105-115 PS) N40 B16 A	06.2002→02.2005		7.06117.00.0	SV-NWV	EL	mit Dichtring with O-ring
316 ti 77-85 kW (105-115 PS) N40 B16 A, N45 B16 A	06.2002→02.2005		7.06117.00.0	SV-NWV	EL	mit Dichtring with O-ring
318 td 85-120 kW (116-163 PS) M47 D20 (204D4)	03.2003→02.2005		7.22796.01.0	DW-AGR	EP	
			7.22796.01.0	DW-TL	EP	
			7.02318.01.0	EUV-AGR	EL	
318 ti 95-125 kW (129-170 PS) N42 B20 A, N46 B20 A	03.2001→12.2004		7.06117.00.0	SV-NWV	EL	mit Dichtring with O-ring
318 ti 95-125 kW (129-170 PS) N42 B20 A, N46 B20 A	03.2001→12.2004		7.06117.00.0	SV-NWV	EL	mit Dichtring with O-ring
320 td 85-120 kW (116-163 PS) M47 D20 (204D4)	09.2001→02.2005		7.22796.01.0	DW-AGR	EP	
			7.22796.01.0	DW-TL	EP	
			7.02318.01.0	EUV-KL	EL	
320 td 85-120 kW (116-163 PS) M47 D20 (204D4)	10.2001→12.2002		7.22796.01.0	DW-AGR	EP	
			7.22796.01.0	DW-TL	EP	
			7.02318.01.0	EUV-KL	EL	
325 ti 137-141 kW (186-192 PS) M54 B25 (256S5)	04.2001→12.2004		7.00784.01.0	EUV-SL	EP	

































							
3 Convertible (E36)						15	B
320 i 100-110 kW (136-150 PS) M52 B20 (206S3)	12.1993→11.1999		7.02318.01.0	EUV-AGK	EL		
323 i 120-141 kW (163-192 PS) M52 B25 (256S3)	05.1995→11.1999		7.00784.01.0	EUV-SL	EP		
			7.02318.01.0	EUV-AGK	EL		
			7.02318.01.0	EUV-SL	EL		
328 i 141-143 kW (192-194 PS) M52 B28 (286S1)	01.1995→11.1999		7.00784.01.0	EUV-SL	EP		
			7.02318.01.0	EUV-AGK	EL		
			7.02318.01.0	EUV-SL	EL		
M3 3.2 236 kW (321 PS) S50 B32 (326S1)	03.1996→09.1999		7.00784.01.0	EUV-SL	EP		
M3 3.2 176-179 kW (239-243 PS) S52 B32 (326S2)	01.1998→09.1999		7.02318.01.0	EUV-SL	EL		
3 Convertible (E46)						16	
318 Ci 95-125 kW (129-170 PS) N42 B20 A, N46 B20 A	12.2000→08.2006		7.06117.00.0	SV-NWV	EL	mit Dichtring with O-ring	
	09.2001→12.2007		7.06117.00.0	SV-NWV	EL	mit Dichtring with O-ring	
318 Ci 95-125 kW (129-170 PS) N46 B20 A	03.2004→08.2006		7.06117.00.0	SV-NWV	EL	mit Dichtring with O-ring	
320 Cd 85-120 kW (116-163 PS) M47 D20 (204D4)	02.2005→12.2007		7.22796.01.0	DW-AGR	EP		
			7.22796.01.0	DW-TL	EP		
			7.02318.01.0	EUV-KL	EL		
			7.02318.01.0	EUV-SR	EL		
320 Ci 120-125 kW (163-170 PS) M54 B22 (226S1)	09.2000→12.2007		7.00784.01.0	EUV-SL	EP		
323 Ci 120-141 kW (163-192 PS) M52 B25 (256S4)	04.2000→09.2000		7.00784.01.0	EUV-SL	EP		
325 Ci 137-141 kW (186-192 PS) M54 B25 (256S5)	09.2000→08.2006		7.00784.01.0	EUV-SL	EP		
330 Cd 150-160 kW (204-218 PS) M57 D30 (306D2)	08.2005→12.2007		7.22796.01.0	DW-AGR	EP		
			7.22796.01.0	DW-TL	EP		
			7.02318.01.0	EUV-SR	EL		
			7.02318.01.0	EUV-SL	EP		
330 Ci 163-170 kW (222-231 PS) M54 B30 (306S3)	06.2000→08.2006		7.00784.01.0	EUV-SL	EP		
3 Convertible (E93)						17	
318 i 90-125 kW (122-170 PS) N43 B20 A	03.2010→12.2013		7.02318.01.0	EUV-SR	EL		
320 d 66-150 kW (90-204 PS) N47 D20 A, N47 D20 C	09.2007→02.2010		7.02063.02.0	DW-AGR	EP		
			7.02318.01.0	EUV-AGR	EL		
			7.02318.01.0	EUV-ML	EL		
320 d 66-150 kW (90-204 PS) N47 D20 C	01.2008→12.2013		7.02063.02.0	DW-AGR	EP		
			7.02318.01.0	EUV-AGR	EL		
			7.02318.01.0	EUV-ML	EL		
			7.02318.01.0	EUV-ML	EL		
320 d 66-150 kW (90-204 PS) N47 D20 A, N47 D20 C	03.2008→02.2010		7.02063.02.0	DW-AGR	EP		
			7.02318.01.0	EUV-AGR	EL		
			7.02318.01.0	EUV-ML	EL		
			7.02318.01.0	EUV-ML	EL		
320 d 66-150 kW (90-204 PS) N47 D20 C	03.2010→10.2013		7.02063.02.0	DW-AGR	EP		
			7.02318.01.0	EUV-AGR	EL		



























B

3 Convertible (E93)

17

320 d 66-150 kW (90-204 PS) N47 D20 C	03.2010→10.2013	 7.02318.01.0	EUV-ML	EL	
		 7.02063.02.0	DW-AGR	EP	
320 i 90-125 kW (122-170 PS) N43 B20 A	09.2006→10.2013	 7.02318.01.0	EUV-AGR	EL	
		 7.02318.01.0	EUV-ML	EL	
320 i 95-125 kW (129-170 PS) N46 B20 B	01.2007→08.2013	 7.02318.01.0	EUV-ML	EL	mit Dichtring with O-ring
		 7.02318.01.0	EUV-SR	EL	
		 7.06117.00.0	SV-NWV	EL	
320 i 90-125 kW (122-170 PS) N43 B20 A	03.2007→10.2013	 7.02318.01.0	EUV-ML	EL	
		 7.02318.01.0	EUV-SR	EL	
323 i 130-160 kW (177-218 PS) N52 B25 A	03.2007→09.2011	 7.06117.01.0	SV-NWV	EL	mit Dichtring with O-ring
323 i 130-160 kW (177-218 PS) N52 B25 A	03.2007→09.2011	 7.06117.01.0	SV-NWV	EL	mit Dichtring with O-ring
325 d 135-173 kW (184-235 PS) M57 D30 (306D3)	03.2007→12.2010	 7.22796.01.0	DW-AGR	EP	
		 7.02318.01.0	EUV-ML	EL	
325 d 135-173 kW (184-235 PS) M57 D30 (306D3)	03.2007→12.2010	 7.22796.01.0	DW-AGR	EP	
		 7.02318.01.0	EUV-ML	EL	
325 d 150-210 kW (204-286 PS) N57 D30 A	09.2009→09.2013	 7.02318.01.0	EUV-AGR	EL	
		 7.02318.01.0	EUV-ML	EL	
325 i 150-200 kW (204-272 PS) N53 B30 A	10.2006→12.2013	 7.02318.01.0	EUV-ML	EL	mit Dichtring with O-ring
		 7.06117.01.0	SV-NWV	EL	
325 i 130-160 kW (177-218 PS) N52 B25 A	12.2006→02.2010	 7.06117.01.0	SV-NWV	EL	mit Dichtring with O-ring
325 i 150-200 kW (204-272 PS) N53 B30 A	03.2007→12.2013	 7.02318.01.0	EUV-ML	EL	mit Dichtring with O-ring
		 7.06117.01.0	SV-NWV	EL	
325 i 130-160 kW (177-218 PS) N52 B25 A	03.2010→10.2013	 7.06117.01.0	SV-NWV	EL	mit Dichtring with O-ring
328 i 160-172 kW (218-234 PS) N51 B30 A	03.2007→12.2013	 7.06117.01.0	SV-NWV	EL	mit Dichtring with O-ring
330 d 135-173 kW (184-235 PS) M57 D30 (306D3)	03.2007→12.2013	 7.22796.01.0	DW-AGR	EP	
		 7.02318.01.0	EUV-ML	EL	
		 7.02318.01.0	EUV-SR	EL	
330 d 150-210 kW (204-286 PS) N57 D30 A	01.2009→12.2013	 7.02318.01.0	EUV-AGR	EL	
		 7.02318.01.0	EUV-ML	EL	
330 i 150-200 kW (204-272 PS) N53 B30 A	03.2007→10.2013	 7.02318.01.0	EUV-ML	EL	mit Dichtring with O-ring
		 7.06117.01.0	SV-NWV	EL	
330 i 155-200 kW (211-272 PS) N52 B30 A	03.2007→02.2010	 7.06117.01.0	SV-NWV	EL	mit Dichtring with O-ring
330 i 155-200 kW (211-272 PS) N52 B30 A, N52 B30 AF	03.2010→10.2013	 7.06117.01.0	SV-NWV	EL	mit Dichtring with O-ring





							
3 Convertible (E93)						17	B
335 i 200-264 kW (272-359 PS) N54 B30 A	05.2006→10.2013		7.00887.19.0	DW-TL	EP		
			7.06117.01.0	SV-NWV	EL	mit Dichtring with O-ring	
335 i 200-272 kW (272-370 PS) N55 B30 A	05.2006→10.2013		7.00887.21.0	DW-TL	EP	Produktionsdatum bis: 31.05.2012 Production date to: 31.05.2012	
			7.00887.22.0	DW-TL	EP	Produktionsdatum ab: 01.06.2012 Production date from: 01.06.2012	
			7.06117.36.0	SV-NWV	EL	mit Dichtring with O-ring	
335 i 200-264 kW (272-359 PS) N54 B30 A	12.2006→02.2010		7.00887.19.0	DW-TL	EP		
			7.06117.01.0	SV-NWV	EL	mit Dichtring with O-ring	
335 i 200-264 kW (272-359 PS) N54 B30 A	01.2007→10.2013		7.00887.19.0	DW-TL	EP		
			7.06117.01.0	SV-NWV	EL	mit Dichtring with O-ring	
335 i 200-272 kW (272-370 PS) N55 B30 A	03.2010→10.2013		7.00887.21.0	DW-TL	EP	Produktionsdatum bis: 31.05.2012 Production date to: 31.05.2012	
			7.00887.22.0	DW-TL	EP	Produktionsdatum ab: 01.06.2012 Production date from: 01.06.2012	
			7.06117.36.0	SV-NWV	EL	mit Dichtring with O-ring	
M3 309 kW (420 PS) S65 B40 A	03.2008→10.2013		7.06117.58.0	SV-NWV	EH	mit Dichtring with O-ring	
3 Coupe (E36)						18	
323 i 120-141 kW (163-192 PS) M52 B25 (256S3)	05.1995→04.1999		7.00784.01.0	EUV-SL	EP		
			7.02318.01.0	EUV-AGK	EL		
			7.02318.01.0	EUV-SL	EL		
328 i 141-143 kW (192-194 PS) M52 B28 (286S1)	01.1995→04.1999		7.00784.01.0	EUV-SL	EP		
			7.02318.01.0	EUV-AGK	EL		
			7.02318.01.0	EUV-SL	EL		
M3 3.2 236 kW (321 PS) S50 B32 (326S1)	10.1995→11.1998		7.00784.01.0	EUV-SL	EP		
M3 3.2 176-179 kW (239-243 PS) S52 B32 (326S2)	06.1996→04.1999		7.02318.01.0	EUV-SL	EL		
3 Coupe (E46)						19	
316 Ci 85 kW (115 PS) N45 B16 A	06.2002→07.2006		7.06117.00.0	SV-NWV	EL	mit Dichtring with O-ring	
			7.06117.00.0	SV-NWV	EL	mit Dichtring with O-ring	
318 Ci 95-125 kW (129-170 PS) N42 B20 A, N46 B20 A	12.2000→05.2006		7.06117.00.0	SV-NWV	EL	mit Dichtring with O-ring	
			7.06117.00.0	SV-NWV	EL	mit Dichtring with O-ring	
318 Ci 100-110 kW (136-150 PS) N42 B20 A	09.2001→02.2004		7.06117.00.0	SV-NWV	EL	mit Dichtring with O-ring	
			7.06117.00.0	SV-NWV	EL	mit Dichtring with O-ring	
318 Ci 95-125 kW (129-170 PS) N46 B20 A, N46 B20 C	03.2004→05.2006		7.06117.00.0	SV-NWV	EL	mit Dichtring with O-ring	
			7.06117.00.0	SV-NWV	EL	mit Dichtring with O-ring	
320 Cd 85-120 kW (116-163 PS) M47 D20 (204D4)	11.2003→07.2006		7.22796.01.0	DW-AGR	EP		
			7.22796.01.0	DW-TL	EP		
			7.02318.01.0	EUV-KL	EL		
320 Ci 100-110 kW (136-150 PS) M52 B20 (206S4)	02.1999→08.2001		7.00784.01.0	EUV-SL	EP		
			7.00784.01.0	EUV-SL	EP		
320 Ci 120-125 kW (163-170 PS) M54 B22 (226S1)	01.2000→05.2006		7.00784.01.0	EUV-SL	EP		
			7.00784.01.0	EUV-SL	EP		
323 Ci 120-141 kW (163-192 PS) M52 B25 (256S4)	04.1999→09.2000		7.00784.01.0	EUV-SL	EP		



B

3 Coupe (E46)

19

325 Ci 137-141 kW (186-192 PS) M54 B25 (256S5)	09.2000→05.2006		7.00784.01.0	EUV-SL	EP
328 Ci 141-144 kW (192-196 PS) M52 B28 (286S2)	12.1998→05.2000		7.00784.01.0	EUV-SL	EP
			7.02318.01.0	EUV-SL	EL
330 Cd 150-160 kW (204-218 PS) M57 D30 (306D2)	03.2003→07.2006		7.22796.01.0	DW-AGR	EP
			7.22796.01.0	DW-TL	EP
			7.02318.01.0	EUV-ML	EL
330 Ci 163-170 kW (222-231 PS) M54 B30 (306S3)	06.2000→05.2006		7.00784.01.0	EUV-SL	EP
330 xi 163-170 kW (222-231 PS) M54 B30 (306S3)	06.2000→07.2006		7.00784.01.0	EUV-SL	EP

3 Coupe (E92)

20

316 i 89-90 kW (121-122 PS) N43 B16 AA	09.2007→06.2013		7.02318.01.0	EUV-ML	EL
			7.02318.01.0	EUV-SR	EL
318 i 90-125 kW (122-170 PS) N43 B20 A	03.2010→12.2013		7.02318.01.0	EUV-SR	EL
320 d 66-150 kW (90-204 PS) N47 D20 A, N47 D20 C	09.2006→02.2010		7.02063.02.0	DW-AGR	EP
			7.02318.01.0	EUV-AGR	EL
			7.02318.01.0	EUV-ML	EL
320 d 66-150 kW (90-204 PS) N47 D20 A, N47 D20 C	09.2006→02.2010		7.02063.02.0	DW-AGR	EP
			7.02318.01.0	EUV-AGR	EL
			7.02318.01.0	EUV-ML	EL
320 d 66-150 kW (90-204 PS) N47 D20 A, N47 D20 C	03.2007→06.2013		7.02063.02.0	DW-AGR	EP
			7.02318.01.0	EUV-AGR	EL
			7.02318.01.0	EUV-ML	EL
320 d 66-150 kW (90-204 PS) N47 D20 C	03.2010→06.2013		7.02063.02.0	DW-AGR	EP
			7.02318.01.0	EUV-AGR	EL
			7.02318.01.0	EUV-ML	EL
320 d xDrive 66-150 kW (90-204 PS) N47 D20 C	09.2008→02.2010		7.02318.01.0	EUV-AGR	EL
			7.02318.01.0	EUV-ML	EL
320 d xDrive 66-150 kW (90-204 PS) N47 D20 C	09.2008→02.2010		7.02318.01.0	EUV-AGR	EL
			7.02318.01.0	EUV-ML	EL
320 d xDrive 66-150 kW (90-204 PS) N47 D20 C	09.2008→06.2013		7.02318.01.0	EUV-AGR	EL
			7.02318.01.0	EUV-ML	EL
320 d xDrive 66-150 kW (90-204 PS) N47 D20 C	03.2010→06.2013		7.02318.01.0	EUV-AGR	EL
			7.02318.01.0	EUV-ML	EL

3 Coupe (E92) **20** **B**



















320 d xDrive 66-150 kW (90-204 PS) N47 D20 C	03.2010→06.2013		7.02318.01.0	EUV-AGR	EL	
			7.02318.01.0	EUV-ML	EL	
320 i 90-125 kW (122-170 PS) N43 B20 A	01.2007→12.2013		7.02318.01.0	EUV-ML	EL	
			7.02318.01.0	EUV-SR	EL	
320 i 90-125 kW (122-170 PS) N43 B20 A	03.2007→12.2013		7.02318.01.0	EUV-ML	EL	
			7.02318.01.0	EUV-SR	EL	
320 i 95-125 kW (129-170 PS) N46 B20 B	06.2007→12.2013		7.06117.00.0	SV-NWV	EL	mit Dichtring with O-ring
320 i 95-125 kW (129-170 PS) N46 B20 B, N46 B20 CC, N46 B20 CD, N46 B20 E	01.2010→12.2013		7.06117.00.0	SV-NWV	EL	mit Dichtring with O-ring
323 i 130-160 kW (177-218 PS) N52 B25 A	06.2006→08.2008		7.06117.01.0	SV-NWV	EL	mit Dichtring with O-ring
325 d 135-173 kW (184-235 PS) M57 D30 (306D3)	02.2007→02.2010		7.22796.01.0	DW-AGR	EP	
			7.02318.01.0	EUV-ML	EL	
325 d 135-173 kW (184-235 PS) M57 D30 (306D3)	02.2007→02.2010		7.22796.01.0	DW-AGR	EP	
			7.02318.01.0	EUV-ML	EL	
325 d 150-210 kW (204-286 PS) N57 D30 A	09.2009→12.2013		7.02318.01.0	EUV-AGR	EL	
			7.02318.01.0	EUV-ML	EL	
325 i 130-160 kW (177-218 PS) N52 B25 A, N52 B25 AF, N52 B25 BF	06.2006→02.2010		7.06117.01.0	SV-NWV	EL	mit Dichtring with O-ring
			7.02318.01.0	EUV-ML	EL	
325 i 150-200 kW (204-272 PS) N53 B30 A	09.2007→06.2013		7.02318.01.0	EUV-ML	EL	
			7.06117.01.0	SV-NWV	EL	mit Dichtring with O-ring
325 i 130-160 kW (177-218 PS) N52 B25 A, N52 B25 AF, N52 B25 BF	03.2010→06.2013		7.06117.01.0	SV-NWV	EL	mit Dichtring with O-ring
			7.02318.01.0	EUV-ML	EL	
325 i 150-200 kW (204-272 PS) N53 B30 A	03.2010→06.2013		7.02318.01.0	EUV-ML	EL	
			7.06117.01.0	SV-NWV	EL	mit Dichtring with O-ring
325 i 130-160 kW (177-218 PS) N52 B25 A, N52 B25 AF, N52 B25 BF	03.2010→10.2013		7.06117.01.0	SV-NWV	EL	mit Dichtring with O-ring
			7.02318.01.0	EUV-ML	EL	
325 i xDrive 150-200 kW (204-272 PS) N53 B30 A	09.2008→12.2013		7.02318.01.0	EUV-ML	EL	
			7.06117.01.0	SV-NWV	EL	mit Dichtring with O-ring
325 i xDrive 150-200 kW (204-272 PS) N53 B30 A	09.2008→06.2013		7.02318.01.0	EUV-ML	EL	
			7.06117.01.0	SV-NWV	EL	mit Dichtring with O-ring
325 i xDrive 130-160 kW (177-218 PS) N52 B25 A	03.2010→04.2013		7.06117.01.0	SV-NWV	EL	mit Dichtring with O-ring
			7.02318.01.0	EUV-ML	EL	
325 i xDrive 150-160 kW (204-218 PS) N52 B25 AF	03.2010→04.2013		7.06117.01.0	SV-NWV	EL	mit Dichtring with O-ring
			7.02318.01.0	EUV-ML	EL	























B

3 Coupe (E92)

20

325 xi 130-160 kW (177-218 PS) N52 B25 A	09.2006→02.2010	 7.06117.01.0	SV-NWV	EL	mit Dichtring with O-ring
325 xi 150-200 kW (204-272 PS) N53 B30 A	09.2007→08.2008	 7.06117.01.0	SV-NWV	EL	mit Dichtring with O-ring
328 i 160-172 kW (218-234 PS) N51 B30 A	09.2006→06.2013	 7.06117.01.0	SV-NWV	EL	mit Dichtring with O-ring
328 i xDrive 160-172 kW (218-234 PS) N51 B30 A	09.2008→06.2013	 7.06117.01.0	SV-NWV	EL	mit Dichtring with O-ring
328 xi 160-172 kW (218-234 PS) N51 B30 A	09.2006→08.2008	 7.06117.01.0	SV-NWV	EL	mit Dichtring with O-ring
330 d 135-173 kW (184-235 PS) M57 D30 (306D3)	03.2006→08.2008	 7.22796.01.0	DW-AGR	EP	
		7.02318.01.0	EUV-ML	EL	
		7.02318.01.0	EUV-SR	EL	
330 d 150-210 kW (204-286 PS) N57 D30 A	01.2009→12.2013	 7.02318.01.0	EUV-AGR	EL	
		7.02318.01.0	EUV-ML	EL	
330 d xDrive 150-210 kW (204-286 PS) N57 D30 A	02.2010→06.2013	 7.02318.01.0	EUV-AGR	EL	
		7.02318.01.0	EUV-ML	EL	
330 i 155-200 kW (211-272 PS) N52 B30 A, N52 B30 AF, N52 B30 BF	09.2006→02.2010	 7.06117.01.0	SV-NWV	EL	mit Dichtring with O-ring
330 i 150-200 kW (204-272 PS) N53 B30 A	09.2007→06.2013	 7.02318.01.0	EUV-ML	EL	
		7.06117.01.0	SV-NWV	EL	mit Dichtring with O-ring
330 i 155-200 kW (211-272 PS) N52 B30 A	03.2010→06.2013	 7.06117.01.0	SV-NWV	EL	mit Dichtring with O-ring
330 i xDrive 150-200 kW (204-272 PS) N53 B30 A	03.2010→06.2013	 7.06117.01.0	SV-NWV	EL	mit Dichtring with O-ring
330 xd 135-173 kW (184-235 PS) M57 D30 (306D3)	03.2006→08.2008	 7.22796.01.0	DW-AGR	EP	
		7.02318.01.0	EUV-ML	EL	
		7.02318.01.0	EUV-SR	EL	
330 xi 155-200 kW (211-272 PS) N52 B30 A	09.2006→08.2007	 7.06117.01.0	SV-NWV	EL	mit Dichtring with O-ring
330 xi 155-200 kW (211-272 PS) N52 B30 A	09.2006→08.2007	 7.06117.01.0	SV-NWV	EL	mit Dichtring with O-ring
330 xi 150-200 kW (204-272 PS) N53 B30 A	03.2007→02.2010	 7.02318.01.0	EUV-ML	EL	
		7.06117.01.0	SV-NWV	EL	mit Dichtring with O-ring
335 d 198-221 kW (269-301 PS) M57 D30 (306D5)	03.2006→03.2013	 7.22796.01.0	DW-AGR	EP	
		7.02256.27.0	DW-TL	EP	
		7.02318.01.0	EUV-AGR	EL	
		7.02318.01.0	EUV-ML	EL	
		7.02318.01.0	EUV-SR	EL	
		7.02318.01.0	LDRV	EL	
335 i 200-264 kW (272-359 PS) N54 B30 A	06.2006→06.2013	 7.00887.19.0	DW-TL	EP	
		7.06117.01.0	SV-NWV	EL	mit Dichtring with O-ring
335 i 200-272 kW (272-370 PS) N55 B30 A	06.2006→06.2013	 7.00887.21.0	DW-TL	EP	Produktionsdatum bis: 31.05.2012 Production date to: 31.05.2012







						
3 Coupe (E92)					20	B
			7.00887.22.0	DW-TL	EP	Produktionsdatum ab: 01.06.2012 Production date from: 01.06.2012
			7.06117.36.0	SV-NWV	EL	mit Dichtring with O-ring
335 i 200-264 kW (272-359 PS) N54 B30 A	06.2006→06.2013		7.00887.19.0	DW-TL	EP	
			7.06117.01.0	SV-NWV	EL	mit Dichtring with O-ring
335 i 200-272 kW (272-370 PS) N55 B30 A	06.2006→06.2013		7.00887.21.0	DW-TL	EP	Produktionsdatum bis: 31.05.2012 Production date to: 31.05.2012
			7.00887.22.0	DW-TL	EP	Produktionsdatum ab: 01.06.2012 Production date from: 01.06.2012
			7.06117.36.0	SV-NWV	EL	mit Dichtring with O-ring
335 i 200-264 kW (272-359 PS) N54 B30 A	03.2007→06.2013		7.00887.19.0	DW-TL	EP	
			7.06117.01.0	SV-NWV	EL	mit Dichtring with O-ring
335 i xDrive 200-264 kW (272-359 PS) N54 B30 A	11.2008→12.2013		7.00887.19.0	DW-TL	EP	
			7.06117.01.0	SV-NWV	EL	mit Dichtring with O-ring
335 i xDrive 200-272 kW (272-370 PS) N55 B30 A	11.2008→12.2013		7.00887.21.0	DW-TL	EP	Produktionsdatum bis: 31.05.2012 Production date to: 31.05.2012
			7.00887.22.0	DW-TL	EP	Produktionsdatum ab: 01.06.2012 Production date from: 01.06.2012
			7.06117.36.0	SV-NWV	EL	mit Dichtring with O-ring
335 i xDrive 200-272 kW (272-370 PS) N55 B30 A	11.2008→06.2013		7.00887.21.0	DW-TL	EP	Produktionsdatum bis: 31.05.2012 Production date to: 31.05.2012
			7.00887.22.0	DW-TL	EP	Produktionsdatum ab: 01.06.2012 Production date from: 01.06.2012
			7.06117.36.0	SV-NWV	EL	mit Dichtring with O-ring
335 i xDrive 200-264 kW (272-359 PS) N54 B30 A	01.2009→06.2013		7.00887.19.0	DW-TL	EP	
			7.06117.01.0	SV-NWV	EL	mit Dichtring with O-ring
335 xi 200-264 kW (272-359 PS) N54 B30 A	03.2007→02.2010		7.00887.19.0	DW-TL	EP	
			7.06117.01.0	SV-NWV	EL	mit Dichtring with O-ring
335 xi 200-272 kW (272-370 PS) N55 B30 A	03.2007→02.2010		7.06117.36.0	SV-NWV	EL	mit Dichtring with O-ring
335 xi 200-264 kW (272-359 PS) N54 B30 A	03.2007→02.2010		7.00887.19.0	DW-TL	EP	
			7.06117.01.0	SV-NWV	EL	mit Dichtring with O-ring
M3 309 kW (420 PS) S65 B40 A	06.2007→06.2013		7.06117.58.0	SV-NWV	EH	mit Dichtring with O-ring
M3 GTS 331 kW (450 PS) S65 B44 A	03.2007→12.2013		7.06117.58.0	SV-NWV	EH	mit Dichtring with O-ring
3 Gran Turismo (F34)					21	
318 d 66-150 kW (90-204 PS) N47 D20 C	03.2013→06.2015		7.02318.01.0	EUV-AGR	EL	
318 d 66-150 kW (90-204 PS) N47 D20 C	03.2013→06.2015		7.02318.01.0	EUV-AGR	EL	





















B

3 Gran Turismo (F34)

21

320 d 66-150 kW (90-204 PS) N47 D20 C	03.2013→06.2015		7.02318.01.0	EUV-AGR	EL	
320 d 66-150 kW (90-204 PS) N47 D20 C	03.2013→06.2015		7.02318.01.0	EUV-AGR	EL	
320 d xDrive 66-150 kW (90-204 PS) N47 D20 C	07.2013→06.2015		7.02318.01.0	EUV-AGR	EL	
320 d xDrive 66-150 kW (90-204 PS) N47 D20 C	07.2013→06.2015		7.02318.01.0	EUV-AGR	EL	
320 d xDrive 66-150 kW (90-204 PS) N47 D20 C	07.2013→06.2015		7.02318.01.0	EUV-AGR	EL	
320 i 110-205 kW (150-279 PS) N20 B20 A, N20 B20 B	03.2013→06.2016		7.00887.21.0	DW-TL	EP	
			7.04216.05.0	SUV	EL	
320 i 110-205 kW (150-279 PS) N20 B20 A, N20 B20 B	03.2013→06.2016		7.00887.21.0	DW-TL	EP	
			7.04216.05.0	SUV	EL	
320 i xDrive 110-205 kW (150-279 PS) N20 B20 A	11.2012→06.2016		7.04216.05.0	SUV	EL	
320 i xDrive 120-135 kW (163-184 PS) N20 B20 B	11.2012→06.2016		7.00887.21.0	DW-TL	EP	
			7.04216.05.0	SUV	EL	
320 i xDrive 110-205 kW (150-279 PS) N20 B20 A	07.2013→06.2016		7.04216.05.0	SUV	EL	
320 i xDrive 120-135 kW (163-184 PS) N20 B20 B	07.2013→06.2016		7.00887.21.0	DW-TL	EP	
			7.04216.05.0	SUV	EL	
325 d 150-160 kW (204-218 PS) N47 D20 D	07.2013→06.2016		7.02256.27.0	DW-TL	EP	
			7.02318.01.0	EUV-AGR	EL	
			7.02318.01.0	LDRV	EL	
325 d 150-160 kW (204-218 PS) N47 D20 D	07.2013→06.2016		7.02256.27.0	DW-TL	EP	
			7.02318.01.0	EUV-AGR	EL	
			7.02318.01.0	LDRV	EL	
325 d 85-170 kW (116-231 PS) B47 D20 B	07.2016→02.2018		7.02256.27.0	DW-TL	EP	
328 i 110-205 kW (150-279 PS) N20 B20 A	03.2013→06.2016		7.00887.21.0	DW-TL	EP	
			7.04216.05.0	SUV	EL	
328 i 179-180 kW (243-245 PS) N26 B20 A	07.2014→06.2015		7.04216.05.0	SUV	EL	USA USA
328 i xDrive 110-205 kW (150-279 PS) N20 B20 A	07.2013→06.2016		7.00887.21.0	DW-TL	EP	
			7.04216.05.0	SUV	EL	
328 i xDrive 179-180 kW (243-245 PS) N26 B20 A	07.2014→06.2016		7.04216.05.0	SUV	EL	USA USA
330 d 150-210 kW (204-286 PS) N57 D30 A	03.2014→		7.02318.01.0	EUV-AGR	EL	
			7.02318.01.0	EUV-ML	EL	











3 Gran Turismo (F34)						21	B
330 d 150-210 kW (204-286 PS) N57 D30 A	03.2014→		7.02318.01.0	EUV-AGR	EL		
			7.02318.01.0	EUV-ML	EL		
330 d xDrive 150-210 kW (204-286 PS) N57 D30 A	03.2014→		7.02318.01.0	EUV-AGR	EL		
			7.02318.01.0	EUV-ML	EL		
330 d xDrive 150-210 kW (204-286 PS) N57 D30 A	03.2014→		7.02318.01.0	EUV-AGR	EL		
			7.02318.01.0	EUV-ML	EL		
335 d xDrive 220-230 kW (299-313 PS) N57 D30 B	03.2014→		7.02256.27.0	DW-TL	EP		
			7.02318.01.0	EUV-AGR	EL		
			7.02318.01.0	EUV-ML	EL		
			7.02318.01.0	LDRV	EL		
335 i 200-272 kW (272-370 PS) N55 B30 A	03.2013→03.2014		7.06117.36.0	SV-NWV	EL	mit Dichtring with O-ring	
335 i 200-272 kW (272-370 PS) N55 B30 A	03.2013→06.2016		7.06117.36.0	SV-NWV	EL	mit Dichtring with O-ring	
335 i 200-272 kW (272-370 PS) N55 B30 A	04.2014→06.2016		7.06117.36.0	SV-NWV	EL	mit Dichtring with O-ring	
335 i xDrive 200-272 kW (272-370 PS) N55 B30 A	03.2013→03.2014		7.06117.36.0	SV-NWV	EL	mit Dichtring with O-ring	
335 i xDrive 200-272 kW (272-370 PS) N55 B30 A	07.2013→06.2016		7.06117.36.0	SV-NWV	EL	mit Dichtring with O-ring	
335 i xDrive 200-272 kW (272-370 PS) N55 B30 A	04.2014→06.2016		7.06117.36.0	SV-NWV	EL	mit Dichtring with O-ring	
3 Touring (E36)						22	
316 i 75-77 kW (102-105 PS) M43 B16 (164E2)	03.1997→05.1999		7.02318.01.0	EUV-SL	EL		
323 i 120-141 kW (163-192 PS) M52 B25 (256S3)	12.1995→04.1999		7.00784.01.0	EUV-SL	EP		
325 tds 85-105 kW (115-143 PS) M51 D25 (256T1)	03.1995→04.1999		7.21903.73.0	DW-AGR	EP	01.1996→	
328 i 141-143 kW (192-194 PS) M52 B28 (286S1)	02.1995→04.1999		7.02318.01.0	EUV-AGK	EL		
			7.00784.01.0	EUV-SL	EP		
3 Touring (E46)						23	
316 i 85 kW (115 PS) N42 B18 A, N46 B18 A	03.2002→02.2005		7.06117.00.0	SV-NWV	EL	mit Dichtring with O-ring	
318 d 85-100 kW (116-136 PS) M47 D20 (204D1)	10.2002→03.2003		7.22796.01.0	DW-AGR	EP		
			7.22796.01.0	DW-TL	EP		
			7.02318.01.0	EUV-AGR	EL		
318 d 85-120 kW (116-163 PS) M47 D20 (204D4)	03.2003→02.2005		7.22796.01.0	DW-AGR	EP		
			7.22796.01.0	DW-TL	EP		
			7.02318.01.0	EUV-SR	EL		
318 i 77-87 kW (105-118 PS) M43 B19 (194E1)	10.1999→09.2001		7.02318.01.0	EUV-SL	EL		
318 i 77-87 kW (105-118 PS) M43 B19 (194E1)	10.1999→09.2001		7.02318.01.0	EUV-SL	EL		



B





3 Touring (E46)









23

318 i 95-125 kW (129-170 PS) N42 B20 A, N46 B20 A, N46 B20 C	09.2001→07.2005		7.06117.00.0	SV-NWV	EL	mit Dichtring with O-ring
320 d 85-100 kW (116-136 PS) M47 D20 (204D1)	03.2000→09.2001		7.22796.01.0	DW-AGR	EP	
			7.22796.01.0	DW-TL	EP	
			7.02318.01.0	EUV-AGR	EL	
320 d 85-120 kW (116-163 PS) M47 D20 (204D4)	09.2001→02.2005		7.22796.01.0	DW-AGR	EP	
			7.22796.01.0	DW-TL	EP	
			7.02318.01.0	EUV-AGR	EL	
320 i 100-110 kW (136-150 PS) M52 B20 (206S4)	10.1999→09.2000		7.00784.01.0	EUV-SL	EP	
320 i 120-125 kW (163-170 PS) M54 B22 (226S1)	09.2000→02.2005		7.00784.01.0	EUV-SL	EP	
			7.02318.01.0	EUV-SL	EL	
320 i 120-125 kW (163-170 PS) M54 B22 (226S1)	09.2000→02.2005		7.02318.01.0	EUV-SL	EL	
325 i 137-141 kW (186-192 PS) M54 B25 (256S5)	09.2000→02.2005		7.00784.01.0	EUV-SL	EP	
325 i 132 kW (179 PS) M56 B25 (256S6)	09.2002→07.2005		7.02318.01.0	EUV-AGK	EL	
325 xi 137-141 kW (186-192 PS) M54 B25 (256S5)	09.2000→02.2005		7.00784.01.0	EUV-SL	EP	
328 i 141-144 kW (192-196 PS) M52 B28 (286S2)	06.1999→05.2000		7.00784.01.0	EUV-SL	EP	
			7.22796.01.0	DW-AGR	EP	
			7.22796.01.0	DW-TL	EP	
330 d 135-142 kW (184-193 PS) M57 D30 (306D1)	10.1999→02.2005		7.02318.01.0	EUV-AGR	EL	
			7.22796.01.0	DW-AGR	EP	
			7.22796.01.0	DW-TL	EP	
330 d 150-160 kW (204-218 PS) M57 D30 (306D2)	03.2003→02.2005		7.02318.01.0	EUV-ML	EL	
			7.22796.01.0	DW-AGR	EP	
			7.22796.01.0	DW-TL	EP	
330 i 163-170 kW (222-231 PS) M54 B30 (306S3)	06.2000→02.2005		7.00784.01.0	EUV-SL	EP	
330 xd 135-142 kW (184-193 PS) M57 D30 (306D1)	01.2000→03.2003		7.22796.01.0	DW-AGR	EP	
			7.22796.01.0	DW-TL	EP	
			7.02318.01.0	EUV-SR	EL	
330 xd 150-160 kW (204-218 PS) M57 D30 (306D2)	08.2002→05.2005		7.22796.01.0	DW-AGR	EP	
			7.22796.01.0	DW-TL	EP	
			7.02318.01.0	EUV-AGR	EL	
330 xi 163-170 kW (222-231 PS) M54 B30 (306S3)	06.2000→02.2005		7.00784.01.0	EUV-SL	EP	

3 Touring (E91)

24

316 d 66-150 kW (90-204 PS) N47 D20 C	09.2009→06.2012		7.02318.01.0	EUV-AGR	EL	
316 i 89-90 kW (121-122 PS) N43 B16 AA	09.2008→06.2012		7.02318.01.0	EUV-ML	EL	
			7.02318.01.0	EUV-SR	EL	
318 d 85-120 kW (116-163 PS) M47 D20 (204D4)	09.2005→08.2007		7.22796.01.0	DW-AGR	EP	
			7.02318.01.0	EUV-AGR	EL	
318 d 66-150 kW (90-204 PS) N47 D20 A, N47 D20 C	07.2007→06.2012		7.02063.02.0	DW-AGR	EP	























					
3 Touring (E91)					
					24
					B
318 d 66-150 kW (90-204 PS) N47 D20 A, N47 D20 C	09.2007→06.2012		7.02318.01.0 7.02063.02.0 7.02318.01.0 7.02318.01.0	EUV-AGR DW-AGR EUV-AGR EUV-ML	EL EP EL EL
318 i 95-125 kW (129-170 PS) N46 B20 B	01.2006→08.2007		7.06117.00.0	SV-NWV	EL mit Dichtring with O-ring
318 i 90-125 kW (122-170 PS) N43 B20 A	05.2007→05.2012		7.02318.01.0 7.02318.01.0	EUV-ML EUV-SR	EL EL
318 i 95-125 kW (129-170 PS) N46 B20 B	09.2007→03.2012		7.06117.00.0	SV-NWV	EL mit Dichtring with O-ring
320 d 85-120 kW (116-163 PS) M47 D20 (204D4)	12.2004→08.2007		7.22796.01.0 7.02318.01.0	DW-AGR EUV-SR	EP EL
320 d 85-120 kW (116-163 PS) M47 D20 (204D4)	06.2005→08.2007		7.22796.01.0 7.02318.01.0	DW-AGR EUV-AGR	EP →07.2008 EL
320 d 66-150 kW (90-204 PS) N47 D20 A, N47 D20 C	02.2007→12.2010		7.02063.02.0 7.02318.01.0 7.02318.01.0	DW-AGR EUV-AGR EUV-ML	EP EL EL
320 d 66-150 kW (90-204 PS) N47 D20 A, N47 D20 C	02.2007→02.2010		7.02063.02.0 7.02318.01.0 7.02318.01.0	DW-AGR EUV-AGR EUV-ML	EP EL EL
320 d 66-145 kW (90-197 PS) N47 D20 A	09.2007→02.2010		7.02318.01.0	EUV-AGR	EL
320 d 66-150 kW (90-204 PS) N47 D20 C	09.2008→06.2012		7.02063.02.0 7.02318.01.0 7.02318.01.0	DW-AGR EUV-AGR EUV-ML	EP Euro 3 (D3) EL EL Euro 3 (D3)
320 d 66-150 kW (90-204 PS) N47 D20 C	03.2010→05.2012		7.02063.02.0 7.02318.01.0 7.02318.01.0	DW-AGR EUV-AGR EUV-ML	EP EL EL
320 d 66-150 kW (90-204 PS) N47 D20 C	03.2010→05.2012		7.02063.02.0 7.02318.01.0 7.02318.01.0	DW-AGR EUV-AGR EUV-ML	EP EL EL
320 d xDrive 66-150 kW (90-204 PS) N47 D20 C	02.2008→02.2010		7.02318.01.0 7.02318.01.0	EUV-AGR EUV-ML	EL EL
320 d xDrive 66-150 kW (90-204 PS) N47 D20 C	09.2008→02.2010		7.02318.01.0 7.02318.01.0	EUV-AGR EUV-ML	EL EL
320 d xDrive 66-150 kW (90-204 PS) N47 D20 C	07.2009→06.2012		7.02318.01.0 7.02318.01.0	EUV-AGR EUV-ML	EL EL
320 d xDrive 66-150 kW (90-204 PS) N47 D20 C	03.2010→06.2012		7.02318.01.0 7.02318.01.0	EUV-AGR EUV-ML	EL EL

















B

3 Touring (E91)

24

320 d xDrive 66-150 kW (90-204 PS) N47 D20 C	03.2010→05.2012	 7.02318.01.0	EUV-AGR	EL	
		 7.02318.01.0	EUV-ML	EL	
320 i 95-125 kW (129-170 PS) N46 B20 B, N46 B20 C	09.2005→06.2012	 7.06117.00.0	SV-NWV	EL	mit Dichtring with O-ring
320 i 95-125 kW (129-170 PS) N46 B20 B, N46 B20 BD, N46 B20 C	09.2005→06.2012	 7.06117.00.0	SV-NWV	EL	mit Dichtring with O-ring
320 i 90-125 kW (122-170 PS) N43 B20 A	02.2007→12.2012	 7.02318.01.0	EUV-ML	EL	
		 7.02318.01.0	EUV-SR	EL	
320 i 90-125 kW (122-170 PS) N43 B20 A	02.2007→05.2012	 7.02318.01.0	EUV-ML	EL	
		 7.02318.01.0	EUV-SR	EL	
323 i 130-160 kW (177-218 PS) N52 B25 A	04.2006→06.2007	 7.06117.01.0	SV-NWV	EL	mit Dichtring with O-ring
323 i 130-160 kW (177-218 PS) N52 B25 A	09.2006→07.2008	 7.06117.01.0	SV-NWV	EL	mit Dichtring with O-ring
325 d 135-173 kW (184-235 PS) M57 D30 (306D3)	09.2006→06.2012	 7.22796.01.0	DW-AGR	EP	
		 7.02318.01.0	EUV-ML	EL	
325 d 150-210 kW (204-286 PS) N57 D30 A	02.2010→06.2012	 7.02318.01.0	EUV-AGR	EL	
		 7.02318.01.0	EUV-ML	EL	
325 i 130-160 kW (177-218 PS) N52 B25 A	12.2004→08.2008	 7.06117.01.0	SV-NWV	EL	mit Dichtring with O-ring
325 i 130-160 kW (177-218 PS) N52 B25 A	12.2004→12.2010	 7.06117.01.0	SV-NWV	EL	mit Dichtring with O-ring
325 i 150-200 kW (204-272 PS) N53 B30 A	09.2007→06.2012	 7.02318.01.0	EUV-ML	EL	
		 7.06117.01.0	SV-NWV	EL	mit Dichtring with O-ring
325 i 150-200 kW (204-272 PS) N53 B30 A	09.2007→06.2012	 7.02318.01.0	EUV-ML	EL	
		 7.06117.01.0	SV-NWV	EL	mit Dichtring with O-ring
325 i xDrive 150-200 kW (204-272 PS) N53 B30 A	09.2008→06.2012	 7.06117.01.0	SV-NWV	EL	mit Dichtring with O-ring
325 xi 130-160 kW (177-218 PS) N52 B25 A	08.2005→08.2008	 7.06117.01.0	SV-NWV	EL	mit Dichtring with O-ring
325 xi 150-200 kW (204-272 PS) N53 B30 A	09.2007→08.2008	 7.06117.01.0	SV-NWV	EL	mit Dichtring with O-ring
325 xi 150-200 kW (204-272 PS) N53 B30 A	09.2007→08.2008	 7.06117.01.0	SV-NWV	EL	mit Dichtring with O-ring
328 i 155-200 kW (211-272 PS) N52 B30 A	03.2007→06.2012	 7.06117.01.0	SV-NWV	EL	mit Dichtring with O-ring
330 d 135-173 kW (184-235 PS) M57 D30 (306D3)	12.2004→08.2008	 7.22796.01.0	DW-AGR	EP	
		 7.02318.01.0	EUV-ML	EL	
		 7.02318.01.0	EUV-SR	EL	
330 d 135-210 kW (184-286 PS) M57 D30 (306D3), N57 D30 A	06.2005→05.2012	 7.02318.01.0	EUV-AGR	EL	
		 7.02318.01.0	EUV-ML	EL	
		 7.02318.01.0	EUV-SR	EL	
330 d 150-210 kW (204-286 PS) N57 D30 A	02.2008→05.2012	 7.02318.01.0	EUV-AGR	EL	

3 Touring (E91)
24
B





			7.02318.01.0	EUV-ML	EL	
330 d xDrive 150-210 kW (204-286 PS) N57 D30 A	01.2009→06.2012		7.02318.01.0	EUV-AGR	EL	
			7.02318.01.0	EUV-ML	EL	
330 i 155-200 kW (211-272 PS) N52 B30 A	08.2005→08.2007		7.06117.01.0	SV-NWV	EL	mit Dichtring with O-ring
330 i 150-200 kW (204-272 PS) N53 B30 A	09.2007→06.2012		7.06117.01.0	SV-NWV	EL	mit Dichtring with O-ring
330 i xDrive 150-200 kW (204-272 PS) N53 B30 A	09.2007→06.2012		7.06117.01.0	SV-NWV	EL	mit Dichtring with O-ring
330 xd 135-173 kW (184-235 PS) M57 D30 (306D3)	09.2005→06.2012		7.22796.01.0	DW-AGR	EP	
			7.02318.01.0	EUV-ML	EL	
			7.02318.01.0	EUV-SR	EL	
330 xi 155-200 kW (211-272 PS) N52 B30 A	09.2005→08.2007		7.06117.01.0	SV-NWV	EL	mit Dichtring with O-ring
330 xi 150-200 kW (204-272 PS) N53 B30 A	09.2007→06.2012		7.06117.01.0	SV-NWV	EL	mit Dichtring with O-ring
335 d 198-221 kW (269-301 PS) M57 D30 (306D5)	09.2006→06.2012		7.22796.01.0	DW-AGR	EP	
			7.02256.27.0	DW-TL	EP	
			7.02318.01.0	EUV-AGR	EL	
			7.02318.01.0	EUV-ML	EL	
			7.02318.01.0	EUV-SR	EL	
			7.02318.01.0	LDRV	EL	
335 i 200-264 kW (272-359 PS) N54 B30 A	09.2006→06.2012		7.00887.19.0	DW-TL	EP	
			7.06117.01.0	SV-NWV	EL	mit Dichtring with O-ring
335 i 200-272 kW (272-370 PS) N55 B30 A	09.2006→06.2012		7.00887.21.0	DW-TL	EP	Produktionsdatum bis: 31.05.2012 Production date to: 31.05.2012
			7.00887.22.0	DW-TL	EP	Produktionsdatum ab: 01.06.2012 Production date from: 01.06.2012
			7.06117.36.0	SV-NWV	EL	mit Dichtring with O-ring
335 i 200-264 kW (272-359 PS) N54 B30 A	09.2006→06.2012		7.00887.19.0	DW-TL	EP	
			7.06117.01.0	SV-NWV	EL	mit Dichtring with O-ring
335 i 200-272 kW (272-370 PS) N55 B30 A	09.2006→06.2012		7.00887.21.0	DW-TL	EP	Produktionsdatum bis: 31.05.2012 Production date to: 31.05.2012
			7.00887.22.0	DW-TL	EP	Produktionsdatum ab: 01.06.2012 Production date from: 01.06.2012
			7.06117.36.0	SV-NWV	EL	mit Dichtring with O-ring
335 i xDrive 200-264 kW (272-359 PS) N54 B30 A	09.2008→06.2012		7.00887.19.0	DW-TL	EP	
			7.06117.01.0	SV-NWV	EL	mit Dichtring with O-ring
335 i xDrive 200-272 kW (272-370 PS) N55 B30 A	09.2008→06.2012		7.00887.21.0	DW-TL	EP	Produktionsdatum bis: 31.05.2012 Production date to: 31.05.2012
			7.00887.22.0	DW-TL	EP	Produktionsdatum ab: 01.06.2012 Production date from: 01.06.2012
			7.06117.36.0	SV-NWV	EL	mit Dichtring with O-ring



B













3 Touring (E91)

24















335 i xDrive 200-264 kW (272-359 PS) N54 B30 A	09.2008→06.2012		7.00887.19.0	DW-TL	EP	
			7.06117.01.0	SV-NWV	EL	mit Dichtring with O-ring
335 i xDrive 200-272 kW (272-370 PS) N55 B30 A	09.2008→06.2012		7.00887.21.0	DW-TL	EP	Produktionsdatum bis: 31.05.2012 Production date to: 31.05.2012
			7.00887.22.0	DW-TL	EP	Produktionsdatum ab: 01.06.2012 Production date from: 01.06.2012
			7.06117.36.0	SV-NWV	EL	mit Dichtring with O-ring
335 xi 200-264 kW (272-359 PS) N54 B30 A	03.2007→08.2008		7.00887.19.0	DW-TL	EP	
			7.06117.01.0	SV-NWV	EL	mit Dichtring with O-ring
335 xi 200-272 kW (272-370 PS) N55 B30 A	03.2007→08.2008		7.06117.36.0	SV-NWV	EL	mit Dichtring with O-ring
335 xi 200-264 kW (272-359 PS) N54 B30 A	03.2007→08.2008		7.00887.19.0	DW-TL	EP	
			7.06117.01.0	SV-NWV	EL	mit Dichtring with O-ring

3 Touring (F31)

25

316 d 66-150 kW (90-204 PS) N47 D20 C	11.2012→06.2019		7.02318.01.0	EUV-AGR	EL	
316 i 75-130 kW (102-177 PS) N13 B16 A	03.2013→06.2015		7.01777.17.0	DW-TL	EP	
			7.01762.04.0	SUV	EL	
			7.06117.02.0	SV-NWV	EL	
318 d 66-150 kW (90-204 PS) N47 D20 C	11.2012→06.2015		7.02318.01.0	EUV-AGR	EL	
318 d 66-150 kW (90-204 PS) N47 D20 C	11.2012→06.2019		7.02318.01.0	EUV-AGR	EL	
318 d xDrive 66-150 kW (90-204 PS) N47 D20 C	07.2013→06.2015		7.02318.01.0	EUV-AGR	EL	
320 d 66-150 kW (90-204 PS) N47 D20 C	07.2012→02.2016		7.02318.01.0	EUV-AGR	EL	
320 d 66-150 kW (90-204 PS) N47 D20 C	07.2012→06.2019		7.02318.01.0	EUV-AGR	EL	
320 d 66-150 kW (90-204 PS) N47 D20 C	07.2012→02.2016		7.02318.01.0	EUV-AGR	EL	
320 d xDrive 66-150 kW (90-204 PS) N47 D20 C	03.2013→06.2015		7.02318.01.0	EUV-AGR	EL	
320 d xDrive 66-150 kW (90-204 PS) N47 D20 C	03.2013→06.2015		7.02318.01.0	EUV-AGR	EL	
320 d xDrive 66-150 kW (90-204 PS) N47 D20 C	03.2013→06.2015		7.02318.01.0	EUV-AGR	EL	
			7.02318.01.0	EUV-AGR	EL	
320 i 120-135 kW (163-184 PS) N20 B20 B	11.2012→06.2015		7.00887.21.0	DW-TL	EP	
			7.04216.05.0	SUV	EL	
			7.00887.21.0	DW-TL	EP	
320 i 120-135 kW (163-184 PS) N20 B20 B	11.2012→06.2015		7.00887.21.0	DW-TL	EP	
			7.04216.05.0	SUV	EL	

3 Touring (F31)
25
B



320 i xDrive 120-135 kW (163-184 PS) N20 B20 B	03.2013→06.2015		7.00887.21.0	DW-TL	EP	
			7.04216.05.0	SUV	EL	
320 i xDrive 120-135 kW (163-184 PS) N20 B20 B	03.2013→06.2015		7.00887.21.0	DW-TL	EP	
			7.04216.05.0	SUV	EL	
325 d 150-160 kW (204-218 PS) N47 D20 D	03.2013→02.2016		7.02256.27.0	DW-TL	EP	
			7.02318.01.0	EUV-AGR	EL	
			7.02318.01.0	LDRV	EL	
325 d 150-160 kW (204-218 PS) N47 D20 D	03.2013→02.2016		7.02256.27.0	DW-TL	EP	
			7.02318.01.0	EUV-AGR	EL	
			7.02318.01.0	LDRV	EL	
325 d 85-170 kW (116-231 PS) B47 D20 B	03.2016→02.2018		7.02256.27.0	DW-TL	EP	
328 i 110-205 kW (150-279 PS) N20 B20 A	07.2012→06.2015		7.00887.21.0	DW-TL	EP	
			7.04216.05.0	SUV	EL	
328 i xDrive 110-205 kW (150-279 PS) N20 B20 A	03.2013→06.2016		7.00887.21.0	DW-TL	EP	
			7.02318.01.0	EUV-AGR	EL	
			7.04216.05.0	SUV	EL	
330 d 150-210 kW (204-286 PS) N57 D30 A	07.2012→06.2019		7.02318.01.0	EUV-AGR	EL	
			7.02318.01.0	EUV-ML	EL	
330 d 150-210 kW (204-286 PS) N57 D30 A	07.2012→06.2019		7.02318.01.0	EUV-AGR	EL	
			7.02318.01.0	EUV-ML	EL	
330 d xDrive 150-210 kW (204-286 PS) N57 D30 A	03.2013→06.2019		7.02318.01.0	EUV-AGR	EL	
			7.02318.01.0	EUV-ML	EL	
330 d xDrive 150-210 kW (204-286 PS) N57 D30 A	03.2013→06.2019		7.02318.01.0	EUV-AGR	EL	
			7.02318.01.0	EUV-ML	EL	
			7.02318.01.0	EUV-ML	EL	
335 d xDrive 220-230 kW (299-313 PS) N57 D30 B	11.2013→06.2019		7.02256.27.0	DW-TL	EP	
			7.02318.01.0	EUV-AGR	EL	
			7.02318.01.0	EUV-ML	EL	
			7.02318.01.0	LDRV	EL	
335 i 200-272 kW (272-370 PS) N55 B30 A	03.2013→06.2013		7.01762.04.0	SUV	EL	
			7.06117.36.0	SV-NWV	EL	mit Dichtring with O-ring
335 i 200-272 kW (272-370 PS) N55 B30 A	03.2013→06.2015		7.01762.04.0	SUV	EL	
			7.06117.36.0	SV-NWV	EL	mit Dichtring with O-ring
335 i 200-272 kW (272-370 PS) N55 B30 A	07.2013→06.2015		7.01762.04.0	SUV	EL	
			7.06117.36.0	SV-NWV	EL	mit Dichtring with O-ring



B















3 Touring (F31)

25







335 i xDrive 200-272 kW (272-370 PS) N55 B30 A	03.2013→06.2013		7.01762.04.0	SUV	EL	
			7.06117.36.0	SV-NWV	EL	
335 i xDrive 200-272 kW (272-370 PS) N55 B30 A	03.2013→06.2015		7.01762.04.0	SUV	EL	
			7.06117.36.0	SV-NWV	EL	
335 i xDrive 200-272 kW (272-370 PS) N55 B30 A	07.2013→06.2015		7.01762.04.0	SUV	EL	
			7.06117.36.0	SV-NWV	EL	

4 Convertible (F33, F83)















26

420 d 66-150 kW (90-204 PS) N47 D20 C	10.2013→06.2015		7.02318.01.0	EUV-AGR	EL	
			7.02318.01.0	EUV-AGR	EL	
420 d 66-150 kW (90-204 PS) N47 D20 C	10.2013→06.2015		7.02318.01.0	EUV-AGR	EL	
			7.02318.01.0	EUV-AGR	EL	
420 d 66-150 kW (90-204 PS) N47 D20 C	11.2013→		7.02318.01.0	EUV-AGR	EL	
			7.02318.01.0	EUV-AGR	EL	
420 i 120-135 kW (163-184 PS) N20 B20 B	07.2014→02.2016		7.04216.05.0	SUV	EL	
			7.04216.05.0	SUV	EL	
425 d 150-160 kW (204-218 PS) N47 D20 D	07.2014→02.2016		7.02256.27.0	DW-TL	EP	
			7.02318.01.0	EUV-AGR	EL	
			7.02318.01.0	LDRV	EL	
425 d 150-160 kW (204-218 PS) N47 D20 D	07.2014→02.2016		7.02256.27.0	DW-TL	EP	
			7.02318.01.0	EUV-AGR	EL	
			7.02318.01.0	LDRV	EL	
425 d 85-170 kW (116-231 PS) B47 D20 B	03.2016→02.2018		7.02256.27.0	DW-TL	EP	
			7.02256.27.0	DW-TL	EP	
428 i 110-205 kW (150-279 PS) N20 B20 A	11.2013→02.2016		7.00887.21.0	DW-TL	EP	
			7.04216.05.0	SUV	EL	
428 i 179-180 kW (243-245 PS) N26 B20 A	11.2013→02.2017		7.04216.05.0	SUV	EL	
			7.04216.05.0	SUV	EL	
428 i xDrive 110-205 kW (150-279 PS) N20 B20 A	03.2014→02.2016		7.00887.21.0	DW-TL	EP	
			7.04216.05.0	SUV	EL	
428 i xDrive 179-180 kW (243-245 PS) N26 B20 A	03.2014→02.2016		7.04216.05.0	SUV	EL	
			7.04216.05.0	SUV	EL	
430 d 150-210 kW (204-286 PS) N57 D30 A	07.2014→		7.02318.01.0	EUV-AGR	EL	
			7.02318.01.0	EUV-ML	EL	
430 d 150-210 kW (204-286 PS) N57 D30 A	07.2014→		7.02318.01.0	EUV-AGR	EL	
			7.02318.01.0	EUV-ML	EL	
			7.02318.01.0	EUV-ML	EL	
435 d xDrive 220-230 kW (299-313 PS) N57 D30 B	07.2014→		7.02256.27.0	DW-TL	EP	
			7.02318.01.0	EUV-AGR	EL	

4 Convertible (F33, F83)
26
B

			7.02318.01.0	EUV-ML	EL	
			7.02318.01.0	LDRV	EL	
435 i 200-272 kW (272-370 PS) N55 B30 A	11.2013→02.2016		7.06117.36.0	SV-NWV	EL	mit Dichtring with O-ring
435 i 200-272 kW (272-370 PS) N55 B30 A	11.2013→02.2016		7.06117.36.0	SV-NWV	EL	mit Dichtring with O-ring
435 i xDrive 200-272 kW (272-370 PS) N55 B30 A	07.2014→02.2016		7.06117.36.0	SV-NWV	EL	mit Dichtring with O-ring
435 i xDrive 200-272 kW (272-370 PS) N55 B30 A	07.2014→02.2016		7.06117.36.0	SV-NWV	EL	mit Dichtring with O-ring
M4 272-368 kW (370-500 PS) S55 B30 A	07.2014→		7.06117.36.0	SV-NWV	EL	mit Dichtring with O-ring
M4 Competition 272-368 kW (370-500 PS) S55 B30 A	03.2016→		7.06117.36.0	SV-NWV	EL	mit Dichtring with O-ring

4 Coupe (F32, F82)
27















420 d 66-150 kW (90-204 PS) N47 D20 C	07.2013→03.2015		7.02318.01.0	EUV-AGR	EL	
420 d 66-150 kW (90-204 PS) N47 D20 C	07.2013→02.2015		7.02318.01.0	EUV-AGR	EL	
420 d 66-150 kW (90-204 PS) N47 D20 C	07.2013→02.2015		7.02318.01.0	EUV-AGR	EL	
420 d xDrive 66-150 kW (90-204 PS) N47 D20 C	11.2013→03.2015		7.02318.01.0	EUV-AGR	EL	
420 d xDrive 66-150 kW (90-204 PS) N47 D20 C	11.2013→02.2015		7.02318.01.0	EUV-AGR	EL	
420 d xDrive 66-150 kW (90-204 PS) N47 D20 C	11.2013→		7.02318.01.0	EUV-AGR	EL	
420 i 110-205 kW (150-279 PS) N20 B20 A, N20 B20 B	11.2013→02.2017		7.04216.05.0	SUV	EL	
420 i 110-205 kW (150-279 PS) N20 B20 A, N20 B20 B	11.2013→02.2017		7.04216.05.0	SUV	EL	
420 i xDrive 110-205 kW (150-279 PS) N20 B20 A, N20 B20 B	11.2013→02.2016		7.04216.05.0	SUV	EL	
420 i xDrive 110-205 kW (150-279 PS) N20 B20 A, N20 B20 B	11.2013→02.2016		7.04216.05.0	SUV	EL	
425 d 150-160 kW (204-218 PS) N47 D20 D	03.2014→02.2016		7.02256.27.0	DW-TL	EP	
			7.02318.01.0	EUV-AGR	EL	
			7.02318.01.0	LDRV	EL	
425 d 150-160 kW (204-218 PS) N47 D20 D	03.2014→02.2016		7.02256.27.0	DW-TL	EP	
			7.02318.01.0	EUV-AGR	EL	
			7.02318.01.0	LDRV	EL	
425 d 85-170 kW (116-231 PS) B47 D20 B	03.2016→10.2017		7.02256.27.0	DW-TL	EP	
428 i 110-205 kW (150-279 PS) N20 B20 A	07.2013→06.2016		7.00887.21.0	DW-TL	EP	PKW, Coupe/ Passenger car, coupé
			7.04216.05.0	SUV	EL	
428 i 179-180 kW (243-245 PS) N26 B20 A	07.2013→02.2017		7.04216.05.0	SUV	EL	



B





4 Coupe (F32, F82)































27

428 i xDrive 110-205 kW (150-279 PS) N20 B20 A	07.2013→02.2016		7.00887.21.0	DW-TL	EP	PKW, Coupe/ Passenger car, coupé
			7.04216.05.0	SUV	EL	
428 i xDrive 179-180 kW (243-245 PS) N26 B20 A	07.2013→02.2016		7.04216.05.0	SUV	EL	USA USA
430 d 150-210 kW (204-286 PS) N57 D30 A	11.2013→		7.02318.01.0	EUV-AGR	EL	
			7.02318.01.0	EUV-ML	EL	
430 d 150-210 kW (204-286 PS) N57 D30 A	11.2013→		7.02318.01.0	EUV-AGR	EL	
			7.02318.01.0	EUV-ML	EL	
430 d xDrive 150-210 kW (204-286 PS) N57 D30 A	03.2014→		7.02318.01.0	EUV-AGR	EL	
			7.02318.01.0	EUV-ML	EL	
430 d xDrive 150-210 kW (204-286 PS) N57 D30 A	03.2014→		7.02318.01.0	EUV-AGR	EL	
			7.02318.01.0	EUV-ML	EL	
435 d xDrive 220-230 kW (299-313 PS) N57 D30 B	11.2013→12.2020		7.02256.27.0	DW-TL	EP	
			7.02318.01.0	EUV-AGR	EL	
			7.02318.01.0	EUV-ML	EL	
			7.02318.01.0	LDRV	EL	
435 i 200-272 kW (272-370 PS) N55 B30 A	07.2013→02.2016		7.06117.36.0	SV-NWV	EL	mit Dichtring with O-ring
435 i 200-272 kW (272-370 PS) N55 B30 A	07.2013→02.2016		7.06117.36.0	SV-NWV	EL	mit Dichtring with O-ring
435 i xDrive 200-272 kW (272-370 PS) N55 B30 A	07.2013→02.2016		7.06117.36.0	SV-NWV	EL	mit Dichtring with O-ring
435 i xDrive 200-272 kW (272-370 PS) N55 B30 A	07.2013→02.2016		7.06117.36.0	SV-NWV	EL	mit Dichtring with O-ring
M4 272-368 kW (370-500 PS) S55 B30 A	03.2014→		7.06117.36.0	SV-NWV	EL	mit Dichtring with O-ring
M4 CS 272-368 kW (370-500 PS) S55 B30 A	07.2017→06.2019		7.06117.36.0	SV-NWV	EL	mit Dichtring with O-ring
M4 Competition 272-368 kW (370-500 PS) S55 B30 A	03.2016→		7.06117.36.0	SV-NWV	EL	mit Dichtring with O-ring
M4 GTS 272-368 kW (370-500 PS) S55 B30 A	03.2016→02.2017		7.06117.36.0	SV-NWV	EL	mit Dichtring with O-ring

4 Gran Coupe (F36)

28

418 d 66-150 kW (90-204 PS) N47 D20 C	03.2014→06.2015		7.02318.01.0	EUV-AGR	EL	
418 d 66-150 kW (90-204 PS) N47 D20 C	03.2014→06.2015		7.02318.01.0	EUV-AGR	EL	
420 d 66-150 kW (90-204 PS) N47 D20 C	03.2014→02.2015		7.02318.01.0	EUV-AGR	EL	
420 d 66-150 kW (90-204 PS) N47 D20 C	03.2014→02.2015		7.02318.01.0	EUV-AGR	EL	
420 d xDrive 66-150 kW (90-204 PS) N47 D20 C	03.2014→02.2015		7.02318.01.0	EUV-AGR	EL	



							
4 Gran Coupe (F36)						28	B
420 d xDrive 66-150 kW (90-204 PS) N47 D20 C	03.2014→02.2015		7.02318.01.0	EUV-AGR	EL		
420 d xDrive 66-150 kW (90-204 PS) N47 D20 C	03.2014→02.2015		7.02318.01.0	EUV-AGR	EL		
420 i 120-135 kW (163-184 PS) N20 B20 B	03.2014→02.2017		7.00887.21.0	DW-TL	EP		
			7.04216.05.0	SUV	EL		
420 i 120-135 kW (163-184 PS) N20 B20 B	03.2014→02.2017		7.00887.21.0	DW-TL	EP		
			7.04216.05.0	SUV	EL		
420 i xDrive 120-135 kW (163-184 PS) N20 B20 B	07.2014→02.2016		7.04216.05.0	SUV	EL		
420 i xDrive 120-135 kW (163-184 PS) N20 B20 B	07.2014→02.2016		7.04216.05.0	SUV	EL		
425 d 85-170 kW (116-231 PS) B47 D20 B	03.2016→02.2018		7.02256.27.0	DW-TL	EP		
425 d 85-170 kW (116-231 PS) B47 D20 B	03.2016→02.2018		7.02256.27.0	DW-TL	EP		
428 i 110-205 kW (150-279 PS) N20 B20 A, N26 B20 A	03.2014→06.2016		7.00887.21.0	DW-TL	EP	 USA  USA	
			7.04216.05.0	SUV	EL	 USA  USA	
428 i xDrive 110-205 kW (150-279 PS) N20 B20 A, N26 B20 A	03.2014→02.2016		7.00887.21.0	DW-TL	EP	 USA  USA	
			7.04216.05.0	SUV	EL	 USA  USA	
430 d 150-210 kW (204-286 PS) N57 D30 A	07.2014→		7.02318.01.0	EUV-AGR	EL		
			7.02318.01.0	EUV-ML	EL		
430 d 150-210 kW (204-286 PS) N57 D30 A	07.2014→		7.02318.01.0	EUV-AGR	EL		
			7.02318.01.0	EUV-ML	EL		
430 d xDrive 150-210 kW (204-286 PS) N57 D30 A	07.2014→		7.02318.01.0	EUV-AGR	EL		
			7.02318.01.0	EUV-ML	EL		
430 d xDrive 150-210 kW (204-286 PS) N57 D30 A	07.2014→		7.02318.01.0	EUV-AGR	EL		
			7.02318.01.0	EUV-ML	EL		
435 d xDrive 220-230 kW (299-313 PS) N57 D30 B	07.2014→		7.02256.27.0	DW-TL	EP		
			7.02318.01.0	EUV-AGR	EL		
			7.02318.01.0	EUV-ML	EL		
			7.02318.01.0	LDRV	EL		
435 i 200-272 kW (272-370 PS) N55 B30 A	03.2014→02.2016		7.06117.36.0	SV-NWV	EL	mit Dichtring with O-ring	
435 i 200-272 kW (272-370 PS) N55 B30 A	03.2014→02.2016		7.06117.36.0	SV-NWV	EL	mit Dichtring with O-ring	



B













4 Gran Coupe (F36)

28











435 i xDrive 200-272 kW (272-370 PS) N55 B30 A	07.2014→02.2016	 7.06117.36.0	SV-NWV	EL	mit Dichtring with O-ring
435 i xDrive 200-272 kW (272-370 PS) N55 B30 A	07.2014→02.2016	 7.06117.36.0	SV-NWV	EL	mit Dichtring with O-ring

5 (E39)

























29

520 d 85-100 kW (116-136 PS) M47 D20 (204D1)	02.2000→06.2003	 7.22796.01.0	DW-AGR	EP	
		7.22796.01.0	DW-TL	EP	
		7.02318.01.0	EUV-ML	EL	
520 i 100-110 kW (136-150 PS) M52 B20 (206S3)	01.1996→08.1998	 7.02318.01.0	EUV-SL	EL	
520 i 100-110 kW (136-150 PS) M52 B20 (206S3)	01.1996→08.1998	 7.02318.01.0	EUV-SL	EL	
520 i 100-110 kW (136-150 PS) M52 B20 (206S4)	09.1998→06.2003	 7.00784.01.0	EUV-SL	EP	
		7.02318.01.0	EUV-SL	EL	
520 i 100-110 kW (136-150 PS) M52 B20 (206S4)	09.1998→06.2003	 7.00784.01.0	EUV-SL	EP	
		7.02318.01.0	EUV-SL	EL	
520 i 120-125 kW (163-170 PS) M54 B22 (226S1)	09.2000→06.2003	 7.00784.01.0	EUV-SL	EP	
		7.02318.01.0	EUV-SL	EL	
520 i 120-125 kW (163-170 PS) M54 B22 (226S1)	09.2000→06.2003	 7.02318.01.0	EUV-SL	EL	
		7.02318.01.0	EUV-SL	EL	
523 i 120-141 kW (163-192 PS) M52 B25 (256S3)	09.1995→08.1998	 7.02318.01.0	EUV-SL	EL	
		7.00784.01.0	EUV-SL	EP	
523 i 120-141 kW (163-192 PS) M52 B25 (256S4)	09.1998→08.2000	 7.00784.01.0	EUV-SL	EP	
		7.02318.01.0	EUV-SL	EL	
		7.22796.01.0	DW-AGR	EP	
525 d 120 kW (163 PS) M57 D25 (256D1)	02.2000→06.2003	 7.22796.01.0	DW-AGR	EP	
		7.22796.01.0	DW-TL	EP	
		7.02318.01.0	EUV-ML	EL	
		7.02318.01.0	EUV-SR	EL	
525 i 137-141 kW (186-192 PS) M54 B25 (256S5)	09.2000→12.2002	 7.02318.01.0	EUV-SL	EL	
		7.00784.01.0	EUV-SL	EP	
525 i 137-141 kW (186-192 PS) M54 B25 (256S5)	09.2000→06.2003	 7.00784.01.0	EUV-SL	EP	
		7.02318.01.0	EUV-SL	EL	
525 td 85-105 kW (115-143 PS) M51 D25 (256T1)	01.1997→06.2003	 7.21903.73.0	DW-AGR	EP	
		7.02318.01.0	EUV-KL	EL	
		7.02318.01.0	EUV-ML	EL	
525 tds 85-105 kW (115-143 PS) M51 D25 (256T1)	01.1996→06.2003	 7.21903.73.0	DW-AGR	EP	
		7.02318.01.0	EUV-KL	EL	
		7.02318.01.0	EUV-ML	EL	
528 i 141-144 kW (192-196 PS) M52 B28 (286S1), M52 B28 (286S2)	09.1995→08.2000	 7.00784.01.0	EUV-SL	EP	
		7.02318.01.0	EUV-SL	EL	
		7.02318.01.0	EUV-ML	EL	
530 d 135-142 kW (184-193 PS) M57 D30 (306D1)	08.1998→09.2000	 7.22796.01.0	DW-AGR	EP	
		7.22796.01.0	DW-TL	EP	
		7.02318.01.0	EUV-ML	EL	03.2000→

5 (E39) **29** **B**

530 d 135-142 kW (184-193 PS) M57 D30 (306D1)	09.1998→06.2003	 7.02318.01.0	EUV-SR	EL	03.2000→
		 7.22796.01.0	DW-AGR	EP	
		 7.22796.01.0	DW-TL	EP	
		 7.02318.01.0	EUV-ML	EL	
530 i 163-170 kW (222-231 PS) M54 B30 (306S3)	09.2000→06.2003	 7.02318.01.0	EUV-SL	EL	
		 7.00784.01.0	EUV-SL	EP	
530 i 163-170 kW (222-231 PS) M54 B30 (306S3)	09.2000→06.2003	 7.02318.01.0	EUV-SL	EL	
		 7.06117.10.0	SV-NWV	EL	
535 i 173-180 kW (235-245 PS) M62 B35 (358S2)	09.1998→06.2003	 7.06117.10.0	SV-NWV	EL	Produktionsdatum ab: 09.1998 Production date from: 09.1998
540 i 210 kW (286 PS) M62 B44 (448S2)	03.1996→06.2003	 7.06117.10.0	SV-NWV	EL	Produktionsdatum ab: 09.1998 Production date from: 09.1998
M5 294 kW (400 PS) S62 B50 (508S1)	10.1998→06.2003	 7.02318.01.0	EUV-SL	EL	

5 (E60) **30**



520 d 66-150 kW (90-204 PS) N47 D20 C	09.2005→12.2009	 7.02063.02.0	DW-AGR	EP	
		 7.02318.01.0	EUV-AGR	EL	
		 7.02318.01.0	EUV-ML	EL	
520 d 85-120 kW (116-163 PS) M47 D20 (204D4)	09.2005→12.2009	 7.22796.01.0	DW-AGR	EP	
		 7.02318.01.0	EUV-ML	EL	
		 7.02318.01.0	EUV-SR	EL	
520 d 85-120 kW (116-163 PS) M47 D20 (204D4)	09.2005→02.2007	 7.22796.01.0	DW-AGR	EP	
		 7.02318.01.0	EUV-ML	EL	
		 7.02318.01.0	EUV-SR	EL	
520 d 66-150 kW (90-204 PS) N47 D20 A, N47 D20 C	09.2007→12.2009	 7.02063.02.0	DW-AGR	EP	
		 7.02318.01.0	EUV-AGR	EL	
		 7.02318.01.0	EUV-ML	EL	
520 d 66-145 kW (90-197 PS) N47 D20 A	09.2007→12.2009	 7.02063.02.0	DW-AGR	EP	
		 7.02318.01.0	EUV-AGR	EL	
		 7.02318.01.0	EUV-ML	EL	
520 i 90-125 kW (122-170 PS) N43 B20 A	12.2006→03.2010	 7.02318.01.0	EUV-SR	EL	
520 i 90-125 kW (122-170 PS) N43 B20 A	09.2007→12.2009	 7.02318.01.0	EUV-SR	EL	
520 i 95-125 kW (129-170 PS) N46 B20 B	09.2007→02.2010	 7.06117.00.0	SV-NWV	EL	mit Dichtring with O-ring
523 i 130-160 kW (177-218 PS) N52 B25 A, N52 B25 B, N52 B25 BE	10.2004→02.2007	 7.06117.01.0	SV-NWV	EL	mit Dichtring with O-ring
523 i 130-160 kW (177-218 PS) N52 B25 A, N52 B25 BE	03.2007→12.2009	 7.06117.01.0	SV-NWV	EL	mit Dichtring with O-ring
523 i 140 kW (190 PS) N53 B25 A	03.2007→12.2009	 7.02318.01.0	EUV-ML	EL	
		 7.06117.01.0	SV-NWV	EL	
525 d 120-130 kW (163-177 PS) M57 D25 (256D2)	06.2004→03.2010	 7.22796.01.0	DW-AGR	EP	
		 7.02318.01.0	EUV-ML	EL	
		 7.02318.01.0	EUV-SR	EL	



















B

5 (E60)

30

525 d 120-130 kW (163-177 PS) M57 D25 (256D2)	12.2004→03.2010		7.22796.01.0	DW-AGR	EP	
			7.02318.01.0 7.02318.01.0	EUV-ML EUV-SR	EL EL	
525 d 135-173 kW (184-235 PS) M57 D30 (306D3)	01.2007→03.2010		7.22796.01.0	DW-AGR	EP	
			7.02318.01.0	EUV-ML	EL	
525 d xDrive 135-173 kW (184-235 PS) M57 D30 (306D3)	09.2007→12.2009		7.22796.01.0	DW-AGR	EP	
525 i 130-160 kW (177-218 PS) N52 B25 A, N52 B25 B, N52 B25 BF	03.2005→12.2009		7.06117.01.0	SV-NWV	EL	mit Dichtring with O-ring
525 i 155-200 kW (211-272 PS) N52 B30 A	03.2005→03.2007		7.06117.01.0	SV-NWV	EL	mit Dichtring with O-ring
525 i 130-160 kW (177-218 PS) N52 B25 A	07.2005→03.2010		7.06117.01.0	SV-NWV	EL	mit Dichtring with O-ring
525 i 150-200 kW (204-272 PS) N53 B30 A	01.2007→03.2010		7.02318.01.0	EUV-ML	EL	
			7.06117.01.0	SV-NWV	EL	mit Dichtring with O-ring
525 i 150-200 kW (204-272 PS) N53 B30 A	01.2007→03.2010		7.02318.01.0	EUV-ML	EL	
			7.06117.01.0	SV-NWV	EL	mit Dichtring with O-ring
525 i xDrive 150-200 kW (204-272 PS) N53 B30 A	09.2008→03.2010		7.06117.01.0	SV-NWV	EL	mit Dichtring with O-ring
525 xd 135-173 kW (184-235 PS) M57 D30 (306D3)	11.2006→08.2007		7.22796.01.0	DW-AGR	EP	
			7.02318.01.0	EUV-ML	EL	
525 xi 130-160 kW (177-218 PS) N52 B25 A	04.2005→02.2007		7.06117.01.0	SV-NWV	EL	mit Dichtring with O-ring
525 xi 150-200 kW (204-272 PS) N53 B30 A	03.2007→12.2009		7.02318.01.0	EUV-ML	EL	
			7.06117.01.0	SV-NWV	EL	mit Dichtring with O-ring
528 i 155-200 kW (211-272 PS) N52 B30 A	03.2007→12.2009		7.06117.01.0	SV-NWV	EL	mit Dichtring with O-ring
528 i xDrive 155-200 kW (211-272 PS) N52 B30 A	09.2006→12.2009		7.06117.01.0	SV-NWV	EL	mit Dichtring with O-ring
530 d 150-160 kW (204-218 PS) M57 D30 (306D2)	09.2002→09.2005		7.22796.01.0	DW-AGR	EP	
			7.22796.01.0	DW-TL	EP	
			7.02318.01.0	EUV-ML	EL	
			7.02318.01.0	EUV-SR	EL	
530 d 135-173 kW (184-235 PS) M57 D30 (306D3)	09.2002→12.2009		7.22796.01.0	DW-AGR	EP	
			7.02318.01.0	EUV-ML	EL	
			7.02318.01.0	EUV-SR	EL	
530 d 150-160 kW (204-218 PS) M57 D30 (306D2)	09.2002→12.2009		7.02318.01.0	EUV-ML	EL	
			7.02318.01.0	EUV-SR	EL	
			7.02318.01.0	EUV-ML	EL	
			7.02318.01.0	EUV-SR	EL	
530 d 135-173 kW (184-235 PS) M57 D30 (306D3)	09.2005→03.2007		7.22796.01.0	DW-AGR	EP	
			7.02318.01.0	EUV-ML	EL	
			7.02318.01.0	EUV-SR	EL	

							
5 (E60)						30	B
530 d 135-173 kW (184-235 PS) M57 D30 (306D3)	02.2007→12.2009		7.22796.01.0	DW-AGR	EP		
			7.02318.01.0	EUV-ML	EL		
			7.02318.01.0	EUV-SR	EL		
530 d xDrive 135-173 kW (184-235 PS) M57 D30 (306D3)	09.2007→12.2009		7.22796.01.0	DW-AGR	EP		
			7.02318.01.0	EUV-ML	EL		
			7.02318.01.0	EUV-SR	EL		
530 i 155-200 kW (211-272 PS) N52 B30 A, N52 B30 BF	03.2005→03.2007		7.06117.01.0	SV-NWV	EL	mit Dichtring with O-ring	
530 i 155-200 kW (211-272 PS) N52 B30 A	03.2005→03.2010		7.06117.01.0	SV-NWV	EL	mit Dichtring with O-ring	
530 i 150-200 kW (204-272 PS) N53 B30 A	03.2007→12.2009		7.02318.01.0	EUV-ML	EL		
			7.06117.01.0	SV-NWV	EL	mit Dichtring with O-ring	
530 i 155-200 kW (211-272 PS) N52 B30 A, N52 B30 BF	03.2007→12.2009		7.06117.01.0	SV-NWV	EL	mit Dichtring with O-ring	
530 i 155-200 kW (211-272 PS) N52 B30 A	09.2007→12.2009		7.06117.01.0	SV-NWV	EL	mit Dichtring with O-ring	
530 i xDrive 150-200 kW (204-272 PS) N53 B30 A	09.2008→12.2009		7.06117.01.0	SV-NWV	EL	mit Dichtring with O-ring	
530 xd 135-173 kW (184-235 PS) M57 D30 (306D3)	02.2005→02.2007		7.22796.01.0	DW-AGR	EP		
			7.02318.01.0	EUV-AGR	EL		
530 xd 135-173 kW (184-235 PS) M57 D30 (306D3)	03.2007→08.2007		7.22796.01.0	DW-AGR	EP		
			7.02318.01.0	EUV-AGR	EL		
530 xi 155-200 kW (211-272 PS) N52 B30 A	09.2004→02.2007		7.06117.01.0	SV-NWV	EL	mit Dichtring with O-ring	
530 xi 150-200 kW (204-272 PS) N53 B30 A	02.2007→08.2008		7.02318.01.0	EUV-ML	EL		
			7.06117.01.0	SV-NWV	EL	mit Dichtring with O-ring	
530 xi 155-200 kW (211-272 PS) N52 B30 A	03.2007→10.2009		7.06117.01.0	SV-NWV	EL	mit Dichtring with O-ring	
535 d 198-200 kW (269-272 PS) M57 D30 (306D4)	09.2004→03.2010		7.22796.01.0	DW-AGR	EP		
			7.22796.01.0	DW-TL	EP		
			7.02318.01.0	EUV-AGK	EL		
			7.02318.01.0	EUV-ML	EL		
			7.02318.01.0	EUV-SR	EL		
535 d 198-221 kW (269-301 PS) M57 D30 (306D5)	01.2007→03.2010		7.02256.27.0	DW-TL	EP		
			7.02318.01.0	EUV-ML	EL		
			7.02318.01.0	EUV-SR	EL		
			7.02318.01.0	LDRV	EL		
535 i 200-264 kW (272-359 PS) N54 B30 A	04.2006→12.2009		7.00887.19.0	DW-TL	EP	USA USA	
			7.02318.01.0	EUV-AGK	EL		
			7.06117.01.0	SV-NWV	EL	mit Dichtring with O-ring	
535 i 200-264 kW (272-359 PS) N54 B30 A	09.2007→03.2010		7.00887.19.0	DW-TL	EP	USA USA	
			7.02318.01.0	EUV-AGK	EL		



B

5 (E60)





















30

			7.06117.01.0	SV-NWV	EL	mit Dichtring with O-ring
535 i xDrive 200-264 kW (272-359 PS) N54 B30 A	09.2008→12.2009		7.00887.19.0	DW-TL	EP	USA USA
			7.06117.01.0	SV-NWV	EL	mit Dichtring with O-ring
535 xi 200-264 kW (272-359 PS) N54 B30 A	03.2007→08.2008		7.00887.19.0	DW-TL	EP	USA USA
			7.02318.01.0	EUV-AGK	EL	
			7.06117.01.0	SV-NWV	EL	mit Dichtring with O-ring
540 i 200-225 kW (272-306 PS) N62 B40 A	09.2005→02.2007		7.06117.00.0	SV-NWV	EL	mit Dichtring with O-ring
540 i 200-225 kW (272-306 PS) N62 B40 A	03.2007→12.2009		7.02318.01.0	EUV-AGK	EL	
			7.06117.00.0	SV-NWV	EL	mit Dichtring with O-ring
545 i 235-245 kW (320-333 PS) N62 B44 A	09.2003→12.2005		7.02318.01.0	EUV-AGK	EL	
			7.06117.00.0	SV-NWV	EL	mit Dichtring with O-ring
545 i 235-245 kW (320-333 PS) N62 B44 A	09.2003→08.2005		7.02318.01.0	EUV-AGK	EL	
			7.06117.00.0	SV-NWV	EL	mit Dichtring with O-ring
550 i 261-270 kW (355-367 PS) N62 B48 B	09.2005→03.2010		7.02318.01.0	EUV-AGK	EL	
			7.06117.00.0	SV-NWV	EL	mit Dichtring with O-ring
550 i 261-270 kW (355-367 PS) N62 B48 B	09.2005→12.2009		7.02318.01.0	EUV-SL	EL	
			7.06117.00.0	SV-NWV	EL	mit Dichtring with O-ring
M5 373 kW (507 PS) S85 B50 A	09.2004→12.2009		7.00784.01.0	EUV-SL	EP	
			7.02318.01.0	EUV-SL	EL	

5 (F10)

31

518 d 66-150 kW (90-204 PS) N47 D20 C	07.2013→06.2014		7.02318.01.0	EUV-AGR	EL	
			7.02318.01.0	EUV-ML	EL	
518 d 66-150 kW (90-204 PS) N47 D20 C	07.2013→06.2014		7.02318.01.0	EUV-AGR	EL	
			7.02318.01.0	EUV-ML	EL	
520 d 66-150 kW (90-204 PS) N47 D20 C	06.2010→06.2014		7.02318.01.0	EUV-AGR	EL	
			7.02318.01.0	EUV-ML	EL	
520 d 66-150 kW (90-204 PS) N47 D20 C	06.2010→06.2014		7.02318.01.0	EUV-AGR	EL	
			7.02318.01.0	EUV-ML	EL	
520 d 66-150 kW (90-204 PS) N47 D20 C	01.2013→06.2014		7.02318.01.0	EUV-AGR	EL	
			7.02318.01.0	EUV-ML	EL	
520 d xDrive 66-150 kW (90-204 PS) N47 D20 C	01.2013→06.2014		7.02318.01.0	EUV-AGR	EL	
			7.02318.01.0	EUV-ML	EL	

							
5 (F10)						31	B
520 d xDrive 66-150 kW (90-204 PS) N47 D20 C	01.2013→06.2014		7.02318.01.0	EUV-AGR	EL		
			7.02318.01.0	EUV-ML	EL		
520 d xDrive 66-150 kW (90-204 PS) N47 D20 C	07.2013→06.2014		7.02318.01.0	EUV-AGR	EL		
			7.02318.01.0	EUV-ML	EL		
520 i 110-205 kW (150-279 PS) N20 B20 A, N20 B20 B	09.2011→10.2016		7.00887.21.0	DW-TL	EP		
			7.04216.05.0	SUV	EL		
520 i 110-205 kW (150-279 PS) N20 B20 A, N20 B20 B	09.2011→10.2016		7.00887.21.0	DW-TL	EP		
			7.04216.05.0	SUV	EL		
520 i 105-135 kW (143-184 PS) N20 B16 A	07.2013→10.2016		7.04216.05.0	SUV	EL		
			7.04216.05.0	SUV	EL		
523 i 150-200 kW (204-272 PS) N53 B30 A	06.2009→08.2011		7.02318.01.0	EUV-ML	EL		
			7.06117.01.0	SV-NWV	EL	mit Dichtring with O-ring	
523 i 130-160 kW (177-218 PS) N52 B25 A, N52 B25 AF, N52 B25 B, N52 B25 BF	01.2010→08.2011		7.06117.01.0	SV-NWV	EL	mit Dichtring with O-ring	
			7.06117.01.0	SV-NWV	EL	mit Dichtring with O-ring	
523 i 150-200 kW (204-272 PS) N53 B30 A	01.2010→08.2011		7.02318.01.0	EUV-ML	EL		
			7.06117.01.0	SV-NWV	EL	mit Dichtring with O-ring	
525 d 150-210 kW (204-286 PS) N57 D30 A	03.2010→08.2011		7.02318.01.0	EUV-AGR	EL		
			7.02318.01.0	EUV-ML	EL		
			7.02318.01.0	LDRV	EL		
525 d 150-160 kW (204-218 PS) N47 D20 D	09.2011→10.2016		7.02256.27.0	DW-TL	EP		
			7.02318.01.0	EUV-AGR	EL		
			7.02318.01.0	EUV-ML	EL		
			7.02318.01.0	LDRV	EL		
525 d 150-160 kW (204-218 PS) N47 D20 D	09.2011→10.2016		7.02256.27.0	DW-TL	EP		
			7.02318.01.0	EUV-AGR	EL		
			7.02318.01.0	EUV-ML	EL		
			7.02318.01.0	LDRV	EL		
525 d xDrive 150-160 kW (204-218 PS) N47 D20 D	09.2011→10.2016		7.02256.27.0	DW-TL	EP		
			7.02318.01.0	EUV-AGR	EL		
			7.02318.01.0	EUV-ML	EL		
			7.02318.01.0	LDRV	EL		
525 d xDrive 150-160 kW (204-218 PS) N47 D20 D	09.2011→10.2016		7.02256.27.0	DW-TL	EP		
			7.02318.01.0	EUV-AGR	EL		
			7.02318.01.0	EUV-ML	EL		
			7.02318.01.0	LDRV	EL		
528 i 155-200 kW (211-272 PS) N52 B30 A	10.2009→08.2011		7.06117.01.0	SV-NWV	EL	mit Dichtring with O-ring	
			7.06117.01.0	SV-NWV	EL	mit Dichtring with O-ring	
528 i 150-200 kW (204-272 PS) N53 B30 A	03.2010→08.2011		7.02318.01.0	EUV-ML	EL		

















B

5 (F10)

31

			7.06117.01.0	SV-NWV	EL	mit Dichtring with O-ring
528 i 110-205 kW (150-279 PS) N20 B20 A	09.2011→10.2016		7.00887.21.0	DW-TL	EP	
			7.02318.01.0	EUV-AGK	EL	
			7.04216.05.0	SUV	EL	
528 i 110-205 kW (150-279 PS) N20 B20 A	10.2014→10.2016		7.00887.21.0	DW-TL	EP	
			7.02318.01.0	EUV-AGK	EL	
			7.04216.05.0	SUV	EL	
528 i xDrive 110-205 kW (150-279 PS) N20 B20 A	09.2011→10.2016		7.00887.21.0	DW-TL	EP	
			7.02318.01.0	EUV-AGK	EL	
			7.04216.05.0	SUV	EL	
530 d 150-210 kW (204-286 PS) N57 D30 A	01.2010→08.2011		7.02318.01.0	EUV-AGR	EL	
			7.02318.01.0	EUV-ML	EL	
530 d 150-210 kW (204-286 PS) N57 D30 A	09.2010→10.2016		7.02318.01.0	EUV-AGR	EL	
			7.02318.01.0	EUV-ML	EL	
530 d 150-210 kW (204-286 PS) N57 D30 A	09.2011→10.2016		7.02318.01.0	EUV-AGR	EL	
			7.02318.01.0	EUV-ML	EL	
530 d xDrive 150-210 kW (204-286 PS) N57 D30 A	03.2011→10.2016		7.02318.01.0	EUV-AGR	EL	
			7.02318.01.0	EUV-ML	EL	
530 d xDrive 150-210 kW (204-286 PS) N57 D30 A	03.2011→10.2016		7.02318.01.0	EUV-AGR	EL	
			7.02318.01.0	EUV-ML	EL	
530 i 155-200 kW (211-272 PS) N52 B30 A, N52 B30 AF, N52 B30 BF	03.2010→06.2013		7.06117.01.0	SV-NWV	EL	mit Dichtring with O-ring
			7.02318.01.0	EUV-ML	EL	
530 i 150-200 kW (204-272 PS) N53 B30 A	05.2011→06.2013		7.06117.01.0	SV-NWV	EL	mit Dichtring with O-ring
			7.02318.01.0	EUV-ML	EL	
535 d 220-230 kW (299-313 PS) N57 D30 B	09.2010→08.2011		7.02256.27.0	DW-TL	EP	
			7.02318.01.0	EUV-AGR	EL	
			7.02318.01.0	EUV-ML	EL	
			7.02318.01.0	LDRV	EL	
535 d 220-230 kW (299-313 PS) N57 D30 B	09.2011→10.2016		7.02256.27.0	DW-TL	EP	
			7.02318.01.0	EUV-AGR	EL	
			7.02318.01.0	EUV-ML	EL	
			7.02318.01.0	LDRV	EL	
535 d xDrive 220-230 kW (299-313 PS) N57 D30 B	09.2011→10.2016		7.02256.27.0	DW-TL	EP	
			7.02318.01.0	EUV-AGR	EL	
			7.02318.01.0	EUV-ML	EL	
			7.02318.01.0	LDRV	EL	
535 i 200-272 kW (272-370 PS) N55 B30 A	01.2009→10.2016		7.00887.21.0	DW-TL	EP	Produktionsdatum bis: 31.05.2012 Production date to: 31.05.2012









						
5 (F10)					31	B
			7.00887.22.0 7.01762.04.0 7.06117.36.0	DW-TL SUV SV-NWV	EP EL EL mit Dichtring with O-ring	Produktionsdatum ab: 01.06.2012 Production date from: 01.06.2012
535 i 200-272 kW (272-370 PS) N55 B30 A	01.2010→10.2016		7.00887.21.0 7.00887.22.0 7.01762.04.0 7.06117.36.0	DW-TL DW-TL SUV SV-NWV	EP EP EL EL mit Dichtring with O-ring	Produktionsdatum bis: 31.05.2012 Production date to: 31.05.2012 Produktionsdatum ab: 01.06.2012 Production date from: 01.06.2012
535 i 200-272 kW (272-370 PS) N55 B30 A	07.2013→10.2016		7.00887.22.0 7.01762.04.0 7.06117.36.0	DW-TL SUV SV-NWV	EP EL EL mit Dichtring with O-ring	
535 i xDrive 200-272 kW (272-370 PS) N55 B30 A	03.2011→10.2016		7.00887.21.0 7.00887.22.0 7.01762.04.0 7.06117.36.0	DW-TL DW-TL SUV SV-NWV	EP EP EL EL mit Dichtring with O-ring	Produktionsdatum bis: 31.05.2012 Production date to: 31.05.2012 Produktionsdatum ab: 01.06.2012 Production date from: 01.06.2012
535 i xDrive 200-272 kW (272-370 PS) N55 B30 A	07.2013→10.2016		7.00887.22.0 7.01762.04.0 7.06117.36.0	DW-TL SUV SV-NWV	EP EL EL mit Dichtring with O-ring	
550 i 298-330 kW (405-449 PS) N63 B44 A	03.2010→06.2013		7.00887.19.0 7.02318.01.0 7.01762.04.0 7.06117.36.0	DW-TL EUV-AGK SUV SV-NWV	EP EL EL EL mit Dichtring with O-ring	
550 i 298-330 kW (405-449 PS) N63 B44 A	09.2010→06.2013		7.00887.19.0 7.02318.01.0 7.01762.04.0 7.06117.36.0	DW-TL EUV-AGK SUV SV-NWV	EP EL EL EL mit Dichtring with O-ring	
550 i 298-339 kW (405-461 PS) N63 B44 B	07.2013→10.2016		7.00887.21.0 7.02318.01.0 7.06117.36.0	DW-TL EUV-AGK SV-NWV	EP EL EL mit Dichtring with O-ring	
550 i 298-339 kW (405-461 PS) N63 B44 B	07.2013→10.2016		7.00887.21.0 7.02318.01.0 7.06117.36.0	DW-TL EUV-AGK SV-NWV	EP EL EL mit Dichtring with O-ring	
550 i xDrive 298-330 kW (405-449 PS) N63 B44 A	08.2010→06.2013		7.00887.19.0 7.02318.01.0 7.01762.04.0 7.06117.36.0	DW-TL EUV-AGK SUV SV-NWV	EP EL EL EL mit Dichtring with O-ring	

























B

5 (F10)

31

550 i xDrive 298-330 kW (405-449 PS) N63 B44 A	09.2012→06.2013		7.00887.19.0	DW-TL	EP	mit Dichtring with O-ring	
			7.02318.01.0	EUV-AGK	EL		
			7.01762.04.0	SUV	EL		
550 i xDrive 298-339 kW (405-461 PS) N63 B44 B	07.2013→10.2016		7.00887.21.0	DW-TL	EP	mit Dichtring with O-ring	
			7.02318.01.0	EUV-AGK	EL		
			7.06117.36.0	SV-NWV	EL		
550 i xDrive 298-339 kW (405-461 PS) N63 B44 B	08.2013→10.2016		7.00887.21.0	DW-TL	EP	mit Dichtring with O-ring	
			7.02318.01.0	EUV-AGK	EL		
			7.06117.36.0	SV-NWV	EL		
ActiveHybrid 200-272 kW (272-370 PS) N55 B30 A	12.2011→10.2016		7.00887.21.0	DW-TL	EP	Produktionsdatum bis: 31.05.2012 Production date to: 31.05.2012	
			7.00887.22.0	DW-TL	EP		Produktionsdatum ab: 01.06.2012 Production date from: 01.06.2012
			7.02318.01.0	EUV-AGK	EL		
			7.02318.01.0	EUV-LS	EL		
			7.02318.01.0	EUV-ML	EL		
			7.01762.04.0	SUV	EL		
7.06117.36.0	SV-NWV	EL					
ActiveHybrid 200-272 kW (272-370 PS) N55 B30 A	12.2011→10.2016		7.00887.21.0	DW-TL	EP	Produktionsdatum bis: 31.05.2012 Production date to: 31.05.2012	
			7.00887.22.0	DW-TL	EP		Produktionsdatum ab: 01.06.2012 Production date from: 01.06.2012
			7.02318.01.0	EUV-AGK	EL		
			7.02318.01.0	EUV-LS	EL		
			7.02318.01.0	EUV-ML	EL		
			7.01762.04.0	SUV	EL		
7.06117.36.0	SV-NWV	EL					
M 550 d xDrive 280 kW (381 PS) N57 D30 C	03.2012→10.2016		7.02256.27.0	DW-TL	EP		
			7.02318.01.0	EUV-AGR	EL		
			7.02318.01.0	EUV-ML	EL		
			7.02318.01.0	LDRV	EL		
M5 412-467 kW (560-635 PS) S63 B44 B	09.2011→10.2016		7.00887.21.0	DW-TL	EP	mit Dichtring with O-ring	
			7.02318.01.0	EUV-AGK	EL		
			7.06117.36.0	SV-NWV	EL		
M5 412-467 kW (560-635 PS) S63 B44 B	09.2013→10.2016		7.00887.21.0	DW-TL	EP	mit Dichtring with O-ring	
			7.02318.01.0	EUV-AGK	EL		
			7.06117.36.0	SV-NWV	EL		
M5 30th Anniversary 412-467 kW (560-635 PS) S63 B44 B	07.2014→10.2016		7.00887.21.0	DW-TL	EP		









							
5 (F10)						31	B
			7.02318.01.0 7.06117.36.0	EUV-AGK SV-NWV	EL EL	mit Dichtring with O-ring	
M5 Competition 412-467 kW (560-635 PS) S63 B44 B	02.2013→10.2016		7.00887.21.0	DW-TL	EP		
			7.02318.01.0 7.06117.36.0	EUV-AGK SV-NWV	EL EL	mit Dichtring with O-ring	
5 (G30, F90)						32	
525 d 85-170 kW (116-231 PS) B47 D20 B	07.2017→06.2019		7.02256.27.0	DW-TL	EP		
525 d 85-170 kW (116-231 PS) B47 D20 B	07.2017→06.2019		7.02256.27.0	DW-TL	EP		
540 d xDrive 155-250 kW (211-340 PS) B57 D30 B	07.2017→06.2020		7.02256.27.0	DW-TL	EP		
M 550 d xDrive 294 kW (400 PS) B57 D30 C	06.2017→		7.02256.27.0	DW-TL	EP		
5 Gran Turismo (F07)						33	
520 d 66-150 kW (90-204 PS) N47 D20 C	04.2011→02.2017		7.02318.01.0 7.02318.01.0	EUV-AGR EUV-ML	EL EL		
520 d 66-150 kW (90-204 PS) N47 D20 C	07.2012→06.2013		7.02318.01.0	EUV-AGR	EL		
			7.02318.01.0	EUV-ML	EL		
520 d 66-150 kW (90-204 PS) N47 D20 C	07.2013→02.2017		7.02318.01.0	EUV-AGR	EL		
			7.02318.01.0	EUV-ML	EL		
528 i 110-205 kW (150-279 PS) N20 B20 A	07.2013→02.2017		7.00887.21.0	DW-TL	EP		
			7.02318.01.0 7.04216.05.0	EUV-AGK SUV	EL EL		
530 d 150-210 kW (204-286 PS) N57 D30 A	08.2009→06.2012		7.02318.01.0	EUV-AGR	EL		
			7.02318.01.0	EUV-ML	EL		
530 d 150-210 kW (204-286 PS) N57 D30 A	09.2010→02.2017		7.02318.01.0	EUV-AGR	EL		
			7.02318.01.0	EUV-ML	EL		
530 d 150-210 kW (204-286 PS) N57 D30 A	07.2012→02.2017		7.02318.01.0	EUV-AGR	EL		
			7.02318.01.0	EUV-ML	EL		
530 d xDrive 150-210 kW (204-286 PS) N57 D30 A	06.2010→06.2012		7.02318.01.0	EUV-AGR	EL		
			7.02318.01.0	EUV-ML	EL		
530 d xDrive 150-210 kW (204-286 PS) N57 D30 A	07.2012→02.2017		7.02318.01.0	EUV-AGR	EL		
			7.02318.01.0	EUV-ML	EL		
535 d 220-230 kW (299-313 PS) N57 D30 B	03.2010→06.2012		7.02256.27.0	DW-TL	EP		
			7.02318.01.0 7.02318.01.0 7.02318.01.0	EUV-AGR EUV-ML LDRV	EL EL EL		
535 d 220-230 kW (299-313 PS) N57 D30 B	07.2012→02.2017		7.02256.27.0	DW-TL	EP		



B

5 Gran Turismo (F07)

33















			7.02318.01.0	EUV-AGR	EL	
			7.02318.01.0	EUV-ML	EL	
			7.02318.01.0	LDRV	EL	
535 d xDrive 220-230 kW (299-313 PS) N57 D30 B	03.2010→06.2012		7.02256.27.0	DW-TL	EP	
			7.02318.01.0	EUV-AGR	EL	
			7.02318.01.0	EUV-ML	EL	
			7.02318.01.0	LDRV	EL	
535 d xDrive 220-230 kW (299-313 PS) N57 D30 B	07.2012→02.2017		7.02256.27.0	DW-TL	EP	
			7.02318.01.0	EUV-AGR	EL	
			7.02318.01.0	EUV-ML	EL	
			7.02318.01.0	LDRV	EL	
535 i 200-272 kW (272-370 PS) N55 B30 A	01.2009→02.2017		7.00887.21.0	DW-TL	EP	Produktionsdatum bis: 31.05.2012 Production date to: 31.05.2012
			7.00887.22.0	DW-TL	EP	Produktionsdatum ab: 01.06.2012 Production date from: 01.06.2012
			7.01762.04.0	SUV	EL	
			7.06117.36.0	SV-NWV	EL	mit Dichtring with O-ring
535 i xDrive 200-272 kW (272-370 PS) N55 B30 A	09.2010→02.2017		7.00887.21.0	DW-TL	EP	Produktionsdatum bis: 31.05.2012 Production date to: 31.05.2012
			7.00887.22.0	DW-TL	EP	Produktionsdatum ab: 01.06.2012 Production date from: 01.06.2012
			7.01762.04.0	SUV	EL	
			7.06117.36.0	SV-NWV	EL	mit Dichtring with O-ring
535 i xDrive 200-272 kW (272-370 PS) N55 B30 A	09.2010→02.2017		7.00887.21.0	DW-TL	EP	Produktionsdatum bis: 31.05.2012 Production date to: 31.05.2012
			7.00887.22.0	DW-TL	EP	Produktionsdatum ab: 01.06.2012 Production date from: 01.06.2012
			7.01762.04.0	SUV	EL	
			7.06117.36.0	SV-NWV	EL	mit Dichtring with O-ring
550 i 298-330 kW (405-449 PS) N63 B44 A	08.2009→06.2012		7.00887.19.0	DW-TL	EP	
			7.02318.01.0	EUV-AGK	EL	
			7.01762.04.0	SUV	EL	
			7.06117.36.0	SV-NWV	EL	mit Dichtring with O-ring
550 i 298-330 kW (405-449 PS) N63 B44 A	07.2012→02.2017		7.00887.19.0	DW-TL	EP	
			7.02318.01.0	EUV-AGK	EL	
			7.01762.04.0	SUV	EL	
550 i 298-339 kW (405-461 PS) N63 B44 B	07.2012→02.2017		7.00887.21.0	DW-TL	EP	
			7.02318.01.0	EUV-AGK	EL	
			7.06117.36.0	SV-NWV	EL	mit Dichtring with O-ring
550 i xDrive 298-330 kW (405-449 PS) N63 B44 A	06.2010→06.2012		7.00887.19.0	DW-TL	EP	
			7.02318.01.0	EUV-AGK	EL	
			7.01762.04.0	SUV	EL	

					
---	---	---	---	--	---

5 Gran Turismo (F07)	33	B
-----------------------------	-----------	----------

			7.06117.36.0	SV-NWV	EL	mit Dichtring with O-ring
550 i xDrive 300 kW (408 PS) N63 B40 A	07.2012→02.2017		7.00887.21.0	DW-TL	EP	
			7.02318.01.0	EUV-AGK	EL	
			7.06117.36.0	SV-NWV	EL	mit Dichtring with O-ring
550 i xDrive 298-339 kW (405-461 PS) N63 B44 B	07.2012→02.2017		7.00887.21.0	DW-TL	EP	
			7.02318.01.0	EUV-AGK	EL	
			7.06117.36.0	SV-NWV	EL	mit Dichtring with O-ring

5 Touring (E39)	34
------------------------	-----------



















520 d 85-100 kW (116-136 PS) M47 D20 (204D1)	02.2000→09.2003		7.22796.01.0	DW-AGR	EP	
			7.22796.01.0	DW-TL	EP	
			7.02318.01.0	EUV-ML	EL	
520 i 100-110 kW (136-150 PS) M52 B20 (206S3)	03.1997→08.1998		7.02318.01.0	EUV-SL	EL	
520 i 100-110 kW (136-150 PS) M52 B20 (206S3)	03.1997→08.1998		7.02318.01.0	EUV-SL	EL	
520 i 100-110 kW (136-150 PS) M52 B20 (206S4)	09.1998→08.2001		7.00784.01.0	EUV-SL	EP	
			7.02318.01.0	EUV-SL	EL	
520 i 100-110 kW (136-150 PS) M52 B20 (206S4)	09.1998→08.2001		7.00784.01.0	EUV-SL	EP	
			7.02318.01.0	EUV-SL	EL	
520 i 120-125 kW (163-170 PS) M54 B22 (226S1)	09.2000→12.2003		7.00784.01.0	EUV-SL	EP	
523 i 120-141 kW (163-192 PS) M52 B25 (256S3), M52 B25 (256S4)	03.1997→08.2000		7.00784.01.0	EUV-SL	EP	
			7.02318.01.0	EUV-SL	EL	
523 i 120-141 kW (163-192 PS) M52 B25 (256S4)	09.1998→08.2000		7.02318.01.0	EUV-SL	EL	
525 d 120 kW (163 PS) M57 D25 (256D1)	02.2000→05.2004		7.22796.01.0	DW-AGR	EP	
			7.22796.01.0	DW-TL	EP	
			7.02318.01.0	EUV-ML	EL	
			7.02318.01.0	EUV-SR	EL	
525 i 137-141 kW (186-192 PS) M54 B25 (256S5)	09.2000→12.2003		7.02318.01.0	EUV-SL	EL	
525 i 137-141 kW (186-192 PS) M54 B25 (256S5)	09.2000→05.2004		7.00784.01.0	EUV-SL	EP	
			7.02318.01.0	EUV-SL	EL	
525 tds 85-105 kW (115-143 PS) M51 D25 (256T1)	03.1997→05.2004		7.21903.73.0	DW-AGR	EP	
			7.02318.01.0	EUV-KL	EL	
			7.02318.01.0	EUV-ML	EL	
528 i 141-144 kW (192-196 PS) M52 B28 (286S1), M52 B28 (286S2)	11.1996→08.2000		7.00784.01.0	EUV-SL	EP	
			7.02318.01.0	EUV-SL	EL	
530 d 135-142 kW (184-193 PS) M57 D30 (306D1)	08.1998→09.2000		7.22796.01.0	DW-AGR	EP	
			7.22796.01.0	DW-TL	EP	
			7.02318.01.0	EUV-ML	EL	

B
5 Touring (E39)
34

			7.02318.01.0	EUV-SR	EL	Produktionsdatum ab: 01.03.2000 Production date from: 01.03.2000
530 d 135-142 kW (184-193 PS) M57 D30 (306D1)	09.2000→05.2004		7.22796.01.0	DW-AGR	EP	
			7.22796.01.0	DW-TL	EP	
			7.02318.01.0	EUV-ML	EL	
			7.02318.01.0	EUV-SR	EL	
530 i 163-170 kW (222-231 PS) M54 B30 (306S3)	09.2000→12.2003		7.00784.01.0	EUV-SL	EP	
			7.02318.01.0	EUV-SL	EL	
540 i 210 kW (286 PS) M62 B44 (448S2)	04.1997→12.2003		7.06117.10.0	SV-NWV	EL	Produktionsdatum ab: 09.1998 Production date from: 09.1998

5 Touring (E61)
35

520 d 66-150 kW (90-204 PS) N47 D20 C	04.2005→05.2010		7.02063.02.0	DW-AGR	EP	
			7.02318.01.0	EUV-AGR	EL	Produktionsnummer ab: 01.09.2008 Production number from: 01.09.2008
			7.02318.01.0	EUV-ML	EL	
520 d 85-120 kW (116-163 PS) M47 D20 (204D4)	04.2005→05.2010		7.22796.01.0	DW-AGR	EP	
			7.02318.01.0	EUV-ML	EL	
			7.02318.01.0	EUV-SR	EL	
520 d 85-120 kW (116-163 PS) M47 D20 (204D4)	09.2005→02.2007		7.22796.01.0	DW-AGR	EP	
			7.02318.01.0	EUV-ML	EL	
			7.02318.01.0	EUV-SR	EL	
520 d 66-150 kW (90-204 PS) N47 D20 A, N47 D20 C	09.2007→05.2010		7.02063.02.0	DW-AGR	EP	
			7.02318.01.0	EUV-AGR	EL	N47 D20 A, N47 D20 C: Produktionsdatum ab: 01.09.2008 Production date from: 01.09.2008
			7.02318.01.0	EUV-ML	EL	
523 i 130-160 kW (177-218 PS) N52 B25 A, N52 B25 B, N52 B25 BE	10.2004→02.2007		7.06117.01.0	SV-NWV	EL	mit Dichtring with O-ring
523 i 140 kW (190 PS) N53 B25 A	01.2007→12.2010		7.02318.01.0	EUV-ML	EL	
			7.06117.01.0	SV-NWV	EL	mit Dichtring with O-ring
523 i 130-160 kW (177-218 PS) N52 B25 A	03.2007→01.2010		7.06117.01.0	SV-NWV	EL	mit Dichtring with O-ring
525 d 120-130 kW (163-177 PS) M57 D25 (256D2)	03.2004→03.2007		7.22796.01.0	DW-AGR	EP	
			7.02318.01.0	EUV-ML	EL	
			7.02318.01.0	EUV-SR	EL	
525 d 120-130 kW (163-177 PS) M57 D25 (256D2)	03.2004→03.2007		7.22796.01.0	DW-AGR	EP	
			7.02318.01.0	EUV-ML	EL	
			7.02318.01.0	EUV-SR	EL	
525 d 135-173 kW (184-235 PS) M57 D30 (306D3)	03.2007→05.2010		7.22796.01.0	DW-AGR	EP	
			7.02318.01.0	EUV-ML	EL	
525 d xDrive 135-173 kW (184-235 PS) M57 D30 (306D3)	09.2008→05.2010		7.22796.01.0	DW-AGR	EP	
525 i 130-160 kW (177-218 PS) N52 B25 A, N52 B25 B, N52 B25 BF	03.2005→05.2010		7.06117.01.0	SV-NWV	EL	mit Dichtring with O-ring













						
5 Touring (E61)						
525 i 130-160 kW (177-218 PS) N52 B25 A	03.2005→05.2010		7.06117.01.0	SV-NWV	EL	mit Dichtring with O-ring
525 i 150-200 kW (204-272 PS) N53 B30 A	01.2007→12.2010		7.02318.01.0	EUV-ML	EL	
			7.06117.01.0	SV-NWV	EL	mit Dichtring with O-ring
525 i 150-200 kW (204-272 PS) N53 B30 A	01.2007→12.2010		7.02318.01.0	EUV-ML	EL	
			7.06117.01.0	SV-NWV	EL	mit Dichtring with O-ring
525 i xDrive 150-200 kW (204-272 PS) N53 B30 A	09.2008→12.2010		7.06117.01.0	SV-NWV	EL	mit Dichtring with O-ring
525 xd 135-173 kW (184-235 PS) M57 D30 (306D3)	09.2007→09.2008		7.22796.01.0	DW-AGR	EP	
			7.02318.01.0	EUV-ML	EL	
525 xi 130-160 kW (177-218 PS) N52 B25 A	07.2005→12.2010		7.06117.01.0	SV-NWV	EL	mit Dichtring with O-ring
			525 xi 150-200 kW (204-272 PS) N53 B30 A	01.2007→12.2010		7.02318.01.0
7.06117.01.0	SV-NWV	EL				mit Dichtring with O-ring
530 d 150-160 kW (204-218 PS) M57 D30 (306D2)	03.2004→09.2005		7.22796.01.0	DW-AGR	EP	
			7.22796.01.0	DW-TL	EP	
			7.02318.01.0	EUV-ML	EL	
			7.02318.01.0	EUV-SR	EL	
530 d 135-173 kW (184-235 PS) M57 D30 (306D2), M57 D30 (306D3)	03.2004→05.2010		7.22796.01.0	DW-AGR	EP	
			7.22796.01.0	DW-TL	EP	
			7.02318.01.0	EUV-ML	EL	
			7.02318.01.0	EUV-SR	EL	
530 d 135-173 kW (184-235 PS) M57 D30 (306D3)	02.2005→02.2007		7.22796.01.0	DW-AGR	EP	
			7.02318.01.0	EUV-ML	EL	
			7.02318.01.0	EUV-SR	EL	
			530 d 135-173 kW (184-235 PS) M57 D30 (306D3)	02.2007→05.2010		7.22796.01.0
7.02318.01.0	EUV-ML	EL				
7.02318.01.0	EUV-SR	EL				
530 d xDrive 135-173 kW (184-235 PS) M57 D30 (306D3)	09.2007→05.2010					7.22796.01.0
			7.02318.01.0	EUV-ML	EL	
			7.02318.01.0	EUV-SR	EL	
			530 i 155-200 kW (211-272 PS) N52 B30 A, N52 B30 BF	09.2004→02.2007		7.02318.01.0
7.06117.01.0	SV-NWV	EL				mit Dichtring with O-ring
530 i 155-200 kW (211-272 PS) N52 B30 A	09.2006→03.2010		7.02318.01.0	EUV-AGK	EL	
			7.06117.01.0	SV-NWV	EL	mit Dichtring with O-ring
530 i 150-200 kW (204-272 PS) N53 B30 A	01.2007→12.2010		7.02318.01.0	EUV-AGK	EL	
			7.02318.01.0	EUV-ML	EL	
			7.06117.01.0	SV-NWV	EL	mit Dichtring with O-ring



B



5 Touring (E61)

35

















530 i xDrive 150-200 kW (204-272 PS) N53 B30 A	09.2008→05.2010		7.06117.01.0	SV-NWV	EL	mit Dichtring with O-ring
530 xd 135-173 kW (184-235 PS) M57 D30 (306D3)	02.2005→02.2007		7.22796.01.0	DW-AGR	EP	
			7.02318.01.0	EUV-AGR	EL	
530 xd 135-173 kW (184-235 PS) M57 D30 (306D3)	03.2007→08.2007		7.22796.01.0	DW-AGR	EP	
			7.02318.01.0	EUV-AGR	EL	
530 xi 155-200 kW (211-272 PS) N52 B30 A	04.2005→02.2007		7.02318.01.0	EUV-AGK	EL	
			7.06117.01.0	SV-NWV	EL	mit Dichtring with O-ring
530 xi 150-200 kW (204-272 PS) N53 B30 A	09.2006→09.2008		7.02318.01.0	EUV-AGK	EL	
			7.02318.01.0	EUV-ML	EL	
			7.06117.01.0	SV-NWV	EL	mit Dichtring with O-ring
530 xi 155-200 kW (211-272 PS) N52 B30 A	03.2007→05.2010		7.02318.01.0	EUV-AGK	EL	
			7.06117.01.0	SV-NWV	EL	mit Dichtring with O-ring
535 d 198-200 kW (269-272 PS) M57 D30 (306D4)	09.2004→12.2010		7.22796.01.0	DW-AGR	EP	
			7.22796.01.0	DW-TL	EP	
			7.02318.01.0	EUV-ML	EL	
			7.02318.01.0	EUV-SR	EL	
			7.02318.01.0	LDRV	EL	
535 d 198-221 kW (269-301 PS) M57 D30 (306D5)	01.2007→12.2010		7.22796.01.0	DW-AGR	EP	
			7.02256.27.0	DW-TL	EP	
			7.02318.01.0	EUV-ML	EL	
			7.02318.01.0	EUV-SR	EL	
			7.02318.01.0	LDRV	EL	
535 xi 200-264 kW (272-359 PS) N54 B30 A	03.2007→05.2010		7.00887.19.0	DW-TL	EP	USA USA
			7.02318.01.0	EUV-AGK	EL	
			7.06117.01.0	SV-NWV	EL	mit Dichtring with O-ring
545 i 235-245 kW (320-333 PS) N62 B44 A	06.2004→12.2010		7.02318.01.0	EUV-AGK	EL	
			7.06117.00.0	SV-NWV	EL	mit Dichtring with O-ring
550 i 261-270 kW (355-367 PS) N62 B48 A	07.2005→12.2010		7.02318.01.0	EUV-AGK	EL	
550 i 261-270 kW (355-367 PS) N62 B48 B	07.2005→12.2010		7.02318.01.0	EUV-AGK	EL	
			7.06117.00.0	SV-NWV	EL	mit Dichtring with O-ring
M5 373 kW (507 PS) S85 B50 A	02.2007→12.2010		7.02318.01.0	EUV-SL	EL	

5 Touring (F11)

36

518 d 66-150 kW (90-204 PS) N47 D20 C	07.2013→06.2014		7.02318.01.0	EUV-AGR	EL	
			7.02318.01.0	EUV-ML	EL	
518 d 66-150 kW (90-204 PS) N47 D20 C	07.2013→06.2014		7.02318.01.0	EUV-AGR	EL	
			7.02318.01.0	EUV-ML	EL	

5 Touring (F11) **36** **B**









520 d 66-150 kW (90-204 PS) N47 D20 C	06.2010→06.2014	 7.02318.01.0	EUV-AGR	EL	
		7.02318.01.0	EUV-ML	EL	
520 d 66-150 kW (90-204 PS) N47 D20 C	06.2010→02.2017	 7.02318.01.0	EUV-AGR	EL	
		7.02318.01.0	EUV-ML	EL	
520 d 66-150 kW (90-204 PS) N47 D20 C	06.2010→06.2014	 7.02318.01.0	EUV-AGR	EL	
		7.02318.01.0	EUV-ML	EL	
520 d 66-150 kW (90-204 PS) N47 D20 C	06.2010→06.2014	 7.02318.01.0	EUV-AGR	EL	
		7.02318.01.0	EUV-ML	EL	
520 d xDrive 66-150 kW (90-204 PS) N47 D20 C	07.2013→06.2014	 7.02318.01.0	EUV-AGR	EL	
		7.02318.01.0	EUV-ML	EL	
520 d xDrive 66-150 kW (90-204 PS) N47 D20 C	07.2013→06.2014	 7.02318.01.0	EUV-AGR	EL	
		7.02318.01.0	EUV-ML	EL	
520 d xDrive 66-150 kW (90-204 PS) N47 D20 C	07.2013→06.2014	 7.02318.01.0	EUV-AGR	EL	
		7.02318.01.0	EUV-ML	EL	
520 i 110-205 kW (150-279 PS) N20 B20 A	10.2010→02.2017	 7.04216.05.0	SUV	EL	
		7.04216.05.0	SUV	EL	
520 i 120-135 kW (163-184 PS) N20 B20 B	10.2010→02.2017	 7.00887.21.0	DW-TL	EP	
		7.04216.05.0	SUV	EL	
520 i 110-205 kW (150-279 PS) N20 B20 A	09.2011→02.2017	 7.04216.05.0	SUV	EL	
		7.04216.05.0	SUV	EL	
520 i 120-135 kW (163-184 PS) N20 B20 B	09.2011→02.2017	 7.00887.21.0	DW-TL	EP	
		7.04216.05.0	SUV	EL	
523 i 150-200 kW (204-272 PS) N53 B30 A	11.2009→08.2011	 7.02318.01.0	EUV-AGK	EL	
		7.06117.01.0	SV-NWV	EL	mit Dichtring with O-ring
523 i 130-160 kW (177-218 PS) N52 B25 A, N52 B25 AF, N52 B25 B	11.2009→08.2011	 7.02318.01.0	EUV-AGK	EL	
		7.02318.01.0	EUV-ML	EL	
		7.06117.01.0	SV-NWV	EL	mit Dichtring with O-ring
525 d 150-210 kW (204-286 PS) N57 D30 A	09.2010→08.2011	 7.02318.01.0	EUV-AGR	EL	
		7.02318.01.0	EUV-ML	EL	
525 d 150-160 kW (204-218 PS) N47 D20 D	09.2011→02.2017	 7.02256.27.0	DW-TL	EP	
		7.02318.01.0	EUV-AGR	EL	
		7.02318.01.0	EUV-ML	EL	
		7.02318.01.0	LDRV	EL	
525 d 150-160 kW (204-218 PS) N47 D20 D	09.2011→02.2017	 7.02256.27.0	DW-TL	EP	
		7.02318.01.0	EUV-AGR	EL	
		7.02318.01.0	EUV-ML	EL	
		7.02318.01.0	LDRV	EL	





















B

5 Touring (F11)

36

525 d xDrive 150-160 kW (204-218 PS) N47 D20 D	07.2013→02.2017		7.02256.27.0	DW-TL	EP		
			7.02318.01.0	EUV-AGR	EL		
			7.02318.01.0	EUV-ML	EL		
525 d xDrive 150-160 kW (204-218 PS) N47 D20 D	07.2013→02.2017		7.02256.27.0	DW-TL	EP		
			7.02318.01.0	EUV-AGR	EL		
			7.02318.01.0	EUV-ML	EL		
528 i 150-200 kW (204-272 PS) N53 B30 A	11.2009→08.2011		7.02318.01.0	EUV-AGK	EL		
			7.02318.01.0	EUV-ML	EL		
			7.06117.01.0	SV-NWV	EL		mit Dichtring with O-ring
528 i 110-205 kW (150-279 PS) N20 B20 A	09.2011→02.2017		7.00887.21.0	DW-TL	EP		
			7.02318.01.0	EUV-AGK	EL		
			7.04216.05.0	SUV	EL		
528 i xDrive 110-205 kW (150-279 PS) N20 B20 A	09.2011→02.2017		7.00887.21.0	DW-TL	EP		
			7.02318.01.0	EUV-AGK	EL		
			7.04216.05.0	SUV	EL		
530 d 150-210 kW (204-286 PS) N57 D30 A	06.2010→08.2011		7.02318.01.0	EUV-AGR	EL		
			7.02318.01.0	EUV-ML	EL		
			7.02318.01.0	EUV-AGR	EL		
530 d 150-210 kW (204-286 PS) N57 D30 A	09.2011→02.2017		7.02318.01.0	EUV-AGR	EL		
			7.02318.01.0	EUV-ML	EL		
			7.02318.01.0	EUV-AGR	EL		
530 d 150-210 kW (204-286 PS) N57 D30 A	09.2011→02.2017		7.02318.01.0	EUV-AGR	EL		
			7.02318.01.0	EUV-ML	EL		
			7.02318.01.0	EUV-AGR	EL		
530 d xDrive 150-210 kW (204-286 PS) N57 D30 A	03.2011→02.2017		7.02318.01.0	EUV-AGR	EL		
			7.02318.01.0	EUV-ML	EL		
			7.02318.01.0	EUV-AGR	EL		
530 d xDrive 150-210 kW (204-286 PS) N57 D30 A	03.2011→02.2017		7.02318.01.0	EUV-AGR	EL		
			7.02318.01.0	EUV-ML	EL		
			7.02318.01.0	EUV-AGR	EL		
530 i 155-200 kW (211-272 PS) N52 B30 A, N52 B30 AF	03.2010→05.2013		7.02318.01.0	EUV-AGK	EL		
			7.06117.01.0	SV-NWV	EL		mit Dichtring with O-ring
			7.02318.01.0	EUV-AGK	EL		
530 i 150-200 kW (204-272 PS) N53 B30 A	07.2011→06.2013		7.02318.01.0	EUV-AGK	EL		
			7.02318.01.0	EUV-ML	EL		
			7.06117.01.0	SV-NWV	EL		mit Dichtring with O-ring
535 d 220-230 kW (299-313 PS) N57 D30 B	09.2010→08.2011		7.02256.27.0	DW-TL	EP		
			7.02318.01.0	EUV-AGR	EL		
			7.02318.01.0	EUV-ML	EL		
			7.02318.01.0	LDRV	EL		







							
5 Touring (F11)						36	B
535 d 220-230 kW (299-313 PS) N57 D30 B	09.2011→02.2017		7.02256.27.0	DW-TL	EP		
535 d xDrive 220-230 kW (299-313 PS) N57 D30 B	09.2011→02.2017		7.02256.27.0	DW-TL	EP		
			7.02318.01.0	EUV-AGR	EL		
			7.02318.01.0	EUV-ML	EL		
535 i 200-272 kW (272-370 PS) N55 B30 A	06.2010→02.2017		7.02318.01.0	LDRV	EL		
7.00887.21.0			DW-TL	EP	Produktionsdatum bis: 31.05.2012 Production date to: 31.05.2012		
7.00887.22.0			DW-TL	EP	Produktionsdatum ab: 01.06.2012 Production date from: 01.06.2012		
7.01762.04.0			SUV	EL			
535 i 200-272 kW (272-370 PS) N55 B30 A	07.2013→02.2017		7.06117.36.0	SV-NWV	EL	mit Dichtring with O-ring	
			7.01762.04.0	SUV	EL		
			7.00887.22.0	DW-TL	EP		
535 i xDrive 200-272 kW (272-370 PS) N55 B30 A	09.2011→02.2017		7.01762.04.0	SV-NWV	EL	mit Dichtring with O-ring	
			7.06117.36.0	SV-NWV	EL		
			7.00887.21.0	DW-TL	EP	Produktionsdatum bis: 31.05.2012 Production date to: 31.05.2012	
			7.00887.22.0	DW-TL	EP	Produktionsdatum ab: 01.06.2012 Production date from: 01.06.2012	
535 i xDrive 200-272 kW (272-370 PS) N55 B30 A	07.2013→02.2017		7.01762.04.0	SUV	EL		
			7.06117.36.0	SV-NWV	EL	mit Dichtring with O-ring	
			7.00887.22.0	DW-TL	EP		
550 i 298-330 kW (405-449 PS) N63 B44 A	09.2010→06.2013		7.01762.04.0	SUV	EL		
			7.06117.36.0	SV-NWV	EL	mit Dichtring with O-ring	
			7.02318.01.0	EUV-AGK	EL		
			7.00887.19.0	DW-TL	EP		
550 i 298-339 kW (405-461 PS) N63 B44 B	07.2013→02.2017		7.06117.36.0	SV-NWV	EL	mit Dichtring with O-ring	
			7.00887.21.0	DW-TL	EP		
M 550 d xDrive 280 kW (381 PS) N57 D30 C	03.2012→02.2017		7.02256.27.0	DW-TL	EP		
			7.02318.01.0	EUV-AGR	EL		
			7.02318.01.0	EUV-ML	EL		
			7.02318.01.0	LDRV	EL		
5 Touring (G31)						37	
525 d 85-170 kW (116-231 PS) B47 D20 B	07.2017→06.2019		7.02256.27.0	DW-TL	EP		
525 d 85-170 kW (116-231 PS) B47 D20 B	07.2017→06.2019		7.02256.27.0	DW-TL	EP		
540 d xDrive 155-250 kW (211-340 PS) B57 D30 B	07.2017→06.2020		7.02256.27.0	DW-TL	EP		
M 550 d xDrive 294 kW (400 PS) B57 D30 C	07.2017→		7.02256.27.0	DW-TL	EP		



B



6 (E63)

38

630 i 155-200 kW (211-272 PS) N52 B30 A, N52 B30 BF	09.2004→08.2007	 7.06117.01.0	SV-NWV	EL	mit Dichtring with O-ring
630 i 150-200 kW (204-272 PS) N53 B30 A	09.2007→08.2010	 7.02318.01.0	EUV-ML	EL	
		7.06117.01.0	SV-NWV	EL	
630 i 155-200 kW (211-272 PS) N52 B30 A, N52 B30 B, N52 B30 BF	09.2007→08.2010	 7.06117.01.0	SV-NWV	EL	mit Dichtring with O-ring
635 d 198-221 kW (269-301 PS) M57 D30 (306D5)	07.2007→07.2010	 7.22796.01.0	DW-AGR	EP	
		7.02256.27.0	DW-TL	EP	
		7.02318.01.0	EUV-ML	EL	
		7.02318.01.0	EUV-SR	EL	
645 Ci 235-245 kW (320-333 PS) N62 B44 A	09.2003→08.2005	 7.06117.00.0	SV-NWV	EL	mit Dichtring with O-ring
	01.2004→12.2005	 7.06117.00.0	SV-NWV	EL	mit Dichtring with O-ring
650 i 261-270 kW (355-367 PS) N62 B48 B	09.2005→08.2010	 7.06117.00.0	SV-NWV	EL	mit Dichtring with O-ring



6 Convertible (E64)

39

630 i 155-200 kW (211-272 PS) N52 B30 A, N52 B30 B, N52 B30 BF	09.2004→08.2007	 7.06117.01.0	SV-NWV	EL	mit Dichtring with O-ring
630 i 150-200 kW (204-272 PS) N53 B30 A	09.2007→08.2010	 7.02318.01.0	EUV-ML	EL	
		7.06117.01.0	SV-NWV	EL	
630 i 155-200 kW (211-272 PS) N52 B30 A, N52 B30 B, N52 B30 BF	09.2007→08.2010	 7.06117.01.0	SV-NWV	EL	mit Dichtring with O-ring
635 d 198-221 kW (269-301 PS) M57 D30 (306D5)	07.2007→07.2010	 7.22796.01.0	DW-AGR	EP	
		7.02256.27.0	DW-TL	EP	
		7.02318.01.0	EUV-ML	EL	
		7.02318.01.0	EUV-SR	EL	
645 Ci 235-245 kW (320-333 PS) N62 B44 A	04.2004→12.2005	 7.06117.00.0	SV-NWV	EL	mit Dichtring with O-ring
	04.2004→08.2005	 7.06117.00.0	SV-NWV	EL	mit Dichtring with O-ring
650 i 261-270 kW (355-367 PS) N62 B48 B	09.2005→08.2010	 7.06117.00.0	SV-NWV	EL	mit Dichtring with O-ring

6 Convertible (F12)

40

640 d 220-230 kW (299-313 PS) N57 D30 B	09.2011→06.2018	 7.02256.27.0	DW-TL	EP	
		7.02318.01.0	EUV-AGR	EL	
		7.02318.01.0	EUV-ML	EL	
		7.02318.01.0	LDRV	EL	
640 d xDrive 220-230 kW (299-313 PS) N57 D30 B	03.2012→06.2018	 7.02256.27.0	DW-TL	EP	
		7.02318.01.0	EUV-AGR	EL	
		7.02318.01.0	EUV-ML	EL	
		7.02318.01.0	LDRV	EL	







							
6 Convertible (F12)						40	B
640 i 200-272 kW (272-370 PS) N55 B30 A	09.2011→06.2018		7.00887.21.0	DW-TL	EP	Produktionsdatum bis: 31.05.2012 Production date to: 31.05.2012 Produktionsdatum ab: 01.06.2012 Production date from: 01.06.2012 Produktionsdatum bis: 29.02.2015 Production date to: 29.02.2015	
			7.00887.22.0	DW-TL	EP		
			7.01762.04.0	SUV	EL		
			7.06117.36.0	SV-NWV	EL		mit Dichtring with O-ring
640 i xDrive 200-272 kW (272-370 PS) N55 B30 A	03.2013→06.2018		7.00887.22.0	DW-TL	EP	Produktionsdatum bis: 29.02.2015 Production date to: 29.02.2015	
			7.01762.04.0	SUV	EL		
			7.06117.36.0	SV-NWV	EL		mit Dichtring with O-ring
650 i 298-330 kW (405-449 PS) N63 B44 A	12.2010→06.2012		7.00887.19.0	DW-TL	EP	mit Dichtring with O-ring	
			7.02318.01.0	EUV-AGK	EL		
			7.01762.04.0	SUV	EL		
			7.06117.36.0	SV-NWV	EL		
650 i 298-330 kW (405-449 PS) N63 B44 A	09.2011→12.2012		7.00887.19.0	DW-TL	EP	mit Dichtring with O-ring	
			7.02318.01.0	EUV-AGK	EL		
			7.01762.04.0	SUV	EL		
			7.06117.36.0	SV-NWV	EL		
650 i 298-339 kW (405-461 PS) N63 B44 B	07.2012→06.2018		7.00887.21.0	DW-TL	EP	mit Dichtring with O-ring	
			7.02318.01.0	EUV-AGK	EL		
			7.06117.36.0	SV-NWV	EL		
650 i 298-330 kW (405-449 PS) N63 B44 A	07.2012→06.2018		7.00887.19.0	DW-TL	EP		
			7.02318.01.0	EUV-AGK	EL		
			7.01762.04.0	SUV	EL		
650 i 298-339 kW (405-461 PS) N63 B44 B	07.2012→06.2018		7.00887.21.0	DW-TL	EP	mit Dichtring with O-ring	
			7.02318.01.0	EUV-AGK	EL		
			7.06117.36.0	SV-NWV	EL		
			7.01762.04.0	SUV	EL		
650 i xDrive 298-330 kW (405-449 PS) N63 B44 A	09.2011→06.2012		7.00887.19.0	DW-TL	EP	mit Dichtring with O-ring	
			7.02318.01.0	EUV-AGK	EL		
			7.01762.04.0	SUV	EL		
			7.06117.36.0	SV-NWV	EL		
650 i xDrive 298-330 kW (405-449 PS) N63 B44 A	09.2011→06.2012		7.00887.19.0	DW-TL	EP	mit Dichtring with O-ring	
			7.02318.01.0	EUV-AGK	EL		
			7.01762.04.0	SUV	EL		
			7.06117.36.0	SV-NWV	EL		
650 i xDrive 300 kW (408 PS) N63 B40 A	07.2012→06.2018		7.00887.21.0	DW-TL	EP	mit Dichtring with O-ring	
			7.02318.01.0	EUV-AGK	EL		
			7.06117.36.0	SV-NWV	EL		



B





6 Convertible (F12)

40

650 i xDrive 298-330 kW (405-449 PS) N63 B44 A	07.2012→06.2018		7.00887.19.0	DW-TL	EP	
			7.02318.01.0 7.01762.04.0	EUV-AGK SUV	EL EL	
650 i xDrive 298-339 kW (405-461 PS) N63 B44 B	07.2012→06.2018		7.00887.21.0	DW-TL	EP	
			7.02318.01.0 7.06117.36.0	EUV-AGK SV-NWV	EL EL	
650 i xDrive 298-339 kW (405-461 PS) N63 B44 B	07.2012→06.2018		7.00887.21.0	DW-TL	EP	
			7.02318.01.0 7.06117.36.0	EUV-AGK SV-NWV	EL EL	
M6 412-467 kW (560-635 PS) S63 B44 B	03.2012→06.2018		7.00887.21.0	DW-TL	EP	
			7.02318.01.0 7.06117.36.0	EUV-AGK SV-NWV	EL EL	
M6 Competition 412-467 kW (560-635 PS) S63 B44 B	07.2013→02.2015		7.00887.21.0	DW-TL	EP	
			7.02318.01.0 7.06117.36.0	EUV-AGK SV-NWV	EL EL	
M6 Competition 412-467 kW (560-635 PS) S63 B44 B	03.2015→06.2018		7.00887.21.0	DW-TL	EP	
			7.02318.01.0 7.06117.36.0	EUV-AGK SV-NWV	EL EL	

6 Coupe (F13)

41

640 d 220-230 kW (299-313 PS) N57 D30 B	09.2011→10.2017		7.02256.27.0	DW-TL	EP	
			7.02318.01.0	EUV-AGR	EL	
			7.02318.01.0	EUV-ML	EL	
			7.02318.01.0	LDRV	EL	
640 d xDrive 220-230 kW (299-313 PS) N57 D30 B	03.2012→10.2017		7.02256.27.0	DW-TL	EP	
			7.02318.01.0	EUV-AGR	EL	
			7.02318.01.0	EUV-ML	EL	
			7.02318.01.0	LDRV	EL	
640 i 200-272 kW (272-370 PS) N55 B30 A	07.2011→10.2017		7.00887.21.0	DW-TL	EP	Produktionsdatum bis: 31.05.2012 Production date to: 31.05.2012
			7.00887.22.0	DW-TL	EP	
			7.01762.04.0 7.06117.36.0	SUV SV-NWV	EL EL	mit Dichtring with O-ring
640 i xDrive 200-272 kW (272-370 PS) N55 B30 A	03.2013→10.2017		7.00887.22.0	DW-TL	EP	Produktionsdatum bis: 29.02.2015 Production date to: 29.02.2015
			7.01762.04.0	SUV	EL	

6 Coupe (F13) **41** **B**



			7.06117.36.0	SV-NWV	EL	mit Dichtring with O-ring
650 i 298-330 kW (405-449 PS) N63 B44 A	07.2011→06.2012		7.00887.19.0	DW-TL	EP	
			7.02318.01.0	EUV-AGK	EL	
			7.01762.04.0	SUV	EL	
			7.06117.36.0	SV-NWV	EL	mit Dichtring with O-ring
650 i 298-330 kW (405-449 PS) N63 B44 A	09.2011→12.2012		7.00887.19.0	DW-TL	EP	
			7.02318.01.0	EUV-AGK	EL	
			7.01762.04.0	SUV	EL	
			7.06117.36.0	SV-NWV	EL	mit Dichtring with O-ring
650 i 298-339 kW (405-461 PS) N63 B44 B	07.2012→10.2017		7.00887.21.0	DW-TL	EP	
			7.02318.01.0	EUV-AGK	EL	
			7.06117.36.0	SV-NWV	EL	mit Dichtring with O-ring
650 i 298-339 kW (405-461 PS) N63 B44 B	07.2012→10.2017		7.00887.21.0	DW-TL	EP	
			7.02318.01.0	EUV-AGK	EL	
			7.06117.36.0	SV-NWV	EL	mit Dichtring with O-ring
650 i xDrive 298-330 kW (405-449 PS) N63 B44 A	09.2011→06.2012		7.00887.19.0	DW-TL	EP	
			7.02318.01.0	EUV-AGK	EL	
			7.01762.04.0	SUV	EL	
			7.06117.36.0	SV-NWV	EL	mit Dichtring with O-ring
650 i xDrive 298-330 kW (405-449 PS) N63 B44 A	09.2011→02.2015		7.00887.19.0	DW-TL	EP	
			7.02318.01.0	EUV-AGK	EL	
			7.01762.04.0	SUV	EL	
			7.06117.36.0	SV-NWV	EL	mit Dichtring with O-ring
650 i xDrive 300 kW (408 PS) N63 B40 A	07.2012→10.2017		7.00887.21.0	DW-TL	EP	
			7.02318.01.0	EUV-AGK	EL	
			7.06117.36.0	SV-NWV	EL	mit Dichtring with O-ring
650 i xDrive 298-339 kW (405-461 PS) N63 B44 B	07.2012→10.2017		7.00887.21.0	DW-TL	EP	
			7.02318.01.0	EUV-AGK	EL	
			7.06117.36.0	SV-NWV	EL	mit Dichtring with O-ring
650 i xDrive 298-339 kW (405-461 PS) N63 B44 B	07.2012→10.2017		7.00887.21.0	DW-TL	EP	
			7.02318.01.0	EUV-AGK	EL	
			7.06117.36.0	SV-NWV	EL	mit Dichtring with O-ring
M6 412-467 kW (560-635 PS) S63 B44 B	07.2012→10.2017		7.00887.21.0	DW-TL	EP	
			7.02318.01.0	EUV-AGK	EL	
			7.06117.36.0	SV-NWV	EL	mit Dichtring with O-ring



B







6 Coupe (F13)





















41

M6 412-467 kW (560-635 PS) S63 B44 B	07.2012→10.2017		7.00887.21.0	DW-TL	EP	mit Dichtring with O-ring
			7.02318.01.0 7.06117.36.0	EUV-AGK SV-NWV	EL EL	
M6 Competition 412-467 kW (560-635 PS) S63 B44 B	07.2013→02.2015		7.00887.21.0	DW-TL	EP	mit Dichtring with O-ring
			7.06117.36.0	SV-NWV	EL	
M6 Competition 412-467 kW (560-635 PS) S63 B44 B	03.2015→10.2017		7.00887.21.0	DW-TL	EP	mit Dichtring with O-ring
			7.06117.36.0	SV-NWV	EL	

6 Gran Coupe (F06)

42

640 d 220-230 kW (299-313 PS) N57 D30 B	03.2012→10.2018		7.02256.27.0	DW-TL	EP		
			7.02318.01.0	EUV-AGR	EL		
			7.02318.01.0	EUV-ML	EL		
			7.02318.01.0	LDRV	EL		
640 d xDrive 220-230 kW (299-313 PS) N57 D30 B	03.2013→10.2018		7.02256.27.0	DW-TL	EP		
			7.02318.01.0	EUV-AGR	EL		
			7.02318.01.0	EUV-ML	EL		
			7.02318.01.0	LDRV	EL		
640 i 200-272 kW (272-370 PS) N55 B30 A	03.2012→10.2018		7.00887.21.0	DW-TL	EP	Produktionsdatum bis: 31.05.2012 Production date to: 31.05.2012	
			7.00887.22.0	DW-TL	EP		Produktionsdatum ab: 01.06.2012 Production date from: 01.06.2012 Produktionsdatum bis: 29.02.2015 Production date to: 29.02.2015
			7.06117.36.0	SV-NWV	EL		
640 i xDrive 200-272 kW (272-370 PS) N55 B30 A	03.2013→10.2018		7.00887.22.0	DW-TL	EP	Produktionsdatum bis: 29.02.2015 Production date to: 29.02.2015	
			7.06117.36.0	SV-NWV	EL		mit Dichtring with O-ring
650 i 298-339 kW (405-461 PS) N63 B44 B	07.2012→10.2018		7.00887.21.0	DW-TL	EP	mit Dichtring with O-ring	
			7.02318.01.0	EUV-AGK	EL		
			7.06117.36.0	SV-NWV	EL		
650 i 298-339 kW (405-461 PS) N63 B44 B	07.2013→10.2018		7.00887.21.0	DW-TL	EP	mit Dichtring with O-ring	
			7.02318.01.0	EUV-AGK	EL		
			7.06117.36.0	SV-NWV	EL		
650 i xDrive 298-339 kW (405-461 PS) N63 B44 B	07.2012→10.2018		7.00887.21.0	DW-TL	EP	mit Dichtring with O-ring	
			7.02318.01.0	EUV-AGK	EL		
			7.06117.36.0	SV-NWV	EL		
650 i xDrive 300 kW (408 PS) N63 B40 A	05.2013→10.2018		7.00887.21.0	DW-TL	EP	mit Dichtring with O-ring	
			7.06117.36.0	SV-NWV	EL		

















							
6 Gran Coupe (F06)						42	B
650 i xDrive 298-339 kW (405-461 PS) N63 B44 B	07.2013→10.2018		7.00887.21.0	DW-TL	EP	mit Dichtring with O-ring	
			7.02318.01.0 7.06117.36.0	EUV-AGK SV-NWV	EL EL		
M6 412-467 kW (560-635 PS) S63 B44 B	03.2013→10.2018		7.00887.21.0	DW-TL	EP		mit Dichtring with O-ring
			7.02318.01.0 7.06117.36.0	EUV-AGK SV-NWV	EL EL		
M6 Competition 412-467 kW (560-635 PS) S63 B44 B	07.2013→02.2015		7.00887.21.0	DW-TL	EP	mit Dichtring with O-ring	
			7.06117.36.0	SV-NWV	EL		
M6 Competition 412-467 kW (560-635 PS) S63 B44 B	03.2015→10.2018		7.00887.21.0	DW-TL	EP		mit Dichtring with O-ring
			7.06117.36.0	SV-NWV	EL		
6 Gran Turismo (G32)						43	
640 d xDrive 155-250 kW (211-340 PS) B57 D30 B	11.2017→06.2020		7.02256.27.0	DW-TL	EP		
7 (E38)						44	
725 tds 85-105 kW (115-143 PS) M51 D25 (256T1)	04.1996→11.2001		7.21903.73.0	DW-AGR	EP		
			7.02318.01.0	EUV-KL	EL		
			7.02318.01.0	EUV-ML	EL		
728 i, iL 141-144 kW (192-196 PS) M52 B28 (286S1), M52 B28 (286S2)	08.1995→11.2001		7.00784.01.0	EUV-SL	EP		
			7.02318.01.0	EUV-SL	EL		
728i X 141-143 kW (192-194 PS) M52 B28 (286S1)	11.1995→09.2001		7.00784.01.0	EUV-SL	EP		
730 d 135-142 kW (184-193 PS) M57 D30 (306D1)	08.1998→04.2000		7.22796.01.0	DW-AGR	EP		
			7.22796.01.0	DW-TL	EP		
			7.02318.01.0	EUV-ML	EL		
			7.02318.01.0	EUV-SR	EL		
730 d 135-142 kW (184-193 PS) M57 D30 (306D1)	04.2000→11.2001		7.22796.01.0	DW-AGR	EP		
			7.22796.01.0	DW-TL	EP		
			7.02318.01.0	EUV-ML	EL		
735 i, iL 173-180 kW (235-245 PS) M62 B35 (358S2)	09.1998→07.2001		7.06117.10.0	SV-NWV	EL	Produktionsdatum ab: 09.1998 Production date from: 09.1998	
			7.22796.01.0	DW-AGR	EP		
740 d 180-190 kW (245-258 PS) M67 D39 (398D1)	05.1999→11.2001		7.22796.01.0	DW-AGR	EP		
			7.02318.01.0	EUV-ML	EL		
740 i, iL 210 kW (286 PS) M62 B44 (448S2)	09.1998→07.2001		7.06117.10.0	SV-NWV	EL	Produktionsdatum ab: 09.1998 Production date from: 09.1998	
			7.02318.01.0	EUV-SL	EL		
750 i, iL 240-243 kW (326-330 PS) M73 B54 (54121), M73 B54 (54122)	11.1994→07.2001		7.02318.01.0	EUV-SL	EL		
			7.02318.01.0	EUV-SL	EL		
750 i, iL 240-243 kW (326-330 PS) M73 B54 (54122)	09.1998→07.2001		7.02318.01.0	EUV-SL	EL		



B

7 (E65, E66, E67)

45

730 Ld 135-173 kW (184-235 PS) M57 D30 (306D3)	07.2005→08.2008		7.22796.01.0	DW-AGR	EP	
			7.02318.01.0	EUV-AGK	EL	
			7.02318.01.0	EUV-ML	EL	
			7.02318.01.0	EUV-SR	EL	
730 d 150-160 kW (204-218 PS) M57 D30 (306D2)	06.2002→02.2005		7.22796.01.0	DW-AGR	EP	
			7.22796.01.0	DW-TL	EP	
			7.02318.01.0	EUV-AGK	EL	
			7.02318.01.0	EUV-ML	EL	
730 d 150-160 kW (204-218 PS) M57 D30 (306D2)	09.2002→08.2003		7.22796.01.0	DW-AGR	EP	
			7.22796.01.0	DW-TL	EP	
			7.02318.01.0	EUV-AGK	EL	
			7.02318.01.0	EUV-ML	EL	
730 d 135-173 kW (184-235 PS) M57 D30 (306D2), M57 D30 (306D3)	09.2003→08.2008		7.22796.01.0	DW-AGR	EP	
			7.22796.01.0	DW-TL	EP	
			7.02318.01.0	EUV-AGK	EL	
			7.02318.01.0	EUV-ML	EL	
730 i, Li 155-200 kW (211-272 PS) N52 B30 A	03.2005→08.2008		7.06117.01.0	SV-NWV	EL	mit Dichtring with O-ring
			7.06117.01.0	SV-NWV	EL	mit Dichtring with O-ring
730 i, Li 155-200 kW (211-272 PS) N52 B30 A	03.2005→07.2008		7.06117.01.0	SV-NWV	EL	mit Dichtring with O-ring
735 i, Li 200 kW (272 PS) N62 B36 A	11.2001→02.2005		7.06117.00.0	SV-NWV	EL	mit Dichtring with O-ring
740 d 180-190 kW (245-258 PS) M67 D39 (398D1)	10.2002→02.2005		7.22796.01.0	DW-AGR	EP	
			7.02318.01.0	EUV-ML	EL	
740 i, Li 200-225 kW (272-306 PS) N62 B40 A	03.2005→08.2008		7.02318.01.0	EUV-AGK	EL	
			7.06117.00.0	SV-NWV	EL	mit Dichtring with O-ring
745 d 220-242 kW (300-329 PS) M67 D44 (448D1)	03.2005→08.2005		7.02318.01.0	EUV-ML	EL	
745 d 220-242 kW (300-329 PS) M67 D44 (448D1)	07.2005→07.2008		7.02318.01.0	EUV-ML	EL	
745 i 235-245 kW (320-333 PS) N62 B44 A	11.2001→12.2003		7.06117.00.0	SV-NWV	EL	mit Dichtring with O-ring
745 i 235-245 kW (320-333 PS) N62 B44 A	09.2003→12.2005		7.06117.00.0	SV-NWV	EL	mit Dichtring with O-ring
745 i, Li 235-245 kW (320-333 PS) N62 B44 A	07.2001→03.2005		7.06117.00.0	SV-NWV	EL	mit Dichtring with O-ring
750 i, Li 261-270 kW (355-367 PS) N62 B48 B	03.2005→08.2008		7.02318.01.0	EUV-AGK	EL	
			7.06117.00.0	SV-NWV	EL	mit Dichtring with O-ring
760 i 320-327 kW (435-445 PS) N73 B60 A, N73 B60 B	02.2003→08.2005		7.02318.01.0	EUV-AGK	EL	
			7.02318.01.0	EUV-LS	EL	
			7.06117.00.0	SV-NWV	EL	mit Dichtring with O-ring
760 i, Li 320-327 kW (435-445 PS) N73 B60 A, N73 B60 B	01.2003→08.2008		7.02318.01.0	EUV-AGK	EL	













						
7 (E65, E66, E67)					45	B
			7.02318.01.0 7.06117.00.0	EUV-LS SV-NWV	EL EL	mit Dichtring with O-ring
7 (F01, F02, F03, F04)					46	
730 d 150-210 kW (204-286 PS) N57 D30 A	02.2008→05.2015		7.02318.01.0 7.02318.01.0	EUV-AGR EUV-ML	EL EL	
730 d 150-210 kW (204-286 PS) N57 D30 A	09.2008→06.2012		7.02318.01.0 7.02318.01.0	EUV-AGR EUV-ML	EL EL	
730 d 150-210 kW (204-286 PS) N57 D30 A	07.2012→05.2015		7.02318.01.0 7.02318.01.0	EUV-AGR EUV-ML	EL EL	
730 d xDrive 150-210 kW (204-286 PS) N57 D30 A	11.2011→05.2015		7.02318.01.0 7.02318.01.0	EUV-AGR EUV-ML	EL EL	
730 d xDrive 150-210 kW (204-286 PS) N57 D30 A	11.2011→05.2015		7.02318.01.0 7.02318.01.0	EUV-AGR EUV-ML	EL EL	
730 i, Li 155-200 kW (211-272 PS) N52 B30 A, N52 B30 AF, N52 B30 BF	09.2009→06.2015		7.02318.01.0 7.06117.01.0	EUV-AGK SV-NWV	EL EL	mit Dichtring with O-ring
740 d 220-230 kW (299-313 PS) N57 D30 B	09.2009→06.2012		7.02256.27.0 7.02318.01.0 7.02318.01.0 7.02318.01.0	DW-TL EUV-AGR EUV-ML LDRV	EP EL EL EL	
740 d 220-230 kW (299-313 PS) N57 D30 B	07.2012→06.2015		7.02256.27.0 7.02318.01.0 7.02318.01.0 7.02318.01.0	DW-TL EUV-AGR EUV-ML LDRV	EP EL EL EL	
740 d xDrive 220-230 kW (299-313 PS) N57 D30 B	09.2010→12.2012		7.02256.27.0 7.02318.01.0 7.02318.01.0 7.02318.01.0	DW-TL EUV-AGR EUV-ML LDRV	EP EL EL EL	
740 d xDrive 220-230 kW (299-313 PS) N57 D30 B	07.2012→06.2015		7.02256.27.0 7.02318.01.0 7.02318.01.0 7.02318.01.0	DW-TL EUV-AGR EUV-ML LDRV	EP EL EL EL	
740 i, Li 200-264 kW (272-359 PS) N54 B30 A	09.2008→06.2012		7.00887.20.0 7.03075.02.0 7.06117.01.0	DW-TL EUV-LS SV-NWV	EP EL EL	mit Dichtring with O-ring
740 i, Li 200-264 kW (272-359 PS) N54 B30 A	09.2010→12.2015		7.03075.02.0 7.06117.01.0	EUV-LS SV-NWV	EL EL	mit Dichtring with O-ring





















B

7 (F01, F02, F03, F04)

46

740 i, Li 200-272 kW (272-370 PS) N55 B30 A	07.2012→12.2015		7.00887.22.0	DW-TL	EP	mit Dichtring with O-ring
			7.02318.01.0	EUV-AGK	EL	
			7.01762.04.0	SUV	EL	
740 i, Li xDrive 200-272 kW (272-370 PS) N55 B30 A	07.2012→12.2015		7.00887.22.0	DW-TL	EP	mit Dichtring with O-ring
			7.02318.01.0	EUV-AGK	EL	
			7.01762.04.0	SUV	EL	
750 Li 298-339 kW (405-461 PS) N63 B44 B	09.2008→08.2015		7.00887.21.0	DW-TL	EP	mit Dichtring with O-ring
			7.06117.36.0	SV-NWV	EL	
750 Li xDrive 300 kW (408 PS) N63 B40 A	07.2013→06.2015		7.02318.01.0	EUV-AGK	EL	
750 d xDrive 280 kW (381 PS) N57 D30 C	07.2012→12.2015		7.02256.27.0	DW-TL	EP	
			7.02318.01.0	EUV-AGR	EL	
			7.02318.01.0	EUV-ML	EL	
750 i 298-339 kW (405-461 PS) N63 B44 B	09.2012→06.2015		7.00887.21.0	DW-TL	EP	mit Dichtring with O-ring
			7.06117.36.0	SV-NWV	EL	
750 i, Li 298-330 kW (405-449 PS) N63 B44 A	09.2008→06.2012		7.00887.19.0	DW-TL	EP	mit Dichtring with O-ring
			7.02318.01.0	EUV-AGK	EL	
			7.01762.04.0	SUV	EL	
750 i, Li 298-339 kW (405-461 PS) N63 B44 B	07.2012→06.2015		7.00887.21.0	DW-TL	EP	mit Dichtring with O-ring
			7.02318.01.0	EUV-AGK	EL	
			7.06117.36.0	SV-NWV	EL	
750 i, Li xDrive 298-330 kW (405-449 PS) N63 B44 A	09.2009→06.2012		7.00887.19.0	DW-TL	EP	mit Dichtring with O-ring
			7.02318.01.0	EUV-AGK	EL	
			7.01762.04.0	SUV	EL	
750 i, Li xDrive 298-339 kW (405-461 PS) N63 B44 B	07.2012→06.2015		7.00887.21.0	DW-TL	EP	mit Dichtring with O-ring
			7.02318.01.0	EUV-AGK	EL	
			7.06117.36.0	SV-NWV	EL	
760 i, Li 326-400 kW (443-544 PS) N74 B60 A	09.2009→12.2015		7.00887.21.0	DW-TL	EP	mit Dichtring with O-ring
			7.02318.01.0	EUV-AGK	EL	
			7.06117.36.0	SV-NWV	EL	
ActiveHybrid 7 298-330 kW (405-449 PS) N63 B44 A	04.2010→06.2012		7.00887.19.0	DW-TL	EP	

							
7 (F01, F02, F03, F04)						46	B
			7.02318.01.0 7.01762.04.0 7.06117.36.0	EUV-AGK SUV SV-NWV	EL EL EL	mit Dichtring with O-ring	
ActiveHybrid 7 298-330 kW (405-449 PS) N63 B44 A	04.2010→06.2012		7.00887.19.0	DW-TL	EP		
			7.02318.01.0 7.01762.04.0 7.06117.36.0	EUV-AGK SUV SV-NWV	EL EL EL	mit Dichtring with O-ring	
ActiveHybrid 7 200-272 kW (272-370 PS) N55 B30 A	08.2012→06.2015		7.00887.22.0	DW-TL	EP		
			7.02318.01.0 7.02318.01.0 7.01762.04.0 7.06117.36.0	EUV-AGK EUV-LS SUV SV-NWV	EL EL EL EL	mit Dichtring with O-ring	
ActiveHybrid 7 200-272 kW (272-370 PS) N55 B30 A	08.2012→06.2015		7.00887.22.0	DW-TL	EP		
			7.02318.01.0 7.02318.01.0 7.01762.04.0 7.06117.36.0	EUV-AGK EUV-LS SUV SV-NWV	EL EL EL EL	mit Dichtring with O-ring	
7 (G11, G12)						47	
725 d, Ld 85-170 kW (116-231 PS) B47 D20 B	07.2016→02.2019		7.02256.27.0	DW-TL	EP		
725 d, Ld 85-170 kW (116-231 PS) B47 D20 B	07.2016→02.2019		7.02256.27.0	DW-TL	EP		
740 d, Ld xDrive 155-250 kW (211-340 PS) B57 D30 B	11.2015→06.2020		7.02256.27.0	DW-TL	EP		
750 d, Ld xDrive 294 kW (400 PS) B57 D30 C	07.2016→		7.02256.27.0	DW-TL	EP		
M 760 Li xDrive 430 kW (585 PS) N74 B66 C	03.2019→		7.04216.05.0	SUV	EL		
			7.06117.36.0	SV-NWV	EL	mit Dichtring with O-ring	
M 760 i, Li xDrive 448 kW (610 PS) N74 B66 B	12.2016→02.2019		7.04216.05.0	SUV	EL		
			7.06117.36.0	SV-NWV	EL	mit Dichtring with O-ring	
8 (E31)						48	
850 Ci 240 kW (326 PS) M73 B54 (54121)	09.1994→12.1999		7.02318.01.0	EUV-SL	EL		
8 Convertible (G14, F91)						49	
840 d xDrive 155-250 kW (211-340 PS) B57 D30 B	11.2018→10.2020		7.02256.27.0	DW-TL	EP		
8 Coupe (G15, F92)						50	
840 d xDrive 155-250 kW (211-340 PS) B57 D30 B	07.2018→10.2020		7.02256.27.0	DW-TL	EP		



B















8 Gran Coupe (G16, F93)

















51

840 d xDrive 155-250 kW (211-340 PS) B57 D30 B	07.2019→10.2020		7.02256.27.0	DW-TL	EP	
---	-----------------	---	---------------------	-------	----	--

X1 (E84)

52

sDrive 16 d 66-150 kW (90-204 PS) N47 D20 C	04.2012→06.2015		7.02318.01.0	EUV-AGR	EL	
			7.02318.01.0	EUV-ML	EL	
sDrive 16 i 105-135 kW (143-184 PS) N20 B16 A	03.2013→06.2015		7.00887.21.0	DW-TL	EP	
			7.02318.01.0	EUV-AGK	EL	
			7.04216.05.0	SUV	EL	
sDrive 18 d 66-150 kW (90-204 PS) N47 D20 C	03.2009→06.2015		7.02318.01.0	EUV-AGR	EL	
			7.02318.01.0	EUV-ML	EL	
sDrive 18 d 66-150 kW (90-204 PS) N47 D20 C	12.2009→06.2015		7.02318.01.0	EUV-AGR	EL	
			7.02318.01.0	EUV-ML	EL	
sDrive 18 i 95-125 kW (129-170 PS) N46 B20 B, N46 B20 BD	03.2010→06.2015		7.06117.00.0	SV-NWV	EL	mit Dichtring with O-ring
sDrive 18 i 95-125 kW (129-170 PS) N46 B20 B, N46 B20 BD, N46 B20 C, N46 B20 CC, N46 B20 CD, N46 B20 E	03.2010→06.2015		7.06117.00.0	SV-NWV	EL	mit Dichtring with O-ring
sDrive 20 d 66-150 kW (90-204 PS) N47 D20 C	10.2009→06.2015		7.02318.01.0	EUV-AGR	EL	
			7.02318.01.0	EUV-ML	EL	
sDrive 20 d 66-150 kW (90-204 PS) N47 D20 C	03.2010→06.2015		7.02318.01.0	EUV-AGR	EL	
			7.02318.01.0	EUV-ML	EL	
sDrive 20 d 66-150 kW (90-204 PS) N47 D20 C	07.2012→06.2015		7.02318.01.0	EUV-AGR	EL	
			7.02318.01.0	EUV-ML	EL	
sDrive 20 i 110-205 kW (150-279 PS) N20 B20 A	09.2011→06.2015		7.00887.21.0	DW-TL	EP	
			7.02318.01.0	EUV-AGK	EL	
			7.04216.05.0	SUV	EL	
sDrive 20 i Flex 110-205 kW (150-279 PS) N20 B20 A	08.2014→06.2015		7.04216.05.0	SUV	EL	
sDrive 28 i 110-205 kW (150-279 PS) N20 B20 A	09.2012→06.2015		7.00887.21.0	DW-TL	EP	
			7.02318.01.0	EUV-AGK	EL	
			7.04216.05.0	SUV	EL	USA USA
xDrive 18 d 66-150 kW (90-204 PS) N47 D20 C	03.2009→06.2015		7.02318.01.0	EUV-AGR	EL	
			7.02318.01.0	EUV-ML	EL	
xDrive 18 d 66-150 kW (90-204 PS) N47 D20 C	10.2009→06.2015		7.02318.01.0	EUV-AGR	EL	
			7.02318.01.0	EUV-ML	EL	
xDrive 20 d 66-150 kW (90-204 PS) N47 D20 C	09.2009→06.2012		7.02318.01.0	EUV-AGR	EL	
			7.02318.01.0	EUV-ML	EL	

							
X1 (E84)						52	B
xDrive 20 d 66-150 kW (90-204 PS) N47 D20 C	03.2010→06.2015		7.02318.01.0	EUV-AGR	EL		
			7.02318.01.0	EUV-ML	EL		
xDrive 20 d 66-150 kW (90-204 PS) N47 D20 C	07.2012→06.2015		7.02318.01.0	EUV-AGR	EL		
			7.02318.01.0	EUV-ML	EL		
xDrive 20 i 110-205 kW (150-279 PS) N20 B20 A	09.2011→06.2015		7.00887.21.0	DW-TL	EP		
			7.02318.01.0	EUV-AGK	EL		
			7.04216.05.0	SUV	EL		
xDrive 23 d 150-160 kW (204-218 PS) N47 D20 D	10.2009→06.2015		7.02256.27.0	DW-TL	EP		
			7.02318.01.0	EUV-AGR	EL		
			7.02318.01.0	LDRV	EL		
xDrive 25 d 150-160 kW (204-218 PS) N47 D20 D	10.2009→06.2015		7.02256.27.0	DW-TL	EP		
			7.02318.01.0	EUV-AGR	EL		
			7.02318.01.0	EUV-ML	EL		
			7.02318.01.0	LDRV	EL		
xDrive 25 i 155-200 kW (211-272 PS) N52 B30 A	03.2010→08.2011		7.02318.01.0	EUV-AGK	EL		
			7.06117.01.0	SV-NWV	EL	mit Dichtring with O-ring	
xDrive 28 i 155-200 kW (211-272 PS) N52 B30 A	09.2009→08.2011		7.02318.01.0	EUV-AGK	EL		
			7.06117.01.0	SV-NWV	EL	mit Dichtring with O-ring	
xDrive 28 i 155-200 kW (211-272 PS) N52 B30 A	03.2010→06.2011		7.02318.01.0	EUV-AGK	EL		
			7.06117.01.0	SV-NWV	EL	mit Dichtring with O-ring	
xDrive 28 i 110-205 kW (150-279 PS) N20 B20 A	03.2011→06.2015		7.00887.21.0	DW-TL	EP		
			7.02318.01.0	EUV-AGK	EL		
xDrive 28 i Flex 110-205 kW (150-279 PS) N20 B20 A	04.2011→06.2015		7.02318.01.0	EUV-AGK	EL		
			7.04216.05.0	SUV	EL		
xDrive 35 i 200-272 kW (272-370 PS) N55 B30 A	03.2011→06.2015		7.00887.21.0	DW-TL	EP	Produktionsdatum bis: 31.05.2012 Production date to: 31.05.2012	
			7.00887.22.0	DW-TL	EP	Produktionsdatum ab: 01.06.2012 Production date from: 01.06.2012	
			7.02318.01.0	EUV-AGK	EL		
			7.06117.36.0	SV-NWV	EL	mit Dichtring with O-ring	
X1 (F48)						53	
xDrive 25 d 100-170 kW (136-231 PS) B47 C20 B	11.2014→		7.02256.27.0	DW-TL	EP		



B















X2 (F39)

























54

xDrive 25 d 100-170 kW (136-231 PS) B47 C20 B	11.2017→		7.02256.27.0	DW-TL	EP	
---	----------	---	---------------------	-------	----	--

X3 (E83)

55

2.0 d 85-120 kW (116-163 PS) M47 D20 (204D4)	09.2004→08.2007		7.22796.01.0	DW-AGR	EP	
			7.22796.01.0	DW-TL	EP	
			7.02318.01.0	EUV-SR	EL	
2.0 i 95-125 kW (129-170 PS) N46 B20 B	07.2005→08.2008		7.06117.00.0	SV-NWV	EL	mit Dichtring with O-ring
2.0 sd 66-145 kW (90-197 PS) N47 D20 A	09.2007→08.2008		7.02063.02.0	DW-AGR	EP	
			7.02318.01.0	EUV-AGR	EL	
2.5 si 150-160 kW (204-218 PS) N52 B25 AF	08.2006→08.2008		7.06117.01.0	SV-NWV	EL	mit Dichtring with O-ring
2.5 si xDrive 130-160 kW (177-218 PS) N52 B25 A	08.2006→08.2008		7.06117.01.0	SV-NWV	EL	mit Dichtring with O-ring
3.0 d 150-160 kW (204-218 PS) M57 D30 (306D2)	01.2004→08.2005		7.22796.01.0	DW-AGR	EP	
			7.22796.01.0	DW-TL	EP	
			7.02318.01.0	EUV-AGR	EL	
			7.02318.01.0	EUV-ML	EL	
			7.02318.01.0	EUV-SR	EL	
3.0 d 135-173 kW (184-235 PS) M57 D30 (306D3)	09.2005→08.2008		7.22796.01.0	DW-AGR	EP	
			7.02318.01.0	EUV-AGR	EL	
			7.02318.01.0	EUV-ML	EL	
			7.02318.01.0	EUV-SR	EL	
3.0 d 135-173 kW (184-235 PS) M57 D30 (306D3)	09.2005→08.2008		7.22796.01.0	DW-AGR	EP	
			7.02318.01.0	EUV-AGR	EL	
			7.02318.01.0	EUV-ML	EL	
			7.02318.01.0	EUV-SR	EL	
3.0 i 163-170 kW (222-231 PS) M54 B30 (306S3)	01.2004→12.2006		7.02318.01.0	EUV-AGK	EL	
3.0 i xDrive 163-170 kW (222-231 PS) M54 B30 (306S3)	09.2003→07.2006		7.02318.01.0	EUV-AGK	EL	
3.0 sd 198-221 kW (269-301 PS) M57 D30 (306D5)	09.2006→08.2008		7.22796.01.0	DW-AGR	EP	
			7.02256.27.0	DW-TL	EP	
			7.02318.01.0	EUV-ML	EL	
			7.02318.01.0	EUV-SR	EL	
			7.02318.01.0	LDRV	EL	
3.0 si 155-200 kW (211-272 PS) N52 B30 A	08.2006→08.2008		7.02318.01.0	EUV-AGK	EL	
			7.06117.01.0	SV-NWV	EL	mit Dichtring with O-ring
3.0 si 160-200 kW (218-272 PS) N52 B30 BF	08.2006→08.2008		7.02318.01.0	EUV-AGK	EL	
3.0 si 155-200 kW (211-272 PS) N52 B30 A	09.2006→08.2008		7.02318.01.0	EUV-AGK	EL	
			7.06117.01.0	SV-NWV	EL	mit Dichtring with O-ring
xDrive 18 d 66-150 kW (90-204 PS) N47 D20 C	09.2008→12.2011		7.02318.01.0	EUV-AGR	EL	











							
X3 (E83)						55	B
xDrive 18 d 66-150 kW (90-204 PS) N47 D20 C	04.2009→12.2011		7.02318.01.0	EUV-AGR	EL		
xDrive 20 d 66-150 kW (90-204 PS) N47 D20 A, N47 D20 C	09.2008→08.2010		7.02318.01.0	EUV-AGR	EL		
xDrive 20 d 66-150 kW (90-204 PS) N47 D20 A, N47 D20 C	09.2008→08.2010		7.02318.01.0	EUV-AGR	EL		
xDrive 20 i 95-125 kW (129-170 PS) N46 B20 B	09.2008→08.2011		7.06117.00.0	SV-NWV	EL	mit Dichtring with O-ring	
xDrive 25 i 130-160 kW (177-218 PS) N52 B25 A	09.2008→08.2010		7.06117.01.0	SV-NWV	EL	mit Dichtring with O-ring	
xDrive 30 d 135-173 kW (184-235 PS) M57 D30 (306D3)	09.2008→08.2010		7.22796.01.0	DW-AGR	EP		
			7.02318.01.0	EUV-AGR	EL		
			7.02318.01.0	EUV-ML	EL		
xDrive 30 d 135-173 kW (184-235 PS) M57 D30 (306D3)	09.2008→08.2010		7.02318.01.0	EUV-SR	EL		
			7.22796.01.0	DW-AGR	EP		
			7.02318.01.0	EUV-AGR	EL		
xDrive 30 d 135-173 kW (184-235 PS) M57 D30 (306D3)	09.2008→08.2010		7.02318.01.0	EUV-ML	EL		
			7.02318.01.0	EUV-SR	EL		
xDrive 30 i 155-200 kW (211-272 PS) N52 B30 A	08.2006→08.2010		7.06117.01.0	SV-NWV	EL	mit Dichtring with O-ring	
xDrive 30 i 155-200 kW (211-272 PS) N52 B30 A	09.2008→08.2010		7.06117.01.0	SV-NWV	EL	mit Dichtring with O-ring	
xDrive 30 i 155-200 kW (211-272 PS) N52 B30 A	09.2008→08.2010		7.06117.01.0	SV-NWV	EL	mit Dichtring with O-ring	
xDrive 35 d 198-221 kW (269-301 PS) M57 D30 (306D5)	09.2008→08.2011		7.22796.01.0	DW-AGR	EP		
X3 (F25)						56	
sDrive 18 d 66-150 kW (90-204 PS) N47 D20 C	10.2012→03.2014		7.02318.01.0	EUV-AGR	EL		
			7.02318.01.0	EUV-ML	EL		
sDrive 18 d 66-150 kW (90-204 PS) N47 D20 C	10.2012→03.2014		7.02318.01.0	EUV-AGR	EL		
			7.02318.01.0	EUV-ML	EL		
sDrive 20 i 110-205 kW (150-279 PS) N20 B20 A	04.2014→08.2017		7.00887.21.0	DW-TL	EP		
sDrive 28 i 110-205 kW (150-279 PS) N20 B20 A	04.2014→08.2017		7.00887.21.0	DW-TL	EP		
			7.02318.01.0	EUV-AGK	EL		
xDrive 20 d 66-150 kW (90-204 PS) N47 D20 C	09.2010→03.2014		7.02318.01.0	EUV-AGR	EL		
xDrive 20 d 66-150 kW (90-204 PS) N47 D20 C	09.2010→03.2014		7.02318.01.0	EUV-AGR	EL		
xDrive 20 i 110-205 kW (150-279 PS) N20 B20 A	10.2011→08.2017		7.00887.21.0	DW-TL	EP		
			7.04216.05.0	SUV	EL		



B



X3 (F25)



56

xDrive 28 d 66-150 kW (90-204 PS) N47 D20 C	04.2014→12.2016		7.02318.01.0	EUV-AGR	EL	
xDrive 28 i 155-200 kW (211-272 PS) N52 B30 A, N52 B30 AF, N52 B30 BF	01.2011→10.2012		7.06117.01.0	SV-NWV	EL	mit Dichtring with O-ring
xDrive 28 i 110-205 kW (150-279 PS) N20 B20 A	04.2012→08.2017		7.00887.21.0	DW-TL	EP	
			7.02318.01.0	EUV-AGK SUV	EL EL	
xDrive 30 d 150-210 kW (204-286 PS) N57 D30 A	04.2011→08.2017		7.02318.01.0	EUV-AGR	EL	
			7.02318.01.0	EUV-ML	EL	
xDrive 30 d 150-210 kW (204-286 PS) N57 D30 A	04.2011→08.2017		7.02318.01.0	EUV-AGR	EL	
			7.02318.01.0	EUV-ML	EL	
xDrive 30 d 150-210 kW (204-286 PS) N57 D30 A	04.2011→05.2016		7.02318.01.0	EUV-AGR	EL	
			7.02318.01.0	EUV-ML	EL	
xDrive 30 d 150-210 kW (204-286 PS) N57 D30 A	06.2011→08.2017		7.02318.01.0	EUV-AGR	EL	
			7.02318.01.0	EUV-ML	EL	
xDrive 30 d 150-210 kW (204-286 PS) N57 D30 A	06.2016→08.2017		7.02318.01.0	EUV-AGR	EL	
			7.02318.01.0	EUV-ML	EL	
xDrive 35 d 220-230 kW (299-313 PS) N57 D30 B	10.2011→08.2017		7.02256.27.0	DW-TL	EP	
			7.02318.01.0	EUV-AGR	EL	
			7.02318.01.0	EUV-ML	EL	
			7.02318.01.0	LDRV	EL	
xDrive 35 i 200-272 kW (272-370 PS) N55 B30 A	09.2010→08.2017		7.00887.21.0	DW-TL	EP	Produktionsdatum bis: 31.05.2012 Production date to: 31.05.2012
			7.00887.22.0	DW-TL	EP	Produktionsdatum ab: 01.06.2012 Production date from: 01.06.2012
			7.02318.01.0	EUV-AGK	EL	
			7.06117.36.0	SV-NWV	EL	mit Dichtring with O-ring

X3 (G01, F97)

57

xDrive 25 d 85-170 kW (116-231 PS) B47 D20 B	04.2018→		7.02256.27.0	DW-TL	EP	
xDrive 25 d 85-170 kW (116-231 PS) B47 D20 B	04.2018→		7.02256.27.0	DW-TL	EP	
xDrive M40 d 155-250 kW (211-340 PS) B57 D30 B	08.2018→06.2020		7.02256.27.0	DW-TL	EP	



					
X4 (F26)					
M 40 i 200-272 kW (272-370 PS) N55 B30 A	12.2015→03.2018		7.02318.01.0	EUV-AGK	EL
			7.06117.36.0	SV-NWV	EL
xDrive 20 i 110-205 kW (150-279 PS) N20 B20 A	04.2014→03.2018		7.00887.21.0	DW-TL	EP
			7.04216.05.0	SUV	EL
xDrive 28 i 110-205 kW (150-279 PS) N20 B20 A	04.2014→03.2018		7.00887.21.0	DW-TL	EP
			7.02318.01.0 7.04216.05.0	EUV-AGK SUV	EL EL
xDrive 28 i 110-205 kW (150-279 PS) N20 B20 A	04.2014→03.2018		7.00887.21.0	DW-TL	EP
			7.02318.01.0 7.04216.05.0	EUV-AGK SUV	EL EL
xDrive 30 d 150-210 kW (204-286 PS) N57 D30 A	04.2014→03.2018		7.02318.01.0	EUV-AGR	EL
			7.02318.01.0	EUV-ML	EL
xDrive 30 d 150-210 kW (204-286 PS) N57 D30 A	04.2014→03.2018		7.02318.01.0	EUV-AGR	EL
			7.02318.01.0	EUV-ML	EL
xDrive 30 d 150-210 kW (204-286 PS) N57 D30 A	04.2014→03.2018		7.02318.01.0	EUV-AGR	EL
			7.02318.01.0	EUV-ML	EL
xDrive 30 d 150-210 kW (204-286 PS) N57 D30 A	04.2014→03.2018		7.02318.01.0	EUV-AGR	EL
			7.02318.01.0	EUV-ML	EL
xDrive 30 d 150-210 kW (204-286 PS) N57 D30 A	04.2015→03.2018		7.02318.01.0	EUV-AGR	EL
			7.02318.01.0	EUV-ML	EL
xDrive 35 d 220-230 kW (299-313 PS) N57 D30 B	04.2014→03.2018		7.02256.27.0	DW-TL	EP
			7.02318.01.0	EUV-AGR	EL
			7.02318.01.0 7.02318.01.0	EUV-ML LDRV	EL EL
xDrive 35 i 200-272 kW (272-370 PS) N55 B30 A	04.2014→03.2018		7.00887.22.0	DW-TL	EP
			7.02318.01.0 7.06117.36.0	EUV-AGK SV-NWV	EL EL
xDrive 35 i 200-272 kW (272-370 PS) N55 B30 A	01.2015→03.2018		7.00887.22.0	DW-TL	EP
			7.02318.01.0 7.06117.36.0	EUV-AGK SV-NWV	EL EL



B









X4 (G02, F98)

59

M40 d xDrive 155-250 kW (211-340 PS) B57 D30 B	04.2018→06.2020		7.02256.27.0	DW-TL	EP	
xDrive 25 d 85-170 kW (116-231 PS) B47 D20 B	04.2018→		7.02256.27.0	DW-TL	EP	
xDrive 25 d 85-170 kW (116-231 PS) B47 D20 B	04.2018→		7.02256.27.0	DW-TL	EP	





X5 (E53)





















60

3.0 d 135-142 kW (184-193 PS) M57 D30 (306D1)	04.2001→09.2003		7.22796.01.0	DW-AGR	EP	
			7.22796.01.0	DW-TL	EP	
			7.02318.01.0	EUV-ML	EL	
			7.02318.01.0	EUV-SR	EL	
3.0 d 150-160 kW (204-218 PS) M57 D30 (306D2)	10.2003→09.2006		7.22796.01.0	DW-AGR	EP	
			7.22796.01.0	DW-TL	EP	
			7.02318.01.0	EUV-ML	EL	
3.0 d 150-160 kW (204-218 PS) M57 D30 (306D2)	10.2003→09.2006		7.22796.01.0	DW-AGR	EP	
			7.22796.01.0	DW-TL	EP	
			7.02318.01.0	EUV-ML	EL	
3.0 i 163-170 kW (222-231 PS) M54 B30 (306S3)	04.2000→10.2006		7.00784.01.0	EUV-SL	EP	
			7.02318.01.0	EUV-SL	EL	
3.0 i 163-170 kW (222-231 PS) M54 B30 (306S3)	06.2000→12.2006		7.02318.01.0	EUV-SL	EL	
4.4 i 210 kW (286 PS) M62 B44 (448S2)	01.2000→09.2003		7.06117.10.0	SV-NWV	EL	
4.4 i 235-245 kW (320-333 PS) N62 B44 A	10.2003→10.2006		7.06117.00.0	SV-NWV	EL	mit Dichtring with O-ring
4.6 is 255-261 kW (347-355 PS) M62 B46 (468S1)	10.2001→09.2003		7.06117.10.0	SV-NWV	EL	
4.8 is 261-270 kW (355-367 PS) N62 B48 A	04.2004→09.2006		7.06117.00.0	SV-NWV	EL	mit Dichtring with O-ring

X5 (E70)

61

3.0 3.0d 135-173 kW (184-235 PS) M57 D30 (306D3)	02.2007→09.2008		7.22796.01.0	DW-AGR	EP	
			7.02318.01.0	EUV-ML	EL	
			7.02318.01.0	EUV-SR	EL	
3.0 d 135-173 kW (184-235 PS) M57 D30 (306D3)	12.2006→09.2008		7.22796.01.0	DW-AGR	EP	
			7.02318.01.0	EUV-ML	EL	
			7.02318.01.0	EUV-SR	EL	
3.0 sd 198-221 kW (269-301 PS) M57 D30 (306D5)	10.2007→09.2008		7.22796.01.0	DW-AGR	EP	
			7.02256.27.0	DW-TL	EP	
			7.02318.01.0	EUV-ML	EL	
			7.02318.01.0	EUV-SR	EL	
			7.02318.01.0	LDRV	EL	
3.0 si 155-200 kW (211-272 PS) N52 B30 A, N52 B30 AF, N52 B30 BF	10.2006→09.2008		7.06117.01.0	SV-NWV	EL	mit Dichtring with O-ring







							
X5 (E70)						61	B
4.8 i xDrive 261-270 kW (355-367 PS) N62 B48 B	10.2006→09.2008		7.06117.00.0	SV-NWV	EL	mit Dichtring with O-ring	
M 408-414 kW (555-563 PS) S63 B44 A	07.2009→07.2013		7.00887.21.0	DW-TL	EP	mit Dichtring with O-ring	
			7.02318.01.0	EUV-AGK	EL		
			7.01762.04.0	SUV	EL		
M 408-414 kW (555-563 PS) S63 B44 A	09.2009→06.2013		7.06117.36.0	SV-NWV	EL		
			7.00887.21.0	DW-TL	EP		
			7.02318.01.0	EUV-AGK	EL		
M 50 d 280 kW (381 PS) N57 D30 C	08.2011→06.2013		7.01762.04.0	SUV	EL		
			7.02318.01.0	SV-NWV	EL		
			7.06117.36.0	SV-NWV	EL		
xDrive 30 d 135-173 kW (184-235 PS) M57 D30 (306D3)	10.2008→03.2010		7.02256.27.0	DW-TL	EP	mit Dichtring with O-ring	
xDrive 30 d 135-173 kW (184-235 PS) M57 D30 (306D3)	10.2008→03.2010		7.02318.01.0	EUV-AGR	EL		
			7.02318.01.0	EUV-ML	EL		
xDrive 30 d 150-210 kW (204-286 PS) N57 D30 A	04.2010→07.2013		7.02318.01.0	EUV-AGR	EL	mit Dichtring with O-ring	
xDrive 30 d 150-210 kW (204-286 PS) N57 D30 A	04.2010→07.2013		7.02318.01.0	EUV-ML	EL		
			7.02318.01.0	EUV-AGR	EL		
xDrive 30 i 155-200 kW (211-272 PS) N52 B30 A	02.2007→12.2012		7.02318.01.0	EUV-AGR	EL	mit Dichtring with O-ring	
xDrive 30 i 155-200 kW (211-272 PS) N52 B30 A	09.2008→12.2010		7.06117.01.0	SV-NWV	EL		
			7.06117.01.0	SV-NWV	EL		
xDrive 30 i 155-200 kW (211-272 PS) N52 B30 A	10.2008→03.2010		7.06117.01.0	SV-NWV	EL	mit Dichtring with O-ring	
			7.02318.01.0	EUV-AGR	EL		
			7.02318.01.0	EUV-ML	EL		
			7.02318.01.0	EUV-AGR	EL		
			7.02318.01.0	LDRV	EL		
xDrive 35 d 198-221 kW (269-301 PS) M57 D30 (306D5)	10.2008→07.2013		7.06117.01.0	SV-NWV	EL	mit Dichtring with O-ring	
			7.02063.02.0	DW-AGR	EP		
			7.02256.27.0	DW-TL	EP		
			7.02318.01.0	EUV-AGR	EL		
			7.02318.01.0	EUV-ML	EL		
xDrive 35 i 200-272 kW (272-370 PS) N55 B30 A	04.2010→07.2013		7.02318.01.0	LDRV	EL	Produktionsdatum bis: 31.05.2012 Production date to: 31.05.2012	
			7.00887.21.0	DW-TL	EP		
			7.00887.22.0	DW-TL	EP		
			7.02318.01.0	EUV-AGK	EL		
xDrive 35 i 200-272 kW (272-370 PS) N55 B30 A	04.2010→07.2013		7.01762.04.0	SUV	EL	Produktionsdatum ab: 01.06.2012 Production date from: 01.06.2012	
			7.02318.01.0	EUV-AGK	EL		



B





X5 (E70)









61

			7.06117.36.0	SV-NWV	EL	mit Dichtring with O-ring
xDrive 35 i 200-272 kW (272-370 PS) N55 B30 A	02.2012→06.2013		7.00887.21.0	DW-TL	EP	Produktionsdatum bis: 31.05.2012 Production date to: 31.05.2012
			7.00887.22.0	DW-TL	EP	Produktionsdatum ab: 01.06.2012 Production date from: 01.06.2012
			7.01762.04.0	SUV	EL	
			7.06117.36.0	SV-NWV	EL	mit Dichtring with O-ring
xDrive 40 d 220-230 kW (299-313 PS) N57 D30 B	09.2010→06.2013		7.02256.27.0	DW-TL	EP	
			7.02318.01.0	EUV-AGR	EL	
			7.02318.01.0	EUV-ML	EL	
			7.02318.01.0	LDRV	EL	
xDrive 40 i 200-272 kW (272-370 PS) N55 B30 A	01.2012→06.2013		7.00887.21.0	DW-TL	EP	Produktionsdatum bis: 31.05.2012 Production date to: 31.05.2012
			7.00887.22.0	DW-TL	EP	Produktionsdatum ab: 01.06.2012 Production date from: 01.06.2012
			7.02318.01.0	EUV-AGK	EL	
			7.01762.04.0	SUV	EL	
			7.06117.36.0	SV-NWV	EL	mit Dichtring with O-ring
xDrive 48 i 261-270 kW (355-367 PS) N62 B48 B	10.2008→03.2010		7.06117.00.0	SV-NWV	EL	mit Dichtring with O-ring
xDrive 50 i 298-330 kW (405-449 PS) N63 B44 A	09.2009→06.2013		7.00887.19.0	DW-TL	EP	
			7.01762.04.0	SUV	EL	
			7.06117.36.0	SV-NWV	EL	mit Dichtring with O-ring
xDrive 50 i 298-330 kW (405-449 PS) N63 B44 A	04.2010→07.2013		7.00887.19.0	DW-TL	EP	
			7.01762.04.0	SUV	EL	
			7.06117.36.0	SV-NWV	EL	mit Dichtring with O-ring

X5 (F15, F85)

62

M 412-467 kW (560-635 PS) S63 B44 B	12.2014→07.2018		7.00887.21.0	DW-TL	EP	
			7.06117.36.0	SV-NWV	EL	mit Dichtring with O-ring
M 50 d 280 kW (381 PS) N57 D30 C	12.2013→07.2018		7.02256.27.0	DW-TL	EP	
			7.02318.01.0	EUV-AGR	EL	
			7.02318.01.0	EUV-ML	EL	
			7.02318.01.0	LDRV	EL	
sDrive 25 d 150-160 kW (204-218 PS) N47 D20 D	12.2013→07.2015		7.02256.27.0	DW-TL	EP	
sDrive 25 d 150-160 kW (204-218 PS) N47 D20 D	12.2013→07.2015		7.02256.27.0	DW-TL	EP	
			7.02318.01.0	EUV-AGR	EL	
			7.02318.01.0	EUV-ML	EL	
			7.02318.01.0	LDRV	EL	



					
X5 (F15, F85)					
sDrive 25 d 85-170 kW (116-231 PS) B47 D20 B	08.2015→07.2018		7.02256.27.0	DW-TL	EP
sDrive 35 i 200-272 kW (272-370 PS) N55 B30 A	08.2013→07.2018		7.06117.36.0	SV-NWV	EL mit Dichtring with O-ring
xDrive 25 d 150-160 kW (204-218 PS) N47 D20 D	12.2013→07.2015		7.02256.27.0	DW-TL	EP
			7.02318.01.0	EUV-AGR	EL
			7.02318.01.0	EUV-ML	EL
			7.02318.01.0	LDRV	EL
xDrive 25 d 150-160 kW (204-218 PS) N47 D20 D	12.2013→07.2015		7.02256.27.0	DW-TL	EP
			7.02318.01.0	EUV-AGR	EL
			7.02318.01.0	EUV-ML	EL
			7.02318.01.0	LDRV	EL
xDrive 25 d 85-170 kW (116-231 PS) B47 D20 B	08.2015→07.2018		7.02256.27.0	DW-TL	EP
xDrive 28 i 110-205 kW (150-279 PS) N20 B20 A	06.2015→07.2018		7.04216.05.0	SUV	EL
xDrive 30 d 150-210 kW (204-286 PS) N57 D30 A	08.2013→07.2018		7.02318.01.0	EUV-AGR	EL
			7.02318.01.0	EUV-ML	EL
xDrive 30 d 150-210 kW (204-286 PS) N57 D30 A	08.2013→07.2018		7.02318.01.0	EUV-AGR	EL
			7.02318.01.0	EUV-ML	EL
xDrive 35 i 200-272 kW (272-370 PS) N55 B30 A	12.2013→07.2018		7.06117.36.0	SV-NWV	EL mit Dichtring with O-ring
xDrive 35 i 200-272 kW (272-370 PS) N55 B30 A	12.2013→07.2018		7.06117.36.0	SV-NWV	EL mit Dichtring with O-ring
xDrive 40 d 220-230 kW (299-313 PS) N57 D30 B	12.2013→07.2018		7.02256.27.0	DW-TL	EP
			7.02318.01.0	EUV-AGR	EL
			7.02318.01.0	EUV-ML	EL
			7.02318.01.0	LDRV	EL
xDrive 40e 110-205 kW (150-279 PS) N20 B20 A	08.2015→07.2018		7.02318.01.0	EUV-LS	EL
			7.04216.05.0	SUV	EL
xDrive 40e 110-205 kW (150-279 PS) N20 B20 A	08.2015→07.2018		7.02318.01.0	EUV-LS	EL
			7.04216.05.0	SUV	EL
xDrive 40e 110-205 kW (150-279 PS) N20 B20 A	08.2015→07.2018		7.02318.01.0	EUV-LS	EL
			7.04216.05.0	SUV	EL
xDrive 40e 110-205 kW (150-279 PS) N20 B20 A	08.2015→07.2018		7.02318.01.0	EUV-LS	EL



B

X5 (F15, F85)

62

			7.04216.05.0	SUV	EL	
xDrive 50 i 300 kW (408 PS) N63 B40 A	08.2013→07.2018		7.00887.21.0	DW-TL	EP	
			7.06117.36.0	SV-NWV	EL	mit Dichtring with O-ring
xDrive 50 i 298-339 kW (405-461 PS) N63 B44 B	08.2013→07.2018		7.00887.21.0	DW-TL	EP	
			7.06117.36.0	SV-NWV	EL	mit Dichtring with O-ring
xDrive 50 i 298-339 kW (405-461 PS) N63 B44 B	08.2013→07.2018		7.00887.21.0	DW-TL	EP	
			7.06117.36.0	SV-NWV	EL	mit Dichtring with O-ring







X5 (G05, F95)















63

xDrive M 50 d 294 kW (400 PS) B57 D30 C	08.2018→		7.02256.27.0	DW-TL	EP	
---	----------	---	---------------------	-------	----	--

X6 (E71, E72)

64

ActiveHybrid 298-330 kW (405-449 PS) N63 B44 A	01.2009→10.2011		7.00887.19.0	DW-TL	EP	
			7.01762.04.0	SUV	EL	mit Dichtring with O-ring
			7.06117.36.0	SV-NWV	EL	
ActiveHybrid xDrive 298-330 kW (405-449 PS) N63 B44 A	01.2009→10.2011		7.00887.19.0	DW-TL	EP	
			7.01762.04.0	SUV	EL	mit Dichtring with O-ring
			7.06117.36.0	SV-NWV	EL	
M 408-414 kW (555-563 PS) S63 B44 A	07.2008→06.2014		7.00887.21.0	DW-TL	EP	
			7.02318.01.0	EUV-AGK	EL	mit Dichtring with O-ring
			7.01762.04.0	SUV	EL	
			7.06117.36.0	SV-NWV	EL	
M 408-414 kW (555-563 PS) S63 B44 A	07.2009→07.2014		7.00887.21.0	DW-TL	EP	
			7.02318.01.0	EUV-AGK	EL	mit Dichtring with O-ring
			7.01762.04.0	SUV	EL	
			7.06117.36.0	SV-NWV	EL	
M 50 d 280 kW (381 PS) N57 D30 C	08.2011→06.2014		7.02256.27.0	DW-TL	EP	
			7.02318.01.0	EUV-AGR	EL	
			7.02318.01.0	EUV-ML	EL	
			7.02318.01.0	LDRV	EL	
xDrive 30 d 135-173 kW (184-235 PS) M57 D30 (306D3)	04.2008→03.2010		7.22796.01.0	DW-AGR	EP	
			7.02318.01.0	EUV-ML	EL	
			7.02318.01.0	EUV-SR	EL	
xDrive 30 d 150-210 kW (204-286 PS) N57 D30 A	04.2010→07.2014		7.02318.01.0	EUV-AGR	EL	
			7.02318.01.0	EUV-ML	EL	

							
X6 (E71, E72)						64	B
xDrive 30 d 150-210 kW (204-286 PS) N57 D30 A	04.2010→07.2014		7.02318.01.0	EUV-AGR	EL		
			7.02318.01.0	EUV-ML	EL		
xDrive 35 d 198-221 kW (269-301 PS) M57 D30 (306D5)	01.2008→03.2010		7.22796.01.0	DW-AGR	EP		
			7.02256.27.0	DW-TL	EP		
			7.02318.01.0	EUV-ML	EL		
			7.02318.01.0	EUV-SR	EL		
xDrive 35 i 200-264 kW (272-359 PS) N54 B30 A	06.2007→03.2010		7.02318.01.0	LDRV	EL		
			7.00887.20.0	DW-TL	EP		
			7.02318.01.0	EUV-AGK	EL		
			7.03075.02.0	EUV-LS	EL		
xDrive 35 i 200-264 kW (272-359 PS) N54 B30 A	01.2008→07.2014		7.06117.01.0	SV-NWV	EL	Produktionsdatum ab: 10.2008 Production date from: 10.2008 mit Dichtring with O-ring	
			7.00887.20.0	DW-TL	EP		
			7.02318.01.0	EUV-AGK	EL		
xDrive 35 i 200-272 kW (272-370 PS) N55 B30 A	01.2008→07.2014		7.03075.02.0	EUV-LS	EL	Produktionsdatum ab: 10.2008 Production date from: 10.2008 mit Dichtring with O-ring	
			7.06117.01.0	SV-NWV	EL		
			7.00887.21.0	DW-TL	EP		
xDrive 35 i 200-272 kW (272-370 PS) N55 B30 A	01.2008→07.2014		7.00887.21.0	DW-TL	EP	Produktionsdatum bis: 31.05.2012 Production date to: 31.05.2012	
			7.00887.22.0	DW-TL	EP		
			7.02318.01.0	EUV-AGK	EL		
			7.01762.04.0	SUV	EL		
xDrive 35 i 200-264 kW (272-359 PS) N54 B30 A	01.2008→06.2014		7.06117.36.0	SV-NWV	EL	Produktionsdatum ab: 01.06.2012 Production date from: 01.06.2012	
			7.00887.21.0	DW-TL	EP		
			7.02318.01.0	EUV-AGK	EL		
			7.03075.02.0	EUV-LS	EL		
xDrive 35 i 200-264 kW (272-359 PS) N54 B30 A	01.2008→06.2014		7.06117.01.0	SV-NWV	EL	Produktionsdatum ab: 10.2008 Production date from: 10.2008 mit Dichtring with O-ring	
			7.00887.21.0	DW-TL	EP		
			7.02318.01.0	EUV-AGK	EL		
			7.03075.02.0	EUV-LS	EL		
xDrive 35 i 200-272 kW (272-370 PS) N55 B30 A	01.2008→06.2014		7.00887.21.0	DW-TL	EP	Produktionsdatum bis: 31.05.2012 Production date to: 31.05.2012	
			7.00887.22.0	DW-TL	EP		
			7.02318.01.0	EUV-AGK	EL		
			7.01762.04.0	SUV	EL		
xDrive 35 i 200-272 kW (272-370 PS) N55 B30 A	07.2009→06.2014		7.06117.36.0	SV-NWV	EL	Produktionsdatum ab: 01.06.2012 Production date from: 01.06.2012	
			7.00887.21.0	DW-TL	EP		
			7.02318.01.0	EUV-AGK	EL		
			7.01762.04.0	SUV	EL		



B

X6 (E71, E72)

























64

			7.06117.36.0	SV-NWV	EL	mit Dichtring with O-ring
xDrive 40 d 220-230 kW (299-313 PS) N57 D30 B	07.2009→06.2014		7.02256.27.0	DW-TL	EP	
			7.02318.01.0	EUV-AGR	EL	
			7.02318.01.0	EUV-ML	EL	
			7.02318.01.0	LDRV	EL	
xDrive 50 i 298-330 kW (405-449 PS) N63 B44 A	10.2007→06.2014		7.00887.19.0	DW-TL	EP	
			7.02318.01.0	EUV-AGK	EL	
			7.01762.04.0	SUV	EL	
xDrive 50 i 298-330 kW (405-449 PS) N63 B44 A	07.2008→07.2014		7.00887.19.0	DW-TL	EP	mit Dichtring with O-ring
			7.02318.01.0	EUV-AGK	EL	
			7.01762.04.0	SUV	EL	
xDrive 50 i 298-330 kW (405-449 PS) N63 B44 A	07.2008→07.2014		7.00887.19.0	DW-TL	EP	
			7.02318.01.0	EUV-AGK	EL	
			7.01762.04.0	SUV	EL	
xDrive 50 i 298-330 kW (405-449 PS) N63 B44 A	07.2008→07.2014		7.00887.19.0	DW-TL	EP	mit Dichtring with O-ring
			7.02318.01.0	EUV-AGK	EL	
			7.01762.04.0	SUV	EL	

X6 (F16, F86)

65

M 412-467 kW (560-635 PS) S63 B44 B	12.2014→07.2019		7.00887.21.0	DW-TL	EP	
			7.06117.36.0	SV-NWV	EL	mit Dichtring with O-ring
M 50 d 280 kW (381 PS) N57 D30 C	08.2014→07.2019		7.02256.27.0	DW-TL	EP	
			7.02318.01.0	EUV-AGR	EL	
			7.02318.01.0	EUV-ML	EL	
sDrive 35 i 200-272 kW (272-370 PS) N55 B30 A	08.2014→07.2019		7.06117.36.0	SV-NWV	EL	mit Dichtring with O-ring
			7.02318.01.0	EUV-AGR	EL	
			7.02318.01.0	EUV-ML	EL	
xDrive 28 i 110-205 kW (150-279 PS) N20 B20 A	06.2015→07.2019		7.04216.05.0	SUV	EL	
			7.02318.01.0	EUV-AGR	EL	
			7.02318.01.0	EUV-ML	EL	
xDrive 30 d 150-210 kW (204-286 PS) N57 D30 A	08.2014→07.2019		7.02318.01.0	EUV-AGR	EL	
			7.02318.01.0	EUV-ML	EL	
			7.02318.01.0	EUV-AGR	EL	
xDrive 30 d 150-210 kW (204-286 PS) N57 D30 A	08.2014→07.2019		7.02318.01.0	EUV-AGR	EL	
			7.02318.01.0	EUV-ML	EL	
			7.02318.01.0	EUV-AGR	EL	
xDrive 30 d 150-210 kW (204-286 PS) N57 D30 A	08.2014→07.2019		7.02318.01.0	EUV-AGR	EL	
			7.02318.01.0	EUV-ML	EL	
			7.02318.01.0	EUV-AGR	EL	
xDrive 30 d 150-210 kW (204-286 PS) N57 D30 A	12.2014→07.2019		7.02318.01.0	EUV-AGR	EL	
			7.02318.01.0	EUV-ML	EL	
			7.02318.01.0	EUV-AGR	EL	
xDrive 30 d 150-210 kW (204-286 PS) N57 D30 A	09.2016→07.2019		7.02318.01.0	EUV-AGR	EL	
			7.02318.01.0	EUV-ML	EL	
			7.02318.01.0	EUV-AGR	EL	





							
X6 (F16, F86)						65	B
xDrive 35 i 200-272 kW (272-370 PS) N55 B30 A	08.2014→07.2019		7.06117.36.0	SV-NWV	EL	mit Dichtring with O-ring	
xDrive 35 i 200-272 kW (272-370 PS) N55 B30 A	08.2014→07.2019		7.06117.36.0	SV-NWV	EL	mit Dichtring with O-ring	
xDrive 40 d 220-230 kW (299-313 PS) N57 D30 B	12.2014→07.2019		7.02256.27.0	DW-TL	EP		
			7.02318.01.0	EUV-AGR	EL		
			7.02318.01.0	EUV-ML	EL		
			7.02318.01.0	LDRV	EL		
xDrive 50 i 300 kW (408 PS) N63 B40 A	08.2014→07.2019		7.00887.21.0	DW-TL	EP		
			7.06117.36.0	SV-NWV	EL	mit Dichtring with O-ring	
xDrive 50 i 298-339 kW (405-461 PS) N63 B44 B	08.2014→07.2019		7.00887.21.0	DW-TL	EP		
			7.06117.36.0	SV-NWV	EL	mit Dichtring with O-ring	
X7 (G07)						66	
xDrive M 50 d 294 kW (400 PS) B57 D30 C	03.2019→		7.02256.27.0	DW-TL	EP		
Z3 Coupe (E36)						67	
2.8 i 141-144 kW (192-196 PS) M52 B28 (286S2)	09.1998→05.2000		7.00784.01.0	EUV-SL	EP		
			7.02318.01.0	EUV-SL	EL		
3.0 i 163-170 kW (222-231 PS) M54 B30 (306S3)	06.2000→06.2003		7.00784.01.0	EUV-SL	EP		
			7.02318.01.0	EUV-SL	EL		
3.0 i 163-170 kW (222-231 PS) M54 B30 (306S3)	01.2001→12.2002		7.02318.01.0	EUV-SL	EL		
M 3.2 176-179 kW (239-243 PS) S52 B32 (326S2)	02.1998→06.2000		7.02318.01.0	EUV-SL	EL		
Z3 Roadster (E36)						68	
1.9 i 77-87 kW (105-118 PS) M43 B19 (194E1)	07.1998→01.2003		7.02318.01.0	EUV-SL	EL		
1.9 i 77-87 kW (105-118 PS) M43 B19 (194E1)	01.1999→01.2003		7.02318.01.0	EUV-SL	EL		
2.0 i 100-110 kW (136-150 PS) M52 B20 (206S4)	04.1999→01.2003		7.00784.01.0	EUV-SL	EP		
			7.02318.01.0	EUV-AGK	EL		
			7.02318.01.0	EUV-SL	EL		
2.2 i 120-125 kW (163-170 PS) M54 B22 (226S1)	08.2000→01.2003		7.02318.01.0	EUV-SL	EL		
2.2 i 120-125 kW (163-170 PS) M54 B22 (226S1)	10.2000→06.2002		7.00784.01.0	EUV-SL	EP		
			7.02318.01.0	EUV-SL	EL		
2.5 120-141 kW (163-192 PS) M52 B25 (256S4)	09.1998→09.2000		7.02318.01.0	EUV-SL	EL		
2.5 i 137-141 kW (186-192 PS) M54 B25 (256S5)	10.2000→08.2002		7.02318.01.0	EUV-SL	EL		
2.8 i 141-143 kW (192-194 PS) M52 B28 (286S1)	01.1996→07.2000		7.00784.01.0	EUV-SL	EP		
2.8 i 141-144 kW (192-196 PS) M52 B28 (286S2)	01.1996→07.2000		7.00784.01.0	EUV-SL	EP		



B



Z3 Roadster (E36)

68

			7.02318.01.0	EUV-AGK	EL	
			7.02318.01.0	EUV-SL	EL	
2.8 i 141-143 kW (192-194 PS) M52 B28 (286S1)	11.1996→05.2000		7.00784.01.0	EUV-SL	EP	
3.0 i 163-170 kW (222-231 PS) M54 B30 (306S3)	06.2000→12.2002		7.02318.01.0	EUV-AGK	EL	
			7.02318.01.0	EUV-SL	EL	
3.0 i 163-170 kW (222-231 PS) M54 B30 (306S3)	06.2000→01.2003		7.00784.01.0	EUV-SL	EP	
			7.02318.01.0	EUV-AGK	EL	
			7.02318.01.0	EUV-SL	EL	
M 3.2 176-179 kW (239-243 PS) S52 B32 (326S2)	02.1998→06.2000		7.02318.01.0	EUV-SL	EL	





Z4 Coupe (E86)

69

3.0 si 155-200 kW (211-272 PS) N52 B30 A	03.2006→01.2009		7.06117.01.0	SV-NWV	EL	mit Dichtring with O-ring
3.0 si 155-200 kW (211-272 PS) N52 B30 A	03.2006→08.2008		7.06117.01.0	SV-NWV	EL	mit Dichtring with O-ring
3.0 si 155-200 kW (211-272 PS) N52 B30 A	04.2006→08.2008		7.06117.01.0	SV-NWV	EL	mit Dichtring with O-ring





Z4 Roadster (E85)

70





2.0 i 95-125 kW (129-170 PS) N46 B20 B	03.2005→02.2009		7.06117.00.0	SV-NWV	EL	mit Dichtring with O-ring
2.5 i 130-160 kW (177-218 PS) N52 B25 A	09.2005→02.2009		7.06117.01.0	SV-NWV	EL	mit Dichtring with O-ring
2.5 si 130-160 kW (177-218 PS) N52 B25 A, N52 B25 AF	09.2005→02.2009		7.06117.01.0	SV-NWV	EL	mit Dichtring with O-ring
2.5 si 130-160 kW (177-218 PS) N52 B25 A	01.2006→08.2008		7.06117.01.0	SV-NWV	EL	mit Dichtring with O-ring
3.0 si 155-200 kW (211-272 PS) N52 B30 A	09.2005→12.2008		7.06117.01.0	SV-NWV	EL	mit Dichtring with O-ring
3.0 si 155-200 kW (211-272 PS) N52 B30 A, N52 B30 BF	01.2006→08.2008		7.06117.01.0	SV-NWV	EL	mit Dichtring with O-ring
3.0 si 155-200 kW (211-272 PS) N52 B30 A	01.2006→08.2008		7.06117.01.0	SV-NWV	EL	mit Dichtring with O-ring

Z4 Roadster (E89)

71

sDrive 18 i 110-205 kW (150-279 PS) N20 B20 A	04.2013→08.2016		7.00887.21.0	DW-TL	EP	
			7.02318.01.0	EUV-AGK	EL	
			7.04216.05.0	SUV	EL	
sDrive 20 i 110-205 kW (150-279 PS) N20 B20 A	09.2011→08.2016		7.00887.21.0	DW-TL	EP	
			7.02318.01.0	EUV-AGK	EL	
			7.04216.05.0	SUV	EL	
sDrive 20 i 110-205 kW (150-279 PS) N20 B20 A	09.2011→08.2016		7.00887.21.0	DW-TL	EP	
			7.02318.01.0	EUV-AGK	EL	
			7.04216.05.0	SUV	EL	
sDrive 23 i 130-160 kW (177-218 PS) N52 B25 A, N52 B25 BF	03.2009→08.2011		7.06117.01.0	SV-NWV	EL	mit Dichtring with O-ring
sDrive 28 i 110-205 kW (150-279 PS) N20 B20 A	09.2011→08.2016		7.00887.21.0	DW-TL	EP	

Z4 Roadster (E89) **71** **B**

			7.02318.01.0	EUV-AGK	EL	
			7.04216.05.0	SUV	EL	
sDrive 30 i 155-200 kW (211-272 PS) N52 B30 A, N52 B30 B, N52 B30 BF	02.2009→08.2011		7.06117.01.0	SV-NWV	EL	mit Dichtring with O-ring
sDrive 30 i 155-200 kW (211-272 PS) N52 B30 A	05.2009→08.2011		7.06117.01.0	SV-NWV	EL	mit Dichtring with O-ring
sDrive 35 i 200-264 kW (272-359 PS) N54 B30 A	02.2009→08.2016		7.00887.19.0	DW-TL	EP	
			7.02318.01.0	EUV-AGK	EL	
			7.06117.01.0	SV-NWV	EL	mit Dichtring with O-ring
sDrive 35 i 200-264 kW (272-359 PS) N54 B30 A	02.2009→08.2016		7.00887.19.0	DW-TL	EP	
			7.02318.01.0	EUV-AGK	EL	
			7.06117.01.0	SV-NWV	EL	mit Dichtring with O-ring
sDrive 35 is 200-264 kW (272-359 PS) N54 B30 A	03.2010→08.2016		7.00887.19.0	DW-TL	EP	
			7.02318.01.0	EUV-AGK	EL	
			7.06117.01.0	SV-NWV	EL	mit Dichtring with O-ring

Z8 Roadster (E52) **72**

4.9 294 kW (400 PS) S62 B50 (508S1)	01.2000→12.2003		7.02318.01.0	EUV-SL	EL	
---	-----------------	---	---------------------	--------	----	--



B

3 SERIES (E46)

1

318 i 105-107 kW (143-146 PS) N42 B20 BZ, N46 B20 CA	06.2004→06.2005		7.06117.00.0	SV-NWV	EL	mit Dichtring with O-ring
--	-----------------	---	---------------------	--------	----	------------------------------

3 SERIES (E90)

2

318 i 100-122 kW (136-166 PS) N46 B20 CC, N46 B20 E	01.2009→09.2012		7.06117.00.0	SV-NWV	EL	mit Dichtring with O-ring
320 i 100-115 kW (136-156 PS) N46 B20 CB	01.2005→12.2007		7.06117.00.0	SV-NWV	EL	mit Dichtring with O-ring
320 i 100-115 kW (136-156 PS) N46 B20 CC	12.2007→12.2010		7.06117.00.0	SV-NWV	EL	mit Dichtring with O-ring
320 i 100-122 kW (136-166 PS) N46 B20 E	01.2010→09.2012		7.06117.00.0	SV-NWV	EL	mit Dichtring with O-ring
325 i 150-160 kW (204-218 PS) N52 B25 BF	06.2005→09.2012		7.06117.01.0	SV-NWV	EL	mit Dichtring with O-ring





3 SERIES (F30, F35)

























3

316 Li 75-125 kW (102-170 PS) N13 B16 A	08.2013→		7.01777.17.0	DW-TL	EP	
			7.01762.04.0	SUV	EL	
			7.06117.02.0	SV-NWV	EL	
316 i 75-125 kW (102-170 PS) N13 B16 A	08.2013→		7.01777.17.0	DW-TL	EP	
			7.01762.04.0	SUV	EL	
			7.06117.02.0	SV-NWV	EL	
320 Li 135-180 kW (184-245 PS) N20 B20 D	07.2012→		7.00887.21.0	DW-TL	EP	
			7.04216.05.0	SUV	EL	
320 i 135-180 kW (184-245 PS) N20 B20 D	07.2012→		7.04216.05.0	SUV	EL	
328 Li 115-180 kW (156-245 PS) N20 B20 C	07.2012→		7.00887.21.0	DW-TL	EP	
			7.04216.05.0	SUV	EL	
328 Li xDrive 115-180 kW (156-245 PS) N20 B20 C	05.2014→		7.04216.05.0	SUV	EL	
328 i 115-180 kW (156-245 PS) N20 B20 C	07.2012→		7.00887.21.0	DW-TL	EP	
			7.04216.05.0	SUV	EL	
328 i xDrive 115-180 kW (156-245 PS) N20 B20 C	05.2014→		7.00887.21.0	DW-TL	EP	
			7.04216.05.0	SUV	EL	
335 Li 225 kW (306 PS) N55 B30 A	07.2012→		7.00887.22.0	DW-TL	EP	
			7.01762.04.0	SUV	EL	
			7.06117.36.0	SV-NWV	EL	mit Dichtring with O-ring

5 SERIES (E60)

4

520 Li 110 kW (150 PS) N46 B20 CD	06.2009→09.2010		7.06117.00.0	SV-NWV	EL	mit Dichtring with O-ring
523 Li 120-130 kW (163-177 PS) N52 B25 BE	10.2006→12.2010		7.06117.01.0	SV-NWV	EL	mit Dichtring with O-ring
523 Li 120-130 kW (163-177 PS) N52 B25 BE	01.2008→08.2010		7.06117.01.0	SV-NWV	EL	mit Dichtring with O-ring
523 i 120-130 kW (163-177 PS) N52 B25 BE	03.2005→12.2007		7.06117.01.0	SV-NWV	EL	mit Dichtring with O-ring
525 Li 150-160 kW (204-218 PS) N52 B25 BF	11.2006→04.2010		7.06117.01.0	SV-NWV	EL	mit Dichtring with O-ring

								
5 SERIES (E60)							4	B
525 i 150-160 kW (204-218 PS) N52 B25 BF	01.2005→01.2006		7.06117.01.0	SV-NWV	EL	mit Dichtring with O-ring		
530 Li 190 kW (258 PS) N52 B30 BF	11.2006→05.2010		7.06117.01.0	SV-NWV	EL	mit Dichtring with O-ring		
530 i 190 kW (258 PS) N52 B30 BF	01.2005→12.2006		7.06117.01.0	SV-NWV	EL	mit Dichtring with O-ring		
5 SERIES (F10, F18)							5	
520 Li 130-150 kW (177-204 PS) N52 B25 AF	12.2010→12.2012		7.06117.01.0	SV-NWV	EL	mit Dichtring with O-ring		
520 Li 135-180 kW (184-245 PS) N20 B20 D	09.2013→05.2017		7.00887.21.0	DW-TL	EP			
523 Li 130-160 kW (177-218 PS) N52 B25 AF, N52 B25 BF	08.2010→09.2012		7.06117.01.0	SV-NWV	EL	mit Dichtring with O-ring		
525 Li 115-180 kW (156-245 PS) N20 B20 C	08.2012→05.2017		7.00887.21.0	DW-TL	EP			
			7.04216.05.0	SUV	EL			
528 Li 190 kW (258 PS) N52 B30 AF	08.2010→11.2011		7.06117.01.0	SV-NWV	EL	mit Dichtring with O-ring		
528 Li 115-180 kW (156-245 PS) N20 B20 C	05.2014→05.2017		7.04216.05.0	SUV	EL			
528 Li xDrive 115-180 kW (156-245 PS) N20 B20 C	05.2014→05.2017		7.04216.05.0	SUV	EL			
530 Le Hybrid 115-180 kW (156-245 PS) N20 B20 C	01.2015→05.2017		7.04216.05.0	SUV	EL			
530 Li 190 kW (258 PS) N52 B30 AF	11.2011→05.2014		7.06117.01.0	SV-NWV	EL	mit Dichtring with O-ring		
535 Li 225 kW (306 PS) N55 B30 A	08.2010→05.2017		7.00887.21.0	DW-TL	EP	Produktionsdatum bis: 31.05.2012 Production date to: 31.05.2012		
			7.00887.22.0	DW-TL	EP	Produktionsdatum ab: 01.06.2012 Production date from: 01.06.2012		
			7.01762.04.0	SUV	EL			
			7.06117.36.0	SV-NWV	EL	mit Dichtring with O-ring		
X1 (E84)							6	
sDrive 20 i 135-180 kW (184-245 PS) N20 B20 A	03.2012→		7.00887.21.0	DW-TL	EP			
			7.04216.05.0	SUV	EL			
sDrive18 i 100-122 kW (136-166 PS) N46 B20 B, N46 B20 CC, N46 B20 CD, N46 B20 E	03.2012→12.2014		7.06117.00.0	SV-NWV	EL	mit Dichtring with O-ring		
sDrive18 i 115-180 kW (156-245 PS) N20 B20 C	06.2014→		7.04216.05.0	SUV	EL			
xDrive 20 i 115-180 kW (156-245 PS) N20 B20 C	03.2012→		7.00887.21.0	DW-TL	EP			
			7.04216.05.0	SUV	EL			
xDrive 28 i 115-180 kW (156-245 PS) N20 B20 C	03.2012→		7.00887.21.0	DW-TL	EP			
			7.04216.05.0	SUV	EL			



B

40S (W221)

1

3.0 (222.165) 245 kW (333 PS)
M 276.824

08.2014→



7.00782.11.0

DW-TL EP

7.02256.37.0

EUV-AGK EL

7.01870.06.0

SUV EL

50S (W221)

2

4.7 4M (221.094) 320 kW (435 PS)
M 278.932

10.2012→



7.00782.11.0

DW-TL EP

60S (W221)

3





















5.5 (221.176) 380 kW (517 PS)
M 275.953

04.2011→



7.02256.37.0

EUV-SL EL









								
ALLURE Saloon							1	B
3.0 188-226 kW (256-307 PS) LF1	09.2009→12.2010		7.06117.04.0	SV-NWV	EH	mit Wellendichtring With shaft sealing ring 2010 2010		
3.6 179-215 kW (243-292 PS) LY7	09.2004→12.2008		7.06117.04.0	SV-NWV	EH	mit Wellendichtring With shaft sealing ring 2005 2005 2009 2009		
3.6 209-227 kW (284-309 PS) LLT	09.2009→12.2010		7.06117.04.0	SV-NWV	EH	mit Wellendichtring With shaft sealing ring 2010 2010 2011 2011		
ENCLAVE							2	
3.6 179-215 kW (243-292 PS) LY7	04.2007→12.2008		7.06117.04.0	SV-NWV	EH	mit Wellendichtring With shaft sealing ring 2007 2007 2008 2008		
3.6 209-227 kW (284-309 PS) LLT	09.2008→04.2017		7.06117.04.0	SV-NWV	EH	mit Wellendichtring With shaft sealing ring 2009 2009 2017 2017		
3.6 AWD 179-215 kW (243-292 PS) LY7	04.2007→12.2008		7.06117.04.0	SV-NWV	EH	mit Wellendichtring With shaft sealing ring 2007 2007 2008 2008		
3.6 AWD 209-227 kW (284-309 PS) LLT	09.2008→04.2017		7.06117.04.0	SV-NWV	EH	mit Wellendichtring With shaft sealing ring 2009 2009 2017 2017		
ENCORE SUV							3	
1.4 103-104 kW (140-141 PS) LUV	09.2012→		7.06117.07.0	ZM-NWV	EL	mit Dichtring with O-ring		
1.4 114 kW (155 PS) LE2(85CUL4)	09.2012→		7.03351.12.0	LDRV	EP			
1.4 AWD 103-104 kW (140-141 PS) LUV	09.2012→		7.06117.07.0	ZM-NWV	EL	mit Dichtring with O-ring		
1.4 AWD 114 kW (155 PS) LE2(85CUL4)	09.2012→		7.03351.12.0	LDRV	EP			
ENVISION							4	
2.0 AWD 186-205 kW (253-279 PS) LTG	03.2016→		7.03357.04.0	LDRV	EL			
LA CROSSE Saloon							5	
2.4 136 kW (185 PS) LAF	09.2009→		7.06117.05.0	SV-NWV	EH	mit Dichtring with O-ring		
			7.06117.06.0	SV-NWV	EH	mit Dichtring with O-ring		
2.4 AWD 136 kW (185 PS) LAF	09.2010→12.2011		7.06117.05.0	SV-NWV	EH	mit Dichtring with O-ring		
			7.06117.06.0	SV-NWV	EH	mit Dichtring with O-ring		















B

LA CROSSE Saloon

5

2.4 Hybrid 136-147 kW (185-200 PS) LUK	09.2011→12.2016		7.06117.05.0	SV-NWV	EH	mit Dichtring with O-ring
			7.06117.06.0	SV-NWV	EH	mit Dichtring with O-ring
2.4 Hybrid 136-147 kW (185-200 PS) LUK	09.2012→		7.06117.05.0	SV-NWV	EH	mit Dichtring with O-ring
			7.06117.06.0	SV-NWV	EH	mit Dichtring with O-ring
2.4 Hybrid AWD 136-147 kW (185-200 PS) LUK	09.2011→		7.06117.05.0	SV-NWV	EH	mit Dichtring with O-ring
			7.06117.06.0	SV-NWV	EH	mit Dichtring with O-ring
2.4 Hybrid AWD 136-147 kW (185-200 PS) LUK	09.2011→12.2016		7.06117.05.0	SV-NWV	EH	mit Dichtring with O-ring
			7.06117.06.0	SV-NWV	EH	mit Dichtring with O-ring
3.0 188-226 kW (256-307 PS) LF1	09.2009→		7.06117.04.0	SV-NWV	EH	mit Wellendichtring With shaft sealing ring 2010 2010
			7.06117.04.0	SV-NWV	EH	mit Wellendichtring With shaft sealing ring 2010 2010
3.6 179-215 kW (243-292 PS) LY7	09.2004→12.2007		7.06117.04.0	SV-NWV	EH	mit Wellendichtring With shaft sealing ring 2005 2005 2009 2009
			7.06117.04.0	SV-NWV	EH	mit Wellendichtring With shaft sealing ring 2012 2012 2016 2016 LLT: 2010 2010 2011 2011
3.6 209-227 kW (284-309 PS) LFX, LLT	09.2013→		7.06117.04.0	SV-NWV	EH	mit Wellendichtring With shaft sealing ring LFX: 2012 2012 2016 2016 LLT: 2010 2010 2011 2011
			7.06117.04.0	SV-NWV	EH	mit Wellendichtring With shaft sealing ring LFX: 2012 2012 2016 2016 LLT: 2010 2010 2011 2011
3.6 FLEX 227 kW (309 PS) LFX	09.2011→		7.06117.04.0	SV-NWV	EH	mit Wellendichtring With shaft sealing ring 2012 2012 2016 2016
			7.06117.04.0	SV-NWV	EH	mit Wellendichtring With shaft sealing ring 2012 2012 2016 2016
3.6 FLEX AWD 227 kW (309 PS) LFX	09.2011→		7.06117.04.0	SV-NWV	EH	mit Wellendichtring With shaft sealing ring 2012 2012 2016 2016
			7.06117.04.0	SV-NWV	EH	mit Wellendichtring With shaft sealing ring 2012 2012 2016 2016







							
LA CROSSE Saloon						5	B
3.6 VVTi 209-227 kW (284-309 PS) LLT	01.2010→12.2011		7.06117.04.0	SV-NWV	EH	mit Wellendichtring With shaft sealing ring 2010 2010 2011 2011	
3.6 VVTi AWD 209-227 kW (284-309 PS) LLT	09.2010→12.2011		7.06117.04.0	SV-NWV	EH	mit Wellendichtring With shaft sealing ring 2010 2010 2011 2011	
REGAL Regal TourX						6	
2.0 AWD 186-205 kW (253-279 PS) LTG	11.2017→		7.03357.04.0	LDRV	EL		
REGAL Saloon						7	
2.0 164-201 kW (223-273 PS) LHU	09.2012→12.2013		5.02549.03.0*	EUV-VB	EL	mit Halter with holder 2011 2011 2013 2013	
			↳ 7.01441.04.0	EUV-VB	EL		
			7.02721.06.0*	EUV-VB	EL	mit Halter with holder 2011 2011 2013 2013	
			↳ 7.01441.04.0	EUV-VB	EL		
			7.06117.05.0	SV-NWV	EH	mit Dichtring with O-ring	
			7.06117.06.0	SV-NWV	EH	mit Dichtring with O-ring	
2.0 186-205 kW (253-279 PS) LTG	07.2013→		7.03357.04.0	LDRV	EL		
			7.06117.56.0	SV-NWV	EH	mit Dichtring with O-ring 2014 2014 2017 2017	
			7.06117.57.0	SV-NWV	EH	mit Dichtring with O-ring 2014 2014 2017 2017	
2.0 186-205 kW (253-279 PS) LTG	01.2014→12.2016		7.03357.04.0	LDRV	EL		
			7.06117.56.0	SV-NWV	EH	mit Dichtring with O-ring 2014 2014 2017 2017	
			7.06117.57.0	SV-NWV	EH	mit Dichtring with O-ring 2014 2014 2017 2017	
2.0 AWD 186-205 kW (253-279 PS) LTG	07.2013→		7.03357.04.0	LDRV	EL		

















B

REGAL Saloon

7

			7.06117.56.0	SV-NWV	EH	mit Dichtring with O-ring 2014 2014 2017 2017
			7.06117.57.0	SV-NWV	EH	mit Dichtring with O-ring 2014 2014 2017 2017
2.0 FLEX 164-201 kW (223-273 PS) LHU	09.2010→		5.02549.03.0*	EUV-VB	EL	mit Halter with holder 2011 2011 2013 2013
			↳ 7.01441.04.0	EUV-VB	EL	
			7.02721.06.0*	EUV-VB	EL	mit Halter with holder 2011 2011 2013 2013
			↳ 7.01441.04.0	EUV-VB	EL	
			7.06117.05.0	SV-NWV	EH	mit Dichtring with O-ring
			7.06117.06.0	SV-NWV	EH	mit Dichtring with O-ring
2.0 FLEX AWD 164-201 kW (223-273 PS) LHU	09.2011→		5.02549.03.0*	EUV-VB	EL	mit Halter with holder 2011 2011 2013 2013
			↳ 7.01441.04.0	EUV-VB	EL	
			7.02721.06.0*	EUV-VB	EL	mit Halter with holder 2011 2011 2013 2013
			↳ 7.01441.04.0	EUV-VB	EL	
			7.06117.05.0	SV-NWV	EH	mit Dichtring with O-ring
			7.06117.06.0	SV-NWV	EH	mit Dichtring with O-ring
2.4 136 kW (185 PS) LAF	09.2010→		7.06117.05.0	SV-NWV	EH	mit Dichtring with O-ring
			7.06117.06.0	SV-NWV	EH	mit Dichtring with O-ring
2.4 AWD 136 kW (185 PS) LAF	09.2010→		7.06117.05.0	SV-NWV	EH	mit Dichtring with O-ring
			7.06117.06.0	SV-NWV	EH	mit Dichtring with O-ring
2.4 FLEX 134-136 kW (182-185 PS) LEA	09.2011→		7.06117.05.0	SV-NWV	EH	mit Dichtring with O-ring
			7.06117.06.0	SV-NWV	EH	mit Dichtring with O-ring
2.4 FLEX AWD 134-136 kW (182-185 PS) LEA	05.2016→		7.06117.05.0	SV-NWV	EH	mit Dichtring with O-ring
			7.06117.06.0	SV-NWV	EH	mit Dichtring with O-ring



							
REGAL Saloon						7	B
2.4 Hybrid 136-147 kW (185-200 PS) LUK	09.2011→		7.06117.05.0	SV-NWV	EH	mit Dichtring with O-ring	
			7.06117.06.0	SV-NWV	EH	mit Dichtring with O-ring	
2.4 Hybrid AWD 136-147 kW (185-200 PS) LUK	07.2013→		7.06117.05.0	SV-NWV	EH	mit Dichtring with O-ring	
			7.06117.06.0	SV-NWV	EH	mit Dichtring with O-ring	
REGAL Sportback						8	
2.0 186-205 kW (253-279 PS) LTG	11.2017→		7.03357.04.0	LDRV	EL		
2.0 AWD 186-205 kW (253-279 PS) LTG	11.2017→		7.03357.04.0	LDRV	EL		
RENDEZVOUZ						9	
3.6 179-215 kW (243-292 PS) LY7	09.2004→09.2006		7.06117.04.0	SV-NWV	EH	mit Wellendichtring With shaft sealing ring 2004 2004 2006 2006	
3.6 AWD 179-215 kW (243-292 PS) LY7	09.2005→12.2006		7.06117.04.0	SV-NWV	EH	mit Wellendichtring With shaft sealing ring 2004 2004 2006 2006	
VERANO Saloon						10	
2.0 164-201 kW (223-273 PS) LHU	09.2013→		5.02549.03.0*	EUV-VB	EL	mit Halter with holder 2013 2013 2016 2016	
			↳7.01441.04.0	EUV-VB	EL		
			7.02721.06.0*	EUV-VB	EL	mit Halter with holder 2013 2013 2016 2016	
			↳7.01441.04.0	EUV-VB	EL		
			7.06117.05.0	SV-NWV	EH	mit Dichtring with O-ring	
			7.06117.06.0	SV-NWV	EH	mit Dichtring with O-ring	
2.0 FLEX 164-201 kW (223-273 PS) LHU	09.2012→		5.02549.03.0*	EUV-VB	EL	mit Halter with holder 2013 2013 2016 2016	
			↳7.01441.04.0	EUV-VB	EL		
			7.02721.06.0*	EUV-VB	EL	mit Halter with holder 2013 2013 2016 2016	
			↳7.01441.04.0	EUV-VB	EL		
			7.06117.05.0	SV-NWV	EH	mit Dichtring with O-ring	
			7.06117.06.0	SV-NWV	EH	mit Dichtring with O-ring	





























B











VERANO Saloon

10

			7.06117.06.0	SV-NWV	EH	mit Dichtring with O-ring
2.4 134-136 kW (182-185 PS) LEA	09.2013→12.2015		7.06117.05.0	SV-NWV	EH	mit Dichtring with O-ring
			7.06117.06.0	SV-NWV	EH	mit Dichtring with O-ring
2.4 FLEX 134-136 kW (182-185 PS) LEA	09.2012→		7.06117.05.0	SV-NWV	EH	mit Dichtring with O-ring
			7.06117.06.0	SV-NWV	EH	mit Dichtring with O-ring

								
ENCORE (SJ2)							1	B
1.4 103 kW (140 PS) LUJ	07.2012→11.2013		7.03833.02.0	EUV-VB	EL			
			7.06117.07.0	ZM-NWV	EL		mit Dichtring with O-ring	
1.4 AWD 103 kW (140 PS) LUJ	07.2012→11.2013		7.03833.02.0	EUV-VB	EL			
			7.06117.07.0	ZM-NWV	EL		mit Dichtring with O-ring	
ENVISION (CP4)							2	
20T 1.5 119-125 kW (162-1709 PS) LFV	04.2015→		7.03351.12.0	LDRV	EP			
			7.03381.14.0	SUV	EL			
20T 1.5 4WD 119-125 kW (162-1709 PS) LFV	04.2015→		7.03381.14.0	SUV	EL			
28T 2.0 4WD 191-192 kW (260-261 PS) LTG	10.2014→		7.03357.04.0	LDRV	EL			
			7.03381.15.0	SUV	EL			
EXCELLE GT (CP2)							3	
1.6 86-89 kW (117-121 PS) LDE	06.2010→12.2015		7.02256.38.0	AKF	EL			
			7.06117.08.0	SV-NWV	EH		mit Dichtring with O-ring	
1.8 102-108 kW (139-147 PS) 2H0	06.2010→12.2015		7.06117.08.0	SV-NWV	EH	mit Dichtring with O-ring		
EXCELLE XT (CP2)							4	
1.6 86-89 kW (117-121 PS) LDE	01.2010→12.2015		7.02256.38.0	AKF	EL			
			7.06117.08.0	SV-NWV	EH		mit Dichtring with O-ring	
1.8 102-108 kW (139-147 PS) 2H0	01.2010→12.2012		7.06117.08.0	SV-NWV	EH	mit Dichtring with O-ring		
GL8 S II (CU3)							5	
2.4 SIDI 105-131 kW (143-178 PS) LE5	11.2011→12.2012		7.06117.05.0	SV-NWV	EH	mit Dichtring with O-ring		
			7.06117.06.0	SV-NWV	EH	mit Dichtring with O-ring		
2.4 SIDI 136-137 kW (185-186 PS) LAF	01.2013→12.2016		7.06117.05.0	SV-NWV	EH	mit Dichtring with O-ring		
			7.06117.06.0	SV-NWV	EH	mit Dichtring with O-ring		
3.0 V6 SIDI 190-195 kW (258-265 PS) LFW	11.2010→		7.06117.04.0	SV-NWV	EH	mit Wellendichtring With shaft sealing ring		
LACROSSE (CW2, CW3)							6	
2.4 105-131 kW (143-178 PS) LE5	03.2006→07.2009		7.06117.05.0	SV-NWV	EH	mit Dichtring with O-ring		
			7.06117.06.0	SV-NWV	EH	mit Dichtring with O-ring		
2.4 Hybrid 105-131 kW (143-178 PS) LE5	07.2008→07.2009		7.06117.05.0	SV-NWV	EH	mit Dichtring with O-ring		
			7.06117.06.0	SV-NWV	EH	mit Dichtring with O-ring		







					
B					
LACROSSE (EG2)					7
2.0 Turbo 162-187 kW (220-254 PS) LDK	04.2010→12.2013		7.06117.05.0	SV-NWV	EH mit Dichtring with O-ring
			7.06117.06.0	SV-NWV	EH mit Dichtring with O-ring
2.0 Turbo 162-187 kW (220-254 PS) LDK	06.2013→03.2016		7.06117.05.0	SV-NWV	EH mit Dichtring with O-ring
			7.06117.06.0	SV-NWV	EH mit Dichtring with O-ring
2.4 105-131 kW (143-178 PS) LE5	07.2009→12.2012		7.06117.05.0	SV-NWV	EH mit Dichtring with O-ring
			7.06117.06.0	SV-NWV	EH mit Dichtring with O-ring
2.4 136-137 kW (185-186 PS) LAF	01.2011→12.2016		7.06117.05.0	SV-NWV	EH mit Dichtring with O-ring
			7.06117.06.0	SV-NWV	EH mit Dichtring with O-ring
2.4 Hybrid 137 kW (186 PS) LUK	08.2011→12.2015		7.06117.05.0	SV-NWV	EH mit Dichtring with O-ring
			7.06117.06.0	SV-NWV	EH mit Dichtring with O-ring
3.0 187-190 kW (254-258 PS) LF1	07.2009→12.2012		7.06117.04.0	SV-NWV	EH mit Wellendichtring With shaft sealing ring
3.0 190-195 kW (258-265 PS) LFW	02.2012→03.2016		7.06117.04.0	SV-NWV	EH mit Wellendichtring With shaft sealing ring
PARK AVENUE (S8E)					8
3.0 187-190 kW (254-258 PS) LF1	10.2009→12.2013		7.06117.04.0	SV-NWV	EH mit Wellendichtring With shaft sealing ring
3.6 183-194 kW (249-264 PS) LY7	04.2007→10.2009		7.06117.04.0	SV-NWV	EH mit Wellendichtring With shaft sealing ring
REGAL GS (EG7)					9
28T 191-192 kW (260-261 PS) LTG	07.2017→		7.03357.04.0	LDRV	EL
REGAL II (EG1)					10
1.6 Turbo 132-135 kW (179-184 PS) LLU	09.2009→12.2012		7.01039.03.0	EUV-VB	EL
			7.01039.03.0	EUV-VB	EL
2.0 108-113 kW (147-154 PS) LTD	12.2008→12.2013		7.06117.05.0	SV-NWV	EH mit Dichtring with O-ring
			7.06117.06.0	SV-NWV	EH mit Dichtring with O-ring
2.0 162-187 kW (220-254 PS) LDK	06.2009→12.2013		7.06117.05.0	SV-NWV	EH mit Dichtring with O-ring
			7.06117.06.0	SV-NWV	EH mit Dichtring with O-ring
2.0 108-113 kW (147-154 PS) LTD	09.2013→12.2017		7.06117.05.0	SV-NWV	EH mit Dichtring with O-ring
			7.06117.06.0	SV-NWV	EH mit Dichtring with O-ring
2.4 105-131 kW (143-178 PS) LE5	12.2008→12.2011		7.06117.05.0	SV-NWV	EH mit Dichtring with O-ring
			7.06117.06.0	SV-NWV	EH mit Dichtring with O-ring
2.4 136-137 kW (185-186 PS) LAF	01.2011→12.2015		7.06117.05.0	SV-NWV	EH mit Dichtring with O-ring















							
REGAL II (EG1)						10	B
			7.06117.06.0	SV-NWV	EH	mit Dichtring with O-ring	
GS 2.0 162-187 kW (220-254 PS) LDK	09.2013→		7.06117.05.0	SV-NWV	EH	mit Dichtring with O-ring	
			7.06117.06.0	SV-NWV	EH	mit Dichtring with O-ring	
REGAL III (EG7)						11	
28T 191-192 kW (260-261 PS) LTG	07.2017→		7.03357.04.0	LDRV	EL		
ROYAUM (S8W)						12	
3.6 183-194 kW (249-264 PS) H7E, LY7	12.2004→09.2006		7.06117.04.0	SV-NWV	EH	mit Wellendichtring With shaft sealing ring	
VERANO Saloon (CP5)						13	
1.5 T 119-125 kW (162-1709 PS) LFV	06.2015→		7.03351.12.0	LDRV	EP		



ATS **1**

C

2.0 177-250 kW (241-340 PS) LTG	02.2013→	 7.03357.04.0	LDRV	EL	mit Dichtring with O-ring 2013 2013 2018 2018
		7.03381.15.0	SUV	EL	
		7.06117.56.0	SV-NWV	EH	
2.0 AWD 177-250 kW (241-340 PS) LTG	02.2013→	 7.03357.04.0	LDRV	EL	mit Dichtring with O-ring 2013 2013 2018 2018
		7.06117.56.0	SV-NWV	EH	
		7.06117.57.0	SV-NWV	EH	
2.0 AWD 177-250 kW (241-340 PS) LTG	02.2013→	 7.03357.04.0	LDRV	EL	mit Dichtring with O-ring 2013 2013 2018 2018
		7.06117.56.0	SV-NWV	EH	
		7.06117.57.0	SV-NWV	EH	
2.5 150-151 kW (204-205 PS) LCV	02.2013→	 7.06117.56.0	SV-NWV	EH	mit Dichtring with O-ring 2013 2013 2017 2017
		7.06117.57.0	SV-NWV	EH	
		 7.06117.56.0	SV-NWV	EH	
2.5 AWD 150-151 kW (204-205 PS) LCV	02.2013→	 7.06117.56.0	SV-NWV	EH	mit Dichtring with O-ring 2013 2013 2017 2017
		7.06117.57.0	SV-NWV	EH	
		 7.06117.57.0	SV-NWV	EH	







					
ATS					
1					
3.6 FLEX 218-239 kW (296-325 PS) LFX	07.2014→		7.06117.04.0	SV-NWV	EH mit Wellendichtring With shaft sealing ring 2013 2013 2015 2015
3.6 FLEX AWD 218-239 kW (296-325 PS) LFX	07.2014→		7.06117.04.0	SV-NWV	EH mit Wellendichtring With shaft sealing ring 2013 2013 2015 2015
3.6 V 339-346 kW (461-471 PS) LF4(218CUV6)	04.2015→		7.03351.12.0	LDRV	EP Baujahr bis: 12.2019 Construction year to: 12.2019
3.6 V 339-346 kW (461-471 PS) LF4(218CUV6)	09.2015→		7.03351.12.0	LDRV	EP Baujahr bis: 12.2019 Construction year to: 12.2019
ATS Coupe					
2					
2.0 177-250 kW (241-340 PS) LTG	02.2013→		7.03357.04.0	LDRV	EL
			7.06117.56.0	SV-NWV	EH mit Dichtring with O-ring 2015 2015 2019 2019
			7.06117.57.0	SV-NWV	EH mit Dichtring with O-ring 2015 2015 2019 2019
2.0 177-250 kW (241-340 PS) LTG	02.2013→		7.03357.04.0	LDRV	EL
			7.06117.56.0	SV-NWV	EH mit Dichtring with O-ring 2015 2015 2019 2019
			7.06117.57.0	SV-NWV	EH mit Dichtring with O-ring 2015 2015 2019 2019
2.0 AWD 177-250 kW (241-340 PS) LTG	02.2013→		7.03357.04.0	LDRV	EL
			7.06117.56.0	SV-NWV	EH mit Dichtring with O-ring 2015 2015 2019 2019
			7.06117.57.0	SV-NWV	EH mit Dichtring with O-ring 2015 2015 2019 2019
2.0 AWD 177-250 kW (241-340 PS) LTG	02.2013→		7.03357.04.0	LDRV	EL

C







ATS Coupe **2**





C

			7.06117.56.0	SV-NWV	EH	mit Dichtring with O-ring 2015 2015 2019 2019
			7.06117.57.0	SV-NWV	EH	mit Dichtring with O-ring 2015 2015 2019 2019
2.5 150-151 kW (204-205 PS) LCV	02.2013→		7.06117.56.0	SV-NWV	EH	mit Dichtring with O-ring
			7.06117.57.0	SV-NWV	EH	mit Dichtring with O-ring
2.5 AWD 150-151 kW (204-205 PS) LCV	02.2013→		7.06117.56.0	SV-NWV	EH	mit Dichtring with O-ring
			7.06117.57.0	SV-NWV	EH	mit Dichtring with O-ring
3.6 FLEX 218-239 kW (296-325 PS) LFX	07.2014→		7.06117.04.0	SV-NWV	EH	mit Wellendichtring With shaft sealing ring 2015 2015
3.6 FLEX AWD 218-239 kW (296-325 PS) LFX	07.2014→		7.06117.04.0	SV-NWV	EH	mit Wellendichtring With shaft sealing ring 2015 2015
3.6 V 339-346 kW (461-471 PS) LF4(218CUV6)	04.2015→		7.03351.12.0	LDRV	EP	Baujahr bis: 12.2019 Construction year to: 12.2019
3.6 V 339-346 kW (461-471 PS) LF4(218CUV6)	09.2015→		7.03351.12.0	LDRV	EP	Baujahr bis: 12.2019 Construction year to: 12.2019





BLS **3**

2.0 T 129 kW (175 PS) Z 20 NET	04.2006→12.2010		7.00326.03.0	EUV-VB	EL	
			7.28311.04.0	LDRV	EP	
2.8 T 188 kW (255 PS) B284L	04.2006→		7.00175.04.0	SUV	EL	
2.8 T 188-206 kW (256-280 PS) B284R, Z 28 NET	12.2009→12.2010		7.00175.04.0	SUV	EL	
2.8 T AWD 188-206 kW (256-280 PS) Z 28 NET	10.2008→		7.00175.04.0	SUV	EL	

BLS Wagon **4**

2.0 T 129 kW (175 PS) Z 20 NET	12.2007→12.2010		7.00326.03.0	EUV-VB	EL	
			7.28311.04.0	LDRV	EP	
2.8 T 188-206 kW (256-280 PS) Z 28 NET	12.2007→		7.00175.04.0	SUV	EL	
2.8 T 203-206 kW (276-280 PS) B284R	08.2010→		7.00175.04.0	SUV	EL	
2.8 T AWD 188-206 kW (256-280 PS) Z 28 NET	10.2008→		7.00175.04.0	SUV	EL	















CT6						5
2.0 Plug-In Hybrid 177-250 kW (241-340 PS) LTG	07.2017→12.2019		7.03357.04.0	LDRV	EL	
			7.06117.56.0	SV-NWV	EH	mit Dichtring with O-ring 2016 2016 2019 2019
			7.06117.57.0	SV-NWV	EH	mit Dichtring with O-ring 2016 2016 2019 2019
2.0 Turbo 177-250 kW (241-340 PS) LTG	08.2016→12.2019		7.03357.04.0	LDRV	EL	
			7.06117.56.0	SV-NWV	EH	mit Dichtring with O-ring 2016 2016 2019 2019
			7.06117.57.0	SV-NWV	EH	mit Dichtring with O-ring 2016 2016 2019 2019
2.0 Turbo AWD 177-250 kW (241-340 PS) LTG	08.2016→12.2019		7.03357.04.0	LDRV	EL	
			7.06117.56.0	SV-NWV	EH	mit Dichtring with O-ring 2016 2016 2019 2019
			7.06117.57.0	SV-NWV	EH	mit Dichtring with O-ring 2016 2016 2019 2019
CTS						6
2.0 Turbo 177-250 kW (241-340 PS) LTG	09.2013→		7.03357.04.0	LDRV	EL	
			7.03381.15.0	SUV	EL	
			7.06117.56.0	SV-NWV	EH	mit Dichtring with O-ring 2014 2014 2019 2019
2.0 Turbo 177-250 kW (241-340 PS) LTG	08.2016→		7.06117.57.0	SV-NWV	EH	mit Dichtring with O-ring 2014 2014 2019 2019
			7.03357.04.0	LDRV	EL	

C



CTS **6**

C

2.0 Turbo 177-250 kW (241-340 PS) LTG	08.2016→	 7.03357.04.0	LDRV	EL	
2.0 Turbo AWD 177-250 kW (241-340 PS) LTG	01.2014→	 7.03357.04.0 7.03381.15.0 7.06117.56.0 7.06117.57.0	LDRV SUV SV-NWV SV-NWV	EL EL EH EH	mit Dichtring with O-ring 2014 2014 2019 2019 mit Dichtring with O-ring 2014 2014 2019 2019
2.0 Turbo AWD 177-250 kW (241-340 PS) LTG	08.2016→	 7.03357.04.0	LDRV	EL	
2.0 Turbo AWD 177-250 kW (241-340 PS) LTG	08.2016→	 7.03357.04.0	LDRV	EL	
2.0 VVTi 177-250 kW (241-340 PS) LTG	01.2017→	 7.03357.04.0	LDRV	EL	
2.0 VVTi AWD 177-250 kW (241-340 PS) LTG	01.2017→	 7.03357.04.0	LDRV	EL	
2.8 156-158 kW (212-215 PS) LP1	03.2005→09.2007	 7.06117.04.0	SV-NWV	EH	mit Wellendichtring With shaft sealing ring 2005 2005 2007 2007
2.8 156-158 kW (212-215 PS) LP1	01.2008→12.2009	 7.06117.04.0	SV-NWV	EH	mit Wellendichtring With shaft sealing ring 2008 2008 2009 2009
3.0 183-203 kW (249-276 PS) LF1	01.2008→	 7.06117.04.0	SV-NWV	EH	mit Wellendichtring With shaft sealing ring 2010 2010 2011 2011
3.0 183-203 kW (249-276 PS) LF1	09.2009→10.2013	 7.06117.04.0	SV-NWV	EH	mit Wellendichtring With shaft sealing ring 2010 2010 2011 2011
3.0 AWD 183-203 kW (249-276 PS) LF1	01.2008→12.2010	 7.06117.04.0	SV-NWV	EH	mit Wellendichtring With shaft sealing ring 2010 2010 2011 2011
3.0 AWD 183-203 kW (249-276 PS) LF1	09.2009→10.2013	 7.06117.04.0	SV-NWV	EH	mit Wellendichtring With shaft sealing ring 2010 2010 2011 2011

					
CTS					
					6
3.6 189-196 kW (257-266 PS) LY7	09.2003→12.2007		7.06117.04.0	SV-NWV	EH mit Wellendichtring With shaft sealing ring 2004 2004 2007 2007
3.6 189-196 kW (257-266 PS) LY7	03.2005→09.2007		7.06117.04.0	SV-NWV	EH mit Wellendichtring With shaft sealing ring 2004 2004 2007 2007
3.6 199-237 kW (271-322 PS) LLT	01.2008→09.2013		7.06117.04.0	SV-NWV	EH mit Wellendichtring With shaft sealing ring 2008 2008 2011 2011
3.6 189-196 kW (257-266 PS) LY7	01.2008→12.2010		7.06117.04.0	SV-NWV	EH mit Wellendichtring With shaft sealing ring 2008 2008 2009 2009
3.6 199-237 kW (271-322 PS) LLT	09.2011→09.2013		7.06117.04.0	SV-NWV	EH mit Wellendichtring With shaft sealing ring 2008 2008 2011 2011
3.6 218-239 kW (296-325 PS) LFX	09.2011→12.2012		7.06117.04.0	SV-NWV	EH mit Wellendichtring With shaft sealing ring 2012 2012 2013 2013
3.6 218-239 kW (296-325 PS) LFX	09.2013→		7.06117.04.0	SV-NWV	EH mit Wellendichtring With shaft sealing ring 2014 2014 2015 2015
3.6 AWD 199-237 kW (271-322 PS) LLT	01.2008→09.2013		7.06117.04.0	SV-NWV	EH mit Wellendichtring With shaft sealing ring 2008 2008 2011 2011
3.6 AWD 199-237 kW (271-322 PS) LLT	01.2010→09.2013		7.06117.04.0	SV-NWV	EH mit Wellendichtring With shaft sealing ring 2008 2008 2011 2011
3.6 AWD 199-237 kW (271-322 PS) LLT	09.2011→09.2013		7.06117.04.0	SV-NWV	EH mit Wellendichtring With shaft sealing ring 2008 2008 2011 2011
3.6 AWD 218-239 kW (296-325 PS) LFX	09.2011→12.2012		7.06117.04.0	SV-NWV	EH mit Wellendichtring With shaft sealing ring 2012 2012 2013 2013

C



CTS **6**

C

3.6 FLEX 218-239 kW (296-325 PS) LFX	07.2014→	 PIERBURG	7.06117.04.0	SV-NWV	EH	mit Wellendichtring With shaft sealing ring 2014 2014 2015 2015
3.6 FLEX AWD 218-239 kW (296-325 PS) LFX	07.2014→	 PIERBURG	7.06117.04.0	SV-NWV	EH	mit Wellendichtring With shaft sealing ring 2014 2014 2015 2015
3.6 Flexfuel 218-239 kW (296-325 PS) LFX	09.2012→12.2013	 PIERBURG	7.06117.04.0	SV-NWV	EH	mit Wellendichtring With shaft sealing ring 2012 2012 2013 2013
3.6 Flexfuel 218-239 kW (296-325 PS) LFX	09.2012→	 PIERBURG	7.06117.04.0	SV-NWV	EH	mit Wellendichtring With shaft sealing ring 2012 2012 2013 2013
3.6 Flexfuel AWD 218-239 kW (296-325 PS) LFX	09.2012→12.2013	 PIERBURG	7.06117.04.0	SV-NWV	EH	mit Wellendichtring With shaft sealing ring 2012 2012 2013 2013
3.6 Flexfuel AWD 218-239 kW (296-325 PS) LFX	09.2012→	 PIERBURG	7.06117.04.0	SV-NWV	EH	mit Wellendichtring With shaft sealing ring 2012 2012 2013 2013
3.6 VVTi 199-237 kW (271-322 PS) LLT	01.2008→	 PIERBURG	7.06117.04.0	SV-NWV	EH	mit Wellendichtring With shaft sealing ring 2008 2008 2011 2011
3.6 VVTi 199-237 kW (271-322 PS) LLT	03.2008→12.2012	 PIERBURG	7.06117.04.0	SV-NWV	EH	mit Wellendichtring With shaft sealing ring 2008 2008 2011 2011
3.6 VVTi AWD 199-237 kW (271-322 PS) LLT	03.2008→12.2011	 PIERBURG	7.06117.04.0	SV-NWV	EH	mit Wellendichtring With shaft sealing ring 2008 2008 2011 2011

CTS Coupe **7**

2.0 Turbo 177-250 kW (241-340 PS) LTG	07.2014→	 PIERBURG	7.03357.04.0	LDRV	EL	
2.0 Turbo AWD 177-250 kW (241-340 PS) LTG	07.2014→	 PIERBURG	7.03357.04.0	LDRV	EL	
3.0 183-203 kW (249-276 PS) LF1	01.2010→	 PIERBURG	7.06117.04.0	SV-NWV	EH	mit Wellendichtring With shaft sealing ring 2011 2011

					
CTS Coupe					
					7
3.0 AWD 183-203 kW (249-276 PS) LF1	01.2010→		7.06117.04.0	SV-NWV	EH mit Wellendichtring With shaft sealing ring 2011 2011
3.6 199-237 kW (271-322 PS) LLT	01.2008→		7.06117.04.0	SV-NWV	EH mit Wellendichtring With shaft sealing ring 2011 2011
3.6 199-237 kW (271-322 PS) LLT	09.2010→		7.06117.04.0	SV-NWV	EH mit Wellendichtring With shaft sealing ring 2011 2011
3.6 199-237 kW (271-322 PS) LLT	09.2011→		7.06117.04.0	SV-NWV	EH mit Wellendichtring With shaft sealing ring 2011 2011
3.6 218-239 kW (296-325 PS) LFX	09.2011→12.2012		7.06117.04.0	SV-NWV	EH mit Wellendichtring With shaft sealing ring 2012 2012 2014 2014
3.6 AWD 199-237 kW (271-322 PS) LLT	01.2008→12.2012		7.06117.04.0	SV-NWV	EH mit Wellendichtring With shaft sealing ring 2011 2011
3.6 AWD 199-237 kW (271-322 PS) LLT	09.2010→		7.06117.04.0	SV-NWV	EH mit Wellendichtring With shaft sealing ring 2011 2011
3.6 AWD 199-237 kW (271-322 PS) LLT	09.2011→07.2014		7.06117.04.0	SV-NWV	EH mit Wellendichtring With shaft sealing ring 2011 2011
3.6 AWD 218-239 kW (296-325 PS) LFX	09.2011→12.2012		7.06117.04.0	SV-NWV	EH mit Wellendichtring With shaft sealing ring 2012 2012 2014 2014
3.6 FLEX 218-239 kW (296-325 PS) LFX	09.2012→12.2013		7.06117.04.0	SV-NWV	EH mit Wellendichtring With shaft sealing ring 2012 2012 2014 2014
3.6 FLEX AWD 218-239 kW (296-325 PS) LFX	09.2012→12.2013		7.06117.04.0	SV-NWV	EH mit Wellendichtring With shaft sealing ring 2012 2012 2014 2014
3.6 Flexfuel 218-239 kW (296-325 PS) LFX	09.2011→		7.06117.04.0	SV-NWV	EH mit Wellendichtring With shaft sealing ring 2012 2012 2014 2014
3.6 Flexfuel AWD 218-239 kW (296-325 PS) LFX	09.2012→		7.06117.04.0	SV-NWV	EH mit Wellendichtring With shaft sealing ring 2012 2012 2014 2014

















C



CTS Sport Wagon **8**

C

2.0 Turbo 177-250 kW (241-340 PS) LTG	07.2014→		7.03357.04.0	LDRV	EL	
2.0 Turbo AWD 177-250 kW (241-340 PS) LTG	07.2014→		7.03357.04.0	LDRV	EL	
3.0 183-203 kW (249-276 PS) LF1	01.2008→		7.06117.04.0	SV-NWV	EH	mit Wellendichtring With shaft sealing ring 2010 2010 2011 2011
3.0 183-203 kW (249-276 PS) LF1	09.2009→12.2011		7.06117.04.0	SV-NWV	EH	mit Wellendichtring With shaft sealing ring 2010 2010 2011 2011
3.0 AWD 183-203 kW (249-276 PS) LF1	01.2008→		7.06117.04.0	SV-NWV	EH	mit Wellendichtring With shaft sealing ring 2010 2010 2011 2011
3.0 AWD 183-203 kW (249-276 PS) LF1	09.2009→12.2010		7.06117.04.0	SV-NWV	EH	mit Wellendichtring With shaft sealing ring 2010 2010 2011 2011
3.6 199-237 kW (271-322 PS) LLT	01.2008→12.2011		7.06117.04.0	SV-NWV	EH	mit Wellendichtring With shaft sealing ring 2010 2010 2011 2011
3.6 199-237 kW (271-322 PS) LLT	09.2009→12.2010		7.06117.04.0	SV-NWV	EH	mit Wellendichtring With shaft sealing ring 2010 2010 2011 2011
3.6 199-237 kW (271-322 PS) LLT	09.2011→07.2014		7.06117.04.0	SV-NWV	EH	mit Wellendichtring With shaft sealing ring 2010 2010 2011 2011
3.6 218-239 kW (296-325 PS) LFX	09.2011→12.2012		7.06117.04.0	SV-NWV	EH	mit Wellendichtring With shaft sealing ring 2012 2012 2014 2014
3.6 AWD 199-237 kW (271-322 PS) LLT	01.2008→12.2011		7.06117.04.0	SV-NWV	EH	mit Wellendichtring With shaft sealing ring 2010 2010 2011 2011
3.6 AWD 199-237 kW (271-322 PS) LLT	09.2009→12.2010		7.06117.04.0	SV-NWV	EH	mit Wellendichtring With shaft sealing ring 2010 2010 2011 2011

						
CTS Sport Wagon						8
3.6 AWD 199-237 kW (271-322 PS) LLT	09.2011→07.2014		7.06117.04.0	SV-NWV	EH mit Wellendichtring With shaft sealing ring 2010 2010 2011 2011	
3.6 AWD 218-239 kW (296-325 PS) LFX	09.2011→12.2012		7.06117.04.0	SV-NWV	EH mit Wellendichtring With shaft sealing ring 2012 2012 2014 2014	
3.6 FLEX 218-239 kW (296-325 PS) LFX	09.2011→		7.06117.04.0	SV-NWV	EH mit Wellendichtring With shaft sealing ring 2012 2012 2014 2014	
3.6 FLEX AWD 218-239 kW (296-325 PS) LFX	09.2012→		7.06117.04.0	SV-NWV	EH mit Wellendichtring With shaft sealing ring 2012 2012 2014 2014	
ELR						9
1.4 Range Extender 63 kW (86 PS) LUU	09.2013→02.2016		7.06117.07.0	ZM-NWV	EL mit Dichtring with O-ring	
1.4 Range extender 63 kW (86 PS) LUU	09.2013→02.2016		7.06117.07.0	ZM-NWV	EL mit Dichtring with O-ring	
SRX						10
2.8 AWD 224 kW (305 PS) LAU	01.2009→		7.28311.04.0	LDRV	EP 2010 2010 2011 2011	
			7.00175.04.0	SUV	EL 2010 2010 2011 2011	
			7.06117.04.0	SV-NWV	EH mit Wellendichtring With shaft sealing ring 2010 2010 2011 2011	
3.0 183-203 kW (249-276 PS) LF1	01.2009→12.2016		7.06117.04.0	SV-NWV	EH mit Wellendichtring With shaft sealing ring 2010 2010 2011 2011	
3.0 AWD 183-203 kW (249-276 PS) LF1	01.2009→		7.06117.04.0	SV-NWV	EH mit Wellendichtring With shaft sealing ring 2010 2010 2011 2011	
3.0 AWD 183-203 kW (249-276 PS) LF1	01.2009→		7.06117.04.0	SV-NWV	EH mit Wellendichtring With shaft sealing ring 2010 2010 2011 2011	







C





















SRX **10**

















C	<p>3.0 AWD 183-203 kW (249-276 PS) LF1</p>	10.2009→04.2016	<p>7.06117.04.0</p> 	SV-NWV	EH	mit Wellendichtring With shaft sealing ring 2010 2010 2011 2011
	<p>3.6 189-196 kW (257-266 PS) LY7</p>	09.2003→12.2006	<p>7.06117.04.0</p> 	SV-NWV	EH	mit Wellendichtring With shaft sealing ring 2004 2004 2009 2009
	<p>3.6 189-196 kW (257-266 PS) LY7</p>	01.2004→12.2008	<p>7.06117.04.0</p> 	SV-NWV	EH	mit Wellendichtring With shaft sealing ring 2004 2004 2009 2009
	<p>3.6 218-239 kW (296-325 PS) LFX</p>	01.2012→04.2016	<p>7.06117.04.0</p> 	SV-NWV	EH	mit Wellendichtring With shaft sealing ring 2012 2012 2016 2016
	<p>3.6 AWD 189-196 kW (257-266 PS) LY7</p>	09.2003→12.2006	<p>7.06117.04.0</p> 	SV-NWV	EH	mit Wellendichtring With shaft sealing ring 2004 2004 2009 2009
	<p>3.6 AWD 189-196 kW (257-266 PS) LY7</p>	07.2004→12.2008	<p>7.06117.04.0</p> 	SV-NWV	EH	mit Wellendichtring With shaft sealing ring 2004 2004 2009 2009
	<p>3.6 AWD 218-239 kW (296-325 PS) LFX</p>	01.2012→04.2016	<p>7.06117.04.0</p> 	SV-NWV	EH	mit Wellendichtring With shaft sealing ring 2012 2012 2016 2016
	<p>3.6 AWD 218-239 kW (296-325 PS) LFX</p>	10.2012→04.2016	<p>7.06117.04.0</p> 	SV-NWV	EH	mit Wellendichtring With shaft sealing ring 2012 2012 2016 2016
	<p>3.6 Flexfuel 218-239 kW (296-325 PS) LFX</p>	09.2011→	<p>7.06117.04.0</p> 	SV-NWV	EH	mit Wellendichtring With shaft sealing ring 2012 2012 2016 2016
	<p>3.6 Flexfuel AWD 218-239 kW (296-325 PS) LFX</p>	09.2011→	<p>7.06117.04.0</p> 	SV-NWV	EH	mit Wellendichtring With shaft sealing ring 2012 2012 2016 2016



STS						11
3.6 189-196 kW (257-266 PS) LY7	05.2005→12.2007		7.06117.04.0	SV-NWV	EH	mit Wellendichtring With shaft sealing ring 2005 2005 2009 2009
3.6 199-237 kW (271-322 PS) LLT	09.2007→12.2011		7.06117.04.0	SV-NWV	EH	mit Wellendichtring With shaft sealing ring 2008 2008 2011 2011
3.6 199-237 kW (271-322 PS) LLT	10.2009→12.2012		7.06117.04.0	SV-NWV	EH	mit Wellendichtring With shaft sealing ring 2008 2008 2011 2011
3.6 AWD 189-196 kW (257-266 PS) LY7	09.2004→12.2005		7.06117.04.0	SV-NWV	EH	mit Wellendichtring With shaft sealing ring 2005 2005 2009 2009
3.6 AWD 199-237 kW (271-322 PS) LLT	09.2007→12.2011		7.06117.04.0	SV-NWV	EH	mit Wellendichtring With shaft sealing ring 2008 2008 2011 2011
3.6 VVT AWD 199-237 kW (271-322 PS) LLT	01.2005→12.2007		7.06117.04.0	SV-NWV	EH	mit Wellendichtring With shaft sealing ring 2008 2008 2011 2011

XTS (1P5)						12
3.6 218-239 kW (296-325 PS) LFX	09.2011→		7.06117.04.0	SV-NWV	EH	mit Wellendichtring With shaft sealing ring 2013 2013 2017 2017
3.6 AWD 218-239 kW (296-325 PS) LFX	04.2012→		7.06117.04.0	SV-NWV	EH	mit Wellendichtring With shaft sealing ring 2013 2013 2017 2017

			 PIERBURG			
ATS-L (SA1)						1
C	25T 169-205 kW (230-279 PS) LTG	08.2014→	 7.03357.04.0	LDRV	EL	
			7.03381.15.0	SUV	EL	
	28T 169-205 kW (230-279 PS) LTG	08.2014→	 7.03357.04.0	LDRV	EL	
			7.03381.15.0	SUV	EL	
CT6 (CK1)						2
	28T 2.0 169-205 kW (230-279 PS) LTG	01.2016→	 7.03357.04.0	LDRV	EL	
	30E 2.0 169-205 kW (230-279 PS) LTG	12.2016→	 7.03357.04.0	LDRV	EL	
SLS (S6D)						3
	2.0 T 193 kW (262 PS) LNF	12.2010→12.2013	 7.06117.05.0	SV-NWV	EH	mit Dichtring with O-ring
			7.06117.06.0	SV-NWV	EH	mit Dichtring with O-ring
	3.0 203 kW (276 PS) LF1	12.2009→12.2013	 7.06117.04.0	SV-NWV	EH	mit Wellendichtring With shaft sealing ring
	3.6 183-194 kW (249-264 PS) LY7	12.2006→12.2009	 7.06117.04.0	SV-NWV	EH	mit Wellendichtring With shaft sealing ring
	3.6 229 kW (311 PS) LLT	12.2009→12.2012	 7.06117.04.0	SV-NWV	EH	mit Wellendichtring With shaft sealing ring
XTS (EG4)						4
	2.0 T 169-205 kW (230-279 PS) LTG	03.2013→11.2017	 7.03357.04.0	LDRV	EL	
			7.03381.15.0	SUV	EL	
	3.6 227 kW (309 PS) LFX	03.2013→12.2015	 7.06117.04.0	SV-NWV	EH	mit Wellendichtring With shaft sealing ring

						
AVEO / KALOS Hatchback (T250, T255)						1
1.4 74 kW (101 PS) LDT	04.2008→		7.06117.08.0	SV-NWV	EH	mit Dichtring with O-ring 2009 2009 2011 2011
AVEO / KALOS Saloon (T250, T255)						2
1.4 74 kW (101 PS) LDT	09.2008→		7.06117.08.0	SV-NWV	EH	mit Dichtring with O-ring 2009 2009 2011 2011
AVEO Hatchback (T300)						3
1.2 51 kW (69 PS) LWD	03.2011→		7.02256.43.0	EUV-SR	EL	2012 2012
			7.02256.45.0	EUV-SR	EL	2012 2012
1.2 63-65 kW (86-88 PS) LDC	03.2011→		7.02256.43.0	EUV-SR	EL	2012 2012
			7.02256.45.0	EUV-SR	EL	2012 2012
1.2 LPG 63-65 kW (86-88 PS) LDC	11.2012→12.2015		7.02256.43.0	EUV-SR	EL	2012 2012
			7.02256.45.0	EUV-SR	EL	2012 2012
1.3 D 55-57 kW (75-78 PS) LDV	07.2011→12.2015		7.03073.01.0	DW-TL	EP	2012 2012 2015 2015
			7.01981.07.0	SV-AGR-K	EP	2012 2012 2015 2015
1.3 D 70 kW (95 PS) LSF	07.2011→12.2015		7.03073.01.0	DW-TL	EP	2012 2012 2015 2015
			7.01981.07.0	SV-AGR-K	EP	2012 2012 2015 2015
1.4 Turbo 103 kW (140 PS) LUJ	08.2013→		7.03833.02.0	EUV-VB	EL	
1.6 83-91 kW (113-124 PS) LDE	03.2011→		7.02256.43.0	EUV-SR	EL	
			7.02256.45.0	EUV-SR	EL	
			7.06117.08.0	SV-NWV	EH	mit Dichtring with O-ring 2019 2019
1.6 83-91 kW (113-124 PS) LDE	06.2011→		7.02256.43.0	EUV-SR	EL	
			7.02256.45.0	EUV-SR	EL	
			7.06117.08.0	SV-NWV	EH	mit Dichtring with O-ring 2019 2019

C









AVEO Hatchback (T300) **3**

C

1.8 101-103 kW (136-140 PS) LWE	09.2011→07.2015	 PIERBURG	7.06117.08.0	SV-NWV	EH	mit Dichtring with O-ring USA, Kanada USA, Kanada 2013 2013 2017 2017
1.8 101-103 kW (136-140 PS) LWE	07.2015→	 PIERBURG	7.06117.08.0	SV-NWV	EH	mit Dichtring with O-ring USA, Kanada USA, Kanada 2013 2013 2017 2017
1.8 Flexfuel 101-106 kW (136-144 PS) LUW	09.2013→07.2015	 PIERBURG	7.06117.08.0	SV-NWV	EH	mit Dichtring with O-ring USA, Kanada USA, Kanada 2012 2012 2017 2017
1.8 Flexfuel 101-106 kW (136-144 PS) LUW	07.2015→	 PIERBURG	7.06117.08.0	SV-NWV	EH	mit Dichtring with O-ring USA, Kanada USA, Kanada 2012 2012 2017 2017

AVEO Saloon (T300) **4**

1.2 63-65 kW (86-88 PS) LDC	03.2011→	 PIERBURG	7.02256.43.0	EUV-SR	EL	2012 2012
			7.02256.45.0	EUV-SR	EL	2012 2012
1.2 51 kW (69 PS) LWD	03.2011→	 PIERBURG	7.02256.43.0	EUV-SR	EL	2012 2012
			7.02256.45.0	EUV-SR	EL	2012 2012
1.2 LPG 63-65 kW (86-88 PS) LDC	11.2012→12.2015	 PIERBURG	7.02256.43.0	EUV-SR	EL	2012 2012
			7.02256.45.0	EUV-SR	EL	2012 2012
1.3 D 55-57 kW (75-78 PS) LDV	07.2011→12.2015	 PIERBURG	7.03073.01.0	DW-TL	EP	2012 2012 2015 2015
			7.01981.07.0	SV-AGR-K	EP	2012 2012 2015 2015
1.3 D 70 kW (95 PS) LSF	07.2011→12.2015	 PIERBURG	7.03073.01.0	DW-TL	EP	2012 2012 2015 2015
			7.01981.07.0	SV-AGR-K	EP	2012 2012 2015 2015
1.4 103 kW (140 PS) LUV	09.2011→	 PIERBURG	7.06117.07.0	ZM-NWV	EL	mit Dichtring with O-ring USA, Kanada USA, Kanada

					
AVEO Saloon (T300)					
1.6 83-91 kW (113-124 PS) LDE	03.2011→		7.02256.43.0	EUV-SR	EL
			7.02256.45.0	EUV-SR	EL
			7.06117.08.0	SV-NWV	EH
					mit Dichtring with O-ring 2019 2019
1.8 101-103 kW (136-140 PS) LWE	09.2011→07.2015		7.06117.08.0	SV-NWV	EH
					mit Dichtring with O-ring USA, Kanada USA, Kanada 2013 2013 2017 2017
1.8 101-103 kW (136-140 PS) LWE	07.2015→		7.06117.08.0	SV-NWV	EH
					mit Dichtring with O-ring USA, Kanada USA, Kanada 2013 2013 2017 2017
1.8 Flexfuel 101-106 kW (136-144 PS) LUW	09.2013→07.2015		7.06117.08.0	SV-NWV	EH
					mit Dichtring with O-ring USA, Kanada USA, Kanada 2012 2012 2017 2017
1.8 Flexfuel 101-106 kW (136-144 PS) LUW	07.2015→		7.06117.08.0	SV-NWV	EH
					mit Dichtring with O-ring USA, Kanada USA, Kanada 2012 2012 2017 2017
CAMARO					
2.0 Turbo 175-205 kW (253-276 PS) LTG	09.2015→		7.03381.15.0	SUV	EL
2.0 Turbo 175-205 kW (253-276 PS) LTG	09.2015→		7.03357.04.0	LDRV	EL
			7.06117.56.0	SV-NWV	EH
			7.06117.57.0	SV-NWV	EH
					mit Dichtring with O-ring 2016 2016 mit Dichtring with O-ring 2016 2016
2.0 Turbo 175-205 kW (253-276 PS) LTG	01.2016→		7.03357.04.0	LDRV	EL
2.0 Turbo 175-205 kW (253-276 PS) LTG	01.2016→		7.03357.04.0	LDRV	EL
2.0 Turbo 175-205 kW (253-276 PS) LTG	08.2016→		7.03357.04.0	LDRV	EL





















CAMARO **5**

C

3.6 204-233 kW (277-317 PS) LLT	02.2009→01.2012	 7.06117.04.0	SV-NWV	EH	mit Wellendichtring With shaft sealing ring 2010 2010 2011 2011
3.6 204-233 kW (277-317 PS) LLT	09.2009→12.2010	 7.06117.04.0	SV-NWV	EH	mit Wellendichtring With shaft sealing ring 2010 2010 2011 2011
3.6 204-233 kW (277-317 PS) LLT	09.2009→12.2010	 7.06117.04.0	SV-NWV	EH	mit Wellendichtring With shaft sealing ring 2010 2010 2011 2011
3.6 204-233 kW (277-317 PS) LLT	01.2011→12.2015	 7.06117.04.0	SV-NWV	EH	mit Wellendichtring With shaft sealing ring 2010 2010 2011 2011
3.6 204-233 kW (277-317 PS) LLT	04.2011→12.2011	 7.06117.04.0	SV-NWV	EH	mit Wellendichtring With shaft sealing ring 2010 2010 2011 2011
3.6 224-241 kW (305-328 PS) LFX	09.2011→12.2015	 7.06117.04.0	SV-NWV	EH	mit Wellendichtring With shaft sealing ring 2012 2012 2015 2015

CAMARO Convertible **6**





2.0 Turbo 175-205 kW (253-276 PS) LTG	09.2015→	 7.03357.04.0	LDRV	EL	
		7.06117.56.0	SV-NWV	EH	mit Dichtring with O-ring 2016 2016
		7.06117.57.0	SV-NWV	EH	mit Dichtring with O-ring 2016 2016
2.0 Turbo 175-205 kW (253-276 PS) LTG	08.2016→	 7.03357.04.0	LDRV	EL	
3.6 204-233 kW (277-317 PS) LLT	01.2011→12.2011	 7.06117.04.0	SV-NWV	EH	mit Wellendichtring With shaft sealing ring 2010 2010 2011 2011

					
CAMARO Convertible					
6					
3.6 204-233 kW (277-317 PS) LLT	01.2011→		7.06117.04.0	SV-NWV	EH mit Wellendichtring With shaft sealing ring 2010 2010 2011 2011
3.6 224-241 kW (305-328 PS) LFX	09.2011→		7.06117.04.0	SV-NWV	EH mit Wellendichtring With shaft sealing ring 2012 2012 2015 2015
CAPTIVA (C100, C140)					
7					
2.4 119-137 kW (162-186 PS) LE9(145CUL4)	01.2011→		7.06117.05.0	SV-NWV	EH mit Dichtring with O-ring
			7.06117.06.0	SV-NWV	EH mit Dichtring with O-ring
2.4 111-130 kW (149-177 PS) LE5	03.2011→		7.06117.05.0	SV-NWV	EH mit Dichtring with O-ring
			7.06117.06.0	SV-NWV	EH mit Dichtring with O-ring
2.4 119-137 kW (162-186 PS) LE9(145CUL4)	11.2012→		7.06117.05.0	SV-NWV	EH mit Dichtring with O-ring
			7.06117.06.0	SV-NWV	EH mit Dichtring with O-ring
2.4 4WD 111-130 kW (149-177 PS) LE5	03.2011→		7.06117.05.0	SV-NWV	EH mit Dichtring with O-ring
			7.06117.06.0	SV-NWV	EH mit Dichtring with O-ring
2.4 4WD 119-137 kW (162-186 PS) LE9(145CUL4)	11.2012→		7.06117.05.0	SV-NWV	EH mit Dichtring with O-ring
			7.06117.06.0	SV-NWV	EH mit Dichtring with O-ring
3.0 4WD 190-197 kW (258-268 PS) LF1	11.2010→09.2018		7.06117.04.0	SV-NWV	EH mit Wellendichtring With shaft sealing ring 2011 2011
3.0 4WD 186-197 kW (253-268 PS) LFW	09.2011→10.2013		7.06117.04.0	SV-NWV	EH mit Wellendichtring With shaft sealing ring 2012 2012 2017 2017
3.0 4WD 186-197 kW (253-268 PS) LFW	01.2012→		7.06117.04.0	SV-NWV	EH mit Wellendichtring With shaft sealing ring 2012 2012 2017 2017
CAPTIVA SPORT					
8					
2.4 130-136 kW (174-185 PS) LEA	01.2012→		7.06117.05.0	SV-NWV	EH mit Dichtring with O-ring
			7.06117.06.0	SV-NWV	EH mit Dichtring with O-ring
2.4 130-136 kW (174-185 PS) LAF, LEA	01.2012→		7.06117.05.0	SV-NWV	EH mit Dichtring with O-ring
			7.06117.06.0	SV-NWV	EH mit Dichtring with O-ring
2.4 FLEX 130-136 kW (174-185 PS) LEA	09.2011→12.2013		7.06117.05.0	SV-NWV	EH mit Dichtring with O-ring
			7.06117.06.0	SV-NWV	EH mit Dichtring with O-ring





CAPTIVA SPORT **8**

C





















2.4 FLEX 130-136 kW (174-185 PS) LEA	09.2013→		7.06117.05.0	SV-NWV	EH	mit Dichtring with O-ring
			7.06117.06.0	SV-NWV	EH	mit Dichtring with O-ring
3.0 190-197 kW (258-268 PS) LF1	01.2012→		7.06117.04.0	SV-NWV	EH	mit Wellendichtring With shaft sealing ring 2011 2011
			7.06117.04.0	SV-NWV	EH	mit Wellendichtring With shaft sealing ring 2011 2011
3.0 AWD 190-197 kW (258-268 PS) LF1	01.2012→		7.06117.04.0	SV-NWV	EH	mit Wellendichtring With shaft sealing ring 2011 2011
			7.06117.04.0	SV-NWV	EH	mit Wellendichtring With shaft sealing ring 2011 2011
3.0 FLEX 186-197 kW (253-268 PS) LFW	09.2011→		7.06117.04.0	SV-NWV	EH	mit Wellendichtring With shaft sealing ring 2012 2012 2017 2017
			7.06117.04.0	SV-NWV	EH	mit Wellendichtring With shaft sealing ring 2012 2012 2017 2017
3.0 FLEX AWD 186-197 kW (253-268 PS) LFW	09.2011→		7.06117.04.0	SV-NWV	EH	mit Wellendichtring With shaft sealing ring 2012 2012 2017 2017
			7.06117.04.0	SV-NWV	EH	mit Wellendichtring With shaft sealing ring 2012 2012 2017 2017

COBALT **9**

2.0 SS 186-194 kW (253-264 PS) LNF	09.2008→12.2009		5.02549.03.0*	EUV-VB	EL	mit Halter with holder 2008 2008 2010 2010
			↳ 7.01441.04.0	EUV-VB	EL	
			7.02721.06.0*	EUV-VB	EL	mit Halter with holder 2010 2010
			↳ 7.01441.04.0	EUV-VB	EL	
2.2 116 kW (158 PS) LAP	09.2008→12.2010		7.06117.05.0	SV-NWV	EH	mit Dichtring with O-ring
			7.06117.06.0	SV-NWV	EH	mit Dichtring with O-ring
2.4 111-130 kW (149-177 PS) LE5	07.2004→		7.06117.05.0	SV-NWV	EH	mit Dichtring with O-ring
			7.06117.06.0	SV-NWV	EH	mit Dichtring with O-ring

COBALT Coupe **10**

2.0 SS 186-194 kW (253-264 PS) LNF	09.2008→12.2010		5.02549.03.0*	EUV-VB	EL	mit Halter with holder 2008 2008 2010 2010
			↳ 7.01441.04.0	EUV-VB	EL	
			7.02721.06.0*	EUV-VB	EL	mit Halter with holder 2010 2010





						
COBALT Coupe					10	
			↳ 7.01441.04.0	EUV-VB	EL	
			7.06117.05.0	SV-NWV	EH	mit Dichtring with O-ring
			7.06117.06.0	SV-NWV	EH	mit Dichtring with O-ring
2.2 116 kW (158 PS) LAP	09.2008→12.2010		7.06117.05.0	SV-NWV	EH	mit Dichtring with O-ring
			7.06117.06.0	SV-NWV	EH	mit Dichtring with O-ring
2.4 111-130 kW (149-177 PS) LE5	07.2004→12.2008		7.06117.05.0	SV-NWV	EH	mit Dichtring with O-ring
			7.06117.06.0	SV-NWV	EH	mit Dichtring with O-ring
COLORADO					11	
2.8 D (7, K) 103 kW (140 PS) LLK(171CUL4)	08.2005→12.2012		7.03964.01.0	DW-TL	EP	
2.8 D 4x4 (7) 103 kW (140 PS) LLK	01.2006→		7.03964.01.0	DW-TL	EP	
COLORADO Crew Cab Pickup					12	
2.5 142-152 kW (193-206 PS) LCV	09.2014→		7.06117.56.0	SV-NWV	EH	mit Dichtring with O-ring 2015
			7.06117.57.0	SV-NWV	EH	mit Dichtring with O-ring 2015
2.5 4WD 142-152 kW (193-206 PS) LCV	09.2014→		7.06117.56.0	SV-NWV	EH	mit Dichtring with O-ring 2015
			7.06117.57.0	SV-NWV	EH	mit Dichtring with O-ring 2015
2.8 130-131 kW (177-178 PS) LK5	09.2006→12.2006		7.06117.03.0	SV-NWV	EH	mit Dichtring with O-ring
2.8 4WD 130-131 kW (177-178 PS) LK5	09.2003→12.2006		7.06117.03.0	SV-NWV	EH	mit Dichtring with O-ring
2.8 D 135-149 kW (184-203 PS) LWN	09.2015→		7.02256.44.0	EUV-AGR	EL	
2.8 D 4WD 135-149 kW (184-203 PS) LWN	09.2015→		7.02256.44.0	EUV-AGR	EL	
2.9 138 kW (188 PS) LLV	09.2006→12.2012		7.06117.03.0	SV-NWV	EH	mit Dichtring with O-ring
2.9 4WD 138 kW (188 PS) LLV	09.2006→12.2012		7.06117.03.0	SV-NWV	EH	mit Dichtring with O-ring
3.5 164 kW (223 PS) L52	09.2003→12.2006		7.06117.03.0	SV-NWV	EH	mit Dichtring with O-ring
3.5 4WD 164 kW (223 PS) L52	09.2003→12.2006		7.06117.03.0	SV-NWV	EH	mit Dichtring with O-ring
3.6 224-241 kW (305-328 PS) LFX	09.2014→		7.06117.04.0	SV-NWV	EH	mit Wellendichtring With shaft sealing ring 2015 2015 2016 2016

C



































COLORADO Crew Cab Pickup **12**

C

3.6 224-241 kW (305-328 PS) LFX	09.2014→		7.06117.04.0	SV-NWV	EH	mit Wellendichtring With shaft sealing ring 2015 2015 2016 2016
3.6 4WD 224-241 kW (305-328 PS) LFX	09.2014→		7.06117.04.0	SV-NWV	EH	mit Wellendichtring With shaft sealing ring 2015 2015 2016 2016
3.6 4WD 224-241 kW (305-328 PS) LFX	09.2014→		7.06117.04.0	SV-NWV	EH	mit Wellendichtring With shaft sealing ring 2015 2015 2016 2016
3.7 180 kW (245 PS) LLR	09.2006→12.2012		7.06117.03.0	SV-NWV	EH	mit Dichtring with O-ring
3.7 4WD 180 kW (245 PS) LLR	09.2006→12.2012		7.06117.03.0	SV-NWV	EH	mit Dichtring with O-ring

COLORADO Extended Cab Pickup **13**

2.5 142-152 kW (193-206 PS) LCV	09.2014→		7.06117.56.0	SV-NWV	EH	mit Dichtring with O-ring 2015 2015
			7.06117.57.0	SV-NWV	EH	mit Dichtring with O-ring 2015 2015
2.5 4WD 142-152 kW (193-206 PS) LCV	09.2014→		7.06117.56.0	SV-NWV	EH	mit Dichtring with O-ring 2015 2015
			7.06117.57.0	SV-NWV	EH	mit Dichtring with O-ring 2015 2015
2.8 130-131 kW (177-178 PS) LK5	09.2003→12.2006		7.06117.03.0	SV-NWV	EH	mit Dichtring with O-ring
2.8 4WD 130-131 kW (177-178 PS) LK5	09.2003→12.2006		7.06117.03.0	SV-NWV	EH	mit Dichtring with O-ring
2.8 D 135-149 kW (184-203 PS) LWN	09.2015→		7.02256.44.0	EUV-AGR	EL	
2.8 D 4WD 135-149 kW (184-203 PS) LWN	09.2015→		7.02256.44.0	EUV-AGR	EL	
2.9 138 kW (188 PS) LLV	09.2006→12.2012		7.06117.03.0	SV-NWV	EH	mit Dichtring with O-ring
2.9 4WD 138 kW (188 PS) LLV	09.2006→12.2012		7.06117.03.0	SV-NWV	EH	mit Dichtring with O-ring
3.5 164 kW (223 PS) L52	09.2003→12.2006		7.06117.03.0	SV-NWV	EH	mit Dichtring with O-ring
3.5 4WD 164 kW (223 PS) L52	09.2003→12.2006		7.06117.03.0	SV-NWV	EH	mit Dichtring with O-ring
3.6 224-241 kW (305-328 PS) LFX	09.2014→		7.06117.04.0	SV-NWV	EH	mit Wellendichtring With shaft sealing ring 2015 2015 2016 2016

						
COLORADO Extended Cab Pickup						13
3.6 224-241 kW (305-328 PS) LFX	09.2014→		7.06117.04.0	SV-NWV	EH mit Wellendichtring With shaft sealing ring 2015 2015 2016 2016	
3.6 4WD 224-241 kW (305-328 PS) LFX	09.2014→		7.06117.04.0	SV-NWV	EH mit Wellendichtring With shaft sealing ring 2015 2015 2016 2016	
3.6 4WD 224-241 kW (305-328 PS) LFX	09.2014→		7.06117.04.0	SV-NWV	EH mit Wellendichtring With shaft sealing ring 2015 2015 2016 2016	
3.7 180 kW (245 PS) LLR	09.2006→12.2012		7.06117.03.0	SV-NWV	EH mit Dichtring with O-ring	
3.7 4WD 180 kW (245 PS) LLR	09.2006→12.2012		7.06117.03.0	SV-NWV	EH mit Dichtring with O-ring	
COLORADO Standard Cab Pickup						14
2.8 130-131 kW (177-178 PS) LK5	09.2003→12.2006		7.06117.03.0	SV-NWV	EH mit Dichtring with O-ring	
2.8 4WD 130-131 kW (177-178 PS) LK5	09.2003→12.2006		7.06117.03.0	SV-NWV	EH mit Dichtring with O-ring	
2.9 138 kW (188 PS) LLV	09.2006→12.2012		7.06117.03.0	SV-NWV	EH mit Dichtring with O-ring	
2.9 4WD 138 kW (188 PS) LLV	09.2006→12.2012		7.06117.03.0	SV-NWV	EH mit Dichtring with O-ring	
3.5 164 kW (223 PS) L52	09.2003→12.2006		7.06117.03.0	SV-NWV	EH mit Dichtring with O-ring	
3.5 4WD 164 kW (223 PS) L52	09.2003→12.2006		7.06117.03.0	SV-NWV	EH mit Dichtring with O-ring	
3.7 180 kW (245 PS) LLR	09.2006→12.2012		7.06117.03.0	SV-NWV	EH mit Dichtring with O-ring	
3.7 4WD 180 kW (245 PS) LLR	09.2006→12.2012		7.06117.03.0	SV-NWV	EH mit Dichtring with O-ring	
CRUZE (J300)						15
1.4 103 kW (140 PS) LUJ	09.2010→		7.03833.02.0	EUV-VB	EL	
			7.06117.07.0	ZM-NWV	EL mit Dichtring with O-ring	
1.6 83-91 kW (113-124 PS) LDE	05.2009→		7.02256.38.0	AKF	EL	
			7.02256.43.0	EUV-SR	EL	
			7.02256.45.0	EUV-SR	EL	
			7.06117.08.0	SV-NWV	EH mit Dichtring with O-ring 2017 2017	
1.6 83-91 kW (113-124 PS) LDE	05.2009→		7.02256.43.0	EUV-SR	EL	
			7.02256.45.0	EUV-SR	EL	
			7.06117.08.0	SV-NWV	EH mit Dichtring with O-ring 2010 2010 2017 2017	





















C



CRUZE (J300) **15**

C

1.6 83-91 kW (113-124 PS) LDE	12.2012→		7.06117.08.0	SV-NWV	EH	mit Dichtring with O-ring 2017 2017
1.7 D 96 kW (131 PS) LUD	01.2012→		7.03073.01.0	DW-TL	EP	2012 2012 2014 2014
			7.02461.01.0	EUV-LS	EL	Produktionsdatum bis: 31.12.2014 Production date to: 31.12.2014
1.7 TD 81 kW (110 PS) LKR	11.2013→		7.03073.01.0	DW-TL	EP	
			7.02461.01.0	EUV-LS	EL	Produktionsdatum bis: 31.12.2014 Production date to: 31.12.2014
1.8 101-103 kW (136-140 PS) LWE	05.2009→		7.06117.08.0	SV-NWV	EH	mit Dichtring with O-ring USA, Kanada USA, Canada 2013 2013 2016 2016
1.8 102-106 kW (139-144 PS) 2H0	05.2009→		7.06117.08.0	SV-NWV	EH	mit Dichtring with O-ring 2017 2017
1.8 101-103 kW (136-140 PS) LWE	11.2009→		7.06117.08.0	SV-NWV	EH	mit Dichtring with O-ring USA, Kanada USA, Canada 2013 2013 2016 2016
1.8 Flex 101-106 kW (136-144 PS) LUW	09.2013→		7.06117.08.0	SV-NWV	EH	mit Dichtring with O-ring USA, Kanada USA, Canada 2011 2011 2016 2016
1.8 Flex 101-106 kW (136-144 PS) LUW	08.2015→		7.06117.08.0	SV-NWV	EH	mit Dichtring with O-ring USA, Kanada USA, Canada 2011 2011 2016 2016
1.8 LPG 102-106 kW (139-144 PS) 2H0	06.2011→		7.06117.08.0	SV-NWV	EH	mit Dichtring with O-ring 2010 2010 2017 2017
2.0 CDI 110-113 kW (150-154 PS) LUZ	09.2013→		7.03978.01.0	DW-TL	EP	2014 2014 2015 2015
2.0 CDI 110-113 kW (150-154 PS) LUZ	09.2013→12.2015		7.03978.01.0	DW-TL	EP	2014 2014 2015 2015





						
CRUZE Hatchback						16
1.4 110-114 kW (150-155 PS) LE2(85CUL4)	01.2017→		7.03351.12.0	LDRV	EP	Baujahr bis: 12.2019 Construction year to: 12.2019 USA, Kanada USA, Kanada
1.4 Flex 110-114 kW (150-155 PS) LE2(85CUL4)	01.2017→		7.03351.12.0	LDRV	EP	Baujahr bis: 12.2019 Construction year to: 12.2019 USA, Kanada USA, Kanada
CRUZE Hatchback (J305)						17
1.4 103 kW (140 PS) LUJ	06.2012→		7.03833.02.0	EUV-VB	EL	
			7.06117.07.0	ZM-NWV	EL	mit Dichtring with O-ring
1.6 83-91 kW (113-124 PS) LDE	06.2011→		7.02256.43.0	EUV-SR	EL	
			7.02256.45.0	EUV-SR	EL	
			7.06117.08.0	SV-NWV	EH	mit Dichtring with O-ring
1.6 83-91 kW (113-124 PS) LDE	12.2012→		7.02256.43.0	EUV-SR	EL	
			7.02256.45.0	EUV-SR	EL	
			7.06117.08.0	SV-NWV	EH	mit Dichtring with O-ring
1.6 83-91 kW (113-124 PS) LDE	12.2012→		7.06117.08.0	SV-NWV	EH	mit Dichtring with O-ring
1.7 D 96 kW (131 PS) LUD	01.2012→12.2015		7.03073.01.0	DW-TL	EP	2012 2012 2014 2014
			7.02461.01.0	EUV-LS	EL	Produktionsdatum bis: 31.12.2014 Production date to: 31.12.2014
1.7 TD 81 kW (110 PS) LKR	08.2013→12.2015		7.03073.01.0	DW-TL	EP	
			7.02461.01.0	EUV-LS	EL	Produktionsdatum bis: 31.12.2014 Production date to: 31.12.2014
1.8 102-106 kW (139-144 PS) 2H0	06.2011→		7.06117.08.0	SV-NWV	EH	mit Dichtring with O-ring
1.8 102-106 kW (139-144 PS) 2H0	10.2011→		7.06117.08.0	SV-NWV	EH	mit Dichtring with O-ring
1.8 LPG 102-106 kW (139-144 PS) 2H0	06.2011→12.2015		7.06117.08.0	SV-NWV	EH	mit Dichtring with O-ring 2017 2017
CRUZE Saloon						18
1.4 110-114 kW (150-155 PS) LE2(85CUL4)	11.2015→		7.03351.12.0	LDRV	EP	Baujahr bis: 12.2019 Construction year to: 12.2019 USA, Kanada USA, Kanada
1.4 Flex 110-114 kW (150-155 PS) LE2(85CUL4)	01.2017→		7.03351.12.0	LDRV	EP	Baujahr bis: 12.2019 Construction year to: 12.2019 USA, Kanada USA, Kanada
CDTi 99 kW (135 PS) B 16 DTH	11.2015→		7.08681.01.0	EOV	EH	
			7.02256.44.0	EUV-AGR	EL	
CRUZE Station Wagon (J308)						19
1.4 103 kW (140 PS) LUJ	08.2012→		7.03833.02.0	EUV-VB	EL	
			7.06117.07.0	ZM-NWV	EL	mit Dichtring with O-ring

C











CRUZE Station Wagon (J308) **19**

C

1.6 83-91 kW (113-124 PS) LDE	08.2012→12.2015		7.02256.38.0	AKF	EL	mit Dichtring with O-ring 2016 2016
			7.02256.43.0	EUV-SR	EL	
			7.02256.45.0	EUV-SR	EL	
			7.06117.08.0	SV-NWV	EH	
1.6 83-91 kW (113-124 PS) LDE	12.2012→12.2015		7.02256.38.0	AKF	EL	mit Dichtring with O-ring 2016 2016
			7.02256.43.0	EUV-SR	EL	
			7.02256.45.0	EUV-SR	EL	
			7.06117.08.0	SV-NWV	EH	
1.7 TD 96 kW (131 PS) LUD	08.2012→		7.03073.01.0	DW-TL	EP	2013 2013 2014 2014
1.7 TD 81 kW (110 PS) LKR	11.2013→12.2015		7.03073.01.0	DW-TL	EP	Produktionsdatum bis: 31.12.2014 Production date to: 31.12.2014
			7.02461.01.0	EUV-LS	EL	
1.8 102-106 kW (139-144 PS) 2H0	08.2012→		7.06117.08.0	SV-NWV	EH	mit Dichtring with O-ring 2016 2016

EQUINOX **20**

2.0 175-205 kW (253-276 PS) LTG	03.2017→		7.03357.04.0	LDRV	EL	
2.0 AWD 175-205 kW (253-276 PS) LTG	03.2017→		7.03357.04.0	LDRV	EL	
2.0 LT 175-205 kW (253-276 PS) LTG	03.2017→		7.03357.04.0	LDRV	EL	
2.0 LT AWD 175-205 kW (253-276 PS) LTG	03.2017→		7.03357.04.0	LDRV	EL	
2.4 130-136 kW (174-185 PS) LAF, LEA	09.2009→12.2017		7.06117.05.0	SV-NWV	EH	mit Dichtring with O-ring
			7.06117.06.0	SV-NWV	EH	
2.4 AWD 130-136 kW (174-185 PS) LAF, LEA	09.2009→12.2017		7.06117.05.0	SV-NWV	EH	mit Dichtring with O-ring
			7.06117.06.0	SV-NWV	EH	
2.4 FLEX 130-136 kW (174-185 PS) LEA	09.2011→12.2017		7.06117.05.0	SV-NWV	EH	mit Dichtring with O-ring
			7.06117.06.0	SV-NWV	EH	
2.4 FLEX AWD 130-136 kW (174-185 PS) LEA	09.2011→12.2017		7.06117.05.0	SV-NWV	EH	mit Dichtring with O-ring
			7.06117.06.0	SV-NWV	EH	
3.0 190-197 kW (258-268 PS) LF1	09.2009→12.2010		7.06117.04.0	SV-NWV	EH	mit Wellendichtring With shaft sealing ring 2010 2010



EQUINOX 20

3.0 AWD 190-197 kW (258-268 PS) LF1	09.2009→12.2012	 7.06117.04.0	SV-NWV	EH	mit Wellendichtring With shaft sealing ring 2010 2010
3.0 FLEX 186-197 kW (253-268 PS) LFW	09.2010→12.2012	 7.06117.04.0	SV-NWV	EH	mit Wellendichtring With shaft sealing ring 2011 2011 2012 2012
3.0 FLEX AWD 186-197 kW (253-268 PS) LFW	09.2010→12.2012	 7.06117.04.0	SV-NWV	EH	mit Wellendichtring With shaft sealing ring 2011 2011 2012 2012
3.6 147-204 kW (200-277 PS) LY7	09.2007→12.2009	 7.06117.04.0	SV-NWV	EH	mit Wellendichtring With shaft sealing ring 2008 2008 2009 2009
3.6 224-241 kW (305-328 PS) LFX	07.2013→12.2017	 7.06117.04.0	SV-NWV	EH	mit Wellendichtring With shaft sealing ring 2013 2013 2017 2017
3.6 AWD 147-204 kW (200-277 PS) LY7	09.2007→12.2009	 7.06117.04.0	SV-NWV	EH	mit Wellendichtring With shaft sealing ring 2008 2008 2009 2009
3.6 AWD 224-241 kW (305-328 PS) LFX	07.2013→12.2017	 7.06117.04.0	SV-NWV	EH	mit Wellendichtring With shaft sealing ring 2013 2013 2017 2017
3.6 FLEX 224-241 kW (305-328 PS) LFX	09.2012→12.2017	 7.06117.04.0	SV-NWV	EH	mit Wellendichtring With shaft sealing ring 2013 2013 2017 2017
3.6 FLEX AWD 224-241 kW (305-328 PS) LFX	09.2012→12.2017	 7.06117.04.0	SV-NWV	EH	mit Wellendichtring With shaft sealing ring 2013 2013 2017 2017

HHR 21

2.0 Turbo 186-194 kW (253-264 PS) LNF	08.2007→12.2010	 5.02549.03.0*	EUV-VB	EL	mit Halter with holder 2008 2008 2010 2010
		↳7.01441.04.0	EUV-VB	EL	
		7.02721.06.0*	EUV-VB	EL	mit Halter with holder 2010 2010
		↳7.01441.04.0 7.06117.05.0	EUV-VB SV-NWV	EL EH	mit Dichtring with O-ring





HHR **21**

C





			7.06117.06.0	SV-NWV	EH	mit Dichtring with O-ring
2.2 Flexfuel 116-120 kW (158-163 PS) LE8(134CUL4)	09.2008→12.2010		7.06117.05.0	SV-NWV	EH	mit Dichtring with O-ring
			7.06117.06.0	SV-NWV	EH	mit Dichtring with O-ring
2.2 Flexfuel 116-120 kW (158-163 PS) LE8(134CUL4)	09.2010→12.2011		7.06117.05.0	SV-NWV	EH	mit Dichtring with O-ring
			7.06117.06.0	SV-NWV	EH	mit Dichtring with O-ring
2.4 111-130 kW (149-177 PS) LE5	01.2006→12.2011		7.06117.05.0	SV-NWV	EH	mit Dichtring with O-ring
			7.06117.06.0	SV-NWV	EH	mit Dichtring with O-ring
2.4 111-130 kW (149-177 PS) LE5	09.2006→12.2007		7.06117.05.0	SV-NWV	EH	mit Dichtring with O-ring
			7.06117.06.0	SV-NWV	EH	mit Dichtring with O-ring
2.4 111-130 kW (149-177 PS) LE5	10.2007→12.2011		7.06117.05.0	SV-NWV	EH	mit Dichtring with O-ring
			7.06117.06.0	SV-NWV	EH	mit Dichtring with O-ring
2.4 Flexfuel 119-137 kW (162-186 PS) LE9(145CUL4)	09.2008→12.2009		7.06117.05.0	SV-NWV	EH	mit Dichtring with O-ring
			7.06117.06.0	SV-NWV	EH	mit Dichtring with O-ring
2.4 Flexfuel 119-137 kW (162-186 PS) LE9(145CUL4)	09.2009→12.2011		7.06117.05.0	SV-NWV	EH	mit Dichtring with O-ring
			7.06117.06.0	SV-NWV	EH	mit Dichtring with O-ring

IMPALA Saloon **22**

2.5 FLEX 142-152 kW (193-206 PS) LCV	06.2015→		7.06117.56.0	SV-NWV	EH	mit Dichtring with O-ring 2016 2016 2019 2019
			7.06117.57.0	SV-NWV	EH	mit Dichtring with O-ring 2016 2016 2019 2019
3.6 224-241 kW (305-328 PS) LFX	09.2011→12.2013		7.06117.04.0	SV-NWV	EH	mit Wellendichtring With shaft sealing ring 2012 2012 2013 2013
3.6 224-241 kW (305-328 PS) LFX	07.2013→12.2014		7.06117.04.0	SV-NWV	EH	mit Wellendichtring With shaft sealing ring 2014 2014 2016 2016







IMPALA Saloon 22

3.6 FLEX 224-241 kW (305-328 PS) LFX	07.2013→		7.06117.04.0	SV-NWV	EH	mit Wellendichtring With shaft sealing ring 2014 2014 2016 2016
	07.2013→		7.06117.04.0	SV-NWV	EH	mit Wellendichtring With shaft sealing ring 2014 2014 2016 2016
	07.2013→12.2014		7.06117.04.0	SV-NWV	EH	mit Wellendichtring With shaft sealing ring 2014 2014 2016 2016
	09.2011→12.2013		7.06117.04.0	SV-NWV	EH	mit Wellendichtring With shaft sealing ring 2012 2012 2013 2013

C

MALIBU 23











2.0 175-205 kW (253-276 PS) LTG	09.2012→		7.03357.04.0	LDRV	EL	
			7.06117.56.0	SV-NWV	EH	mit Dichtring with O-ring 2013 2013 2015 2015
			7.06117.57.0	SV-NWV	EH	mit Dichtring with O-ring 2013 2013 2015 2015
2.0 175-205 kW (253-276 PS) LTG	09.2015→		7.03357.04.0	LDRV	EL	
			7.06117.56.0	SV-NWV	EH	mit Dichtring with O-ring 2016 2016
			7.06117.57.0	SV-NWV	EH	mit Dichtring with O-ring 2016 2016
2.4 111-130 kW (149-177 PS) LE5	01.2008→12.2012		7.06117.05.0	SV-NWV	EH	mit Dichtring with O-ring
			7.06117.06.0	SV-NWV	EH	mit Dichtring with O-ring
2.4 111-130 kW (149-177 PS) LE5	01.2012→		7.06117.05.0	SV-NWV	EH	mit Dichtring with O-ring
			7.06117.06.0	SV-NWV	EH	mit Dichtring with O-ring
2.4 Flexfuel 119-137 kW (162-186 PS) LE9(145CUL4)	09.2009→12.2012		7.06117.05.0	SV-NWV	EH	mit Dichtring with O-ring

























MALIBU **23**

C			7.06117.06.0	SV-NWV	EH	mit Dichtring with O-ring
	3.6 147-204 kW (200-277 PS) LY7	01.2008→12.2012	7.06117.04.0 	SV-NWV	EH	mit Wellendichtring With shaft sealing ring 2007 2007 2012 2012

MALIBU (V300) **24**

2.0 175-205 kW (253-276 PS) LTG	01.2012→12.2015		7.03357.04.0	LDRV	EL	
			7.06117.56.0	SV-NWV	EH	mit Dichtring with O-ring 2013 2013 2015 2015
			7.06117.57.0	SV-NWV	EH	mit Dichtring with O-ring 2013 2013 2015 2015
2.0 D 115-118 kW (160 PS) LBS	04.2012→		7.01420.02.0	DW-TL	EP	
			7.03978.01.0	DW-TL	EP	2012 2012 2015 2015
2.4 119-137 kW (162-186 PS) LE9(145CUL4)	01.2012→		7.06117.05.0	SV-NWV	EH	mit Dichtring with O-ring
			7.06117.06.0	SV-NWV	EH	mit Dichtring with O-ring
2.4 119-137 kW (162-186 PS) LE9(145CUL4)	01.2012→		7.06117.05.0	SV-NWV	EH	mit Dichtring with O-ring
			7.06117.06.0	SV-NWV	EH	mit Dichtring with O-ring
2.5 137-152 kW (193-206 PS) LCV, LKW	07.2013→		7.06117.56.0	SV-NWV	EH	mit Dichtring with O-ring  LCV: 2013 2013 2016 2016  LKW: 2014 2014 2015 2015
			7.06117.57.0	SV-NWV	EH	mit Dichtring with O-ring  LCV: 2013 2013 2016 2016  LKW: 2014 2014 2015 2015
			7.06117.04.0	SV-NWV	EH	mit Wellendichtring With shaft sealing ring 2012 2012 2015 2015
3.0 186-197 kW (253-268 PS) LFW	04.2013→		7.06117.04.0	SV-NWV	EH	mit Wellendichtring With shaft sealing ring 2012 2012 2015 2015

						
MALIBU IV						25
2.0 Turbo 175-205 kW (253-276 PS) LTG	09.2012→		7.03381.15.0	SUV	EL	
ORLANDO (J309)						26
1.4 103 kW (140 PS) LUJ	06.2012→		7.03833.02.0	EUV-VB	EL	
1.8 102-106 kW (139-144 PS) 2H0	02.2011→		7.02256.43.0	EUV-SR	EL	mit Dichtring with O-ring
			7.02256.45.0	EUV-SR	EL	
7.06117.08.0	SV-NWV	EH				
1.8 LPG 102-106 kW (139-144 PS) 2H0	06.2011→12.2015		7.02256.43.0	EUV-SR	EL	
			7.02256.45.0	EUV-SR	EL	
S10 BLAZER						27
2.8 D 103 kW (140 PS) Y28DTC	01.2006→12.2009		7.03964.01.0	DW-TL	EP	
2.8 D 4WD 103 kW (140 PS) Y28DTC	08.2005→05.2009		7.03964.01.0	DW-TL	EP	
TRAVERSE						28
2.0 175-205 kW (253-276 PS) LTG	07.2017→		7.03357.04.0	LDRV	EL	
3.6 204-233 kW (277-317 PS) LLT	09.2008→		7.06117.04.0	SV-NWV	EH	mit Wellendichtring With shaft sealing ring 2009 2009 2017 2017
3.6 204-233 kW (277-317 PS) LLT	09.2008→		7.06117.04.0	SV-NWV	EH	mit Wellendichtring With shaft sealing ring 2009 2009 2017 2017
3.6 4WD 204-233 kW (277-317 PS) LLT	09.2008→		7.06117.04.0	SV-NWV	EH	mit Wellendichtring With shaft sealing ring 2009 2009 2017 2017
3.6 AWD 204-233 kW (277-317 PS) LLT	09.2008→		7.06117.04.0	SV-NWV	EH	mit Wellendichtring With shaft sealing ring 2009 2009 2017 2017
TRAX						29
1.4 103 kW (140 PS) LUJ	12.2012→		7.03833.02.0	EUV-VB	EL	
1.4 AWD 103 kW (140 PS) LUJ	12.2012→		7.03833.02.0	EUV-VB	EL	
1.4 Flex 110-114 kW (150-155 PS) LE2(85CUL4)	01.2017→		7.03351.12.0	LDRV	EP	Baujahr ab: 01.2019 Construction year from: 01.2019
1.4 LPG 103 kW (140 PS) LUJ	04.2013→		7.03833.02.0	EUV-VB	EL	
1.6 83-91 kW (113-124 PS) LDE	12.2012→		7.02256.38.0	AKF	EL	
			7.02256.43.0	EUV-SR	EL	
			7.02256.45.0	EUV-SR	EL	



TRAX **29**

C

			7.06117.08.0	SV-NWV	EH	mit Dichtring with O-ring 2015 2015
1.6 D 100 kW (136 PS) LVL	11.2014→12.2015		7.02256.44.0	EUV-AGR	EL	
1.7 TD 96 kW (131 PS) LUD	12.2012→		7.03073.01.0	DW-TL	EP	2013 2013 2015 2015
			7.02461.03.0	EUV-AGR	EL	
1.7 TD AWD 96 kW (131 PS) LUD	12.2012→		7.03073.01.0	DW-TL	EP	2013 2013 2015 2015
			7.02461.03.0	EUV-AGR	EL	
1.8 102-106 kW (139-144 PS) 2H0	03.2013→		7.02256.43.0	EUV-SR	EL	
			7.02256.45.0	EUV-SR	EL	
			7.06117.08.0	SV-NWV	EH	mit Dichtring with O-ring 2017 2017
1.8 AWD 102-106 kW (139-144 PS) 2H0	03.2013→		7.02256.43.0	EUV-SR	EL	
			7.02256.45.0	EUV-SR	EL	
			7.06117.08.0	SV-NWV	EH	mit Dichtring with O-ring 2017 2017

VOLT **30**

EV 150 54 kW (73 PS) LUU	11.2011→		7.06117.07.0	ZM-NWV	EL	mit Dichtring with O-ring
------------------------------------	----------	---	---------------------	--------	----	------------------------------

COLORADO Cab & Chassis **31**

2.8 130-131 kW (177-178 PS) LK5	09.2003→12.2006		7.06117.03.0	SV-NWV	EH	mit Dichtring with O-ring
2.9 138 kW (188 PS) LLV	09.2007→12.2012		7.06117.03.0	SV-NWV	EH	mit Dichtring with O-ring
2.9 4WD 138 kW (188 PS) LLV	09.2007→12.2012		7.06117.03.0	SV-NWV	EH	mit Dichtring with O-ring
3.5 164 kW (223 PS) L52	09.2003→12.2006		7.06117.03.0	SV-NWV	EH	mit Dichtring with O-ring
3.7 180 kW (245 PS) LLR	09.2007→12.2012		7.06117.03.0	SV-NWV	EH	mit Dichtring with O-ring
3.7 4WD 180 kW (245 PS) LLR	09.2007→12.2012		7.06117.03.0	SV-NWV	EH	mit Dichtring with O-ring

EXPRESS 2500 Extended Cargo Van **32**

2.8 D 135-149 kW (184-203 PS) LWN	11.2017→		7.02256.44.0	EUV-AGR	EL	
---	----------	---	---------------------	---------	----	--

EXPRESS 2500 Standard Cargo Van **33**

2.8 D 135-149 kW (184-203 PS) LWN	11.2017→		7.02256.44.0	EUV-AGR	EL	
---	----------	---	---------------------	---------	----	--



EXPRESS 2500 Standard Passenger Van **34**

2.8 D 135-149 kW (184-203 PS) LWN	11.2017→		7.02256.44.0	EUV-AGR	EL	
---	----------	---	---------------------	---------	----	--



















EXPRESS 3500 Cutaway Van **35**

2.8 D 135-149 kW (184-203 PS) LWN	11.2017→		7.02256.44.0	EUV-AGR	EL	
---	----------	---	---------------------	---------	----	--











EXPRESS 3500 Extended Cargo Van					36
2.8 D 135-149 kW (184-203 PS) LWN	11.2017->	 7.02256.44.0	EUV-AGR	EL	
EXPRESS 3500 Standard Cargo Van					37
2.8 D 135-149 kW (184-203 PS) LWN	11.2017->	 7.02256.44.0	EUV-AGR	EL	
EXPRESS 3500 Standard Passenger Van					38
2.8 D 135-149 kW (184-203 PS) LWN	11.2017->	 7.02256.44.0	EUV-AGR	EL	

C

			 PIERBURG			
AVEO Hatchback (SJ1)						1
C 1.6 86-89 kW (117-121 PS) LDE	05.2011→12.2017		7.02256.38.0	AKF	EL	mit Dichtring with O-ring
			7.06117.08.0	SV-NWV	EH	
AVEO Saloon (SJ1)						2
1.6 86-89 kW (117-121 PS) LDE	05.2011→12.2017		7.02256.38.0	AKF	EL	mit Dichtring with O-ring
			7.06117.08.0	SV-NWV	EH	
CAPTIVA (S7L)						3
2.4 105-131 kW (143-178 PS) LE5, LE9	12.2011→		7.06117.05.0	SV-NWV	EH	mit Dichtring with O-ring
			7.06117.06.0	SV-NWV	EH	mit Dichtring with O-ring
2.4 4x4 105-131 kW (143-178 PS) LE5, LE9	03.2012→		7.06117.05.0	SV-NWV	EH	mit Dichtring with O-ring
			7.06117.06.0	SV-NWV	EH	mit Dichtring with O-ring
CRUZE Hatchback (CP1)						4
1.6 86-89 kW (117-121 PS) LDE	09.2013→02.2017		7.02256.38.0	AKF	EL	mit Dichtring with O-ring
			7.06117.08.0	SV-NWV	EH	
CRUZE Saloon (CP1)						5
1.6 86-89 kW (117-121 PS) LDE	08.2010→06.2014		7.02256.38.0	AKF	EL	mit Dichtring with O-ring
			7.06117.08.0	SV-NWV	EH	
1.8 102-108 kW (139-147 PS) 2H0	12.2011→06.2014		7.06117.08.0	SV-NWV	EH	mit Dichtring with O-ring
CRUZE Saloon (CP3)						6
1.4 T 110 kW (150 PS) LE2	08.2014→07.2016		7.03351.12.0	LDRV	EP	
			7.03381.14.0	SUV	EL	
EPICA (SEV, CEV)						7
1.8 102-108 kW (139-147 PS) 2H0	10.2009→12.2015		7.06117.08.0	SV-NWV	EH	mit Dichtring with O-ring
EQUINOX (CP8)						8
550T AWD 191-192 kW (260-261 PS) LTG	04.2017→		7.03357.04.0	LDRV	EL	
MALIBU (EG3)						9
1.6 T 135 kW (184 PS) LLU	02.2012→		7.01039.03.0	EUV-VB	EL	
2.0 113 kW (154 PS) LTD	02.2012→12.2016		7.06117.05.0	SV-NWV	EH	mit Dichtring with O-ring
			7.06117.06.0	SV-NWV	EH	mit Dichtring with O-ring
2.4 137 kW (186 PS) LAF	02.2012→		7.06117.05.0	SV-NWV	EH	mit Dichtring with O-ring
			7.06117.06.0	SV-NWV	EH	mit Dichtring with O-ring









CROSSFIRE						1
3.2 160 kW (218 PS) EGX	07.2003→12.2008	 7.02256.37.0	EUV-SL	EL		
CROSSFIRE Roadster						2
3.2 160 kW (218 PS) EGX	05.2004→12.2008	 7.02256.37.0	EUV-SL	EL		
DELTA						3
1.4 16V 103 kW (140 PS) 198 A7.000	08.2011→	 7.02909.07.0	SUV	EL		
1.6 D Multijet 88 kW (120 PS) 198 A2.000	08.2011→	 7.03003.01.0	DW-TL	EP		
2.0 D Multijet 121 kW (165 PS) 198 A5.000	08.2011→	 7.03003.01.0	DW-TL	EP		
YPSILON						4
0.9 Twinair 63 kW (86 PS) 312 A2.000	05.2011→	 7.03003.01.0	DW-TL	EP		
		 7.02909.07.0	SUV	EL		
1.2 51 kW (69 PS) 169 A4.000	05.2011→	 7.06117.38.0	SV-NWV	EL	mit Dichtring with O-ring	
1.3 Multijet 70 kW (95 PS) 199 B1.000	05.2011→	 7.03003.01.0	DW-TL	EP		

C











BERLINGO (ER_, EC_) 1

C



























1.2 PureTech 110 81 kW (110 PS) HNP (EB2ADT)	06.2018→		7.08681.09.0	EOV	EH	 HNP (EB2ADT): Euro 6d-Temp Euro 6d-Temp  HNP (EB2ADT): Organisationsnummer ab: 15575 RPO number from: 15575 Euro 6d Euro 6d
1.2 PureTech 130 96 kW (131 PS) HNS (EB2ADTS)	07.2019→		7.08681.09.0	EOV	EH	Organisationsnummer ab: 15575 RPO number from: 15575 Euro 6d Euro 6d
1.5 BlueHDi 100 73-75 kW (99-102 PS) YHY (DV5RD)	06.2018→		7.08681.00.0	EOV	EH	
1.5 BlueHDi 130 (ECYHZJ, ECYHZR) 96 kW (131 PS) YHZ (DV5RC)	06.2018→		7.08681.00.0	EOV	EH	
1.5 BlueHDi 75 55 kW (75 PS) YHW (DV5RE)	06.2018→		7.08681.00.0	EOV	EH	

BERLINGO / BERLINGO FIRST MPV (MF_, GJK_, GFK_) 2

1.6 HDI 75 (MF9HW, GJ9HWC, GF9HWC, GN9HWC) 55 kW (75 PS) 9HW (DV6BTED4), DV6B	07.2005→12.2011		7.00968.04.0	DW-TL	EP	
1.6 HDI 90 (MF9HX) 66-68 kW (90-92 PS) 9HX (DV6ATED4)	07.2005→05.2008		7.00968.04.0	DW-TL	EP	
1.8 i (MFLFX) 58-66 kW (90 PS) LFX (XU7JB)	05.1997→10.2002		7.05432.06.0	SM	EL	mit Dichtring with O-ring
1.8 i 4WD (MFLFX) 58-66 kW (90 PS) LFX (XU7JB)	05.1997→10.2001		7.05432.06.0	SM	EL	mit Dichtring with O-ring
1.9 D (MFWJZ) 51-52 kW (69-70 PS) WJY (DW8B)	07.1998→10.2005		7.02256.24.0	DW-RK	EP	
1.9 D 4WD (MFWJZ) 51-52 kW (69-70 PS) WJY (DW8B)	07.1998→10.2005		7.02256.24.0	DW-RK	EP	
2.0 HDI 90 (MFRHY) 66 kW (90 PS) RHY (DW10TD)	12.1999→10.2005		7.02256.24.0	DW-AGR	EP	
2.0 HDi 4x4 (MFRHY) 66 kW (90 PS) RHY (DW10TD)	11.2002→10.2005		7.02256.24.0	DW-RK	EP	
			7.02256.24.0	DW-AGR	EP	
			7.02256.24.0	DW-RK	EP	

BERLINGO MULTISPACE (B9) 3

1.2 PureTech 110 81 kW (110 PS) HNZ (EB2DT)	02.2016→		7.08681.09.0	EOV	EH	
1.6 BlueHDi 100 73-75 kW (99-102 PS) BHY (DV6FD)	12.2014→		7.08681.00.0	EOV	EH	 BHY (DV6FD): Getriebetyp: BE4R Transmission Type: BE4R Organisationsnummer ab: 14420 RPO number from: 14420 für Fahrzeuge mit Start-Stopp-Funktion for vehicles with start-stop function  BHY (DV6FD): Getriebetyp: MC Transmission Type: MC Organisationsnummer ab: 14420 RPO number from: 14420
1.6 HDi 110 80 kW (109 PS) 9HZ (DV6TED4)	04.2008→		7.00968.04.0	DW-TL	EP	

							
BERLINGO MULTISPACE (B9)							3
1.6 HDi 110 82-84 kW (111-114 PS) 9HL (DV6C), 9HR (DV6C)	07.2010→		7.01633.06.0	DW-TL	EP		
1.6 HDi 115 82-84 kW (111-114 PS) 9HR (DV6C)	07.2010→		7.01633.06.0	DW-TL	EP		
1.6 HDi 115 4x4 82-84 kW (111-114 PS) 9HR (DV6C)	02.2012→		7.01633.06.0	DW-TL	EP		
1.6 HDi 75 / BlueHDi 75 55 kW (75 PS) BHW (DV6FE)	04.2008→		7.08681.00.0	EOV	EH	Getriebetyp: BE4R Transmission Type: BE4R Organisationsnummer ab: 14420 RPO number from: 14420 für Fahrzeuge mit Start-Stopp-Funktion for vehicles with start-stop function	
1.6 HDi 90 66-68 kW (90-92 PS) 9HV (DV6TED4B), 9HX (DV6ATED4)	04.2008→		7.00968.04.0	DW-TL	EP		
1.6 VTi 120 88 kW (120 PS) 5FS (EP6C)	11.2009→		7.06117.45.0	SV-NWV	EL		
1.6 VTi 95 72 kW (98 PS) 5FK (EP6CB)	07.2010→		7.06117.45.0	SV-NWV	EL		
BX (XB-_)							4
1.6 83-85 kW (113-116 PS) B6D, B6E	01.1987→01.1992		7.05432.02.0	SM	EL	mit Dichtring with O-ring  B6D, B6E: 06.1991→	
16 76 kW (103 PS) 180Z	03.1986→02.1993		7.05432.02.0	SM	EL	mit Dichtring with O-ring 06.1991→	
16 E 65-66 kW (88-90 PS) BDY (XU5M)	03.1991→02.1993		7.05432.02.0	SM	EL	mit Dichtring with O-ring  BDY (XU5M): Organisationsnummer ab: 05307 RPO number from: 05307 für Fahrzeuge mit Automatikgetriebe for vehicles with automatic transmission  BDY (XU5M): Organisationsnummer ab: 05285 RPO number from: 05285 für Fahrzeuge mit Schaltgetriebe for vehicles with manual transmission	
BX Break (XB-_)							5
1.6 83-85 kW (113-116 PS) B6D, B6E	01.1987→01.1992		7.05432.02.0	SM	EL	mit Dichtring with O-ring  B6D, B6E: 06.1991→	
16 76 kW (103 PS) 180Z	03.1986→12.1994		7.05432.02.0	SM	EL	mit Dichtring with O-ring 06.1991→	
16 65-66 kW (88-90 PS) BDY (XU5M)	03.1991→12.1993		7.05432.02.0	SM	EL	mit Dichtring with O-ring  BDY (XU5M): Organisationsnummer ab: 05307 RPO number from: 05307 für Fahrzeuge mit Automatikgetriebe for vehicles with automatic transmission  BDY (XU5M): Organisationsnummer ab: 05285 RPO number from: 05285 für Fahrzeuge mit Schaltgetriebe for vehicles with manual transmission	
C-ELYSEE (DD-_)							6
1.2 VTi 82 60-66 kW (82-90 PS) HMZ (EB2F)	12.2014→		7.06117.45.0	SV-NWV	EL		
1.5 BlueHDi 100 73-75 kW (99-102 PS) YHY (DV5RD)	05.2018→		7.08681.00.0	EOV	EH		











C2 (JM_) 7









C

































1.4 16V 65 kW (88 PS) KFU (ET3J4)	04.2005→12.2009	 7.06117.34.0	SV-NWV	EL	mit Dichtring with O-ring
1.4 HDi 50-52 kW (68-71 PS) 8HZ (DV4TD)	07.2003→12.2009	 7.00964.03.0	DW-AGR	EP	Euro 3 Euro 3
1.4 HDi 50-55 kW (68-75 PS) 8HX (DV4TD)	09.2003→04.2005	 7.00964.03.0	DW-AGR	EP	Euro 3 Euro 3
1.6 HDi 80 kW (109 PS) 9HZ (DV6TED4)	09.2005→12.2009	 7.00968.04.0	DW-TL	EP	

C3 AIRCROSS II (2R_, 2C_) 8

1.2 PureTech 110 (2RHNZB, 2RHNZW, 2RHNPX, 2RHNPJ) 81 kW (110 PS) HNP (EB2ADT)	06.2017→	 7.08681.09.0	EOV	EH	
1.2 PureTech 110 (2RHNZB, 2RHNZW, 2RHNPX, 2RHNPJ) 81 kW (110 PS) HNV (EB2DTM), HNZ (EB2DT)	06.2017→	 7.08681.09.0	EOV	EH	
		7.06117.45.0	SV-NWV	EL	
1.2 PureTech 130 (2RHNYH) 96 kW (131 PS) HNS (EB2ADTS)	07.2017→	 7.08681.09.0	EOV	EH	
1.2 PureTech 130 (2RHNYH) 96 kW (131 PS) HNY (EB2DTS)	07.2017→	 7.08681.09.0	EOV	EH	
		7.06117.45.0	SV-NWV	EL	
1.2 PureTech 82 (2RHMRC, 2RHMZB) 60-66 kW (82-90 PS) HMZ (EB2F)	06.2017→	 7.06117.45.0	SV-NWV	EL	
1.5 BlueHDi 100 (2CYHYJ) 73-75 kW (99-102 PS) YHY (DV5RD)	08.2018→	 7.08681.00.0	EOV	EH	
1.5 BlueHDi 120 (2CYHXX) 88 kW (120 PS) YHX (DV5RC)	08.2018→	 7.08681.00.0	EOV	EH	
1.6 BlueHDi 115 (2CBHXH) 85 kW (115 PS) BHX (DV6FC)	06.2017→	 7.08681.00.0	EOV	EH	
1.6 BlueHDi 120 (2CBHZH) 88 kW (120 PS) BHZ (DV6FC)	07.2017→	 7.08681.00.0	EOV	EH	

C3 I (FC_, FN_) 9









1.4 16V 65 kW (88 PS) KFU (ET3J4)	12.2003→	 7.06117.34.0	SV-NWV	EL	mit Dichtring with O-ring
1.4 16V HDi 66 kW (90 PS) 8HY (DV4TED4)	02.2002→	 7.02256.24.0	DW-AGR	EP	
		7.02256.24.0	DW-TL	EP	
1.4 HDi 50-55 kW (68-75 PS) 8HX (DV4TD), 8HZ (DV4TD)	02.2002→	 7.00964.03.0	DW-AGR	EP	 8HX (DV4TD), 8HZ (DV4TD): Euro 3 Euro 3
1.4 HDi 50-52 kW (68-71 PS) 8HZ (DV4TD)	07.2003→02.2011	 7.00964.03.0	DW-AGR	EP	Euro 3 Euro 3
1.4 HDi 50-55 kW (68-75 PS) 8HX (DV4TD)	05.2005→	 7.00964.03.0	DW-AGR	EP	Euro 3 Euro 3
1.6 16V HDi 80 kW (109 PS) 9HZ (DV6TED4)	09.2005→	 7.00968.04.0	DW-TL	EP	
1.6 16V HDi 66-68 kW (90-92 PS) 9HX (DV6ATED4)	10.2005→	 7.00968.04.0	DW-TL	EP	

						
C3 II (SC_)						10
1.0 VTi 68 50 kW (68 PS) ZMZ (EB0)	08.2012→		7.06117.45.0	SV-NWV	EL	C
1.2 THP 110 81 kW (110 PS) HNZ (EB2DT)	10.2014→		7.08681.09.0	EOV	EH	
			7.06117.45.0	SV-NWV	EL	
1.2 VTi 82 60-66 kW (82-90 PS) HMZ (EB2), HMZ (EB2F)	06.2012→09.2016		7.06117.45.0	SV-NWV	EL	
1.4 HDi 70 50-52 kW (68-71 PS) 8HZ (DV4TD)	11.2009→		7.00964.03.0	DW-AGR	EP Euro 3 Euro 3	
1.4 LPG 70 kW (95 PS) 8FN (EP3)	06.2013→		7.06117.45.0	SV-NWV	EL	
1.4 VTi 95 70 kW (95 PS) 8FP (EP3C)	11.2009→		7.06117.45.0	SV-NWV	EL	
1.6 BlueHDi 100 73-75 kW (99-102 PS) BHY (DV6FD)	07.2014→		7.08681.00.0	EOV	EH Organisationsnummer ab: 14420 RPO number from: 14420	
1.6 BlueHDi 75 55 kW (75 PS) BHW (DV6FE)	04.2015→		7.08681.00.0	EOV	EH Organisationsnummer ab: 14574 RPO number from: 14574	
1.6 HDi 110 82-84 kW (111-114 PS) 9HR (DV6C)	11.2009→		7.01633.06.0	DW-TL	EP	
1.6 HDi 115 84 kW (114 PS) 9HD (DV6C)	09.2012→		7.01633.06.0	DW-TL	EP	
1.6 HDi 90 66-68 kW (90-92 PS) 9HX (DV6ATED4)	11.2009→		7.00968.04.0	DW-TL	EP	
1.6 VTi 120 88 kW (120 PS) 5FS (EP6C)	11.2009→		7.06117.45.0	SV-NWV	EL	
C3 III (SX)						11
1.2 THP 110 81 kW (110 PS) HNP (EB2ADT)	07.2016→		7.08681.09.0	EOV	EH  HNP (EB2ADT): Organisationsnummer ab: 1514876 RPO number from: 1514876 Euro 6d-Temp Euro 6d-Temp  HNP (EB2ADT): Euro 6d Euro 6d	
1.2 THP 110 81 kW (110 PS) HNV (EB2DTM), HNZ (EB2DT)	07.2016→		7.08681.09.0	EOV	EH  HNV (EB2DTM), HNZ (EB2DT): Organisationsnummer ab: 1425976 RPO number from: 1425976	
			7.06117.45.0	SV-NWV	EL  HNV (EB2DTM), HNZ (EB2DT): Organisationsnummer ab: 1425976 RPO number from: 1425976	
1.2 VTi 68 50 kW (68 PS) HMP (EB2FB)	07.2016→		7.06117.45.0	SV-NWV	EL Organisationsnummer ab: 1425976 RPO number from: 1425976	
1.2 VTi 82 60-66 kW (82-90 PS) HMZ (EB2F)	07.2016→		7.06117.45.0	SV-NWV	EL Organisationsnummer ab: 1425976 RPO number from: 1425976	
1.2 VTi 82 LPG 60-66 kW (82-90 PS) HMZ (EB2F)	07.2016→		7.06117.45.0	SV-NWV	EL Organisationsnummer ab: 1425976 RPO number from: 1425976	
1.5 BlueHDi 100 73-75 kW (99-102 PS) YHY (DV5RD)	05.2018→		7.08681.00.0	EOV	EH Produktionsdatum ab: 30.04.2018 Production date from: 30.04.2018	
1.6 BlueHDi 75 55 kW (75 PS) BHW (DV6FE)	07.2016→		7.08681.00.0	EOV	EH Organisationsnummer ab: 1425976 RPO number from: 1425976	
C3 PICASSO (SH_)						12
1.2 THP 110 81 kW (110 PS) HNZ (EB2DT)	01.2015→		7.08681.09.0	EOV	EH	
			7.06117.45.0	SV-NWV	EL	
1.4 VTi 95 70 kW (95 PS) 8FP (EP3C), 8FS (EP3)	02.2009→		7.06117.45.0	SV-NWV	EL für Fahrzeuge mit Schaltgetriebe for vehicles with manual transmission	
1.4 VTi 95 LPG 70 kW (95 PS) 8FN (EP3)	01.2012→		7.06117.45.0	SV-NWV	EL	

C3 PICASSO (SH_)					12
C	1.6 BlueHDi 100 73-75 kW (99-102 PS) BHY (DV6FD)	01.2015→	7.08681.00.0	EOV	EH Organisationsnummer ab: 14420 RPO number from: 14420
	1.6 HDi 80 kW (109 PS) 9HZ (DV6TED4)	02.2009→	7.00968.04.0	DW-TL	EP
	1.6 HDi 110 82-84 kW (111-114 PS) 9HR (DV6C)	05.2010→	7.01633.06.0	DW-TL	EP
	1.6 HDi 115 84 kW (114 PS) 9HD (DV6C)	01.2013→	7.01633.06.0	DW-TL	EP
	1.6 VTi 120 88 kW (120 PS) 5FS (EP6C), 5FW (EP6)	02.2009→	7.06117.45.0	SV-NWV	EL 5FS (EP6C), 5FW (EP6): für Fahrzeuge mit Schaltgetriebe for vehicles with manual transmission
C3 Pluriel (HB_)					13
1.4 HDi 50-55 kW (68-75 PS) 8HX (DV4TD)	04.2004→	7.00964.03.0	DW-AGR	EP ab Euro 4 From Euro 4	
C4 AIRCROSS					14
1.6 HDi 115 AWC 82-84 kW (111-114 PS) 9HL (DV6C)	05.2012→	7.01633.06.0	DW-TL	EP	
C4 CACTUS					15
1.2 PureTech 130 96 kW (131 PS) HNS (EB2ADTS)	11.2017→	7.08681.09.0	EOV	EH	
1.2 PureTech 130 96 kW (131 PS) HNY (EB2DTS)	11.2017→	7.08681.09.0	EOV	EH	
1.2 THP 110 81 kW (110 PS) HNP (EB2ADT)	09.2014→	7.06117.45.0	SV-NWV	EL	
1.2 THP 110 81 kW (110 PS) HNV (EB2DTM), HNZ (EB2DT)	09.2014→	7.08681.09.0	EOV	EH	
1.2 VTi 75 / PureTech 75 55 kW (75 PS) HMU (EB2D), HMU (EB2FD)	09.2014→	7.06117.45.0	SV-NWV	EL	
1.2 VTi 82 60-66 kW (82-90 PS) HMZ (EB2F)	09.2014→	7.06117.45.0	SV-NWV	EL	
1.5 BlueHDi 100 73-75 kW (99-102 PS) YHY (DV5RD)	06.2018→	7.08681.00.0	EOV	EH	
1.5 BlueHDi 120 88 kW (120 PS) YHX (DV5RC)	09.2018→	7.08681.00.0	EOV	EH	
1.6 BlueHDi 100 73-75 kW (99-102 PS) BHY (DV6FD)	09.2014→	7.08681.00.0	EOV	EH Getriebetyp: BE4R Transmission Type: BE4R Organisationsnummer ab: 14420 RPO number from: 14420	
C4 Coupe (LA_)					16
1.4 16V 65 kW (88 PS) KFU (ET3J4)	11.2004→07.2011	7.06117.34.0	SV-NWV	EL mit Dichtring with O-ring	
1.6 HDi 80-85 kW (109-116 PS) 9HY (DV6TED4), 9HZ (DV6TED4)	11.2004→07.2011	7.00968.04.0	DW-TL	EP	
1.6 THP 103 kW (140 PS) 5FT (EP6DT)	06.2008→07.2011	7.01777.18.0	DW-TL	EP Getriebeautomatik 4 Gang 4-Speed Automatic Transmission	
		7.01777.19.0	DW-TL	EP für Fahrzeuge mit Schaltgetriebe for vehicles with manual transmission	
1.6 THP 150 110 kW (150 PS) 5FX (EP6DT)	07.2008→07.2011	7.01777.18.0	DW-TL	EP Getriebeautomatik 4 Gang 4-Speed Automatic Transmission	
		7.01777.19.0	DW-TL	EP für Fahrzeuge mit Schaltgetriebe for vehicles with manual transmission	
		7.06117.45.0	SV-NWV	EL	







C4 Coupe (LA_) 16

1.6 VTi 120 88 kW (120 PS) 5FW (EP6)	07.2008→07.2011		7.06117.45.0	SV-NWV	EL	
2.0 16V 130 kW (177 PS) RFK (EW10J4S)	11.2004→12.2010		7.06117.34.0	SV-NWV	EL	mit Dichtring with O-ring
2.0 HDi 100-101 kW (136-138 PS) RHR (DW10BTED4)	11.2004→12.2010		7.00612.01.0	DW-AGR	EP	 RHR (DW10BTED4): →01.2006 Schaltgetriebe Manual Transmission Organisationsnummer bis: 10618 RPO number to: 10618 für Fahrzeuge mit Diesel-Partikel-Filter (DPF) for vehicles with diesel soot filter
						 RHR (DW10BTED4): →03.2006 Organisationsnummer bis: 10746 RPO number to: 10746 für Fahrzeuge ohne Diesel-Partikel-Filter (DPF) for vehicles without diesel soot filter
						 RHR (DW10BTED4): Getriebeautomatik 6 Gang 6-Speed Automatic Transmission für Fahrzeuge mit Diesel-Partikel-Filter (DPF) for vehicles with diesel soot filter
			7.01632.02.0	DW-RK	EP	 RHR (DW10BTED4): Schaltgetriebe Manual Transmission Organisationsnummer ab: 10619 RPO number from: 10619 für Fahrzeuge mit Diesel-Partikel-Filter (DPF) for vehicles with diesel soot filter
			7.01632.02.0	DW-TL	EP	 RHR (DW10BTED4): Organisationsnummer bis: 10746 RPO number to: 10746 für Fahrzeuge ohne Diesel-Partikel-Filter (DPF) for vehicles without diesel soot filter
			7.01633.04.0	DW-TL	EP	 RHR (DW10BTED4): Schaltgetriebe Manual Transmission Organisationsnummer ab: 10619 RPO number from: 10619 für Fahrzeuge mit Diesel-Partikel-Filter (DPF) for vehicles with diesel soot filter

C

C4 GRAND PICASSO I (UA_) 17



1.6 16V 103 kW (140 PS) 5FT (EP6DT)	07.2008→12.2010		7.01777.18.0	DW-TL	EP	
			7.06117.45.0	SV-NWV	EL	
1.6 16V 110 kW (150 PS) 5FX (EP6DT)	10.2008→08.2013		7.01777.18.0	DW-TL	EP	
			7.06117.45.0	SV-NWV	EL	
1.6 HDi 80-85 kW (109-116 PS) 9HY (DV6TED4), 9HZ (DV6TED4)	10.2006→06.2011		7.00968.04.0	DW-TL	EP	
1.6 HDi 110 82-84 kW (111-114 PS) 9HR (DV6C)	09.2010→08.2013		7.01633.06.0	DW-TL	EP	
1.6 THP 155 115 kW (156 PS) 5FV (EP6CDT)	09.2010→08.2013		7.01777.18.0	DW-TL	EP	











C4 GRAND PICASSO I (UA_) 17

C			 PIERBURG			
			7.06117.45.0	SV-NWV	EL	für Fahrzeuge mit Schaltgetriebe for vehicles with manual transmission
	1.6 VTi 120 88 kW (120 PS) 5FW (EP6)	07.2008→08.2013	 7.06117.45.0	SV-NWV	EL	

C4 GRAND PICASSO II (DA_, DE_) 18



	1.2 THP 130 96 kW (131 PS) HNY (EB2DTS)	04.2014→	 7.08681.09.0	EOV	EH	
			7.06117.45.0	SV-NWV	EL	
	1.6 HDi / BlueHDi 115 82-85 kW (112-116 PS) 9HC (DV6C)	09.2013→	 7.01633.06.0	DW-TL	EP	
	1.6 THP 155 115 kW (156 PS) 5FV (EP6CDT)	09.2013→	 7.01777.18.0	DW-TL	EP	Schaltgetriebe Manual Transmission
			7.06117.45.0	SV-NWV	EL	für Fahrzeuge mit Schaltgetriebe for vehicles with manual transmission
	1.6 THP 165 121 kW (165 PS) 5GZ (EP6FDT)	07.2014→	 7.01777.19.0	DW-TL	EP	für Fahrzeuge mit Automatikgetriebe for vehicles with automatic transmission
			7.06117.45.0	SV-NWV	EL	für Fahrzeuge mit Automatikgetriebe for vehicles with automatic transmission
	1.6 VTi 120 88 kW (120 PS) 5FS (EP6C)	09.2013→	 7.06117.45.0	SV-NWV	EL	

C4 I (LC_) 19

	1.4 16V 65 kW (88 PS) KFU (ET3J4)	11.2004→07.2011	 7.06117.34.0	SV-NWV	EL	mit Dichtring with O-ring
	1.6 HDi 80-85 kW (109-116 PS) 9HY (DV6TED4), 9HZ (DV6TED4)	11.2004→07.2011	 7.00968.04.0	DW-TL	EP	
	1.6 HDi 80-85 kW (109-116 PS) 9HY (DV6TED4)	07.2006→07.2011	 7.00968.04.0	DW-TL	EP	
	1.6 THP 140 103 kW (140 PS) 5FT (EP6DT)	07.2008→07.2011	 7.01777.18.0	DW-TL	EP	Getriebeautomatik 4 Gang 4-Speed Automatic Transmission
			7.01777.19.0	DW-TL	EP	für Fahrzeuge mit Schaltgetriebe for vehicles with manual transmission
			7.06117.45.0	SV-NWV	EL	
	1.6 THP 150 110 kW (150 PS) 5FX (EP6DT)	07.2008→07.2011	 7.01777.18.0	DW-TL	EP	Getriebeautomatik 4 Gang 4-Speed Automatic Transmission
			7.01777.19.0	DW-TL	EP	für Fahrzeuge mit Schaltgetriebe for vehicles with manual transmission
			7.06117.45.0	SV-NWV	EL	
	1.6 VTi 120 88 kW (120 PS) 5FW (EP6)	07.2008→07.2011	 7.06117.45.0	SV-NWV	EL	
	2.0 16V 103-111 kW (140-151 PS) RFJ (EW10A)	11.2004→07.2011	 7.06117.34.0	SV-NWV	EL	mit Dichtring with O-ring Organisationsnummer bis: 10653 UW, 10919 88 RPO number to: 10653 UW, 10919 88
	2.0 16V 130 kW (177 PS) RFK (EW10J4S)	11.2004→07.2008	 7.06117.34.0	SV-NWV	EL	mit Dichtring with O-ring
	2.0 16V 103-111 kW (140-151 PS) RFJ (EW10A)	09.2006→07.2009	 7.06117.34.0	SV-NWV	EL	mit Dichtring with O-ring Organisationsnummer bis: 10653 UW, 10919 88 RPO number to: 10653 UW, 10919 88





C4 I (LC_) 19



2.0 HDi 100-101 kW (136-138 PS) RHR (DW10BTED4)	11.2004→07.2011		7.00612.01.0	DW-AGR	EP	RHR (DW10BTED4): →01.2006 Schaltgetriebe Manual Transmission Organisationsnummer bis: 10618 RPO number to: 10618 für Fahrzeuge mit Diesel-Partikel-Filter (DPF) for vehicles with diesel soot filter RHR (DW10BTED4): →03.2006 Organisationsnummer bis: 10746 RPO number to: 10746 für Fahrzeuge ohne Diesel-Partikel-Filter (DPF) for vehicles without diesel soot filter
			7.01632.02.0	DW-RK	EP	RHR (DW10BTED4): Getriebeautomatik 6 Gang 6-Speed Automatic Transmission für Fahrzeuge mit Diesel-Partikel-Filter (DPF) for vehicles with diesel soot filter RHR (DW10BTED4): Schaltgetriebe Manual Transmission Organisationsnummer ab: 10619 RPO number from: 10619 für Fahrzeuge mit Diesel-Partikel-Filter (DPF) for vehicles with diesel soot filter Herstellerausschluss: Delphi Manufacturer Exclusion: Delphi
			7.01632.02.0	DW-TL	EP	RHR (DW10BTED4): Organisationsnummer bis: 10746 RPO number to: 10746 für Fahrzeuge ohne Diesel-Partikel-Filter (DPF) for vehicles without diesel soot filter RHR (DW10BTED4): Schaltgetriebe Manual Transmission Organisationsnummer ab: 10619 RPO number from: 10619 für Fahrzeuge mit Diesel-Partikel-Filter (DPF) for vehicles with diesel soot filter Herstellerausschluss: Delphi Manufacturer Exclusion: Delphi
2.0 HDi 79-81 kW (107-110 PS) RHZ (DW10ATED)	04.2007→07.2008		7.02256.24.0	DW-AGR	EP	
			7.02256.24.0	DW-TL	EP	

C

C4 I Saloon 20

1.6 HDi 80-85 kW (109-116 PS) 9HY (DV6TED4), 9HZ (DV6TED4)	07.2006→07.2011		7.00968.04.0	DW-TL	EP	
2.0 16V 103-111 kW (140-151 PS) RFJ (EW10A)	07.2006→07.2011		7.06117.34.0	SV-NWV	EL	mit Dichtring with O-ring Organisationsnummer bis: 10653 UW, 10919 88 RPO number to: 10653 UW, 10919 88
2.0 HDi 79-81 kW (107-110 PS) RHZ (DW10ATED)	04.2007→12.2011		7.02256.24.0	DW-AGR	EP	
			7.02256.24.0	DW-TL	EP	









C4 II (B7) 21

1.2 THP 110 81 kW (110 PS) HNZ (EB2DT)	02.2015→		7.08681.09.0	EOV	EH	
			7.06117.45.0	SV-NWV	EL	
1.2 THP 130 96 kW (131 PS) HNY (EB2DTS)	04.2014→		7.08681.09.0	EOV	EH	





C4 II (B7) **21**

C

			7.06117.45.0	SV-NWV	EL	
1.4 VTi 95 70 kW (95 PS) 8FP (EP3C)	11.2009→		7.06117.45.0	SV-NWV	EL	
1.6 BlueHDi 100 73-75 kW (99-102 PS) BHY (DV6FD)	07.2014→		7.08681.00.0	EOV	EH	Organisationsnummer ab: 14420 RPO number from: 14420
1.6 BlueHDi 115 85 kW (115 PS) BHX (DV6FC)	08.2014→		7.08681.00.0	EOV	EH	Organisationsnummer ab: 14420 RPO number from: 14420
1.6 BlueHDi 120 88 kW (120 PS) BHZ (DV6FC)	02.2015→		7.08681.00.0	EOV	EH	Organisationsnummer ab: 14420 RPO number from: 14420
1.6 HDi 110 82-84 kW (111-114 PS) 9HR (DV6C)	11.2009→		7.01633.06.0	DW-TL	EP	
1.6 HDi 115 84 kW (114 PS) 9HD (DV6C)	07.2012→		7.01633.06.0	DW-TL	EP	
1.6 THP 155 115 kW (156 PS) 5FV (EP6CDT)	11.2009→12.2016		7.01777.18.0	DW-TL	EP	
			7.01115.08.0	SUV	EL	
			7.06117.45.0	SV-NWV	EL	für Fahrzeuge mit Schaltgetriebe for vehicles with manual transmission
1.6 VTi 120 88 kW (120 PS) 5FS (EP6C)	11.2009→12.2016		7.06117.45.0	SV-NWV	EL	
1.6 VTi 120 LPG 88 kW (120 PS) 5FS (EP6C)	09.2011→		7.06117.45.0	SV-NWV	EL	für Fahrzeuge mit Schaltgetriebe for vehicles with manual transmission







C4 II Saloon (NC_) **22**

























1.6 HDi 82-84 kW (111-114 PS) 9HD (DV6C), 9HR (DV6C)	08.2013→		7.01633.06.0	DW-TL	EP	
1.6 THP 110 kW (150 PS) 5FE (EP6CDTMD)	01.2013→		7.01777.18.0	DW-TL	EP	Getriebeautomatik 6 Gang 6-Speed Automatic Transmission
			7.01115.08.0	SUV	EL	
1.6 THP 165 120-127 kW (163-173 PS) 5FM (EP6CDTM)	08.2013→		7.01777.18.0	DW-TL	EP	

C4 PICASSO **23**

1.6i THP 16V 103-115 kW (140-156 PS) 5FT (EP6DT), 5FV (EP6CDT), 5FX (EP6DT)	07.2008→		7.01115.08.0	SUV	EL	
---	----------	---	---------------------	-----	----	--

C4 PICASSO I MPV (UD_) **24**

1.6 16V 110 kW (150 PS) 5FX (EP6DT)	07.2008→08.2013		7.01777.18.0	DW-TL	EP	
			7.06117.45.0	SV-NWV	EL	
1.6 HDi 80-85 kW (109-116 PS) 9HY (DV6TED4), 9HZ (DV6TED4)	02.2007→08.2013		7.00968.04.0	DW-TL	EP	
1.6 HDi 110 82-84 kW (111-114 PS) 9HR (DV6C)	09.2010→08.2013		7.01633.06.0	DW-TL	EP	
1.6 THP 140 103 kW (140 PS) 5FT (EP6DT)	07.2008→08.2013		7.01777.18.0	DW-TL	EP	
			7.06117.45.0	SV-NWV	EL	
1.6 THP 155 115 kW (156 PS) 5FV (EP6CDT)	09.2010→08.2013		7.01777.18.0	DW-TL	EP	
			7.06117.45.0	SV-NWV	EL	für Fahrzeuge mit Schaltgetriebe for vehicles with manual transmission
1.6 VTi 120 88 kW (120 PS) 5FW (EP6)	07.2008→08.2013		7.06117.45.0	SV-NWV	EL	
2.0 HDi 138 100-101 kW (136-138 PS) RHR (DW10BTED4)	10.2006→08.2013		7.01633.04.0	DW-TL	EP	→12.2007 für Fahrzeuge mit Diesel-Partikel-Filter (DPF) for vehicles with diesel soot filter

						
C4 PICASSO II						25
1.2 THP 110 81 kW (110 PS) HNZ (EB2DT)	04.2016→		7.08681.09.0	EOV	EH	
1.2 THP 130 96 kW (131 PS) HNY (EB2DTS)	04.2014→		7.08681.09.0 7.06117.45.0	EOV SV-NWV	EH EL	
1.6 HDi / BlueHDi 115 82-85 kW (112-116 PS) 9HC (DV6C)	02.2013→		7.01633.06.0	DW-TL	EP	
1.6 THP 150 110 kW (150 PS) 5FX (EP6DT)	09.2014→		7.01115.08.0	SUV	EL	
1.6 THP 155 115 kW (156 PS) 5FV (EP6CDT)	02.2013→		7.01777.18.0 7.01115.08.0 7.06117.45.0	DW-TL SUV SV-NWV	EP EL EL	Schaltgetriebe Manual Transmission für Fahrzeuge mit Schaltgetriebe for vehicles with manual transmission
1.6 THP 165 121 kW (165 PS) 5GZ (EP6FDT)	07.2014→		7.01777.19.0 7.01115.08.0 7.06117.45.0	DW-TL SUV SV-NWV	EP EL EL	für Fahrzeuge mit Automatikgetriebe for vehicles with automatic transmission für Fahrzeuge mit Automatikgetriebe for vehicles with automatic transmission
1.6 VTi 120 88 kW (120 PS) 5FS (EP6C)	02.2013→		7.06117.45.0	SV-NWV	EL	
C4 SPACETOURER (3D_)						26
1.2 PureTech 110 81 kW (110 PS) HNX (EB2DTSD)	04.2018→		7.08681.09.0	EOV	EH	
1.2 PureTech 130 96 kW (131 PS) HNY (EB2DTS)	04.2018→		7.08681.09.0 7.06117.45.0	EOV SV-NWV	EH EL	
1.5 BlueHDi 130 96 kW (131 PS) YHZ (DV5RC)	05.2018→		7.08681.00.0	EOV	EH	Produktionsdatum ab: 02.07.2018 Production date from: 02.07.2018
1.6 BlueHDi 120 88 kW (120 PS) BHZ (DV6FC)	04.2018→		7.08681.00.0	EOV	EH	Getriebetyp: ML6C Transmission Type: ML6C Organisationsnummer ab: 14988 RPO number from: 14988
1.6 THP 165 121 kW (165 PS) 5GZ (EP6FDT)	04.2018→		7.01777.19.0 7.01115.08.0 7.06117.45.0	DW-TL SUV SV-NWV	EP EL EL	für Fahrzeuge mit Automatikgetriebe for vehicles with automatic transmission für Fahrzeuge mit Automatikgetriebe for vehicles with automatic transmission
C5 AIRCROSS						27
1.2 PureTech 130 96 kW (131 PS) HNS (EB2ADTS)	11.2018→		7.08681.09.0	EOV	EH	
1.5 BlueHDi 130 96 kW (131 PS) YHZ (DV5RC)	11.2018→		7.08681.00.0	EOV	EH	
1.6 PureTech 180 133 kW (181 PS) 5GF (EP6FADTXD)	11.2018→		7.06117.45.0	SV-NWV	EL	für Fahrzeuge mit Automatikgetriebe for vehicles with automatic transmission
C5 I (DC_)						28
2.0 HDi 79-81 kW (107-110 PS) RHS (DW10ATED), RHZ (DW10ATED)	03.2001→08.2004		7.02256.24.0 7.02256.24.0 7.02256.24.0	DW-AGR DW-RK DW-TL	EP EP EP	
2.0 HDi (DCRHYP) 66 kW (90 PS) RHY (DW10TD)	03.2001→08.2004		7.02256.24.0 7.02256.24.0	DW-AGR DW-RK	EP EP	
2.0 HDi (DCRHZB, DCRHZE) 79-81 kW (107-110 PS) RHZ (DW10ATED)	03.2001→08.2004		7.02256.24.0	DW-AGR	EP	







C5 I (DC_) 28







C

			7.02256.24.0	DW-RK	EP	
			7.02256.24.0	DW-TL	EP	
2.2 HDi (DC4HXB, DC4HXE) 98 kW (133 PS) 4HX (DW12TED4)	03.2001→08.2004		7.02256.24.0	DW-AGR	EP	
			7.02256.23.0	DW-TL	EP	für OE-Nummer: 1628 HC für OE number: 1628 HC





C5 I Break (DE_) 29

2.0 HDi (DERHSB, DERHSE) 79 kW (107 PS) RHS (DW10ATED)	06.2001→08.2004		7.02256.24.0	DW-AGR	EP	
			7.02256.24.0	DW-RK	EP	
			7.02256.24.0	DW-TL	EP	
2.0 HDi (DERHYB) 66 kW (90 PS) RHY (DW10TD)	06.2001→08.2004		7.02256.24.0	DW-AGR	EP	
			7.02256.24.0	DW-RK	EP	
2.0 HDi (DERHZB, DERHZE) 79-81 kW (107-110 PS) RHZ (DW10ATED)	06.2001→08.2004		7.02256.24.0	DW-AGR	EP	
			7.02256.24.0	DW-RK	EP	
			7.02256.24.0	DW-TL	EP	
2.2 HDi (DE4HXB, DE4HXE) 98 kW (133 PS) 4HX (DW12TED4)	06.2001→08.2004		7.02256.24.0	DW-AGR	EP	
			7.02256.23.0	DW-TL	EP	für OE-Nummer: 1628 HC für OE number: 1628 HC











C5 II (RC_) 30

1.6 HDi (RC8HXB) 80-85 kW (109-116 PS) 9HY (DV6TED4)	09.2004→		7.00968.04.0	DW-TL	EP	
2.0 16V 103-111 kW (140-151 PS) RFJ (EW10A)	03.2005→11.2007		7.06117.34.0	SV-NWV	EL	mit Dichtring with O-ring Organisationsnummer bis: 10919 RPO number to: 10919
2.0 16V (RCRFJB, RCRFJC) 103-111 kW (140-151 PS) RFJ (EW10A)	09.2004→		7.06117.34.0	SV-NWV	EL	mit Dichtring with O-ring Organisationsnummer bis: 10919 RPO number to: 10919
2.0 HDi (RCRHRH) 100-101 kW (136-138 PS) RHR (DW10BTED4)	09.2004→		7.01632.02.0	DW-RK	EP	Organisationsnummer ab: 10703 RPO number from: 10703
			7.00612.01.0	DW-AGR	EP	→04.2005 Organisationsnummer bis: 10401 RPO number to: 10401
			7.00612.01.0	DW-TL	EP	→04.2005 Organisationsnummer bis: 10401 RPO number to: 10401
			7.00968.04.0	DW-TL	EP	
			7.01633.04.0	DW-TL	EP	Organisationsnummer ab: 10703 RPO number from: 10703
2.2 HDi 125 kW (170 PS) 4HT (DW12BTED4)	04.2006→		7.01633.04.0	DW-TL	EP	für Fahrzeuge mit Diesel-Partikel-Filter (DPF) for vehicles with diesel soot filter
2.2 HDi 120 kW (163 PS) 4HR (DW12BTED4)	05.2006→		7.01633.04.0	DW-TL	EP	für Fahrzeuge mit Diesel-Partikel-Filter (DPF) for vehicles with diesel soot filter
2.2 HDi (RC4HXE) 98 kW (133 PS) 4HX (DW12TED4)	09.2004→		7.02256.24.0	DW-AGR	EP	





C5 II Break (RE_) 31

1.6 HDi (RE8HZB) 80-85 kW (109-116 PS) 9HY (DV6TED4)	09.2004→		7.00968.04.0	DW-TL	EP	
2.0 16V (RERFJB, RERFJC) 103-111 kW (140-151 PS) RFJ (EW10A)	09.2004→		7.06117.34.0	SV-NWV	EL	mit Dichtring with O-ring Organisationsnummer bis: 10919 RPO number to: 10919
2.0 HDi (RERHRH) 100-101 kW (136-138 PS) RHR (DW10BTED4)	09.2004→		7.01632.02.0	DW-RK	EP	Organisationsnummer ab: 10703 RPO number from: 10703
			7.00612.01.0	DW-AGR	EP	→04.2005 Organisationsnummer bis: 10401 RPO number to: 10401
			7.00612.01.0	DW-TL	EP	→04.2005 Organisationsnummer bis: 10401 RPO number to: 10401
			7.00968.04.0 7.01633.04.0	DW-TL DW-TL	EP EP	Organisationsnummer ab: 10703 RPO number from: 10703
2.2 HDi 125 kW (170 PS) 4HT (DW12BTED4)	04.2006→		7.01633.04.0	DW-TL	EP	für Fahrzeuge mit Diesel-Partikel-Filter (DPF) for vehicles with diesel soot filter
2.2 HDi (RE4HXE) 98 kW (133 PS) 4HX (DW12TED4)	09.2004→		7.02256.24.0	DW-AGR	EP	

C
C5 III (RD_) 32

1.6 HDi 110 80 kW (109 PS) 9HZ (DV6TED4)	02.2008→		7.00968.04.0	DW-TL	EP	
1.6 HDi 110 82-84 kW (111-114 PS) 9HL (DV6C), 9HR (DV6C)	07.2010→		7.01633.06.0	DW-TL	EP	
1.6 HDi 115 82-84 kW (111-114 PS) 9HL (DV6C), 9HR (DV6C)	01.2012→		7.01633.06.0	DW-TL	EP	
1.6 THP 150 110 kW (150 PS) 5FN (EP6CDT)	07.2010→		7.01777.18.0	DW-TL	EP	
			7.01115.08.0	SUV	EL	
1.6 THP 155 115 kW (156 PS) 5FV (EP6CDT)	04.2009→		7.01777.18.0	DW-TL	EP	
			7.01115.08.0	SUV	EL	
			7.06117.45.0	SV-NWV	EL	
1.6 VTi 120 88 kW (120 PS) 5FS (EP6C)	07.2010→		7.06117.45.0	SV-NWV	EL	
2.0 HDi 100-101 kW (136-138 PS) RHR (DW10BTED4)	02.2008→		7.01633.04.0	DW-TL	EP	für Fahrzeuge mit Diesel-Partikel-Filter (DPF) for vehicles with diesel soot filter
2.2 HDi 125 kW (170 PS) 4HT (DW12BTED4)	02.2008→		7.01633.04.0	DW-TL	EP	für Fahrzeuge mit Diesel-Partikel-Filter (DPF) for vehicles with diesel soot filter
2.2 HDi 120 kW (163 PS) 4HP (DW12BTED4), 4HR (DW12BTED4)	04.2009→12.2011		7.01633.04.0	DW-TL	EP	 4HP (DW12BTED4), 4HR (DW12BTED4): für Fahrzeuge mit Diesel-Partikel-Filter (DPF) for vehicles with diesel soot filter





C5 III Break (RW_) 33

1.6 HDi 110 80 kW (109 PS) 9HZ (DV6TED4)	02.2008→		7.00968.04.0	DW-TL	EP	
1.6 HDi 110 82-84 kW (111-114 PS) 9HL (DV6C), 9HR (DV6C)	07.2010→		7.01633.06.0	DW-TL	EP	
1.6 HDi 115 82-84 kW (111-114 PS) 9HL (DV6C), 9HR (DV6C)	01.2012→		7.01633.06.0	DW-TL	EP	
1.6 THP 150 110 kW (150 PS) 5FN (EP6CDT)	04.2009→		7.01777.18.0	DW-TL	EP	
			7.01115.08.0	SUV	EL	



C5 III Break (RW_) 33











C

1.6 THP 155 115 kW (156 PS) 5FV (EP6CDT)	04.2009→		7.01777.18.0	DW-TL	EP	
			7.01115.08.0	SUV	EL	
			7.06117.45.0	SV-NWV	EL	
1.6 VTI 120 88 kW (120 PS) 5FS (EP6C)	07.2010→		7.06117.45.0	SV-NWV	EL	
2.0 HDi 100-101 kW (136-138 PS) RHR (DW10BTED4)	02.2008→		7.01632.02.0	DW-RK	EP	Organisationsnummer ab: 10703 RPO number from: 10703
			7.00968.04.0	DW-TL	EP	
			7.01633.04.0	DW-TL	EP	Organisationsnummer ab: 10703 RPO number from: 10703
2.2 HDi 125 kW (170 PS) 4HT (DW12BTED4)	02.2008→		7.01633.04.0	DW-TL	EP	für Fahrzeuge mit Diesel-Partikel-Filter (DPF) for vehicles with diesel soot filter

C6 (TD_) 34

2.2 HDi 125 kW (170 PS) 4HT (DW12BTED4)	06.2006→12.2012		7.01633.04.0	DW-TL	EP	für Fahrzeuge mit Diesel-Partikel-Filter (DPF) for vehicles with diesel soot filter
2.2 HDi 120 kW (163 PS) 4HP (DW12BTED4)	06.2006→12.2010		7.01633.04.0	DW-TL	EP	für Fahrzeuge mit Diesel-Partikel-Filter (DPF) for vehicles with diesel soot filter





C8 (EA_, EB_) 35

2.0 16V 103-111 kW (140-151 PS) RFJ (EW10A)	09.2005→		7.06117.34.0	SV-NWV	EL	mit Dichtring with O-ring Organisationsnummer bis: 10919 RPO number to: 10919
2.0 HDi 76-81 kW (103-110 PS) RHM (DW10ATED4), RHT (DW10ATED4)	07.2002→		7.02256.23.0	DW-RK	EP	 RHM (DW10ATED4), RHT (DW10ATED4): für OE-Nummer: 1628 HC for OE number: 1628 HC
			7.02256.24.0	DW-AGR	EP	
			7.02256.24.0	DW-TL	EP	
2.0 HDi 79-80 kW (107-109 PS) RHW (DW10ATED4)	07.2002→		7.02256.23.0	DW-RK	EP	für OE-Nummer: 1628 HC for OE number: 1628 HC
			7.02256.24.0	DW-TL	EP	
2.0 HDi 79-81 kW (107-110 PS) RHT (DW10ATED4)	07.2002→		7.02256.24.0	DW-AGR	EP	
			7.02256.23.0	DW-RK	EP	für OE-Nummer: 1628 HC for OE number: 1628 HC
2.0 HDi 79-88 kW (107-120 PS) RHK (DW10UTED4)	07.2006→		7.01632.02.0	DW-RK	EP	Organisationsnummer bis: 10990 RPO number to: 10990
			7.01633.04.0	DW-TL	EP	Organisationsnummer bis: 11381 RPO number to: 11381
2.0 HDi 135 100-101 kW (136-138 PS) RHR (DW10BTED4)	03.2006→		7.01632.02.0	DW-RK	EP	Organisationsnummer bis: 10990 RPO number to: 10990
			7.01633.04.0	DW-TL	EP	Organisationsnummer bis: 11381 RPO number to: 11381
2.2 HDi 94 kW (128 PS) 4HW (DW12TED4)	07.2002→		7.02256.24.0	DW-AGR	EP	
			7.02256.23.0	DW-RK	EP	
			7.02256.23.0	DW-TL	EP	Organisationsnummer bis: 10569 RPO number to: 10569
2.2 HDi 125 kW (170 PS) 4HT (DW12BTED4)	06.2006→		7.01633.04.0	DW-TL	EP	für Fahrzeuge mit Diesel-Partikel-Filter (DPF) for vehicles with diesel soot filter
2.2 HDi 120 kW (163 PS) 4HP (DW12BTED4), 4HR (DW12BTED4)	06.2007→		7.01633.04.0	DW-TL	EP	 4HP (DW12BTED4), 4HR (DW12BTED4): für Fahrzeuge mit Diesel-Partikel-Filter (DPF) for vehicles with diesel soot filter

DS3
36

1.2 THP 110 81 kW (110 PS) HNZ (EB2DT)	10.2014→03.2015		7.08681.09.0	EOV	EH	
			7.06117.45.0	SV-NWV	EL	
1.2 VTi 82 60-66 kW (82-90 PS) HMZ (EB2F)	01.2013→03.2015		7.06117.45.0	SV-NWV	EL	
			7.06117.45.0	SV-NWV	EL	
1.4 VTi 95 70 kW (95 PS) 8FP (EP3C)	04.2010→07.2015		7.06117.45.0	SV-NWV	EL	
			7.06117.45.0	SV-NWV	EL	
1.4 VTi 95 LPG 70-72 kW (95-98 PS) 8FR (EP3C)	08.2012→07.2015		7.06117.45.0	SV-NWV	EL	
			7.06117.45.0	SV-NWV	EL	
1.6 120-128 kW (163-173 PS) 5FM (EP6DT)	01.2012→07.2015		7.01777.18.0	DW-TL	EP	
			7.01115.08.0	SUV	EL	
1.6 BlueHDi 100 73-75 kW (99-102 PS) BHY (DV6FD)	07.2014→07.2015		7.08681.00.0	EOV	EH	Organisationsnummer ab: 14420 RPO number from: 14420
			7.08681.00.0	EOV	EH	
1.6 BlueHDi 75 55 kW (75 PS) BHW (DV6FE)	03.2015→07.2015		7.08681.00.0	EOV	EH	Organisationsnummer ab: 14420 RPO number from: 14420
			7.08681.00.0	EOV	EH	
1.6 HDi 110 82-84 kW (111-114 PS) 9HR (DV6C)	11.2009→07.2015		7.01633.06.0	DW-TL	EP	
			7.01633.06.0	DW-TL	EP	
1.6 HDi 115 84 kW (114 PS) 9HD (DV6C)	08.2012→07.2015		7.01633.06.0	DW-TL	EP	
			7.01633.06.0	DW-TL	EP	
1.6 Racing 149 kW (203 PS) 5FF (EP6DTS)	02.2011→07.2015		7.01115.08.0	SUV	EL	
			7.01115.08.0	SUV	EL	
1.6 Racing 152 kW (207 PS) 5FD (EP6DTS)	02.2011→07.2015		7.01777.18.0	DW-TL	EP	
			7.01115.08.0	SUV	EL	
			7.06117.45.0	SV-NWV	EL	
			7.06117.45.0	SV-NWV	EL	
1.6 THP 150 110 kW (150 PS) 5FN (EP6CDT)	01.2010→07.2015		7.01115.08.0	SUV	EL	
			7.06117.45.0	SV-NWV	EL	
1.6 THP 150 110 kW (150 PS) 5FX (EP6DT)	01.2010→07.2015		7.01777.18.0	DW-TL	EP	
			7.01115.08.0	SUV	EL	
			7.01115.08.0	SUV	EL	
1.6 THP 155 115 kW (156 PS) 5FR (EP6DT)	04.2010→07.2015		7.01777.18.0	DW-TL	EP	
			7.01115.08.0	SUV	EL	
1.6 THP 155 115 kW (156 PS) 5FV (EP6CDT)	04.2010→07.2015		7.01115.08.0	SUV	EL	
			7.06117.45.0	SV-NWV	EL	
			7.06117.45.0	SV-NWV	EL	
1.6 THP 165 121 kW (165 PS) 5GZ (EP6FDT)	10.2014→06.2015		7.01777.19.0	DW-TL	EP	für Fahrzeuge mit Schaltgetriebe for vehicles with manual transmission
			7.01115.08.0	SUV	EL	
			7.06117.45.0	SV-NWV	EL	
1.6 VTi 120 88 kW (120 PS) 5FS (EP6C)	04.2010→07.2015		7.06117.45.0	SV-NWV	EL	für Fahrzeuge mit Schaltgetriebe for vehicles with manual transmission
			7.06117.45.0	SV-NWV	EL	



DS3 Convertible
37

1.2 THP 110 81 kW (110 PS) HNZ (EB2DT)	10.2014→07.2015		7.08681.09.0	EOV	EH	
			7.06117.45.0	SV-NWV	EL	
1.2 VTi 82 60-66 kW (82-90 PS) HMZ (EB2F)	01.2013→07.2015		7.06117.45.0	SV-NWV	EL	
			7.06117.45.0	SV-NWV	EL	
1.6 BlueHDi 100 73-75 kW (99-102 PS) BHY (DV6FD)	07.2014→07.2015		7.08681.00.0	EOV	EH	Organisationsnummer ab: 14420 RPO number from: 14420
			7.08681.00.0	EOV	EH	
1.6 Racing 152 kW (207 PS) 5FD (EP6DTS)	03.2014→07.2015		7.01777.18.0	DW-TL	EP	
			7.01777.18.0	DW-TL	EP	





































DS3 Convertible **37**

C

			7.01115.08.0	SUV	EL	
			7.06117.45.0	SV-NWV	EL	
1.6 Racing 149 kW (203 PS) 5FF (EP6DTS)	03.2014→07.2015		7.01115.08.0	SUV	EL	
1.6 THP 150 110 kW (150 PS) 5FN (EP6CDT)	01.2013→07.2015		7.01777.18.0	DW-TL	EP	
			7.01115.08.0	SUV	EL	
			7.06117.45.0	SV-NWV	EL	
1.6 THP 155 115 kW (156 PS) 5FV (EP6CDT)	01.2013→07.2015		7.01777.18.0	DW-TL	EP	
			7.01115.08.0	SUV	EL	
			7.06117.45.0	SV-NWV	EL	
1.6 THP 165 121 kW (165 PS) 5GZ (EP6FDT)	10.2014→07.2015		7.01777.19.0	DW-TL	EP	für Fahrzeuge mit Schaltgetriebe for vehicles with manual transmission
			7.01115.08.0	SUV	EL	
			7.06117.45.0	SV-NWV	EL	für Fahrzeuge mit Schaltgetriebe for vehicles with manual transmission
1.6 THP 165 120-128 kW (163-173 PS) 5FM (EP6DT)	02.2015→07.2015		7.01115.08.0	SUV	EL	
1.6 VTi 120 88 kW (120 PS) 5FS (EP6C)	01.2013→07.2015		7.06117.45.0	SV-NWV	EL	

DS4 (NX_) **38**







1.2 THP 130 96 kW (131 PS) HNY (EB2DTS)	07.2014→07.2015		7.08681.09.0	EOV	EH	
			7.06117.45.0	SV-NWV	EL	
1.6 BlueHDi 115 85 kW (115 PS) BHX (DV6FC)	07.2014→07.2015		7.08681.00.0	EOV	EH	Organisationsnummer ab: 14420 RPO number from: 14420
1.6 BlueHDi 120 88 kW (120 PS) BHZ (DV6FC)	07.2014→07.2015		7.08681.00.0	EOV	EH	Organisationsnummer ab: 14420 RPO number from: 14420
1.6 HDi 110 82-84 kW (111-114 PS) 9HR (DV6C)	04.2011→07.2015		7.01633.06.0	DW-TL	EP	
1.6 HDi 115 84 kW (114 PS) 9HD (DV6C)	08.2012→07.2015		7.01633.06.0	DW-TL	EP	
1.6 THP 150 110 kW (150 PS) 5FE (EP6CDTMD)	04.2011→07.2015		7.01777.18.0	DW-TL	EP	
1.6 THP 155 115 kW (156 PS) 5FV (EP6CDT)	04.2011→07.2015		7.01777.18.0	DW-TL	EP	
			7.01115.08.0	SUV	EL	
			7.06117.45.0	SV-NWV	EL	für Fahrzeuge mit Schaltgetriebe for vehicles with manual transmission
1.6 THP 160 120-127 kW (163-173 PS) 5FM (EP6CDTM)	04.2012→07.2015		7.01777.18.0	DW-TL	EP	
			7.06117.45.0	SV-NWV	EL	
1.6 THP 165 120-127 kW (163-173 PS) 5FM (EP6CDTM)	01.2012→07.2015		7.01777.18.0	DW-TL	EP	
			7.01115.08.0	SUV	EL	
1.6 THP 165 121 kW (165 PS) 5GZ (EP6FDT)	01.2012→07.2015		7.01777.19.0	DW-TL	EP	für Fahrzeuge mit Automatikgetriebe for vehicles with automatic transmission
			7.01115.08.0	SUV	EL	
			7.06117.45.0	SV-NWV	EL	für Fahrzeuge mit Automatikgetriebe for vehicles with automatic transmission
1.6 THP 200 147 kW (200 PS) 5FU (EP6DTX)	04.2011→07.2015		7.01777.19.0	DW-TL	EP	

					
DS4 (NX_)					38
1.6 VTi 120 88 kW (120 PS) 5FS (EP6C)	04.2011→07.2015		7.06117.45.0	SV-NWV	EL
			7.06117.45.0	SV-NWV	EL
DS5					39
1.6 BlueHDi 120 88 kW (120 PS) BHZ (DV6FC)	07.2014→07.2015		7.08681.00.0	EOV	EH Organisationsnummer ab: 14420 RPO number from: 14420
1.6 HDi 85 85 kW (115 PS) BHX (DV6FC)	11.2013→07.2015		7.08681.00.0	EOV	EH Organisationsnummer ab: 14420 RPO number from: 14420
1.6 HDi 110 82-84 kW (111-114 PS) 9HR (DV6C)	11.2011→07.2015		7.01633.06.0	DW-TL	EP
1.6 HDi 115 84 kW (114 PS) 9HD (DV6C)	06.2012→07.2015		7.01633.06.0	DW-TL	EP
1.6 THP 150 110 kW (150 PS) 5FE (EP6CDTMD)	11.2011→07.2015		7.01777.18.0	DW-TL	EP
			7.01115.08.0	SUV	EL
1.6 THP 155 115 kW (156 PS) 5FV (EP6CDT)	11.2011→07.2015		7.01777.18.0	DW-TL	EP
			7.01115.08.0	SUV	EL
			7.06117.45.0	SV-NWV	EL für Fahrzeuge mit Automatikgetriebe for vehicles with automatic transmission
1.6 THP 165 120-127 kW (163-173 PS) 5FM (EP6CDTM)	01.2012→07.2015		7.01777.18.0	DW-TL	EP
1.6 THP 165 121 kW (165 PS) 5GZ (EP6FDT)	01.2012→07.2015		7.01777.19.0	DW-TL	EP für Fahrzeuge mit Automatikgetriebe for vehicles with automatic transmission
			7.01115.08.0	SUV	EL
1.6 THP 165 Hybrid 121 kW (165 PS) 5GZ (EP6FDT)	06.2012→07.2015		7.01777.19.0	DW-TL	EP für Fahrzeuge mit Automatikgetriebe for vehicles with automatic transmission
1.6 THP 200 147 kW (200 PS) 5FU (EP6DTX)	11.2011→07.2015		7.01777.19.0	DW-TL	EP für Fahrzeuge mit Schaltgetriebe for vehicles with manual transmission
			7.06117.45.0	SV-NWV	EL für Fahrzeuge mit Schaltgetriebe for vehicles with manual transmission
EVASION MPV (22, U6)					40
1.8 73-76 kW (99-103 PS) LFZ (XU7JP)	05.1997→07.2002		7.02256.05.0	OEL-HV	EH
2.0 89 kW (121 PS) RFU (XU10J2/C)	06.1994→07.2002		7.02256.05.0	OEL-HV	EH
			7.05432.02.0	SM	EL mit Dichtring with O-ring
2.0 16V 97-99 kW (132-135 PS) RFV (XU10J4R)	05.1998→04.2000		7.02256.05.0	OEL-HV	EH
2.0 16V 88-105 kW (136-143 PS) RFN (EW10J4)	05.2000→07.2002		7.02256.05.0	OEL-HV	EH
2.0 HDI 79-81 kW (107-110 PS) RHZ (DW10ATED)	08.1999→07.2002		7.02256.24.0	DW-AGR	EP
			7.02256.24.0	DW-TL	EP
			7.02256.05.0	OEL-HV	EH
2.0 HDI 16V 79-80 kW (107-109 PS) RHW (DW10ATED4)	09.1999→07.2002		7.02256.24.0	DW-AGR	EP
			7.02256.24.0	DW-RK	EP
			7.02256.24.0	DW-TL	EP
			7.02256.05.0	OEL-HV	EH



GRAND C4 SPACETOURER (3A_, 3E_) 41







C

























1.2 PureTech 130 96 kW (131 PS) HNS (EB2ADTS)	04.2018→		7.08681.09.0	EOV	EH	
1.2 PureTech 130 96 kW (131 PS) HNY (EB2DTS)	04.2018→		7.08681.09.0 7.06117.45.0	EOV SV-NWV	EH EL	
1.5 BlueHDi 130 96 kW (131 PS) YHZ (DV5RC)	05.2018→		7.08681.00.0	EOV	EH	Produktionsdatum ab: 02.07.2018 Production date from: 02.07.2018
1.6 BlueHDi 120 88 kW (120 PS) BHZ (DV6FC)	04.2018→		7.08681.00.0	EOV	EH	Getriebetyp: ML6C Transmission Type: ML6C Organisationsnummer ab: 14988 RPO number from: 14988
1.6 HDi 115 82-85 kW (112-116 PS) 9HC (DV6C)	04.2018→		7.01633.06.0	DW-TL	EP	
1.6 PureTech 180 133 kW (181 PS) 5GF (EP6FADTXD)	04.2018→		7.06117.45.0	SV-NWV	EL	
1.6 THP 165 121 kW (165 PS) 5GZ (EP6FDT)	04.2018→		7.06117.45.0	SV-NWV	EL	für Fahrzeuge mit Automatikgetriebe for vehicles with automatic transmission

NEMO MPV 42

1.3 HDi 75 55 kW (75 PS) FHZ (F13DTE5)	10.2010→		7.03003.01.0 7.01981.07.0 7.08681.03.0 7.08681.04.0 7.08681.05.0 7.08681.06.0	DW-TL SV-AGR-K SV-HYAT SV-HYAT SV-HYAT SV-HYAT	EP EP EH EH EH EH	für OE-Nummer: 2574 24 for OE number: 2574 24 für OE-Nummer: 2574 22 for OE number: 2574 22
--	----------	---	--	---	----------------------------------	--

XANTIA (X1_, X2_) 43













1.6 i 65-66 kW (88-90 PS) BFZ (XU5JP)	10.1993→03.2001		7.02256.05.0 7.05432.02.0	OEL-HV SM	EH EL	mit Dichtring with O-ring
1.8 i 73-76 kW (99-103 PS) LFZ (XU7JP)	03.1993→01.1998		7.02256.05.0 7.05432.02.0	OEL-HV SM	EH EL	mit Dichtring with O-ring für OE-Nummer: 1920 N1 for OE number: 1920 N1
1.8 i 58-66 kW (90 PS) LFX (XU7JB)	05.1997→04.2003		7.02256.05.0 7.05432.06.0	OEL-HV SM	EH EL	mit Dichtring with O-ring
1.8 i 16V 76-85 kW (110-116 PS) LFY (XU7JP4)	06.1995→12.2001		7.02256.05.0 7.05432.06.0	OEL-HV SM	EH EL	mit Dichtring with O-ring für OE-Nummer: 1920 4X for OE number: 1920 4X
2.0 89-95 kW (121-129 PS) RFX XU10J2C/Z L3	03.1993→05.1995		7.05432.02.0	SM	EL	mit Dichtring with O-ring
2.0 HDI 109 79-81 kW (107-110 PS) RHZ (DW10ATED)	02.1999→04.2003		7.02256.23.0 7.02256.24.0 7.02256.24.0 7.02256.24.0	DW-AGR DW-AGR DW-RK DW-TL	EP EP EP EP	für OE-Nummer: 1628 HC for OE number: 1628 HC für OE-Nummer: 1628 LQ for OE number: 1628 LQ für OE-Nummer: 1628 LQ for OE number: 1628 LQ für OE-Nummer: 1628 LQ for OE number: 1628 LQ
2.0 HDI 90 66 kW (90 PS) RHY (DW10TD)	03.1999→04.2003		7.02256.24.0	DW-AGR	EP	

					
XANTIA (X1_, X2_)					43
2.0 i 89-90 kW (120-122 PS) RFX (XU10J2C)	03.1993→04.2003	 7.02256.24.0	DW-RK	EP	mit Dichtring with O-ring
		 7.02256.05.0	OEL-HV	EH	
		 7.05432.02.0	SM	EL	
2.0 i 16V 110-114 kW (150-155 PS) RFY (XU10J4/Z)	03.1993→01.1998	 7.02256.05.0	OEL-HV	EH	
2.0 i 16V 110-114 kW (150-155 PS) RFT (XU10J4/Z)	06.1994→01.1998	 7.02256.05.0	OEL-HV	EH	
2.0 i 16V 97-99 kW (132-135 PS) RFV (XU10J4R)	06.1995→04.2003	 7.02256.05.0	OEL-HV	EH	
XANTIA Break (X1_, X2_)					44
1.8 i 73-76 kW (99-103 PS) LFZ (XU7JP)	06.1995→01.1998	 7.02256.05.0	OEL-HV	EH	mit Dichtring with O-ring für OE-Nummer: 1920 N1 for OE number: 1920 N1
		 7.05432.02.0	SM	EL	
1.8 i 58-66 kW (90 PS) LFX (XU7JB)	05.1997→04.2003	 7.02256.05.0	OEL-HV	EH	mit Dichtring with O-ring
		 7.05432.06.0	SM	EL	
1.8 i 16V 76-85 kW (110-116 PS) LFY (XU7JP4)	06.1995→04.2003	 7.02256.05.0	OEL-HV	EH	mit Dichtring with O-ring für OE-Nummer: 1920 4X for OE number: 1920 4X
		 7.05432.06.0	SM	EL	
2.0 HDI 109 79-81 kW (107-110 PS) RHZ (DW10ATED)	02.1999→04.2003	 7.02256.23.0	DW-AGR	EP	für OE-Nummer: 1628 HC for OE number: 1628 HC
		 7.02256.24.0	DW-AGR	EP	für OE-Nummer: 1628 LQ for OE number: 1628 LQ
		 7.02256.24.0	DW-RK	EP	für OE-Nummer: 1628 LQ for OE number: 1628 LQ
		 7.02256.24.0	DW-TL	EP	für OE-Nummer: 1628 LQ for OE number: 1628 LQ
2.0 HDI 90 66 kW (90 PS) RHY (DW10TD)	03.1999→04.2003	 7.02256.24.0	DW-AGR	EP	
		 7.02256.24.0	DW-RK	EP	
2.0 i 89-90 kW (120-122 PS) RFX (XU10J2C)	06.1995→04.2003	 7.02256.05.0	OEL-HV	EH	mit Dichtring with O-ring
		 7.05432.02.0	SM	EL	
2.0 i 16V 97-99 kW (132-135 PS) RFV (XU10J4R)	06.1995→04.2003	 7.02256.05.0	OEL-HV	EH	
XSARA (N1)					45
1.4 HDi 50-55 kW (68-75 PS) 8HX (DV4TD)	01.2003→03.2005	 7.00964.03.0	DW-AGR	EP	
1.6 i 65-67 kW (88-91 PS) NFZ (TU5JP)	08.1997→09.2000	 7.02256.05.0	OEL-HV	EH	
1.8 i 58-66 kW (90 PS) LFX (XU7JB)	05.1997→09.2000	 7.05432.06.0	SM	EL	mit Dichtring with O-ring
		 7.05432.06.0	SM	EL	mit Dichtring with O-ring für OE-Nummer: 1920 4X for OE number: 1920 4X
1.8 i Aut. 73-76 kW (99-103 PS) LFZ (XU7JP)	04.1997→09.2000	 7.05432.02.0	SM	EL	mit Dichtring with O-ring







XSARA (N1) **45**

C





1.9 D 51-52 kW (69-70 PS) WJY (DW8B)	04.2000→04.2005	 7.02256.24.0	DW-RK	EP	→01.2003 für Hersteller-Abgasnorm: CEE2000 for manufacturer exhaust norm: CEE2000
		 7.02256.23.0	DW-RK	EP	Organisationsnummer ab: 09562 RPO number from: 09562 für Hersteller-Abgasnorm: CEE2000 for manufacturer exhaust norm: CEE2000 Produktionsdatum ab: 27.02.2002 Production date from: 27.02.2002
1.9 D 51-52 kW (69-70 PS) WJY (DW8B)	11.2000→03.2005	 7.02256.24.0	DW-RK	EP	→01.2003 für Hersteller-Abgasnorm: CEE2000 for manufacturer exhaust norm: CEE2000
		 7.02256.23.0	DW-RK	EP	Organisationsnummer ab: 09562 RPO number from: 09562 für Hersteller-Abgasnorm: CEE2000 for manufacturer exhaust norm: CEE2000 Produktionsdatum ab: 27.02.2002 Production date from: 27.02.2002
2.0 HDi 109 79-81 kW (107-110 PS) RHZ (DW10ATED)	05.2001→03.2005	 7.02256.24.0	DW-RK	EP	 RHZ (DW10ATED): →11.2002  RHZ (DW10ATED): →11.2002
		 7.02256.23.0	DW-AGR	EP	Organisationsnummer ab: 09492 RPO number from: 09492 Produktionsdatum ab: 27.02.2002 Production date from: 27.02.2002
		 7.02256.23.0	DW-TL	EP	Organisationsnummer ab: 09492 RPO number from: 09492 Produktionsdatum ab: 27.02.2002 Production date from: 27.02.2002
2.0 HDi 90 66 kW (90 PS) RHY (DW10TD)	02.1999→03.2005	 7.02256.24.0	DW-AGR	EP	→11.2002
		 7.02256.24.0	DW-RK	EP	→11.2002
		 7.02256.23.0	DW-AGR	EP	Organisationsnummer ab: 09492 RPO number from: 09492 Produktionsdatum ab: 27.02.2002 Production date from: 27.02.2002
		 7.02256.23.0	DW-TL	EP	Organisationsnummer ab: 09492 RPO number from: 09492 Produktionsdatum ab: 27.02.2002 Production date from: 27.02.2002

XSARA Break (N2) **46**

1.4 HDi 50-55 kW (68-75 PS) 8HX (DV4TD)	01.2003→08.2005	 7.00964.03.0	DW-AGR	EP	
1.6 i 65-67 kW (88-91 PS) NFZ (TU5JP)	10.1997→09.2000	 7.02256.05.0	OEL-HV	EH	
1.8 i 58-66 kW (90 PS) LFX (XU7JB)	10.1997→09.2000	 7.05432.06.0	SM	EL	mit Dichtring with O-ring
1.8 i 16V 76-85 kW (110-116 PS) LFY (XU7JP4)	10.1997→09.2000	 7.05432.06.0	SM	EL	mit Dichtring with O-ring für OE-Nummer: 1920 4X for OE number: 1920 4X
1.8 i Aut. 73-76 kW (99-103 PS) LFZ (XU7JP)	10.1997→09.2000	 7.05432.02.0	SM	EL	mit Dichtring with O-ring
1.9 D 51-52 kW (69-70 PS) WJY (DW8B)	11.2000→08.2005	 7.02256.24.0	DW-RK	EP	→01.2003 für Hersteller-Abgasnorm: CEE2000 for manufacturer exhaust norm: CEE2000









XSARA Break (N2) 46

			7.02256.23.0	DW-RK	EP	Organisationsnummer ab: 09562 RPO number from: 09562 für Hersteller-Abgasnorm: CEE2000 for manufacturer exhaust norm: CEE2000 Produktionsdatum ab: 27.02.2002 Production date from: 27.02.2002
2.0 HDi 90 66 kW (90 PS) RHY (DW10TD)	02.1999→08.2005		7.02256.24.0	DW-AGR	EP	→11.2002
			7.02256.24.0	DW-RK	EP	→11.2002
			7.02256.23.0	DW-AGR	EP	Organisationsnummer ab: 09492 RPO number from: 09492
2.0 HDi 109 79-81 kW (107-110 PS) RHZ (DW10ATED)	05.2001→08.2005		7.02256.24.0	DW-RK	EP	 RHZ (DW10ATED): →11.2002  RHZ (DW10ATED): →11.2002
			7.02256.23.0	DW-AGR	EP	Organisationsnummer ab: 09492 RPO number from: 09492 Produktionsdatum ab: 27.02.2002 Production date from: 27.02.2002
			7.02256.23.0	DW-TL	EP	Organisationsnummer ab: 09492 RPO number from: 09492 Produktionsdatum ab: 27.02.2002 Production date from: 27.02.2002

C

XSARA Coupe (N0) 47

1.4 HDi 50-55 kW (68-75 PS) 8HX (DV4TD)	01.2003→03.2005		7.00964.03.0	DW-AGR	EP	
1.6 i 65-67 kW (88-91 PS) NFZ (TU5JP)	02.1998→09.2000		7.02256.05.0	OEL-HV	EH	
1.8 i 58-66 kW (90 PS) LFX (XU7JB)	02.1998→09.2000		7.05432.06.0	SM	EL	mit Dichtring with O-ring
1.8 i 73-76 kW (99-103 PS) LFZ (XU7JP)	02.1998→09.2000		7.05432.02.0	SM	EL	mit Dichtring with O-ring
1.8 i 16V 76-85 kW (110-116 PS) LFY (XU7JP4)	02.1998→09.2000		7.05432.06.0	SM	EL	mit Dichtring with O-ring für OE-Nummer: 1920 4X for OE number: 1920 4X
1.9 D 51-52 kW (69-70 PS) WJY (DW8B)	11.2000→03.2005		7.02256.24.0	DW-RK	EP	→01.2003 für Hersteller-Abgasnorm: CEE2000 for manufacturer exhaust norm: CEE2000
			7.02256.23.0	DW-RK	EP	Organisationsnummer ab: 09562 RPO number from: 09562 für Hersteller-Abgasnorm: CEE2000 for manufacturer exhaust norm: CEE2000 Produktionsdatum ab: 27.02.2002 Production date from: 27.02.2002
2.0 HDi 90 66 kW (90 PS) RHY (DW10TD)	02.1999→03.2005		7.02256.24.0	DW-AGR	EP	→11.2002 für Hersteller-Abgasnorm: CEE2000, CEE95 for manufacturer exhaust norm: CEE2000, CEE95
			7.02256.24.0	DW-RK	EP	→11.2002
			7.02256.23.0	DW-AGR	EP	Organisationsnummer ab: 09492 RPO number from: 09492 Produktionsdatum ab: 27.02.2002 Production date from: 27.02.2002
			7.02256.23.0	DW-TL	EP	Organisationsnummer ab: 09492 RPO number from: 09492 Produktionsdatum ab: 27.02.2002 Production date from: 27.02.2002



XSARA Coupe (N0) **47**







C

























2.0 HDi 109 79-81 kW (107-110 PS) RHZ (DW10ATED)	05.2001→03.2005	 7.02256.24.0	DW-RK	EP	RHZ (DW10ATED): →11.2002 RHZ (DW10ATED): →11.2002 Organisationsnummer ab: 09492 RPO number from: 09492 Produktionsdatum ab: 27.02.2002 Production date from: 27.02.2002 Organisationsnummer ab: 09492 RPO number from: 09492 Produktionsdatum ab: 27.02.2002 Production date from: 27.02.2002
		7.02256.23.0	DW-AGR	EP	
		7.02256.23.0	DW-TL	EP	

XSARA PICASSO (N68) **48**

1.6 65-67 kW (88-91 PS) NFZ (TU5JP)	06.2000→09.2001	 7.02256.05.0	OEL-HV	EH	Getriebetyp: AL4 Transmission Type: AL4 Automatikgetriebe Automatic Transmission Organisationsnummer bis: 08757 RPO number to: 08757
1.6 65-67 kW (88-91 PS) NFZ (TU5JP)	06.2002→08.2005	 7.02256.05.0	OEL-HV	EH	Getriebetyp: AL4 Transmission Type: AL4 Automatikgetriebe Automatic Transmission Organisationsnummer bis: 08757 RPO number to: 08757
1.6 HDi 80-85 kW (109-116 PS) 9HY (DV6TED4), 9HZ (DV6TED4)	05.2004→12.2011	 7.00968.04.0	DW-TL	EP	
1.6 HDi 66-68 kW (90-92 PS) 9HX (DV6ATED4)	09.2005→12.2011	 7.00968.04.0	DW-TL	EP	
2.0 HDi 66 kW (90 PS) RHY (DW10TD)	12.1999→12.2011	 7.02256.24.0	DW-AGR	EP	→11.2002 für Hersteller-Abgasnorm: CEE2000, CEE95 for manufacturer exhaust norm: CEE2000, CEE95
			7.02256.24.0	DW-RK	EP

ZX (N2) **49**

1.4 i 55 kW (75 PS) KDX (TU3M/Z)	03.1991→06.1997	 7.05432.04.0	SM	EL	mit Dichtring with O-ring Vergasertyp: Solex Carburettor Type: Solex
1.6 65-66 kW (88-90 PS) BDY (XU5M), BFZ (XU5JP)	07.1994→10.1997	 7.05432.02.0	SM	EL	mit Dichtring with O-ring Organisationsnummer ab: 05546 RPO number from: 05546 für Fahrzeuge mit Automatikgetriebe for vehicles with automatic transmission
1.6 i 65-66 kW (88-90 PS) BDY (XU5M), BFZ (XU5JP)	03.1991→06.1997	 7.05432.02.0	SM	EL	mit Dichtring with O-ring Organisationsnummer ab: 05546 RPO number from: 05546 für Fahrzeuge mit Automatikgetriebe for vehicles with automatic transmission
1.8 73-76 kW (99-103 PS) LFZ (XU7JP)	03.1991→10.1997	 7.05432.02.0	SM	EL	mit Dichtring with O-ring
1.8 i 73-76 kW (99-103 PS) LFZ (XU7JP)	07.1992→06.1997	 7.05432.02.0	SM	EL	mit Dichtring with O-ring
2.0 89-90 kW (120-122 PS) RFX (XU10J2C)	07.1994→10.1997	 7.05432.02.0	SM	EL	mit Dichtring with O-ring
2.0 i 89-90 kW (120-122 PS) RFX (XU10J2C)	07.1992→06.1997	 7.05432.02.0	SM	EL	mit Dichtring with O-ring







						
ZX Break (N2)						50
1.4 i 55 kW (75 PS) KDX (TU3M/Z)	10.1993→10.1997		7.05432.04.0	SM	EL mit Dichtring with O-ring Vergasertyp: Solex Carburettor Type: Solex	
1.6 i 65-66 kW (88-90 PS) BDY (XU5M), BFZ (XU5JP)	10.1993→10.1997		7.05432.02.0	SM	EL mit Dichtring with O-ring Organisationsnummer ab: 05546 RPO number from: 05546 für Fahrzeuge mit Automatikgetriebe for vehicles with automatic transmission	
1.8 i 73-76 kW (99-103 PS) LFZ (XU7JP)	10.1993→10.1997		7.05432.02.0	SM	EL mit Dichtring with O-ring	
2.0 89-95 kW (121-129 PS) RFX XU10J2C/Z L3	10.1993→11.1995		7.05432.02.0	SM	EL mit Dichtring with O-ring	
BERLINGO / BERLINGO FIRST Box Body/MPV (M_)						51
1.6 HDI 90 (MB9HX, MC9HX) 66-68 kW (90-92 PS) 9HX (DV6ATED4)	07.2005→12.2011		7.00968.04.0	DW-TL	EP	
1.8 i 58-66 kW (90 PS) LFX (XU7JB)	05.1998→10.2002		7.05432.06.0	SM	EL mit Dichtring with O-ring	
1.8 i	10.1999→12.2003		7.05432.02.0	SM	EL mit Dichtring with O-ring	
1.9 D 70 (MBWJZ, MCWJZ) 51-52 kW (69-70 PS) WJY (DW8B)	04.1999→12.2011		7.02256.24.0	DW-RK	EP	
1.9 D 70 4WD (MBWJZ, MCWJZ) 51-52 kW (69-70 PS) WJY (DW8B)	07.1998→03.2006		7.02256.24.0	DW-RK	EP	
2.0 HDI 90 (MBRHY, MCRHY) 66 kW (90 PS) RHY (DW10TD)	12.1999→12.2011		7.02256.24.0	DW-AGR	EP	
2.0 HDI 90 4WD (MBRHY, MCRHY) 66 kW (90 PS) RHY (DW10TD)	11.2000→10.2005		7.02256.24.0	DW-RK	EP	
			7.02256.24.0	DW-AGR	EP	
			7.02256.24.0	DW-RK	EP	
BERLINGO Box Body/MPV (B9)						52
1.6 BlueHdi 100 73-75 kW (99-102 PS) BHY (DV6FD)	12.2014→		7.08681.00.0	EOV	EH  BHY (DV6FD): Getriebetyp: BE4R Transmission Type: BE4R Organisationsnummer ab: 14420 RPO number from: 14420 für Fahrzeuge mit Start-Stopp-Funktion for vehicles with start-stop function  BHY (DV6FD): Getriebetyp: MC Transmission Type: MC Organisationsnummer ab: 14420 RPO number from: 14420	
1.6 BlueHdi 100 4x4 73-75 kW (99-102 PS) BHY (DV6FD)	12.2014→		7.08681.00.0	EOV	EH  BHY (DV6FD): Getriebetyp: BE4R Transmission Type: BE4R Organisationsnummer ab: 14420 RPO number from: 14420 für Fahrzeuge mit Start-Stopp-Funktion for vehicles with start-stop function  BHY (DV6FD): Getriebetyp: MC Transmission Type: MC Organisationsnummer ab: 14420 RPO number from: 14420	
1.6 Hdi / BlueHdi 75 55 kW (75 PS) BHW (DV6FE)	07.2010→		7.08681.00.0	EOV	EH Getriebetyp: BE4R Transmission Type: BE4R Organisationsnummer ab: 14420 RPO number from: 14420 für Fahrzeuge mit Start-Stopp-Funktion for vehicles with start-stop function	

					
---	---	---	---	--	---





BERLINGO Box Body/MPV (B9) 52
C

1.6 HDi 110 80 kW (109 PS) 9HZ (DV6TED4)	04.2008→		7.00968.04.0	DW-TL	EP	
1.6 HDi 110 82-84 kW (111-114 PS) 9HL (DV6C), 9HR (DV6C)	07.2010→		7.01633.06.0	DW-TL	EP	
1.6 HDi 115 82-84 kW (111-114 PS) 9HL (DV6C)	07.2010→		7.01633.06.0	DW-TL	EP	
1.6 HDi 75 55 kW (75 PS) 9HT (DV6BTED4), 9HT (DV6BUTED4)	04.2008→		7.00968.04.0	DW-TL	EP	
1.6 HDi 90 16V 66 kW (90 PS) 9HS (DV6TED4BU), 9HX (DV6AUTED4)	04.2008→		7.00968.04.0	DW-TL	EP	
1.6 VTi 120 88 kW (120 PS) 5FS (EP6C)	11.2009→		7.06117.45.0	SV-NWV	EL	
1.6 VTi 95 72 kW (98 PS) 5FK (EP6CB)	07.2010→		7.06117.45.0	SV-NWV	EL	
PureTech 110 81 kW (110 PS) HNZ (EB2DT)	01.2018→		7.08681.09.0	EOV	EH	



BERLINGO Box Body/MPV (K9) 53

















1.5 BlueHDi 100 73-75 kW (99-102 PS) YHY (DV5RD)	06.2018→		7.08681.00.0	EOV	EH	
1.5 BlueHDi 130 96 kW (131 PS) YHZ (DV5RC)	06.2018→		7.08681.00.0	EOV	EH	
1.5 BlueHDi 75 55 kW (75 PS) YHW (DV5RE)	10.2019→		7.08681.00.0	EOV	EH	
PureTech 110 81 kW (110 PS) HNP (EB2ADT)	06.2018→		7.08681.09.0	EOV	EH	 HNP (EB2ADT): Euro 6d-Temp Euro 6d-Temp  HNP (EB2ADT): Organisationsnummer ab: 15575 RPO number from: 15575 Euro 6d Euro 6d
PureTech 130 96 kW (131 PS) HNS (EB2ADTS)	10.2019→		7.08681.09.0	EOV	EH	Organisationsnummer ab: 15575 RPO number from: 15575 Euro 6d Euro 6d

BERLINGO Platform/Chassis (B9) 54





















1.6 BlueHDi 100 73-75 kW (99-102 PS) BHY (DV6FD)	12.2014→		7.08681.00.0	EOV	EH	 BHY (DV6FD): Getriebetyp: BE4R Transmission Type: BE4R Organisationsnummer ab: 14420 RPO number from: 14420 für Fahrzeuge mit Start-Stopp-Funktion for vehicles with start-stop function  BHY (DV6FD): Getriebetyp: MC Transmission Type: MC Organisationsnummer ab: 14420 RPO number from: 14420
1.6 HDi 90 16V 66-68 kW (90-92 PS) 9HX (DV6ATED4)	04.2008→		7.00968.04.0	DW-TL	EP	

























C15 Box Body/MPV (VD_) 55

1.9 D 51-52 kW (69-70 PS) WJY (DW8B)	01.2000→07.2005		7.02256.24.0	DW-RK	EP	
1.9 D 44 kW (60 PS) WJX (DW8B)	12.2000→12.2005		7.02256.24.0	DW-RK	EP	

					
C2 ENTERPRISE (JG_)					56
1.4 HDi 50-52 kW (68-71 PS) 8HZ (DV4TD)	11.2003→04.2005		7.00964.03.0	DW-AGR	EP Euro 3 Euro 3
1.4 HDi 50-55 kW (68-75 PS) 8HX (DV4TD)	09.2006→12.2009		7.00964.03.0	DW-AGR	EP Euro 3 Euro 3
C4 I Hatchback Van (LR_)					57
2.0 HDi 100-101 kW (136-138 PS) RHR (DW10BTED4)	02.2005→12.2010		7.00612.01.0	DW-AGR	EP  RHR (DW10BTED4): →01.2006 Schaltgetriebe Manual Transmission Organisationsnummer bis: 10618 RPO number to: 10618 für Fahrzeuge mit Diesel-Partikel-Filter (DPF) for vehicles with diesel soot filter
			7.01632.02.0	DW-RK	EP  RHR (DW10BTED4): →03.2006 Organisationsnummer bis: 10746 RPO number to: 10746 für Fahrzeuge ohne Diesel-Partikel-Filter (DPF) for vehicles without diesel soot filter
			7.01632.02.0	DW-TL	EP  RHR (DW10BTED4): Getriebeautomatik 6 Gang 6-Speed Automatic Transmission für Fahrzeuge mit Diesel-Partikel-Filter (DPF) for vehicles with diesel soot filter
			7.01633.04.0	DW-TL	EP  RHR (DW10BTED4): Schaltgetriebe Manual Transmission Organisationsnummer ab: 10619 RPO number from: 10619 für Fahrzeuge mit Diesel-Partikel-Filter (DPF) for vehicles with diesel soot filter Herstellerausschluss: Delphi Manufacturer Exclusion: Delphi
C4 II Hatchback Van (NC_)					58
1.6 HDi 82-84 kW (111-114 PS) 9HR (DV6C)	11.2009→		7.01633.06.0	DW-TL	EP
C5 Estate Van (DE_, RE_)					59
2.0 HDi 79-81 kW (107-110 PS) RHZ (DW10ATED)	06.2002→08.2004		7.02256.24.0	DW-AGR	EP
			7.02256.24.0	DW-RK	EP
			7.02256.24.0	DW-TL	EP
2.0 HDi 66 kW (90 PS) RHY (DW10TD)	06.2002→08.2004		7.02256.24.0	DW-AGR	EP
			7.02256.24.0	DW-RK	EP
2.0 HDi 100-101 kW (136-138 PS) RHR (DW10BTED4)	09.2004→01.2008		7.01632.02.0	DW-RK	EP Organisationsnummer ab: 10703 RPO number from: 10703

C





			 PIERBURG		
C5 Estate Van (DE_, RE_)					59
C			7.00612.01.0	DW-AGR	EP →04.2005 Organisationsnummer bis: 10401 RPO number to: 10401
			7.00612.01.0	DW-TL	EP →04.2005 Organisationsnummer bis: 10401 RPO number to: 10401
C8 Van (EA_, EB_)					60
2.0 (EBRFJC) 103-111 kW (140-151 PS) RFJ (EW10A)	06.2004→12.2011		7.06117.34.0	SV-NWV	EL mit Dichtring with O-ring Organisationsnummer bis: 10919 RPO number to: 10919
JUMPER Bus					61
3.0 HDi 160 115-130 kW (156-177 PS) F1CE0481D (F30DT)	09.2006→		7.02256.03.0	DW-AGR	EP
JUMPER Bus (230P)					62
2.0 80 kW (109 PS) RFW (XU10J2U)	02.1994→04.2002		7.05432.02.0	SM	EL mit Dichtring with O-ring für OE-Nummer: 1920 N1 for OE number: 1920 N1
2.0 4x4 80 kW (109 PS) RFW (XU10J2U)	08.1996→04.2002		7.05432.02.0	SM	EL mit Dichtring with O-ring für OE-Nummer: 1920 N1 for OE number: 1920 N1
2.8 D 64 kW (87 PS) 8140.63 (F28D)	01.1999→02.2002		7.02256.03.0	DW-AGR	EP
2.8 HDi 94 kW (128 PS) 8140.43S	09.2000→04.2002		7.02256.03.0	DW-AGR	EP
2.8 HDi 4x4 94 kW (128 PS) 8140.43S	09.2000→04.2002		7.02256.03.0	DW-AGR	EP
JUMPER Bus (244, Z_)					63
2.0 HDi 62 kW (84 PS) RHV (DW10UTD)	04.2002→		7.02256.23.0	DW-AGR	EP
2.2 HDi 74 kW (101 PS) 4HY (DW12UTED)	04.2002→		7.02256.23.0	DW-AGR	EP
			7.02256.24.0	DW-RK	EP für OE-Nummer: 1628 LQ for OE number: 1628 LQ
2.8 HDi 94 kW (128 PS) 8140.43S	04.2002→		7.02256.03.0	DW-AGR	EP
2.8 HDi All-wheel Drive 94 kW (128 PS) 8140.43S	04.2002→		7.02256.03.0	DW-AGR	EP
JUMPER Platform/Chassis					64
3.0 HDi 160 115-130 kW (156-177 PS) F1CE0481D (F30DT)	09.2006→		7.02256.03.0	DW-AGR	EP
JUMPER Platform/Chassis (230)					65
2.0 80 kW (109 PS) RFW (XU10J2U)	03.1994→04.2002		7.05432.02.0	SM	EL mit Dichtring with O-ring für OE-Nummer: 1920 N1 for OE number: 1920 N1
2.8 D 64 kW (87 PS) 8140.63 (F28D)	01.1999→02.2002		7.02256.03.0	DW-AGR	EP
2.8 HDi 94 kW (128 PS) 8140.43S	09.2000→04.2002		7.02256.03.0	DW-AGR	EP

						
JUMPER Platform/Chassis (244)						66
2.0 HDi 62 kW (84 PS) RHV (DW10UTD)	04.2002→		7.02256.23.0	DW-AGR	EP	
2.2 HDi 74 kW (101 PS) 4HY (DW12UTED)	02.2002→06.2006		7.02256.23.0	DW-AGR	EP	
			7.02256.24.0	DW-RK	EP	
2.2 HDi 74 kW (101 PS) 4HY (DW12UTED)	04.2002→		7.02256.23.0	DW-AGR	EP	
			7.02256.24.0	DW-RK	EP	
2.8 HDi 94 kW (128 PS) 8140.43S	04.2002→		7.02256.03.0	DW-AGR	EP	
JUMPER Van						67
3.0 HDi 160 115-130 kW (156-177 PS) F1CE0481D (F30DT)	09.2006→		7.02256.03.0	DW-AGR	EP	
JUMPER Van (230L)						68
2.0 80 kW (109 PS) RFW (XU10J2U)	03.1994→04.2002		7.05432.02.0	SM	EL	mit Dichtring with O-ring für OE-Nummer: 1920 N1 for OE number: 1920 N1
2.0 4x4 80 kW (109 PS) RFW (XU10J2U)	10.1996→01.2002		7.05432.02.0	SM	EL	mit Dichtring with O-ring für OE-Nummer: 1920 N1 for OE number: 1920 N1
2.0 HDi 62 kW (84 PS) RHV (DW10TD)	11.2001→04.2002		7.02256.23.0	DW-AGR	EP	für OE-Nummer: 1628 HC for OE number: 1628 HC
			7.02256.24.0	DW-AGR	EP	für OE-Nummer: 1628 LQ for OE number: 1628 LQ
			7.02256.24.0	DW-RK	EP	für OE-Nummer: 1628 LQ for OE number: 1628 LQ
2.8 D 64 kW (87 PS) 8140.63 (F28D)	01.1999→02.2002		7.02256.03.0	DW-AGR	EP	
2.8 HDi 94 kW (128 PS) 8140.43S	09.2000→04.2002		7.02256.03.0	DW-AGR	EP	
2.8 HDi 4x4 94 kW (128 PS) 8140.43S	09.2000→04.2002		7.02256.03.0	DW-AGR	EP	
JUMPER Van (244)						69
2.0 HDi 62 kW (84 PS) RHV (DW10UTD)	04.2002→		7.02256.23.0	DW-AGR	EP	
2.2 HDi 74 kW (101 PS) 4HY (DW12UTED)	04.2002→		7.02256.23.0	DW-AGR	EP	
			7.02256.24.0	DW-RK	EP	
2.8 HDi 94 kW (128 PS) 8140.43S	04.2002→		7.02256.03.0	DW-AGR	EP	
2.8 HDi 94 kW (128 PS) 8140.43S	07.2005→10.2010		7.02256.03.0	DW-AGR	EP	
2.8 HDi 4x4 94 kW (128 PS) 8140.43S	04.2002→		7.02256.03.0	DW-AGR	EP	
JUMPY (U6U_)						70
1.6 58-60 kW (79-81 PS) 1580 SPI, 220 A2.000	10.1995→08.2000		7.02256.05.0	OEL-HV	EH	
1.9 D 70 51-52 kW (69-70 PS) WJY (DW8B)	04.1998→11.2003		7.02256.23.0	DW-RK	EP	Organisationsnummer ab: 09857 RPO number from: 09857 Produktionsdatum ab: 04.11.2003 Production date from: 04.11.2003
			7.02256.24.0	DW-RK	EP	





JUMPY (U6U_) **70**

C

2.0 88-105 kW (136-143 PS) RFN (EW10J4)	04.2000→12.2006	 7.02256.05.0	OEL-HV	EH	
2.0 HDi 110 79-80 kW (107-109 PS) RHW (DW10ATED4)	03.2000→10.2006	 7.02256.24.0	DW-AGR	EP	
		7.02256.24.0	DW-RK	EP	
		7.02256.24.0	DW-TL	EP	
		7.02256.05.0	OEL-HV	EH	
2.0 HDi 110 79-81 kW (107-110 PS) RHZ (DW10ATED)	03.2000→10.2006	 7.02256.05.0	OEL-HV	EH	
2.0 HDi 95 69 kW (94 PS) RHX (DW10BTED)	10.1999→10.2006	 7.02256.24.0	DW-AGR	EP	
		7.02256.24.0	DW-RK	EP	
		7.02256.24.0	DW-TL	EP	
		7.02256.05.0	OEL-HV	EH	
2.0 i 16V 88-105 kW (136-143 PS) RFN (EW10J4)	03.2000→10.2006	 7.02256.05.0	OEL-HV	EH	







JUMPY (VF7) **71**

2.0 HDi 120 79-88 kW (107-120 PS) RHK (DW10UTED4)	01.2007→03.2016	 7.01633.04.0	DW-TL	EP	Organisationsnummer bis: 11381 RPO number to: 11381
2.0 HDi 140 100-101 kW (136-138 PS) RHR (DW10BTED4)	01.2007→03.2016	 7.01633.04.0	DW-TL	EP	Organisationsnummer bis: 11381 RPO number to: 11381 für Fahrzeuge mit Diesel-Partikel-Filter (DPF) for vehicles with diesel soot filter
2.0 i 103-111 kW (140-151 PS) RFH (EW10A), RFJ (EW10A)	01.2007→03.2016	 7.02256.05.0	OEL-HV	EH	

JUMPY Bus (V_) **72**

1.5 BlueHDi 100 75 kW (102 PS) YHR (DV5RUCd)	06.2018→	 7.08681.00.0	EOV	EH	Produktionsdatum ab: 08.10.2018 Production date from: 08.10.2018
---	----------	---	-----	----	---



JUMPY Platform/Chassis (BU_, BV_, BW_, BX_) **73**

1.9 TD 51-52 kW (69-70 PS) WJY (DW8B)	11.2000→10.2006	 7.02256.24.0	DW-RK	EP	→11.2003
		7.02256.23.0	DW-RK	EP	Organisationsnummer ab: 09857 RPO number from: 09857 Produktionsdatum ab: 04.11.2003 Production date from: 04.11.2003
2.0 88-105 kW (136-143 PS) RFN (EW10J4)	12.2003→10.2006	 7.02256.05.0	OEL-HV	EH	
2.0 HDi 110 79-81 kW (107-110 PS) RHZ (DW10ATED)	12.2003→10.2006	 7.02256.24.0	DW-AGR	EP	
		7.02256.24.0	DW-RK	EP	
		7.02256.24.0	DW-TL	EP	
		7.02256.05.0	OEL-HV	EH	
2.0 HDi 110 80 kW (109 PS) RHZ (DW10BTED), RHZ (DW10BTED+), RHZ (DW10CTED), RHZ (DW10CTED+)	12.2003→10.2006	 7.02256.05.0	OEL-HV	EH	
2.0 HDi 110 16V 79-80 kW (107-109 PS) RHW (DW10ATED4)	12.2003→10.2006	 7.02256.24.0	DW-AGR	EP	
		7.02256.24.0	DW-RK	EP	
		7.02256.24.0	DW-TL	EP	
		7.02256.05.0	OEL-HV	EH	
2.0 HDi 95 69 kW (94 PS) RHX (DW10BTED)	10.1999→10.2006	 7.02256.24.0	DW-AGR	EP	
		7.02256.24.0	DW-RK	EP	









JUMPY Platform/Chassis (BU_, BV_, BW_, BX_) 73

7.02256.24.0	DW-TL	EP
7.02256.05.0	OEL-HV	EH

JUMPY Van 74

2.0 HDi 120 4x4 79-88 kW (107-120 PS) RHK (DW10UTED4)	01.2010→03.2016		7.01633.04.0	DW-TL	EP	Organisationsnummer bis: 11381 RPO number to: 11381
2.0 HDi 140 100-101 kW (136-138 PS) RHR (DW10BTED4)	01.2007→03.2016		7.01633.04.0	DW-TL	EP	Organisationsnummer bis: 11381 RPO number to: 11381 für Fahrzeuge mit Diesel-Partikel-Filter (DPF) for vehicles with diesel soot filter
2.0 i 103 kW (140 PS) RFH (EW10A)	01.2007→03.2016		7.02256.05.0	OEL-HV	EH	

JUMPY Van (BS_, BT_, BY_, BZ_) 75

1.6 i 58-60 kW (79-81 PS) 1580 SPI, 220 A2.000	10.1995→08.2000		7.02256.05.0	OEL-HV	EH	
1.9 D 70 51-52 kW (69-70 PS) WJY (DW8B)	04.1998→10.2006		7.02256.24.0	DW-RK	EP	→11.2003
			7.02256.23.0	DW-RK	EP	Organisationsnummer ab: 09857 RPO number from: 09857 Produktionsdatum ab: 04.11.2003 Production date from: 04.11.2003
2.0 HDi 110 79-81 kW (107-110 PS) RHZ (DW10ATED)	10.2001→10.2006		7.02256.24.0	DW-AGR	EP	
			7.02256.24.0	DW-RK	EP	
			7.02256.24.0	DW-TL	EP	
			7.02256.05.0	OEL-HV	EH	
2.0 HDi 110 80 kW (109 PS) RHZ (DW10BTED), RHZ (DW10BTED+), RHZ (DW10CTED), RHZ (DW10CTED+)	10.2001→10.2006		7.02256.05.0	OEL-HV	EH	
2.0 HDi 110 79-80 kW (107-109 PS) RHW (DW10ATED4)	01.2002→10.2006		7.02256.24.0	DW-AGR	EP	
			7.02256.24.0	DW-RK	EP	
			7.02256.24.0	DW-TL	EP	
			7.02256.05.0	OEL-HV	EH	
2.0 HDi 95 69 kW (94 PS) RHX (DW10BTED)	10.1999→10.2006		7.02256.24.0	DW-AGR	EP	
			7.02256.24.0	DW-RK	EP	
			7.02256.24.0	DW-TL	EP	
			7.02256.05.0	OEL-HV	EH	
2.0 i 16V 88-105 kW (136-143 PS) RFN (EW10J4)	03.2000→10.2006		7.02256.05.0	OEL-HV	EH	

JUMPY Van (V_) 76

1.5 BlueHDi 100 75 kW (102 PS) YHR (DV5RUCd)	06.2018→		7.08681.00.0	EOV	EH	Produktionsdatum ab: 08.10.2018 Production date from: 08.10.2018
--	----------	---	---------------------	-----	----	---

NEMO Box Body/MPV (AA_) 77

1.3 HDi 75 55 kW (75 PS) FHZ (F13DTE5)	10.2010→		7.03003.01.0	DW-TL	EP	
			7.01981.07.0	SV-AGR-K	EP	
			7.08681.03.0	SV-HYAT	EH	für OE-Nummer: 2574 24 for OE number: 2574 24
			7.08681.04.0	SV-HYAT	EH	
			7.08681.05.0	SV-HYAT	EH	für OE-Nummer: 2574 22 for OE number: 2574 22
			7.08681.06.0	SV-HYAT	EH	



SPACETOURER Bus (V_) 78

C

1.5 BlueHDi 100 75 kW (102 PS) YHR (DV5RUCd)	06.2018→	 7.08681.00.0	EOV	EH	
1.5 BlueHDi 120 88 kW (120 PS) YHV (DV5RUC)	06.2018→	 7.08681.00.0	EOV	EH	Produktionsdatum ab: 02.07.2018 Production date from: 02.07.2018

XANTIA Estate Van (X2_) 79









2.0 HDi 66 kW (90 PS) RHY (DW10TD)	06.1999→04.2003	 7.02256.24.0	DW-AGR	EP	
		7.02256.24.0	DW-RK	EP	

XSARA Estate Van 80

2.0 HDi 66 kW (90 PS) RHY (DW10TD)	09.2000→03.2005	 7.02256.24.0	DW-AGR	EP	→11.2002
		7.02256.24.0	DW-RK	EP	→11.2002
		7.02256.23.0	DW-AGR	EP	Organisationsnummer ab: 09492 RPO number from: 09492 Produktionsdatum ab: 27.02.2002 Production date from: 27.02.2002
		7.02256.23.0	DW-TL	EP	Organisationsnummer ab: 09492 RPO number from: 09492 Produktionsdatum ab: 27.02.2002 Production date from: 27.02.2002

XSARA Hatchback Van (N3_) 81









2.0 HDi 66 kW (90 PS) RHY (DW10TD)	09.2000→03.2005	 7.02256.24.0	DW-AGR	EP	→11.2002
		7.02256.24.0	DW-RK	EP	→11.2002
		7.02256.23.0	DW-AGR	EP	Organisationsnummer ab: 09492 RPO number from: 09492 Produktionsdatum ab: 27.02.2002 Production date from: 27.02.2002
		7.02256.23.0	DW-TL	EP	Organisationsnummer ab: 09492 RPO number from: 09492 Produktionsdatum ab: 27.02.2002 Production date from: 27.02.2002

							
C3-XR						1	
1.6 T 120-123 kW (163-167 PS) 5G02 10UF01 (EP6FDTM)	12.2014->	 7.01115.08.0	SUV	EL		C	
C4 L							2
1.6 THP 120 kW (163 PS) 5F06 10FJBZ (EP6CDTM)	12.2012->12.2015	 7.01115.08.0	SUV	EL			
C5						3	
1.6 120-123 kW (163-167 PS) 5G02 10UF01 (EP6FDTM)	05.2014->	 7.01115.08.0	SUV	EL			



DOKKER MPV (KE_)

1

D	1.2 TCe (KEM0, KEAY) 74-97 kW (101-132 PS) H5F 408	11.2012→	 7.01343.04.0	LDRV	EP	
			7.02476.09.0	SUV	EL	
	1.2 TCe (KEM0, KEAY) 84-85 kW (115-116 PS) H5F 402	11.2012→	 7.08681.15.0	EOV	EH	
			7.01343.04.0	LDRV	EP	
	1.3 TCe 100 (KENU) 75-110 kW (102-150 PS) H5H 470	08.2019→	 7.04818.04.0	SUV	EL	
	1.3 TCe 130 (KENE) 75-110 kW (102-150 PS) H5H 470	03.2019→	 7.04818.04.0	SUV	EL	
	1.5 dCi (KEAJ, KEAH) 55-66 kW (75-90 PS) K9K 612, K9K 626	11.2012→	 7.01814.12.0	DW-TL	EP	
1.5 dCi (KEMW) 55-66 kW (75-90 PS) K9K 612, K9K 830	11.2012→	 7.01814.12.0	DW-TL	EP	Produktionsdatum bis: 20.12.2015 Production date to: 20.12.2015	
1.5 dCi / Blue dCi 75 (KEAJ, KEAH, KEJW) 55-66 kW (75-90 PS) K9K 612, K9K 626	11.2012→	 7.01814.12.0	DW-TL	EP	 K9K 612, K9K 626: Produktionsdatum bis: 20.12.2015 Production date to: 20.12.2015	







DUSTER (HM_)



























2

	1.2 TCe 125 (HMMA) 74-97 kW (101-132 PS) H5F 408	10.2017→	 7.08681.15.0	EOV	EH	
			7.01343.04.0	LDRV	EP	
			7.02476.09.0	SUV	EL	
	1.2 TCe 125 4x4 (HMMA) 92 kW (125 PS) H5F 410	10.2017→	 7.08681.15.0	EOV	EH	
			7.01343.04.0	LDRV	EP	
			7.02476.09.0	SUV	EL	























DUSTER (HS_)

















3

	1.2 TCe 125 74-97 kW (101-132 PS) H5F 408	10.2013→01.2018	 7.01343.04.0	LDRV	EP	
	1.2 TCe 125 92 kW (125 PS) H5F 404	10.2013→01.2018	 7.08681.15.0	EOV	EH	
			7.01343.04.0	LDRV	EP	
	1.2 TCe 125 4x4 92 kW (125 PS) H5F 410	06.2015→01.2018	 7.08681.15.0	EOV	EH	
			7.01343.04.0	LDRV	EP	
			7.02476.09.0	SUV	EL	
	1.5 dCi 63 kW (86 PS) K9K 830	04.2010→01.2018	 7.01814.12.0	DW-TL	EP	
	1.5 dCi 80-81 kW (109-110 PS) K9K 658, K9K 666	08.2013→01.2018	 7.01814.12.0	DW-TL	EP	 K9K 658, K9K 666: Produktionsdatum bis: 20.12.2015 Production date to: 20.12.2015
	1.5 dCi 80 kW (109 PS) K9K 658	08.2013→01.2018	 7.01814.12.0	DW-TL	EP	Produktionsdatum bis: 20.12.2015 Production date to: 20.12.2015
	1.5 dCi 4x4 80 kW (109 PS) K9K 658	08.2013→01.2018	 7.01814.12.0	DW-TL	EP	Produktionsdatum bis: 20.12.2015 Production date to: 20.12.2015

						
LOGGY (JS_)						4
1.2 TCe (JSAY, JSM0) 74-97 kW (101-132 PS) H5F 408	03.2012→		7.01343.04.0	LDRV	EP	
			7.02476.09.0	SUV	EL	
1.2 TCe (JSAY, JSM0) 84-85 kW (115-116 PS) H5F 402	03.2012→		7.08681.15.0	EOV	EH	
			7.01343.04.0	LDRV	EP	
1.3 TCe 100 (JSNU) 75-110 kW (102-150 PS) H5H 470	01.2019→		7.04818.04.0	SUV	EL	
1.3 TCe 130 (JSNE) 75-110 kW (102-150 PS) H5H 470	01.2019→		7.04818.04.0	SUV	EL	
1.5 dCi 55-66 kW (75-90 PS) K9K 612, K9K 626	03.2012→		7.01814.12.0	DW-TL	EP	
1.5 dCi 79-81 kW (107-110 PS) K9K 666, K9K 846	03.2012→		7.01814.12.0	DW-TL	EP	
1.5 dCi 79-81 kW (107-110 PS) K9K 846	01.2013→		7.01814.12.0	DW-TL	EP	Produktionsdatum bis: 20.12.2015 Production date to: 20.12.2015
1.5 dCi 79-81 kW (107-110 PS) K9K 666, K9K 846	06.2015→		7.01814.12.0	DW-TL	EP	 K9K 666, K9K 846: Produktionsdatum bis: 20.12.2015 Production date to: 20.12.2015
1.5 dCi (JSMW) 55-66 kW (75-90 PS) K9K 612, K9K 830	11.2012→		7.01814.12.0	DW-TL	EP	Produktionsdatum bis: 20.12.2015 Production date to: 20.12.2015
LOGAN (LS_)						5
1.5 dCi (LS0W) 63 kW (86 PS) K9K 796	09.2007→12.2011		7.02256.21.0	DW-TL	EP	Produktionsdatum bis: 02.09.2009 Production date to: 02.09.2009
LOGAN II						6
1.5 dCi 55-63 kW (75-86 PS) K9K 830, K9K 838	01.2013→		7.01814.12.0	DW-TL	EP	
TCe 90 66 kW (90 PS) H4B 400, H4B 408	10.2012→		7.08681.15.0	EOV	EH	
			7.01343.04.0	LDRV	EP	
TCe 90 LPG 66 kW (90 PS) H4B 410	09.2015→		7.08681.15.0	EOV	EH	
			7.01343.04.0	LDRV	EP	
LOGAN MCV (KS_)						7
1.5 dCi (KS0W) 63 kW (86 PS) K9K 796	09.2007→12.2012		7.02256.21.0	DW-TL	EP	Produktionsdatum bis: 02.09.2009 Production date to: 02.09.2009
LOGAN MCV II						8
1.5 dCi 55-63 kW (75-86 PS) K9K 830, K9K 838	02.2013→		7.01814.12.0	DW-TL	EP	
TCe 90 66 kW (90 PS) H4B 400, H4B 408	02.2013→		7.08681.15.0	EOV	EH	
			7.01343.04.0	LDRV	EP	
TCe 90 LPG 66 kW (90 PS) H4B 410	09.2015→		7.08681.15.0	EOV	EH	
			7.01343.04.0	LDRV	EP	
LOGAN Pickup (US_)						9
1.5 dCi (US0W) 63 kW (86 PS) K9K 796	03.2008→		7.02256.21.0	DW-TL	EP	Produktionsdatum bis: 02.09.2009 Production date to: 02.09.2009
SANDERO						10
1.5 dCi 63 kW (86 PS) K9K 796	11.2008→		7.02256.21.0	DW-TL	EP	Produktionsdatum bis: 02.09.2009 Production date to: 02.09.2009











D

						
SANDERO II						11
1.5 dCi 63 kW (86 PS) K9K 830	01.2013→		7.01814.12.0	DW-TL	EP	
1.5 dCi 75 / Blue dCi 75 (B8JW, B8M4, B8AH, B8M7, B8M6) 55-63 kW (75-86 PS) K9K 838	10.2012→		7.01814.12.0	DW-TL	EP	
TCe 90 66 kW (90 PS) H4B 400	10.2012→		7.08681.15.0	EOV	EH	
			7.01343.04.0	LDRV	EP	
DOKKER Express Box Body/MPV						12
1.2 TCe 115 (FEAY) 74-97 kW (101-132 PS) H5F 408	07.2015→		7.01343.04.0	LDRV	EP	
			7.02476.09.0	SUV	EL	
1.2 TCe 115 (FEM0) 84-85 kW (115-116 PS) H5F 402	12.2012→		7.08681.15.0	EOV	EH	
			7.01343.04.0	LDRV	EP	
1.3 TCe 100 (FENU) 75-110 kW (102-150 PS) H5H 470	08.2019→		7.04818.04.0	SUV	EL	
1.3 TCe 130 (FENE) 75-110 kW (102-150 PS) H5H 470	08.2019→		7.04818.04.0	SUV	EL	
1.5 dCi 55-63 kW (75-86 PS) K9K 838	11.2012→		7.01814.12.0	DW-TL	EP	
1.5 dCi (FEAJ) 55-66 kW (75-90 PS) K9K 612, K9K 626	12.2012→		7.01814.12.0	DW-TL	EP	
1.5 dCi (FEMW) 55-66 kW (75-90 PS) K9K 612, K9K 830	12.2012→		7.01814.12.0	DW-TL	EP	Produktionsdatum bis: 20.12.2015 Production date to: 20.12.2015
1.5 dCi 75 / Blue dCi 75 (FEJW, FEAH) 55-66 kW (75-90 PS) K9K 612, K9K 626	12.2012→		7.01814.12.0	DW-TL	EP	 K9K 612, K9K 626: Produktionsdatum bis: 20.12.2015 Production date to: 20.12.2015
DUSTER SUV Van						13
1.2 TCe 125 4x4 92 kW (125 PS) H5F 404	10.2013→		7.08681.15.0	EOV	EH	
			7.01343.04.0	LDRV	EP	
1.5 dCi 80-81 kW (109-110 PS) K9K 666	04.2013→		7.01814.12.0	DW-TL	EP	Produktionsdatum bis: 20.12.2015 Production date to: 20.12.2015
1.5 dCi 4x4 80 kW (109 PS) K9K 658	04.2013→		7.01814.12.0	DW-TL	EP	Produktionsdatum bis: 20.12.2015 Production date to: 20.12.2015
LOGAN EXPRESS (FS_)						14
1.5 dCi (FS0W) 63 kW (86 PS) K9K 796	03.2009→		7.02256.21.0	DW-TL	EP	→09.2009

							
CALIBER							1
2.2 CRD 120 kW (163 PS) ENE	07.2010→11.2011		7.02256.37.0	EUV-AGK	EL		
			7.02256.37.0	EUV-AGR	EL		
			7.02256.37.0	EUV-AT	EL		
			7.02256.37.0	EUV-DS	EL		
			7.02256.37.0	EUV-KK	EL		
			7.02256.37.0	EUV-SL	EL		
			7.02256.37.0	EUV-SR	EL		
			7.02256.37.0	EUV-VB	EL		
FORZA							2
1.4 CNG 58 kW (79 PS) 350A1000	06.2013→		7.06117.38.0	SV-NWV	EL	mit Dichtring with O-ring	
JOURNEY							3
2.0 CRD 100-103 kW (136-140 PS) ECE	06.2008→		7.03003.01.0	DW-TL	EP		
	06.2008→12.2011		7.03003.01.0	DW-TL	EP		
SPRINTER 2500 Cab & Chassis							4
3.5 190 kW (258 PS) EG2	09.2006→12.2007		7.02256.37.0	EUV-SL	EL		
			7.22355.01.0	EUV-SR	EL		
SPRINTER 2500 Standard Cargo Van							5
3.5 190 kW (258 PS) EG2	09.2006→12.2008		7.02256.37.0	EUV-SL	EL		
			7.22355.01.0	EUV-SR	EL		
SPRINTER 2500 Standard Passenger Van							6
3.5 190 kW (258 PS) EG2	09.2006→12.2008		7.02256.37.0	EUV-SL	EL		
			7.22355.01.0	EUV-SR	EL		
SPRINTER 3500 Cab & Chassis							7
3.5 190 kW (258 PS) EG2	09.2006→12.2008		7.02256.37.0	EUV-SL	EL		
			7.22355.01.0	EUV-SR	EL		
SPRINTER 3500 Standard Cargo Van							8
3.5 190 kW (258 PS) EG2	09.2006→12.2008		7.02256.37.0	EUV-SL	EL		
			7.22355.01.0	EUV-SR	EL		
SPRINTER 3500 Standard Passenger Van							9
3.5 190 kW (258 PS) EG2	09.2006→12.2007		7.02256.37.0	EUV-SL	EL		
			7.22355.01.0	EUV-SR	EL		

D







DS 3 (SA_) **1**

D	1.2 THP 110 / PureTech 110 (SAHNPS) 81 kW (110 PS) HNZ (EB2DT)	04.2015→07.2019	 7.08681.09.0	EOV	EH	
			7.06117.45.0	SV-NWV	EL	
	1.2 THP 130 96 kW (130 PS) HNY (EB2DTS)	09.2015→07.2019	 7.08681.09.0	EOV	EH	
			7.06117.45.0	SV-NWV	EL	
	1.2 VTi 82 60 kW (82 PS) HMZ (EB2), HMZ (EB2F)	04.2015→07.2019	 7.06117.45.0	SV-NWV	EL	
	1.6 BlueHDi 100 73 kW (99 PS) BHY (DV6FD)	04.2015→07.2019	 7.08681.00.0	EOV	EH	Organisationsnummer ab: 14420 RPO number from: 14420
	1.6 BlueHDi 75 55 kW (75 PS) BHW (DV6FE)	07.2015→07.2019	 7.08681.00.0	EOV	EH	Organisationsnummer ab: 14420 RPO number from: 14420
	1.6 THP 120-121 kW (163-165 PS) 5GZ (EP6FDT)	07.2015→07.2019	 7.01777.19.0	DW-TL	EP	für Fahrzeuge mit Schaltgetriebe for vehicles with manual transmission
			7.01115.08.0	SUV	EL	
	1.6 THP 110 kW (150 PS) 5GW (EP6FDT)	07.2015→07.2019	 7.06117.45.0	SV-NWV	EL	für Fahrzeuge mit Schaltgetriebe for vehicles with manual transmission
	1.6 THP 156 115 kW (156 PS) 5FV (EP6CDT)	07.2016→07.2019	 7.01777.18.0	DW-TL	EP	
			7.06117.45.0	SV-NWV	EL	
	1.6 THP 165 120-121 kW (163-165 PS) 5GZ (EP6FDT)	07.2015→07.2019	 7.01777.19.0	DW-TL	EP	für Fahrzeuge mit Schaltgetriebe for vehicles with manual transmission
			7.01115.08.0	SUV	EL	
		7.06117.45.0	SV-NWV	EL	für Fahrzeuge mit Schaltgetriebe for vehicles with manual transmission	
1.6 THP 208 153 kW (208 PS) 5GR (EP6FDTX)	09.2015→07.2019	 7.01777.19.0	DW-TL	EP	für Fahrzeuge mit Schaltgetriebe for vehicles with manual transmission	
		7.01115.08.0	SUV	EL		
		7.06117.45.0	SV-NWV	EL	für Fahrzeuge mit Schaltgetriebe for vehicles with manual transmission	
1.6 Vti 88 kW (120 PS) 5FS (EP6C)	07.2015→07.2019	 7.06117.45.0	SV-NWV	EL		



DS 3 CROSSBACK (UR_, UC_, UJ_) **2**

1.2 PureTech 100 74 kW (101 PS) HNK (EB2ADTD)	10.2018→	 7.08681.09.0	EOV	EH	
1.2 PureTech 130 96 kW (130 PS) HNS (EB2ADTS)	10.2018→	 7.08681.09.0	EOV	EH	Euro 6d Euro 6d
1.2 PureTech 155 115 kW (156 PS) HNN (EB2ADTX)	10.2018→	 7.08681.09.0	EOV	EH	
1.5 BlueHDi 100 75 kW (102 PS) YHY (DV5RD)	10.2018→	 7.08681.00.0	EOV	EH	Organisationsnummer ab: 1539681 RPO number from: 1539681
1.5 BlueHDi 130 96 kW (130 PS) YHZ (DV5RC)	10.2018→	 7.08681.00.0	EOV	EH	Organisationsnummer ab: 1539681 RPO number from: 1539681









DS 3 Convertible (SB_) **3**

1.2 THP 110 81 kW (110 PS) HNP (EB2ADT), HNZ (EB2DT)	07.2015→07.2019	 7.08681.09.0	EOV	EH	
		7.06117.45.0	SV-NWV	EL	
1.2 THP 130 96 kW (130 PS) HNY (EB2DTS)	09.2015→07.2019	 7.08681.09.0	EOV	EH	
		7.06117.45.0	SV-NWV	EL	
1.2 VTi 82 60 kW (82 PS) HMZ (EB2F)	07.2015→07.2019	 7.06117.45.0	SV-NWV	EL	
1.6 BlueHDi 100 73 kW (99 PS) BHY (DV6FD)	07.2015→07.2019	 7.08681.00.0	EOV	EH	Organisationsnummer ab: 14420 RPO number from: 14420
1.6 THP 120-121 kW (163-165 PS) 5GZ (EP6FDT)	07.2015→07.2019	 7.01777.19.0	DW-TL	EP	für Fahrzeuge mit Schaltgetriebe for vehicles with manual transmission



DS 3 Convertible (SB_) 3

1.6 THP 165 120-121 kW (163-165 PS) 5GZ (EP6FDT)	07.2015→07.2019		7.01115.08.0	SUV	EL	für Fahrzeuge mit Schaltgetriebe for vehicles with manual transmission
			7.01777.19.0	DW-TL	EP	
			7.01115.08.0	SUV	EL	für Fahrzeuge mit Schaltgetriebe for vehicles with manual transmission
			7.06117.45.0	SV-NWV	EL	
1.6 THP 208 153 kW (208 PS) 5GR (EP6FDTX)	09.2015→07.2019		7.01777.19.0	DW-TL	EP	für Fahrzeuge mit Schaltgetriebe for vehicles with manual transmission
			7.01115.08.0	SUV	EL	für Fahrzeuge mit Schaltgetriebe for vehicles with manual transmission
			7.06117.45.0	SV-NWV	EL	

D
DS 4 / DS 4 CROSSBACK (NX_) 4

1.2 THP 130 (NXHNYM) 96 kW (130 PS) HNY (EB2DTS)	07.2015→12.2018		7.08681.09.0	EOV	EH	
			7.06117.45.0	SV-NWV	EL	
1.6 BlueHDi 100 73 kW (99 PS) BHY (DV6FD)	04.2016→12.2018		7.08681.00.0	EOV	EH	Organisationsnummer ab: 14420 RPO number from: 14420
1.6 BlueHDi 120 85-88 kW (116-120 PS) BHZ (DV6FC)	07.2015→12.2018		7.08681.00.0	EOV	EH	Organisationsnummer ab: 14420 RPO number from: 14420
1.6 THP 150 110 kW (150 PS) 5FE (EP6CDTMD)	10.2016→12.2018		7.01777.18.0	DW-TL	EP	
1.6 THP 160 120-127 kW (163-173 PS) 5FM (EP6CDTM)	07.2015→12.2018		7.01777.18.0	DW-TL	EP	
			7.01115.08.0	SUV	EL	
1.6 THP 165 120-121 kW (163-165 PS) 5GZ (EP6FDT)	07.2015→12.2018		7.01777.19.0	DW-TL	EP	für Fahrzeuge mit Automatikgetriebe for vehicles with automatic transmission
			7.01115.08.0	SUV	EL	für Fahrzeuge mit Automatikgetriebe for vehicles with automatic transmission
			7.06117.45.0	SV-NWV	EL	
1.6 THP 208 153 kW (208 PS) 5GR (EP6FDTX)	03.2017→12.2018		7.01777.19.0	DW-TL	EP	für Fahrzeuge mit Schaltgetriebe for vehicles with manual transmission
			7.01115.08.0	SUV	EL	für Fahrzeuge mit Schaltgetriebe for vehicles with manual transmission
			7.01777.19.0	DW-TL	EP	
1.6 THP 210 153-155 kW (208-211 PS) 5GM (EP6FDTX)	07.2015→12.2018		7.01777.19.0	DW-TL	EP	für Fahrzeuge mit Schaltgetriebe for vehicles with manual transmission
			7.01115.08.0	SUV	EL	für Fahrzeuge mit Schaltgetriebe for vehicles with manual transmission
			7.06117.45.0	SV-NWV	EL	
1.6 e-HDi 115 82-84 kW (112-114 PS) 9HD (DV6C)	07.2015→12.2018		7.01633.06.0	DW-TL	EP	

DS 5 (KF_) 5

1.6 BlueHDi 115 85 kW (116 PS) BHX (DV6C)	06.2015→12.2018		7.08681.00.0	EOV	EH	Organisationsnummer ab: 14420 RPO number from: 14420
			7.08681.00.0	EOV	EH	Organisationsnummer ab: 14420 RPO number from: 14420
1.6 BlueHDi 120 85-88 kW (116-120 PS) BHZ (DV6FC)	06.2015→12.2018		7.08681.00.0	EOV	EH	Organisationsnummer ab: 14420 RPO number from: 14420
			7.08681.00.0	EOV	EH	Organisationsnummer ab: 14420 RPO number from: 14420
1.6 THP 160 120-127 kW (163-173 PS) 5FM (EP6CDTM)	07.2015→12.2018		7.01777.18.0	DW-TL	EP	
			7.01115.08.0	SUV	EL	
1.6 THP 165 (KF5GZT) 120-121 kW (163-165 PS) 5GZ (EP6FDT)	07.2015→12.2018		7.01777.19.0	DW-TL	EP	für Fahrzeuge mit Automatikgetriebe for vehicles with automatic transmission
			7.01777.19.0	DW-TL	EP	für Fahrzeuge mit Automatikgetriebe for vehicles with automatic transmission



DS 5 (KF_) **5**





D

			7.01115.08.0 7.06117.45.0	SUV SV-NWV	EL EL	für Fahrzeuge mit Automatikgetriebe for vehicles with automatic transmission
1.6 THP 210 153-155 kW (208-211 PS) 5GM (EP6FDTX)	04.2015→12.2018		7.01777.19.0	DW-TL	EP	für Fahrzeuge mit Schaltgetriebe for vehicles with manual transmission
			7.01115.08.0 7.06117.45.0	SUV SV-NWV	EL EL	für Fahrzeuge mit Schaltgetriebe for vehicles with manual transmission























DS 7 Crossback (J_) **6**

















1.5 BlueHDi 130 96 kW (130 PS) YHZ (DV5RC)	09.2017→		7.08681.00.0	EOV	EH	
1.6 PureTech 165 121 kW (165 PS) 5GY (EP6FDTM)	07.2018→		7.06117.45.0	SV-NWV	EL	für Fahrzeuge mit Automatikgetriebe for vehicles with automatic transmission
1.6 PureTech 180 133 kW (180 PS) 5GF (EP6FADTXD)	04.2018→		7.06117.45.0	SV-NWV	EL	für Fahrzeuge mit Automatikgetriebe for vehicles with automatic transmission
1.6 PureTech 225 165 kW (225 PS) 5GC (EP6FADTX)	09.2017→		7.06117.45.0	SV-NWV	EL	für Fahrzeuge mit Automatikgetriebe for vehicles with automatic transmission
E-TENSE 4x4 147 kW (200 PS) 5GB (EP6FADTXHP)	05.2019→		7.06117.45.0	SV-NWV	EL	für Fahrzeuge mit Automatikgetriebe for vehicles with automatic transmission
PureTech 130 96 kW (130 PS) HNS (EB2ADTS)	10.2018→		7.08681.09.0	EOV	EH	Euro 6d Euro 6d





























DS 5						1
1.6 THP 160 120 kW (163 PS) 5F06 10FJBZ (EP6CDTM)	09.2013->	 7.01115.08.0	SUV	EL		
1.6 THP 200 147 kW (200 PS) 5F03 (EP6CDTX)	09.2013->12.2015	 7.01115.08.0	SUV	EL		
DS 5 LS						2
1.6 THP 160 120 kW (163 PS) 5F06 10FJBZ (EP6CDTM)	03.2014->	 7.01115.08.0	SUV	EL		
1.6 THP 200 147 kW (200 PS) 5F03 (EP6CDTX)	03.2014->	 7.01115.08.0	SUV	EL		
DS 6						3
1.6 THP 160 120-123 kW (163-167 PS) 5G02 10UF01 (EP6FDTM)	09.2014->	 7.01115.08.0	SUV	EL		























D

			 PIERBURG			
360 (F131)						1
3.6 Challenge Stradale 305-316 kW (415-430 PS) F 131 B44	05.2003→03.2005		7.22687.44.0	EUV-AGK	EP	
3.6 Modena 294 kW (400 PS) F 131 B40	03.1999→03.2005		7.22687.44.0	EUV-AGK	EP	
360 Spider (F131)						2
3.6 294 kW (400 PS) F 131 B40	02.2000→08.2005		7.22687.44.0	EUV-AGK	EP	
458						3
4.5 419-425 kW (570-578 PS) F 136 FB	12.2009→		7.22687.44.0	EUV-AGK	EP	
			7.22687.44.0	EUV-SR	EP	
4.5 425-445 kW (600-605 PS) F 136 FL	09.2013→		7.22687.44.0	EUV-AGK	EP	
			7.22687.44.0	EUV-SR	EP	
458 Spider						4
4.5 419-425 kW (570-578 PS) F 136 FB	09.2011→		7.22687.44.0	EUV-AGK	EP	
			7.22687.44.0	EUV-SR	EP	
4.5 425-445 kW (600-605 PS) F 136 FL	12.2014→		7.22687.44.0	EUV-AGK	EP	
			7.22687.44.0	EUV-SR	EP	
488 GTB (F142M)						5
3.9 493 kW (670 PS) F 154 CB	04.2015→		7.02909.12.0	SUV	EL	
Pista 3.9 530 kW (720 PS) F 154 CD	03.2018→		7.02909.12.0	SUV	EL	
488 Spider						6
3.9 493 kW (670 PS) F 154 CB	10.2015→		7.02909.12.0	SUV	EL	
3.9 Pista 530 kW (720 PS) F 154 CD	08.2018→		7.02909.12.0	SUV	EL	
812 GTS Spider (F152)						7
6.5 585-596 kW (795-810 PS) F140 GA	01.2020→		7.22687.44.0	EUV-AGK	EP	
812 SUPERFAST (F152M)						8
6.5 585-596 kW (795-810 PS) F140 GA	03.2017→		7.22687.44.0	EUV-AGK	EP	
CALIFORNIA						9
3.9 T 412 kW (560 PS) F 154 BB	06.2014→		7.03003.12.0	DW-TL	EP	
			7.22687.44.0	EUV-AGK	EP	
			7.02909.12.0	SUV	EL	
					für OE-Nummer: 315495 for OE number: 315495	
ENZO FERRARI						10
6.0 485 kW (660 PS) F 140 B49	10.2002→12.2003		7.22687.44.0	EUV-AGK	EP	
F12 Berlinetta (F152)						11
6.3 544 kW (740 PS) F140FC	10.2012→		7.22687.44.0	EUV-AGK	EP	
6.3 tdf 574-585 kW (781-796 PS) FER62	11.2015→		7.22687.44.0	EUV-AGK	EP	



























						
F430						12
4.3 357-360 kW (486-490 PS) F 131 B43	03.2005→12.2009		7.22687.44.0	EUV-AGK	EP	
4.3 375-376 kW (510-511 PS) F 131 B47	09.2007→12.2009		7.22687.44.0	EUV-AGK	EP	
F430 Spider						13
4.3 357-360 kW (486-490 PS) F 131 B43	05.2005→12.2009		7.22687.44.0	EUV-AGK	EP	
			7.22687.39.0	EUV-LS	EL	
4.3 375-376 kW (510-511 PS) F 131 B47	04.2007→12.2009		7.22687.44.0	EUV-AGK	EP	
F8 Spider						14
3.9 530 kW (720 PS) F 154 CD	12.2019→		7.02909.12.0	SUV	EL	
F8 Tributo Coupe						15
3.9 530 kW (720 PS) F 154 CD	03.2019→		7.02909.12.0	SUV	EL	
GTC4 Lusso / Lusso T						16
3.9 T 441-456 kW (600-620 PS) F 154 BD	10.2016→		7.22687.44.0	EUV-AGK	EP	
			7.02909.12.0	SUV	EL	
6.3 507 kW (689 PS) F 140 ED	04.2016→		7.22687.44.0	EUV-AGK	EP	
LaFERRARI (F150)						17
6.3 Hybrid 585-588 kW (796-800 PS) F 140 FE	11.2014→		7.22687.44.0	EUV-AGK	EP	
PORTOFINO						18
3.9 441-456 kW (600-620 PS) F 154 BD	08.2017→		7.02909.12.0	SUV	EL	























F

						
124 Spider (348_)						1
1.4 (348) 101-122 kW (137-166 PS) EAM	03.2016→		7.02909.07.0	SUV	EL	
1.4 (348) 103 kW (140 PS) 552 53 268	03.2016→		7.02909.07.0	SUV	EL	
1.4 (348) 101-122 kW (137-166 PS) EAM	03.2016→12.2017		7.02909.07.0	SUV	EL	
500 (312_)						2
F 0.9 (312AXG1A, 312.AXG11) 57-66 kW (77-90 PS) 312 A2.000	07.2010→		7.00607.02.0	DW-TL	EP	
			7.03003.01.0	DW-TL	EP	
			7.02909.07.0	SUV	EL	
0.9 (312AXM1B) 74-77 kW (101-105 PS) 199 B6.000	10.2013→		7.03003.01.0	DW-TL	EP	
			7.02909.07.0	SUV	EL	
0.9 (312AXN1A) 57-63 kW (77-86 PS) 312 A5.000	12.2013→		7.03003.01.0	DW-TL	EP	
			7.02909.07.0	SUV	EL	
1.2 (312AXA1A) 51 kW (69 PS) 169 A4.000	07.2007→		7.06117.35.0	SV-NWV	EL	 →3952691
			7.06117.38.0	SV-NWV	EL	mit Dichtring with O-ring  3952691→
1.2 LPG (312AXA1A) 51 kW (69 PS) 169 A4.000	12.2010→		7.06117.35.0	SV-NWV	EL	 →3952691
			7.06117.38.0	SV-NWV	EL	mit Dichtring with O-ring  3952691→
1.3 D Multijet (312AXB1A) 55 kW (75 PS) 169 A1.000	10.2007→		7.03003.01.0	DW-TL	EP	
1.3 D Multijet (312AXE1A) 64-70 kW (87-95 PS) 199 B1.000, 312 B1.000	12.2009→		7.03003.01.0	DW-TL	EP	
			7.01981.07.0	SV-AGR-K	EP	
1.3 D Multijet (312AYA1A) 57 kW (78 PS) 312 B5.000	06.2016→		7.03003.01.0	DW-TL	EP	
500 C (312_)						3
0.9 (312AG1A) 57-66 kW (77-90 PS) 312 A2.000	09.2009→		7.03003.01.0	DW-TL	EP	
			7.02909.07.0	SUV	EL	
0.9 (312AXM1B) 74-77 kW (101-105 PS) 199 B6.000	12.2013→		7.03003.01.0	DW-TL	EP	
			7.02909.07.0	SUV	EL	
0.9 (312AXN1A, 312AXN11) 57-63 kW (77-86 PS) 312 A5.000	12.2013→		7.03003.01.0	DW-TL	EP	
			7.02909.07.0	SUV	EL	
1.2 (312CXA1A, 312AXA1A) 51 kW (69 PS) 169 A4.000	09.2009→		7.06117.35.0	SV-NWV	EL	 →3952691

					
500 C (312_)					3
			7.06117.38.0	SV-NWV	EL mit Dichtring with O-ring  3952691→
1.3 D Multijet (312CXB1A) 55 kW (75 PS) 169 A1.000	09.2009→		7.03003.01.0	DW-TL	EP
1.3 D Multijet (312CXE1A, 312AXE1A) 64-70 kW (87-95 PS) 199 B1.000, 312 B1.000	09.2009→		7.03003.01.0	DW-TL	EP
			7.01981.07.0	SV-AGR-K	EP
500L (351_, 352_)					4
0.9 (199LYC1B) 74-77 kW (101-105 PS) 199 B6.000	09.2012→		7.03003.01.0	DW-TL	EP
			7.02909.07.0	SUV	EL
0.9 Natural Power (199LYC1B) 57-66 kW (77-90 PS) 312 A2.000	03.2013→		7.00607.02.0	DW-TL	EP
			7.03003.01.0	DW-TL	EP
			7.02909.07.0	SUV	EL
0.9 Natural Power (199LYC1B) 57-66 kW (77-90 PS) 312 A2.000	04.2017→		7.03003.01.0	DW-TL	EP
			7.02909.07.0	SUV	EL
1.3 D Multijet (199.LYM11, 199.LYM1A) 70 kW (95 PS) 330 A1.000	06.2014→		7.03003.01.0	DW-TL	EP
			7.01981.07.0	SV-AGR-K	EP Euro 6d Euro 6d
1.3 D Multijet (199LXY1A, 199LXY11) 62 kW (84 PS) 199 B4.000	09.2012→		7.03003.01.0	DW-TL	EP
			7.01981.07.0	SV-AGR-K	EP
1.4 101-122 kW (137-166 PS) EAM	09.2013→		7.02909.07.0	SUV	EL
1.4 88-93 kW (120-126 PS) 940 B7.000	05.2014→		7.02909.07.0	SUV	EL
1.4 (199LYF1B) 88-93 kW (120-126 PS) 940 B7.000	10.2013→		7.01835.06.0	SUV	EL
			7.02909.07.0	SUV	EL
1.4 LPG (199LYF1B) 88-93 kW (120-126 PS) 940 B7.000	02.2014→		7.01835.06.0	SUV	EL
500X (334_)					5
1.3 D Multijet (334AXH1A) 59-70 kW (80-95 PS) 552 66 963, 552 83 775	11.2014→		7.03003.01.0	DW-TL	EP
1.4 (334AXC1B) 100-103 kW (136-140 PS) 552 63 624	09.2014→		7.02909.07.0	SUV	EL
1.4 (334AXC1B) 101-122 kW (137-166 PS) EAM	01.2016→		7.02909.07.0	SUV	EL
1.4 (334AXC1B, 334AXC11) 100-103 kW (136-140 PS) 552 63 624	09.2014→		7.02909.07.0	SUV	EL

F







						
500X (334_)						5
1.4 4x4 (334AXF22) 119-125 kW (162-170 PS) 552 63 623	02.2015→		7.02909.07.0	SUV	EL	
1.4 4x4 (334AXF22) 119-125 kW (162-170 PS) 552 63 623	02.2015→		7.02909.07.0	SUV	EL	
1.4 LPG (334AXL1B) 88 kW (120 PS) 552 77 701	03.2017→		7.01835.06.0	SUV	EL	
BARCETTA (183_)						6
1.8 16V 92-97 kW (125-132 PS) 183 A1.000	04.1995→05.2005		7.06269.06.0	LLR	EL	 →05.1998 Vett No. →0037640
BRAVA (182_)						7
1.6 16V (182.BB) 76-85 kW (103-116 PS) 182 A4.000	02.1996→10.2001		7.05432.09.0	SM	EL	mit Dichtring with O-ring →04.1998 für OE-Nummer: 9945635 for OE number: 9945635
1.6 16V (182.BH) 66 kW (90 PS) 182 A6.000	10.1995→10.2001		7.05432.09.0	SM	EL	mit Dichtring with O-ring für Fahrzeuge mit Schaltgetriebe for vehicles with manual transmission
1.6 16V (182.BU) 68-100 kW (92-136 PS) 182 B6.000	01.1999→12.2002		7.05432.09.0	SM	EL	mit Dichtring with O-ring für Fahrzeuge mit Schaltgetriebe for vehicles with manual transmission
1.8 GT 16V (182.BC) 83 kW (113 PS) 182 A2.000	10.1995→08.2001		7.06269.06.0	LLR	EL	 →07.1999 Vett No. →4873621
1.9 JTD 74-79 kW (100-107 PS) 182 B9.000	09.2000→10.2001		7.02256.03.0	DW-AGR	EP	
			7.02256.50.0	EUV-RK	EL	
1.9 TD 100 S (182.BF) 74 kW (100 PS) 182 A7.000	03.1996→10.2001		7.02256.03.0	DW-AGR	EP	
1.9 TD 75 S (182.BF) 55 kW (75 PS) 182 A8.000	03.1996→10.2001		7.02256.03.0	DW-AGR	EP	
BRAVO I (182_)						8
1.6 68-100 kW (92-136 PS) 182 B6.000	09.2000→10.2001		7.05432.09.0	SM	EL	mit Dichtring with O-ring für OE-Nummer: 9945635 for OE number: 9945635
1.6 16V (182.AB) 76-85 kW (103-116 PS) 182 A4.000	03.1996→10.2001		7.05432.09.0	SM	EL	mit Dichtring with O-ring →04.1998 für OE-Nummer: 9945635 for OE number: 9945635
1.6 16V (182.AH) 66 kW (90 PS) 182 A6.000	10.1995→10.2001		7.05432.09.0	SM	EL	mit Dichtring with O-ring →04.1998 für OE-Nummer: 9945635 for OE number: 9945635
1.8 GT (182.AC) 83 kW (113 PS) 182 A2.000	10.1995→10.2001		7.06269.06.0	LLR	EL	 →07.1999 Vett No. →4873621
1.9 JTD 74-79 kW (100-107 PS) 182 B9.000	09.2000→10.2001		7.02256.03.0	DW-AGR	EP	
			7.02256.50.0	EUV-RK	EL	
1.9 JTD 105 77-79 kW (105-107 PS) 182 B4.000	12.1998→10.2001		7.02256.03.0	DW-AGR	EP	

						
BRAVO I (182_)						8
1.9 TD 100 S (182.AF) 74 kW (100 PS) 182 A7.000	03.1996→10.2001		7.02256.03.0	DW-AGR	EP	
1.9 TD 75 S (182.AF) 55 kW (75 PS) 182 A8.000	03.1996→10.2001		7.02256.03.0	DW-AGR	EP	
BRAVO II (198_)						9
1.4 (198AXA1B) 66 kW (90 PS) 192 B2.000	04.2007→12.2014		7.00607.02.0	DW-TL	EP	
1.4 16V (198AXS1B) 103 kW (140 PS) 198 A7.000	04.2010→12.2014		7.02909.07.0	SUV	EL	
1.4 T-Jet (198AXF1B) 104-112 kW (141-152 PS) 198 A1.000	09.2007→12.2014		7.00607.02.0	DW-TL	EP	
			7.02256.49.0	LDRV	EP	
			7.01835.06.0	SUV	EL	
1.4 T-Jet (198AXG1B) 88 kW (120 PS) 198 A4.000	10.2007→12.2014		7.00607.02.0	DW-TL	EP	
			7.02256.49.0	LDRV	EP	
			7.01835.06.0	SUV	EL	
1.6 D Multijet (198AXH1B) 77 kW (105 PS) 198 A3.000, 844 A3.000	09.2007→12.2014		7.03003.01.0	DW-TL	EP	
			7.03003.01.0	DW-TL	EP	
1.6 D Multijet (198AXL1B) 88 kW (120 PS) 198 A2.000	03.2008→12.2014		7.03003.01.0	DW-TL	EP	
			7.03003.01.0	DW-TL	EP	
1.6 D Multijet (198AXM1B) 66 kW (90 PS) 198 A6.000	03.2008→12.2014		7.03003.01.0	DW-TL	EP	
			7.03003.01.0	DW-TL	EP	
1.9 D Multijet (198AXB1A) 88 kW (120 PS) 192 A8.000	04.2007→12.2014		7.00607.02.0	DW-TL	EP	
			7.03003.01.0	DW-TL	EP	
			7.02256.50.0	EUV-RK	EL	
1.9 D Multijet (198AXC1B) 110 kW (150 PS) 937 A5.000	04.2007→12.2014		7.00607.02.0	DW-TL	EP	
			7.03003.01.0	DW-TL	EP	
			7.02256.50.0	EUV-RK	EL	
1.9 D Multijet (198AXE1A) 66 kW (90 PS) 192 B5.000	04.2007→12.2008		7.00607.02.0	DW-TL	EP	
			7.02256.50.0	EUV-RK	EL	
2.0 D Multijet (198AXN1B) 121 kW (165 PS) 198 A5.000	09.2008→12.2014		7.00607.02.0	DW-TL	EP	
			7.00607.02.0	DW-TL	EP	
2.0 D Multijet (198AXPIB) 120 kW (163 PS) 198 A8.000, 844 A2.000	09.2008→12.2014		7.00607.02.0	DW-TL	EP	
			7.00607.02.0	DW-TL	EP	
COUPE (175_)						10
1.8 16V 92-97 kW (125-132 PS) 183 A1.000	03.1996→08.2000		7.06269.06.0	LLR	EL 	
					→05.1998  →1070426	















F





CROMA (194_) **11**

























1.8 16V 96-103 kW (131-140 PS) 939 A4.000	12.2005→		7.06117.08.0	SV-NWV	EH	mit Dichtring with O-ring
1.9 D Multijet 85 kW (115 PS) 939 A7.000	06.2005→		7.00607.02.0	DW-TL	EP	
1.9 D Multijet 100 kW (136 PS) 939 A8.000	12.2005→		7.00607.02.0	DW-TL	EP	
1.9 D Multijet (194AXB1B) 88 kW (120 PS) 939 A1.000	06.2005→12.2011		7.00607.02.0	DW-TL	EP	
1.9 D Multijet (194AXC1B, 194AXC12) 110 kW (150 PS) 939 A2.000	06.2005→12.2011		7.00607.02.0	DW-TL	EP	
2.4 D Multijet 147 kW (200 PS) 939 A3.000	06.2005→		7.00607.02.0	DW-TL	EP	

DOBLO MPV (119_, 223_) **12**

1.3 D Multijet 62 kW (84 PS) 223 A9.000	10.2005→		7.00607.02.0	DW-TL	EP	
1.3 JTD 16V 51-66 kW (70-90 PS) 188 A9.000	12.2004→05.2005		7.02256.49.0	LDRV	EP	
1.4 51-63 kW (69-86 PS) 350 A1.000	10.2005→		7.06117.35.0	SV-NWV	EL	 →3952691
			7.06117.38.0	SV-NWV	EL	mit Dichtring with O-ring  3952691→
1.4 60-70 kW (82-95 PS) 310 A2.011	08.2009→08.2013		7.06117.35.0	SV-NWV	EL	 →3952681
1.4 Flex (119107, 119307) 60-70 kW (82-95 PS) 310 A2.011	11.2009→12.2016		7.06117.35.0	SV-NWV	EL	 →3952681
1.9 D Multijet 88 kW (120 PS) 186 A9.000	10.2005→		7.00607.02.0	DW-TL	EP	
			7.02256.50.0	EUV-RK	EL	
1.9 JTD 77 kW (105 PS) 223 A7.000	07.2003→		7.00607.02.0	DW-TL	EP	
			7.28170.03.0	EUV-RK	EP	
			7.02256.49.0	LDRV	EP	
1.9 JTD 77 kW (105 PS) 223 B1.000	07.2003→		7.00607.02.0	DW-TL	EP	
			7.28170.03.0	EUV-RK	EP	
			7.02256.14.0	EUV-RK	EL	
			7.02256.49.0	LDRV	EP	
1.9 JTD (223AXE1A) 74-79 kW (100-107 PS) 182 B9.000, 223 B2.000	10.2001→		7.00607.02.0	DW-TL	EP	 182 B9.000, 223 B2.000: 01.2005→
			7.28170.03.0	EUV-RK	EP	
			7.02256.49.0	LDRV	EP	

FIORINO MPV (225_) **13**

1.4 (225AXA1A) 51-63 kW (69-86 PS) 350 A1.000	07.2014→		7.06117.38.0	SV-NWV	EL	mit Dichtring with O-ring
1.4 CNG (225AXC1A) 51-63 kW (69-86 PS) 350 A1.000	07.2014→		7.06117.38.0	SV-NWV	EL	mit Dichtring with O-ring
1.4 CNG (225AXC1A, 225BXC1A) 51-63 kW (69-86 PS) 350 A1.000	06.2008→		7.06117.38.0	SV-NWV	EL	mit Dichtring with O-ring



























						
FIORINO MPV (225_)						13
JTD Multijet (225BXB1A, 225BXB11) 55-68 kW (75-93 PS) 199 A2.000, 199 A9.000	11.2007→		7.01981.07.0	SV-AGR-K	EP	
JTD Multijet (225BXE1A) 64-70 kW (87-95 PS) 199 B1.000	01.2011→		7.01981.07.0	SV-AGR-K	EP	
FIORINO Pick up (146_)						14
1.7 TD 46 kW (63 PS) 146 D7.000	01.1997→05.2001		7.02256.03.0	DW-AGR	EP	
FREEMONT (345_)						15
2.0 JTD 100-125 kW (140-170 PS) 939 B5.000	08.2011→		7.03003.01.0	DW-TL	EP	
2.0 JTD 100-125 kW (140-170 PS) 939 B5.000, 940 A5.000	08.2011→		7.03003.01.0	DW-TL	EP	
2.0 JTD 100-125 kW (140-170 PS) 939 B5.000, 940 A5.000	08.2011→		7.03003.01.0	DW-TL	EP	
2.0 JTD 100-125 kW (140-170 PS) 939 B5.000	08.2011→		7.03003.01.0	DW-TL	EP	
2.0 JTD 4x4 100-125 kW (140-170 PS) 939 B5.000	08.2011→		7.03003.01.0	DW-TL	EP	
2.0 JTD 4x4 100-125 kW (140-170 PS) 939 B5.000, 940 A5.000	08.2011→		7.03003.01.0	DW-TL	EP	
GRANDE PUNTO (199_)						16
1.2 48-51 kW (65-69 PS) 199 A4.000	10.2005→		7.00607.02.0	DW-TL	EP	
1.2 51 kW (69 PS) 169 A4.000	09.2010→		7.06117.38.0	SV-NWV	EL mit Dichtung with O-ring	
1.3 D Multijet 55-68 kW (75-93 PS) 199 A2.000	10.2005→		7.00607.02.0	DW-TL	EP Produktionsdatum bis: 19.02.2010 Production date to: 19.02.2010	
			7.03003.01.0	DW-TL	EP Produktionsdatum ab: 19.02.2010 Production date from: 19.02.2010	
1.3 D Multijet 51 kW (69 PS) 199 B2.000	07.2008→		7.00607.02.0	DW-TL	EP	
			7.03003.01.0	DW-TL	EP Produktionsdatum ab: 19.02.2010 Production date from: 19.02.2010	
1.3 D Multijet 55-68 kW (75-93 PS) 199 A2.000	06.2009→07.2014		7.00607.02.0	DW-TL	EP Produktionsdatum bis: 19.02.2010 Production date to: 19.02.2010	
			7.03003.01.0	DW-TL	EP Produktionsdatum ab: 19.02.2010 Production date from: 19.02.2010	
1.3 D Multijet 62 kW (84 PS) 199 B4.000	04.2010→		7.00607.02.0	DW-TL	EP	
			7.03003.01.0	DW-TL	EP	
			7.01981.07.0	SV-AGR-K	EP	
1.3 D Multijet 62 kW (84 PS) 223 A9.000	04.2010→		7.00607.02.0	DW-TL	EP	
			7.03003.01.0	DW-TL	EP	
1.3 D Multijet 55-68 kW (75-93 PS) 199 A2.000	01.2012→01.2013		7.03003.01.0	DW-TL	EP	
			7.00607.02.0	DW-TL	EP	
1.3 D Multijet (199.AXD11, 199.AXD1A, 199.AXD1B,...) 63-70 kW (86-95 PS) 199 A3.000	10.2005→12.2010		7.00607.02.0	DW-TL	EP	
			7.03003.01.0	DW-TL	EP Produktionsdatum ab: 19.02.2010 Production date from: 19.02.2010	

F





GRANDE PUNTO (199_)

16



















F	1.4 (199AXB11, 199AXB1A, 199BxB1A, 199AXL1A) 51-63 kW (69-86 PS) 350 A1.000	06.2005→12.2015	 7.06117.35.0	SV-NWV	EL	 →3952691
			 7.06117.38.0	SV-NWV	EL	mit Dichtring with O-ring  3952691→
1.4 (199AXB1A) 55 kW (75 PS) 199 A7.000	10.2005→07.2007	 7.06117.35.0	7.06117.38.0	SV-NWV	EL	 →3952691
				SV-NWV	EL	mit Dichtring with O-ring  3952691→
1.4 16V 104-112 kW (141-152 PS) 198 A1.000	09.2007→07.2012	 7.02256.49.0	LDRV	EP		
1.4 16V 66-92 kW (90-125 PS) 323 B6.600	06.2009→07.2014	 7.06117.35.0	SV-NWV	EL	 Indien  India	
1.4 16V (199BxG1B, 199AXG1B) 70-71 kW (95-97 PS) 199 A6.000	10.2005→08.2011	 7.06117.35.0	7.02256.30.0	SV-NWV	EL	 Indien  India
				SV-PDA	EP	→05.2008
1.4 LPG 51-63 kW (69-86 PS) 350 A1.000	12.2008→	 7.06117.35.0	7.06117.38.0	SV-NWV	EL	 →3952691
				SV-NWV	EL	mit Dichtring with O-ring  3952691→
1.4 Natural Power 51-63 kW (69-86 PS) 350 A1.000	07.2008→	 7.06117.35.0	7.06117.38.0	SV-NWV	EL	 →3952691
				SV-NWV	EL	mit Dichtring with O-ring  3952691→
1.4 T-Jet (199AXM1A, 199BXM1A, 199BXN1A) 88 kW (120 PS) 198 A4.000	09.2007→	 7.02256.49.0	7.01835.06.0	LDRV	EP	
				SUV	EL	
				SV-NWV	EL	 Indien  India
1.9 D Multijet 88 kW (120 PS) 939 A1.000	10.2005→	 7.00607.02.0	DW-TL	EP		
1.9 D Multijet 96 kW (131 PS) 199 A5.000	10.2005→	 7.00607.02.0	DW-TL	EP		
1.9 D Multijet 85 kW (115 PS) 939 A7.000	06.2006→12.2009	 7.00607.02.0	DW-TL	EP		

IDEA (350_)







17

1.3 D Multijet 51-66 kW (70-90 PS) 188 A9.000	01.2004→	 7.00607.02.0	7.08681.03.0	SV-HYAT	EH	für OE-Nummer: 71737621, 71753780 for OE number: 71737621, 71753780
			7.08681.04.0	SV-HYAT	EH	
			7.08681.05.0	SV-HYAT	EH	für OE-Nummer: 71737623, 71753782 for OE number: 71737623, 71753782
			7.08681.06.0	SV-HYAT	EH	
			7.00607.02.0	DW-TL	EP	
1.3 D Multijet 63-70 kW (86-95 PS) 199 A3.000	10.2005→	 7.00607.02.0	7.08681.03.0	SV-HYAT	EH	für OE-Nummer: 71737621, 71753780 for OE number: 71737621, 71753780
			7.08681.04.0	SV-HYAT	EH	
			7.08681.05.0	SV-HYAT	EH	für OE-Nummer: 71737623, 71753782 for OE number: 71737623, 71753782
			7.08681.06.0	SV-HYAT	EH	
			7.00607.02.0	DW-TL	EP	

IDEA (350_) **17**



1.3 D Multijet 64-70 kW (87-95 PS) 199 B1.000	05.2008→12.2012	 7.00607.02.0	DW-TL	EP	für OE-Nummer: 71737621, 71753780 für OE number: 71737621, 71753780
		7.01981.07.0	SV-AGR-K	EP	
		7.08681.03.0	SV-HYAT	EH	
		7.08681.04.0	SV-HYAT	EH	
		7.08681.05.0	SV-HYAT	EH	
1.4 51-63 kW (69-86 PS) 350 A1.000	10.2005→	 7.06117.35.0	SV-NWV	EL	 →3952691
		7.06117.38.0	SV-NWV	EL	mit Dichtring with O-ring  3952691→
1.4 57-63 kW (78-86 PS) 178 F3.011	01.2006→	 7.06117.35.0	SV-NWV	EL	 →3952691
1.4 57-63 kW (78-86 PS) 178 F3.011	08.2010→	 7.06117.35.0	SV-NWV	EL	 →3952691
1.4 Flex 57-63 kW (78-86 PS) 178 F3.011	09.2005→12.2015	 7.06117.35.0	SV-NWV	EL	 →3952691
1.4 Flex 57-63 kW (78-86 PS) 178 F3.011	09.2005→	 7.06117.35.0	SV-NWV	EL	 →3952691
1.4 LPG 51-63 kW (69-86 PS) 350 A1.000	03.2009→	 7.06117.35.0	SV-NWV	EL	 →3952691
		7.06117.38.0	SV-NWV	EL	mit Dichtring with O-ring  3952691→
1.6 77-87 kW (109-118 PS) 310 A5.011	08.2010→	 7.00607.02.0	DW-TL	EP	
1.6 77-87 kW (109-118 PS) 310 A5.011	08.2010→	 7.00607.02.0	DW-TL	EP	
1.6 D Multijet 85-88 kW (116-120 PS) 350 A2.000	05.2008→	 7.00607.02.0	DW-TL	EP	
1.9 JTD 74 kW (101 PS) 188 B2.000	01.2004→	 7.00607.02.0	DW-TL	EP	
		7.28170.03.0	EUV-RK	EP	
		7.02256.49.0	LDRV	EP	

F
LINEA (323_, 110_) **18**

1.3 D Multijet 63-70 kW (86-95 PS) 199 A3.000	11.2008→12.2019	 7.03003.01.0	DW-TL	EP	
1.3 D Multijet (323AXB11, 323AXB1A) 63-70 kW (86-95 PS) 199 A3.000	06.2007→	 7.00607.02.0	DW-TL	EP	
		7.03003.01.0	DW-TL	EP	
1.3 D Multijet (323AXB1A) 63-70 kW (86-95 PS) 199 A3.000	09.2009→	 7.00607.02.0	DW-TL	EP	
		7.03003.01.0	DW-TL	EP	
1.3 D Multijet (323AXB1A) 64-70 kW (87-95 PS) 199 B1.000	09.2009→	 7.01981.07.0	SV-AGR-K	EP	
1.3 JTD Multijet (323AXB1A) 63-70 kW (86-95 PS) 199 A3.000	10.2006→	 7.03003.01.0	DW-TL	EP	
1.4 51-63 kW (69-86 PS) 350 A1.000	06.2007→	 7.06117.35.0	SV-NWV	EL	 →3952691











					
---	---	---	---	--	---

LINEA (323_, 110_)	18
---------------------------	-----------





			7.06117.38.0	SV-NWV	EL	mit Dichtring with O-ring 3952691 →
1.4 66-92 kW (90-125 PS) 323 B6.600	12.2008 →		7.06117.35.0	SV-NWV	EL	Indien India
1.4 T-Jet (323AXC1A) 88 kW (120 PS) 198 A4.000	05.2007 →		7.01835.06.0	SUV	EL	
1.6 D Multijet 77 kW (105 PS) 198 A3.000	06.2009 →		7.03003.01.0	DW-TL	EP	

F





MAREA (185_)	19
---------------------	-----------

1.6 100 16V 76-85 kW (103-116 PS) 182 A4.000	09.1996 → 05.2002		7.05432.09.0	SM	EL	mit Dichtring with O-ring Vett No. →0176690 Vett No. →5054799 für Fahrzeuge mit Schaltgetriebe for vehicles with manual transmission
1.6 16V 68-76 kW (92-103 PS) 185 A3.000	04.1997 → 02.1999		7.05432.09.0	SM	EL	mit Dichtring with O-ring
1.8 115 16V 83 kW (113 PS) 182 A2.000	09.1996 → 05.2002		7.06269.06.0	LLR	EL	 Vett No. →0270957 Vett No. →2018321
1.9 JTD 74-79 kW (100-107 PS) 182 B4.000, 182 B9.000	01.2001 → 12.2007		7.02256.03.0	DW-AGR	EP	
			7.00607.02.0	DW-TL	EP	
			7.21903.48.0	DW-TL	EP	
1.9 JTD 105 (185AXN1A) 77-79 kW (105-107 PS) 182 B4.000	12.1998 → 12.2002		7.02256.03.0	DW-AGR	EP	
			7.00607.02.0	DW-TL	EP	
			7.21903.48.0	DW-TL	EP	
1.9 JTD 110 (185AXT1A) 81 kW (110 PS) 186 A6.000	09.2000 → 08.2002		7.00607.02.0	DW-TL	EP	
			7.21903.48.0	DW-TL	EP	
			7.02256.50.0	EUV-RK	EL	
1.9 TD 100 (185AX_) 74 kW (100 PS) 182 A7.000	05.1996 → 12.2002		7.02256.03.0	DW-AGR	EP	
			7.00607.02.0	DW-TL	EP	
			7.02256.50.0	EUV-RK	EL	
1.9 TD 75 55 kW (75 PS) 182 A8.000	09.1996 → 05.2002		7.02256.03.0	DW-AGR	EP	
2.4 JTD 130 96 kW (130 PS) 185 A6.000	04.1999 → 05.2002		7.02256.03.0	DW-AGR	EP	
2.4 TD 125 91 kW (125 PS) 185 A2.000	09.1996 → 04.1999		7.02256.03.0	DW-AGR	EP	



MAREA Weekend (185_)	20
-----------------------------	-----------

1.6 100 16V 76-85 kW (103-116 PS) 182 A4.000	09.1996 → 05.2002		7.05432.09.0	SM	EL	mit Dichtring with O-ring Vett No. →0176690 Vett No. →5054799 für Fahrzeuge mit Schaltgetriebe for vehicles with manual transmission
1.8 115 16V 83 kW (113 PS) 182 A2.000	09.1996 → 05.2002		7.06269.06.0	LLR	EL	 Vett No. →0270957 Vett No. →2018321
1.9 JTD 105 (185BXN1A) 77-79 kW (105-107 PS) 182 B4.000	12.1998 → 12.2002		7.02256.03.0	DW-AGR	EP	













MAREA Weekend (185_)
20

1.9 JTD 110 (185BXT1A) 81 kW (110 PS) 186 A6.000	09.2000→08.2002		7.00607.02.0	DW-TL	EP	
			7.21903.48.0	DW-TL	EP	
1.9 TD 100 (185BX_) 74 kW (100 PS) 182 A7.000	09.1996→06.2003		7.00607.02.0	DW-TL	EP	
			7.21903.48.0	DW-TL	EP	
1.9 TD 100 (185BX_) 74-79 kW (100-107 PS) 182 B9.000	09.1996→06.2003		7.02256.50.0	EUV-RK	EL	
			7.02256.03.0	DW-AGR	EP	
1.9 TD 100 (185BX_) 74-79 kW (100-107 PS) 182 B9.000	09.1996→06.2003		7.00607.02.0	DW-TL	EP	
			7.02256.50.0	EUV-RK	EL	
1.9 TD 75 55 kW (75 PS) 182 A8.000	09.1996→05.2002		7.02256.03.0	DW-AGR	EP	
2.4 JTD 130 96 kW (130 PS) 185 A6.000	04.1999→05.2002		7.02256.03.0	DW-AGR	EP	
2.4 TD 125 91 kW (125 PS) 185 A2.000	09.1996→04.1999		7.02256.03.0	DW-AGR	EP	

F
MULTIPLA (186_)
21

1.9 JTD (186AXE1A) 88 kW (120 PS) 186 A9.000	04.2002→06.2010		7.00607.02.0	DW-TL	EP	
			7.02256.50.0	EUV-RK	EL	
1.9 JTD 105 (186AXB1A) 77-79 kW (105-107 PS) 182 B4.000	04.1999→06.2010		7.02256.03.0	DW-AGR	EP	
1.9 JTD 110 81 kW (110 PS) 186 A6.000	03.2001→07.2002		7.00607.02.0	DW-TL	EP	
			7.02256.50.0	EUV-RK	EL	
1.9 JTD 115 85 kW (115 PS) 186 A8.000	07.2002→06.2010		7.00607.02.0	DW-TL	EP	
			7.02256.50.0	EUV-RK	EL	

PALIO (178_)
22

1.4 57-63 kW (78-86 PS) 178 F3.011	04.2005→12.2008		7.06117.35.0	SV-NWV	EL	 →3952681
1.4 51-63 kW (69-86 PS) 350 A1.000	10.2005→		7.06117.35.0	SV-NWV	EL	 →3952681
			7.06117.38.0	SV-NWV	EL	mit Dichtring with O-ring  3952681→
1.4 57-63 kW (78-86 PS) 178 F3.011	08.2010→07.2012		7.06117.35.0	SV-NWV	EL	 →3952681
1.4 Flex 57-63 kW (78-86 PS) 178 F3.011	06.2005→12.2008		7.06117.35.0	SV-NWV	EL	 →3952681
1.6 16V 74-85 kW (100-116 PS) 178 B3.000	04.1996→10.2002		7.05432.09.0	SM	EL	mit Dichtring with O-ring →10.1999
1.7 D 42 kW (57 PS) 176 B3.000	04.1996→09.2002		7.02256.03.0	DW-AGR	EP	
1.7 TD 51-53 kW (69-72 PS) 176 A3.000	02.1997→10.2003		7.02256.03.0	DW-AGR	EP	Produktionsdatum ab: 01.01.2002 Production date from: 01.01.2002
			7.28170.03.0	EUV-RK	EP	
			7.02256.49.0	LDRV	EP	









PALIO (178_) **22**





















1.7 TD 52-59 kW (71-80 PS) 176 A5.000	02.1997→10.2003	 7.02256.03.0	DW-AGR	EP	Produktionsdatum ab: 01.01.2002 Production date from: 01.01.2002
		7.28170.03.0	EUV-RK	EP	
1.7 TD 51-53 kW (69-72 PS) 176 A3.000	09.2001→	 7.02256.03.0	DW-AGR	EP	
		7.28170.03.0	EUV-RK	EP	
		7.02256.49.0	LDRV	EP	
1.7 TD 52-59 kW (71-80 PS) 176 A5.000	09.2001→	 7.02256.03.0	DW-AGR	EP	
		7.28170.03.0	EUV-RK	EP	
1.7 TD 51-53 kW (69-72 PS) 176 A3.000	10.2002→01.2012	 7.02256.03.0	DW-AGR	EP	
		7.28170.03.0	EUV-RK	EP	
		7.02256.49.0	LDRV	EP	

PALIO Weekend (178_, 173_, 373_, 374_, 171_) **23**

























1.6 16V (178DXD1A) 74-85 kW (100-116 PS) 178 B3.000	06.1996→02.2001	 7.05432.09.0	SM	EL	mit Dichtring with O-ring →10.1999
1.7 TD 51-53 kW (69-72 PS) 176 A3.000	04.1996→03.2001	 7.02256.03.0	DW-AGR	EP	
		7.02256.49.0	LDRV	EP	
1.7 TD 52-59 kW (71-80 PS) 176 A5.000	07.1997→	 7.28170.03.0	EUV-RK	EP	Produktionsdatum ab: 01.01.2002 Production date from: 01.01.2002
1.7 TD 52-59 kW (71-80 PS) 176 A5.000	06.2001→03.2010	 7.28170.03.0	EUV-RK	EP	
1.9 JTD 59 kW (80 PS) 188 A2.000	09.2001→	 7.28170.03.0	EUV-RK	EP	
		7.02256.49.0	LDRV	EP	

PANDA (169_) **24**

















1.2 (169AXF2A, 169AXF1A) 51 kW (69 PS) 169 A4.000	03.2010→08.2013	 7.06117.38.0	SV-NWV	EL	mit Dichtring with O-ring
1.2 4x4 (169AXF2A, 169AXF1A) 51 kW (69 PS) 169 A4.000	04.2010→08.2013	 7.06117.38.0	SV-NWV	EL	mit Dichtring with O-ring
		7.06117.38.0	SV-NWV	EL	mit Dichtring with O-ring
1.2 LPG (169CXF1A) 51 kW (69 PS) 169 A4.000	11.2010→08.2013	 7.06117.38.0	SV-NWV	EL	mit Dichtring with O-ring
1.3 D Multijet (169.AXC1A) 51 kW (70 PS) 188 A8.000	09.2003→	 7.00607.02.0	DW-TL	EP	
		7.00607.02.0	DW-TL	EP	
1.3 D Multijet (169AXG1A, 169AXD1A) 55 kW (75 PS) 169 A1.000	06.2006→08.2013	 7.00607.02.0	DW-TL	EP	→12.2009
		7.03003.01.0	DW-TL	EP	
1.3 D Multijet (169AXG1A, 169AXD1A) 55 kW (75 PS) 169 A5.000	06.2006→08.2013	 7.00607.02.0	DW-TL	EP	→12.2009
		7.03003.01.0	DW-TL	EP	
		7.01981.07.0	SV-AGR-K	EP	
1.3 D Multijet 4x4 (169.AXC2A) 51 kW (70 PS) 188 A8.000	10.2004→	 7.00607.02.0	DW-TL	EP	
		7.00607.02.0	DW-TL	EP	
1.3 JTD Multijet 4x4 (169AXG1A, 169AXG2A) 55 kW (75 PS) 169 A1.000	09.2010→08.2013	 7.03003.01.0	DW-TL	EP	
		7.03003.01.0	DW-TL	EP	

					
PANDA (169_)					24
1.3 JTD Multijet 4x4 (169AXG1A, 169AXG2A) 55 kW (75 PS) 169 A5.000	09.2010→08.2013		7.03003.01.0	DW-TL	EP
			7.01981.07.0	SV-AGR-K	EP
1.4 Natural Power (169AXHIA) 51-63 kW (69-86 PS) 350 A1.000	09.2010→08.2013		7.06117.38.0	SV-NWV	EL
					mit Dichtring with O-ring
PANDA (312_, 319_)					25
0.9 (312PXG1A) 57-66 kW (77-90 PS) 312 A2.000	02.2012→		7.03003.01.0	DW-TL	EP
			7.02909.07.0	SUV	EL
0.9 (312PXN1A, 312PXN11) 57-66 kW (77-90 PS) 312 A2.000, 312 A7.000	02.2012→		7.03003.01.0	DW-TL	EP
			7.02909.07.0	SUV	EL
0.9 (312PXN1A, 312PXN11) 57-63 kW (77-86 PS) 312 A5.000	12.2013→		7.03003.01.0	DW-TL	EP
			7.02909.07.0	SUV	EL
0.9 4x4 (312PXG1A) 57-66 kW (77-90 PS) 312 A2.000	09.2012→		7.03003.01.0	DW-TL	EP
			7.02909.07.0	SUV	EL
0.9 4x4 (312PXR2B) 57-66 kW (77-90 PS) 312 A2.000, 312 A7.000	06.2014→		7.03003.01.0	DW-TL	EP
			7.02909.07.0	SUV	EL
0.9 Natural Power (312PXG1A, 312PYC1A) 57-66 kW (77-90 PS) 312 A2.000	07.2012→		7.03003.01.0	DW-TL	EP
			7.02909.07.0	SUV	EL
0.9 Natural Power (312PXN1A) 57-66 kW (77-90 PS) 312 A2.000	01.2015→		7.03003.01.0	DW-TL	EP
			7.02909.07.0	SUV	EL
0.9 Natural Power (312PXN1A) 51-63 kW (69-86 PS) 463 37 566	03.2019→		7.03003.01.0	DW-TL	EP
			7.02909.07.0	SUV	EL
1.2 (312PXA1A) 51 kW (69 PS) 169 A4.000	02.2012→		7.06117.38.0	SV-NWV	EL
1.2 LPG (312PXA1A) 51 kW (69 PS) 169 A4.000	06.2012→		7.06117.38.0	SV-NWV	EL
					mit Dichtring with O-ring
1.3 D Multijet (312PXL1A) 55 kW (75 PS) 199 A1.000	02.2012→		7.00607.02.0	DW-TL	EP
			7.03003.01.0	DW-TL	EP
1.3 D Multijet (312PXL1A) 55-59 kW (75-80 PS) 199 A9.000	02.2012→		7.00607.02.0	DW-TL	EP
			7.03003.01.0	DW-TL	EP
			7.01981.07.0	SV-AGR-K	EP
1.3 D Multijet (312PXU1A, 312PXW1A) 64-70 kW (87-95 PS) 199 B1.000	04.2015→		7.03003.01.0	DW-TL	EP





F

			 PIERBURG			
PANDA (312_, 319_) 25						
F	1.3 D Multijet (312PXU1A, 312PXW1A) 70 kW (95 PS) 312 B1.000, 330 A1.000	04.2015→	 7.03003.01.0	DW-TL	EP	
			 7.01981.07.0	SV-AGR-K	EP	
	1.3 D Multijet 4x4 (312PXL1A) 55 kW (75 PS) 199 A1.000	06.2012→	 7.03003.01.0	DW-TL	EP	
	1.3 D Multijet 4x4 (312PXL1A) 55-59 kW (75-80 PS) 199 A9.000	06.2012→	 7.03003.01.0	DW-TL	EP	
			 7.01981.07.0	SV-AGR-K	EP	
1.3 D Multijet 4x4 (312PXS2A) 55-59 kW (75-80 PS) 199 A9.000, 225 A2.000, 312 A8.000, 312 B2.000	06.2014→	 7.03003.01.0	DW-TL	EP		
1.3 D Multijet 4x4 (312PXU1A) 64-70 kW (87-95 PS) 199 B1.000, 312 B1.000, 330 A1.000	04.2015→	 7.03003.01.0	DW-TL	EP		
PUNTO (176_) 26						
1.7 TD 52-59 kW (71-80 PS) 176 A5.000	01.1994→09.1999	 7.02256.03.0	DW-AGR	EP		
1.7 TD 51-53 kW (69-72 PS) 176 A3.000	01.1994→09.1999	 7.02256.03.0	DW-AGR	EP	01.1997→	
1.7 TD (176AT) 46-47 kW (63-64 PS) 176 B7.000	09.1996→09.1999	 7.02256.03.0	DW-AGR	EP		
PUNTO (188_) 27						
1.3 JTD 16V 51-66 kW (70-90 PS) 188 A9.000			7.08681.03.0	SV-HYAT	EH	für OE-Nummer: 71737621, 71753780 for OE number: 71737621, 71753780
			7.08681.04.0	SV-HYAT	EH	
			7.08681.05.0	SV-HYAT	EH	
			7.08681.06.0	SV-HYAT	EH	
1.9 JTD 63 kW (86 PS) 188 A7.000	10.2001→03.2012		7.28170.03.0	EUV-RK	EP	
			7.02256.49.0	LDRV	EP	
1.9 JTD 74 kW (101 PS) 188 B2.000	06.2003→03.2012		7.28170.03.0	EUV-RK	EP	
			7.02256.49.0	LDRV	EP	
1.9 JTD 80 (188.237, .257, .337, .357) 59 kW (80 PS) 188 A2.000	09.1999→03.2012		7.28170.03.0	EUV-RK	EP	
			7.02256.49.0	LDRV	EP	
PUNTO (199_) 28						
0.9 74-77 kW (101-105 PS) 199 B6.000	07.2013→		7.03003.01.0	DW-TL	EP	
			7.02909.07.0	SUV	EL	
0.9 74-77 kW (101-105 PS) 199 B6.000	12.2013→		7.03003.01.0	DW-TL	EP	
			7.02909.07.0	SUV	EL	
0.9 74 kW (101 PS) 199 B7.000	12.2013→		7.03003.01.0	DW-TL	EP	
0.9 Bifuel 57-66 kW (77-90 PS) 312 A2.000	03.2012→		7.03003.01.0	DW-TL	EP	

PUNTO (199_)
28

0.9 Twinair Turbo 57-66 kW (77-90 PS) 312 A2.000	03.2012→		7.00607.02.0	DW-TL	EP	
			7.02909.07.0	SUV	EL	
1.2 (199AXZ1A, 199BXZ1A) 51 kW (69 PS) 169 A4.000	03.2012→		7.06117.38.0	SV-NWV	EL	mit Dichtring with O-ring
1.3 D Multijet 55-68 kW (75-93 PS) 199 A2.000	03.2012→		7.03003.01.0	DW-TL	EP	
1.3 D Multijet 55-59 kW (75-80 PS) 199 A9.000	03.2012→		7.03003.01.0	DW-TL	EP	
			7.01981.07.0	SV-AGR-K	EP	
1.3 D Multijet 62 kW (84 PS) 199 B4.000	03.2012→		7.03003.01.0	DW-TL	EP	
			7.01981.07.0	SV-AGR-K	EP	
1.3 D Multijet 64-70 kW (87-95 PS) 199 B1.000	03.2012→		7.03003.01.0	DW-TL	EP	
			7.01981.07.0	SV-AGR-K	EP	
1.3 D Multijet 70 kW (95 PS) 330 A1.000	03.2012→		7.03003.01.0	DW-TL	EP	
1.3 D Multijet 59 kW (80 PS) 199 B8.000	12.2013→		7.03003.01.0	DW-TL	EP	
1.3 JTD Multijet (199.AYR1A, 199.BYR1A) 66 kW (90 PS) 955 B2.000	05.2018→		7.03003.01.0	DW-TL	EP	
1.4 99-101 kW (135-137 PS) 955 A2.000	09.2012→		7.02909.07.0	SUV	EL	
1.4 (199AXB1A, 199BXB1A, 199BXB11, 199AXB11) 51-63 kW (69-86 PS) 350 A1.000	03.2012→		7.06117.38.0	SV-NWV	EL	mit Dichtring with O-ring
1.4 (199AXH1A, 199BXH1A) 55 kW (75 PS) 199 A7.000	03.2012→		7.06117.38.0	SV-NWV	EL	mit Dichtring with O-ring
1.4 Bifuel 51-63 kW (69-86 PS) 350 A1.000	03.2012→		7.06117.38.0	SV-NWV	EL	mit Dichtring with O-ring
1.4 Multi Air 77 kW (105 PS) 955 A6.000	03.2012→		7.02909.07.0	SUV	EL	
1.4 Natural Power 51-63 kW (69-86 PS) 350 A1.000	03.2012→		7.06117.38.0	SV-NWV	EL	mit Dichtring with O-ring
1.4 Turbo Multi Air 99-101 kW (135-137 PS) 955 A2.000	03.2012→		7.02909.07.0	SUV	EL	







F
PUNTO EVO (199_)
29

1.2 51 kW (69 PS) 169 A4.000	10.2009→02.2012		7.06117.38.0	SV-NWV	EL	mit Dichtring with O-ring
1.3 D Multijet 51 kW (69 PS) 199 B2.000	07.2008→02.2012		7.00607.02.0	DW-TL	EP	
1.3 D Multijet 62 kW (84 PS) 199 B4.000	10.2009→02.2012		7.00607.02.0	DW-TL	EP	
			7.01981.07.0	SV-AGR-K	EP	
1.3 D Multijet 62 kW (84 PS) 223 A9.000	10.2009→02.2012		7.00607.02.0	DW-TL	EP	
1.3 D Multijet 64-70 kW (87-95 PS) 199 B1.000	10.2009→02.2012		7.00607.02.0	DW-TL	EP	
			7.01981.07.0	SV-AGR-K	EP	









PUNTO EVO (199_) **29**



F



























1.3 D Multijet 55-70 kW (75-95 PS) 199 A2.000, 199 A3.000	10.2014→		7.03003.01.0	DW-TL	EP	
1.3 D Multijet (199AXC1A, 199BXC1A, 199AXT1A, 199BXT1A) 55-68 kW (75-93 PS) 199 A2.000	10.2009→02.2012		7.00607.02.0	DW-TL	EP	
1.3 D Multijet (199AXC1A, 199BXC1A, 199AXT1A, 199BXT1A) 55-59 kW (75-80 PS) 199 A9.000	10.2009→02.2012		7.00607.02.0	DW-TL	EP	
			7.01981.07.0	SV-AGR-K	EP	
1.3 D Multijet (199AXD1B, 199AXD1A, 199BXD1B, 199BXD1A,...) 63-70 kW (86-95 PS) 199 A3.000	10.2009→02.2012		7.00607.02.0	DW-TL	EP	
1.3 D Multijet (199BXC1A) 55-68 kW (75-93 PS) 199 A2.000, 199 A9.000	09.2010→		7.00607.02.0	DW-TL	EP	
1.4 16V 77 kW (105 PS) 955 A6.000	10.2009→02.2012		7.02909.07.0	SUV	EL	
1.4 16V (199AXW1A) 99-101 kW (135-137 PS) 955 A2.000	10.2009→02.2012		7.02909.07.0	SUV	EL	

QUBO (225_) **30**

1.3 D Multijet (225AXE1A, 225CXE1A, 225AXH1A, 225AXL1A,...) 64-70 kW (87-95 PS) 199 B1.000	07.2010→		7.01981.07.0	SV-AGR-K	EP	
1.3 D Multijet (225AXG1A, 225CXG1A, 225AXG11, 225CXG11) 59 kW (80 PS) 225 A2.000	03.2015→		7.03003.01.0	DW-TL	EP	
1.3 D Multijet (225CXB1A, 225AXB1A, 225CXB11, 225AXB11,...) 55-68 kW (75-93 PS) 199 A2.000	02.2008→		7.03003.01.0	DW-TL	EP	
			7.01981.07.0	SV-AGR-K	EP	
1.3 D Multijet (225CXB1A, 225AXB1A, 225CXB11, 225AXB11,...) 55-59 kW (75-80 PS) 199 A9.000	02.2008→		7.03003.01.0	DW-TL	EP	
			7.01981.07.0	SV-AGR-K	EP	
			7.08681.03.0	SV-HYAT	EH	für OE-Nummer: 71737621, 71753780 for OE number: 71737621, 71753780
			7.08681.04.0	SV-HYAT	EH	
			7.08681.05.0	SV-HYAT	EH	für OE-Nummer: 71737623, 71753782 for OE number: 71737623, 71753782
			7.08681.06.0	SV-HYAT	EH	
1.4 (225AXA1A, 225CXA1A) 51-63 kW (69-86 PS) 350 A1.000	10.2009→		7.06117.38.0	SV-NWV	EL	mit Dichtring with O-ring
1.4 Natural Power (225AXC1A) 51-63 kW (69-86 PS) 350 A1.000	10.2009→		7.06117.38.0	SV-NWV	EL	mit Dichtring with O-ring

SEDICI (189_) **31**











1.9 D Multijet 88 kW (120 PS) D19AA	06.2006→10.2011		7.02534.01.0	DW-TL	EP	
1.9 D Multijet 4x4 88 kW (120 PS) D19AA	06.2006→10.2011		7.02534.01.0	DW-TL	EP	

						
SEDICI (189_)						31
2.0 D Multijet 99 kW (135 PS) D20AA	06.2006→10.2014		7.02534.01.0	DW-TL	EP	
2.0 D Multijet 4x4 99 kW (135 PS) D20AA	06.2006→10.2014		7.02534.01.0	DW-TL	EP	
SIENA (178_, 172_)						32
1.4 51-63 kW (69-86 PS) 350 A1.000	01.2007→12.2009		7.06117.35.0	SV-NWV	EL  →3952681	
			7.06117.38.0	SV-NWV	EL mit Dichtring with O-ring  3952681→	
1.4 8V (17201A1, 17245A1) 57-63 kW (78-86 PS) 178 F3.011	04.2006→12.2010		7.06117.35.0	SV-NWV	EL  →3952681	
1.4 Flex 57-63 kW (78-86 PS) 178 F3.011	06.2004→10.2007		7.06117.35.0	SV-NWV	EL  →3952681	
1.6 16V 74-85 kW (100-116 PS) 178 B3.000	09.1998→12.2009		7.05432.09.0	SM	EL mit Dichtring with O-ring →10.1999	
1.7 D 46-47 kW (63-64 PS) 176 B7.000	05.1999→12.2009		7.02256.03.0	DW-AGR	EP Euro 2	
1.7 D 51-53 kW (69-72 PS) 176 A3.000	03.2002→12.2009		7.02256.03.0	DW-AGR	EP Euro 2	
			7.02256.49.0	LDRV	EP	
1.7 TD 51-53 kW (69-72 PS) 176 A3.000	02.2006→12.2009		7.02256.03.0	DW-AGR	EP Euro 2	
			7.02256.49.0	LDRV	EP Euro 2	
STILO (192_)						33
1.9 D Multijet 88 kW (120 PS) 192 A8.000	09.2005→11.2006		7.00607.02.0	DW-TL	EP	
			7.02256.50.0	EUV-RK	EL	
1.9 D Multijet 110 kW (150 PS) 937 A5.000	09.2005→11.2006		7.00607.02.0	DW-TL	EP	
			7.02256.50.0	EUV-RK	EL	
1.9 D Multijet 74 kW (100 PS) 192 A9.000	09.2005→11.2006		7.02256.50.0	EUV-RK	EL	
			7.02256.49.0	LDRV	EP	
1.9 JTD 93 kW (126 PS) 937 A4.000	09.2003→11.2006		7.21903.48.0	DW-TL	EP	
			7.00607.02.0	DW-TL	EP	
			7.02256.50.0	EUV-RK	EL	
1.9 JTD 103 kW (140 PS) 192 A5.000	01.2004→11.2006		7.00607.02.0	DW-TL	EP	
			7.02256.50.0	EUV-RK	EL	
1.9 JTD 100 kW (136 PS) 192 B1.000	04.2004→11.2006		7.00607.02.0	DW-TL	EP	
			7.02256.50.0	EUV-RK	EL	
1.9 JTD (192AXS1B, 192BXS1B) 66 kW (90 PS) 192 B5.000	09.2004→11.2006		7.02256.50.0	EUV-RK	EL	
1.9 JTD (192_XE1A) 85 kW (115 PS) 192 A1.000, 937 A7.000	10.2001→11.2006		7.21903.48.0	DW-TL	EP	
			7.00607.02.0	DW-TL	EP  192 A1.000, 937 A7.000: →12.2003	
			7.02256.50.0	EUV-RK	EL	
1.9 JTD (192_XF1A) 59 kW (80 PS) 192 A3.000	02.2002→11.2006		7.21903.48.0	DW-TL	EP	
			7.02256.50.0	EUV-RK	EL	
			7.02256.49.0	LDRV	EP	

F







STILO Multi Wagon (192_) **34**

























F	1.9 D 66 kW (90 PS) 192 B5.000	09.2004→08.2008	 7.02256.50.0	EUV-RK	EL	
	1.9 D Multijet 88 kW (120 PS) 192 A8.000	09.2005→08.2008	 7.00607.02.0	DW-TL	EP	
			7.02256.50.0	EUV-RK	EL	
	1.9 D Multijet 74 kW (100 PS) 192 A9.000	09.2005→08.2008	 7.02256.50.0	EUV-RK	EL	
	1.9 D Multijet (192DXT1B) 110 kW (150 PS) 937 A5.000	09.2005→08.2008	 7.00607.02.0	DW-TL	EP	
			7.02256.50.0	EUV-RK	EL	
	1.9 JTD 59 kW (80 PS) 192 A3.000	01.2003→08.2008	 7.21903.48.0	DW-TL	EP	
			7.02256.50.0	EUV-RK	EL	
	1.9 JTD 85 kW (115 PS) 192 A1.000, 937 A7.000	01.2003→08.2008	 7.21903.48.0	DW-TL	EP	 192 A1.000, 937 A7.000: →12.2003
			7.00607.02.0	DW-TL	EP	
		7.02256.50.0	EUV-RK	EL		
1.9 JTD 93 kW (126 PS) 937 A4.000	09.2003→08.2008	 7.21903.48.0	DW-TL	EP		
		7.00607.02.0	DW-TL	EP		
		7.02256.50.0	EUV-RK	EL		
1.9 JTD 103 kW (140 PS) 192 A5.000	01.2004→08.2008	 7.00607.02.0	DW-TL	EP		
		7.02256.50.0	EUV-RK	EL		
1.9 JTD 100 kW (136 PS) 192 B1.000	04.2004→08.2008	 7.00607.02.0	DW-TL	EP		
		7.02256.50.0	EUV-RK	EL		

STRADA Pickup (178_) **35**

1.3 D Multijet 62 kW (84 PS) 223 A9.000	05.2006→	 7.00607.02.0	DW-TL	EP	
1.3 D Multijet (278AYR1A) 64-70 kW (87-95 PS) 199 B1.000	03.2010→	 7.03003.01.0	DW-TL	EP	
1.3 D Multijet (278AYR1A) 64-70 kW (87-95 PS) 199 B1.000	10.2010→	 7.03003.01.0	DW-TL	EP	
		7.01981.07.0	SV-AGR-K	EP	
1.7 TD 51-53 kW (69-72 PS) 176 A3.000	06.1999→12.2006	 7.02256.03.0	DW-AGR	EP	01.2003→
		7.02256.49.0	LDRV	EP	
1.7 TD 51-53 kW (69-72 PS) 176 A3.000	02.2002→01.2010	 7.02256.03.0	DW-AGR	EP	
		7.02256.49.0	LDRV	EP	
1.9 JTD 59 kW (80 PS) 188 A2.000	04.2003→	 7.28170.03.0	EUV-RK	EP	
		7.02256.49.0	LDRV	EP	Produktionsdatum ab: 01.03.2003 Production date from: 01.03.2003

TEMPRA (159_) **36**

1.8 i.e. (159.AV) 76 kW (103 PS) 835 C2.000	09.1993→08.1996	 7.05432.09.0	SM	EL	mit Dichtring with O-ring  1509143→
1.8 i.e. (159.AZ) 66 kW (90 PS) 835 C4.000	09.1993→08.1996	 7.05432.09.0	SM	EL	mit Dichtring with O-ring  1509143→
1.8 i.e. (159.BY) 71-74 kW (97-101 PS) 836 A5.000	10.1994→08.1996	 7.05432.09.0	SM	EL	mit Dichtring with O-ring  1509143→

						
TEMPRA S.W. (159_)						37
1.8 i.e. (159.AV) 76 kW (103 PS) 835 C2.000	09.1993→08.1996		7.05432.09.0	SM	EL	mit Dichtring with O-ring  1509143→
1.8 i.e. (159.AZ) 66 kW (90 PS) 835 C4.000	09.1993→08.1996		7.05432.09.0	SM	EL	mit Dichtring with O-ring  1509143→
1.8 i.e. (159.BY) 71-74 kW (97-101 PS) 836 A5.000	10.1994→08.1996		7.05432.09.0	SM	EL	mit Dichtring with O-ring  1509143→
TIPO (160_)						38
1.8 i.e. 71-74 kW (97-101 PS) 836 A5.000	03.1993→04.1995		7.05432.09.0	SM	EL	mit Dichtring with O-ring
1.8 i.e. 66 kW (90 PS) 835 C4.000	09.1993→04.1995		7.05432.09.0	SM	EL	mit Dichtring with O-ring
1.8 i.e. (160.AY) 77 kW (105 PS) 159 A4.046	10.1990→06.1993		7.05432.09.0	SM	EL	mit Dichtring with O-ring
1.8 i.e. (160.EQ, 160.AM) 71-74 kW (97-101 PS) 836 A5.000	10.1994→10.1995		7.05432.09.0	SM	EL	mit Dichtring with O-ring
TIPO Estate (356_)						39
1.3 D (356WXH1A) 59-70 kW (80-95 PS) 552 66 963, 552 83 775	03.2016→		7.03003.01.0	DW-TL	EP	
			7.01981.07.0	SV-AGR-K	EP	 552 66 963, 552 83 775: Euro4/Euro5, Euro 6d Euro4/Euro5, Euro 6d
1.4 (356WXF1B) 88-93 kW (120-126 PS) 940 B7.000	03.2016→		7.01835.06.0	SUV	EL	
1.4 LPG (356WXF1B) 88-93 kW (120-126 PS) 940 B7.000	05.2016→		7.01835.06.0	SUV	EL	
TIPO Hatchback (356_)						40
1.3 D (356HXH1A) 59-70 kW (80-95 PS) 552 66 963, 552 83 775	03.2016→		7.03003.01.0	DW-TL	EP	
			7.01981.07.0	SV-AGR-K	EP	 552 66 963, 552 83 775: Euro4/Euro5, Euro 6d Euro4/Euro5, Euro 6d
1.4 (356HXF1B) 88-93 kW (120-126 PS) 940 B7.000	03.2016→		7.01835.06.0	SUV	EL	
1.4 LPG (356HXF1B) 88-93 kW (120-126 PS) 940 B7.000	05.2016→		7.01835.06.0	SUV	EL	
TIPO Saloon (356_)						41
1.3 D (356SXB1A, 356SXH1A, 356SXD1A) 59-70 kW (80-95 PS) 552 66 963, 552 83 775	10.2015→		7.03003.01.0	DW-TL	EP	
			7.01981.07.0	SV-AGR-K	EP	 552 66 963, 552 83 775: Euro4/Euro5, Euro 6d Euro4/Euro5, Euro 6d
1.3 D (356SXB1A, 356SXH1A, 356SXD1A) 64-70 kW (87-95 PS) 199 B1.000	10.2015→		7.03003.01.0	DW-TL	EP	
1.4 LPG (356SXF1B) 88-93 kW (120-126 PS) 940 B7.000	05.2016→		7.01835.06.0	SUV	EL	

F

--	--	--	--	--	--

ULYSSE (179_)	42
----------------------	-----------

2.0 (179BXA11, 179BXA1A) 100 kW (136 PS) RFN (EW10J4)	08.2002→06.2011		7.02256.05.0	OEL-HV	EH	
2.0 D Multijet 88 kW (120 PS) RHK	05.2006→06.2011		7.01632.02.0	DW-RK	EP	Vett No. →10991 Produktionsdatum bis: 15.12.2006 Production date to: 15.12.2006
2.0 D Multijet 100 kW (136 PS) RHR	05.2006→06.2011		7.01632.02.0	DW-RK	EP	Vett No. →10991 Produktionsdatum bis: 15.12.2006 Production date to: 15.12.2006
			7.01633.04.0	DW-TL	EP	→01.2008 ab Euro 3 From Euro 3
2.0 JTD 80 kW (109 PS) RHW (DW10ATED4)	08.2002→08.2006		7.02256.24.0	DW-AGR	EP	
			7.02256.24.0	DW-TL	EP	

ULYSSE (220_)	43
----------------------	-----------



















1.8 (220.BB5) 73 kW (99 PS) LFW (XU7JP)	05.1997→08.2002		7.05432.02.0	SM	EL	mit Dichtring with O-ring
2.0 (220.AC5) 89 kW (121 PS) RFU (XU10J2C)	06.1994→08.2002		7.05432.02.0	SM	EL	mit Dichtring with O-ring
2.0 16V 97-100 kW (132-136 PS) RFV	07.1998→09.2000		7.02256.05.0	OEL-HV	EH	
2.0 16V (220AQ5) 100 kW (136 PS) RFN (EW10J4)	09.2000→08.2002		7.02256.05.0	OEL-HV	EH	
2.0 JTD 80 kW (109 PS) RHZ	10.1999→08.2002		7.02256.24.0	DW-AGR	EP	
			7.02256.24.0	DW-TL	EP	
2.0 JTD 16V 80 kW (109 PS) RHW (DW10ATED4)	05.1999→08.2002		7.02256.24.0	DW-AGR	EP	
			7.02256.24.0	DW-TL	EP	

BRAVO Van (198_)	44
-------------------------	-----------

1.6 JTD Multijet (198AXH1B) 77 kW (105 PS) 198 A3.000	03.2008→12.2014		7.03003.01.0	DW-TL	EP	
--	-----------------	--	---------------------	-------	----	--

DOBLO Box Body/MPV (223_)	45
----------------------------------	-----------









1.3 JTD 16V 51-66 kW (70-90 PS) 188 A8.000, 188 A9.000	05.2004→12.2006		7.02256.49.0	LDRV	EP	
1.3 JTD 16V Multijet 62 kW (84 PS) 223 A9.000	08.2006→		7.00607.02.0	DW-TL	EP	
1.4 51-63 kW (69-86 PS) 350 A1.000	10.2005→		7.06117.35.0	SV-NWV	EL	→3952691
			7.06117.38.0	SV-NWV	EL	mit Dichtring with O-ring 3952691→
1.4 Flexfuel 60-70 kW (82-95 PS) 310 A2.011	11.2009→12.2016		7.06117.35.0	SV-NWV	EL	→3952681
1.4 Flexfuel 60-70 kW (82-95 PS) 310 A2.011	11.2009→		7.06117.35.0	SV-NWV	EL	→3952681
1.9 JTD 77 kW (105 PS) 223 A7.000, 223 B1.000	07.2003→		7.00607.02.0	DW-TL	EP	223 A7.000, 223 B1.000: 01.2005→
			7.28170.03.0	EUV-RK	EP	
			7.02256.49.0	LDRV	EP	
1.9 JTD (223ZXE1A) 74-79 kW (100-107 PS) 182 B9.000	10.2001→		7.00607.02.0	DW-TL	EP	01.2005→
			7.28170.03.0	EUV-RK	EP	
			7.02256.49.0	LDRV	EP	

					
DOBLO Box Body/MPV (223_)					
45					
1.9 JTD Multijet 88 kW (120 PS) 186 A9.000	12.2006→		7.00607.02.0	DW-TL	EP
			7.02256.50.0	EUV-RK	EL
DOBLO Bus (263_)					
46					
1.3 D Multijet (263AXC1A) 63-70 kW (86-95 PS) 199 A3.000, 263 A2.000	02.2010→		7.03003.01.0	DW-TL	EP
			7.01981.07.0	SV-AGR-K	EP
1.3 D Multijet (263AXU1A) 70 kW (95 PS) 330 A1.000	03.2016→		7.03003.01.0	DW-TL	EP
1.4 (263AXG1B, 263AXG1A) 88 kW (120 PS) 198 A4.000	10.2011→		7.02256.49.0	LDRV	EP
			7.01835.06.0	SUV	EL
1.4 Natural Power (263AXG1B) 88 kW (120 PS) 198 A4.000	02.2010→		7.02256.49.0	LDRV	EP
			7.01835.06.0	SUV	EL
1.6 D Multijet (263AXD1B) 77 kW (105 PS) 198 A3.000, 263 A8.000	01.2010→		7.03003.01.0	DW-TL	EP
1.6 D Multijet (263AXE1B) 74 kW (101 PS) 263 A3.000, 263 A9.000	03.2016→		7.03003.01.0	DW-TL	EP
1.6 D Multijet (263AXH1A, 263AXL11, 263AXH1B) 66 kW (90 PS) 263 A4.000	02.2010→		7.03003.01.0	DW-TL	EP
			7.08681.03.0	SV-HYAT	EH für OE-Nummer: 71737621, 71753780 for OE number: 71737621, 71753780
			7.08681.04.0	SV-HYAT	EH
			7.08681.05.0	SV-HYAT	EH für OE-Nummer: 71737623, 71753782 for OE number: 71737623, 71753782
			7.08681.06.0	SV-HYAT	EH
1.6 D Multijet (263AXN1B) 88 kW (120 PS) 940 C1.000	03.2015→		7.03003.01.0	DW-TL	EP
1.6 D Multijet (263AXP1B) 70 kW (95 PS) 263 A7.000	03.2015→		7.03003.01.0	DW-TL	EP
2.0 D Multijet (263AXF1B) 99 kW (135 PS) 263 A1.000	01.2010→		7.03003.01.0	DW-TL	EP
DOBLO Cargo (263_)					
47					
1.3 D Multijet 63-70 kW (86-95 PS) 199 A3.000, 263 A2.000	02.2010→		7.03003.01.0	DW-TL	EP
			7.01981.07.0	SV-AGR-K	EP
1.3 D Multijet 55 kW (75 PS) 263 A6.000	11.2013→		7.03003.01.0	DW-TL	EP
1.3 D Multijet 59 kW (80 PS) 225 A2.000	03.2016→		7.03003.01.0	DW-TL	EP
1.3 D Multijet (263WXU1A) 70 kW (95 PS) 330 A1.000	03.2016→		7.03003.01.0	DW-TL	EP
1.4 88 kW (120 PS) 198 A4.000	10.2011→		7.02256.49.0	LDRV	EP
			7.01835.06.0	SUV	EL











F





























DOBLO Cargo (263_) **47**

F	1.4 Natural Power 88 kW (120 PS) 198 A4.000	06.2010→	 7.02256.49.0	LDRV	EP		
			7.01835.06.0	SUV	EL		
	1.6 D Multijet 77 kW (105 PS) 198 A3.000, 263 A8.000	02.2010→	 7.03003.01.0	DW-TL	EP		
	1.6 D Multijet 66 kW (90 PS) 263 A4.000, 263 A5.000	02.2010→		7.03003.01.0	DW-TL	EP	
				7.08681.03.0	SV-HYAT	EH	 263 A4.000, 263 A5.000: für OE-Nummer: 71737621, 71753780 for OE number: 71737621, 71753780
				7.08681.04.0	SV-HYAT	EH	
				7.08681.05.0	SV-HYAT	EH	 263 A4.000, 263 A5.000: für OE-Nummer: 71737623, 71753782 for OE number: 71737623, 71753782
				7.08681.06.0	SV-HYAT	EH	
	1.6 D Multijet 74 kW (101 PS) 263 A3.000, 263 A9.000	02.2010→	 7.03003.01.0	DW-TL	EP		
	1.6 D Multijet (263.WXN1B, 263.ZXN1B) 88 kW (120 PS) 940 C1.000	02.2016→	 7.03003.01.0	DW-TL	EP		
1.6 D Multijet (263ZXR1B) 70 kW (95 PS) 263 A7.000	03.2015→	 7.03003.01.0	DW-TL	EP			
2.0 D Multijet 99 kW (135 PS) 263 A1.000	02.2010→	 7.03003.01.0	DW-TL	EP			

DOBLO Platform/Chassis (263_) **48**























	1.3 D Multijet 63-70 kW (86-95 PS) 199 A3.000, 263 A2.000	02.2010→	 7.03003.01.0	DW-TL	EP		
			7.01981.07.0	SV-AGR-K	EP		
	1.3 D Multijet 55 kW (75 PS) 263 A6.000	11.2013→	 7.03003.01.0	DW-TL	EP		
	1.3 D Multijet (263.HXT1A, 263.YXT1A) 59 kW (80 PS) 225 A2.000	03.2016→		7.03003.01.0	DW-TL	EP	
				7.03003.01.0	DW-TL	EP	
	1.3 D Multijet (263.HXU1A, 263.YXU1A) 70 kW (95 PS) 330 A1.000	03.2016→		7.03003.01.0	DW-TL	EP	
				7.03003.01.0	DW-TL	EP	
	1.4 88 kW (120 PS) 198 A4.000	10.2011→		7.02256.49.0	LDRV	EP	
				7.01835.06.0	SUV	EL	
	1.4 Natural Power 88 kW (120 PS) 198 A4.000	06.2010→		7.02256.49.0	LDRV	EP	
7.01835.06.0				SUV	EL		
1.6 D Multijet 77 kW (105 PS) 198 A3.000, 263 A8.000	02.2010→	 7.03003.01.0	DW-TL	EP			
1.6 D Multijet 66 kW (90 PS) 263 A4.000, 263 A5.000	02.2010→		7.03003.01.0	DW-TL	EP		
			7.08681.03.0	SV-HYAT	EH	 263 A4.000, 263 A5.000: für OE-Nummer: 71737621, 71753780 for OE number: 71737621, 71753780	
			7.08681.04.0	SV-HYAT	EH		
			7.08681.05.0	SV-HYAT	EH	 263 A4.000, 263 A5.000: für OE-Nummer: 71737623, 71753782 for OE number: 71737623, 71753782	
			7.08681.06.0	SV-HYAT	EH		
1.6 D Multijet 74 kW (101 PS) 263 A3.000, 263 A9.000	02.2011→	 7.03003.01.0	DW-TL	EP			

						
DOBLO Platform/Chassis (263_)						48
1.6 D Multijet (263.HXN1B, 263.YXN1B) 88 kW (120 PS) 940 C1.000	02.2016→		7.03003.01.0	DW-TL	EP	
2.0 D Multijet 99 kW (135 PS) 263 A1.000	02.2010→		7.03003.01.0	DW-TL	EP	
DUCATO Bus (230_)						49
2.0 JTD 62 kW (84 PS) RHV	10.2001→04.2002		7.02256.23.0	DW-AGR	EP	
2.8 D 64 kW (87 PS) 8140.63	02.1998→04.2002		7.02256.03.0	DW-AGR	EP	
2.8 JTD 93-103 kW (127-140 PS) 8140.43S	11.2000→04.2002		7.02256.03.0	DW-AGR	EP	
2.8 JTD 4x4 93-103 kW (127-140 PS) 8140.43S	11.2000→04.2002		7.00607.02.0	DW-TL	EP	
			7.02256.03.0	DW-AGR	EP	
2.8 TDI 90 kW (122 PS) 8140.43	10.1997→04.2002		7.02256.03.0	DW-AGR	EP	
2.8 TDI 4x4 90 kW (122 PS) 8140.43	07.1999→04.2002		7.02256.03.0	DW-AGR	EP	
DUCATO Bus (244_)						50
2.0 JTD 62 kW (84 PS) RHV	04.2002→		7.02256.23.0	DW-AGR	EP	
2.3 JTD 81 kW (110 PS) F1AE0481C	04.2002→		7.02256.03.0	DW-AGR	EP	
2.8 JTD 93-103 kW (127-140 PS) 8140.43S	04.2002→		7.02256.03.0	DW-AGR	EP	
			7.00607.02.0	DW-TL	EP →12.2006	
2.8 JTD 107 kW (146 PS) 8140.43N	04.2004→07.2006		7.00607.02.0	DW-TL	EP	
2.8 JTD 4x4 93-103 kW (127-140 PS) 8140.43S	07.2002→		7.02256.03.0	DW-AGR	EP	
			7.00607.02.0	DW-TL	EP →12.2006	
DUCATO Bus (250_)						51
110 Multijet 2,3 D 82-83 kW (111-113 PS) F1AE3481G	10.2011→		7.08681.13.0	SV-HYAT	EH für OE-Nummer: 71773490 for OE number: 71773490	
			7.08681.14.0	SV-HYAT	EH für OE-Nummer: 71773491 for OE number: 71773491	
115 Multijet 2,0 D 85 kW (116 PS) 250 A1.000, 250 A2.000	06.2011→		7.04881.08.0*	SUV	EL mit Rohrstützen with pipe socket  250 A1.000, 250 A2.000: Produktionsdatum bis: 06.07.2018 Production date to: 06.07.2018	
			↳ 7.02909.12.0	SUV	EL	
120 Multijet 2,3 D 88 kW (120 PS) F1AE0481D	07.2006→		7.02256.20.0	DW-AGR	EP	
130 Multijet 2,3 D 96 kW (131 PS) F1AE0481N	06.2011→		7.02256.20.0	DW-AGR	EP	
130 Multijet 2,3 D 96 kW (131 PS) F1AE3481D, F1AGL411D	06.2011→		7.02256.20.0	DW-AGR	EP	
			7.08681.13.0	SV-HYAT	EH  F1AE3481D: für OE-Nummer: 71773490 for OE number: 71773490  F1AGL411D: Produktionsdatum bis: 02.05.2017 Production date to: 02.05.2017	

















F



DUCATO Bus (250_) **51**

			7.08681.14.0	SV-HYAT	EH	 F1AE3481D: für OE-Nummer: 71773491 for OE number: 71773491  F1AGL411D: Produktionsdatum bis: 02.05.2017 Production date to: 02.05.2017
130 Multijet 2,3 D 4x4 96 kW (131 PS) F1AE0481N	06.2011→		7.02256.20.0	DW-AGR	EP	
F 130 Multijet 2,3 D 4x4 96 kW (131 PS) F1AE3481D, F1AGL411D	06.2011→		7.02256.20.0	DW-AGR	EP	
			7.08681.13.0	SV-HYAT	EH	 F1AE3481D: für OE-Nummer: 71773490 for OE number: 71773490  F1AGL411D: Produktionsdatum bis: 02.05.2017 Production date to: 02.05.2017
			7.08681.14.0	SV-HYAT	EH	 F1AE3481D: für OE-Nummer: 71773491 for OE number: 71773491  F1AGL411D: Produktionsdatum bis: 02.05.2017 Production date to: 02.05.2017
140 Natural Power 100 kW (136 PS) F1CE0441A, F1CFA401A	04.2009→		7.02256.20.0	DW-AGR	EP	
150 Multijet 2,3 D 109-110 kW (148-150 PS) F1AE3481E	06.2011→		7.02256.20.0	DW-AGR	EP	→12.2014 ■ Finland, Skandinavien, Island ■ Finland, Scandinavia, Iceland
			7.08681.13.0	SV-HYAT	EH	für OE-Nummer: 71773490 for OE number: 71773490
			7.08681.14.0	SV-HYAT	EH	für OE-Nummer: 71773491 for OE number: 71773491
150 Multijet 2,3 D 110 kW (150 PS) F1AGL411A, F1AGL411C	04.2015→		7.08681.13.0	SV-HYAT	EH	 F1AGL411A, F1AGL411C: Produktionsdatum bis: 02.05.2017 Production date to: 02.05.2017
			7.08681.14.0	SV-HYAT	EH	 F1AGL411A, F1AGL411C: Produktionsdatum bis: 02.05.2017 Production date to: 02.05.2017
150 Multijet 2,3 D 4x4 110 kW (150 PS) F1AGL411A, F1AGL411C	04.2015→		7.08681.13.0	SV-HYAT	EH	 F1AGL411A, F1AGL411C: Produktionsdatum bis: 02.05.2017 Production date to: 02.05.2017
			7.08681.14.0	SV-HYAT	EH	 F1AGL411A, F1AGL411C: Produktionsdatum bis: 02.05.2017 Production date to: 02.05.2017
150 Multijet 3,0 D 103-107 kW (140-145 PS) F1CE3481N	04.2010→		7.02256.20.0	DW-AGR	EP	
			7.08681.13.0	SV-HYAT	EH	 ch. 2118065→ für OE-Nummer: 71773490 for OE number: 71773490
			7.08681.14.0	SV-HYAT	EH	 ch. 2118065→ für OE-Nummer: 71773491 for OE number: 71773491
			7.08681.07.0	SV-HYAT	EH	 →ch. 2118065 für OE-Nummer: 71749996 for OE number: 71749996
160 Multijet 2,3 D 118 kW (160 PS) F1AGL4112	05.2019→		7.03003.01.0	DW-TL	EP	
160 Multijet 3,0 D 115-116 kW (156-158 PS) F1CE0481D	07.2006→		7.03003.01.0	DW-TL	EP	

DUCATO Bus (250_) **51**

			7.08681.13.0	SV-HYAT	EH	 ch. 2118065→ für OE-Nummer: 71773490 for OE number: 71773490
			7.08681.14.0	SV-HYAT	EH	 ch. 2118065→ für OE-Nummer: 71773491 for OE number: 71773491
			7.08681.07.0	SV-HYAT	EH	 →ch. 2118065 für OE-Nummer: 71749996 for OE number: 71749996
160 Multijet 3,0 D 115 kW (156 PS) F1CE3481M	07.2006→		7.03003.01.0	DW-TL	EP	
160 Multijet 3,0 D 115-116 kW (156-158 PS) F1CE0481D	10.2006→		7.03003.01.0	DW-TL	EP	
			7.08681.13.0	SV-HYAT	EH	 ch. 2118065→ für OE-Nummer: 71773490 for OE number: 71773490
			7.08681.14.0	SV-HYAT	EH	 ch. 2118065→ für OE-Nummer: 71773491 for OE number: 71773491
			7.08681.07.0	SV-HYAT	EH	 →ch. 2118065 für OE-Nummer: 71749996 for OE number: 71749996
160 Multijet 3,0 D 4x4 115-116 kW (156-158 PS) F1CE0481D	07.2006→		7.03003.01.0	DW-TL	EP	
			7.08681.13.0	SV-HYAT	EH	 ch. 2118065→ für OE-Nummer: 71773490 for OE number: 71773490
			7.08681.14.0	SV-HYAT	EH	 ch. 2118065→ für OE-Nummer: 71773491 for OE number: 71773491
			7.08681.07.0	SV-HYAT	EH	 →ch. 2118065 für OE-Nummer: 71749996 for OE number: 71749996
160 Multijet 3,0 D 4x4 115 kW (156 PS) F1CE3481M	07.2006→		7.03003.01.0	DW-TL	EP	
180 Multijet 3,0 D 130 kW (177 PS) F1CE3481E	06.2011→		7.08681.13.0	SV-HYAT	EH	 ch. 2118065→ für OE-Nummer: 71773490 for OE number: 71773490
			7.08681.14.0	SV-HYAT	EH	 ch. 2118065→ für OE-Nummer: 71773491 for OE number: 71773491
			7.08681.07.0	SV-HYAT	EH	 →ch. 2118065 für OE-Nummer: 71749996 for OE number: 71749996

F
DUCATO II (244) **52**





2.8 TD 90 kW (122 PS) 8140.43.3700	10.2002→06.2006		7.02256.03.0	DW-AGR	EP	
--	-----------------	---	---------------------	--------	----	--

DUCATO Platform/Chassis (230_) **53**









2.0 80 kW (109 PS) RFW	03.1994→04.2002		7.05432.02.0	SM	EL	mit Dichtring with O-ring
2.0 4x4 80 kW (109 PS) RFW	11.1994→09.2001		7.05432.02.0	SM	EL	mit Dichtring with O-ring
2.0 JTD 62 kW (84 PS) RHV	07.2001→04.2002		7.02256.23.0	DW-AGR	EP	
2.8 JTD 93-103 kW (127-140 PS) 8140.43S	11.2000→04.2002		7.02256.03.0	DW-AGR	EP	
			7.00607.02.0	DW-TL	EP	















DUCATO Platform/Chassis (230_) 53

F	2.8 JTD 4x4 93-103 kW (127-140 PS) 8140.43S	10.2001→04.2002	 7.02256.03.0	DW-AGR	EP	
			 7.00607.02.0	DW-TL	EP	
	2.8 TD 4x4 64 kW (87 PS) 8140.63	05.1998→11.2001	 7.02256.03.0	DW-AGR	EP	
	2.8 TDI 90 kW (122 PS) 8140.43	12.1998→04.2002	 7.02256.03.0	DW-AGR	EP	
2.8 iDTD 4x4 90 kW (122 PS) 8140.43	05.1998→09.2001	 7.02256.03.0	DW-AGR	EP		





















DUCATO Platform/Chassis (244_) 54

2.0 JTD 62 kW (84 PS) RHV	04.2002→07.2006	 7.02256.23.0	DW-AGR	EP	
2.3 JTD 81 kW (110 PS) F1AE0481C	04.2002→07.2006	 7.02256.03.0	DW-AGR	EP	
2.8 JTD 93-103 kW (127-140 PS) 8140.43S	04.2002→07.2006	 7.02256.03.0	DW-AGR	EP	
		 7.00607.02.0	DW-TL	EP	
2.8 JTD 90 kW (122 PS) 8140.43	11.2003→07.2006	 7.00607.02.0	DW-TL	EP	
2.8 JTD 4x4 93-103 kW (127-140 PS) 8140.43S	10.2002→07.2006	 7.02256.03.0	DW-AGR	EP	
		 7.00607.02.0	DW-TL	EP	
2.8 JTD 4x4 90 kW (122 PS) 8140.43	11.2003→07.2006	 7.00607.02.0	DW-TL	EP	
2.8 JTD Power 107 kW (146 PS) 8140.43N	05.2004→07.2006	 7.00607.02.0	DW-TL	EP	

DUCATO Platform/Chassis (250_) 55

110 Multijet 2,3 D 82-83 kW (111-113 PS) F1AE3481G	10.2011→	 7.08681.13.0	SV-HYAT	EH	für OE-Nummer: 71773490 for OE number: 71773490
		 7.08681.14.0	SV-HYAT	EH	für OE-Nummer: 71773491 for OE number: 71773491
115 Multijet 2,0 D 85 kW (116 PS) 250 A1.000, 250 A2.000	06.2011→	 7.04881.08.0*	SUV	EL	mit Rohrstutzen with pipe socket  250 A1.000, 250 A2.000: Produktionsdatum bis: 06.07.2018 Production date to: 06.07.2018
		 ↪ 7.02909.12.0	SUV	EL	
120 Multijet 2,3 D 88 kW (120 PS) F1AGL4114	07.2006→	 7.02256.20.0	DW-AGR	EP	→12.2014 ■ Finland, Skandinavien, Island ■ Finland, Scandinavia, Iceland
120 Multijet 2,3 D 4x4 88 kW (120 PS) F1AE0481D	03.2010→	 7.02256.20.0	DW-AGR	EP	
130 Multijet 2,3 D 96 kW (131 PS) F1AE0481N	07.2006→	 7.02256.20.0	DW-AGR	EP	
130 Multijet 2,3 D 96 kW (131 PS) F1AE3481D, F1AGL411D	07.2006→	 7.02256.20.0	DW-AGR	EP	
		 7.08681.13.0	SV-HYAT	EH	 F1AE3481D: für OE-Nummer: 71773490 for OE number: 71773490  F1AGL411D: Produktionsdatum bis: 02.05.2017 Production date to: 02.05.2017











DUCATO Platform/Chassis (250_) **55**

			7.08681.14.0	SV-HYAT	EH	 F1AE3481D: für OE-Nummer: 71773491 for OE number: 71773491  F1AGL411D: Produktionsdatum bis: 02.05.2017 Production date to: 02.05.2017
140 Natural Power 100 kW (136 PS) F1CE0441A, F1CFA401A	04.2009→		7.02256.20.0	DW-AGR	EP	
150 Multijet 2,3 D 109-110 kW (148-150 PS) F1AE3481E	06.2011→		7.02256.20.0	DW-AGR	EP	
			7.08681.13.0	SV-HYAT	EH	für OE-Nummer: 71773490 for OE number: 71773490
			7.08681.14.0	SV-HYAT	EH	für OE-Nummer: 71773491 for OE number: 71773491
150 Multijet 2,3 D 110 kW (150 PS) F1AGL411C	12.2015→		7.08681.13.0	SV-HYAT	EH	Produktionsdatum bis: 02.05.2017 Production date to: 02.05.2017
			7.08681.14.0	SV-HYAT	EH	Produktionsdatum bis: 02.05.2017 Production date to: 02.05.2017
150 Multijet 3,0 D 103-107 kW (140-145 PS) F1CE3481N	04.2010→		7.02256.20.0	DW-AGR	EP	
			7.08681.13.0	SV-HYAT	EH	 ch. 2118065→ für OE-Nummer: 71773490 for OE number: 71773490
			7.08681.14.0	SV-HYAT	EH	 ch. 2118065→ für OE-Nummer: 71773491 for OE number: 71773491
			7.08681.07.0	SV-HYAT	EH	 →ch. 2118065 für OE-Nummer: 71749996 for OE number: 71749996
160 Multijet 2,3 D 118 kW (160 PS) F1AGL4112	05.2019→		7.03003.01.0	DW-TL	EP	
160 Multijet 3,0 D 115-116 kW (156-158 PS) F1CE0481D	07.2006→		7.03003.01.0	DW-TL	EP	
			7.08681.13.0	SV-HYAT	EH	 ch. 2118065→ für OE-Nummer: 71773490 for OE number: 71773490
			7.08681.14.0	SV-HYAT	EH	 ch. 2118065→ für OE-Nummer: 71773491 for OE number: 71773491
			7.08681.07.0	SV-HYAT	EH	 →ch. 2118065 für OE-Nummer: 71749996 for OE number: 71749996
160 Multijet 3,0 D 115 kW (156 PS) F1CE3481M	07.2006→12.2011		7.03003.01.0	DW-TL	EP	
180 Multijet 2,3 D 130 kW (177 PS) F1AGL411B	12.2015→		7.08681.13.0	SV-HYAT	EH	Produktionsdatum bis: 02.05.2017 Production date to: 02.05.2017
			7.08681.14.0	SV-HYAT	EH	Produktionsdatum bis: 02.05.2017 Production date to: 02.05.2017
180 Multijet 3,0 D 130 kW (177 PS) F1CE3481E	06.2011→		7.08681.13.0	SV-HYAT	EH	 ch. 2118065→ für OE-Nummer: 71773490 for OE number: 71773490
			7.08681.14.0	SV-HYAT	EH	 ch. 2118065→ für OE-Nummer: 71773491 for OE number: 71773491
			7.08681.07.0	SV-HYAT	EH	 →ch. 2118065 für OE-Nummer: 71749996 for OE number: 71749996

F



DUCATO Van (230_) 56

2.0 80 kW (109 PS) RFW	03.1994→04.2002		7.05432.02.0	SM	EL	mit Dichtring with O-ring
2.0 4x4 80 kW (109 PS) RFW	11.1994→04.2002		7.05432.02.0	SM	EL	mit Dichtring with O-ring
2.0 JTD 62 kW (84 PS) RHV	10.2001→04.2002		7.02256.23.0	DW-AGR	EP	
2.8 D 64 kW (87 PS) 8140.63	05.1998→04.2002		7.02256.03.0	DW-AGR	EP	
2.8 D 4x4 64 kW (87 PS) 8140.63	08.1998→04.2002		7.02256.03.0	DW-AGR	EP	
2.8 JTD 93-103 kW (127-140 PS) 8140.43S	11.2000→04.2002		7.02256.03.0	DW-AGR	EP	
			7.00607.02.0	DW-TL	EP	
2.8 JTD 4x4 93-103 kW (127-140 PS) 8140.43S	11.2000→04.2002		7.02256.03.0	DW-AGR	EP	
			7.00607.02.0	DW-TL	EP	
2.8 TD 4x4 90 kW (122 PS) 8140.43	05.1998→09.2001		7.02256.03.0	DW-AGR	EP	
2.8 TDI 90 kW (122 PS) 8140.43	10.1997→04.2002		7.02256.03.0	DW-AGR	EP	
2.8 TDI 4x4 90 kW (122 PS) 8140.43	06.1999→04.2002		7.02256.03.0	DW-AGR	EP	

DUCATO Van (244_) 57

2.0 JTD 62 kW (84 PS) RHV	04.2002→		7.02256.23.0	DW-AGR	EP	
2.3 JTD 81 kW (110 PS) F1AE0481C	04.2002→		7.02256.03.0	DW-AGR	EP	
2.8 JTD 93-103 kW (127-140 PS) 8140.43S	04.2002→		7.02256.03.0	DW-AGR	EP	
			7.00607.02.0	DW-TL	EP	→12.2006
2.8 JTD 4x4 93-103 kW (127-140 PS) 8140.43S	07.2002→		7.02256.03.0	DW-AGR	EP	
			7.00607.02.0	DW-TL	EP	→12.2006
2.8 JTD Power 107 kW (146 PS) 8140.43N	05.2004→		7.00607.02.0	DW-TL	EP	→12.2006

DUCATO Van (250_) 58

















110 Multijet 2,3 D 82-83 kW (111-113 PS) F1AE3481G	10.2011→		7.08681.13.0	SV-HYAT	EH	für OE-Nummer: 71773490 for OE number: 71773490
			7.08681.14.0	SV-HYAT	EH	für OE-Nummer: 71773491 for OE number: 71773491
115 Multijet 2,0 D 85 kW (116 PS) 250 A1.000, 250 A2.000	06.2011→		7.04881.08.0*	SUV	EL	mit Rohrstützen with pipe socket 🌀 250 A1.000, 250 A2.000: Produktionsdatum bis: 06.07.2018 Production date to: 06.07.2018
			↳ 7.02909.12.0	SUV	EL	
120 Multijet 2,3 D 88 kW (120 PS) F1AE0481D, F1AGL4114	07.2006→		7.02256.20.0	DW-AGR	EP	🌀 F1AE0481D, F1AGL4114: →12.2014 🇫🇮 Finnland, Skandinavien, Island 🇫🇮 Finland, Scandinavia, Iceland
120 Multijet 2,3 D 4x4 88 kW (120 PS) F1AE0481D	03.2010→		7.02256.20.0	DW-AGR	EP	→12.2014 🇫🇮 Finnland, Skandinavien, Island 🇫🇮 Finland, Scandinavia, Iceland
130 Multijet 2,3 D 96 kW (131 PS) F1AE0481N	06.2011→		7.02256.20.0	DW-AGR	EP	
130 Multijet 2,3 D 96 kW (131 PS) F1AE3481D, F1AGL411D	06.2011→		7.02256.20.0	DW-AGR	EP	

DUCATO Van (250_)					58
			7.08681.13.0	SV-HYAT	EH F1AE3481D: für OE-Nummer: 71773490 for OE number: 71773490 F1AGL411D: Produktionsdatum bis: 02.05.2017 Production date to: 02.05.2017
			7.08681.14.0	SV-HYAT	EH F1AE3481D: für OE-Nummer: 71773491 for OE number: 71773491 F1AGL411D: Produktionsdatum bis: 02.05.2017 Production date to: 02.05.2017
130 Multijet 2,3 D 4x4 96 kW (131 PS) F1AE0481N	06.2011→		7.02256.20.0	DW-AGR	EP
130 Multijet 2,3 D 4x4 96 kW (131 PS) F1AE3481D, F1AGL411D	06.2011→		7.02256.20.0	DW-AGR	EP
			7.08681.13.0	SV-HYAT	EH F1AE3481D: für OE-Nummer: 71773490 for OE number: 71773490 F1AGL411D: Produktionsdatum bis: 02.05.2017 Production date to: 02.05.2017
			7.08681.14.0	SV-HYAT	EH F1AE3481D: für OE-Nummer: 71773491 for OE number: 71773491 F1AGL411D: Produktionsdatum bis: 02.05.2017 Production date to: 02.05.2017
140 Natural Power 100 kW (136 PS) F1CE0441A, F1CFA401A	04.2009→		7.02256.20.0	DW-AGR	EP
150 Multijet 2,3 D 109-110 kW (148-150 PS) F1AE3481E	06.2011→		7.02256.20.0	DW-AGR	EP
			7.08681.13.0	SV-HYAT	EH für OE-Nummer: 71773490 for OE number: 71773490
			7.08681.14.0	SV-HYAT	EH für OE-Nummer: 71773491 for OE number: 71773491
150 Multijet 2,3 D 110 kW (150 PS) F1AGL411A, F1AGL411C	12.2015→		7.08681.13.0	SV-HYAT	EH F1AGL411A, F1AGL411C: Produktionsdatum bis: 02.05.2017 Production date to: 02.05.2017
			7.08681.14.0	SV-HYAT	EH F1AGL411A, F1AGL411C: Produktionsdatum bis: 02.05.2017 Production date to: 02.05.2017
150 Multijet 2,3 D 4x4 110 kW (150 PS) F1AGL411A, F1AGL411C	04.2015→		7.08681.13.0	SV-HYAT	EH F1AGL411A, F1AGL411C: Produktionsdatum bis: 02.05.2017 Production date to: 02.05.2017
			7.08681.14.0	SV-HYAT	EH F1AGL411A, F1AGL411C: Produktionsdatum bis: 02.05.2017 Production date to: 02.05.2017
150 Multijet 3,0 D 103-107 kW (140-145 PS) F1CE3481N	04.2010→		7.02256.20.0	DW-AGR	EP
			7.08681.13.0	SV-HYAT	EH ch. 2118065→ für OE-Nummer: 71773490 for OE number: 71773490
			7.08681.14.0	SV-HYAT	EH ch. 2118065→ für OE-Nummer: 71773491 for OE number: 71773491
			7.08681.07.0	SV-HYAT	EH →ch. 2118065 für OE-Nummer: 71749996 for OE number: 71749996

F





DUCATO Van (250_) **58**

























160 Multijet 2,3 D 118 kW (160 PS) F1AGL4112	05.2019→		7.03003.01.0	DW-TL	EP	
160 Multijet 3,0 D 115-116 kW (156-158 PS) F1CE0481D	07.2006→		7.03003.01.0	DW-TL	EP	
			7.08681.13.0	SV-HYAT	EH	 ch. 2118065→ für OE-Nummer: 71773490 for OE number: 71773490
			7.08681.14.0	SV-HYAT	EH	 ch. 2118065→ für OE-Nummer: 71773491 for OE number: 71773491
7.08681.07.0	SV-HYAT	EH	 →ch. 2118065 für OE-Nummer: 71749996 for OE number: 71749996			
160 Multijet 3,0 D 115 kW (156 PS) F1CE3481M	07.2006→12.2011		7.03003.01.0	DW-TL	EP	
160 Multijet 3,0 D 4x4 115-116 kW (156-158 PS) F1CE0481D	07.2006→		7.03003.01.0	DW-TL	EP	
			7.08681.13.0	SV-HYAT	EH	 ch. 2118065→ für OE-Nummer: 71773490 for OE number: 71773490
			7.08681.14.0	SV-HYAT	EH	 ch. 2118065→ für OE-Nummer: 71773491 for OE number: 71773491
7.08681.07.0	SV-HYAT	EH	 →ch. 2118065 für OE-Nummer: 71749996 for OE number: 71749996			
160 Multijet 3,0 D 4x4 115 kW (156 PS) F1CE3481M	07.2006→		7.03003.01.0	DW-TL	EP	
180 Multijet 2,3 D 130 kW (177 PS) F1AGL411B	12.2015→		7.08681.13.0	SV-HYAT	EH	Produktionsdatum bis: 02.05.2017 Production date to: 02.05.2017
			7.08681.14.0	SV-HYAT	EH	Produktionsdatum bis: 02.05.2017 Production date to: 02.05.2017
180 Multijet 3,0 D 130 kW (177 PS) F1CE3481E	06.2011→		7.08681.13.0	SV-HYAT	EH	 ch. 2118065→ für OE-Nummer: 71773490 for OE number: 71773490
			7.08681.14.0	SV-HYAT	EH	 ch. 2118065→ für OE-Nummer: 71773491 for OE number: 71773491
			7.08681.07.0	SV-HYAT	EH	 →ch. 2118065 für OE-Nummer: 71749996 for OE number: 71749996

FIORINO Box Body/MPV (146_) **59**

1.7 TD 46 kW (63 PS) 146 D7.000	01.1997→05.2000		7.02256.03.0	DW-AGR	EP	
65 1.7 TD 46 kW (63 PS) 146 D7.000	01.1997→05.2001		7.02256.03.0	DW-AGR	EP	

FIORINO Box Body/MPV (225_) **60**



1.3 D Multijet (225BXD1A, 225BxB1A, 225BxB11) 55-68 kW (75-93 PS) 199 A2.000	11.2007→		7.03003.01.0	DW-TL	EP	
			7.01981.07.0	SV-AGR-K	EP	
1.3 D Multijet (225BXD1A, 225BxB1A, 225BxB11) 55-59 kW (75-80 PS) 199 A9.000	11.2007→		7.03003.01.0	DW-TL	EP	
			7.08681.03.0	SV-HYAT	EH	für OE-Nummer: 71737621, 71753780 for OE number: 71737621, 71753780
			7.08681.04.0	SV-HYAT	EH	

					
FIORINO Box Body/MPV (225_)					60
			7.08681.05.0	SV-HYAT	EH für OE-Nummer: 71737623, 71753782 for OE number: 71737623, 71753782
			7.08681.06.0	SV-HYAT	EH
1.3 D Multijet (225BXE1A) 64-70 kW (87-95 PS) 199 B1.000	07.2009→		7.01981.07.0	SV-AGR-K	EP
1.3 D Multijet (225CXG1A, 225AXL1A, 225AXG11, 225BXL1A,...) 59-70 kW (80-95 PS) 225 A2.000, 552 83 775	03.2015→		7.03003.01.0	DW-TL	EP
1.4 (225AXA1A, 225BXA1A) 51-63 kW (69-86 PS) 350 A1.000	10.2009→		7.06117.38.0	SV-NWV	EL mit Dichtring with O-ring
1.4 Natural Power (225AXC1A, 225BXC1A) 51-63 kW (69-86 PS) 350 A1.000	06.2008→		7.06117.38.0	SV-NWV	EL mit Dichtring with O-ring
1.4 Natural Power (225BXC1A, 225AXC1A) 51-63 kW (69-86 PS) 350 A1.000	06.2008→		7.06117.38.0	SV-NWV	EL mit Dichtring with O-ring
FIORINO Box Body/MPV (265_)					61
1.4 (265122) 62-68 kW (85-92 PS) 327 A.011	05.2014→		7.06117.38.0	SV-NWV	EL mit Dichtring with O-ring Euro 6 Euro 6
1.4 Flex (265122) 62-68 kW (85-92 PS) 327 A.011	11.2013→12.2015		7.06117.38.0	SV-NWV	EL mit Dichtring with O-ring Euro 6 Euro 6
1.4 Flex (265122) 62-68 kW (85-92 PS) 327 A.011	05.2014→		7.06117.38.0	SV-NWV	EL mit Dichtring with O-ring Euro 6 Euro 6
GRANDE PUNTO Van (199_)					62
1.3 JTD Multijet (199CXC1A) 55-68 kW (75-93 PS) 199 A2.000	02.2006→06.2013		7.00607.02.0	DW-TL	EP
1.3 JTD Multijet (199CXD1B) 63-70 kW (86-95 PS) 199 A3.000	02.2006→08.2010		7.00607.02.0	DW-TL	EP
1.4 (199CXB1A, 199DXB1A) 51-63 kW (69-86 PS) 350 A1.000	02.2006→06.2013		7.06117.38.0	SV-NWV	EL mit Dichtring with O-ring  3952691→
1.4 LPG (199CXB1A, 199DXB1A) 51-63 kW (69-86 PS) 350 A1.000	03.2009→12.2012		7.06117.38.0	SV-NWV	EL mit Dichtring with O-ring  3952691→
1.4 Natural Power (199BXB1A) 51-63 kW (69-86 PS) 350 A1.000	03.2009→12.2012		7.06117.38.0	SV-NWV	EL mit Dichtring with O-ring  3952691→
IDEA Van (350_)					63
MJTD (350BXD1A) 74 kW (101 PS) 188 B2.000	10.2004→12.2010		7.28170.03.0	EUV-RK	EP
PANDA Hatchback Van (169_)					64
1.2 51 kW (69 PS) 169 A4.000	09.2010→		7.06117.38.0	SV-NWV	EL mit Dichtring with O-ring
1.2 4x4 51 kW (69 PS) 169 A4.000	09.2010→		7.06117.38.0	SV-NWV	EL mit Dichtring with O-ring
1.2 LPG 51 kW (69 PS) 169 A4.000	09.2010→		7.06117.38.0	SV-NWV	EL mit Dichtring with O-ring

F









					
---	---	---	---	--	---

PANDA Hatchback Van (169_)	64
-----------------------------------	-----------



1.3 D Multijet 51 kW (70 PS) 188 A8.000	03.2004→		7.00607.02.0	DW-TL	EP	
1.3 D Multijet 4x4 51 kW (70 PS) 188 A8.000	10.2004→12.2006		7.00607.02.0	DW-TL	EP	
1.3 D Multijet 4x4 55 kW (75 PS) 169 A1.000	01.2006→		7.00607.02.0	DW-TL	EP	→12.2009
1.4 Natural Power 51-63 kW (69-86 PS) 350 A1.000	10.2009→		7.06117.38.0	SV-NWV	EL	mit Dichtring with O-ring























F

PANDA VAN (312_, 519_)	65
-------------------------------	-----------

0.9 (312.PXN1A) 57-66 kW (77-90 PS) 312 A2.000	11.2013→		7.03003.01.0	DW-TL	EP	
0.9 (312DXG1A) 57-66 kW (77-90 PS) 312 A2.000	02.2012→		7.03003.01.0	DW-TL	EP	
			7.02909.07.0	SUV	EL	
0.9 4x4 (312CXG2B) 57-66 kW (77-90 PS) 312 A2.000	09.2012→		7.03003.01.0	DW-TL	EP	
			7.02909.07.0	SUV	EL	
0.9 Natural Power (312CXG1A) 57-66 kW (77-90 PS) 312 A2.000	01.2015→		7.03003.01.0	DW-TL	EP	
0.9 Natural Power (312DXG1A) 57-66 kW (77-90 PS) 312 A2.000	07.2012→		7.03003.01.0	DW-TL	EP	
1.2 (312CXA1A, 312DXA1A) 51 kW (69 PS) 169 A4.000	02.2012→		7.06117.38.0	SV-NWV	EL	mit Dichtring with O-ring
1.2 LPG (312CXA1A) 51 kW (69 PS) 169 A4.000	06.2012→		7.06117.38.0	SV-NWV	EL	mit Dichtring with O-ring
1.3 D Multijet (312CXL1A, 312DXL1A) 55-59 kW (75-80 PS) 199 A9.000	02.2012→		7.03003.01.0	DW-TL	EP	
			7.01981.07.0	SV-AGR-K	EP	
1.3 D Multijet (312PXS2A) 59 kW (80 PS) 225 A2.000, 312 A8.000, 312 B2.000	12.2015→		7.03003.01.0	DW-TL	EP	
1.3 D Multijet 4x4 (312CXL2A) 55-59 kW (75-80 PS) 199 A9.000	06.2012→		7.03003.01.0	DW-TL	EP	
			7.01981.07.0	SV-AGR-K	EP	
1.3 D Multijet 4x4 (312PXS2A) 59 kW (80 PS) 225 A2.000	06.2014→		7.03003.01.0	DW-TL	EP	



PUNTO EVO Hatchback Van (199_)	66
---------------------------------------	-----------

1.3 D Multijet (199.AXT1A, 199.AXC1A) 55-68 kW (75-93 PS) 199 A2.000	03.2009→02.2012		7.00607.02.0	DW-TL	EP	
1.3 D Multijet (199.AXT1A, 199.AXC1A) 55-59 kW (75-80 PS) 199 A9.000	03.2009→02.2012		7.00607.02.0	DW-TL	EP	
			7.01981.07.0	SV-AGR-K	EP	
1.3 D Multijet (199.AXU1A) 64-70 kW (87-95 PS) 199 B1.000	03.2009→02.2012		7.00607.02.0	DW-TL	EP	





						
PUNTO EVO Hatchback Van (199_)						66
1.3 D Multijet (199CXD1B, 199CXD1A) 63-70 kW (86-95 PS) 199 A3.000	03.2009→02.2012		7.01981.07.0 7.00607.02.0	SV-AGR-K DW-TL	EP EP	
PUNTO Hatchback Van (188_)						67
1.9 JTD 63 kW (86 PS) 188 A7.000	02.2000→10.2009		7.28170.03.0 7.02256.49.0	EUV-RK LDRV	EP EP	
PUNTO Hatchback Van (199_)						68
0.9 Twinair Turbo 57-66 kW (77-90 PS) 312 A2.000	03.2012→		7.00607.02.0	DW-TL	EP	
1.3 D Multijet 55-59 kW (75-80 PS) 199 A9.000	04.2008→		7.01981.07.0	SV-AGR-K	EP	
1.3 D Multijet 64-70 kW (87-95 PS) 199 B1.000	03.2009→		7.01981.07.0	SV-AGR-K	EP	
1.3 D Multijet 62 kW (84 PS) 199 B4.000	03.2012→		7.01981.07.0	SV-AGR-K	EP	
PUNTO Van (176_)						69
1.7 TD 46-47 kW (63-64 PS) 176 B7.000	09.1996→09.1999		7.02256.03.0	DW-AGR	EP	→12.1997
SCUDO Bus (220_)						70
2.0 16V 100 kW (136 PS) RFN (EW10J4)	06.2000→12.2006		7.02256.05.0	OEL-HV	EH	Automatikgetriebe Automatic Transmission
2.0 JTD 80 kW (109 PS) RHZ	12.1999→12.2006		7.02256.24.0 7.02256.24.0	DW-AGR DW-TL	EP EP	
2.0 JTD 69 kW (94 PS) RHX	01.2004→12.2006		7.02256.24.0 7.02256.24.0	DW-AGR DW-TL	EP EP	
2.0 JTD 16V 80 kW (109 PS) RHW (DW10ATED4)	05.1999→12.2006		7.02256.24.0 7.02256.24.0	DW-AGR DW-TL	EP EP	
SCUDO Bus (270_, 272_)						71
2.0 D Multijet 88 kW (120 PS) RHK	01.2007→		7.01633.04.0	DW-TL	EP	→01.2008 Euro 4 Euro 4
2.0 D Multijet 100 kW (136 PS) RHR	01.2007→		7.01633.04.0	DW-TL	EP	→01.2008 Euro 4 Euro 4
2.0 D Multijet 4x4 88 kW (120 PS) RHK	01.2007→		7.01633.04.0	DW-TL	EP	→01.2008 Euro 4 Euro 4
2.0 D Multijet 4x4 100 kW (136 PS) RHR	01.2007→		7.01633.04.0	DW-TL	EP	→01.2008 Euro 4 Euro 4
SCUDO Platform/Chassis (220_)						72
2.0 JTD 69 kW (94 PS) RHX	10.1999→12.2006		7.02256.24.0 7.02256.24.0	DW-AGR DW-TL	EP EP	
2.0 JTD 80 kW (109 PS) RHZ	12.2002→12.2006		7.02256.24.0 7.02256.24.0	DW-AGR DW-TL	EP EP	
2.0 JTD 16V 80 kW (109 PS) RHW (DW10ATED4)	05.1999→12.2006		7.02256.24.0 7.02256.24.0	DW-AGR DW-TL	EP EP	

F





SCUDO Platform/Chassis (270_, 272_) 73

2.0 D Multijet 88 kW (120 PS) RHK	01.2007→	 7.01633.04.0	DW-TL	EP	→01.2008 Euro 4 Euro 4
2.0 D Multijet 100 kW (136 PS) DW10BTED4, RHR	01.2007→	 7.01633.04.0	DW-TL	EP	 DW10BTED4, RHR: →01.2008 Euro 4 Euro 4





SCUDO Van (220_) 74
F



















1.9 D 51 kW (69 PS) WJY (DW8B)	04.1998→12.2006	 7.02256.24.0	DW-AGR	EP	→11.2003
		7.02256.24.0	DW-RK	EP	→11.2003
		7.02256.24.0	DW-TL	EP	→11.2003
2.0 100 kW (136 PS) RFN (EW10J4)	05.2000→12.2006	 7.02256.05.0	OEL-HV	EH	Automatikgetriebe Automatic Transmission
2.0 JTD 69 kW (94 PS) RHX	10.1999→12.2006	 7.02256.24.0	DW-AGR	EP	
		7.02256.24.0	DW-TL	EP	
2.0 JTD 80 kW (109 PS) RHZ	12.2002→12.2006	 7.02256.24.0	DW-AGR	EP	
		7.02256.24.0	DW-TL	EP	
2.0 JTD 16V 80 kW (109 PS) RHW (DW10ATED4)	05.1999→12.2006	 7.02256.24.0	DW-AGR	EP	
		7.02256.24.0	DW-TL	EP	

SCUDO Van (270_, 272_) 75

2.0 D Multijet 88 kW (120 PS) RHK	01.2007→	 7.01633.04.0	DW-TL	EP	→01.2008 Euro 4 Euro 4
2.0 D Multijet 100 kW (136 PS) RHR	01.2007→	 7.01633.04.0	DW-TL	EP	→01.2008 Euro 4 Euro 4
2.0 D Multijet 4x4 88 kW (120 PS) RHK	01.2007→	 7.01633.04.0	DW-TL	EP	→01.2008 Euro 4 Euro 4
2.0 D Multijet 4x4 100 kW (136 PS) RHR	01.2007→	 7.01633.04.0	DW-TL	EP	→01.2008 Euro 4 Euro 4

STILO VAN (192_) 76







1.9 JTD (192DXE1A) 85 kW (115 PS) 192 A1.000	10.2001→08.2005	 7.00607.02.0	DW-TL	EP	
		7.02256.50.0	EUV-RK	EL	
1.9 JTD (192DXF1A) 59 kW (80 PS) 192 A3.000	10.2001→08.2005	 7.02256.50.0	EUV-RK	EL	
1.9 JTD (192DXG1B) 93 kW (126 PS) 937 A4.000	09.2003→08.2005	 7.00607.02.0	DW-TL	EP	
		7.02256.50.0	EUV-RK	EL	
1.9 JTD (192DXG1B) 103 kW (140 PS) 192 A5.000	09.2003→08.2005	 7.00607.02.0	DW-TL	EP	
		7.02256.50.0	EUV-RK	EL	
1.9 JTD (192DXG1B) 100 kW (136 PS) 192 B1.000	02.2004→08.2008	 7.00607.02.0	DW-TL	EP	
		7.02256.50.0	EUV-RK	EL	
1.9 JTD (192DXS1A) 88 kW (120 PS) 192 A8.000	09.2005→08.2008	 7.00607.02.0	DW-TL	EP	
		7.02256.50.0	EUV-RK	EL	

						
STILO VAN (192_)						76
1.9 JTD (192DXT1B) 110 kW (150 PS) 937 A5.000	09.2005→08.2008		7.00607.02.0	DW-TL	EP	
			7.02256.50.0	EUV-RK	EL	
TALENTO Bus (296_)						77
1.6 D 70-89 kW (95-121 PS) R9M 413	06.2016→		7.01814.12.0	DW-TL	EP	
			7.01814.22.0	DW-TL	EP	
1.6 D 92-107 kW (125-145 PS) R9M 452	06.2016→		7.01814.12.0	DW-TL	EP	für OE-Nummer: 6000616752 for OE number: 6000616752
			7.01814.22.0	DW-TL	EP	
1.6 D 92-107 kW (125-145 PS) R9M 452	06.2016→		7.01814.12.0	DW-TL	EP	für OE-Nummer: 6000616752 for OE number: 6000616752
			7.01814.22.0	DW-TL	EP	
TALENTO Platform/Chassis (296_)						78
1.6 D 92-107 kW (125-145 PS) R9M 452	06.2016→		7.01814.12.0	DW-TL	EP	für OE-Nummer: 6000616752 for OE number: 6000616752
			7.01814.22.0	DW-TL	EP	
1.6 D 92-107 kW (125-145 PS) R9M 452	06.2016→		7.01814.12.0	DW-TL	EP	für OE-Nummer: 6000616752 for OE number: 6000616752
			7.01814.22.0	DW-TL	EP	
1.6 D 70-89 kW (95-121 PS) R9M 413	06.2016→		7.01814.12.0	DW-TL	EP	
TALENTO Van (296_)						79
1.6 D 66-85 kW (90-116 PS) R9M 408	06.2016→		7.01814.12.0	DW-TL	EP	
1.6 D 70-89 kW (95-121 PS) R9M 413	06.2016→		7.01814.12.0	DW-TL	EP	
1.6 D 70-89 kW (95-121 PS) R9M 413	06.2016→		7.01814.12.0	DW-TL	EP	
1.6 D 92-107 kW (125-145 PS) R9M 452	06.2016→		7.01814.12.0	DW-TL	EP	für OE-Nummer: 6000616752 for OE number: 6000616752
			7.01814.22.0	DW-TL	EP	
1.6 D 92-107 kW (125-145 PS) R9M 452	06.2016→		7.01814.12.0	DW-TL	EP	für OE-Nummer: 6000616752 for OE number: 6000616752
			7.01814.22.0	DW-TL	EP	











F





B-MAX (JK) **1**

F	1.0 EcoBoost 74 kW (100-101 PS) SFJA, SFJB, SFJC, SFJD	10.2012→	 7.07400.12.0*	STE	EP	SFJA, SFJB, SFJC, SFJD: Produktionsdatum bis: 26.10.2012 Production date to: 26.10.2012 mit Dichtring with O-ring	
			↳ 7.04011.05.0	DW-TL	EP		
			↳ 7.22687.44.0	EUV-VB	EP		
			7.06117.12.0	ZM-NWV	EL		
	1.0 EcoBoost 88 kW (120 PS) M1JA	10.2012→	 7.07400.12.0*	STE	EP		Produktionsdatum bis: 14.11.2012 Production date to: 14.11.2012
			↳ 7.04011.05.0	DW-TL	EP		mit Dichtring with O-ring
		↳ 7.22687.44.0	EUV-VB	EP			
		7.06117.12.0	ZM-NWV	EL			
1.0 EcoBoost 92 kW (125 PS) M1JE	10.2012→	 7.07400.12.0*	STE	EP	Produktionsdatum bis: 14.11.2012 Production date to: 14.11.2012		
		↳ 7.04011.05.0	DW-TL	EP	mit Dichtring with O-ring		
		↳ 7.22687.44.0	EUV-VB	EP			
		7.06117.12.0	ZM-NWV	EL			
1.0 EcoBoost 92 kW (125 PS) M1JH	10.2012→	 7.07400.12.0*	STE	EP	Produktionsdatum bis: 14.11.2012 Production date to: 14.11.2012		
		↳ 7.04011.05.0	DW-TL	EP			
		↳ 7.22687.44.0	EUV-VB	EP			
1.0 EcoBoost 103 kW (140 PS) YYJC	02.2016→	 7.06117.12.0	ZM-NWV	EL	mit Dichtring with O-ring		
1.5 TDCi 55 kW (75 PS) UGJC	10.2012→	 7.08681.00.0	EOV	EH	Produktionsdatum ab: 19.11.2015 Production date from: 19.11.2015		
1.5 TDCi 70 kW (95 PS) XVJA, XVJC	04.2015→	 7.08681.00.0	EOV	EH	XVJA, XVJC: Produktionsdatum ab: 19.11.2015 Production date from: 19.11.2015		

C-MAX (DM2) **2**

1.6 TDCi 74 kW (100 PS) G8DC, MTDA	02.2007→09.2010	 7.00968.04.0	DW-TL	EP	
1.6 TDCi 66 kW (90 PS) GPDA, HHDA, HHDB	02.2007→09.2010	 7.00968.04.0	DW-TL	EP	
1.6 TDCi 80 kW (109 PS) G8DA, G8DB, G8DD	02.2007→09.2010	 7.00968.04.0	DW-TL	EP	
1.8 92 kW (125 PS) QQDA, QQDB	02.2007→09.2010	 7.02256.48.0	STE	EP	
1.8 Flexifuel 92 kW (125 PS) Q7DA	02.2007→09.2010	 7.02256.48.0	STE	EP	
2.0 104-107 kW (141-145 PS) AODA, AODB, AODE	02.2007→09.2010	 7.02256.48.0	STE	EP	
2.0 CNG 104-109 kW (143-146 PS) SYDA	04.2009→09.2010	 7.02256.48.0	STE	EP	
2.0 LPG 104-109 kW (143-146 PS) SYDA	06.2008→09.2010	 7.02256.48.0	STE	EP	
2.0 TDCi 100 kW (136 PS) G6DA, G6DB, G6DD, G6DG	02.2007→09.2010	 7.01771.01.0	DW-RK	EP	
		7.01771.01.0	DW-TL	EP	
2.0 TDCi 81 kW (110 PS) IXDA	02.2008→09.2010	 7.01771.01.0	DW-RK	EP	
		7.01771.01.0	DW-TL	EP	

C-MAX II (DXA/CB7, DXA/CEU) **3**















1.0 EcoBoost 74 kW (100 PS) M2DA	10.2012→	 7.06117.12.0	ZM-NWV	EL	mit Dichtring with O-ring →03.2019
1.0 EcoBoost 74 kW (100 PS) M2DC	10.2012→	 7.22687.44.0	EUV-VB	EP	für heiße Klimazonen for hot climate zones

C-MAX II (DXA/CB7, DXA/CEU)						3
1.0 EcoBoost 92 kW (125 PS) M1DA	10.2012→		7.06117.12.0	ZM-NWV	EL	mit Dichtring with O-ring →03.2019
1.0 EcoBoost 92 kW (125 PS) M1DD	10.2012→		7.22687.44.0	EUV-VB	EP	für heiße Klimazonen for hot climate zones
			7.06117.12.0	ZM-NWV	EL	mit Dichtring with O-ring →03.2019
1.5 EcoBoost 110 kW (150 PS) M8DB	03.2015→		7.07400.13.0*	DW-TL	EP	mit Halter with holder Produktionsdatum bis: 13.11.2015 Production date to: 13.11.2015
			↳ 7.04011.05.0	DW-TL	EP	mit Halter with holder Produktionsdatum ab: 13.11.2015 Production date from: 13.11.2015 Produktionsdatum bis: 18.11.2015 Production date to: 18.11.2015
			7.07400.14.0*	DW-TL	EP	
			↳ 7.04011.05.0	DW-TL	EP	mit Halter with holder Produktionsdatum ab: 18.11.2015 Production date from: 18.11.2015
			7.07400.15.0*	DW-TL	EP	
			↳ 7.04011.05.0	DW-TL	EP	mit Halter with holder Produktionsdatum ab: 18.11.2015 Production date from: 18.11.2015
7.04615.03.0	SUV	EL				
1.5 EcoBoost 132-134 kW (179-182 PS) M9DB	03.2015→		7.07400.13.0*	DW-TL	EP	mit Halter with holder Produktionsdatum bis: 13.11.2015 Production date to: 13.11.2015
			↳ 7.04011.05.0	DW-TL	EP	mit Halter with holder Produktionsdatum ab: 13.11.2015 Production date from: 13.11.2015 Produktionsdatum bis: 18.11.2015 Production date to: 18.11.2015
			7.07400.14.0*	DW-TL	EP	
			↳ 7.04011.05.0	DW-TL	EP	mit Halter with holder Produktionsdatum ab: 18.11.2015 Production date from: 18.11.2015
			7.07400.15.0*	DW-TL	EP	
			↳ 7.04011.05.0	DW-TL	EP	
7.04615.03.0	SUV	EL				
1.5 TDCi 70 kW (95 PS) XXDA	03.2015→		7.08681.00.0	EOV	EH	Produktionsdatum ab: 07.12.2015 Production date from: 07.12.2015
			7.07400.01.0*	STE	EP	
			↳ 7.01633.06.0	DW-TL	EP	
1.5 TDCi 70 kW (95 PS) XXDC, XXDD	03.2015→		7.07400.01.0*	STE	EP	
			↳ 7.01633.06.0	DW-TL	EP	
1.5 TDCi 88 kW (120 PS) XWDA, XWDB, XWDC, XWDD, XWDE	03.2015→		7.08681.00.0	EOV	EH	XWDA, XWDB, XWDC, XWDD, XWDE: Produktionsdatum ab: 07.12.2015 Production date from: 07.12.2015
			7.07400.01.0*	STE	EP	
			↳ 7.01633.06.0	DW-TL	EP	
1.5 TDCi ECOnetic 77 kW (105 PS) AEDA	03.2015→		7.08681.00.0	EOV	EH	Produktionsdatum ab: 07.12.2015 Production date from: 07.12.2015
			7.07400.01.0*	STE	EP	Produktionsdatum bis: 07.12.2019 Production date to: 07.12.2019
			↳ 7.01633.06.0	DW-TL	EP	









F



C-MAX II (DXA/CB7, DXA/CEU) 3











































1.6 EcoBoost 110 kW (150 PS) JQDA, JQDB	12.2010→		7.07400.19.0*	EUV-VB	EP	mit Halter with holder
			↳ 7.22687.44.0	EUV-VB	EP	
			7.03162.09.0	LDRV	EP	 JQDA, JQDB: Produktionsdatum bis: 30.01.2012 Production date to: 30.01.2012
			7.04492.07.0	LDRV	EP	 JQDA, JQDB: Produktionsdatum ab: 30.01.2012 Production date from: 30.01.2012 Produktionsdatum bis: 02.06.2015 Production date to: 02.06.2015
			7.04269.04.0	SUV	EL	
1.6 EcoBoost 134 kW (182 PS) JTDA, JTDB	12.2010→		7.07400.19.0*	EUV-VB	EP	mit Halter with holder
			↳ 7.22687.44.0	EUV-VB	EP	
			7.03162.09.0	LDRV	EP	 JTDA, JTDB: Produktionsdatum bis: 30.01.2012 Production date to: 30.01.2012
			7.04492.07.0	LDRV	EP	 JTDA, JTDB: Produktionsdatum ab: 30.01.2012 Production date from: 30.01.2012 Produktionsdatum bis: 02.06.2015 Production date to: 02.06.2015
			7.04269.04.0	SUV	EL	
1.6 TDCi 70 kW (95 PS) T3DA, T3DB	12.2010→		7.07400.01.0*	STE	EP	 T3DA, T3DB: Produktionsdatum bis: 07.12.2019 Production date to: 07.12.2019
			↳ 7.01633.06.0	DW-TL	EP	
1.6 TDCi 85 kW (115 PS) T1DA, T1DB	12.2010→		7.07400.01.0*	STE	EP	 T1DA, T1DB: Produktionsdatum bis: 07.12.2019 Production date to: 07.12.2019
			↳ 7.01633.06.0	DW-TL	EP	
2.0 Energi 103-136 kW (140-185 PS) UADA	01.2015→		7.06117.33.0	SV-NWV	EL	
2.0 TDCi 103 kW (140 PS) UFDB	04.2010→		7.01771.01.0	DW-TL	EP	
2.0 TDCi 85 kW (116 PS) TYDA	02.2011→		7.01771.01.0	DW-TL	EP	
2.0 TDCi 100 kW (136 PS) UKDB	02.2011→		7.01771.01.0	DW-TL	EP	

COUGAR (EC_) 4









2.0 16V 96 kW (131 PS) EDBA, EDBB, EDBC, EDBD	08.1998→12.2001		7.06269.24.0	LLR	EL	
2.5 ST 200 151 kW (205 PS) SGA	01.2000→12.2001		7.02256.46.0	EUV-AGR	EL	für OE-Nummer: 3508280, 3998144, F57E-9J459-CA, F63E-9J459-AA for OE number: 3508280, 3998144, F57E-9J459-CA, F63E-9J459-AA
			7.06269.21.0	LLR	EL	 →09.2000
			7.06269.10.0	LLR	EL	 10.2000→
2.5 V6 24V 125 kW (170 PS) LCBA	08.1998→12.2001		7.02256.46.0	EUV-AGR	EL	für OE-Nummer: 3508280, 3998144, F57E-9J459-CA, F63E-9J459-AA for OE number: 3508280, 3998144, F57E-9J459-CA, F63E-9J459-AA
			7.06269.21.0	LLR	EL	 →09.2000
			7.06269.10.0	LLR	EL	 10.2000→

COUGAR (EC_)						4
2.5 V6 24V 125 kW (170 PS) LCBB, LCBC, LCBE	08.1998→12.2001		7.02256.46.0	EUV-AGR	EL LCBB, LCBC, LCBE: für OE-Nummer: 3508280, 3998144, F57E-9J459-CA, F63E-9J459-AA for OE number: 3508280, 3998144, F57E-9J459-CA, F63E-9J459-AA	
2.5 V6 24V 125 kW (170 PS) LCBB, LCBC, LCBE	06.2000→12.2001		7.02256.46.0	EUV-AGR	EL LCBB, LCBC, LCBE: für OE-Nummer: 3508280, 3998144, F57E-9J459-CA, F63E-9J459-AA for OE number: 3508280, 3998144, F57E-9J459-CA, F63E-9J459-AA	
			7.06269.21.0	LLR	EL LCBB, LCBC, LCBE: →09.2000	
			7.06269.10.0	LLR	EL LCBB, LCBC, LCBE: 10.2000→	
COURIER Pickup						5
1.8 D 44 kW (60 PS) RTK	06.1999→02.2002		7.02256.47.0	EUV-AGR	EL	
ECOSPORT						6
1.0 EcoBoost 92 kW (125 PS) M1JC, M1JJ, M1JU	10.2013→		7.06117.12.0	ZM-NWV	EL mit Dichtring with O-ring M1JC, M1JJ, M1JU: →03.2019	
1.0 EcoBoost 103 kW (140 PS) YYJD	03.2016→		7.06117.12.0	ZM-NWV	EL mit Dichtring with O-ring →03.2019	
1.0 EcoBoost 74 kW (100 PS) SFJL	04.2018→		7.06117.12.0	ZM-NWV	EL mit Dichtring with O-ring →03.2019	
1.5 EcoBlue TDCi 70 kW (95 PS) XVJD	05.2015→		7.08681.00.0	EOV	EH Produktionsdatum ab: 19.01.2016 Production date from: 19.01.2016	
1.5 TDCi 66-67 kW (90-91 PS) UGJE	10.2013→		7.08681.00.0	EOV	EH Produktionsdatum ab: 19.01.2016 Production date from: 19.01.2016	
1.5 TDCi 74 kW (100 PS) UGJM, XUJH	05.2015→		7.08681.00.0	EOV	EH UGJM, XUJH: Produktionsdatum ab: 06.11.2017 Production date from: 06.11.2017	
1.5 TDCi EcoBlue 92 kW (125 PS) ZTJA, ZTJB, ZTJC	11.2017→		7.08681.00.0	EOV	EH ZTJA, ZTJB, ZTJC: Produktionsdatum ab: 06.11.2017 Production date from: 06.11.2017	
1.5 TDCi EcoBlue 4x4 92 kW (125 PS) ZTJA, ZTJB, ZTJC	11.2017→		7.08681.00.0	EOV	EH ZTJA, ZTJB, ZTJC: Produktionsdatum ab: 06.11.2017 Production date from: 06.11.2017	
ENDEAVOUR						7
2.5 TDCi 105 kW (143 PS) WLAA	08.2006→		7.02256.25.0	DW-AGR	EP	
			7.02256.25.0	DW-TL	EP	
3.0 TDCi 115 kW (156 PS) WEAT	08.2006→		7.02256.25.0	DW-AGR	EP	
			7.02256.25.0	DW-TL	EP	
ESCORT CLASSIC (AAL, ABL)						8
1.6 16V 66 kW (90 PS) L1E	10.1998→07.2000		7.06269.02.0	LLR	EL 96 EEC 96 EEC	
1.8 TD 66 kW (90 PS) RFD, RFK	10.1998→07.2000		7.02256.47.0	EUV-AGR	EL	
ESCORT CLASSIC Turnier (ANL)						9
1.6 16V 66 kW (90 PS) L1E	02.1999→07.2000		7.06269.02.0	LLR	EL 96 EEC 96 EEC	
1.8 TD 66 kW (90 PS) RFD, RFK	02.1999→07.2000		7.02256.47.0	EUV-AGR	EL	







F

			 PIERBURG		
ESCORT Coupe					10
1.8 67-85 kW (91-116 PS) RDA	10.1995→08.2002	 7.02256.29.0	EUV-AGR	EL	
ESCORT V (AAL, ABL)					11
RS 2000 110 kW (150 PS) N7A	05.1991→01.1995	 4.02003.62.0	LLR	EL	
RS 2000 4x4 110 kW (150 PS) N7A	05.1991→01.1995	 4.02003.62.0	LLR	EL	
F RS Cosworth 4x4 162-167 kW (220-227 PS) N5F	10.1991→01.1995	 7.06269.26.0	LLR	EL	
ESCORT VI (GAL, AAL, ABL)					12
1.3 44 kW (60 PS) J4B, J6A	01.1995→10.1998	 7.06269.02.0	LLR	EL	  J4B, J6A: →01.1998
		7.06269.03.0	LLR	EL	  J4B, J6A: 02.1998→
1.6 66-70 kW (90-95 PS) L1K	01.2001→08.2002	 7.02256.29.0	EUV-AGR	EL	
1.6 16V 66 kW (90 PS) L1E	01.1995→10.1998	 7.02256.29.0	EUV-AGR	EL	
		7.06269.02.0	LLR	EL	 96 EEC 96 EEC
1.6 16V 4x4 66 kW (90 PS) L1E	01.1995→10.1998	 7.02256.29.0	EUV-AGR	EL	
		7.06269.02.0	LLR	EL	 96 EEC 96 EEC
1.6 i 16V 65 kW (88 PS) L1H	01.1995→08.1995	 7.02256.29.0	EUV-AGR	EL	
		7.06269.02.0	LLR	EL	 96 EEC 96 EEC
1.8 67-85 kW (91-116 PS) RDA	02.2000→11.2001	 7.06269.02.0	LLR	EL	
1.8 16V 85 kW (115 PS) RKC	01.1995→10.1998	 7.02256.29.0	EUV-AGR	EL	
		7.06269.02.0	LLR	EL	 96 EEC 96 EEC
1.8 16V 77 kW (105 PS) RDA	01.1995→08.1995	 7.02256.29.0	EUV-AGR	EL	
		7.06269.02.0	LLR	EL	 96 EEC 96 EEC
1.8 D 44 kW (60 PS) RTE, RTF, RTH	01.1995→12.1996	 7.02256.47.0	EUV-AGR	EL	 RTE, RTF, RTH: Produktionsdatum ab: 01.10.1995 Production date from: 01.10.1995
1.8 TD 66 kW (90 PS) RFD, RFK	01.1995→10.1998	 7.02256.47.0	EUV-AGR	EL	 RFD, RFK: Produktionsdatum ab: 01.10.1995 Production date from: 01.10.1995
1.8 Turbo D 51 kW (70 PS) RVA	12.1995→10.1998	 7.02256.47.0	EUV-AGR	EL	
RS 2000 110 kW (150 PS) N7A	02.1995→02.1998	 4.02003.62.0	LLR	EL	
RS 2000 4x4 110 kW (150 PS) N7A	02.1995→10.1998	 4.02003.62.0	LLR	EL	
RS Cosworth 4x4 162-167 kW (220-227 PS) N5F	02.1995→10.1998	 7.06269.26.0	LLR	EL	

ESCORT VI Convertible (ALL)
13



1.6 16V XR3i 65 kW (88 PS) L1H	02.1995→12.1996	 7.02256.29.0	EUV-AGR	EL	
		7.06269.02.0	LLR	EL	96 EEC 96 EEC
1.6 16V XR3i 66 kW (90 PS) L1E	02.1995→09.1999	 7.02256.29.0	EUV-AGR	EL	
		7.06269.02.0	LLR	EL	96 EEC 96 EEC
1.6 16V XR3i 66-70 kW (90-95 PS) L1K	02.1995→09.1999	 7.02256.29.0	EUV-AGR	EL	
1.8 16V XR3i 96 kW (130 PS) RQB	02.1995→08.2000	 7.02256.29.0	EUV-AGR	EL	
		7.06269.02.0	LLR	EL	96 EEC 96 EEC
1.8 16V XR3i 77 kW (105 PS) RDA	02.1995→08.1998	 7.02256.29.0	EUV-AGR	EL	
		7.06269.02.0	LLR	EL	96 EEC 96 EEC
1.8 16V XR3i 85 kW (115 PS) RKC	10.1995→08.1998	 7.02256.29.0	EUV-AGR	EL	
		7.06269.02.0	LLR	EL	96 EEC 96 EEC
1.8 TD 66 kW (90 PS) RFD, RFK	09.1995→08.1998	 7.02256.47.0	EUV-AGR	EL	
1.8 Turbo D 51 kW (70 PS) RVA	10.1996→08.1999	 7.02256.47.0	EUV-AGR	EL	

F
ESCORT VI Saloon (GAL, AFL)
14













1.3 44 kW (60 PS) J4B, J6A	01.1995→02.1999	 7.06269.02.0	LLR	EL	96 EEC J4B, J6A: →01.1998
		7.06269.03.0	LLR	EL	J4B, J6A: 02.1998→
1.6 66-70 kW (90-95 PS) L1K	01.2001→08.2002	 7.02256.29.0	EUV-AGR	EL	
1.6 i 16V 66-70 kW (90-95 PS) L1E, L1K	01.1995→02.1999	 7.02256.29.0	EUV-AGR	EL	
		7.06269.02.0	LLR	EL	96 EEC L1E, L1K: 96 EEC 96 EEC
1.6 i 16V 65 kW (88 PS) L1H	01.1995→08.1995	 7.02256.29.0	EUV-AGR	EL	
		7.06269.02.0	LLR	EL	96 EEC 96 EEC
1.8 16V 85 kW (115 PS) RKC	01.1995→02.1999	 7.02256.29.0	EUV-AGR	EL	
		7.06269.02.0	LLR	EL	96 EEC 96 EEC
1.8 16V 77 kW (105 PS) RDA	01.1995→08.1995	 7.02256.29.0	EUV-AGR	EL	
		7.06269.02.0	LLR	EL	96 EEC 96 EEC
1.8 D 44 kW (60 PS) RTE, RTF, RTH	01.1995→12.1996	 7.02256.47.0	EUV-AGR	EL	RTE, RTF, RTH: Produktionsdatum ab: 01.10.1995 Production date from: 01.10.1995





ESCORT VI Saloon (GAL, AFL) 14

1.8 TD 66 kW (90 PS) RFD, RFK	01.1995→02.1999	 7.02256.47.0	EUV-AGR	EL	 RFD, RFK: Produktionsdatum ab: 01.10.1995 Production date from: 01.10.1995
1.8 Turbo D 51 kW (70 PS) RVA	12.1995→02.1999	 7.02256.47.0	EUV-AGR	EL	

ESCORT VI Turnier (GAL, ANL) 15

1.3 44 kW (60 PS) J4B, J6A	01.1995→01.1999	 7.06269.02.0	LLR	EL	 J4B, J6A: →01.1998
		7.06269.03.0	LLR	EL	
1.6 16V 66 kW (90 PS) L1E	01.1995→02.1999	 7.02256.29.0	EUV-AGR	EL	
		7.06269.02.0	LLR	EL	
1.6 16V 66-70 kW (90-95 PS) L1K	01.1995→02.1999	 7.02256.29.0	EUV-AGR	EL	
1.6 GL 70-81 kW (95-110 PS) 16LSEZ	01.2001→08.2002	 7.02256.29.0	EUV-AGR	EL	
1.6 i 16V 65 kW (88 PS) L1H	01.1995→08.1995	 7.02256.29.0	EUV-AGR	EL	
		7.06269.02.0	LLR	EL	
1.8 16V 85 kW (115 PS) RKC	01.1995→02.1999	 7.02256.29.0	EUV-AGR	EL	
		7.06269.02.0	LLR	EL	
1.8 16V 77 kW (105 PS) RDA	01.1995→08.1995	 7.02256.29.0	EUV-AGR	EL	
		7.06269.02.0	LLR	EL	
1.8 D 44 kW (60 PS) RTE, RTF, RTH	01.1995→02.1999	 7.02256.47.0	EUV-AGR	EL	 RTE, RTF, RTH: Produktionsdatum ab: 01.10.1995 Production date from: 01.10.1995
1.8 TD 66 kW (90 PS) RFD, RFK	01.1995→02.1999	 7.02256.47.0	EUV-AGR	EL	 RFD, RFK: Produktionsdatum ab: 01.10.1995 Production date from: 01.10.1995
1.8 Turbo D 51 kW (70 PS) RVA	12.1995→02.1999	 7.02256.47.0	EUV-AGR	EL	

EVEREST 16























2.5 TD 105 kW (143 PS) WLAA	08.2006→	 7.02256.25.0	DW-AGR	EP	
		7.02256.25.0	DW-TL	EP	
3.0 TD 115 kW (156 PS) WEAT	08.2006→	 7.02256.25.0	DW-AGR	EP	
		7.02256.25.0	DW-TL	EP	

EXPLORER (U502) 17







































3.5i Turbo 24V 265-272 kW (360-370 PS) 35PDTD	06.2012→	 7.02328.08.0	SUV	EL	
--	----------	---	-----	----	--

F-150 18

F-150 3.5i Turbo 24V 265-272 kW (360-370 PS) 35PDTD	01.2011→	 7.02328.08.0	SUV	EL	
--	----------	---	-----	----	--

					
FIESTA III (GFJ)					
19					
1.6 i 16V 65-66 kW (88-90 PS) L1G	01.1994→12.1995	 7.02256.29.0	EUV-AGR	EL	 01.1995→ für OE-Nummer: 1063996, 95BF-9F715-AC for OE number: 1063996, 95BF-9F715-AC
		7.06269.02.0	LLR	EL	
1.8 16V 77 kW (105 PS) RDB	02.1992→12.1995	 7.02256.29.0	EUV-AGR	EL	 01.1995→ für OE-Nummer: 1063996, 95BF-9F715-AC for OE number: 1063996, 95BF-9F715-AC
		7.06269.02.0	LLR	EL	
1.8 XR2i 16V 96 kW (130 PS) RQC	02.1992→12.1995	 7.02256.29.0	EUV-AGR	EL	 01.1995→ für OE-Nummer: 1063996, 95BF-9F715-AC for OE number: 1063996, 95BF-9F715-AC
		7.06269.02.0	LLR	EL	
FIESTA IV (JA_, JB_)					
20					
1.25 i 16V 55 kW (75 PS) DHA, DHB, DHC, DHD, DHE, DHF, DHG	08.1995→01.2002	 7.06269.27.0	LLR	EL	 DHA, DHB, DHC, DHD, DHE, DHF, DHG: Produktionsdatum ab: 01.01.1997 Production date from: 01.01.1997 Produktionsdatum bis: 31.12.1999 Production date to: 31.12.1999
		7.06269.28.0	LLR	EL	
		7.05432.03.0	SM	EL	
1.3 i 37 kW (50 PS) JJA, JJC, JJE, JJJ, JJK, JJM	08.1995→01.2002	 7.06269.02.0	LLR	EL	 JJA, JJC, JJE, JJJ, JJK, JJM: →01.1998
		7.06269.03.0	LLR	EL	
1.3 i 44 kW (60 PS) J4C, J4J, J4L, J4Q, J4R, J4T, JBC	08.1995→01.2002	 7.06269.02.0	LLR	EL	 J4C, J4J, J4L, J4Q, J4R, J4T, JBC: →01.1998
		7.06269.03.0	LLR	EL	
1.4 i 16V 66 kW (90 PS) FHA, FHE	04.1996→01.2002	 7.06269.27.0	LLR	EL	 FHA, FHE: Produktionsdatum ab: 01.01.1997 Production date from: 01.01.1997
		7.06269.28.0	LLR	EL	
1.6 16V Sport 70-76 kW (95-103 PS) L1T, L1V	02.2000→01.2002	 7.06269.04.0	LLR	EL	 FHA, FHE: Produktionsdatum bis: 31.01.1997 Production date to: 31.01.1997

F













			 PIERBURG		
FIESTA IV (JA_, JB_) 20					
1.8 D 44 kW (60 PS) RTJ, RTK	08.1995→04.2000	 7.02256.47.0	EUV-AGR	EL	
1.8 DI 55-57 kW (75-78 PS) RTN, RTP, RTQ	04.2000→01.2002	 7.02256.07.0	EUV-AGR	EL	
FIESTA Saloon 21					
1.0 EcoBoost 92 kW (125 PS) M1JE, M1JH	09.2013→	 7.06117.12.0	ZM-NWV	EL	mit Dichtring with O-ring  M1JE, M1JH: →02.2019
F FIESTA V (JH_, JD_) 22					
1.3 44 kW (60 PS) BAJA	11.2001→06.2008	 7.05432.13.0	SM	EL	
1.3 51 kW (69 PS) A9JA, A9JB	11.2001→06.2008	 7.05432.13.0	SM	EL	
1.6 TDCi 66 kW (90 PS) HHJA, HHJB	11.2004→06.2008	 7.00968.04.0	DW-TL	EP	
ST150 110 kW (150 PS) N4JB	03.2005→06.2008	 7.02256.51.0	EUV-SR	EL	
FIESTA VI (CB1, CCN) 23					
1.0 59-63 kW (80-86 PS) P4JA, P4JB, P4JC, P4JD	10.2012→	 7.06117.12.0	ZM-NWV	EL	mit Dichtring with O-ring  P4JA, P4JB, P4JC, P4JD: →02.2019
1.0 48 kW (65 PS) XMJA, XMJB	01.2013→	 7.06117.12.0	ZM-NWV	EL	mit Dichtring with O-ring  XMJA, XMJB: →02.2019
1.0 EcoBoost 92 kW (125 PS) M1JE, M1JH	09.2012→	 7.06117.12.0	ZM-NWV	EL	mit Dichtring with O-ring  M1JE, M1JH: →02.2019
1.0 EcoBoost 74 kW (100-101 PS) SFJA, SFJB, SFJC, SFJD	01.2013→	 7.06117.12.0	ZM-NWV	EL	mit Dichtring with O-ring  SFJA, SFJB, SFJC, SFJD: →02.2019
1.0 Sport 103 kW (140 PS) YYJA, YYJB	05.2014→	 7.06117.12.0	ZM-NWV	EL	mit Dichtring with O-ring  YYJA, YYJB: →02.2019
1.5 TDCi 55 kW (75 PS) UGJC, XUJA, XUJB	09.2012→	 7.08681.00.0	EOV	EH	 UGJC, XUJA, XUJB: Produktionsdatum ab: 15.10.2015 Production date from: 15.10.2015
1.6 ST 134 kW (182 PS) JTJA, JTJB	03.2013→	 7.04492.07.0	LDRV	EP	 JTJA, JTJB: Produktionsdatum bis: 12.08.2019 Production date to: 12.08.2019
1.6 ST200 147 kW (200 PS) JTJC	04.2016→	 7.04492.07.0	LDRV	EP	Produktionsdatum bis: 12.08.2019 Production date to: 12.08.2019
1.6 TDCi 66 kW (90 PS) HHJC, HHJD, HHJE	06.2008→	 7.00968.04.0	DW-TL	EP	
1.6 TDCi 55 kW (75 PS) HHJF, UBJA	06.2008→	 7.00968.04.0	DW-TL	EP	
1.6 TDCi 70 kW (95 PS) T3JA, TZJA, TZJB	02.2010→	 7.00968.04.0	DW-TL	EP	
FIESTA VII (HJ, HF) 24					
1.0 EcoBoost 74 kW (101 PS) SFJE, SFJF, SFJH, SFJJ, SFJK, SFJN, SFJP	05.2017→	 7.06117.12.0	ZM-NWV	EL	mit Dichtring with O-ring  SFJE, SFJF, SFJH, SFJJ, SFJK, SFJN, SFJP: →02.2019
1.0 EcoBoost 92 kW (125 PS) M1JL, M1JM	05.2017→	 7.06117.12.0	ZM-NWV	EL	mit Dichtring with O-ring  M1JL, M1JM: →02.2019
1.0 EcoBoost 103 kW (140 PS) YYJE	06.2017→	 7.06117.12.0	ZM-NWV	EL	mit Dichtring with O-ring →02.2019

FIESTA VII (HJ, HF)						24
1.0 EcoBoost 63 kW (85 PS) Q0JA, Q0JB, Q0JC, Q0JD	04.2018→		7.06117.12.0	ZM-NWV	EL	mit Dichtring with O-ring Q0JA, Q0JB, Q0JC, Q0JD: →02.2019
1.5 TDCi 63 kW (86 PS) XUJC, XUJD, XUJE, XUJF, XUJG, XUJK, XUJL, XUJM, XUJN	05.2017→		7.08681.00.0	EOV	EH	XUJC, XUJD, XUJE, XUJF, XUJG, XUJK, XUJL, XUJM, XUJN: Produktionsdatum ab: 15.05.2017 Production date from: 15.05.2017
1.5 TDCi 88 kW (120 PS) XWJA, XWJB, XWJC	05.2017→		7.08681.00.0	EOV	EH	XWJA, XWJB, XWJC: Produktionsdatum ab: 15.05.2017 Production date from: 15.05.2017
FLEX						25
3.5i Turbo 24V 265-272 kW (360-370 PS) 35PDTD	09.2008→		7.02328.08.0	SUV	EL	
FOCUS C-MAX (DM2)						26
1.6 TDCi 80 kW (109 PS) G8DA, G8DB	10.2003→03.2007		7.00968.04.0	DW-TL	EP	
1.6 TDCi 66 kW (90 PS) HHDA, HHDB	02.2005→03.2007		7.00968.04.0	DW-TL	EP	
1.8 88 kW (120 PS) CSDA, CSDB	10.2003→03.2007		7.02256.48.0	STE	EP	
1.8 92 kW (125 PS) QQDA, QQDB	04.2004→03.2007		7.02256.48.0	STE	EP	
1.8 Flexifuel 92 kW (125 PS) Q7DA	01.2006→03.2007		7.02256.48.0	STE	EP	
2.0 107 kW (145 PS) AODA, AODB	03.2004→03.2007		7.02256.48.0	STE	EP	
2.0 TDCi 100 kW (136 PS) G6DA, G6DB, G6DD, G6DG	10.2003→03.2007		7.28328.07.0	DW-RK	EP	G6DA, G6DB, G6DD, G6DG: →09.2006 Euro 4 Euro 4 für Fahrzeuge mit Diesel-Partikel-Filter (DPF) for vehicles with diesel soot filter
			7.28328.07.0	DW-TL	EP	G6DA, G6DB, G6DD, G6DG: →09.2006 Euro 4 Euro 4 für Fahrzeuge mit Diesel-Partikel-Filter (DPF) for vehicles with diesel soot filter
			7.01771.01.0	DW-RK	EP	
			7.01771.01.0	DW-TL	EP	
FOCUS I (DAW, DBW)						27
1.4 16V 55 kW (75 PS) FXDA	10.1998→11.2004		7.06269.23.0	LLR	EL	08.2000→
1.4 16V 55 kW (75 PS) FXDB, FXDC, FXDD	10.1998→11.2004		7.06269.04.0	LLR	EL	FXDB, FXDC, FXDD, FXDD: →07.2000
			7.06269.23.0	LLR	EL	FXDB, FXDC, FXDD: 08.2000→
1.4 16V 55 kW (75 PS) FXDA	10.1998→09.1999		7.06269.04.0	LLR	EL	
1.6 16V 74-75 kW (100-102 PS) FYDA, FYDB, FYDC, FYDD	10.1998→11.2004		7.06269.04.0	LLR	EL	FYDA, FYDB, FYDC, FYDD: →07.2000
			7.06269.23.0	LLR	EL	FYDA, FYDB, FYDC, FYDD: 08.2000→
1.6 16V 74-75 kW (100-102 PS) FYDH	10.1998→11.2004		7.06269.23.0	LLR	EL	10.2001→
1.6 16V Flexifuel 74-75 kW (100-102 PS) FYDH	01.2002→11.2004		7.06269.23.0	LLR	EL	





















FOCUS I (DAW, DBW)

27

1.8 16V 82-85 kW (111-115 PS) EYDB, EYDC, EYDD, EYDE, EYDF, EYDG, EYDI, EYDJ, EYDL	10.1998→11.2004		7.06269.03.0	LLR	EL	
1.8 16V BiFuel 85 kW (115 PS) EYDD, EYDG, EYDI	09.2002→07.2004		7.06269.03.0	LLR	EL	
1.8 DI / TDDi 55-57 kW (75-78 PS) BHDA, BHDB	08.1999→11.2004		7.02256.07.0	EUV-AGR	EL	
1.8 Turbo DI / TDDi 66 kW (90 PS) C9DA, C9DB, C9DC	10.1998→11.2004		7.02256.07.0	EUV-AGR	EL	
2.0 16V 85-96 kW (116-131 PS) EDDB, EDDC, EDDD, EDDF	10.1998→11.2004		7.06269.03.0	LLR	EL	
RS 158 kW (215 PS) HMDA	10.2002→11.2004		7.00036.03.0	LDRV	EL	
			7.06269.04.0	LLR	EL	
ST170 127 kW (173 PS) ALDA	03.2002→11.2004		7.06269.04.0	LLR	EL	

















FOCUS I Saloon (DFW)































28

1.4 16V 55 kW (75 PS) FXDA, FXDB, FXDC, FXDD	02.1999→11.2004		7.06269.04.0	LLR	EL	  FXDA, FXDB, FXDC, FXDD: →07.2000
			7.06269.23.0	LLR	EL	  FXDA, FXDB, FXDC, FXDD: 08.2000→
1.6 16V 74-75 kW (100-102 PS) FYDA, FYDB, FYDC, FYDD	02.1999→11.2004		7.06269.04.0	LLR	EL	  FYDA, FYDB, FYDC, FYDD: →07.2000
			7.06269.23.0	LLR	EL	  FYDA, FYDB, FYDC, FYDD: 08.2000→
1.6 16V 74-75 kW (100-102 PS) FYDH	02.1999→11.2004		7.06269.23.0	LLR	EL	 10.2001→
1.8 16V 82-85 kW (111-115 PS) EYDB, EYDC, EYDD, EYDE, EYDF, EYDG, EYDI, EYDJ, EYDL	02.1999→11.2004		7.06269.03.0	LLR	EL	
1.8 Turbo DI / TDDi 66 kW (90 PS) C9DA, C9DB, C9DC	02.1999→11.2004		7.02256.07.0	EUV-AGR	EL	
1.8 Turbo DI / TDDi 55-57 kW (75-78 PS) BHDA, BHDB	08.2001→03.2005		7.02256.07.0	EUV-AGR	EL	
2.0 85-96 kW (116-131 PS) EDDD	02.1999→11.2004		7.06269.03.0	LLR	EL	
2.0 16V 85-96 kW (116-131 PS) EDDB, EDDC, EDDD, EDDF	02.1999→11.2004		7.06269.03.0	LLR	EL	

FOCUS I Turnier (DNW)



29

1.4 16V 55 kW (75 PS) FXDA, FXDB, FXDC, FXDD	02.1999→11.2004		7.06269.04.0	LLR	EL	  FXDA, FXDB, FXDC, FXDD: →07.2000
			7.06269.23.0	LLR	EL	  FXDA, FXDB, FXDC, FXDD: 08.2000→
1.6 16V 74-75 kW (100-102 PS) FYDA, FYDB, FYDC, FYDD	02.1999→11.2004		7.06269.04.0	LLR	EL	  FYDA, FYDB, FYDC, FYDD: →07.2000
			7.06269.23.0	LLR	EL	  FYDA, FYDB, FYDC, FYDD: 08.2000→
1.6 16V 74-75 kW (100-102 PS) FYDH	02.1999→11.2004		7.06269.23.0	LLR	EL	 10.2001→
1.6 16V Flexifuel 74-75 kW (100-102 PS) FYDH	01.2002→11.2004		7.06269.23.0	LLR	EL	
1.8 16V 82-85 kW (111-115 PS) EYDB, EYDC, EYDD, EYDE, EYDF, EYDG, EYDI, EYDJ, EYDL	02.1999→11.2004		7.06269.03.0	LLR	EL	
1.8 DI / TDDi 55-57 kW (75-78 PS) BHDA, BHDB	08.1999→11.2004		7.02256.07.0	EUV-AGR	EL	

						
FOCUS I Turnier (DNW)						29
1.8 Turbo DI / TDDi 66 kW (90 PS) C9DA, C9DB, C9DC	02.1999→11.2004		7.02256.07.0	EUV-AGR	EL	
2.0	09.1999→12.2003		7.06269.03.0	LLR	EL	
2.0 16V 85-96 kW (116-131 PS) EDDB, EDDC, EDDD, EDDF	02.1999→11.2004		7.06269.03.0	LLR	EL	
ST170 127 kW (173 PS) ALDA	08.2002→11.2004		7.06269.04.0	LLR	EL	
FOCUS II (DA_, HCP, DP)						30
1.6 TDCi 74 kW (100 PS) G8DC, MTDA	07.2004→09.2012		7.00968.04.0	DW-TL	EP	
1.6 TDCi 80 kW (109 PS) G8DA, G8DB	07.2004→09.2012		7.00968.04.0	DW-TL	EP	
1.6 TDCi 66 kW (90 PS) GPDA, GPDB, GPDC, HHDA, HHDB	01.2005→09.2012		7.00968.04.0	DW-TL	EP	
1.8 92 kW (125 PS) QQDA, QQDB	03.2006→09.2012		7.02256.48.0	STE	EP	
1.8 Flexifuel 92 kW (125 PS) Q7DA	01.2006→09.2012		7.02256.48.0	STE	EP	
2.0 104-107 kW (141-145 PS) AODA, AODB, AODE	07.2004→09.2012		7.02256.48.0	STE	EP	
2.0 CNG 104-109 kW (143-146 PS) SYDA	04.2009→07.2011		7.02256.48.0	STE	EP	
2.0 Flex 104-109 kW (143-146 PS) SYDA	10.2008→03.2010		7.02256.48.0	STE	EP	
2.0 LPG 104-109 kW (143-146 PS) SYDA	06.2008→07.2011		7.02256.48.0	STE	EP	
2.0 TDCi 98 kW (133 PS) G6DE, G6DF	07.2004→01.2008		7.28328.07.0	DW-RK	EP	 G6DE, G6DF: →09.2006 Euro 4 für Fahrzeuge mit Diesel-Partikel-Filter (DPF) for vehicles with diesel soot filter
			7.28328.07.0	DW-TL	EP	 G6DE, G6DF: →09.2006 Euro 4 für Fahrzeuge mit Diesel-Partikel-Filter (DPF) for vehicles with diesel soot filter
2.0 TDCi 100 kW (136 PS) G6DA, G6DB, G6DD, G6DG	07.2004→09.2012		7.28328.07.0	DW-RK	EP	 G6DA, G6DB, G6DD, G6DG: →09.2006 Euro 4 für Fahrzeuge mit Diesel-Partikel-Filter (DPF) for vehicles with diesel soot filter
			7.28328.07.0	DW-TL	EP	 G6DA, G6DD, G6DG: →09.2006 Euro 4 für Fahrzeuge mit Diesel-Partikel-Filter (DPF) for vehicles with diesel soot filter  G6DB: →06.2009 Euro 4 für Fahrzeuge mit Diesel-Partikel-Filter (DPF) for vehicles with diesel soot filter
			7.01771.01.0	DW-RK	EP	
			7.01771.01.0	DW-TL	EP	
2.5 RS 224-257 kW (305-350 PS) JZDA	01.2009→07.2011		7.02256.39.0	AKF	EL	





FOCUS II (DA_, HCP, DP) 30









			7.28197.16.0	LDRV	EL	
2.5 RS 500 224-257 kW (305-350 PS) JZDA	05.2010→07.2011		7.02256.39.0	AKF	EL	
			7.28197.16.0	LDRV	EL	
2.5 ST 166 kW (225 PS) HYDA	10.2005→09.2012		7.02256.39.0	AKF	EL	
			7.28197.16.0	LDRV	EL	

F





FOCUS II Convertible 31

2.0 107 kW (145 PS) AODA, AODB	10.2006→09.2010		7.02256.48.0	STE	EP	
2.0 TDCi 100 kW (136 PS) G6DA, G6DB, G6DD, G6DG	10.2006→09.2010		7.01771.01.0	DW-RK	EP	
			7.01771.01.0	DW-TL	EP	

FOCUS II Saloon (DB_, FCH, DH) 32

1.6 TDCi 80 kW (109 PS) G8DA, G8DB	04.2005→09.2012		7.00968.04.0	DW-TL	EP	
1.8 92 kW (125 PS) QQDA, QQDB	03.2006→09.2012		7.02256.48.0	STE	EP	
1.8 Flexifuel 92 kW (125 PS) Q7DA	06.2006→07.2011		7.02256.48.0	STE	EP	
2.0 107 kW (145 PS) AODA, AODB	04.2005→07.2011		7.02256.48.0	STE	EP	
2.0 TDCi 100 kW (136 PS) G6DA, G6DB, G6DD	04.2005→09.2012		7.28328.07.0	DW-RK	EP	 G6DA, G6DB, G6DD: →09.2006 Euro 4 für Fahrzeuge mit Diesel-Partikel-Filter (DPF) for vehicles with diesel soot filter
			7.28328.07.0	DW-TL	EP	 G6DA, G6DB, G6DD: →09.2006 Euro 4 für Fahrzeuge mit Diesel-Partikel-Filter (DPF) for vehicles with diesel soot filter
			7.01771.01.0	DW-RK	EP	
			7.01771.01.0	DW-TL	EP	
2.0 TDCi 100 kW (136 PS) G6DG	04.2005→09.2012		7.01771.01.0	DW-RK	EP	
			7.01771.01.0	DW-TL	EP	

FOCUS II Turnier (DA_, FFS, DS) 33

1.6 TDCi 80 kW (109 PS) G8DA, G8DB	07.2004→09.2012		7.00968.04.0	DW-TL	EP	
1.6 TDCi 66 kW (90 PS) GPDA, GPDB, GPDC, HHDA, HHDB	07.2004→09.2012		7.00968.04.0	DW-TL	EP	
1.6 TDCi 80 kW (109 PS) G8DA	12.2007→09.2012		7.00968.04.0	DW-TL	EP	
1.8 92 kW (125 PS) QQDA, QQDB	03.2006→09.2012		7.02256.48.0	STE	EP	
1.8 Flexifuel 92 kW (125 PS) Q7DA	01.2006→09.2012		7.02256.48.0	STE	EP	
2.0 104-107 kW (141-145 PS) AODA, AODB, AODE	07.2004→09.2012		7.02256.48.0	STE	EP	
2.0 LPG 104-109 kW (143-146 PS) SYDA	06.2008→07.2011		7.02256.48.0	STE	EP	

FOCUS II Turnier (DA_, FFS, DS)
33



















2.0 TDCi 100 kW (136 PS) G6DA, G6DB, G6DD, G6DG	07.2004→09.2012		7.28328.07.0	DW-RK	EP	G6DA, G6DB, G6DD, G6DG: →09.2006 Euro 4 Euro 4 für Fahrzeuge mit Diesel-Partikel-Filter (DPF) for vehicles with diesel soot filter	
			7.28328.07.0	DW-TL	EP		G6DA, G6DB, G6DD, G6DG: →09.2006 Euro 4 Euro 4 für Fahrzeuge mit Diesel-Partikel-Filter (DPF) for vehicles with diesel soot filter
			7.01771.01.0 7.01771.01.0	DW-RK DW-TL	EP EP		

F
FOCUS III
34

1.0 EcoBoost 92 kW (125 PS) M1DA	02.2012→		7.07400.12.0*	STE	EP	Produktionsdatum bis: 07.08.2012 Production date to: 07.08.2012
			↳ 7.04011.05.0	DW-TL	EP	
			↳ 7.22687.44.0	EUV-VB	EP	
			7.06117.12.0	ZM-NWV	EL	
1.0 EcoBoost 92 kW (125 PS) M1DC, M1DD	02.2012→		7.22687.44.0	EUV-VB	EP	M1DC, M1DD: für heiße Klimazonen for hot climate zones
			7.06117.12.0	ZM-NWV	EL	
1.0 EcoBoost 74 kW (100 PS) M2DA	02.2012→		7.07400.12.0*	STE	EP	Produktionsdatum bis: 07.08.2012 Production date to: 07.08.2012
			↳ 7.04011.05.0	DW-TL	EP	
			↳ 7.22687.44.0	EUV-VB	EP	
			7.06117.12.0	ZM-NWV	EL	
1.0 EcoBoost 74 kW (100 PS) M2DB, M2DC, SFDB	02.2012→		7.22687.44.0	EUV-VB	EP	M2DB, M2DC, SFDB: für heiße Klimazonen for hot climate zones
1.0 EcoBoost 74 kW (100 PS) SFDA	02.2012→		7.07400.12.0*	STE	EP	Produktionsdatum bis: 07.08.2012 Production date to: 07.08.2012
			↳ 7.04011.05.0	DW-TL	EP	
			↳ 7.22687.44.0	EUV-VB	EP	
1.0 EcoBoost 103 kW (140 PS) M1DH	10.2017→		7.22687.44.0	EUV-VB	EP	für heiße Klimazonen for hot climate zones
			7.06117.12.0	ZM-NWV	EL	
1.5 EcoBoost 110 kW (150 PS) M8DA, M8DB	09.2014→		7.07400.13.0*	DW-TL	EP	mit Halter with holder M8DA, M8DB: Produktionsdatum bis: 13.11.2015 Production date to: 13.11.2015
			↳ 7.04011.05.0	DW-TL	EP	
			7.07400.14.0*	DW-TL	EP	mit Halter with holder M8DA, M8DB: Produktionsdatum ab: 13.11.2015 Production date from: 13.11.2015 Produktionsdatum bis: 18.11.2015 Production date to: 18.11.2015
			↳ 7.04011.05.0	DW-TL	EP	



FOCUS III **34**

			7.07400.15.0*	DW-TL	EP	mit Halter with holder  M8DA, M8DB: Produktionsdatum ab: 18.11.2015 Production date from: 18.11.2015
			↳ 7.04011.05.0 7.04615.03.0	DW-TL SUV	EP EL	
F 1.5 EcoBoost 132-134 kW (179-182 PS) M9DA, M9DB	09.2014→		7.07400.13.0*	DW-TL	EP	mit Halter with holder  M9DA, M9DB: Produktionsdatum bis: 13.11.2015 Production date to: 13.11.2015
			↳ 7.04011.05.0 7.07400.14.0*	DW-TL DW-TL	EP EP	mit Halter with holder  M9DA, M9DB: Produktionsdatum ab: 13.11.2015 Production date from: 13.11.2015 Produktionsdatum bis: 18.11.2015 Production date to: 18.11.2015
			↳ 7.04011.05.0 7.07400.15.0*	DW-TL DW-TL	EP EP	mit Halter with holder  M9DA, M9DB: Produktionsdatum ab: 18.11.2015 Production date from: 18.11.2015
			↳ 7.04011.05.0 7.07400.15.0*	DW-TL DW-TL	EP EP	mit Halter with holder  M9DA, M9DB: Produktionsdatum ab: 18.11.2015 Production date from: 18.11.2015
			↳ 7.04011.05.0 7.04615.03.0	DW-TL SUV	EP EL	
1.5 TDCi 70 kW (95 PS) XXDA, XXDC	09.2014→		7.08681.00.0	EOV	EH	 XXDA, XXDC: Produktionsdatum ab: 07.12.2015 Production date from: 07.12.2015
1.5 TDCi 88 kW (120 PS) XWDA, XWDB, XWDC, XWDD, XWDE	09.2014→		7.08681.00.0	EOV	EH	 XWDA, XWDB, XWDC, XWDD, XWDE: Produktionsdatum ab: 07.12.2015 Production date from: 07.12.2015
1.5 TDCi ECOnetic 77 kW (105 PS) XXDB	09.2014→		7.08681.00.0	EOV	EH	Produktionsdatum ab: 07.12.2015 Production date from: 07.12.2015
1.6 EcoBoost 110 kW (150 PS) JQDA, JQDB, YUDA	07.2010→		7.07400.19.0*	EUV-VB	EP	mit Halter with holder
			↳ 7.22687.44.0 7.03162.09.0	EUV-VB LDRV	EP EP	 JQDA, JQDB, YUDA: Produktionsdatum bis: 30.01.2012 Production date to: 30.01.2012
			7.04492.07.0	LDRV	EP	 JQDA, JQDB, YUDA: Produktionsdatum ab: 30.01.2012 Production date from: 30.01.2012 Produktionsdatum bis: 21.07.2015 Production date to: 21.07.2015
			7.04269.04.0	SUV	EL	
1.6 EcoBoost 134 kW (182 PS) JTDA, JTDB	07.2010→		7.07400.19.0*	EUV-VB	EP	mit Halter with holder
			↳ 7.22687.44.0 7.03162.09.0	EUV-VB LDRV	EP EP	 JTDA, JTDB: Produktionsdatum bis: 30.01.2012 Production date to: 30.01.2012
			7.04492.07.0	LDRV	EP	 JTDA, JTDB: Produktionsdatum ab: 30.01.2012 Production date from: 30.01.2012 Produktionsdatum bis: 21.07.2015 Production date to: 21.07.2015
			7.04269.04.0	SUV	EL	
1.6 Flexifuel 110 kW (150 PS) YUDA	07.2013→		7.07400.19.0*	EUV-VB	EP	mit Halter with holder
			↳ 7.22687.44.0	EUV-VB	EP	

FOCUS III
34



















		7.04492.07.0	LDRV	EP	Produktionsdatum ab: 30.01.2012 Production date from: 30.01.2012 Produktionsdatum bis: 21.07.2015 Production date to: 21.07.2015
		7.04269.04.0	SUV	EL	
1.6 TDCi 70 kW (95 PS) T3DA, T3DB	07.2010→	7.07400.01.0*	STE	EP	
		↳ 7.01633.06.0	DW-TL	EP	
1.6 TDCi 85 kW (115 PS) T1DA, T1DB	07.2010→	7.07400.01.0*	STE	EP	
		↳ 7.01633.06.0	DW-TL	EP	
1.6 TDCi ECOnetic 77 kW (105 PS) NGDA, NGDB	05.2012→	7.01633.06.0	DW-TL	EP	
2.0 ST 184 kW (250 PS) R9DA	07.2012→	7.03306.16.0	LDRV	EP	
		7.07400.06.0*	STE	EP	
		↳ 7.02087.05.0	EUV-VB	EP	
		7.06117.33.0	SV-NWV	EL	
2.0 ST 184 kW (250 PS) R9DB, R9DC, R9DD	07.2012→	7.03306.16.0	LDRV	EP	
2.0 TDCi 85 kW (116 PS) TYDA	07.2010→	7.01771.01.0	DW-AGR	EP	01.2011→07.2015
		7.01771.01.0	DW-TL	EP	01.2011→07.2015
2.0 TDCi 103 kW (140 PS) UFDB	07.2010→	7.01771.01.0	DW-AGR	EP	01.2011→07.2015
		7.01771.01.0	DW-TL	EP	01.2011→07.2015
2.0 TDCi 120 kW (163 PS) TXDB	07.2010→	7.01771.01.0	DW-AGR	EP	→07.2015
		7.01771.01.0	DW-TL	EP	→07.2015
2.0 TDCi 100 kW (136 PS) UKDB	07.2010→	7.01771.01.0	DW-AGR	EP	01.2011→07.2015
		7.01771.01.0	DW-TL	EP	01.2011→07.2015
2.0 TDCi 110 kW (150 PS) T7DB	11.2014→	7.01771.01.0	DW-AGR	EP	→07.2015
		7.01771.01.0	DW-TL	EP	→07.2015
2.3 RS AWD 257 kW (350 PS) YVDA	07.2015→	7.06117.33.0	SV-NWV	EL	

F
FOCUS III Saloon
35

1.0 EcoBoost 74 kW (100 PS) M2DA	02.2012→	7.07400.12.0*	STE	EP	Produktionsdatum bis: 07.08.2012 Production date to: 07.08.2012
		↳ 7.04011.05.0	DW-TL	EP	
		↳ 7.22687.44.0	EUV-VB	EP	
		7.06117.12.0	ZM-NWV	EL	mit Dichtring with O-ring →02.2019
1.0 EcoBoost 74 kW (100 PS) M2DB, M2DC, SFDB	02.2012→	7.22687.44.0	EUV-VB	EP	M2DB, M2DC, SFDB: für heiße Klimazonen for hot climate zones
1.0 EcoBoost 74 kW (100 PS) SFDA	02.2012→	7.07400.12.0*	STE	EP	Produktionsdatum bis: 07.08.2012 Production date to: 07.08.2012
		↳ 7.04011.05.0	DW-TL	EP	
		↳ 7.22687.44.0	EUV-VB	EP	
1.0 EcoBoost 92 kW (125 PS) M1DA	02.2012→	7.07400.12.0*	STE	EP	Produktionsdatum bis: 07.08.2012 Production date to: 07.08.2012
		↳ 7.04011.05.0	DW-TL	EP	
		↳ 7.22687.44.0	EUV-VB	EP	



FOCUS III Saloon **35**

			7.06117.12.0	ZM-NWV	EL	mit Dichtring with O-ring →02.2019
1.0 EcoBoost 92 kW (125 PS) M1DC, M1DD	02.2012→		7.22687.44.0	EUV-VB	EP	 M1DC, M1DD: für heiße Klimazonen for hot climate zones
			7.06117.12.0	ZM-NWV	EL	mit Dichtring with O-ring  M1DC, M1DD: →02.2019
F 1.0 EcoBoost 103 kW (140 PS) M1DH	10.2017→		7.22687.44.0	EUV-VB	EP	für heiße Klimazonen for hot climate zones
			7.06117.12.0	ZM-NWV	EL	mit Dichtring with O-ring →02.2019
1.5 EcoBoost 110 kW (150 PS) M8DA, M8DB	11.2014→		7.07400.13.0*	DW-TL	EP	mit Halter with holder  M8DA, M8DB: Produktionsdatum bis: 13.11.2015 Production date to: 13.11.2015
			↳ 7.04011.05.0	DW-TL	EP	
			7.07400.14.0*	DW-TL	EP	mit Halter with holder  M8DA, M8DB: Produktionsdatum ab: 13.11.2015 Production date from: 13.11.2015 Produktionsdatum bis: 18.11.2015 Production date to: 18.11.2015
			↳ 7.04011.05.0	DW-TL	EP	
			7.07400.15.0*	DW-TL	EP	mit Halter with holder  M8DA, M8DB: Produktionsdatum ab: 18.11.2015 Production date from: 18.11.2015
			↳ 7.04011.05.0	DW-TL	EP	
1.5 EcoBoost 132-134 kW (179-182 PS) M9DA, M9DB	11.2014→		7.07400.13.0*	DW-TL	EP	mit Halter with holder  M9DA, M9DB: Produktionsdatum bis: 13.11.2015 Production date to: 13.11.2015
			↳ 7.04011.05.0	DW-TL	EP	
			7.07400.14.0*	DW-TL	EP	mit Halter with holder  M9DA, M9DB: Produktionsdatum ab: 13.11.2015 Production date from: 13.11.2015 Produktionsdatum bis: 18.11.2015 Production date to: 18.11.2015
			↳ 7.04011.05.0	DW-TL	EP	
			7.07400.15.0*	DW-TL	EP	mit Halter with holder  M9DA, M9DB: Produktionsdatum ab: 18.11.2015 Production date from: 18.11.2015
			↳ 7.04011.05.0	DW-TL	EP	
1.5 TDCi 70 kW (95 PS) XXDA, XXDC	11.2014→		7.08681.00.0	EOV	EH	 XXDA, XXDC: Produktionsdatum ab: 07.12.2015 Production date from: 07.12.2015
1.5 TDCi 88 kW (120 PS) XWDA, XWDB, XWDC, XWDD	11.2014→		7.08681.00.0	EOV	EH	 XWDA, XWDB, XWDC, XWDD: Produktionsdatum ab: 07.12.2015 Production date from: 07.12.2015
1.5 TDCi ECOnetic 77 kW (105 PS) XXDB	11.2014→		7.08681.00.0	EOV	EH	Produktionsdatum ab: 07.12.2015 Production date from: 07.12.2015
1.6 EcoBoost 110 kW (150 PS) JQDA, JQDB, YUDA	07.2010→		7.07400.19.0*	EUV-VB	EP	mit Halter with holder

FOCUS III Saloon **35**















			↳ 7.22687.44.0 7.03162.09.0	EUV-VB LDRV	EP EP	🌀 JQDA, JQDB, YUDA: Produktionsdatum bis: 30.01.2012 Production date to: 30.01.2012
			7.04492.07.0	LDRV	EP	🌀 JQDA, JQDB, YUDA: Produktionsdatum ab: 30.01.2012 Production date from: 30.01.2012 Produktionsdatum bis: 21.07.2015 Production date to: 21.07.2015
			7.04269.04.0	SUV	EL	
1.6 EcoBoost 134 kW (182 PS) JTDA, JTDB	07.2010→		7.07400.19.0*	EUV-VB	EP	mit Halter with holder
			↳ 7.22687.44.0 7.03162.09.0	EUV-VB LDRV	EP EP	🌀 JTDA, JTDB: Produktionsdatum bis: 30.01.2012 Production date to: 30.01.2012
			7.04492.07.0	LDRV	EP	🌀 JTDA, JTDB: Produktionsdatum ab: 30.01.2012 Production date from: 30.01.2012 Produktionsdatum bis: 21.07.2015 Production date to: 21.07.2015
			7.04269.04.0	SUV	EL	
1.6 Flexifuel 110 kW (150 PS) YUDA	07.2013→		7.07400.19.0*	EUV-VB	EP	mit Halter with holder
			↳ 7.22687.44.0 7.04492.07.0	EUV-VB LDRV	EP EP	Produktionsdatum ab: 30.01.2012 Production date from: 30.01.2012 Produktionsdatum bis: 21.07.2015 Production date to: 21.07.2015
			7.04269.04.0	SUV	EL	
1.6 TDCi 70 kW (95 PS) T3DA, T3DB	07.2010→		7.07400.01.0*	STE	EP	
			↳ 7.01633.06.0	DW-TL	EP	
1.6 TDCi 85 kW (115 PS) T1DA, T1DB	07.2010→		7.07400.01.0*	STE	EP	
			↳ 7.01633.06.0	DW-TL	EP	
1.6 TDCi 77 kW (105 PS) NGDA, NGDB	05.2012→		7.01633.06.0	DW-TL	EP	
2.0 TDCi 85 kW (116 PS) TYDA	07.2010→		7.01771.01.0	DW-AGR	EP	01.2011→07.2015
			7.01771.01.0	DW-TL	EP	01.2011→07.2015
2.0 TDCi 103 kW (140 PS) UFDB	07.2010→		7.01771.01.0	DW-AGR	EP	01.2011→07.2015
			7.01771.01.0	DW-TL	EP	01.2011→07.2015
2.0 TDCi 120 kW (163 PS) TXDB	07.2010→		7.01771.01.0	DW-AGR	EP	01.2011→07.2015
			7.01771.01.0	DW-TL	EP	01.2011→07.2015
2.0 TDCi 100 kW (136 PS) UKDB	07.2010→		7.01771.01.0	DW-AGR	EP	01.2011→07.2015
			7.01771.01.0	DW-TL	EP	01.2011→07.2015
2.0 TDCi 110 kW (150 PS) T7DB	11.2014→		7.01771.01.0	DW-AGR	EP	→07.2015
			7.01771.01.0	DW-TL	EP	→07.2015

























FOCUS III Turnier **36**

1.0 EcoBoost 74 kW (100 PS) M2DA	02.2012→		7.07400.12.0*	STE	EP	Produktionsdatum bis: 07.08.2012 Production date to: 07.08.2012
			↳ 7.04011.05.0	DW-TL	EP	
			↳ 7.22687.44.0	EUV-VB	EP	



FOCUS III Turnier **36**

			7.06117.12.0	ZM-NWV	EL	mit Dichtring with O-ring →02.2019
1.0 EcoBoost 74 kW (100 PS) M2DB, M2DC, SFDB	02.2012→		7.22687.44.0	EUV-VB	EP	 M2DB, M2DC, SFDB: für heiße Klimazonen for hot climate zones
			7.06117.12.0	ZM-NWV	EL	mit Dichtring with O-ring  M2DB, M2DC, SFDB: →02.2019
F 1.0 EcoBoost 74 kW (100 PS) SFDA	02.2012→		7.07400.12.0*	STE	EP	Produktionsdatum bis: 07.08.2012 Production date to: 07.08.2012
			↳ 7.04011.05.0	DW-TL	EP	
			↳ 7.22687.44.0	EUV-VB	EP	
1.0 EcoBoost 92 kW (125 PS) M1DA	02.2012→		7.07400.12.0*	STE	EP	Produktionsdatum bis: 07.08.2012 Production date to: 07.08.2012
			↳ 7.04011.05.0	DW-TL	EP	
			↳ 7.22687.44.0	EUV-VB	EP	
			7.06117.12.0	ZM-NWV	EL	mit Dichtring with O-ring →02.2019
1.0 EcoBoost 92 kW (125 PS) M1DC, M1DD	02.2012→		7.22687.44.0	EUV-VB	EP	 M1DC, M1DD: für heiße Klimazonen for hot climate zones
1.0 EcoBoost 103 kW (140 PS) M1DH	10.2017→		7.22687.44.0	EUV-VB	EP	für heiße Klimazonen for hot climate zones
			7.06117.12.0	ZM-NWV	EL	mit Dichtring with O-ring →02.2019
1.5 EcoBoost 110 kW (150 PS) M8DA, M8DB	09.2014→		7.07400.13.0*	DW-TL	EP	mit Halter with holder  M8DA, M8DB: Produktionsdatum bis: 13.11.2015 Production date to: 13.11.2015
			↳ 7.04011.05.0	DW-TL	EP	
			7.07400.14.0*	DW-TL	EP	mit Halter with holder  M8DA, M8DB: Produktionsdatum ab: 13.11.2015 Production date from: 13.11.2015 Produktionsdatum bis: 18.11.2015 Production date to: 18.11.2015
			↳ 7.04011.05.0	DW-TL	EP	
			7.07400.15.0*	DW-TL	EP	mit Halter with holder  M8DA, M8DB: Produktionsdatum ab: 18.11.2015 Production date from: 18.11.2015
			↳ 7.04011.05.0	DW-TL	EP	
			7.04615.03.0	SUV	EL	
1.5 EcoBoost 132-134 kW (179-182 PS) M9DA, M9DB	09.2014→		7.07400.13.0*	DW-TL	EP	mit Halter with holder  M9DA, M9DB: Produktionsdatum bis: 13.11.2015 Production date to: 13.11.2015
			↳ 7.04011.05.0	DW-TL	EP	
			7.07400.14.0*	DW-TL	EP	mit Halter with holder  M9DA, M9DB: Produktionsdatum ab: 13.11.2015 Production date from: 13.11.2015 Produktionsdatum bis: 18.11.2015 Production date to: 18.11.2015
			↳ 7.04011.05.0	DW-TL	EP	

					
FOCUS III Turnier					36
			7.07400.15.0*	DW-TL	EP mit Halter with holder  M9DA, M9DB: Produktionsdatum ab: 18.11.2015 Production date from: 18.11.2015
			↳7.04011.05.0 7.04615.03.0	DW-TL SUV	EP EL
1.5 TDCi 70 kW (95 PS) XXDA, XXDC	09.2014→		7.08681.00.0	EOV	EH  XXDA, XXDC: Produktionsdatum ab: 07.12.2015 Production date from: 07.12.2015
1.5 TDCi 88 kW (120 PS) XWDA, XWDB, XWDC, XWDD, XWDE	09.2014→		7.08681.00.0	EOV	EH  XWDA, XWDB, XWDC, XWDD, XWDE: Produktionsdatum ab: 07.12.2015 Production date from: 07.12.2015
1.5 TDCi ECOnetic 77 kW (105 PS) XXDB	09.2014→		7.08681.00.0	EOV	EH Produktionsdatum ab: 07.12.2015 Production date from: 07.12.2015
1.6 EcoBoost 110 kW (150 PS) JQDA, JQDB, YUDA	07.2010→		7.07400.19.0* ↳7.22687.44.0 7.03162.09.0 7.04492.07.0 7.04269.04.0	EUV-VB EUV-VB LDRV LDRV SUV	EP mit Halter with holder EP EP  JQDA, JQDB, YUDA: Produktionsdatum bis: 30.01.2012 Production date to: 30.01.2012 EP  JQDA, JQDB, YUDA: Produktionsdatum ab: 30.01.2012 Production date from: 30.01.2012 Produktionsdatum bis: 21.07.2015 Production date to: 21.07.2015 EL
1.6 EcoBoost 134 kW (182 PS) JTDA, JTDB	07.2010→		7.07400.19.0* ↳7.22687.44.0 7.03162.09.0 7.04492.07.0 7.04269.04.0	EUV-VB EUV-VB LDRV LDRV SUV	EP mit Halter with holder EP EP  JTDA, JTDB: Produktionsdatum bis: 30.01.2012 Production date to: 30.01.2012 EP  JTDA, JTDB: Produktionsdatum ab: 30.01.2012 Production date from: 30.01.2012 Produktionsdatum bis: 21.07.2015 Production date to: 21.07.2015 EL
1.6 Flexifuel 110 kW (150 PS) YUDA	07.2013→		7.07400.19.0* ↳7.22687.44.0 7.04492.07.0 7.04269.04.0	EUV-VB EUV-VB LDRV SUV	EP mit Halter with holder EP EP Produktionsdatum ab: 30.01.2012 Production date from: 30.01.2012 Produktionsdatum bis: 21.07.2015 Production date to: 21.07.2015 EL
1.6 TDCi 70 kW (95 PS) T3DA, T3DB	07.2010→		7.07400.01.0* ↳7.01633.06.0	STE DW-TL	EP EP
1.6 TDCi 85 kW (115 PS) T1DA, T1DB	07.2010→		7.07400.01.0* ↳7.01633.06.0	STE DW-TL	EP EP
1.6 TDCi ECOnetic 77 kW (105 PS) NGDA, NGDB	05.2012→		7.01633.06.0	DW-TL	EP
1.6 Ti 63 kW (85 PS) XTDA	08.2011→		7.06117.12.0	ZM-NWV	EL mit Dichtring with O-ring →02.2019
2.0 ST 184 kW (250 PS) R9DA	07.2012→		7.03306.16.0 7.07400.06.0*	LDRV STE	EP EP

F















FOCUS III Turnier **36**







		↳ 7.02087.05.0 7.06117.33.0	EUV-VB SV-NWV	EP EL	
2.0 ST 184 kW (250 PS) R9DB, R9DC, R9DD	07.2012→	 7.03306.16.0	LDRV	EP	

FOCUS IV (HN) **37**

F

1.0 EcoBoost 74 kW (101 PS) B3DA	01.2018→	 7.04615.03.0 7.06117.12.0	SUV ZM-NWV	EL EL	mit Dichtring with O-ring →02.2019
1.0 EcoBoost 92 kW (125 PS) B7DA	01.2018→	 7.04615.03.0 7.06117.12.0	SUV ZM-NWV	EL EL	mit Dichtring with O-ring →02.2019
1.0 EcoBoost 63 kW (85 PS) SFDC	05.2018→	 7.04615.03.0 7.06117.12.0	SUV ZM-NWV	EL EL	mit Dichtring with O-ring →02.2019
1.0 EcoBoost mHEV	06.2020→	 7.04615.03.0	SUV	EL	
1.0 EcoBoost mHEV 92 kW (125 PS) B7DA	06.2020→	 7.04615.03.0	SUV	EL	
1.5 EcoBlue 70 kW (95 PS) Z2DA	01.2018→	 7.08681.00.0	EOV	EH	Produktionsdatum ab: 14.05.2018 Production date from: 14.05.2018
1.5 EcoBlue 88 kW (120 PS) ZTDA, ZTDB	01.2018→	 7.08681.00.0	EOV	EH	 ZTDA, ZTDB: Produktionsdatum ab: 14.05.2018 Production date from: 14.05.2018
1.5 EcoBoost 110 kW (150 PS) YZDA	09.2018→	 7.04615.03.0	SUV	EL	
1.5 EcoBoost 134 kW (182 PS) Y1DA	09.2018→	 7.04615.03.0	SUV	EL	
1.5 Ti-VCT 90 kW (123 PS) Y2DA	11.2018→	 7.04615.03.0	SUV	EL	
2.0 EcoBlue 110 kW (150 PS) YLDA	01.2018→	 7.08681.08.0	EOV	EH	Produktionsdatum ab: 20.08.2018 Production date from: 20.08.2018
2.3 ST EcoBoost 206 kW (280 PS) N3DA, N3DB	04.2019→	 7.04615.03.0	SUV	EL	

FOCUS IV Saloon (HM) **38**















1.0 EcoBoost 74 kW (101 PS) B3DA	11.2018→	 7.04615.03.0 7.06117.12.0	SUV ZM-NWV	EL EL	mit Dichtring with O-ring →02.2019
1.0 EcoBoost 92 kW (125 PS) B7DA	11.2018→	 7.04615.03.0 7.06117.12.0	SUV ZM-NWV	EL EL	mit Dichtring with O-ring →02.2019
1.5 EcoBlue 88 kW (120 PS) ZTDA, ZTDB	11.2018→	 7.08681.00.0	EOV	EH	 ZTDA, ZTDB: Produktionsdatum ab: 14.05.2018 Production date from: 14.05.2018
1.5 EcoBoost 110 kW (150 PS) YZDA	11.2018→	 7.04615.03.0	SUV	EL	
1.5 Ti-VCT 90 kW (123 PS) Y2DA	11.2018→	 7.04615.03.0	SUV	EL	
1.5 Ti-VCT 134 kW (182 PS) Y1DA	11.2018→	 7.04615.03.0	SUV	EL	

FOCUS IV Turnier (HP)						39
1.0 EcoBoost 63 kW (85 PS) SFDC	09.2018→		7.04615.03.0	SUV	EL	mit Dichtring with O-ring →02.2019
			7.06117.12.0	ZM-NWV	EL	
1.0 EcoBoost 74 kW (101 PS) B3DA	09.2018→		7.04615.03.0	SUV	EL	mit Dichtring with O-ring →02.2019
			7.06117.12.0	ZM-NWV	EL	
1.0 EcoBoost 92 kW (125 PS) B7DA	09.2018→		7.04615.03.0	SUV	EL	mit Dichtring with O-ring →02.2019
			7.06117.12.0	ZM-NWV	EL	
1.0 EcoBoost mHEV	07.2020→		7.04615.03.0	SUV	EL	
1.0 EcoBoost mHEV	07.2020→		7.04615.03.0	SUV	EL	
1.5 EcoBlue 70 kW (95 PS) Z2DA	09.2018→		7.08681.00.0	EOV	EH	Produktionsdatum ab: 14.05.2018 Production date from: 14.05.2018
1.5 EcoBlue 88 kW (120 PS) ZTDA, ZTDB	09.2018→		7.08681.00.0	EOV	EH	ZTDA, ZTDB: Produktionsdatum ab: 14.05.2018 Production date from: 14.05.2018
1.5 EcoBoost 110 kW (150 PS) YZDA	09.2018→		7.04615.03.0	SUV	EL	
1.5 EcoBoost 134 kW (182 PS) Y1DA	09.2018→		7.04615.03.0	SUV	EL	
1.5 Ti-VCT 90 kW (123 PS) Y2DA	09.2018→		7.04615.03.0	SUV	EL	
2.0 EcoBlue 110 kW (150 PS) YLDA	09.2018→		7.08681.08.0	EOV	EH	Produktionsdatum ab: 20.08.2018 Production date from: 20.08.2018
2.3 ST EcoBoost 206 kW (280 PS) N3DA, N3DB	04.2019→		7.04615.03.0	SUV	EL	
FUSION (USA)						40
1.5 EcoBoost (USA)	07.2013→		7.07400.17.0*	DW-TL	EP	mit Halter with holder
			↳7.04011.05.0	DW-TL	EP	
			7.04615.03.0	SUV	EL	
FUSION (JU_)						41
1.3 44 kW (60 PS) BAJA	11.2002→07.2005		7.05432.13.0	SM	EL	
1.6 TDCi 66 kW (90 PS) HHJA, HHJB	11.2004→12.2012		7.00968.04.0	DW-TL	EP	
FUSION Saloon						42
2.3 107-119 kW (146-162 PS) C23HDEX	05.2006→04.2009		7.06117.55.0	SV-NWV	EH	
2.5 114-131 kW (155-178 PS) C25HDEX	05.2009→12.2012		7.06117.33.0	SV-NWV	EL	
GALAXY I (WGR)						43
1.9 TDI 66 kW (90 PS) 1Z, AHU	03.1995→05.2006		7.21903.70.0	DW-AGR	EP	1Z, AHU: 11.1997→03.2000 1Z, AHU: für Fahrzeuge mit Standheizung for vehicles with parking heater Produktionsdatum ab: 01.04.2000 Production date from: 01.04.2000
			7.21903.75.0	DW-TL	EP	
			7.28098.04.0	EUV-KA	EL	

F



GALAXY I (WGR) **43**

			7.21895.55.0	LDRV	EL	 1Z, AHU: Produktionsdatum ab: 01.11.1995 Production date from: 01.11.1995 Produktionsdatum bis: 30.03.2000 Production date to: 30.03.2000
1.9 TDI 81 kW (110 PS) AFN	08.1997→04.2000		7.21903.70.0	DW-AGR	EP	
			7.21903.75.0	DW-TL	EP	
1.9 TDI 81 kW (110 PS) AVG	08.1997→04.2000		7.21903.70.0	DW-AGR	EP	
1.9 TDI 66 kW (90 PS) ANU	04.2000→05.2006		7.21903.70.0	DW-AGR	EP	
			7.02256.00.0	EUV-AGR	EP	
			7.28098.04.0	EUV-KA	EL	für Fahrzeuge mit Standheizung for vehicles with parking heater
			7.01037.02.0	LDRV	EL	
1.9 TDI 85 kW (115 PS) AUY	04.2000→05.2006		7.02256.00.0	EUV-AGR	EP	
			7.28098.04.0	EUV-KA	EL	für Fahrzeuge mit Standheizung for vehicles with parking heater
1.9 TDI 96 kW (130 PS) ASZ	02.2003→05.2006		7.02256.00.0	EUV-AGR	EP	
			7.28098.04.0	EUV-KA	EL	für Fahrzeuge mit Standheizung for vehicles with parking heater
1.9 TDI 110 kW (150 PS) BTB	05.2005→05.2006		7.02256.00.0	EUV-AGR	EP	
			7.28098.04.0	EUV-KA	EL	für Fahrzeuge mit Standheizung for vehicles with parking heater
2.0 i 85 kW (116 PS) NSE	11.1995→05.2006		7.28098.04.0	EUV-KA	EL	für Fahrzeuge mit Standheizung for vehicles with parking heater Produktionsdatum ab: 01.04.2000 Production date from: 01.04.2000
			4.02003.62.0	LLR	EL	<input checked="" type="checkbox"/>
2.0 i 85 kW (116 PS) ZVSA	11.1995→05.2006		7.28098.04.0	EUV-KA	EL	für Fahrzeuge mit Standheizung for vehicles with parking heater Produktionsdatum ab: 01.04.2000 Production date from: 01.04.2000
			4.02003.62.0	LLR	EL	<input checked="" type="checkbox"/>
			7.06269.00.0	LLR	EL	<input type="checkbox"/>
2.3 16V 107 kW (146 PS) E5SA	03.2000→05.2006		7.28098.04.0	EUV-KA	EL	für Fahrzeuge mit Standheizung for vehicles with parking heater
			7.06269.05.0	LLR	EL	<input type="checkbox"/>
2.3 16V 103 kW (140 PS) E5SB	09.2001→05.2006		7.28098.04.0	EUV-KA	EL	für Fahrzeuge mit Standheizung for vehicles with parking heater
			7.06269.05.0	LLR	EL	<input type="checkbox"/>
2.8 V6 150 kW (204 PS) AYL	04.2000→05.2006		7.28098.04.0	EUV-KA	EL	für OE-Nummer: 1112424, YM21-12B573-GA for OE number: 1112424, YM21-12B573-GA für Fahrzeuge mit Standheizung for vehicles with parking heater
2.8 i V6 128 kW (174 PS) AAA, AMY	11.1995→04.2000		7.21483.54.0	EUV-AGR	EL	
2.8 i V6 4x4 128 kW (174 PS) AAA, AMY	04.1996→04.2000		7.21483.54.0	EUV-AGR	EL	

GALAXY II (WA6) **44**

1.6 EcoBoost 118 kW (160 PS) JTWA, JTWB	11.2010→06.2015		7.07400.19.0*	EUV-VB	EP	mit Halter with holder
			↳ 7.22687.44.0	EUV-VB	EP	

GALAXY II (WA6)
44







			7.03162.09.0	LDRV	EP	JTWA, JTWB: Produktionsdatum bis: 02.04.2012 Production date to: 02.04.2012 JTWA, JTWB: Produktionsdatum ab: 02.04.2012 Production date from: 02.04.2012
			7.04492.07.0	LDRV	EP	
			7.04269.04.0	SUV	EL	
1.6 TDCi 85 kW (115 PS) T1WA, T1WB	02.2011→06.2015		7.07400.00.0*	STE	EP	
			↳ 7.01633.06.0	DW-TL	EP	
2.0 107 kW (145 PS) AOWA, AOWB	05.2006→06.2015		7.02256.48.0	STE	EP	
2.0 EcoBoost 149 kW (203 PS) TNWA	03.2010→06.2015		7.06117.52.0	SV-NWV	EH	Produktionsdatum ab: 06.08.2011 Production date from: 06.08.2011 Einlassseite Intake Side Produktionsdatum bis: 06.08.2011 Production date to: 06.08.2011
			7.06117.53.0	SV-NWV	EH	
			7.06117.55.0	SV-NWV	EH	
2.0 EcoBoost 146 kW (199 PS) TNWB	07.2010→06.2015		7.06117.52.0	SV-NWV	EH	Produktionsdatum ab: 06.08.2011 Production date from: 06.08.2011 Einlassseite Intake Side Produktionsdatum bis: 06.08.2011 Production date to: 06.08.2011
			7.06117.53.0	SV-NWV	EH	
			7.06117.55.0	SV-NWV	EH	
2.0 Flexifuel 107 kW (145 PS) TBWA, TBWB	05.2006→06.2015		7.02256.48.0	STE	EP	
2.0 TDCi 96 kW (130 PS) AZWA	05.2006→06.2015		7.01771.01.0	DW-RK	EP	
			7.01771.01.0	DW-TL	EP	
2.0 TDCi 103 kW (140 PS) QXWA, QXWB, QXWC, UFWA	05.2006→06.2015		7.01771.01.0	DW-RK	EP	
			7.01771.01.0	DW-TL	EP	
2.0 TDCi 85 kW (115 PS) KLWA, TYWA	11.2007→06.2015		7.01771.01.0	DW-AGR	EP	
			7.01771.01.0	DW-RK	EP	
			7.01771.01.0	DW-TL	EP	
2.3 118 kW (160 PS) SEWA	09.2007→06.2015		7.02256.51.0	EUV-SR	EL	für OE-Nummer: 1119940, 1357314, 1S7G-9J559-BA, 1S7G-9J559-BB for OE number: 1119940, 1357314, 1S7G-9J559-BA, 1S7G-9J559-BB
			7.06117.55.0	SV-NWV	EH	

F
GALAXY III (CK)
45







1.5 EcoBoost 118 kW (160 PS) UNCJ	01.2015→06.2018		7.07400.16.0*	DW-TL	EP	mit Halter with holder
			↳ 7.04011.05.0	DW-TL	EP	
			7.04615.03.0	SUV	EL	
1.5 EcoBoost 118 kW (160 PS) UNCK	01.2015→06.2018		7.07400.16.0*	DW-TL	EP	mit Halter with holder
			↳ 7.04011.05.0	DW-TL	EP	
1.5 EcoBoost 121-129 kW (165-175 PS) C15HDTX	07.2018→		7.07400.18.0*	DW-TL	EP	mit Halter with holder
			↳ 7.04011.05.0	DW-TL	EP	
2.0 EcoBlue 88 kW (120 PS) YNCA	07.2018→		7.08681.08.0	EOV	EH	Produktionsdatum ab: 02.07.2018 Production date from: 02.07.2018



GALAXY III (CK) 45

F	2.0 EcoBlue 110 kW (150 PS) YMCB	07.2018→	 7.08681.08.0	EOV	EH	Produktionsdatum ab: 02.07.2018 Production date from: 02.07.2018
	2.0 EcoBlue 140 kW (190 PS) BCCC	07.2018→	 7.08681.08.0	EOV	EH	Produktionsdatum ab: 02.07.2018 Production date from: 02.07.2018
	2.0 EcoBlue 4x4 110 kW (150 PS) YMCB	07.2018→	 7.08681.08.0	EOV	EH	Produktionsdatum ab: 02.07.2018 Production date from: 02.07.2018
	2.0 EcoBlue 4x4 140 kW (190 PS) BCCC	07.2018→	 7.08681.08.0	EOV	EH	Produktionsdatum ab: 02.07.2018 Production date from: 02.07.2018
	2.0 EcoBlue Bi-Turbo 176 kW (240 PS) YLCB	07.2018→	 7.08681.08.0	EOV	EH	Produktionsdatum ab: 02.07.2018 Production date from: 02.07.2018
	2.0 EcoBoost 176 kW (240 PS) R9CD, R9CI	01.2015→	 7.04492.07.0	LDRV	EP	 R9CD, R9CI: für OE-Nummer: 2010734, CJ5G-9K378-BB, CJ5Z-9K378-B for OE number: 2010734, CJ5G-9K378-BB, CJ5Z-9K378-B
				7.07400.06.0*	STE	EP
↳ 7.02087.05.0				EUV-VB	EP	
			7.06117.33.0	SV-NWV	EL	

GRAND C-MAX (DXA/CB7, DXA/CEU) 46

1.0 EcoBoost 74 kW (100 PS) M2DA	10.2012→	 7.06117.12.0	ZM-NWV	EL	mit Dichtring with O-ring →03.2019	
1.0 EcoBoost 74 kW (100 PS) M2DC	10.2012→	 7.22687.44.0	EUV-VB	EP	für heiße Klimazonen for hot climate zones	
1.0 EcoBoost 92 kW (125 PS) B7DA, M1DA	10.2012→	 7.06117.12.0	ZM-NWV	EL	mit Dichtring with O-ring  B7DA, M1DA: →03.2019	
1.0 EcoBoost 92 kW (125 PS) M1DD	10.2012→	 7.22687.44.0	EUV-VB	EP	für heiße Klimazonen for hot climate zones	
			7.06117.12.0	ZM-NWV	EL	mit Dichtring with O-ring →03.2019
1.5 EcoBoost 110 kW (150 PS) M8DB	03.2015→	 7.07400.13.0*	DW-TL	EP	mit Halter with holder Produktionsdatum bis: 13.11.2015 Production date to: 13.11.2015	
			↳ 7.04011.05.0	DW-TL	EP	
			7.07400.14.0*	DW-TL	EP	mit Halter with holder Produktionsdatum ab: 13.11.2015 Production date from: 13.11.2015 Produktionsdatum bis: 18.11.2015 Production date to: 18.11.2015
			↳ 7.04011.05.0	DW-TL	EP	
			7.07400.15.0*	DW-TL	EP	mit Halter with holder Produktionsdatum ab: 18.11.2015 Production date from: 18.11.2015
1.5 EcoBoost 132-134 kW (179-182 PS) M9DB	03.2015→	 7.07400.13.0*	DW-TL	EP	mit Halter with holder Produktionsdatum bis: 13.11.2015 Production date to: 13.11.2015	
			↳ 7.04011.05.0	DW-TL	EP	
			7.07400.14.0*	DW-TL	EP	mit Halter with holder Produktionsdatum ab: 13.11.2015 Production date from: 13.11.2015 Produktionsdatum bis: 18.11.2015 Production date to: 18.11.2015

GRAND C-MAX (DXA/CB7, DXA/CEU)
46

			↳ 7.04011.05.0 7.07400.15.0*	DW-TL DW-TL	EP EP	mit Halter with holder Produktionsdatum ab: 18.11.2015 Production date from: 18.11.2015
			↳ 7.04011.05.0 7.08681.00.0	DW-TL EOV	EP EH	
1.5 TDCi 70 kW (95 PS) XXDA, XXDC	03.2015→		7.08681.00.0 7.07400.01.0* ↳ 7.01633.06.0	EOV STE DW-TL	EH EP EP	XXDA, XXDC: Produktionsdatum ab: 07.12.2015 Production date from: 07.12.2015
1.5 TDCi 88 kW (120 PS) XWDA, XWDB, XWDD	03.2015→		7.08681.00.0 7.07400.01.0* ↳ 7.01633.06.0	EOV STE DW-TL	EH EP EP	XWDA, XWDB, XWDD: Produktionsdatum ab: 07.12.2015 Production date from: 07.12.2015
1.5 TDCi 88 kW (120 PS) XWDC, XWDE	03.2015→		7.07400.01.0* ↳ 7.01633.06.0	STE DW-TL	EP EP	
1.6 EcoBoost 110 kW (150 PS) JQDA, JQDB	12.2010→		7.07400.19.0* ↳ 7.22687.44.0 7.03162.09.0 7.04492.07.0 7.04269.04.0	EUV-VB EUV-VB LDRV LDRV SUV	EP EP EP EP EL	mit Halter with holder JQDA, JQDB: Produktionsdatum bis: 30.01.2012 Production date to: 30.01.2012 JQDA, JQDB: Produktionsdatum ab: 30.01.2012 Production date from: 30.01.2012 Produktionsdatum bis: 02.06.2015 Production date to: 02.06.2015
1.6 EcoBoost 134 kW (182 PS) JTDA, JTDB	12.2010→		7.07400.19.0* ↳ 7.22687.44.0 7.03162.09.0 7.04492.07.0 7.04269.04.0	EUV-VB EUV-VB LDRV LDRV SUV	EP EP EP EP EL	mit Halter with holder JTDA, JTDB: Produktionsdatum bis: 30.01.2012 Production date to: 30.01.2012 JTDA, JTDB: Produktionsdatum ab: 30.01.2012 Production date from: 30.01.2012 Produktionsdatum bis: 02.06.2015 Production date to: 02.06.2015
1.6 TDCi 70 kW (95 PS) T3DA, T3DB	12.2010→		7.07400.01.0* ↳ 7.01633.06.0	STE DW-TL	EP EP	T3DA, T3DB: Produktionsdatum bis: 07.12.2019 Production date to: 07.12.2019
1.6 TDCi 85 kW (115 PS) T1DA, T1DB	12.2010→		7.07400.01.0* ↳ 7.01633.06.0	STE DW-TL	EP EP	T1DA, T1DB: Produktionsdatum bis: 07.12.2019 Production date to: 07.12.2019

F
GT
47















3.5 EcoBoost V6 254-483 kW (345-657 PS) C35PDTD	09.2016→		7.04615.03.0	SUV	EL	
--	----------	--	---------------------	-----	----	--

KA (RB_)
48

1.3 i 37 kW (50 PS) JJB	09.1996→10.2002		7.06269.02.0 7.06269.03.0	LLR LLR	EL EL	→09.1998 10.1998→
-----------------------------------	-----------------	--	--	----------------	--------------	----------------------



KA (RB_) **48**

1.3 i 44 kW (60 PS) BAA	09.1996→11.2008	 7.06269.02.0	LLR	EL	 →09.1998
		7.06269.03.0	LLR	EL	 10.1998→
		7.05432.13.0	SM	EL	
1.3 i 44 kW (60 PS) J4D, J4K, J4M, J4N, J4P, J4S	09.1996→11.2008	 7.06269.02.0	LLR	EL	 J4D, J4K, J4M, J4N, J4P, J4S: →09.1998
		7.06269.03.0	LLR	EL	 J4D, J4K, J4M, J4N, J4P, J4S: 10.1998→
1.3 i 36 kW (49 PS) JJD, JJF, JJG, JJH, JJJ	06.1998→11.2008	 7.06269.02.0	LLR	EL	 JJD, JJF, JJG, JJH, JJJ: →09.1998
		7.06269.03.0	LLR	EL	 JJD, JJF, JJG, JJH, JJJ: 10.1998→
1.3 i 51 kW (70 PS) A9A, A9B	08.2002→11.2008	 7.05432.13.0	SM	EL	
1.6 i 70 kW (95 PS) CDB, CDC	02.2001→11.2008	 7.05432.13.0	SM	EL	

F

KA (RU8) **49**

1.2 51 kW (69 PS) 169A4000	10.2008→05.2016	 7.06117.38.0	SV-NWV	EL	mit Dichtring with O-ring
1.3 TDCi 55 kW (75 PS) 169A1000, FD4	10.2008→05.2016	 7.00607.02.0	DW-TL	EP	
		7.01981.07.0	SV-AGR-K	EP	 169A1000, FD4: Produktionsdatum ab: 02.11.2010 Production date from: 02.11.2010



KA+ III (UK, FK) **50**

1.5 TDCi 66-74 kW (91-101 PS) 15DSOX, DV5FD	02.2018→	 7.08681.00.0	EOV	EH	
--	----------	---	-----	----	--

KUGA I **51**



































2.0 TDCi 100 kW (136 PS) G6DG, UKDA	03.2008→11.2012	 7.01771.01.0	DW-AGR	EP	
		7.01771.01.0	DW-RK	EP	
		7.01771.01.0	DW-TL	EP	
2.0 TDCi 4x4 100 kW (136 PS) G6DG, UKDA	03.2008→11.2012	 7.01771.01.0	DW-AGR	EP	
		7.01771.01.0	DW-RK	EP	
		7.01771.01.0	DW-TL	EP	
2.5 147 kW (200 PS) HYDB	03.2009→11.2012	 7.02256.39.0	AKF	EL	
		7.28197.16.0	LDRV	EL	
2.5 147 kW (200 PS) HYDC	03.2009→11.2012	 7.28197.16.0	LDRV	EL	
		7.02256.39.0	AKF	EL	
2.5 4x4 147 kW (200 PS) HYDB	02.2008→11.2012	 7.02256.39.0	AKF	EL	
		7.28197.16.0	LDRV	EL	
2.5 4x4 147 kW (200 PS) HYDC	02.2008→11.2012	 7.28197.16.0	LDRV	EL	





































KUGA II (DM2) **52**

1.5 EcoBoost 110 kW (150 PS) M8MA	09.2014→	 7.07400.13.0*	DW-TL	EP	mit Halter with holder
		↳ 7.04011.05.0	DW-TL	EP	
1.5 EcoBoost 88 kW (120 PS) BNMA	01.2016→	 7.07400.13.0*	DW-TL	EP	mit Halter with holder
		↳ 7.04011.05.0	DW-TL	EP	
1.5 EcoBoost 132-134 kW (182 PS) M9MA	06.2016→	 7.07400.13.0*	DW-TL	EP	mit Halter with holder

KUGA II (DM2)					52
			↳ 7.04011.05.0 7.07400.15.0*	DW-TL DW-TL	EP EP mit Halter with holder USA USA
			↳ 7.04011.05.0 7.07400.13.0*	DW-TL DW-TL	EP EP mit Halter with holder
1.5 EcoBoost 4x4 132-134 kW (182 PS) M9MA	09.2014→		↳ 7.04011.05.0 7.07400.14.0*	DW-TL DW-TL	EP EP mit Halter with holder USA USA
			↳ 7.04011.05.0 7.07400.13.0*	DW-TL DW-TL	EP EP mit Halter with holder
1.5 EcoBoost 4x4 110 kW (150 PS) M8MA	07.2016→		↳ 7.04011.05.0 7.07400.13.0*	DW-TL DW-TL	EP EP mit Halter with holder
1.5 EcoBoost 4x4 121-129 kW (165-175 PS) C15HDTX	08.2018→		↳ 7.04011.05.0 7.07400.13.0*	DW-TL DW-TL	EP EP mit Halter with holder
1.5 TDCi 88 kW (120 PS) XWMB, XWMC	07.2016→		7.08681.00.0	EOV	EH XWMB, XWMC: Produktionsdatum ab: 19.09.2016 Production date from: 19.09.2016
1.6 EcoBoost 110 kW (150 PS) JQMA, JQMB	03.2013→		7.04492.07.0 7.04269.04.0	LDRV SUV	EP EL
1.6 EcoBoost 4x4 130-134 kW (179-182 PS) JTMA	10.2012→04.2015		7.04492.07.0 7.04269.04.0	LDRV SUV	EP EL Produktionsdatum ab: 05.11.2012 Production date from: 05.11.2012
1.6 EcoBoost 4x4 130-134 kW (179-182 PS) JTMA	03.2013→		7.04492.07.0 7.04269.04.0	LDRV SUV	EP EL
1.6 EcoBoost 4x4 110 kW (150 PS) JQMA, JQMB	03.2013→		7.04492.07.0 7.04269.04.0	LDRV SUV	EP EL
2.0 179-183 kW (243-249 PS) TPWA	03.2013→06.2016		7.02256.53.0 7.06117.33.0	DW-TL SV-NWV	EP EL
2.0 179-183 kW (243-249 PS) TPWA	06.2016→		7.02256.53.0 7.06117.33.0	DW-TL SV-NWV	EP EL
2.0 4x4 179-183 kW (243-249 PS) TPWA	06.2016→		7.02256.53.0 7.06117.33.0	DW-TL SV-NWV	EP EL
2.0 EcoBoost 4x4 177-178 kW (241-242 PS) R9MA	08.2017→		7.03306.16.0 7.07400.06.0* ↳ 7.02087.05.0 7.04615.03.0 7.06117.33.0	LDRV STE EUV-VB SUV SV-NWV	EP EP EL EL
2.5	09.2013→		7.06117.33.0	SV-NWV	EL

















F

			 PIERBURG			
KUGA II (DM2)						52
2.5 110 kW (150 PS) YTMA	01.2014→		7.06117.33.0	SV-NWV	EL	
2.5 4x4 114-131 kW (155-178 PS) C25HDEX	09.2014→		7.06117.33.0	SV-NWV	EL	
KUGA III (DFK)						53
2.0 EcoBlue 4x4 140 kW (190 PS) YMDA	07.2019→		7.08681.08.0	EOV	EH	
2.0 EcoBlue mHEV 110 kW (150 PS) YLDC	07.2019→		7.08681.08.0	EOV	EH	Produktionsdatum ab: 07.01.2020 Production date from: 07.01.2020
MAVERICK						54
2.0 16V 91 kW (124 PS) YF	02.2001→		7.02256.46.0	EUV-AGR	EL	
2.0 16V FWD 91 kW (124 PS) YF	02.2001→		7.02256.46.0	EUV-AGR	EL	
3.0 V6 24V 145-149 kW (197-203 PS) AJ	02.2001→		7.02256.46.0	EUV-AGR	EL	
3.0 V6 24V 145-149 kW (197-203 PS) AJ	03.2004→		7.02256.46.0	EUV-AGR	EL	
3.0 V6 24V FWD 145-149 kW (197-203 PS) AJ	02.2001→		7.02256.46.0	EUV-AGR	EL	
MONDEO I (GBP)						55
1.6 i 16V 66 kW (90 PS) L1F	02.1993→08.1996		7.02256.29.0	EUV-AGR	EL	
			7.06269.28.0	LLR	EL	
1.6 i 16V 65-66 kW (88-90 PS) L1J	07.1994→07.1996		7.02256.29.0	EUV-AGR	EL	
			7.06269.28.0	LLR	EL	
1.8 TD 65-66 kW (88-90 PS) RFM, RFN	06.1993→08.1996		7.02256.47.0	EUV-AGR	EL	 RFM, RFN: Produktionsdatum ab: 01.03.1995 Production date from: 01.03.1995
1.8 TD 65-66 kW (88-90 PS) RFM, RFN	10.1995→08.1996		7.02256.47.0	EUV-AGR	EL	
1.8 i 16V 85 kW (115 PS) RKA	02.1993→08.1996		7.02256.29.0	EUV-AGR	EL	
			7.06269.28.0	LLR	EL	
1.8 i 16V 82-85 kW (111-116 PS) RKB	07.1994→08.1996		7.02256.29.0	EUV-AGR	EL	
			7.06269.28.0	LLR	EL	
1.8 i 16V 4x4 85 kW (115 PS) RKA	02.1993→08.1996		7.02256.29.0	EUV-AGR	EL	
			7.06269.28.0	LLR	EL	
2.0 i 16V 96-100 kW (131-136 PS) NGA	02.1993→08.1996		7.02256.29.0	EUV-AGR	EL	
			7.06269.28.0	LLR	EL	
2.0 i 16V 96-100 kW (131-136 PS) NGA	12.1994→08.1996		7.02256.29.0	EUV-AGR	EL	
			7.06269.28.0	LLR	EL	
2.0 i 16V 4x4 96-100 kW (131-136 PS) NGA	04.1993→08.1996		7.02256.29.0	EUV-AGR	EL	
			7.06269.28.0	LLR	EL	







						
MONDEO I (GBP)						55
2.0 i 16V 4x4 96-100 kW (131-136 PS) NGA	12.1994→08.1996		7.02256.29.0	EUV-AGR	EL	
			7.06269.28.0	LLR	EL	
2.5 i 24V 125 kW (170 PS) SEA	07.1994→08.1996		7.02256.46.0	EUV-AGR	EL	für OE-Nummer: 3508280, 3998144, F57E-9J459-CA, F63E-9J459-AA for OE number: 3508280, 3998144, F57E-9J459-CA, F63E-9J459-AA
			7.06269.11.0	LLR	EL	 08.1994→
MONDEO I Saloon (GBP)						56
1.6 i 16V 66 kW (90 PS) L1F	02.1993→08.1996		7.02256.29.0	EUV-AGR	EL	
			7.06269.28.0	LLR	EL	
1.6 i 16V 65-66 kW (88-90 PS) L1J	07.1994→07.1996		7.02256.29.0	EUV-AGR	EL	
			7.06269.28.0	LLR	EL	
1.8 4x4 85 kW (115 PS) RKA	02.1993→08.1996		7.02256.29.0	EUV-AGR	EL	
			7.06269.28.0	LLR	EL	
1.8 TD 65-66 kW (88-90 PS) RFM, RFN	06.1993→08.1996		7.02256.47.0	EUV-AGR	EL	 RFM, RFN: Produktionsdatum ab: 01.03.1995 Production date from: 01.03.1995
			7.02256.47.0	EUV-AGR	EL	
1.8 i 16V 85 kW (115 PS) RKA	02.1993→08.1996		7.02256.29.0	EUV-AGR	EL	
			7.06269.28.0	LLR	EL	
1.8 i 16V 82-85 kW (111-116 PS) RKB	01.1994→08.1996		7.02256.29.0	EUV-AGR	EL	
			7.06269.28.0	LLR	EL	
2.0 i 16V 96-100 kW (131-136 PS) NGA	02.1993→08.1996		7.02256.29.0	EUV-AGR	EL	
			7.06269.28.0	LLR	EL	
2.0 i 16V 4x4 96-100 kW (131-136 PS) NGA	02.1993→08.1996		7.02256.29.0	EUV-AGR	EL	
			7.06269.28.0	LLR	EL	
2.0 i 16V 4x4 96-100 kW (131-136 PS) NGA	12.1994→08.1996		7.02256.29.0	EUV-AGR	EL	
			7.06269.28.0	LLR	EL	
2.5 i 24V 125 kW (170 PS) SEA	07.1994→08.1996		7.02256.46.0	EUV-AGR	EL	für OE-Nummer: 3508280, 3998144, F57E-9J459-CA, F63E-9J459-AA for OE number: 3508280, 3998144, F57E-9J459-CA, F63E-9J459-AA
			7.06269.11.0	LLR	EL	 08.1994→
MONDEO I Turnier (BNP)						57
1.6 i 16V 66 kW (90 PS) L1F	04.1993→08.1996		7.02256.29.0	EUV-AGR	EL	
			7.06269.28.0	LLR	EL	
1.6 i 16V 65-66 kW (88-90 PS) L1J	07.1994→07.1996		7.02256.29.0	EUV-AGR	EL	
			7.06269.28.0	LLR	EL	
1.8 TD 65-66 kW (88-90 PS) RFM, RFN	06.1993→08.1996		7.02256.47.0	EUV-AGR	EL	 RFM, RFN: Produktionsdatum ab: 01.03.1995 Production date from: 01.03.1995



MONDEO I Turnier (BNP) **57**

F	1.8 TD 65-66 kW (88-90 PS) RFM, RFN	11.1995→08.1996	 7.02256.47.0	EUV-AGR	EL	
	1.8 i 16V 85 kW (115 PS) RKA	04.1993→08.1996	 7.02256.29.0 7.06269.28.0	EUV-AGR LLR	EL EL	
	1.8 i 16V 82-85 kW (111-116 PS) RKB	07.1994→08.1996	 7.02256.29.0 7.06269.28.0	EUV-AGR LLR	EL EL	
	1.8 i 16V 4x4 85 kW (115 PS) RKA	04.1993→08.1996	 7.02256.29.0 7.06269.28.0	EUV-AGR LLR	EL EL	
	2.0 i 16V 96-100 kW (131-136 PS) NGA	01.1993→08.1996	 7.02256.29.0 7.06269.28.0	EUV-AGR LLR	EL EL	
	2.0 i 16V 96-100 kW (131-136 PS) NGA	04.1993→08.1996	 7.02256.29.0 7.06269.28.0	EUV-AGR LLR	EL EL	
	2.0 i 16V 4x4 96-100 kW (131-136 PS) NGA	04.1993→08.1996	 7.02256.29.0 7.06269.28.0	EUV-AGR LLR	EL EL	
	2.0 i 16V 4x4 96-100 kW (131-136 PS) NGA	12.1994→08.1996	 7.02256.29.0 7.06269.28.0	EUV-AGR LLR	EL EL	
	2.5 i 24V 125 kW (170 PS) SEA	07.1994→08.1996	 7.02256.46.0 7.06269.11.0	EUV-AGR LLR	EL EL	für OE-Nummer: 3508280, 3998144, F57E-9J459-CA, F63E-9J459-AA for OE number: 3508280, 3998144, F57E-9J459-CA, F63E-9J459-AA  08.1994→

MONDEO II (BAP) **58**

	1.6 i 65-66 kW (88-90 PS) L1J	08.1996→09.2000	 7.02256.29.0 7.02256.46.0 7.06269.02.0 7.06269.24.0	EUV-AGR EUV-AGR LLR LLR	EL EL EL EL	für OE-Nummer: 3508280, 3998144, F57E-9J459-CA, F63E-9J459-AA for OE number: 3508280, 3998144, F57E-9J459-CA, F63E-9J459-AA  01.1998→ für OE-Nummer: 1063996, 95BF-9F715-AC for OE number: 1063996, 95BF-9F715-AC  für OE-Nummer: 1022494, 978F-9F715-AB for OE number: 1022494, 978F-9F715-AB
	1.6 i 16V 70 kW (95 PS) L1L, L1N, L1Q	05.1998→09.2000	 7.02256.29.0 7.02256.46.0 7.06269.02.0	EUV-AGR EUV-AGR LLR	EL EL EL	 L1L, L1N, L1Q: für OE-Nummer: 3508280, 3998144, F57E-9J459-CA, F63E-9J459-AA for OE number: 3508280, 3998144, F57E-9J459-CA, F63E-9J459-AA  L1L, L1N, L1Q: für OE-Nummer: 1063996, 95BF-9F715-AC for OE number: 1063996, 95BF-9F715-AC

MONDEO II (BAP)
58

			7.06269.24.0	LLR	EL	L1L, L1N, L1Q: für OE-Nummer: 1022494, 978F-9F715-AB for OE number: 1022494, 978F-9F715-AB
1.8 TD 65-66 kW (88-90 PS) RFN	08.1996→09.2000		7.02256.47.0	EUV-AGR	EL	
1.8 i 82-85 kW (111-116 PS) RKB, RKF, RKH, RKJ, RKK	08.1996→09.2000		7.02256.29.0	EUV-AGR	EL	
			7.02256.46.0	EUV-AGR	EL	RKB, RKF, RKH, RKJ, RKK: für OE-Nummer: 3508280, 3998144, F57E-9J459-CA, F63E-9J459-AA for OE number: 3508280, 3998144, F57E-9J459-CA, F63E-9J459-AA
			7.06269.02.0	LLR	EL	RKB, RKF, RKH, RKJ, RKK: 01.1998→ für OE-Nummer: 1063996, 95BF-9F715-AC for OE number: 1063996, 95BF-9F715-AC
			7.06269.24.0	LLR	EL	RKB, RKF, RKH, RKJ, RKK: für OE-Nummer: 1022494, 978F-9F715-AB for OE number: 1022494, 978F-9F715-AB
2.0 i 96-100 kW (131-136 PS) NGA, NGB, NGC, NGD	08.1996→09.2000		7.02256.29.0	EUV-AGR	EL	
			7.02256.46.0	EUV-AGR	EL	NGA, NGB, NGC, NGD: für OE-Nummer: 3508280, 3998144, F57E-9J459-CA, F63E-9J459-AA for OE number: 3508280, 3998144, F57E-9J459-CA, F63E-9J459-AA
			7.06269.24.0	LLR	EL	
2.5 24V 125 kW (170 PS) SEA	08.1996→09.2000		7.02256.46.0	EUV-AGR	EL	für OE-Nummer: 3508280, 3998144, F57E-9J459-CA, F63E-9J459-AA for OE number: 3508280, 3998144, F57E-9J459-CA, F63E-9J459-AA
			7.06269.21.0	LLR	EL	
2.5 24V 125 kW (170 PS) SEB, SEC	06.2000→09.2000		7.02256.46.0	EUV-AGR	EL	SEB, SEC: für OE-Nummer: 3508280, 3998144, F57E-9J459-CA, F63E-9J459-AA for OE number: 3508280, 3998144, F57E-9J459-CA, F63E-9J459-AA
			7.06269.21.0	LLR	EL	
2.5 ST 200 151 kW (205 PS) SGA	05.1999→09.2000		7.02256.46.0	EUV-AGR	EL	für OE-Nummer: 3508280, 3998144, F57E-9J459-CA, F63E-9J459-AA for OE number: 3508280, 3998144, F57E-9J459-CA, F63E-9J459-AA
			7.06269.21.0	LLR	EL	

F
MONDEO II Saloon (BFP)
59







1.6 i 65-66 kW (88-90 PS) L1J	08.1996→09.2000		7.02256.29.0	EUV-AGR	EL	
			7.02256.46.0	EUV-AGR	EL	für OE-Nummer: 3508280, 3998144, F57E-9J459-CA, F63E-9J459-AA for OE number: 3508280, 3998144, F57E-9J459-CA, F63E-9J459-AA
			7.06269.02.0	LLR	EL	01.1998→ für OE-Nummer: 1063996, 95BF-9F715-AC for OE number: 1063996, 95BF-9F715-AC
			7.06269.24.0	LLR	EL	für OE-Nummer: 1022494, 978F-9F715-AB for OE number: 1022494, 978F-9F715-AB



MONDEO II Saloon (BFP)

59

F





1.6 i 16V 70 kW (95 PS) L1L, L1N, L1Q	05.1998→09.2000	 7.02256.29.0	EUV-AGR	EL	L1L, L1N, L1Q: für OE-Nummer: 3508280, 3998144, F57E-9J459-CA, F63E-9J459-AA for OE number: 3508280, 3998144, F57E-9J459-CA, F63E-9J459-AA L1L, L1N, L1Q: für OE-Nummer: 1063996, 95BF-9F715-AC for OE number: 1063996, 95BF-9F715-AC L1L, L1N, L1Q: für OE-Nummer: 1022494, 978F-9F715-AB for OE number: 1022494, 978F-9F715-AB
		7.02256.46.0	EUV-AGR	EL	
		7.06269.02.0	LLR	EL	
1.8 TD 65-66 kW (88-90 PS) RFN	08.1996→09.2000	 7.02256.47.0	EUV-AGR	EL	
		 7.02256.29.0 7.02256.46.0	EUV-AGR	EL	RKB, RKF, RKH, RKJ, RKK: für OE-Nummer: 3508280, 3998144, F57E-9J459-CA, F63E-9J459-AA for OE number: 3508280, 3998144, F57E-9J459-CA, F63E-9J459-AA
			7.06269.02.0	LLR	
1.8 i 82-85 kW (111-116 PS) RKB, RKF, RKH, RKJ, RKK	08.1996→09.2000	7.02256.29.0	EUV-AGR	EL	RKB, RKF, RKH, RKJ, RKK: 01.1998→ für OE-Nummer: 1063996, 95BF-9F715-AC for OE number: 1063996, 95BF-9F715-AC RKB, RKF, RKH, RKJ, RKK: für OE-Nummer: 1022494, 978F-9F715-AB for OE number: 1022494, 978F-9F715-AB
		7.02256.46.0	EUV-AGR	EL	
		7.06269.02.0	LLR	EL	
2.0 i 96-100 kW (131-136 PS) NGA, NGB, NGC, NGD	08.1996→09.2000	 7.02256.29.0	EUV-AGR	EL	NGA, NGB, NGC, NGD: für OE-Nummer: 3508280, 3998144, F57E-9J459-CA, F63E-9J459-AA for OE number: 3508280, 3998144, F57E-9J459-CA, F63E-9J459-AA
		7.02256.46.0	EUV-AGR	EL	
		7.06269.24.0	LLR	EL	
2.5 24V 125 kW (170 PS) SEA	08.1996→09.2000	 7.02256.46.0	EUV-AGR	EL	für OE-Nummer: 3508280, 3998144, F57E-9J459-CA, F63E-9J459-AA for OE number: 3508280, 3998144, F57E-9J459-CA, F63E-9J459-AA
		7.06269.21.0	LLR	EL	
2.5 24V 125 kW (170 PS) SEB, SEC	06.2000→09.2000	 7.02256.46.0	EUV-AGR	EL	SEB, SEC: für OE-Nummer: 3508280, 3998144, F57E-9J459-CA, F63E-9J459-AA for OE number: 3508280, 3998144, F57E-9J459-CA, F63E-9J459-AA
		7.06269.21.0	LLR	EL	
2.5 ST 200 151 kW (205 PS) SGA	05.1999→09.2000	 7.02256.46.0	EUV-AGR	EL	für OE-Nummer: 3508280, 3998144, F57E-9J459-CA, F63E-9J459-AA for OE number: 3508280, 3998144, F57E-9J459-CA, F63E-9J459-AA
		7.06269.21.0	LLR	EL	

MONDEO II Turnier (BNP)					
60					
1.6 i 65-66 kW (88-90 PS) L1J	08.1996→09.2000		7.02256.29.0	EUV-AGR	EL
			7.02256.46.0	EUV-AGR	EL
			7.06269.02.0	LLR	EL
			7.06269.24.0	LLR	EL
für OE-Nummer: 3508280, 3998144, F57E-9J459-CA, F63E-9J459-AA for OE number: 3508280, 3998144, F57E-9J459-CA, F63E-9J459-AA					
01.1998→ für OE-Nummer: 1063996, 95BF-9F715-AC for OE number: 1063996, 95BF-9F715-AC					
für OE-Nummer: 1022494, 978F-9F715-AB for OE number: 1022494, 978F-9F715-AB					
1.6 i 16V 70 kW (95 PS) L1L, L1N, L1Q	05.1998→09.2000		7.02256.29.0	EUV-AGR	EL
			7.02256.46.0	EUV-AGR	EL
			7.06269.02.0	LLR	EL
			7.06269.24.0	LLR	EL
für OE-Nummer: 3508280, 3998144, F57E-9J459-CA, F63E-9J459-AA for OE number: 3508280, 3998144, F57E-9J459-CA, F63E-9J459-AA					
für OE-Nummer: 1063996, 95BF-9F715-AC for OE number: 1063996, 95BF-9F715-AC					
für OE-Nummer: 1022494, 978F-9F715-AB for OE number: 1022494, 978F-9F715-AB					
1.8 TD 65-66 kW (88-90 PS) RFN	08.1996→09.2000		7.02256.47.0	EUV-AGR	EL
1.8 i 82-85 kW (111-116 PS) RKB, RKF, RKH, RKJ, RKK	08.1996→09.2000		7.02256.29.0	EUV-AGR	EL
			7.02256.46.0	EUV-AGR	EL
			7.06269.02.0	LLR	EL
			7.06269.24.0	LLR	EL
für OE-Nummer: 3508280, 3998144, F57E-9J459-CA, F63E-9J459-AA for OE number: 3508280, 3998144, F57E-9J459-CA, F63E-9J459-AA					
01.1998→ für OE-Nummer: 1063996, 95BF-9F715-AC for OE number: 1063996, 95BF-9F715-AC					
für OE-Nummer: 1022494, 978F-9F715-AB for OE number: 1022494, 978F-9F715-AB					
1.8 i 85 kW (115 PS) RKA	08.1996→09.2000		7.06269.02.0	LLR	EL
01.1998→ für OE-Nummer: 1063996, 95BF-9F715-AC for OE number: 1063996, 95BF-9F715-AC					
2.0 i 96-100 kW (131-136 PS) NGA, NGB, NGC, NGD	08.1996→09.2000		7.02256.29.0	EUV-AGR	EL
			7.02256.46.0	EUV-AGR	EL
			7.06269.02.0	LLR	EL
			7.06269.24.0	LLR	EL
für OE-Nummer: 3508280, 3998144, F57E-9J459-CA, F63E-9J459-AA for OE number: 3508280, 3998144, F57E-9J459-CA, F63E-9J459-AA					













F







MONDEO II Turnier (BNP) **60**























2.5 24V 125 kW (170 PS) SEA	08.1996→09.2000		7.02256.46.0	EUV-AGR	EL	für OE-Nummer: 3508280, 3998144, F57E-9J459-CA, F63E-9J459-AA for OE number: 3508280, 3998144, F57E-9J459-CA, F63E-9J459-AA
			7.06269.21.0	LLR	EL	
2.5 24V 125 kW (170 PS) SEB, SEC	10.1999→09.2000		7.02256.46.0	EUV-AGR	EL	 SEB, SEC: für OE-Nummer: 3508280, 3998144, F57E-9J459-CA, F63E-9J459-AA for OE number: 3508280, 3998144, F57E-9J459-CA, F63E-9J459-AA
			7.06269.21.0	LLR	EL	
2.5 ST 200 151 kW (205 PS) SGA	05.1999→09.2000		7.02256.46.0	EUV-AGR	EL	für OE-Nummer: 3508280, 3998144, F57E-9J459-CA, F63E-9J459-AA for OE number: 3508280, 3998144, F57E-9J459-CA, F63E-9J459-AA
			7.06269.21.0	LLR	EL	

MONDEO III (B5Y) **61**

1.8 16V 81 kW (110 PS) CGBA, CGBB	10.2000→03.2007		7.02256.51.0	EUV-SR	EL	
			7.06269.22.0	LLR	EL	
1.8 16V 92 kW (125 PS) CHBA, CHBB	10.2000→03.2007		7.02256.51.0	EUV-SR	EL	
			7.06269.22.0	LLR	EL	
2.0 16V 106-107 kW (144-146 PS) CJBA, CJBB	10.2000→03.2007		7.02256.51.0	EUV-SR	EL	
			7.06269.22.0	LLR	EL	
2.0 16V DI / TDDi / TDCi 66 kW (90 PS) SDBA	10.2000→03.2007		7.01122.03.0*	DW-AGR	EP	mit Halter with holder Euro 4 Euro 4 Produktionsdatum ab: 02.03.2006 Production date from: 02.03.2006
			↳ 7.00756.05.0	DW-AGR	EP	
2.0 16V TDDi / TDCi 85 kW (115 PS) HJBA, HJBB, HJBC	10.2000→03.2007		7.01122.03.0*	DW-AGR	EP	mit Halter with holder  HJBA, HJBB, HJBC: Euro 4 Euro 4 für Fahrzeuge mit Schaltgetriebe for vehicles with manual transmission Produktionsdatum ab: 01.08.2005 Production date from: 01.08.2005
			↳ 7.00756.05.0	DW-AGR	EP	
			7.01349.01.0*	DW-AGR	EP	mit Halter with holder  HJBA, HJBB, HJBC: Euro 4 Euro 4 für Fahrzeuge mit Diesel-Partikel-Filter (DPF) for vehicles with diesel soot filter Produktionsdatum ab: 06.02.2006 Production date from: 06.02.2006
			↳ 7.00756.05.0	DW-AGR	EP	
2.5 V6 24V 125 kW (170 PS) LCBD	10.2000→03.2007		7.06269.10.0	LLR	EL	

MONDEO III Saloon (B4Y) **62**



1.8 16V 81 kW (110 PS) CGBA, CGBB	10.2000→03.2007		7.02256.51.0	EUV-SR	EL	
			7.06269.22.0	LLR	EL	
1.8 16V 92 kW (125 PS) CHBA, CHBB	10.2000→03.2007		7.02256.51.0	EUV-SR	EL	
			7.06269.22.0	LLR	EL	

					
MONDEO III Saloon (B4Y)					
62					
2.0 16V 106-107 kW (144-146 PS) CJBA, CJBB	10.2000→03.2007		7.02256.51.0	EUV-SR	EL
			7.06269.22.0	LLR	EL 
2.0 16V DI / TDDi / TDCi 66 kW (90 PS) SDBA	10.2000→03.2007		7.01122.03.0*	DW-AGR	EP mit Halter with holder Euro 4 Euro 4 Produktionsdatum ab: 02.03.2006 Production date from: 02.03.2006
			↳ 7.00756.05.0	DW-AGR	EP
2.0 16V TDDi / TDCi 85 kW (115 PS) HJBA, HJBB, HJBC	10.2000→03.2007		7.01122.03.0*	DW-AGR	EP mit Halter with holder  HJBA, HJBB, HJBC: Euro 4 Euro 4 für Fahrzeuge mit Schaltgetriebe for vehicles with manual transmission Produktionsdatum ab: 01.08.2005 Production date from: 01.08.2005
			↳ 7.00756.05.0	DW-AGR	EP
			7.01349.01.0*	DW-AGR	EP mit Halter with holder  HJBA, HJBB, HJBC: Euro 4 Euro 4 für Fahrzeuge mit Diesel-Partikel-Filter (DPF) for vehicles with diesel soot filter Produktionsdatum ab: 06.02.2006 Production date from: 06.02.2006
			↳ 7.00756.05.0	DW-AGR	EP
2.5 V6 24V 125 kW (170 PS) LCBD	10.2000→03.2007		7.06269.10.0	LLR	EL 
MONDEO III Turnier (BWY)					
63					
1.8 16V 81 kW (110 PS) CGBA, CGBB	10.2000→03.2007		7.02256.51.0	EUV-SR	EL
			7.06269.22.0	LLR	EL 
1.8 16V 92 kW (125 PS) CHBA, CHBB	10.2000→03.2007		7.02256.51.0	EUV-SR	EL
			7.06269.22.0	LLR	EL 
2.0 16V 106-107 kW (144-146 PS) CJBA, CJBB	10.2000→03.2007		7.02256.51.0	EUV-SR	EL
			7.06269.22.0	LLR	EL 
2.0 16V DI / TDDi / TDCi 66 kW (90 PS) SDBA	10.2000→03.2007		7.01122.03.0*	DW-AGR	EP mit Halter with holder Euro 4 Euro 4 Produktionsdatum ab: 02.03.2006 Production date from: 02.03.2006
			↳ 7.00756.05.0	DW-AGR	EP
2.0 16V TDDi / TDCi 85 kW (115 PS) HJBA, HJBB, HJBC	10.2000→03.2007		7.01122.03.0*	DW-AGR	EP mit Halter with holder  HJBA, HJBB, HJBC: Euro 4 Euro 4 für Fahrzeuge mit Schaltgetriebe for vehicles with manual transmission Produktionsdatum ab: 01.08.2005 Production date from: 01.08.2005
			↳ 7.00756.05.0	DW-AGR	EP















F

























MONDEO III Turnier (BWY) 63

			7.01349.01.0*	DW-AGR	EP	mit Halter with holder  HJBA, HJBB, HJBC: Euro 4 Euro 4 für Fahrzeuge mit Diesel-Partikel-Filter (DPF) for vehicles with diesel soot filter Produktionsdatum ab: 06.02.2006 Production date from: 06.02.2006
			↳ 7.00756.05.0	DW-AGR	EP	
F	2.5 V6 24V 125 kW (170 PS) LCBD	10.2000→03.2007	 7.06269.10.0	LLR	EL	

MONDEO IV (BA7) 64

	1.6 EcoBoost 118 kW (160 PS) JTBA, JTBB	02.2011→01.2015	 7.07400.19.0*	EUV-VB	EP	mit Halter with holder
			↳ 7.22687.44.0	EUV-VB	EP	
			7.03162.09.0	LDRV	EP	 JTBA, JTBB: Produktionsdatum bis: 02.04.2012 Production date to: 02.04.2012
			7.04492.07.0	LDRV	EP	 JTBA, JTBB: Produktionsdatum ab: 02.04.2012 Production date from: 02.04.2012
			7.04269.04.0	SUV	EL	 JTBA, JTBB: Produktionsdatum ab: 02.04.2012 Production date from: 02.04.2012
	1.6 TDCi 85 kW (115-116 PS) T1BA, T1BB, T1BC	02.2011→01.2015	 7.07400.00.0*	STE	EP	
			↳ 7.01633.06.0	DW-TL	EP	
	2.0 107 kW (145 PS) AOBA, AOBC	03.2007→01.2015	 7.02256.48.0	STE	EP	
	2.0 EcoBoost 176 kW (239 PS) TPBA	07.2010→01.2015	 7.06117.52.0	SV-NWV	EH	
			7.06117.53.0	SV-NWV	EH	Produktionsdatum ab: 22.08.2011 Production date from: 22.08.2011
			7.06117.55.0	SV-NWV	EH	Einlassseite Intake Side Produktionsdatum bis: 22.08.2011 Production date to: 22.08.2011
	2.0 Flexifuel 107 kW (145 PS) TBBA, TBBB	03.2009→01.2015	 7.02256.48.0	STE	EP	
	2.0 LPG 107 kW (145 PS) TBBA	07.2009→01.2015	 7.02256.48.0	STE	EP	
	2.0 SCTi 149 kW (203 PS) TNBA	03.2010→01.2015	 7.06117.52.0	SV-NWV	EH	
			7.06117.53.0	SV-NWV	EH	Produktionsdatum ab: 22.08.2011 Production date from: 22.08.2011
			7.06117.55.0	SV-NWV	EH	Einlassseite Intake Side Produktionsdatum bis: 22.08.2011 Production date to: 22.08.2011
	2.0 TDCi 100-103 kW (136-140 PS) AZBC, UKBA, UKBB	03.2007→12.2014	 7.01771.01.0	DW-AGR	EP	
			7.01771.01.0	DW-TL	EP	
	2.0 TDCi 103 kW (140 PS) QXBA, QXBB, UFBA, UFBB	03.2007→01.2015	 7.01771.01.0	DW-AGR	EP	
			7.01771.01.0	DW-TL	EP	
	2.0 TDCi 85 kW (115-116 PS) KLBA, LPBA, TYBA	11.2007→01.2015	 7.01771.01.0	DW-AGR	EP	
			7.01771.01.0	DW-RK	EP	
			7.01771.01.0	DW-TL	EP	
	2.0 TDCi 120 kW (163 PS) TXBA, TXBB	03.2010→01.2015	 7.01771.01.0	DW-AGR	EP	

					
MONDEO IV (BA7)					64
2.3 118 kW (160 PS) SEBA	07.2007→01.2015		7.01771.01.0	DW-TL	EP
			7.02256.51.0	EUV-SR	EL
2.5 162 kW (220 PS) HUBA	03.2007→01.2015		7.06117.55.0	SV-NWV	EH
			7.02256.39.0	AKF	EL
			7.28197.16.0	LDRV	EL
MONDEO IV Saloon (BA7)					65
1.6 EcoBoost 118 kW (160 PS) JTBA, JTBB	11.2010→01.2015		7.07400.19.0*	EUV-VB	EP
			↪ 7.22687.44.0	EUV-VB	EP
			7.03162.09.0	LDRV	EP
			7.04492.07.0	LDRV	EP
			7.04269.04.0	SUV	EL
<p>mit Halter with holder</p> <p> JTBA, JTBB: Produktionsdatum bis: 02.04.2012 Production date to: 02.04.2012</p> <p> JTBA, JTBB: Produktionsdatum ab: 02.04.2012 Production date from: 02.04.2012</p> <p> JTBA, JTBB: Produktionsdatum ab: 02.04.2012 Production date from: 02.04.2012</p>					
1.6 TDCi 85 kW (115-116 PS) T1BA, T1BB, T1BC	12.2010→01.2015		7.07400.00.0*	STE	EP
			↪ 7.01633.06.0	DW-TL	EP
2.0 107 kW (145 PS) AOBA, AOBC	03.2007→01.2015		7.02256.48.0	STE	EP
2.0 EcoBoost 176 kW (239 PS) TPBA	03.2010→09.2014		7.06117.52.0	SV-NWV	EH
			7.06117.53.0	SV-NWV	EH
			7.06117.55.0	SV-NWV	EH
<p>Produktionsdatum ab: 22.08.2011 Production date from: 22.08.2011</p> <p>Einlassseite Intake Side Produktionsdatum bis: 22.08.2011 Production date to: 22.08.2011</p>					
2.0 Flexifuel 107 kW (145 PS) TBBA, TBBB	03.2009→01.2015		7.02256.48.0	STE	EP
2.0 LPG 107 kW (145 PS) TBBA	07.2009→01.2015		7.02256.48.0	STE	EP
2.0 SCTi 149 kW (203 PS) TNBA	03.2010→01.2015		7.06117.52.0	SV-NWV	EH
			7.06117.53.0	SV-NWV	EH
			7.06117.55.0	SV-NWV	EH
2.0 TDCi 103 kW (140 PS) QXBA, QXBB, UFBA, UFBB	03.2007→01.2015		7.01771.01.0	DW-AGR	EP
			7.01771.01.0	DW-TL	EP
2.0 TDCi 85 kW (115-116 PS) KLBA, LPBA, TYBA	11.2007→01.2015		7.01771.01.0	DW-AGR	EP
			7.01771.01.0	DW-RK	EP
			7.01771.01.0	DW-TL	EP
2.0 TDCi 100-103 kW (136-140 PS) AZBC, UKBA, UKBB	08.2008→12.2014		7.01771.01.0	DW-AGR	EP
			7.01771.01.0	DW-TL	EP
2.0 TDCi 120 kW (163 PS) TXBA, TXBB	03.2010→01.2015		7.01771.01.0	DW-AGR	EP
			7.01771.01.0	DW-TL	EP
2.3 118 kW (160 PS) SEBA	07.2007→01.2015		7.02256.51.0	EUV-SR	EL
			7.06117.55.0	SV-NWV	EH

F

MONDEO IV Saloon (BA7)					65
2.5 162 kW (220 PS) HUBA	03.2007→01.2015		7.02256.39.0	AKF	EL
			7.28197.16.0	LDRV	EL
MONDEO IV Turnier (BA7)					66
1.6 EcoBoost 118 kW (160 PS) JTBA	02.2011→01.2015		7.07400.19.0*	EUV-VB	EP mit Halter with holder
			↳ 7.22687.44.0	EUV-VB	EP
			7.03162.09.0	LDRV	EP Produktionsdatum bis: 02.04.2012 Production date to: 02.04.2012
			7.04492.07.0	LDRV	EP Produktionsdatum ab: 02.04.2012 Production date from: 02.04.2012
1.6 EcoBoost 118 kW (160 PS) JTBB	02.2011→01.2015		7.04269.04.0	SUV	EL JTBA: Produktionsdatum ab: 02.04.2012 Production date from: 02.04.2012 JTBA: Produktionsdatum ab: 02.04.2012 Production date from: 02.04.2012
			7.07400.19.0*	EUV-VB	EP mit Halter with holder
			↳ 7.22687.44.0	EUV-VB	EP
1.6 TDCi 85 kW (115-116 PS) T1BA, T1BB, T1BC	02.2011→01.2015		7.03162.09.0	LDRV	EP Produktionsdatum bis: 02.04.2012 Production date to: 02.04.2012
			7.04492.07.0	LDRV	EP Produktionsdatum ab: 02.04.2012 Production date from: 02.04.2012
2.0 107 kW (145 PS) AOBA, AOBC	03.2007→01.2015		7.07400.00.0*	STE	EP
			↳ 7.01633.06.0	DW-TL	EP
2.0 EcoBoost 176 kW (239 PS) TPBA	07.2010→01.2015		7.02256.48.0	STE	EP
			7.06117.52.0	SV-NWV	EH
			7.06117.53.0	SV-NWV	EH Produktionsdatum ab: 22.08.2011 Production date from: 22.08.2011
2.0 Flexifuel 107 kW (145 PS) TBBA, TBBA	03.2009→01.2015		7.06117.55.0	SV-NWV	EH Einlasseite Intake Side Produktionsdatum bis: 22.08.2011 Production date to: 22.08.2011
			7.02256.48.0	STE	EP
2.0 LPG 107 kW (145 PS) TBBA	07.2009→01.2015		7.02256.48.0	STE	EP
			7.06117.52.0	SV-NWV	EH
			7.06117.53.0	SV-NWV	EH Produktionsdatum ab: 22.08.2011 Production date from: 22.08.2011
2.0 SCTi 149 kW (203 PS) TNBA	03.2010→01.2015		7.06117.55.0	SV-NWV	EH Einlasseite Intake Side Produktionsdatum bis: 22.08.2011 Production date to: 22.08.2011
			7.01771.01.0	DW-AGR	EP
2.0 TDCi 100-103 kW (136-140 PS) AZBC, UKBA, UKBB	03.2007→12.2014		7.01771.01.0	DW-TL	EP
			7.01771.01.0	DW-AGR	EP
2.0 TDCi 103 kW (140 PS) QXBA, QXBB, UFBA, UFBB	03.2007→01.2015		7.01771.01.0	DW-TL	EP
			7.01771.01.0	DW-AGR	EP
			7.01771.01.0	DW-TL	EP
2.0 TDCi 85 kW (115-116 PS) KLBA, LPBA, TYBA	11.2007→01.2015		7.01771.01.0	DW-AGR	EP
			7.01771.01.0	DW-RK	EP
			7.01771.01.0	DW-TL	EP
2.0 TDCi 120 kW (163 PS) TXBA, TXBB	03.2010→01.2015		7.01771.01.0	DW-AGR	EP
			7.01771.01.0	DW-AGR	EP



















F

MONDEO IV Turnier (BA7)					66	
2.3 118 kW (160 PS) SEBA	07.2007→01.2015		7.01771.01.0	DW-TL	EP	
			7.02256.51.0	EUV-SR	EL	
			7.06117.55.0	SV-NWV	EH	
2.5 162 kW (220 PS) HUBA	03.2007→12.2012		7.02256.39.0	AKF	EL	
			7.28197.16.0	LDRV	EL	
MONDEO V Hatchback (CE)					67	
1.0 EcoBoost 92 kW (125 PS) M1CA, M1CB	02.2015→		7.22687.44.0	EUV-VB	EP	
			7.06117.12.0	ZM-NWV	EL	mit Dichtring with O-ring
1.5 EcoBoost 118 kW (160 PS) UNCA, UNCB, UNCE, UNCF	09.2014→		7.07400.16.0*	DW-TL	EP	mit Halter with holder UNCA, UNCB, UNCE, UNCF: Produktionsdatum bis: 07.05.2018 Production date to: 07.05.2018
			↳7.04011.05.0	DW-TL	EP	
			7.04615.03.0	SUV	EL	
1.5 EcoBoost 121 kW (165 PS) UNCN	05.2018→		7.07400.18.0*	DW-TL	EP	mit Halter with holder Produktionsdatum ab: 07.05.2018 Production date from: 07.05.2018
			↳7.04011.05.0	DW-TL	EP	
1.5 TDCi 88 kW (120 PS) UGCC, XUCA	03.2015→		7.08681.00.0	EOV	EH	UGCC, XUCA: Produktionsdatum ab: 18.01.2016 Production date from: 18.01.2016
2.0 EcoBlue 88 kW (120 PS) BCCD	01.2019→		7.08681.08.0	EOV	EH	Produktionsdatum ab: 04.02.2019 Production date from: 04.02.2019
2.0 EcoBlue 110 kW (150 PS) YLCC	01.2019→		7.08681.08.0	EOV	EH	Produktionsdatum ab: 04.02.2019 Production date from: 04.02.2019
2.0 EcoBlue 140 kW (190 PS) YMCC	01.2019→		7.08681.08.0	EOV	EH	Produktionsdatum ab: 04.02.2019 Production date from: 04.02.2019
2.0 EcoBlue 4x4 140 kW (190 PS) YMCC	01.2019→		7.08681.08.0	EOV	EH	Produktionsdatum ab: 04.02.2019 Production date from: 04.02.2019
2.0 EcoBoost 149 kW (203 PS) TNCD, TNCF	09.2014→		7.03306.16.0	LDRV	EP	
			7.07400.06.0*	STE	EP	
			↳7.02087.05.0	EUV-VB	EP	
			7.06117.33.0	SV-NWV	EL	
2.0 EcoBoost 176 kW (240 PS) R9CB, R9CF, R9CH	09.2014→		7.03306.16.0	LDRV	EP	
			7.07400.06.0*	STE	EP	
			↳7.02087.05.0	EUV-VB	EP	
			7.06117.33.0	SV-NWV	EL	
MONDEO V Saloon (CD)					68	
1.0 EcoBoost 92 kW (125 PS) M1CA, M1CB	02.2015→		7.22687.44.0	EUV-VB	EP	
			7.06117.12.0	ZM-NWV	EL	mit Dichtring with O-ring
1.5 EcoBoost 118 kW (160 PS) UNCA, UNCB, UNCE, UNCF	09.2014→		7.07400.16.0*	DW-TL	EP	mit Halter with holder UNCA, UNCB, UNCE, UNCF: Produktionsdatum bis: 07.05.2018 Production date to: 07.05.2018
			↳7.04011.05.0	DW-TL	EP	
1.5 EcoBoost 121 kW (165 PS) UNCN	01.2019→		7.07400.18.0*	DW-TL	EP	mit Halter with holder Produktionsdatum ab: 07.05.2018 Production date from: 07.05.2018





































MONDEO V Saloon (CD) **68**



























F

		↳ 7.04011.05.0	DW-TL	EP	
1.5 TDCi 88 kW (120 PS) UGCC, XUCA	03.2015→	 7.08681.00.0	EOV	EH	 UGCC, XUCA: Produktionsdatum ab: 18.01.2016 Production date from: 18.01.2016
2.0 179-188 kW (243-256 PS) C20HDTX	08.2016→	 7.02256.53.0	DW-TL	EP	
2.0 4x4 179-188 kW (243-256 PS) C20HDTX	08.2016→	 7.02256.53.0	DW-TL	EP	
2.0 EcoBlue 88 kW (120 PS) BCCD	01.2019→	 7.08681.08.0	EOV	EH	Produktionsdatum ab: 04.02.2019 Production date from: 04.02.2019
2.0 EcoBlue 140 kW (190 PS) YMCC	01.2019→	 7.08681.08.0	EOV	EH	Produktionsdatum ab: 04.02.2019 Production date from: 04.02.2019
2.0 EcoBlue 110 kW (150 PS) YLCC	01.2019→	 7.08681.08.0	EOV	EH	Produktionsdatum ab: 04.02.2019 Production date from: 04.02.2019
2.0 EcoBlue 4x4 140 kW (190 PS) YMCC	01.2019→	 7.08681.08.0	EOV	EH	Produktionsdatum ab: 04.02.2019 Production date from: 04.02.2019
2.0 EcoBoost 176 kW (240 PS) R9CB, R9CF, R9CH	05.2015→	 7.03306.16.0	LDRV	EP	
		7.07400.06.0*	STE	EP	
		↳ 7.02087.05.0	EUV-VB	EP	
		7.06117.33.0	SV-NWV	EL	
2.0 EcoBoost 149 kW (203 PS) TNCD, TNCF	05.2015→	 7.03306.16.0	LDRV	EP	
		7.07400.06.0*	STE	EP	
		↳ 7.02087.05.0	EUV-VB	EP	
		7.06117.33.0	SV-NWV	EL	
2.0 EcoBoost 146 kW (199 PS) TNCC	05.2015→	 7.03306.16.0	LDRV	EP	
		7.07400.06.0*	STE	EP	
		↳ 7.02087.05.0	EUV-VB	EP	
		7.06117.33.0	SV-NWV	EL	
2.0 EcoBoost 4x4 176 kW (240 PS) R9CB, R9CF, R9CH	01.2013→	 7.02256.53.0	DW-TL	EP	 R9CB, R9CF, R9CH:  USA  USA Produktionsdatum ab: 04.04.2016 Production date from: 04.04.2016
		7.03306.16.0	LDRV	EP	
2.0 Hybrid 130-138 kW (177-188 PS) C20EDEF	09.2014→	 7.06117.33.0	SV-NWV	EL	
2.0 Hybrid 103 kW (140 PS) UACA	10.2014→	 7.06117.33.0	SV-NWV	EL	
2.5 110 kW (149 PS) S7CB	05.2015→	 7.06117.33.0	SV-NWV	EL	

MONDEO V Turnier (CF) **69**

1.0 EcoBoost 92 kW (125 PS) M1CA, M1CB	02.2015→	 7.22687.44.0	EUV-VB	EP	
		7.06117.12.0	ZM-NWV	EL	mit Dichtring with O-ring
1.5 EcoBoost 118 kW (160 PS) UNCA, UNCB, UNCE, UNCF	09.2014→	7.07400.16.0*	DW-TL	EP	mit Halter with holder  UNCA, UNCB, UNCE, UNCF: Produktionsdatum bis: 07.05.2018 Production date to: 07.05.2018
		↳ 7.04011.05.0	DW-TL	EP	
		7.04615.03.0	SUV	EL	
1.5 EcoBoost 121 kW (165 PS) UNCN	05.2018→	 7.07400.18.0*	DW-TL	EP	mit Halter with holder Produktionsdatum ab: 07.05.2018 Production date from: 07.05.2018

					
MONDEO V Turnier (CF)					69
1.5 TDCi 88 kW (120 PS) UGCC, XUCA	03.2015→	 7.04011.05.0 7.08681.00.0	DW-TL EOV	EP EH	 UGCC, XUCA: Produktionsdatum ab: 18.01.2016 Production date from: 18.01.2016
2.0 EcoBlue 88 kW (120 PS) BCCD	01.2019→	 7.08681.08.0	EOV	EH	Produktionsdatum ab: 04.02.2019 Production date from: 04.02.2019
2.0 EcoBlue 110 kW (150 PS) YLCC	01.2019→	 7.08681.08.0	EOV	EH	Produktionsdatum ab: 04.02.2019 Production date from: 04.02.2019
2.0 EcoBlue 140 kW (190 PS) YMCC	01.2019→	 7.08681.08.0	EOV	EH	Produktionsdatum ab: 04.02.2019 Production date from: 04.02.2019
2.0 EcoBlue 4x4 140 kW (190 PS) YMCC	01.2019→	 7.08681.08.0	EOV	EH	Produktionsdatum ab: 04.02.2019 Production date from: 04.02.2019
2.0 EcoBoost 149 kW (203 PS) TNCD, TNCF	09.2014→	 7.03306.16.0 7.07400.06.0* ↳ 7.02087.05.0 7.06117.33.0	LDRV STE EUV-VB SV-NWV	EP EP EP EL	
2.0 EcoBoost 176 kW (240 PS) R9CB, R9CF, R9CH	09.2014→	 7.03306.16.0 7.07400.06.0* ↳ 7.02087.05.0 7.06117.33.0	LDRV STE EUV-VB SV-NWV	EP EP EP EL	
P 100 II					70
2.0 57 kW (78 PS) NAE	10.1987→12.1992	 7.06269.26.0	LLR	EL	
PUMA					71
1.0 EcoBoost 92 kW (125 PS) B7JA, B7JB	09.2019→	 7.04615.03.0	SUV	EL	
1.0 EcoBoost 70 kW (95 PS) M0JA	09.2019→	 7.04615.03.0	SUV	EL	
1.0 EcoBoost mHEV 92 kW (125 PS) B7JA, B7JB	09.2019→	 7.04615.03.0	SUV	EL	
1.0 EcoBoost mHEV 114 kW (155 PS) BZJA	09.2019→	 7.04615.03.0	SUV	EL	
PUMA (EC_)					72
1.4 16V 66 kW (90 PS) FHD, FHF	11.1997→10.2000	 7.06269.27.0	LLR	EL	
1.6 16V 76 kW (103 PS) L1W	08.2000→06.2002	 7.06269.04.0	LLR	EL	
1.7 16V 92-114 kW (125-155 PS) MHA, MHB	03.1997→06.2002	 7.06269.27.0	LLR	EL	
Racing ST 160 92-114 kW (125-155 PS) MHA	06.1999→06.2002	 7.06269.27.0	LLR	EL	
RANGER (ET)					73
2.5 TDCi 4x4 105 kW (143 PS) WLAA	05.2006→07.2012	 7.02256.25.0 7.02256.25.0	DW-AGR DW-TL	EP EP	
2.5 TDdi 105 kW (143 PS) WLAA	05.2006→07.2012	 7.02256.25.0 7.02256.25.0	DW-AGR DW-TL	EP EP	
3.0 TDCi 115 kW (156 PS) MD30DITC	05.2006→07.2012	 7.02256.25.0 7.02256.25.0	DW-AGR DW-TL	EP EP	

			 PIERBURG		
RANGER (ET)					73
3.0 TDCi 4x4 115 kW (156 PS) WEC	05.2006→07.2012		7.02256.25.0	DW-AGR	EP
			7.02256.25.0	DW-TL	EP
RANGER (TKE)					74
2.5 i 122 kW (166 PS) GBVAF, GBVAK, GBVAL	11.2011→		7.06117.33.0	SV-NWV	EL  GBVAF, GBVAK, GBVAL: Produktionsdatum ab: 06.07.2012 Production date from: 06.07.2012
			7.06117.55.0	SV-NWV	EH  GBVAF, GBVAK, GBVAL: Produktionsdatum bis: 06.07.2012 Production date to: 06.07.2012
2.5 i 4x4 122 kW (166 PS) GBVAF, GBVAK, GBVAL	11.2011→		7.06117.33.0	SV-NWV	EL  GBVAF, GBVAK, GBVAL: Produktionsdatum ab: 06.07.2012 Production date from: 06.07.2012
			7.06117.55.0	SV-NWV	EH  GBVAF, GBVAK, GBVAL: Produktionsdatum bis: 06.07.2012 Production date to: 06.07.2012
S-MAX (CJ, WA6)					75
1.5 EcoBoost 118 kW (160 PS) UNCI, UNCJ, UNCK	01.2015→06.2018		7.07400.16.0*	DW-TL	EP mit Halter with holder
			↳ 7.04011.05.0	DW-TL	EP
			7.04615.03.0	SUV	EL
1.5 EcoBoost 121-129 kW (165-175 PS) C15HDTX	07.2018→		7.07400.18.0*	DW-TL	EP mit Halter with holder
			↳ 7.04011.05.0	DW-TL	EP
2.0 EcoBlue 140 kW (190 PS) BCCC	07.2018→		7.08681.08.0	EOV	EH Produktionsdatum ab: 02.07.2018 Production date from: 02.07.2018
2.0 EcoBlue 88 kW (120 PS) YNCA	07.2018→		7.08681.08.0	EOV	EH Produktionsdatum ab: 02.07.2018 Production date from: 02.07.2018
2.0 EcoBlue 110 kW (150 PS) YMCB	07.2018→		7.08681.08.0	EOV	EH Produktionsdatum ab: 02.07.2018 Production date from: 02.07.2018
2.0 EcoBlue 4x4 140 kW (190 PS) BCCC	07.2018→		7.08681.08.0	EOV	EH Produktionsdatum ab: 02.07.2018 Production date from: 02.07.2018
2.0 EcoBlue 4x4 110 kW (150 PS) YMCB	07.2018→		7.08681.08.0	EOV	EH Produktionsdatum ab: 02.07.2018 Production date from: 02.07.2018
2.0 EcoBlue BI-Turbo 176 kW (240 PS) YLCB	07.2018→		7.08681.08.0	EOV	EH Produktionsdatum ab: 02.07.2018 Production date from: 02.07.2018
2.0 EcoBoost 176 kW (240 PS) R9CD, R9CI	01.2015→		7.04492.07.0	LDRV	EP  R9CD, R9CI: für OE-Nummer: 2010734, CJ5G-9K378-BB, CJ5Z-9K378-B for OE number: 2010734, CJ5G-9K378-BB, CJ5Z-9K378-B
			7.07400.06.0*	STE	EP  R9CD, R9CI: für OE-Nummer: 5247043, CJ5E-9961-BF for OE number: 5247043, CJ5E-9961-BF
			↳ 7.02087.05.0	EUV-VB	EP
			7.06117.33.0	SV-NWV	EL
S-MAX (WA6)					76
1.6 EcoBoost 118 kW (160 PS) JTWA, JTWB	02.2011→12.2014		7.07400.19.0*	EUV-VB	EP mit Halter with holder
			↳ 7.22687.44.0	EUV-VB	EP
			7.03162.09.0	LDRV	EP  JTWA, JTWB: Produktionsdatum bis: 02.04.2012 Production date to: 02.04.2012
			7.04492.07.0	LDRV	EP  JTWA, JTWB: Produktionsdatum ab: 02.04.2012 Production date from: 02.04.2012
			7.04269.04.0	SUV	EL











S-MAX (WA6)					76
1.6 TDCi 85 kW (115 PS) T1WA, T1WB	02.2011→12.2014		7.07400.00.0*	STE	EP
			↳7.01633.06.0	DW-TL	EP
2.0 107 kW (145 PS) AOWA, AOWB	05.2006→12.2014		7.02256.48.0	STE	EP
2.0 EcoBoost 149 kW (203 PS) TNWA	03.2010→12.2014		7.06117.52.0	SV-NWV	EH
			7.06117.53.0	SV-NWV	EH
			7.06117.55.0	SV-NWV	EH
					Produktionsdatum ab: 06.08.2011 Production date from: 06.08.2011 Einlassseite Intake Side Produktionsdatum bis: 06.08.2011 Production date to: 06.08.2011
2.0 EcoBoost 146 kW (199 PS) TNWB	07.2010→12.2014		7.06117.52.0	SV-NWV	EH
			7.06117.53.0	SV-NWV	EH
			7.06117.55.0	SV-NWV	EH
					Produktionsdatum ab: 06.08.2011 Production date from: 06.08.2011 Einlassseite Intake Side Produktionsdatum bis: 06.08.2011 Production date to: 06.08.2011
2.0 EcoBoost 176 kW (239 PS) TPWA	07.2010→12.2014		7.06117.52.0	SV-NWV	EH
			7.06117.53.0	SV-NWV	EH
			7.06117.55.0	SV-NWV	EH
					Produktionsdatum ab: 06.08.2011 Production date from: 06.08.2011 Einlassseite Intake Side Produktionsdatum bis: 06.08.2011 Production date to: 06.08.2011
2.0 Flexifuel 107 kW (145 PS) TBWA, TBWB	05.2006→12.2014		7.02256.48.0	STE	EP
2.0 TDCi 96 kW (130 PS) AZWA	05.2006→12.2014		7.01771.01.0	DW-RK	EP
			7.01771.01.0	DW-TL	EP
2.0 TDCi 103 kW (140 PS) QXWA, QXWB, QXWC, UFWA	05.2006→12.2014		7.01771.01.0	DW-RK	EP
			7.01771.01.0	DW-TL	EP
2.0 TDCi 85 kW (115 PS) KLWA, TYWA	11.2007→12.2014		7.01771.01.0	DW-AGR	EP
			7.01771.01.0	DW-RK	EP
			7.01771.01.0	DW-TL	EP
2.3 118 kW (160 PS) SEWA	07.2007→12.2014		7.02256.51.0	EUV-SR	EL
			7.06117.55.0	SV-NWV	EH
					für OE-Nummer: 1119940, 1357314, 1S7G-9J559-BA, 1S7G-9J559-BB for OE number: 1119940, 1357314, 1S7G-9J559-BA, 1S7G-9J559-BB
2.5 ST 162 kW (220 PS) HUWA	05.2006→12.2014		7.02256.39.0	AKF	EL
			7.28197.16.0	LDRV	EL
SCORPIO I (GAE, GGE)					77
2.0 i 85 kW (115 PS) NRA, NRI	04.1985→02.1992		4.02003.62.0	LLR	EL <input checked="" type="checkbox"/>
			7.06269.26.0	LLR	EL <input type="checkbox"/>
2.0 i 74 kW (100 PS) NRC	10.1985→12.1990		4.02003.62.0	LLR	EL <input checked="" type="checkbox"/>
2.0 i 88 kW (120 PS) N9D	05.1989→09.1994		4.02003.62.0	LLR	EL <input checked="" type="checkbox"/>
			7.06269.26.0	LLR	EL <input type="checkbox"/>
2.0 i 85 kW (115 PS) NRA, NRI	02.1992→09.1994		4.02003.62.0	LLR	EL <input checked="" type="checkbox"/>

F



































SCORPIO I (GAE, GGE) 77

F

			7.06269.26.0	LLR	EL	<input type="radio"/>
2.4 i 96 kW (130 PS) ARC	09.1986→09.1988		7.06269.26.0	LLR	EL	<input type="radio"/> für OE-Nummer: 6631855, 87TF-9F715-CB for OE number: 6631855, 87TF-9F715-CB
2.4 i 92 kW (125 PS) ARD	10.1988→02.1992		7.06269.26.0	LLR	EL	<input type="radio"/> für OE-Nummer: 6631855, 87TF-9F715-CB for OE number: 6631855, 87TF-9F715-CB
2.4 i Cat 92 kW (125 PS) ARD	10.1988→09.1994		7.06269.26.0	LLR	EL	<input type="radio"/> für OE-Nummer: 6631855, 87TF-9F715-CB for OE number: 6631855, 87TF-9F715-CB
2.9 i 107 kW (145 PS) BRD, BRE, BRF	09.1986→09.1994		7.06269.26.0	LLR	EL	<input type="radio"/>  BRD, BRE, BRF: für OE-Nummer: 6631855, 87TF-9F715-CB for OE number: 6631855, 87TF-9F715-CB
2.9 i 110 kW (150 PS) BRC	09.1986→09.1994		7.06269.26.0	LLR	EL	<input type="radio"/> für OE-Nummer: 6631855, 87TF-9F715-CB for OE number: 6631855, 87TF-9F715-CB
2.9 i 24V 143 kW (195 PS) BOA	04.1991→09.1994		7.06269.26.0	LLR	EL	<input type="radio"/>
2.9 i 4x4 110 kW (150 PS) BRC	09.1986→09.1994		7.06269.26.0	LLR	EL	<input type="radio"/> für OE-Nummer: 6631855, 87TF-9F715-CB for OE number: 6631855, 87TF-9F715-CB
2.9 i 4x4 107 kW (145 PS) BRD, BRE, BRF	05.1988→02.1993		7.06269.26.0	LLR	EL	<input type="radio"/>  BRD, BRE, BRF: für OE-Nummer: 6631855, 87TF-9F715-CB for OE number: 6631855, 87TF-9F715-CB
2.9 i Cat 107 kW (145 PS) BRE	10.1987→09.1994		7.06269.26.0	LLR	EL	<input type="radio"/> für OE-Nummer: 6631855, 87TF-9F715-CB for OE number: 6631855, 87TF-9F715-CB

SCORPIO I Saloon (GGE) 78



1.9 85 kW (115 PS) NRA	11.1992→09.1993		4.02003.62.0	LLR	EL	<input checked="" type="checkbox"/>
			7.06269.26.0	LLR	EL	<input type="radio"/>
2.0 i 88 kW (120 PS) N9D	05.1989→09.1994		4.02003.62.0	LLR	EL	<input checked="" type="checkbox"/>
			7.06269.26.0	LLR	EL	<input type="radio"/>
2.0 i 92 kW (125 PS) N9B	05.1989→02.1992		4.02003.62.0	LLR	EL	<input checked="" type="checkbox"/>
2.0 i 85 kW (115 PS) N9F	02.1992→09.1994		4.02003.62.0	LLR	EL	<input checked="" type="checkbox"/>
			7.06269.26.0	LLR	EL	<input type="radio"/>
2.4 i 92 kW (125 PS) ARD	10.1988→10.1994		7.06269.26.0	LLR	EL	<input type="radio"/> für OE-Nummer: 6631855, 87TF-9F715-CB for OE number: 6631855, 87TF-9F715-CB
2.9 i 107 kW (145 PS) BRD, BRE, BRF	09.1986→12.1994		7.06269.26.0	LLR	EL	<input type="radio"/>  BRD, BRE, BRF: für OE-Nummer: 6631855, 87TF-9F715-CB for OE number: 6631855, 87TF-9F715-CB
2.9 i 24V 143 kW (195 PS) BOA	04.1991→09.1994		7.06269.26.0	LLR	EL	<input type="radio"/>
2.9 i 4x4 107 kW (145 PS) BRD, BRE, BRF	12.1989→10.1994		7.06269.26.0	LLR	EL	<input type="radio"/>  BRD, BRE, BRF: für OE-Nummer: 6631855, 87TF-9F715-CB for OE number: 6631855, 87TF-9F715-CB

						
SCORPIO I Turnier (GGE)						79
2.0 i 85 kW (115 PS) N9F	09.1991→09.1994		4.02003.62.0	LLR	EL <input checked="" type="checkbox"/>	
			7.06269.26.0	LLR	EL <input type="checkbox"/>	
2.0 i 88 kW (120 PS) N9D	09.1991→09.1994		4.02003.62.0	LLR	EL <input checked="" type="checkbox"/>	
			7.06269.26.0	LLR	EL <input type="checkbox"/>	
2.4 i 92 kW (125 PS) ARD	09.1991→09.1994		7.06269.26.0	LLR	EL <input type="checkbox"/> für OE-Nummer: 6631855, 87TF-9F715-CB for OE number: 6631855, 87TF-9F715-CB	
2.9 24V 143 kW (195 PS) BOA	08.1993→09.1994		7.06269.26.0	LLR	EL <input type="checkbox"/>	
2.9 i 107 kW (145 PS) BRD, BRE, BRF	09.1991→09.1994		7.06269.26.0	LLR	EL <input type="checkbox"/>  BRD, BRE, BRF: für OE-Nummer: 6631855, 87TF-9F715-CB for OE number: 6631855, 87TF-9F715-CB	
2.9 i 4x4 107 kW (145 PS) BRD, BRE, BRF	05.1988→02.1993		7.06269.26.0	LLR	EL <input type="checkbox"/>  BRD, BRE, BRF: für OE-Nummer: 6631855, 87TF-9F715-CB for OE number: 6631855, 87TF-9F715-CB	
SCORPIO II (GFR, GGR)						80
2.0 i 85 kW (115 PS) NSD	10.1994→08.1998		4.02003.62.0	LLR	EL <input checked="" type="checkbox"/>	
			7.06269.02.0	LLR	EL <input type="checkbox"/> für OE-Nummer: 1063996, 95BF-9F715-AC for OE number: 1063996, 95BF-9F715-AC	
2.0 i 16V 100 kW (136 PS) N3A	10.1994→08.1998		4.02003.62.0	LLR	EL <input checked="" type="checkbox"/>	
			7.06269.02.0	LLR	EL <input type="checkbox"/> für OE-Nummer: 1063996, 95BF-9F715-AC for OE number: 1063996, 95BF-9F715-AC	
2.9 i 110 kW (150 PS) BRG	02.1995→08.1998		7.06269.26.0	LLR	EL <input type="checkbox"/> für OE-Nummer: 6631855, 87TF-9F715-CB for OE number: 6631855, 87TF-9F715-CB	
2.9 i 24V 152 kW (207 PS) BOB	10.1994→08.1998		7.06269.26.0	LLR	EL <input type="checkbox"/>	
SCORPIO II Turnier (GNR, GGR)						81
2.0 i 85 kW (115 PS) NSD	10.1994→08.1998		4.02003.62.0	LLR	EL <input checked="" type="checkbox"/>	
			7.06269.02.0	LLR	EL <input type="checkbox"/> für OE-Nummer: 1063996, 95BF-9F715-AC for OE number: 1063996, 95BF-9F715-AC	
2.0 i 16V 100 kW (136 PS) N3A	10.1994→08.1998		4.02003.62.0	LLR	EL <input checked="" type="checkbox"/>	
			7.06269.02.0	LLR	EL <input type="checkbox"/> für OE-Nummer: 1063996, 95BF-9F715-AC for OE number: 1063996, 95BF-9F715-AC	
2.9 i 110 kW (150 PS) BRG	02.1995→08.1998		7.06269.26.0	LLR	EL <input type="checkbox"/> für OE-Nummer: 6631855, 87TF-9F715-CB for OE number: 6631855, 87TF-9F715-CB	
2.9 i 24V 152 kW (207 PS) BOB	10.1994→08.1998		7.06269.26.0	LLR	EL <input type="checkbox"/>	

F





















SIERRA I Hatchback (GBC) 82



2.0 4x4 150 kW (204 PS) N5B	10.1985→02.1987	 4.02003.62.0	LLR	EL	<input checked="" type="checkbox"/>
2.0 i 85 kW (115 PS) NR2, NRB	03.1985→12.1986	 7.06269.26.0	LLR	EL	<input type="checkbox"/>





















































SIERRA II (GBG, GB4) 83

F





































2.0 77 kW (105 PS) N8C, NES	01.1987→02.1993	 4.02003.62.0	LLR	EL	<input checked="" type="checkbox"/>
2.0 80 kW (109 PS) N8A	07.1989→12.1992	 4.02003.62.0	LLR	EL	<input checked="" type="checkbox"/>
2.0 16V Cosworth 4x4 162 kW (220 PS) N5C	01.1990→02.1993	 4.02003.62.0	LLR	EL	<input checked="" type="checkbox"/>
2.0 4x4 88-92 kW (120-125 PS) N9C	01.1990→02.1993	 7.06269.26.0	LLR	EL	<input type="checkbox"/>
2.0 4x4 88-92 kW (120-125 PS) N9C	01.1990→02.1993	 7.06269.26.0	LLR	EL	<input type="checkbox"/>
2.0 RS Cosworth 150 kW (204 PS) N5B	11.1987→01.1990	 4.02003.62.0	LLR	EL	<input checked="" type="checkbox"/>
2.0 i 85 kW (115 PS) N4A, N4I	01.1987→02.1993	 7.06269.26.0	LLR	EL	<input type="checkbox"/>
2.0 i 88-92 kW (120-125 PS) N9C	01.1990→02.1993	 7.06269.26.0	LLR	EL	<input type="checkbox"/>
2.0 i 88-92 kW (120-125 PS) N9C	01.1990→02.1993	 7.06269.26.0	LLR	EL	<input type="checkbox"/>
2.0 i 90 kW (122 PS) N9A	01.1990→02.1993	 7.06269.26.0	LLR	EL	<input type="checkbox"/>
2.0 i DOHC 85 kW (115 PS) N9E	12.1991→02.1993	 7.06269.26.0	LLR	EL	<input type="checkbox"/>
2.9 4x4 107-110 kW (145-150 PS) B4B, B4C	08.1988→02.1993	 7.06269.26.0	LLR	EL	<input type="checkbox"/>  B4B, B4C: für OE-Nummer: 6631855, 87TF-9F715-CB for OE number: 6631855, 87TF-9F715-CB
2.9 4x4 107-110 kW (145-150 PS) B4B, B4C	08.1988→02.1993	 7.06269.26.0	LLR	EL	<input type="checkbox"/>  B4B, B4C: für OE-Nummer: 6631855, 87TF-9F715-CB for OE number: 6631855, 87TF-9F715-CB
2.9 i 107-110 kW (145-150 PS) B4B, B4C	08.1988→02.1993	 7.06269.26.0	LLR	EL	<input type="checkbox"/>  B4B, B4C: für OE-Nummer: 6631855, 87TF-9F715-CB for OE number: 6631855, 87TF-9F715-CB
2.9 i 107-110 kW (145-150 PS) B4B, B4C	08.1988→02.1993	 7.06269.26.0	LLR	EL	<input type="checkbox"/>  B4B, B4C: für OE-Nummer: 6631855, 87TF-9F715-CB for OE number: 6631855, 87TF-9F715-CB









SIERRA II Hatchback (GBC, GBG) 84

2.0 77 kW (105 PS) N8C, NES	01.1987→02.1993	 4.02003.62.0	LLR	EL	<input checked="" type="checkbox"/>
2.0 16V Cosworth 4x4 158-162 kW (215-220 PS) N5D	01.1990→02.1993	 4.02003.62.0	LLR	EL	<input checked="" type="checkbox"/>
2.0 16V Cosworth Cat 4x4 162 kW (220 PS) N5C	01.1990→02.1993	 4.02003.62.0	LLR	EL	<input checked="" type="checkbox"/>
2.0 4x4 88-92 kW (120-125 PS) N9C	10.1991→03.1993	 7.06269.26.0	LLR	EL	<input type="checkbox"/>
2.0 RS Cosworth 150 kW (204 PS) N5B	11.1987→01.1990	 4.02003.62.0	LLR	EL	<input checked="" type="checkbox"/>
2.0 i 85 kW (115 PS) N4A, N4I	01.1987→02.1993	 7.06269.26.0	LLR	EL	<input type="checkbox"/>

						
SIERRA II Hatchback (GBC, GBG)						84
2.0 i 88-92 kW (120-125 PS) N9C	06.1989→02.1993		7.06269.26.0	LLR	EL 	
2.0 i 80 kW (109 PS) N8A	06.1989→02.1993		4.02003.62.0	LLR	EL 	
2.0 i DOHC 85 kW (115 PS) N9E	12.1991→02.1993		7.06269.26.0	LLR	EL 	
2.9 i 107-110 kW (145-150 PS) B4B, B4C	08.1988→02.1993		7.06269.26.0	LLR	EL   B4B, B4C: für OE-Nummer: 6631855, 87TF-9F715-CB for OE number: 6631855, 87TF-9F715-CB	
2.9 i XR 4x4 110 kW (150 PS) B4A	08.1988→02.1993		7.06269.26.0	LLR	EL  für OE-Nummer: 6631855, 87TF-9F715-CB for OE number: 6631855, 87TF-9F715-CB	
2.9 i XR 4x4 107-110 kW (145-150 PS) B4B, B4C	08.1988→02.1993		7.06269.26.0	LLR	EL   B4B, B4C: für OE-Nummer: 6631855, 87TF-9F715-CB for OE number: 6631855, 87TF-9F715-CB	
SIERRA II Turnier (BNG)						85
1.9 80 kW (109 PS) N8A	10.1988→09.1991		4.02003.62.0	LLR	EL 	
2.0 77 kW (105 PS) N8C, NES	01.1987→02.1993		4.02003.62.0	LLR	EL 	
2.0 4x4 88-92 kW (120-125 PS) N9C	05.1989→02.1993		7.06269.26.0	LLR	EL 	
2.0 4x4 88-92 kW (120-125 PS) N9C	02.1990→02.1993		7.06269.26.0	LLR	EL 	
2.0 i 85 kW (115 PS) N4A, N4I	01.1987→02.1993		7.06269.26.0	LLR	EL 	
2.0 i 88-92 kW (120-125 PS) N9C	05.1989→02.1993		7.06269.26.0	LLR	EL 	
2.0 i 88-92 kW (120-125 PS) N9C	05.1989→02.1993		7.06269.26.0	LLR	EL 	
2.0 i DOHC 85 kW (115 PS) N9E	12.1991→02.1993		7.06269.26.0	LLR	EL 	
2.9 107-110 kW (145-150 PS) B4B, B4C	08.1988→02.1993		7.06269.26.0	LLR	EL   B4B, B4C: für OE-Nummer: 6631855, 87TF-9F715-CB for OE number: 6631855, 87TF-9F715-CB	
2.9 4x4 107-110 kW (145-150 PS) B4B, B4C	08.1988→02.1993		7.06269.26.0	LLR	EL   B4B, B4C: für OE-Nummer: 6631855, 87TF-9F715-CB for OE number: 6631855, 87TF-9F715-CB	
2.9 4x4 107-110 kW (145-150 PS) B4B, B4C	08.1988→02.1993		7.06269.26.0	LLR	EL   B4B, B4C: für OE-Nummer: 6631855, 87TF-9F715-CB for OE number: 6631855, 87TF-9F715-CB	
2.9 i 107-110 kW (145-150 PS) B4B, B4C	08.1988→02.1993		7.06269.26.0	LLR	EL   B4B, B4C: für OE-Nummer: 6631855, 87TF-9F715-CB for OE number: 6631855, 87TF-9F715-CB	
SIERRA Turnier (BNC)						86
2.0 85 kW (115 PS) NR2, NRB	03.1985→12.1986		7.06269.26.0	LLR	EL 	
STREET KA (RL2)						87
1.6 70 kW (95 PS) CDRA, CDRB	05.2003→07.2005		7.05432.13.0	SM	EL 	
TAURUS VI						88
3.5i Turbo 24V 265-272 kW (360-370 PS) 35PDTD	06.2009→		7.02328.08.0	SUV	EL	

F

			 PIERBURG			
TOURNEO CONNECT						89
1.8 16V 85 kW (115-116 PS) EYPA, EYPB, EYPC, EYPD	06.2002→12.2013		7.06269.03.0	LLR	EL 	
1.8 TDCi /TDDi /DI 55-57 kW (75-78 PS) BHPA, P7PA, P7PB, R2PA	06.2002→12.2013		7.02256.07.0	EUV-AGR	EL  BHPA, P7PA, P7PB, R2PA: Produktionsdatum bis: 31.07.2006 Production date to: 31.07.2006	
TOURNEO CONNECT / GRAND TOURNEO CONNECT V408 MPV						90
1.0 EcoBoost 74 kW (100 PS) M2GA, M2GB	11.2013→		7.04615.03.0	SUV	EL	
			7.06117.12.0	ZM-NWV	EL mit Dichtring with O-ring  M2GA, M2GB: →03.2019	
1.0 EcoBoost 74 kW (100 PS) B3GA, SFCB	11.2013→		7.04615.03.0	SUV	EL	
1.5 TDCi 55 kW (75 PS) XUGA	05.2015→		7.08681.00.0	EOV	EH Produktionsdatum ab: 18.01.2016 Production date from: 18.01.2016	
1.5 TDCi 74 kW (101 PS) XVGA, XVGB, XVGC	05.2015→		7.08681.00.0	EOV	EH  XVGA, XVGB, XVGC: Produktionsdatum ab: 18.01.2016 Production date from: 18.01.2016	
1.5 TDCi 88 kW (120 PS) XWGA, XWGB	05.2015→		7.08681.00.0	EOV	EH  XWGA, XWGB: Produktionsdatum ab: 18.01.2016 Production date from: 18.01.2016	
1.6 EcoBoost 110 kW (150 PS) JQGA	11.2013→		7.04492.07.0	LDRV	EP	
			7.04269.04.0	SUV	EL	
TOURNEO COURIER B460 MPV						91
1.0 EcoBoost 74 kW (100 PS) SFCA, SFCB, SFCC, SFCD	02.2014→		7.06117.12.0	ZM-NWV	EL mit Dichtring with O-ring  SFCA, SFCB, SFCC, SFCD: →03.2019	
1.5 EcoBlue 74 kW (100 PS) XXCA, XXCB, XXCC	04.2018→		7.08681.00.0	EOV	EH  XXCA, XXCB, XXCC: Produktionsdatum ab: 08.01.2016 Production date from: 08.01.2016	
1.5 TDCi 55 kW (75 PS) UGCA, UGCB, XUCC, XUCD	02.2014→		7.08681.00.0	EOV	EH  UGCA, UGCB, XUCC, XUCD: Produktionsdatum ab: 08.01.2016 Production date from: 08.01.2016	
1.5 TDCi 70 kW (95 PS) XVCA, XVCB, XVCC	05.2015→		7.08681.00.0	EOV	EH  XVCA, XVCB, XVCC: Produktionsdatum ab: 08.01.2016 Production date from: 08.01.2016	
TRANSIT CONNECT MPV						92
1.5 TDCi 74 kW (101 PS) XVGA, XVGB, XVGC	05.2015→		7.08681.00.0	EOV	EH  XVGA, XVGB, XVGC: Produktionsdatum ab: 18.01.2016 Production date from: 18.01.2016	
1.5 TDCi 88 kW (120 PS) XWGA, XWGB	05.2015→		7.08681.00.0	EOV	EH  XWGA, XWGB: Produktionsdatum ab: 18.01.2016 Production date from: 18.01.2016	
1.5 TDCi 55 kW (75 PS) XUGA	08.2015→		7.08681.00.0	EOV	EH Produktionsdatum ab: 18.01.2016 Production date from: 18.01.2016	
1.6 TDCi 55 kW (75 PS) UBGA	02.2013→		7.07400.01.0*	STE	EP	
			↳ 7.01633.06.0	DW-TL	EP	
1.6 TDCi 70 kW (95 PS) TZGA, TZGB	02.2013→		7.07400.01.0*	STE	EP	
			↳ 7.01633.06.0	DW-TL	EP	
1.6 TDCi 85 kW (115 PS) T1GA	02.2013→		7.07400.01.0*	STE	EP	
			↳ 7.01633.06.0	DW-TL	EP	
2.5 Duratec 125-126 kW (170-171 PS) S7GA, S7GB	09.2013→		7.06117.33.0	SV-NWV	EL	











					
TRANSIT COURIER B460 MPV					
93					
1.0 EcoBoost 74 kW (100 PS) SFCA, SFCB, SFCC, SFCD	02.2014→		7.06117.12.0	ZM-NWV	EL mit Dichtring with O-ring  SFCA, SFCB, SFCC, SFCD: →03.2019
1.5 EcoBlue 74 kW (100 PS) XXCA, XXCB, XXCC	04.2018→		7.08681.00.0	EOV	EH  XXCA, XXCB, XXCC: Produktionsdatum ab: 08.01.2016 Production date from: 08.01.2016
1.5 TDCi 55 kW (75 PS) UGCA, UGCB, XUCC, XUCD, XWCA, XWCB	02.2014→		7.08681.00.0	EOV	EH  UGCA, UGCB, XUCC, XUCD, XWCA, XWCB: Produktionsdatum ab: 08.01.2016 Production date from: 08.01.2016
1.5 TDCi 70 kW (95 PS) XVCA, XVCB, XVCC	05.2015→		7.08681.00.0	EOV	EH  XVCA, XVCB, XVCC: Produktionsdatum ab: 08.01.2016 Production date from: 08.01.2016
1.6 TDCi 70 kW (95 PS) T3CA, T3CB, T3CC	02.2014→		7.07400.01.0* ↳ 7.01633.06.0	STE DW-TL	EP EP
B-MAX Van (JK)					
94					
1.0 EcoBoost 88 kW (120 PS) M1JA	08.2012→		7.22687.44.0	EUV-VB	EP Produktionsdatum bis: 14.11.2012 Production date to: 14.11.2012
1.0 EcoBoost 74 kW (100-101 PS) SFJA, SFJB, SFJC, SFJD	10.2012→		7.07400.12.0* ↳ 7.04011.05.0 ↳ 7.22687.44.0 7.06117.12.0	STE DW-TL EUV-VB ZM-NWV	EP  SFJA, SFJB, SFJC, SFJD: Produktionsdatum bis: 26.10.2012 Production date to: 26.10.2012 EP EP EL mit Dichtring with O-ring
1.0 EcoBoost 92 kW (125 PS) M1JE	10.2012→		7.07400.12.0* ↳ 7.04011.05.0 ↳ 7.22687.44.0 7.06117.12.0	STE DW-TL EUV-VB ZM-NWV	EP Produktionsdatum bis: 14.11.2012 Production date to: 14.11.2012 EP EP EL mit Dichtring with O-ring
1.0 EcoBoost 92 kW (125 PS) M1JH	10.2012→		7.07400.12.0* ↳ 7.04011.05.0 ↳ 7.22687.44.0	STE DW-TL EUV-VB	EP Produktionsdatum bis: 14.11.2012 Production date to: 14.11.2012 EP EP
1.5 TDCi 55 kW (75 PS) UGJC	10.2012→		7.08681.00.0	EOV	EH Produktionsdatum ab: 19.11.2015 Production date from: 19.11.2015
1.5 TDCi 70 kW (95 PS) XVJA, XVJC	04.2015→		7.08681.00.0	EOV	EH  XVJA, XVJC: Produktionsdatum ab: 19.11.2015 Production date from: 19.11.2015
C-MAX II Van					
95					
1.0 EcoBoost 74 kW (100 PS) M2DA	10.2012→		7.06117.12.0	ZM-NWV	EL mit Dichtring with O-ring →03.2019
1.0 EcoBoost 74 kW (100 PS) M2DC	10.2012→		7.22687.44.0	EUV-VB	EP für heiße Klimazonen for hot climate zones
1.0 EcoBoost 92 kW (125 PS) M1DA	10.2012→		7.06117.12.0	ZM-NWV	EL mit Dichtring with O-ring →03.2019
1.0 EcoBoost 92 kW (125 PS) M1DD	10.2012→		7.22687.44.0	EUV-VB	EP für heiße Klimazonen for hot climate zones
1.5 EcoBoost 110 kW (150 PS) M8DB	03.2015→		7.07400.13.0* ↳ 7.04011.05.0	DW-TL DW-TL	EP mit Halter with holder Produktionsdatum bis: 13.11.2015 Production date to: 13.11.2015 EP









































F















































C-MAX II Van **95**

F

			7.07400.14.0*	DW-TL	EP	mit Halter with holder Produktionsdatum ab: 13.11.2015 Production date from: 13.11.2015 Produktionsdatum bis: 18.11.2015 Production date to: 18.11.2015
			↳ 7.04011.05.0	DW-TL	EP	
			7.07400.15.0*	DW-TL	EP	mit Halter with holder Produktionsdatum ab: 18.11.2015 Production date from: 18.11.2015
			↳ 7.04011.05.0	DW-TL	EP	
			7.04615.03.0	SUV	EL	
1.5 EcoBoost 132-134 kW (179-182 PS) M9DB	03.2015→		7.07400.13.0*	DW-TL	EP	mit Halter with holder Produktionsdatum bis: 13.11.2015 Production date to: 13.11.2015
			↳ 7.04011.05.0	DW-TL	EP	
			7.07400.14.0*	DW-TL	EP	mit Halter with holder Produktionsdatum ab: 13.11.2015 Production date from: 13.11.2015 Produktionsdatum bis: 18.11.2015 Production date to: 18.11.2015
			↳ 7.04011.05.0	DW-TL	EP	
			7.07400.15.0*	DW-TL	EP	mit Halter with holder Produktionsdatum ab: 18.11.2015 Production date from: 18.11.2015
			↳ 7.04011.05.0	DW-TL	EP	
			7.04615.03.0	SUV	EL	
1.5 TDCi 88 kW (120 PS) XWDA, XWDB	03.2015→		7.08681.00.0	EOV	EH	 XWDA, XWDB: Produktionsdatum ab: 07.12.2015 Production date from: 07.12.2015
1.5 TDCi ECOnetic 77 kW (105 PS) AEDA	03.2015→		7.08681.00.0	EOV	EH	Produktionsdatum ab: 07.12.2015 Production date from: 07.12.2015
1.6 EcoBoost 110 kW (150 PS) JQDA, JQDB	12.2010→		7.07400.19.0*	EUV-VB	EP	mit Halter with holder
			↳ 7.22687.44.0	EUV-VB	EP	
			7.03162.09.0	LDRV	EP	 JQDA, JQDB: Produktionsdatum bis: 30.01.2012 Production date to: 30.01.2012
			7.04492.07.0	LDRV	EP	 JQDA, JQDB: Produktionsdatum ab: 30.01.2012 Production date from: 30.01.2012 Produktionsdatum bis: 02.06.2015 Production date to: 02.06.2015
			7.04269.04.0	SUV	EL	
1.6 EcoBoost 134 kW (182 PS) JTDA, JTDB	12.2010→		7.07400.19.0*	EUV-VB	EP	mit Halter with holder
			↳ 7.22687.44.0	EUV-VB	EP	
			7.04492.07.0	LDRV	EP	 JTDA, JTDB: Produktionsdatum ab: 30.01.2012 Production date from: 30.01.2012 Produktionsdatum bis: 02.06.2015 Production date to: 02.06.2015
			7.04269.04.0	SUV	EL	
2.0 TDCi 85 kW (116 PS) TYDA	02.2011→		7.01771.01.0	DW-TL	EP	
2.0 TDCi 103 kW (140 PS) UFDB	02.2011→		7.01771.01.0	DW-TL	EP	

						
ESCORT VI Estate Van (AVL)						96
1.8 D 44 kW (60 PS) RTE, RTF, RTH	01.1995→08.2000		7.02256.47.0	EUV-AGR	EL  RTE, RTF, RTH: Produktionsdatum ab: 01.10.1995 Production date from: 01.10.1995	
1.8 TD 66 kW (90 PS) RFD, RFK, RFS	01.1995→08.2000		7.02256.47.0	EUV-AGR	EL  RFD, RFK, RFS: Produktionsdatum ab: 01.10.1995 Production date from: 01.10.1995	
1.8 Turbo D 51 kW (70 PS) RVA	12.1995→06.2001		7.02256.47.0	EUV-AGR	EL	
FIESTA Box Body/MPV (J5_, J3_)						97
1.3 44 kW (60 PS) J4C, J4J, J4L, J4Q, J4T	02.1996→08.2003		7.06269.02.0	LLR	EL  J4C, J4J, J4L, J4Q, J4T: →01.1998	
			7.06269.03.0	LLR	EL  J4C, J4J, J4L, J4Q, J4T: 09.1998→	
1.3 44 kW (60 PS) J4R	02.1996→08.2003		7.06269.02.0	LLR	EL  →01.1998	
1.4 i 66 kW (90 PS) FHA	04.1996→10.1999		7.06269.28.0	LLR	EL  Produktionsdatum bis: 31.01.1997 Production date to: 31.01.1997	
1.8 D 44 kW (60 PS) RTJ, RTK	02.1996→04.2002		7.02256.47.0	EUV-AGR	EL	
1.8 DI 55-57 kW (75-78 PS) RTN, RTP	09.2000→08.2003		7.02256.07.0	EUV-AGR	EL	
FIESTA Box Body/MPV (JV_)						98
D 1.8 44 kW (60 PS) RTJ, RTK	05.1998→04.2002		7.02256.47.0	EUV-AGR	EL	
TD 1.8 55-57 kW (75-78 PS) RTN, RTP, RTQ	03.2000→08.2003		7.02256.07.0	EUV-AGR	EL	
FIESTA V Van						99
1.3 51 kW (69 PS) A9JA, A9JB	10.2003→07.2005		7.05432.13.0	SM	EL 	
1.6 TDCi 66 kW (90 PS) HHJA, HHJB, HHJD	04.2007→09.2009		7.00968.04.0	DW-TL	EP	
FIESTA VI Van						100
1.0 59-63 kW (80-86 PS) P4JA, P4JB, P4JC, P4JD	10.2012→		7.06117.12.0	ZM-NWV	EL mit Dichtring with O-ring  P4JA, P4JB, P4JC, P4JD: →02.2019	
1.0 48 kW (65 PS) XMJA, XMJB	01.2013→		7.06117.12.0	ZM-NWV	EL mit Dichtring with O-ring  XMJA, XMJB: →02.2019	
1.0 EcoBoost 92 kW (125 PS) M1JE	09.2012→		7.06117.12.0	ZM-NWV	EL mit Dichtring with O-ring →02.2019	
1.0 EcoBoost 74 kW (100-101 PS) SFJA, SFJB, SFJC, SFJD	01.2013→		7.06117.12.0	ZM-NWV	EL mit Dichtring with O-ring  SFJA, SFJB, SFJC, SFJD: →02.2019	
1.0 EcoBoost 103 kW (140 PS) YYJA, YYJB	05.2014→		7.06117.12.0	ZM-NWV	EL mit Dichtring with O-ring  YYJA, YYJB: →02.2019	
1.5 TDCi 55 kW (75 PS) UGJC, XUJA, XUJB	10.2012→		7.08681.00.0	EOV	EH  UGJC, XUJA, XUJB: Produktionsdatum ab: 15.10.2015 Production date from: 15.10.2015	
1.6 ST 134 kW (182 PS) JTJA, JTJB	03.2013→		7.04492.07.0	LDRV	EP  JTJA, JTJB: Produktionsdatum bis: 12.08.2019 Production date to: 12.08.2019	
			7.04269.04.0	SUV	EL	
1.6 TDCi 66 kW (90 PS) HHJC, HHJD, HHJE	01.2009→		7.00968.04.0	DW-TL	EP	
1.6 TDCi 70 kW (95 PS) T3JA, TZJA, TZJB	02.2010→		7.00968.04.0	DW-TL	EP	

						
FIESTA VII Van						101
1.0 EcoBoost 92 kW (125 PS) M1JL, M1JM	09.2018→		7.06117.12.0	ZM-NWV	EL	mit Dichtring with O-ring  M1JL, M1JM: →02.2019
1.5 TDCi 88 kW (120 PS) XWJA, XWJB, XWJC	09.2018→		7.08681.00.0	EOV	EH	 XWJA, XWJB, XWJC: Produktionsdatum ab: 15.05.2017 Production date from: 15.05.2017
FOCUS I Estate Van (DNW)						102
1.8 85 kW (115 PS) EYDB, EYDC, EYDD, EYDE, EYDF, EYDG	04.1999→03.2005		7.06269.03.0	LLR	EL	
1.8 TDDi 66 kW (90 PS) C9DA, C9DB, C9DC	08.1998→03.2005		7.02256.07.0	EUV-AGR	EL	
1.8 TDDi 55-57 kW (75-78 PS) BHDA, BHDB	08.1999→03.2005		7.02256.07.0	EUV-AGR	EL	
FOCUS II Estate Van						103
2.0 TDCi 100 kW (136 PS) G6DB	09.2005→07.2011		7.28328.07.0	DW-RK	EP	→09.2006 Euro 4 Euro 4 für Fahrzeuge mit Diesel-Partikel-Filter (DPF) for vehicles with diesel soot filter
			7.28328.07.0	DW-TL	EP	→09.2006 Euro 4 Euro 4 für Fahrzeuge mit Diesel-Partikel-Filter (DPF) for vehicles with diesel soot filter
FOCUS III Estate Van						104
1.0 EcoBoost 74 kW (100 PS) M2DA	02.2012→		7.07400.12.0*	STE	EP	Produktionsdatum bis: 07.08.2012 Production date to: 07.08.2012
			↳ 7.04011.05.0	DW-TL	EP	
			↳ 7.22687.44.0	EUV-VB	EP	
			7.06117.12.0	ZM-NWV	EL	mit Dichtring with O-ring →02.2019
1.0 EcoBoost 74 kW (100 PS) M2DB, M2DC, SFDB	02.2012→		7.22687.44.0	EUV-VB	EP	 M2DB, M2DC, SFDB: für heiße Klimazonen for hot climate zones
1.0 EcoBoost 74 kW (100 PS) SFDA	02.2012→		7.07400.12.0*	STE	EP	Produktionsdatum bis: 07.08.2012 Production date to: 07.08.2012
			↳ 7.04011.05.0	DW-TL	EP	
			↳ 7.22687.44.0	EUV-VB	EP	
1.0 EcoBoost 92 kW (125 PS) M1DA	02.2012→		7.07400.12.0*	STE	EP	Produktionsdatum bis: 07.08.2012 Production date to: 07.08.2012
			↳ 7.04011.05.0	DW-TL	EP	
			↳ 7.22687.44.0	EUV-VB	EP	
			7.06117.12.0	ZM-NWV	EL	mit Dichtring with O-ring →02.2019
1.0 EcoBoost 92 kW (125 PS) M1DC, M1DD	02.2012→		7.22687.44.0	EUV-VB	EP	 M1DC, M1DD: für heiße Klimazonen for hot climate zones
1.5 EcoBoost 110 kW (150 PS) M8DA, M8DB	09.2014→		7.07400.13.0*	DW-TL	EP	mit Halter with holder  M8DA, M8DB: Produktionsdatum bis: 13.11.2015 Production date to: 13.11.2015
			↳ 7.04011.05.0	DW-TL	EP	

					
FOCUS III Estate Van					104
			7.07400.14.0*	DW-TL	EP mit Halter with holder  M8DA, M8DB: Produktionsdatum ab: 13.11.2015 Production date from: 13.11.2015 Produktionsdatum bis: 18.11.2015 Production date to: 18.11.2015
			↳7.04011.05.0	DW-TL	EP
			7.07400.15.0*	DW-TL	EP mit Halter with holder  M8DA, M8DB: Produktionsdatum ab: 18.11.2015 Production date from: 18.11.2015
			↳7.04011.05.0	DW-TL	EP
			7.04615.03.0	SUV	EL
1.5 EcoBoost 110 kW (150 PS) M8DD, M8DE	09.2014→		7.07400.13.0*	DW-TL	EP mit Halter with holder  M8DD, M8DE: Produktionsdatum bis: 13.11.2015 Production date to: 13.11.2015
			↳7.04011.05.0	DW-TL	EP
			7.07400.14.0*	DW-TL	EP mit Halter with holder  M8DD, M8DE: Produktionsdatum ab: 13.11.2015 Production date from: 13.11.2015 Produktionsdatum bis: 18.11.2015 Production date to: 18.11.2015
			↳7.04011.05.0	DW-TL	EP
			7.07400.15.0*	DW-TL	EP mit Halter with holder  M8DD, M8DE: Produktionsdatum ab: 18.11.2015 Production date from: 18.11.2015
			↳7.04011.05.0	DW-TL	EP
1.5 EcoBoost 132-134 kW (179-182 PS) M9DA, M9DB	09.2014→		7.07400.13.0*	DW-TL	EP mit Halter with holder  M9DA, M9DB: Produktionsdatum bis: 13.11.2015 Production date to: 13.11.2015
			↳7.04011.05.0	DW-TL	EP
			7.07400.14.0*	DW-TL	EP mit Halter with holder  M9DA, M9DB: Produktionsdatum ab: 13.11.2015 Production date from: 13.11.2015 Produktionsdatum bis: 18.11.2015 Production date to: 18.11.2015
			↳7.04011.05.0	DW-TL	EP
			7.07400.15.0*	DW-TL	EP mit Halter with holder  M9DA, M9DB: Produktionsdatum ab: 18.11.2015 Production date from: 18.11.2015
			↳7.04011.05.0	DW-TL	EP
			7.04615.03.0	SUV	EL
1.5 TDCi 70 kW (95 PS) XXDA, XXDC	09.2014→		7.08681.00.0	EOV	EH  XXDA, XXDC: Produktionsdatum ab: 07.12.2015 Production date from: 07.12.2015
1.5 TDCi 88 kW (120 PS) XWDA, XWDB, XWDC, XWDD	09.2014→		7.08681.00.0	EOV	EH  XWDA, XWDB, XWDC, XWDD: Produktionsdatum ab: 07.12.2015 Production date from: 07.12.2015
1.5 TDCi ECONetic 77 kW (105 PS) XXDB	09.2014→		7.08681.00.0	EOV	EH Produktionsdatum ab: 07.12.2015 Production date from: 07.12.2015

F

















FOCUS III Estate Van **104**

2.0 TDCi 110 kW (150 PS) T7DB	11.2014→	 7.01771.01.0	DW-AGR	EP	→07.2015
		7.01771.01.0	DW-TL	EP	→07.2015

FOCUS III Hatchback Van **105**

F





















1.0 EcoBoost 74 kW (100 PS) M2DA	02.2012→	 7.07400.12.0*	STE	EP	Produktionsdatum bis: 07.08.2012 Production date to: 07.08.2012 mit Dichtring with O-ring →02.2019
		↳ 7.04011.05.0	DW-TL	EP	
		↳ 7.22687.44.0	EUV-VB	EP	
		7.06117.12.0	ZM-NWV	EL	
1.0 EcoBoost 74 kW (100 PS) M2DB, M2DC, SFDB	02.2012→	 7.22687.44.0	EUV-VB	EP	 M2DB, M2DC, SFDB: für heiße Klimazonen for hot climate zones
1.0 EcoBoost 74 kW (100 PS) SFDA	02.2012→	 7.07400.12.0*	STE	EP	Produktionsdatum bis: 07.08.2012 Production date to: 07.08.2012
		↳ 7.04011.05.0	DW-TL	EP	
		↳ 7.22687.44.0	EUV-VB	EP	
1.0 EcoBoost 92 kW (125 PS) M1DA	02.2012→	 7.07400.12.0*	STE	EP	Produktionsdatum bis: 07.08.2012 Production date to: 07.08.2012 mit Dichtring with O-ring →02.2019
		↳ 7.04011.05.0	DW-TL	EP	
		↳ 7.22687.44.0	EUV-VB	EP	
		7.06117.12.0	ZM-NWV	EL	
1.0 EcoBoost 92 kW (125 PS) M1DC, M1DD	02.2012→	 7.22687.44.0	EUV-VB	EP	 M1DC, M1DD: für heiße Klimazonen for hot climate zones
1.5 EcoBoost 110 kW (150 PS) M8DA, M8DB	09.2014→	 7.07400.13.0*	DW-TL	EP	mit Halter with holder  M8DA, M8DB: Produktionsdatum bis: 13.11.2015 Production date to: 13.11.2015
		↳ 7.04011.05.0	DW-TL	EP	
		7.07400.14.0*	DW-TL	EP	mit Halter with holder  M8DA, M8DB: Produktionsdatum ab: 13.11.2015 Production date from: 13.11.2015 Produktionsdatum bis: 18.11.2015 Production date to: 18.11.2015
		↳ 7.04011.05.0	DW-TL	EP	
		7.07400.15.0*	DW-TL	EP	mit Halter with holder  M8DA, M8DB: Produktionsdatum ab: 18.11.2015 Production date from: 18.11.2015
		↳ 7.04011.05.0	DW-TL	EP	
1.5 EcoBoost 132-134 kW (179-182 PS) M9DA, M9DB	09.2014→	 7.07400.13.0*	DW-TL	EP	mit Halter with holder  M9DA, M9DB: Produktionsdatum bis: 13.11.2015 Production date to: 13.11.2015
		↳ 7.04011.05.0	DW-TL	EP	
		7.07400.14.0*	DW-TL	EP	mit Halter with holder  M9DA, M9DB: Produktionsdatum ab: 13.11.2015 Production date from: 13.11.2015 Produktionsdatum bis: 18.11.2015 Production date to: 18.11.2015
		↳ 7.04011.05.0	DW-TL	EP	



















FOCUS III Hatchback Van
105

			7.07400.15.0*	DW-TL	EP	mit Halter with holder M9DA, M9DB: Produktionsdatum ab: 18.11.2015 Production date from: 18.11.2015
			↳7.04011.05.0	DW-TL	EP	
1.5 TDCi 70 kW (95 PS) XXDA, XXDC	09.2014→		7.08681.00.0	EOV	EH	XXDA, XXDC: Produktionsdatum ab: 07.12.2015 Production date from: 07.12.2015
1.5 TDCi 88 kW (120 PS) XWDA, XWDB, XWDC, XWDD	09.2014→		7.08681.00.0	EOV	EH	XWDA, XWDB, XWDC, XWDD: Produktionsdatum ab: 07.12.2015 Production date from: 07.12.2015
1.5 TDCi ECONetic 77 kW (105 PS) XXDB	09.2014→		7.08681.00.0	EOV	EH	Produktionsdatum ab: 07.12.2015 Production date from: 07.12.2015
1.6 EcoBoost 134 kW (182 PS) JTDA, JTDB	11.2011→06.2014		7.07400.19.0*	EUV-VB	EP	mit Halter with holder
			↳7.22687.44.0	EUV-VB	EP	
			7.03162.09.0	LDRV	EP	JTDA, JTDB: Produktionsdatum bis: 30.01.2012 Production date to: 30.01.2012
			7.04492.07.0	LDRV	EP	JTDA, JTDB: Produktionsdatum ab: 30.01.2012 Production date from: 30.01.2012
			7.04269.04.0	SUV	EL	
1.6 EcoBoost 110 kW (150 PS) JQDA, JQDB, YUDA	11.2011→06.2014		7.07400.19.0*	EUV-VB	EP	mit Halter with holder
			↳7.22687.44.0	EUV-VB	EP	
			7.03162.09.0	LDRV	EP	JQDA, JQDB, YUDA: Produktionsdatum bis: 30.01.2012 Production date to: 30.01.2012
			7.04492.07.0	LDRV	EP	JQDA, JQDB, YUDA: Produktionsdatum ab: 30.01.2012 Production date from: 30.01.2012
			7.04269.04.0	SUV	EL	
2.0 TDCi 85 kW (116 PS) TYDA	01.2011→06.2014		7.01771.01.0	DW-AGR	EP	
			7.01771.01.0	DW-TL	EP	
2.0 TDCi 103 kW (140 PS) UFDB	01.2011→06.2014		7.01771.01.0	DW-AGR	EP	
			7.01771.01.0	DW-TL	EP	
2.0 TDCi 110 kW (150 PS) T7DB	11.2014→		7.01771.01.0	DW-AGR	EP	→07.2015
			7.01771.01.0	DW-TL	EP	→07.2015

GALAXY MK I VAN (WGR)
106

1.9 TDi 66 kW (90 PS) AHU	09.1996→08.1999		7.21895.55.0	LDRV	EL	
1.9 TDi 66 kW (90 PS) ANU	09.1999→03.2006		7.28098.04.0	EUV-KA	EL	für Fahrzeuge mit Standheizung for vehicles with parking heater Produktionsdatum ab: 01.04.2000 Production date from: 01.04.2000
2.8 128 kW (174 PS) AAA	11.1995→07.2000		7.21483.54.0	EUV-AGR	EL	
2.8 150 kW (204 PS) AYL	05.2000→03.2006		7.28098.04.0	EUV-KA	EL	für OE-Nummer: 1112424, YM21-12B573-GA for OE number: 1112424, YM21-12B573-GA für Fahrzeuge mit Standheizung for vehicles with parking heater



						
GALAXY MK II VAN (WA6)						107
EcoBoost 118 kW (160 PS) JTWA, JTWB	02.2011→06.2015		7.07400.19.0*	EUV-VB	EP	mit Halter with holder
			↳ 7.22687.44.0 7.04492.07.0	EUV-VB LDRV	EP EP	 JTWA, JTWB: Produktionsdatum ab: 02.04.2012 Production date from: 02.04.2012
			7.04269.04.0	SUV	EL	
GALAXY MK III VAN (CK)						108
2.0 EcoBlue 110 kW (150 PS) YMCB	03.2019→		7.08681.08.0	EOV	EH	
2.0 EcoBlue AWD 140 kW (190 PS) BCCC	03.2019→		7.08681.08.0	EOV	EH	
GRAND C-MAX Van						109
1.0 EcoBoost 74 kW (100 PS) M2DA	10.2012→		7.06117.12.0	ZM-NWV	EL	mit Dichtring with O-ring →03.2019
1.0 EcoBoost 74 kW (100 PS) M2DC	10.2012→		7.22687.44.0	EUV-VB	EP	für heiße Klimazonen for hot climate zones
1.0 EcoBoost 92 kW (125 PS) M1DA	10.2012→		7.06117.12.0	ZM-NWV	EL	mit Dichtring with O-ring →03.2019
1.0 EcoBoost 92 kW (125 PS) M1DD	10.2012→		7.22687.44.0	EUV-VB	EP	für heiße Klimazonen for hot climate zones
1.5 EcoBoost 110 kW (150 PS) M8DB	03.2015→		7.07400.13.0*	DW-TL	EP	mit Halter with holder Produktionsdatum bis: 13.11.2015 Production date to: 13.11.2015
			↳ 7.04011.05.0 7.07400.14.0*	DW-TL DW-TL	EP EP	mit Halter with holder Produktionsdatum ab: 13.11.2015 Production date from: 13.11.2015 Produktionsdatum bis: 18.11.2015 Production date to: 18.11.2015
			↳ 7.04011.05.0 7.07400.15.0*	DW-TL DW-TL	EP EP	mit Halter with holder Produktionsdatum ab: 18.11.2015 Production date from: 18.11.2015
			↳ 7.04011.05.0	DW-TL	EP	
1.5 TDCi 88 kW (120 PS) XWDA, XWDB	03.2015→		7.08681.00.0	EOV	EH	 XWDA, XWDB: Produktionsdatum ab: 07.12.2015 Production date from: 07.12.2015
1.6 EcoBoost 110 kW (150 PS) JQDA, JQDB	12.2010→		7.07400.19.0*	EUV-VB	EP	mit Halter with holder
			↳ 7.22687.44.0 7.03162.09.0	EUV-VB LDRV	EP EP	 JQDA, JQDB: Produktionsdatum bis: 30.01.2012 Production date to: 30.01.2012  JQDA, JQDB: Produktionsdatum ab: 30.01.2012 Production date from: 30.01.2012 Produktionsdatum bis: 02.06.2015 Production date to: 02.06.2015
			7.04492.07.0	LDRV	EP	
			7.04269.04.0	SUV	EL	
1.6 EcoBoost 134 kW (182 PS) JTDA, JTDB	12.2010→		7.07400.19.0*	EUV-VB	EP	mit Halter with holder
			↳ 7.22687.44.0	EUV-VB	EP	

					
GRAND C-MAX Van					109
			7.04492.07.0	LDRV	EP  JTDA, JTDB: Produktionsdatum ab: 30.01.2012 Production date from: 30.01.2012 Produktionsdatum bis: 02.06.2015 Production date to: 02.06.2015
			7.04269.04.0	SUV	EL
KA Van (RB)					110
1.3 i 44 kW (60 PS) BAA, J4D, J4K, J4M, J4N, J4P, J4S	05.2002→05.2005		7.06269.03.0	LLR	EL 
KUGA II VAN					111
1.5 EcoBoost 110 kW (150 PS) M8MA	09.2014→		7.07400.13.0*	DW-TL	EP mit Halter with holder
			↳ 7.04011.05.0	DW-TL	EP
1.5 EcoBoost 88 kW (120 PS) BNMA	06.2019→		7.07400.13.0*	DW-TL	EP mit Halter with holder
			↳ 7.04011.05.0	DW-TL	EP
1.5 EcoBoost 4x4 132-134 kW (182 PS) M9MA	09.2014→		7.07400.13.0*	DW-TL	EP mit Halter with holder
			↳ 7.04011.05.0	DW-TL	EP
1.5 EcoBoost 4x4 121-129 kW (165-175 PS) C15HDTX	06.2019→		7.07400.13.0*	DW-TL	EP mit Halter with holder
			↳ 7.04011.05.0	DW-TL	EP
MONDEO IV Van					112
1.6 EcoBoost 118 kW (160 PS) JTBA	11.2010→09.2014		7.07400.19.0*	EUV-VB	EP mit Halter with holder
			↳ 7.22687.44.0	EUV-VB	EP
			7.04492.07.0	LDRV	EP Produktionsdatum ab: 02.04.2012 Production date from: 02.04.2012
1.6 TDCi 85 kW (115-116 PS) T1BA, T1BB, T1BC	03.2013→09.2014		7.07400.00.0*	STE	EP
			↳ 7.01633.06.0	DW-TL	EP
2.0 EcoBoost 176 kW (239 PS) TPBA	03.2010→09.2014		7.06117.52.0	SV-NWV	EH
			7.06117.53.0	SV-NWV	EH Produktionsdatum ab: 22.08.2011 Production date from: 22.08.2011
			7.06117.55.0	SV-NWV	EH Einlasseite Intake Side Produktionsdatum bis: 22.08.2011 Production date to: 22.08.2011
2.0 EcoBoost 149 kW (203 PS) TNBA	03.2010→09.2014		7.06117.52.0	SV-NWV	EH
			7.06117.53.0	SV-NWV	EH Produktionsdatum ab: 22.08.2011 Production date from: 22.08.2011
			7.06117.55.0	SV-NWV	EH Einlasseite Intake Side Produktionsdatum bis: 22.08.2011 Production date to: 22.08.2011
S-MAX VAN (WA6)					113
1.6 118 kW (160 PS) JTWA	02.2011→12.2014		7.07400.19.0*	EUV-VB	EP mit Halter with holder
			↳ 7.22687.44.0	EUV-VB	EP
			7.04492.07.0	LDRV	EP Produktionsdatum ab: 02.04.2012 Production date from: 02.04.2012

F



TOURNEO CUSTOM V362 Bus (F3) **114**











2.0 EcoBlue 136 kW (185 PS) BCFA, BCFB	05.2019→	 7.08681.08.0	EOV	EH	 BCFA, BCFB: Produktionsdatum ab: 20.05.2019 Production date from: 20.05.2019
2.0 EcoBlue mHEV 136 kW (185 PS) BCFC, BCFD	05.2019→	 7.08681.08.0	EOV	EH	 BCFC, BCFD: Produktionsdatum ab: 20.05.2019 Production date from: 20.05.2019
2.0 EcoBlue mHEV 96 kW (130 PS) BKFC, BKFD	05.2019→	 7.08681.08.0	EOV	EH	 BKFC, BKFD: Produktionsdatum ab: 20.05.2019 Production date from: 20.05.2019



































F

TRANSIT Bus (E_ _) **115**

2.0 66 kW (90 PS) NBA	09.1991→09.1994	 4.02003.62.0	LLR	EL	<input checked="" type="checkbox"/>
2.0 (EBL, EBS, ECL, EDS, EDL, EGL, ESS, ESL, EUS) 74-84 kW (101-114 PS) NSF, NSG, NSH	08.1994→03.2000	 4.02003.62.0	LLR	EL	<input checked="" type="checkbox"/>
2.0 CNG 74-84 kW (101-114 PS) NSH	06.1994→03.2000	 4.02003.62.0	LLR	EL	<input checked="" type="checkbox"/>
		7.06269.26.0	LLR	EL	<input type="checkbox"/> für OE-Nummer: 6631855, 87TF-9F715-CB for OE number: 6631855, 87TF-9F715-CB
2.5 TD (EBL, EDL, EDS, EGL, ESL, ESS, EUS) 63 kW (85-86 PS) 4GA, 4GB, 4GC, 4GD, 4GE, 4GF	01.1995→03.2000	 7.02256.47.0	EUV-AGR	EL	
2.5 TD (ECL, EDL, EDS, ESL, ESS, EUS) 74 kW (101 PS) 4EB, 4EC	07.1994→03.2000	 7.02256.47.0	EUV-AGR	EL	
2.9 i 104-107 kW (141-145 PS) BRT	01.1991→09.1994	 7.06269.26.0	LLR	EL	<input type="checkbox"/> für OE-Nummer: 6631855, 87TF-9F715-CB for OE number: 6631855, 87TF-9F715-CB

TRANSIT Bus (FD_ _, FB_ _, FS_ _, FZ_ _, FC_ _) **116**

2.2 TDCi 63 kW (85 PS) P8FA, P8FB	04.2006→08.2014	 7.02256.29.0	EUV-KA	EL	 P8FA, P8FB: für Fahrzeuge mit Klimaanlage for vehicles with air conditioning
2.2 TDCi 81 kW (110 PS) QVFA	04.2006→08.2014	 7.02256.29.0	EUV-KA	EL	für Fahrzeuge mit Klimaanlage for vehicles with air conditioning
2.2 TDCi 96 kW (130 PS) QWFA	04.2006→08.2014	 7.02256.29.0	EUV-KA	EL	für Fahrzeuge mit Klimaanlage for vehicles with air conditioning
2.2 TDCi 103 kW (140 PS) PGFA, PGFB, UHFA, UHFB, UHFC	10.2007→08.2014	 7.02256.29.0	EUV-KA	EL	 PGFA, PGFB, UHFA, UHFB, UHFC: für Fahrzeuge mit Klimaanlage for vehicles with air conditioning
2.2 TDCi 85 kW (115 PS) SRFA, SRFB, SRFC, SRFD, SRFE	10.2008→08.2014	 7.02256.29.0	EUV-KA	EL	 SRFA, SRFB, SRFC, SRFD, SRFE: für Fahrzeuge mit Klimaanlage for vehicles with air conditioning
2.2 TDCi 74 kW (101 PS) DRFA, DRFB, DRFC, DRFD, DRFE	10.2011→08.2014	 7.02256.29.0	EUV-KA	EL	 DRFA, DRFB, DRFC, DRFD, DRFE: für Fahrzeuge mit Klimaanlage for vehicles with air conditioning
2.2 TDCi 92 kW (125 PS) CYFA, CYFB, CYFC, CYFD	10.2011→08.2014	 7.02256.29.0	EUV-KA	EL	 CYFA, CYFB, CYFC, CYFD: für Fahrzeuge mit Klimaanlage for vehicles with air conditioning
2.2 TDCi RWD 92 kW (125 PS) CYRA	09.2011→12.2014	 7.02256.29.0	EUV-KA	EL	für Fahrzeuge mit Klimaanlage for vehicles with air conditioning
2.2 TDCi RWD 100 kW (136 PS) USRA, USRB	09.2011→08.2014	 7.02256.29.0	EUV-KA	EL	 USRA, USRB: für Fahrzeuge mit Klimaanlage for vehicles with air conditioning
2.2 TDCi RWD 74 kW (101 PS) DRRA, DRRB, DRRC	10.2011→08.2014	 7.02256.29.0	EUV-KA	EL	 DRRA, DRRB, DRRC: für Fahrzeuge mit Klimaanlage for vehicles with air conditioning

					
TRANSIT Bus (FD __, FB __, FS __, FZ __, FC __)					
116					
2.3 16V RWD (F_B_, F_C_, F_A_) 103-107 kW (140-146 PS) E5FA, E5FC	08.2000→05.2006		7.02256.46.0	EUV-AGR	EL
			7.06269.05.0	LLR	EL 
2.4 TDCi 85 kW (115 PS) JXFA, JXFC	04.2006→08.2014		7.02256.29.0	EUV-KA	EL  JXFA, JXFC: für Fahrzeuge mit Klimaanlage for vehicles with air conditioning
2.4 TDCi 103 kW (140 PS) H9FD	04.2006→08.2014		7.02256.29.0	EUV-KA	EL für Fahrzeuge mit Klimaanlage for vehicles with air conditioning
2.4 TDCi 74 kW (100 PS) PHFA, PHFC	04.2006→08.2014		7.02256.29.0	EUV-KA	EL  PHFA, PHFC: für Fahrzeuge mit Klimaanlage for vehicles with air conditioning
2.4 TDCi 4x4 103 kW (140 PS) H9FB	11.2006→08.2014		7.02256.29.0	EUV-KA	EL für Fahrzeuge mit Klimaanlage for vehicles with air conditioning
2.4 TDCi RWD 88 kW (120 PS) SWFA	01.2007→12.2011		7.02256.29.0	EUV-KA	EL für Fahrzeuge mit Klimaanlage for vehicles with air conditioning
3.2 TDCi 147 kW (200 PS) SAFA, SAFB	02.2008→08.2014		7.02256.29.0	EUV-KA	EL  SAFA, SAFB: für Fahrzeuge mit Klimaanlage for vehicles with air conditioning
TRANSIT CONNECT (P65_, P70_, P80_)					
117					
1.8 16V 85 kW (115-116 PS) EYPA, EYPC, EYPD	06.2002→12.2013		7.06269.03.0	LLR	EL 
1.8 16V LPG 85 kW (115-116 PS) EYPA, EYPC, EYPD	06.2002→12.2013		7.06269.03.0	LLR	EL 
1.8 Di 55-57 kW (75-78 PS) BHFA, P7PA, P7PB, R2PA	06.2002→12.2013		7.02256.07.0	EUV-AGR	EL  BHFA, P7PA, P7PB, R2PA: Produktionsdatum bis: 31.07.2006 Production date to: 31.07.2006
1.8 TDCi 81 kW (110 PS) RWPA	08.2006→12.2013		7.02256.07.0	EUV-AGR	EL für OE-Nummer: 1079561, 98AB-9E882-AA for OE number: 1079561, 98AB-9E882-AA
TRANSIT CONNECT V408 Box Body/MPV					
118					
1.0 EcoBoost 74 kW (100 PS) M2GA	02.2013→		7.04615.03.0	SUV	EL
			7.06117.12.0	ZM-NWV	EL mit Dichtring with O-ring →03.2019
1.0 EcoBoost 74 kW (100 PS) B3GA, M2GB	08.2015→		7.04615.03.0	SUV	EL
1.5 TDCi 74 kW (101 PS) XVGA, XVGB, XVGC	05.2015→		7.08681.00.0	EOV	EH  XVGA, XVGB, XVGC: Produktionsdatum ab: 18.01.2016 Production date from: 18.01.2016
1.5 TDCi 88 kW (120 PS) XWGA, XWGB	05.2015→		7.08681.00.0	EOV	EH  XWGA, XWGB: Produktionsdatum ab: 18.01.2016 Production date from: 18.01.2016
1.5 TDCi 55 kW (75 PS) XUGA	08.2015→		7.08681.00.0	EOV	EH Produktionsdatum ab: 18.01.2016 Production date from: 18.01.2016
1.6 EcoBoost 110 kW (150 PS) JQGA	11.2013→		7.04492.07.0	LDRV	EP
			7.04269.04.0	SUV	EL
1.6 TDCi 55 kW (75 PS) UBGA	02.2013→		7.07400.01.0*	STE	EP
			↳ 7.01633.06.0	DW-TL	EP
1.6 TDCi 70 kW (95 PS) TZGA, TZGB	02.2013→		7.07400.01.0*	STE	EP
			↳ 7.01633.06.0	DW-TL	EP
1.6 TDCi 85 kW (115 PS) T1GA	02.2013→		7.07400.01.0*	STE	EP

F











TRANSIT CONNECT V408 Box Body/MPV **118**











		↳ 7.01633.06.0	DW-TL	EP	
2.5 Duratec 125-126 kW (170-171 PS) S7GA, S7GB	09.2013→	 7.06117.33.0	SV-NWV	EL	

TRANSIT COURIER B460 Box Body/MPV **119**







F

1.0 EcoBoost 74 kW (100 PS) SFCA, SFCB, SFCC, SFCD	02.2014→	 7.06117.12.0	ZM-NWV	EL	mit Dichtring with O-ring  SFCA, SFCB, SFCC, SFCD: →03.2019
1.5 EcoBlue 74 kW (100 PS) XXCA, XXCB, XXCC	04.2018→	 7.08681.00.0	EOV	EH	 XXCA, XXCB, XXCC: Produktionsdatum ab: 08.01.2016 Production date from: 08.01.2016
1.5 TDCi 55 kW (75 PS) UGCA, UGCB, XUCC, XUCD, XWCA, XWCB	02.2014→	 7.08681.00.0	EOV	EH	 UGCA, UGCB, XUCC, XUCD, XWCA, XWCB: Produktionsdatum ab: 08.01.2016 Production date from: 08.01.2016
1.5 TDCi 70 kW (95 PS) XVCA, XVCB, XVCC	05.2015→	 7.08681.00.0	EOV	EH	 XVCA, XVCB, XVCC: Produktionsdatum ab: 08.01.2016 Production date from: 08.01.2016
1.6 TDCi 70 kW (95 PS) T3CA, T3CB, T3CC	02.2014→	 7.07400.01.0* ↳ 7.01633.06.0	STE DW-TL	EP EP	

TRANSIT CUSTOM V362 Bus (F3) **120**







































2.0 EcoBlue 136 kW (185 PS) BCFA, BCFB	05.2019→	 7.08681.08.0	EOV	EH	 BCFA, BCFB: Produktionsdatum ab: 20.05.2019 Production date from: 20.05.2019
2.0 EcoBlue mHEV 136 kW (185 PS) BCFC, BCFD	05.2019→	 7.08681.08.0	EOV	EH	 BCFC, BCFD: Produktionsdatum ab: 20.05.2019 Production date from: 20.05.2019
2.0 EcoBlue mHEV 96 kW (130 PS) BKFC, BKFD	05.2019→	 7.08681.08.0	EOV	EH	 BKFC, BKFD: Produktionsdatum ab: 20.05.2019 Production date from: 20.05.2019
2.0 EcoBlue mHEV 125 kW (170 PS) BLFC, BLFD	05.2019→	 7.08681.08.0	EOV	EH	 BLFC, BLFD: Produktionsdatum ab: 20.05.2019 Production date from: 20.05.2019
2.0 EcoBlue mHEV 77 kW (105 PS) BJFC, BJFD	05.2019→	 7.08681.08.0	EOV	EH	 BJFC, BJFD: Produktionsdatum ab: 20.05.2019 Production date from: 20.05.2019

TRANSIT CUSTOM V362 Van (FY, FZ) **121**

2.0 EcoBlue 136 kW (185 PS) BCFA, BCFB	05.2019→	 7.08681.08.0	EOV	EH	 BCFA, BCFB: Produktionsdatum ab: 20.05.2019 Production date from: 20.05.2019
2.0 EcoBlue mHEV 96 kW (130 PS) BKFC, BKFD	05.2019→	 7.08681.08.0	EOV	EH	 BKFC, BKFD: Produktionsdatum ab: 20.05.2019 Production date from: 20.05.2019
2.0 EcoBlue mHEV 125 kW (170 PS) BLFC, BLFD	05.2019→	 7.08681.08.0	EOV	EH	 BLFC, BLFD: Produktionsdatum ab: 20.05.2019 Production date from: 20.05.2019
2.0 EcoBlue mHEV 136 kW (185 PS) BCFC, BCFD	05.2019→	 7.08681.08.0	EOV	EH	 BCFC, BCFD: Produktionsdatum ab: 20.05.2019 Production date from: 20.05.2019

TRANSIT Platform/Chassis (E_ _) **122**



2.0 (EME/L/S, ENE/L/S) 72 kW (98 PS) NCA	09.1991→08.1994	 4.02003.62.0	LLR	EL	<input checked="" type="checkbox"/>
2.0 (EME/L/S, ENE/L/S) 84 kW (114 PS) NSF, NSG	08.1994→03.2000	 4.02003.62.0	LLR	EL	<input checked="" type="checkbox"/>

						
TRANSIT Platform/Chassis (E_ _)						122
2.5 TD (EME/L/S, ENE/L/S) 63 kW (85-86 PS) 4GA, 4GB, 4GC, 4GD, 4GE, 4GF	08.1994→03.2000		7.02256.47.0	EUV-AGR	EL	
2.5 TD (EME/L/S, ENE/L/S) 74 kW (101 PS) 4EB, 4EC	08.1994→03.2000		7.02256.47.0	EUV-AGR	EL	
TRANSIT Platform/Chassis (FM_ _, FN_ _)						123
2.3 103-107 kW (140-146 PS) E5FC	03.2001→03.2006		7.02256.46.0	EUV-AGR	EL	
2.3 16V (F_A_, F_B_, F_C_, F_D_) 103-107 kW (140-146 PS) E5FA, E5FC	04.2001→05.2006		7.02256.46.0	EUV-AGR	EL	
			7.06269.05.0	LLR	EL 	
TRANSIT Platform/Chassis (FM_ _, FN_ _, FF_ _)						124
2.2 TDCi 81 kW (110 PS) QVFA	04.2006→08.2014		7.02256.29.0	EUV-KA	EL für Fahrzeuge mit Klimaanlage for vehicles with air conditioning	
2.2 TDCi 63 kW (85 PS) P8FA, P8FB	04.2006→08.2014		7.02256.29.0	EUV-KA	EL  P8FA, P8FB: für Fahrzeuge mit Klimaanlage for vehicles with air conditioning	
2.2 TDCi 96 kW (130 PS) QWFA	04.2006→08.2014		7.02256.29.0	EUV-KA	EL für Fahrzeuge mit Klimaanlage for vehicles with air conditioning	
2.2 TDCi 103 kW (140 PS) PGFA, PGFB, UHFA, UHFB, UHFC	10.2007→09.2011		7.02256.29.0	EUV-KA	EL  PGFA, PGFB, UHFA, UHFB, UHFC: für Fahrzeuge mit Klimaanlage for vehicles with air conditioning	
2.2 TDCi 85 kW (115 PS) SRFA, SRFB, SRFC, SRFD, SRFE	10.2008→08.2014		7.02256.29.0	EUV-KA	EL  SRFA, SRFB, SRFC, SRFD, SRFE: für Fahrzeuge mit Klimaanlage for vehicles with air conditioning	
2.2 TDCi 74 kW (101 PS) DRFA, DRFB, DRFC, DRFD, DRFE	10.2011→08.2014		7.02256.29.0	EUV-KA	EL  DRFA, DRFB, DRFC, DRFD, DRFE: für Fahrzeuge mit Klimaanlage for vehicles with air conditioning	
2.2 TDCi 92 kW (125 PS) CYFA, CYFB, CYFC, CYFD	10.2011→08.2014		7.02256.29.0	EUV-KA	EL  CYFA, CYFB, CYFC, CYFD: für Fahrzeuge mit Klimaanlage for vehicles with air conditioning	
2.2 TDCi 4x4 92 kW (125 PS) CYRB, CYRC	10.2011→08.2014		7.02256.29.0	EUV-KA	EL  CYRB, CYRC: für Fahrzeuge mit Klimaanlage for vehicles with air conditioning	
2.2 TDCi RWD 74 kW (101 PS) DRRA, DRRB, DRRC	10.2011→08.2014		7.02256.29.0	EUV-KA	EL  DRRA, DRRB, DRRC: für Fahrzeuge mit Klimaanlage for vehicles with air conditioning	
2.2 TDCi RWD 92 kW (125 PS) CYRA	10.2011→08.2014		7.02256.29.0	EUV-KA	EL für Fahrzeuge mit Klimaanlage for vehicles with air conditioning	
2.2 TDCi RWD 114 kW (155 PS) CVRA, CVRB, CVRC	10.2011→08.2014		7.02256.29.0	EUV-KA	EL  CVRA, CVRB, CVRC: für Fahrzeuge mit Klimaanlage for vehicles with air conditioning	
2.3 16V CNG RWD 100-107 kW (136-145 PS) GZFC	04.2006→08.2014		7.02256.29.0	EUV-KA	EL für Fahrzeuge mit Klimaanlage for vehicles with air conditioning	
2.3 16V LPG RWD 100-107 kW (136-145 PS) GZFC	04.2006→08.2014		7.02256.29.0	EUV-KA	EL für Fahrzeuge mit Klimaanlage for vehicles with air conditioning	
2.3 16V RWD 100-107 kW (136-145 PS) GZFA, GZFC	04.2006→08.2014		7.02256.29.0	EUV-KA	EL  GZFA, GZFC: für Fahrzeuge mit Klimaanlage for vehicles with air conditioning	
2.4 TDCi 4x4 103 kW (140 PS) H9FB	11.2006→08.2014		7.02256.29.0	EUV-KA	EL für Fahrzeuge mit Klimaanlage for vehicles with air conditioning	
2.4 TDCi RWD 74 kW (100 PS) PHFA, PHFC	04.2006→08.2014		7.02256.29.0	EUV-KA	EL  PHFA, PHFC: für Fahrzeuge mit Klimaanlage for vehicles with air conditioning	
2.4 TDCi RWD 85 kW (115 PS) JXFA, JXFC	04.2006→08.2014		7.02256.29.0	EUV-KA	EL  JXFA, JXFC: für Fahrzeuge mit Klimaanlage for vehicles with air conditioning	

F









TRANSIT Platform/Chassis (FM_ , FN_ , FF_) **124**

2.4 TDCi RWD 103 kW (140 PS) H9FD	04.2006→08.2014	 7.02256.29.0	EUV-KA	EL	für Fahrzeuge mit Klimaanlage for vehicles with air conditioning
3.2 TDCi RWD 147 kW (200 PS) SAFA, SAFB	09.2007→08.2014	 7.02256.29.0	EUV-KA	EL	 SAFA, SAFB: für Fahrzeuge mit Klimaanlage for vehicles with air conditioning

TRANSIT TOURNEO Bus **125**

2.0 74-84 kW (101-114 PS) NSH	11.1994→12.2000	 4.02003.62.0	LLR	EL	<input checked="" type="checkbox"/>
		7.06269.26.0	LLR	EL	<input type="checkbox"/> für OE-Nummer: 6631855, 87TF-9F715-CB for OE number: 6631855, 87TF-9F715-CB
2.0 84 kW (114 PS) NSF, NSG	11.1994→12.2000	 4.02003.62.0	LLR	EL	<input checked="" type="checkbox"/>
2.2 TDCi 81 kW (110 PS) QVFA	07.2006→08.2014	 7.02256.29.0	EUV-KA	EL	für Fahrzeuge mit Klimaanlage for vehicles with air conditioning
2.2 TDCi 96 kW (130 PS) QWFA	07.2006→08.2014	 7.02256.29.0	EUV-KA	EL	für Fahrzeuge mit Klimaanlage for vehicles with air conditioning
2.2 TDCi 103 kW (140 PS) PGFA, PGFB, UHFA, UHFB	10.2007→08.2014	 7.02256.29.0	EUV-KA	EL	 PGFA, PGFB, UHFA, UHFB: für Fahrzeuge mit Klimaanlage for vehicles with air conditioning
2.2 TDCi 85 kW (115 PS) SRFA, SRFB, SRFC, SRFD, SRFE	10.2008→08.2014	 7.02256.29.0	EUV-KA	EL	 SRFA, SRFB, SRFC, SRFD, SRFE: für Fahrzeuge mit Klimaanlage for vehicles with air conditioning
2.5 TD 63 kW (85-86 PS) 4GA, 4GB, 4GC, 4GD	11.1994→12.2000	 7.02256.47.0	EUV-AGR	EL	
2.5 TD 74 kW (101 PS) 4EB, 4EC	04.1998→12.2000	 7.02256.47.0	EUV-AGR	EL	







TRANSIT V363 Bus (FAD, FBD) **126**

2.0 EcoBlue RWD 96 kW (130 PS) YMHA	05.2019→	 7.08681.08.0	EOV	EH	Motorcode: EcoBlue D, EcoBlue E, EcoBlue F, EcoBlue G Engine Code: EcoBlue D, EcoBlue E, EcoBlue F, EcoBlue G Produktionsdatum ab: 20.05.2019 Production date from: 20.05.2019
2.0 EcoBlue RWD 125 kW (170 PS) BLHA	05.2019→	 7.08681.08.0	EOV	EH	Motorcode: EcoBlue D, EcoBlue E, EcoBlue F, EcoBlue G Engine Code: EcoBlue D, EcoBlue E, EcoBlue F, EcoBlue G Produktionsdatum ab: 20.05.2019 Production date from: 20.05.2019
2.0 EcoBlue mHEV 96 kW (130 PS) BKFC, BKFD	05.2019→	 7.08681.08.0	EOV	EH	 BKFC, BKFD: Motorcode: EcoBlue D, EcoBlue E, EcoBlue F, EcoBlue G Engine Code: EcoBlue D, EcoBlue E, EcoBlue F, EcoBlue G Produktionsdatum ab: 20.05.2019 Production date from: 20.05.2019
2.0 EcoBlue mHEV 125 kW (170 PS) BLFC, BLFD	05.2019→	 7.08681.08.0	EOV	EH	 BLFC, BLFD: Motorcode: EcoBlue D, EcoBlue E, EcoBlue F, EcoBlue G Engine Code: EcoBlue D, EcoBlue E, EcoBlue F, EcoBlue G Produktionsdatum ab: 20.05.2019 Production date from: 20.05.2019

TRANSIT V363 Platform/Chassis (FED, FFD)
127



2.0 EcoBlue 136 kW (185 PS) BCFB	05.2019→	 7.08681.08.0	EOV	EH	Motorcode: EcoBlue D, EcoBlue E, EcoBlue F, EcoBlue G Engine Code: EcoBlue D, EcoBlue E, EcoBlue F, EcoBlue G Produktionsdatum ab: 20.05.2019 Production date from: 20.05.2019
2.0 EcoBlue RWD 136 kW (185 PS) BCRA	05.2019→	 7.08681.08.0	EOV	EH	Motorcode: EcoBlue D, EcoBlue E, EcoBlue F, EcoBlue G Engine Code: EcoBlue D, EcoBlue E, EcoBlue F, EcoBlue G Produktionsdatum ab: 20.05.2019 Production date from: 20.05.2019
2.0 EcoBlue mHEV 96 kW (130 PS) BKFC, BKFD	05.2019→	 7.08681.08.0	EOV	EH	 BKFC, BKFD: Motorcode: EcoBlue D, EcoBlue E, EcoBlue F, EcoBlue G Engine Code: EcoBlue D, EcoBlue E, EcoBlue F, EcoBlue G Produktionsdatum ab: 20.05.2019 Production date from: 20.05.2019
2.0 EcoBlue mHEV 125 kW (170 PS) BLFC, BLFD	05.2019→	 7.08681.08.0	EOV	EH	 BLFC, BLFD: Motorcode: EcoBlue D, EcoBlue E, EcoBlue F, EcoBlue G Engine Code: EcoBlue D, EcoBlue E, EcoBlue F, EcoBlue G Produktionsdatum ab: 20.05.2019 Production date from: 20.05.2019
2.0 EcoBlue mHEV RWD 96 kW (130 PS) BKRB	05.2019→	 7.08681.08.0	EOV	EH	Motorcode: EcoBlue D, EcoBlue E, EcoBlue F, EcoBlue G Engine Code: EcoBlue D, EcoBlue E, EcoBlue F, EcoBlue G Produktionsdatum ab: 20.05.2019 Production date from: 20.05.2019
2.0 EcoBlue mHEV RWD 125 kW (170 PS) BLRB	05.2019→	 7.08681.08.0	EOV	EH	Motorcode: EcoBlue D, EcoBlue E, EcoBlue F, EcoBlue G Engine Code: EcoBlue D, EcoBlue E, EcoBlue F, EcoBlue G Produktionsdatum ab: 20.05.2019 Production date from: 20.05.2019

F
TRANSIT V363 Van (FCD, FDD)
128

2.0 EcoBlue 136 kW (185 PS) BCFB	05.2019→	 7.08681.08.0	EOV	EH	Motorcode: EcoBlue D, EcoBlue E, EcoBlue F, EcoBlue G Engine Code: EcoBlue D, EcoBlue E, EcoBlue F, EcoBlue G Produktionsdatum ab: 20.05.2019 Production date from: 20.05.2019
2.0 EcoBlue RWD 136 kW (185 PS) BCRA	05.2019→	 7.08681.08.0	EOV	EH	Motorcode: EcoBlue D, EcoBlue E, EcoBlue F, EcoBlue G Engine Code: EcoBlue D, EcoBlue E, EcoBlue F, EcoBlue G Produktionsdatum ab: 20.05.2019 Production date from: 20.05.2019
2.0 EcoBlue mHEV 96 kW (130 PS) BKFC, BKFD	05.2019→	 7.08681.08.0	EOV	EH	 BKFC, BKFD: Motorcode: EcoBlue D, EcoBlue E, EcoBlue F, EcoBlue G Engine Code: EcoBlue D, EcoBlue E, EcoBlue F, EcoBlue G Produktionsdatum ab: 20.05.2019 Production date from: 20.05.2019
2.0 EcoBlue mHEV 125 kW (170 PS) BLFC, BLFD	05.2019→	 7.08681.08.0	EOV	EH	 BLFC, BLFD: Motorcode: EcoBlue D, EcoBlue E, EcoBlue F, EcoBlue G Engine Code: EcoBlue D, EcoBlue E, EcoBlue F, EcoBlue G Produktionsdatum ab: 20.05.2019 Production date from: 20.05.2019







TRANSIT V363 Van (FCD, FDD) 128























2.0 EcoBlue mHEV RWD 96 kW (130 PS) BKR B	05.2019→	 7.08681.08.0	EOV	EH Motorcode: EcoBlue D, EcoBlue E, EcoBlue F, EcoBlue G Engine Code: EcoBlue D, EcoBlue E, EcoBlue F, EcoBlue G Produktionsnummer ab: 20.05.2019 Production number from: 20.05.2019
2.0 EcoBlue mHEV RWD 125 kW (170 PS) BLRB	05.2019→	 7.08681.08.0	EOV	EH Motorcode: EcoBlue D, EcoBlue E, EcoBlue F, EcoBlue G Engine Code: EcoBlue D, EcoBlue E, EcoBlue F, EcoBlue G Produktionsdatum ab: 20.05.2019 Production date from: 20.05.2019























F

TRANSIT Van (E_ _) 129

2.0 (EAL, EAS) 74-84 kW (101-114 PS) NSH	06.1994→03.2000	 4.02003.62.0	LLR	EL <input checked="" type="checkbox"/>
2.0 (EAL, EAS) 84 kW (114 PS) NSF, NSG	06.1994→03.2000	 4.02003.62.0 7.06269.26.0	LLR	EL <input checked="" type="checkbox"/> EL <input type="checkbox"/>  NSF, NSG: für OE-Nummer: 6631855, 87TF-9F715-CB for OE number: 6631855, 87TF-9F715-CB
2.5 TD (EAL, EAS) 63 kW (85-86 PS) 4GA, 4GB, 4GC, 4GD, 4GE, 4GF	06.1994→03.2000	 7.02256.47.0	EUV-AGR	EL
2.5 TDI (EAL, EAS) 74 kW (101 PS) 4EB, 4EC	06.1994→03.2000	 7.02256.47.0	EUV-AGR	EL





TRANSIT Van (FA_ _) 130

2.2 TDCi 81 kW (110 PS) QVFA	04.2006→08.2014	 7.02256.29.0	EUV-KA	EL für Fahrzeuge mit Klimaanlage for vehicles with air conditioning
2.2 TDCi 96 kW (130 PS) QWFA	04.2006→08.2014	 7.02256.29.0	EUV-KA	EL für Fahrzeuge mit Klimaanlage for vehicles with air conditioning
2.2 TDCi 63 kW (85 PS) P8FA, P8FB	04.2006→08.2014	 7.02256.29.0	EUV-KA	EL  P8FA, P8FB: für Fahrzeuge mit Klimaanlage for vehicles with air conditioning
2.2 TDCi 103 kW (140 PS) PGFA, PGFB, UHFA, UHFB, UHFC	10.2007→08.2014	 7.02256.29.0	EUV-KA	EL  PGFA, PGFB, UHFA, UHFB, UHFC: für Fahrzeuge mit Klimaanlage for vehicles with air conditioning
2.2 TDCi 85 kW (115 PS) SRFA, SRFB, SRFC, SRFD, SRFE	10.2008→08.2014	 7.02256.29.0	EUV-KA	EL  SRFA, SRFB, SRFC, SRFD, SRFE: für Fahrzeuge mit Klimaanlage for vehicles with air conditioning
2.2 TDCi 74 kW (101 PS) DRFA, DRFB, DRFC, DRFD, DRFE	10.2011→08.2014	 7.02256.29.0	EUV-KA	EL  DRFA, DRFB, DRFC, DRFD, DRFE: für Fahrzeuge mit Klimaanlage for vehicles with air conditioning
2.2 TDCi 92 kW (125 PS) CYFA, CYFB, CYFC, CYFD	10.2011→08.2014	 7.02256.29.0	EUV-KA	EL  CYFA, CYFB, CYFC, CYFD: für Fahrzeuge mit Klimaanlage for vehicles with air conditioning
2.2 TDCi 4x4 92 kW (125 PS) CYRB, CYRC	10.2011→08.2014	 7.02256.29.0	EUV-KA	EL  CYRB, CYRC: für Fahrzeuge mit Klimaanlage for vehicles with air conditioning
2.2 TDCi RWD 92 kW (125 PS) CYRA	09.2011→12.2014	 7.02256.29.0	EUV-KA	EL für Fahrzeuge mit Klimaanlage for vehicles with air conditioning
2.2 TDCi RWD 74 kW (101 PS) DRRA, DRRB, DRRC	10.2011→08.2014	 7.02256.29.0	EUV-KA	EL  DRRA, DRRB, DRRC: für Fahrzeuge mit Klimaanlage for vehicles with air conditioning
2.2 TDCi RWD 114 kW (155 PS) CVRA, CVRB, CVRC	10.2011→08.2014	 7.02256.29.0	EUV-KA	EL  CVRA, CVRB, CVRC: für Fahrzeuge mit Klimaanlage for vehicles with air conditioning
2.2 TDCi RWD 100 kW (136 PS) USRA, USRB	10.2011→08.2014	 7.02256.29.0	EUV-KA	EL  USRA, USRB: für Fahrzeuge mit Klimaanlage for vehicles with air conditioning
2.3 103-107 kW (140-146 PS) E5FC	03.2001→03.2006	 7.02256.46.0	EUV-AGR	EL

























 				
TRANSIT Van (FA_ _)				130
		7.06269.05.0	LLR	EL 
2.3 16V CNG RWD 100-107 kW (136-145 PS) GZFC	04.2006→08.2014	 7.02256.29.0	EUV-KA	EL für Fahrzeuge mit Klimaanlage for vehicles with air conditioning
2.3 16V LPG RWD 100-107 kW (136-145 PS) GZFC	04.2006→08.2014	 7.02256.29.0	EUV-KA	EL für Fahrzeuge mit Klimaanlage for vehicles with air conditioning
2.3 16V RWD 100-107 kW (136-145 PS) GZFA, GZFC	04.2006→08.2014	 7.02256.29.0	EUV-KA	EL  GZFA, GZFC: für Fahrzeuge mit Klimaanlage for vehicles with air conditioning
2.3 16V RWD (FAA_, FAB_, FAC_) 103-107 kW (140-146 PS) E5FA, E5FC	04.2001→05.2006	 7.02256.46.0	EUV-AGR	EL
		7.06269.05.0	LLR	EL 
2.3 BiFuel 103-107 kW (140-146 PS) E5FC	03.2001→03.2006	 7.02256.46.0	EUV-AGR	EL
2.4 TDCi 4x4 103 kW (140 PS) H9FB	11.2006→08.2014	 7.02256.29.0	EUV-KA	EL für Fahrzeuge mit Klimaanlage for vehicles with air conditioning
2.4 TDCi RWD 85 kW (115 PS) JXFA, JXFC	04.2006→08.2014	 7.02256.29.0	EUV-KA	EL  JXFA, JXFC: für Fahrzeuge mit Klimaanlage for vehicles with air conditioning
2.4 TDCi RWD 103 kW (140 PS) H9FD	04.2006→08.2014	 7.02256.29.0	EUV-KA	EL für Fahrzeuge mit Klimaanlage for vehicles with air conditioning
2.4 TDCi RWD 74 kW (100 PS) PHFA, PHFC	04.2006→08.2014	 7.02256.29.0	EUV-KA	EL  PHFA, PHFC: für Fahrzeuge mit Klimaanlage for vehicles with air conditioning
2.4 TDCi RWD 88 kW (120 PS) SWFA	01.2007→12.2011	 7.02256.29.0	EUV-KA	EL für Fahrzeuge mit Klimaanlage for vehicles with air conditioning
3.2 TDCi RWD 147 kW (200 PS) SAFA, SAFB	09.2007→08.2014	 7.02256.29.0	EUV-KA	EL  SAFA, SAFB: für Fahrzeuge mit Klimaanlage for vehicles with air conditioning

F































RANGER (PX)						1
2.5 iVCT 122 kW (166 PS) GBVAF, GBVAK, GBVAL	04.2011→	 7.06117.55.0	SV-NWV	EH	 GBVAF, GBVAK, GBVAL: Produktionsdatum bis: 06.07.2012 Production date to: 06.07.2012	
2.5 iVCT 4x4 122 kW (166 PS) GBVAF, GBVAK, GBVAL	04.2011→	 7.06117.55.0	SV-NWV	EH	 GBVAF, GBVAK, GBVAL: Produktionsdatum bis: 06.07.2012 Production date to: 06.07.2012	

F

						
ECOSPORT (BK, BL)						1
1.0 EcoBoost 92 kW (125 PS) M1JC	12.2013→09.2017		7.06117.12.0	ZM-NWV	EL mit Dichtring with O-ring	
ENDURA (CA)						2
2.0 140 kW (190 PS) BCCA, BCCB	10.2018→12.2019		7.08681.08.0	EOV	EH  BCCA, BCCB: Produktionsdatum ab: 06.09.2018 Production date from: 06.09.2018	
2.0 AWD 140 kW (190 PS) BCCA, BCCB	10.2018→12.2019		7.08681.08.0	EOV	EH  BCCA, BCCB: Produktionsdatum ab: 06.09.2018 Production date from: 06.09.2018	
FIESTA Hatchback (WZ)						3
1.0 EcoBoost 92 kW (125 PS) M1JE	09.2013→		7.06117.12.0	ZM-NWV	EL mit Dichtring with O-ring →02.2019	
1.6 ST 134 kW (182 PS) JTJA, JTJB	09.2013→		7.04492.07.0	LDRV	EP  JTJA, JTJB: Produktionsdatum bis: 12.08.2019 Production date to: 12.08.2019	
			7.04269.04.0	SUV	EL	
FOCUS Estate (SA)						4
2.0 EcoBlue 110 kW (150 PS) YLDA	08.2018→		7.08681.08.0	EOV	EH Produktionsdatum ab: 20.08.2018 Production date from: 20.08.2018	
FOCUS Hatchback (LT)						5
2.0 i 107 kW (145 PS) AODB, AODE	07.2007→03.2009		7.02256.48.0	STE	EP	
FOCUS Hatchback (LV)						6
2.0 i 107 kW (145 PS) AODB, AODE	03.2009→08.2011		7.02256.48.0	STE	EP	
FOCUS Saloon (LS, LT)						7
2.0 i 107 kW (145 PS) AODB, AODE	05.2005→03.2009		7.02256.48.0	STE	EP	
FOCUS Saloon (LV)						8
2.0 i 107 kW (145 PS) AODB, AODE	03.2009→08.2011		7.02256.48.0	STE	EP	
KUGA (TF)						9
1.6 EcoBoost 110 kW (150 PS) JQMA, JQMB	04.2013→11.2014		7.04492.07.0	LDRV	EP	
			7.04269.04.0	SUV	EL	
1.6 EcoBoost AWD 134 kW (182 PS) JTMA	04.2013→11.2014		7.04492.07.0	LDRV	EP	
			7.04269.04.0	SUV	EL	
MONDEO Estate (MB, MC)						10
2.3 i 16 V 118 kW (160 PS) SEBA	06.2009→11.2014		7.06117.55.0	SV-NWV	EH	
MONDEO Hatchback (MA, MB, MC)						11
2.0 i 16V 149 kW (203 PS) TNBA	09.2010→01.2015		7.06117.52.0	SV-NWV	EH	
			7.06117.53.0	SV-NWV	EH Produktionsdatum ab: 22.08.2011 Production date from: 22.08.2011	
			7.06117.55.0	SV-NWV	EH Einlassseite Intake Side Produktionsdatum bis: 22.08.2011 Production date to: 22.08.2011	
2.3 i 16V 118 kW (160 PS) SEBA	03.2007→11.2014		7.06117.55.0	SV-NWV	EH	

F

					
MONDEO Saloon (MA, MB)					12
2.3 i 16 V 118 kW (160 PS) SEBA	03.2007→01.2015		7.06117.55.0	SV-NWV	EH
TRANSIT Bus (VF, VG)					13
2.5 TD 74 kW (101 PS) 4EB	07.1994→03.2000		7.02256.47.0	EUV-AGR	EL
2.5 TD 63 kW (85 PS) 4GF	01.1995→03.2000		7.02256.47.0	EUV-AGR	EL
F TRANSIT Platform/Chassis (VF, VG)					14
2.0 84 kW (114 PS) NSF, NSG	01.1996→12.2000		4.02003.62.0	LLR	EL <input checked="" type="checkbox"/>
2.5 TD 63 kW (85 PS) 4GF	08.1994→03.2000		7.02256.47.0	EUV-AGR	EL
2.5 TD 74 kW (101 PS) 4EB	08.1994→03.2000		7.02256.47.0	EUV-AGR	EL





























						
EDGE						1
2.0 GTDi 180 kW (245 PS) CAF488WQ5, CAF488WQB6	04.2015→		7.02087.05.0	EUV-VB	EP	
2.0 GTDi 4WD 180 kW (245 PS) CAF488WQ5, CAF488WQB6	04.2015→		7.02087.05.0	EUV-VB	EP	
KUGA						2
2.0 GTDi AWD 178 kW (242 PS) CAF488WQ2	01.2013→		7.02087.05.0	EUV-VB	EP	
MONDEO						3
2.0 104-110 kW (141-150 PS) LF-DE	05.2003→12.2007		7.06269.22.0	LLR	EL 	
2.0 178 kW (242 PS) CAF488WQ4	08.2013→		7.02087.05.0	EUV-VB	EP	
2.0 180 kW (245 PS) CAF488WQ6	11.2016→		7.02087.05.0	EUV-VB	EP	
MONDEO / ZHISHENG						4
2.0 GTDi200 149 kW (203 PS) CAF488WQ0, GTDIQ0	03.2011→		7.02087.05.0	EUV-VB	EP	
2.0 GTDi240 176 kW (240 PS) CAF488WQ1, GTDIQ1	03.2011→12.2013		7.02087.05.0	EUV-VB	EP	
TAURUS						5
2.0 GTDi 172-180 kW (234-245 PS) CAF488WQ7	11.2015→		7.02087.05.0	EUV-VB	EP	

F



EVEREST						1
2.0 GTDi 180 kW (245 PS) 4G205L	10.2015→	 7.02087.05.0	EUV-VB	EP		
2.0 GTDi 4x4 180 kW (245 PS) 4G205L	10.2015→	 7.02087.05.0	EUV-VB	EP		

















F

						
CONTOUR						1
2.5	09.1997→12.1998		7.02256.46.0	EUV-AGR	EL	
2.5 127-149 kW (173-203 PS) MP99L	09.1997→08.2000		7.02256.46.0	EUV-AGR	EL	
2.5 SVT 127-149 kW (173-203 PS) MP99L	09.1997→08.2000		7.02256.46.0	EUV-AGR	EL	
2.5 i 127-149 kW (173-203 PS) MP99L	09.1997→08.2000		7.02256.46.0	EUV-AGR	EL	
CROWN VICTORIA						2
4.6	09.1997→12.2000		7.02256.46.0	EUV-AGR	EL	
4.6 130-218 kW (177-296 PS) 99W	09.1997→12.2000		7.02256.46.0	EUV-AGR	EL	
4.6 130-218 kW (177-296 PS) 99W	09.2001→04.2005		7.02256.46.0	EUV-AGR	EL	Produktionsdatum bis: 31.12.2006 Production date to: 31.12.2006
4.6 130-218 kW (177-296 PS) 99W	09.2001→12.2002		7.02256.46.0	EUV-AGR	EL	
4.6 130-218 kW (177-296 PS) 99W	09.2002→12.2007		7.02256.46.0	EUV-AGR	EL	Produktionsdatum bis: 31.12.2006 Production date to: 31.12.2006
4.6 149-186 kW (203-253 PS) C46RSEM	09.2004→12.2012		7.02256.46.0	EUV-AGR	EL	
4.6 FlexFuel	05.1998→12.2011		7.02256.46.0	EUV-AGR	EL	
4.6 FlexFuel 149-186 kW (203-253 PS) C46RSEM	09.2005→12.2012		7.02256.46.0	EUV-AGR	EL	
EDGE						3
2.0 179-188 kW (243-256 PS) C20HDTX	09.2014→		7.02256.53.0	DW-TL	EP	
			7.06117.33.0	SV-NWV	EL	
2.0 179-188 kW (243-256 PS) C20HDTX	01.2015→		7.02256.53.0	DW-TL	EP	
			7.06117.33.0	SV-NWV	EL	
2.0 AWD 179-188 kW (243-256 PS) C20HDTX	09.2014→		7.02256.53.0	DW-TL	EP	
			7.06117.33.0	SV-NWV	EL	
2.0 AWD 179-188 kW (243-256 PS) C20HDTX	01.2015→		7.02256.53.0	DW-TL	EP	
			7.06117.33.0	SV-NWV	EL	
2.0 EcoBlue 110 kW (150 PS) YMCA	08.2018→		7.08681.08.0	EOV	EH	Produktionsdatum ab: 06.09.2018 Production date from: 06.09.2018
2.0 EcoBlue AWD 140 kW (190 PS) BCCA, BCCB	08.2018→		7.08681.08.0	EOV	EH	 BCCA, BCCB: Produktionsdatum ab: 06.09.2018 Production date from: 06.09.2018
2.0 EcoBlue AWD 175 kW (238 PS) YLCA	08.2018→		7.08681.08.0	EOV	EH	Produktionsdatum ab: 06.09.2018 Production date from: 06.09.2018
EDGE (U387)						4
2.0 179-188 kW (243-256 PS) C20HDTX	09.2011→		7.04663.14.0	DW-TL	EL	
			7.06117.33.0	SV-NWV	EL	
2.0 AWD 179-188 kW (243-256 PS) C20HDTX	09.2011→		7.04663.14.0	DW-TL	EL	
			7.06117.33.0	SV-NWV	EL	



ESCAPE

5

2.0 82-97 kW (112-132 PS) C20HDEZ	01.2001→12.2004		7.02256.46.0	EUV-AGR	EL
2.0	01.2001→02.2004		7.02256.46.0	EUV-AGR	EL
2.0 4x4 82-97 kW (112-132 PS) C20HDEZ	01.2001→12.2004		7.02256.46.0	EUV-AGR	EL
3.0	01.2001→07.2007		7.02256.46.0	EUV-AGR	EL
3.0	02.2004→03.2005		7.02256.46.0	EUV-AGR	EL
3.0 144-179 kW (196-243 PS) C30PDED	09.2007→12.2008		7.02256.46.0	EUV-AGR	EL
3.0 144-179 kW (196-243 PS) C30PDED	01.2009→12.2012		7.02256.46.0	EUV-AGR	EL
3.0	09.2009→12.2012		7.02256.46.0	EUV-AGR	EL
3.0 4WD	08.2007→12.2008		7.02256.46.0	EUV-AGR	EL
3.0 4WD 144-179 kW (196-243 PS) C30PDED	09.2008→12.2009		7.02256.46.0	EUV-AGR	EL
3.0 4WD 144-179 kW (196-243 PS) C30PDED	01.2009→12.2012		7.02256.46.0	EUV-AGR	EL
3.0 4x4 149 kW (203 PS) AJ	01.2001→07.2007		7.02256.46.0	EUV-AGR	EL
3.0 4x4 145-152 kW (197-207 PS) AJ03	01.2001→04.2004		7.02256.46.0	EUV-AGR	EL
3.0 AWD	08.2007→12.2012		7.02256.46.0	EUV-AGR	EL
3.0 FLEX	09.2009→12.2012		7.02256.46.0	EUV-AGR	EL
3.0 FLEX 4WD	09.2009→12.2012		7.02256.46.0	EUV-AGR	EL

EXPEDITION

6

4.6 130-218 kW (177-296 PS) 99W	10.2002→02.2006		7.02256.46.0	EUV-AGR	EL
4.6 4x4 130-218 kW (177-296 PS) 99W	10.2002→02.2006		7.02256.46.0	EUV-AGR	EL
5.4 172-194 kW (234-264 PS) C54MSEM	10.2002→02.2006		7.02256.46.0	EUV-AGR	EL
5.4 4x4 172-194 kW (234-264 PS) C54MSEM	10.2002→02.2006		7.02256.46.0	EUV-AGR	EL

EXPLORER

7

2.0 179-188 kW (243-256 PS) C20HDTX	09.2011→		7.04663.14.0	DW-TL	EL
			7.06117.33.0	SV-NWV	EL
2.0 4WD 179-188 kW (243-256 PS) C20HDTX	09.2011→		7.04663.14.0	DW-TL	EL
			7.06117.33.0	SV-NWV	EL
4.0 114-157 kW (155-214 PS) 99X	09.2001→12.2005		7.02256.46.0	EUV-AGR	EL
4.0	09.2001→		7.02256.46.0	EUV-AGR	EL
4.0 4WD	09.2001→		7.02256.46.0	EUV-AGR	EL
4.0 4WD 114-157 kW (155-214 PS) 99X	09.2003→12.2004		7.02256.46.0	EUV-AGR	EL
4.0 Flexfuel 114-157 kW (155-214 PS) 99X	09.2003→12.2005		7.02256.46.0	EUV-AGR	EL



EXPLORER 7

4.0 Flexfuel 4WD 114-157 kW (155-214 PS) 99X	09.2003→12.2005	7.02256.46.0	EUV-AGR	EL	
4.6	09.2001→12.2005	7.02256.46.0	EUV-AGR	EL	
4.6 4WD	09.2001→12.2005	7.02256.46.0	EUV-AGR	EL	

EXPLORER (U2, U_) 8

4.0 114-157 kW (155-214 PS) 99X	09.1994→12.2002	7.02256.46.0	EUV-AGR	EL	
4.0	11.1994→08.1996	7.02256.46.0	EUV-AGR	EL	
4.0	09.1996→08.2002	7.02256.46.0	EUV-AGR	EL	
		7.06269.20.0	LLR	EL	
4.0 114-157 kW (155-214 PS) 99X	09.1998→12.2001	7.02256.46.0	EUV-AGR	EL	
4.0 114-157 kW (155-214 PS) 99X	10.1999→08.2002	7.02256.46.0	EUV-AGR	EL	USA USA
4.0 4WD 114-157 kW (155-214 PS) 99X	09.1998→12.2001	7.02256.46.0	EUV-AGR	EL	
4.0 4WD 114-157 kW (155-214 PS) 99X	10.1999→12.2001	7.02256.46.0	EUV-AGR	EL	USA USA
4.0 Flexfuel 114-157 kW (155-214 PS) 99X	09.2000→12.2001	7.02256.46.0	EUV-AGR	EL	
4.0 Flexfuel 4WD 114-157 kW (155-214 PS) 99X	09.2000→12.2001	7.02256.46.0	EUV-AGR	EL	
4.0 V6 4WD 114-157 kW (155-214 PS) 99X	11.1994→12.2002	7.02256.46.0	EUV-AGR	EL	99X: Europa Europe Produktionsdatum ab: 01.11.1995 Production date from: 01.11.1995 Produktionsdatum bis: 31.08.1996 Production date to: 31.08.1996 99X: USA USA
4.0 V6 4WD	03.1995→12.2001	7.02256.46.0	EUV-AGR	EL	
4.0 V6 4WD	10.1996→12.2001	7.02256.46.0	EUV-AGR	EL	
		7.06269.20.0	LLR	EL	
4.0 V6 4WD	10.1998→12.2001	7.02256.46.0	EUV-AGR	EL	
		7.06269.20.0	LLR	EL	
4.0 V6 4WD	06.2000→12.2001	7.02256.46.0	EUV-AGR	EL	
		7.06269.20.0	LLR	EL	
4.9	09.1995→12.2001	7.02256.46.0	EUV-AGR	EL	
4.9 157-160 kW (213-218 PS) 99E	09.1997→12.2001	7.02256.46.0	EUV-AGR	EL	
4.9 4WD	01.1996→12.2001	7.02256.46.0	EUV-AGR	EL	
4.9 4WD 157-160 kW (213-218 PS) 99E	09.1997→12.2001	7.02256.46.0	EUV-AGR	EL	

F



EXPLORER (U251) **9**

4.0 114-157 kW (155-214 PS) 99X	05.2006→12.2010		7.02256.46.0	EUV-AGR	EL	
4.0 4WD 114-157 kW (155-214 PS) 99X	05.2006→12.2010		7.02256.46.0	EUV-AGR	EL	
4.6	05.2006→12.2010		7.02256.46.0	EUV-AGR	EL	
4.6 4WD	05.2006→12.2010		7.02256.46.0	EUV-AGR	EL	





F EXPLORER SPORT TRAC Pickup **10**

4.0 114-157 kW (155-214 PS) 99X	09.2000→12.2005		7.02256.46.0	EUV-AGR	EL	
4.0 4WD 114-157 kW (155-214 PS) 99X	09.2000→12.2005		7.02256.46.0	EUV-AGR	EL	
4.0 FlexFuel 114-157 kW (155-214 PS) 99X	09.2002→12.2005		7.02256.46.0	EUV-AGR	EL	
4.0 FlexFuel 4WD 114-157 kW (155-214 PS) 99X	09.2002→12.2005		7.02256.46.0	EUV-AGR	EL	



F-150 Crew Cab Pickup **11**

2.7	09.2014→		7.04663.14.0	DW-TL	EL	
2.7 4WD	09.2014→		7.04663.14.0	DW-TL	EL	
4.6	09.2000→12.2003		7.02256.46.0	EUV-AGR	EL	
4.6 4WD	09.2000→12.2003		7.02256.46.0	EUV-AGR	EL	

F-150 Extended Cab Pickup **12**

2.7	09.2014→		7.04663.14.0	DW-TL	EL	
2.7 4WD	09.2014→		7.04663.14.0	DW-TL	EL	
4.6	09.1996→12.2003		7.02256.46.0	EUV-AGR	EL	
4.6 4WD	09.1996→12.2003		7.02256.46.0	EUV-AGR	EL	

F-150 Standard Cab Pickup **13**



























2.7	09.2014→		7.04663.14.0	DW-TL	EL	
2.7 4WD	09.2014→		7.04663.14.0	DW-TL	EL	
4.6	09.1998→12.2003		7.02256.46.0	EUV-AGR	EL	
4.6 4WD	09.1998→12.2003		7.02256.46.0	EUV-AGR	EL	

F-250 SUPER DUTY Crew Cab Pickup **14**





























5.4	09.1998→12.2004		7.02256.46.0	EUV-AGR	EL	
5.4 4WD	09.1998→12.2004		7.02256.46.0	EUV-AGR	EL	































F-250 SUPER DUTY Extended Cab Pickup **15**

5.4	09.1998→12.2004		7.02256.46.0	EUV-AGR	EL	
5.4 4WD	09.1998→12.2004		7.02256.46.0	EUV-AGR	EL	































						
F-250 SUPER DUTY Standard Cab Pickup						16
5.4	09.1998→12.2004		7.02256.46.0	EUV-AGR	EL	
5.4 4WD	09.1998→12.2004		7.02256.46.0	EUV-AGR	EL	
F-350 SUPER DUTY Crew Cab Pickup						17
5.4	09.1998→12.2004		7.02256.46.0	EUV-AGR	EL	
5.4 4WD	09.1998→12.2004		7.02256.46.0	EUV-AGR	EL	
F-350 SUPER DUTY Extended Cab Pickup						18
5.4	09.1998→12.2004		7.02256.46.0	EUV-AGR	EL	
5.4 4WD	09.1998→12.2004		7.02256.46.0	EUV-AGR	EL	
F-350 SUPER DUTY Standard Cab Pickup						19
5.4	09.1998→12.2004		7.02256.46.0	EUV-AGR	EL	
5.4 4WD	09.1998→12.2004		7.02256.46.0	EUV-AGR	EL	
FOCUS						20
2.0 82-97 kW (112-132 PS) C20HDEZ	09.1999→12.2004		7.02256.46.0	EUV-AGR	EL	
FOCUS Estate						21
2.0	09.1999→12.2004		7.02256.46.0	EUV-AGR	EL	
FOCUS Hatchback						22
2.0	09.1999→12.2004		7.02256.46.0	EUV-AGR	EL	
2.0 SVT 127 kW (173 PS) ALDA	01.2002→12.2004		7.02256.46.0	EUV-AGR	EL	
FUSION						23
2.3 107-119 kW (146-162 PS) C23HDEX	06.2005→12.2009		7.06117.55.0	SV-NWV	EH	
2.3 107-119 kW (146-162 PS) C23HDEX	09.2005→12.2010		7.06117.55.0	SV-NWV	EH	
2.3 AWD 107-119 kW (146-162 PS) C23HDEX	09.2006→12.2009		7.06117.55.0	SV-NWV	EH	
MUSTANG Convertible						24
2.3 EcoBoost 201-243 kW (273-330 PS) C23HD0D	01.2015→		7.06117.33.0	SV-NWV	EL	
2.3 EcoBoost 231-257 kW (314-350 PS) HD0D, N48H	07.2015→		7.04615.03.0	SUV	EL	
			7.06117.33.0	SV-NWV	EL	
2.3 EcoBoost 201-243 kW (273-330 PS) C23HD0D	09.2017→		7.06117.33.0	SV-NWV	EL	
MUSTANG Convertible (C)						25
3.8	09.1998→12.2004		7.02256.46.0	EUV-AGR	EL	
3.8	06.1999→09.2003		7.02256.46.0	EUV-AGR	EL	
3.9	09.2003→12.2004		7.02256.46.0	EUV-AGR	EL	













F

						
MUSTANG Convertible (C)						25
4.6	09.1998→12.2004		7.02256.46.0	EUV-AGR	EL	
4.6 Turbo 291 kW (396 PS) V99V	09.2003→12.2004		7.02256.46.0	EUV-AGR	EL	
MUSTANG Coupe						26
2.3 EcoBoost 231-233 kW (314-317 PS) N38H, N48H	01.2015→		7.06117.33.0	SV-NWV	EL	
2.3 EcoBoost 231-233 kW (314-317 PS) N48H	07.2015→		7.04615.03.0	SUV	EL	
			7.06117.33.0	SV-NWV	EL	
2.3 EcoBoost 201-243 kW (273-330 PS) C23HD0D	09.2017→		7.06117.33.0	SV-NWV	EL	
MUSTANG Coupe (C)						27
3.8	09.1998→09.2003		7.02256.46.0	EUV-AGR	EL	
3.9	09.2003→12.2004		7.02256.46.0	EUV-AGR	EL	
4.6	09.1995→12.2004		7.02256.46.0	EUV-AGR	EL	
4.6	09.1998→12.2004		7.02256.46.0	EUV-AGR	EL	
4.6	09.1998→12.2004		7.02256.46.0	EUV-AGR	EL	
4.6	09.2000→12.2001		7.02256.46.0	EUV-AGR	EL	
4.6 291 kW (396 PS) V99V	09.2002→12.2004		7.02256.46.0	EUV-AGR	EL	
4.6 194-236 kW (264-321 PS) V99V	09.2002→12.2004		7.02256.46.0	EUV-AGR	EL	
RANGER Standard Cab Pickup						28
4.0	09.2000→12.2011		7.02256.46.0	EUV-AGR	EL	
4.0 4WD	09.2000→12.2011		7.02256.46.0	EUV-AGR	EL	
TAURUS						29
2.0 179-188 kW (243-256 PS) C20HDTX	09.2012→		7.03306.16.0	LDRV	EP	
			7.06117.33.0	SV-NWV	EL	
2.0 AWD 179-188 kW (243-256 PS) C20HDTX	09.2012→		7.03306.16.0	LDRV	EP	
			7.06117.33.0	SV-NWV	EL	
TAURUS Estate						30
3.0	09.1999→12.2004		7.02256.46.0	EUV-AGR	EL	
3.0	09.1999→12.2003		7.02256.46.0	EUV-AGR	EL	
3.0	09.2004→12.2005		7.02256.46.0	EUV-AGR	EL	
3.0 24V	09.2003→12.2005		7.02256.46.0	EUV-AGR	EL	
3.0 Flexfuel	09.1999→12.2004		7.02256.46.0	EUV-AGR	EL	

						
TAURUS Saloon						31
3.0	09.1999→12.2007		7.02256.46.0	EUV-AGR	EL	
3.0	01.2000→12.2005		7.02256.46.0	EUV-AGR	EL	
3.0 24V	09.1999→12.2003		7.02256.46.0	EUV-AGR	EL	
3.0 24V	09.2003→12.2005		7.02256.46.0	EUV-AGR	EL	
3.0 Flexfuel	09.1999→12.2006		7.02256.46.0	EUV-AGR	EL	
THUNDERBIRD Convertible						32
4.0 188 kW (256 PS) AJ30	02.2000→12.2002		7.02256.46.0	EUV-AGR	EL	
WINDSTAR						33
3.0	01.1999→12.2000		7.02256.46.0	EUV-AGR	EL	
3.8	02.1999→12.2003		7.02256.46.0	EUV-AGR	EL	
WINDSTAR (A3)						34
3.0	01.1995→12.1998		7.02256.46.0	EUV-AGR	EL	
3.0 V6	01.1995→12.2000		7.02256.46.0	EUV-AGR	EL	
3.0 V6	03.1995→02.1999		7.02256.46.0	EUV-AGR	EL	
3.8	09.2000→08.2004		7.02256.46.0	EUV-AGR	EL	
E-150 Extended Cargo Van						35
5.4	09.2008→		7.02256.46.0	EUV-AGR	EL	
5.4 CNG	09.2011→		7.02256.46.0	EUV-AGR	EL	
5.4 FLEX	09.2008→		7.02256.46.0	EUV-AGR	EL	
5.4 LPG	09.2012→		7.02256.46.0	EUV-AGR	EL	
E-150 Standard Cargo Van						36
5.4	09.1996→12.1999		7.02256.46.0	EUV-AGR	EL	
5.4	09.1999→12.2008		7.02256.46.0	EUV-AGR	EL	
5.4 BI-FUEL	09.1997→12.1998		7.02256.46.0	EUV-AGR	EL	
5.4 CNG 168-224 kW (228-305 PS) C54RSEM	09.2009→		7.02256.46.0	EUV-AGR	EL	
5.4 Flexfuel 168-224 kW (228-305 PS) C54RSEM	09.2008→		7.02256.46.0	EUV-AGR	EL	
5.4 LPG 168-224 kW (228-305 PS) C54RSEM	09.2009→		7.02256.46.0	EUV-AGR	EL	
E-150 Standard Passenger Van						37
5.4	09.1996→12.1999		7.02256.46.0	EUV-AGR	EL	
5.4 168-224 kW (228-305 PS) C54RSEM	09.1999→12.2008		7.02256.46.0	EUV-AGR	EL	
5.4 BI-FUEL	09.1997→12.1998		7.02256.46.0	EUV-AGR	EL	

F

			 PIERBURG			
E-150 Standard Passenger Van						37
5.4 CNG 168-224 kW (228-305 PS) C54RSEM	09.2009→		7.02256.46.0	EUV-AGR	EL	
5.4 Flexfuel 168-224 kW (228-305 PS) C54RSEM	09.2008→		7.02256.46.0	EUV-AGR	EL	
E-250 Extended Cargo Van						38
5.4 168-224 kW (228-305 PS) C54RSEM	09.1999→12.2008		7.02256.46.0	EUV-AGR	EL	
5.4 CNG 168-224 kW (228-305 PS) C54RSEM	09.1999→12.2012		7.02256.46.0	EUV-AGR	EL	
E-250 Standard Cargo Van						39
5.4	09.1999→12.2008		7.02256.46.0	EUV-AGR	EL	
5.4 CNG 168-224 kW (228-305 PS) C54RSEM	09.1999→12.2013		7.02256.46.0	EUV-AGR	EL	
E-250 Stripped Chassis						40
5.4	09.1999→12.2005		7.02256.46.0	EUV-AGR	EL	
5.4 CNG	09.1999→12.2005		7.02256.46.0	EUV-AGR	EL	
E-350 Cutaway Van						41
5.4	09.1996→12.1999		7.02256.46.0	EUV-AGR	EL	
5.4	09.1999→12.2003		7.02256.46.0	EUV-AGR	EL	
5.4 BiFuel	09.1997→12.1999		7.02256.46.0	EUV-AGR	EL	
5.4 CNG	09.1996→12.1999		7.02256.46.0	EUV-AGR	EL	
5.4 CNG	09.1999→12.2003		7.02256.46.0	EUV-AGR	EL	
E-350 Extended Cargo Van						42
5.4	09.1996→12.1999		7.02256.46.0	EUV-AGR	EL	
5.4	09.1999→12.2003		7.02256.46.0	EUV-AGR	EL	
5.4 BiFuel	09.1997→12.1999		7.02256.46.0	EUV-AGR	EL	
5.4 CNG	09.1996→12.1999		7.02256.46.0	EUV-AGR	EL	
5.4 CNG	09.1999→12.2003		7.02256.46.0	EUV-AGR	EL	
E-350 Extended Passenger Van						43
5.4	09.1996→12.1999		7.02256.46.0	EUV-AGR	EL	
5.4	09.1999→12.2005		7.02256.46.0	EUV-AGR	EL	
5.4 BIFUEL	09.1997→12.1999		7.02256.46.0	EUV-AGR	EL	
5.4 CNG	09.1996→12.1999		7.02256.46.0	EUV-AGR	EL	
5.4 CNG	09.1999→12.2005		7.02256.46.0	EUV-AGR	EL	
E-350 SUPER DUTY Cutaway Van						44
5.4	09.1998→12.1999		7.02256.46.0	EUV-AGR	EL	

					
E-350 SUPER DUTY Cutaway Van 44					
5.4	09.1999→12.2008		7.02256.46.0	EUV-AGR	EL
5.4 CNG 168-224 kW (228-305 PS) C54RSEM	09.2001→		7.02256.46.0	EUV-AGR	EL
E-350 SUPER DUTY Extended Cargo Van 45					
5.4	09.1998→12.1999		7.02256.46.0	EUV-AGR	EL
5.4	08.1999→12.2008		7.02256.46.0	EUV-AGR	EL
5.4 CNG	09.2001→		7.02256.46.0	EUV-AGR	EL
E-350 SUPER DUTY Standard Cargo Van 46					
5.4	09.1998→12.1999		7.02256.46.0	EUV-AGR	EL
5.4	09.1999→12.2008		7.02256.46.0	EUV-AGR	EL
5.4 CNG	09.2001→		7.02256.46.0	EUV-AGR	EL
E-350 SUPER DUTY Stripped Chassis 47					
5.4	09.1998→12.1999		7.02256.46.0	EUV-AGR	EL
5.4	09.1999→12.2008		7.02256.46.0	EUV-AGR	EL
5.4 CNG 168-224 kW (228-305 PS) C54RSEM	09.2001→		7.02256.46.0	EUV-AGR	EL
E-350 Standard Cargo Van 48					
5.4	09.1996→12.1999		7.02256.46.0	EUV-AGR	EL
5.4	09.1999→12.2008		7.02256.46.0	EUV-AGR	EL
5.4 BIFUEL	09.1997→12.1999		7.02256.46.0	EUV-AGR	EL
5.4 CNG	09.1996→12.1999		7.02256.46.0	EUV-AGR	EL
5.4 CNG	09.1999→12.2003		7.02256.46.0	EUV-AGR	EL
E-350 Standard Passenger Van 49					
5.4	09.1996→12.1999		7.02256.46.0	EUV-AGR	EL
5.4	09.1999→12.2005		7.02256.46.0	EUV-AGR	EL
5.4 BIFUEL	09.1997→12.1999		7.02256.46.0	EUV-AGR	EL
5.4 CNG	09.1996→12.1999		7.02256.46.0	EUV-AGR	EL
5.4 CNG	09.1999→12.2005		7.02256.46.0	EUV-AGR	EL
E-350 Stripped Chassis 50					
5.4	09.1996→12.1999		7.02256.46.0	EUV-AGR	EL
5.4	09.1999→12.2003		7.02256.46.0	EUV-AGR	EL
5.4 BiFuel	09.1997→12.1999		7.02256.46.0	EUV-AGR	EL
5.4 CNG	09.1996→12.1999		7.02256.46.0	EUV-AGR	EL
5.4 CNG	09.1999→12.2002		7.02256.46.0	EUV-AGR	EL

F



E-450 SUPER DUTY Cab & Chassis 51

5.4	09.2003→12.2004	 7.02256.46.0	EUV-AGR	EL
-----	-----------------	---	---------	----

E-450 SUPER DUTY Cutaway Van 52

5.4	09.1999→12.2008	 7.02256.46.0	EUV-AGR	EL
-----	-----------------	---	---------	----

5.4 CNG 168-224 kW (228-305 PS) C54RSEM	09.1999→12.2014	 7.02256.46.0	EUV-AGR	EL
--	-----------------	---	---------	----

F

5.4 Flexfuel 168-224 kW (228-305 PS) C54RSEM	09.2008→	 7.02256.46.0	EUV-AGR	EL
--	----------	---	---------	----

5.4 LPG 168-224 kW (228-305 PS) C54RSEM	09.2009→	 7.02256.46.0	EUV-AGR	EL
--	----------	---	---------	----





















E-450 SUPER DUTY Stripped Chassis 53

5.4	09.2002→12.2008	 7.02256.46.0	EUV-AGR	EL
-----	-----------------	---	---------	----

5.4 CNG 168-224 kW (228-305 PS) C54RSEM	09.2010→	 7.02256.46.0	EUV-AGR	EL
--	----------	---	---------	----

5.4 FLEX	09.2010→	 7.02256.46.0	EUV-AGR	EL
----------	----------	---	---------	----

5.4 LPG 168-224 kW (228-305 PS) C54RSEM	09.2010→	 7.02256.46.0	EUV-AGR	EL
--	----------	---	---------	----



					
SPRINTER 2500 Cab & Chassis 1					
3.5	09.2006→12.2007		7.02256.37.0	EUV-SL	EL
SPRINTER 2500 Extended Cargo Van 2					
2.1 CDI 120 kW (163 PS) OM 651.955	09.2013→		7.00782.12.0	DW-TL	EP
			7.02256.37.0	EUV-AGR	EL
			7.02256.37.0	EUV-WP	EL
2.1 CDI 4WD 120 kW (163 PS) OM 651.955	09.2014→		7.00782.12.0	DW-TL	EP
			7.02256.37.0	EUV-AGR	EL
			7.02256.37.0	EUV-WP	EL
SPRINTER 2500 Standard Cargo Van 3					
2.1 CDI 120 kW (163 PS) OM 651.955	09.2013→		7.00782.12.0	DW-TL	EP
			7.02256.37.0	EUV-AGR	EL
			7.02256.37.0	EUV-WP	EL
2.1 CDI 4WD 120 kW (163 PS) OM 651.955	09.2014→		7.00782.12.0	DW-TL	EP
			7.02256.37.0	EUV-AGR	EL
			7.02256.37.0	EUV-WP	EL
3.5 190-200 kW (258-272 PS) EG2	09.2006→12.2008		7.02256.37.0	EUV-SL	EL
			7.22355.01.0	EUV-SR	EL
SPRINTER 2500 Standard Passenger Van 4					
2.1 CDI 120 kW (163 PS) OM 651.955	09.2013→		7.00782.12.0	DW-TL	EP
			7.02256.37.0	EUV-AGR	EL
			7.02256.37.0	EUV-WP	EL
2.1 CDI 4WD 120 kW (163 PS) OM 651.955	09.2014→		7.00782.12.0	DW-TL	EP
			7.02256.37.0	EUV-AGR	EL
			7.02256.37.0	EUV-WP	EL
3.5 190-200 kW (258-272 PS) EG2	09.2006→12.2008		7.02256.37.0	EUV-SL	EL
			7.22355.01.0	EUV-SR	EL
SPRINTER 3500 Cab & Chassis 5					
2.1 CDI 120 kW (163 PS) OM 651.955	09.2013→		7.00782.12.0	DW-TL	EP
			7.02256.37.0	EUV-AGR	EL
			7.02256.37.0	EUV-WP	EL
2.1 CDI 4WD 120 kW (163 PS) OM 651.955	09.2014→		7.00782.12.0	DW-TL	EP
			7.02256.37.0	EUV-AGR	EL
			7.02256.37.0	EUV-WP	EL
3.5	09.2006→12.2008		7.02256.37.0	EUV-SL	EL
SPRINTER 3500 Extended Cargo Van 6					
2.1 CDI 120 kW (163 PS) OM 651.955	09.2013→		7.00782.12.0	DW-TL	EP
			7.02256.37.0	EUV-AGR	EL
			7.02256.37.0	EUV-WP	EL
2.1 CDI 4WD 120 kW (163 PS) OM 651.955	09.2014→		7.00782.12.0	DW-TL	EP
			7.02256.37.0	EUV-AGR	EL
			7.02256.37.0	EUV-WP	EL

F



SPRINTER 3500 Standard Cargo Van



7

2.1 CDI 120 kW (163 PS) OM 651.955	09.2013→		7.00782.12.0	DW-TL	EP
			7.02256.37.0	EUV-AGR	EL
			7.02256.37.0	EUV-WP	EL
2.1 CDI 4WD 120 kW (163 PS) OM 651.955	09.2014→		7.00782.12.0	DW-TL	EP
			7.02256.37.0	EUV-AGR	EL
			7.02256.37.0	EUV-WP	EL
3.5 190-200 kW (258-272 PS) EG2	09.2006→12.2008		7.02256.37.0	EUV-SL	EL
			7.22355.01.0	EUV-SR	EL

F

SPRINTER 3500 Standard Passenger Van





8

2.1 CDI 120 kW (163 PS) OM 651.955	09.2013→		7.00782.12.0	DW-TL	EP
			7.02256.37.0	EUV-AGR	EL
			7.02256.37.0	EUV-WP	EL
3.5 190-200 kW (258-272 PS) EG2	09.2006→12.2007		7.02256.37.0	EUV-SL	EL
			7.22355.01.0	EUV-SR	EL



CANTER





















1

3C13 96 kW (131 PS) 4P10-T2	11.2010→	 7.02968.02.0	DW-TL	EP	
3C15 110 kW (150 PS) 4P10-T4	11.2010→	 7.02968.02.0	DW-TL	EP	
3C18 129 kW (175 PS) 4P10-T6	11.2010→	 7.02968.02.0	DW-TL	EP	
3S13 96 kW (131 PS) 4P10-T2	11.2010→	 7.02968.02.0	DW-TL	EP	
3S15 110 kW (150 PS) 4P10-T4	11.2010→	 7.02968.02.0	DW-TL	EP	F
3S18 129 kW (175 PS) 4P10-T6	11.2010→	 7.02968.02.0	DW-TL	EP	
6C18 129 kW (175 PS) 4P10-T6	06.2013→	 7.02968.02.0	DW-TL	EP	
6S15 110 kW (150 PS) 4P10-T4	11.2010→	 7.02968.02.0	DW-TL	EP	
7C15 110 kW (150 PS) 4P10-T4	11.2010→	 7.02968.02.0	DW-TL	EP	
7C15 EcoHybrid 110 kW (150 PS) 4P10-T4	06.2013→	 7.02968.02.0	DW-TL	EP	
7C18 129 kW (175 PS) 4P10-T6	11.2010→	 7.02968.02.0	DW-TL	EP	
9C15 110 kW (150 PS) 4P10-T4	06.2013→	 7.02968.02.0	DW-TL	EP	
9C18 129 kW (175 PS) 4P10-T6	06.2013→	 7.02968.02.0	DW-TL	EP	













ACADIA **1**











G

<p>2.5 144-149 kW (196-203 PS) LCV</p>	<p>03.2016→</p>	<p> PIERBURG</p> <p>7.06117.56.0</p> <p></p> <p>7.06117.57.0</p>	<p>SV-NWV</p> <p>EH</p>	<p>mit Dichtring with O-ring 2017 2017</p> <p>mit Dichtring with O-ring 2017 2017</p>
<p>2.5 AWD 144-149 kW (196-203 PS) LCV</p>	<p>09.2017→</p>	<p> PIERBURG</p> <p>7.06117.56.0</p> <p></p> <p>7.06117.57.0</p>	<p>SV-NWV</p> <p>EH</p>	<p>mit Dichtring with O-ring 2017 2017</p> <p>mit Dichtring with O-ring 2017 2017</p>
<p>3.6 205-215 kW (279-292 PS) LY7</p>	<p>09.2006→12.2008</p>	<p> PIERBURG</p> <p>7.06117.04.0</p> <p></p>	<p>SV-NWV</p> <p>EH</p>	<p>mit Wellendichtring With shaft sealing ring 2007 2007 2008 2008</p>
<p>3.6 205-215 kW (279-292 PS) LY7</p>	<p>09.2008→12.2013</p>	<p> PIERBURG</p> <p>7.06117.04.0</p> <p></p>	<p>SV-NWV</p> <p>EH</p>	<p>mit Wellendichtring With shaft sealing ring 2007 2007 2008 2008</p>
<p>3.6 209-215 kW (284-292 PS) LLT</p>	<p>05.2015→</p>	<p> PIERBURG</p> <p>7.06117.04.0</p> <p></p>	<p>SV-NWV</p> <p>EH</p>	<p>mit Wellendichtring With shaft sealing ring 2009 2009 2017 2017</p>
<p>3.6 AWD 205-215 kW (279-292 PS) LY7</p>	<p>09.2006→12.2008</p>	<p> PIERBURG</p> <p>7.06117.04.0</p> <p></p>	<p>SV-NWV</p> <p>EH</p>	<p>mit Wellendichtring With shaft sealing ring 2007 2007 2008 2008</p>
<p>3.6 AWD 205-215 kW (279-292 PS) LY7</p>	<p>09.2008→12.2013</p>	<p> PIERBURG</p> <p>7.06117.04.0</p> <p></p>	<p>SV-NWV</p> <p>EH</p>	<p>mit Wellendichtring With shaft sealing ring 2007 2007 2008 2008</p>
<p>3.6 AWD 209-215 kW (284-292 PS) LLT</p>	<p>05.2015→</p>	<p> PIERBURG</p> <p>7.06117.04.0</p> <p></p>	<p>SV-NWV</p> <p>EH</p>	<p>mit Wellendichtring With shaft sealing ring 2009 2009 2017 2017</p>
<p>3.6 DI 209-215 kW (284-292 PS) LLT</p>	<p>09.2013→</p>	<p> PIERBURG</p> <p>7.06117.04.0</p> <p></p>	<p>SV-NWV</p> <p>EH</p>	<p>mit Wellendichtring With shaft sealing ring 2009 2009 2017 2017</p>
<p>3.6 DI AWD 209-215 kW (284-292 PS) LLT</p>	<p>09.2013→</p>	<p> PIERBURG</p> <p>7.06117.04.0</p> <p></p>	<p>SV-NWV</p> <p>EH</p>	<p>mit Wellendichtring With shaft sealing ring 2009 2009 2017 2017</p>









CANYON Crew Cab Pickup
2

2.8 130 kW (177 PS) LK5	09.2003→12.2006	 7.06117.03.0	SV-NWV	EH	mit Dichtring with O-ring
2.8 4WD 130 kW (177 PS) LK5	09.2003→12.2006	 7.06117.03.0	SV-NWV	EH	mit Dichtring with O-ring
2.8 D 135 kW (184 PS) LWN	09.2015→	 7.02256.44.0	EUV-AGR	EL	
2.8 D 4WD 135 kW (184 PS) LWN	09.2015→	 7.02256.44.0	EUV-AGR	EL	
2.9 138 kW (188 PS) LLV	09.2006→12.2012	 7.06117.03.0	SV-NWV	EH	mit Dichtring with O-ring
2.9 4WD 138 kW (188 PS) LLV	09.2006→12.2012	 7.06117.03.0	SV-NWV	EH	mit Dichtring with O-ring
3.5 164 kW (223 PS) L52	09.2003→12.2006	 7.06117.03.0	SV-NWV	EH	mit Dichtring with O-ring
3.5 4WD 164 kW (223 PS) L52	09.2003→12.2006	 7.06117.03.0	SV-NWV	EH	mit Dichtring with O-ring
3.7 180 kW (245 PS) LLR	09.2006→12.2012	 7.06117.03.0	SV-NWV	EH	mit Dichtring with O-ring
3.7 4WD 180 kW (245 PS) LLR	09.2006→12.2012	 7.06117.03.0	SV-NWV	EH	mit Dichtring with O-ring

CANYON Extended Cab Pickup
3

2.8 130 kW (177 PS) LK5	09.2003→12.2006	 7.06117.03.0	SV-NWV	EH	mit Dichtring with O-ring
2.8 4WD 130 kW (177 PS) LK5	09.2003→12.2006	 7.06117.03.0	SV-NWV	EH	mit Dichtring with O-ring
2.8 D 135 kW (184 PS) LWN	09.2015→	 7.02256.44.0	EUV-AGR	EL	
2.8 D 4WD 135 kW (184 PS) LWN	09.2015→	 7.02256.44.0	EUV-AGR	EL	
2.9 138 kW (188 PS) LLV	09.2006→12.2012	 7.06117.03.0	SV-NWV	EH	mit Dichtring with O-ring
2.9 4WD 138 kW (188 PS) LLV	09.2006→12.2012	 7.06117.03.0	SV-NWV	EH	mit Dichtring with O-ring
3.5 164 kW (223 PS) L52	09.2003→12.2006	 7.06117.03.0	SV-NWV	EH	mit Dichtring with O-ring
3.5 4WD 164 kW (223 PS) L52	09.2003→12.2006	 7.06117.03.0	SV-NWV	EH	mit Dichtring with O-ring
3.7 180 kW (245 PS) LLR	09.2006→12.2012	 7.06117.03.0	SV-NWV	EH	mit Dichtring with O-ring
3.7 4WD 180 kW (245 PS) LLR	09.2006→12.2012	 7.06117.03.0	SV-NWV	EH	mit Dichtring with O-ring

CANYON Standard Cab Pickup
4

2.8 130 kW (177 PS) LK5	09.2003→12.2006	 7.06117.03.0	SV-NWV	EH	mit Dichtring with O-ring
2.8 4WD 130 kW (177 PS) LK5	09.2003→12.2006	 7.06117.03.0	SV-NWV	EH	mit Dichtring with O-ring
2.9 138 kW (188 PS) LLV	09.2006→12.2012	 7.06117.03.0	SV-NWV	EH	mit Dichtring with O-ring
2.9 4WD 138 kW (188 PS) LLV	09.2006→12.2012	 7.06117.03.0	SV-NWV	EH	mit Dichtring with O-ring
3.5 164 kW (223 PS) L52	09.2003→12.2006	 7.06117.03.0	SV-NWV	EH	mit Dichtring with O-ring
3.5 4WD 164 kW (223 PS) L52	09.2003→12.2006	 7.06117.03.0	SV-NWV	EH	mit Dichtring with O-ring
3.7 180 kW (245 PS) LLR	09.2006→12.2012	 7.06117.03.0	SV-NWV	EH	mit Dichtring with O-ring
3.7 4WD 180 kW (245 PS) LLR	09.2006→12.2012	 7.06117.03.0	SV-NWV	EH	mit Dichtring with O-ring









TERRAIN **5**

2.0 186-188 kW (253-256 PS) LTG	01.2017→	 7.03357.04.0	LDRV	EL	
2.0 AWD 186-188 kW (253-256 PS) LTG	01.2017→	 7.03357.04.0	LDRV	EL	
2.4 136 kW (185 PS) LAF, LEA	09.2009→	 7.06117.05.0	SV-NWV	EH	mit Dichtring with O-ring
		7.06117.06.0	SV-NWV	EH	mit Dichtring with O-ring
2.4 AWD 136 kW (185 PS) LAF, LEA	09.2009→	 7.06117.05.0	SV-NWV	EH	mit Dichtring with O-ring
		7.06117.06.0	SV-NWV	EH	mit Dichtring with O-ring
2.4 Flexfuel 136 kW (185 PS) LEA	08.2009→	 7.06117.05.0	SV-NWV	EH	mit Dichtring with O-ring
		7.06117.06.0	SV-NWV	EH	mit Dichtring with O-ring
2.4 Flexfuel AWD 136 kW (185 PS) LEA	08.2009→	 7.06117.05.0	SV-NWV	EH	mit Dichtring with O-ring
		7.06117.06.0	SV-NWV	EH	mit Dichtring with O-ring
3.0 197 kW (268 PS) LF1	09.2009→12.2012	 7.06117.04.0	SV-NWV	EH	mit Wellendichtring With shaft sealing ring 2010 2010
3.0 AWD 197 kW (268 PS) LF1	09.2009→12.2010	 7.06117.04.0	SV-NWV	EH	mit Wellendichtring With shaft sealing ring 2010 2010
3.0 Flexfuel DI 197 kW (268 PS) LF1	09.2010→	 7.06117.04.0	SV-NWV	EH	mit Wellendichtring With shaft sealing ring 2010 2010
3.0 Flexfuel DI AWD 197 kW (268 PS) LF1	09.2010→	 7.06117.04.0	SV-NWV	EH	mit Wellendichtring With shaft sealing ring 2010 2010
3.6 DI 224-227 kW (305-309 PS) LFX	09.2012→	 7.06117.04.0	SV-NWV	EH	mit Wellendichtring With shaft sealing ring 2013 2013 2017 2017
3.6 DI AWD 224-227 kW (305-309 PS) LFX	07.2013→	 7.06117.04.0	SV-NWV	EH	mit Wellendichtring With shaft sealing ring 2013 2013 2017 2017
3.6 Flexfuel DI 224-227 kW (305-309 PS) LFX	09.2012→	 7.06117.04.0	SV-NWV	EH	mit Wellendichtring With shaft sealing ring 2013 2013 2017 2017
3.6 Flexfuel DI AWD 224-227 kW (305-309 PS) LFX	09.2012→	 7.06117.04.0	SV-NWV	EH	mit Wellendichtring With shaft sealing ring 2013 2013 2017 2017

CANYON Cab & Chassis **6**

2.8 130 kW (177 PS) LK5	09.2005→12.2006	 7.06117.03.0	SV-NWV	EH	mit Dichtring with O-ring
2.8 4WD 130 kW (177 PS) LK5	09.2005→12.2006	 7.06117.03.0	SV-NWV	EH	mit Dichtring with O-ring



CANYON Cab & Chassis						6
2.9 138 kW (188 PS) LLV	09.2006→12.2012	 7.06117.03.0	SV-NWV	EH	mit Dichtring with O-ring	
2.9 4WD 138 kW (188 PS) LLV	09.2006→12.2012	 7.06117.03.0	SV-NWV	EH	mit Dichtring with O-ring	
3.5 164 kW (223 PS) L52	09.2005→12.2006	 7.06117.03.0	SV-NWV	EH	mit Dichtring with O-ring	
3.5 4WD 164 kW (223 PS) L52	09.2005→12.2006	 7.06117.03.0	SV-NWV	EH	mit Dichtring with O-ring	
3.7 180 kW (245 PS) LLR	09.2006→12.2012	 7.06117.03.0	SV-NWV	EH	mit Dichtring with O-ring	
3.7 4WD 180 kW (245 PS) LLR	09.2006→12.2012	 7.06117.03.0	SV-NWV	EH	mit Dichtring with O-ring	
SAVANA 2500 Standard Cargo Van						7
2.8 D 135 kW (184 PS) LWN	11.2017→	 7.02256.44.0	EUV-AGR	EL		
SAVANA 2500 Standard Passenger Van						8
2.8 D 135 kW (184 PS) LWN	11.2017→	 7.02256.44.0	EUV-AGR	EL		
SAVANA 3500 Cutaway Van						9
2.8 D 135 kW (184 PS) LWN	11.2017→	 7.02256.44.0	EUV-AGR	EL		
SAVANA 3500 Extended Cargo Van						10
2.8 D 135 kW (184 PS) LWN	11.2017→	 7.02256.44.0	EUV-AGR	EL		
SAVANA 3500 Extended Passenger Van						11
2.8 D 135 kW (184 PS) LWN	11.2017→	 7.02256.44.0	EUV-AGR	EL		
SAVANA 3500 Standard Cargo Van						12
2.8 D 135 kW (184 PS) LWN	11.2017→	 7.02256.44.0	EUV-AGR	EL		



G

			 PIERBURG			
BARINA Hatchback (SB)						1
1.2 i 33 kW (45 PS) C 12 NZ	04.1994→07.1997		7.05432.01.0	SM	EL	mit Dichtring with O-ring
1.4 i 44 kW (60 PS) C 14 NZ	04.1994→07.1997		7.05432.01.0	SM	EL	mit Dichtring with O-ring
BARINA Hatchback (XC)						2
1.4 Efi 66 kW (90 PS) Z 14 XEP	01.2004→02.2005		7.02256.28.0	SV-PDA	EP	
CALAIS Hatchback (ZB)						3
2.0 188-191 kW (256-260 PS) LTG	10.2017→10.2020		7.03357.04.0	LDRV	EL	
COMMODORE Estate (ZB)						4
2.0 188-191 kW (256-260 PS) LTG	10.2017→10.2020		7.03357.04.0	LDRV	EL	
COMMODORE Hatchback (ZB)						5
2.0 188-191 kW (256-260 PS) LTG	10.2017→10.2020		7.03357.04.0	LDRV	EL	
CRUZE Hatchback (JH)						6
1.4 i Turbo 103 kW (140 PS) A 14 NET	11.2011→12.2016		7.03833.02.0	EUV-VB	EL	
CRUZE Saloon (JH)						7
1.4 i Turbo 103 kW (140 PS) A 14 NET	04.2011→12.2016		7.03833.02.0	EUV-VB	EL	
EQUINOX (EQ)						8
2.0 188-191 kW (256-260 PS) LTG	09.2017→10.2020		7.03357.04.0	LDRV	EL	
2.0 AWD 188-191 kW (256-260 PS) LTG	09.2017→10.2020		7.03357.04.0	LDRV	EL	
TRAX (TJ)						9
1.4 (TJ) 103 kW (140 PS) A 14 NET	08.2014→10.2020		7.03833.02.0	EUV-VB	EL	
COMBO Van (SB)						10
1.4 i 44 kW (60 PS) C 14 NZ	03.1996→07.1997		7.05432.01.0	SM	EL	mit Dichtring with O-ring
COMBO Van (XC)						11
1.4 i 66 kW (90 PS) Z 14 XEP	04.2005→12.2012		7.02256.28.0	SV-PDA	EP	



HUMMER H3

1

3.5 162-164 kW (220-223 PS) L52	04.2005→	 7.06117.03.0	SV-NWV	EH	mit Dichtring with O-ring
3.7 4WD 180 kW (245 PS) LLR	09.2006→	 7.06117.03.0	SV-NWV	EH	mit Dichtring with O-ring

























HUMMER H3T

2

3.7 4WD 180 kW (245 PS) LLR	10.2008→12.2010	 7.06117.03.0	SV-NWV	EH	mit Dichtring with O-ring
--------------------------------	-----------------	---	--------	----	------------------------------























H

					
ACCENT II (LC) 1					
1.5 CRDi 60 kW (82 PS) D3DA	04.2002→11.2005	 7.00272.03.0	DW-AGR	EP	
		7.03085.02.0	DW-AGR	EP	
		7.03085.02.0	DW-TL	EP	
ACCENT II Saloon (LC) 2					
1.5 CRDi 60 kW (82 PS) D3DA	01.2002→11.2005	 7.00272.03.0	DW-AGR	EP	
		7.03085.02.0	DW-AGR	EP	08.2002→
		7.03085.02.0	DW-TL	EP	08.2002→
ACCENT III (MC) 3					
1.5 CRDi GLS 65-85 kW (88-116 PS) D4FA	11.2005→11.2010	 7.00272.03.0	DW-AGR	EP	
		7.03294.02.0	LDRV	EL	
ACCENT III Saloon (MC) 4					
1.5 CRDi GLS 65-85 kW (88-116 PS) D4FA	11.2005→11.2010	 7.00272.03.0	DW-AGR	EP	
		7.03294.02.0	LDRV	EL	
ACCENT IV (RB) 5					
1.6 CRDi 66-100 kW (90-136 PS) D4FB	07.2011→	 7.00272.03.0	DW-AGR	EP	→05.2015
ACCENT IV Saloon (RB) 6					
1.6 CRDi 66-100 kW (90-136 PS) D4FB	04.2011→	 7.00272.03.0	DW-AGR	EP	→05.2015
1.6 CRDi 66-100 kW (90-136 PS) D4FB	11.2010→12.2017	 7.00272.03.0	DW-AGR	EP	→05.2015
ELANTRA III (XD) 7					
2.0 CRDi 83-110 kW (113-150 PS) D4EA	04.2001→07.2006	 7.03085.02.0	DW-AGR	EP	06.2003→05.2006
		7.03085.02.0	DW-TL	EP	06.2003→05.2006
ELANTRA III Saloon (XD) 8					
2.0 CRDi 83-110 kW (113-150 PS) D4EA	04.2001→07.2006	 7.03085.02.0	DW-AGR	EP	06.2003→05.2006
		7.03085.02.0	DW-TL	EP	06.2003→05.2006
ELANTRA IV Saloon (HD) 9					
1.6 CRDi 66-100 kW (90-136 PS) D4FB	11.2005→12.2011	 7.00272.03.0	DW-AGR	EP	
		7.03294.02.0	LDRV	EL	Produktionsdatum ab: 01.09.2006 Production date from: 01.09.2006 Produktionsdatum bis: 11.02.2009 Production date to: 11.02.2009
ELANTRA V Saloon (MD, UD) 10					
1.6 CRDi 66-100 kW (90-136 PS) D4FB	02.2011→12.2015	 7.00272.03.0	DW-AGR	EP	
GETZ (TB) 11					
1.5 CRDi 60 kW (82 PS) D3EA	03.2003→09.2005	 7.03085.02.0	DW-AGR	EP	
		7.03085.02.0	DW-TL	EP	
GRANDEUR (TG) 12					
2.2 CRDi 102-114 kW (139-155 PS) D4EB	06.2006→12.2011	 7.00272.03.0	DW-AGR	EP	→08.2010
2.2 CRDi 102-114 kW (139-155 PS) D4EB	06.2006→10.2010	 7.00272.03.0	DW-AGR	EP	

						
LAVITA						13
1.5 CRDi 12V 60 kW (82 PS) D3EA	01.2004→		7.00272.03.0	DW-AGR	EP	
MATRIX (FC)						14
1.5 CRDi 60 kW (82 PS) D3EA	10.2001→08.2010		7.00272.03.0	DW-AGR	EP	10.2004→
			7.03085.02.0	DW-AGR	EP	→05.2005
			7.03085.02.0	DW-TL	EP	→05.2005
			7.03294.02.0	LDRV	EL	
1.5 CRDi 65-85 kW (88-116 PS) D4FA	12.2004→08.2010		7.00272.03.0	DW-AGR	EP	
			7.03294.02.0	LDRV	EL	
1.5 CRDi VGT 65-85 kW (88-116 PS) D4FA	08.2005→08.2010		7.00272.03.0	DW-AGR	EP	
			7.03294.02.0	LDRV	EL	
SANTA FÉ I (SM)						15
2.0 CRDi 83-110 kW (113-150 PS) D4EA	08.2001→03.2006		7.03085.02.0	DW-AGR	EP	→12.2005
			7.03085.02.0	DW-TL	EP	→12.2005
2.0 CRDi 4x4 83-110 kW (113-150 PS) D4EA	04.2001→03.2006		7.03085.02.0	DW-AGR	EP	→12.2005
			7.03085.02.0	DW-TL	EP	→12.2005
SANTA FÉ II (CM)						16
2.2 CRDi 102-114 kW (139-155 PS) D4EB	03.2006→12.2012		7.00272.03.0	DW-AGR	EP	→08.2009
2.2 CRDi 102-114 kW (139-155 PS) D4EB	03.2006→12.2009		7.00272.03.0	DW-AGR	EP	
2.2 CRDi 4x4 102-114 kW (139-155 PS) D4EB	03.2006→12.2012		7.00272.03.0	DW-AGR	EP	
2.2 CRDi 4x4 102-114 kW (139-155 PS) D4EB	03.2006→12.2009		7.00272.03.0	DW-AGR	EP	
2.2 CRDi GLS 102-114 kW (139-155 PS) D4EB	03.2006→12.2009		7.00272.03.0	DW-AGR	EP	
2.2 CRDi GLS 4x4 102-114 kW (139-155 PS) D4EB	03.2006→12.2009		7.00272.03.0	DW-AGR	EP	
SONATA V (NF)						17
2.0 CRDi 83-110 kW (113-150 PS) D4EA	02.2006→12.2010		7.00272.03.0	DW-AGR	EP	
2.0 CRDi 83-110 kW (113-150 PS) D4EA	02.2006→12.2010		7.00272.03.0	DW-AGR	EP	
2.0 CRDi 83-110 kW (113-150 PS) D4EA	03.2009→12.2010		7.00272.03.0	DW-AGR	EP	
TERRACAN (HP)						18
2.9 CRDi 110-120 kW (150-163 PS) J3(CRDi)	11.2001→07.2003		7.00272.03.0	DW-AGR	EP	
2.9 CRDi 4WD 110-120 kW (150-163 PS) J3(CRDi)	12.2001→12.2006		7.00272.03.0	DW-AGR	EP	
2.9 CRDi 4WD 110-120 kW (150-163 PS) J3(CRDi)	11.2003→12.2006		7.00272.03.0	DW-AGR	EP	

H

						
TRAJET (FO)						19
2.0 CRDi 83-110 kW (113-150 PS) D4EA	04.2001→07.2008		7.03085.02.0	DW-AGR	EP →06.2007	
			7.00272.03.0	DW-AGR	EP	
2.0 CRDi 83-110 kW (113-150 PS) D4EA	08.2005→07.2008		7.00272.03.0	DW-AGR	EP	
TUCSON (JM)						20
2.0 CRDi 83-110 kW (113-150 PS) D4EA	08.2004→03.2010		7.00272.03.0	DW-AGR	EP	
2.0 CRDi 83-110 kW (113-150 PS) D4EA	01.2006→03.2010		7.00272.03.0	DW-AGR	EP	
2.0 CRDi 83-110 kW (113-150 PS) D4EA	01.2006→03.2010		7.00272.03.0	DW-AGR	EP	
2.0 CRDi 83-110 kW (113-150 PS) D4EA	01.2007→03.2010		7.00272.03.0	DW-AGR	EP	
2.0 CRDi 83-110 kW (113-150 PS) D4EA	01.2009→03.2010		7.00272.03.0	DW-AGR	EP	
2.0 CRDi All-wheel Drive 83-110 kW (113-150 PS) D4EA	08.2004→03.2010		7.00272.03.0	DW-AGR	EP	
2.0 CRDi All-wheel Drive 83-110 kW (113-150 PS) D4EA	01.2006→03.2010		7.00272.03.0	DW-AGR	EP	
2.0 CRDi All-wheel Drive 83-110 kW (113-150 PS) D4EA	01.2006→03.2010		7.00272.03.0	DW-AGR	EP	
2.0 CRDi All-wheel Drive 83-110 kW (113-150 PS) D4EA	01.2007→03.2010		7.00272.03.0	DW-AGR	EP	
2.0 CRDi All-wheel Drive 83-110 kW (113-150 PS) D4EA	01.2009→03.2010		7.00272.03.0	DW-AGR	EP	
VERNA						21
1.5 CRDi 12V 60 kW (82 PS) D3EA	01.2002→		7.00272.03.0	DW-AGR	EP	
i10 I (PA)						22
1.1 CRDi 52-55 kW (71-75 PS) D3FA	01.2008→12.2011		7.00272.03.0	DW-AGR	EP	
i20 ACTIVE (IB, GB)						23
1.4 CRDi 55-66 kW (75-90 PS) D4FC	09.2015→		7.00272.03.0	DW-AGR	EP	
i20 I (PB, PBT)						24
1.1 CRDi 52-55 kW (71-75 PS) D3FA	03.2012→12.2015		7.00272.03.0	DW-AGR	EP	
1.4 CRDi 55-66 kW (75-90 PS) D4FC	08.2008→12.2015		7.00272.03.0	DW-AGR	EP	
1.4 CRDi 55-66 kW (75-90 PS) D4FC	09.2008→12.2012		7.00272.03.0	DW-AGR	EP	
1.6 CRDi 66-100 kW (90-136 PS) D4FB	09.2008→12.2012		7.00272.03.0	DW-AGR	EP	
1.6 CRDi 66-100 kW (90-136 PS) D4FB	01.2009→12.2012		7.00272.03.0	DW-AGR	EP	
i20 II (GB, IB)						25
1.1 CRDi 52-55 kW (71-75 PS) D3FA	11.2014→		7.00272.03.0	DW-AGR	EP →02.2018	

						
i20 II (GB, IB)						25
1.4 CRDi 55-66 kW (75-90 PS) D4FC	11.2014→		7.00272.03.0	DW-AGR	EP	→08.2019
1.4 CRDi 55-66 kW (75-90 PS) D4FC	01.2018→		7.00272.03.0	DW-AGR	EP	→08.2019
i20 II Coupe (GB)						26
1.1 CRDi 52-55 kW (71-75 PS) D3FA	05.2015→		7.00272.03.0	DW-AGR	EP	→02.2018
1.4 CRDi 55-66 kW (75-90 PS) D4FC	05.2015→		7.00272.03.0	DW-AGR	EP	→08.2019
i30 (FD)						27
1.6 CRDi 66-100 kW (90-136 PS) D4FB	10.2007→11.2011		7.00272.03.0	DW-AGR	EP	
			7.03294.02.0	EUV-AGR	EL	
			7.03294.02.0	LDRV	EL	
1.6 CRDi 66-100 kW (90-136 PS) D4FB	10.2007→11.2011		7.00272.03.0	DW-AGR	EP	
			7.03294.02.0	EUV-AGR	EL	
			7.03294.02.0	LDRV	EL	
1.6 CRDi 66-100 kW (90-136 PS) D4FB	01.2010→11.2011		7.00272.03.0	DW-AGR	EP	
			7.03294.02.0	EUV-AGR	EL	
			7.03294.02.0	LDRV	EL	
1.6 CRDi VGT 66-100 kW (90-136 PS) D4FB	10.2007→11.2011		7.00272.03.0	DW-AGR	EP	
			7.03294.02.0	EUV-AGR	EL	
			7.03294.02.0	LDRV	EL	
i30 (GD)						28
1.4 CRDi 55-66 kW (75-90 PS) D4FC	12.2011→12.2016		7.00272.03.0	DW-AGR	EP	
1.6 CRDi 66-100 kW (90-136 PS) D4FB	11.2011→12.2016		7.00272.03.0	DW-AGR	EP	
1.6 CRDi 66-100 kW (90-136 PS) D4FB	12.2011→12.2015		7.00272.03.0	DW-AGR	EP	
1.6 CRDi 66-100 kW (90-136 PS) D4FB	12.2011→12.2016		7.00272.03.0	DW-AGR	EP	
i30 Coupe						29
1.4 CRDi 55-66 kW (75-90 PS) D4FC	05.2013→		7.00272.03.0	DW-AGR	EP	
1.6 CRDi 66-100 kW (90-136 PS) D4FB	05.2013→		7.00272.03.0	DW-AGR	EP	
i30 Estate (FD)						30
1.6 CRDi 66-100 kW (90-136 PS) D4FB	02.2008→06.2012		7.00272.03.0	DW-AGR	EP	
			7.03294.02.0	EUV-AGR	EL	
			7.03294.02.0	LDRV	EL	
1.6 CRDi 66-100 kW (90-136 PS) D4FB	02.2008→06.2012		7.00272.03.0	DW-AGR	EP	
			7.03294.02.0	EUV-AGR	EL	
			7.03294.02.0	LDRV	EL	
1.6 CRDi 66-100 kW (90-136 PS) D4FB	01.2010→06.2012		7.00272.03.0	DW-AGR	EP	
			7.03294.02.0	EUV-AGR	EL	
			7.03294.02.0	LDRV	EL	



H



i30 Estate (GD) 31

1.4 CRDi 55-66 kW (75-90 PS) D4FC	06.2012→	 7.00272.03.0	DW-AGR	EP	
1.6 CRDi 66-100 kW (90-136 PS) D4FB	06.2012→12.2015	 7.00272.03.0	DW-AGR	EP	
1.6 CRDi 66-100 kW (90-136 PS) D4FB	06.2012→	 7.00272.03.0	DW-AGR	EP	
1.6 CRDi 66-100 kW (90-136 PS) D4FB	01.2015→	 7.00272.03.0	DW-AGR	EP	

i40 I (VF) 32

























1.7 CRDi 85-104 kW (116-141 PS) D4FD	10.2012→	 7.00272.03.0	DW-AGR	EP	→12.2014
		7.03294.02.0	EUV-AGR	EL	Produktionsdatum bis: 26.01.2015 Production date to: 26.01.2015
		7.03294.02.0	LDRV	EL	Produktionsdatum bis: 26.01.2015 Production date to: 26.01.2015
1.7 CRDi 85-104 kW (116-141 PS) D4FD	03.2012→	 7.00272.03.0	DW-AGR	EP	→12.2014
		7.03294.02.0	EUV-AGR	EL	Produktionsdatum bis: 26.01.2015 Production date to: 26.01.2015
		7.03294.02.0	LDRV	EL	Produktionsdatum bis: 26.01.2015 Production date to: 26.01.2015
1.7 CRDi 85-104 kW (116-141 PS) D4FD	03.2012→	 7.00272.03.0	DW-AGR	EP	→12.2014
		7.03294.02.0	EUV-AGR	EL	Produktionsdatum bis: 26.01.2015 Production date to: 26.01.2015
		7.03294.02.0	LDRV	EL	Produktionsdatum bis: 26.01.2015 Production date to: 26.01.2015

i40 I CW (VF) 33

1.7 CRDi 85-104 kW (116-141 PS) D4FD	03.2012→	 7.00272.03.0	DW-AGR	EP	→12.2014
		7.03294.02.0	EUV-AGR	EL	Produktionsdatum bis: 26.01.2015 Production date to: 26.01.2015
		7.03294.02.0	LDRV	EL	Produktionsdatum bis: 26.01.2015 Production date to: 26.01.2015
1.7 CRDi 85-104 kW (116-141 PS) D4FD	07.2011→	 7.00272.03.0	DW-AGR	EP	→12.2014
		7.03294.02.0	EUV-AGR	EL	Produktionsdatum bis: 26.01.2015 Production date to: 26.01.2015
		7.03294.02.0	LDRV	EL	Produktionsdatum bis: 26.01.2015 Production date to: 26.01.2015
1.7 CRDi 85-104 kW (116-141 PS) D4FD	07.2011→	 7.00272.03.0	DW-AGR	EP	→12.2014
		7.03294.02.0	EUV-AGR	EL	Produktionsdatum bis: 26.01.2015 Production date to: 26.01.2015
		7.03294.02.0	LDRV	EL	Produktionsdatum bis: 26.01.2015 Production date to: 26.01.2015

ix20 (JC) 34

1.4 CRDi 55-66 kW (75-90 PS) D4FC	11.2010→	 7.00272.03.0	DW-AGR	EP	→06.2018
1.4 CRDi 55-66 kW (75-90 PS) D4FC	06.2011→	 7.00272.03.0	DW-AGR	EP	→06.2018
1.6 CRDi 66-100 kW (90-136 PS) D4FB	06.2011→	 7.00272.03.0	DW-AGR	EP	→04.2015
1.6 CRDi 66-100 kW (90-136 PS) D4FB	06.2011→	 7.00272.03.0	DW-AGR	EP	→04.2015

						
ix35 (LM, EL, ELH)						35
1.7 CRDi 85-104 kW (116-141 PS) D4FD	11.2010→		7.00272.03.0	DW-AGR	EP	07.2011→06.2015
			7.03294.02.0	EUV-AGR	EL	Produktionsdatum bis: 15.06.2015 Production date to: 15.06.2015
			7.03294.02.0	LDRV	EL	Produktionsdatum bis: 15.06.2015 Production date to: 15.06.2015
2.0 CRDi 100-150 kW (136-204 PS) D4HA	01.2010→		7.03085.02.0	DW-AGR	EP	09.2013→04.2015
2.0 CRDi 100-150 kW (136-204 PS) D4HA	01.2010→06.2015		7.03085.02.0	DW-AGR	EP	09.2013→04.2015
2.0 CRDi 100-150 kW (136-204 PS) D4HA	01.2012→		7.03085.02.0	DW-AGR	EP	09.2013→04.2015
2.0 CRDi 100-150 kW (136-204 PS) D4HA	01.2012→		7.03085.02.0	DW-AGR	EP	09.2013→04.2015
2.0 CRDi 100-150 kW (136-204 PS) D4HA	10.2012→06.2015		7.03085.02.0	DW-AGR	EP	09.2013→04.2015
2.0 CRDi 4WD 100-150 kW (136-204 PS) D4HA	01.2010→		7.03085.02.0	DW-AGR	EP	09.2013→04.2015
2.0 CRDi 4WD 100-150 kW (136-204 PS) D4HA	01.2010→		7.03085.02.0	DW-AGR	EP	09.2013→04.2015
2.0 CRDi 4WD 100-150 kW (136-204 PS) D4HA	01.2010→06.2015		7.03085.02.0	DW-AGR	EP	09.2013→04.2015
2.0 CRDi 4WD 100-150 kW (136-204 PS) D4HA	01.2011→		7.03085.02.0	DW-AGR	EP	09.2013→04.2015
2.0 CRDi 4WD 100-150 kW (136-204 PS) D4HA	10.2012→06.2015		7.03085.02.0	DW-AGR	EP	09.2013→04.2015
H-1 / STAREX Bus (A1)						36
2.5 CRDi 74-129 kW (110-175 PS) D4CB	12.2002→09.2007		7.00272.03.0	DW-AGR	EP	
			7.03085.02.0	DW-AGR	EP	→01.2007
			7.03085.02.0	DW-TL	EP	→01.2007
2.5 CRDi 74-129 kW (110-175 PS) D4CB	12.2002→04.2004		7.00272.03.0	DW-AGR	EP	
			7.03085.02.0	DW-TL	EP	
2.5 CRDi 74-129 kW (110-175 PS) D4CB	06.2006→12.2007		7.03085.02.0	DW-AGR	EP	→01.2007
			7.03085.02.0	DW-TL	EP	→01.2007
2.5 CRDi 4WD 74-129 kW (110-175 PS) D4CB	12.2002→04.2004		7.03085.02.0	DW-TL	EP	
H-1 Cargo (TQ)						37
2.5 CRDi 74-129 kW (110-175 PS) D4CB	01.2009→		7.00272.03.0	DW-AGR	EP	
			7.03294.02.0	EUV-AGR	EL	Produktionsdatum bis: 02.07.2009 Production date to: 02.07.2009
2.5 CRDi 74-129 kW (110-175 PS) D4CB	02.2008→		7.00272.03.0	DW-AGR	EP	
			7.03294.02.0	EUV-AGR	EL	Produktionsdatum bis: 02.07.2009 Production date to: 02.07.2009
2.5 CRDi 74-129 kW (110-175 PS) D4CB	02.2008→		7.00272.03.0	DW-AGR	EP	
			7.03294.02.0	EUV-AGR	EL	Produktionsdatum bis: 02.07.2009 Production date to: 02.07.2009

H













H-1 Cargo (TQ) 37

2.5 CRDi 74-129 kW (110-175 PS) D4CB	02.2008→		7.00272.03.0	DW-AGR	EP	Produktionsdatum bis: 02.07.2009 Production date to: 02.07.2009
			7.03294.02.0	EUV-AGR	EL	
2.5 CRDi 74-129 kW (110-175 PS) D4CB	01.2009→		7.00272.03.0	DW-AGR	EP	Produktionsdatum bis: 02.07.2009 Production date to: 02.07.2009
			7.03294.02.0	EUV-AGR	EL	
2.5 CRDi 74-129 kW (110-175 PS) D4CB	08.2009→		7.00272.03.0	DW-AGR	EP	
			7.03294.02.0	EUV-AGR	EL	
			7.03294.02.0	EUV-RK	EL	
			7.03294.02.0	LDRV	EL	
2.5 TDCi 59-78 kW (80-106 PS) D4BH	09.2007→		7.03294.02.0	EUV-AGR	EL	Produktionsdatum bis: 02.07.2009 Production date to: 02.07.2009

H



H-1 Travel (TQ) 38

2.5 CRDi 74-129 kW (110-175 PS) D4CB	02.2008→		7.00272.03.0	DW-AGR	EP	Produktionsdatum bis: 02.07.2009 Production date to: 02.07.2009
			7.03294.02.0	EUV-AGR	EL	
2.5 CRDi 74-129 kW (110-175 PS) D4CB	07.2008→		7.00272.03.0	DW-AGR	EP	Produktionsdatum bis: 02.07.2009 Production date to: 02.07.2009
			7.03294.02.0	EUV-AGR	EL	
2.5 CRDi 74-129 kW (110-175 PS) D4CB	10.2018→		7.00272.03.0	DW-AGR	EP	
2.5 CRDi 74-129 kW (110-175 PS) D4CB	02.2008→		7.00272.03.0	DW-AGR	EP	
2.5 CRDi 74-129 kW (110-175 PS) D4CB	03.2008→		7.00272.03.0	DW-AGR	EP	
2.5 CRDi 74-129 kW (110-175 PS) D4CB	05.2008→		7.00272.03.0	DW-AGR	EP	Produktionsdatum bis: 02.07.2009 Production date to: 02.07.2009
			7.03294.02.0	EUV-AGR	EL	
2.5 CRDi 74-129 kW (110-175 PS) D4CB	05.2008→		7.00272.03.0	DW-AGR	EP	Produktionsdatum bis: 02.07.2009 Production date to: 02.07.2009
			7.03294.02.0	EUV-AGR	EL	
2.5 CRDi 74-129 kW (110-175 PS) D4CB	07.2010→		7.00272.03.0	DW-AGR	EP	
2.5 CRDi 74-129 kW (110-175 PS) D4CB	08.2011→		7.00272.03.0	DW-AGR	EP	
2.5 CRDi 74-129 kW (110-175 PS) D4CB	01.2015→		7.00272.03.0	DW-AGR	EP	
2.5 TDCi 59-78 kW (80-106 PS) D4BH	09.2007→		7.03294.02.0	EUV-AGR	EL	Produktionsdatum bis: 02.07.2009 Production date to: 02.07.2009

H-1 Van (A1) 39

2.5 CRDi 74-129 kW (110-175 PS) D4CB	08.2003→12.2007		7.00272.03.0	DW-AGR	EP	
---	-----------------	---	--------------	--------	----	--

H100 Platform/Chassis (HR) 40

2.5 CRDi 74-129 kW (110-175 PS) D4CB	01.2004→		7.00272.03.0	DW-AGR	EP	01.2009→
2.5 TCI 59-78 kW (80-106 PS) D4BH	01.2004→12.2012		7.00272.03.0	DW-AGR	EP	01.2009→
2.5 TD 62-74 kW (84-101 PS) 4D56-T	11.2006→		7.00272.03.0	DW-AGR	EP	01.2009→



ix35 Van **41**

<p>CRDi 85-104 kW (116-141 PS) D4FD</p>	<p>09.2010→12.2015</p>	<p> 7.03294.02.0 7.03294.02.0</p>	<p>EUV-AGR LDRV</p>	<p>EL EL</p>	<p>Produktionsdatum bis: 15.06.2015 Production date to: 15.06.2015 Produktionsdatum bis: 15.06.2015 Production date to: 15.06.2015</p>
---	------------------------	--	-------------------------	------------------	--

H















PEUGEOT 405 Saloon (15B) **1**















1.8 74-85 kW (101-116 PS) XU7JP4	01.1999→12.2003	 7.05432.06.0	SM	EL	mit Dichtring with O-ring
-------------------------------------	-----------------	---	----	----	------------------------------

I





























DAILY V Platform/Chassis						1
29L15 V, 35S15, 35C15L V, 40C15L V, 50C15L V 107 kW (146 PS) F1AE3481C	09.2011→02.2014		7.00607.04.0	DW-TL	EP	
35C17, 35C17D, 35S17, 40C17, 45C17, 50C17, 60C17, 70C17 125 kW (170 PS) F1CE3481C, F1CE3481K	09.2011→02.2014		7.00607.04.0	DW-TL	EP	
35C21, 35S21, 40C21, 45C21, 50C21, 60C21, 70C21 150 kW (205 PS) F1CE3481D	09.2011→02.2014		7.00607.04.0	DW-TL	EP	
55S17W 4x4 125 kW (170 PS) F1CE3481C	09.2011→02.2014		7.00607.04.0	DW-TL	EP	
DAILY V Van						2
29L15 V, 35S15 V, 35C15L V, 40C15L V, 50C15L V 107 kW (146 PS) F1AE3481C	09.2011→02.2014		7.00607.04.0	DW-TL	EP	
35C15 V, 40C15 V, 45C15 V, 50C15 V, 60C15 V, 65C15 V 107 kW (145 PS) F1CE3481B	09.2011→02.2014		7.00607.04.0	DW-TL	EP	
35C17 V, 35S17 V, 40C17 V, 45C17 V, 50C17 V, 60C17 V 125 kW (170 PS) F1CE3481C, F1CE3481K	09.2011→02.2014		7.00607.04.0	DW-TL	EP	
35C21 V, 35S21 V, 40C21 V, 45C21 V, 50C21 V 150 kW (205 PS) F1CE3481D	09.2011→02.2014		7.00607.04.0	DW-TL	EP	
DAILY VI Platform/Chassis						3
33S14, 35S14, 35C14 100 kW (136 PS) F1AGL411J	04.2016→		7.00607.04.0	DW-TL	EP	
33S15, 35S15, 35C15 107 kW (146 PS) F1AFL411C	03.2014→04.2016		7.00607.04.0	DW-TL	EP	
35S17, 35C17, 40C17, 45S17, 45C17, 50C17, 55C17, 65C17, ... 125 kW (170 PS) F1CFL411H	03.2014→04.2016		7.00607.04.0	DW-TL	EP	
35S21, 35C21, 40C21, 50C21, 65C21, 70C21 150 kW (205 PS) F1CFL411G	03.2014→		7.00607.04.0	DW-TL	EP	
DAILY VI Van						4
33S14, 35S14, 35C14 100 kW (136 PS) F1AGL411J	04.2016→		7.00607.04.0	DW-TL	EP	
33S15, 35S15, 35C15 107 kW (146 PS) F1AFL411C	03.2014→04.2016		7.00607.04.0	DW-TL	EP	
35S17, 35C17, 40C17, 50C17, 55C17, 65C17, 70C17 125 kW (170 PS) F1CFL411H	03.2014→04.2016		7.00607.04.0	DW-TL	EP	
35S21, 35C21, 40C21, 50C21, 65C21, 70C21 150 kW (205 PS) F1CFL411G	03.2014→		7.00607.04.0	DW-TL	EP	



						
F-PACE (X761)						1
2.0 Ti4 147-184 kW (200-250 PS) 204PT	05.2016→		7.06117.52.0	SV-NWV	EH	
			7.06117.53.0	SV-NWV	EH	
3.0 SDV6 AWD 177-221 kW (241-300 PS) 306DT	09.2015→		7.02436.02.0	EUV-AGR	EL	hinten Rear
			7.02428.02.0	EUV-LS	EL	vorne Front
			7.07400.11.0*	LDRV	EL	
			↳7.22687.46.0	LDRV	EL	
			7.02207.05.0	SUV	EL	
X-TYPE I (X400)						2
2.0 D 96 kW (130 PS) FMBA, FMBB	07.2003→11.2009		7.01121.02.0*	DW-AGR	EP	mit Halter with holder  FMBA, FMBB: Fahrgestellnummer ab: J06604 Vehicle Identification Number from: J06604
			↳7.00756.05.0	DW-AGR	EP	
2.2 D 107-114 kW (145-155 PS) QJBA	01.2007→11.2009		7.01569.04.0*	DW-AGR	EP	mit Halter with holder für Fahrzeuge mit Diesel-Partikel-Filter (DPF), für Fahrzeuge mit Schaltgetriebe for vehicles with diesel soot filter, for vehicles with manual transmission
			↳7.00756.05.0	DW-AGR	EP	
			7.01569.05.0*	DW-AGR	EP	mit Halter with holder Fahrgestellnummer ab: J39906 Vehicle Identification Number from: J39906 für Fahrzeuge mit Automatikgetriebe for vehicles with automatic transmission
			↳7.00756.05.0	DW-AGR	EP	
X-TYPE I Estate (X400)						3
2.0 D 96 kW (130 PS) FMBA, FMBB	02.2004→12.2009		7.01121.02.0*	DW-AGR	EP	mit Halter with holder  FMBA, FMBB: Fahrgestellnummer ab: J06604 Vehicle Identification Number from: J06604
			↳7.00756.05.0	DW-AGR	EP	
2.2 D 107-114 kW (145-155 PS) QJBA	01.2007→12.2009		7.01569.04.0*	DW-AGR	EP	mit Halter with holder für Fahrzeuge mit Diesel-Partikel-Filter (DPF), für Fahrzeuge mit Schaltgetriebe for vehicles with diesel soot filter, for vehicles with manual transmission
			↳7.00756.05.0	DW-AGR	EP	
			7.01569.05.0*	DW-AGR	EP	mit Halter with holder Fahrgestellnummer ab: J39906 Vehicle Identification Number from: J39906 für Fahrzeuge mit Automatikgetriebe for vehicles with automatic transmission
			↳7.00756.05.0	DW-AGR	EP	
XE (X760)						4
2.0 147-184 kW (200-250 PS) 204PT	03.2015→		7.06117.52.0	SV-NWV	EH	
			7.06117.53.0	SV-NWV	EH	

J

			 PIERBURG			
XE (X760)						4
2.0 147-184 kW (200-250 PS) 204PT	03.2015→		7.06117.52.0	SV-NWV	EH	
			7.06117.53.0	SV-NWV	EH	
XF I (X250)						5
2.0 147-184 kW (200-250 PS) 204PT	06.2012→04.2015		7.06117.52.0	SV-NWV	EH	
			7.06117.53.0	SV-NWV	EH	
2.0 147-184 kW (200-250 PS) 204PT	06.2012→04.2015		7.06117.52.0	SV-NWV	EH	
			7.06117.53.0	SV-NWV	EH	
3.0 D 155-202 kW (211-275 PS) AJV6D	03.2009→04.2015		7.02436.02.0	EUV-AGR	EL hinten Rear	
			7.02428.02.0	EUV-LS	EL vorne Front	
			7.02207.05.0	SUV	EL	
3.0 D 155-221 kW (211-300 PS) 306DT, AJV6D	03.2009→04.2015		7.02436.02.0	EUV-AGR	EL  306DT, AJV6D: hinten Rear	
			7.02428.02.0	EUV-LS	EL  306DT, AJV6D: vorne Front	
			7.02207.05.0	SUV	EL	
3.0 D 155-221 kW (211-300 PS) 306DT, AJV6D	03.2009→04.2015		7.02436.02.0	EUV-AGR	EL  306DT, AJV6D: hinten Rear	
			7.02428.02.0	EUV-LS	EL  306DT, AJV6D: vorne Front	
			7.02207.05.0	SUV	EL	
XF II (X260)						6
2.0 147-184 kW (200-250 PS) 204PT	05.2015→		7.06117.52.0	SV-NWV	EH	
			7.06117.53.0	SV-NWV	EH	
3.0 D 177-221 kW (241-300 PS) 306DT	05.2015→		7.02436.02.0	EUV-AGR	EL hinten Rear	
			7.02428.02.0	EUV-LS	EL vorne Front	
			7.07400.11.0*	LDRV	EL	
			↳7.22687.46.0	LDRV	EL	
			7.02207.05.0	SUV	EL	
XF SPORTBRAKE (X250)						7
2.0 T 147-184 kW (200-250 PS) 204PT	08.2013→12.2015		7.06117.52.0	SV-NWV	EH	
			7.06117.53.0	SV-NWV	EH	
3.0 D 155-221 kW (211-300 PS) 306DT, AJV6D	09.2012→04.2014		7.02436.02.0	EUV-AGR	EL  306DT, AJV6D: hinten Rear	
			7.02428.02.0	EUV-LS	EL  306DT, AJV6D: vorne Front	
			7.02207.05.0	SUV	EL	
3.0 D 155-221 kW (211-300 PS) 306DT, AJV6D	09.2012→04.2014		7.02436.02.0	EUV-AGR	EL  306DT, AJV6D: hinten Rear	
			7.02428.02.0	EUV-LS	EL  306DT, AJV6D: vorne Front	
			7.02207.05.0	SUV	EL	
XF SPORTBRAKE (X260)						8
3.0 D 177-221 kW (241-300 PS) 306DT	07.2017→		7.02436.02.0	EUV-AGR	EL hinten Rear	
			7.02428.02.0	EUV-LS	EL vorne Front	
			7.07400.11.0*	LDRV	EL	



















XF SPORTBRAKE (X260)
8























↳ 7.22687.46.0	LDRV	EL
7.02207.05.0	SUV	EL

XJ (X351)
9























2.0 Ti4 147-184 kW (200-250 PS) 204PT	05.2012→	 7.06117.52.0	SV-NWV	EH	
		7.06117.53.0	SV-NWV	EH	
3.0 SDV6 177-221 kW (241-300 PS) 306DT	10.2009→04.2016	 7.02207.05.0	SUV	EL	
3.0 SDV6 177-221 kW (241-300 PS) 306DT	04.2015→	 7.02436.02.0	EUV-AGR	EL	hinten Rear
		7.02428.02.0	EUV-LS	EL	vorne Front
		7.02207.05.0	SUV	EL	

J





















			 PIERBURG		
CHEROKEE (KL) 1					
2.0 T-GDi 199-200 kW (270-272 PS) EC1	01.2019→		7.02909.12.0	SUV	EL
2.0 T-GDi 4x4 199-200 kW (270-272 PS) EC1	09.2018→		7.02909.12.0	SUV	EL
COMPASS (MK49) 2					
2.2 CRD 100-120 kW (136-163 PS) ENE	05.2011→		7.02256.37.0	EUV-AGR	EL
2.2 CRD 4x4 100-120 kW (136-163 PS) OM 651.925	12.2010→		7.02256.37.0	EUV-VB	EL
			7.02256.37.0	EUV-WP	EL
2.2 CRD 4x4 100-120 kW (136-163 PS) ENE	05.2011→		7.02256.37.0	EUV-AGR	EL
PATRIOT (MK74) 3					
2.2 CRD 4x4 100-120 kW (136-163 PS) ENE	01.2011→12.2017		7.02256.37.0	EUV-AGR	EL
RENEGADE SUV (BU, B1) 4					
1.4 103-125 kW (140-170 PS) EAM	07.2014→		7.02909.07.0	SUV	EL
1.4 100-125 kW (136-170 PS) 552 63 624, EAM	07.2014→		7.02909.07.0	SUV	EL
1.4 100-103 kW (136-140 PS) 552 63 624	01.2016→		7.02909.07.0	SUV	EL
1.4 4x4 103-125 kW (140-170 PS) EAM	07.2014→		7.02909.07.0	SUV	EL
1.4 4x4 103-125 kW (140-170 PS) 552 63 623, EAM	07.2014→		7.02909.07.0	SUV	EL
WRANGLER IV (JL) 5					
2.0 T-GDi (JL72, JL74) 199-200 kW (270-272 PS) EC1	11.2017→		7.02909.12.0	SUV	EL

					
CARENS III MPV (UN)					
1					
1.6 CRDi 110 66-100 kW (90-136 PS) D4FB	10.2010→		7.00272.03.0	DW-AGR	EP →12.2016
1.6 CRDi 128 66-100 kW (90-136 PS) D4FB	10.2010→		7.00272.03.0	DW-AGR	EP →12.2016
2.0 CRDi 83-110 kW (113-150 PS) D4EA	01.2008→04.2010		7.00272.03.0	DW-AGR	EP
2.0 CRDi 115 83-110 kW (113-150 PS) D4EA	05.2007→		7.00272.03.0	DW-AGR	EP →12.2016
2.0 CRDi 135 83-110 kW (113-150 PS) D4EA	08.2009→		7.00272.03.0	DW-AGR	EP →12.2016
2.0 CRDi 140 83-110 kW (113-150 PS) D4EA	09.2006→		7.00272.03.0	DW-AGR	EP →12.2016
CARENS IV					
2					
1.7 CRDi 85-104 kW (116-141 PS) D4FD	03.2013→		7.00272.03.0	DW-AGR	EP →12.2016
1.7 CRDi 85-104 kW (116-141 PS) D4FD	03.2013→		7.00272.03.0	DW-AGR	EP →12.2016
1.7 CRDi 85-104 kW (116-141 PS) D4FD	03.2013→		7.00272.03.0	DW-AGR	EP →12.2016
1.7 CRDi 85-104 kW (116-141 PS) D4FD	07.2015→		7.00272.03.0	DW-AGR	EP →12.2016
CARNIVAL / GRAND CARNIVAL III (VQ)					
3					
2.9 CRDi 92-141 kW (125-192 PS) J3(CRDi)	04.2006→		7.00272.03.0	DW-AGR	EP →12.2006
2.9 CRDi LX 92-141 kW (125-192 PS) J3(CRDi)	09.2006→		7.00272.03.0	DW-AGR	EP →12.2006
CARNIVAL II (GO)					
4					
2.9 CRDi 92-141 kW (125-192 PS) J3(CRDi)	02.2001→09.2007		7.00272.03.0	DW-AGR	EP 04.2006→12.2006
2.9 CRDi 92-141 kW (125-192 PS) J3(CRDi)	10.2001→06.2006		7.00272.03.0	DW-AGR	EP
CEE'D (JD)					
5					
1.4 CRDi 90 55-66 kW (75-90 PS) D4FC	05.2012→		7.00272.03.0	DW-AGR	EP →05.2018
1.6 CRDi 110 66-100 kW (90-136 PS) D4FB	05.2012→		7.00272.03.0	DW-AGR	EP →05.2018
1.6 CRDi 128 66-100 kW (90-136 PS) D4FB	05.2012→		7.00272.03.0	DW-AGR	EP
1.6 CRDi 136 66-100 kW (90-136 PS) D4FB	07.2015→		7.00272.03.0	DW-AGR	EP →05.2018
CEE'D Hatchback (ED)					
6					
1.6 CRDi 115 66-100 kW (90-136 PS) D4FB	12.2006→12.2012		7.00272.03.0	DW-AGR	EP
			7.03294.02.0	EUV-AGR	EL
			7.03294.02.0	LDRV	EL

K

						
CEE'D Hatchback (ED)						6
1.6 CRDi 128 66-100 kW (90-136 PS) D4FB	10.2010→12.2012		7.00272.03.0	DW-AGR	EP	
			7.03294.02.0 7.03294.02.0	EUV-AGR LDRV	EL EL	
1.6 CRDi 90 66-100 kW (90-136 PS) D4FB	12.2006→12.2012		7.00272.03.0	DW-AGR	EP	
			7.03294.02.0	EUV-AGR	EL	
			7.03294.02.0	LDRV	EL	
CEE'D SW (ED)						7
1.6 CRDi 115 66-100 kW (90-136 PS) D4FB	09.2007→12.2012		7.00272.03.0	DW-AGR	EP	
			7.03294.02.0	EUV-AGR	EL	
			7.03294.02.0	LDRV	EL	
1.6 CRDi 128 66-100 kW (90-136 PS) D4FB	10.2010→12.2012		7.00272.03.0	DW-AGR	EP	
			7.03294.02.0	EUV-AGR	EL	
			7.03294.02.0	LDRV	EL	
1.6 CRDi 90 66-100 kW (90-136 PS) D4FB	09.2007→12.2012		7.00272.03.0	DW-AGR	EP	
			7.03294.02.0	EUV-AGR	EL	
			7.03294.02.0	LDRV	EL	
CEE'D Sportswagon (JD)						8
1.4 CRDi 90 55-66 kW (75-90 PS) D4FC	09.2012→		7.00272.03.0	DW-AGR	EP →05.2018	
1.6 CRDi 110 66-100 kW (90-136 PS) D4FB	03.2013→		7.00272.03.0	DW-AGR	EP →05.2018	
1.6 CRDi 128 66-100 kW (90-136 PS) D4FB	09.2012→		7.00272.03.0	DW-AGR	EP →05.2018	
1.6 CRDi 136 66-100 kW (90-136 PS) D4FB	07.2015→		7.00272.03.0	DW-AGR	EP →05.2018	
CERATO I Hatchback (LD)						9
1.5 CRDi 54-85 kW (73-116 PS) D4FA	07.2005→		7.00272.03.0	DW-AGR	EP	
1.5 CRDi 54-85 kW (73-116 PS) D4FA	07.2005→		7.00272.03.0	DW-AGR	EP	
1.5 CRDi 54-85 kW (73-116 PS) D4FA	07.2005→08.2006		7.00272.03.0	DW-AGR	EP	
1.6 CRDi 66-100 kW (90-136 PS) D4FB	06.2005→		7.00272.03.0	DW-AGR	EP →10.2008	
2.0 CRDi 83-110 kW (113-150 PS) D4EA	04.2004→		7.00272.03.0	DW-AGR	EP	
CERATO I Saloon (LD)						10
1.5 CRDi 54-85 kW (73-116 PS) D4FA	07.2005→08.2006		7.00272.03.0	DW-AGR	EP	
1.5 CRDi 54-85 kW (73-116 PS) D4FA	07.2005→12.2009		7.00272.03.0	DW-AGR	EP	
1.5 CRDi 54-85 kW (73-116 PS) D4FA	07.2005→08.2006		7.00272.03.0	DW-AGR	EP	

























K

						
CERATO I Saloon (LD)						10
1.6 CRDi 66-100 kW (90-136 PS) D4FB	06.2005→12.2009		7.00272.03.0	DW-AGR	EP	
2.0 CRDi 83-110 kW (113-150 PS) D4EA	04.2004→05.2006		7.00272.03.0	DW-AGR	EP	
MAGENTIS (MG)						11
2.0 CRDi 83-110 kW (113-150 PS) D4EA	11.2005→12.2008		7.00272.03.0	DW-AGR	EP	
2.0 CRDi 83-110 kW (113-150 PS) D4EA	04.2006→		7.00272.03.0	DW-AGR	EP	→12.2010
2.0 CRDi 83-110 kW (113-150 PS) D4EA	04.2006→		7.00272.03.0	DW-AGR	EP	→12.2010
OPTIMA (FSGDS6B)						12
1.7 CRDi 85-104 kW (116-141 PS) D4FD	03.2012→		7.00272.03.0	DW-AGR	EP	→12.2015
PICANTO (SA)						13
1.1 CRDi 55 kW (75 PS) D3FA	11.2005→		7.00272.03.0	DW-AGR	EP	→12.2011
PRO CEE'D (ED)						14
1.6 CRDi 115 66-100 kW (90-136 PS) D4FB	02.2008→09.2012		7.00272.03.0	DW-AGR	EP	
			7.03294.02.0	EUV-AGR	EL	
			7.03294.02.0	LDRV	EL	
1.6 CRDi 128 66-100 kW (90-136 PS) D4FB	10.2010→09.2012		7.00272.03.0	DW-AGR	EP	
			7.03294.02.0	EUV-AGR	EL	
			7.03294.02.0	LDRV	EL	
1.6 CRDi 90 66-100 kW (90-136 PS) D4FB	02.2008→09.2012		7.00272.03.0	DW-AGR	EP	
			7.03294.02.0	EUV-AGR	EL	
			7.03294.02.0	LDRV	EL	
PRO CEE'D (JD)						15
1.4 CRDi 90 55-66 kW (75-90 PS) D4FC	03.2013→		7.00272.03.0	DW-AGR	EP	→05.2018
1.6 CRDi 110 66-100 kW (90-136 PS) D4FB	03.2013→		7.00272.03.0	DW-AGR	EP	→05.2018
1.6 CRDi 128 66-100 kW (90-136 PS) D4FB	03.2013→		7.00272.03.0	DW-AGR	EP	→05.2018
1.6 CRDi 136 66-100 kW (90-136 PS) D4FB	07.2015→		7.00272.03.0	DW-AGR	EP	→05.2018
RIO II (JB)						16
1.5 CRDi 54-85 kW (73-116 PS) D4FA	03.2005→12.2011		7.00272.03.0	DW-AGR	EP	
			7.03294.02.0	LDRV	EL	Produktionsdatum bis: 22.10.2010 Production date to: 22.10.2010
1.5 CRDi 54-85 kW (73-116 PS) D4FA	06.2008→12.2011		7.00272.03.0	DW-AGR	EP	
			7.03294.02.0	LDRV	EL	Produktionsdatum bis: 22.10.2010 Production date to: 22.10.2010

K

RIO II Saloon (JB)						17
1.5 CRDi 54-85 kW (73-116 PS) D4FA	03.2005→12.2011		7.00272.03.0	DW-AGR	EP	Produktionsdatum bis: 22.10.2010 Production date to: 22.10.2010
			7.03294.02.0	LDRV	EL	
1.5 CRDi 54-85 kW (73-116 PS) D4FA	06.2008→12.2011		7.00272.03.0	DW-AGR	EP	
			7.03294.02.0	LDRV	EL	
RIO III (UB)						18
1.1 CRDi 55 kW (75 PS) D3FA	09.2011→		7.00272.03.0	DW-AGR	EP	→12.2017
1.4 CRDi 55-66 kW (75-90 PS) D4FC	09.2011→		7.00272.03.0	DW-AGR	EP	→12.2016
RIO IV (YB, SC, FB)						19
1.4 CRDi 77 55-66 kW (75-90 PS) D4FC	01.2017→		7.00272.03.0	DW-AGR	EP	
1.4 CRDi 90 55-66 kW (75-90 PS) D4FC	01.2017→		7.00272.03.0	DW-AGR	EP	
SORENTO I (JC)						20
2.5 CRDi 95-131 kW (129-178 PS) D4CB	08.2002→		7.00272.03.0	DW-AGR	EP	01.2006→12.2008
			7.03294.02.0	EUV-RK	EL	Produktionsdatum ab: 26.04.2006 Production date from: 26.04.2006 Produktionsdatum bis: 31.12.2006 Production date to: 31.12.2006
2.5 CRDi 95-131 kW (129-178 PS) D4CB	05.2006→		7.00272.03.0	DW-AGR	EP	→12.2008
			7.03294.02.0	EUV-RK	EL	Produktionsdatum bis: 31.12.2006 Production date to: 31.12.2006
2.5 CRDi 95-131 kW (129-178 PS) D4CB	09.2006→		7.00272.03.0	DW-AGR	EP	→12.2008
			7.03294.02.0	EUV-RK	EL	Produktionsdatum bis: 31.12.2006 Production date to: 31.12.2006
2.5 CRDi 95-131 kW (129-178 PS) D4CB	12.2006→		7.00272.03.0	DW-AGR	EP	→12.2008
			7.03294.02.0	EUV-RK	EL	Produktionsdatum bis: 31.12.2006 Production date to: 31.12.2006
2.5 CRDi 4WD 95-131 kW (129-178 PS) D4CB	09.2006→12.2011		7.00272.03.0	DW-AGR	EP	→12.2008
			7.03294.02.0	EUV-RK	EL	Produktionsdatum bis: 31.12.2006 Production date to: 31.12.2006
SOUL I (AM)						21
1.6 CRDi 115 66-100 kW (90-136 PS) D4FB	02.2009→		7.00272.03.0	DW-AGR	EP	→08.2016
1.6 CRDi 128 66-100 kW (90-136 PS) D4FB	02.2009→		7.00272.03.0	DW-AGR	EP	→08.2016
SOUL II (PS)						22
1.6 CRDi 128 66-100 kW (90-136 PS) D4FB	02.2014→		7.00272.03.0	DW-AGR	EP	→08.2016
1.6 CRDi 136 66-100 kW (90-136 PS) D4FB	04.2015→		7.00272.03.0	DW-AGR	EP	→08.2016

K

						
SPORTAGE II (JE_, KM)						23
2.0 CRDi 83-110 kW (113-150 PS) D4EA	02.2005→		7.00272.03.0	DW-AGR	EP →01.2010	
2.0 CRDi 83-110 kW (113-150 PS) D4EA	01.2006→05.2010		7.00272.03.0	DW-AGR	EP →01.2010	
2.0 CRDi 83-110 kW (113-150 PS) D4EA	01.2006→		7.00272.03.0	DW-AGR	EP →01.2010	
2.0 CRDi 83-110 kW (113-150 PS) D4EA	09.2007→		7.00272.03.0	DW-AGR	EP →01.2010	
2.0 CRDi 100-137 kW (136-186 PS) D4HA	01.2009→05.2010		7.00272.03.0	DW-AGR	EP	
2.0 CRDi 4WD 83-110 kW (113-150 PS) D4EA	09.2004→		7.00272.03.0	DW-AGR	EP →01.2010	
2.0 CRDi 4WD 83-110 kW (113-150 PS) D4EA	01.2006→		7.00272.03.0	DW-AGR	EP →01.2010	
2.0 CRDi 4WD 83-110 kW (113-150 PS) D4EA	01.2006→05.2010		7.00272.03.0	DW-AGR	EP →01.2010	
2.0 CRDi 4WD 83-110 kW (113-150 PS) D4EA	09.2008→05.2010		7.00272.03.0	DW-AGR	EP →01.2010	
SPORTAGE III (SL)						24
1.7 CRDi 85-104 kW (116-141 PS) D4FD	12.2010→		7.03294.02.0	LDRV	EL Euro 6 Euro 6 Produktionsdatum bis: 05.12.2015 Production date to: 05.12.2015	
STONIC (YB)						25
1.6 CRDi 66-100 kW (90-136 PS) D4FB	07.2017→		7.00272.03.0	DW-AGR	EP	
1.6 CRDi 85-100 kW (116-136 PS) D4FE	08.2018→		7.00272.03.0	DW-AGR	EP	
1.6 CRDi 85-100 kW (116-136 PS) D4FE	08.2018→		7.00272.03.0	DW-AGR	EP	
VENGA (YN)						26
1.4 CRDi 75 55-66 kW (75-90 PS) D4FC	02.2010→		7.00272.03.0	DW-AGR	EP	
1.4 CRDi 75 55-66 kW (75-90 PS) D4FC	02.2010→		7.00272.03.0	DW-AGR	EP	
1.4 CRDi 90 55-66 kW (75-90 PS) D4FC	02.2010→		7.00272.03.0	DW-AGR	EP	
1.6 CRDi 115 66-100 kW (90-136 PS) D4FB	02.2010→		7.00272.03.0	DW-AGR	EP →06.2018	
1.6 CRDi 128 66-100 kW (90-136 PS) D4FB	02.2010→		7.00272.03.0	DW-AGR	EP →06.2018	
SORENTO I VAN (JC)						27
2.5 CRDi 4WD 95-131 kW (129-178 PS) D4CB	08.2005→10.2006		7.03294.02.0	EUV-RK	EL Produktionsdatum ab: 26.04.2006 Production date from: 26.04.2006	

K

































HURACÁN

1

5.2 LP 580-2 386-470 kW
(525-639 PS)
BUJ

L







						
DEDRA (835_)						1
1.8 16V LE (835FG) 66-83 kW (90-113 PS) 182 A2.000	03.1996→07.1999		7.06269.06.0	LLR	EL 	
1.8 GT 16V (835EH) 96 kW (131 PS) 183 A1.000	03.1996→07.1999		7.06269.06.0	LLR	EL 	
1.8 i.e. (835FA) 74 kW (101 PS) 836 A5.000	07.1994→07.1999		7.05432.09.0	SM	EL mit Dichtring with O-ring	
DEDRA SW (835_)						2
1.8 16V LE (835FG) 66-83 kW (90-113 PS) 182 A2.000	03.1996→07.1999		7.06269.06.0	LLR	EL 	
1.8 GT 16V (835EH) 96 kW (131 PS) 183 A1.000	03.1996→07.1999		7.06269.06.0	LLR	EL 	
1.8 i.e. (835FA) 74 kW (101 PS) 836 A5.000	07.1994→07.1999		7.05432.09.0	SM	EL mit Dichtring with O-ring	
DELTA II (836_)						3
1.6 i.e. (836AP) 66 kW (90 PS) 182 A6.000	03.1996→08.1999		7.05432.09.0	SM	EL mit Dichtring with O-ring Vett No. →3297145	
1.6 i.e. 16V (836AO) 76 kW (103 PS) 182 A4.000	01.1996→08.1999		7.05432.09.0	SM	EL mit Dichtring with O-ring Vett No. →3297145	
1.8 i.e. (836AE) 76 kW (103 PS) 835 C2.000	06.1993→08.1999		7.05432.09.0	SM	EL mit Dichtring with O-ring	
1.8 i.e. (836AG, 836AL) 66 kW (90 PS) 836 A6.000	07.1994→08.1999		7.05432.09.0	SM	EL mit Dichtring with O-ring	
1.8 i.e. 16V (836AQ) 66-83 kW (90-113 PS) 182 A2.000	03.1996→08.1999		7.06269.06.0	LLR	EL 	
1.8 i.e. 16V GT (836AR) 96 kW (131 PS) 183 A1.000	03.1996→08.1999		7.06269.06.0	LLR	EL  →04.1998	
DELTA III (844_)						4
1.4 (844.AXA1A) 88 kW (120 PS) 198 A4.000	09.2008→08.2014		7.02256.49.0	LDRV	EP	
			7.01835.06.0	SUV	EL	
1.4 (844.AXB1A) 110 kW (150 PS) 198 A1.000	09.2008→08.2014		7.02256.49.0	LDRV	EP	
			7.01835.06.0	SUV	EL	
1.4 16V (844.AXL1A) 103 kW (140 PS) 198 A7.000	07.2010→08.2014		7.02909.07.0	SUV	EL	
1.4 Bifuel (844.AXA1A) 88 kW (120 PS) 198 A4.000	07.2011→08.2014		7.02256.49.0	LDRV	EP	
			7.01835.06.0	SUV	EL	
1.6 D Multijet (844.AXC11, 844.AXC1A) 88 kW (120 PS) 198 A2.000	09.2008→08.2014		7.00607.02.0	DW-TL	EP →12.2011	
			7.03003.01.0	DW-TL	EP	
1.6 D Multijet (844.AXF11, 844.AXF1A) 85 kW (116 PS) 955 A4.000	08.2008→08.2014		7.00607.02.0	DW-TL	EP →12.2011	
			7.03003.01.0	DW-TL	EP	

L



			 PIERBURG		
DELTA III (844_) 4					
1.6 D Multijet (844.AXP1A) 77 kW (105 PS) 944 A 3.000	04.2011→08.2014		7.03003.01.0	DW-TL	EP
1.8 (844.AXH12) 147 kW (200 PS) 939 B1.000	01.2009→08.2014		7.06117.38.0	SV-NWV	EL mit Dichtring with O-ring
1.9 D Multijet (844.AXE1A) 140 kW (190 PS) 844 A1.000	01.2009→08.2014		7.00607.02.0	DW-TL	EP →12.2011
2.0 D Multijet (844.AXD1A, 844.AXM1A) 121 kW (165 PS) 198 A5.000, 198 A8.000	09.2008→08.2014		7.00607.02.0	DW-TL	EP  198 A5.000, 198 A8.000: →12.2011
2.0 D Multijet (844.AXG1A, 844.AXN1A) 120 kW (163 PS) 844 A2.000	09.2008→08.2014		7.00607.02.0	DW-TL	EP →12.2011
			7.03003.01.0	DW-TL	EP
KAPPA (838_) 5					
2.4 JTD (838AL1AA) 100 kW (136 PS) 838 A8.000	06.1998→10.2001		7.02256.03.0	DW-AGR	EP
KAPPA Coupe (838_) 6					
2.4 20V (838CC) 129 kW (175 PS) 838 A2.000	11.1996→03.2001		7.02256.03.0	DW-AGR	EP
KAPPA SW (838_) 7					
2.4 JTD (838BL1AA) 100 kW (136 PS) 838 A8.000	06.1998→10.2001		7.02256.03.0	DW-AGR	EP
LYBRA (839_) 8					
1.9 JTD (839.AXI1A, 839.AXN1A, 839.CXL1A) 85 kW (116 PS) 937 A2.000	05.2001→10.2005		7.00607.02.0	DW-TL	EP
			7.21903.48.0	DW-TL	EP
			7.02256.50.0	EUV-RK	EL
1.9 JTD (839AXD1A) 77 kW (105 PS) AR 32302	07.1999→09.2000		7.02256.03.0	DW-AGR	EP
			7.21903.48.0	DW-TL	EP
1.9 JTD (839AXI1A) 80-85 kW (109-116 PS) AR 37101	09.2000→05.2001		7.00607.02.0	DW-TL	EP
			7.21903.48.0	DW-TL	EP
			7.02256.50.0	EUV-RK	EL
2.4 JTD (839.AXE1A) 110 kW (150 PS) 841 C.000	05.2002→10.2005		7.00607.02.0	DW-TL	EP
			7.21903.48.0	DW-TL	EP
			7.02256.50.0	EUV-RK	EL
2.4 JTD (839AXE1A) 96-100 kW (131-136 PS) 839 A5.000, AR 32501	07.1999→02.2001		7.02256.03.0	DW-AGR	EP
			7.21903.48.0	DW-TL	EP
2.4 JTD (839AXL1A) 103 kW (140 PS) 839 A6.000	09.2000→05.2002		7.00607.02.0	DW-TL	EP
			7.21903.48.0	DW-TL	EP
			7.02256.50.0	EUV-RK	EL













































LYBRA SW (839_) 9

1.9 JTD (839.BX11A, 839.BXN1A, 839.CXL1A) 85 kW (116 PS) 937 A2.000	05.2001→10.2005		7.00607.02.0 DW-TL EP	
			7.21903.48.0 DW-TL EP	
			7.02256.50.0 EUV-RK EL	
1.9 JTD (839BXD1A) 77 kW (105 PS) AR 32302	07.1999→09.2001		7.02256.03.0 DW-AGR EP	
			7.21903.48.0 DW-TL EP	
1.9 JTD (839BXI1A) 80-85 kW (109-116 PS) AR 37101	09.2000→05.2001		7.00607.02.0 DW-TL EP	
			7.21903.48.0 DW-TL EP	
			7.02256.50.0 EUV-RK EL	
2.4 JTD (839.BXE1A) 110 kW (150 PS) 841 C.000	05.2002→10.2005		7.00607.02.0 DW-TL EP	
			7.21903.48.0 DW-TL EP	
			7.02256.50.0 EUV-RK EL	
2.4 JTD (839BXE1A) 96-100 kW (131-136 PS) 839 A5.000, AR 32501	10.1999→09.2000		7.02256.03.0 DW-AGR EP	
2.4 JTD (839BXL1A) 103 kW (140 PS) 839 A6.000	09.2000→10.2005		7.00607.02.0 DW-TL EP	
			7.21903.48.0 DW-TL EP	
			7.02256.50.0 EUV-RK EL	

MUSA (350_) 10

1.3 D Multijet (350.AXB11, 350.AXB1A) 51 kW (70 PS) 188 A9.000	10.2004→09.2012		7.00607.02.0 DW-TL EP		
			7.03003.01.0 DW-TL EP		
			7.08681.03.0 SV-HYAT EH		für OE-Nummer: 71737621, 71753780 for OE number: 71737621, 71753780
			7.08681.04.0 SV-HYAT EH		
			7.08681.05.0 SV-HYAT EH		für OE-Nummer: 71737623, 71753782 for OE number: 71737623, 71753782
			7.08681.06.0 SV-HYAT EH		
1.3 D Multijet (350.AXG11, 350.AXG1A) 66-77 kW (90-105 PS) 199 A3.000	09.2006→09.2012		7.00607.02.0 DW-TL EP		
			7.03003.01.0 DW-TL EP		
			7.08681.03.0 SV-HYAT EH		für OE-Nummer: 71737621, 71753780 for OE number: 71737621, 71753780
			7.08681.04.0 SV-HYAT EH		
			7.08681.05.0 SV-HYAT EH		für OE-Nummer: 71737623, 71753782 for OE number: 71737623, 71753782
			7.08681.06.0 SV-HYAT EH		
1.3 D Multijet (350.AXM11, 350.AXM1A, 350.AX11A) 57-70 kW (77-95 PS) 199 B1.000	03.2009→09.2012		7.00607.02.0 DW-TL EP		
			7.03003.01.0 DW-TL EP		
			7.01981.07.0 SV-AGR-K EP		
			7.08681.03.0 SV-HYAT EH		für OE-Nummer: 71737621, 71753780 for OE number: 71737621, 71753780
			7.08681.04.0 SV-HYAT EH		











					
MUSA (350_)					10
			7.08681.05.0	SV-HYAT	EH für OE-Nummer: 71737623, 71753782 for OE number: 71737623, 71753782
			7.08681.06.0	SV-HYAT	EH
1.4 (350.AXF1A) 55-57 kW (75-78 PS) 350 A1.000	09.2005→09.2012		7.06117.35.0	SV-NWV	EL  →3952691
			7.06117.38.0	SV-NWV	EL mit Dichtring with O-ring  3952691→
1.4 LPG (350.AXF1A) 55-57 kW (75-78 PS) 350 A1.000	11.2010→09.2012		7.06117.35.0	SV-NWV	EL  →3952691
			7.06117.38.0	SV-NWV	EL mit Dichtring with O-ring  3952691→
1.6 D Multijet (350.AXH1A) 85-88 kW (116-120 PS) 350 A2.000	07.2008→09.2012		7.00607.02.0	DW-TL	EP
			7.03003.01.0	DW-TL	EP
1.6 D Multijet (350.AXL1A, 350.AXH1A) 85-88 kW (116-120 PS) 350 A2.000, 350 A3.000	07.2008→09.2012		7.00607.02.0	DW-TL	EP
			7.03003.01.0	DW-TL	EP
1.9 D Multijet (350.AXC1A) 74 kW (101 PS) 188 B2.000	10.2004→09.2012		7.00607.02.0	DW-TL	EP
			7.28170.03.0	EUV-RK	EP
			7.02256.49.0	LDRV	EP
PHEDRA (179_)					11
2.0 D Multijet (179.AXL1B, 179.BXL1B) 100 kW (136 PS) RHR (DW10BTED4)	07.2006→11.2010		7.01632.02.0	DW-RK	EP Vett No. →10991 Produktionsdatum bis: 15.12.2006 Production date to: 15.12.2006
			7.01633.04.0	DW-TL	EP →01.2008 Euro 4 Euro 4
2.0 JTD (179.AXH1B, 179.BXH1B) 79-88 kW (107-120 PS) RHK (DW10UTED4)	06.2006→11.2010		7.01632.02.0	DW-RK	EP Vett No. →11173
2.0 JTD (179.AXB1A) 80-81 kW (109-110 PS) RHW (DW10ATED4)	09.2002→11.2010		7.02256.24.0	DW-AGR	EP
			7.02256.24.0	DW-TL	EP
2.2 JTD (179.AXN1B, 179.AXQ11, 179.BXN1B, 179.BXQ11) 120 kW (163 PS) 4HP, 4HR	04.2006→11.2010		7.01633.04.0	DW-TL	EP  4HP, 4HR: →01.2008 Euro 4 Euro 4
2.2 JTD (179.AXC1A) 94 kW (128 PS) 4HW (DW12ATED4)	09.2002→11.2010		7.02256.24.0	DW-RK	EP
THESIS (841_)					12
2.0 Turbo (841.AXA1B03) 136 kW (185 PS) 841 E.000	07.2002→07.2009		7.02256.49.0	LDRV	EP
2.4 D Multijet (841.AXN111, 841.AXH110) 136 kW (185 PS) 841 P.000	04.2006→07.2009		7.00607.02.0	DW-TL	EP →12.2007
2.4 JTD (841.AXE1B0, 841.AXH110) 129 kW (175 PS) 841 G.000	05.2003→07.2009		7.00607.02.0	DW-TL	EP

					
THESIS (841_)					12
2.4 JTD (841.AXE1B0, 841.AXH110) 120-147 kW (163-200 PS) 841 M.000, 841 N.000	09.2003→07.2009		7.02256.50.0	EUV-RK	EL
			7.00607.02.0	DW-TL	EP
2.4 JTD (841AXD1B02) 110 kW (150 PS) 841 C.000	07.2002→07.2009		7.02256.50.0	EUV-RK	EL
			7.00607.02.0	DW-TL	EP
YPSILON (312_)					13
0.9 CNG (312.YXG1A) 59-63 kW (80-86 PS) 312 A2.000	05.2011→		7.00607.02.0	DW-TL	EP
			7.03003.01.0	DW-TL	EP
			7.02909.07.0	SUV	EL
0.9 CNG (312.YXN1A) 57-63 kW (77-86 PS) 312 A5.000	01.2014→		7.00607.02.0	DW-TL	EP →12.2018
			7.03003.01.0	DW-TL	EP
			7.02909.07.0	SUV	EL
0.9 TwinAir (312.PXG11, 312.PXG1A, 312.YXG11, 312.YXG1A) 59-63 kW (80-86 PS) 312 A2.000	05.2011→		7.00607.02.0	DW-TL	EP →12.2018
			7.03003.01.0	DW-TL	EP
			7.02909.07.0	SUV	EL
0.9 TwinAir (312.YXN11, 312.YXN1A) 57-63 kW (77-86 PS) 312 A2.000, 312 A5.000	12.2013→		7.00607.02.0	DW-TL	EP  312 A2.000, 312 A5.000: →12.2018
			7.03003.01.0	DW-TL	EP
			7.02909.07.0	SUV	EL
1.2 (312.PXA1A, 312.YXA1A) 49-51 kW (67-69 PS) 169 A4.000	05.2011→		7.06117.38.0	SV-NWV	EL mit Dichtring with O-ring
1.2 Bi-fuel (312.YXA1A) 49-51 kW (67-69 PS) 169 A4.000	05.2011→		7.06117.38.0	SV-NWV	EL mit Dichtring with O-ring
1.2 Bi-fuel (312.YXA1A) 49-51 kW (67-69 PS) 169 A4.000	05.2011→		7.06117.38.0	SV-NWV	EL mit Dichtring with O-ring
1.3 D Multijet (312.YXE1A, 312.YXU1A) 57-70 kW (77-95 PS) 199 B1.000, 312 B1.000	05.2011→		7.03003.01.0	DW-TL	EP
			7.01981.07.0	SV-AGR-K	EP
YPSILON (843_)					14
1.2 (843.AXL1A) 49-51 kW (67-69 PS) 169 A4.000	08.2010→12.2011		7.06117.38.0	SV-NWV	EL mit Dichtring with O-ring
1.3 D Multijet (843.AXE11, 843.AXE1A) 66-77 kW (90-105 PS) 199 A3.000	09.2006→12.2011		7.03003.01.0	DW-TL	EP 07.2010→
			7.00607.02.0	DW-TL	EP
			7.08681.03.0	SV-HYAT	EH für OE-Nummer: 71737621, 71753780 für OE number: 71737621, 71753780
			7.08681.04.0	SV-HYAT	EH





L























YPSILON (843_) **14**

			7.08681.05.0	SV-HYAT	EH	für OE-Nummer: 71737623, 71753782 for OE number: 71737623, 71753782
			7.08681.06.0	SV-HYAT	EH	
1.3 D Multijet (843.AXF11, 843.AXF1A, 843.AXM11,...) 55 kW (75 PS) 199 A2.000	09.2006→12.2011		7.03003.01.0	DW-TL	EP	07.2010→
			7.00607.02.0	DW-TL	EP	
			7.01981.07.0	SV-AGR-K	EP	Euro 5 Euro 5
			7.08681.03.0	SV-HYAT	EH	für OE-Nummer: 71737621, 71753780 for OE number: 71737621, 71753780
			7.08681.04.0	SV-HYAT	EH	
			7.08681.05.0	SV-HYAT	EH	für OE-Nummer: 71737623, 71753782 for OE number: 71737623, 71753782
1.3 D Multijet (843.AXH1A, 843.AXE1A) 66-77 kW (90-105 PS) 199 A3.000	05.2007→12.2011		7.03003.01.0	DW-TL	EP	07.2010→
			7.00607.02.0	DW-TL	EP	
			7.08681.03.0	SV-HYAT	EH	für OE-Nummer: 71737621, 71753780 for OE number: 71737621, 71753780
1.3 JTD (843.AXD11, 843.AXD1A) 51 kW (70 PS) 188 A9.000	10.2003→12.2011		7.08681.03.0	SV-HYAT	EH	für OE-Nummer: 71737621, 71753780 for OE number: 71737621, 71753780
			7.08681.04.0	SV-HYAT	EH	
			7.08681.05.0	SV-HYAT	EH	für OE-Nummer: 71737623, 71753782 for OE number: 71737623, 71753782
1.4 (843.AXG1A) 55-57 kW (75-78 PS) 350 A1.000	02.2006→12.2011		7.06117.35.0	SV-NWV	EL	 →3952691
			7.06117.38.0	SV-NWV	EL	mit Dichtring with O-ring  3952691→
			7.06117.35.0	SV-NWV	EL	 →3952691
1.4 LPG (843.AXG1A) 55-57 kW (75-78 PS) 350 A1.000	11.2010→12.2011		7.06117.35.0	SV-NWV	EL	 →3952691
			7.06117.38.0	SV-NWV	EL	mit Dichtring with O-ring  3952691→

ZETA (22_) **15**



2.0 16V (220AL5) 97 kW (132 PS) RFV (XU10J4R)	05.1998→07.2000		7.02256.05.0	OEL-HV	EH	
2.0 16V (220AQ5, 220AQ4) 100 kW (136 PS) RFN	07.2000→09.2002		7.02256.05.0	OEL-HV	EH	
2.0 JTD (220.AR5, 220.AN5) 80 kW (109 PS) RHZ (DW10ATED)	09.1999→09.2002		7.02256.24.0	DW-AGR	EP	
			7.02256.24.0	DW-RK	EP	
			7.02256.24.0	DW-TL	EP	
2.0 JTD 16V (220.AR5OOL) 80-81 kW (109-110 PS) RHW (DW10ATED4)	04.2001→10.2003		7.02256.24.0	DW-AGR	EP	
			7.02256.24.0	DW-RK	EP	
			7.02256.24.0	DW-TL	EP	

						
DEFENDER Cabrio (L316)						1
2.5 Td5 4x4 (L316) 90-102 kW (122-139 PS) 10 P, 14 P, 15 P	06.1998→02.2016		7.22572.01.0	EUV-VB	EL	
DEFENDER Pick Up (L316)						2
2.5 Td5 4x4 (L316) 90-102 kW (122-139 PS) 10 P, 15 P	06.1998→02.2016		7.22572.01.0	EUV-VB	EL	
DEFENDER Station Wagon (L316)						3
2.5 Td5 4x4 (L316) 90-102 kW (122-139 PS) 10 P, 14 P, 15 P	06.1998→02.2016		7.22572.01.0	EUV-VB	EL	
DISCOVERY II (L318)						4
2.5 Td5 4x4 90-102 kW (122-139 PS) 10 P, 15 P	11.1998→06.2004		7.22572.01.0	EUV-VB	EL	
2.5 Td5 4x4 90-102 kW (122-139 PS) 10 P, 15 P	11.1998→06.2004		7.22572.01.0	EUV-VB	EL	
4.0 4x4 136-140 kW (185-190 PS) 56 D	11.1998→12.2002		7.02318.01.0	EUV-SL	EL	
4.0 V8 4x4 134-140 kW (182-190 PS) 35 D, 56 D, 94 D	11.1998→06.2004		7.02318.01.0	EUV-SL	EL	
4.6 4x4 165-168 kW (224-228 PS) 46 D	09.1999→12.2002		7.02318.01.0	EUV-SL	EL	
4.6 4x4	09.2002→12.2003		7.02318.01.0	EUV-SL	EL	
4.6 4x4 160 kW (218 PS) 60 D	09.2002→06.2004		7.02318.01.0	EUV-SL	EL	
DISCOVERY IV (L319)						5
3.0 SDV6 4x4 155-250 kW (211-340 PS) 306DT	11.2009→12.2018		7.02436.02.0	EUV-AGR	EL Fahrgestellnummer ab: EA730191 Vehicle Identification Number from: EA730191 hinten Rear	
			7.02428.02.0	EUV-LS	EL Fahrgestellnummer ab: EA730191 Vehicle Identification Number from: EA730191 vorne Front	
			7.07400.11.0*	LDRV	EL Fahrgestellnummer ab: AA546303 Vehicle Identification Number from: AA546303	
			 7.22687.46.0 7.02207.05.0	LDRV SUV	EL EL	
3.0 TD 4x4 155-250 kW (211-340 PS) 306DT	09.2009→12.2018		7.02436.02.0	EUV-AGR	EL Fahrgestellnummer ab: EA730191 Vehicle Identification Number from: EA730191 hinten Rear	
			7.02428.02.0	EUV-LS	EL Fahrgestellnummer ab: EA730191 Vehicle Identification Number from: EA730191 vorne Front	
			7.02207.05.0	SUV	EL	
3.0 TD 4x4 155-250 kW (211-340 PS) 306DT	09.2009→12.2018		7.02436.02.0	EUV-AGR	EL Fahrgestellnummer ab: EA730191 Vehicle Identification Number from: EA730191 hinten Rear	





L



DISCOVERY IV (L319) **5**

			7.02428.02.0	EUV-LS	EL	Fahrgestellnummer ab: EA730191 Vehicle Identification Number from: EA730191 vorne Front
			7.07400.11.0*	LDRV	EL	Fahrgestellnummer ab: AA546303 Vehicle Identification Number from: AA546303
			↳ 7.22687.46.0	LDRV	EL	
			7.02207.05.0	SUV	EL	
3.0 TD 4x4 155-250 kW (211-340 PS) 306DT	05.2010→12.2018		7.02436.02.0	EUV-AGR	EL	Fahrgestellnummer ab: EA730191 Vehicle Identification Number from: EA730191 hinten Rear
			7.02428.02.0	EUV-LS	EL	Fahrgestellnummer ab: EA730191 Vehicle Identification Number from: EA730191 vorne Front
			7.07400.11.0*	LDRV	EL	Fahrgestellnummer ab: AA546303 Vehicle Identification Number from: AA546303
			↳ 7.22687.46.0	LDRV	EL	
			7.02207.05.0	SUV	EL	
3.0 TD 4x4 155-250 kW (211-340 PS) 306DT	07.2012→12.2018		7.02436.02.0	EUV-AGR	EL	Fahrgestellnummer ab: EA730191 Vehicle Identification Number from: EA730191 hinten Rear
			7.02428.02.0	EUV-LS	EL	Fahrgestellnummer ab: EA730191 Vehicle Identification Number from: EA730191 vorne Front
			7.07400.11.0*	LDRV	EL	Fahrgestellnummer ab: AA546303 Vehicle Identification Number from: AA546303
			↳ 7.22687.46.0	LDRV	EL	
			7.02207.05.0	SUV	EL	

DISCOVERY SPORT (L550) **6**



2.0 4x4 176-179 kW (240-243 PS) 204PT	11.2014→		7.04663.14.0	DW-TL	EL	 ch. EH000001→
			7.06117.52.0	SV-NWV	EH	
			7.06117.53.0	SV-NWV	EH	
2.0 4x4 176-179 kW (240-243 PS) 204PT	03.2015→		7.04663.14.0	DW-TL	EL	 ch. EH000001→
			7.06117.52.0	SV-NWV	EH	
			7.06117.53.0	SV-NWV	EH	

DISCOVERY V (L462) **7**

























3.0 D 4x4 155-250 kW (211-340 PS) 306DT	09.2016→		7.02436.02.0	EUV-AGR	EL	Fahrgestellnummer ab: JA000001, K2000001 Vehicle Identification Number from: JA000001, K2000001 hinten Rear
			7.02428.02.0	EUV-LS	EL	Fahrgestellnummer ab: JA000001, K2000001 Vehicle Identification Number from: JA000001, K2000001 vorne Front



DISCOVERY V (L462) 7

		7.07400.11.0* ↳7.22687.46.0 7.02207.05.0	LDRV LDRV SUV	EL EL EL	Fahrgestellnummer ab: AA000001, K2000001 Vehicle Identification Number from: AA000001, K2000001 Fahrgestellnummer ab: K2000001, KA000001 Vehicle Identification Number from: K2000001, KA000001
3.0 D 4x4 155-250 kW (211-340 PS) 306DT	09.2016→	 7.02436.02.0 7.02428.02.0 7.02207.05.0	EUV-AGR EUV-LS SUV	EL EL EL	Fahrgestellnummer ab: JA000001, K2000001 Vehicle Identification Number from: JA000001, K2000001 hinten Rear Fahrgestellnummer ab: JA000001, K2000001 Vehicle Identification Number from: JA000001, K2000001 vorne Front Fahrgestellnummer ab: K2000001, KA000001 Vehicle Identification Number from: K2000001, KA000001
3.0 SDV6 4x4 155-250 kW (211-340 PS) 306DT	09.2018→	 7.02436.02.0 7.02428.02.0 7.07400.11.0* ↳7.22687.46.0 7.02207.05.0	EUV-AGR EUV-LS LDRV LDRV SUV	EL EL EL EL EL	Fahrgestellnummer ab: JA000001, K2000001 Vehicle Identification Number from: JA000001, K2000001 hinten Rear Fahrgestellnummer ab: JA000001, K2000001 Vehicle Identification Number from: JA000001, K2000001 vorne Front Fahrgestellnummer ab: AA000001, K2000001 Vehicle Identification Number from: AA000001, K2000001 Fahrgestellnummer ab: K2000001, KA000001 Vehicle Identification Number from: K2000001, KA000001
3.0 Td6 4x4 155-250 kW (211-340 PS) 306DT	09.2016→	 7.02436.02.0 7.02428.02.0 7.07400.11.0* ↳7.22687.46.0 7.02207.05.0	EUV-AGR EUV-LS LDRV LDRV SUV	EL EL EL EL EL	Fahrgestellnummer ab: JA000001, K2000001 Vehicle Identification Number from: JA000001, K2000001 hinten Rear Fahrgestellnummer ab: JA000001, K2000001 Vehicle Identification Number from: JA000001, K2000001 vorne Front Fahrgestellnummer ab: AA000001, K2000001 Vehicle Identification Number from: AA000001, K2000001 Fahrgestellnummer ab: K2000001, KA000001 Vehicle Identification Number from: K2000001, KA000001

L





						
FREELANDER 2 (L359)						8
2.0 Si4 4x4 176-179 kW (240-243 PS) 204PT	10.2011→10.2014		7.06117.52.0	SV-NWV	EH	
			7.06117.53.0	SV-NWV	EH	
2.0 Si4 4x4 176-179 kW (240-243 PS) 204PT	08.2012→10.2014		7.06117.52.0	SV-NWV	EH	
			7.06117.53.0	SV-NWV	EH	
3.2 4x4 170-175 kW (231-238 PS) B 6324 S	10.2006→10.2014		7.06117.18.0	SV-NWV	EH	mit Dichtring with O-ring Ohne Pfandrückgabe des Altteils. Keine Rückgabe des Magnetventils nötig. Without deposit return for used part. No return of the solenoid valve.
FREELANDER I (L314)						9
2.0 Td4 4x4 80-82 kW (109-112 PS) M 47	11.2000→10.2006		7.21903.73.0	DW-TL	EP	
RANGE ROVER EVOQUE (L538)						10
2.0 4x4 176-179 kW (240-243 PS) 204PT	06.2011→12.2019		7.04663.14.0	DW-TL	EL	 ch. EH000001→
			7.06117.52.0	SV-NWV	EH	
			7.06117.53.0	SV-NWV	EH	
2.0 4x4 176-179 kW (240-243 PS) 204PT	09.2011→12.2019		7.04663.14.0	DW-TL	EL	 ch. EH000001→
			7.06117.52.0	SV-NWV	EH	
			7.06117.53.0	SV-NWV	EH	
2.0 4x4 176-179 kW (240-243 PS) 204PT	01.2012→12.2015		7.04663.14.0	DW-TL	EL	
			7.06117.52.0	SV-NWV	EH	
			7.06117.53.0	SV-NWV	EH	
RANGE ROVER EVOQUE Convertible (L538)						11
2.0 4x4 176-179 kW (240-243 PS) 204PT	11.2015→12.2019		7.04663.14.0	DW-TL	EL	Fahrgestellnummer ab: EH000001 Vehicle Identification Number from: EH000001
			7.06117.52.0	SV-NWV	EH	
			7.06117.53.0	SV-NWV	EH	
RANGE ROVER II (P38A)						12
2.5 D 4x4 100 kW (136 PS) 25 6T (BMW)	07.1994→03.2002		7.21903.73.0	DW-AGR	EP	
3.9 4x4 136-142 kW (185-193 PS) 42 D	07.1994→03.2002		7.02318.01.0	EUV-SL	EL	
3.9 4x4 136-142 kW (185-193 PS) 42 D	01.1995→03.2002		7.02318.01.0	EUV-SL	EL	
4.0 4x4 136-142 kW (185-193 PS) 42 D	01.1995→03.2002		7.02318.01.0	EUV-SL	EL	
4.6 4x4 157 kW (213 PS) 48 D	01.1995→12.1996		7.02318.01.0	EUV-SL	EL	
4.6 4x4 165-168 kW (224-228 PS) 46 D	09.1995→03.2002		7.02318.01.0	EUV-SL	EL	
4.6 4x4 165-168 kW (224-228 PS) 46 D	04.1997→03.2002		7.02318.01.0	EUV-SL	EL	
4.6 4x4 160 kW (218 PS) 60 D	06.1998→03.2002		7.02318.01.0	EUV-SL	EL	



RANGE ROVER III (L322) 13

3.0 D 4x4 130 kW (177 PS) 306D1	03.2002→08.2012	 7.21903.73.0	DW-AGR	EP	
4.4 4x4 210-212 kW (286-288 PS) M62 B44	03.2002→08.2005	 7.06117.10.0	SV-NWV	EL	
4.4 4x4 210-212 kW (286-288 PS) M62 B44	09.2004→12.2005	 7.06117.10.0	SV-NWV	EL	
4.4 D 4x4 230-253 kW (313-344 PS) 448DT	07.2010→08.2012	 7.02207.05.0	SUV	EL	







RANGE ROVER IV (L405) 14

3.0 SDV6 4x4 155-250 kW (211-340 PS) 306DT	08.2012→	 7.02436.02.0	EUV-AGR	EL	Fahrgestellnummer ab: JA000001 Vehicle Identification Number from: JA000001 hinten Rear Fahrgestellnummer ab: JA000001 Vehicle Identification Number from: JA000001 vorne Front
		7.02428.02.0	EUV-LS	EL	
		7.07400.11.0* ↳ 7.22687.46.0 7.02207.05.0	LDRV LDRV SUV	EL EL EL	
3.0 SDV6 4x4 155-250 kW (211-340 PS) 306DT	10.2012→	 7.02436.02.0	EUV-AGR	EL	Fahrgestellnummer ab: JA000001 Vehicle Identification Number from: JA000001 hinten Rear Fahrgestellnummer ab: JA000001 Vehicle Identification Number from: JA000001 vorne Front
		7.02428.02.0	EUV-LS	EL	
		7.07400.11.0* ↳ 7.22687.46.0 7.02207.05.0	LDRV LDRV SUV	EL EL EL	
3.0 SDV6 4x4 155-250 kW (211-340 PS) 306DT	12.2014→	 7.02436.02.0	EUV-AGR	EL	hinten Rear Fahrerhausseriennummer ab: JA000001 Driver cab serial number from: JA000001 Fahrgestellnummer ab: JA000001 Vehicle Identification Number from: JA000001 vorne Front
		7.02428.02.0	EUV-LS	EL	
		7.02207.05.0	SUV	EL	
3.0 SDV6 4x4 155-250 kW (211-340 PS) 306DT	10.2018→	 7.02436.02.0	EUV-AGR	EL	Fahrgestellnummer ab: JA000001 Vehicle Identification Number from: JA000001 hinten Rear Fahrgestellnummer ab: JA000001 Vehicle Identification Number from: JA000001 vorne Front
		7.02428.02.0	EUV-LS	EL	
		7.07400.11.0* ↳ 7.22687.46.0 7.02207.05.0	LDRV LDRV SUV	EL EL EL	

L



RANGE ROVER IV (L405) 14





3.0 SDV6 Hybrid 4x4 155-250 kW (211-340 PS) 306DT	10.2013→		7.02436.02.0 EUV-AGR EL	Fahrgestellnummer ab: JA000001 Vehicle Identification Number from: JA000001 hinten Rear
			7.02428.02.0 EUV-LS EL	Fahrgestellnummer ab: JA000001 Vehicle Identification Number from: JA000001 vorne Front
			7.07400.11.0* LDRV EL ↳ 7.22687.46.0 LDRV EL 7.02207.05.0 SUV EL	
3.0 SDV6 Hybrid 4x4 155-250 kW (211-340 PS) 306DT	06.2015→		7.02436.02.0 EUV-AGR EL	Fahrgestellnummer ab: JA000001 Vehicle Identification Number from: JA000001 hinten Rear
			7.02428.02.0 EUV-LS EL	Fahrgestellnummer ab: JA000001 Vehicle Identification Number from: JA000001 vorne Front
			7.02207.05.0 SUV EL	
3.0 SDV6 Hybrid 4x4 155-250 kW (211-340 PS) 306DT	06.2015→		7.02436.02.0 EUV-AGR EL	Fahrgestellnummer ab: JA000001 Vehicle Identification Number from: JA000001 hinten Rear
			7.02428.02.0 EUV-LS EL	Fahrgestellnummer ab: JA000001 Vehicle Identification Number from: JA000001 vorne Front
			7.02207.05.0 SUV EL	
3.0 TDV6 4x4 155-250 kW (211-340 PS) 306DT	08.2012→		7.02436.02.0 EUV-AGR EL	Fahrgestellnummer ab: JA000001 Vehicle Identification Number from: JA000001 hinten Rear
			7.02428.02.0 EUV-LS EL	Fahrgestellnummer ab: JA000001 Vehicle Identification Number from: JA000001 vorne Front
			7.07400.11.0* LDRV EL ↳ 7.22687.46.0 LDRV EL 7.02207.05.0 SUV EL	
3.0 TDV6 4x4 155-250 kW (211-340 PS) 306DT	10.2013→		7.02436.02.0 EUV-AGR EL	Fahrgestellnummer ab: JA000001 Vehicle Identification Number from: JA000001 hinten Rear
			7.02428.02.0 EUV-LS EL	Fahrgestellnummer ab: JA000001 Vehicle Identification Number from: JA000001 vorne Front
			7.07400.11.0* LDRV EL ↳ 7.22687.46.0 LDRV EL 7.02207.05.0 SUV EL	
4.4 SDV8 4x4 230-253 kW (313-344 PS) 448DT	08.2012→		7.02207.05.0 SUV EL	

L







RANGE ROVER SPORT I (L320)

15

3.0 D 4x4 155-250 kW (211-340 PS) 306DT	09.2009→03.2013		7.02436.02.0	EUV-AGR	EL	Fahrgestellnummer ab: DA798700 Vehicle Identification Number from: DA798700 hinten Rear
			7.02428.02.0	EUV-LS	EL	Fahrgestellnummer ab: DA798700 Vehicle Identification Number from: DA798700 vorne Front
			7.07400.11.0*	LDRV	EL	Fahrgestellnummer ab: AA256676 Vehicle Identification Number from: AA256676
			↳ 7.22687.46.0 7.02207.05.0	LDRV SUV	EL EL	
3.0 D 4x4 155-250 kW (211-340 PS) 306DT	05.2010→03.2013		7.02207.05.0	SUV	EL	
3.0 D 4x4 155-250 kW (211-340 PS) 306DT	06.2011→03.2013		7.02207.05.0	SUV	EL	
3.0 D 4x4 155-250 kW (211-340 PS) 306DT	08.2012→03.2013		7.02436.02.0	EUV-AGR	EL	Fahrgestellnummer ab: DA798700 Vehicle Identification Number from: DA798700 hinten Rear
			7.02428.02.0	EUV-LS	EL	Fahrgestellnummer ab: DA798700 Vehicle Identification Number from: DA798700 vorne Front
			7.07400.11.0*	LDRV	EL	Fahrgestellnummer ab: AA256676 Vehicle Identification Number from: AA256676
			↳ 7.22687.46.0 7.02207.05.0	LDRV SUV	EL EL	

RANGE ROVER SPORT II (L494)

16







2.0 GTDI 4x4 176-179 kW (240-243 PS) 204PT	10.2015→		7.06117.52.0	SV-NWV	EH	
			7.06117.53.0	SV-NWV	EH	
3.0 SDV6 4x4 155-250 kW (211-340 PS) 306DT	04.2013→12.2016		7.02436.02.0	EUV-AGR	EL	Fahrgestellnummer ab: JA000001 Vehicle Identification Number from: JA000001 hinten Rear
			7.02428.02.0	EUV-LS	EL	Fahrgestellnummer ab: JA000001 Vehicle Identification Number from: JA000001 vorne Front
			7.07400.11.0*	LDRV	EL	
			↳ 7.22687.46.0 7.02207.05.0	LDRV SUV	EL EL	
3.0 SDV6 4x4 155-250 kW (211-340 PS) 306DT	04.2013→		7.02207.05.0	SUV	EL	
3.0 SDV6 4x4 155-250 kW (211-340 PS) 306DT	09.2014→		7.02436.02.0	EUV-AGR	EL	Fahrgestellnummer ab: JA000001 Vehicle Identification Number from: JA000001 hinten Rear

L



RANGE ROVER SPORT II (L494)

16

			7.02428.02.0	EUV-LS	EL	Fahrgestellnummer ab: JA000001 Vehicle Identification Number from: JA000001 vorne Front
			7.07400.11.0*	LDRV	EL	
			↳ 7.22687.46.0	LDRV	EL	
			7.02207.05.0	SUV	EL	
3.0 SDV6 Hybrid 4x4 155-250 kW (211-340 PS) 306DT	10.2013→		7.02436.02.0	EUV-AGR	EL	Fahrgestellnummer ab: JA000001 Vehicle Identification Number from: JA000001 hinten Rear
			7.02428.02.0	EUV-LS	EL	Fahrgestellnummer ab: JA000001 Vehicle Identification Number from: JA000001 vorne Front
			7.07400.11.0*	LDRV	EL	
			↳ 7.22687.46.0	LDRV	EL	
			7.02207.05.0	SUV	EL	
3.0 SDV6 Hybrid 4x4 155-250 kW (211-340 PS) 306DT	12.2014→12.2017		7.02436.02.0	EUV-AGR	EL	Fahrgestellnummer ab: JA000001 Vehicle Identification Number from: JA000001 hinten Rear
			7.02428.02.0	EUV-LS	EL	Fahrgestellnummer ab: JA000001 Vehicle Identification Number from: JA000001 vorne Front
			7.02207.05.0	SUV	EL	
3.0 SDV6 Hybrid 4x4 155-250 kW (211-340 PS) 306DT	06.2015→12.2017		7.02436.02.0	EUV-AGR	EL	Fahrgestellnummer ab: JA000001 Vehicle Identification Number from: JA000001 hinten Rear
			7.02428.02.0	EUV-LS	EL	Fahrgestellnummer ab: JA000001 Vehicle Identification Number from: JA000001 vorne Front
			7.02207.05.0	SUV	EL	
3.0 TDV6 4x4 155-250 kW (211-340 PS) 306DT	04.2013→		7.02207.05.0	SUV	EL	
3.0 TDV6 4x4 155-250 kW (211-340 PS) 306DT	04.2013→12.2018		7.02207.05.0	SUV	EL	
4.4 SDV8 4x4 230-253 kW (313-344 PS) 448DT	10.2013→		7.02207.05.0	SUV	EL	

RANGE ROVER VELAR (L560)

17

3.0 D275 SDV6 4x4 155-250 kW (211-340 PS) 306DT	04.2018→		7.02436.02.0	EUV-AGR	EL	hinten Rear
			7.02428.02.0	EUV-LS	EL	vorne Front
			7.07400.11.0*	LDRV	EL	
			↳ 7.22687.46.0	LDRV	EL	
			7.02207.05.0	SUV	EL	



RANGE ROVER VELAR (L560)



















17

<p>3.0 D300 SDV6 4x4 155-250 kW (211-340 PS) 306DT</p>	<p>03.2017-></p>	 <p>7.02436.02.0</p> <p>7.02428.02.0</p> <p>7.07400.11.0*</p> <p>↳ 7.22687.46.0</p> <p>7.02207.05.0</p>	<p>EUV-AGR</p> <p>EUV-LS</p> <p>LDRV</p> <p>LDRV</p> <p>SUV</p>	<p>EL</p> <p>EL</p> <p>EL</p> <p>EL</p> <p>EL</p>	<p>hinten Rear</p> <p>vorne Front</p>
---	---------------------	--	---	---	---

L



GS (_L1_) 1

<p>200t (ARL10_) 170-180 kW (231-245 PS) 8AR-FTS</p>	<p>09.2015→</p>	<p>7.00513.19.0</p> <p style="text-align: center;"></p> <p>7.04654.10.0</p>	<p>DW-TL</p> <p>EP</p> <p>SUV</p> <p>EL</p>	<p> 8AR-FTS: Fahrgestellnummer ab: 0001007 Vehicle Identification Number from: 0001007 Fahrgestellnummer bis: 9999999 Vehicle Identification Number to: 9999999  Japan  Japan  8AR-FTS:  USA  USA Produktionsdatum bis: 08.2019 Production date to: 08.2019  8AR-FTS: Fahrgestellnummer ab: A000101 Vehicle Identification Number from: A000101 Fahrgestellnummer bis: A008326 Vehicle Identification Number to: A008326  Europa  Europe Produktionsdatum bis: 09.2018 Production date to: 09.2018  8AR-FTS: Fahrgestellnummer ab: 0001007 Vehicle Identification Number from: 0001007 Fahrgestellnummer bis: 9999999 Vehicle Identification Number to: 9999999  Japan  Japan  8AR-FTS:  USA  USA Produktionsdatum bis: 08.2019 Production date to: 08.2019  8AR-FTS: Fahrgestellnummer ab: A000101 Vehicle Identification Number from: A000101 Fahrgestellnummer bis: A008326 Vehicle Identification Number to: A008326  Europa  Europe Produktionsdatum bis: 09.2018 Production date to: 09.2018</p>
---	-----------------	--	---	---

L





















GS (_L1_) 1

<p>200t (ARL10_) 170-180 kW (231-245 PS) 8AR-FTS</p>	<p>09.2015→09.2017</p>	<p>7.00513.19.0</p>  <p>7.04654.10.0</p>	<p>DW-TL</p> <p>SUV</p>	<p>EP</p> <p>8AR-FTS: Fahrgestellnummer ab: 0001007 Vehicle Identification Number from: 0001007 Fahrgestellnummer bis: 9999999 Vehicle Identification Number to: 9999999 Japan Japan 8AR-FTS: USA USA Produktionsdatum bis: 08.2019 Production date to: 08.2019</p> <p>8AR-FTS: Fahrgestellnummer ab: A000101 Vehicle Identification Number from: A000101 Fahrgestellnummer bis: A008326 Vehicle Identification Number to: A008326 Europa Europe Produktionsdatum bis: 09.2018 Production date to: 09.2018</p> <p>EL</p> <p>8AR-FTS: Fahrgestellnummer ab: 0001007 Vehicle Identification Number from: 0001007 Fahrgestellnummer bis: 9999999 Vehicle Identification Number to: 9999999 Japan Japan 8AR-FTS: Fahrgestellnummer ab: A000101 Vehicle Identification Number from: A000101 Fahrgestellnummer bis: A008326 Vehicle Identification Number to: A008326 Europa Europe Produktionsdatum bis: 09.2018 Production date to: 09.2018 8AR-FTS: USA USA Produktionsdatum bis: 08.2019 Production date to: 08.2019</p>
---	------------------------	---	-------------------------	--























GS (_L1_) 1

<p>300 (ARL10_) 170-180 kW (231-245 PS) 8AR-FTS</p>	<p>09.2017→</p>	<p>7.00513.19.0</p> <div style="text-align: center;">  </div> <p>7.04654.10.0</p>	<p>DW-TL</p> <p>EP</p> <p>SUV</p> <p>EL</p>	<p> 8AR-FTS: Fahrgestellnummer ab: 0001007 Vehicle Identification Number from: 0001007 Fahrgestellnummer bis: 9999999 Vehicle Identification Number to: 9999999  Japan  Japan  8AR-FTS:  USA  USA Produktionsdatum bis: 08.2019 Production date to: 08.2019  8AR-FTS: Fahrgestellnummer ab: A000101 Vehicle Identification Number from: A000101 Fahrgestellnummer bis: A008326 Vehicle Identification Number to: A008326  Europa  Europe Produktionsdatum bis: 09.2018 Production date to: 09.2018  8AR-FTS:  USA  USA Produktionsdatum bis: 08.2019 Production date to: 08.2019  8AR-FTS: Fahrgestellnummer ab: 0001007 Vehicle Identification Number from: 0001007 Fahrgestellnummer bis: 9999999 Vehicle Identification Number to: 9999999  Japan  Japan  8AR-FTS: Fahrgestellnummer ab: A000101 Vehicle Identification Number from: A000101 Fahrgestellnummer bis: A008326 Vehicle Identification Number to: A008326  Europa  Europe Produktionsdatum bis: 09.2018 Production date to: 09.2018</p>
--	-----------------	--	---	--

L



						
IS III (_E3_)						3
300 (ASE30_) 170-180 kW (231-245 PS) 8AR-FTS	10.2017→		7.00513.19.0	DW-TL	EP	
			7.04654.10.0	SUV	EL	
300 (ASE30_) 170-180 kW (231-245 PS) 8AR-FTS	10.2017→		7.00513.19.0	DW-TL	EP	
			7.04654.10.0	SUV	EL	
NX (_Z1_)						4
200t (AGZ10_) 170-180 kW (231-245 PS) 8AR-FTS	07.2014→		7.00513.19.0	DW-TL	EP	
			7.04654.10.0	SUV	EL	
200t AWD (AGZ15_) 170-180 kW (231-245 PS) 8AR-FTS	07.2014→		7.00513.19.0	DW-TL	EP	
			7.04654.10.0	SUV	EL	
200t AWD (AGZ15_) 170-180 kW (231-245 PS) 8AR-FTS	07.2014→09.2017		7.00513.19.0	DW-TL	EP	
			7.04654.10.0	SUV	EL	
300 (AGZ10_) 170-180 kW (231-245 PS) 8AR-FTS	09.2017→		7.00513.19.0	DW-TL	EP	
			7.04654.10.0	SUV	EL	
300 AWD (AGZ15_) 170-180 kW (231-245 PS) 8AR-FTS	09.2017→		7.00513.19.0	DW-TL	EP	
			7.04654.10.0	SUV	EL	
RC (_C1_)						5
200t (ASC10) 170-180 kW (231-245 PS) 8AR-FTS	08.2015→		7.00513.19.0	DW-TL	EP	
			7.04654.10.0	SUV	EL	
300 (ASC10_) 170-180 kW (231-245 PS) 8AR-FTS	11.2017→		7.00513.19.0	DW-TL	EP	
			7.04654.10.0	SUV	EL	
RX (_L2_)						6
200t (AGL20_) 170-180 kW (231-245 PS) 8AR-FTS	10.2015→12.2017		7.00513.19.0	DW-TL	EP	
			7.04654.10.0	SUV	EL	
200t (AGL20_) 170-180 kW (231-245 PS) 8AR-FTS	10.2015→12.2017		7.00513.19.0	DW-TL	EP	
			7.04654.10.0	SUV	EL	
200t 4WD (AGL25_) 170-180 kW (231-245 PS) 8AR-FTS	10.2015→12.2017		7.00513.19.0	DW-TL	EP	
			7.04654.10.0	SUV	EL	
200t AWD (AGL25_) 170-180 kW (231-245 PS) 8AR-FTS	10.2015→12.2017		7.00513.19.0	DW-TL	EP	
			7.04654.10.0	SUV	EL	

L





























RX (_L2_)





















6

300 (AGL20_) 170-180 kW (231-245 PS) 8AR-FTS	12.2017→	 7.00513.19.0	DW-TL EP	
300 AWD (AGL25_) 170-180 kW (231-245 PS) 8AR-FTS	12.2017→	 7.04654.10.0 7.00513.19.0	SUV DW-TL EP	
300 AWD (AGL25_) 170-180 kW (231-245 PS) 8AR-FTS	12.2017→	 7.00513.19.0 7.04654.10.0	DW-TL EP SUV EL	

























L





























						
BLACKWOOD						1
5.4	05.2000→08.2005		7.02256.46.0	EUV-AGR	EL	
CONTINENTAL						2
2.0	11.2016→		7.02256.53.0	DW-TL	EP	
2.0	01.2019→		7.02256.53.0	DW-TL	EP	
LS						3
3.0	09.1999→12.2001		7.02256.46.0	EUV-AGR	EL	
3.0	09.2000→08.2003		7.02256.46.0	EUV-AGR	EL	
3.0	09.2003→08.2006		7.02256.46.0	EUV-AGR	EL	
3.9 180-209 kW (245-284 PS) 99A	09.1999→12.2003		7.02256.46.0	EUV-AGR	EL	
4.0 180-209 kW (245-284 PS) 99A	09.2002→08.2006		7.02256.46.0	EUV-AGR	EL	
MKC						4
2.0 149-186 kW (203-253 PS) TPWA	03.2014→		7.02256.53.0	DW-TL	EP	
			7.03306.16.0	LDRV	EP	
			7.06117.33.0	SV-NWV	EL	
2.0 149-186 kW (203-253 PS) TPWA	10.2014→		7.02256.53.0	DW-TL	EP	
			7.03306.16.0	LDRV	EP	
			7.06117.33.0	SV-NWV	EL	
2.0 149-186 kW (203-253 PS) TPWA	10.2014→		7.02256.53.0	DW-TL	EP	
			7.03306.16.0	LDRV	EP	
			7.06117.33.0	SV-NWV	EL	
2.0	06.2016→		7.02256.53.0	DW-TL	EP	
			7.03306.16.0	LDRV	EP	
			7.06117.33.0	SV-NWV	EL	
2.0 AWD 149-186 kW (203-253 PS) TPWA	03.2014→		7.02256.53.0	DW-TL	EP	
			7.03306.16.0	LDRV	EP	
			7.06117.33.0	SV-NWV	EL	
2.0 AWD 149-186 kW (203-253 PS) TPWA	10.2014→		7.02256.53.0	DW-TL	EP	
			7.03306.16.0	LDRV	EP	
			7.06117.33.0	SV-NWV	EL	
2.0 AWD 149-186 kW (203-253 PS) TPWA	10.2014→		7.02256.53.0	DW-TL	EP	
			7.03306.16.0	LDRV	EP	
			7.06117.33.0	SV-NWV	EL	
2.0 AWD 149-186 kW (203-253 PS) TPWA	10.2014→		7.02256.53.0	DW-TL	EP	
			7.03306.16.0	LDRV	EP	
			7.06117.33.0	SV-NWV	EL	
2.3 210-213 kW (286-290 PS) C23HD0D	03.2014→		7.06117.33.0	SV-NWV	EL	
2.3 AWD 210-213 kW (286-290 PS) C23HD0D	03.2014→		7.06117.33.0	SV-NWV	EL	
2.3 AWD 210-213 kW (286-290 PS) C23HD0D	11.2016→		7.06117.33.0	SV-NWV	EL	
MKT						5
2.0 177-186 kW (241-253 PS) C20HDTX	09.2013→		7.03306.16.0	LDRV	EP	
			7.06117.33.0	SV-NWV	EL	

L

					
MKX					
6					
2.0 T 177-186 kW (241-253 PS) C20HDTX	10.2015→12.2018		7.02256.53.0	DW-TL	EP
			7.06117.33.0	SV-NWV	EL
2.0 T AWD 177-186 kW (241-253 PS) C20HDTX	10.2015→12.2018		7.02256.53.0	DW-TL	EP
			7.06117.33.0	SV-NWV	EL
MKZ					
7					
2.0 149-186 kW (203-253 PS) TPWA	09.2012→06.2016		7.02256.53.0	DW-TL	EP
			7.03306.16.0	LDRV	EP
			7.06117.33.0	SV-NWV	EL
2.0 149-186 kW (203-253 PS) TPWA	10.2014→		7.02256.53.0	DW-TL	EP
			7.03306.16.0	LDRV	EP
2.0 149-186 kW (203-253 PS) TPWA	10.2014→		7.02256.53.0	DW-TL	EP
			7.03306.16.0	LDRV	EP
			7.06117.33.0	SV-NWV	EL
2.0 149-186 kW (203-253 PS) TPWA	06.2016→		7.02256.53.0	DW-TL	EP
			7.03306.16.0	LDRV	EP
2.0 149-186 kW (203-253 PS) TPWA	06.2016→		7.02256.53.0	DW-TL	EP
			7.03306.16.0	LDRV	EP
2.0	01.2019→		7.02256.53.0	DW-TL	EP
			7.03306.16.0	LDRV	EP
			7.06117.33.0	SV-NWV	EL
2.0 AWD 149-186 kW (203-253 PS) TPWA	09.2012→06.2016		7.03306.16.0	LDRV	EP
			7.06117.33.0	SV-NWV	EL
2.0 AWD 149-186 kW (203-253 PS) TPWA	06.2016→		7.03306.16.0	LDRV	EP
2.0 AWD 149-186 kW (203-253 PS) TPWA	06.2016→		7.02256.53.0	DW-TL	EP
2.0 Hybrid 140 kW (190 PS) C20HDEA	09.2012→		7.06117.33.0	SV-NWV	EL
NAVIGATOR (U228)					
8					
5.4 224 kW (305 PS) C54DSEM	09.2002→12.2004		7.02256.46.0	EUV-AGR	EL
			7.02256.46.0	EUV-AGR	EL
5.4 AWD 224 kW (305 PS) C54DSEM	09.2002→12.2004		7.02256.46.0	EUV-AGR	EL

L









						
TGE Bus						1
2.0 TDI 75 kW (102 PS) DAUB	02.2017→		7.02256.41.0	SV-KK	EL für Fahrzeuge mit Standheizung for vehicles with parking heater	
2.0 TDI 103 kW (140 PS) DAUA	02.2017→		7.02256.41.0	SV-KK	EL für Fahrzeuge mit Standheizung for vehicles with parking heater	
2.0 TDI 130 kW (177 PS) DAVA	02.2017→		7.02256.00.0	EUV-AGR	EP	
			7.02256.41.0	SV-KK	EL für Fahrzeuge mit Standheizung for vehicles with parking heater	
2.0 TDI AWD 103 kW (140 PS) DAUA	02.2017→		7.02256.41.0	SV-KK	EL für Fahrzeuge mit Standheizung for vehicles with parking heater	
2.0 TDI AWD 130 kW (177 PS) DAVA	02.2017→		7.02256.00.0	EUV-AGR	EP	
			7.02256.41.0	SV-KK	EL für Fahrzeuge mit Standheizung for vehicles with parking heater	
2.0 TDI RWD	01.2019→		7.02256.41.0	SV-KK	EL	
TGE Platform/Chassis (UZ_)						2
2.0 TDI 75 kW (102 PS) DAUB	11.2016→		7.02256.41.0	SV-KK	EL für Fahrzeuge mit Standheizung for vehicles with parking heater	
2.0 TDI 103 kW (140 PS) DAUA	11.2016→		7.02256.41.0	SV-KK	EL für Fahrzeuge mit Standheizung for vehicles with parking heater	
2.0 TDI 130 kW (177 PS) DAVA	11.2016→		7.02256.00.0	EUV-AGR	EP	
			7.02256.41.0	SV-KK	EL für Fahrzeuge mit Standheizung for vehicles with parking heater	
2.0 TDI AWD 103 kW (140 PS) DAUA	11.2017→		7.02256.41.0	SV-KK	EL für Fahrzeuge mit Standheizung for vehicles with parking heater	
2.0 TDI AWD 130 kW (177 PS) DAVA	11.2017→		7.02256.00.0	EUV-AGR	EP	
			7.02256.41.0	SV-KK	EL für Fahrzeuge mit Standheizung for vehicles with parking heater	
2.0 TDI RWD 130 kW (177 PS) DAWA	07.2017→		7.02256.00.0	EUV-AGR	EP	
			7.02256.41.0	SV-KK	EL für Fahrzeuge mit Standheizung for vehicles with parking heater	
2.0 TDI RWD 90 kW (122 PS) DASA	08.2017→		7.02256.41.0	SV-KK	EL für Fahrzeuge mit Standheizung for vehicles with parking heater	
2.0 TDI RWD 103 kW (140 PS) DASB	11.2017→		7.02256.41.0	SV-KK	EL für Fahrzeuge mit Standheizung for vehicles with parking heater	
TGE Van						3
2.0 TDI (01V, 03V, 36V, UYB, UYC, UYD) 75 kW (102 PS) DAUB	02.2017→		7.02256.41.0	SV-KK	EL für Fahrzeuge mit Standheizung for vehicles with parking heater	
2.0 TDI (01V, 03V, 36V, UYB, UYC, UYD) 103 kW (140 PS) DAUA	02.2017→		7.02256.41.0	SV-KK	EL für Fahrzeuge mit Standheizung for vehicles with parking heater	
2.0 TDI (01V, 03V, 36V, UYB, UYC, UYD) 130 kW (177 PS) DAVA	02.2017→		7.02256.00.0	EUV-AGR	EP	
			7.02256.41.0	SV-KK	EL für Fahrzeuge mit Standheizung for vehicles with parking heater	
2.0 TDI AWD (02V, 04V, 37V, UYB, UYC, UYD) 130 kW (177 PS) DAVA	03.2017→		7.02256.00.0	EUV-AGR	EP	
			7.02256.41.0	SV-KK	EL für Fahrzeuge mit Standheizung for vehicles with parking heater	
2.0 TDI AWD (02V, 04V, 37V, UYB, UYC, UYD) 103 kW (140 PS) DAUA	04.2017→		7.02256.41.0	SV-KK	EL für Fahrzeuge mit Standheizung for vehicles with parking heater	

						
TGE Van						3
2.0 TDI RWD (11V, 12V, 33V, 34V, UYB, UYC, UYD) 130 kW (177 PS) DAWA	05.2017→		7.02256.00.0	EUV-AGR	EP	
			7.02256.41.0	SV-KK	EL für Fahrzeuge mit Standheizung for vehicles with parking heater	
2.0 TDI RWD (11V, 12V, 33V, 34V, UYB, UYC, UYD) 90 kW (122 PS) DASA	08.2017→		7.02256.41.0	SV-KK	EL für Fahrzeuge mit Standheizung for vehicles with parking heater	
2.0 TDI RWD (11V, UYB, UYC) 103 kW (140 PS) DASB	10.2017→		7.02256.41.0	SV-KK	EL für Fahrzeuge mit Standheizung for vehicles with parking heater	
LION ´S CITY						4
19.240 176 kW (239 PS) D 0836 LUH 41	05.2004→10.2009		7.00380.04.0	LDRV	EL	
19.280 206 kW (280 PS) D 0836 LUH 40	05.2004→		7.00380.04.0	LDRV	EL	
A 22 228-235 kW (310-320 PS) E 2876 LUH 03	10.2009→		7.00380.04.0	LDRV	EL	
A 37 206 kW (280 PS) D 0836 LUH 40, D 0836 LUH 51	01.2002→10.2009		7.00380.04.0	LDRV	EL	
TGL						5
10.180 132 kW (180 PS) D 0834 LFL 51	04.2005→		7.00380.11.0	LDRV	EP	
10.180 132 kW (180 PS) D 0834 LFL 41	05.2005→		7.00380.04.0	LDRV	EL	
10.210 151 kW (206 PS) D 0834 LFL 42	05.2005→		7.00380.04.0	LDRV	EL	
10.240 176 kW (240 PS) D 0836 LFL 50	04.2005→		7.00380.11.0	LDRV	EP	
12.180 132 kW (180 PS) D 0834 LFL 51	04.2005→		7.00380.11.0	LDRV	EP	
12.180 132 kW (180 PS) D 0834 LFL 41	05.2005→		7.00380.04.0	LDRV	EL	
12.210 151 kW (206 PS) D 0834 LFL 42	05.2005→		7.00380.04.0	LDRV	EL	
12.240 176 kW (240 PS) D 0836 LFL 50	04.2005→		7.00380.11.0	LDRV	EP	
7.150, 8.150 110 kW (150 PS) D 0834 LFL 50	04.2005→		7.00380.11.0	LDRV	EP	
7.150, 8.150 110 kW (150 PS) D 0834 LFL 40	05.2005→		7.00380.04.0	LDRV	EL	
7.180, 8.180 132 kW (180 PS) D 0834 LFL 51	04.2005→		7.00380.11.0	LDRV	EP	
7.180, 8.180 132 kW (180 PS) D 0834 LFL 41	05.2005→		7.00380.04.0	LDRV	EL	
8.180 132 kW (180 PS) D 0834 LFL 51	04.2005→		7.00380.11.0	LDRV	EP	
8.180 132 kW (180 PS) D 0834 LFL 41	05.2005→		7.00380.04.0	LDRV	EL	
8.210 151 kW (206 PS) D 0834 LFL 42	05.2005→		7.00380.04.0	LDRV	EL	
8.240 176 kW (240 PS) D 0836 LFL 50	04.2005→		7.00380.11.0	LDRV	EP	

M



TGM **6**











12.240 176 kW (240 PS) D 0836 LFL 50	12.2005→	 7.00380.11.0	LDRV	EP	
12.280 206 kW (280 PS) D 0836 LFL 51	12.2005→	 7.00380.11.0	LDRV	EP	
13.240 176 kW (240 PS) D 0836 LFL 50	05.2006→	 7.00380.11.0	LDRV	EP	
13.280 206 kW (280 PS) D 0836 LFL 51	05.2006→	 7.00380.11.0	LDRV	EP	
15.240 176 kW (240 PS) D 0836 LFL 50	10.2005→	 7.00380.11.0	LDRV	EP	
15.280 206 kW (280 PS) D 0836 LFL 51	10.2005→	 7.00380.11.0	LDRV	EP	
26.280 206 kW (280 PS) D 0836 LFL 51	04.2006→	 7.00380.11.0	LDRV	EP	
26.330 240 kW (326 PS) D 0836 LFL 52	04.2006→	 7.00380.11.0	LDRV	EP	



















TGX **7**

18.580 427 kW (580 PS) D 3876 LF07	09.2016→	 7.00380.11.0	LDRV	EP	
18.640 471 kW (640 PS) D 3876 LF09	09.2016→	 7.00380.11.0	LDRV	EP	
33.640 471 kW (640 PS) D 3876 LF09	09.2016→	 7.00380.11.0	LDRV	EP	
35.640 471 kW (640 PS) D 3876 LF09	09.2016→	 7.00380.11.0	LDRV	EP	

M ENGINE **8**

ENGINE 240-353 kW (326-480 PS) D 0834 LE123-125, D 0836 LE 122-124, D 0836 LF 15, D 0836 LFG 50, D 0836 LFG 51, D 2676 LE 621, D 2676 LE 623, D 2676 LE 624		 7.00380.11.0	LDRV	EP	<ul style="list-style-type: none">  D 0834 LE123-125: 09.2008→  D 0836 LE 122-124: 02.2007→  D 0836 LF 15, D 2676 LE 623, D 2676 LE 624: 06.2002→  D 0836 LFG 50, D 0836 LFG 51: 06.2005→  D 2676 LE 621: 06.2012→
ENGINE D 0834 LF 01, D 0834 LF 02, D 0834 LF 06		 7.01904.03.0	LDRV	EP	<ul style="list-style-type: none">  D 0834 LF 01, D 0834 LF 02, D 0834 LF 06: 08.2009→
ENGINE 176-206 kW (239-280 PS) D 0836 LUH 41, D 0836 LUH 50, E 0836 LOH		 7.00380.04.0	LDRV	EL	<ul style="list-style-type: none">  D 0836 LUH 41, D 0836 LUH 50: 06.2003→  E 0836 LOH: 03.2010→



























					
RITZ					
1.3 DDiS 55-66 kW (75-90 PS) D13A	04.2009→10.2016	 7.02534.01.0	DW-TL	EP	für Fahrzeuge mit Diesel-Partikel-Filter (DPF) for vehicles with diesel soot filter
S-CROSS					
1.6 DDiS 88 kW (120 PS) D16AA	08.2015→09.2017	 7.02534.01.0	DW-TL	EP	Euro 5 Euro 5
SWIFT					
1.3 DDiS 55-66 kW (75-90 PS) D13A	04.2007→06.2011	 7.02534.01.0	DW-TL	EP	für Fahrzeuge mit Diesel-Partikel-Filter (DPF) for vehicles with diesel soot filter
1.3 DDiS 55-66 kW (75-90 PS) D13A	07.2011→12.2017	 7.02534.01.0	DW-TL	EP	
1.3 DDiS 55-66 kW (75-90 PS) D13A	01.2018→03.2020	 7.02534.01.0	DW-TL	EP	



























						
GHIBLI III (M157)						1
3.0 257 kW (350 PS) M 156 D	08.2013→		7.03003.12.0	DW-TL	EP	
			7.28286.13.0	EUV-AGK	EP	
3.0 243-301 kW (330-409 PS) F160AM	08.2013→		7.03003.12.0	DW-TL	EP	
			7.28286.13.0	EUV-AGK	EP	
3.0 S 301-316 kW (409-430 PS) M 156 B	08.2013→		7.03003.12.0	DW-TL	EP	
			7.28286.13.0	EUV-AGK	EP	
3.0 S 301-316 kW (409-430 PS) M 156 B	07.2017→		7.03003.12.0	DW-TL	EP	
			7.28286.13.0	EUV-AGK	EP	
3.0 S Q4 301-316 kW (409-430 PS) M 156 B	08.2013→		7.03003.12.0	DW-TL	EP	
			7.28286.13.0	EUV-AGK	EP	
3.0 S Q4 301-316 kW (409-430 PS) M 156 B	07.2017→		7.03003.12.0	DW-TL	EP	
			7.28286.13.0	EUV-AGK	EP	
LEVANTE SUV (M161)						2
3.0 Q4 257 kW (350 PS) M 156 D	06.2016→		7.03003.12.0	DW-TL	EP	
			7.28286.13.0	EUV-AGK	EP	
3.0 S Q4 316 kW (430 PS) M 156 E	06.2016→		7.03003.12.0	DW-TL	EP	
			7.28286.13.0	EUV-AGK	EP	
QUATTROPORTE VI						3
3.0 S 301-316 kW (409-430 PS) M 156 B	05.2013→		7.03003.12.0	DW-TL	EP	
			7.28286.13.0	EUV-AGK	EP	
3.0 S 301-316 kW (409-430 PS) M 156 B	07.2017→		7.03003.12.0	DW-TL	EP	
			7.28286.13.0	EUV-AGK	EP	
3.0 S Q4 301-316 kW (409-430 PS) M 156 B	05.2013→		7.03003.12.0	DW-TL	EP	
			7.28286.13.0	EUV-AGK	EP	
3.0 S Q4 301-316 kW (409-430 PS) M 156 B	07.2017→		7.03003.12.0	DW-TL	EP	
			7.28286.13.0	EUV-AGK	EP	
3.8 GT S 390-427 kW (530-581 PS) M 156 A	01.2013→		7.03003.12.0	DW-TL	EP	
			7.28286.13.0	EUV-AGK	EP	
			7.28286.13.0	EUV-SL	EP	



























M

					
57 (W240)					
5.5 (240.078) 405 kW (551 PS) M 285.950	09.2002→12.2012		7.00017.02.0	EUV-LS	EP
			7.02256.37.0	EUV-SL	EL
62 (V240)					
5.5 (240.178) 405 kW (551 PS) M 285.950	09.2002→12.2012		7.02256.37.0	EUV-SL	EL

M

			 PIERBURG			
121 III (JASM, JBSM)						1
1.25 55 kW (75 PS) DHF, DHG	03.1996→04.2003		7.06269.27.0	LLR	EL  DHF, DHG: Produktionsdatum ab: 16.01.1997 Production date from: 16.01.1997 Produktionsdatum bis: 01.12.1999 Production date to: 01.12.1999	
			7.06269.28.0	LLR	EL  DHF, DHG: Produktionsdatum bis: 16.01.1997 Production date to: 16.01.1997	
			7.05432.03.0	SM	EL  DHF, DHG: Produktionsdatum ab: 01.12.1999 Production date from: 01.12.1999	
1.8 D 44 kW (60 PS) RTJ, RTK	03.1996→04.2003		7.02256.47.0	EUV-AGR	EL	
2 (DL, DJ)						2
1.5 D 77 kW (105 PS) S5Y2, S5Y5, S5Y6, S5Y7, S5Y8	08.2014→02.2018		7.05314.02.0	DW-TL	EP	
2 Saloon (DL)						3
1.5 SkyActive-D 77 kW (105 PS) S5Y2	04.2015→12.2017		7.05314.02.0	DW-TL	EP	
3 (BK)						4
1.6 DI Turbo 80-81 kW (109-110 PS) Y601, Y603, Y605, Y642	06.2004→06.2009		7.00968.04.0	DW-TL	EP	
2.0 102-118 kW (139-160 PS) LF50, LF72, LFDE, LFN7, LFN8, LFVE	10.2003→12.2009		7.06117.55.0	SV-NWV	EH	
2.0 AWD 102-110 kW (139-150 PS) LFVE	06.2004→03.2009		7.06117.55.0	SV-NWV	EH	
2.3 114-119 kW (155-162 PS) L3-V	10.2003→12.2006		7.02256.51.0	EUV-SR	EL	
			7.06117.55.0	SV-NWV	EH	
2.3 175-204 kW (238-277 PS) L3-VDT	04.2006→03.2009		7.06117.55.0	SV-NWV	EH	
2.3 110-126 kW (150-171 PS) L3-VE	09.2007→03.2009		7.02256.51.0	EUV-SR	EL	
			7.06117.55.0	SV-NWV	EH	
2.3 DiSi Turbo MPS 184 kW (250 PS) L3YH	06.2006→06.2009		7.06117.55.0	SV-NWV	EH	
2.3 MPS 175-204 kW (238-277 PS) L3-VDT	01.2007→06.2009		7.06117.55.0	SV-NWV	EH	
2.3 MPS Turbo (BK14) 191 kW (260 PS) L3M6	12.2006→06.2009		7.06117.55.0	SV-NWV	EH	
2.3 MZR 110-126 kW (150-171 PS) L3-VE	10.2003→03.2009		7.02256.51.0	EUV-SR	EL	
			7.06117.55.0	SV-NWV	EH	
2.3 MZR Sport 126 kW (171 PS) L3YS, L3YT	10.2003→06.2009		7.02256.51.0	EUV-SR	EL	
			7.06117.55.0	SV-NWV	EH	
3 (BL)						5
1.6 MZ-CD 80 kW (109 PS) Y642	12.2008→05.2013		7.00968.04.0	DW-TL	EP	
2.0 108-111 kW (147-151 PS) LF5H	06.2010→05.2013		7.02256.51.0	EUV-SR	EL für Fahrzeuge mit Start-Stopp-Funktion for vehicles with start-stop function	





					
3 (BL)					
2.0 DISI (BLEFP) 110 kW (150 PS) LF-VDS	05.2009→02.2012		7.02256.51.0	EUV-SR	EL für Fahrzeuge mit Start-Stopp-Funktion for vehicles with start-stop function
2.0 MZR 108-111 kW (147-151 PS) LF5H, LF5W	01.2009→09.2014		7.02256.51.0	EUV-SR	EL  LF5H, LF5W: für Fahrzeuge mit Start-Stopp-Funktion for vehicles with start-stop function
			7.06117.55.0	SV-NWV	EH
2.0 MZR 108-111 kW (147-151 PS) LF5H, LF5W	04.2009→09.2014		7.02256.51.0	EUV-SR	EL  LF5H, LF5W: für Fahrzeuge mit Start-Stopp-Funktion for vehicles with start-stop function
			7.06117.55.0	SV-NWV	EH
2.0 MZR DISI 110-111 kW (150-151 PS) LFZ2	12.2008→05.2013		7.02256.51.0	EUV-SR	EL für Fahrzeuge mit Start-Stopp-Funktion for vehicles with start-stop function
			7.06117.55.0	SV-NWV	EH
2.3 MPS Turbo 175-204 kW (238-277 PS) L3-VDT	06.2009→09.2014		7.06117.55.0	SV-NWV	EH
2.3 MPS Turbo (BL14) 175-191 kW (238-260 PS) L3Y7	12.2008→09.2014		7.06117.55.0	SV-NWV	EH
2.3 MPS Turbo (BL3FW) 175-204 kW (238-277 PS) L3-VDT	06.2009→12.2013		7.06117.55.0	SV-NWV	EH
2.5 117-125 kW (159-170 PS) L5-VE	03.2009→09.2014		7.06117.55.0	SV-NWV	EH
2.5 120-123 kW (166-167 PS) L5-Y3	09.2009→12.2011		7.06117.55.0	SV-NWV	EH
2.5 117-125 kW (159-170 PS) L5-VE	01.2012→12.2013		7.06117.55.0	SV-NWV	EH
3 (BM, BN)					
2.2 D 110-129 kW (150-175 PS) SHY4	02.2014→		7.03554.10.0	DW-TL	EP
2.2 D 129-140 kW (175-190 PS) SH-VPTR	06.2016→		7.03554.10.0	DW-TL	EP
2.2 D 4WD 129-140 kW (175-190 PS) SH-VPTR	06.2016→		7.03554.10.0	DW-TL	EP
3 Hatchback (BP)					
2.0 SKYACTIV-G M Hybrid 90-115 kW (122-156 PS) PEXN	11.2018→		7.09000.03.0	SV-KK	EL
2.0 SKYACTIV-G M Hybrid 90-115 kW (122-156 PS) PEXN	01.2020→		7.09000.03.0	SV-KK	EL
			7.09000.03.0	SV-KK	EL
SKYACTIV-X M Hybrid 90-132 kW (122-179 PS) HFY1	06.2019→		7.09000.03.0	SV-KK	EL
SKYACTIV-X M Hybrid AWD 90-132 kW (122-179 PS) HFY1	06.2019→		7.09000.03.0	SV-KK	EL
3 Saloon (BK)					
1.6 DI Turbo (BK12Y) 80-81 kW (109-110 PS) Y601, Y603, Y605, Y642	06.2004→06.2009		7.00968.04.0	DW-TL	EP
2.0 102-118 kW (139-160 PS) LF50, LF72, LFDE, LFN7, LFN8, LFVE	10.2003→12.2009		7.02256.51.0	EUV-SR	EL
			7.06117.55.0	SV-NWV	EH

						
3 Saloon (BK)						8
2.3 110-126 kW (150-171 PS) L3-VE	03.2004→03.2009		7.02256.51.0	EUV-SR	EL	
			7.06117.55.0	SV-NWV	EH	
2.3 110-126 kW (150-171 PS) L3-VE	04.2004→03.2009		7.02256.51.0	EUV-SR	EL	
			7.06117.55.0	SV-NWV	EH	
2.3 114-119 kW (155-162 PS) L3-V	09.2006→06.2009		7.02256.51.0	EUV-SR	EL	
			7.06117.55.0	SV-NWV	EH	
2.3 MPS 175-204 kW (238-277 PS) L3-VDT	01.2004→06.2009		7.06117.55.0	SV-NWV	EH	
2.3 SP23 110-126 kW (150-171 PS) L3-VE	10.2003→06.2009		7.02256.51.0	EUV-SR	EL	
			7.06117.55.0	SV-NWV	EH	
3 Saloon (BL)						9
2.0 108-111 kW (147-151 PS) LF5H	06.2010→05.2013		7.02256.51.0	EUV-SR	EL	für Fahrzeuge mit Start-Stopp-Funktion for vehicles with start-stop function
2.0 MZR 108-111 kW (147-151 PS) LF5H, LF5W	04.2009→09.2014		7.02256.51.0	EUV-SR	EL	 LF5H, LF5W: für Fahrzeuge mit Start-Stopp-Funktion for vehicles with start-stop function
			7.06117.55.0	SV-NWV	EH	
2.0 MZR (BL12) 108-111 kW (147-151 PS) LF5H, LF5W	03.2009→09.2014		7.02256.51.0	EUV-SR	EL	 LF5H, LF5W: für Fahrzeuge mit Start-Stopp-Funktion for vehicles with start-stop function
			7.06117.55.0	SV-NWV	EH	
M 2.0 MZR DISI (BL12) 110-111 kW (150-151 PS) LFZ2	02.2009→05.2013		7.02256.51.0	EUV-SR	EL	für Fahrzeuge mit Start-Stopp-Funktion for vehicles with start-stop function
			7.06117.55.0	SV-NWV	EH	
2.5 117-125 kW (159-170 PS) L5-VE	04.2009→09.2014		7.06117.55.0	SV-NWV	EH	
2.5 125 kW (170 PS) L5-X	01.2010→12.2013		7.06117.55.0	SV-NWV	EH	
3 Saloon (BM_, BN_)						10
2.2 D 110-129 kW (150-175 PS) SHY4, SHY6	09.2013→		7.03554.10.0	DW-TL	EP	
2.2 D 129-140 kW (175-190 PS) SH-VPTR	10.2014→		7.03554.10.0	DW-TL	EP	
3 Saloon (BP_)						11
1.8 SKYACTIV-D 85 kW (116 PS) S8Y1, S8Y2	01.2019→		7.05314.02.0	DW-TL	EP	
2.0 SKYACTIV-G M Hybrid 90-115 kW (122-156 PS) PEXN	11.2018→		7.09000.03.0	SV-KK	EL	
2.0 SKYACTIV-X M Hybrid 90-132 kW (122-179 PS) HFY1	06.2019→		7.09000.03.0	SV-KK	EL	
5 (CR19)						12
2.0 107 kW (146 PS) LFF7	02.2005→05.2010		7.06117.55.0	SV-NWV	EH	
2.0 AWD 102-110 kW (139-150 PS) LFVE	10.2006→05.2010		7.06117.55.0	SV-NWV	EH	
5 (CW)						13
2.0 106-110 kW (144-150 PS) LF-ZB	06.2010→		7.02256.51.0	EUV-SR	EL	
			7.06117.55.0	SV-NWV	EH	





						
5 (CW)						13
2.0 106-110 kW (144-150 PS) LF-ZB	09.2010→		7.02256.51.0	EUV-SR	EL	
			7.06117.55.0	SV-NWV	EH	
2.0 106-110 kW (144-150 PS) LF-ZB	01.2011→		7.02256.51.0	EUV-SR	EL	
			7.06117.55.0	SV-NWV	EH	
2.0 4WD 102-110 kW (139-150 PS) LFVE	08.2014→		7.06117.55.0	SV-NWV	EH	
6 Estate (GH)						14
1.8 MZR 75-88 kW (102-120 PS) L813	02.2008→07.2013		7.02256.51.0	EUV-SR	EL	
2.0 (GHEFW) 106-112 kW (144-152 PS) LF-VD	10.2012→07.2013		7.02256.51.0	EUV-SR	EL  Europa  Europe 2009 2009	
			7.06117.55.0	SV-NWV	EH	
2.0 MZR 104-110 kW (141-150 PS) LF17	12.2007→07.2013		7.02256.51.0	EUV-SR	EL  Europa  Europe 2009 2009	
			7.06117.55.0	SV-NWV	EH	
2.0 MZR 104-118 kW (141-160 PS) LFDE	01.2010→07.2013		7.02256.51.0	EUV-SR	EL  Europa  Europe 2009 2009	
			7.06117.55.0	SV-NWV	EH	
2.5 MZR 117-125 kW (159-170 PS) L5-VE	02.2008→07.2013		7.06117.55.0	SV-NWV	EH	
6 Estate (GJ, GL)						15
2.2 D 110-140 kW (150-190 PS) SHY1, SHY4, SHY6, SHY8	12.2012→		7.03554.10.0	DW-TL	EP  SHY1, SHY4, SHY6, SHY8: →02.2018	
			7.03554.10.0	DW-TL	EP →02.2018	
2.2 D 129-140 kW (175-190 PS) SH-VPTR	07.2014→		7.03554.10.0	DW-TL	EP →02.2018	
			7.03554.10.0	DW-TL	EP →02.2018	
2.2 D 4WD 129-140 kW (175-190 PS) SH-VPTR	07.2014→		7.03554.10.0	DW-TL	EP →02.2018	
			7.03554.10.0	DW-TL	EP  SHY4, SHY6, SHY8: →02.2018	
2.2 D AWD 110-140 kW (150-190 PS) SHY4, SHY6, SHY8	12.2012→		7.03554.10.0	DW-TL	EP  SHY4, SHY6, SHY8: →02.2018	
			7.03554.10.0	DW-TL	EP →02.2018	
2.2 D AWD 110-129 kW (150-175 PS) SHY4	02.2015→		7.03554.10.0	DW-TL	EP →02.2018	
6 Hatchback (GG)						16
1.8 75-88 kW (102-120 PS) L813	08.2002→08.2007		7.02256.51.0	EUV-SR	EL	
2.0 104-110 kW (141-150 PS) LF17, LF18	08.2002→08.2007		7.02256.51.0	EUV-SR	EL  LF17, LF18: 2004 2004	
			7.06117.55.0	SV-NWV	EH	
2.0 107 kW (146 PS) LFF7	03.2005→08.2007		7.06117.55.0	SV-NWV	EH	
2.3 116-122 kW (162-166 PS) L3C1	08.2002→08.2007		7.02256.51.0	EUV-SR	EL	
			7.06117.55.0	SV-NWV	EH	
2.3 114-119 kW (155-162 PS) L3X	09.2003→12.2006		7.02256.51.0	EUV-SR	EL	
			7.06117.55.0	SV-NWV	EH	



6 Hatchback (GH) **17**

1.8 MZR 75-88 kW (102-120 PS) L813	08.2007→07.2013		7.02256.51.0	EUV-SR	EL	
2.0 MZR 104-110 kW (141-150 PS) LF17	08.2007→07.2013		7.02256.51.0	EUV-SR	EL	Europa Europe 2009 2009
			7.06117.55.0	SV-NWV	EH	
2.0 MZR 104-118 kW (141-160 PS) LFDE	01.2010→12.2012		7.02256.51.0	EUV-SR	EL	Europa Europe 2009 2009
			7.06117.55.0	SV-NWV	EH	
2.5 MZR 117-125 kW (159-170 PS) L5-VE	08.2007→03.2013		7.06117.55.0	SV-NWV	EH	





























6 Saloon (GG) **18**



























1.8 75-88 kW (102-120 PS) L813, L829	08.2002→08.2007		7.02256.51.0	EUV-SR	EL	
2.0 104-110 kW (141-150 PS) LF17, LF18	06.2002→08.2007		7.02256.51.0	EUV-SR	EL	LF17, LF18: 2004 2004
			7.06117.55.0	SV-NWV	EH	
2.0 107 kW (146 PS) LFF7	03.2005→08.2007		7.06117.55.0	SV-NWV	EH	
2.3 116-122 kW (162-166 PS) L3C1	06.2002→08.2007		7.02256.51.0	EUV-SR	EL	
			7.06117.55.0	SV-NWV	EH	
2.3 114-119 kW (155-162 PS) L3X	07.2003→02.2005		7.02256.51.0	EUV-SR	EL	
			7.06117.55.0	SV-NWV	EH	
2.3 116-122 kW (162-166 PS) L3C1	03.2005→07.2007		7.02256.51.0	EUV-SR	EL	
2.3 114-119 kW (155-162 PS) L3X	09.2006→12.2008		7.02256.51.0	EUV-SR	EL	
2.3 AWD 175-204 kW (238-277 PS) L3-VDT	09.2005→12.2006		7.06117.55.0	SV-NWV	EH	
2.3 AWD	09.2006→12.2007		7.06117.55.0	SV-NWV	EH	
2.3 MPS Turbo 191 kW (260 PS) L3KG	12.2005→08.2007		7.06117.55.0	SV-NWV	EH	



















M

6 Saloon (GH) **19**

1.8 MZR 75-88 kW (102-120 PS) L813	08.2007→07.2013		7.02256.51.0	EUV-SR	EL	
2.0 106-112 kW (144-152 PS) LF-VD	01.2010→12.2012		7.02256.51.0	EUV-SR	EL	Europa Europe 2009 2009
2.0 MZR 108 kW (147 PS) LF4J, LF4K, LFYA, LFYB	08.2007→12.2012		7.02256.51.0	EUV-SR	EL	LF4J, LF4K, LFYA, LFYB: Europa Europe 2009 2009
			7.06117.55.0	SV-NWV	EH	
2.0 MZR 104-118 kW (141-160 PS) LFDE	01.2010→12.2012		7.02256.51.0	EUV-SR	EL	Europa Europe 2009 2009
			7.06117.55.0	SV-NWV	EH	
2.5 MZR 117-125 kW (159-170 PS) L5-VE	08.2007→07.2013		7.06117.55.0	SV-NWV	EH	

						
6 Saloon (GJ, GL)						20
2.2 D 110-129 kW (150-175 PS) SHY1	12.2012→		7.03554.10.0	DW-TL	EP	→02.2018
2.2 D 110-140 kW (150-190 PS) SHY1, SHY4, SHY6, SHY8	12.2012→		7.03554.10.0	DW-TL	EP	 SHY1, SHY4, SHY6, SHY8: →02.2018
2.2 D 129-140 kW (175-190 PS) SH-VPTR	07.2014→		7.03554.10.0	DW-TL	EP	→02.2018
2.2 D 4WD 129-140 kW (175-190 PS) SH-VPTR	07.2014→		7.03554.10.0	DW-TL	EP	→02.2018
6 Station Wagon (GY)						21
1.8 75-88 kW (102-120 PS) L813	08.2002→08.2007		7.02256.51.0	EUV-SR	EL	
2.0 104-110 kW (141-150 PS) LF17, LF18	08.2002→08.2007		7.02256.51.0	EUV-SR	EL	 LF17, LF18: 2004 2004
2.0 107 kW (146 PS) LFF7	03.2005→08.2007		7.06117.55.0	SV-NWV	EH	
2.3 116-122 kW (162-166 PS) L3C1	01.2002→02.2008		7.02256.51.0	EUV-SR	EL	
2.3 AWD 116-122 kW (162-166 PS) L3C1	11.2002→08.2007		7.02256.51.0	EUV-SR	EL	
			7.06117.55.0	SV-NWV	EH	
BT-50 II Pickup (B22, B32, UP, UR)						22
2.5 CNG 120-123 kW (166-167 PS) L5-Y3	11.2011→		7.06117.55.0	SV-NWV	EH	Produktionsdatum bis: 17.07.2013 Production date to: 17.07.2013
2.5 MZI 120-123 kW (166-167 PS) L5-Y3	11.2011→		7.06117.55.0	SV-NWV	EH	Produktionsdatum bis: 17.07.2013 Production date to: 17.07.2013
2.5 MZI 4WD 120-123 kW (166-167 PS) L5-Y3	11.2011→		7.06117.55.0	SV-NWV	EH	Produktionsdatum bis: 28.03.2013 Production date to: 28.03.2013
BT-50 Pickup (CD, UN)						23
2.5 MRZ-CD 105 kW (143 PS) WLAA	08.2006→06.2013		7.02256.25.0	DW-AGR	EP	
			7.02256.25.0	DW-TL	EP	
2.5 MRZ-CD 4x4 105 kW (143 PS) WLAA	12.2006→12.2015		7.02256.25.0	DW-AGR	EP	
			7.02256.25.0	DW-TL	EP	
3.0 CDVi 115 kW (156 PS) WEAT	12.2006→12.2015		7.02256.25.0	DW-AGR	EP	
			7.02256.25.0	DW-TL	EP	
3.0 CDVi 4x4 115 kW (156 PS) WEAT	10.2006→12.2015		7.02256.25.0	DW-AGR	EP	
			7.02256.25.0	DW-TL	EP	
CX-3 (DK)						24
1.5 SKYACTIV-D 77 kW (105 PS) S5Y2, S5Y5, S5Y7, S5Y9	02.2015→01.2018		7.05314.02.0	DW-TL	EP	
1.5 SKYACTIV-D AWD 77 kW (105 PS) S5Y2, S5Y5, S5Y7, S5Y9	02.2015→01.2018		7.05314.02.0	DW-TL	EP	
1.8 SKYACTIV-D 85 kW (116 PS) S8Y1	02.2018→		7.05314.02.0	DW-TL	EP	für Linksklenker for left-hand drive vehicles
1.8 SKYACTIV-D AWD 85 kW (116 PS) S8Y1	02.2018→		7.05314.02.0	DW-TL	EP	



						
CX-30 (DM)						25
SKYACTIV-G M Hybrid 90-115 kW (122-156 PS) PEXN	07.2019→		7.09000.03.0	SV-KK	EL	
SKYACTIV-G M Hybrid (DM5W, DM6W) 110 kW (150 PS) PEXW	01.2020→		7.09000.03.0	SV-KK	EL	
SKYACTIV-G M Hybrid AWD 90-115 kW (122-156 PS) PEXN	07.2019→		7.09000.03.0	SV-KK	EL	
SKYACTIV-G M Hybrid AWD (DMEW, DMFW) 110 kW (150 PS) PEXW	01.2020→		7.09000.03.0	SV-KK	EL	
SKYACTIV-X M Hybrid 90-132 kW (122-179 PS) HFY1	07.2019→		7.09000.03.0	SV-KK	EL	
SKYACTIV-X M Hybrid AWD 90-132 kW (122-179 PS) HFY1	07.2019→		7.09000.03.0	SV-KK	EL	
CX-5 (KE, GH)						26
2.2 D 110-129 kW (150-175 PS) SHY1	04.2012→02.2017		7.03554.10.0	DW-TL	EP	
2.2 D 129-140 kW (175-190 PS) SH-VPTS	04.2012→02.2017		7.03554.10.0	DW-TL	EP	
2.2 D 110-129 kW (150-175 PS) SHY1	04.2012→02.2017		7.03554.10.0	DW-TL	EP	
2.2 D 4WD 129-140 kW (175-190 PS) SH-VPTS	04.2012→02.2017		7.03554.10.0	DW-TL	EP	
2.2 D AWD 110-129 kW (150-175 PS) SHY1	04.2012→02.2017		7.03554.10.0	DW-TL	EP	
CX-5 (KF)						27
2.2 D 129-140 kW (175-190 PS) SH-VPTS	11.2016→		7.03554.10.0	DW-TL	EP →02.2018	
2.2 D 110-129 kW (150-175 PS) SHY6	05.2017→		7.03554.10.0	DW-TL	EP	
2.2 D AWD 129-140 kW (175-190 PS) SH-VPTS	11.2016→		7.03554.10.0	DW-TL	EP →02.2018	
2.2 D AWD 110-129 kW (150-175 PS) SHY6	05.2017→		7.03554.10.0	DW-TL	EP	
2.2 D AWD 110-129 kW (150-175 PS) SHY6	05.2017→		7.03554.10.0	DW-TL	EP	
CX-7 (ER)						28
2.3 175-204 kW (238-277 PS) L3-VDT	06.2006→12.2012		7.06117.55.0	SV-NWV	EH	
2.3 AWD 175-204 kW (238-277 PS) L3-VDT	06.2006→12.2012		7.06117.55.0	SV-NWV	EH	
2.3 DISi 177 kW (241 PS) L3K7	06.2006→06.2009		7.06117.55.0	SV-NWV	EH	
2.3 MZR DISi Turbo 175-191 kW (238-260 PS) L3Y7	01.2007→12.2012		7.06117.55.0	SV-NWV	EH	

						
CX-7 (ER)						28
2.3 MZR DISI Turbo 175-191 kW (238-260 PS) L3Y7	01.2007→03.2013		7.06117.55.0	SV-NWV	EH	
2.3 MZR DISI Turbo AWD 175-204 kW (238-277 PS) L3-VDT	06.2006→12.2014		7.06117.55.0	SV-NWV	EH	
2.3 MZR DISI Turbo AWD 175-191 kW (238-260 PS) L3Y7	01.2007→03.2013		7.06117.55.0	SV-NWV	EH	
2.3 MZR DISI Turbo AWD 175-204 kW (238-277 PS) L3-VDT	10.2007→08.2009		7.06117.55.0	SV-NWV	EH	
2.3 MZR DISI Turbo AWD 175-204 kW (238-277 PS) L3-VDT	06.2009→03.2013		7.06117.55.0	SV-NWV	EH	
2.5 MZR 117-125 kW (159-170 PS) L5-VE	07.2009→03.2013		7.06117.55.0	SV-NWV	EH	
2.5 MZR AWD 117-125 kW (159-170 PS) L5-VE	09.2010→12.2012		7.06117.55.0	SV-NWV	EH	
MPV II (LW)						29
2.3 104-109 kW (141-148 PS) L3	07.2002→02.2006		7.02256.51.0	EUV-SR	EL	
MX-5 III (NC)						30
1.8 88-93 kW (120-126 PS) L828, L831	03.2005→12.2014		7.02256.51.0	EUV-SR	EL	
2.0 118 kW (160 PS) LFG7	03.2005→12.2007		7.02256.51.0	EUV-SR	EL	
2.0	09.2005→12.2012		7.02256.51.0	EUV-SR	EL	
2.0	01.2006→08.2012		7.02256.51.0	EUV-SR	EL	
2.0	09.2007→12.2014		7.02256.51.0	EUV-SR	EL	
2.0 118-123 kW (160-167 PS) LFY7	10.2008→12.2014		7.02256.51.0	EUV-SR	EL	
2.0 (NC18) 118-123 kW (160-167 PS) LFG7, LFG8, LFY7, LFZD	07.2005→12.2014		7.02256.51.0	EUV-SR	EL	
			7.06117.55.0	SV-NWV	EH	
TRIBUTE (EP)						31
2.0 91-97 kW (124-132 PS) YF	03.2000→05.2008		7.02256.46.0	EUV-AGR	EL	
2.0 4WD 91-97 kW (124-132 PS) YF	03.2000→05.2008		7.02256.46.0	EUV-AGR	EL	
2.3 110-126 kW (150-171 PS) L3-VE	01.2005→12.2006		7.02256.51.0	EUV-SR	EL	
2.3 4WD 110-126 kW (150-171 PS) L3-VE	01.2005→12.2006		7.02256.51.0	EUV-SR	EL	
2.3 AWD 110-126 kW (150-171 PS) L3-VE	04.2004→05.2008		7.02256.51.0	EUV-SR	EL	
2.3 All-wheel Drive 104-109 kW (141-148 PS) L3	07.2006→05.2008		7.02256.51.0	EUV-SR	EL	



M





TRIBUTE (EP) 31

2.3 GX 110-126 kW (150-171 PS) L3-VE	12.2003→10.2004	 7.02256.51.0	EUV-SR	EL
3.0 V6 24V 4WD 145-164 kW (197-223 PS) AJ	03.2000→05.2008	 7.02256.46.0	EUV-AGR	EL































6 Estate Van (GJ) 32

2.2 D 110-129 kW (150-175 PS) SHY4	04.2015→05.2016	 7.03554.10.0	DW-TL	EP
2.2 D 110-129 kW (150-175 PS) SHY4	04.2015→05.2016	 7.03554.10.0	DW-TL	EP
2.2 D AWD 110-129 kW (150-175 PS) SHY4	01.2013→05.2016	 7.03554.10.0	DW-TL	EP
2.2 D AWD 110-129 kW (150-175 PS) SHY4	04.2015→05.2016	 7.03554.10.0	DW-TL	EP





















BT-50 Platform/Chassis (CD, UN) 33

3.0 CDVi 115 kW (156 PS) WEAT	12.2006→	 7.02256.25.0	DW-AGR	EP
		7.02256.25.0	DW-TL	EP
3.0 CDVi 4x4 115 kW (156 PS) WEAT	12.2006→	 7.02256.25.0	DW-AGR	EP
		7.02256.25.0	DW-TL	EP

M

						
/8 (W114)						1
230.6 (114.015) 88 kW (120 PS) M 180.954	01.1968→11.1976		7.21071.50.0	EUV-SR	EP	
250 (114.010) 85-96 kW (116-130 PS) M 114.920	01.1968→08.1972		7.21071.50.0	EUV-SR	EP  USA, Kanada  USA, Kanada	
250 2.8 (114.011) 96 kW (130 PS) M 130.923	06.1972→11.1976		7.21071.50.0	EUV-SR	EP	
280 (114.060) 118 kW (160 PS) M 110.921	06.1972→11.1976		7.21071.50.0	AKF	EP	
			7.21071.50.0	EUV-SR	EP	
280 E (114.062) 136 kW (185 PS) M 110.981	06.1972→11.1976		7.21071.50.0	UAV	EP	
/8 (W115)						2
220 (115.010) 66 kW (90 PS) M 115.924	01.1968→07.1973		7.21071.50.0	EUV-SR	EP	
220 (115.010) 77 kW (105 PS) M 115.920	01.1968→07.1973		7.21071.50.0	EUV-SR	EP	
230.4 (115.017) 81 kW (110 PS) M 115.951	08.1973→12.1976		7.21071.50.0	EUV-SR	EP	
/8 Coupe (W114)						3
250 C 2.8 (114.023) 96 kW (130 PS) M 130.923	06.1972→11.1976		7.21071.50.0	EUV-SR	EP	
280 C (114.073) 118 kW (160 PS) M 110.921	06.1972→02.1977		7.21071.50.0	EUV-SR	EP	
280 CE (114.072) 136 kW (185 PS) M 110.981	06.1972→01.1977		7.21071.50.0	UAV	EP	
123 Coupe (C123)						4
230 C (123.043) 80 kW (109 PS) M 115.954	05.1977→04.1980		7.21071.50.0	EUV-KA	EP	
230 CE (123.243) 100 kW (136 PS) M 102.980	04.1980→12.1985		7.21071.50.0	EUV-KA	EP	
280 C 105-136 kW (185 PS) M 110.984	03.1977→12.1980		7.21071.50.0	UAV	EP	
280 C (123.050) 115 kW (156 PS) M 110.923	03.1977→03.1980		7.21071.50.0	EUV-KA	EP	
123 Saloon (W123)						5
200 (123.220) 74-80 kW (100-109 PS) M 102.920	06.1980→11.1985		7.21071.50.0	EUV-KA	EP	
230 (123.023) 80 kW (109 PS) M 115.954	02.1976→03.1981		7.21071.50.0	EUV-KA	EP	
230 E (123.223) 100 kW (136 PS) M 102.980	04.1980→12.1985		7.21071.50.0	EUV-KA	EP	
240 D (123.123) 46-53 kW (63-72 PS) OM 616.912	03.1979→11.1985		7.21071.50.0	EUV-KA	EP	
280 E (123.033) 105-136 kW (177-185 PS) M 110.984, M 110.988	02.1976→11.1985		7.21071.50.0	EUV-KA	EP  M 110.984, M 110.988:  USA, Kanada  USA, Kanada	
			7.21071.50.0	UAV	EP	
300 D (123.130) 59-65 kW (80-88 PS) OM 617.912	02.1976→07.1980		7.21071.50.0	EUV-KA	EP  USA, Kanada  USA, Kanada	

M

						
123 Saloon (W123)						5
300 D (123.130) 59-65 kW (80-88 PS) OM 617.912	03.1979→11.1985		7.21071.50.0	EUV-KA	EP USA, Kanada USA, Canada	
300 Turbo-D (123.133) 92 kW (125 PS) OM 617.952	08.1981→07.1985		7.21071.50.0	EUV-KA	EP	
123 T-Model (S123)						6
200 T (123.280) 74-80 kW (100-109 PS) M 102.939	11.1980→11.1985		7.21071.50.0	EUV-KA	EP	
230 T (123.083) 80 kW (109 PS) M 115.954	09.1977→03.1980		7.21071.50.0	EUV-KA	EP	
230 TE (123.283) 100 kW (136 PS) M 102.980	04.1980→11.1985		7.21071.50.0	EUV-KA	EP	
250 T (123.086) 95-103 kW (129-140 PS) M 123.921	05.1978→10.1979		7.21071.50.0	EUV-KA	EP	
280 TE (123.093) 130-136 kW (177-185 PS) M 110.988	09.1977→11.1985		7.21071.50.0	EUV-KA	EP	
300 T D (123.190) 59-65 kW (80-88 PS) OM 617.912	09.1977→02.1979		7.21071.50.0	EUV-KA	EP	
124 Convertible (A124)						7
M 300 CE / 320 CE (124.066) 162 kW (220 PS) M 104.992	10.1992→05.1993		7.21071.50.0	EUV-AT	EP	
			7.21071.50.0	EUV-SL	EP	
			7.06117.20.0	ZM-NWV	EL	
300 CE-24 (124.061) 162-170 kW (220-231 PS) M 104.980	04.1992→06.1993		7.21071.50.0	EUV-AT	EP	
300 CE-24 (124.061) 162-170 kW (220-231 PS) M 104.980	04.1992→06.1993		7.21071.50.0	EUV-AT	EP	
			7.06117.20.0	ZM-NWV	EL	
124 Coupe (C124)						8
220 CE (124.042) 110 kW (150 PS) M 111.960	10.1992→05.1993		7.06117.20.0	ZM-NWV	EL	
300 CE-24 (124.051) 162-170 kW (220-231 PS) M 104.980	09.1989→12.1992		7.21071.50.0	EUV-AT	EP	
300 CE-24 (124.051) 162-170 kW (220-231 PS) M 104.980	09.1989→12.1992		7.21071.50.0	EUV-AT	EP	
			7.06117.20.0	ZM-NWV	EL	
320 CE (124.052) 162 kW (220 PS) M 104.992	10.1992→05.1993		7.21071.50.0	EUV-AT	EP	
			7.21071.50.0	EUV-LS	EP	
			7.21071.50.0	EUV-SL	EP	
			7.06117.20.0	ZM-NWV	EL	

					
124 Saloon (W124)					
200 (124.020) 75-80 kW (102-109 PS) M 102.922	12.1985→05.1990		7.21071.50.0	EUV-AGR	EP
200 (124.020) 75-80 kW (102-109 PS) M 102.922	01.1986→05.1990		7.21071.50.0	EUV-AGR	EP
200 D (124.120) 53-55 kW (72-75 PS) OM 601.912	12.1984→08.1989		7.21071.50.0	EUV-LS	EP
200 D (124.120) 53-55 kW (72-75 PS) OM 601.912	08.1989→06.1993		7.21071.50.0	EUV-LS	EP
200 E (124.021) 87-90 kW (118-122 PS) M 102.963	09.1988→08.1993		7.21071.50.0	EUV-AGR	EP
200 E (124.021) 87-90 kW (118-122 PS) M 102.963	09.1988→12.1989		7.21071.50.0	EUV-AGR	EP
220 E (124.022) 110 kW (150 PS) M 111.960	10.1992→06.1993		7.06117.20.0	ZM-NWV	EL
230 E (124.023) 97-100 kW (132-136 PS) M 102.982	12.1984→03.1992		7.21071.50.0	EUV-AGR	EP
230 E (124.023) 97-100 kW (132-136 PS) M 102.982	01.1985→06.1993		7.21071.50.0	EUV-AGR	EP
230 E Cat (124.023) 97-100 kW (132-136 PS) M 102.982	06.1989→06.1993		7.21071.50.0	EUV-AGR	EP
250 D (124.125) 66-69 kW (90-94 PS) OM 602.912	04.1985→06.1993		7.21071.50.0	EUV-LS	EP
250 D (124.125) 66-69 kW (90-94 PS) OM 602.912	01.1989→06.1993		7.21071.50.0	EUV-LS	EP
260 E (124.026) 118-122 kW (160-166 PS) M 103.940	09.1985→08.1992		7.21071.50.0	EUV-AGR	EP
260 E (124.026) 118-122 kW (160-166 PS) M 103.940	09.1985→12.1989		7.21071.50.0	EUV-AGR	EP
280 E (124.028) 142-145 kW (193-197 PS) M 104.942	10.1992→06.1993		7.21071.50.0	EUV-LS	EP
			7.21071.50.0	EUV-SL	EP
			7.06117.20.0	ZM-NWV	EL
300 AMG (124.031) 265 kW (360 PS) M 104.980 (AMG 3.4)	09.1988→06.1993		7.06117.20.0	ZM-NWV	EL
300 D (124.130) 80-83 kW (109-113 PS) OM 603.912	12.1984→08.1989		7.21071.50.0	EUV-LS	EP
300 D (124.130) 80-83 kW (109-113 PS) OM 603.912	08.1989→06.1993		7.21071.50.0	EUV-LS	EP
300 D (124.130) 80-83 kW (109-113 PS) OM 603.912	06.1990→06.1993		7.21071.50.0	EUV-LS	EP



124 Saloon (W124) **9**

300 D 4-matic (124.330) 80-83 kW (109-113 PS) OM 603.913	09.1986→08.1992	 7.21071.50.0	EUV-LS	EP
300 D 4-matic (124.330) 80-83 kW (109-113 PS) OM 603.913	08.1989→06.1993	 7.21071.50.0	EUV-LS	EP
300 E (124.030) 132-138 kW (179-188 PS) M 103.983	08.1985→08.1992	 7.21071.50.0	EUV-AGR	EP
320 E (124.032) 162 kW (220 PS) M 104.992	10.1992→06.1993	 7.21071.50.0	EUV-LS	EP
		7.21071.50.0	EUV-SL	EP
		7.06117.20.0	ZM-NWV	EL
400 E 4.2 (124.034) 205 kW (279 PS) M 119.975	10.1992→06.1993	 7.21071.50.0	EUV-LS	EP

124 T-Model (S124) **10**

M



















200 T D (124.180) 53-55 kW (72-75 PS) OM 601.912	09.1985→08.1991	 7.21071.50.0	EUV-LS	EP
200 T D (124.180) 53-55 kW (72-75 PS) OM 601.912	09.1988→08.1991	 7.21071.50.0	EUV-LS	EP
200 TE (124.079) 100 kW (136 PS) M 111.940	05.1986→06.1993	 7.21071.50.0	EUV-AT	EP
200 TE (124.081) 87-90 kW (118-122 PS) M 102.963	09.1988→08.1992	 7.21071.50.0	EUV-AT	EP
		220 TE (124.082) 110 kW (150 PS) M 111.960	10.1992→05.1993	 7.21071.50.0
		7.06117.20.0	ZM-NWV	EL
230 TE (124.083) 97-100 kW (132-136 PS) M 102.982	09.1985→08.1992	 7.21071.50.0	EUV-AT	EP
230 TE (124.083) 97-100 kW (132-136 PS) M 102.982	09.1985→08.1992	 7.21071.50.0	EUV-AT	EP
230 TE Cat (124.083) 97-100 kW (132-136 PS) M 102.982	06.1989→08.1992	 7.21071.50.0	EUV-AT	EP
250 T D (124.185) 66-69 kW (90-94 PS) OM 602.912	09.1985→06.1993	 7.21071.50.0	EUV-LS	EP
250 T D (124.185) 66-69 kW (90-94 PS) OM 602.912	01.1989→06.1993	 7.21071.50.0	EUV-LS	EP
280 TE (124.088) 142-145 kW (193-197 PS) M 104.942	10.1992→06.1993	 7.21071.50.0	EUV-AT	EP
		7.21071.50.0	EUV-LS	EP
		7.21071.50.0	EUV-SL	EP
		7.06117.20.0	ZM-NWV	EL
300 T D (124.190) 80-83 kW (109-113 PS) OM 603.912	09.1986→06.1993	 7.21071.50.0	EUV-LS	EP
300 T D (124.190) 80-83 kW (109-113 PS) OM 603.912	01.1989→06.1993	 7.21071.50.0	EUV-LS	EP

						
124 T-Model (S124)						10
300 T D (124.190) 80-83 kW (109-113 PS) OM 603.912	01.1989→06.1993		7.21071.50.0	EUV-LS	EP	
300 T Turbo-D 4-matic (124.393) 105-108 kW (143-147 PS) OM 603.963	09.1986→01.1989		7.21071.50.0	EUV-AGR	EP	
300 T Turbo-D 4-matic (124.393) 100-108 kW (136-147 PS) OM 603.960	01.1989→06.1993		7.21071.50.0	EUV-AGR	EP	
300 TE-24 (124.091) 162-170 kW (220-231 PS) M 104.980	09.1989→08.1992		7.21071.50.0	EUV-AT	EP	
300 TE-24 (124.091) 162-170 kW (220-231 PS) M 104.980	09.1989→08.1992		7.21071.50.0	EUV-AT	EP	
320 TE (124.092) 162 kW (220 PS) M 104.992	10.1992→06.1993		7.06117.20.0	ZM-NWV	EL	
			7.21071.50.0	EUV-LS	EP	
			7.21071.50.0	EUV-SL	EP	
190 (W201)						11
190 D (201.122) 54 kW (72 PS) OM 601.921	09.1984→12.1985		7.21071.50.0	EUV-LS	EP	
2.0 (201.022) 63-77 kW (86-105 PS) M 102.921	10.1982→10.1984		7.21071.50.0	EUV-LS	EP	
2.0 (201.023) 75-77 kW (102-105 PS) M 102.924	01.1986→05.1990		7.21071.50.0	EUV-LS	EP	
D 2.0 (201.122) 53-55 kW (72-75 PS) OM 601.911	08.1983→08.1989		7.21071.50.0	EUV-LS	EP	
D 2.0 (201.122) 53-55 kW (72-75 PS) OM 601.911	08.1989→08.1993		7.21071.50.0	EUV-LS	EP	
D 2.5 (201.126) 66-69 kW (90-94 PS) OM 602.911	04.1985→08.1993		7.21071.50.0	EUV-LS	EP	
D 2.5 (201.126) 66-69 kW (90-94 PS) OM 602.911	08.1989→08.1993		7.21071.50.0	EUV-LS	EP	
E 1.8 (201.018) 80 kW (109 PS) M 102.910	04.1990→08.1993		7.21071.50.0	EUV-LS	EP	
E 2.0 (201.024) 83-93 kW (113-126 PS) M 102.961, M 102.962	10.1982→06.1993		7.21071.50.0	EUV-LS	EP	
E 2.0 (201.024) 83-93 kW (113-126 PS) M 102.961, M 102.962	02.1985→12.1986		7.21071.50.0	EUV-LS	EP	
E 2.0 (201.024) 83-90 kW (115-122 PS) M 102.962	02.1985→12.1986		7.21071.50.0	EUV-LS	EP	
E 2.3 (201.028) 97-100 kW (132-136 PS) M 102.985	10.1986→08.1993		7.21071.50.0	EUV-LS	EP	
E 2.3-16 (201.034) 125-136 kW (170-185 PS) M 102.983	04.1984→01.1987		7.21071.50.0	EUV-LS	EP	

M

						
190 (W201)						11
E 2.6 (201.029) 118-122 kW (160-166 PS) M 103.942	09.1986→08.1993		7.21071.50.0	EUV-LS	EP	
Turbo-D 2.5 (201.128) 90-93 kW (122-126 PS) OM 602.961	02.1988→08.1993		7.21071.50.0	EUV-LS	EP	
Turbo-D 2.5 (201.128) 90-93 kW (122-126 PS) OM 602.961	02.1988→08.1993		7.21071.50.0	EUV-LS	EP	
300						12
E 3.2 (124) 162-200 kW (220-272 PS) M 104.992, M 104.992 (AMG 3.6)	09.1992→06.1993		7.21071.50.0	EUV-LS	EP	
SE 2.8 (124) 142-145 kW (193-197 PS) M 104.942	01.1993→06.1993		7.21071.50.0	EUV-LS	EP	
SE 2.8 (126) 142-145 kW (193-197 PS) M 104.942	01.1993→06.1993		7.21071.50.0	EUV-LS	EP	
SE 2.8 (140) 142-145 kW (193-197 PS) M 104.944	09.1992→05.1993		7.21071.50.0	EUV-LS	EP	
A-CLASS (W168)						13
A 140 (168.031, 168.131) 60 kW (82 PS) M 166.940	09.1997→08.2004		7.02256.37.0	EUV-SL	EL	
A 140 (168.031, 168.131) 60-75 kW (82-102 PS) M 166.960	01.2001→08.2004		7.02256.37.0	EUV-SL	EL	
A 160 (168.033, 168.133) 60-75 kW (82-102 PS) M 166.960	09.1997→08.2004		7.02256.37.0	EUV-SL	EL	
A-CLASS (W169)						14
A 150 (169.031, 169.331) 70 kW (95 PS) M 266.920	09.2004→06.2012		7.02256.37.0	EUV-SL	EL	
A 160 (169.031, 169.331) 70 kW (95 PS) M 266.920	04.2009→06.2012		7.02256.37.0	EUV-SL	EL	
A 160 CDI (169.006, 169.306) 60 kW (82 PS) OM 640.942	09.2004→06.2012		7.00782.04.0	DW-TL	EP	
A 170 (169.032, 169.332) 85 kW (116 PS) M 266.940	09.2004→06.2012		7.02256.37.0	EUV-SL	EL	
A 180 (169.032, 169.332) 85 kW (116 PS) M 266.940	04.2009→06.2012		7.02256.37.0	EUV-SL	EL	
A 180 CDI (169.007, 169.307) 80 kW (109 PS) OM 640.940	09.2004→06.2012		7.00782.04.0	DW-TL	EP	
A 200 (169.033, 169.333) 85-100 kW (116-136 PS) M 266.960	09.2004→06.2012		7.02256.37.0	EUV-SL	EL	
A 200 CDI (169.008, 169.308) 100-103 kW (136-140 PS) OM 640.941	09.2004→06.2012		7.00782.04.0	DW-TL	EP	













M

					
A-CLASS (W169)					14
A 200 CDI (169.308, 169.008) 100-103 kW (136-140 PS) OM 640.941	09.2004→06.2012		7.00782.04.0	DW-TL	EP
A 200 TURBO (169.034, 169.334) 142 kW (193 PS) M 266.980	09.2005→06.2012		7.02256.37.0	EUV-SL	EL
			7.00017.03.0	LDRV	EP
A-CLASS (W176)					15
A 160 (176.041) 75-115 kW (102-156 PS) M 270.910	07.2015→05.2018		7.00782.16.0	DW-TL	EP
			7.01870.06.0	SUV	EL
			7.04818.04.0	SUV	EL
					<p> M 270.910: Fahrgestellnummer bis: 30786355 Vehicle Identification Number to: 30786355 Produktionsdatum bis: 03.08.2015 Production date to: 03.08.2015</p> <p> M 270.910: Fahrgestellnummer bis: 10044275 Vehicle Identification Number to: 10044275 Produktionsdatum bis: 22.12.2015 Production date to: 22.12.2015</p> <p> M 270.910: Fahrgestellnummer ab: 30786355 Vehicle Identification Number from: 30786355 Produktionsdatum ab: 03.08.2015 Production date from: 03.08.2015</p> <p> M 270.910: Fahrgestellnummer ab: 10044275 Vehicle Identification Number from: 10044275 Produktionsdatum ab: 22.12.2015 Production date from: 22.12.2015</p>
A 180 (176.042) 75-115 kW (102-156 PS) M 270.910	09.2012→05.2018		7.00782.16.0	DW-TL	EP
			7.02256.37.0	EUV-KK	EL
			7.01870.06.0	SUV	EL
			7.04818.04.0	SUV	EL
					<p> M 270.910: Fahrgestellnummer bis: 10044275 Vehicle Identification Number to: 10044275 Produktionsdatum bis: 22.12.2015 Production date to: 22.12.2015</p> <p> M 270.910: Fahrgestellnummer bis: 30786355 Vehicle Identification Number to: 30786355 Produktionsdatum bis: 03.08.2015 Production date to: 03.08.2015</p> <p> M 270.910: Fahrgestellnummer ab: 30786355 Vehicle Identification Number from: 30786355 Produktionsdatum ab: 03.08.2015 Production date from: 03.08.2015</p> <p> M 270.910: Fahrgestellnummer ab: 10044275 Vehicle Identification Number from: 10044275 Produktionsdatum ab: 22.12.2015 Production date from: 22.12.2015</p>
A 180 CDI (176.000) 80-100 kW (109-136 PS) OM 651.901	06.2012→10.2014		7.02256.37.0	EUV-WP	EL

M















A-CLASS (W176) 15

<p>A 220 4-matic (176.047) 115-160 kW (156-218 PS) M 270.920</p>	<p>05.2014→05.2018</p>	<p> 7.00782.16.0</p> <p>7.02256.37.0</p> <p>7.01870.06.0</p> <p>7.04818.04.0</p>	<p>DW-TL EP</p> <p>EUV-KK EL</p> <p>SUV EL</p> <p>SUV EL</p>	<p> M 270.920: Fahrgestellnummer bis: 10044275 Vehicle Identification Number to: 10044275 Produktionsdatum bis: 22.12.2015 Production date to: 22.12.2015</p> <p> M 270.920: Fahrgestellnummer bis: 30786355 Vehicle Identification Number to: 30786355 Produktionsdatum bis: 03.08.2015 Production date to: 03.08.2015</p> <p> M 270.920: Fahrgestellnummer ab: 30786355 Vehicle Identification Number from: 30786355 Produktionsdatum ab: 03.08.2015 Production date from: 03.08.2015</p> <p> M 270.920: Fahrgestellnummer ab: 10044275 Vehicle Identification Number from: 10044275 Produktionsdatum ab: 22.12.2015 Production date from: 22.12.2015</p>
<p>A 220 CDI (176.003) 80-130 kW (109-177 PS) OM 651.930</p>	<p>09.2012→05.2018</p>	<p> 7.02256.37.0</p>	<p>EUV-WP EL</p>	
<p>A 220 CDI (176.003) 80-130 kW (109-177 PS) OM 651.930</p>	<p>01.2014→05.2018</p>	<p> 7.02256.37.0</p>	<p>EUV-WP EL</p>	
<p>A 220 CDI 4-matic (176.005) 80-130 kW (109-177 PS) OM 651.930</p>	<p>02.2014→05.2018</p>	<p> 7.02256.37.0</p>	<p>EUV-WP EL</p>	
<p>A 220 d 4-matic (176.005) 80-130 kW (109-177 PS) OM 651.930</p>	<p>07.2015→05.2018</p>	<p> 7.02256.37.0</p>	<p>EUV-WP EL</p>	
<p>A 250 (176.044) 115-160 kW (156-218 PS) M 270.920</p>	<p>06.2012→05.2018</p>	<p> 7.00782.16.0</p> <p>7.02256.37.0</p> <p>7.01870.06.0</p>	<p>DW-TL EP</p> <p>EUV-KK EL</p> <p>SUV EL</p>	<p> M 270.920: Fahrgestellnummer bis: 10044275 Vehicle Identification Number to: 10044275 Produktionsdatum bis: 22.12.2015 Production date to: 22.12.2015</p> <p> M 270.920: Fahrgestellnummer bis: 30786355 Vehicle Identification Number to: 30786355 Produktionsdatum bis: 03.08.2015 Production date to: 03.08.2015</p>

M





A-CLASS (W176) 15

			7.04818.04.0	SUV	EL	 M 270.920: Fahrgestellnummer ab: 10044275 Vehicle Identification Number from: 10044275 Produktionsdatum ab: 22.12.2015 Production date from: 22.12.2015  M 270.920: Fahrgestellnummer ab: 30786355 Vehicle Identification Number from: 30786355 Produktionsdatum ab: 03.08.2015 Production date from: 03.08.2015
A 250 (176.050) 115-160 kW (156-218 PS) M 270.920	07.2015→05.2018		7.00782.16.0	DW-TL	EP	
			7.02256.37.0	EUV-KK	EL	
			7.01870.06.0	SUV	EL	 M 270.920: Fahrgestellnummer bis: 10044275 Vehicle Identification Number to: 10044275 Produktionsdatum bis: 22.12.2015 Production date to: 22.12.2015  M 270.920: Fahrgestellnummer bis: 30786355 Vehicle Identification Number to: 30786355 Produktionsdatum bis: 03.08.2015 Production date to: 03.08.2015
			7.04818.04.0	SUV	EL	 M 270.920: Fahrgestellnummer ab: 10044275 Vehicle Identification Number from: 10044275 Produktionsdatum ab: 22.12.2015 Production date from: 22.12.2015  M 270.920: Fahrgestellnummer ab: 30786355 Vehicle Identification Number from: 30786355 Produktionsdatum ab: 03.08.2015 Production date from: 03.08.2015
A 250 4-matic (176.046) 115-160 kW (156-218 PS) M 270.920	06.2013→05.2018		7.00782.16.0	DW-TL	EP	
			7.02256.37.0	EUV-KK	EL	
			7.01870.06.0	SUV	EL	 M 270.920: Fahrgestellnummer bis: 10044275 Vehicle Identification Number to: 10044275 Produktionsdatum bis: 22.12.2015 Production date to: 22.12.2015  M 270.920: Fahrgestellnummer bis: 30786355 Vehicle Identification Number to: 30786355 Produktionsdatum bis: 03.08.2015 Production date to: 03.08.2015
			7.04818.04.0	SUV	EL	 M 270.920: Fahrgestellnummer ab: 10044275 Vehicle Identification Number from: 10044275 Produktionsdatum ab: 22.12.2015 Production date from: 22.12.2015  M 270.920: Fahrgestellnummer ab: 30786355 Vehicle Identification Number from: 30786355 Produktionsdatum ab: 03.08.2015 Production date from: 03.08.2015

M







A-CLASS (W176) 15





A 250 4-matic (176.051) 115-160 kW (156-218 PS) M 270.920	07.2015→05.2018	 7.00782.16.0	DW-TL	EP	M 270.920: Fahrgestellnummer bis: 10044275 Vehicle Identification Number to: 10044275 Produktionsdatum bis: 22.12.2015 Production date to: 22.12.2015 M 270.920: Fahrgestellnummer bis: 30786355 Vehicle Identification Number to: 30786355 Produktionsdatum bis: 03.08.2015 Production date to: 03.08.2015 M 270.920: Fahrgestellnummer ab: 10044275 Vehicle Identification Number from: 10044275 Produktionsdatum ab: 22.12.2015 Production date from: 22.12.2015 M 270.920: Fahrgestellnummer ab: 30786355 Vehicle Identification Number from: 30786355 Produktionsdatum ab: 03.08.2015 Production date from: 03.08.2015
		7.02256.37.0 7.01870.06.0	EUV-KK SUV	EL EL	
A 45 AMG 4-matic (176.052) 250-280 kW (340-381 PS) M 133.980	06.2013→05.2018	 7.00782.11.0	DW-TL	EP	
		7.04818.04.0	SUV	EL	
AMG A 45 4-matic (176.052) 250-280 kW (340-381 PS) M 133.980	07.2015→05.2018	 7.00782.11.0	DW-TL	EP	

M







A-CLASS (W177) 16























A 160 (177.082) 80-160 kW (109-218 PS) M 282.914	06.2018→	 7.08681.15.0	EOV	EH	für OE-Nummer: A 000 153 18 59, A 282 090 02 80 for OE number: A 000 153 18 59, A 282 090 02 80
		7.04818.04.0	SUV	EL	
A 180 (177.084) 80-160 kW (109-218 PS) M 282.914	06.2018→	 7.08681.15.0	EOV	EH	für OE-Nummer: A 000 153 18 59, A 282 090 02 80 for OE number: A 000 153 18 59, A 282 090 02 80
		7.04818.04.0	SUV	EL	
A 200 (177.087) 80-160 kW (109-218 PS) M 282.914	03.2018→	 7.08681.15.0	EOV	EH	für OE-Nummer: A 000 153 18 59, A 282 090 02 80 for OE number: A 000 153 18 59, A 282 090 02 80
		7.04818.04.0	SUV	EL	
A 200 (177.087) 80-160 kW (109-218 PS) M 282.914	06.2018→	 7.04818.04.0	SUV	EL	für OE-Nummer: A 000 153 18 59, A 282 090 02 80 for OE number: A 000 153 18 59, A 282 090 02 80
		7.02256.37.0	EUV-AGR	EL	
A 200 d (177.012) 84-235 kW (114-320 PS) OM 654.920	11.2018→	 7.02256.37.0	EUV-AGR	EL	Produktionsdatum bis: 15.12.2020 Production date to: 15.12.2020

























A-CLASS (W177)						16
A 200 d 4-matic (177.013) 84-235 kW (114-320 PS) OM 654.920	10.2019→		7.02256.37.0	EUV-AGR	EL	Produktionsdatum bis: 15.12.2020 Production date to: 15.12.2020
A 220 (177.044) 140-225 kW (190-306 PS) M 260.920	07.2018→		7.04927.08.0	SUV	EL	Ladeluftkühler Intercooler
A 220 4-matic (177.045) 140-225 kW (190-306 PS) M 260.920	07.2018→10.2019		7.04927.08.0	SUV	EL	Ladeluftkühler Intercooler
A 220 d (177.014) 84-235 kW (114-320 PS) OM 654.920	11.2018→		7.02256.37.0	EUV-AGR	EL	Produktionsdatum bis: 15.12.2020 Production date to: 15.12.2020
A 220 d 4-matic (177.015) 84-235 kW (114-320 PS) OM 654.920	10.2019→		7.02256.37.0	EUV-AGR	EL	Produktionsdatum bis: 15.12.2020 Production date to: 15.12.2020
A 250 (177.046) 140-225 kW (190-306 PS) M 260.920	03.2018→		7.04927.08.0	SUV	EL	Ladeluftkühler Intercooler
A 250 4-matic (177.047) 140-225 kW (190-306 PS) M 260.920	07.2018→		7.04927.08.0	SUV	EL	Ladeluftkühler Intercooler
A 250 e (177.086) 80-160 kW (109-218 PS) M 282.914	08.2019→		7.04818.04.0	SUV	EL	für OE-Nummer: A 000 153 18 59, A 282 090 02 80 for OE number: A 000 153 18 59, A 282 090 02 80
A 250 e (177.086) 80-160 kW (109-218 PS) M 282.914	08.2019→		7.04818.04.0	SUV	EL	für OE-Nummer: A 000 153 18 59, A 282 090 02 80 for OE number: A 000 153 18 59, A 282 090 02 80
AMG A 35 4-matic (177.051) 140-225 kW (190-306 PS) M 260.920	09.2018→		7.04927.08.0	SUV	EL	Ladeluftkühler Intercooler

M

A-CLASS Saloon (V177)						17
A 180 (177.184) 80-160 kW (109-218 PS) M 282.914	04.2019→		7.04818.04.0	SUV	EL	für OE-Nummer: A 000 153 18 59, A 282 090 02 80 for OE number: A 000 153 18 59, A 282 090 02 80
A 200 (177.187) 80-160 kW (109-218 PS) M 282.914	09.2018→		7.08681.15.0	EOV	EH	
			7.04818.04.0	SUV	EL	für OE-Nummer: A 000 153 18 59, A 282 090 02 80 for OE number: A 000 153 18 59, A 282 090 02 80
A 200 (177.187) 80-160 kW (109-218 PS) M 282.914	09.2018→		7.04818.04.0	SUV	EL	für OE-Nummer: A 000 153 18 59, A 282 090 02 80 for OE number: A 000 153 18 59, A 282 090 02 80
A 200 d (177.112) 84-235 kW (114-320 PS) OM 654.920	08.2019→		7.02256.37.0	EUV-AGR	EL	Produktionsdatum bis: 15.12.2020 Production date to: 15.12.2020
A 200 d 4-matic (177.113) 84-235 kW (114-320 PS) OM 654.920	10.2019→		7.02256.37.0	EUV-AGR	EL	Produktionsdatum bis: 15.12.2020 Production date to: 15.12.2020
A 220 4-matic (177.145) 140-225 kW (190-306 PS) M 260.920	09.2018→		7.04927.08.0	SUV	EL	Ladeluftkühler Intercooler
A 220 d (177.114) 84-235 kW (114-320 PS) OM 654.920	08.2019→		7.02256.37.0	EUV-AGR	EL	Produktionsdatum bis: 15.12.2020 Production date to: 15.12.2020













						
A-CLASS Saloon (V177)						17
A 220 d 4-matic (177.115) 84-235 kW (114-320 PS) OM 654.920	10.2019→		7.02256.37.0	EUV-AGR	EL Produktionsdatum bis: 15.12.2020 Production date to: 15.12.2020	
A 250 (177.146) 140-225 kW (190-306 PS) M 260.920	09.2018→		7.04927.08.0	SUV	EL Ladeluftkühler Intercooler	
A 250 4-matic (177.147) 140-225 kW (190-306 PS) M 260.920	09.2018→		7.04927.08.0	SUV	EL Ladeluftkühler Intercooler	
A 250 e (177.186) 80-160 kW (109-218 PS) M 282.914	08.2019→		7.04818.04.0	SUV	EL für OE-Nummer: A 000 153 18 59, A 282 090 02 80 for OE number: A 000 153 18 59, A 282 090 02 80	
A 250 e (177.186) 80-160 kW (109-218 PS) M 282.914	08.2019→		7.04818.04.0	SUV	EL für OE-Nummer: A 000 153 18 59, A 282 090 02 80 for OE number: A 000 153 18 59, A 282 090 02 80	
AMG GT (C190)						18
GT (190.377) 340-430 kW (462-585 PS) M 178.980	08.2015→		7.00782.16.0	DW-TL	EP	
GT (190.377) 340-430 kW (462-585 PS) M 178.980	01.2017→		7.00782.16.0	DW-TL	EP	
GT C (190.380) 340-430 kW (462-585 PS) M 178.980	03.2017→		7.00782.16.0	DW-TL	EP	
GT R (190.379) 340-430 kW (462-585 PS) M 178.980	11.2016→		7.00782.16.0	DW-TL	EP	
GT S (190.378) 340-430 kW (462-585 PS) M 178.980	10.2014→		7.00782.16.0	DW-TL	EP	
GT S (190.378) 340-430 kW (462-585 PS) M 178.980	01.2017→		7.00782.16.0	DW-TL	EP	
AMG GT (X290)						19
63 4-matic+ (290.688) 350-470 kW (476-639 PS) M 177.980	07.2018→		7.00782.16.0	DW-TL	EP	
			7.04927.08.0	SUV	EL Luftfiltergehäuse Air Filter Housing	
63 S 4-matic+ (290.689) 350-470 kW (476-639 PS) M 177.980	07.2018→		7.00782.16.0	DW-TL	EP	
			7.04927.08.0	SUV	EL Luftfiltergehäuse Air Filter Housing	
AMG GT Roadster (R190)						20
GT (190.477) 340-430 kW (462-585 PS) M 178.980	11.2016→		7.00782.16.0	DW-TL	EP	
GT (190.482) 340-430 kW (462-585 PS) M 178.980	07.2020→		7.00782.16.0	DW-TL	EP	
GT C (190.480) 340-430 kW (462-585 PS) M 178.980	11.2016→		7.00782.16.0	DW-TL	EP	

M

						
AMG GT Roadster (R190)						20
GT R (190.479) 340-430 kW (462-585 PS) M 178.980	04.2019→		7.00782.16.0	DW-TL	EP	
GT S (190.478) 340-430 kW (462-585 PS) M 178.980	05.2018→		7.00782.16.0	DW-TL	EP	
B-CLASS Sports Tourer (W245)						21
B 150 (245.231) 70 kW (95 PS) M 266.920	03.2005→11.2011		7.02256.37.0	EUV-SL	EL	
B 160 (245.231) 70 kW (95 PS) M 266.920	04.2009→11.2011		7.02256.37.0	EUV-SL	EL	
B 170 (245.232) 85 kW (116 PS) M 266.940	03.2005→11.2011		7.02256.37.0	EUV-SL	EL	
B 170 NGT (245.233) 85-100 kW (116-136 PS) M 266.960	04.2008→11.2011		7.02256.37.0	EUV-SL	EL	
B 180 (245.232) 85 kW (116 PS) M 266.940	04.2009→11.2011		7.02256.37.0	EUV-SL	EL	
B 180 CDI (245.207) 80 kW (109 PS) OM 640.940	03.2005→11.2011		7.00782.04.0	DW-TL	EP	
B 180 NGT (245.233) 85-100 kW (116-136 PS) M 266.960	04.2008→11.2011		7.02256.37.0	EUV-SL	EL	
B 200 (245.233) 85-100 kW (116-136 PS) M 266.960	03.2005→11.2011		7.02256.37.0	EUV-SL	EL	
B 200 CDI (245.208) 100-103 kW (136-140 PS) OM 640.941	03.2005→11.2011		7.00782.04.0	DW-TL	EP	
B 200 CDI (245.208) 100-103 kW (136-140 PS) OM 640.941	03.2005→11.2011		7.00782.04.0	DW-TL	EP	
B 200 TURBO (245.234) 142 kW (193 PS) M 266.980	03.2005→11.2011		7.02256.37.0	EUV-SL	EL	
			7.00017.03.0	LDRV	EP	
B-CLASS Sports Tourer (W246, W242)						22
B 160 (246.241) 75-115 kW (102-156 PS) M 270.910	07.2015→12.2018		7.00782.16.0	DW-TL	EP	
			7.01870.06.0	SUV	EL	
					<p> M 270.910: Fahrgestellnummer bis: 10044275 Vehicle Identification Number to: 10044275 Produktionsdatum bis: 22.12.2015 Production date to: 22.12.2015</p> <p> M 270.910: Fahrgestellnummer bis: 30786355 Vehicle Identification Number to: 30786355 Produktionsdatum bis: 03.08.2015 Production date to: 03.08.2015</p>	















B-CLASS Sports Tourer (W246, W242) 22

			7.04818.04.0	SUV	EL	 M 270.910: Fahrgestellnummer ab: 30786355 Vehicle Identification Number from: 30786355 Produktionsdatum ab: 03.08.2015 Production date from: 03.08.2015  M 270.910: Fahrgestellnummer ab: 10044275 Vehicle Identification Number from: 10044275 Produktionsdatum ab: 22.12.2015 Production date from: 22.12.2015
B 180 (246.242) 75-115 kW (102-156 PS) M 270.910	11.2011→12.2018		7.00782.16.0	DW-TL	EP	
			7.02256.37.0	EUV-KK	EL	 M 270.910: Fahrgestellnummer bis: 22.12.2015 Vehicle Identification Number to: 22.12.2015 Produktionsdatum bis: 10044275 Production date to: 10044275  M 270.910: Fahrgestellnummer bis: 30786355 Vehicle Identification Number to: 30786355 Produktionsdatum bis: 03.08.2015 Production date to: 03.08.2015
			7.01870.06.0	SUV	EL	
			7.04818.04.0	SUV	EL	 M 270.910: Fahrgestellnummer ab: 30786355 Vehicle Identification Number from: 30786355 Produktionsdatum ab: 03.08.2015 Production date from: 03.08.2015  M 270.910: Fahrgestellnummer ab: 10044275 Vehicle Identification Number from: 10044275 Produktionsdatum ab: 22.12.2015 Production date from: 22.12.2015
B 180 CDI (246.200) 80-100 kW (109-136 PS) OM 651.901	11.2011→08.2014		7.02256.37.0	EUV-WP	EL	
B 180 CDI (246.207) 80-130 kW (109-177 PS) OM 651.930	06.2013→08.2014		7.02256.37.0	EUV-WP	EL	
B 200 (246.243) 75-115 kW (102-156 PS) M 270.910	11.2011→12.2018		7.00782.16.0	DW-TL	EP	
			7.02256.37.0	EUV-KK	EL	 M 270.910: Fahrgestellnummer bis: 10044275 Vehicle Identification Number to: 10044275 Produktionsdatum bis: 22.12.2015 Production date to: 22.12.2015  M 270.910: Fahrgestellnummer bis: 30786355 Vehicle Identification Number to: 30786355 Produktionsdatum bis: 03.08.2015 Production date to: 03.08.2015
			7.01870.06.0	SUV	EL	

M















B-CLASS Sports Tourer (W246, W242) 22

			7.04818.04.0	SUV	EL	 M 270.910: Fahrgestellnummer ab: 30786355 Vehicle Identification Number from: 30786355 Produktionsdatum ab: 03.08.2015 Production date from: 03.08.2015  M 270.910: Fahrgestellnummer ab: 10044275 Vehicle Identification Number from: 10044275 Produktionsdatum ab: 22.12.2015 Production date from: 22.12.2015
B 200 CDI (246.201) 80-100 kW (109-136 PS) OM 651.901	11.2011→08.2014		7.02256.37.0	EUV-WP	EL	
B 200 CDI / d (246.208) 80-130 kW (109-177 PS) OM 651.930	08.2014→12.2018		7.02256.37.0	EUV-WP	EL	
B 200 CDI / d 4-matic (246.202) 80-130 kW (109-177 PS) OM 651.930	08.2014→12.2018		7.02256.37.0	EUV-WP	EL	
B 200 Flexfuel (246.243) 75-115 kW (102-156 PS) M 270.910	11.2011→12.2018		7.00782.16.0	DW-TL	EP	
			7.01870.06.0	SUV	EL	 M 270.910: Fahrgestellnummer bis: 10044275 Vehicle Identification Number to: 10044275 Produktionsdatum bis: 22.12.2015 Production date to: 22.12.2015  M 270.910: Fahrgestellnummer bis: 30786355 Vehicle Identification Number to: 30786355 Produktionsdatum bis: 03.08.2015 Production date to: 03.08.2015
			7.04818.04.0	SUV	EL	 M 270.910: Fahrgestellnummer ab: 10044275 Vehicle Identification Number from: 10044275 Produktionsdatum ab: 22.12.2015 Production date from: 22.12.2015  M 270.910: Fahrgestellnummer ab: 30786355 Vehicle Identification Number from: 30786355 Produktionsdatum ab: 03.08.2015 Production date from: 03.08.2015
B 200 Natural Gas Drive / B 200 c (242.848) 115-160 kW (156-218 PS) M 270.920	11.2012→12.2017		7.00782.16.0	DW-TL	EP	
			7.01870.06.0	SUV	EL	 M 270.920: Fahrgestellnummer bis: 10044275 Vehicle Identification Number to: 10044275 Produktionsdatum bis: 22.12.2015 Production date to: 22.12.2015  M 270.920: Fahrgestellnummer bis: 30786355 Vehicle Identification Number to: 30786355 Produktionsdatum bis: 03.08.2015 Production date to: 03.08.2015

M







B-CLASS Sports Tourer (W246, W242) 22

			7.04818.04.0	SUV	EL	 M 270.920: Fahrgestellnummer ab: 10044275 Vehicle Identification Number from: 10044275 Produktionsdatum ab: 22.12.2015 Production date from: 22.12.2015  M 270.920: Fahrgestellnummer ab: 30786355 Vehicle Identification Number from: 30786355 Produktionsdatum ab: 03.08.2015 Production date from: 03.08.2015
B 220 (246.245) 115-160 kW (156-218 PS) M 270.920	08.2014→12.2018		7.00782.16.0	DW-TL	EP	
			7.01870.06.0	SUV	EL	 M 270.920: Fahrgestellnummer bis: 10044275 Vehicle Identification Number to: 10044275 Produktionsdatum bis: 22.12.2015 Production date to: 22.12.2015  M 270.920: Fahrgestellnummer bis: 30786355 Vehicle Identification Number to: 30786355 Produktionsdatum bis: 03.08.2015 Production date to: 03.08.2015
			7.04818.04.0	SUV	EL	 M 270.920: Fahrgestellnummer ab: 10044275 Vehicle Identification Number from: 10044275 Produktionsdatum ab: 22.12.2015 Production date from: 22.12.2015  M 270.920: Fahrgestellnummer ab: 30786355 Vehicle Identification Number from: 30786355 Produktionsdatum ab: 03.08.2015 Production date from: 03.08.2015
B 220 4-matic (246.247) 115-160 kW (156-218 PS) M 270.920	05.2013→12.2018		7.00782.16.0	DW-TL	EP	
			7.02256.37.0	EUV-KK	EL	
			7.01870.06.0	SUV	EL	 M 270.920: Fahrgestellnummer bis: 10044275 Vehicle Identification Number to: 10044275 Produktionsdatum bis: 22.12.2015 Production date to: 22.12.2015  M 270.920: Fahrgestellnummer bis: 30786355 Vehicle Identification Number to: 30786355 Produktionsdatum bis: 03.08.2015 Production date to: 03.08.2015
			7.04818.04.0	SUV	EL	 M 270.920: Fahrgestellnummer ab: 10044275 Vehicle Identification Number from: 10044275 Produktionsdatum ab: 22.12.2015 Production date from: 22.12.2015  M 270.920: Fahrgestellnummer ab: 30786355 Vehicle Identification Number from: 30786355 Produktionsdatum ab: 03.08.2015 Production date from: 03.08.2015









M



B-CLASS Sports Tourer (W246, W242) 22

		7.01870.06.0	SUV	EL	 M 270.920: Fahrgestellnummer bis: 10044275 Vehicle Identification Number to: 10044275 Produktionsdatum bis: 22.12.2015 Production date to: 22.12.2015  M 270.920: Fahrgestellnummer bis: 30786355 Vehicle Identification Number to: 30786355 Produktionsdatum bis: 03.08.2015 Production date to: 03.08.2015
		7.04818.04.0	SUV	EL	 M 270.920: Fahrgestellnummer ab: 10044275 Vehicle Identification Number from: 10044275 Produktionsdatum ab: 22.12.2015 Production date from: 22.12.2015  M 270.920: Fahrgestellnummer ab: 30786355 Vehicle Identification Number from: 30786355 Produktionsdatum ab: 03.08.2015 Production date from: 03.08.2015































B-CLASS Sports Tourer (W247) 23

B 160 (247.082) 80-160 kW (109-218 PS) M 282.914	04.2019→	 7.04818.04.0	SUV	EL	für OE-Nummer: A 000 153 18 59, A 282 090 02 80 for OE number: A 000 153 18 59, A 282 090 02 80
B 180 (247.084) 80-160 kW (109-218 PS) M 282.914	12.2018→	 7.04818.04.0	SUV	EL	für OE-Nummer: A 000 153 18 59, A 282 090 02 80 for OE number: A 000 153 18 59, A 282 090 02 80
B 200 (247.087) 80-160 kW (109-218 PS) M 282.914	12.2018→	 7.04818.04.0	SUV	EL	für OE-Nummer: A 000 153 18 59, A 282 090 02 80 for OE number: A 000 153 18 59, A 282 090 02 80
B 200 (247.087) 80-160 kW (109-218 PS) M 282.914	01.2019→	 7.04818.04.0	SUV	EL	für OE-Nummer: A 000 153 18 59, A 282 090 02 80 for OE number: A 000 153 18 59, A 282 090 02 80
B 200 d (247.012) 84-235 kW (114-320 PS) OM 654.920	12.2018→	 7.02256.37.0	EUV-AGR	EL	Produktionsdatum bis: 15.12.2020 Production date to: 15.12.2020
B 200 d 4-matic (247.013) 84-235 kW (114-320 PS) OM 654.920	10.2019→	 7.02256.37.0	EUV-AGR	EL	Produktionsdatum bis: 15.12.2020 Production date to: 15.12.2020
B 220 d (247.014) 84-235 kW (114-320 PS) OM 654.920	12.2018→	 7.02256.37.0	EUV-AGR	EL	Produktionsdatum bis: 15.12.2020 Production date to: 15.12.2020
B 220 d 4-matic (247.015) 84-235 kW (114-320 PS) OM 654.920	10.2019→	 7.02256.37.0	EUV-AGR	EL	Produktionsdatum bis: 15.12.2020 Production date to: 15.12.2020
B 250 e (247.086) 80-160 kW (109-218 PS) M 282.914	06.2020→	 7.04818.04.0	SUV	EL	für OE-Nummer: A 000 153 18 59, A 282 090 02 80 for OE number: A 000 153 18 59, A 282 090 02 80
B 250 e (247.086) 80-160 kW (109-218 PS) M 282.914	06.2020→	 7.04818.04.0	SUV	EL	für OE-Nummer: A 000 153 18 59, A 282 090 02 80 for OE number: A 000 153 18 59, A 282 090 02 80

M









C-CLASS (W202) **24**

C 180 (202.018) 89-90 kW (121-122 PS) M 111.921	03.1993→05.2000		7.21071.50.0	EUV-LS	EP	
			7.06117.20.0	ZM-NWV	EL	PKW, Stufenheck/ Passenger car, notchback
C 180 (202.018) 90 kW (122 PS) M 111.920	03.1993→05.2000		7.21071.50.0	EUV-LS	EP	
C 180 (202.018) 89-90 kW (121-122 PS) M 111.921	11.1994→05.2000		7.21071.50.0	EUV-LS	EP	
			7.06117.20.0	ZM-NWV	EL	PKW, Stufenheck/ Passenger car, notchback
C 200 (202.020) 100 kW (136 PS) M 111.941	01.1994→05.2000		7.21071.50.0	EUV-LS	EP	
C 200 (202.020) 100 kW (136 PS) M 111.945	01.1994→05.2000		7.21071.50.0	EUV-LS	EP	
			7.06117.20.0	ZM-NWV	EL	PKW, Stufenheck/ Passenger car, notchback
C 200 D (202.122) 65-85 kW (88-116 PS) OM 604.915	10.1996→05.2000		7.02256.37.0	EUV-AGR	EL	 ch. A 436536→ Stufenheck Saloon
C 200 Kompressor (202.025) 132-141 kW (180-192 PS) M 111.944	10.1995→05.2000		7.06117.20.0	ZM-NWV	EL	 000018→  005591→
			7.06117.20.0	ZM-NWV	EL	 000018→  005591→
C 220 (202.022) 110 kW (150 PS) M 111.961	03.1993→05.2000		7.21071.50.0	EUV-LS	EP	
			7.06117.20.0	ZM-NWV	EL	PKW, Stufenheck/ Passenger car, notchback
C 220 CDI (202.133) 75-92 kW (102-125 PS) OM 611.960	09.1997→05.2000		7.02256.37.0	EUV-AGR	EL	 ch. A 436536→ Stufenheck Saloon
C 220 D (202.021) 55-70 kW (75-95 PS) OM 604.910	07.1996→05.2000		7.02256.37.0	EUV-AGR	EL	 ch. A 436536→ Stufenheck Saloon
C 220 D (202.121) 55-70 kW (75-95 PS) OM 604.910	08.1993→05.2000		7.02256.37.0	EUV-AGR	EL	 ch. A 436536→ Stufenheck Saloon
			7.21071.50.0	EUV-LS	EP	
C 230 (202.023) 110 kW (150 PS) M 111.974	06.1996→06.1997		7.21071.50.0	EUV-LS	EP	
			7.06117.20.0	ZM-NWV	EL	PKW, Stufenheck/ Passenger car, notchback
C 230 (202.024) 138-142 kW (188-193 PS) M 111.975	09.1998→05.2000		7.06117.20.0	ZM-NWV	EL	 000268→  005591→
C 230 Kompressor (202.024) 138-142 kW (188-193 PS) M 111.975	10.1995→05.2000		7.06117.20.0	ZM-NWV	EL	PKW, Stufenheck/ Passenger car, notchback  000268→  005591→
			7.02256.37.0	EUV-SL	EL	
C 240 (202.026) 125 kW (170 PS) M 112.910	06.1997→05.2000		7.22355.01.0	EUV-SR	EL	
			7.02256.37.0	EUV-AGR	EL	 ch. F 483848→ Kombi Estate
C 250 D (202.125) 83 kW (113 PS) OM 605.910	05.1993→05.2000		7.21071.50.0	EUV-LS	EP	
C 250 Turbo-D (202.128) 110 kW (150 PS) OM 605.960	10.1995→05.2000		7.02256.37.0	EUV-AGR	EL	 ch. F 483848→ Kombi Estate
			7.21071.50.0	EUV-LS	EP	

















M



C-CLASS (W202) 24

C 280 (202.028) 142 kW (193 PS) M 104.941	05.1993→05.2000		7.21071.50.0	EUV-LS	EP	PKW, Stufenheck/ Passenger car, notchback
			7.21071.50.0	EUV-SL	EP	
			7.06117.20.0	ZM-NWV	EL	
C 280 (202.029) 145-150 kW (197-204 PS) M 112.920	06.1997→05.2000		7.21071.50.0	EUV-LS	EP	
			7.02256.37.0	EUV-SL	EL	
			7.22355.01.0	EUV-SR	EL	
C 36 AMG (202.028) 200-206 kW (272-280 PS) M 104.941 (AMG 3.6)	05.1994→05.2000		7.21071.50.0	EUV-LS	EP	
			7.21071.50.0	EUV-SL	EP	
			7.06117.20.0	ZM-NWV	EL	
C 36 AMG (202.028) 200-206 kW (272-280 PS) M 104.941 (AMG 3.6)	09.1994→12.1996		7.21071.50.0	EUV-SL	EP	
			7.22355.01.0	EUV-SR	EL	
C 43 AMG (202.033) 205-225 kW (279-306 PS) M 113.944	08.1997→05.2000		7.21071.50.0	EUV-LS	EP	
			7.02256.37.0	EUV-SL	EL	
C 43 AMG (202.033) 205-225 kW (279-306 PS) M 113.944	09.1997→12.1998		7.02256.37.0	EUV-SL	EL	
			7.22355.01.0	EUV-SR	EL	
C 43 AMG (202.033) 205-225 kW (279-306 PS) M 113.944	08.1997→05.2000		7.21071.50.0	EUV-LS	EP	
			7.02256.37.0	EUV-SL	EL	
			7.22355.01.0	EUV-SR	EL	











C-CLASS (W203) 25

3.5 (203.056) 170-200 kW (231-272 PS) M 272.960	01.2005→02.2007		7.22355.01.0	EUV-SR	EL	
			7.06117.60.0	ZM-NWV	EL	
C 180 (203.035) 95 kW (129 PS) M 111.951	10.2000→05.2002		7.02256.37.0	EUV-SL	EL	
			7.06117.21.0	ZM-NWV	EL	
C 180 Kompressor (203.046) 105-125 kW (143-170 PS) M 271.946	05.2002→02.2007		7.06117.24.0	ZM-NWV	EL	 mit Dichtring with O-ring
			7.06117.24.0	ZM-NWV	EL	 mit Dichtring with O-ring
C 200 CGI Kompressor (203.043) 125 kW (170 PS) M 271.942	07.2003→02.2007		7.06117.24.0	ZM-NWV	EL	 mit Dichtring with O-ring
			7.06117.24.0	ZM-NWV	EL	 mit Dichtring with O-ring
C 200 Kompressor (203.042) 120 kW (163 PS) M 271.940	05.2002→02.2007		7.06117.24.0	ZM-NWV	EL	 mit Dichtring with O-ring
			7.06117.21.0	ZM-NWV	EL	mit Trag-/Führungsgelenk With support/ steering link
C 200 Kompressor (203.045) 120 kW (163 PS) M 111.955	05.2000→06.2002		7.06117.21.0	ZM-NWV	EL	mit Trag-/Führungsgelenk With support/ steering link
			7.06117.21.0	ZM-NWV	EL	mit Trag-/Führungsgelenk With support/ steering link
C 230 (203.052) 150 kW (204 PS) M 272.920	01.2005→02.2007		7.22355.01.0	EUV-SR	EL	
			7.06117.60.0	ZM-NWV	EL	
C 230 Kompressor (203.040) 141 kW (192 PS) M 271.948	02.2004→02.2007		7.06117.24.0	ZM-NWV	EL	 mit Dichtring with O-ring
			7.06117.24.0	ZM-NWV	EL	 mit Dichtring with O-ring
C 240 (203.061) 120-125 kW (163-170 PS) M 112.912	05.2000→02.2007		7.02256.37.0	EUV-SL	EL	
			7.02256.37.0	EUV-SL	EL	

M



C-CLASS (W203) 25

					
C 240 4-matic (203.081) 125 kW (170 PS) M 112.916	07.2002→02.2007		7.22355.01.0 7.02256.37.0	EUV-SR EUV-SL	EL EL
C 280 (203.054) 170 kW (231 PS) M 272.940	01.2005→02.2007		7.22355.01.0 7.06117.60.0	EUV-SR ZM-NWV	EL EL mit Dichtring with O-ring
C 280 4-matic (203.092) 170 kW (231 PS) M 272.941	01.2005→02.2007		7.22355.01.0 7.06117.60.0	EUV-SR ZM-NWV	EL EL mit Dichtring with O-ring
C 32 AMG Kompressor (203.065) 260 kW (354 PS) M 112.961	02.2001→02.2007		7.02256.37.0	EUV-SL	EL
C 320 (203.064) 160 kW (218 PS) M 112.946	05.2000→02.2007		7.02256.37.0	EUV-SL	EL
C 320 4-matic (203.084) 160 kW (218 PS) M 112.953	07.2002→02.2007		7.02256.37.0 7.22355.01.0	EUV-SL EUV-SR	EL EL
C 350 (203.056) 170-200 kW (231-272 PS) M 272.960	01.2005→02.2007		7.22355.01.0 7.06117.60.0	EUV-SR ZM-NWV	EL EL mit Dichtring with O-ring
C 350 4-matic (203.087) 170-200 kW (231-272 PS) M 272.960	01.2005→02.2007		7.22355.01.0	EUV-SR	EL
C 350 4-matic (203.087) 200 kW (272 PS) M 272.970	01.2005→02.2007		7.22355.01.0 7.06117.60.0	EUV-SR ZM-NWV	EL EL mit Dichtring with O-ring
C 55 AMG 260-270 kW (354-367 PS) M 113.988	09.2004→12.2005		7.02256.37.0 7.22355.01.0	EUV-SL EUV-SR	EL EL
C 55 AMG (203.076) 260-270 kW (354-367 PS) M 113.988	02.2004→02.2007		7.02256.37.0 7.22355.01.0	EUV-SL EUV-SR	EL EL















M

C-CLASS (W204) 26

C 180 CDI (204.000) 88-105 kW (120-143 PS) OM 651.913	04.2010→03.2014		7.00782.12.0 7.02256.37.0 7.02256.37.0	DW-TL EUV-VB EUV-WP	EP EL EL
C 180 CGI (204.031) 95-115 kW (129-156 PS) M 274.910	01.2008→01.2014		7.00782.16.0 7.04818.04.0	DW-TL SUV	EP EL
C 180 CGI (204.049) 115-137 kW (156-186 PS) M 271.820	01.2007→01.2014		7.00017.03.0 7.01870.06.0	LDRV SUV	EP EL







C-CLASS (W204) 26

C 180 Kompressor (204.044, 204.045) 105-115 kW (143-156 PS) M 271.910	01.2008→01.2014	 7.06117.24.0	ZM-NWV	EL	 mit Dichtring with O-ring
C 180 Kompressor (204.046) 115 kW (156 PS) M 271.952	01.2007→01.2014	 7.06117.24.0	ZM-NWV	EL	 mit Dichtring with O-ring
C 200 (204.048) 115-137 kW (156-186 PS) M 271.820	05.2011→01.2014	 7.01870.06.0	SUV	EL	
C 200 CDI (204.001) 88-105 kW (120-143 PS) OM 651.913	11.2009→03.2014	 7.00782.12.0	DW-TL	EP	
		7.02256.37.0	EUV-VB	EL	
		7.02256.37.0	EUV-WP	EL	
C 200 CGI (204.048) 115-150 kW (156-204 PS) M 271.820, M 271.860	01.2007→01.2014	 7.00017.03.0	LDRV	EP	
		7.01870.06.0	SUV	EL	
C 200 Kompressor (204.041) 120-135 kW (163-184 PS) M 271.950	01.2007→01.2014	 7.06117.24.0	ZM-NWV	EL	 mit Dichtring with O-ring
C 220 CDI (204.002) 120-150 kW (163-204 PS) OM 651.911	10.2008→01.2014	 7.00782.12.0	DW-TL	EP	
		7.02256.37.0	EUV-VB	EL	
		7.02256.37.0	EUV-WP	EL	
C 220 CDI (204.002) 120-150 kW (163-204 PS) OM 651.911	12.2008→01.2014	 7.00782.12.0	DW-TL	EP	
		7.02256.37.0	EUV-VB	EL	
		7.02256.37.0	EUV-WP	EL	
C 220 CDI 4-matic (204.084) 120-150 kW (163-204 PS) OM 651.912	02.2013→01.2014	 7.00782.12.0	DW-TL	EP	
		7.02256.37.0	EUV-WP	EL	
C 230 (204.052) 150 kW (204 PS) M 272.921	01.2007→01.2014	 7.22355.01.0	EUV-SR	EL	
		7.06117.60.0	ZM-NWV	EL	mit Dichtring with O-ring
C 230 4-matic (204.085) 150 kW (204 PS) M 272.911	07.2007→01.2014	 7.22355.01.0	EUV-SR	EL	
		7.06117.60.0	ZM-NWV	EL	mit Dichtring with O-ring
C 250 CDI (204.003) 120-150 kW (163-204 PS) OM 651.911	08.2008→01.2014	 7.00782.12.0	DW-TL	EP	
		7.02256.37.0	EUV-VB	EL	
		7.02256.37.0	EUV-WP	EL	
C 250 CDI 4-matic (204.082) 120-150 kW (163-204 PS) OM 651.912	01.2011→01.2014	 7.00782.12.0	DW-TL	EP	
		7.02256.37.0	EUV-WP	EL	
C 250 CGI (204.047) 135-150 kW (184-204 PS) M 271.860	07.2009→01.2014	 7.00017.03.0	LDRV	EP	
		7.01870.06.0	SUV	EL	



M



C-CLASS (W204) 26

C 280 (204.054) 170 kW (231 PS) M 272.947	01.2007→01.2014		7.22355.01.0	EUV-SR	EL	
			7.06117.60.0	ZM-NWV	EL	mit Dichtring with O-ring
C 280 4-matic (204.081) 170 kW (231 PS) M 272.948	07.2007→01.2014		7.22355.01.0	EUV-SR	EL	
			7.06117.60.0	ZM-NWV	EL	mit Dichtring with O-ring
C 300 (204.054) 170 kW (231 PS) M 272.947	07.2009→01.2014		7.22355.01.0	EUV-SR	EL	
			7.06117.60.0	ZM-NWV	EL	mit Dichtring with O-ring
C 300 4-matic (204.081) 170 kW (231 PS) M 272.948	07.2007→01.2014		7.22355.01.0	EUV-SR	EL	
			7.06117.60.0	ZM-NWV	EL	mit Dichtring with O-ring
C 350 (204.056) 200 kW (272 PS) M 272.961	01.2007→01.2014		7.22355.01.0	EUV-SR	EL	
			7.06117.60.0	ZM-NWV	EL	mit Dichtring with O-ring
C 350 4-matic (204.087) 200 kW (272 PS) M 272.971	07.2007→01.2014		7.22355.01.0	EUV-SR	EL	
			7.06117.60.0	ZM-NWV	EL	mit Dichtring with O-ring
M C 350 CGI (204.065) 215 kW (292 PS) M 272.982	09.2008→01.2014		7.22355.01.0	EUV-SR	EL	
			7.06117.60.0	ZM-NWV	EL	mit Dichtring with O-ring
C 63 AMG (204.077) 336-410 kW (457-558 PS) M 156.985	02.2008→01.2014		7.02256.37.0	EUV-SL	EL	
			7.22355.01.0	EUV-SR	EL	
C 63 AMG (204.077) 336-410 kW (457-558 PS) M 156.985	02.2008→01.2014		7.02256.37.0	EUV-SL	EL	
			7.22355.01.0	EUV-SR	EL	
C 63 AMG (204.077) 336-410 kW (457-558 PS) M 156.985	02.2008→01.2014		7.02256.37.0	EUV-SL	EL	
			7.22355.01.0	EUV-SR	EL	

C-CLASS (W205) 27













AMG C 43 4-matic (205.064) 200-295 kW (272-401 PS) M 276.823	04.2016→05.2018		7.00782.11.0	DW-TL	EP	
			7.01870.06.0	SUV	EL	
AMG C 43 4-matic (205.064) 200-295 kW (272-401 PS) M 276.823	05.2018→		7.00782.11.0	DW-TL	EP	
			7.01870.06.0	SUV	EL	
AMG C 63 (205.086) 350-470 kW (476-639 PS) M 177.980	10.2014→		7.00782.16.0	DW-TL	EP	
			7.04927.08.0	SUV	EL	Ladeluftkühler Intercooler



C-CLASS (W205) 27

AMG C 63 S (205.087) 350-470 kW (476-639 PS) M 177.980	10.2014→		7.00782.16.0	DW-TL	EP	
			7.04927.08.0	SUV	EL	
C 160 (205.044) 95-115 kW (129-156 PS) M 274.910	04.2015→		7.00782.16.0	DW-TL	EP	
			7.04818.04.0	SUV	EL	
C 180 (205.040) 95-115 kW (129-156 PS) M 274.910	10.2018→		7.00782.16.0	DW-TL	EP	
			7.04818.04.0	SUV	EL	
C 180 (205.040, 205.140) 95-115 kW (129-156 PS) M 274.910	03.2014→		7.00782.16.0	DW-TL	EP	
			7.04818.04.0	SUV	EL	
C 180 BlueTEC / d (205.036) 85-100 kW (116-136 PS) OM 626.951	05.2014→05.2018		7.01814.12.0	DW-TL	EP	
C 180 Flex (205.040) 95-115 kW (129-156 PS) M 274.910	03.2014→		7.00782.16.0	DW-TL	EP	
			7.04818.04.0	SUV	EL	
C 180 d (205.000) 90-118 kW (122-160 PS) OM 654.916	05.2018→		7.02256.37.0	EUV-AGR	EL	Produktionsdatum bis: 15.12.2020 Production date to: 15.12.2020
C 200 (205.042) 115-245 kW (156-333 PS) M 274.920	12.2013→08.2018		7.00782.16.0	DW-TL	EP	
			7.02256.37.0	EUV-WP	EL	
			7.04818.04.0	SUV	EL	
C 200 4-matic (205.043) 115-245 kW (156-333 PS) M 274.920	04.2015→08.2018		7.00782.16.0	DW-TL	EP	
			7.02256.37.0	EUV-WP	EL	
			7.04818.04.0	SUV	EL	
C 200 BlueTEC / d (205.037) 85-100 kW (116-136 PS) OM 626.951	05.2014→05.2018		7.01814.12.0	DW-TL	EP	
C 200 EQ Boost (205.077) 95-145 kW (129-197 PS) M 264.915	04.2018→		7.04927.08.0	SUV	EL	Ladeluftkühler Intercooler
C 200 EQ Boost 4-matic (205.078) 95-145 kW (129-197 PS) M 264.915	04.2018→		7.04927.08.0	SUV	EL	Ladeluftkühler Intercooler
C 200 d (205.001) 90-118 kW (122-160 PS) OM 654.916	05.2018→		7.02256.37.0	EUV-AGR	EL	Produktionsdatum bis: 15.12.2020 Production date to: 15.12.2020
C 200 d (205.007) 100-150 kW (136-204 PS) OM 651.921	10.2015→05.2018		7.00782.12.0	DW-TL	EP	
			7.02256.37.0	EUV-VB	EL	
			7.02256.37.0	EUV-WP	EL	
C 200 d (205.011) 84-235 kW (114-320 PS) OM 654.920	05.2018→		7.02256.37.0	EUV-AGR	EL	Produktionsdatum bis: 15.12.2020 Production date to: 15.12.2020

M

					
C-CLASS (W205)					
C 220 BlueTEC / d (205.002, 205.004) 100-150 kW (136-204 PS) OM 651.921	02.2014→05.2018		7.00782.12.0	DW-TL	EP
			7.02256.37.0	EUV-VB	EL
C 220 BlueTEC / d (205.003) 100-150 kW (136-204 PS) OM 651.921	03.2014→05.2016		7.00782.12.0	DW-TL	EP
			7.02256.37.0	EUV-VB	EL
C 220 d (205.014) 84-235 kW (114-320 PS) OM 654.920	05.2018→		7.02256.37.0	EUV-AGR	EL
					Produktionsdatum bis: 15.12.2020 Production date to: 15.12.2020
C 220 d 4-matic (205.005) 100-150 kW (136-204 PS) OM 651.921	04.2015→05.2018		7.00782.12.0	DW-TL	EP
			7.02256.37.0	EUV-VB	EL
C 220 d 4-matic (205.015) 84-235 kW (114-320 PS) OM 654.920	05.2018→		7.02256.37.0	EUV-AGR	EL
					Produktionsdatum bis: 15.12.2020 Production date to: 15.12.2020
C 250 (205.045) 115-245 kW (156-333 PS) M 274.920	03.2014→05.2018		7.00782.16.0	DW-TL	EP
			7.02256.37.0	EUV-WP	EL
C 250 BlueTEC / d (205.008, 205.006) 100-150 kW (136-204 PS) OM 651.921	02.2014→05.2018		7.04818.04.0	SUV	EL
			7.00782.12.0	DW-TL	EP
C 250 BlueTEC / d 4-matic (205.009) 100-150 kW (136-204 PS) OM 651.921	02.2014→05.2018		7.02256.37.0	EUV-VB	EL
			7.02256.37.0	EUV-WP	EL
C 300 (205.048) 115-245 kW (156-333 PS) M 274.920	09.2015→08.2018		7.00782.16.0	DW-TL	EP
			7.02256.37.0	EUV-WP	EL
C 300 (205.083) 145-220 kW (197-299 PS) M 264.920	05.2018→		7.04818.04.0	SUV	EL
			7.04927.08.0	SUV	EL
C 300 4-matic (205.049) 115-245 kW (156-333 PS) M 274.920	12.2013→08.2018		7.00782.16.0	DW-TL	EP
			7.02256.37.0	EUV-WP	EL
C 300 BlueTEC Hybrid / h (205.012) 100-150 kW (136-204 PS) OM 651.921	05.2014→05.2018		7.04818.04.0	SUV	EL
			7.00782.12.0	DW-TL	EP
			7.02256.37.0	EUV-VB	EL
			7.02256.37.0	EUV-WP	EL

M





C-CLASS (W205) 27

C 300 d (205.018) 84-235 kW (114-320 PS) OM 654.920	06.2018→		7.02256.37.0	EUV-AGR	EL	Produktionsdatum bis: 15.12.2020 Production date to: 15.12.2020
C 300 d 4-matic (205.019) 84-235 kW (114-320 PS) OM 654.920	06.2018→		7.02256.37.0	EUV-AGR	EL	Produktionsdatum bis: 15.12.2020 Production date to: 15.12.2020
C 300 de (205.013) 84-235 kW (114-320 PS) OM 654.920	05.2019→		7.02256.37.0	EUV-AGR	EL	Produktionsdatum bis: 15.12.2020 Production date to: 15.12.2020
C 300 de (205.013) 84-235 kW (114-320 PS) OM 654.920	05.2019→		7.02256.37.0	EUV-AGR	EL	Produktionsdatum bis: 15.12.2020 Production date to: 15.12.2020
C 300 e (205.053) 115-245 kW (156-333 PS) M 274.920	07.2019→		7.00782.16.0	DW-TL	EP	
			7.02256.37.0	EUV-WP	EL	
			7.04818.04.0	SUV	EL	
C 300 e (205.053) 115-245 kW (156-333 PS) M 274.920	07.2019→		7.00782.16.0	DW-TL	EP	
			7.02256.37.0	EUV-WP	EL	
			7.04818.04.0	SUV	EL	
C 300 e 4-matic (205.054) 115-245 kW (156-333 PS) M 274.920	07.2019→		7.00782.16.0	DW-TL	EP	
			7.02256.37.0	EUV-WP	EL	
			7.04818.04.0	SUV	EL	
C 300 e 4-matic (205.054) 115-245 kW (156-333 PS) M 274.920	07.2019→		7.00782.16.0	DW-TL	EP	
C 350 e (205.047) 115-245 kW (156-333 PS) M 274.920	02.2015→08.2018		7.00782.16.0	DW-TL	EP	
			7.02256.37.0	EUV-WP	EL	
			7.04818.04.0	SUV	EL	
C 350 e (205.047) 115-245 kW (156-333 PS) M 274.920	02.2015→08.2018		7.00782.16.0	DW-TL	EP	
			7.02256.37.0	EUV-WP	EL	
			7.04818.04.0	SUV	EL	
C 400 4-matic (205.066) 200-295 kW (272-401 PS) M 276.823	10.2014→		7.00782.11.0	DW-TL	EP	
			7.01870.06.0	SUV	EL	
C 450 AMG 4-matic (205.064) 200-295 kW (272-401 PS) M 276.823	04.2015→05.2018		7.00782.11.0	DW-TL	EP	
			7.01870.06.0	SUV	EL	

M













C-CLASS Convertible (A205) 28

AMG C 43 4-matic (205.464) 200-295 kW (272-401 PS) M 276.823	10.2016→05.2018		7.00782.11.0	DW-TL	EP	
			7.01870.06.0	SUV	EL	
AMG C 43 4-matic (205.464) 200-295 kW (272-401 PS) M 276.823	05.2018→		7.00782.11.0	DW-TL	EP	
			7.01870.06.0	SUV	EL	



C-CLASS Convertible (A205)

28







AMG C 63 (205.486) 350-470 kW (476-639 PS) M 177.980	10.2016→		7.00782.16.0	DW-TL	EP	
			7.04927.08.0	SUV	EL	Ladeluftkühler Intercooler
AMG C 63 S (205.487) 350-470 kW (476-639 PS) M 177.980	10.2016→		7.00782.16.0	DW-TL	EP	
			7.04927.08.0	SUV	EL	Ladeluftkühler Intercooler
C 180 (205.440) 95-115 kW (129-156 PS) M 274.910	06.2016→		7.00782.16.0	DW-TL	EP	
			7.04818.04.0	SUV	EL	
C 200 (205.442) 115-245 kW (156-333 PS) M 274.920	06.2016→05.2018		7.00782.16.0	DW-TL	EP	
			7.02256.37.0	EUV-WP	EL	
			7.04818.04.0	SUV	EL	
C 200 4-matic (205.443) 115-245 kW (156-333 PS) M 274.920	06.2016→05.2018		7.00782.16.0	DW-TL	EP	
			7.02256.37.0	EUV-WP	EL	
			7.04818.04.0	SUV	EL	
C 200 EQ Boost (205.477) 95-145 kW (129-197 PS) M 264.915	05.2018→		7.04927.08.0	SUV	EL	Ladeluftkühler Intercooler
			7.04927.08.0	SUV	EL	Ladeluftkühler Intercooler
C 200 d (205.401) 90-118 kW (122-160 PS) OM 654.916	07.2018→		7.02256.37.0	EUV-AGR	EL	Produktionsdatum bis: 15.12.2020 Production date to: 15.12.2020
			7.02256.37.0	EUV-VB	EL	
C 220 d (205.404) 100-150 kW (136-204 PS) OM 651.921	06.2016→05.2018		7.00782.12.0	DW-TL	EP	
			7.02256.37.0	EUV-VB	EL	
			7.02256.37.0	EUV-WP	EL	
C 220 d (205.404) 100-150 kW (136-204 PS) OM 651.921	06.2016→05.2018		7.00782.12.0	DW-TL	EP	
			7.02256.37.0	EUV-VB	EL	
			7.02256.37.0	EUV-WP	EL	
C 220 d (205.414) 84-235 kW (114-320 PS) OM 654.920	04.2018→		7.02256.37.0	EUV-AGR	EL	Produktionsdatum bis: 15.12.2020 Production date to: 15.12.2020
			7.02256.37.0	EUV-AGR	EL	Produktionsdatum bis: 15.12.2020 Production date to: 15.12.2020
C 220 d 4-matic (205.405) 100-150 kW (136-204 PS) OM 651.921	06.2016→05.2018		7.00782.12.0	DW-TL	EP	
			7.02256.37.0	EUV-VB	EL	
			7.02256.37.0	EUV-WP	EL	
C 220 d 4-matic (205.415) 84-235 kW (114-320 PS) OM 654.920	06.2018→		7.02256.37.0	EUV-AGR	EL	Produktionsdatum bis: 15.12.2020 Production date to: 15.12.2020
			7.02256.37.0	EUV-AGR	EL	Produktionsdatum bis: 15.12.2020 Production date to: 15.12.2020
C 250 (205.445) 115-245 kW (156-333 PS) M 274.920	06.2016→05.2018		7.00782.16.0	DW-TL	EP	
			7.02256.37.0	EUV-WP	EL	
			7.04818.04.0	SUV	EL	



C-CLASS Convertible (A205) 28





C 250 d (205.408) 100-150 kW (136-204 PS) OM 651.921	06.2016→05.2018		7.00782.12.0	DW-TL	EP	
			7.02256.37.0	EUV-VB	EL	
C 300 (205.448) 115-245 kW (156-333 PS) M 274.920	06.2016→05.2018		7.00782.16.0	DW-TL	EP	
			7.02256.37.0	EUV-WP	EL	
C 300 (205.483) 145-220 kW (197-299 PS) M 264.920	05.2018→		7.04927.08.0	SUV	EL	Ladeluftkühler Intercooler
C 300 4-matic (205.449) 115-245 kW (156-333 PS) M 274.920	01.2017→12.2018		7.00782.16.0	DW-TL	EP	
			7.02256.37.0	EUV-WP	EL	
C 300 d (205.418) 84-235 kW (114-320 PS) OM 654.920	07.2018→		7.02256.37.0	EUV-AGR	EL	Produktionsdatum bis: 15.12.2020 Production date to: 15.12.2020
C 400 4-matic (205.466) 200-295 kW (272-401 PS) M 276.823	06.2016→		7.00782.11.0	DW-TL	EP	
			7.01870.06.0	SUV	EL	

C-CLASS Coupe (C204) 29

C 180 (204.331) 95-115 kW (129-156 PS) M 274.910	01.2013→		7.00782.16.0	DW-TL	EP	
			7.04818.04.0	SUV	EL	
C 180 (204.349) 115-137 kW (156-186 PS) M 271.820	06.2011→		7.00017.03.0	LDRV	EP	
			7.01870.06.0	SUV	EL	
C 200 CGI (204.348) 135-150 kW (184-204 PS) M 271.860	06.2011→		7.00017.03.0	LDRV	EP	
			7.01870.06.0	SUV	EL	
C 220 CDI (204.302) 120-150 kW (163-204 PS) OM 651.911	06.2011→		7.00782.12.0	DW-TL	EP	
			7.02256.37.0	EUV-VB	EL	Produktionsdatum bis: 14.12.2020 Production date to: 14.12.2020
			7.02256.37.0	EUV-WP	EL	Produktionsdatum bis: 14.12.2020 Production date to: 14.12.2020
C 220 CDI (204.302) 120-150 kW (163-204 PS) OM 651.911	06.2011→		7.00782.12.0	DW-TL	EP	
			7.02256.37.0	EUV-VB	EL	Produktionsdatum bis: 14.12.2020 Production date to: 14.12.2020
			7.02256.37.0	EUV-WP	EL	Produktionsdatum bis: 14.12.2020 Production date to: 14.12.2020
C 250 (204.347) 135-150 kW (184-204 PS) M 271.860	06.2011→		7.00017.03.0	LDRV	EP	
			7.01870.06.0	SUV	EL	
C 250 CDI (204.303) 120-150 kW (163-204 PS) OM 651.911	06.2011→		7.00782.12.0	DW-TL	EP	







C-CLASS Coupe (C204) **29**

			7.02256.37.0	EUV-VB	EL	
			7.02256.37.0	EUV-WP	EL	
C 63 AMG (204.377) 336-410 kW (457-558 PS) M 156.985	06.2011→		7.02256.37.0	EUV-SL	EL	
			7.22355.01.0	EUV-SR	EL	
C 63 AMG (204.377) 336-410 kW (457-558 PS) M 156.985	01.2012→		7.02256.37.0	EUV-SL	EL	
			7.22355.01.0	EUV-SR	EL	
C 63 AMG (204.377) 336-410 kW (457-558 PS) M 156.985	01.2012→		7.02256.37.0	EUV-SL	EL	
			7.22355.01.0	EUV-SR	EL	
C 63 AMG (204.377) 336-410 kW (457-558 PS) M 156.985	09.2012→		7.02256.37.0	EUV-SL	EL	
C 63 AMG (204.377) 336-410 kW (457-558 PS) M 156.985	11.2012→		7.02256.37.0	EUV-SL	EL	
			7.22355.01.0	EUV-SR	EL	















C-CLASS Coupe (C205) **30**

M

AMG C 43 4-matic (205.364) 200-295 kW (272-401 PS) M 276.823	04.2016→05.2018		7.00782.11.0	DW-TL	EP	
			7.01870.06.0	SUV	EL	
AMG C 43 4-matic (205.364) 200-295 kW (272-401 PS) M 276.823	05.2018→		7.00782.11.0	DW-TL	EP	
			7.01870.06.0	SUV	EL	
AMG C 63 (205.386) 350-470 kW (476-639 PS) M 177.980	02.2016→		7.00782.16.0	DW-TL	EP	
			7.04927.08.0	SUV	EL	Ladeluftkühler Intercooler
AMG C 63 S (205.387) 350-470 kW (476-639 PS) M 177.980	02.2016→		7.00782.16.0	DW-TL	EP	
			7.04927.08.0	SUV	EL	Ladeluftkühler Intercooler
C 180 (205.340) 95-115 kW (129-156 PS) M 274.910	10.2015→		7.00782.16.0	DW-TL	EP	
			7.04818.04.0	SUV	EL	
C 180 (205.340) 95-115 kW (129-156 PS) M 274.910	11.2018→		7.00782.16.0	DW-TL	EP	
			7.04818.04.0	SUV	EL	
C 200 (205.342) 115-245 kW (156-333 PS) M 274.920	10.2015→05.2018		7.00782.16.0	DW-TL	EP	
			7.02256.37.0	EUV-WP	EL	
			7.04818.04.0	SUV	EL	
C 200 4-matic (205.343) 115-245 kW (156-333 PS) M 274.920	04.2016→05.2018		7.00782.16.0	DW-TL	EP	
			7.02256.37.0	EUV-WP	EL	
			7.04818.04.0	SUV	EL	























C-CLASS Coupe (C205) 30

C 200 EQ Boost (205.377) 95-145 kW (129-197 PS) M 264.915	05.2018→		7.04927.08.0	SUV	EL	Ladeluftkühler Intercooler
C 200 EQ Boost 4-matic (205.378) 95-145 kW (129-197 PS) M 264.915	05.2018→		7.04927.08.0	SUV	EL	Ladeluftkühler Intercooler
C 200 d (205.301) 90-118 kW (122-160 PS) OM 654.916	07.2018→		7.02256.37.0	EUV-AGR	EL	Produktionsdatum bis: 15.12.2020 Production date to: 15.12.2020
C 220 d (205.304) 100-150 kW (136-204 PS) OM 651.921	10.2015→05.2018		7.00782.12.0	DW-TL	EP	
			7.02256.37.0	EUV-VB	EL	
			7.02256.37.0	EUV-WP	EL	
C 220 d (205.304) 100-150 kW (136-204 PS) OM 651.921	10.2015→05.2018		7.00782.12.0	DW-TL	EP	
			7.02256.37.0	EUV-VB	EL	
			7.02256.37.0	EUV-WP	EL	
C 220 d (205.314) 84-235 kW (114-320 PS) OM 654.920	04.2018→		7.02256.37.0	EUV-AGR	EL	Produktionsdatum bis: 15.12.2020 Production date to: 15.12.2020
C 220 d 4-matic (205.305) 100-150 kW (136-204 PS) OM 651.921	04.2016→05.2018		7.00782.12.0	DW-TL	EP	
			7.02256.37.0	EUV-VB	EL	
			7.02256.37.0	EUV-WP	EL	
C 220 d 4-matic (205.315) 84-235 kW (114-320 PS) OM 654.920	06.2018→		7.02256.37.0	EUV-AGR	EL	Produktionsdatum bis: 15.12.2020 Production date to: 15.12.2020
C 250 (205.345) 115-245 kW (156-333 PS) M 274.920	10.2015→05.2018		7.00782.16.0	DW-TL	EP	
			7.02256.37.0	EUV-WP	EL	
			7.04818.04.0	SUV	EL	
C 250 d (205.308) 100-150 kW (136-204 PS) OM 651.921	10.2015→05.2018		7.00782.12.0	DW-TL	EP	
			7.02256.37.0	EUV-VB	EL	
			7.02256.37.0	EUV-WP	EL	
C 250 d 4-matic (205.309) 100-150 kW (136-204 PS) OM 651.921	04.2016→05.2018		7.00782.12.0	DW-TL	EP	
			7.02256.37.0	EUV-VB	EL	
			7.02256.37.0	EUV-WP	EL	
C 300 (205.348) 115-245 kW (156-333 PS) M 274.920	10.2015→12.2018		7.00782.16.0	DW-TL	EP	
			7.02256.37.0	EUV-WP	EL	
			7.04818.04.0	SUV	EL	
C 300 (205.383) 145-220 kW (197-299 PS) M 264.920	05.2018→		7.04927.08.0	SUV	EL	Ladeluftkühler Intercooler
C 300 4-matic (205.349) 115-245 kW (156-333 PS) M 274.920	09.2016→12.2018		7.00782.16.0	DW-TL	EP	
			7.02256.37.0	EUV-WP	EL	
			7.04818.04.0	SUV	EL	

M



C-CLASS Coupe (C205)						30
C 300 d (205.318) 84-235 kW (114-320 PS) OM 654.920	07.2018→		7.02256.37.0	EUV-AGR	EL	Produktionsdatum bis: 15.12.2020 Production date to: 15.12.2020
C 300 d 4-matic (205.319) 84-235 kW (114-320 PS) OM 654.920	07.2018→		7.02256.37.0	EUV-AGR	EL	Produktionsdatum bis: 15.12.2020 Production date to: 15.12.2020
C 400 4-matic (205.366) 200-295 kW (272-401 PS) M 276.823	04.2016→		7.00782.11.0	DW-TL	EP	
			7.01870.06.0	SUV	EL	

















C-CLASS Coupe (CL203)						31
C 160 Kompressor (203.730) 90-95 kW (122-129 PS) M 271.921	05.2002→05.2008		7.06117.24.0	ZM-NWV	EL	 mit Dichtring with O-ring
C 180 (203.735) 95 kW (129 PS) M 111.951	03.2001→05.2002		7.02256.37.0	EUV-SL	EL	
			7.06117.21.0	ZM-NWV	EL	mit Trag-/Führungsgelenk With support/ steering link
C 180 Kompressor (203.746) 105-125 kW (143-170 PS) M 271.946	05.2002→05.2008		7.06117.24.0	ZM-NWV	EL	 mit Dichtring with O-ring
C 200 CGI Kompressor (203.743) 125 kW (170 PS) M 271.942	03.2003→05.2008		7.06117.24.0	ZM-NWV	EL	 mit Dichtring with O-ring
C 200 Kompressor (203.742) 120 kW (163 PS) M 271.940	05.2002→05.2008		7.06117.24.0	ZM-NWV	EL	 mit Dichtring with O-ring
C 200 Kompressor (203.745) 120 kW (163 PS) M 111.955	03.2001→05.2002		7.06117.21.0	ZM-NWV	EL	mit Trag-/Führungsgelenk With support/ steering link
C 220 120 kW (163 PS) M 271.940	05.2002→05.2008		7.06117.24.0	ZM-NWV	EL	 mit Dichtring with O-ring
C 230 (203.752) 150 kW (204 PS) M 272.920	01.2005→05.2008		7.22355.01.0	EUV-SR	EL	
			7.06117.60.0	ZM-NWV	EL	mit Dichtring with O-ring
C 230 Kompressor (203.740) 141 kW (192 PS) M 271.948	05.2002→05.2008		7.06117.24.0	ZM-NWV	EL	 mit Dichtring with O-ring
C 230 Kompressor (203.747) 143-145 kW (194-197 PS) M 111.981	03.2001→05.2002		7.06117.21.0	ZM-NWV	EL	mit Trag-/Führungsgelenk With support/ steering link
C 230 Kompressor (203.747) 143-145 kW (194-197 PS) M 111.981	09.2001→12.2002		7.06117.21.0	ZM-NWV	EL	mit Trag-/Führungsgelenk With support/ steering link
C 32 AMG Kompressor (203.765) 260 kW (354 PS) M 112.961	05.2002→05.2008		7.02256.37.0	EUV-SL	EL	
C 320 (203.764) 160 kW (218 PS) M 112.946	09.2002→05.2008		7.02256.37.0	EUV-SL	EL	
			7.22355.01.0	EUV-SR	EL	
C 350 (203.756) 170-200 kW (231-272 PS) M 272.960	01.2005→05.2008		7.22355.01.0	EUV-SR	EL	
			7.06117.60.0	ZM-NWV	EL	mit Dichtring with O-ring

M



C-CLASS T-Model (S202)

32

C 180 T (202.078) 89-90 kW (121-122 PS) M 111.921	06.1996→09.2000		7.06117.20.0	ZM-NWV	EL	PKW, Kombi/ Passenger car, estate
C 180 T (202.081) 95 kW (129 PS) M 111.952	09.2000→03.2001		7.02256.37.0	EUV-SL	EL	Kombi Estate
			7.06117.21.0	ZM-NWV	EL	mit Trag-/Führungsgelenk With support/ steering link
C 200 T (202.080) 100 kW (136 PS) M 111.945	06.1996→03.2001		7.06117.20.0	ZM-NWV	EL	PKW, Kombi/ Passenger car, estate
C 200 T D (202.180) 65-85 kW (88-116 PS) OM 604.915	10.1996→03.2001		7.02256.37.0	EUV-AGR	EL	 ch. A 436536→ Stufenheck Saloon
			7.21071.50.0	EUV-LS	EP	
C 200 T Kompressor (202.082) 132-141 kW (180-192 PS) M 111.944	11.1996→03.2001		7.06117.20.0	ZM-NWV	EL	 000018→  005591→
			7.06117.21.0	ZM-NWV	EL	mit Trag-/Führungsgelenk With support/ steering link
C 200 T Kompressor (202.087) 120 kW (163 PS) M 111.956	09.2000→03.2001		7.06117.21.0	ZM-NWV	EL	mit Trag-/Führungsgelenk With support/ steering link
			7.02256.37.0	EUV-AGR	EL	 ch. A 436536→ Stufenheck Saloon
C 220 T CDI (202.193) 75-92 kW (102-125 PS) OM 611.960	09.1997→03.2001		7.02256.37.0	EUV-AGR	EL	 ch. A 436536→ Stufenheck Saloon
			7.21071.50.0	EUV-LS	EP	
C 220 T D (202.182) 55-70 kW (75-95 PS) OM 604.910	06.1996→09.1998		7.02256.37.0	EUV-AGR	EL	 ch. A 436536→ Stufenheck Saloon
			7.21071.50.0	EUV-LS	EP	
C 220 T D (202.182) 55-70 kW (75-95 PS) OM 604.910	06.1996→03.2001		7.02256.37.0	EUV-AGR	EL	 ch. A 436536→ Stufenheck Saloon
			7.21071.50.0	EUV-LS	EP	
C 230 T (202.083) 110 kW (150 PS) M 111.974	06.1996→06.1998		7.06117.20.0	ZM-NWV	EL	PKW, Kombi/ Passenger car, estate
			7.06117.20.0	ZM-NWV	EL	PKW, Kombi/ Passenger car, estate
C 230 T Kompressor (202.085) 138-142 kW (188-193 PS) M 111.975	06.1997→09.2000		7.06117.20.0	ZM-NWV	EL	PKW, Kombi/ Passenger car, estate
			7.02256.37.0	EUV-SL	EL	 000268→  005591→
C 240 T (202.086) 125 kW (170 PS) M 112.910	06.1997→09.2000		7.02256.37.0	EUV-SL	EL	
			7.22355.01.0	EUV-SR	EL	
C 240 T (202.088) 125 kW (170 PS) M 112.915	09.2000→03.2001		7.02256.37.0	EUV-SL	EL	Kombi Estate
			7.22355.01.0	EUV-SR	EL	
C 250 T Turbo-D (202.188) 110 kW (150 PS) OM 605.960	06.1996→03.2001		7.02256.37.0	EUV-AGR	EL	 ch. F 483848→ Kombi Estate
			7.21071.50.0	EUV-LS	EP	
C 280 T (202.089) 145-150 kW (197-204 PS) M 112.920	06.1997→03.2001		7.21071.50.0	EUV-LS	EP	
			7.02256.37.0	EUV-SL	EL	
			7.22355.01.0	EUV-SR	EL	
C 43 AMG (202.093) 205-225 kW (279-306 PS) M 113.944	08.1997→03.2001		7.02256.37.0	EUV-SL	EL	
			7.22355.01.0	EUV-SR	EL	

M































C-CLASS T-Model (S203)

33

C 180 (203.235) 95 kW (129 PS) M 111.951	03.2001→05.2002		7.02256.37.0	EUV-SL	EL	
			7.06117.21.0	ZM-NWV	EL	mit Trag-/Führungsgelenk With support/ steering link



















C-CLASS T-Model (S203) 33

C 180 Kompressor (203.246) 105-125 kW (143-170 PS) M 271.946	05.2002→08.2007	 7.06117.24.0	ZM-NWV	EL	 mit Dichtring with O-ring
C 200 CGI Kompressor (203.243) 125 kW (170 PS) M 271.942	07.2003→08.2007	 7.06117.24.0	ZM-NWV	EL	 mit Dichtring with O-ring
C 200 Kompressor (203.242) 120 kW (163 PS) M 271.940	05.2002→08.2007	 7.06117.24.0	ZM-NWV	EL	 mit Dichtring with O-ring
C 200 Kompressor (203.245) 120 kW (163 PS) M 111.955	03.2001→05.2002	 7.06117.21.0	ZM-NWV	EL	mit Trag-/Führungsgelenk With support/ steering link
C 230 (203.252) 150 kW (204 PS) M 272.920	01.2005→08.2007	 7.22355.01.0	EUV-SR	EL	
		 7.06117.60.0	ZM-NWV	EL	mit Dichtring with O-ring
C 230 Kompressor (203.240) 141 kW (192 PS) M 271.948	02.2004→08.2007	 7.06117.24.0	ZM-NWV	EL	 mit Dichtring with O-ring
C 240 (203.261) 120-125 kW (163-170 PS) M 112.912	03.2001→08.2007	 7.02256.37.0	EUV-SL	EL	
		 7.22355.01.0	EUV-SR	EL	
C 240 4-matic (203.281) 125 kW (170 PS) M 112.916	07.2002→08.2007	 7.02256.37.0	EUV-SL	EL	
		 7.22355.01.0	EUV-SR	EL	
C 280 (203.254) 170 kW (231 PS) M 272.940	01.2005→08.2007	 7.22355.01.0	EUV-SR	EL	
		 7.06117.60.0	ZM-NWV	EL	mit Dichtring with O-ring
C 280 4-matic (203.292) 170 kW (231 PS) M 272.941	01.2005→08.2007	 7.22355.01.0	EUV-SR	EL	
		 7.06117.60.0	ZM-NWV	EL	mit Dichtring with O-ring
C 32 AMG Kompressor (203.265) 260 kW (354 PS) M 112.961	03.2001→08.2007	 7.02256.37.0	EUV-SL	EL	
C 320 (203.264) 160 kW (218 PS) M 112.946	03.2001→08.2007	 7.02256.37.0	EUV-SL	EL	
		 7.22355.01.0	EUV-SR	EL	
C 320 4-matic (203.284) 160 kW (218 PS) M 112.953	07.2002→08.2007	 7.02256.37.0	EUV-SL	EL	
		 7.22355.01.0	EUV-SR	EL	
C 350 (203.256) 170-200 kW (231-272 PS) M 272.960	01.2005→08.2007	 7.22355.01.0	EUV-SR	EL	
		 7.06117.60.0	ZM-NWV	EL	mit Dichtring with O-ring
C 350 4-matic (203.287) 200 kW (272 PS) M 272.970	01.2005→08.2007	 7.22355.01.0	EUV-SR	EL	
		 7.06117.60.0	ZM-NWV	EL	mit Dichtring with O-ring
C 55 AMG (203.276) 260-270 kW (354-367 PS) M 113.988	02.2004→08.2007	 7.02256.37.0	EUV-SL	EL	
		 7.22355.01.0	EUV-SR	EL	

M



C-CLASS T-Model (S204) 34

C 180 (204.231) 95-115 kW (129-156 PS) M 274.910	02.2012→08.2014		7.00782.16.0	DW-TL	EP	
			7.04818.04.0	SUV	EL	
C 180 CDI (204.200) 88-105 kW (120-143 PS) OM 651.913	01.2011→08.2014		7.00782.12.0	DW-TL	EP	
			7.02256.37.0	EUV-VB	EL	
			7.02256.37.0	EUV-WP	EL	
C 180 CGI (204.249) 115-137 kW (156-186 PS) M 271.820	11.2009→08.2014		7.00017.03.0	LDRV	EP	
			7.01870.06.0	SUV	EL	
C 180 Kompressor (204.245) 105-115 kW (143-156 PS) M 271.910	01.2008→08.2014		7.06117.24.0	ZM-NWV	EL	 mit Dichtring with O-ring
C 180 Kompressor (204.246) 115 kW (156 PS) M 271.952	08.2007→08.2014		7.06117.24.0	ZM-NWV	EL	 mit Dichtring with O-ring
C 200 CDI (204.201) 88-105 kW (120-143 PS) OM 651.913	08.2010→08.2014		7.00782.12.0	DW-TL	EP	
			7.02256.37.0	EUV-VB	EL	
			7.02256.37.0	EUV-WP	EL	
C 200 CGI (204.248) 115-150 kW (156-204 PS) M 271.820, M 271.860	08.2007→08.2014		7.00017.03.0	LDRV	EP	
			7.01870.06.0	SUV	EL	
C 200 Kompressor (204.241) 120-135 kW (163-184 PS) M 271.950	08.2007→08.2014		7.06117.24.0	ZM-NWV	EL	 mit Dichtring with O-ring
C 220 CDI (204.202) 120-150 kW (163-204 PS) OM 651.911	12.2008→08.2014		7.00782.12.0	DW-TL	EP	
			7.02256.37.0	EUV-VB	EL	
			7.02256.37.0	EUV-WP	EL	
C 220 CDI (204.202) 120-150 kW (163-204 PS) OM 651.911	12.2008→08.2014		7.00782.12.0	DW-TL	EP	
			7.02256.37.0	EUV-VB	EL	
			7.02256.37.0	EUV-WP	EL	
C 220 CDI 4-matic (204.284) 120-150 kW (163-204 PS) OM 651.912	02.2013→08.2014		7.00782.12.0	DW-TL	EP	
			7.02256.37.0	EUV-WP	EL	
C 230 (204.252) 150 kW (204 PS) M 272.921	08.2007→08.2014		7.22355.01.0	EUV-SR	EL	
			7.06117.60.0	ZM-NWV	EL	mit Dichtring with O-ring
C 250 115-245 kW (156-333 PS) M 274.920	03.2014→08.2014		7.00782.16.0	DW-TL	EP	
			7.02256.37.0	EUV-WP	EL	
			7.04818.04.0	SUV	EL	
C 250 (204.252) 150 kW (204 PS) M 272.921	02.2008→12.2012		7.22355.01.0	EUV-SR	EL	
			7.06117.60.0	ZM-NWV	EL	mit Dichtring with O-ring





M



C-CLASS T-Model (S204) 34







C 250 CDI (204.203) 120-150 kW (163-204 PS) OM 651.911	01.2009→08.2014		7.00782.12.0	DW-TL	EP	
			7.02256.37.0	EUV-VB	EL	
C 250 CDI 4-matic (204.282) 120-150 kW (163-204 PS) OM 651.912	04.2010→08.2014		7.00782.12.0	DW-TL	EP	
			7.02256.37.0	EUV-WP	EL	
C 250 CGI (204.247) 135-150 kW (184-204 PS) M 271.860	07.2009→08.2014		7.00017.03.0	LDRV	EP	
			7.01870.06.0	SUV	EL	
C 280 (204.254) 170 kW (231 PS) M 272.947	08.2007→08.2014		7.22355.01.0	EUV-SR	EL	
			7.06117.60.0	ZM-NWV	EL	mit Dichtring with O-ring
C 300 (204.254) 170 kW (231 PS) M 272.947	08.2007→08.2014		7.22355.01.0	EUV-SR	EL	
			7.06117.60.0	ZM-NWV	EL	mit Dichtring with O-ring
C 350 (204.256) 200 kW (272 PS) M 272.961	08.2007→08.2014		7.22355.01.0	EUV-SR	EL	
			7.06117.60.0	ZM-NWV	EL	mit Dichtring with O-ring
M C 63 AMG 336-410 kW (457-558 PS) M 156.985	06.2013→08.2014		7.02256.37.0	EUV-SL	EL	
			7.22355.01.0	EUV-SR	EL	
C 63 AMG (204.277) 336-410 kW (457-558 PS) M 156.985	02.2008→08.2014		7.02256.37.0	EUV-SL	EL	
			7.22355.01.0	EUV-SR	EL	
C 63 AMG (204.277) 336-410 kW (457-558 PS) M 156.985	01.2012→08.2014		7.02256.37.0	EUV-SL	EL	
			7.22355.01.0	EUV-SR	EL	

C-CLASS T-Model (S205) 35



















AMG C 43 4-matic (205.264) 200-295 kW (272-401 PS) M 276.823	04.2016→05.2018		7.00782.11.0	DW-TL	EP	
			7.01870.06.0	SUV	EL	
AMG C 43 4-matic (205.264) 200-295 kW (272-401 PS) M 276.823	05.2018→		7.00782.11.0	DW-TL	EP	
			7.01870.06.0	SUV	EL	
AMG C 63 (205.286) 350-470 kW (476-639 PS) M 177.980	10.2015→		7.00782.16.0	DW-TL	EP	
			7.04927.08.0	SUV	EL	Ladeluftkühler Intercooler
AMG C 63 S (205.287) 350-470 kW (476-639 PS) M 177.980	10.2015→		7.00782.16.0	DW-TL	EP	
			7.04927.08.0	SUV	EL	Ladeluftkühler Intercooler
C 160 (205.244) 95-115 kW (129-156 PS) M 274.910	04.2015→		7.00782.16.0	DW-TL	EP	





















C-CLASS T-Model (S205) 35



















		7.04818.04.0	SUV	EL	
C 180 (205.240) 95-115 kW (129-156 PS) M 274.910	09.2014→	 7.00782.16.0	DW-TL	EP	
		7.04818.04.0	SUV	EL	
C 180 BlueTEC / d (205.236) 85-100 kW (116-136 PS) OM 626.951	09.2014→05.2018	 7.01814.12.0	DW-TL	EP	
C 180 Flex (205.240) 95-115 kW (129-156 PS) M 274.910	06.2015→	 7.00782.16.0	DW-TL	EP	
		7.04818.04.0	SUV	EL	
C 180 d (205.200) 90-118 kW (122-160 PS) OM 654.916	05.2018→	 7.02256.37.0	EUV-AGR	EL	Produktionsdatum bis: 15.12.2020 Production date to: 15.12.2020
C 200 (205.242) 115-245 kW (156-333 PS) M 274.920	09.2014→05.2018	 7.00782.16.0	DW-TL	EP	
		7.02256.37.0	EUV-WP	EL	
		7.04818.04.0	SUV	EL	
C 200 4-matic (205.243) 115-245 kW (156-333 PS) M 274.920	04.2015→05.2018	 7.00782.16.0	DW-TL	EP	
		7.02256.37.0	EUV-WP	EL	
		7.04818.04.0	SUV	EL	
C 200 BlueTEC / d (205.237) 85-100 kW (116-136 PS) OM 626.951	09.2014→05.2018	 7.01814.12.0	DW-TL	EP	
C 200 EQ Boost (205.277) 95-145 kW (129-197 PS) M 264.915	04.2018→	 7.04927.08.0	SUV	EL	Ladeluftkühler Intercooler
C 200 EQ Boost 4-matic (205.278) 95-145 kW (129-197 PS) M 264.915	04.2018→	 7.04927.08.0	SUV	EL	Ladeluftkühler Intercooler
C 200 d (205.201) 90-118 kW (122-160 PS) OM 654.916	05.2018→	 7.02256.37.0	EUV-AGR	EL	Produktionsdatum bis: 15.12.2020 Production date to: 15.12.2020
C 200 d (205.207) 100-150 kW (136-204 PS) OM 651.921	10.2015→05.2018	 7.00782.12.0	DW-TL	EP	
		7.02256.37.0	EUV-VB	EL	
		7.02256.37.0	EUV-WP	EL	
C 200 d (205.211) 84-235 kW (114-320 PS) OM 654.920	05.2018→	 7.02256.37.0	EUV-AGR	EL	Produktionsdatum bis: 15.12.2020 Production date to: 15.12.2020
C 220 BlueTEC / d (205.204) 100-150 kW (136-204 PS) OM 651.921	09.2014→05.2018	 7.00782.12.0	DW-TL	EP	
		7.02256.37.0	EUV-VB	EL	
		7.02256.37.0	EUV-WP	EL	
C 220 BlueTEC / d (205.204) 100-150 kW (136-204 PS) OM 651.921	09.2014→05.2018	 7.00782.12.0	DW-TL	EP	
		7.02256.37.0	EUV-VB	EL	
		7.02256.37.0	EUV-WP	EL	
C 220 d (205.214) 84-235 kW (114-320 PS) OM 654.920	04.2018→	 7.02256.37.0	EUV-AGR	EL	Produktionsdatum bis: 15.12.2020 Production date to: 15.12.2020

M

					
C-CLASS T-Model (S205)					
C 220 d 4-matic (205.205) 100-150 kW (136-204 PS) OM 651.921	04.2015→05.2018		7.00782.12.0	DW-TL	EP
			7.02256.37.0	EUV-VB	EL
C 220 d 4-matic (205.215) 84-235 kW (114-320 PS) OM 654.920	05.2018→		7.02256.37.0	EUV-AGR	EL
					Produktionsdatum bis: 15.12.2020 Production date to: 15.12.2020
C 250 (205.245) 115-245 kW (156-333 PS) M 274.920	09.2014→05.2018		7.00782.16.0	DW-TL	EP
			7.02256.37.0	EUV-WP	EL
			7.04818.04.0	SUV	EL
C 250 BlueTEC / d (205.208) 100-150 kW (136-204 PS) OM 651.921	09.2014→05.2018		7.00782.12.0	DW-TL	EP
C 250 BlueTEC / d 4-matic (205.209) 100-150 kW (136-204 PS) OM 651.921	10.2014→05.2018		7.00782.12.0	DW-TL	EP
			7.02256.37.0	EUV-VB	EL
			7.02256.37.0	EUV-WP	EL
C 300 (205.248) 115-245 kW (156-333 PS) M 274.920	09.2015→05.2018		7.00782.16.0	DW-TL	EP
			7.02256.37.0	EUV-WP	EL
			7.04818.04.0	SUV	EL
C 300 (205.283) 145-220 kW (197-299 PS) M 264.920	05.2018→		7.04927.08.0	SUV	EL
					Ladeluftkühler Intercooler
C 300 4-matic (205.249) 115-245 kW (156-333 PS) M 274.920	09.2015→05.2018		7.00782.16.0	DW-TL	EP
C 300 BlueTEC Hybrid / h (205.212) 100-150 kW (136-204 PS) OM 651.921	10.2014→05.2018		7.00782.12.0	DW-TL	EP
			7.02256.37.0	EUV-VB	EL
			7.02256.37.0	EUV-WP	EL
C 300 d (205.218) 84-235 kW (114-320 PS) OM 654.920	06.2018→		7.02256.37.0	EUV-AGR	EL
					Produktionsdatum bis: 15.12.2020 Production date to: 15.12.2020
C 300 d 4-matic (205.219) 84-235 kW (114-320 PS) OM 654.920	06.2018→		7.02256.37.0	EUV-AGR	EL
					Produktionsdatum bis: 15.12.2020 Production date to: 15.12.2020
C 300 de (205.213) 84-235 kW (114-320 PS) OM 654.920	05.2019→		7.02256.37.0	EUV-AGR	EL
					Produktionsdatum bis: 15.12.2020 Production date to: 15.12.2020
C 300 de (205.213) 84-235 kW (114-320 PS) OM 654.920	05.2019→		7.02256.37.0	EUV-AGR	EL
					Produktionsdatum bis: 15.12.2020 Production date to: 15.12.2020
C 300 e (205.253) 115-245 kW (156-333 PS) M 274.920	07.2019→		7.00782.16.0	DW-TL	EP
			7.02256.37.0	EUV-WP	EL
			7.04818.04.0	SUV	EL
C 300 e (205.253) 115-245 kW (156-333 PS) M 274.920	07.2019→		7.00782.16.0	DW-TL	EP

					
C-CLASS T-Model (S205)					35
			7.02256.37.0	EUV-WP	EL
			7.04818.04.0	SUV	EL
C 350 e (205.247) 115-245 kW (156-333 PS) M 274.920	02.2015→05.2018		7.00782.16.0	DW-TL	EP
			7.02256.37.0	EUV-WP	EL
			7.04818.04.0	SUV	EL
C 350 e (205.247) 115-245 kW (156-333 PS) M 274.920	02.2015→05.2018		7.00782.16.0	DW-TL	EP
			7.02256.37.0	EUV-WP	EL
			7.04818.04.0	SUV	EL
C 400 4-matic (205.266) 200-295 kW (272-401 PS) M 276.823	10.2014→		7.00782.11.0	DW-TL	EP
			7.01870.06.0	SUV	EL
C 450 AMG 4-matic (205.264) 200-295 kW (272-401 PS) M 276.823	04.2015→05.2018		7.00782.11.0	DW-TL	EP
			7.01870.06.0	SUV	EL
CABRIOLET (W111, W112)					36
280 SE 3.5 (111.025) 147 kW (200 PS) M 116.980	04.1968→12.1971		7.21071.50.0	EUV-SR	EP
CITAN MPV (415)					37
112 (415.703) 84 kW (114 PS) M 200.711	06.2013→		7.08681.15.0	EOV	EH
			7.01343.04.0	LDRV	EP
CLA (C118)					38
CLA 180 (118.384) 80-160 kW (109-218 PS) M 282.914	03.2019→		7.04818.04.0	SUV	EL für OE-Nummer: A 000 153 18 59, A 282 090 02 80 for OE number: A 000 153 18 59, A 282 090 02 80
CLA 200 (118.387) 80-160 kW (109-218 PS) M 282.914	03.2019→		7.04818.04.0	SUV	EL für OE-Nummer: A 000 153 18 59, A 282 090 02 80 for OE number: A 000 153 18 59, A 282 090 02 80
CLA 200 (118.387) 80-160 kW (109-218 PS) M 282.914	03.2019→		7.04818.04.0	SUV	EL für OE-Nummer: A 000 153 18 59, A 282 090 02 80 for OE number: A 000 153 18 59, A 282 090 02 80
CLA 200 d (118.312) 84-235 kW (114-320 PS) OM 654.920	04.2019→		7.02256.37.0	EUV-AGR	EL Produktionsdatum bis: 15.12.2020 Production date to: 15.12.2020
CLA 200 d 4-matic (118.313) 84-235 kW (114-320 PS) OM 654.920	04.2019→		7.02256.37.0	EUV-AGR	EL Produktionsdatum bis: 15.12.2020 Production date to: 15.12.2020
CLA 220 d (118.314) 84-235 kW (114-320 PS) OM 654.920	04.2019→		7.02256.37.0	EUV-AGR	EL Produktionsdatum bis: 15.12.2020 Production date to: 15.12.2020
CLA 220 d 4-matic (118.315) 84-235 kW (114-320 PS) OM 654.920	07.2020→		7.02256.37.0	EUV-AGR	EL Produktionsdatum bis: 15.12.2020 Production date to: 15.12.2020















M

					
CLA (C118)					38
CLA 250 e (118.386) 80-160 kW (109-218 PS) M 282.914	06.2020→		7.04818.04.0	SUV	EL für OE-Nummer: A 000 153 18 59, A 282 090 02 80 for OE number: A 000 153 18 59, A 282 090 02 80
CLA 250 e (118.386) 80-160 kW (109-218 PS) M 282.914	06.2020→		7.04818.04.0	SUV	EL für OE-Nummer: A 000 153 18 59, A 282 090 02 80 for OE number: A 000 153 18 59, A 282 090 02 80
CLA Coupe (C117)					39
AMG CLA 45 4-matic (117.352) 250-280 kW (340-381 PS) M 133.980	07.2015→03.2019		7.00782.11.0	DW-TL	EP
CLA 180 (117.342) 75-115 kW (102-156 PS) M 270.910	01.2013→03.2019		7.00782.16.0	DW-TL	EP
			7.02256.37.0	EUV-KK	EL
			7.01870.06.0	SUV	EL
			7.04818.04.0	SUV	EL
					<p> M 270.910: Fahrgestellnummer bis: 10044275 Vehicle Identification Number to: 10044275 Produktionsdatum bis: 22.12.2015 Production date to: 22.12.2015</p> <p> M 270.910: Fahrgestellnummer bis: 30786355 Vehicle Identification Number to: 30786355 Produktionsdatum bis: 03.08.2015 Production date to: 03.08.2015</p> <p> M 270.910: Fahrgestellnummer ab: 30786355 Vehicle Identification Number from: 30786355 Produktionsdatum ab: 03.08.2015 Production date from: 03.08.2015</p> <p> M 270.910: Fahrgestellnummer ab: 10044275 Vehicle Identification Number from: 10044275 Produktionsdatum ab: 22.12.2015 Production date from: 22.12.2015</p>
CLA 200 115-160 kW (156-218 PS) M 270.920	08.2015→03.2019		7.00782.16.0	DW-TL	EP
			7.01870.06.0	SUV	EL
			7.04818.04.0	SUV	EL
					<p> M 270.920: Fahrgestellnummer bis: 10044275 Vehicle Identification Number to: 10044275 Produktionsdatum bis: 22.12.2015 Production date to: 22.12.2015</p> <p> M 270.920: Fahrgestellnummer bis: 30786355 Vehicle Identification Number to: 30786355 Produktionsdatum bis: 03.08.2014 Production date to: 03.08.2014</p> <p> M 270.920: Fahrgestellnummer ab: 10044275 Vehicle Identification Number from: 10044275 Produktionsdatum ab: 22.12.2015 Production date from: 22.12.2015</p> <p> M 270.920: Fahrgestellnummer ab: 30786355 Vehicle Identification Number from: 30786355 Produktionsdatum ab: 03.08.2015 Production date from: 03.08.2015</p>

M

















CLA Coupe (C117) 39

<p>CLA 200 (117.343) 75-115 kW (102-156 PS) M 270.910</p>	<p>01.2013→03.2019</p>	<p> 7.00782.16.0</p> <p>7.02256.37.0</p> <p>7.01870.06.0</p> <p>7.04818.04.0</p>	<p>DW-TL EP</p> <p>EUV-KK EL</p> <p>SUV EL</p> <p>SUV EL</p>	<p> M 270.910: Fahrgestellnummer bis: 10044275 Vehicle Identification Number to: 10044275 Produktionsdatum bis: 22.12.2015 Production date to: 22.12.2015</p> <p> M 270.910: Fahrgestellnummer bis: 30786355 Vehicle Identification Number to: 30786355 Produktionsdatum bis: 03.08.2015 Production date to: 03.08.2015</p> <p> M 270.910: Fahrgestellnummer ab: 30786355 Vehicle Identification Number from: 30786355 Produktionsdatum ab: 03.08.2015 Production date from: 03.08.2015</p> <p> M 270.910: Fahrgestellnummer ab: 10044275 Vehicle Identification Number from: 10044275 Produktionsdatum ab: 22.12.2015 Production date from: 22.12.2015</p>
<p>CLA 200 (117.343) 75-115 kW (102-156 PS) M 270.910</p>	<p>07.2018→03.2019</p>	<p> 7.00782.16.0</p> <p>7.04818.04.0</p>	<p>DW-TL EP</p> <p>SUV EL</p>	<p> M 270.910: Fahrgestellnummer ab: 10044275 Vehicle Identification Number from: 10044275 Produktionsdatum ab: 22.12.2015 Production date from: 22.12.2015</p> <p> M 270.910: Fahrgestellnummer ab: 30786355 Vehicle Identification Number from: 30786355 Produktionsdatum ab: 03.08.2015 Production date from: 03.08.2015</p>
<p>CLA 200 CDI (117.301) 80-100 kW (109-136 PS) OM 651.901</p>	<p>06.2013→08.2014</p>	<p> 7.02256.37.0</p>	<p>EUV-WP EL</p>	
<p>CLA 200 CDI / d (117.308) 80-130 kW (109-177 PS) OM 651.930</p>	<p>07.2014→03.2019</p>	<p> 7.02256.37.0</p>	<p>EUV-WP EL</p>	
<p>CLA 200 CDI / d 4-matic (117.302) 80-130 kW (109-177 PS) OM 651.930</p>	<p>07.2014→03.2019</p>	<p> 7.02256.37.0</p>	<p>EUV-WP EL</p>	
<p>CLA 200 Flex 75-115 kW (102-156 PS) M 270.910</p>	<p>01.2013→03.2019</p>	<p> 7.00782.16.0</p> <p>7.01870.06.0</p>	<p>DW-TL EP</p> <p>SUV EL</p>	<p> M 270.910: Fahrgestellnummer bis: 10044275 Vehicle Identification Number to: 10044275 Produktionsdatum bis: 22.12.2015 Production date to: 22.12.2015</p> <p> M 270.910: Fahrgestellnummer bis: 30786355 Vehicle Identification Number to: 30786355 Produktionsdatum bis: 03.08.2015 Production date to: 03.08.2015</p>

M















CLA Coupe (C117) **39**

			7.04818.04.0	SUV	EL	 M 270.910: Fahrgestellnummer ab: 30786355 Vehicle Identification Number from: 30786355 Produktionsdatum ab: 03.08.2015 Production date from: 03.08.2015  M 270.910: Fahrgestellnummer ab: 10044275 Vehicle Identification Number from: 10044275 Produktionsdatum ab: 22.12.2015 Production date from: 22.12.2015
CLA 220 (117.345) 115-160 kW (156-218 PS) M 270.920	04.2016→03.2019		7.00782.16.0	DW-TL	EP	
			7.04818.04.0	SUV	EL	 M 270.920: Fahrgestellnummer ab: 30786355 Vehicle Identification Number from: 30786355 Produktionsdatum ab: 03.08.2015 Production date from: 03.08.2015  M 270.920: Fahrgestellnummer ab: 10044275 Vehicle Identification Number from: 10044275 Produktionsdatum ab: 22.12.2015 Production date from: 22.12.2015
CLA 220 4-matic (117.347) 115-160 kW (156-218 PS) M 270.920	04.2016→03.2019		7.00782.16.0	DW-TL	EP	
			7.04818.04.0	SUV	EL	 M 270.920: Fahrgestellnummer ab: 30786355 Vehicle Identification Number from: 30786355 Produktionsdatum ab: 03.08.2015 Production date from: 03.08.2015  M 270.920: Fahrgestellnummer ab: 10044275 Vehicle Identification Number from: 10044275 Produktionsdatum ab: 22.12.2015 Production date from: 22.12.2015
CLA 220 CDI / d (117.303) 80-130 kW (109-177 PS) OM 651.930	01.2013→03.2019		7.02256.37.0	EUV-WP	EL	
CLA 220 CDI / d (117.303) 80-130 kW (109-177 PS) OM 651.930	01.2013→03.2019		7.02256.37.0	EUV-WP	EL	
CLA 220 CDI / d (117.303) 80-130 kW (109-177 PS) OM 651.930	09.2014→03.2019		7.02256.37.0	EUV-WP	EL	
CLA 220 CDI / d 4-matic (117.305) 80-130 kW (109-177 PS) OM 651.930	08.2014→03.2019		7.02256.37.0	EUV-WP	EL	
CLA 220 CDI / d 4-matic (117.305) 80-130 kW (109-177 PS) OM 651.930	09.2014→03.2019		7.02256.37.0	EUV-WP	EL	
CLA 220 CDI 4-matic (117.305) 80-130 kW (109-177 PS) OM 651.930	07.2014→03.2019		7.02256.37.0	EUV-WP	EL	
CLA 250 (117.344) 115-160 kW (156-218 PS) M 270.920	01.2013→03.2019		7.00782.16.0	DW-TL	EP	
			7.02256.37.0	EUV-KK	EL	

M





CLA Coupe (C117) **39**

		7.01870.06.0	SUV	EL	 M 270.920: Fahrgestellnummer bis: 10044275 Vehicle Identification Number to: 10044275 Produktionsdatum bis: 22.12.2015 Production date to: 22.12.2015  M 270.920: Fahrgestellnummer bis: 30786355 Vehicle Identification Number to: 30786355 Produktionsdatum bis: 03.08.2015 Production date to: 03.08.2015
		7.04818.04.0	SUV	EL	 M 270.920: Fahrgestellnummer ab: 10044275 Vehicle Identification Number from: 10044275 Produktionsdatum ab: 22.12.2015 Production date from: 22.12.2015  M 270.920: Fahrgestellnummer ab: 30786355 Vehicle Identification Number from: 30786355 Produktionsdatum ab: 03.08.2015 Production date from: 03.08.2015
CLA 250 (117.350) 115-160 kW (156-218 PS) M 270.920	07.2015→03.2019	 7.00782.16.0	DW-TL	EP	
		7.02256.37.0	EUV-KK	EL	
		7.01870.06.0	SUV	EL	 M 270.920: Fahrgestellnummer bis: 10044275 Vehicle Identification Number to: 10044275 Produktionsdatum bis: 22.12.2015 Production date to: 22.12.2015  M 270.920: Fahrgestellnummer bis: 30786355 Vehicle Identification Number to: 30786355 Produktionsdatum bis: 03.08.2015 Production date to: 03.08.2015
		7.04818.04.0	SUV	EL	 M 270.920: Fahrgestellnummer ab: 30786355 Vehicle Identification Number from: 30786355 Produktionsdatum ab: 03.08.2015 Production date from: 03.08.2015  M 270.920: Fahrgestellnummer ab: 10044275 Vehicle Identification Number from: 10044275 Produktionsdatum ab: 22.12.2015 Production date from: 22.12.2015
CLA 250 4-matic (117.346) 115-160 kW (156-218 PS) M 270.920	07.2013→03.2019	 7.00782.16.0	DW-TL	EP	
		7.02256.37.0	EUV-KK	EL	
		7.01870.06.0	SUV	EL	 M 270.920: Fahrgestellnummer bis: 10044275 Vehicle Identification Number to: 10044275 Produktionsdatum bis: 22.12.2015 Production date to: 22.12.2015  M 270.920: Fahrgestellnummer bis: 30786355 Vehicle Identification Number to: 30786355 Produktionsdatum bis: 03.08.2015 Production date to: 03.08.2015

M







CLA Coupe (C117) **39**

		7.04818.04.0	SUV	EL	 M 270.920: Fahrgestellnummer ab: 30786355 Vehicle Identification Number from: 30786355 Produktionsdatum ab: 03.08.2015 Production date from: 03.08.2015  M 270.920: Fahrgestellnummer ab: 10044275 Vehicle Identification Number from: 10044275 Produktionsdatum ab: 22.12.2015 Production date from: 22.12.2015
CLA 250 4-matic (117.351) 115-160 kW (156-218 PS) M 270.920	07.2015→03.2019	 7.00782.16.0	DW-TL	EP	
		7.02256.37.0	EUV-KK	EL	
		7.01870.06.0	SUV	EL	 M 270.920: Fahrgestellnummer bis: 10044275 Vehicle Identification Number to: 10044275 Produktionsdatum bis: 22.12.2015 Production date to: 22.12.2015  M 270.920: Fahrgestellnummer bis: 30786355 Vehicle Identification Number to: 30786355 Produktionsdatum bis: 03.08.2015 Production date to: 03.08.2015
		7.04818.04.0	SUV	EL	 M 270.920: Fahrgestellnummer ab: 30786355 Vehicle Identification Number from: 30786355 Produktionsdatum ab: 03.08.2015 Production date from: 03.08.2015  M 270.920: Fahrgestellnummer ab: 10044275 Vehicle Identification Number from: 10044275 Produktionsdatum ab: 22.12.2015 Production date from: 22.12.2015
CLA 45 AMG 4-matic (117.352) 250-280 kW (340-381 PS) M 133.980	07.2013→03.2019	 7.00782.11.0	DW-TL	EP	















M

CLA Shooting Brake (X117) **40**

AMG CLA 45 4-matic (117.952) 250-280 kW (340-381 PS) M 133.980	07.2015→03.2019	 7.00782.11.0	DW-TL	EP	
CLA 180 (117.942) 75-115 kW (102-156 PS) M 270.910	01.2015→03.2019	 7.00782.16.0	DW-TL	EP	
		7.01870.06.0	SUV	EL	 M 270.910: Fahrgestellnummer bis: 10044275 Vehicle Identification Number to: 10044275 Produktionsdatum bis: 22.12.2015 Production date to: 22.12.2015  M 270.910: Fahrgestellnummer bis: 30786355 Vehicle Identification Number to: 30786355 Produktionsdatum bis: 03.08.2015 Production date to: 03.08.2015















CLA Shooting Brake (X117) 40

			7.04818.04.0	SUV	EL	 M 270.910: Fahrgestellnummer ab: 30786355 Vehicle Identification Number from: 30786355 Produktionsdatum ab: 03.08.2015 Production date from: 03.08.2015  M 270.910: Fahrgestellnummer ab: 10044275 Vehicle Identification Number from: 10044275 Produktionsdatum ab: 22.12.2015 Production date from: 22.12.2015
CLA 200 (117.943) 75-115 kW (102-156 PS) M 270.910	01.2015→03.2019		7.00782.16.0	DW-TL	EP	
			7.02256.37.0	EUV-KK	EL	
			7.01870.06.0	SUV	EL	 M 270.910: Fahrgestellnummer bis: 10044275 Vehicle Identification Number to: 10044275 Produktionsdatum bis: 22.12.2015 Production date to: 22.12.2015  M 270.910: Fahrgestellnummer bis: 30786355 Vehicle Identification Number to: 30786355 Produktionsdatum bis: 03.08.2015 Production date to: 03.08.2015
			7.04818.04.0	SUV	EL	 M 270.910: Fahrgestellnummer ab: 10044275 Vehicle Identification Number from: 10044275 Produktionsdatum ab: 22.12.2015 Production date from: 22.12.2015  M 270.910: Fahrgestellnummer ab: 30786355 Vehicle Identification Number from: 30786355 Produktionsdatum ab: 03.08.2015 Production date from: 03.08.2015
CLA 200 CDI / d (117.908) 80-130 kW (109-177 PS) OM 651.930	01.2015→03.2019		7.02256.37.0	EUV-WP	EL	
CLA 200 CDI / d 4-matic (117.902) 80-130 kW (109-177 PS) OM 651.930	01.2015→03.2019		7.02256.37.0	EUV-WP	EL	
CLA 220 4-matic (117.947) 115-160 kW (156-218 PS) M 270.920	04.2016→03.2019		7.00782.16.0	DW-TL	EP	
			7.04818.04.0	SUV	EL	 M 270.920: Fahrgestellnummer ab: 30786355 Vehicle Identification Number from: 30786355 Produktionsdatum ab: 03.08.2015 Production date from: 03.08.2015  M 270.920: Fahrgestellnummer ab: 10044275 Vehicle Identification Number from: 10044275 Produktionsdatum ab: 22.12.2015 Production date from: 22.12.2015
CLA 220 CDI / d (117.903) 80-130 kW (109-177 PS) OM 651.930	01.2015→03.2019		7.02256.37.0	EUV-WP	EL	
CLA 220 CDI / d (117.903) 80-130 kW (109-177 PS) OM 651.930	01.2015→03.2019		7.02256.37.0	EUV-WP	EL	

M



CLA Shooting Brake (X117) 40









<p>CLA 220 CDI / d 4-matic (117.905) 80-130 kW (109-177 PS) OM 651.930</p>	<p>01.2015→03.2019</p>	<p> 7.02256.37.0</p>	<p>EUV-WP EL</p>	
<p>CLA 220 CDI / d 4-matic (117.905) 80-130 kW (109-177 PS) OM 651.930</p>	<p>09.2015→03.2019</p>	<p> 7.02256.37.0</p>	<p>EUV-WP EL</p>	
<p>CLA 220 d (117.903) 80-130 kW (109-177 PS) OM 651.930</p>	<p>07.2018→03.2019</p>	<p> 7.02256.37.0</p>	<p>EUV-WP EL</p>	
<p>CLA 220 d 4-matic (117.905) 80-130 kW (109-177 PS) OM 651.930</p>	<p>07.2018→03.2019</p>	<p> 7.02256.37.0</p>	<p>EUV-WP EL</p>	
<p>CLA 250 (117.944) 115-160 kW (156-218 PS) M 270.920</p>	<p>01.2015→03.2019</p>	<p> 7.00782.16.0</p>	<p>DW-TL EP</p>	<p> M 270.920: Fahrgestellnummer bis: 10044275 Vehicle Identification Number to: 10044275 Produktionsdatum bis: 22.12.2015 Production date to: 22.12.2015  M 270.920: Fahrgestellnummer bis: 30786355 Vehicle Identification Number to: 30786355 Produktionsdatum bis: 03.08.2015 Production date to: 03.08.2015  M 270.920: Fahrgestellnummer ab: 10044275 Vehicle Identification Number from: 10044275 Produktionsdatum ab: 22.12.2015 Production date from: 22.12.2015  M 270.920: Fahrgestellnummer ab: 30786355 Vehicle Identification Number from: 30786355 Produktionsdatum ab: 03.08.2015 Production date from: 03.08.2015</p>
		<p>7.02256.37.0</p>	<p>EUV-KK EL</p>	
		<p>7.01870.06.0</p>	<p>SUV EL</p>	
<p>CLA 250 4-matic (117.946) 115-160 kW (156-218 PS) M 270.920</p>	<p>01.2015→03.2019</p>	<p> 7.00782.16.0</p>	<p>DW-TL EP</p>	<p> M 270.920: Fahrgestellnummer bis: 10044275 Vehicle Identification Number to: 10044275 Produktionsdatum bis: 22.12.2015 Production date to: 22.12.2015  M 270.920: Fahrgestellnummer bis: 30786355 Vehicle Identification Number to: 30786355 Produktionsdatum bis: 03.08.2015 Production date to: 03.08.2015</p>
<p>7.02256.37.0</p>	<p>EUV-KK EL</p>			
<p>7.01870.06.0</p>	<p>SUV EL</p>			

M



CLA Shooting Brake (X117)







40































		7.04818.04.0	SUV	EL	 M 270.920: Fahrgestellnummer ab: 30786355 Vehicle Identification Number from: 30786355 Produktionsdatum ab: 03.08.2015 Production date from: 03.08.2015  M 270.920: Fahrgestellnummer ab: 10044275 Vehicle Identification Number from: 10044275 Produktionsdatum ab: 22.12.2015 Production date from: 22.12.2015
CLA 250 4-matic (117.951) 115-160 kW (156-218 PS) M 270.920	07.2015→03.2019	 7.00782.16.0	DW-TL	EP	
		7.01870.06.0	SUV	EL	 M 270.920: Fahrgestellnummer bis: 10044275 Vehicle Identification Number to: 10044275 Produktionsdatum bis: 22.12.2015 Production date to: 22.12.2015  M 270.920: Fahrgestellnummer bis: 30786355 Vehicle Identification Number to: 30786355 Produktionsdatum bis: 03.08.2015 Production date to: 03.08.2015
		7.04818.04.0	SUV	EL	 M 270.920: Fahrgestellnummer ab: 30786355 Vehicle Identification Number from: 30786355 Produktionsdatum ab: 03.08.2015 Production date from: 03.08.2015  M 270.920: Fahrgestellnummer ab: 10044275 Vehicle Identification Number from: 10044275 Produktionsdatum ab: 22.12.2015 Production date from: 22.12.2015
CLA 45 AMG 4-matic (117.952) 250-280 kW (340-381 PS) M 133.980	01.2015→07.2015	 7.00782.11.0	DW-TL	EP	

























M

CLA Shooting Brake (X118)































41



















CLA 180 (118.684) 80-160 kW (109-218 PS) M 282.914	06.2019→	 7.04818.04.0	SUV	EL	für OE-Nummer: A 000 153 18 59, A 282 090 02 80 for OE number: A 000 153 18 59, A 282 090 02 80
CLA 200 (118.687) 80-160 kW (109-218 PS) M 282.914	06.2019→	 7.04818.04.0	SUV	EL	für OE-Nummer: A 000 153 18 59, A 282 090 02 80 for OE number: A 000 153 18 59, A 282 090 02 80
CLA 200 (118.687) 80-160 kW (109-218 PS) M 282.914	06.2019→	 7.04818.04.0	SUV	EL	für OE-Nummer: A 000 153 18 59, A 282 090 02 80 for OE number: A 000 153 18 59, A 282 090 02 80
CLA 200 d (118.612) 84-235 kW (114-320 PS) OM 654.920	06.2019→	 7.02256.37.0	EUV-AGR	EL	Produktionsdatum bis: 15.12.2020 Production date to: 15.12.2020
CLA 200 d 4-matic (118.613) 84-235 kW (114-320 PS) OM 654.920	10.2019→	 7.02256.37.0	EUV-AGR	EL	Produktionsdatum bis: 15.12.2020 Production date to: 15.12.2020
CLA 220 d (118.614) 84-235 kW (114-320 PS) OM 654.920	06.2019→	 7.02256.37.0	EUV-AGR	EL	Produktionsdatum bis: 15.12.2020 Production date to: 15.12.2020

					
CLA Shooting Brake (X118)					41
CLA 220 d 4-matic (118.615) 84-235 kW (114-320 PS) OM 654.920	10.2019→		7.02256.37.0	EUV-AGR	EL Produktionsdatum bis: 15.12.2020 Production date to: 15.12.2020
CLA 250 e (118.686) 80-160 kW (109-218 PS) M 282.914	06.2020→		7.04818.04.0	SUV	EL für OE-Nummer: A 000 153 18 59, A 282 090 02 80 for OE number: A 000 153 18 59, A 282 090 02 80
CLA 250 e (118.686) 80-160 kW (109-218 PS) M 282.914	06.2020→		7.04818.04.0	SUV	EL für OE-Nummer: A 000 153 18 59, A 282 090 02 80 for OE number: A 000 153 18 59, A 282 090 02 80
CLC-CLASS (CL203)					42
CLC 160 (203.731) 95 kW (129 PS) M 271.911	02.2009→06.2011		7.06117.24.0	ZM-NWV	EL  mit Dichtring with O-ring
CLC 180 Kompressor (203.746) 105-125 kW (143-170 PS) M 271.946	05.2008→06.2011		7.06117.24.0	ZM-NWV	EL  mit Dichtring with O-ring
CLC 200 Kompressor (203.741) 120-135 kW (163-184 PS) M 271.957	05.2008→06.2011		7.06117.24.0	ZM-NWV	EL  mit Dichtring with O-ring
CLC 230 (203.752) 150 kW (204 PS) M 272.920	05.2008→06.2011		7.22355.01.0	EUV-SR	EL
CLC 250 150 kW (204 PS) M 272.920	06.2009→06.2011		7.06117.60.0	ZM-NWV	EL mit Dichtring with O-ring
			7.22355.01.0	EUV-SR	EL
CLC 350 (203.756) 170-200 kW (231-272 PS) M 272.960	05.2008→06.2011		7.06117.60.0	ZM-NWV	EL mit Dichtring with O-ring
			7.22355.01.0	EUV-SR	EL
CLK (C208)					43
200 (208.335) 100 kW (136 PS) M 111.945	06.1997→06.2002		7.06117.20.0	ZM-NWV	EL PKW, Cabriolet/ Passenger car, cabriolet
200 Kompressor (208.344) 120 kW (163 PS) M 111.956	06.2000→06.2002		7.06117.21.0	ZM-NWV	EL mit Trag-/Führungsgelenk With support/ steering link
200 Kompressor (208.345) 132-141 kW (180-192 PS) M 111.944	06.1997→06.2000		7.06117.20.0	ZM-NWV	EL PKW, Cabriolet/ Passenger car, cabriolet  000018→  003441→
230 Kompressor (208.347) 138-142 kW (188-193 PS) M 111.973, M 111.975	06.1997→06.2000		7.06117.20.0	ZM-NWV	EL  000268→  005591→
230 Kompressor (208.348) 145 kW (197 PS) M 111.982	06.2000→06.2002		7.06117.21.0	ZM-NWV	EL mit Trag-/Führungsgelenk With support/ steering link
320 (208.365) 160-162 kW (218-220 PS) M 112.940	06.1997→06.2002		7.02256.37.0	EUV-SL	EL
			7.22355.01.0	EUV-SR	EL
430 (208.370) 205 kW (279 PS) M 113.943	07.1998→06.2002		7.02256.37.0	EUV-SL	EL
			7.22355.01.0	EUV-SR	EL
5.4 255-260 kW (347-354 PS) M 113.984	10.1998→07.2002		7.02256.37.0	EUV-SL	EL
			7.22355.01.0	EUV-SR	EL

						
CLK (C208)						43
55 AMG (208.374) 255 kW (347 PS) M 113.981	08.1999→06.2002		7.22355.01.0	EUV-SR	EL	
55 AMG (208.374) 255-260 kW (347-354 PS) M 113.984	08.1999→06.2002		7.02256.37.0	EUV-SL	EL	
			7.22355.01.0	EUV-SR	EL	
CLK (C209)						44
200 CGI (209.343) 125 kW (170 PS) M 271.942	07.2003→05.2009		7.06117.24.0	ZM-NWV	EL  mit Dichtring with O-ring	
200 Kompressor (209.341) 135 kW (184 PS) M 271.955	10.2006→05.2009		7.06117.24.0	ZM-NWV	EL  mit Dichtring with O-ring	
200 Kompressor (209.342) 120 kW (163 PS) M 271.940	09.2002→05.2009		7.06117.24.0	ZM-NWV	EL  mit Dichtring with O-ring	
240 (209.361) 120-125 kW (163-170 PS) M 112.912	06.2002→05.2009		7.02256.37.0	EUV-SL	EL	
			7.22355.01.0	EUV-SR	EL	
240 (209.361) 120-125 kW (163-170 PS) M 112.912	06.2002→05.2009		7.02256.37.0	EUV-SL	EL	
			7.22355.01.0	EUV-SR	EL	
280 (209.354) 170 kW (231 PS) M 272.940	01.2005→05.2009		7.22355.01.0	EUV-SR	EL	
			7.06117.60.0	ZM-NWV	EL mit Dichtring with O-ring	
320 (209.365) 160 kW (218 PS) M 112.955	06.2002→05.2009		7.02256.37.0	EUV-SL	EL	
			7.22355.01.0	EUV-SR	EL	
350 (209.356) 170-200 kW (231-272 PS) M 272.960	01.2005→05.2009		7.22355.01.0	EUV-SR	EL	
			7.06117.60.0	ZM-NWV	EL mit Dichtring with O-ring	
500 215-225 kW (292-306 PS) M 113.968	09.2002→12.2005		7.22355.01.0	EUV-SR	EL	
500 (209.372) 285 kW (388 PS) M 273.965	06.2006→05.2009		7.22355.01.0	EUV-SR	EL	
			7.06117.60.0	ZM-NWV	EL mit Dichtring with O-ring	
500 (209.375) 215-225 kW (292-306 PS) M 113.968	06.2002→05.2009		7.02256.37.0	EUV-SL	EL	
			7.22355.01.0	EUV-SR	EL	
55 AMG 260-270 kW (354-367 PS) M 113.987	09.2002→12.2005		7.02256.37.0	EUV-SL	EL	
			7.22355.01.0	EUV-SR	EL	
55 AMG (209.376) 260-270 kW (354-367 PS) M 113.987	09.2002→05.2009		7.02256.37.0	EUV-SL	EL	
			7.22355.01.0	EUV-SR	EL	
63 AMG (209.377) 354-373 kW (481-507 PS) M 156.982	04.2006→05.2009		7.02256.37.0	EUV-SL	EL	
			7.22355.01.0	EUV-SR	EL	

M











			 PIERBURG			
CLK (C209)						44
63 AMG (209.377) 354-373 kW (481-507 PS) M 156.982	05.2007→05.2009		7.02256.37.0	EUV-SL	EL	
			7.22355.01.0	EUV-SR	EL	
CLK Convertible (A208)						45
200 (208.435) 100 kW (136 PS) M 111.945	03.1998→03.2002		7.06117.20.0	ZM-NWV	EL PKW, Cabriolet/ Passenger car, cabriolet	
200 Kompressor (208.444) 120 kW (163 PS) M 111.956	06.2000→03.2002		7.06117.21.0	ZM-NWV	EL mit Trag-/Führungsgelenk With support/ steering link	
200 Kompressor (208.445) 132-141 kW (180-192 PS) M 111.944	03.1998→06.2000		7.06117.20.0	ZM-NWV	EL  000018→  003441→	
230 Kompressor (208.447) 138-142 kW (188-193 PS) M 111.973, M 111.975	03.1998→06.2000		7.06117.20.0	ZM-NWV	EL  000268→  005591→	
230 Kompressor (208.448) 145 kW (197 PS) M 111.982	06.2000→03.2002		7.06117.21.0	ZM-NWV	EL mit Trag-/Führungsgelenk With support/ steering link	
320 (208.465) 160-162 kW (218-220 PS) M 112.940	03.1998→03.2002		7.02256.37.0	EUV-SL	EL	
			7.22355.01.0	EUV-SR	EL	
430 (208.470) 205 kW (279 PS) M 113.943	09.1998→03.2002		7.02256.37.0	EUV-SL	EL	
			7.22355.01.0	EUV-SR	EL	
55 AMG (208.474) 255 kW (347 PS) M 113.981	01.2000→03.2002		7.22355.01.0	EUV-SR	EL	
55 AMG (208.474) 255-260 kW (347-354 PS) M 113.984	01.2000→03.2002		7.02256.37.0	EUV-SL	EL	
			7.22355.01.0	EUV-SR	EL	
55 AMG (208.474) 255-260 kW (347-354 PS) M 113.981, M 113.984	09.2001→03.2002		7.02256.37.0	EUV-SL	EL	
CLK Convertible (A209)						46
CLK 200 CGI (209.343) 125 kW (170 PS) M 271.942	07.2003→03.2010		7.06117.24.0	ZM-NWV	EL  mit Dichtring with O-ring	
CLK 200 Kompressor (209.441) 135 kW (184 PS) M 271.955	10.2006→03.2010		7.06117.24.0	ZM-NWV	EL  mit Dichtring with O-ring	
CLK 200 Kompressor (209.442) 120 kW (163 PS) M 271.940	02.2003→03.2010		7.06117.24.0	ZM-NWV	EL  mit Dichtring with O-ring	
CLK 240 (209.461) 120-125 kW (163-170 PS) M 112.912	02.2003→03.2010		7.02256.37.0	EUV-SL	EL	
			7.22355.01.0	EUV-SR	EL	
CLK 280 (209.454) 170 kW (231 PS) M 272.940	01.2005→03.2010		7.22355.01.0	EUV-SR	EL	
			7.06117.60.0	ZM-NWV	EL mit Dichtring with O-ring	
CLK 320 (209.465) 160 kW (218 PS) M 112.955	02.2003→03.2010		7.02256.37.0	EUV-SL	EL	
			7.22355.01.0	EUV-SR	EL	

						
CLK Convertible (A209)						46
CLK 350 (209.456) 170-200 kW (231-272 PS) M 272.960	01.2005→03.2010		7.22355.01.0	EUV-SR	EL	
			7.06117.60.0	ZM-NWV	EL mit Dichtring with O-ring	
CLK 500 215-225 kW (292-306 PS) M 113.968	09.2003→12.2005		7.02256.37.0	EUV-SL	EL	
			7.22355.01.0	EUV-SR	EL	
CLK 500 (209.472) 285 kW (388 PS) M 273.967	06.2006→03.2010		7.22355.01.0	EUV-SR	EL	
			7.06117.60.0	ZM-NWV	EL mit Dichtring with O-ring	
CLK 500 (209.475) 215-225 kW (292-306 PS) M 113.968	02.2003→03.2010		7.02256.37.0	EUV-SL	EL	
			7.22355.01.0	EUV-SR	EL	
CLK 55 AMG 260-270 kW (354-367 PS) M 113.987	09.2003→12.2005		7.02256.37.0	EUV-SL	EL	
			7.22355.01.0	EUV-SR	EL	
CLK 55 AMG (209.476) 260-270 kW (354-367 PS) M 113.987	06.2002→03.2010		7.02256.37.0	EUV-SL	EL	
			7.22355.01.0	EUV-SR	EL	
CLK 63 AMG (209.477) 354-373 kW (481-507 PS) M 156.982	04.2006→03.2010		7.02256.37.0	EUV-SL	EL	
			7.22355.01.0	EUV-SR	EL	
CLK 63 AMG (209.477) 354-373 kW (481-507 PS) M 156.982	09.2006→12.2009		7.02256.37.0	EUV-SL	EL	
CLS (C218)						47
CLS 220 BlueTEC / d (218.301) 120-150 kW (163-204 PS) OM 651.924	05.2014→12.2017		7.00782.12.0	DW-TL	EP	
			7.02256.37.0	EUV-VB	EL	
			7.02256.37.0	EUV-WP	EL	
CLS 220 BlueTEC / d (218.301) 120-150 kW (163-204 PS) OM 651.924	05.2014→12.2017		7.00782.12.0	DW-TL	EP	
			7.02256.37.0	EUV-VB	EL	
			7.02256.37.0	EUV-WP	EL	
CLS 220 BlueTEC / d (218.301) 120-150 kW (163-204 PS) OM 651.924	05.2014→12.2017		7.00782.12.0	DW-TL	EP	
			7.02256.37.0	EUV-VB	EL	
			7.02256.37.0	EUV-WP	EL	
CLS 250 BlueTEC / d 4-matic (218.397) 120-150 kW (163-204 PS) OM 651.924	05.2014→12.2017		7.00782.12.0	DW-TL	EP	
			7.02256.37.0	EUV-VB	EL	
			7.02256.37.0	EUV-WP	EL	
CLS 250 CDI / BlueTEC / d (218.303, 218.304) 120-150 kW (163-204 PS) OM 651.924	04.2011→12.2017		7.00782.12.0	DW-TL	EP	
			7.02256.37.0	EUV-VB	EL	





















M



CLS (C218) **47**

			7.02256.37.0	EUV-WP	EL
CLS 260 (218.336) 115-245 kW (156-333 PS) M 274.920	01.2015→12.2017		7.00782.16.0	DW-TL	EP
			7.02256.37.0	EUV-WP	EL
CLS 320 (218.362) 200-245 kW (272-333 PS) M 276.820	01.2015→12.2017		7.04818.04.0	SUV	EL
			7.00782.11.0	DW-TL	EP
CLS 350 (218.359) 185-245 kW (252-333 PS) M 276.952	01.2011→08.2014		7.01870.06.0	SUV	EL
			7.02288.01.0	EUV-SR	EL
CLS 400 (218.361) 245 kW (333 PS) M 276.850	07.2014→12.2017		7.00782.11.0	DW-TL	EP
			7.01870.06.0	SUV	EL
CLS 400 (218.365) 200-245 kW (272-333 PS) M 276.820	05.2014→12.2017		7.00782.11.0	DW-TL	EP
			7.01870.06.0	SUV	EL
CLS 400 4-matic (218.367) 200-245 kW (272-333 PS) M 276.820	05.2014→12.2017		7.00782.11.0	DW-TL	EP
			7.01870.06.0	SUV	EL
CLS 400 4-matic (218.368) 245 kW (333 PS) M 276.850	07.2014→12.2017		7.00782.11.0	DW-TL	EP
			7.01870.06.0	SUV	EL
CLS 500 (218.373) 300-320 kW (408-435 PS) M 278.922	02.2011→12.2017		7.00782.11.0	DW-TL	EP
			7.00782.11.0	DW-TL	EP
CLS 500 4-matic (218.391) 300-320 kW (408-435 PS) M 278.922	09.2011→12.2017		7.00782.11.0	DW-TL	EP
			7.00782.11.0	DW-TL	EP
CLS 550 300-320 kW (408-435 PS) M 278.922	09.2011→12.2017		7.00782.11.0	DW-TL	EP
			7.00782.11.0	DW-TL	EP
CLS 550 4-matic 300-320 kW (408-435 PS) M 278.922	09.2011→12.2017		7.00782.11.0	DW-TL	EP
			7.00782.11.0	DW-TL	EP
CLS 63 AMG (218.374) 386-430 kW (525-585 PS) M 157.981	01.2011→12.2017		7.00782.11.0	DW-TL	EP
			7.00782.11.0	DW-TL	EP
CLS 63 AMG (218.374) 386-430 kW (525-585 PS) M 157.980, M 157.981	01.2011→12.2017		7.00782.11.0	DW-TL	EP
			7.00782.11.0	DW-TL	EP
CLS 63 AMG (218.374) 386-430 kW (525-585 PS) M 157.980, M 157.981	09.2011→12.2017		7.00782.11.0	DW-TL	EP
			7.00782.11.0	DW-TL	EP
CLS 63 AMG (218.375) 386-430 kW (525-585 PS) M 157.981	02.2013→12.2017		7.00782.11.0	DW-TL	EP
			7.00782.11.0	DW-TL	EP
CLS 63 AMG 4-matic (218.376) 386-430 kW (525-585 PS) M 157.981	02.2013→12.2017		7.00782.11.0	DW-TL	EP
			7.00782.11.0	DW-TL	EP
CLS 63 AMG 4-matic (218.392) 386-430 kW (525-585 PS) M 157.981	05.2013→12.2017		7.00782.11.0	DW-TL	EP
			7.00782.11.0	DW-TL	EP

M

						
CLS (C219)						48
CLS 280 (219.354) 170 kW (231 PS) M 272.943	07.2008→12.2010		7.22355.01.0	EUV-SR	EL	
			7.06117.60.0	ZM-NWV	EL	mit Dichtring with O-ring
CLS 300 (219.354) 170 kW (231 PS) M 272.943	04.2009→12.2010		7.22355.01.0	EUV-SR	EL	
			7.06117.60.0	ZM-NWV	EL	mit Dichtring with O-ring
CLS 350 (219.356) 200 kW (272 PS) M 272.964	10.2004→12.2010		7.22355.01.0	EUV-SR	EL	
			7.06117.60.0	ZM-NWV	EL	mit Dichtring with O-ring
CLS 350 (219.357) 215 kW (292 PS) M 272.985	04.2006→12.2010		7.22355.01.0	EUV-SR	EL	
			7.06117.60.0	ZM-NWV	EL	mit Dichtring with O-ring
CLS 500 215-225 kW (292-306 PS) M 113.967	09.2005→12.2006		7.02256.37.0	EUV-SL	EL	
			7.22355.01.0	EUV-SR	EL	
CLS 500 (219.372) 285 kW (388 PS) M 273.960	04.2006→12.2010		7.22355.01.0	EUV-SR	EL	
			7.06117.60.0	ZM-NWV	EL	mit Dichtring with O-ring
CLS 500 (219.375) 215-225 kW (292-306 PS) M 113.967	10.2004→12.2010		7.02256.37.0	EUV-SL	EL	
			7.22355.01.0	EUV-SR	EL	
CLS 55 AMG (219.376) 350 kW (476 PS) M 113.990	01.2005→12.2010		7.02256.37.0	EUV-SL	EL	
CLS 63 AMG (219.377) 378 kW (514 PS) M 156.983	04.2006→12.2010		7.02256.37.0	EUV-SL	EL	
			7.22355.01.0	EUV-SR	EL	
CLS 63 AMG (219.377) 378 kW (514 PS) M 156.983	09.2006→12.2010		7.02256.37.0	EUV-SL	EL	
CLS (C257)						49
CLS 220 d (257.314) 84-235 kW (114-320 PS) OM 654.920	06.2018→		7.02256.37.0	EUV-AGR	EL	Produktionsdatum bis: 15.12.2020 Production date to: 15.12.2020
CLS 300 d (257.318) 84-235 kW (114-320 PS) OM 654.920	04.2018→		7.02256.37.0	EUV-AGR	EL	Produktionsdatum bis: 15.12.2020 Production date to: 15.12.2020
CLS 350 EQ Boost (257.350) 145-220 kW (197-299 PS) M 264.920	08.2018→		7.04927.08.0	SUV	EL	Ladeluftkühler Intercooler
CLS 350 d (257.320) 183-250 kW (249-340 PS) OM 656.929	08.2018→		7.02256.37.0	EUV-AGR	EL	Produktionsdatum bis: 14.12.2020 Production date to: 14.12.2020
			7.02256.37.0	EUV-WP	EL	Produktionsdatum bis: 14.12.2020 Production date to: 14.12.2020
CLS 350 d 4-matic (257.321) 183-250 kW (249-340 PS) OM 656.929	12.2017→		7.02256.37.0	EUV-AGR	EL	Produktionsdatum bis: 14.12.2020 Production date to: 14.12.2020









M

























CLS (C257) 49

			7.02256.37.0	EUV-WP	EL	Produktionsdatum bis: 14.12.2020 Production date to: 14.12.2020
CLS 350 d 4-matic (257.321) 183-250 kW (249-340 PS) OM 656.929	12.2017→		7.02256.37.0	EUV-AGR	EL	Produktionsdatum bis: 14.12.2020 Production date to: 14.12.2020
			7.02256.37.0	EUV-WP	EL	Produktionsdatum bis: 14.12.2020 Production date to: 14.12.2020
CLS 400 d 4-matic (257.323) 183-250 kW (249-340 PS) OM 656.929	12.2017→		7.02256.37.0	EUV-AGR	EL	Produktionsdatum bis: 14.12.2020 Production date to: 14.12.2020
			7.02256.37.0	EUV-WP	EL	Produktionsdatum bis: 14.12.2020 Production date to: 14.12.2020
CLS 400 d 4-matic (257.323) 183-250 kW (249-340 PS) OM 656.929	06.2020→		7.02256.37.0	EUV-AGR	EL	Produktionsdatum bis: 14.12.2020 Production date to: 14.12.2020
			7.02256.37.0	EUV-WP	EL	Produktionsdatum bis: 14.12.2020 Production date to: 14.12.2020

CLS Shooting Brake (X218) 50

CLS 220 BlueTEC / d (218.901) 120-150 kW (163-204 PS) OM 651.924	05.2014→12.2017		7.00782.12.0	DW-TL	EP	
			7.02256.37.0	EUV-VB	EL	
			7.02256.37.0	EUV-WP	EL	
CLS 220 BlueTEC / d (218.901) 120-150 kW (163-204 PS) OM 651.924	05.2014→12.2017		7.00782.12.0	DW-TL	EP	
			7.02256.37.0	EUV-VB	EL	
			7.02256.37.0	EUV-WP	EL	
CLS 220 BlueTEC / d (218.901) 120-150 kW (163-204 PS) OM 651.924	05.2014→12.2017		7.00782.12.0	DW-TL	EP	
			7.02256.37.0	EUV-VB	EL	
			7.02256.37.0	EUV-WP	EL	
CLS 250 BlueTEC / d 4-matic (218.997) 120-150 kW (163-204 PS) OM 651.924	05.2014→12.2017		7.00782.12.0	DW-TL	EP	
			7.02256.37.0	EUV-VB	EL	
			7.02256.37.0	EUV-WP	EL	
CLS 250 CDI / BlueTEC / d (218.903, 218.904) 120-150 kW (163-204 PS) OM 651.924	10.2012→12.2017		7.00782.12.0	DW-TL	EP	
			7.02256.37.0	EUV-VB	EL	
			7.02256.37.0	EUV-WP	EL	
CLS 400 (218.961) 245 kW (333 PS) M 276.850	07.2014→12.2017		7.00782.11.0	DW-TL	EP	
			7.01870.06.0	SUV	EL	
CLS 400 (218.965) 200-245 kW (272-333 PS) M 276.820	05.2014→12.2017		7.00782.11.0	DW-TL	EP	
			7.01870.06.0	SUV	EL	
CLS 400 4-matic (218.967) 200-245 kW (272-333 PS) M 276.820	05.2014→12.2017		7.00782.11.0	DW-TL	EP	
			7.01870.06.0	SUV	EL	

M

						
CLS Shooting Brake (X218)						50
CLS 400 4-matic (218.968) 245 kW (333 PS) M 276.850	07.2014→12.2017		7.00782.11.0	DW-TL	EP	
			7.01870.06.0	SUV	EL	
CLS 500 (218.973) 300-320 kW (408-435 PS) M 278.922	10.2012→12.2017		7.00782.11.0	DW-TL	EP	
CLS 500 4-matic (218.991) 300-320 kW (408-435 PS) M 278.922	10.2012→12.2017		7.00782.11.0	DW-TL	EP	
CLS 63 AMG (218.974) 386-430 kW (525-585 PS) M 157.981	10.2012→12.2017		7.00782.11.0	DW-TL	EP	
CLS 63 AMG (218.974) 386-430 kW (525-585 PS) M 157.981	05.2013→12.2017		7.00782.11.0	DW-TL	EP	
CLS 63 AMG (218.975) 386-430 kW (525-585 PS) M 157.981	02.2013→12.2017		7.00782.11.0	DW-TL	EP	
CLS 63 AMG 4-matic (218.976) 386-430 kW (525-585 PS) M 157.981	02.2013→12.2017		7.00782.11.0	DW-TL	EP	
CLS 63 AMG 4-matic (218.992) 386-430 kW (525-585 PS) M 157.981	05.2013→12.2017		7.00782.11.0	DW-TL	EP	
COUPE (W111, W112)						51
280 SE (111.024) 118 kW (160 PS) M 130.980	01.1967→12.1971		7.21071.50.0	EUV-SR	EP	
280 SE 3.5 (111.026) 147 kW (200 PS) M 116.980	01.1969→12.1971		7.21071.50.0	EUV-SR	EP	
E-CLASS (W124)						52
E 200 D (124.120) 53-55 kW (72-75 PS) OM 601.912	06.1993→06.1995		7.21071.50.0	EUV-LS	EP	
E 220 (124.022) 110 kW (150 PS) M 111.960	06.1993→06.1995		7.06117.20.0	ZM-NWV	EL	PKW, Coupe/ Passenger car, coupé
E 280 (124.028) 142-145 kW (193-197 PS) M 104.942	06.1993→06.1995		7.21071.50.0	EUV-LS	EP	PKW, Stufenheck/ Passenger car, notchback
			7.21071.50.0 7.06117.20.0	EUV-SL ZM-NWV	EP EL	
E 280 (124.029) 142-145 kW (193-197 PS) M 104.942	06.1993→06.1995		7.21071.50.0	EUV-LS	EP	PKW, Stufenheck/ Passenger car, notchback
			7.21071.50.0 7.06117.20.0	EUV-SL ZM-NWV	EP EL	
E 320 (124.032) 162 kW (220 PS) M 104.992	06.1993→06.1995		7.21071.50.0	EUV-LS	EP	PKW, Stufenheck/ Passenger car, notchback
			7.21071.50.0 7.06117.20.0	EUV-SL ZM-NWV	EP EL	
			7.06117.20.0	ZM-NWV	EL	
E 36 AMG 195-200 kW (265-272 PS) M 104.992 (AMG 3.6)	07.1994→01.1995		7.06117.20.0	ZM-NWV	EL	PKW, Stufenheck/ Passenger car, notchback
E 420 (124.034) 205 kW (279 PS) M 119.975	06.1993→06.1995		7.21071.50.0	EUV-LS	EP	





















M



E-CLASS (W124) 52

			7.06117.20.0	ZM-NWV	EL	PKW, Stufenheck/ Passenger car, notchback
E 500 (124.036) 235-240 kW (320-326 PS) M 119.974	06.1993→06.1995		7.06117.20.0	ZM-NWV	EL	PKW, Stufenheck/ Passenger car, notchback
E 60 AMG (124.036) 275-280 kW (374-381 PS) M 119.974 (AMG 6.0)	05.1994→06.1995		7.06117.20.0	ZM-NWV	EL	PKW, Stufenheck/ Passenger car, notchback

E-CLASS (W210) 53

E 200 (210.035) 100 kW (136 PS) M 111.942	06.1995→08.2000		7.02256.37.0	EUV-AT	EL	
			7.06117.20.0	ZM-NWV	EL	 016445→  022020→
E 200 CDI (210.007) 75-105 kW (102-143 PS) OM 611.961	06.1998→03.2002		7.02256.37.0	EUV-AGR	EL	
E 200 CDI (210.007) 75-105 kW (102-143 PS) OM 611.961	07.1999→03.2002		7.02256.37.0	EUV-AGR	EL	 →ch. A 962231
E 200 D (210.003) 65 kW (88 PS) OM 604.917	01.1996→03.2002		7.02256.37.0	EUV-AGR	EL	
E 200 Kompressor (210.045) 137 kW (186 PS) M 111.947	06.1997→03.2002		7.02256.37.0	EUV-AT	EL	
			7.06117.20.0	ZM-NWV	EL	PKW, Stufenheck/ Passenger car, notchback
E 200 Kompressor (210.048) 120 kW (163 PS) M 111.957	08.2000→03.2002		7.06117.21.0	ZM-NWV	EL	mit Trag-/Führungsgelenk With support/ steering link
E 220 CDI (210.006) 75-105 kW (102-143 PS) OM 611.961	06.1998→07.1999		7.02256.37.0	EUV-AGR	EL	
E 220 CDI (210.006) 75-105 kW (102-143 PS) OM 611.961	07.1999→03.2002		7.02256.37.0	EUV-AGR	EL	
E 220 CDI (210.006) 75-105 kW (102-143 PS) OM 611.961	07.1999→03.2002		7.02256.37.0	EUV-AGR	EL	
E 220 D 55-70 kW (75-95 PS) OM 604.912	05.1996→03.2002		7.02256.37.0	EUV-AGR	EL	 →ch. A 962231 Stufenheck Saloon
E 220 D (210.004) 55-70 kW (75-95 PS) OM 604.912	06.1995→07.1999		7.02256.37.0	EUV-AGR	EL	
E 230 (210.037) 110 kW (150 PS) M 111.970	06.1995→06.1997		7.02256.37.0	EUV-AT	EL	
			7.06117.20.0	ZM-NWV	EL	PKW, Stufenheck/ Passenger car, notchback
E 240 (210.061) 125 kW (170 PS) M 112.911	06.1997→08.2000		7.02256.37.0	EUV-SL	EL	
			7.22355.01.0	EUV-SR	EL	
			7.02256.37.0	EUV-SL	EL	
E 240 (210.062) 125 kW (170 PS) M 112.914	08.2000→03.2002		7.02256.37.0	EUV-SL	EL	
			7.22355.01.0	EUV-SR	EL	
E 250 D (210.010) 83 kW (113 PS) OM 605.912	06.1995→07.1999		7.02256.37.0	EUV-AGR	EL	
E 250 Turbo-D (210.015) 110 kW (150 PS) OM 605.962	06.1997→07.1999		7.02256.37.0	EUV-AGR	EL	

M







E-CLASS (W210) 53

E 280 (210.053) 142 kW (193 PS) M 104.945	01.1996→06.1997	 7.02256.37.0	EUV-AT	EL	PKW, Stufenheck/ Passenger car, notchback
		7.21071.50.0	EUV-LS	EP	
		7.21071.50.0	EUV-SL	EP	
		7.06117.20.0	ZM-NWV	EL	
E 280 (210.063) 150 kW (204 PS) M 112.921	12.1996→03.2002	 7.21071.50.0	EUV-LS	EP	
		7.02256.37.0	EUV-SL	EL	
		7.22355.01.0	EUV-SR	EL	
E 280 4-matic (210.081) 150 kW (204 PS) M 112.921	12.1996→03.2002	 7.21071.50.0	EUV-LS	EP	
		7.02256.37.0	EUV-SL	EL	
		7.22355.01.0	EUV-SR	EL	
E 300 D (210.020) 100 kW (136 PS) OM 606.912	06.1995→06.1997	 7.02256.37.0	EUV-AGR	EL	
E 300 Turbo-D (210.025) 130 kW (177 PS) OM 606.962	03.1997→07.1999	 7.02256.37.0	EUV-AGR	EL	
E 320 (210.055) 162 kW (220 PS) M 104.995	06.1995→06.1997	 7.02256.37.0	EUV-AT	EL	PKW, Stufenheck/ Passenger car, notchback
		7.21071.50.0	EUV-LS	EP	
		7.21071.50.0	EUV-SL	EP	
		7.06117.20.0	ZM-NWV	EL	
E 320 (210.065) 160-165 kW (218-224 PS) M 112.941	06.1997→03.2002	 7.21071.50.0	EUV-LS	EP	
		7.02256.37.0	EUV-SL	EL	
		7.22355.01.0	EUV-SR	EL	
E 320 (210.065) 160-165 kW (218-224 PS) M 112.941	09.1997→12.1998	 7.02256.37.0	EUV-SL	EL	
		7.22355.01.0	EUV-SR	EL	
E 320 4-matic (210.082) 160-165 kW (218-224 PS) M 112.941	06.1997→03.2002	 7.21071.50.0	EUV-LS	EP	
		7.02256.37.0	EUV-SL	EL	
		7.22355.01.0	EUV-SR	EL	
E 320 4-matic (210.082) 160-165 kW (218-224 PS) M 112.941	09.1997→12.1998	 7.02256.37.0	EUV-SL	EL	
		7.22355.01.0	EUV-SR	EL	
E 36 AMG 200 kW (272 PS) M 104.995 (AMG 3.6)	04.1996→01.1998	 7.21071.50.0	EUV-SL	EP	
E 420 (210.072) 205 kW (279 PS) M 119.985	01.1996→06.1997	 7.21071.50.0	EUV-LS	EP	
E 430 (210.070) 205 kW (279 PS) M 113.940	06.1997→03.2002	 7.02256.37.0	EUV-SL	EL	
		7.22355.01.0	EUV-SR	EL	
E 430 4-matic (210.083) 205 kW (279 PS) M 113.940	05.1999→03.2002	 7.02256.37.0	EUV-SL	EL	
		7.22355.01.0	EUV-SR	EL	
E 55 AMG 255-260 kW (347-354 PS) M 113.980	09.1997→02.2002	 7.22355.01.0	EUV-SR	EL	





M



E-CLASS (W210) 53

E 55 AMG (210.074) 255-260 kW (347-354 PS) M 113.980	08.1997→03.2002	 7.02256.37.0	EUV-WP	EL	
		 7.02256.37.0	EUV-SL	EL	
		 7.22355.01.0	EUV-SR	EL	
E 55 AMG (210.074) 255-260 kW (347-354 PS) M 113.980	09.1997→12.1998	 7.02256.37.0	EUV-WP	EL	

E-CLASS (W211) 54









E 200 Kompressor (211.041) 135 kW (184 PS) M 271.956	04.2006→12.2008	 7.06117.24.0	ZM-NWV	EL	 mit Dichtring with O-ring
E 200 Kompressor (211.042) 120 kW (163 PS) M 271.941	11.2002→12.2008	 7.06117.24.0	ZM-NWV	EL	 mit Dichtring with O-ring
E 200 NGT (211.042) 120 kW (163 PS) M 271.941	03.2004→12.2008	 7.06117.24.0	ZM-NWV	EL	 mit Dichtring with O-ring
E 230 (211.052) 150 kW (204 PS) M 272.922	09.2007→12.2008	 7.22355.01.0	EUV-SR	EL	
		 7.06117.60.0	ZM-NWV	EL	mit Dichtring with O-ring
E 240 (211.061) 130 kW (177 PS) M 112.913, M 112.917	03.2002→12.2008	 7.02256.37.0	EUV-SL	EL	
		 7.22355.01.0	EUV-SR	EL	
E 240 4-matic (211.080) 130 kW (177 PS) M 112.917	03.2003→12.2008	 7.02256.37.0	EUV-SL	EL	
		 7.22355.01.0	EUV-SR	EL	
E 280 (211.054) 170 kW (231 PS) M 272.943	03.2005→12.2008	 7.22355.01.0	EUV-SR	EL	
		 7.06117.60.0	ZM-NWV	EL	mit Dichtring with O-ring
E 280 4-matic (211.092) 170 kW (231 PS) M 272.943	01.2006→12.2008	 7.22355.01.0	EUV-SR	EL	
E 280 4-matic (211.092) 170 kW (231 PS) M 272.944	01.2006→12.2008	 7.22355.01.0	EUV-SR	EL	
		 7.06117.60.0	ZM-NWV	EL	mit Dichtring with O-ring
E 320 (211.065) 165 kW (224 PS) M 112.949	03.2002→12.2008	 7.02256.37.0	EUV-SL	EL	
		 7.22355.01.0	EUV-SR	EL	
E 320 4-matic (211.082) 165 kW (224 PS) M 112.954	03.2003→12.2008	 7.02256.37.0	EUV-SL	EL	
		 7.22355.01.0	EUV-SR	EL	
E 350 (211.056) 200 kW (272 PS) M 272.964	03.2005→12.2008	 7.22355.01.0	EUV-SR	EL	
		 7.06117.60.0	ZM-NWV	EL	mit Dichtring with O-ring
E 350 4-matic (211.087) 200-205 kW (272-279 PS) M 272.972	08.2004→08.2006	 7.22355.01.0	EUV-SR	EL	
		 7.06117.60.0	ZM-NWV	EL	mit Dichtring with O-ring
E 350 4-matic (211.087) 200-205 kW (272-279 PS) M 272.972	03.2005→12.2008	 7.22355.01.0	EUV-SR	EL	

M



E-CLASS (W211)





54

			7.06117.60.0	ZM-NWV	EL	mit Dichtring with O-ring
E 350 CGI (211.057) 215 kW (292 PS) M 272.985	09.2007→12.2008		7.22355.01.0	EUV-SR	EL	
			7.06117.60.0	ZM-NWV	EL	mit Dichtring with O-ring
E 500 (211.070) 215-225 kW (292-306 PS) M 113.967	03.2002→12.2008		7.02256.37.0	EUV-SL	EL	
			7.22355.01.0	EUV-SR	EL	
E 500 (211.070) 215-225 kW (292-306 PS) M 113.967	09.2002→12.2005		7.02256.37.0	EUV-SL	EL	
			7.22355.01.0	EUV-SR	EL	
E 500 (211.072) 285 kW (388 PS) M 273.960	04.2006→12.2008		7.22355.01.0	EUV-SR	EL	
			7.06117.60.0	ZM-NWV	EL	mit Dichtring with O-ring
E 500 4-matic (211.083) 225 kW (306 PS) M 113.969	10.2003→12.2008		7.02256.37.0	EUV-SL	EL	
			7.22355.01.0	EUV-SR	EL	
E 500 4-matic (211.090) 285 kW (388 PS) M 273.962	04.2006→12.2008		7.22355.01.0	EUV-SR	EL	
			7.06117.60.0	ZM-NWV	EL	mit Dichtring with O-ring
E 55 AMG Kompressor (211.076) 350 kW (476 PS) M 113.990	10.2002→12.2008		7.02256.37.0	EUV-SL	EL	
E 63 AMG (211.077) 378 kW (514 PS) M 156.983	03.2006→12.2008		7.02256.37.0	EUV-SL	EL	
			7.22355.01.0	EUV-SR	EL	
E 63 AMG (211.077) 378 kW (514 PS) M 156.983	09.2006→12.2008		7.02256.37.0	EUV-SL	EL	

M

E-CLASS (W212)

55



E 180 (212.040) 95-115 kW (129-156 PS) M 274.910	08.2013→12.2015		7.00782.16.0	DW-TL	EP	
			7.04818.04.0	SUV	EL	
E 200 (212.034) 115-245 kW (156-333 PS) M 274.920	01.2013→12.2016		7.00782.16.0	DW-TL	EP	
			7.02256.37.0	EUV-WP	EL	
			7.04818.04.0	SUV	EL	
E 200 CDI / BlueTEC (212.005, 212.006) 100 kW (136 PS) OM 651.925	01.2009→12.2015		7.00782.12.0	DW-TL	EP	
			7.02256.37.0	EUV-VB	EL	
			7.02256.37.0	EUV-WP	EL	
E 200 CGI (212.048, 212.148) 115-150 kW (156-204 PS) M 271.820, M 271.860	08.2009→12.2015		7.00017.03.0	LDRV	EP	
			7.01870.06.0	SUV	EL	



E-CLASS (W212) 55

E 200 NGT (212.035) 115-245 kW (156-333 PS) M 274.920	07.2013→12.2015		7.00782.16.0	DW-TL	EP	
			7.02256.37.0 7.04818.04.0	EUV-WP SUV	EL EL	
E 200 NGT (212.041) 120-135 kW (163-184 PS) M 271.958	03.2011→12.2015		7.06117.24.0	ZM-NWV	EL	 mit Dichtring with O-ring
E 220 BlueTEC (212.001) 120-150 kW (163-204 PS) OM 651.924	05.2014→12.2015		7.00782.12.0 7.02256.37.0 7.02256.37.0	DW-TL EUV-VB EUV-WP	EP EL EL	
E 220 BlueTEC 4-matic (212.011) 120-150 kW (163-204 PS) OM 651.924	01.2015→12.2015		7.00782.12.0 7.02256.37.0 7.02256.37.0	DW-TL EUV-VB EUV-WP	EP EL EL	
E 220 CDI 120-150 kW (163-204 PS) OM 651.924	01.2009→12.2015		7.00782.12.0 7.02256.37.0 7.02256.37.0	DW-TL EUV-VB EUV-WP	EP EL EL	
E 220 CDI / BlueTEC (212.001, 212.002) 120-150 kW (163-204 PS) OM 651.924	01.2009→12.2016		7.00782.12.0	DW-TL	EP	
			7.02256.37.0 7.02256.37.0	EUV-VB EUV-WP	EL EL	
E 250 (212.036) 115-245 kW (156-333 PS) M 274.920	01.2013→12.2016		7.00782.16.0 7.02256.37.0 7.04818.04.0	DW-TL EUV-WP SUV	EP EL EL	
E 250 CDI / BlueTEC (212.003, 212.004) 120-150 kW (163-204 PS) OM 651.924	01.2009→12.2016		7.00782.12.0 7.02256.37.0 7.02256.37.0	DW-TL EUV-VB EUV-WP	EP EL EL	
E 250 CDI / BlueTEC (212.004) 120-150 kW (163-204 PS) OM 651.924	01.2014→12.2015		7.00782.12.0 7.02256.37.0 7.02256.37.0	DW-TL EUV-VB EUV-WP	EP EL EL	
E 250 CDI / BlueTEC 4-matic (212.082, 212.097) 120-150 kW (163-204 PS) OM 651.924	01.2011→12.2015		7.00782.12.0 7.02256.37.0 7.02256.37.0	DW-TL EUV-VB EUV-WP	EP EL EL	
E 250 CDI / BlueTEC 4-matic (212.097) 120-150 kW (163-204 PS) OM 651.924	07.2014→12.2015		7.00782.12.0 7.02256.37.0 7.02256.37.0	DW-TL EUV-VB EUV-WP	EP EL EL	

M

					
E-CLASS (W212)					
E 250 CGI (212.047, 212.147) 135-150 kW (184-204 PS) M 271.860	01.2009→12.2015		7.00017.03.0	LDRV	EP
			7.01870.06.0	SUV	EL
E 300 (212.054) 161-170 kW (219-231 PS) M 272.952	01.2009→12.2013		7.22355.01.0	EUV-SR	EL
			7.06117.60.0	ZM-NWV	EL mit Dichtring with O-ring
E 300 (212.054) 161-170 kW (219-231 PS) M 272.952	01.2011→12.2015		7.22355.01.0	EUV-SR	EL
			7.06117.60.0	ZM-NWV	EL mit Dichtring with O-ring
E 300 (212.055) 185-245 kW (252-333 PS) M 276.952	07.2011→12.2015		7.02288.01.0	EUV-SR	EL
E 300 4-matic (212.080) 185-245 kW (252-333 PS) M 276.952	07.2011→12.2015		7.02288.01.0	EUV-SR	EL
E 300 Hybrid / BlueTEC Hybrid (212.098) 120-150 kW (163-204 PS) OM 651.924	12.2011→12.2016		7.00782.12.0	DW-TL	EP
			7.02256.37.0	EUV-VB	EL
			7.02256.37.0	EUV-WP	EL
E 350 (212.056) 200 kW (272 PS) M 272.980	01.2009→12.2013		7.22355.01.0	EUV-SR	EL
			7.06117.60.0	ZM-NWV	EL mit Dichtring with O-ring
E 350 (212.059) 185-245 kW (252-333 PS) M 276.952	09.2011→12.2015		7.02288.01.0	EUV-SR	EL
E 350 4-matic (212.087) 200 kW (272 PS) M 272.977	01.2009→08.2011		7.22355.01.0	EUV-SR	EL
			7.06117.60.0	ZM-NWV	EL mit Dichtring with O-ring
E 350 4-matic (212.088) 185-245 kW (252-333 PS) M 276.952	09.2011→12.2015		7.02288.01.0	EUV-SR	EL
E 350 CGI (212.057) 215 kW (292 PS) M 272.982	01.2009→08.2011		7.22355.01.0	EUV-SR	EL
E 350 CGI (212.057) 215 kW (292 PS) M 272.983	01.2009→08.2011		7.22355.01.0	EUV-SR	EL
			7.06117.60.0	ZM-NWV	EL mit Dichtring with O-ring
E 400 (212.061) 245 kW (333 PS) M 276.850	07.2014→12.2015		7.00782.11.0	DW-TL	EP
			7.01870.06.0	SUV	EL
E 400 (212.065) 200-245 kW (272-333 PS) M 276.820	01.2013→12.2016		7.00782.11.0	DW-TL	EP
			7.01870.06.0	SUV	EL
E 400 4-matic (212.067) 200-245 kW (272-333 PS) M 276.820	01.2013→12.2016		7.00782.11.0	DW-TL	EP
			7.01870.06.0	SUV	EL

55
M







E-CLASS (W212) 55

E 400 4-matic (212.099) 245 kW (333 PS) M 276.850	07.2014→12.2015		7.00782.11.0	DW-TL	EP	
			7.01870.06.0	SUV	EL	
E 500 (212.072) 285 kW (388 PS) M 273.971	01.2009→12.2011		7.22355.01.0	EUV-SR	EL	
			7.06117.60.0	ZM-NWV	EL	mit Dichtring with O-ring
E 500 (212.073) 300-320 kW (408-435 PS) M 278.922	09.2011→12.2015		7.00782.11.0	DW-TL	EP	
E 500 4-matic (212.090) 285 kW (388 PS) M 273.970	01.2009→12.2011		7.22355.01.0	EUV-SR	EL	
			7.06117.60.0	ZM-NWV	EL	mit Dichtring with O-ring
E 500 4-matic (212.091) 300-320 kW (408-435 PS) M 278.922	09.2011→12.2015		7.00782.11.0	DW-TL	EP	
E 63 AMG 336-410 kW (457-558 PS) M 156.985	01.2009→12.2011		7.02256.37.0	EUV-SL	EL	
			7.22355.01.0	EUV-SR	EL	
E 63 AMG (212.074) 386-430 kW (525-585 PS) M 157.980, M 157.981	02.2011→12.2016		7.00782.11.0	DW-TL	EP	
			7.00782.11.0	DW-TL	EP	
E 63 AMG (212.075) 386-430 kW (525-585 PS) M 157.981	02.2013→12.2016		7.00782.11.0	DW-TL	EP	
			7.00782.11.0	DW-TL	EP	
E 63 AMG (212.077) 336-410 kW (457-558 PS) M 156.985	12.2009→12.2015		7.02256.37.0	EUV-SL	EL	
			7.22355.01.0	EUV-SR	EL	
E 63 AMG 4-matic (212.076) 386-430 kW (525-585 PS) M 157.981	02.2013→12.2016		7.00782.11.0	DW-TL	EP	
E 63 AMG 4-matic (212.092) 386-430 kW (525-585 PS) M 157.981	01.2013→12.2016		7.00782.11.0	DW-TL	EP	



M

E-CLASS (W213) 56





















AMG E 43 4-matic (213.064) 200-295 kW (272-401 PS) M 276.823	07.2016→		7.00782.11.0	DW-TL	EP	
			7.01870.06.0	SUV	EL	
AMG E 63 4-matic+ (213.088) 350-470 kW (476-639 PS) M 177.980	01.2017→		7.00782.16.0	DW-TL	EP	
			7.04927.08.0	SUV	EL	Luftfiltergehäuse Air Filter Housing
AMG E 63 S 4-matic+ (213.089) 350-470 kW (476-639 PS) M 177.980	01.2017→		7.00782.16.0	DW-TL	EP	
			7.04927.08.0	SUV	EL	Luftfiltergehäuse Air Filter Housing
E 180 (213.040) 95-115 kW (129-156 PS) M 274.910	01.2017→		7.00782.16.0	DW-TL	EP	



E-CLASS (W213) 56

		7.04818.04.0	SUV	EL	
E 200 (213.042) 115-245 kW (156-333 PS) M 274.920	01.2016→	 7.00782.16.0	DW-TL	EP	
		7.02256.37.0	EUV-WP	EL	
		7.04818.04.0	SUV	EL	
E 200 4-matic (213.043) 115-245 kW (156-333 PS) M 274.920	07.2016→	 7.00782.16.0	DW-TL	EP	
		7.02256.37.0	EUV-WP	EL	
		7.04818.04.0	SUV	EL	
E 200 d (213.012) 90-118 kW (122-160 PS) OM 654.916	11.2018→	 7.02256.37.0	EUV-AGR	EL	Produktionsdatum bis: 15.12.2020 Production date to: 15.12.2020
E 200 d (213.013) 84-235 kW (114-320 PS) OM 654.920	07.2016→	 7.02256.37.0	EUV-AGR	EL	Produktionsdatum bis: 15.12.2020 Production date to: 15.12.2020
E 220 d (213.004) 84-235 kW (114-320 PS) OM 654.920	01.2016→	 7.02256.37.0	EUV-AGR	EL	Produktionsdatum bis: 15.12.2020 Production date to: 15.12.2020
E 220 d (213.004) 84-235 kW (114-320 PS) OM 654.920	01.2016→	 7.02256.37.0	EUV-AGR	EL	Produktionsdatum bis: 15.12.2020 Production date to: 15.12.2020
E 220 d 4-matic (213.005) 84-235 kW (114-320 PS) OM 654.920	10.2016→	 7.02256.37.0	EUV-AGR	EL	Produktionsdatum bis: 15.12.2020 Production date to: 15.12.2020
E 220 d 4-matic (213.005) 84-235 kW (114-320 PS) OM 654.920	10.2016→	 7.02256.37.0	EUV-AGR	EL	Produktionsdatum bis: 15.12.2020 Production date to: 15.12.2020
E 250 (213.045) 115-245 kW (156-333 PS) M 274.920	07.2016→	 7.00782.16.0	DW-TL	EP	
		7.02256.37.0	EUV-WP	EL	
		7.04818.04.0	SUV	EL	
E 300 (213.048) 115-245 kW (156-333 PS) M 274.920	07.2016→	 7.00782.16.0	DW-TL	EP	
		7.02256.37.0	EUV-WP	EL	
		7.04818.04.0	SUV	EL	
E 300 (213.048) 115-245 kW (156-333 PS) M 274.920	02.2019→	 7.00782.16.0	DW-TL	EP	
		7.02256.37.0	EUV-WP	EL	
		7.04818.04.0	SUV	EL	
E 300 4-matic (213.049) 115-245 kW (156-333 PS) M 274.920	09.2016→	 7.00782.16.0	DW-TL	EP	
		7.02256.37.0	EUV-WP	EL	
		7.04818.04.0	SUV	EL	
E 300 d (213.008) 84-235 kW (114-320 PS) OM 654.920	12.2017→	 7.02256.37.0	EUV-AGR	EL	Produktionsdatum bis: 15.12.2020 Production date to: 15.12.2020
E 300 de (213.016) 84-235 kW (114-320 PS) OM 654.920	10.2018→	 7.02256.37.0	EUV-AGR	EL	Produktionsdatum bis: 15.12.2020 Production date to: 15.12.2020
E 300 de (213.016) 84-235 kW (114-320 PS) OM 654.920	10.2018→	 7.02256.37.0	EUV-AGR	EL	Produktionsdatum bis: 15.12.2020 Production date to: 15.12.2020

M

					
E-CLASS (W213)					56
E 300 de 4-matic (213.011) 84-235 kW (114-320 PS) OM 654.920	06.2020→		7.02256.37.0	EUV-AGR	EL Produktionsdatum bis: 15.12.2020 Production date to: 15.12.2020
E 300 de 4-matic (213.011) 84-235 kW (114-320 PS) OM 654.920	06.2020→		7.02256.37.0	EUV-AGR	EL Produktionsdatum bis: 15.12.2020 Production date to: 15.12.2020
E 300 e (213.053) 115-245 kW (156-333 PS) M 274.920	11.2018→		7.00782.16.0	DW-TL	EP
			7.02256.37.0	EUV-WP	EL
			7.04818.04.0	SUV	EL
E 300 e (213.053) 115-245 kW (156-333 PS) M 274.920	11.2018→		7.00782.16.0	DW-TL	EP
			7.02256.37.0	EUV-WP	EL
			7.04818.04.0	SUV	EL
E 300 e 4-matic (213.054) 115-245 kW (156-333 PS) M 274.920	07.2020→		7.00782.16.0	DW-TL	EP
			7.02256.37.0	EUV-WP	EL
E 300 e 4-matic (213.054) 115-245 kW (156-333 PS) M 274.920	07.2020→		7.00782.16.0	DW-TL	EP
			7.02256.37.0	EUV-WP	EL
E 350 EQ Boost (213.085) 145-220 kW (197-299 PS) M 264.920	08.2018→		7.04927.08.0	SUV	EL Ladeluftkühler Intercooler
E 350 d (213.022) 183-250 kW (249-340 PS) OM 656.929	08.2018→		7.02256.37.0	EUV-AGR	EL Produktionsdatum bis: 14.12.2020 Production date to: 14.12.2020
			7.02256.37.0	EUV-WP	EL Produktionsdatum bis: 14.12.2020 Production date to: 14.12.2020
E 350 e (213.050) 115-245 kW (156-333 PS) M 274.920	07.2016→		7.00782.16.0	DW-TL	EP
			7.02256.37.0	EUV-WP	EL
			7.04818.04.0	SUV	EL
E 350 e (213.050) 115-245 kW (156-333 PS) M 274.920	07.2016→		7.00782.16.0	DW-TL	EP
			7.02256.37.0	EUV-WP	EL
			7.04818.04.0	SUV	EL
E 350 e (213.050) 115-245 kW (156-333 PS) M 274.920	11.2019→		7.00782.16.0	DW-TL	EP
			7.02256.37.0	EUV-WP	EL
			7.04818.04.0	SUV	EL
E 400 4-matic (213.066) 200-295 kW (272-401 PS) M 276.823	06.2016→		7.00782.11.0	DW-TL	EP
			7.01870.06.0	SUV	EL
E 400 4-matic (213.071) 245 kW (333 PS) M 276.853	07.2016→		7.00782.11.0	DW-TL	EP
			7.01870.06.0	SUV	EL
E 400 d (213.020) 183-250 kW (249-340 PS) OM 656.929	12.2018→		7.02256.37.0	EUV-AGR	EL Produktionsdatum bis: 14.12.2020 Production date to: 14.12.2020

M



E-CLASS (W213)

56

			7.02256.37.0	EUV-WP	EL	Produktionsdatum bis: 14.12.2020 Production date to: 14.12.2020
E 400 d 4-matic (213.023) 183-250 kW (249-340 PS) OM 656.929	04.2018→		7.02256.37.0	EUV-AGR	EL	Produktionsdatum bis: 14.12.2020 Production date to: 14.12.2020
			7.02256.37.0	EUV-WP	EL	Produktionsdatum bis: 14.12.2020 Production date to: 14.12.2020
E 400 d 4-matic (213.023) 183-250 kW (249-340 PS) OM 656.929	06.2020→		7.02256.37.0	EUV-AGR	EL	Produktionsdatum bis: 14.12.2020 Production date to: 14.12.2020
			7.02256.37.0	EUV-WP	EL	Produktionsdatum bis: 14.12.2020 Production date to: 14.12.2020
E 450 4-matic (213.068) 200-295 kW (272-401 PS) M 276.823	08.2018→		7.00782.11.0	DW-TL	EP	
			7.01870.06.0	SUV	EL	

E-CLASS All-Terrain (S213)





57

E 220 d 4-matic (213.217) 84-235 kW (114-320 PS) OM 654.920	01.2017→		7.02256.37.0	EUV-AGR	EL	Produktionsdatum bis: 15.12.2020 Production date to: 15.12.2020
E 400 d 4-matic (213.227) 183-250 kW (249-340 PS) OM 656.929	08.2018→		7.02256.37.0	EUV-AGR	EL	Produktionsdatum bis: 14.12.2020 Production date to: 14.12.2020
			7.02256.37.0	EUV-WP	EL	Produktionsdatum bis: 14.12.2020 Production date to: 14.12.2020
E 400 d 4-matic (213.227) 183-250 kW (249-340 PS) OM 656.929	07.2020→		7.02256.37.0	EUV-AGR	EL	Produktionsdatum bis: 14.12.2020 Production date to: 14.12.2020
			7.02256.37.0	EUV-WP	EL	Produktionsdatum bis: 14.12.2020 Production date to: 14.12.2020

M



E-CLASS Convertible (A124)

58

E 200 (124.060) 100 kW (136 PS) M 111.940	06.1993→03.1998		7.21071.50.0	EUV-AT	EP	
E 220 (124.062) 110 kW (150 PS) M 111.960	06.1993→03.1998		7.21071.50.0	EUV-AT	EP	
			7.06117.20.0	ZM-NWV	EL	PKW, Coupe/ Passenger car, coupé
E 320 (124.066) 162 kW (220 PS) M 104.992	06.1993→03.1998		7.21071.50.0	EUV-AT	EP	
			7.21071.50.0	EUV-LS	EP	
			7.21071.50.0	EUV-SL	EP	
			7.06117.20.0	ZM-NWV	EL	PKW, Stufenheck/ Passenger car, notchback
E 36 AMG (124.066) 195-200 kW (265-272 PS) M 104.992 (AMG 3.6)	05.1994→03.1998		7.21071.50.0	EUV-AT	EP	
			7.06117.20.0	ZM-NWV	EL	PKW, Stufenheck/ Passenger car, notchback

E-CLASS Convertible (A207)

59

E 200 (207.434) 115-245 kW (156-333 PS) M 274.920	03.2013→12.2016		7.00782.16.0	DW-TL	EP	
			7.02256.37.0	EUV-WP	EL	
			7.04818.04.0	SUV	EL	
E 200 CGI (207.448) 115-150 kW (156-204 PS) M 271.820, M 271.860	01.2010→12.2016		7.00017.03.0	LDRV	EP	
			7.01870.06.0	SUV	EL	



E-CLASS Convertible (A207) **59**

E 220 BlueTEC (207.401) 120-150 kW (163-204 PS) OM 651.911	05.2014→12.2016		7.00782.12.0	DW-TL	EP	
			7.02256.37.0	EUV-VB	EL	
E 220 CDI (207.402) 120-150 kW (163-204 PS) OM 651.911	02.2010→12.2016		7.00782.12.0	DW-TL	EP	
			7.02256.37.0	EUV-WP	EL	
E 220 CDI / BlueTEC / d (207.402, 207.401) 120-150 kW (163-204 PS) OM 651.911	01.2010→12.2016		7.00782.12.0	DW-TL	EP	
			7.02256.37.0	EUV-VB	EL	
E 250 (207.436) 115-245 kW (156-333 PS) M 274.920	06.2013→12.2016		7.00782.16.0	DW-TL	EP	
			7.02256.37.0	EUV-WP	EL	
E 250 CDI / BlueTEC / d (207.403, 207.404) 120-150 kW (163-204 PS) OM 651.911	01.2010→12.2016		7.00782.12.0	DW-TL	EP	
			7.02256.37.0	EUV-VB	EL	
E 250 CGI (207.447) 135-150 kW (184-204 PS) M 271.860	01.2010→12.2016		7.00017.03.0	LDRV	EP	
			7.01870.06.0	SUV	EL	
E 300 (207.455) 182-225 kW (248-306 PS) M 276.957	04.2011→12.2016		7.02288.01.0	EUV-SR	EL	
E 320 (207.462) 200-245 kW (272-333 PS) M 276.820	07.2014→12.2016		7.00782.11.0	DW-TL	EP	
			7.01870.06.0	SUV	EL	
E 350 (207.456) 200-215 kW (272-292 PS) M 272.961, M 272.988	03.2010→12.2011		7.22355.01.0	EUV-SR	EL	
			7.06117.60.0	ZM-NWV	EL	mit Dichtring with O-ring
E 350 (207.459) 182-225 kW (248-306 PS) M 276.957	04.2011→12.2014		7.02288.01.0	EUV-SR	EL	
E 350 CGI (207.457) 215 kW (292 PS) M 272.982, M 272.984	01.2010→12.2014		7.22355.01.0	EUV-SR	EL	
			7.06117.60.0	ZM-NWV	EL	mit Dichtring with O-ring
E 400 (207.461) 245 kW (333 PS) M 276.850	07.2014→12.2016		7.00782.11.0	DW-TL	EP	
			7.01870.06.0	SUV	EL	
E 400 (207.465) 200-245 kW (272-333 PS) M 276.820	06.2013→12.2016		7.00782.11.0	DW-TL	EP	
			7.01870.06.0	SUV	EL	









M



E-CLASS Convertible (A207) 59

E 500 (207.472) 285 kW (388 PS) M 273.966	01.2010→12.2011		7.22355.01.0	EUV-SR	EL	mit Dichtring with O-ring
			7.06117.60.0	ZM-NWV	EL	
E 500 (207.473) 300-320 kW (408-435 PS) M 278.922	09.2011→12.2016		7.00782.11.0	DW-TL	EP	



E-CLASS Convertible (A238) 60

E 200 (238.442) 115-245 kW (156-333 PS) M 274.920	06.2017→		7.00782.16.0	DW-TL	EP	
			7.02256.37.0	EUV-WP	EL	
			7.04818.04.0	SUV	EL	
E 200 4-matic (238.443) 115-245 kW (156-333 PS) M 274.920	10.2017→		7.00782.16.0	DW-TL	EP	
			7.02256.37.0	EUV-WP	EL	
			7.04818.04.0	SUV	EL	
E 220 d (238.414) 84-235 kW (114-320 PS) OM 654.920	06.2017→		7.02256.37.0	EUV-AGR	EL	Produktionsdatum bis: 15.12.2020 Production date to: 15.12.2020
E 220 d 4-matic (238.415) 84-235 kW (114-320 PS) OM 654.920	10.2017→		7.02256.37.0	EUV-AGR	EL	Produktionsdatum bis: 15.12.2020 Production date to: 15.12.2020
E 300 (238.448) 115-245 kW (156-333 PS) M 274.920	06.2017→		7.00782.16.0	DW-TL	EP	
			7.02256.37.0	EUV-WP	EL	
			7.04818.04.0	SUV	EL	
E 300 d (238.418) 84-235 kW (114-320 PS) OM 654.920	05.2018→		7.02256.37.0	EUV-AGR	EL	Produktionsdatum bis: 15.12.2020 Production date to: 15.12.2020
E 350 EQ Boost (238.485) 145-220 kW (197-299 PS) M 264.920	10.2017→		7.04927.08.0	SUV	EL	Ladeluftkühler Intercooler
E 350 d (238.420) 183-250 kW (249-340 PS) OM 656.929	11.2018→		7.02256.37.0	EUV-AGR	EL	Produktionsdatum bis: 14.12.2020 Production date to: 14.12.2020
			7.02256.37.0	EUV-WP	EL	Produktionsdatum bis: 14.12.2020 Production date to: 14.12.2020
E 400 (238.465) 200-295 kW (272-401 PS) M 276.823	01.2018→12.2018		7.00782.11.0	DW-TL	EP	
			7.01870.06.0	SUV	EL	
E 400 4-matic (238.466) 200-295 kW (272-401 PS) M 276.823	06.2017→		7.00782.11.0	DW-TL	EP	
			7.01870.06.0	SUV	EL	
E 400 d 4-matic (238.423) 183-250 kW (249-340 PS) OM 656.929	08.2018→		7.02256.37.0	EUV-AGR	EL	Produktionsdatum bis: 14.12.2020 Production date to: 14.12.2020
			7.02256.37.0	EUV-WP	EL	Produktionsdatum bis: 14.12.2020 Production date to: 14.12.2020
E 400 d 4-matic (238.423) 183-250 kW (249-340 PS) OM 656.929	07.2020→		7.02256.37.0	EUV-AGR	EL	Produktionsdatum bis: 14.12.2020 Production date to: 14.12.2020
			7.02256.37.0	EUV-WP	EL	Produktionsdatum bis: 14.12.2020 Production date to: 14.12.2020

M



E-CLASS Convertible (A238) 60



E 450 (238.467) 200-295 kW (272-401 PS) M 276.823	01.2019→		7.00782.11.0	DW-TL	EP	
			7.01870.06.0	SUV	EL	
E 450 4-matic (238.468) 200-295 kW (272-401 PS) M 276.823	08.2018→		7.00782.11.0	DW-TL	EP	
			7.01870.06.0	SUV	EL	

E-CLASS Coupe (C124) 61

E 220 (124.042) 110 kW (150 PS) M 111.960	06.1993→06.1997		7.06117.20.0	ZM-NWV	EL	PKW, Coupe/ Passenger car, coupé
			7.21071.50.0	EUV-AT	EP	
E 320 (124.052) 162 kW (220 PS) M 104.992	06.1993→06.1997		7.21071.50.0	EUV-LS	EP	PKW, Stufenheck/ Passenger car, notchback
			7.21071.50.0	EUV-SL	EP	
			7.06117.20.0	ZM-NWV	EL	
E 36 AMG (124.052) 195-200 kW (265-272 PS) M 104.992 (AMG 3.6)	05.1994→06.1997		7.21071.50.0	EUV-AT	EP	PKW, Stufenheck/ Passenger car, notchback
			7.06117.20.0	ZM-NWV	EL	









E-CLASS Coupe (C207) 62

M

E 200 (207.334) 115-245 kW (156-333 PS) M 274.920	06.2013→12.2016		7.00782.16.0	DW-TL	EP	
			7.02256.37.0	EUV-WP	EL	
			7.04818.04.0	SUV	EL	
E 200 CGI (207.348) 115-150 kW (156-204 PS) M 271.820, M 271.860	01.2010→12.2016		7.00017.03.0	LDRV	EP	
			7.01870.06.0	SUV	EL	
E 220 BlueTEC (207.301) 120-150 kW (163-204 PS) OM 651.911	05.2014→12.2016		7.00782.12.0	DW-TL	EP	
			7.02256.37.0	EUV-VB	EL	
			7.02256.37.0	EUV-WP	EL	
E 220 CDI (207.302) 120-150 kW (163-204 PS) OM 651.911	02.2010→12.2014		7.00782.12.0	DW-TL	EP	
			7.02256.37.0	EUV-VB	EL	
			7.02256.37.0	EUV-WP	EL	
E 220 CDI / d (207.302, 207.301) 120-150 kW (163-204 PS) OM 651.911	01.2010→12.2016		7.00782.12.0	DW-TL	EP	
			7.02256.37.0	EUV-VB	EL	
			7.02256.37.0	EUV-WP	EL	
E 250 (207.336) 115-245 kW (156-333 PS) M 274.920	06.2013→12.2016		7.00782.16.0	DW-TL	EP	
			7.02256.37.0	EUV-WP	EL	
			7.04818.04.0	SUV	EL	
E 250 CDI / BlueTEC / d (207.303, 207.304) 120-150 kW (163-204 PS) OM 651.911	01.2009→12.2016		7.00782.12.0	DW-TL	EP	
			7.02256.37.0	EUV-VB	EL	
			7.02256.37.0	EUV-WP	EL	







E-CLASS Coupe (C207) 62

E 250 CGI (207.347) 135-150 kW (184-204 PS) M 271.860	01.2009→12.2016		7.00017.03.0	LDRV	EP	
			7.01870.06.0	SUV	EL	
E 300 (207.355) 182-225 kW (248-306 PS) M 276.957	04.2011→06.2016		7.02288.01.0	EUV-SR	EL	
E 320 (207.362) 200-245 kW (272-333 PS) M 276.820	07.2014→12.2016		7.00782.11.0	DW-TL	EP	
			7.01870.06.0	SUV	EL	
E 350 (207.356) 200-215 kW (272-292 PS) M 272.961, M 272.988	01.2010→12.2011		7.22355.01.0	EUV-SR	EL	
			7.06117.60.0	ZM-NWV	EL	
E 350 (207.359) 182-225 kW (248-306 PS) M 276.957	04.2011→12.2014		7.02288.01.0	EUV-SR	EL	
E 350 4-matic (207.388) 182-225 kW (248-306 PS) M 276.957	02.2013→12.2016		7.02288.01.0	EUV-SR	EL	
E 350 CGI (207.357) 215 kW (292 PS) M 272.982, M 272.984	01.2009→12.2011		7.22355.01.0	EUV-SR	EL	
			7.06117.60.0	ZM-NWV	EL	
E 400 (207.361) 245 kW (333 PS) M 276.850	07.2014→12.2016		7.00782.11.0	DW-TL	EP	
			7.01870.06.0	SUV	EL	
E 400 (207.365) 200-245 kW (272-333 PS) M 276.820	06.2013→12.2016		7.00782.11.0	DW-TL	EP	
			7.01870.06.0	SUV	EL	
E 500 (207.372) 285 kW (388 PS) M 273.966	01.2009→12.2016		7.22355.01.0	EUV-SR	EL	
			7.06117.60.0	ZM-NWV	EL	
E 500 (207.373) 300-320 kW (408-435 PS) M 278.922	09.2011→12.2016		7.00782.11.0	DW-TL	EP	











M

E-CLASS Coupe (C238) 63

E 200 (238.342) 115-245 kW (156-333 PS) M 274.920	12.2016→		7.00782.16.0	DW-TL	EP	
			7.02256.37.0	EUV-WP	EL	
			7.04818.04.0	SUV	EL	
E 200 4-matic (238.343) 115-245 kW (156-333 PS) M 274.920	06.2017→		7.00782.16.0	DW-TL	EP	
			7.02256.37.0	EUV-WP	EL	
			7.04818.04.0	SUV	EL	
E 220 d (238.314) 84-235 kW (114-320 PS) OM 654.920	12.2016→		7.02256.37.0	EUV-AGR	EL	Produktionsdatum bis: 15.12.2020 Production date to: 15.12.2020
E 220 d 4-matic (238.315) 84-235 kW (114-320 PS) OM 654.920	03.2017→		7.02256.37.0	EUV-AGR	EL	Produktionsdatum bis: 15.12.2020 Production date to: 15.12.2020







E-CLASS Coupe (C238) 63

E 300 (238.348) 115-245 kW (156-333 PS) M 274.920	12.2016→		7.00782.16.0	DW-TL	EP	
			7.02256.37.0 7.04818.04.0	EUV-WP SUV	EL EL	
E 300 d (238.318) 84-235 kW (114-320 PS) OM 654.920	05.2018→		7.02256.37.0	EUV-AGR	EL	Produktionsdatum bis: 15.12.2020 Production date to: 15.12.2020
E 350 EQ Boost (238.385) 145-220 kW (197-299 PS) M 264.920	10.2017→		7.04927.08.0	SUV	EL	Ladeluftkühler Intercooler
E 350 d (238.320) 183-250 kW (249-340 PS) OM 656.929	11.2018→		7.02256.37.0	EUV-AGR	EL	Produktionsdatum bis: 14.12.2020 Production date to: 14.12.2020
			7.02256.37.0	EUV-WP	EL	Produktionsdatum bis: 14.12.2020 Production date to: 14.12.2020
E 400 (238.365) 200-295 kW (272-401 PS) M 276.823	01.2018→12.2018		7.00782.11.0	DW-TL	EP	
			7.01870.06.0	SUV	EL	
E 400 4-matic (238.366) 200-295 kW (272-401 PS) M 276.823	12.2016→		7.00782.11.0	DW-TL	EP	
			7.01870.06.0	SUV	EL	
E 400 d 4-matic (238.323) 183-250 kW (249-340 PS) OM 656.929	08.2018→		7.02256.37.0	EUV-AGR	EL	Produktionsdatum bis: 14.12.2020 Production date to: 14.12.2020
			7.02256.37.0	EUV-WP	EL	Produktionsdatum bis: 14.12.2020 Production date to: 14.12.2020
E 400 d 4-matic (238.323) 183-250 kW (249-340 PS) OM 656.929	07.2020→		7.02256.37.0	EUV-AGR	EL	Produktionsdatum bis: 14.12.2020 Production date to: 14.12.2020
			7.02256.37.0	EUV-WP	EL	Produktionsdatum bis: 14.12.2020 Production date to: 14.12.2020
E 450 (238.367) 200-295 kW (272-401 PS) M 276.823	01.2019→		7.00782.11.0	DW-TL	EP	
			7.01870.06.0	SUV	EL	
E 450 4-matic (238.368) 200-295 kW (272-401 PS) M 276.823	08.2018→		7.00782.11.0	DW-TL	EP	
			7.01870.06.0	SUV	EL	



M

E-CLASS T-Model (S124) 64





















E 200 T (124.079) 100 kW (136 PS) M 111.940	06.1993→06.1996		7.21071.50.0	EUV-AT	EP	
E 220 T (124.082) 110 kW (150 PS) M 111.960	06.1993→06.1996		7.21071.50.0	EUV-AT	EP	PKW, Coupe/ Passenger car, coupé
			7.06117.20.0	ZM-NWV	EL	
E 280 T (124.088) 142-145 kW (193-197 PS) M 104.942	06.1993→06.1996		7.21071.50.0	EUV-AT	EP	PKW, Stufenheck/ Passenger car, notchback
			7.21071.50.0	EUV-LS	EP	
			7.21071.50.0	EUV-SL	EP	
			7.06117.20.0	ZM-NWV	EL	
E 280 T (124.088) 142-145 kW (193-197 PS) M 104.942	06.1993→06.1996		7.21071.50.0	EUV-AT	EP	
			7.21071.50.0	EUV-LS	EP	



E-CLASS T-Model (S124) 64

			7.21071.50.0 7.06117.20.0	EUV-SL ZM-NWV	EP EL	PKW, Stufenheck/ Passenger car, notchback
E 320 T (124.092) 162 kW (220 PS) M 104.992	06.1993→06.1996		7.21071.50.0 7.21071.50.0 7.06117.20.0	EUV-LS EUV-SL ZM-NWV	EP EP EL	PKW, Stufenheck/ Passenger car, notchback
E 36 T AMG (124.092) 195-200 kW (265-272 PS) M 104.992 (AMG 3.6)	05.1994→06.1996		7.06117.20.0	ZM-NWV	EL	PKW, Stufenheck/ Passenger car, notchback







E-CLASS T-Model (S210) 65

E 200 T (210.235) 100 kW (136 PS) M 111.942	06.1996→08.2000		7.06117.20.0	ZM-NWV	EL	PKW, Stufenheck/ Passenger car, notchback  016445→  022020→
E 200 T Kompressor (210.245) 137 kW (186 PS) M 111.947	06.1997→03.2003		7.06117.20.0	ZM-NWV	EL	PKW, Stufenheck/ Passenger car, notchback
E 200 T Kompressor (210.248) 120 kW (163 PS) M 111.957	08.2000→03.2003		7.06117.21.0	ZM-NWV	EL	mit Trag-/Führungsgelenk With support/ steering link
E 220 T CDI (210.206) 75-105 kW (102-143 PS) OM 611.961	06.1998→07.1999		7.02256.37.0	EUV-AGR	EL	 →ch. A 962231 Stufenheck Saloon
E 220 T CDI (210.206) 75-105 kW (102-143 PS) OM 611.961	05.1999→03.2003		7.02256.37.0	EUV-AGR	EL	 →ch. A 962231 Stufenheck Saloon
E 220 T CDI (210.206) 75-105 kW (102-143 PS) OM 611.961	07.1999→03.2003		7.02256.37.0	EUV-AGR	EL	 →ch. A 962231 Stufenheck Saloon
E 230 T (210.237) 110 kW (150 PS) M 111.970	06.1996→06.1997		7.06117.20.0	ZM-NWV	EL	PKW, Stufenheck/ Passenger car, notchback
E 240 T (210.261) 125 kW (170 PS) M 112.911	06.1997→03.2003		7.02256.37.0	EUV-SL	EL	
E 240 T (210.262) 125 kW (170 PS) M 112.914	08.2000→03.2003		7.02256.37.0	EUV-SL	EL	
			7.22355.01.0	EUV-SR	EL	
E 250 T D (210.210) 83 kW (113 PS) OM 605.912	06.1996→07.1999		7.02256.37.0	EUV-AGR	EL	
E 250 T Turbo-D (210.215) 110 kW (150 PS) OM 605.962	06.1997→07.1999		7.02256.37.0	EUV-AGR	EL	
E 280 T (210.263) 150 kW (204 PS) M 112.921	12.1996→03.2003		7.21071.50.0	EUV-LS	EP	
			7.02256.37.0	EUV-SL	EL	
			7.22355.01.0	EUV-SR	EL	
E 280 T 4-matic (210.281) 150 kW (204 PS) M 112.921	12.1996→03.2003		7.21071.50.0	EUV-LS	EP	
			7.02256.37.0	EUV-SL	EL	
			7.22355.01.0	EUV-SR	EL	
E 300 T Turbo-D (210.225) 130 kW (177 PS) OM 606.962	03.1997→07.1999		7.02256.37.0	EUV-AGR	EL	
E 320 160-165 kW (218-224 PS) M 112.941	09.1997→12.1998		7.02256.37.0	EUV-SL	EL	

M













E-CLASS T-Model (S210) 65

E 320 T (210.265) 160-165 kW (218-224 PS) M 112.941	12.1996→03.2003		7.22355.01.0 7.21071.50.0 7.02256.37.0 7.22355.01.0	EUV-SR EUV-LS EUV-SL EUV-SR	EL EP EL EL
E 320 T 4-matic (210.282) 160-165 kW (218-224 PS) M 112.941	12.1996→03.2003		7.21071.50.0 7.02256.37.0 7.22355.01.0	EUV-LS EUV-SL EUV-SR	EP EL EL
E 420 T (210.272) 205 kW (279 PS) M 119.985	06.1996→06.1997		7.21071.50.0	EUV-LS	EP
E 430 T (210.270) 205 kW (279 PS) M 113.940	06.1997→03.2003		7.02256.37.0 7.22355.01.0	EUV-SL EUV-SR	EL EL
E 430 T 4-matic (210.283) 205 kW (279 PS) M 113.940	05.1999→03.2003		7.02256.37.0 7.22355.01.0	EUV-SL EUV-SR	EL EL
E 55 T AMG (210.274) 255-260 kW (347-354 PS) M 113.980	08.1997→03.2003		7.02256.37.0 7.22355.01.0	EUV-SL EUV-SR	EL EL













E-CLASS T-Model (S211) 66

M

3.5 4-matic 200-205 kW (272-279 PS) M 272.972	08.2004→08.2006		7.22355.01.0 7.06117.60.0	EUV-SR ZM-NWV	EL EL	mit Dichtring with O-ring
350 CGI (211.257) 215 kW (292 PS) M 272.985	05.2006→07.2009		7.22355.01.0 7.06117.60.0	EUV-SR ZM-NWV	EL EL	mit Dichtring with O-ring
E 200 Kompressor (211.241) 135 kW (184 PS) M 271.956	04.2006→07.2009		7.06117.24.0	ZM-NWV	EL	 mit Dichtring with O-ring
E 200 T Kompressor (211.242) 120 kW (163 PS) M 271.941	03.2003→07.2009		7.06117.24.0	ZM-NWV	EL	 mit Dichtring with O-ring
E 230 T (211.252) 150 kW (204 PS) M 272.922	05.2007→07.2009		7.22355.01.0 7.06117.60.0	EUV-SR ZM-NWV	EL EL	mit Dichtring with O-ring
E 240 T (211.261) 130 kW (177 PS) M 112.913	03.2003→07.2009		7.02256.37.0 7.22355.01.0	EUV-SL EUV-SR	EL EL	
E 240 T 4-matic (211.280) 130 kW (177 PS) M 112.917	07.2003→07.2009		7.02256.37.0 7.22355.01.0	EUV-SL EUV-SR	EL EL	
E 280 T (211.254) 170 kW (231 PS) M 272.943	03.2005→07.2009		7.22355.01.0 7.06117.60.0	EUV-SR ZM-NWV	EL EL	mit Dichtring with O-ring
E 280 T 4-matic (211.292) 170 kW (231 PS) M 272.943	03.2005→07.2009		7.22355.01.0	EUV-SR	EL	





E-CLASS T-Model (S211) 66

E 280 T 4-matic (211.292) 170 kW (231 PS) M 272.944	03.2005→07.2009		7.22355.01.0	EUV-SR	EL	
			7.06117.60.0	ZM-NWV	EL	
E 320 T (211.265) 165 kW (224 PS) M 112.949	03.2003→07.2009		7.02256.37.0	EUV-SL	EL	
			7.22355.01.0	EUV-SR	EL	
E 320 T 4-matic (211.282) 165 kW (224 PS) M 112.954	07.2003→07.2009		7.02256.37.0	EUV-SL	EL	
			7.22355.01.0	EUV-SR	EL	
E 350 T (211.256) 200 kW (272 PS) M 272.964	03.2005→07.2009		7.22355.01.0	EUV-SR	EL	
			7.06117.60.0	ZM-NWV	EL	
E 350 T 4-matic (211.287) 200-205 kW (272-279 PS) M 272.972	03.2005→07.2009		7.22355.01.0	EUV-SR	EL	
			7.06117.60.0	ZM-NWV	EL	
E 500 T (211.270) 215-225 kW (292-306 PS) M 113.967	10.2003→07.2009		7.02256.37.0	EUV-SL	EL	
			7.22355.01.0	EUV-SR	EL	
E 500 T (211.272) 285 kW (388 PS) M 273.960	04.2006→07.2009		7.22355.01.0	EUV-SR	EL	
			7.06117.60.0	ZM-NWV	EL	
E 500 T 4-matic (211.283) 225 kW (306 PS) M 113.969	10.2003→07.2009		7.02256.37.0	EUV-SL	EL	
			7.22355.01.0	EUV-SR	EL	
E 500 T 4-matic (211.290) 285 kW (388 PS) M 273.962	04.2006→07.2009		7.22355.01.0	EUV-SR	EL	
			7.06117.60.0	ZM-NWV	EL	
E 55 T AMG Kompressor 350 kW (476 PS) M 113.990	09.2005→12.2006		7.02256.37.0	EUV-SL	EL	
E 55 T AMG Kompressor (211.276) 350 kW (476 PS) M 113.990	07.2003→07.2009		7.02256.37.0	EUV-SL	EL	
E 63 AMG (211.277) 378 kW (514 PS) M 156.983	03.2006→07.2009		7.02256.37.0	EUV-SL	EL	
			7.22355.01.0	EUV-SR	EL	

M

E-CLASS T-Model (S212) 67

E 200 (212.234) 115-245 kW (156-333 PS) M 274.920	11.2012→12.2016		7.00782.16.0	DW-TL	EP	
			7.02256.37.0	EUV-WP	EL	
			7.04818.04.0	SUV	EL	
E 200 CDI / BlueTEC (212.205, 212.206) 100 kW (136 PS) OM 651.925	11.2009→12.2016		7.00782.12.0	DW-TL	EP	
			7.02256.37.0	EUV-VB	EL	
			7.02256.37.0	EUV-WP	EL	



E-CLASS T-Model (S212) 67

E 200 CGI (212.248) 135-150 kW (184-204 PS) M 271.860	11.2009→12.2016		7.00017.03.0	LDRV	EP	
			7.01870.06.0	SUV	EL	
E 220 BlueTEC 120-150 kW (163-204 PS) OM 651.924	05.2015→12.2016		7.00782.12.0	DW-TL	EP	
			7.02256.37.0	EUV-VB	EL	
			7.02256.37.0	EUV-WP	EL	
E 220 BlueTEC 4-matic (212.211) 120-150 kW (163-204 PS) OM 651.924	12.2014→12.2016		7.00782.12.0	DW-TL	EP	
			7.02256.37.0	EUV-VB	EL	
			7.02256.37.0	EUV-WP	EL	
E 220 CDI (212.202) 120-150 kW (163-204 PS) OM 651.924	08.2009→08.2014		7.00782.12.0	DW-TL	EP	
			7.02256.37.0	EUV-VB	EL	
			7.02256.37.0	EUV-WP	EL	
E 220 CDI / BlueTEC (212.202, 212.201) 120-150 kW (163-204 PS) OM 651.924	11.2009→12.2016		7.00782.12.0	DW-TL	EP	
			7.02256.37.0	EUV-VB	EL	
			7.02256.37.0	EUV-WP	EL	
M E 250 (212.236) 115-245 kW (156-333 PS) M 274.920	11.2012→12.2016		7.00782.16.0	DW-TL	EP	
			7.02256.37.0	EUV-WP	EL	
			7.04818.04.0	SUV	EL	
E 250 CDI / BlueTEC (212.203, 212.204) 120-150 kW (163-204 PS) OM 651.924	11.2009→12.2016		7.00782.12.0	DW-TL	EP	
			7.02256.37.0	EUV-VB	EL	
			7.02256.37.0	EUV-WP	EL	
E 250 CDI / BlueTEC 4-matic (212.282, 212.297) 120-150 kW (163-204 PS) OM 651.924	07.2010→12.2016		7.00782.12.0	DW-TL	EP	
			7.02256.37.0	EUV-VB	EL	
			7.02256.37.0	EUV-WP	EL	
E 250 CGI (212.247) 135-150 kW (184-204 PS) M 271.860	11.2009→12.2013		7.00017.03.0	LDRV	EP	
			7.01870.06.0	SUV	EL	
E 300 (212.254) 161-170 kW (219-231 PS) M 272.952	11.2009→12.2011		7.22355.01.0	EUV-SR	EL	
			7.06117.60.0	ZM-NWV	EL	mit Dichtring with O-ring
E 300 (212.255) 185-245 kW (252-333 PS) M 276.952	07.2011→12.2016		7.02288.01.0	EUV-SR	EL	
			7.02288.01.0	EUV-SR	EL	
E 300 4-matic (212.280) 185-245 kW (252-333 PS) M 276.952	07.2011→12.2016		7.02288.01.0	EUV-SR	EL	



E-CLASS T-Model (S212)



67

E 300 Hybrid / BlueTEC Hybrid (212.298) 120-150 kW (163-204 PS) OM 651.924	12.2011→12.2016		7.00782.12.0 DW-TL EP	
			7.02256.37.0 EUV-VB EL 7.02256.37.0 EUV-WP EL	
E 350 (212.256) 200 kW (272 PS) M 272.980	08.2009→12.2011		7.22355.01.0 EUV-SR EL	
			7.06117.60.0 ZM-NWV EL	mit Dichtring with O-ring
E 350 (212.259) 185-245 kW (252-333 PS) M 276.952	09.2011→12.2014		7.02288.01.0 EUV-SR EL	
E 350 4-matic (212.287) 200 kW (272 PS) M 272.977	11.2009→12.2011		7.22355.01.0 EUV-SR EL	
			7.06117.60.0 ZM-NWV EL	mit Dichtring with O-ring
E 350 4-matic (212.288) 185-245 kW (252-333 PS) M 276.952	09.2011→12.2016		7.02288.01.0 EUV-SR EL	
E 350 CGI (212.257) 215 kW (292 PS) M 272.983	11.2009→12.2011		7.22355.01.0 EUV-SR EL	
			7.06117.60.0 ZM-NWV EL	mit Dichtring with O-ring
E 400 (212.261) 245 kW (333 PS) M 276.850	07.2014→12.2016		7.00782.11.0 DW-TL EP	
			7.01870.06.0 SUV EL	
E 400 (212.265) 200-245 kW (272-333 PS) M 276.820	01.2013→12.2016		7.00782.11.0 DW-TL EP	
			7.01870.06.0 SUV EL	
E 400 4-matic (212.267) 200-245 kW (272-333 PS) M 276.820	01.2013→12.2016		7.00782.11.0 DW-TL EP	
			7.01870.06.0 SUV EL	
E 400 4-matic (212.299) 245 kW (333 PS) M 276.850	07.2014→12.2016		7.00782.11.0 DW-TL EP	
			7.01870.06.0 SUV EL	
E 500 (212.272) 285 kW (388 PS) M 273.971	11.2009→12.2011		7.22355.01.0 EUV-SR EL	
			7.06117.60.0 ZM-NWV EL	mit Dichtring with O-ring
E 500 (212.273) 300-320 kW (408-435 PS) M 278.922	09.2011→12.2016		7.00782.11.0 DW-TL EP	
E 500 4-matic (212.291) 300-320 kW (408-435 PS) M 278.922	09.2011→12.2016		7.00782.11.0 DW-TL EP	
E 63 AMG (212.274) 386-430 kW (525-585 PS) M 157.981	02.2011→12.2016		7.00782.11.0 DW-TL EP	
E 63 AMG (212.274) 386-430 kW (525-585 PS) M 157.981	02.2011→12.2016		7.00782.11.0 DW-TL EP	
E 63 AMG (212.275) 386-430 kW (525-585 PS) M 157.981	02.2013→12.2016		7.00782.11.0 DW-TL EP	

M



E-CLASS T-Model (S212) 67

E 63 AMG (212.277) 336-410 kW (457-558 PS) M 156.985	08.2009→12.2011		7.02256.37.0	EUV-SL	EL	
			7.22355.01.0	EUV-SR	EL	
E 63 AMG 4-matic (212.276) 386-430 kW (525-585 PS) M 157.981	02.2013→12.2016		7.00782.11.0	DW-TL	EP	
E 63 AMG 4-matic (212.292) 386-430 kW (525-585 PS) M 157.981	02.2011→12.2016		7.00782.11.0	DW-TL	EP	

E-CLASS T-Model (S213) 68

AMG E 43 4-matic (213.264) 200-295 kW (272-401 PS) M 276.823	10.2016→		7.00782.11.0	DW-TL	EP	
			7.01870.06.0	SUV	EL	
AMG E 63 4-matic+ (213.288) 350-470 kW (476-639 PS) M 177.980	05.2017→		7.00782.16.0	DW-TL	EP	
			7.04927.08.0	SUV	EL	Luftfiltergehäuse Air Filter Housing
AMG E 63 S 4-matic+ (213.289) 350-470 kW (476-639 PS) M 177.980	05.2017→		7.00782.16.0	DW-TL	EP	
			7.04927.08.0	SUV	EL	Luftfiltergehäuse Air Filter Housing
E 200 (213.242) 115-245 kW (156-333 PS) M 274.920	07.2016→		7.00782.16.0	DW-TL	EP	
			7.02256.37.0	EUV-WP	EL	
			7.04818.04.0	SUV	EL	
E 200 4-matic (213.243) 115-245 kW (156-333 PS) M 274.920	01.2017→		7.00782.16.0	DW-TL	EP	
			7.02256.37.0	EUV-WP	EL	
			7.04818.04.0	SUV	EL	
E 200 d (213.212) 90-118 kW (122-160 PS) OM 654.916	11.2018→		7.02256.37.0	EUV-AGR	EL	Produktionsdatum bis: 15.12.2020 Production date to: 15.12.2020
E 200 d (213.213) 84-235 kW (114-320 PS) OM 654.920	10.2016→		7.02256.37.0	EUV-AGR	EL	Produktionsdatum bis: 15.12.2020 Production date to: 15.12.2020
E 220 d (213.204) 84-235 kW (114-320 PS) OM 654.920	07.2016→		7.02256.37.0	EUV-AGR	EL	Produktionsdatum bis: 15.12.2020 Production date to: 15.12.2020
E 220 d (213.204) 84-235 kW (114-320 PS) OM 654.920	07.2016→		7.02256.37.0	EUV-AGR	EL	Produktionsdatum bis: 15.12.2020 Production date to: 15.12.2020
E 220 d (213.206) 84-235 kW (114-320 PS) OM 654.920	09.2020→		7.02256.37.0	EUV-AGR	EL	Produktionsdatum bis: 15.12.2020 Production date to: 15.12.2020
E 220 d 4-matic (213.205) 84-235 kW (114-320 PS) OM 654.920	01.2017→		7.02256.37.0	EUV-AGR	EL	Produktionsdatum bis: 15.12.2020 Production date to: 15.12.2020
E 250 (213.245) 115-245 kW (156-333 PS) M 274.920	07.2016→		7.00782.16.0	DW-TL	EP	
			7.02256.37.0	EUV-WP	EL	
			7.04818.04.0	SUV	EL	

M



E-CLASS T-Model (S213) 68

E 300 d (213.208) 84-235 kW (114-320 PS) OM 654.920	12.2017→		7.02256.37.0	EUV-AGR	EL	Produktionsdatum bis: 15.12.2020 Production date to: 15.12.2020
E 300 de (213.216) 84-235 kW (114-320 PS) OM 654.920	10.2018→		7.02256.37.0	EUV-AGR	EL	Produktionsdatum bis: 15.12.2020 Production date to: 15.12.2020
E 300 de (213.216) 84-235 kW (114-320 PS) OM 654.920	10.2018→		7.02256.37.0	EUV-AGR	EL	Produktionsdatum bis: 15.12.2020 Production date to: 15.12.2020
E 300 de 4-matic (213.211) 84-235 kW (114-320 PS) OM 654.920	08.2020→		7.02256.37.0	EUV-AGR	EL	Produktionsdatum bis: 15.12.2020 Production date to: 15.12.2020
E 300 de 4-matic (213.211) 84-235 kW (114-320 PS) OM 654.920	08.2020→		7.02256.37.0	EUV-AGR	EL	Produktionsdatum bis: 15.12.2020 Production date to: 15.12.2020
E 300 e (213.253) 115-245 kW (156-333 PS) M 274.920	06.2020→		7.00782.16.0	DW-TL	EP	
			7.02256.37.0 7.04818.04.0	EUV-WP SUV	EL EL	
E 300 e (213.253) 115-245 kW (156-333 PS) M 274.920	06.2020→		7.00782.16.0	DW-TL	EP	
			7.02256.37.0 7.04818.04.0	EUV-WP SUV	EL EL	
E 350 d (213.222) 183-250 kW (249-340 PS) OM 656.929	08.2018→		7.02256.37.0	EUV-AGR	EL	Produktionsdatum bis: 14.12.2020 Production date to: 14.12.2020
			7.02256.37.0	EUV-WP	EL	Produktionsdatum bis: 14.12.2020 Production date to: 14.12.2020
E 400 4-matic (213.271) 245 kW (333 PS) M 276.853	10.2016→		7.00782.11.0	DW-TL	EP	
			7.01870.06.0	SUV	EL	
E 400 d (213.220) 183-250 kW (249-340 PS) OM 656.929	02.2019→		7.02256.37.0	EUV-AGR	EL	Produktionsdatum bis: 14.12.2020 Production date to: 14.12.2020
			7.02256.37.0	EUV-WP	EL	Produktionsdatum bis: 14.12.2020 Production date to: 14.12.2020
E 400 d 4-matic (213.223) 183-250 kW (249-340 PS) OM 656.929	04.2018→		7.02256.37.0	EUV-AGR	EL	Produktionsdatum bis: 14.12.2020 Production date to: 14.12.2020
			7.02256.37.0	EUV-WP	EL	Produktionsdatum bis: 14.12.2020 Production date to: 14.12.2020
E 400 d 4-matic (213.223) 183-250 kW (249-340 PS) OM 656.929	07.2020→		7.02256.37.0	EUV-AGR	EL	Produktionsdatum bis: 14.12.2020 Production date to: 14.12.2020
			7.02256.37.0	EUV-WP	EL	Produktionsdatum bis: 14.12.2020 Production date to: 14.12.2020
E 450 4-matic (213.268) 200-295 kW (272-401 PS) M 276.823	08.2018→		7.00782.11.0	DW-TL	EP	
			7.01870.06.0	SUV	EL	







M

G-CLASS (W460) 69

230 G (460,2) 66-75 kW (90-102 PS) M 115.973	03.1979→07.1993		7.21071.50.0	EUV-LS	EP	
230 G (460,2) 66-75 kW (90-102 PS) M 115.973	02.1980→07.1987		7.21071.50.0	EUV-LS	EP	



G-CLASS (W460) 69









230 GE (460,2) 90-93 kW (122-126 PS) M 102.981, M 102.987, M 102.989	04.1982→08.1992		7.21071.50.0	EUV-KA	EP
230 GE (460,2) 90-92 kW (122-125 PS) M 102.979, M 102.987	05.1987→08.1992		7.21071.50.0	EUV-KA	EP
240 GD (460,3) 53 kW (72 PS) OM 616.936	03.1979→08.1987		7.21071.50.0	EUV-KA	EP
280 GE (460,2) 110-115 kW (150-156 PS) M 110.994	11.1979→08.1989		7.21071.50.0	EUV-KA	EP
280 GE (460,2) 110-115 kW (150-156 PS) M 110.994	08.1984→08.1989		7.21071.50.0	EUV-KA	EP
300 GD (460,3) 65 kW (88 PS) OM 617.931	12.1979→12.1991		7.21071.50.0	EUV-KA	EP

G-CLASS (W461) 70

290 GD/G 290 D (461.337, 461.338) 70-72 kW (95-98 PS) OM 602.942	06.1993→07.2000		7.21071.50.0	EUV-AGR	EP
G 280 CDI (461.304, 461.346, 461.370, 461.334, 461.339,...) 135 kW (184 PS) OM 642.884, OM 642.975	04.2009→		7.02256.37.0	EUV-DS	EL
G 290 TD (461.335, 461.336) 88 kW (120 PS) OM 602.983	07.1997→		7.02256.37.0	EUV-AGR	EL
G 300 CDI (461.333) 135 kW (184 PS) OM 642.884	04.2010→		7.02256.37.0	EUV-DS	EL















M

G-CLASS (W463) 71

200 GE (463.220) 80-85 kW (109-116 PS) M 102.965	01.1990→07.1993		7.21071.50.0	EUV-DS	EP
230 GE (463.224, 463.225) 93 kW (126 PS) M 102.989	06.1990→06.1993		7.21071.50.0	EUV-DS	EP
250 GD (463.324, 463.325) 69 kW (94 PS) OM 602.931	06.1990→10.1992		7.21071.50.0	EUV-DS	EP
300 GD (463.327, 463.328) 83 kW (113 PS) OM 603.931	09.1989→08.1993		7.21071.50.0	EUV-DS	EP
300 GE (463.227, 463.228) 125-128 kW (170-174 PS) M 103.987	09.1989→08.1993		7.21071.50.0	EUV-DS	EP
300 GE (463.227, 463.228) 125-128 kW (170-174 PS) M 103.987	06.1990→08.1997		7.21071.50.0	EUV-DS	EP
350 Turbo GD (463.320, 463.321) 100 kW (136 PS) OM 603.972	09.1991→08.1996		7.21071.50.0	EUV-DS	EP
500 GE (463.228) 164-195 kW (223-265 PS) M 117.965	09.1993→12.1994		7.21071.50.0	EUV-DS	EP
AMG G 63 (463.272) 400-420 kW (544-571 PS) M 157.984	06.2015→		7.00782.11.0	DW-TL	EP
			7.02256.37.0	EUV-DS	EL

















G-CLASS (W463) 71

AMG G 63 (463.276, 463.277) 350-470 kW (476-639 PS) M 177.980	03.2018→		7.00782.16.0	DW-TL	EP	Luftfiltergehäuse Air Filter Housing
			7.04927.08.0	SUV	EL	
AMG G 65 (463.274, 463.275) 450-463 kW (612-630 PS) M 279.982	06.2015→		7.02256.37.0	EUV-DS	EL	
			7.02256.37.0	EUV-SL	EL	
G 270 CDI (463.322, 463.323) 115-120 kW (156-163 PS) OM 612.965	10.2001→07.2003		7.21071.50.0	EUV-DS	EP	
			7.02256.37.0	EUV-DS	EL	
G 300 (463.228, 463.227) 125-128 kW (170-174 PS) M 103.987	06.1993→08.1997		7.21071.50.0	EUV-DS	EP	
G 300 Diesel (463.327, 463.328) 83 kW (113 PS) OM 603.931	09.1993→08.1994		7.21071.50.0	EUV-DS	EP	
G 300 TD (463.330, 463.331) 130 kW (177 PS) OM 606.964	09.1996→07.2000		7.21071.50.0	EUV-DS	EP	
G 320 (463.230, 463.231) 155 kW (211 PS) M 104.996	09.1994→12.1997		7.21071.50.0	EUV-LS	EP	
			7.21071.50.0	EUV-SL	EP	
			7.06117.20.0	ZM-NWV	EL	
G 320 (463.232, 463.233, 463.244, 463.245) 158 kW (215 PS) M 112.945	11.1997→08.2004		7.21071.50.0	EUV-LS	EP	
			7.02256.37.0	EUV-SL	EL	
			7.22355.01.0	EUV-SR	EL	
G 320 CDI (463.321) 100 kW (136 PS) OM 603.972	09.1996→08.1999		7.21071.50.0	EUV-DS	EP	
G 320 CDI (463.340, 463.341, 463.343) 165 kW (224 PS) OM 642.970	09.2006→		7.21071.50.0	EUV-DS	EP	Produktionsdatum ab: 14.02.2011 Production date from: 14.02.2011
			7.02256.37.0	EUV-DS	EL	
G 350 CDI (463.306) 165 kW (224 PS) OM 642.970	06.2009→12.2011		7.21071.50.0	EUV-DS	EP	Produktionsdatum ab: 14.02.2011 Production date from: 14.02.2011
			7.02256.37.0	EUV-DS	EL	
G 350 d (463.348) 180 kW (245 PS) OM 642.887	06.2015→		7.02256.37.0	EUV-DS	EL	
G 350 d 4-matic (463.349) 183-250 kW (249-340 PS) OM 656.929	01.2019→		7.02256.37.0	EUV-AGR	EL	Produktionsdatum bis: 14.12.2020 Production date to: 14.12.2020
			7.02256.37.0	EUV-WP	EL	Produktionsdatum bis: 14.12.2020 Production date to: 14.12.2020
G 36 AMG (463.230) 200 kW (272 PS) M 104.996 (AMG 3.6)	01.1995→07.1998		7.21071.50.0	EUV-DS	EP	
			7.06117.20.0	ZM-NWV	EL	
G 400 CDI (463.332, 463.333) 184 kW (250 PS) OM 628.962	12.2000→07.2006		7.21071.50.0	EUV-DS	EP	





















M



G-CLASS (W463) **71**

			7.02256.37.0	EUV-DS	EL	Produktionsdatum ab: 14.02.2011 Production date from: 14.02.2011
G 400 d 4-matic (463.350) 183-250 kW (249-340 PS) OM 656.929	07.2019→		7.02256.37.0	EUV-AGR	EL	Produktionsdatum bis: 14.12.2020 Production date to: 14.12.2020
			7.02256.37.0	EUV-WP	EL	Produktionsdatum bis: 14.12.2020 Production date to: 14.12.2020
G 500 (463.222, 463.236, 463.237, 463.242) 285-320 kW (388-435 PS) M 273.963, M 273.969	05.2008→		7.21071.50.0	EUV-DS	EP	
			7.02256.37.0	EUV-DS	EL	 M 273.963, M 273.969: Produktionsdatum ab: 14.02.2011 Production date from: 14.02.2011
			7.22355.01.0 7.06117.60.0	EUV-SR ZM-NWV	EL EL	mit Dichtring with O-ring
G 500 (463.234, 463.239) 310-390 kW (422-530 PS) M 176.980	06.2015→		7.02256.37.0	EUV-DS	EL	
			7.04927.08.0	SUV	EL	Ladeluftkühler Intercooler
G 500 (463.247, 463.248, 463.249, 463.240, 463.241,...) 215-218 kW (292-296 PS) M 113.962	04.1998→		7.21071.50.0	EUV-DS	EP	
			7.02256.37.0	EUV-SL	EL	
			7.22355.01.0	EUV-SR	EL	
G 500 (463.249) 215-218 kW (292-296 PS) M 113.962	09.2004→12.2005		7.21071.50.0	EUV-DS	EP	
			7.02256.37.0 7.22355.01.0	EUV-SL EUV-SR	EL EL	
G 500 (463.260, 463.261) 310-390 kW (422-530 PS) M 176.980	01.2018→		7.04927.08.0	SUV	EL	Ladeluftkühler Intercooler
G 55 AMG (463.243, 463.246) 260 kW (354 PS) M 113.982	04.1999→		7.21071.50.0	EUV-DS	EP	
			7.02256.37.0	EUV-SL	EL	
			7.22355.01.0	EUV-SR	EL	
G 55 AMG (463.270, 463.271) 350-373 kW (476-507 PS) M 113.993	06.2004→		7.21071.50.0	EUV-DS	EP	
			7.02256.37.0	EUV-SL	EL	
G 55 AMG (463.270, 463.271) 350-373 kW (476-507 PS) M 113.993	09.2004→12.2011		7.21071.50.0	EUV-DS	EP	
			7.02256.37.0	EUV-SL	EL	
G 55 AMG (463.270, 463.271) 350-373 kW (476-507 PS) M 113.993	08.2006→12.2012		7.21071.50.0	EUV-DS	EP	
			7.02256.37.0	EUV-SL	EL	
G 55 AMG (463.270, 463.271) 350-373 kW (476-507 PS) M 113.993	08.2008→		7.21071.50.0	EUV-DS	EP	
			7.02256.37.0	EUV-SL	EL	
G 63 AMG (463.273) 400-420 kW (544-571 PS) M 157.984	05.2012→		7.00782.11.0	DW-TL	EP	







M

						
G-CLASS (W463)						71
G 63 AMG 6x6 400-420 kW (544-571 PS) M 157.984	12.2014→		7.02256.37.0 7.00782.11.0	EUV-DS DW-TL	EL EP	
G 65 AMG 450-463 kW (612-630 PS) M 279.982	05.2012→		7.02256.37.0	EUV-SL	EL	
G-CLASS Cabrio (W460)						72
200 GE (460.216) 80 kW (109 PS) M 102.964	07.1982→08.1989		7.21071.50.0	EUV-KA	EP	
230 GE (460.218, 460.249) 92 kW (125 PS) M 102.981	07.1982→05.1993		7.21071.50.0	EUV-KA	EP	
240 GD (460.310, 460.341) 53 kW (72 PS) OM 616.936, OM 616.938	03.1979→08.1989		7.21071.50.0	EUV-KA	EP	
280 GE (460.212, 460.243) 110-115 kW (150-156 PS) M 110.994	11.1979→06.1982		7.21071.50.0	EUV-KA	EP	
280 GE (460.212, 460.243) 110-115 kW (150-156 PS) M 110.994	07.1982→05.1993		7.21071.50.0	EUV-KA	EP	
G-CLASS Cabrio (W463)						73
200 GE (463.200) 80-85 kW (109-116 PS) M 102.965	01.1990→07.1993		7.21071.50.0	EUV-DS	EP	
200 GE (463.200) 80-85 kW (109-116 PS) M 102.965	01.1990→07.1993		7.21071.50.0	EUV-DS	EP	
230 GE (463.204) 93 kW (126 PS) M 102.989	06.1990→02.1993		7.21071.50.0	EUV-DS	EP	
300 GD (463.307) 83 kW (113 PS) OM 603.931	09.1989→08.1993		7.21071.50.0	EUV-DS	EP	
300 GE (463.207) 125-128 kW (170-174 PS) M 103.987	09.1989→09.1997		7.21071.50.0	EUV-DS	EP	
320 GE (463.208) 155 kW (211 PS) M 104.996	09.1994→11.1997		7.21071.50.0 7.21071.50.0 7.06117.20.0	EUV-LS EUV-SL ZM-NWV	EP EP EL	
350 G Turbo-D (463.300) 100 kW (136 PS) OM 603.972	09.1991→09.1997		7.21071.50.0	EUV-DS	EP	
G 300 Diesel (463.307) 83 kW (113 PS) OM 603.931	09.1993→08.1994		7.21071.50.0	EUV-DS	EP	
G 300 TD (463.308) 130 kW (177 PS) OM 606.964	09.1996→07.2000		7.21071.50.0	EUV-DS	EP	
G 320 (463.209, 463.250) 158 kW (215 PS) M 112.945	11.1997→		7.21071.50.0 7.02256.37.0 7.22355.01.0	EUV-LS EUV-SL EUV-SR	EP EL EL	
G 320 (463.250) 158 kW (215 PS) M 112.945	11.1997→08.2004		7.21071.50.0	EUV-DS	EP	

M





G-CLASS Cabrio (W463) **73**





G 320 CDI (463.303) 165 kW (224 PS) OM 642.970	09.2006→		7.21071.50.0	EUV-DS	EP		
			7.02256.37.0	EUV-DS	EL		Produktionsdatum ab: 14.02.2011 Production date from: 14.02.2011
G 320 CDI (463.320) 100 kW (136 PS) OM 603.972	09.1996→08.1999		7.21071.50.0	EUV-DS	EP		
G 350 CDI (463.306) 165 kW (224 PS) OM 642.970	06.2009→12.2011		7.21071.50.0	EUV-DS	EP		
			7.02256.37.0	EUV-DS	EL		Produktionsdatum ab: 14.02.2011 Production date from: 14.02.2011
G 400 CDI (463.309) 184 kW (250 PS) OM 628.962	12.2000→		7.21071.50.0	EUV-DS	EP		
			7.02256.37.0	EUV-DS	EL		
G 500 (463) 215-218 kW (292-296 PS) M 113.962	04.1998→		7.02256.37.0	EUV-SL	EL		
			7.22355.01.0	EUV-SR	EL		
G 500 (463.202) 285-320 kW (388-435 PS) M 273.963, M 273.969	12.2009→		7.21071.50.0	EUV-DS	EP		
			7.02256.37.0	EUV-DS	EL		 M 273.963, M 273.969: Produktionsdatum ab: 14.02.2011 Production date from: 14.02.2011
			7.22355.01.0	EUV-SR	EL		
			7.06117.60.0	ZM-NWV	EL		mit Dichtring with O-ring



















M

GL-CLASS (X164) **74**

GL 450 4-matic (164.871) 250 kW (340 PS) M 273.923	09.2006→08.2012		7.22355.01.0	EUV-SR	EL	
			7.06117.60.0	ZM-NWV	EL	
GL 500 4-matic (164.886) 285-320 kW (388-435 PS) M 273.963	09.2006→12.2012		7.22355.01.0	EUV-SR	EL	
			7.06117.60.0	ZM-NWV	EL	

GL-CLASS (X166) **75**













GL 400 4-matic (166.856) 200-325 kW (272-442 PS) M 276.821	08.2013→10.2015		7.00782.11.0	DW-TL	EP	
			7.01870.06.0	SUV	EL	
GL 450 4-matic 200-325 kW (272-442 PS) M 276.821	09.2014→10.2015		7.00782.11.0	DW-TL	EP	
			7.01870.06.0	SUV	EL	
GL 450 4-matic (166.872) 270-335 kW (367-456 PS) M 278.928	07.2012→10.2015		7.00782.11.0	DW-TL	EP	
			7.00782.11.0	DW-TL	EP	
GL 500 4-matic (166.871) 310 kW (422 PS) M 278.912	04.2015→12.2015		7.00782.11.0	DW-TL	EP	
			7.00782.11.0	DW-TL	EP	
GL 500 4-matic (166.873) 270-335 kW (367-456 PS) M 278.928	07.2012→10.2015		7.00782.11.0	DW-TL	EP	
			7.00782.11.0	DW-TL	EP	

						
GL-CLASS (X166)						75
GL 500 4-matic (166.873) 270-335 kW (367-456 PS) M 278.928	07.2014→10.2015		7.00782.11.0	DW-TL	EP	
GL 63 AMG 4-matic 386-430 kW (525-585 PS) M 157.982	07.2012→12.2015		7.00782.11.0	DW-TL	EP	
GL 63 AMG 4-matic (166.874) 386-430 kW (525-585 PS) M 157.982	07.2012→10.2015		7.00782.11.0	DW-TL	EP	
GL 63 AMG 4-matic (166.874) 386-430 kW (525-585 PS) M 157.982	07.2012→10.2015		7.00782.11.0	DW-TL	EP	
GLA (H247)						76
GLA 180 (247.784) 80-160 kW (109-218 PS) M 282.914	07.2020→		7.04818.04.0	SUV	EL für OE-Nummer: A 000 153 18 59, A 282 090 02 80 for OE number: A 000 153 18 59, A 282 090 02 80	
GLA 180 d (247.710) 84-235 kW (114-320 PS) OM 654.920	03.2020→		7.02256.37.0	EUV-AGR	EL Produktionsdatum bis: 15.12.2020 Production date to: 15.12.2020	
GLA 200 (247.787) 80-160 kW (109-218 PS) M 282.914	02.2020→		7.04818.04.0	SUV	EL für OE-Nummer: A 000 153 18 59, A 282 090 02 80 for OE number: A 000 153 18 59, A 282 090 02 80	
GLA 200 d (247.712) 84-235 kW (114-320 PS) OM 654.920	02.2020→		7.02256.37.0	EUV-AGR	EL Produktionsdatum bis: 15.12.2020 Production date to: 15.12.2020	
GLA 200 d 4-matic (247.713) 84-235 kW (114-320 PS) OM 654.920	02.2020→		7.02256.37.0	EUV-AGR	EL Produktionsdatum bis: 15.12.2020 Production date to: 15.12.2020	
GLA 220 d (247.714) 84-235 kW (114-320 PS) OM 654.920	02.2020→		7.02256.37.0	EUV-AGR	EL Produktionsdatum bis: 15.12.2020 Production date to: 15.12.2020	
GLA 220 d 4-matic (247.715) 84-235 kW (114-320 PS) OM 654.920	02.2020→		7.02256.37.0	EUV-AGR	EL Produktionsdatum bis: 15.12.2020 Production date to: 15.12.2020	
GLA 250 e (247.786) 80-160 kW (109-218 PS) M 282.914	06.2020→		7.04818.04.0	SUV	EL für OE-Nummer: A 000 153 18 59, A 282 090 02 80 for OE number: A 000 153 18 59, A 282 090 02 80	
GLA 250 e (247.786) 80-160 kW (109-218 PS) M 282.914	06.2020→		7.04818.04.0	SUV	EL für OE-Nummer: A 000 153 18 59, A 282 090 02 80 for OE number: A 000 153 18 59, A 282 090 02 80	
GLA-CLASS (X156)						77
AMG GLA 45 4-matic (156.952) 250-280 kW (340-381 PS) M 133.980	07.2015→		7.00782.11.0	DW-TL	EP	
AMG GLA 45 4-matic (156.952) 250-280 kW (340-381 PS) M 133.980	01.2019→		7.00782.11.0	DW-TL	EP	
GLA 180 (156.942) 75-115 kW (102-156 PS) M 270.910	02.2015→		7.00782.16.0	DW-TL	EP	
			7.02256.37.0	EUV-KK	EL	

M















GLA-CLASS (X156) **77**

			7.01870.06.0	SUV	EL	<ul style="list-style-type: none">  M 270.910: Fahrgestellnummer bis: 10044275 Vehicle Identification Number to: 10044275 Produktionsdatum bis: 22.12.2015 Production date to: 22.12.2015  M 270.910: Fahrgestellnummer bis: 30786355 Vehicle Identification Number to: 30786355 Produktionsdatum bis: 03.08.2015 Production date to: 03.08.2015
			7.04818.04.0	SUV	EL	<ul style="list-style-type: none">  M 270.910: Fahrgestellnummer ab: 30786355 Vehicle Identification Number from: 30786355 Produktionsdatum ab: 03.08.2015 Production date from: 03.08.2015  M 270.910: Fahrgestellnummer ab: 10044275 Vehicle Identification Number from: 10044275 Produktionsdatum ab: 22.12.2015 Production date from: 22.12.2015
M	GLA 200 (156.943) 75-115 kW (102-156 PS) M 270.910	12.2013→	 7.00782.16.0	DW-TL	EP	
			7.02256.37.0	EUV-KK	EL	
			7.01870.06.0	SUV	EL	<ul style="list-style-type: none">  M 270.910: Fahrgestellnummer bis: 10044275 Vehicle Identification Number to: 10044275 Produktionsdatum bis: 22.12.2015 Production date to: 22.12.2015  M 270.910: Fahrerhausseriennummer bis: 30786355 Driver cab serial number to: 30786355 Produktionsdatum bis: 03.08.2015 Production date to: 03.08.2015
			7.04818.04.0	SUV	EL	<ul style="list-style-type: none">  M 270.910: Fahrgestellnummer ab: 30786355 Vehicle Identification Number from: 30786355 Produktionsdatum ab: 03.08.2015 Production date from: 03.08.2015  M 270.910: Fahrgestellnummer ab: 10044275 Vehicle Identification Number from: 10044275 Produktionsdatum ab: 22.12.2015 Production date from: 22.12.2015
	GLA 200 (156.943) 75-115 kW (102-156 PS) M 270.910	07.2018→	 7.00782.16.0	DW-TL	EP	
			7.04818.04.0	SUV	EL	<ul style="list-style-type: none">  M 270.910: Fahrgestellnummer ab: 10044275 Vehicle Identification Number from: 10044275 Produktionsdatum ab: 22.12.2015 Production date from: 22.12.2015  M 270.910: Fahrgestellnummer ab: 30786355 Vehicle Identification Number from: 30786355 Produktionsdatum ab: 03.08.2015 Production date from: 03.08.2015

















GLA-CLASS (X156) 77

<p>GLA 200 (156.945) 115-160 kW (156-218 PS) M 270.920</p>	<p>09.2014→</p>	<p>7.01870.06.0</p>  <p>7.04818.04.0</p>	<p>SUV</p> <p>SUV</p>	<p>EL  M 270.920: Fahrgestellnummer bis: 10044275 Vehicle Identification Number to: 10044275 Produktionsdatum bis: 22.12.2015 Production date to: 22.12.2015  M 270.920: Fahrgestellnummer bis: 30786355 Vehicle Identification Number to: 30786355 Produktionsdatum bis: 03.08.2015 Production date to: 03.08.2015 EL  M 270.920: Fahrgestellnummer ab: 10044275 Vehicle Identification Number from: 10044275 Produktionsdatum ab: 22.12.2015 Production date from: 22.12.2015  M 270.920: Fahrgestellnummer ab: 30786355 Vehicle Identification Number from: 30786355 Produktionsdatum ab: 03.08.2015 Production date from: 03.08.2015</p>
<p>GLA 200 CDI / d (156.908) 80-130 kW (109-177 PS) OM 651.930</p>	<p>12.2013→</p>	 <p>7.02256.37.0</p>	<p>EUV-WP</p>	<p>EL</p>
<p>GLA 200 CDI 4-matic (156.902) 80-130 kW (109-177 PS) OM 651.930</p>	<p>12.2013→</p>	 <p>7.02256.37.0</p>	<p>EUV-WP</p>	<p>EL Produktionsdatum bis: 14.12.2020 Production date to: 14.12.2020</p>
<p>GLA 200 Flex 75-115 kW (102-156 PS) M 270.910</p>	<p>06.2015→</p>	 <p>7.00782.16.0</p> <p>7.01870.06.0</p> <p>7.04818.04.0</p>	<p>DW-TL</p> <p>SUV</p> <p>SUV</p>	<p>EP</p> <p>EL  M 270.910: Fahrgestellnummer bis: 10044275 Vehicle Identification Number to: 10044275 Produktionsdatum bis: 22.12.2015 Production date to: 22.12.2015  M 270.910: Fahrgestellnummer bis: 30786355 Vehicle Identification Number to: 30786355 Produktionsdatum bis: 03.08.2015 Production date to: 03.08.2015 EL  M 270.910: Fahrgestellnummer ab: 30786355 Vehicle Identification Number from: 30786355 Produktionsdatum ab: 03.08.2015 Production date from: 03.08.2015  M 270.910: Fahrgestellnummer ab: 10044275 Vehicle Identification Number from: 10044275 Produktionsdatum ab: 22.12.2015 Production date from: 22.12.2015</p>
<p>GLA 220 (156.945) 115-160 kW (156-218 PS) M 270.920</p>	<p>01.2017→</p>	 <p>7.00782.16.0</p>	<p>DW-TL</p>	<p>EP</p>

M















GLA-CLASS (X156) **77**























			7.04818.04.0	SUV	EL	 M 270.920: Fahrgestellnummer ab: 30786355 Vehicle Identification Number from: 30786355 Produktionsdatum ab: 03.08.2015 Production date from: 03.08.2015  M 270.920: Fahrgestellnummer ab: 10044275 Vehicle Identification Number from: 10044275 Produktionsdatum ab: 22.12.2015 Production date from: 22.12.2015
M	GLA 220 4-matic (156.947) 115-160 kW (156-218 PS) M 270.920	01.2017→	 7.00782.16.0	DW-TL	EP	 M 270.920: Fahrgestellnummer ab: 10044275 Vehicle Identification Number from: 10044275 Produktionsdatum ab: 22.12.2015 Production date from: 22.12.2015  M 270.920: Fahrgestellnummer ab: 30786355 Vehicle Identification Number from: 30786355 Produktionsdatum ab: 03.08.2015 Production date from: 03.08.2015
			7.04818.04.0	SUV	EL	
	GLA 220 CDI (156.903) 80-130 kW (109-177 PS) OM 651.930	12.2013→	 7.02256.37.0	EUV-WP	EL	Produktionsdatum bis: 14.12.2020 Production date to: 14.12.2020
	GLA 220 CDI / d (156.903) 80-130 kW (109-177 PS) OM 651.930	12.2013→	 7.02256.37.0	EUV-WP	EL	Produktionsdatum bis: 14.12.2020 Production date to: 14.12.2020
	GLA 220 CDI / d 4-matic (156.905) 80-130 kW (109-177 PS) OM 651.930	12.2013→	 7.02256.37.0	EUV-WP	EL	Produktionsdatum bis: 14.12.2020 Production date to: 14.12.2020
	GLA 220 CDI 4-matic (156.905) 80-130 kW (109-177 PS) OM 651.930	12.2013→	 7.02256.37.0	EUV-WP	EL	Produktionsdatum bis: 14.12.2020 Production date to: 14.12.2020
	GLA 220 d (156.903) 80-130 kW (109-177 PS) OM 651.930	07.2015→	 7.02256.37.0	EUV-WP	EL	Produktionsdatum bis: 14.12.2020 Production date to: 14.12.2020
	GLA 220 d 4-matic (156.905) 80-130 kW (109-177 PS) OM 651.930	07.2015→	 7.02256.37.0	EUV-WP	EL	Produktionsdatum bis: 14.12.2020 Production date to: 14.12.2020
	GLA 250 (156.944) 115-160 kW (156-218 PS) M 270.920	12.2013→	 7.00782.16.0	DW-TL	EP	 M 270.920: Fahrgestellnummer bis: 10044275 Vehicle Identification Number to: 10044275 Produktionsdatum bis: 22.12.2015 Production date to: 22.12.2015  M 270.920: Fahrgestellnummer bis: 30786355 Vehicle Identification Number to: 30786355 Produktionsdatum bis: 03.08.2015 Production date to: 03.08.2015
7.02256.37.0			EUV-KK	EL		
7.01870.06.0			SUV	EL		



GLA-CLASS (X156) **77**

		7.04818.04.0	SUV	EL	 M 270.920: Fahrgestellnummer ab: 10044275 Vehicle Identification Number from: 10044275 Produktionsdatum ab: 22.12.2015 Production date from: 22.12.2015  M 270.920: Fahrgestellnummer ab: 30786355 Vehicle Identification Number from: 30786355 Produktionsdatum ab: 03.08.2015 Production date from: 03.08.2015
GLA 250 4-matic (156.946) 115-160 kW (156-218 PS) M 270.920	12.2013->	 7.00782.16.0 7.02256.37.0 7.01870.06.0	DW-TL	EP	
			EUV-KK	EL	 M 270.920: Fahrgestellnummer bis: 10044275 Vehicle Identification Number to: 10044275 Produktionsdatum bis: 22.12.2015 Production date to: 22.12.2015  M 270.920: Fahrgestellnummer bis: 30786355 Vehicle Identification Number to: 30786355 Produktionsdatum bis: 03.08.2015 Production date to: 03.08.2015
			SUV	EL	
		7.04818.04.0	SUV	EL	 M 270.920: Fahrgestellnummer ab: 10044275 Vehicle Identification Number from: 10044275 Produktionsdatum ab: 22.12.2015 Production date from: 22.12.2015  M 270.920: Fahrgestellnummer ab: 30786355 Vehicle Identification Number from: 30786355 Produktionsdatum ab: 03.08.2015 Production date from: 03.08.2015
GLA 250 Flex (156.944) 115-160 kW (156-218 PS) M 270.920	01.2015->	 7.00782.16.0 7.01870.06.0	DW-TL	EP	
			SUV	EL	 M 270.920: Fahrgestellnummer bis: 10044275 Vehicle Identification Number to: 10044275 Produktionsdatum bis: 22.12.2015 Production date to: 22.12.2015  M 270.920: Fahrgestellnummer bis: 30786355 Vehicle Identification Number to: 30786355 Produktionsdatum bis: 03.08.2015 Production date to: 03.08.2015
			SUV	EL	
		7.04818.04.0	SUV	EL	 M 270.920: Fahrgestellnummer ab: 10044275 Vehicle Identification Number from: 10044275 Produktionsdatum ab: 22.12.2015 Production date from: 22.12.2015  M 270.920: Fahrgestellnummer ab: 30786355 Vehicle Identification Number from: 30786355 Produktionsdatum ab: 03.08.2015 Production date from: 03.08.2015















M

						
GLA-CLASS (X156)						77
GLA 250 Flex 4-matic (156.946) 115-160 kW (156-218 PS) M 270.920	01.2015→		7.00782.16.0	DW-TL	EP	
GLA 45 AMG 4-matic (156.952) 250-280 kW (340-381 PS) M 133.980	05.2014→		7.00782.11.0	DW-TL	EP	
GLB (X247)						78
GLB 180 (247.684) 80-160 kW (109-218 PS) M 282.914	04.2020→		7.04818.04.0	SUV	EL für OE-Nummer: A 000 153 18 59, A 282 090 02 80 for OE number: A 000 153 18 59, A 282 090 02 80	
GLB 180 d (247.610) 84-235 kW (114-320 PS) OM 654.920	08.2019→		7.02256.37.0	EUV-AGR	EL Produktionsdatum bis: 15.12.2020 Production date to: 15.12.2020	
GLB 200 (247.687) 80-160 kW (109-218 PS) M 282.914	08.2019→		7.04818.04.0	SUV	EL für OE-Nummer: A 000 153 18 59, A 282 090 02 80 for OE number: A 000 153 18 59, A 282 090 02 80	
GLB 200 d (247.612) 84-235 kW (114-320 PS) OM 654.920	08.2019→		7.02256.37.0	EUV-AGR	EL Produktionsdatum bis: 15.12.2020 Production date to: 15.12.2020	
GLB 200 d 4-matic (247.613) 84-235 kW (114-320 PS) OM 654.920	08.2019→		7.02256.37.0	EUV-AGR	EL Produktionsdatum bis: 15.12.2020 Production date to: 15.12.2020	
GLB 220 d (247.614) 84-235 kW (114-320 PS) OM 654.920	12.2019→		7.02256.37.0	EUV-AGR	EL Produktionsdatum ab: 15.12.2020 Production date from: 15.12.2020	
GLB 220 d 4-matic (247.615) 84-235 kW (114-320 PS) OM 654.920	08.2019→		7.02256.37.0	EUV-AGR	EL Produktionsdatum bis: 15.12.2020 Production date to: 15.12.2020	
GLC (X253)						79
200 (253.942) 115-245 kW (156-333 PS) M 274.920	06.2016→04.2019		7.00782.16.0	DW-TL	EP	
			7.02256.37.0	EUV-WP	EL	
			7.04818.04.0	SUV	EL	
200 4-matic (253.943) 115-245 kW (156-333 PS) M 274.920	06.2016→04.2019		7.00782.16.0	DW-TL	EP	
			7.02256.37.0	EUV-WP	EL	
			7.04818.04.0	SUV	EL	
200 d (253.913) 84-235 kW (114-320 PS) OM 654.920	04.2019→		7.02256.37.0	EUV-AGR	EL Produktionsdatum bis: 15.12.2020 Production date to: 15.12.2020	
200 d 4-matic (253.916) 84-235 kW (114-320 PS) OM 654.920	04.2019→		7.02256.37.0	EUV-AGR	EL Produktionsdatum bis: 15.12.2020 Production date to: 15.12.2020	
220 d (253.914) 84-235 kW (114-320 PS) OM 654.920	04.2019→		7.02256.37.0	EUV-AGR	EL Produktionsdatum bis: 15.12.2020 Production date to: 15.12.2020	
220 d 4-matic (253.905, 253.903) 100-150 kW (136-204 PS) OM 651.921	06.2015→04.2019		7.00782.12.0	DW-TL	EP	
			7.02256.37.0	EUV-VB	EL	
			7.02256.37.0	EUV-WP	EL	
220 d 4-matic (253.905, 253.903) 100-150 kW (136-204 PS) OM 651.921	06.2015→04.2019		7.00782.12.0	DW-TL	EP	
			7.02256.37.0	EUV-VB	EL	

M









GLC (X253) **79**

		7.02256.37.0	EUV-WP	EL	
220 d 4-matic (253.915) 84-235 kW (114-320 PS) OM 654.920	04.2019→	 7.02256.37.0	EUV-AGR	EL	Produktionsdatum bis: 15.12.2020 Production date to: 15.12.2020
250 4-matic (253.946) 115-245 kW (156-333 PS) M 274.920	06.2015→04.2019	 7.00782.16.0	DW-TL	EP	
		7.02256.37.0	EUV-WP	EL	
		7.04818.04.0	SUV	EL	
250 CNG 4-matic (253.946) 115-245 kW (156-333 PS) M 274.920	06.2015→04.2019	 7.00782.16.0	DW-TL	EP	
		7.02256.37.0	EUV-WP	EL	
250 Flexfuel 4-matic (253.946) 115-245 kW (156-333 PS) M 274.920	06.2015→04.2019	 7.00782.16.0	DW-TL	EP	
250 d 4-matic (253.909) 100-150 kW (136-204 PS) OM 651.921	06.2015→04.2019	 7.00782.12.0	DW-TL	EP	
		7.02256.37.0	EUV-VB	EL	
		7.02256.37.0	EUV-WP	EL	
300 (253.948) 115-245 kW (156-333 PS) M 274.920	01.2016→04.2019	 7.00782.16.0	DW-TL	EP	
		7.02256.37.0	EUV-WP	EL	
		7.04818.04.0	SUV	EL	
300 4-matic (253.949) 115-245 kW (156-333 PS) M 274.920	07.2015→04.2019	 7.00782.16.0	DW-TL	EP	
		7.02256.37.0	EUV-WP	EL	
		7.04818.04.0	SUV	EL	
300 4-matic (253.949) 115-245 kW (156-333 PS) M 274.920	07.2015→04.2019	 7.00782.16.0	DW-TL	EP	
		7.02256.37.0	EUV-WP	EL	
		7.04818.04.0	SUV	EL	
300 d 4-matic (253.919) 84-235 kW (114-320 PS) OM 654.920	04.2019→	 7.02256.37.0	EUV-AGR	EL	Produktionsdatum bis: 15.12.2020 Production date to: 15.12.2020
300 de 4-matic (253.911) 84-235 kW (114-320 PS) OM 654.920	05.2020→	 7.02256.37.0	EUV-AGR	EL	Produktionsdatum bis: 15.12.2020 Production date to: 15.12.2020
300 de 4-matic (253.911) 84-235 kW (114-320 PS) OM 654.920	05.2020→	 7.02256.37.0	EUV-AGR	EL	Produktionsdatum bis: 15.12.2020 Production date to: 15.12.2020
300 e 4-matic (253.953) 115-245 kW (156-333 PS) M 274.920	11.2019→	 7.00782.16.0	DW-TL	EP	
		7.02256.37.0	EUV-WP	EL	
		7.04818.04.0	SUV	EL	
300 e 4-matic (253.953) 115-245 kW (156-333 PS) M 274.920	11.2019→	 7.00782.16.0	DW-TL	EP	
		7.02256.37.0	EUV-WP	EL	
		7.04818.04.0	SUV	EL	
350 e 4-matic (253.954) 115-245 kW (156-333 PS) M 274.920	01.2016→04.2019	 7.00782.16.0	DW-TL	EP	

M























GLC (X253) **79**

			7.02256.37.0	EUV-WP	EL	
			7.04818.04.0	SUV	EL	
350 e 4-matic (253.954) 115-245 kW (156-333 PS) M 274.920	01.2016→04.2019		7.00782.16.0	DW-TL	EP	
			7.02256.37.0	EUV-WP	EL	
			7.04818.04.0	SUV	EL	
400 d 4-matic (253.923) 183-250 kW (249-340 PS) OM 656.929	08.2019→		7.02256.37.0	EUV-AGR	EL	Produktionsdatum bis: 14.12.2020 Production date to: 14.12.2020
			7.02256.37.0	EUV-WP	EL	Produktionsdatum bis: 14.12.2020 Production date to: 14.12.2020
AMG 43 4-matic (253.964) 200-295 kW (272-401 PS) M 276.823	04.2016→08.2019		7.00782.11.0	DW-TL	EP	
			7.01870.06.0	SUV	EL	
AMG 43 4-matic (253.964) 200-295 kW (272-401 PS) M 276.823	08.2019→		7.00782.11.0	DW-TL	EP	
			7.01870.06.0	SUV	EL	
AMG 63 4-matic+ (253.988) 350-470 kW (476-639 PS) M 177.980	06.2017→		7.00782.16.0	DW-TL	EP	
			7.04927.08.0	SUV	EL	Ladeluftkühler Intercooler
AMG 63 S 4-matic+ (253.989) 350-470 kW (476-639 PS) M 177.980	06.2017→		7.00782.16.0	DW-TL	EP	
			7.04927.08.0	SUV	EL	Ladeluftkühler Intercooler

M

GLC Coupe (C253) **80**

200 (253.342) 115-245 kW (156-333 PS) M 274.920	06.2016→04.2019		7.00782.16.0	DW-TL	EP	
			7.02256.37.0	EUV-WP	EL	
			7.04818.04.0	SUV	EL	
200 4-matic (253.343) 115-245 kW (156-333 PS) M 274.920	11.2016→04.2019		7.00782.16.0	DW-TL	EP	
			7.02256.37.0	EUV-WP	EL	
			7.04818.04.0	SUV	EL	
200 d (253.313) 84-235 kW (114-320 PS) OM 654.920	04.2019→		7.02256.37.0	EUV-AGR	EL	Produktionsdatum bis: 15.12.2020 Production date to: 15.12.2020
200 d 4-matic (253.316) 84-235 kW (114-320 PS) OM 654.920	04.2019→		7.02256.37.0	EUV-AGR	EL	Produktionsdatum bis: 15.12.2020 Production date to: 15.12.2020
220 d 4-matic (253.303, 253.305) 100-150 kW (136-204 PS) OM 651.921	06.2016→04.2019		7.00782.12.0	DW-TL	EP	
			7.02256.37.0	EUV-VB	EL	
			7.02256.37.0	EUV-WP	EL	
220 d 4-matic (253.303, 253.305) 100-150 kW (136-204 PS) OM 651.921	06.2016→04.2019		7.00782.12.0	DW-TL	EP	
			7.02256.37.0	EUV-VB	EL	
			7.02256.37.0	EUV-WP	EL	

					
GLC Coupe (C253)					80
220 d 4-matic (253.315) 84-235 kW (114-320 PS) OM 654.920	04.2019→		7.02256.37.0	EUV-AGR	EL Produktionsdatum bis: 15.12.2020 Production date to: 15.12.2020
250 4-matic (253.346) 115-245 kW (156-333 PS) M 274.920	06.2016→04.2019		7.00782.16.0	DW-TL	EP
			7.02256.37.0 7.04818.04.0	EUV-WP SUV	EL EL
250 d 4-matic (253.309) 100-150 kW (136-204 PS) OM 651.921	06.2016→04.2019		7.00782.12.0	DW-TL	EP
			7.02256.37.0 7.02256.37.0	EUV-VB EUV-WP	EL EL
300 4-matic (253.349) 115-245 kW (156-333 PS) M 274.920	10.2016→04.2019		7.00782.16.0	DW-TL	EP
			7.04818.04.0	SUV	EL
300 d 4-matic (253.319) 84-235 kW (114-320 PS) OM 654.920	04.2019→		7.02256.37.0	EUV-AGR	EL Produktionsdatum bis: 15.12.2020 Production date to: 15.12.2020
			7.02256.37.0	EUV-VB	EL Produktionsdatum bis: 15.12.2020 Production date to: 15.12.2020
300 de 4-matic (253.311) 84-235 kW (114-320 PS) OM 654.920	05.2020→		7.02256.37.0	EUV-AGR	EL Produktionsdatum bis: 15.12.2020 Production date to: 15.12.2020
300 de 4-matic (253.311) 84-235 kW (114-320 PS) OM 654.920	05.2020→		7.02256.37.0	EUV-AGR	EL Produktionsdatum bis: 15.12.2020 Production date to: 15.12.2020
300 e 4-matic (253.353) 115-245 kW (156-333 PS) M 274.920	11.2019→		7.00782.16.0	DW-TL	EP
			7.02256.37.0 7.04818.04.0	EUV-WP SUV	EL EL
350 e 4-matic (253.354) 115-245 kW (156-333 PS) M 274.920	10.2016→04.2019		7.00782.16.0	DW-TL	EP
			7.02256.37.0 7.04818.04.0	EUV-WP SUV	EL EL
350 e 4-matic (253.354) 115-245 kW (156-333 PS) M 274.920	10.2016→04.2019		7.00782.16.0	DW-TL	EP
			7.02256.37.0 7.04818.04.0	EUV-WP SUV	EL EL
400 d 4-matic (253.323) 183-250 kW (249-340 PS) OM 656.929	08.2019→		7.02256.37.0	EUV-AGR	EL Produktionsdatum bis: 14.12.2020 Production date to: 14.12.2020
			7.02256.37.0	EUV-WP	EL Produktionsdatum bis: 14.12.2020 Production date to: 14.12.2020
AMG 43 4-matic (253.364) 200-295 kW (272-401 PS) M 276.823	10.2016→08.2019		7.00782.11.0	DW-TL	EP
			7.01870.06.0	SUV	EL
AMG 43 4-matic (253.364) 200-295 kW (272-401 PS) M 276.823	08.2019→		7.00782.11.0	DW-TL	EP
			7.01870.06.0	SUV	EL
AMG 63 4-matic+ (253.388) 350-470 kW (476-639 PS) M 177.980	06.2017→		7.00782.16.0	DW-TL	EP









M





GLC Coupe (C253) 80

		7.04927.08.0	SUV	EL	Ladeluftkühler Intercooler
AMG 63 S 4-matic+ (253.389) 350-470 kW (476-639 PS) M 177.980	06.2017→	 7.00782.16.0	DW-TL	EP	
		7.04927.08.0	SUV	EL	Ladeluftkühler Intercooler

GLE (V167) 81

AMG GLE 63 EQ Boost 4-matic+ (167.188) 350-470 kW (476-639 PS) M 177.980	11.2019→05.2021	 7.00782.16.0	DW-TL	EP	
AMG GLE 63 S EQ Boost 4-matic+ (167.189) 350-470 kW (476-639 PS) M 177.980	11.2019→05.2021	 7.00782.16.0	DW-TL	EP	
GLE 300 d 4-matic (167.119) 84-235 kW (114-320 PS) OM 654.920	10.2018→05.2021	 7.02256.37.0	EUV-AGR	EL	Produktionsdatum bis: 15.12.2020 Production date to: 15.12.2020
GLE 350 d 4-matic (167.121) 183-250 kW (249-340 PS) OM 656.929	12.2018→05.2021	 7.02256.37.0	EUV-AGR	EL	Produktionsdatum bis: 14.12.2020 Production date to: 14.12.2020
		7.02256.37.0	EUV-WP	EL	Produktionsdatum bis: 14.12.2020 Production date to: 14.12.2020
GLE 350 de 4-matic (167.117) 84-235 kW (114-320 PS) OM 654.920	11.2019→	 7.02256.37.0	EUV-AGR	EL	Produktionsdatum bis: 15.12.2020 Production date to: 15.12.2020
GLE 350 de 4-matic (167.117) 84-235 kW (114-320 PS) OM 654.920	11.2019→	 7.02256.37.0	EUV-AGR	EL	Produktionsdatum bis: 15.12.2020 Production date to: 15.12.2020
GLE 350 de 4-matic (167.117) 84-235 kW (114-320 PS) OM 654.920	03.2020→	 7.02256.37.0	EUV-AGR	EL	Produktionsdatum bis: 15.12.2020 Production date to: 15.12.2020
GLE 350 e 4-matic (167.154) 115-245 kW (156-333 PS) M 274.920	06.2020→	 7.00782.16.0	DW-TL	EP	
		7.02256.37.0	EUV-WP	EL	
		7.04818.04.0	SUV	EL	
GLE 350 e 4-matic (167.154) 115-245 kW (156-333 PS) M 274.920	06.2020→	 7.00782.16.0	DW-TL	EP	
		7.02256.37.0	EUV-WP	EL	
		7.04818.04.0	SUV	EL	
GLE 400 d 4-matic (167.123) 183-250 kW (249-340 PS) OM 656.929	12.2018→	 7.02256.37.0	EUV-AGR	EL	Produktionsdatum bis: 14.12.2020 Production date to: 14.12.2020
		7.02256.37.0	EUV-WP	EL	Produktionsdatum bis: 14.12.2020 Production date to: 14.12.2020

GLE (W166) 82

250 d (166.006) 150-152 kW (204-207 PS) OM 651.960	04.2015→10.2018	 7.00782.12.0	DW-TL	EP	
		7.02256.37.0	EUV-VB	EL	
		7.02256.37.0	EUV-WP	EL	
250 d 4-matic (166.004) 150-152 kW (204-207 PS) OM 651.960	04.2015→10.2018	 7.00782.12.0	DW-TL	EP	
		7.02256.37.0	EUV-VB	EL	
		7.02256.37.0	EUV-WP	EL	



GLE (W166)



82

320 4-matic (166.062) 200-325 kW (272-442 PS) M 276.821	10.2015→10.2018		7.00782.11.0	DW-TL	EP	
			7.01870.06.0	SUV	EL	
400 4-matic (166.056) 200-325 kW (272-442 PS) M 276.821, M 276.825	04.2015→10.2018		7.00782.11.0	DW-TL	EP	
			7.01870.06.0	SUV	EL	
450 AMG 4-matic (166.064) 200-325 kW (272-442 PS) M 276.821	10.2015→10.2018		7.00782.11.0	DW-TL	EP	
			7.01870.06.0	SUV	EL	
500 4-matic (166.073) 270-335 kW (367-456 PS) M 278.928	04.2015→10.2018		7.00782.11.0	DW-TL	EP	
			7.00782.11.0	DW-TL	EP	
500 4-matic (166.073) 270-335 kW (367-456 PS) M 278.928	04.2015→10.2018		7.00782.11.0	DW-TL	EP	
			7.00782.11.0	DW-TL	EP	
500 4-matic (166.073) 270-335 kW (367-456 PS) M 278.928	10.2015→10.2018		7.00782.11.0	DW-TL	EP	
			7.00782.11.0	DW-TL	EP	
500 e 4-matic (166.063) 200-325 kW (272-442 PS) M 276.821	04.2015→10.2018		7.00782.11.0	DW-TL	EP	
			7.01870.06.0	SUV	EL	
500 e 4-matic (166.063) 200-325 kW (272-442 PS) M 276.821	04.2015→10.2018		7.00782.11.0	DW-TL	EP	
			7.00782.11.0	DW-TL	EP	
AMG 43 4-matic (166.064) 200-325 kW (272-442 PS) M 276.821	05.2016→10.2018		7.00782.11.0	DW-TL	EP	
			7.01870.06.0	SUV	EL	
AMG 43 4-matic (166.064) 200-325 kW (272-442 PS) M 276.821	06.2017→10.2018		7.00782.11.0	DW-TL	EP	
			7.01870.06.0	SUV	EL	
AMG 63 4-matic (166.074) 386-430 kW (525-585 PS) M 157.982	04.2015→10.2018		7.00782.11.0	DW-TL	EP	
			7.00782.11.0	DW-TL	EP	
AMG 63 4-matic (166.074) 386-430 kW (525-585 PS) M 157.982	04.2015→05.2017		7.00782.11.0	DW-TL	EP	
			7.00782.11.0	DW-TL	EP	
AMG 63 S 4-matic (166.075) 386-430 kW (525-585 PS) M 157.982	04.2015→10.2018		7.00782.11.0	DW-TL	EP	
			7.00782.11.0	DW-TL	EP	

M





GLE Coupe (C167)

83

AMG GLE 63 EQ Boost 4-matic+ (167.388) 350-470 kW (476-639 PS) M 177.980	03.2020→05.2021		7.00782.16.0	DW-TL	EP	
			7.00782.16.0	DW-TL	EP	
AMG GLE 63 EQ Boost 4-matic+ (167.389) 350-470 kW (476-639 PS) M 177.980	03.2020→05.2021		7.00782.16.0	DW-TL	EP	
			7.00782.16.0	DW-TL	EP	
GLE 350 d 4-matic (167.321) 183-250 kW (249-340 PS) OM 656.929	11.2019→05.2021		7.02256.37.0	EUV-AGR	EL	Produktionsdatum bis: 14.12.2020 Production date to: 14.12.2020
			7.02256.37.0	EUV-WP	EL	Produktionsdatum bis: 14.12.2020 Production date to: 14.12.2020











GLE Coupe (C167) 83

GLE 350 de 4-matic (167.317) 84-235 kW (114-320 PS) OM 654.920	03.2020→		7.02256.37.0	EUV-AGR	EL	Produktionsdatum bis: 15.12.2020 Production date to: 15.12.2020
GLE 350 de 4-matic (167.317) 84-235 kW (114-320 PS) OM 654.920	03.2020→		7.02256.37.0	EUV-AGR	EL	Produktionsdatum bis: 15.12.2020 Production date to: 15.12.2020
GLE 350 e 4-matic (167.354) 115-245 kW (156-333 PS) M 274.920	06.2020→		7.00782.16.0	DW-TL	EP	
			7.02256.37.0 7.04818.04.0	EUV-WP SUV	EL EL	
GLE 350 e 4-matic (167.354) 115-245 kW (156-333 PS) M 274.920	06.2020→		7.00782.16.0	DW-TL	EP	
			7.02256.37.0 7.04818.04.0	EUV-WP SUV	EL EL	
GLE 400 d 4-matic (167.323) 183-250 kW (249-340 PS) OM 656.929	11.2019→		7.02256.37.0	EUV-AGR	EL	Produktionsdatum bis: 14.12.2020 Production date to: 14.12.2020
			7.02256.37.0	EUV-WP	EL	Produktionsdatum bis: 14.12.2020 Production date to: 14.12.2020

GLE Coupe (C292) 84

M





















320 4-matic (292.362) 200-325 kW (272-442 PS) M 276.821	09.2015→10.2019		7.00782.11.0	DW-TL	EP	
			7.01870.06.0	SUV	EL	
400 4-matic (292.356) 200-325 kW (272-442 PS) M 276.821, M 276.825	03.2015→10.2019		7.00782.11.0	DW-TL	EP	
			7.01870.06.0	SUV	EL	
450 AMG 4-matic (292.364) 200-325 kW (272-442 PS) M 276.821	03.2015→10.2019		7.00782.11.0	DW-TL	EP	
			7.01870.06.0	SUV	EL	
500 4-matic (292.371) 310 kW (422 PS) M 278.912	12.2016→10.2019		7.00782.11.0	DW-TL	EP	
500 4-matic (292.373) 270-335 kW (367-456 PS) M 278.928	10.2015→10.2019		7.00782.11.0	DW-TL	EP	
AMG 43 4-matic (292.364) 200-325 kW (272-442 PS) M 276.821	05.2016→10.2019		7.00782.11.0	DW-TL	EP	
			7.01870.06.0	SUV	EL	
AMG 43 4-matic (292.364) 200-325 kW (272-442 PS) M 276.821	06.2017→10.2019		7.00782.11.0	DW-TL	EP	
			7.01870.06.0	SUV	EL	
AMG 63 4-matic (292.374) 386-430 kW (525-585 PS) M 157.982	03.2015→10.2019		7.00782.11.0	DW-TL	EP	
AMG 63 S 4-matic (292.375) 386-430 kW (525-585 PS) M 157.982	03.2015→10.2019		7.00782.11.0	DW-TL	EP	



GLK-CLASS (X204) 85

200 (204.934) 115-245 kW (156-333 PS) M 274.920	08.2013→06.2015		7.00782.16.0	DW-TL	EP	
			7.02256.37.0 7.04818.04.0	EUV-WP SUV	EL EL	
200 CDI (204.901) 88-125 kW (120-170 PS) OM 651.913, OM 651.916	07.2010→06.2015		7.00782.12.0	DW-TL	EP	
			7.02256.37.0 7.02256.37.0	EUV-VB EUV-WP	EL EL	
			7.00782.12.0 7.02256.37.0 7.02256.37.0	DW-TL EUV-VB EUV-WP	EP EL EL	
200 CDI (204.901) 100-125 kW (136-170 PS) OM 651.916	12.2013→06.2015		7.00782.12.0	DW-TL	EP	
			7.02256.37.0 7.02256.37.0	EUV-VB EUV-WP	EL EL	
			7.00782.12.0 7.02256.37.0 7.02256.37.0	DW-TL EUV-VB EUV-WP	EP EL EL	
220 CDI (204.902) 100-125 kW (136-170 PS) OM 651.916	12.2008→06.2015		7.00782.12.0	DW-TL	EP	
			7.02256.37.0 7.02256.37.0	EUV-VB EUV-WP	EL EL	
			7.00782.12.0 7.02256.37.0 7.02256.37.0	DW-TL EUV-VB EUV-WP	EP EL EL	
220 CDI (204.902) 100-125 kW (136-170 PS) OM 651.916	12.2008→06.2015		7.00782.12.0	DW-TL	EP	
			7.02256.37.0 7.02256.37.0	EUV-WP	EL	
			7.00782.12.0 7.02256.37.0 7.02256.37.0	DW-TL EUV-WP	EP EL	
220 CDI 4-matic (204.984) 120-150 kW (163-204 PS) OM 651.912	12.2008→06.2015		7.00782.12.0	DW-TL	EP	
			7.02256.37.0 7.02256.37.0	EUV-WP	EL	
			7.00782.12.0 7.02256.37.0 7.02256.37.0	DW-TL EUV-WP	EP EL	
220 CDI 4-matic (204.984, 204.997) 120-150 kW (163-204 PS) OM 651.912	12.2008→06.2015		7.00782.12.0	DW-TL	EP	
			7.02256.37.0 7.02256.37.0	EUV-WP	EL	
			7.00782.12.0 7.02256.37.0 7.02256.37.0	DW-TL EUV-WP	EP EL	
250 (204.936) 115-245 kW (156-333 PS) M 274.920	08.2013→06.2015		7.00782.16.0	DW-TL	EP	
			7.02256.37.0 7.04818.04.0	EUV-WP SUV	EL EL	
			7.00782.16.0 7.02256.37.0 7.04818.04.0	DW-TL EUV-WP SUV	EP EL EL	
250 4-matic (204.937) 115-245 kW (156-333 PS) M 274.920	08.2013→06.2015		7.00782.16.0	DW-TL	EP	
			7.02256.37.0 7.04818.04.0	EUV-WP SUV	EL EL	
			7.00782.16.0 7.02256.37.0 7.04818.04.0	DW-TL EUV-WP SUV	EP EL EL	
250 CDI 4-matic 120-150 kW (163-204 PS) OM 651.912	09.2012→06.2015		7.00782.12.0	DW-TL	EP	
			7.02256.37.0 7.02256.37.0	EUV-WP	EL	
250 CDI 4-matic (204.982, 204.904) 120-150 kW (163-204 PS) OM 651.912	09.2009→06.2015		7.00782.12.0	DW-TL	EP	
			7.02256.37.0 7.02256.37.0	EUV-WP	EL	
			7.00782.12.0 7.02256.37.0 7.02256.37.0	DW-TL EUV-WP	EP EL	
280 4-matic (204.981) 170 kW (231 PS) M 272.948	06.2008→06.2009		7.22355.01.0	EUV-SR	EL	
			7.06117.60.0 7.06117.60.0	ZM-NWV	EL	
300 4-matic (204.981) 170 kW (231 PS) M 272.948	07.2009→12.2015		7.22355.01.0	EUV-SR	EL	mit Dichtring with O-ring
			7.22355.01.0 7.22355.01.0	EUV-SR	EL	

M









					
GLK-CLASS (X204)					85
			7.06117.60.0	ZM-NWV	EL mit Dichtring with O-ring
350 (204.956) 200 kW (272 PS) M 272.991	04.2009→06.2015		7.22355.01.0	EUV-SR	EL
			7.06117.60.0	ZM-NWV	EL mit Dichtring with O-ring
350 4-matic (204.987) 200 kW (272 PS) M 272.971	06.2008→04.2011		7.22355.01.0	EUV-SR	EL
			7.06117.60.0	ZM-NWV	EL mit Dichtring with O-ring
GLS (X166)					86
320 4-matic (166.862) 200-325 kW (272-442 PS) M 276.821	10.2017→04.2019		7.00782.11.0	DW-TL	EP
			7.01870.06.0	SUV	EL
400 4-matic (166.856) 200-325 kW (272-442 PS) M 276.821	11.2015→04.2019		7.00782.11.0	DW-TL	EP
			7.01870.06.0	SUV	EL
450 4-matic (166.864) 200-325 kW (272-442 PS) M 276.821	06.2016→04.2019		7.00782.11.0	DW-TL	EP
			7.01870.06.0	SUV	EL
500 4-matic (166.871) 310 kW (422 PS) M 278.912	03.2016→04.2019		7.00782.11.0	DW-TL	EP
500 4-matic (166.873) 270-335 kW (367-456 PS) M 278.928	11.2015→04.2019		7.00782.11.0	DW-TL	EP
AMG 63 4-matic (166.875) 386-430 kW (525-585 PS) M 157.982	11.2015→04.2019		7.00782.11.0	DW-TL	EP
GLS (X167)					87
350 d 4-matic (167.921) 183-250 kW (249-340 PS) OM 656.929	04.2019→		7.02256.37.0	EUV-AGR	EL Produktionsdatum bis: 14.12.2020 Production date to: 14.12.2020
			7.02256.37.0	EUV-WP	EL Produktionsdatum bis: 14.12.2020 Production date to: 14.12.2020
400 d 4-matic (167.923) 183-250 kW (249-340 PS) OM 656.929	04.2019→		7.02256.37.0	EUV-AGR	EL Produktionsdatum bis: 14.12.2020 Production date to: 14.12.2020
			7.02256.37.0	EUV-WP	EL Produktionsdatum bis: 14.12.2020 Production date to: 14.12.2020
AMG 63 4Matic+ EQ Boost 4-matic+ (167.989) 350-470 kW (476-639 PS) M 177.980	11.2019→		7.00782.16.0	DW-TL	EP
Maybach 600 EQ Boost 4-matic (167.987) 350-470 kW (476-639 PS) M 177.980	11.2019→		7.00782.16.0	DW-TL	EP
M-CLASS (W163)					88
ML 230 (163.136) 110 kW (150 PS) M 111.977	02.1998→06.2005		7.06117.20.0	ZM-NWV	EL
ML 320 (163.154) 160 kW (218 PS) M 112.942	02.1998→08.2002		7.02256.37.0	EUV-SL	EL
			7.22355.01.0	EUV-SR	EL





















M-CLASS (W163) 88

ML 350 173-180 kW (235-245 PS) M 112.970	02.2003→06.2005		7.02256.37.0	EUV-SL	EL	
			7.22355.01.0	EUV-SR	EL	
ML 350 (163.157) 173-180 kW (235-245 PS) M 112.970	08.2002→06.2005		7.02256.37.0	EUV-SL	EL	
			7.22355.01.0	EUV-SR	EL	
ML 430 (163.172) 199 kW (271 PS) M 113.942	02.1998→06.2005		7.02256.37.0	EUV-SL	EL	
			7.22355.01.0	EUV-SR	EL	
ML 500 (163.175) 215-225 kW (292-306 PS) M 113.964	09.2001→06.2005		7.22355.01.0	EUV-SR	EL	
			7.02256.37.0	EUV-SL	EL	
ML 500 (163.175) 215 kW (292 PS) M 113.965	09.2001→06.2005		7.02256.37.0	EUV-SL	EL	
			7.22355.01.0	EUV-SR	EL	
ML 55 AMG (163.174) 255 kW (347 PS) M 113.981	02.2000→06.2005		7.02256.37.0	EUV-SL	EL	
			7.22355.01.0	EUV-SR	EL	

M-CLASS (W164) 89





ML 300 4-matic (164.182) 170-180 kW (231-245 PS) M 272.945	03.2010→12.2011		7.22355.01.0	EUV-SR	EL	
			7.06117.60.0	ZM-NWV	EL	mit Dichtring with O-ring
ML 350 (164.156) 200 kW (272 PS) M 272.967	01.2009→12.2011		7.22355.01.0	EUV-SR	EL	
			7.06117.60.0	ZM-NWV	EL	mit Dichtring with O-ring
ML 350 4-matic (164.186) 200 kW (272 PS) M 272.967	02.2005→12.2011		7.22355.01.0	EUV-SR	EL	
			7.06117.60.0	ZM-NWV	EL	mit Dichtring with O-ring
ML 450 Hybrid 4-matic (164.195) 200-208 kW (272-283 PS) M 272.973	09.2009→12.2011		7.22355.01.0	EUV-SR	EL	
			7.06117.60.0	ZM-NWV	EL	mit Dichtring with O-ring
ML 500 4-matic (164.172) 285-320 kW (388-435 PS) M 273.963	12.2007→12.2011		7.22355.01.0	EUV-SR	EL	
			7.06117.60.0	ZM-NWV	EL	mit Dichtring with O-ring
ML 500 4-matic (164.175) 215-225 kW (292-306 PS) M 113.964	07.2005→12.2011		7.02256.37.0	EUV-SL	EL	
			7.22355.01.0	EUV-SR	EL	
ML 500 4-matic (164.175) 215-225 kW (292-306 PS) M 113.964	09.2005→12.2006		7.02256.37.0	EUV-SL	EL	
			7.22355.01.0	EUV-SR	EL	
ML 63 AMG 4-matic (164.177) 375 kW (510 PS) M 156.980	01.2006→12.2011		7.02256.37.0	EUV-SL	EL	
			7.22355.01.0	EUV-SR	EL	

M

					
M-CLASS (W164)					89
ML 63 AMG 4-matic (164.177) 375 kW (510 PS) M 156.980	09.2006→12.2011		7.22355.01.0 7.02256.37.0	EUV-SR EUV-SL	EL EL
M-CLASS (W166)					90
ML 250 CDI / BlueTEC 4-matic (166.004, 166.003) 150-152 kW (204-207 PS) OM 651.960	06.2011→12.2015		7.00782.12.0 7.02256.37.0 7.02256.37.0	DW-TL EUV-VB EUV-WP	EP EL EL
ML 320 4-matic (166.062) 200-325 kW (272-442 PS) M 276.821	11.2013→02.2015		7.00782.11.0 7.01870.06.0	DW-TL SUV	EP EL
ML 350 4-matic (166.057) 183-225 kW (249-306 PS) M 276.955	06.2011→12.2015		7.02288.01.0	EUV-SR	EL
ML 400 4-matic (166.056) 200-325 kW (272-442 PS) M 276.821	08.2013→02.2015		7.00782.11.0 7.01870.06.0	DW-TL SUV	EP EL
ML 500 4-matic (166.073) 270-335 kW (367-456 PS) M 278.928	02.2012→02.2015		7.00782.11.0	DW-TL	EP
ML 63 AMG 4-matic (166.074) 386-430 kW (525-585 PS) M 157.982	11.2011→02.2015		7.00782.11.0	DW-TL	EP
ML 63 AMG 4-matic (166.074) 386-430 kW (525-585 PS) M 157.982	11.2011→02.2015		7.00782.11.0	DW-TL	EP
PAGODE (W113)					91
280 SL (113.044) 125 kW (170 PS) M 130.983	01.1968→03.1971		7.21071.50.0	EUV-SR	EP
R-CLASS (W251, V251)					92
R 280 (251.054, 251.154) 170-180 kW (231-245 PS) M 272.945	01.2007→12.2014		7.22355.01.0 7.06117.60.0	EUV-SR ZM-NWV	EL EL mit Dichtring with O-ring
R 280 4-matic (251.062) 170-180 kW (231-245 PS) M 272.945	05.2007→12.2011		7.22355.01.0 7.06117.60.0	EUV-SR ZM-NWV	EL EL mit Dichtring with O-ring
R 300 (251.054, 251.154) 170-180 kW (231-245 PS) M 272.945	07.2009→12.2014		7.22355.01.0 7.06117.60.0	EUV-SR ZM-NWV	EL EL mit Dichtring with O-ring
R 300 (251.154) 170-180 kW (231-245 PS) M 272.945	01.2011→12.2014		7.06117.60.0	ZM-NWV	EL mit Dichtring with O-ring
R 300 4-matic (251.062) 170-180 kW (231-245 PS) M 272.945	07.2009→12.2011		7.22355.01.0 7.06117.60.0	EUV-SR ZM-NWV	EL EL mit Dichtring with O-ring



R-CLASS (W251, V251) 92

R 320 4-matic (251.163) 200-245 kW (272-333 PS) M 276.826	01.2014→10.2017		7.00782.11.0	DW-TL	EP	
			7.01870.06.0	SUV	EL	
R 350 (251.056, 251.156) 200 kW (272 PS) M 272.967	01.2007→12.2012		7.22355.01.0	EUV-SR	EL	
			7.06117.60.0	ZM-NWV	EL	mit Dichtring with O-ring
R 350 4-matic (251.065, 251.165) 200 kW (272 PS) M 272.967	08.2005→12.2012		7.22355.01.0	EUV-SR	EL	
			7.06117.60.0	ZM-NWV	EL	mit Dichtring with O-ring
R 400 4-matic (251.166) 200-270 kW (272-367 PS) M 276.825, M 276.826	01.2014→10.2017		7.00782.11.0	DW-TL	EP	
			7.01870.06.0	SUV	EL	
R 500 4-matic 218-225 kW (296-306 PS) M 113.971	01.2006→12.2006		7.02256.37.0	EUV-SL	EL	
			7.22355.01.0	EUV-SR	EL	
R 500 4-matic (251.072, 251.172) 285-320 kW (388-435 PS) M 273.963	05.2007→12.2014		7.22355.01.0	EUV-SR	EL	
			7.06117.60.0	ZM-NWV	EL	mit Dichtring with O-ring
R 500 4-matic (251.075, 251.175) 215-225 kW (292-306 PS) M 113.960	08.2005→12.2014		7.22355.01.0	EUV-SR	EL	
			7.02256.37.0	EUV-SL	EL	
R 500 4-matic (251.075, 251.175) 218-225 kW (296-306 PS) M 113.971	08.2005→12.2014		7.22355.01.0	EUV-SR	EL	
			7.22355.01.0	EUV-SR	EL	
R 63 AMG 4-matic (251.077, 251.177) 375 kW (510 PS) M 156.980	02.2006→12.2010		7.02256.37.0	EUV-SL	EL	
			7.22355.01.0	EUV-SR	EL	









M

S-CLASS (W116) 93

280 S (116.020) 115-118 kW (156-160 PS) M 110.922	08.1972→07.1980		7.21071.50.0	EUV-KA	EP	USA, Kanada USA, Kanada
			7.21071.50.0	EUV-KA	EP	USA, Kanada USA, Kanada
280 SE,SEL (116.024) 101-136 kW (137-185 PS) M 110.985	08.1972→07.1980		7.21071.50.0	UAV	EP	
			7.21071.50.0	UAV	EP	
280 SE,SEL (116.024) 130-136 kW (177-185 PS) M 110.983	08.1972→07.1980		7.21071.50.0	UAV	EP	
			7.21071.50.0	UAV	EP	
350 SE,SEL (116.028, 116.029) 147 kW (200 PS) M 116.983	08.1972→02.1976		7.21071.50.0	EUV-KA	EP	
			7.21071.50.0	EUV-SR	EP	
350 SE,SEL (116.028, 116.029) 143-152 kW (195-205 PS) M 116.985	03.1976→03.1980		7.21071.50.0	EUV-KA	EP	
			7.21071.50.0	EUV-SR	EP	



S-CLASS (W116) 93





350 SE,SEL (116.028, 116.029) 143-152 kW (195-205 PS) M 116.985	03.1976→03.1980		7.21071.50.0	EUV-KA	EP
			7.21071.50.0	EUV-SR	EP
450 SE 119-165 kW (162-224 PS) M 117.983	01.1973→12.1976		7.21071.50.0	EUV-LS	EP
			7.21071.50.0	EUV-LS	EP
450 SE, SEL (116.033)	09.1974→12.1979		7.21071.50.0	EUV-KA	EP
			7.21071.50.0	EUV-LS	EP
450 SE,SEL (116.032) 119-165 kW (162-224 PS) M 117.983, M 117.986	01.1973→04.1980		7.21071.50.0	EUV-KA	EP
			7.21071.50.0	EUV-LS	EP
450 SE,SEL (116.033) 119-165 kW (162-224 PS) M 117.983, M 117.986	12.1975→04.1980		7.21071.50.0	EUV-KA	EP
			7.21071.50.0	EUV-LS	EP
450 SEL (116.033) 119-165 kW (162-224 PS) M 117.983	09.1979→07.1980		7.21071.50.0	EUV-KA	EP
			7.21071.50.0	EUV-LS	EP
450 SEL (116.036)	09.1976→12.1979		7.21071.50.0	EUV-KA	EP
			7.21071.50.0	EUV-LS	EP
450 SEL 6.9 (116.036) 186-210 kW (252-286 PS) M 100.985	07.1975→03.1980		7.21071.50.0	EUV-KA	EP
			7.21071.50.0	EUV-LS	EP

M

S-CLASS (W126) 94







280 SE, SEL (126.022, 126.023) 136 kW (185 PS) M 110.987, M 110.989	10.1979→07.1985		7.21071.50.0	EUV-LS	EP
--	-----------------	---	---------------------	--------	----

S-CLASS (W140) 95









300 SE 2.8 (140.028) 142-145 kW (193-197 PS) M 104.944	01.1993→10.1998		7.21071.50.0	EUV-LS	EP
			7.21071.50.0	EUV-SL	EP
			7.06117.20.0	ZM-NWV	EL
300 SE, SEL/S320 (140.032, 140.033) 162-170 kW (220-231 PS) M 104.990, M 104.994	03.1991→10.1998		7.21071.50.0	EUV-LS	EP
			7.21071.50.0	EUV-SL	EP
			7.06117.20.0	ZM-NWV	EL
400 SE, SEL/S420 (140.042, 140.043) 205-214 kW (279-291 PS) M 119.971	02.1991→10.1998		7.21071.50.0	EUV-LS	EP
			7.06117.20.0	ZM-NWV	EL
			7.21071.50.0	EUV-LS	EP
500 SE, SEL (140.050, 140.051) 235-240 kW (320-326 PS) M 119.970	02.1991→10.1998		7.21071.50.0	EUV-LS	EP
			7.06117.20.0	ZM-NWV	EL
			7.21071.50.0	EUV-LS	EP
600 SE, SEL (140.056, 140.057) 270-300 kW (394-408 PS) M 120.980, M 120.982	04.1991→12.1992		7.21071.50.0	EUV-LS	EP
			7.21071.50.0	EUV-LS	EP

















S-CLASS (W140) 95

S 280 (140.028) 142-145 kW (193-197 PS) M 104.944	02.1993→10.1998		7.21071.50.0	EUV-LS	EP
			7.21071.50.0 7.06117.20.0	EUV-SL ZM-NWV	EP EL
S 350 Turbo-D (140.134) 100-110 kW (136-150 PS) OM 603.971	01.1993→10.1998		7.21071.50.0	EUV-LS	EP
S 420 (140.042) 205-214 kW (279-291 PS) M 119.971	01.1993→10.1998		7.21071.50.0 7.06117.20.0	EUV-LS ZM-NWV	EP EL
S 500 (140.050, 140.051) 235-240 kW (320-326 PS) M 119.970	01.1993→10.1998		7.06117.20.0	ZM-NWV	EL
S 500 (140.050, 140.051) 235 kW (320 PS) M 119.980	01.1993→10.1998		7.21071.50.0	EUV-LS	EP
S 600 (140.056, 140.057) 270-300 kW (394-408 PS) M 120.980, M 120.982	01.1993→10.1998		7.21071.50.0	EUV-LS	EP
			7.06117.20.0	ZM-NWV	EL

S-CLASS (W220) 96

370 180 kW (245 PS) M 112.972	09.2002→08.2005		7.22355.01.0	EUV-SR	EL
S 280 (220.063, 220.163) 150 kW (204 PS) M 112.922	10.1998→08.2005		7.02256.37.0	EUV-SL	EL
			7.22355.01.0	EUV-SR	EL
S 320 (220.065, 220.165) 165 kW (224 PS) M 112.944	10.1998→08.2005		7.02256.37.0	EUV-SL	EL
			7.22355.01.0	EUV-SR	EL
S 350 (220.067, 220.167) 180 kW (245 PS) M 112.972	09.2002→08.2005		7.02256.37.0	EUV-SL	EL
			7.22355.01.0	EUV-SR	EL
S 350 4-matic (220.087, 220.187) 180 kW (245 PS) M 112.975	06.2003→08.2005		7.02256.37.0	EUV-SL	EL
			7.22355.01.0	EUV-SR	EL
S 430 (220.070, 220.170) 205 kW (279 PS) M 113.941	10.1998→08.2005		7.02256.37.0	EUV-SL	EL
			7.22355.01.0	EUV-SR	EL
S 430 4-matic (220.083, 220.183) 205 kW (279 PS) M 113.948	09.2002→08.2005		7.02256.37.0	EUV-SL	EL
			7.22355.01.0	EUV-SR	EL
S 500 (220.075, 220.175, 220.875) 215-225 kW (292-306 PS) M 113.960, M 113.966	10.1998→08.2005		7.02256.37.0	EUV-SL	EL
			7.22355.01.0	EUV-SR	EL
S 500 (220.075, 220.175, 220.875) 215-225 kW (292-306 PS) M 113.960	10.1998→12.2003		7.02256.37.0	EUV-SL	EL
			7.22355.01.0	EUV-SR	EL

M

						
S-CLASS (W220)						96
S 500 4-matic (220.084, 220.184) 225 kW (306 PS) M 113.966	09.2002→08.2005		7.02256.37.0	EUV-SL	EL	
			7.22355.01.0	EUV-SR	EL	
S 55 AMG (220.073, 220.173) 265 kW (360 PS) M 113.986	04.1999→08.2005		7.02256.37.0	EUV-SL	EL	
			7.22355.01.0	EUV-SR	EL	
S 55 AMG Kompressor (220.074, 220.174) 349-368 kW (475-500 PS) M 113.991	06.2002→08.2005		7.02256.37.0	EUV-SL	EL	
S 600 (220.176) 368 kW (500 PS) M 275.950	09.2002→08.2005		7.00017.02.0	EUV-LS	EP	
			7.02256.37.0	EUV-SL	EL	
S 65 AMG (220.179) 450 kW (612 PS) M 275.980	03.2004→08.2005		7.02256.37.0	EUV-SL	EL	
			7.01003.01.0	LDRV	EL	
S-CLASS (W221)						97
S 250 CDI (221.003, 221.103) 150 kW (204 PS) OM 651.961	01.2011→12.2013		7.00782.12.0	DW-TL	EP	
			7.02256.37.0	EUV-VB	EL	
			7.02256.37.0	EUV-WP	EL	
S 280 (221.054) 170-180 kW (231-245 PS) M 272.946	08.2006→12.2013		7.22355.01.0	EUV-SR	EL	
			7.06117.60.0	ZM-NWV	EL mit Dichtring with O-ring	
S 300 (221.054, 221.154) 170-180 kW (231-245 PS) M 272.946	08.2006→12.2013		7.22355.01.0	EUV-SR	EL	
			7.06117.60.0	ZM-NWV	EL mit Dichtring with O-ring	
S 300 (221.154) 170-180 kW (231-245 PS) M 272.946	04.2012→12.2013		7.06117.60.0	ZM-NWV	EL mit Dichtring with O-ring	
S 350 (221.056, 221.156) 200 kW (272 PS) M 272.965	10.2005→12.2013		7.22355.01.0	EUV-SR	EL	
			7.06117.60.0	ZM-NWV	EL mit Dichtring with O-ring	
S 350 4-matic (221.087, 221.187) 200 kW (272 PS) M 272.975	02.2008→12.2013		7.22355.01.0	EUV-SR	EL	
			7.06117.60.0	ZM-NWV	EL mit Dichtring with O-ring	
S 400 4-matic 250 kW (340 PS) M 273.924	09.2008→12.2009		7.22355.01.0	EUV-SR	EL	
			7.06117.60.0	ZM-NWV	EL mit Dichtring with O-ring	
S 400 Hybrid (221.095, 221.195) 200-205 kW (272-279 PS) M 272.974	01.2009→12.2013		7.22355.01.0	EUV-SR	EL	
			7.06117.60.0	ZM-NWV	EL mit Dichtring with O-ring	
S 450 (221.070, 221.170) 250 kW (340 PS) M 273.922	12.2005→12.2013		7.22355.01.0	EUV-SR	EL	

M



S-CLASS (W221)

97

			7.06117.60.0	ZM-NWV	EL	mit Dichtring with O-ring
S 450 4-matic (221.084, 221.184) 250 kW (340 PS) M 273.924	12.2005→12.2013		7.22355.01.0	EUV-SR	EL	
			7.06117.60.0	ZM-NWV	EL	mit Dichtring with O-ring
S 500 271-285 kW (369-388 PS) M 273.961	05.2011→12.2013		7.22355.01.0	EUV-SR	EL	
			7.06117.60.0	ZM-NWV	EL	mit Dichtring with O-ring
S 500 (221.071, 221.171) 271-285 kW (369-388 PS) M 273.961	10.2005→12.2013		7.22355.01.0	EUV-SR	EL	
			7.06117.60.0	ZM-NWV	EL	mit Dichtring with O-ring
S 500 4-matic (221.086, 221.186) 271-285 kW (369-388 PS) M 273.961	10.2005→12.2013		7.22355.01.0	EUV-SR	EL	
S 500 4-matic (221.086, 221.186) 285 kW (388 PS) M 273.968	10.2005→12.2013		7.22355.01.0	EUV-SR	EL	
			7.06117.60.0	ZM-NWV	EL	mit Dichtring with O-ring
S 500 CGI (221.073, 221.173) 320 kW (435 PS) M 278.932	04.2011→12.2013		7.00782.11.0	DW-TL	EP	
			7.02256.37.0	EUV-AGK	EL	
S 500 CGI 4-matic (221.094, 221.194) 320 kW (435 PS) M 278.932	03.2011→12.2013		7.00782.11.0	DW-TL	EP	
			7.02256.37.0	EUV-AGK	EL	
S 550 (221.073, 221.173) 320 kW (435 PS) M 278.932	09.2011→12.2013		7.00782.11.0	DW-TL	EP	
			7.00782.11.0	DW-TL	EP	
S 550 4-matic (221.094, 221.194) 320 kW (435 PS) M 278.932	09.2011→12.2013		7.00782.11.0	DW-TL	EP	
			7.00782.11.0	DW-TL	EP	
S 600 (221.176) 380 kW (517 PS) M 275.953	12.2005→12.2013		7.00017.02.0	EUV-LS	EP	
			7.02256.37.0	EUV-SL	EL	
S 63 AMG (221.074, 221.174) 386-420 kW (525-571 PS) M 157.980	03.2011→12.2013		7.00782.11.0	DW-TL	EP	
			7.00782.11.0	DW-TL	EP	
S 63 AMG (221.074, 221.174) 386-420 kW (525-571 PS) M 157.980	02.2012→12.2013		7.00782.11.0	DW-TL	EP	
			7.00782.11.0	DW-TL	EP	
S 63 AMG (221.077, 221.177) 386 kW (525 PS) M 156.984	10.2006→12.2013		7.02256.37.0	EUV-SL	EL	
			7.22355.01.0	EUV-SR	EL	
S 65 AMG (221.179) 450-463 kW (612-630 PS) M 275.982	12.2005→12.2013		7.02256.37.0	EUV-SL	EL	
			7.02256.37.0	EUV-SL	EL	
S 65 AMG (221.179) 450-463 kW (612-630 PS) M 275.982	10.2010→12.2013		7.01003.01.0	LDRV	EL	
			7.02256.37.0	EUV-SL	EL	
			7.01003.01.0	LDRV	EL	

M



S-CLASS (W222, V222, X222)

98













AMG S 63 (222.187) 350-470 kW (476-639 PS) M 177.980	05.2017→		7.00782.16.0	DW-TL	EP	
			7.04927.08.0	SUV	EL	Luftfiltergehäuse Air Filter Housing
AMG S 63 4-matic+ (222.188) 350-470 kW (476-639 PS) M 177.980	05.2017→		7.00782.16.0	DW-TL	EP	
			7.04927.08.0	SUV	EL	Luftfiltergehäuse Air Filter Housing
S 300 BlueTEC Hybrid / h (222.004, 222.104) 100-150 kW (136-204 PS) OM 651.921	02.2014→05.2017		7.00782.12.0	DW-TL	EP	
			7.02256.37.0	EUV-VB	EL	
			7.02256.37.0	EUV-WP	EL	
S 300 BlueTEC Hybrid / h (222.104) 100-150 kW (136-204 PS) OM 651.921	02.2014→05.2017		7.00782.12.0	DW-TL	EP	
			7.02256.37.0	EUV-VB	EL	
			7.02256.37.0	EUV-WP	EL	
S 320 (222.162) 200-350 kW (272-476 PS) M 276.824	05.2014→		7.00782.11.0	DW-TL	EP	
			7.02256.37.0	EUV-AGK	EL	
			7.01870.06.0	SUV	EL	
S 350 L (222.155) 200-350 kW (272-476 PS) M 276.824	09.2017→		7.00782.11.0	DW-TL	EP	
			7.02256.37.0	EUV-AGK	EL	
			7.01870.06.0	SUV	EL	
S 350 d (222.020, 222.120) 183-250 kW (249-340 PS) OM 656.929	07.2017→		7.02256.37.0	EUV-AGR	EL	Produktionsdatum bis: 14.12.2020 Production date to: 14.12.2020
			7.02256.37.0	EUV-WP	EL	Produktionsdatum bis: 14.12.2020 Production date to: 14.12.2020
S 350 d 4-matic (222.021, 222.121) 183-250 kW (249-340 PS) OM 656.929	05.2017→		7.02256.37.0	EUV-AGR	EL	Produktionsdatum bis: 14.12.2020 Production date to: 14.12.2020
			7.02256.37.0	EUV-WP	EL	Produktionsdatum bis: 14.12.2020 Production date to: 14.12.2020
S 350 d 4-matic (222.121) 183-250 kW (249-340 PS) OM 656.929	07.2018→		7.02256.37.0	EUV-AGR	EL	Produktionsdatum bis: 14.12.2020 Production date to: 14.12.2020
			7.02256.37.0	EUV-WP	EL	Produktionsdatum bis: 14.12.2020 Production date to: 14.12.2020
S 400 (222.165) 200-350 kW (272-476 PS) M 276.824	03.2014→05.2017		7.00782.11.0	DW-TL	EP	
			7.02256.37.0	EUV-AGK	EL	
			7.01870.06.0	SUV	EL	
S 400 4-matic (222.067, 222.167) 200-350 kW (272-476 PS) M 276.824	11.2014→05.2017		7.00782.11.0	DW-TL	EP	
			7.02256.37.0	EUV-AGK	EL	
			7.01870.06.0	SUV	EL	
S 400 Maybach 4-matic (222.967) 200-350 kW (272-476 PS) M 276.824	01.2015→05.2017		7.00782.11.0	DW-TL	EP	

M



S-CLASS (W222, V222, X222)











98

			7.02256.37.0	EUV-AGK	EL	
			7.01870.06.0	SUV	EL	
S 400 d (222.034, 222.134) 183-250 kW (249-340 PS) OM 656.929	07.2017→		7.02256.37.0	EUV-AGR	EL	Produktionsdatum bis: 14.12.2020 Production date to: 14.12.2020
			7.02256.37.0	EUV-WP	EL	Produktionsdatum bis: 14.12.2020 Production date to: 14.12.2020
S 400 d 4-matic (222.035, 222.135) 183-250 kW (249-340 PS) OM 656.929	05.2017→		7.02256.37.0	EUV-AGR	EL	Produktionsdatum bis: 14.12.2020 Production date to: 14.12.2020
			7.02256.37.0	EUV-WP	EL	Produktionsdatum bis: 14.12.2020 Production date to: 14.12.2020
S 450 (222.066, 222.166) 200-350 kW (272-476 PS) M 276.824	02.2017→		7.00782.11.0	DW-TL	EP	
			7.02256.37.0	EUV-AGK	EL	
			7.01870.06.0	SUV	EL	
S 450 4-matic (222.064, 222.164, 222.964) 200-350 kW (272-476 PS) M 276.824	02.2017→		7.00782.11.0	DW-TL	EP	
			7.02256.37.0	EUV-AGK	EL	
			7.01870.06.0	SUV	EL	
S 450 Maybach 4-matic (222.964) 200-350 kW (272-476 PS) M 276.824	09.2017→		7.00782.11.0	DW-TL	EP	
			7.02256.37.0	EUV-AGK	EL	
			7.01870.06.0	SUV	EL	
S 500 (222.082, 222.182) 320-338 kW (435-460 PS) M 278.929	05.2013→05.2017		7.00782.11.0	DW-TL	EP	
			7.02256.37.0	EUV-AGK	EL	
S 500 (222.082, 222.182) 320-338 kW (435-460 PS) M 278.929	09.2013→05.2017		7.00782.11.0	DW-TL	EP	
			7.02256.37.0	EUV-AGK	EL	
S 500 (222.182) 320-338 kW (435-460 PS) M 278.929	06.2014→05.2017		7.00782.11.0	DW-TL	EP	
			7.02256.37.0	EUV-AGK	EL	
S 500 4-matic (222.085, 222.185) 320-338 kW (435-460 PS) M 278.929	05.2013→05.2017		7.00782.11.0	DW-TL	EP	
			7.02256.37.0	EUV-AGK	EL	
S 500 4-matic (222.185) 320-338 kW (435-460 PS) M 278.929	09.2013→05.2017		7.00782.11.0	DW-TL	EP	
			7.02256.37.0	EUV-AGK	EL	
S 500 Hybrid / e (222.163) 200-350 kW (272-476 PS) M 276.824	07.2014→05.2017		7.00782.11.0	DW-TL	EP	
			7.02256.37.0	EUV-AGK	EL	
			7.01870.06.0	SUV	EL	
S 500 L 4-matic (222.184) 310 kW (422 PS) M 278.910	02.2014→05.2017		7.00782.11.0	DW-TL	EP	
			7.02256.37.0	EUV-AGK	EL	





















M











S-CLASS (W222, V222, X222) 98

S 500 Maybach (222.982) 320-338 kW (435-460 PS) M 278.929	12.2014→05.2017		7.00782.11.0	DW-TL	EP	
			7.02256.37.0	EUV-AGK	EL	
S 500 Maybach (222.982) 320-338 kW (435-460 PS) M 278.929	12.2014→05.2017		7.00782.11.0	DW-TL	EP	
			7.02256.37.0	EUV-AGK	EL	
S 500 Maybach 4-matic (222.984) 310 kW (422 PS) M 278.910	09.2015→05.2017		7.00782.11.0	DW-TL	EP	
			7.02256.37.0	EUV-AGK	EL	
S 500 Maybach 4-matic (222.985) 320-338 kW (435-460 PS) M 278.929	04.2015→05.2017		7.00782.11.0	DW-TL	EP	
			7.02256.37.0	EUV-AGK	EL	
S 560 (222.083, 222.183) 310-390 kW (422-530 PS) M 176.980	07.2017→		7.00782.11.0	DW-TL	EP	Fahrgestellnummer bis: 30049198 Vehicle Identification Number to: 30049198 Produktionsdatum bis: 01.08.2019 Production date to: 01.08.2019
			7.04927.08.0	SUV	EL	Ladeluftkühler Intercooler
S 560 4-matic (222.086, 222.186) 310-390 kW (422-530 PS) M 176.980	05.2017→		7.00782.11.0	DW-TL	EP	Fahrgestellnummer bis: 30049198 Vehicle Identification Number to: 30049198 Produktionsdatum bis: 01.08.2019 Production date to: 01.08.2019
			7.04927.08.0	SUV	EL	Ladeluftkühler Intercooler
S 560 Maybach (222.983) 310-390 kW (422-530 PS) M 176.980	07.2017→		7.00782.11.0	DW-TL	EP	Fahrgestellnummer bis: 30049198 Vehicle Identification Number to: 30049198 Produktionsdatum bis: 01.08.2019 Production date to: 01.08.2019
			7.04927.08.0	SUV	EL	Ladeluftkühler Intercooler
S 560 Maybach 4-matic (222.986) 310-390 kW (422-530 PS) M 176.980	07.2017→		7.00782.11.0	DW-TL	EP	Fahrgestellnummer bis: 30049198 Vehicle Identification Number to: 30049198 Produktionsdatum bis: 01.08.2019 Production date to: 01.08.2019
			7.04927.08.0	SUV	EL	Ladeluftkühler Intercooler
S 560 e (222.173) 200-350 kW (272-476 PS) M 276.824	10.2018→		7.00782.11.0	DW-TL	EP	
			7.02256.37.0	EUV-AGK	EL	
			7.01870.06.0	SUV	EL	
S 560 e (222.173) 200-350 kW (272-476 PS) M 276.824	10.2018→		7.00782.11.0	DW-TL	EP	
			7.02256.37.0	EUV-AGK	EL	
			7.01870.06.0	SUV	EL	
S 600 (222.176) 390 kW (530 PS) M 277.980	02.2014→		7.02256.37.0	EUV-SR	EL	
S 600 Maybach (222.976) 390 kW (530 PS) M 277.980	12.2014→11.2018		7.02256.37.0	EUV-SR	EL	
S 63 AMG (222.077) 430-435 kW (585-591 PS) M 157.985	01.2014→05.2017		7.00782.11.0	DW-TL	EP	

M







						
S-CLASS (W222, V222, X222)						98
S 63 AMG (222.077, 222.177) 430-435 kW (585-591 PS) M 157.985	05.2013→05.2017		7.00782.11.0	DW-TL	EP	
S 63 AMG 4-matic (222.178) 430-435 kW (585-591 PS) M 157.985	05.2013→05.2017		7.00782.11.0	DW-TL	EP	
S 65 AMG (222.179) 463 kW (630 PS) M 279.980	02.2014→		7.02256.37.0	EUV-SL	EL	
S 650 Maybach (222.980) 463 kW (630 PS) M 279.980	07.2017→		7.02256.37.0	EUV-SL	EL	
S-CLASS (W223)						99
S 350 d (223.030) 183-250 kW (249-340 PS) OM 656.929	09.2020→		7.02256.37.0	EUV-AGR	EL	Produktionsdatum bis: 14.12.2020 Production date to: 14.12.2020
			7.02256.37.0	EUV-WP	EL	Produktionsdatum bis: 14.12.2020 Production date to: 14.12.2020
S 350 d 4-matic (223.031) 183-250 kW (249-340 PS) OM 656.929	09.2020→		7.02256.37.0	EUV-AGR	EL	Produktionsdatum bis: 14.12.2020 Production date to: 14.12.2020
			7.02256.37.0	EUV-WP	EL	Produktionsdatum bis: 14.12.2020 Production date to: 14.12.2020
S 400 d 4-matic (223.033) 183-250 kW (249-340 PS) OM 656.929	09.2020→		7.02256.37.0	EUV-AGR	EL	Produktionsdatum bis: 14.12.2020 Production date to: 14.12.2020
			7.02256.37.0	EUV-WP	EL	Produktionsdatum bis: 14.12.2020 Production date to: 14.12.2020
S-CLASS Convertible (A217)						100
AMG S 63 (217.477) 430-435 kW (585-591 PS) M 157.985	02.2016→10.2017		7.00782.11.0	DW-TL	EP	
AMG S 63 (217.487) 350-470 kW (476-639 PS) M 177.980	12.2018→		7.00782.16.0	DW-TL	EP	
AMG S 63 4-matic (217.478) 430-435 kW (585-591 PS) M 157.985	12.2015→10.2017		7.00782.11.0	DW-TL	EP	
AMG S 63 4-matic+ (217.488) 350-470 kW (476-639 PS) M 177.980	10.2017→		7.00782.16.0	DW-TL	EP	
			7.04927.08.0	SUV	EL	Luftfiltergehäuse Air Filter Housing
AMG S 65 (217.479) 463 kW (630 PS) M 279.980	04.2016→05.2019		7.02256.37.0	EUV-SL	EL	
S 500 (217.482) 320-338 kW (435-460 PS) M 278.929	12.2015→10.2017		7.00782.11.0	DW-TL	EP	
S 560 (217.483) 310-390 kW (422-530 PS) M 176.980	10.2017→08.2020		7.00782.11.0	DW-TL	EP	Fahrgestellnummer bis: 30049198 Vehicle Identification Number to: 30049198 Produktionsdatum bis: 01.08.2019 Production date to: 01.08.2019
			7.04927.08.0	SUV	EL	Ladeluftkühler Intercooler
S 650 Maybach (217.479) 463 kW (630 PS) M 279.980	08.2017→		7.02256.37.0	EUV-SL	EL	

M







						
S-CLASS Coupe (C140)						101
500 SEC / CL 500 (140.070) 235 kW (320 PS) M 119.980	10.1992→12.1999		7.21071.50.0	EUV-LS	EP	
SEC/CL 420 (140.063) 205-214 kW (279-291 PS) M 119.971	10.1994→02.1999		7.21071.50.0	EUV-LS	EP	
			7.06117.20.0	ZM-NWV	EL	
SEC/CL 420 (140.063) 205 kW (279 PS) M 119.981	10.1994→02.1999		7.21071.50.0	EUV-LS	EP	
SEC/CL 600 (140.076) 270-300 kW (394-408 PS) M 120.980, M 120.982	09.1992→02.1999		7.21071.50.0	EUV-LS	EP	
			7.06117.20.0	ZM-NWV	EL	
S-CLASS Coupe (C215)						102
CL 500 (215.375) 215-225 kW (292-306 PS) M 113.960	03.1999→03.2006		7.02256.37.0	EUV-SL	EL	
			7.22355.01.0	EUV-SR	EL	
CL 500 (215.375) 215-225 kW (292-306 PS) M 113.960	09.2004→12.2005		7.02256.37.0	EUV-SL	EL	
			7.22355.01.0	EUV-SR	EL	
CL 55 AMG 349-368 kW (475-500 PS) M 113.991	09.2003→12.2005		7.02256.37.0	EUV-SL	EL	
CL 55 AMG 349-368 kW (475-500 PS) M 113.991	09.2003→08.2006		7.02256.37.0	EUV-SL	EL	
CL 55 AMG (215.373) 265 kW (360 PS) M 113.986	10.1999→03.2006		7.02256.37.0	EUV-SL	EL	
			7.22355.01.0	EUV-SR	EL	
CL 55 AMG Kompressor (215.374) 349-368 kW (475-500 PS) M 113.991	06.2002→03.2006		7.02256.37.0	EUV-SL	EL	
CL 600 (215.376) 368 kW (500 PS) M 275.950	09.2002→03.2006		7.00017.02.0	EUV-LS	EP	
			7.02256.37.0	EUV-SL	EL	
CL 65 AMG (215.379) 450 kW (612 PS) M 275.980	09.2003→03.2006		7.02256.37.0	EUV-SL	EL	
			7.01003.01.0	LDRV	EL	
S-CLASS Coupe (C216)						103
CL 500 (216.371) 271-285 kW (369-388 PS) M 273.961	06.2006→12.2013		7.22355.01.0	EUV-SR	EL	
			7.06117.60.0	ZM-NWV	EL	mit Dichtring with O-ring
CL 500 (216.373) 320 kW (435 PS) M 278.920	02.2011→12.2013		7.00782.11.0	DW-TL	EP	
CL 500 4-matic (216.386) 285 kW (388 PS) M 273.968	02.2008→12.2013		7.22355.01.0	EUV-SR	EL	
			7.06117.60.0	ZM-NWV	EL	mit Dichtring with O-ring
CL 500 4-matic (216.394) 320 kW (435 PS) M 278.920	02.2011→12.2013		7.00782.11.0	DW-TL	EP	



S-CLASS Coupe (C216) 103

CL 600 (216.376) 380 kW (517 PS) M 275.953	05.2006→12.2013		7.00017.02.0	EUV-LS	EP
			7.02256.37.0	EUV-SL	EL
CL 63 AMG (216.374) 386-420 kW (525-571 PS) M 157.980	01.2010→12.2013		7.00782.11.0	DW-TL	EP
CL 63 AMG (216.374) 386-420 kW (525-571 PS) M 157.980	02.2011→12.2013		7.00782.11.0	DW-TL	EP
CL 63 AMG (216.377) 386 kW (525 PS) M 156.984	10.2006→12.2013		7.02256.37.0	EUV-SL	EL
			7.22355.01.0	EUV-SR	EL
CL 63 AMG (216.377) 386 kW (525 PS) M 156.984	09.2007→12.2011		7.02256.37.0	EUV-SL	EL
CL 65 AMG (216.379) 450-463 kW (612-630 PS) M 275.982	10.2006→12.2010		7.02256.37.0	EUV-SL	EL
			7.01003.01.0	LDRV	EL
CL 65 AMG (216.379) 450-463 kW (612-630 PS) M 275.982	02.2011→12.2013		7.02256.37.0	EUV-SL	EL
			7.01003.01.0	LDRV	EL







S-CLASS Coupe (C217) 104

S 400 4-matic (217.364) 200-350 kW (272-476 PS) M 276.824	10.2015→		7.00782.11.0	DW-TL	EP
			7.02256.37.0	EUV-AGK	EL
			7.01870.06.0	SUV	EL
S 450 4-matic (217.364) 200-350 kW (272-476 PS) M 276.824	10.2017→		7.00782.11.0	DW-TL	EP
			7.02256.37.0	EUV-AGK	EL
			7.01870.06.0	SUV	EL
S 500 (217.382) 320-338 kW (435-460 PS) M 278.929	11.2014→10.2017		7.00782.11.0	DW-TL	EP
			7.02256.37.0	EUV-AGK	EL
S 500 4-matic (217.384) 310 kW (422 PS) M 278.910	11.2014→10.2017		7.00782.11.0	DW-TL	EP
			7.02256.37.0	EUV-AGK	EL
S 500 4-matic (217.385) 320-338 kW (435-460 PS) M 278.929	04.2014→10.2017		7.00782.11.0	DW-TL	EP
			7.02256.37.0	EUV-AGK	EL
S 560 (217.383) 310-390 kW (422-530 PS) M 176.980	10.2017→		7.00782.11.0	DW-TL	EP
			7.04927.08.0	SUV	EL
S 560 4-matic (217.386) 310-390 kW (422-530 PS) M 176.980	10.2017→		7.00782.11.0	DW-TL	EP
					Fahrgestellnummer bis: 30049198 Vehicle Identification Number to: 30049198 Produktionsdatum bis: 01.08.2019 Production date to: 01.08.2019 Ladeluftkühler Intercooler

M



S-CLASS Coupe (C217) 104





			7.04927.08.0	SUV	EL	Ladeluftkühler Intercooler
S 63 AMG (217.377) 430-435 kW (585-591 PS) M 157.985	07.2014→10.2017		7.00782.11.0	DW-TL	EP	
S 63 AMG (217.387) 350-470 kW (476-639 PS) M 177.980	12.2018→		7.00782.16.0	DW-TL	EP	
S 63 AMG 4-matic (217.378) 430-435 kW (585-591 PS) M 157.985	04.2014→10.2017		7.00782.11.0	DW-TL	EP	
S 63 AMG 4-matic+ (217.388) 350-470 kW (476-639 PS) M 177.980	10.2017→		7.00782.16.0	DW-TL	EP	
			7.04927.08.0	SUV	EL	Luftfiltergehäuse Air Filter Housing
S 65 AMG (217.379) 463 kW (630 PS) M 279.980	07.2014→05.2019		7.02256.37.0	EUV-SL	EL	

S-CLASS Saloon (W108, W109) 105

M

280 S (108.016) 103 kW (140 PS) M 130.920	10.1967→07.1972		7.21071.50.0	EUV-SR	EP	
280 SE 4.5 (108.067) 131-142 kW (178-193 PS) M 117.984	09.1971→08.1972		7.21071.50.0	EUV-SR	EP	USA, Kanada USA, Kanada
280 SE,SEL (108.018, 108.019) 118 kW (160 PS) M 130.980	01.1968→08.1972		7.21071.50.0	EUV-SR	EP	
280 SE,SEL 3.5 (108.057, 108.058) 147 kW (200 PS) M 116.980	03.1971→08.1972		7.21071.50.0	EUV-SR	EP	
280 SEL 4.5 (108.068) 131-142 kW (178-193 PS) M 117.984	09.1971→08.1972		7.21071.50.0	EUV-SR	EP	
300 SEL (109.016) 118 kW (160 PS) M 130.981	01.1968→08.1972		7.21071.50.0	EUV-SR	EP	
300 SEL 3.5 (109.056) 147 kW (200 PS) M 116.981	01.1970→07.1972		7.21071.50.0	EUV-SR	EP	

SL (R107) 106









280 SL (107.042) 130-136 kW (177-185 PS) M 110.986	08.1974→07.1985		7.21071.50.0	EUV-LS	EP	
280 SL (107.042) 130-136 kW (177-185 PS) M 110.982	06.1976→09.1981		7.21071.50.0	UAV	EP	
300 SL (107.041) 132-138 kW (180-188 PS) M 103.982	09.1985→08.1989		7.21071.50.0	EUV-LS	EP	
300 SL (107.041) 132-138 kW (180-188 PS) M 103.982	09.1985→08.1989		7.21071.50.0	EUV-LS	EP	
350 SL (107.043) 143-147 kW (194-200 PS) M 116.982	05.1971→02.1980		7.21071.50.0	EUV-LS	EP	
350 SL (107.043) 143-147 kW (194-200 PS) M 116.982	05.1971→12.1976		7.21071.50.0	EUV-LS	EP	

						
SL (R107)						106
380 SL (107.045) 160 kW (218 PS) M 116.960	09.1980→08.1981		7.21071.50.0	EUV-LS	EP	
380 SL (107.045) 116-150 kW (158-204 PS) M 116.962	09.1980→08.1985		7.21071.50.0	EUV-LS	EP	
420 SL (107.047) 150-160 kW (204-218 PS) M 116.964	01.1986→08.1989		7.21071.50.0	EUV-LS	EP	
420 SL (107.047) 150-160 kW (204-218 PS) M 116.964	01.1986→08.1989		7.21071.50.0	EUV-LS	EP	
450 SL (107.044) 119-165 kW (162-225 PS) M 117.982, M 117.985	10.1972→10.1980		7.21071.50.0	EUV-LS	EP	
450 SL (107.044) 119-165 kW (162-225 PS) M 117.982, M 117.985	09.1975→10.1980		7.21071.50.0	EUV-LS	EP	
450 SL (107.044) 119-165 kW (162-225 PS) M 117.985	09.1979→12.1980		7.21071.50.0	EUV-LS	EP	
500 SL (107.046) 170-180 kW (231-245 PS) M 117.960, M 117.962	05.1980→12.1985		7.21071.50.0	EUV-LS	EP	
500 SL (107.046) 170-180 kW (231-245 PS) M 117.960	05.1980→12.1981		7.21071.50.0	EUV-LS	EP	
500 SL (107.046) 164-180 kW (223-245 PS) M 117.964	01.1986→08.1989		7.21071.50.0	EUV-LS	EP	
500 SL (107.046) 164-180 kW (223-245 PS) M 117.960, M 117.964	01.1986→08.1989		7.21071.50.0	EUV-LS	EP	
560 SL (107.048) 169-178 kW (230-242 PS) M 117.967	09.1985→12.1989		7.21071.50.0	EUV-LS	EP	
SL (R129)						107
280 (129.058) 142-150 kW (193-204 PS) M 104.943	08.1993→10.2001		7.21071.50.0	EUV-AGR	EP	
			7.21071.50.0	EUV-SL	EP	
			7.06117.20.0	ZM-NWV	EL	
280 (129.059) 150 kW (204 PS) M 112.923	05.1998→10.2001		7.21071.50.0	EUV-AGR	EP	
			7.02256.37.0	EUV-SL	EL	
			7.22355.01.0	EUV-SR	EL	
300 SL (129.060) 140 kW (190 PS) M 103.984	03.1989→08.1993		7.21071.50.0	EUV-LS	EP	
300 SL-24 (129.061) 170 kW (231 PS) M 104.981	03.1989→07.1993		7.21071.50.0	EUV-LS	EP	
			7.06117.20.0	ZM-NWV	EL	
320 (129.063) 162-170 kW (220-231 PS) M 104.991	09.1993→10.2001		7.21071.50.0	EUV-LS	EP	
			7.21071.50.0	EUV-SL	EP	
			7.06117.20.0	ZM-NWV	EL	
320 (129.064) 165 kW (224 PS) M 112.943	05.1998→10.2001		7.21071.50.0	EUV-AGR	EP	
			7.02256.37.0	EUV-SL	EL	

M









SL (R129) 107

			7.22355.01.0	EUV-SR	EL	
500 (129.067) 235-240 kW (320-326 PS) M 119.972	09.1992→10.2001		7.21071.50.0	EUV-AGR	EP	
			7.06117.20.0	ZM-NWV	EL	
500 (129.067) 235 kW (320 PS) M 119.982	09.1992→10.2001		7.21071.50.0	EUV-LS	EP	
500 (129.068) 225 kW (306 PS) M 113.961	05.1998→10.2001		7.21071.50.0	EUV-AGR	EP	
			7.02256.37.0	EUV-SL	EL	
			7.22355.01.0	EUV-SR	EL	
500 SL (129.066) 235-240 kW (320-326 PS) M 119.960	09.1989→08.1992		7.21071.50.0	EUV-LS	EP	
			7.06117.20.0	ZM-NWV	EL	
500 SL (129.066) 235-240 kW (320-326 PS) M 119.972	09.1989→08.1992		7.21071.50.0	EUV-LS	EP	
55 AMG 350-368 kW (476-500 PS) M 113.992	08.1999→07.2001		7.02256.37.0	EUV-SL	EL	
600 (129.076) 280-300 kW (381-408 PS) M 120.981, M 120.983	07.1992→10.2001		7.06117.20.0	ZM-NWV	EL	
600 SL (129.076) 280-300 kW (381-408 PS) M 120.981, M 120.983	02.1992→08.1994		7.06117.20.0	ZM-NWV	EL	
SL 320 (129.063) 162-170 kW (220-231 PS) M 104.991	09.1994→12.1997		7.21071.50.0	EUV-LS	EP	
			7.21071.50.0	EUV-SL	EP	









M

SL (R230) 108

280 (230.454) 170 kW (231 PS) M 272.949	03.2008→01.2012		7.22355.01.0	EUV-SR	EL	
			7.06117.60.0	ZM-NWV	EL	mit Dichtring with O-ring
300 (230.454) 170 kW (231 PS) M 272.949	04.2009→01.2012		7.22355.01.0	EUV-SR	EL	
			7.06117.60.0	ZM-NWV	EL	mit Dichtring with O-ring
350 (230.456) 200 kW (272 PS) M 272.966	03.2006→01.2012		7.22355.01.0	EUV-SR	EL	
			7.06117.60.0	ZM-NWV	EL	mit Dichtring with O-ring
350 (230.458) 232 kW (316 PS) M 272.968	04.2008→01.2012		7.06117.60.0	ZM-NWV	EL	mit Dichtring with O-ring
350 (230.467) 180 kW (245 PS) M 112.973	03.2003→01.2012		7.02256.37.0	EUV-SL	EL	
			7.22355.01.0	EUV-SR	EL	
500 215-225 kW (292-306 PS) M 113.963	09.2002→12.2005		7.02256.37.0	EUV-SL	EL	
			7.22355.01.0	EUV-SR	EL	
500 (230.471) 285 kW (388 PS) M 273.965	03.2006→01.2012		7.22355.01.0	EUV-SR	EL	
			7.06117.60.0	ZM-NWV	EL	mit Dichtring with O-ring
500 (230.475) 215-225 kW (292-306 PS) M 113.963	10.2001→01.2012		7.02256.37.0	EUV-SL	EL	
			7.22355.01.0	EUV-SR	EL	











SL (R230) 108

























55 AMG (230.472) 380 kW (517 PS) M 113.995	03.2006→01.2012		7.02256.37.0	EUV-SL	EL
55 AMG (230.474) 350-368 kW (476-500 PS) M 113.992	10.2001→06.2002		7.02256.37.0	EUV-SL	EL
55 AMG (230.474) 350-368 kW (476-500 PS) M 113.992	09.2003→12.2005		7.02256.37.0	EUV-SL	EL
55 AMG Kompressor (230.474) 350-368 kW (476-500 PS) M 113.992	06.2002→01.2012		7.02256.37.0	EUV-SL	EL
600 (230.476) 368 kW (500 PS) M 275.951	04.2003→01.2012		7.00017.02.0	EUV-LS	EP
			7.02256.37.0	EUV-SL	EL
600 (230.477) 380 kW (517 PS) M 275.954	03.2006→01.2012		7.00017.02.0	EUV-LS	EP
			7.02256.37.0	EUV-SL	EL
63 AMG (230.470) 386 kW (525 PS) M 156.981	03.2008→01.2012		7.02256.37.0	EUV-SL	EL
			7.22355.01.0	EUV-SR	EL
65 AMG (230.479) 450 kW (612 PS) M 275.981	03.2004→01.2012		7.02256.37.0	EUV-SL	EL
			7.01003.01.0	LDRV	EL
65 AMG Black Series (230.479) 493 kW (670 PS) M 275.983	07.2008→01.2012		7.02256.37.0	EUV-SL	EL

M























SL (R231) 109

















400 (231.465) 245-270 kW (333-367 PS) M 276.825	04.2014→		7.00782.11.0	DW-TL	EP
			7.01870.06.0	SUV	EL
400 (231.466) 245-270 kW (333-367 PS) M 276.825	01.2016→		7.00782.11.0	DW-TL	EP
			7.01870.06.0	SUV	EL
500 (231.473) 320-335 kW (435-455 PS) M 278.927	01.2012→		7.00782.11.0	DW-TL	EP
500 (231.473) 320-335 kW (435-455 PS) M 278.927	04.2015→		7.00782.11.0	DW-TL	EP
550 320-335 kW (435-455 PS) M 278.927	01.2012→		7.00782.11.0	DW-TL	EP
63 AMG (231.474) 395-430 kW (537-585 PS) M 157.983	01.2012→		7.00782.11.0	DW-TL	EP
63 AMG (231.474) 395-430 kW (537-585 PS) M 157.983	01.2012→		7.00782.11.0	DW-TL	EP
63 AMG (231.474) 395-430 kW (537-585 PS) M 157.983	04.2014→		7.00782.11.0	DW-TL	EP

						
SL (R231)						109
63 AMG (231.474) 395-430 kW (537-585 PS) M 157.983	07.2018→		7.00782.11.0	DW-TL	EP	
65 AMG (231.479) 463 kW (630 PS) M 279.981	05.2012→		7.02256.37.0	EUV-SL	EL	
SL Coupe (C107)						110
280 SLC (107.022) 130-136 kW (177-185 PS) M 110.982, M 110.986	08.1974→09.1981		7.21071.50.0	UAV	EP	
280 SLC (107.022) 130-136 kW (177-185 PS) M 110.982, M 110.986	06.1976→09.1981		7.21071.50.0	UAV	EP	
350 SLC (107.023) 143-147 kW (194-200 PS) M 116.982	01.1972→02.1976		7.21071.50.0	EUV-LS	EP	
350 SLC (107.023) 143-147 kW (194-200 PS) M 116.982	03.1976→02.1980		7.21071.50.0	EUV-LS	EP	
380 SLC (107.025) 160 kW (218 PS) M 116.960	07.1980→08.1981		7.21071.50.0	EUV-LS	EP	
450 SLC (107.024) 119-165 kW (162-225 PS) M 117.982, M 117.985	01.1973→11.1975		7.21071.50.0	EUV-LS	EP	
M 450 SLC (107.024) 119-165 kW (162-225 PS) M 117.982, M 117.985	09.1975→08.1979		7.21071.50.0	EUV-LS	EP	
450 SLC (107.024) 119-165 kW (162-225 PS) M 117.985	09.1979→12.1980		7.21071.50.0	EUV-LS	EP	
450 SLC 5.0 (107.026) 170-180 kW (231-245 PS) M 117.960	06.1978→02.1980		7.21071.50.0	EUV-LS	EP	
SLC (R172)						111
180 (172.431) 95-115 kW (129-156 PS) M 274.910	01.2016→		7.00782.16.0	DW-TL	EP	
			7.04818.04.0	SUV	EL	
200 (172.434) 115-245 kW (156-333 PS) M 274.920	01.2016→		7.00782.16.0	DW-TL	EP	
			7.02256.37.0	EUV-WP	EL	
			7.04818.04.0	SUV	EL	
250 d (172.404) 150 kW (204 PS) OM 651.980	01.2016→10.2017		7.00782.12.0	DW-TL	EP	
			7.02256.37.0	EUV-VB	EL	
			7.02256.37.0	EUV-WP	EL	
260 (172.435) 115-245 kW (156-333 PS) M 274.920	05.2018→		7.00782.16.0	DW-TL	EP	
			7.02256.37.0	EUV-WP	EL	
300 (172.438) 115-245 kW (156-333 PS) M 274.920	01.2016→		7.00782.16.0	DW-TL	EP	
			7.02256.37.0	EUV-WP	EL	
			7.04818.04.0	SUV	EL	

						
SLC (R172)						111
AMG SLC 43 (172.466) 270-287 kW (367-390 PS) M 276.822	01.2016→		7.00782.11.0	DW-TL	EP	
			7.01870.06.0	SUV	EL	
AMG SLC 43 (172.466) 270-287 kW (367-390 PS) M 276.822	06.2018→		7.00782.11.0	DW-TL	EP	
			7.01870.06.0	SUV	EL	
SLK (R170)						112
200 (170.435) 100 kW (136 PS) M 111.946	09.1996→03.2000		7.06117.20.0	ZM-NWV	EL	
200 Kompressor (170.444) 120 kW (163 PS) M 111.958	03.2000→04.2004		7.06117.21.0	ZM-NWV	EL	mit Trag-/Führungsgelenk With support/ steering link
200 Kompressor (170.445) 132-141 kW (180-192 PS) M 111.943	10.1996→03.2000		7.06117.20.0	ZM-NWV	EL	
230 (170.449) 143-145 kW (194-197 PS) M 111.983	09.2000→04.2004		7.06117.21.0	ZM-NWV	EL	mit Trag-/Führungsgelenk With support/ steering link
230 Kompressor (170.447) 138-142 kW (188-193 PS) M 111.973	09.1996→03.2000		7.06117.20.0	ZM-NWV	EL	
230 Kompressor (170.449) 143-145 kW (194-197 PS) M 111.983	03.2000→04.2004		7.06117.21.0	ZM-NWV	EL	mit Trag-/Führungsgelenk With support/ steering link
32 AMG Kompressor (170.466) 260 kW (354 PS) M 112.960	03.2001→04.2004		7.02256.37.0	EUV-SL	EL	
320 (170.465) 160 kW (218 PS) M 112.947	03.2000→04.2004		7.02256.37.0	EUV-SL	EL	
			7.22355.01.0	EUV-SR	EL	
SLK (R171)						113
200 Kompressor (171.442) 120 kW (163 PS) M 271.944	03.2004→02.2011		7.06117.24.0	ZM-NWV	EL	 mit Dichtring with O-ring
200 Kompressor (171.445) 135 kW (184 PS) M 271.954	01.2008→02.2011		7.06117.24.0	ZM-NWV	EL	 mit Dichtring with O-ring
280 (171.454) 170 kW (231 PS) M 272.942	01.2005→02.2011		7.22355.01.0	EUV-SR	EL	
			7.06117.60.0	ZM-NWV	EL	mit Dichtring with O-ring
300 (171.454) 170 kW (231 PS) M 272.942	04.2009→02.2011		7.22355.01.0	EUV-SR	EL	
			7.06117.60.0	ZM-NWV	EL	mit Dichtring with O-ring
350 (171.456) 200 kW (272 PS) M 272.963	06.2004→02.2011		7.22355.01.0	EUV-SR	EL	
			7.06117.60.0	ZM-NWV	EL	mit Dichtring with O-ring
350 (171.458) 224 kW (305 PS) M 272.969	01.2008→02.2011		7.22355.01.0	EUV-SR	EL	
			7.06117.60.0	ZM-NWV	EL	mit Dichtring with O-ring
55 AMG (171.473) 260-294 kW (354-400 PS) M 113.989	06.2004→02.2011		7.02256.37.0	EUV-SL	EL	
			7.22355.01.0	EUV-SR	EL	

M

						
SLK (R171)						113
55 AMG (171.473) 260-294 kW (354-400 PS) M 113.989	06.2006→02.2011		7.02256.37.0	EUV-SL	EL	
			7.22355.01.0	EUV-SR	EL	
55 AMG (171.473) 260-294 kW (354-400 PS) M 113.989	09.2009→12.2011		7.02256.37.0	EUV-SL	EL	
			7.22355.01.0	EUV-SR	EL	
SLK (R172)						114
200 (172.434) 115-245 kW (156-333 PS) M 274.920	04.2015→		7.00782.16.0	DW-TL	EP	
			7.02256.37.0	EUV-WP	EL	
			7.04818.04.0	SUV	EL	
200 (172.448) 135-150 kW (184-204 PS) M 271.860	02.2011→		7.01870.06.0	SUV	EL	
			7.01870.06.0	SUV	EL	
200 (172.448) 135-150 kW (184-204 PS) M 271.861	02.2011→		7.00017.03.0	LDRV	EP	
			7.01870.06.0	SUV	EL	
250 (172.447) 135-150 kW (184-204 PS) M 271.860	02.2011→		7.01870.06.0	SUV	EL	
			7.01870.06.0	SUV	EL	
250 (172.447) 135-150 kW (184-204 PS) M 271.861	02.2011→		7.00017.03.0	LDRV	EP	
			7.01870.06.0	SUV	EL	
250 CDI / d (172.403) 150 kW (204 PS) OM 651.980	01.2012→		7.00782.12.0	DW-TL	EP	
			7.02256.37.0	EUV-VB	EL	
			7.02256.37.0	EUV-WP	EL	
300 (172.438) 115-245 kW (156-333 PS) M 274.920	07.2015→		7.00782.16.0	DW-TL	EP	
			7.02256.37.0	EUV-WP	EL	
			7.04818.04.0	SUV	EL	
350 (172.457) 225 kW (306 PS) M 276.956	02.2011→		7.02288.01.0	EUV-SR	EL	
SLR (R199)						115
5.4 (199.376) 420-478 kW (571-650 PS) M 155.980	04.2004→		7.02256.37.0	EUV-SL	EL	
			7.02256.37.0	EUV-SL	EL	
5.4 722 Edition 420-478 kW (571-650 PS) M 155.980	10.2006→		7.02256.37.0	EUV-SL	EL	
			7.02256.37.0	EUV-SL	EL	
5.5 (199.376) 420-478 kW (571-650 PS) M 155.980	09.2004→		7.02256.37.0	EUV-SL	EL	
			7.02256.37.0	EUV-SL	EL	
SLR Roadster (R199)						116
5.4 420-478 kW (571-650 PS) M 155.980	10.2006→		7.02256.37.0	EUV-SL	EL	
			7.02256.37.0	EUV-SL	EL	
5.4 420-478 kW (571-650 PS) M 155.980	04.2007→		7.02256.37.0	EUV-SL	EL	
			7.02256.37.0	EUV-SL	EL	
5.5 SLR McLaren 420-478 kW (571-650 PS) M 155.980	04.2007→12.2009		7.02256.37.0	EUV-SL	EL	
			7.02256.37.0	EUV-SL	EL	

						
SLS AMG (C197)						117
6.2 420-464 kW (571-631 PS) M 159.980	06.2013→		7.02256.37.0	EUV-SL	EL	
6.2 (197.377) 420-464 kW (571-631 PS) M 159.980	03.2010→		7.02256.37.0	EUV-SL	EL	
6.2 GT 420-464 kW (571-631 PS) M 159.980	06.2013→		7.02256.37.0	EUV-SL	EL	
6.3 (197.377) 420-464 kW (571-631 PS) M 159.980	09.2010→12.2012		7.02256.37.0	EUV-SL	EL	
SLS AMG Roadster (R197)						118
6.2 (197.477) 420-464 kW (571-631 PS) M 159.980	06.2011→		7.02256.37.0	EUV-SL	EL	
6.2 AMG (197.477) 420-464 kW (571-631 PS) M 159.980	09.2012→		7.02256.37.0	EUV-SL	EL	
6.2 GT (197.478) 420-464 kW (571-631 PS) M 159.980	06.2013→		7.02256.37.0	EUV-SL	EL	
VANEO (414)						119
1.6 (414.700) 60-75 kW (82-102 PS) M 166.961	02.2002→07.2005		7.02256.37.0	EUV-SL	EL	
1.6 (414.700) 60-75 kW (82-102 PS) M 166.961	02.2002→07.2005		7.02256.37.0	EUV-SL	EL	
X-CLASS (470)						120
X 220 d (470.210) 120 kW (163 PS) OM 699.300	09.2017→05.2020		7.01814.22.0	DW-TL	EP	
X 220 d 4-matic (470.211) 120 kW (163 PS) OM 699.300	09.2017→05.2020		7.01814.22.0	DW-TL	EP	
X 250 d (470.230) 140 kW (190 PS) OM 699.301	09.2017→05.2020		7.01814.22.0	DW-TL	EP	
X 250 d 4-matic (470.231) 140 kW (190 PS) OM 699.301	09.2017→05.2020		7.01814.22.0	DW-TL	EP	
2T-SERIES						121
209 D 2.9 70-72 kW (95-98 PS) OM 602.940	01.1994→		7.21071.50.0	EUV-SR	EP	
CITAN Box Body/MPV (W415)						122
112 (415.603) 84 kW (114 PS) M 200.711	06.2013→		7.08681.15.0	EOV	EH	
			7.01343.04.0	LDRV	EP	
E-CLASS Platform/Chassis (VF210)						123
E 280 (210.663) 150 kW (204 PS) M 112.921	07.1999→11.2002		7.02256.37.0	EUV-SL	EL	
			7.22355.01.0	EUV-SR	EL	
MARCO POLO Camper (W447)						124
200 CDI (447.703, 447.813) 84-140 kW (114-190 PS) OM 651.950	03.2015→		7.00782.12.0	DW-TL	EP	
			7.02256.37.0	EUV-WP	EL	Produktionsdatum bis: 14.12.2020 Production date to: 14.12.2020

M



MARCO POLO Camper (W447) **124**

M	200 CDI (447.703, 447.813) 84-235 kW (114-320 PS) OM 654.920	03.2019→	 7.02256.37.0	EUV-AGR	EL	Produktionsdatum bis: 15.12.2020 Production date to: 15.12.2020
	200 CDI 4-matic (447.703, 447.813) 84-140 kW (114-190 PS) OM 651.950	03.2015→	 7.00782.12.0	DW-TL	EP	
			 7.02256.37.0	EUV-WP	EL	Produktionsdatum bis: 14.12.2020 Production date to: 14.12.2020
	200 CDI 4-matic (447.703, 447.813) 84-235 kW (114-320 PS) OM 654.920	03.2019→	 7.02256.37.0	EUV-AGR	EL	Produktionsdatum bis: 15.12.2020 Production date to: 15.12.2020
	220 CDI (447.703, 447.813) 84-140 kW (114-190 PS) OM 651.950	03.2015→	 7.00782.12.0	DW-TL	EP	
			 7.02256.37.0	EUV-WP	EL	Produktionsdatum bis: 14.12.2020 Production date to: 14.12.2020
	220 CDI (447.703, 447.813) 84-235 kW (114-320 PS) OM 654.920	03.2019→	 7.02256.37.0	EUV-AGR	EL	Produktionsdatum bis: 15.12.2020 Production date to: 15.12.2020
	220 CDI 4-matic (447.703, 447.813) 84-140 kW (114-190 PS) OM 651.950	03.2015→	 7.00782.12.0	DW-TL	EP	
			 7.02256.37.0	EUV-WP	EL	Produktionsdatum bis: 14.12.2020 Production date to: 14.12.2020
	220 CDI 4-matic (447.703, 447.813) 84-235 kW (114-320 PS) OM 654.920	03.2019→	 7.02256.37.0	EUV-AGR	EL	Produktionsdatum bis: 15.12.2020 Production date to: 15.12.2020
	250 CDI (447.703, 447.813) 84-140 kW (114-190 PS) OM 651.950	03.2015→	 7.00782.12.0	DW-TL	EP	
			 7.02256.37.0	EUV-WP	EL	Produktionsdatum bis: 14.12.2020 Production date to: 14.12.2020
	250 CDI (447.703, 447.813) 84-235 kW (114-320 PS) OM 654.920	03.2019→	 7.02256.37.0	EUV-AGR	EL	Produktionsdatum bis: 15.12.2020 Production date to: 15.12.2020
	250 CDI 4-matic (447.703, 447.813) 84-140 kW (114-190 PS) OM 651.950	03.2015→	 7.00782.12.0	DW-TL	EP	
			 7.02256.37.0	EUV-WP	EL	Produktionsdatum bis: 14.12.2020 Production date to: 14.12.2020
	250 CDI 4-matic (447.703, 447.813) 84-235 kW (114-320 PS) OM 654.920	03.2019→	 7.02256.37.0	EUV-AGR	EL	Produktionsdatum bis: 15.12.2020 Production date to: 15.12.2020
300 CDI (447.813, 447.703) 84-235 kW (114-320 PS) OM 654.920	03.2019→12.2020	 7.02256.37.0	EUV-AGR	EL	Produktionsdatum bis: 15.12.2020 Production date to: 15.12.2020	
300 CDI 4-matic (447.813, 447.703) 84-235 kW (114-320 PS) OM 654.920	03.2019→12.2020	 7.02256.37.0	EUV-AGR	EL	Produktionsdatum bis: 15.12.2020 Production date to: 15.12.2020	

SPRINTER 2-t Bus (B901, B902) **125**

208 D 58-60 kW (79-82 PS) OM 601.943	02.1995→04.2000	 7.21071.50.0	EUV-DS	EP	
210 D 75-90 kW (102-122 PS) OM 602.980	03.1997→04.2000	 7.21071.50.0	EUV-AGR	EP	
		 7.21071.50.0	EUV-DS	EP	
212 D 75-90 kW (102-122 PS) OM 602.980	02.1995→04.2000	 7.21071.50.0	EUV-AGR	EP	
		 7.21071.50.0	EUV-DS	EP	







SPRINTER 2-t Bus (B901, B902) 125

214 (902.071, 902.072, 902.671, 902.672) 92-105 kW (125-143 PS) M 111.984	02.1995→05.2006		7.02256.37.0	EUV-SR	EL
			7.06117.20.0	ZM-NWV	EL
214 (902.071, 902.072, 902.671, 902.672) 95-105 kW (129-143 PS) M 111.979	02.1995→05.2006		7.21071.50.0	EUV-DS	EP
			7.02256.37.0	EUV-SR	EL
214 NGT 92-105 kW (125-143 PS) M 111.984	02.1995→05.2006		7.02256.37.0	EUV-SR	EL
			7.06117.20.0	ZM-NWV	EL
214 NGT 95-105 kW (129-143 PS) M 111.979	02.1995→05.2006		7.21071.50.0	EUV-DS	EP
			7.02256.37.0	EUV-SR	EL

SPRINTER 2-t Platform/Chassis (B901, B902) 126

208 D 58-60 kW (79-82 PS) OM 601.943	01.1995→04.2000		7.21071.50.0	EUV-DS	EP
			7.21071.50.0	EUV-DS	EP
210 D 75-90 kW (102-122 PS) OM 602.980	01.1997→04.2000		7.21071.50.0	EUV-AGR	EP
			7.21071.50.0	EUV-DS	EP
212 D 75-90 kW (102-122 PS) OM 602.980	02.1995→04.2000		7.21071.50.0	EUV-AGR	EP
			7.21071.50.0	EUV-DS	EP
214 (902.011, 902.012, 902.611, 902.612) 92-105 kW (125-143 PS) M 111.984	02.1995→05.2006		7.02256.37.0	EUV-SR	EL
			7.06117.20.0	ZM-NWV	EL
214 (902.011, 902.012, 902.611, 902.612) 95-105 kW (129-143 PS) M 111.979	02.1995→05.2006		7.21071.50.0	EUV-DS	EP
			7.02256.37.0	EUV-SR	EL
214 NGT 92-105 kW (125-143 PS) M 111.984	02.1995→05.2006		7.02256.37.0	EUV-SR	EL
			7.06117.20.0	ZM-NWV	EL
214 NGT 95-105 kW (129-143 PS) M 111.979	02.1995→05.2006		7.21071.50.0	EUV-DS	EP
			7.02256.37.0	EUV-SR	EL

SPRINTER 2-t Van (B901, B902) 127

208 D 58-60 kW (79-82 PS) OM 601.943	02.1995→04.2000		7.21071.50.0	EUV-DS	EP
			7.21071.50.0	EUV-DS	EP
210 D 75-90 kW (102-122 PS) OM 602.980	01.1997→04.2000		7.21071.50.0	EUV-AGR	EP
			7.21071.50.0	EUV-DS	EP
212 D 75-90 kW (102-122 PS) OM 602.980	02.1995→04.2000		7.21071.50.0	EUV-AGR	EP
			7.21071.50.0	EUV-DS	EP
214 92-105 kW (125-143 PS) M 111.984	02.1995→05.2006		7.02256.37.0	EUV-SL	EL
			7.02256.37.0	EUV-SR	EL
			7.06117.20.0	ZM-NWV	EL
214 95-105 kW (129-143 PS) M 111.979	02.1995→05.2006		7.21071.50.0	EUV-DS	EP
			7.02256.37.0	EUV-SR	EL

M



SPRINTER 2-t Van (B901, B902) 127







214 NGT 92-105 kW (125-143 PS) M 111.984	02.1995→05.2006		7.02256.37.0	EUV-SR	EL	
			7.06117.20.0	ZM-NWV	EL	
214 NGT 95-105 kW (129-143 PS) M 111.979	02.1995→05.2006		7.21071.50.0	EUV-DS	EP	
			7.02256.37.0	EUV-SR	EL	

SPRINTER 3,5-t Bus (B906) 128







310 CDI (906.731, 906.733, 906.735) 70-120 kW (95-163 PS) OM 651.955, OM 651.956	03.2009→12.2013		7.00782.12.0	DW-TL	EP	
			7.02256.37.0	EUV-WP	EL	
311 CDI (906.731, 906.733, 906.735) 80 kW (109 PS) OM 646.985	06.2006→12.2009		7.00782.04.0	DW-TL	EP	
311 CDI (906.731, 906.733, 906.735) 70-120 kW (95-163 PS) OM 651.955	05.2016→		7.00782.12.0	DW-TL	EP	
			7.02256.37.0	EUV-WP	EL	
311 CDI 4x4 (906.731, 906.733, 906.735) 80 kW (109 PS) OM 646.985	02.2008→12.2009		7.00782.04.0	DW-TL	EP	
313 CDI (906.731, 906.733, 906.735) 70-120 kW (95-163 PS) OM 651.955	08.2011→05.2016		7.00782.12.0	DW-TL	EP	
			7.02256.37.0	EUV-WP	EL	
313 CDI 4x4 (906.731, 906.733, 906.735) 70-120 kW (95-163 PS) OM 651.955	08.2011→05.2016		7.00782.12.0	DW-TL	EP	
			7.02256.37.0	EUV-WP	EL	
314 CDI (906.731, 906.733, 906.735) 70-120 kW (95-163 PS) OM 651.955	05.2016→		7.00782.12.0	DW-TL	EP	
			7.02256.37.0	EUV-WP	EL	
314 CDI 4x4 (906.731, 906.733, 906.735) 70-120 kW (95-163 PS) OM 651.955	05.2016→		7.00782.12.0	DW-TL	EP	
			7.02256.37.0	EUV-WP	EL	
315 CDI (906.731, 906.733, 906.735) 95-110 kW (129-150 PS) OM 646.986, OM 646.989, OM 646.990	06.2006→12.2009		7.00782.04.0	DW-TL	EP	
315 CDI (906.733) 85-120 kW (116-163 PS) OM 651.957	06.2013→		7.00782.12.0	DW-TL	EP	
			7.02256.37.0	EUV-WP	EL	
315 CDI 4x4 (906.731, 906.733, 906.735) 95-110 kW (129-150 PS) OM 646.986, OM 646.989, OM 646.990	02.2008→12.2009		7.00782.04.0	DW-TL	EP	
315 CDI 4x4 (906.735) 85-120 kW (116-163 PS) OM 651.957	06.2013→		7.00782.12.0	DW-TL	EP	
			7.02256.37.0	EUV-WP	EL	

M

















SPRINTER 3,5-t Bus (B906)						128
316 (906.733, 906.735) 115 kW (156 PS) M 271.951	09.2008→		7.06117.24.0	ZM-NWV	EL	 mit Dichtring with O-ring
316 CDI (906.731, 906.733, 906.735) 70-120 kW (95-163 PS) OM 651.955, OM 651.957	08.2011→		7.00782.12.0	DW-TL	EP	
			7.02256.37.0	EUV-WP	EL	
316 CDI 4x4 (906.731, 906.733, 906.735) 70-120 kW (95-163 PS) OM 651.955, OM 651.957	08.2011→		7.00782.12.0	DW-TL	EP	
			7.02256.37.0	EUV-WP	EL	
318 CDI (906.731, 906.733, 906.735) 135-140 kW (184-190 PS) OM 642.896, OM 642.986, OM 642.992, OM 642.993	02.2008→12.2009		7.02256.37.0	EUV-VB	EL	
			7.02256.37.0	EUV-VB	EL	
318 CDI 4x4 (906.731, 906.733, 906.735) 135-140 kW (184-190 PS) OM 642.896, OM 642.986, OM 642.992, OM 642.993	02.2008→12.2009		7.02256.37.0	EUV-VB	EL	
			7.02256.37.0	EUV-VB	EL	
324 (906.733, 906.735) 190 kW (258 PS) M 272.979	06.2006→12.2013		7.22355.01.0	EUV-SR	EL	
			7.06117.60.0	ZM-NWV	EL	

M

SPRINTER 3,5-t Platform/Chassis (B906)						129
309 CDI (906.131, 906.133, 906.135, 906.231, 906.233,...) 65 kW (88 PS) OM 646.984	06.2006→12.2009		7.00782.04.0	DW-TL	EP	
310 CDI (906.131, 906.133, 906.135, 906.231, 906.233,...) 70-120 kW (95-163 PS) OM 651.955	03.2009→05.2016		7.00782.12.0	DW-TL	EP	
			7.02256.37.0	EUV-WP	EL	
311 CDI (906.131, 906.133, 906.135, 906.231, 906.233,...) 80 kW (109 PS) OM 646.985	06.2006→12.2009		7.00782.04.0	DW-TL	EP	
			7.00782.04.0	DW-TL	EP	
311 CDI (906.131, 906.133, 906.135, 906.231, 906.233,...) 70-120 kW (95-163 PS) OM 651.955	05.2016→		7.00782.12.0	DW-TL	EP	
			7.02256.37.0	EUV-WP	EL	
311 CDI 4x4 (906.131, 906.133, 906.135, 906.231, 906.233,...) 80 kW (109 PS) OM 646.985	02.2008→12.2009		7.00782.04.0	DW-TL	EP	
			7.00782.04.0	DW-TL	EP	
313 CDI (906.131, 906.133, 906.135, 906.231, 906.233,...) 70-120 kW (95-163 PS) OM 651.955, OM 651.956	06.2006→05.2016		7.00782.12.0	DW-TL	EP	
			7.02256.37.0	EUV-WP	EL	





SPRINTER 3,5-t Platform/Chassis (B906) 129

313 CDI (906.131, 906.133, 906.135, 906.231, 906.233,...) 95-110 kW (129-150 PS) OM 646.986	06.2006→05.2016	 PIERBURG 	7.00782.04.0 DW-TL EP	
313 CDI 4x4 (906.131, 906.133, 906.135, 906.231, 906.233...) 70-120 kW (95-163 PS) OM 651.955	06.2006→05.2016		7.00782.12.0 DW-TL EP 7.02256.37.0 EUV-WP EL	
314 CDI (906.131, 906.133, 906.135, 906.231, 906.233,...) 70-120 kW (95-163 PS) OM 651.955	05.2016→		7.00782.12.0 DW-TL EP 7.02256.37.0 EUV-WP EL	Produktionsdatum bis: 14.12.2020 Production date to: 14.12.2020
314 CDI 4x4 (906.131, 906.133, 906.135, 906.231, 906.233...) 70-120 kW (95-163 PS) OM 651.955	05.2016→		7.00782.12.0 DW-TL EP 7.02256.37.0 EUV-WP EL	Produktionsdatum bis: 14.12.2020 Production date to: 14.12.2020
315 CDI (906.131, 906.133, 906.135, 906.231, 906.233,...) 95-110 kW (129-150 PS) OM 646.986, OM 646.989, OM 646.990	06.2006→12.2009		7.00782.04.0 DW-TL EP	
M 315 CDI 4x4 (906.131, 906.133, 906.135, 906.231, 906.233...) 95-110 kW (129-150 PS) OM 646.986, OM 646.989, OM 646.990	02.2008→12.2009		7.00782.04.0 DW-TL EP	
316 (906.133, 906.135, 906.233, 906.235) 115 kW (156 PS) M 271.951	09.2008→		7.06117.24.0 ZM-NWV EL	 mit Dichtring with O-ring
316 CDI (906.131, 906.133, 906.135, 906.231, 906.233,...) 70-120 kW (95-163 PS) OM 651.955, OM 651.957	03.2009→		7.00782.12.0 DW-TL EP 7.02256.37.0 EUV-WP EL	 OM 651.955, OM 651.957: Produktionsdatum bis: 14.12.2020 Production date to: 14.12.2020
316 CDI 4x4 (906.131, 906.133, 906.135, 906.231, 906.233...) 70-120 kW (95-163 PS) OM 651.955, OM 651.957	03.2009→		7.00782.12.0 DW-TL EP 7.02256.37.0 EUV-WP EL	 OM 651.955, OM 651.957: Produktionsdatum bis: 14.12.2020 Production date to: 14.12.2020
316 LGT (906.133, 906.135, 906.233, 906.235) 115 kW (156 PS) M 271.951	09.2008→		7.06117.24.0 ZM-NWV EL	 mit Dichtring with O-ring
316 NGT (906.133, 906.135, 906.233, 906.235) 115 kW (156 PS) M 271.951	09.2008→		7.06117.24.0 ZM-NWV EL	 mit Dichtring with O-ring
318 CDI (906.131, 906.133, 906.135, 906.231, 906.233,...) 135-140 kW (184-190 PS) OM 642.896, OM 642.992, OM 642.993	06.2006→12.2009		7.02256.37.0 EUV-VB EL	



SPRINTER 3,5-t Platform/Chassis (B906) 129

318 CDI 4x4 (906.131, 906.133, 906.135, 906.231, 906.233... 135-140 kW (184-190 PS) OM 642.896, OM 642.992, OM 642.993	02.2008→12.2009		7.02256.37.0	EUV-VB	EL	
324 (906.133, 906.135, 906.233, 906.235, 906.132,... 190 kW (258 PS) M 272.979	06.2006→12.2013		7.22355.01.0	EUV-SR	EL	
			7.06117.60.0	ZM-NWV	EL	mit Dichtring with O-ring

SPRINTER 3,5-t Platform/Chassis (B907, B910) 130

311 CDI (910.131, 910.133) 84-140 kW (114-190 PS) OM 651.950, OM 651.958	02.2018→		7.00782.12.0	DW-TL	EP	
			7.02256.37.0	EUV-WP	EL	 OM 651.950, OM 651.958: Produktionsdatum bis: 14.12.2020 Production date to: 14.12.2020
311 CDI RWD (907.131, 907.133, 907.135, 907.231, 907.233... 84-120 kW (114-163 PS) OM 651.958	02.2018→		7.00782.12.0	DW-TL	EP	
			7.02256.37.0	EUV-VB	EL	Produktionsdatum bis: 24.02.2021 Production date to: 24.02.2021
311 CDI RWD (907.131, 907.133, 907.135, 907.231, 907.233... 84-235 kW (114-320 PS) OM 654.920	06.2020→		7.02256.37.0	EUV-AGR	EL	Produktionsdatum bis: 15.12.2020 Production date to: 15.12.2020
			7.02256.37.0	EUV-VB	EL	Produktionsdatum bis: 24.02.2021 Production date to: 24.02.2021
314 CDI (910.131, 910.133) 84-140 kW (114-190 PS) OM 651.950, OM 651.958	02.2018→		7.00782.12.0	DW-TL	EP	
			7.02256.37.0	EUV-WP	EL	 OM 651.950, OM 651.958: Produktionsdatum bis: 14.12.2020 Production date to: 14.12.2020
314 CDI All-wheel Drive (907.133, 907.135, 907.233,... 84-120 kW (114-163 PS) OM 651.958	01.2019→		7.00782.12.0	DW-TL	EP	
			7.02256.37.0	EUV-WP	EL	Produktionsdatum bis: 14.12.2020 Production date to: 14.12.2020
314 CDI RWD (907.131, 907.133, 907.135, 907.231, 907.233... 84-120 kW (114-163 PS) OM 651.958	02.2018→		7.00782.12.0	DW-TL	EP	
			7.02256.37.0	EUV-WP	EL	Produktionsdatum bis: 14.12.2020 Production date to: 14.12.2020
315 CDI RWD (907.131, 907.133, 907.135, 907.231, 907.233... 84-235 kW (114-320 PS) OM 654.920	06.2020→		7.02256.37.0	EUV-AGR	EL	Produktionsdatum bis: 15.12.2020 Production date to: 15.12.2020
316 CDI All-wheel Drive (907.133, 907.135, 907.233,... 84-120 kW (114-163 PS) OM 651.958	01.2019→		7.00782.12.0	DW-TL	EP	
			7.02256.37.0	EUV-WP	EL	Produktionsdatum bis: 14.12.2020 Production date to: 14.12.2020
316 CDI RWD (907.131, 907.133, 907.135, 907.231, 907.233... 84-120 kW (114-163 PS) OM 651.958	02.2018→		7.00782.12.0	DW-TL	EP	





M



SPRINTER 3,5-t Platform/Chassis (B907, B910) 130







		7.02256.37.0	EUV-WP	EL	Produktionsdatum bis: 14.12.2020 Production date to: 14.12.2020
317 CDI RWD (907.131, 907.133, 907.135, 907.231, 907.233...) 84-235 kW (114-320 PS) OM 654.920	06.2020→	 7.02256.37.0	EUV-AGR	EL	Produktionsdatum bis: 15.12.2020 Production date to: 15.12.2020

















SPRINTER 3,5-t Tourer Bus (B907) 131

311 CDI (907.731, 907.733, 907.735) 84-120 kW (114-163 PS) OM 651.958	02.2018→	 7.00782.12.0	DW-TL	EP	
		7.02256.37.0	EUV-VB	EL	Produktionsdatum bis: 24.02.2021 Production date to: 24.02.2021
314 CDI (907.731, 907.733, 907.735) 84-120 kW (114-163 PS) OM 651.958	02.2018→	 7.00782.12.0	DW-TL	EP	
		7.02256.37.0	EUV-WP	EL	Produktionsdatum bis: 14.12.2020 Production date to: 14.12.2020
314 CDI All-wheel Drive (907.733) 84-120 kW (114-163 PS) OM 651.958	01.2019→	 7.00782.12.0	DW-TL	EP	
		7.02256.37.0	EUV-WP	EL	Produktionsdatum bis: 14.12.2020 Production date to: 14.12.2020
316 CDI (907.731, 907.733, 907.735) 84-120 kW (114-163 PS) OM 651.958	02.2018→	 7.00782.12.0	DW-TL	EP	
		7.02256.37.0	EUV-WP	EL	Produktionsdatum bis: 14.12.2020 Production date to: 14.12.2020
316 CDI All-wheel Drive (907.733) 84-120 kW (114-163 PS) OM 651.958	01.2019→	 7.00782.12.0	DW-TL	EP	
		7.02256.37.0	EUV-WP	EL	Produktionsdatum bis: 14.12.2020 Production date to: 14.12.2020

M

SPRINTER 3,5-t Van (B906) 132







309 CDI (906.631, 906.633, 906.635, 906.637) 65 kW (88 PS) OM 646.984	06.2006→12.2009	 7.00782.04.0	DW-TL	EP	
310 CDI (906.631, 906.633, 906.635, 906.637) 70-120 kW (95-163 PS) OM 651.955	03.2009→	 7.00782.12.0	DW-TL	EP	
		7.02256.37.0	EUV-WP	EL	Produktionsdatum bis: 14.12.2020 Production date to: 14.12.2020
311 CDI (906.631, 906.633, 906.635, 906.637) 80 kW (109 PS) OM 646.985	06.2006→12.2009	 7.00782.04.0	DW-TL	EP	
311 CDI (906.631, 906.633, 906.635, 906.637) 70-120 kW (95-163 PS) OM 651.955	05.2016→	 7.00782.12.0	DW-TL	EP	
		7.02256.37.0	EUV-WP	EL	Produktionsdatum bis: 14.12.2020 Production date to: 14.12.2020
311 CDI 4x4 (906.631, 906.633, 906.635, 906.637) 80 kW (109 PS) OM 646.985	02.2008→12.2009	 7.00782.04.0	DW-TL	EP	
313 CDI (906.631, 906.633, 906.635, 906.637) 95-110 kW (129-150 PS) OM 646.986	06.2006→	 7.00782.04.0	DW-TL	EP	

					
SPRINTER 3,5-t Van (B906)					
313 CDI (906.631, 906.633, 906.635, 906.637) 70-120 kW (95-163 PS) OM 651.940	05.2009→		7.02256.37.0	EUV-WP	EL Produktionsdatum bis: 14.12.2020 Production date to: 14.12.2020
313 CDI (906.631, 906.633, 906.635, 906.637) 70-120 kW (95-163 PS) OM 651.955	05.2009→		7.00782.12.0	DW-TL	EP
			7.02256.37.0	EUV-WP	EL Produktionsdatum bis: 14.12.2020 Production date to: 14.12.2020
313 CDI 4x4 (906.631, 906.633, 906.635, 906.637) 70-120 kW (95-163 PS) OM 651.955	05.2009→		7.00782.12.0	DW-TL	EP
			7.02256.37.0	EUV-WP	EL Produktionsdatum bis: 14.12.2020 Production date to: 14.12.2020
314 CDI (906.631, 906.633, 906.635, 906.637) 70-120 kW (95-163 PS) OM 651.955	05.2016→		7.00782.12.0	DW-TL	EP
			7.02256.37.0	EUV-WP	EL Produktionsdatum bis: 14.12.2020 Production date to: 14.12.2020
314 CDI 4x4 (906.631, 906.633, 906.635, 906.637) 70-120 kW (95-163 PS) OM 651.955	05.2016→		7.00782.12.0	DW-TL	EP
			7.02256.37.0	EUV-WP	EL Produktionsdatum bis: 14.12.2020 Production date to: 14.12.2020
315 CDI (906.631, 906.633, 906.635, 906.637) 95-110 kW (129-150 PS) OM 646.986, OM 646.989, OM 646.990	06.2006→12.2009		7.00782.04.0	DW-TL	EP
315 CDI (906.633) 70-120 kW (95-163 PS) OM 651.955	12.2014→		7.00782.12.0	DW-TL	EP
			7.02256.37.0	EUV-WP	EL Produktionsdatum bis: 14.12.2020 Production date to: 14.12.2020
315 CDI 4x4 (906.631, 906.633, 906.635, 906.637) 95-110 kW (129-150 PS) OM 646.986, OM 646.989, OM 646.990	02.2008→12.2009		7.00782.04.0	DW-TL	EP
316 (906.635, 906.633) 115 kW (156 PS) M 271.951	09.2008→		7.06117.24.0	ZM-NWV	EL  mit Dichtring with O-ring
316 CDI (906.631, 906.633, 906.635, 906.637) 70-120 kW (95-163 PS) OM 651.955, OM 651.957	03.2009→		7.00782.12.0	DW-TL	EP
			7.02256.37.0	EUV-WP	EL  OM 651.955, OM 651.957: Produktionsdatum bis: 14.12.2020 Production date to: 14.12.2020
316 CDI 4x4 (906.631, 906.633, 906.635, 906.637) 70-120 kW (95-163 PS) OM 651.955, OM 651.957	03.2009→		7.00782.12.0	DW-TL	EP
			7.02256.37.0	EUV-WP	EL  OM 651.955, OM 651.957: Produktionsdatum bis: 14.12.2020 Production date to: 14.12.2020

M





























SPRINTER 3,5-t Van (B906) 132

316 LGT (906.633, 906.635) 115 kW (156 PS) M 271.951	09.2008→		7.06117.24.0	ZM-NWV	EL	 mit Dichtring with O-ring
316 NGT (906.633, 906.635) 115 kW (156 PS) M 271.951	09.2008→		7.06117.24.0	ZM-NWV	EL	 mit Dichtring with O-ring
318 CDI (906.631, 906.633, 906.635, 906.637) 135-140 kW (184-190 PS) OM 642.896, OM 642.986, OM 642.992, OM 642.993	06.2006→12.2009		7.02256.37.0	EUV-VB	EL	
318 CDI 4x4 (906.631, 906.633, 906.635, 906.637) 135-140 kW (184-190 PS) OM 642.896, OM 642.986, OM 642.992, OM 642.993	02.2008→12.2009		7.02256.37.0	EUV-VB	EL	
324 (906.633, 906.635, 906.637) 190 kW (258 PS) M 272.979	06.2006→12.2013		7.22355.01.0	EUV-SR	EL	
			7.06117.60.0	ZM-NWV	EL	mit Dichtring with O-ring

SPRINTER 3,5-t Van (B907, B910) 133

M

311 CDI (910.631, 910.633) 84-140 kW (114-190 PS) OM 651.950, OM 651.958	02.2018→		7.00782.12.0	DW-TL	EP	
			7.02256.37.0	EUV-WP	EL	 OM 651.950, OM 651.958: Produktionsdatum bis: 14.12.2020 Production date to: 14.12.2020
311 CDI RWD (907.631, 907.633, 907.635, 907.637) 84-235 kW (114-320 PS) OM 654.920	06.2020→		7.02256.37.0	EUV-AGR	EL	Produktionsdatum bis: 15.12.2020 Production date to: 15.12.2020
			7.02256.37.0	EUV-VB	EL	Produktionsdatum bis: 24.02.2021 Production date to: 24.02.2021
311 CDI RWD (907.633, 907.635, 907.631, 907.637) 84-120 kW (114-163 PS) OM 651.958	02.2018→		7.00782.12.0	DW-TL	EP	
			7.02256.37.0	EUV-VB	EL	Produktionsdatum bis: 24.02.2021 Production date to: 24.02.2021
314 CDI (910.631, 910.633) 84-140 kW (114-190 PS) OM 651.950, OM 651.958	02.2018→		7.00782.12.0	DW-TL	EP	
			7.02256.37.0	EUV-WP	EL	 OM 651.950, OM 651.958: Produktionsdatum bis: 14.12.2020 Production date to: 14.12.2020
314 CDI All-wheel Drive (907.633, 907.635, 907.637) 84-120 kW (114-163 PS) OM 651.958	01.2019→		7.00782.12.0	DW-TL	EP	
			7.02256.37.0	EUV-WP	EL	Produktionsdatum bis: 14.12.2020 Production date to: 14.12.2020
314 CDI RWD (907.631, 907.633, 907.635, 907.637) 84-120 kW (114-163 PS) OM 651.958	02.2018→		7.00782.12.0	DW-TL	EP	
			7.02256.37.0	EUV-WP	EL	Produktionsdatum bis: 14.12.2020 Production date to: 14.12.2020

					
SPRINTER 3,5-t Van (B907, B910)					
133					
315 CDI RWD (907.631, 907.633, 907.635, 907.637) 84-235 kW (114-320 PS) OM 654.920	06.2020→		7.02256.37.0	EUV-AGR	EL Produktionsdatum bis: 15.12.2020 Production date to: 15.12.2020
316 CDI All-wheel Drive (907.633, 907.635, 907.637) 84-120 kW (114-163 PS) OM 651.958	01.2019→		7.00782.12.0	DW-TL	EP
			7.02256.37.0	EUV-WP	EL Produktionsdatum bis: 14.12.2020 Production date to: 14.12.2020
316 CDI RWD (907.631, 907.633, 907.635, 907.637) 84-120 kW (114-163 PS) OM 651.958	02.2018→		7.00782.12.0	DW-TL	EP
			7.02256.37.0	EUV-WP	EL Produktionsdatum bis: 14.12.2020 Production date to: 14.12.2020
317 CDI RWD (907.631, 907.633, 907.635, 907.637) 84-235 kW (114-320 PS) OM 654.920	06.2020→		7.02256.37.0	EUV-AGR	EL Produktionsdatum bis: 15.12.2020 Production date to: 15.12.2020
SPRINTER 3-t Bus (B903)					
134					
308 D 58-60 kW (79-82 PS) OM 601.943	02.1995→04.2000		7.21071.50.0	EUV-DS	EP
308 D (903.371, 903.372, 903.373) 58-60 kW (79-82 PS) OM 601.943	03.1997→04.2000		7.21071.50.0	EUV-DS	EP
			7.02256.37.0	EUV-AGK	EL
			7.02256.37.0	EUV-AGR	EL
			7.02256.37.0	EUV-AT	EL
			7.02256.37.0	EUV-DS	EL
			7.02256.37.0	EUV-KK	EL
			7.02256.37.0	EUV-SL	EL
			7.02256.37.0	EUV-SR	EL
			7.02256.37.0	EUV-VB	EL
7.02256.37.0	EUV-WP	EL			
310 D (903.471, 903.472, 903.473) 75-90 kW (102-122 PS) OM 602.980	01.1997→12.1999		7.21071.50.0	EUV-AGR	EP
310 D 4x4 75-90 kW (102-122 PS) OM 602.980	05.1997→08.2002		7.21071.50.0	EUV-DS	EP
			7.21071.50.0	EUV-AGR	EP
312 D 2.9 75-90 kW (102-122 PS) OM 602.980	02.1995→04.2000		7.21071.50.0	EUV-AGR	EP
			7.21071.50.0	EUV-DS	EP
312 D 2.9 4x4 75-90 kW (102-122 PS) OM 602.980	05.1997→08.2002		7.21071.50.0	EUV-AGR	EP
			7.21071.50.0	EUV-DS	EP
314 (903.071, 903.072, 903.073, 903.671, 903.672,...) 92-105 kW (125-143 PS) M 111.984	02.1995→05.2006		7.02256.37.0	EUV-SL	EL
			7.02256.37.0	EUV-SR	EL
			7.06117.20.0	ZM-NWV	EL
314 (903.071, 903.072, 903.073, 903.671, 903.672,...) 95-105 kW (129-143 PS) M 111.979	02.1995→05.2006		7.21071.50.0	EUV-DS	EP
			7.02256.37.0	EUV-SL	EL











M



SPRINTER 3-t Bus (B903) 134

			7.02256.37.0	EUV-SR	EL	
314 4x4 92-105 kW (125-143 PS) M 111.984	08.2002→05.2006		7.02256.37.0	EUV-SL	EL	
			7.02256.37.0	EUV-SR	EL	
			7.06117.20.0	ZM-NWV	EL	
			7.02256.37.0	EUV-SR	EL	
314 NGT 92-105 kW (125-143 PS) M 111.984	02.1995→05.2006		7.02256.37.0	EUV-SR	EL	
			7.06117.20.0	ZM-NWV	EL	
314 NGT 95-105 kW (129-143 PS) M 111.979	02.1995→05.2006		7.21071.50.0	EUV-DS	EP	
			7.02256.37.0	EUV-SR	EL	

SPRINTER 3-t Bus (B906) 135

210 CDI (906.711, 906.713) 70-120 kW (95-163 PS) OM 651.955	03.2009→12.2013		7.00782.12.0	DW-TL	EP	
			7.02256.37.0	EUV-WP	EL	
211 CDI (906.711, 906.713) 80 kW (109 PS) OM 646.985	06.2006→12.2009		7.00782.04.0	DW-TL	EP	
			7.02256.37.0	EUV-WP	EL	
211 CDI (906.711, 906.713) 70-120 kW (95-163 PS) OM 651.955	04.2016→		7.00782.12.0	DW-TL	EP	
			7.02256.37.0	EUV-WP	EL	Produktionsdatum bis: 14.12.2020 Production date to: 14.12.2020
213 CDI (906.711, 906.713) 70-120 kW (95-163 PS) OM 651.955	06.2006→05.2016		7.00782.12.0	DW-TL	EP	
			7.02256.37.0	EUV-WP	EL	
214 CDI (906.711, 906.713) 70-120 kW (95-163 PS) OM 651.955	04.2016→		7.00782.12.0	DW-TL	EP	
			7.02256.37.0	EUV-WP	EL	Produktionsdatum bis: 14.12.2020 Production date to: 14.12.2020
215 CDI (906.711, 906.713) 95-110 kW (129-150 PS) OM 646.986, OM 646.989, OM 646.990	06.2006→12.2009		7.00782.04.0	DW-TL	EP	
			7.02256.37.0	EUV-WP	EL	
216 (906.713) 115 kW (156 PS) M 271.951	09.2008→		7.06117.24.0	ZM-NWV	EL	 mit Dichtring with O-ring
			7.02256.37.0	EUV-WP	EL	 OM 651.955, OM 651.957: Produktionsdatum bis: 14.12.2020 Production date to: 14.12.2020
216 CDI (906.711, 906.713) 70-120 kW (95-163 PS) OM 651.955, OM 651.957	06.2006→		7.00782.12.0	DW-TL	EP	
			7.02256.37.0	EUV-WP	EL	
224 (906.713) 190 kW (258 PS) M 272.979	06.2006→12.2013		7.22355.01.0	EUV-SR	EL	
			7.06117.60.0	ZM-NWV	EL	mit Dichtring with O-ring





SPRINTER 3-t Platform/Chassis (B903) 136

308 D 2.3 58-60 kW (79-82 PS) OM 601.943	02.1995→04.2000		7.21071.50.0	EUV-DS	EP	
			7.02256.37.0	EUV-DS	EP	
308 D 2.3 58-60 kW (79-82 PS) OM 601.943	11.1996→04.2000		7.21071.50.0	EUV-DS	EP	
			7.02256.37.0	EUV-DS	EP	
310 D 2.9 75-90 kW (102-122 PS) OM 602.980	01.1997→04.2000		7.21071.50.0	EUV-AGR	EP	
			7.21071.50.0	EUV-DS	EP	



SPRINTER 3-t Platform/Chassis (B903)





136

310 D 2.9 4x4 75-90 kW (102-122 PS) OM 602.980	01.1997→04.2000		7.21071.50.0	EUV-AGR	EP
			7.21071.50.0	EUV-DS	EP
312 D 2.9 75-90 kW (102-122 PS) OM 602.980	02.1995→04.2000		7.21071.50.0	EUV-AGR	EP
			7.21071.50.0	EUV-DS	EP
312 D 2.9 (903.411, 903.412, 903.413, 903.421, 903.422,...) 75-90 kW (102-122 PS) OM 602.980	12.1998→09.2001		7.21071.50.0	EUV-AGR	EP
			7.21071.50.0	EUV-DS	EP
			7.02256.37.0	EUV-SL	EL
314 (903.011, 903.012, 903.013, 903.022, 903.611,...) 92-105 kW (125-143 PS) M 111.984	02.1995→05.2006		7.02256.37.0	EUV-SL	EL
			7.02256.37.0	EUV-SR	EL
			7.06117.20.0	ZM-NWV	EL
314 (903.011, 903.012, 903.013, 903.022, 903.611,...) 95-105 kW (129-143 PS) M 111.979	02.1995→05.2006		7.21071.50.0	EUV-DS	EP
			7.02256.37.0	EUV-SL	EL
			7.02256.37.0	EUV-SR	EL
314 4x4 92-105 kW (125-143 PS) M 111.984	08.2002→05.2006		7.02256.37.0	EUV-SL	EL
			7.02256.37.0	EUV-SR	EL
			7.06117.20.0	ZM-NWV	EL
314 NGT (903.611, 903.612) 92-105 kW (125-143 PS) M 111.984	02.1995→05.2006		7.02256.37.0	EUV-SR	EL
			7.06117.20.0	ZM-NWV	EL
314 NGT (903.611, 903.612) 95-105 kW (129-143 PS) M 111.979	02.1995→05.2006		7.21071.50.0	EUV-DS	EP
			7.02256.37.0	EUV-SR	EL

M









SPRINTER 3-t Platform/Chassis (B906)

137





209 CDI (906.111, 906.113, 906.211, 906.213) 65 kW (88 PS) OM 646.984	06.2006→12.2009		7.00782.04.0	DW-TL	EP
210 CDI (906.111, 906.113, 906.211, 906.213) 70-120 kW (95-163 PS) OM 651.955	03.2009→05.2016		7.00782.12.0	DW-TL	EP
			7.02256.37.0	EUV-WP	EL
211 CDI (906.111, 906.113, 906.211, 906.213) 80 kW (109 PS) OM 646.985	06.2006→12.2009		7.00782.04.0	DW-TL	EP
211 CDI (906.111, 906.113, 906.211, 906.213) 70-120 kW (95-163 PS) OM 651.955	04.2016→		7.00782.12.0	DW-TL	EP
			7.02256.37.0	EUV-WP	EL
					Produktionsdatum bis: 14.12.2020 Production date to: 14.12.2020



SPRINTER 3-t Plattform/Chassis (B906) 137

213 CDI (906.111, 906.113, 906.211, 906.213) 95-110 kW (129-150 PS) OM 646.986	06.2006→12.2009		7.00782.04.0	DW-TL	EP	
213 CDI (906.111, 906.113, 906.211, 906.213) 70-120 kW (95-163 PS) OM 651.955, OM 651.957	03.2009→05.2016		7.00782.12.0	DW-TL	EP	
			7.02256.37.0	EUV-WP	EL	
214 CDI (906.111, 906.113, 906.211, 906.213) 70-120 kW (95-163 PS) OM 651.955	04.2016→		7.00782.12.0	DW-TL	EP	
			7.02256.37.0	EUV-WP	EL	Produktionsdatum bis: 14.12.2020 Production date to: 14.12.2020
215 CDI (906.111, 906.113, 906.211, 906.213) 95-110 kW (129-150 PS) OM 646.986, OM 646.989, OM 646.990	06.2006→12.2009		7.00782.04.0	DW-TL	EP	
216 (906.113, 906.213) 115 kW (156 PS) M 271.951	09.2008→05.2016		7.06117.24.0	ZM-NWV	EL	 mit Dichtring with O-ring
216 CDI (906.111, 906.113, 906.211, 906.213) 85-120 kW (116-163 PS) OM 651.957	03.2009→		7.00782.12.0	DW-TL	EP	
			7.02256.37.0	EUV-WP	EL	Produktionsdatum bis: 14.12.2020 Production date to: 14.12.2020
218 CDI (906.111, 906.113, 906.211, 906.213) 135-140 kW (184-190 PS) OM 642.896, OM 642.992, OM 642.993	06.2006→12.2009		7.02256.37.0	EUV-VB	EL	
224 (906.113, 906.213) 190 kW (258 PS) M 272.979	06.2006→12.2013		7.22355.01.0	EUV-SR	EL	
			7.06117.60.0	ZM-NWV	EL	mit Dichtring with O-ring

SPRINTER 3-t Plattform/Chassis (B910, B907) 138

211 CDI (910.121, 910.123) 84-140 kW (114-190 PS) OM 651.950	02.2018→		7.00782.12.0	DW-TL	EP	
			7.02256.37.0	EUV-WP	EL	Produktionsdatum bis: 14.12.2020 Production date to: 14.12.2020
211 CDI RWD (907.123, 907.221, 907.223) 84-120 kW (114-163 PS) OM 651.958	02.2018→		7.00782.12.0	DW-TL	EP	
			7.02256.37.0	EUV-VB	EL	Produktionsdatum bis: 24.02.2021 Production date to: 24.02.2021
211 CDI RWD (907.221, 907.223) 84-235 kW (114-320 PS) OM 654.920	06.2020→		7.02256.37.0	EUV-AGR	EL	Produktionsdatum bis: 15.12.2020 Production date to: 15.12.2020
			7.02256.37.0	EUV-VB	EL	Produktionsdatum bis: 24.02.2021 Production date to: 24.02.2021
214 CDI (910.121, 910.123) 84-140 kW (114-190 PS) OM 651.950, OM 651.958	02.2018→		7.00782.12.0	DW-TL	EP	
			7.02256.37.0	EUV-WP	EL	 OM 651.950, OM 651.958: Produktionsdatum bis: 14.12.2020 Production date to: 14.12.2020













SPRINTER 3-t Platform/Chassis (B910, B907)

138























214 CDI RWD (907.221, 907.223) 84-120 kW (114-163 PS) OM 651.958	02.2018→		7.00782.12.0 DW-TL EP	Produktionsdatum bis: 14.12.2020 Production date to: 14.12.2020
			7.02256.37.0 EUV-WP EL	
215 CDI RWD (907.221, 907.223) 84-235 kW (114-320 PS) OM 654.920	06.2020→		7.02256.37.0 EUV-AGR EL	Produktionsdatum bis: 15.12.2020 Production date to: 15.12.2020
			7.00782.12.0 DW-TL EP	
216 CDI RWD (907.221, 907.223) 84-120 kW (114-163 PS) OM 651.958	02.2018→		7.00782.12.0 DW-TL EP	Produktionsdatum bis: 14.12.2020 Production date to: 14.12.2020
			7.02256.37.0 EUV-WP EL	
217 CDI RWD (907.221, 907.223) 84-235 kW (114-320 PS) OM 654.920	06.2020→		7.02256.37.0 EUV-AGR EL	Produktionsdatum bis: 15.12.2020 Production date to: 15.12.2020
			7.00782.12.0 DW-TL EP	





















SPRINTER 3-t Van (B903)

139























308 D 2.3 58-60 kW (79-82 PS) OM 601.943	02.1995→04.2000		7.21071.50.0 EUV-DS EP	
			7.21071.50.0 EUV-DS EP	
308 D 2.3 58-60 kW (79-82 PS) OM 601.943	02.1995→04.2000		7.21071.50.0 EUV-AGR EP	
			7.21071.50.0 EUV-DS EP	
310 D 2.9 75-90 kW (102-122 PS) OM 602.980	06.1997→04.2000		7.21071.50.0 EUV-AGR EP	
			7.21071.50.0 EUV-DS EP	
310 D 2.9 4x4 75-90 kW (102-122 PS) OM 602.980	02.1995→04.2000		7.21071.50.0 EUV-AGR EP	
			7.21071.50.0 EUV-DS EP	
312 D 2.9 75-90 kW (102-122 PS) OM 602.980	05.1997→08.2002		7.21071.50.0 EUV-AGR EP	
			7.21071.50.0 EUV-DS EP	
314 92-105 kW (125-143 PS) M 111.984	02.1995→05.2006		7.02256.37.0 EUV-SL EL	
			7.02256.37.0 EUV-SR EL	
			7.06117.20.0 ZM-NWV EL	
314 95-105 kW (129-143 PS) M 111.979	08.2002→05.2006		7.21071.50.0 EUV-DS EP	
			7.02256.37.0 EUV-SR EL	
314 4x4 92-105 kW (125-143 PS) M 111.984	02.1995→05.2006		7.02256.37.0 EUV-SL EL	
			7.02256.37.0 EUV-SR EL	
			7.06117.20.0 ZM-NWV EL	
314 NGT (903.661) 92-105 kW (125-143 PS) M 111.984	02.1995→05.2006		7.02256.37.0 EUV-SR EL	
			7.06117.20.0 ZM-NWV EL	
314 NGT (903.661) 95-105 kW (129-143 PS) M 111.979			7.21071.50.0 EUV-DS EP	
			7.02256.37.0 EUV-SR EL	

M

					
SPRINTER 3-t Van (B906)					140
209 CDI (906.611, 906.613) 65 kW (88 PS) OM 646.984	06.2006→12.2009		7.00782.04.0	DW-TL	EP
210 CDI (906.611, 906.613) 70-120 kW (95-163 PS) OM 651.955	03.2009→		7.00782.12.0 7.02256.37.0	DW-TL EUV-WP	EP EL Produktionsdatum bis: 14.12.2020 Production date to: 14.12.2020
211 CDI (906.611, 906.613) 80 kW (109 PS) OM 646.985	06.2006→12.2009		7.00782.04.0	DW-TL	EP
211 CDI (906.611, 906.613) 70-120 kW (95-163 PS) OM 651.955	04.2016→		7.00782.12.0 7.02256.37.0	DW-TL EUV-WP	EP EL Produktionsdatum bis: 14.12.2020 Production date to: 14.12.2020
213 CDI (906.611, 906.613) 95-110 kW (129-150 PS) OM 646.986	06.2006→12.2009		7.00782.04.0	DW-TL	EP
213 CDI (906.611, 906.613) 70-120 kW (95-163 PS) OM 651.955, OM 651.957	06.2006→		7.00782.12.0 7.02256.37.0	DW-TL EUV-WP	EP EL  OM 651.955, OM 651.957: Produktionsdatum bis: 14.12.2020 Production date to: 14.12.2020
214 CDI (906.611, 906.613) 70-120 kW (95-163 PS) OM 651.955	04.2016→		7.00782.12.0 7.02256.37.0	DW-TL EUV-WP	EP EL Produktionsdatum bis: 14.12.2020 Production date to: 14.12.2020
215 CDI (906.611, 906.613) 95-110 kW (129-150 PS) OM 646.986, OM 646.989, OM 646.990	06.2006→12.2009		7.00782.04.0	DW-TL	EP
216 (906.613) 115 kW (156 PS) M 271.951	09.2008→		7.06117.24.0	ZM-NWV	EL  mit Dichtring with O-ring
216 CDI (906.611, 906.613) 70-120 kW (95-163 PS) OM 651.955, OM 651.957	03.2009→		7.00782.12.0 7.02256.37.0	DW-TL EUV-WP	EP EL  OM 651.955, OM 651.957: Produktionsdatum bis: 14.12.2020 Production date to: 14.12.2020
218 CDI (906.611, 906.613) 135-140 kW (184-190 PS) OM 642.896, OM 642.992	06.2006→12.2009		7.02256.37.0	EUV-VB	EL
224 (906.613) 190 kW (258 PS) M 272.979	06.2006→		7.22355.01.0 7.06117.60.0	EUV-SR ZM-NWV	EL EL mit Dichtring with O-ring
SPRINTER 3-t Van (B910)					141
211 CDI (910.621, 910.623) 84-140 kW (114-190 PS) OM 651.950, OM 651.958	02.2018→		7.00782.12.0 7.02256.37.0	DW-TL EUV-WP	EP EL  OM 651.950, OM 651.958: Produktionsdatum bis: 14.12.2020 Production date to: 14.12.2020



					
SPRINTER 3-t Van (B910) 141					
214 CDI (910.621, 910.623) 84-140 kW (114-190 PS) OM 651.950, OM 651.958	02.2018→		7.00782.12.0	DW-TL	EP
			7.02256.37.0	EUV-WP	EL  OM 651.950, OM 651.958: Produktionsdatum bis: 14.12.2020 Production date to: 14.12.2020
SPRINTER 4,6-t Bus (B906) 142					
415 CDI 85-120 kW (116-163 PS) OM 651.957	06.2006→		7.00782.12.0	DW-TL	EP
			7.02256.37.0	EUV-WP	EL Produktionsdatum bis: 14.12.2020 Production date to: 14.12.2020
SPRINTER 4,6-t Platform/Chassis (B906) 143					
411 CDI (906.153, 906.155, 906.253, 906.255) 80 kW (109 PS) OM 646.985	06.2009→12.2018		7.00782.04.0	DW-TL	EP
411 CDI (906.153, 906.155, 906.253, 906.255) 70-120 kW (95-163 PS) OM 651.955	04.2016→		7.00782.12.0	DW-TL	EP
			7.02256.37.0	EUV-WP	EL Produktionsdatum bis: 14.12.2020 Production date to: 14.12.2020
413 CDI 70-120 kW (95-163 PS) OM 651.955	03.2009→		7.00782.12.0	DW-TL	EP
			7.02256.37.0	EUV-WP	EL Produktionsdatum bis: 14.12.2020 Production date to: 14.12.2020
415 CDI (906.153, 906.155, 906.253, 906.255) 95-110 kW (129-150 PS) OM 646.986, OM 646.989, OM 646.990	06.2006→12.2009		7.00782.04.0	DW-TL	EP
416 CDI (906.153, 906.155, 906.253, 906.255) 70-120 kW (95-163 PS) OM 651.955, OM 651.957	03.2009→		7.00782.12.0	DW-TL	EP
			7.02256.37.0	EUV-WP	EL  OM 651.955, OM 651.957: Produktionsdatum bis: 14.12.2020 Production date to: 14.12.2020
424 (906.153, 906.155, 906.253, 906.255) 190 kW (258 PS) M 272.979	06.2006→12.2013		7.22355.01.0	EUV-SR	EL
			7.06117.60.0	ZM-NWV	EL mit Dichtung with O-ring
SPRINTER 4,6-t Van (B906) 144					
411 CDI (906.653, 906.655, 906.657) 80 kW (109 PS) OM 646.985	06.2009→12.2018		7.00782.04.0	DW-TL	EP
413 CDI (906.653, 906.655, 906.657) 70-120 kW (95-163 PS) OM 651.955, OM 651.956	06.2006→05.2016		7.00782.12.0	DW-TL	EP
			7.02256.37.0	EUV-WP	EL
414 CDI 70-120 kW (95-163 PS) OM 651.955	05.2016→		7.00782.12.0	DW-TL	EP
			7.02256.37.0	EUV-WP	EL Produktionsdatum bis: 14.12.2020 Production date to: 14.12.2020
414 CDI 4x4 70-120 kW (95-163 PS) OM 651.955	05.2016→		7.00782.12.0	DW-TL	EP
			7.02256.37.0	EUV-WP	EL Produktionsdatum bis: 14.12.2020 Production date to: 14.12.2020

M









						
SPRINTER 4,6-t Van (B906)						144
415 CDI 70-120 kW (95-163 PS) OM 651.955, OM 651.957	03.2012→		7.00782.12.0	DW-TL	EP	
			7.02256.37.0	EUV-WP	EL	
OM 651.955, OM 651.957: Produktionsdatum bis: 14.12.2020 Production date to: 14.12.2020						
415 CDI (906.653, 906.655, 906.657) 95-110 kW (129-150 PS) OM 646.986, OM 646.989, OM 646.990	06.2009→12.2009		7.00782.04.0	DW-TL	EP	
416 CDI (906.653, 906.655, 906.657) 70-120 kW (95-163 PS) OM 651.955, OM 651.957	03.2009→		7.00782.12.0	DW-TL	EP	
OM 651.955, OM 651.957: Produktionsdatum bis: 14.12.2020 Production date to: 14.12.2020						
416 CDI 4x4 70-120 kW (95-163 PS) OM 651.955, OM 651.957	11.2013→		7.00782.12.0	DW-TL	EP	
OM 651.955, OM 651.957: Produktionsdatum bis: 14.12.2020 Production date to: 14.12.2020						
424 (906.655, 906.657, 906.653) 190 kW (258 PS) M 272.979	06.2006→12.2013		7.22355.01.0	EUV-SR	EL	
			7.06117.60.0	ZM-NWV	EL	
mit Dichtring with O-ring						
SPRINTER 4-t Bus (B904)						145
414 92-105 kW (125-143 PS) M 111.984	02.1996→05.2006		7.02256.37.0	EUV-SR	EL	
			7.06117.20.0	ZM-NWV	EL	
414 95-105 kW (129-143 PS) M 111.979	02.1996→05.2006		7.02256.37.0	EUV-SR	EL	
SPRINTER 4-t Platform/Chassis (B904)						146
408 D 58-60 kW (79-82 PS) OM 601.943	02.1996→05.2006		7.21071.50.0	EUV-DS	EP	
			7.21071.50.0	EUV-DS	EP	
410 D 75-90 kW (102-122 PS) OM 602.980	02.1996→05.2006		7.21071.50.0	EUV-DS	EP	
410 D 4x4 75-90 kW (102-122 PS) OM 602.980	05.1997→05.2006		7.21071.50.0	EUV-DS	EP	
412 D 75-90 kW (102-122 PS) OM 602.980	02.1996→05.2006		7.21071.50.0	EUV-DS	EP	
412 D 75-90 kW (102-122 PS) OM 602.980	02.1996→05.2006		7.21071.50.0	EUV-DS	EP	
412 D 4x4 75-90 kW (102-122 PS) OM 602.980	05.1997→05.2006		7.21071.50.0	EUV-DS	EP	
412 D 4x4 75-90 kW (102-122 PS) OM 602.980	05.1997→05.2006		7.21071.50.0	EUV-DS	EP	
414 (904.012, 904.013, 904.612, 904.613) 92-105 kW (125-143 PS) M 111.984	02.1995→05.2006		7.02256.37.0	EUV-SL	EL	
			7.02256.37.0	EUV-SR	EL	
			7.06117.20.0	ZM-NWV	EL	
414 (904.012, 904.013, 904.612, 904.613) 95-105 kW (129-143 PS) M 111.979	02.1995→05.2006		7.21071.50.0	EUV-DS	EP	
			7.02256.37.0	EUV-SR	EL	



SPRINTER 4-t Platform/Chassis (B904) 146

414 4x4 (904.012, 904.013, 904.612, 904.613) 92-105 kW (125-143 PS) M 111.984	05.1997→05.2006		7.02256.37.0	EUV-SL	EL	
			7.02256.37.0 7.06117.20.0	EUV-SR ZM-NWV	EL EL	
414 4x4 (904.012, 904.013, 904.612, 904.613) 95-105 kW (129-143 PS) M 111.979	05.1997→05.2006		7.21071.50.0	EUV-DS	EP	
			7.02256.37.0	EUV-SR	EL	
414 NGT 92-105 kW (125-143 PS) M 111.979, M 111.984	02.1995→05.2006		7.02256.37.0	EUV-SR	EL	



SPRINTER 4-t Platform/Chassis (B907, B910) 147

411 CDI (910.143) 84-140 kW (114-190 PS) OM 651.950, OM 651.958	02.2018→		7.00782.12.0	DW-TL	EP	
			7.02256.37.0	EUV-WP	EL	 OM 651.950, OM 651.958: Produktionsdatum bis: 14.12.2020 Production date to: 14.12.2020
411 CDI RWD (907.141, 907.143, 907.145, 907.241, 907.243...) 84-120 kW (114-163 PS) OM 651.958	02.2018→		7.00782.12.0	DW-TL	EP	
			7.02256.37.0	EUV-VB	EL	Produktionsdatum bis: 24.02.2021 Production date to: 24.02.2021
414 CDI (910.141, 910.143) 84-140 kW (114-190 PS) OM 651.950, OM 651.958	02.2018→		7.00782.12.0	DW-TL	EP	
			7.02256.37.0	EUV-WP	EL	 OM 651.950, OM 651.958: Produktionsdatum bis: 14.12.2020 Production date to: 14.12.2020
414 CDI All-wheel Drive (907.143, 907.145, 907.243,...) 84-120 kW (114-163 PS) OM 651.958	01.2019→		7.00782.12.0	DW-TL	EP	
			7.02256.37.0	EUV-WP	EL	Produktionsdatum bis: 14.12.2020 Production date to: 14.12.2020
414 CDI RWD (907.143, 907.145, 907.243, 907.245, 907.141...) 84-120 kW (114-163 PS) OM 651.958	02.2018→		7.00782.12.0	DW-TL	EP	
			7.02256.37.0	EUV-WP	EL	Produktionsdatum bis: 14.12.2020 Production date to: 14.12.2020
416 CDI All-wheel Drive (907.143, 907.145, 907.243,...) 84-120 kW (114-163 PS) OM 651.958	01.2019→		7.00782.12.0	DW-TL	EP	
			7.02256.37.0	EUV-WP	EL	Produktionsdatum bis: 14.12.2020 Production date to: 14.12.2020
416 CDI RWD (907.143, 907.145, 907.243, 907.141, 907.241...) 84-120 kW (114-163 PS) OM 651.958	02.2018→		7.00782.12.0	DW-TL	EP	
			7.02256.37.0	EUV-WP	EL	Produktionsdatum bis: 14.12.2020 Production date to: 14.12.2020













M





SPRINTER 4-t Tourer Bus (B907) 148

414 CDI (907.643) 84-120 kW (114-163 PS) OM 651.958	09.2019→		7.00782.12.0	DW-TL	EP	Produktionsdatum bis: 14.12.2020 Production date to: 14.12.2020
			7.02256.37.0	EUV-WP	EL	
416 CDI (907.843) 84-120 kW (114-163 PS) OM 651.958	09.2019→		7.00782.12.0	DW-TL	EP	Produktionsdatum bis: 14.12.2020 Production date to: 14.12.2020
			7.02256.37.0	EUV-WP	EL	

SPRINTER 4-t Van (B904) 149

408 D 58-60 kW (79-82 PS) OM 601.943	02.1996→05.2006		7.21071.50.0	EUV-DS	EP	
410 D 75-90 kW (102-122 PS) OM 602.980	02.1996→05.2006		7.21071.50.0	EUV-DS	EP	
410 D 4x4 75-90 kW (102-122 PS) OM 602.980	05.1997→05.2006		7.21071.50.0	EUV-DS	EP	
412 D 75-90 kW (102-122 PS) OM 602.980	02.1996→05.2006		7.21071.50.0	EUV-DS	EP	
412 D 75-90 kW (102-122 PS) OM 602.980	02.1996→05.2006		7.21071.50.0	EUV-DS	EP	
412 D 4x4 75-90 kW (102-122 PS) OM 602.980	05.1997→05.2006		7.21071.50.0	EUV-DS	EP	
412 D 4x4 75-90 kW (102-122 PS) OM 602.980	05.1997→05.2006		7.21071.50.0	EUV-DS	EP	
M 414 (904.062, 904.063, 904.662, 904.663) 92-105 kW (125-143 PS) M 111.984	02.1996→05.2006		7.02256.37.0	EUV-SL	EL	
			7.02256.37.0	EUV-SR	EL	
			7.06117.20.0	ZM-NWV	EL	
414 (904.062, 904.063, 904.662, 904.663) 95-105 kW (129-143 PS) M 111.979	02.1996→05.2006		7.21071.50.0	EUV-DS	EP	
			7.02256.37.0	EUV-SR	EL	
414 4x4 (904.062, 904.063, 904.662, 904.663) 92-105 kW (125-143 PS) M 111.984	05.1997→05.2006		7.21071.50.0	EUV-DS	EP	
			7.02256.37.0	EUV-SR	EL	
			7.06117.20.0	ZM-NWV	EL	
414 4x4 (904.062, 904.063, 904.662, 904.663) 95-105 kW (129-143 PS) M 111.979	05.1997→05.2006		7.02256.37.0	EUV-SR	EL	
414 NGT 92-105 kW (125-143 PS) M 111.979, M 111.984	02.1995→05.2006		7.02256.37.0	EUV-SR	EL	







SPRINTER 4-t Van (B907, B910) 150

411 CDI (910.641, 910.643) 84-140 kW (114-190 PS) OM 651.950, OM 651.958	02.2018→		7.00782.12.0	DW-TL	EP	OM 651.950, OM 651.958: Produktionsdatum bis: 14.12.2020 Production date to: 14.12.2020
			7.02256.37.0	EUV-WP	EL	
411 CDI RWD (907.643, 907.645) 84-120 kW (114-163 PS) OM 651.958	02.2018→		7.00782.12.0	DW-TL	EP	Produktionsdatum bis: 24.02.2021 Production date to: 24.02.2021
			7.02256.37.0	EUV-VB	EL	



SPRINTER 4-t Van (B907, B910)



150

414 CDI (910.643, 910.641) 84-120 kW (114-163 PS) OM 651.958	02.2018→		7.00782.12.0 DW-TL EP	Produktionsdatum bis: 14.12.2020 Production date to: 14.12.2020
			7.02256.37.0 EUV-WP EL	
414 CDI All-wheel Drive (907.643, 907.645, 907.647) 84-120 kW (114-163 PS) OM 651.958	01.2019→		7.00782.12.0 DW-TL EP	Produktionsdatum bis: 14.12.2020 Production date to: 14.12.2020
			7.02256.37.0 EUV-WP EL	
414 CDI RWD (907.643, 907.645, 907.647) 84-120 kW (114-163 PS) OM 651.958	02.2018→		7.00782.12.0 DW-TL EP	Produktionsdatum bis: 14.12.2020 Production date to: 14.12.2020
			7.02256.37.0 EUV-WP EL	
416 CDI All-wheel Drive (907.643, 907.645, 907.647) 84-120 kW (114-163 PS) OM 651.958	01.2019→		7.00782.12.0 DW-TL EP	Produktionsdatum bis: 14.12.2020 Production date to: 14.12.2020
			7.02256.37.0 EUV-WP EL	
416 CDI RWD (907.643, 907.645, 907.647) 84-120 kW (114-163 PS) OM 651.958	02.2018→		7.00782.12.0 DW-TL EP	Produktionsdatum bis: 14.12.2020 Production date to: 14.12.2020
			7.02256.37.0 EUV-WP EL	
417 CDI RWD (907.641, 907.643, 907.645, 907.647) 84-235 kW (114-320 PS) OM 654.920	06.2020→		7.02256.37.0 EUV-AGR EL	Produktionsdatum bis: 15.12.2020 Production date to: 15.12.2020

M

SPRINTER 5-t Bus (B906)

151

513 CDI (906.655, 906.657) 70-120 kW (95-163 PS) OM 651.955	03.2009→		7.00782.12.0 DW-TL EP	Produktionsdatum bis: 14.12.2020 Production date to: 14.12.2020
			7.02256.37.0 EUV-VB EL	
515 CDI (906.755, 906.757) 85-120 kW (116-163 PS) OM 651.957	06.2006→		7.00782.12.0 DW-TL EP	Produktionsdatum bis: 14.12.2020 Production date to: 14.12.2020
			7.02256.37.0 EUV-WP EL	
516 CDI (906.655, 906.657) 70-120 kW (95-163 PS) OM 651.955	03.2009→		7.02256.37.0 EUV-WP EL	Produktionsdatum bis: 14.12.2020 Production date to: 14.12.2020

SPRINTER 5-t Platform/Chassis (B906)

152

509 CDI (906.153, 906.155, 906.253, 906.255) 65 kW (88 PS) OM 646.984	06.2006→12.2009		7.00782.04.0 DW-TL EP	
510 CDI (906.153, 906.155, 906.253, 906.255) 70-120 kW (95-163 PS) OM 651.955	03.2009→		7.00782.12.0 DW-TL EP	Produktionsdatum bis: 14.12.2020 Production date to: 14.12.2020
			7.02256.37.0 EUV-WP EL	
511 CDI (906.153, 906.155, 906.253, 906.255) 80 kW (109 PS) OM 646.985	06.2006→12.2009		7.00782.04.0 DW-TL EP	







SPRINTER 5-t Plattform/Chassis (B906) 152

511 CDI (906.153, 906.155, 906.253, 906.255) 70-120 kW (95-163 PS) OM 651.955	05.2016→		7.00782.12.0	DW-TL	EP	Produktionsdatum bis: 14.12.2020 Production date to: 14.12.2020
			7.02256.37.0	EUV-WP	EL	
511 CDI 4x4 (906.155, 906.253, 906.255) 80 kW (109 PS) OM 646.985	06.2006→12.2009		7.00782.04.0	DW-TL	EP	
513 CDI (906.155, 906.253, 906.255) 95-110 kW (129-150 PS) OM 646.986	06.2006→05.2016		7.00782.04.0	DW-TL	EP	
513 CDI (906.155, 906.253, 906.255) 70-120 kW (95-163 PS) OM 651.955, OM 651.957	06.2006→05.2016		7.00782.12.0	DW-TL	EP	
			7.02256.37.0	EUV-WP	EL	
513 CDI 4x4 (906.155, 906.253, 906.255) 70-120 kW (95-163 PS) OM 651.955, OM 651.957	05.2011→05.2016		7.00782.12.0	DW-TL	EP	
			7.02256.37.0	EUV-WP	EL	
514 CDI (906.153, 906.155, 906.253, 906.255) 70-120 kW (95-163 PS) OM 651.955	05.2016→		7.00782.12.0	DW-TL	EP	Produktionsdatum bis: 14.12.2020 Production date to: 14.12.2020
			7.02256.37.0	EUV-WP	EL	
M 514 CDI 4x4 (906.153, 906.155, 906.253, 906.255) 70-120 kW (95-163 PS) OM 651.955	05.2016→		7.00782.12.0	DW-TL	EP	Produktionsdatum bis: 14.12.2020 Production date to: 14.12.2020
			7.02256.37.0	EUV-WP	EL	
515 CDI (906.153, 906.155, 906.253, 906.255) 95-110 kW (129-150 PS) OM 646.986, OM 646.989, OM 646.990	06.2006→12.2009		7.00782.04.0	DW-TL	EP	
515 CDI 4x4 (906.153, 906.155, 906.253, 906.255) 95-110 kW (129-150 PS) OM 646.986, OM 646.989, OM 646.990	06.2006→12.2009		7.00782.04.0	DW-TL	EP	
516 (906.153, 906.155, 906.253, 906.255) 115 kW (156 PS) M 271.951	09.2008→		7.06117.24.0	ZM-NWV	EL	 mit Dichtring with O-ring
516 CDI (906.153, 906.155, 906.253, 906.255) 70-120 kW (95-163 PS) OM 651.955, OM 651.957	03.2009→		7.00782.12.0	DW-TL	EP	OM 651.955, OM 651.957: Produktionsdatum bis: 14.12.2020 Production date to: 14.12.2020
			7.02256.37.0	EUV-WP	EL	
516 CDI 4x4 (906.153, 906.155, 906.255) 70-120 kW (95-163 PS) OM 651.955, OM 651.957	05.2011→		7.00782.12.0	DW-TL	EP	OM 651.955, OM 651.957: Produktionsdatum bis: 14.12.2020 Production date to: 14.12.2020
			7.02256.37.0	EUV-WP	EL	







SPRINTER 5-t Platform/Chassis (B906)

152

516 NGT (906.153, 906.155, 906.253, 906.255) 115 kW (156 PS) M 271.951	09.2008→	 7.06117.24.0	ZM-NWV	EL	 mit Dichtring with O-ring
518 CDI (906.153, 906.155, 906.253, 906.255) 135-140 kW (184-190 PS) OM 642.896, OM 642.986, OM 642.992, OM 642.993	06.2006→12.2009	 7.02256.37.0	EUV-VB	EL	
518 CDI 4x4 (906.153, 906.155, 906.253, 906.255) 135-140 kW (184-190 PS) OM 642.896, OM 642.986, OM 642.992, OM 642.993	06.2006→12.2009	 7.02256.37.0	EUV-VB	EL	
524 (906.153, 906.155, 906.253, 906.255) 190 kW (258 PS) M 272.979	06.2006→12.2013	 7.22355.01.0 7.06117.60.0	EUV-SR ZM-NWV	EL EL	mit Dichtring with O-ring

SPRINTER 5-t Platform/Chassis (B907)

153

511 CDI (907.153, 907.155, 907.253, 907.255) 84-120 kW (114-163 PS) OM 651.958	02.2018→	 7.00782.12.0 7.02256.37.0	DW-TL EUV-VB	EP EL	 Produktionsdatum bis: 24.02.2021 Production date to: 24.02.2021
514 CDI (907.153, 907.155, 907.253, 907.255) 84-120 kW (114-163 PS) OM 651.958	02.2018→	 7.00782.12.0 7.02256.37.0	DW-TL EUV-WP	EP EL	 Produktionsdatum bis: 14.12.2020 Production date to: 14.12.2020
516 CDI (907.153, 907.155, 907.253, 907.255) 84-120 kW (114-163 PS) OM 651.958	02.2018→	 7.00782.12.0 7.02256.37.0	DW-TL EUV-WP	EP EL	 Produktionsdatum bis: 14.12.2020 Production date to: 14.12.2020
516 CDI All-wheel Drive (907.153, 907.155, 907.253, ...) 84-120 kW (114-163 PS) OM 651.958	01.2019→	 7.00782.12.0 7.02256.37.0	DW-TL EUV-WP	EP EL	 Produktionsdatum bis: 14.12.2020 Production date to: 14.12.2020

M



SPRINTER 5-t Tourer Bus (B907)





154





















516 CDI (907.855, 907.857) 84-120 kW (114-163 PS) OM 651.958	09.2019→	 7.00782.12.0 7.02256.37.0	DW-TL EUV-WP	EP EL	 Produktionsdatum bis: 14.12.2020 Production date to: 14.12.2020
--	----------	--	---------------------	--------------	--

SPRINTER 5-t Van (B906)

155

509 CDI (906.653, 906.655, 906.657) 65 kW (88 PS) OM 646.984	06.2006→12.2009	 7.00782.04.0	DW-TL	EP	
510 CDI (906.653, 906.655, 906.657) 70-120 kW (95-163 PS) OM 651.955	03.2009→05.2016	 7.00782.12.0 7.02256.37.0	DW-TL EUV-WP	EP EL	

					
SPRINTER 5-t Van (B906)					155
511 CDI (906.653, 906.655, 906.657) 80 kW (109 PS) OM 646.985	06.2006→12.2009		7.00782.04.0	DW-TL	EP
511 CDI (906.653, 906.655, 906.657) 70-120 kW (95-163 PS) OM 651.955	05.2016→		7.00782.12.0 7.02256.37.0	DW-TL EUV-WP	EP EL Produktionsdatum bis: 14.12.2020 Production date to: 14.12.2020
511 CDI 4x4 (906.653, 906.655, 906.657) 80 kW (109 PS) OM 646.985	06.2006→12.2009		7.00782.04.0	DW-TL	EP
513 CDI (906.653, 906.655, 906.657) 95-110 kW (129-150 PS) OM 646.986	06.2006→		7.00782.04.0	DW-TL	EP
513 CDI (906.653, 906.655, 906.657) 70-120 kW (95-163 PS) OM 651.955, OM 651.957	06.2006→		7.00782.12.0 7.02256.37.0	DW-TL EUV-WP	EP EL  OM 651.955, OM 651.957: Produktionsdatum bis: 14.12.2020 Production date to: 14.12.2020
513 CDI 4x4 (906.653, 906.655, 906.657) 70-120 kW (95-163 PS) OM 651.955, OM 651.957	06.2006→		7.00782.12.0 7.02256.37.0	DW-TL EUV-WP	EP EL  OM 651.955, OM 651.957: Produktionsdatum bis: 14.12.2020 Production date to: 14.12.2020
M 514 CDI (906.653, 906.655, 906.657) 70-120 kW (95-163 PS) OM 651.955	05.2016→		7.00782.12.0 7.02256.37.0	DW-TL EUV-WP	EP EL Produktionsdatum bis: 14.12.2020 Production date to: 14.12.2020
514 CDI 4x4 (906.653, 906.655, 906.657) 70-120 kW (95-163 PS) OM 651.955	05.2016→		7.00782.12.0 7.02256.37.0	DW-TL EUV-WP	EP EL Produktionsdatum bis: 14.12.2020 Production date to: 14.12.2020
515 CDI (906.653, 906.655, 906.657) 95-110 kW (129-150 PS) OM 646.986, OM 646.989, OM 646.990	06.2006→12.2009		7.00782.04.0	DW-TL	EP
515 CDI (906.655, 906.653, 906.957, 906.657) 70-120 kW (95-163 PS) OM 651.955	06.2011→		7.00782.12.0 7.02256.37.0	DW-TL EUV-WP	EP EL Produktionsdatum bis: 14.12.2020 Production date to: 14.12.2020
515 CDI 4x4 (906.653, 906.655, 906.657) 95-110 kW (129-150 PS) OM 646.986, OM 646.989, OM 646.990	06.2006→12.2009		7.00782.04.0	DW-TL	EP
516 CDI (906.653, 906.655, 906.657) 70-120 kW (95-163 PS) OM 651.955, OM 651.957	03.2009→		7.00782.12.0 7.02256.37.0	DW-TL EUV-WP	EP EL  OM 651.955, OM 651.957: Produktionsdatum bis: 14.12.2020 Production date to: 14.12.2020
516 CDI 4x4 (906.653, 906.655, 906.657) 70-120 kW (95-163 PS) OM 651.955, OM 651.957	06.2006→		7.00782.12.0 7.02256.37.0	DW-TL EUV-WP	EP EL  OM 651.955, OM 651.957: Produktionsdatum bis: 14.12.2020 Production date to: 14.12.2020

					
SPRINTER 5-t Van (B906)					
155					
518 CDI (906.653, 906.655, 906.657) 135-140 kW (184-190 PS) OM 642.896, OM 642.986, OM 642.992, OM 642.993	06.2006→12.2009		7.02256.37.0	EUV-VB	EL
518 CDI 4x4 (906.653, 906.655, 906.657) 135-140 kW (184-190 PS) OM 642.896, OM 642.986, OM 642.992, OM 642.993	06.2006→12.2009		7.02256.37.0	EUV-VB	EL
524 (906.653, 906.655, 906.657) 190 kW (258 PS) M 272.979	06.2006→12.2013		7.22355.01.0	EUV-SR	EL
			7.06117.60.0	ZM-NWV	EL mit Dichtring with O-ring
SPRINTER 5-t Van (B907)					
156					
511 CDI (907.653, 907.655, 907.657) 84-120 kW (114-163 PS) OM 651.958	02.2018→		7.00782.12.0	DW-TL	EP
			7.02256.37.0	EUV-VB	EL Produktionsdatum bis: 24.02.2021 Production date to: 24.02.2021
514 CDI (907.653, 907.655, 907.657) 84-120 kW (114-163 PS) OM 651.958	02.2018→		7.00782.12.0	DW-TL	EP
			7.02256.37.0	EUV-WP	EL Produktionsdatum bis: 14.12.2020 Production date to: 14.12.2020
516 CDI (907.653, 907.655, 907.657) 84-120 kW (114-163 PS) OM 651.958	02.2018→		7.00782.12.0	DW-TL	EP
			7.02256.37.0	EUV-WP	EL Produktionsdatum bis: 14.12.2020 Production date to: 14.12.2020
516 CDI All-wheel Drive (907.653, 907.655, 907.657) 84-120 kW (114-163 PS) OM 651.958	01.2019→		7.00782.12.0	DW-TL	EP
			7.02256.37.0	EUV-WP	EL Produktionsdatum bis: 14.12.2020 Production date to: 14.12.2020
T1 Bus (B601)					
157					
208 D 2.3 58-60 kW (79-82 PS) OM 601.940	10.1988→06.1995		7.21071.50.0	EUV-LS	EP
208 D 2.3 (601.371, 601.372, 601.376, 601.377) 58-60 kW (79-82 PS) OM 601.940	10.1988→06.1995		7.21071.50.0	EUV-LS	EP
210 D 2.8 70-72 kW (95-98 PS) OM 602.940	11.1988→02.1996		7.21071.50.0	EUV-SR	EP
210 D 2.8 70-72 kW (95-98 PS) OM 602.940	11.1988→02.1996		7.21071.50.0	EUV-SR	EP
T1 Platform/Chassis (601)					
158					
208 D 2.3 58-60 kW (79-82 PS) OM 601.940	11.1988→06.1995		7.21071.50.0	EUV-LS	EP
208 D 2.3 58-60 kW (79-82 PS) OM 601.940	06.1989→06.1995		7.21071.50.0	EUV-LS	EP
210 D 2.8 70-72 kW (95-98 PS) OM 602.940	11.1988→02.1996		7.21071.50.0	EUV-SR	EP
210 D 2.9 70-72 kW (95-98 PS) OM 602.940	11.1988→02.1996		7.21071.50.0	EUV-SR	EP

M





						
T1 Platform/Chassis (B602)						159
310 2.3 70 kW (95 PS) M 102.942	01.1982→12.1994		7.21071.50.0	EUV-AGK	EP	
T1 Van (601, 611)						160
208 D 2.3 58-60 kW (79-82 PS) OM 601.940	10.1988→06.1995		7.21071.50.0	EUV-LS	EP	
208 D 2.3 58-60 kW (79-82 PS) OM 601.940	11.1988→06.1995		7.21071.50.0	EUV-LS	EP	
210 D 2.8 70-72 kW (95-98 PS) OM 602.940	10.1988→02.1996		7.21071.50.0	EUV-SR	EP	
210 D 2.8 70-72 kW (95-98 PS) OM 602.940	10.1988→02.1996		7.21071.50.0	EUV-SR	EP	
T1 Van (B602)						161
310 2.3 77 kW (105 PS) M 102.945	01.1989→12.1995		7.21071.50.0	EUV-AGK	EP	
T2/LN1 Dump Truck						162
507 DK (667.341, 667.342) 53 kW (72 PS) OM 616.914	04.1986→04.1989		7.21071.50.0	EUV-DS	EP	
508 D (667.301, 667.302, 667.341, 667.342) 58-60 kW (79-82 PS) OM 601.941	03.1989→12.1994		7.21071.50.0	EUV-DS	EP	
609 DK (668.041, 668.042) 66 kW (90 PS) OM 364.906	04.1986→12.1994		7.21042.01.0	EUV-DS	EL	
609 DK (668.041, 668.042) 63 kW (86 PS) OM 364.919	07.1987→12.1994		7.21042.01.0	EUV-DS	EL	
709 DK (669.041, 669.042) 66 kW (90 PS) OM 364.906	04.1986→12.1994		7.21042.01.0	EUV-DS	EL	
709 DK (669.041, 669.042) 63 kW (86 PS) OM 364.921	02.1992→12.1994		7.21042.01.0	EUV-DS	EL	
809 DK (670.041, 670.042) 66 kW (90 PS) OM 364.906	04.1986→12.1994		7.21042.01.0	EUV-DS	EL	
809 DK (670.041, 670.042) 63 kW (86 PS) OM 364.921	02.1992→12.1994		7.21042.01.0	EUV-DS	EL	
811 DK (670.341, 670.342) 85 kW (115 PS) OM 364.952	04.1986→12.1994		7.21042.01.0	EUV-DS	EL	
T2/LN1 Platform/Chassis						163
507 D (667.301, 667.302, 667.341, 667.342) 53 kW (72 PS) OM 616.914	04.1986→04.1989		7.21071.50.0	EUV-DS	EP	
510 (667.001, 667.002) 70-77 kW (95-105 PS) M 102.946	04.1986→12.1994		7.21071.50.0	EUV-DS	EP	
510 (667.001, 667.002) 70-77 kW (95-105 PS) M 102.946	04.1986→12.1994		7.21071.50.0	EUV-DS	EP	
609 D (668.001, 668.002, 668.003) 66 kW (90 PS) OM 364.906	04.1986→12.1994		7.21071.50.0	EUV-DS	EP	
			7.21042.01.0	EUV-DS	EL	

M

T2/LN1 Platform/Chassis
163

609 D (668.001, 668.002, 668.003) 63 kW (86 PS) OM 364.919	07.1987→12.1994		7.21071.50.0	EUV-DS	EP
			7.21042.01.0	EUV-DS	EL
709 D (669.000, 669.001, 669.002, 669.003, 669.041) 66 kW (90 PS) OM 364.906	04.1986→12.1994		7.21071.50.0	EUV-DS	EP
			7.21042.01.0	EUV-DS	EL
709 D (669.001, 669.002, 669.003, 669.041, 669.000) 63 kW (86 PS) OM 364.921	04.1986→12.1994		7.21071.50.0	EUV-DS	EP
			7.21042.01.0	EUV-DS	EL
711 D (669.301, 669.302, 669.303) 85 kW (115 PS) OM 364.950	04.1986→12.1994		7.21071.50.0	EUV-DS	EP
			7.21042.01.0	EUV-DS	EL
711 D (669.301, 669.302, 669.303) 77 kW (105 PS) OM 364.957	02.1992→12.1994		7.21071.50.0	EUV-DS	EP
			7.21042.01.0	EUV-DS	EL
809 D (670.001, 670.002, 670.003) 66 kW (90 PS) OM 364.906	04.1986→12.1994		7.21071.50.0	EUV-DS	EP
			7.21042.01.0	EUV-DS	EL
809 D (670.001, 670.002, 670.003) 63 kW (86 PS) OM 364.921	02.1992→12.1994		7.21071.50.0	EUV-DS	EP
			7.21042.01.0	EUV-DS	EL
811 D (670.302, 670.303) 85 kW (115 PS) OM 364.950	04.1986→12.1994		7.21071.50.0	EUV-DS	EP
			7.21042.01.0	EUV-DS	EL
811 D (670.302, 670.303) 85 kW (115 PS) OM 364.952	04.1986→12.1994		7.21042.01.0	EUV-DS	EL
			7.21071.50.0	EUV-DS	EP
811 D (670.303) 77 kW (105 PS) OM 364.958	02.1992→12.1994		7.21042.01.0	EUV-DS	EL
			7.21071.50.0	EUV-DS	EP
814 D (670.312, 670.313) 100 kW (136 PS) OM 364.981, OM 364.986	11.1987→12.1994		7.21042.01.0	EUV-DS	EL
			7.21071.50.0	EUV-DS	EP
814 D (670.312, 670.313) 103 kW (140 PS) OM 354.924	11.1987→12.1994		7.21042.01.0	EUV-DS	EL
			7.21071.50.0	EUV-DS	EP

M
T2/LN1 Van
164

507 D (667.361, 667.362) 53 kW (72 PS) OM 616.914	04.1986→04.1989		7.21071.50.0	EUV-DS	EP
			7.21042.01.0	EUV-DS	EL
508 D (667.361, 667.362) 58-60 kW (79-82 PS) OM 601.941	03.1989→12.1994		7.21071.50.0	EUV-DS	EP
			7.21042.01.0	EUV-DS	EL
510 (667.061, 667.062) 70-77 kW (95-105 PS) M 102.946	04.1986→12.1994		7.21071.50.0	EUV-DS	EP
			7.21042.01.0	EUV-DS	EL
510 (667.061, 667.062) 70-77 kW (95-105 PS) M 102.946	04.1986→12.1994		7.21071.50.0	EUV-DS	EP
			7.21042.01.0	EUV-DS	EL
609 D (668.061, 668.062, 668.063) 66 kW (90 PS) OM 364.906	04.1986→12.1994		7.21071.50.0	EUV-DS	EP
			7.21042.01.0	EUV-DS	EL



T2/LN1 Van **164**

		7.21042.01.0	EUV-DS	EL	
609 D (668.061, 668.062, 668.063) 63 kW (86 PS) OM 364.919	07.1987→12.1994	 7.21071.50.0	EUV-DS	EP	
		7.21042.01.0	EUV-DS	EL	
709 D (669.061, 669.062, 669.063) 66 kW (90 PS) OM 364.906	04.1986→12.1994	 7.21071.50.0	EUV-DS	EP	
		7.21042.01.0	EUV-DS	EL	
709 D (669.061, 669.062, 669.063) 63 kW (86 PS) OM 364.921	02.1992→12.1994	 7.21071.50.0	EUV-DS	EP	
		7.21042.01.0	EUV-DS	EL	
711 D (669.361, 669.362, 669.363) 85 kW (115 PS) OM 364.950	04.1986→12.1994	 7.21071.50.0	EUV-DS	EP	
		7.21042.01.0	EUV-DS	EL	
711 D (669.361, 669.362, 669.363) 77 kW (105 PS) OM 364.957	02.1992→12.1994	 7.21071.50.0	EUV-DS	EP	
		7.21042.01.0	EUV-DS	EL	
809 D (670.061, 670.062, 670.063) 66 kW (90 PS) OM 364.906	04.1986→12.1994	 7.21071.50.0	EUV-DS	EP	
		7.21042.01.0	EUV-DS	EL	
809 D (670.061, 670.062, 670.063) 63 kW (86 PS) OM 364.921	02.1992→12.1994	 7.21071.50.0	EUV-DS	EP	
		7.21042.01.0	EUV-DS	EL	
811 D (670.362, 670.363) 85 kW (115 PS) OM 364.950	04.1986→12.1994	 7.21071.50.0	EUV-DS	EP	
		7.21042.01.0	EUV-DS	EL	
814 D (670.364, 670.365, 670.366) 100 kW (136 PS) OM 364.981, OM 364.986	11.1987→12.1994	 7.21042.01.0	EUV-DS	EL	
814 D (670.364, 670.365, 670.366) 103 kW (140 PS) OM 354.924	11.1987→12.1994	 7.21042.01.0	EUV-DS	EL	

M

V-CLASS (638/2) **165**

V 200 (638.214, 638.294) 95 kW (129 PS) M 111.950	02.1997→07.2003	 7.02256.37.0	EUV-SL	EL	
		7.02256.37.0	EUV-SR	EL	
		7.06117.20.0	ZM-NWV	EL	
V 230 (638.234, 638.294) 105 kW (143 PS) M 111.980	10.1996→07.2003	 7.02256.37.0	EUV-SR	EL	
		7.06117.20.0	ZM-NWV	EL	01.1999→
V 280 (638.244, 638.294) 128 kW (174 PS) M 104.900	08.1997→07.2003	 7.02256.37.0	EUV-SL	EL	

V-CLASS (W447) **166**

V 200 CDI / d (447811, 447813, 447815) 84-140 kW (114-190 PS) OM 651.950	03.2014→	 7.00782.12.0	DW-TL	EP	
		7.02256.37.0	EUV-WP	EL	Produktionsdatum bis: 14.12.2020 Production date to: 14.12.2020

						
V-CLASS (W447)						166
V 200 CDI / d 4-matic 84-140 kW (114-190 PS) OM 651.950	04.2015→		7.02256.37.0	EUV-WP	EL	Produktionsdatum bis: 14.12.2020 Production date to: 14.12.2020
V 220 CDI / d (447811, 447813, 447815) 84-140 kW (114-190 PS) OM 651.950	03.2014→		7.02256.37.0	EUV-WP	EL	Produktionsdatum bis: 14.12.2020 Production date to: 14.12.2020
V 220 CDI / d (447811, 447813, 447815) 84-235 kW (114-320 PS) OM 654.920	03.2019→		7.02256.37.0	EUV-AGR	EL	Produktionsdatum bis: 15.12.2020 Production date to: 15.12.2020
V 220 CDI / d 4-matic 84-140 kW (114-190 PS) OM 651.950	03.2015→		7.02256.37.0	EUV-WP	EL	Produktionsdatum bis: 14.12.2020 Production date to: 14.12.2020
V 220 CDI / d 4-matic (447811, 447813) 84-235 kW (114-320 PS) OM 654.920	03.2019→		7.02256.37.0	EUV-AGR	EL	Produktionsdatum bis: 15.12.2020 Production date to: 15.12.2020
V 250 (447813, 447815) 115-245 kW (156-333 PS) M 274.920	03.2014→		7.00782.16.0	DW-TL	EP	
			7.02256.37.0	EUV-WP	EL	
			7.04818.04.0	SUV	EL	
V 250 BlueTEC / d (447811, 447813, 447815) 84-140 kW (114-190 PS) OM 651.950	03.2014→		7.02256.37.0	EUV-WP	EL	Produktionsdatum bis: 14.12.2020 Production date to: 14.12.2020
V 250 BlueTEC / d 4-matic 84-140 kW (114-190 PS) OM 651.950	12.2014→		7.00782.12.0	DW-TL	EP	
			7.02256.37.0	EUV-WP	EL	Produktionsdatum bis: 14.12.2020 Production date to: 14.12.2020
V 250 CDI / d (447811, 447813, 447815) 84-235 kW (114-320 PS) OM 654.920	03.2019→		7.02256.37.0	EUV-AGR	EL	Produktionsdatum bis: 15.12.2020 Production date to: 15.12.2020
V 250 CDI / d 4-matic (447811, 447813) 84-235 kW (114-320 PS) OM 654.920	03.2019→		7.02256.37.0	EUV-AGR	EL	Produktionsdatum bis: 15.12.2020 Production date to: 15.12.2020
V 300 CDI / d (447811, 447813, 447815) 84-235 kW (114-320 PS) OM 654.920	03.2019→12.2020		7.02256.37.0	EUV-AGR	EL	Produktionsdatum bis: 15.12.2020 Production date to: 15.12.2020
V 300 CDI / d 4-matic (447811, 447813) 84-235 kW (114-320 PS) OM 654.920	03.2019→12.2020		7.02256.37.0	EUV-AGR	EL	Produktionsdatum bis: 15.12.2020 Production date to: 15.12.2020
VARIO						167
814 D 2.9 90 kW (122 PS) OM 602.984, OM 602.985	09.1996→09.2013		7.21071.50.0	EUV-LS	EP	
VARIO Bus (B670)						168
O 812 (670.373, 670.674) 90 kW (122 PS) OM 602.984, OM 602.985	09.1996→12.2010		7.21071.50.0	EUV-LS	EP	
VARIO Dump Truck						169
612 D (668.331, 668.332) 90 kW (122 PS) OM 602.984, OM 602.985	09.1996→12.2010		7.21071.50.0	EUV-LS	EP	
812 D (670.331, 670.332) 90 kW (122 PS) OM 602.984, OM 602.985	09.1996→12.2010		7.21071.50.0	EUV-LS	EP	



M

					
VARIO Platform/Chassis (B670, B668, B667)					170
512 D (667.321, 667.322, 667.323) 90 kW (122 PS) OM 602.984	09.1996→12.2010		7.21071.50.0	EUV-LS	EP
612 D (668.321, 668.322, 668.323) 90 kW (122 PS) OM 602.984, OM 602.985	09.1996→12.2010		7.21071.50.0	EUV-LS	EP
812 D (670.321, 670.322, 670.323, 670.324) 90 kW (122 PS) OM 602.984, OM 602.985	09.1996→12.2010		7.21071.50.0	EUV-LS	EP
VARIO Van (B667, B670, B668)					171
512 D (667.351, 667.352, 667.353) 90 kW (122 PS) OM 602.984	09.1996→12.2010		7.21071.50.0	EUV-LS	EP
612 D (668.351, 668.352, 668.353) 90 kW (122 PS) OM 602.984, OM 602.985	09.1996→12.2010		7.21071.50.0	EUV-LS	EP
812 D (670.351, 670.352, 670.353) 90 kW (122 PS) OM 602.984, OM 602.985	09.1996→12.2010		7.21071.50.0	EUV-LS	EP
813 DA, 814 DA 4x4 (669.599, 670.451, 670.452, 670.453) 95-100 kW (129-136 PS) OM 904.908	09.1996→12.2013		7.21042.01.0	EUV-DS	EL für OE-Nummer: A 001 540 69 97 for OE number: A 001 540 69 97
813 DA, 814 DA 4x4 (669.599, 670.451, 670.452, 670.453) 95-100 kW (129-136 PS) OM 904.908	09.1996→		7.21042.01.0	EUV-DS	EL für OE-Nummer: A 001 540 69 97 for OE number: A 001 540 69 97
815 DA, 816 DA 4x4 (669.599, 670.451, 670.452, 670.453) 112-115 kW (152-156 PS) OM 904.923	09.1996→12.2010		7.21042.01.0	EUV-DS	EL für OE-Nummer: A 001 540 69 97 for OE number: A 001 540 69 97
815 DA, 816 DA 4x4 (669.599, 670.451, 670.452, 670.453) 112-115 kW (152-156 PS) OM 904.923	09.1996→12.2013		7.21042.01.0	EUV-DS	EL für OE-Nummer: A 001 540 69 97 for OE number: A 001 540 69 97
VIANO (W639)					172
3,0 (639.711, 639.811) 140-160 kW (190-218 PS) M 112.951	09.2003→		7.02256.37.0	EUV-SL	EL
			7.22355.01.0	EUV-SR	EL
3,2 (639.713, 639.813, 639.815) 140-160 kW (190-218 PS) M 112.951	09.2003→		7.02256.37.0	EUV-SL	EL
			7.22355.01.0	EUV-SR	EL
3,5 (639.811, 639.813, 639.815) 190 kW (258 PS) M 272.978	09.2007→		7.06117.60.0	ZM-NWV	EL mit Dichtring with O-ring
3,7 (639.811, 639.813, 639.815) 165-170 kW (224-231 PS) M 112.976	06.2004→07.2007		7.02256.37.0	EUV-SL	EL
			7.22355.01.0	EUV-SR	EL
3,7 (639.815) 165-170 kW (224-231 PS) M 112.976	06.2004→		7.02256.37.0	EUV-SL	EL
			7.22355.01.0	EUV-SR	EL
CDI 2.0 (639.711, 639.713, 639.811, 639.813, 639.815) 80-110 kW (109-150 PS) OM 646.982	09.2003→		7.00262.02.0	DW-TL	EP



VIANO (W639)

172

CDI 2.0 (639.711, 639.713, 639.811, 639.813, 639.815) 80-110 kW (109-150 PS) OM 646.982	08.2005→	 7.00262.02.0	DW-TL	EP	
CDI 2.0 (639.811, 639.813, 639.815) 70-120 kW (95-163 PS) OM 651.940	07.2010→	 7.02256.37.0	EUV-WP	EL	Produktionsdatum bis: 14.12.2020 Production date to: 14.12.2020
CDI 2.0 4-matic (639.711, 639.713, 639.811, 639.813,...) 80-110 kW (109-150 PS) OM 646.982	03.2006→	 7.00262.02.0	DW-TL	EP	
CDI 2.0 4-matic (639.713) 80-110 kW (109-150 PS) OM 646.982	07.2005→	 7.00262.02.0	DW-TL	EP	
CDI 2.0 4-matic (639.811, 639.813, 639.815) 70-120 kW (95-163 PS) OM 651.940	07.2010→	 7.02256.37.0	EUV-WP	EL	Produktionsdatum bis: 14.12.2020 Production date to: 14.12.2020
CDI 2.2 (639.711, 639.713, 639.811, 639.813, 639.815) 70-110 kW (95-150 PS) OM 646.980, OM 646.982	09.2003→	 7.00262.02.0	DW-TL	EP	
CDI 2.2 (639.811, 639.813, 639.815) 70-120 kW (95-163 PS) OM 651.940	07.2010→	 7.02256.37.0	EUV-WP	EL	Produktionsdatum bis: 14.12.2020 Production date to: 14.12.2020
CDI 2.2 4-matic (639.711, 639.713, 639.811, 639.813,...) 80-110 kW (109-150 PS) OM 646.982	07.2005→	 7.00262.02.0	DW-TL	EP	
CDI 2.2 4-matic (639.811, 639.813, 639.815) 70-120 kW (95-163 PS) OM 651.940	07.2010→	 7.02256.37.0	EUV-WP	EL	Produktionsdatum bis: 14.12.2020 Production date to: 14.12.2020
CDI 3.0 (639.811, 639.813, 639.815) 150-165 kW (204-224 PS) OM 642.990	03.2006→	 7.02256.37.0	EUV-SR	EL	
CDI 3.0 (639.811, 639.813, 639.815) 165 kW (224 PS) OM 642.890	07.2010→	 7.02256.37.0	EUV-SR	EL	

M













VITO / MIXTO Van (W639)

173

109 CDI (639.601, 639.603, 639.605) 65-80 kW (88-109 PS) OM 646.983	09.2003→	 7.00262.02.0	DW-TL	EP	
109 CDI (639.601, 639.603, 639.605) 70-110 kW (95-150 PS) OM 646.980, OM 646.981	08.2006→	 7.00262.02.0	DW-TL	EP	
110 CDI (639.601, 639.603, 639.605) 70-120 kW (95-163 PS) OM 651.940	09.2010→	 7.02256.37.0	EUV-WP	EL	Produktionsdatum bis: 14.12.2020 Production date to: 14.12.2020
111 CDI (639.601, 639.603) 70-110 kW (95-150 PS) OM 646.980, OM 646.982	09.2007→	 7.00262.02.0	DW-TL	EP	
111 CDI (639.601, 639.603, 639.605) 80-110 kW (109-150 PS) OM 646.982	09.2003→	 7.00262.02.0	DW-TL	EP	
111 CDI 4x4 (639.601, 639.603, 639.605) 80-110 kW (109-150 PS) OM 646.982	09.2007→	 7.00262.02.0	DW-TL	EP	
113 CDI (639.601, 639.603, 639.605) 70-120 kW (95-163 PS) OM 651.940	09.2010→	 7.02256.37.0	EUV-WP	EL	Produktionsdatum bis: 14.12.2020 Production date to: 14.12.2020



VITO / MIXTO Van (W639) 173

113 CDI 4x4 (639.601, 639.603, 639.605) 70-120 kW (95-163 PS) OM 651.940	09.2010→		7.02256.37.0	EUV-WP	EL	Produktionsdatum bis: 14.12.2020 Production date to: 14.12.2020
115 CDI (639.601, 639.603, 639.605) 70-110 kW (95-150 PS) OM 646.980, OM 646.982	09.2003→		7.00262.02.0	DW-TL	EP	
115 CDI (639.605, 639.601, 639.603) 70-120 kW (95-163 PS) OM 651.940	05.2012→02.2015		7.02256.37.0	EUV-WP	EL	Produktionsdatum bis: 14.12.2020 Production date to: 14.12.2020
115 CDI 4x4 (639.601, 639.603, 639.605) 80-110 kW (109-150 PS) OM 646.982	07.2006→		7.00262.02.0	DW-TL	EP	
116 CDI (639.601, 639.603, 639.605) 70-120 kW (95-163 PS) OM 651.940	09.2010→		7.02256.37.0	EUV-WP	EL	Produktionsdatum bis: 14.12.2020 Production date to: 14.12.2020
116 CDI 4x4 (639.601, 639.603, 639.605) 70-120 kW (95-163 PS) OM 651.940	09.2010→		7.02256.37.0	EUV-WP	EL	Produktionsdatum bis: 14.12.2020 Production date to: 14.12.2020
119 (639.601, 639.603, 639.605) 140-160 kW (190-218 PS) M 112.951	09.2003→		7.02256.37.0	EUV-SL	EL	
			7.22355.01.0	EUV-SR	EL	
120 CDI (639.601, 639.603, 639.605) 150-165 kW (204-224 PS) OM 642.990	07.2006→		7.02256.37.0	EUV-SR	EL	
122 (639.601, 639.603, 639.605) 140-160 kW (190-218 PS) M 112.951	09.2003→		7.02256.37.0	EUV-SL	EL	
			7.22355.01.0	EUV-SR	EL	
122 CDI (639.601, 639.603, 639.605) 165 kW (224 PS) OM 642.890	09.2010→		7.02256.37.0	EUV-SR	EL	
123 (639.601) 165-170 kW (224-231 PS) M 112.976	06.2004→07.2008		7.02256.37.0	EUV-SL	EL	
			7.22355.01.0	EUV-SR	EL	
123 (639.601, 639.603, 639.605) 165-170 kW (224-231 PS) M 112.976	06.2004→07.2008		7.02256.37.0	EUV-SL	EL	
			7.22355.01.0	EUV-SR	EL	
126 (639.601, 639.603, 639.605) 190 kW (258 PS) M 272.978	09.2007→		7.06117.60.0	ZM-NWV	EL	mit Dichtring with O-ring

VITO Bus (W638) 174



















113 2.0 (638.114, 638.194) 95 kW (129 PS) M 111.950	02.1996→07.2003		7.02256.37.0	EUV-SL	EL	
			7.02256.37.0	EUV-SR	EL	
			7.06117.20.0	ZM-NWV	EL	
114 2.3 (638.134, 638.194) 105 kW (143 PS) M 111.980	12.1996→07.2003		7.02256.37.0	EUV-SR	EL	
			7.06117.20.0	ZM-NWV	EL	01.1999→



VITO Bus (W639) 175

109 CDI (639.701) 65-80 kW (88-109 PS) OM 646.983	09.2003→	 7.00262.02.0	DW-TL	EP	
109 CDI (639.701, 639.703) 70-110 kW (95-150 PS) OM 646.980	09.2006→	 7.00262.02.0	DW-TL	EP	
109 CDI 4x4 (639.701) 70 kW (95 PS) OM 646.981	09.2007→08.2014	 7.00262.02.0	DW-TL	EP	
110 CDI (639.701, 639.703, 639.705) 70-120 kW (95-163 PS) OM 651.940	09.2010→08.2014	 7.02256.37.0	EUV-WP	EL	Produktionsdatum bis: 14.12.2020 Production date to: 14.12.2020
111 CDI (639.701, 639.703, 639.705) 80-110 kW (109-150 PS) OM 646.982	09.2003→	 7.00262.02.0	DW-TL	EP	
111 CDI (639.701, 639.703, 639.705) 70-110 kW (95-150 PS) OM 646.980	09.2007→	 7.00262.02.0	DW-TL	EP	
111 CDI 4x4 (639.701, 639.703, 639.705) 80-110 kW (109-150 PS) OM 646.982	09.2007→08.2014	 7.00262.02.0	DW-TL	EP	
113 CDI (639.701, 639.703, 639.705) 70-120 kW (95-163 PS) OM 651.940	09.2010→	 7.02256.37.0	EUV-WP	EL	Produktionsdatum bis: 14.12.2020 Production date to: 14.12.2020
113 CDI 4x4 (639.701, 639.703, 639.705) 70-120 kW (95-163 PS) OM 651.940	09.2010→08.2014	 7.02256.37.0	EUV-WP	EL	Produktionsdatum bis: 14.12.2020 Production date to: 14.12.2020
115 CDI (639.701, 639.703, 639.705) 70-110 kW (95-150 PS) OM 646.980, OM 646.982	09.2003→	 7.00262.02.0	DW-TL	EP	
115 CDI 4x4 (639.701, 639.705) 80-110 kW (109-150 PS) OM 646.982	09.2007→08.2014	 7.00262.02.0	DW-TL	EP	
116 CDI (639.701, 639.703, 639.705) 70-120 kW (95-163 PS) OM 651.940	09.2010→	 7.02256.37.0	EUV-WP	EL	Produktionsdatum bis: 14.12.2020 Production date to: 14.12.2020
116 CDI 4x4 (639.701, 639.703, 639.705) 70-120 kW (95-163 PS) OM 651.940	09.2010→08.2014	 7.02256.37.0	EUV-WP	EL	Produktionsdatum bis: 14.12.2020 Production date to: 14.12.2020
119 (639.701, 639.703, 639.705) 140-160 kW (190-218 PS) M 112.951	09.2003→	 7.02256.37.0	EUV-SL	EL	
		 7.22355.01.0	EUV-SR	EL	
120 CDI (639.701, 639.703, 639.705) 150-165 kW (204-224 PS) OM 642.990	07.2006→	 7.02256.37.0	EUV-SR	EL	
122 (639.701, 639.703, 639.705) 140-160 kW (190-218 PS) M 112.951	09.2003→	 7.02256.37.0	EUV-SL	EL	
		 7.22355.01.0	EUV-SR	EL	
122 CDI (639.701, 639.703, 639.705) 165 kW (224 PS) OM 642.890	09.2010→	 7.02256.37.0	EUV-SR	EL	
123 (639.701) 165-170 kW (224-231 PS) M 112.976	06.2004→07.2008	 7.02256.37.0	EUV-SL	EL	
		 7.22355.01.0	EUV-SR	EL	







M

					
VITO Bus (W639)					175
123 (639.701, 639.703, 639.705) 165-170 kW (224-231 PS) M 112.976	06.2004→07.2008		7.02256.37.0	EUV-SL	EL
			7.22355.01.0	EUV-SR	EL
126 (639.701, 639.703, 639.705) 190 kW (258 PS) M 272.978	09.2007→		7.06117.60.0	ZM-NWV	EL mit Dichtring with O-ring
VITO Mixto (Double Cabin) (W447)					176
114 CDI (447.701, 447.703, 447.705) 84-140 kW (114-190 PS) OM 651.950	10.2014→		7.00782.12.0	DW-TL	EP
			7.02256.37.0	EUV-WP	EL Produktionsdatum bis: 14.12.2020 Production date to: 14.12.2020
114 CDI (447.701, 447.703, 447.705) 84-235 kW (114-320 PS) OM 654.920	03.2019→		7.02256.37.0	EUV-AGR	EL Produktionsdatum bis: 15.12.2020 Production date to: 15.12.2020
114 CDI 4-matic (447.701, 447.703, 447.705) 84-140 kW (114-190 PS) OM 651.950	07.2015→		7.00782.12.0	DW-TL	EP
			7.02256.37.0	EUV-WP	EL Produktionsdatum bis: 14.12.2020 Production date to: 14.12.2020
114 CDI 4-matic (447.701, 447.703, 447.705) 84-235 kW (114-320 PS) OM 654.920	03.2019→		7.02256.37.0	EUV-AGR	EL Produktionsdatum bis: 15.12.2020 Production date to: 15.12.2020
M 116 CDI (447.701, 447.703, 447.705) 84-140 kW (114-190 PS) OM 651.950	10.2014→		7.00782.12.0	DW-TL	EP
			7.02256.37.0	EUV-WP	EL Produktionsdatum bis: 14.12.2020 Production date to: 14.12.2020
116 CDI (447.701, 447.703, 447.705) 84-235 kW (114-320 PS) OM 654.920	03.2019→		7.02256.37.0	EUV-AGR	EL Produktionsdatum bis: 15.12.2020 Production date to: 15.12.2020
116 CDI 4-matic (447.701, 447.703, 447.705) 84-140 kW (114-190 PS) OM 651.950	07.2015→		7.00782.12.0	DW-TL	EP
			7.02256.37.0	EUV-WP	EL Produktionsdatum bis: 14.12.2020 Production date to: 14.12.2020
116 CDI 4-matic (447.701, 447.703, 447.705) 84-235 kW (114-320 PS) OM 654.920	03.2019→		7.02256.37.0	EUV-AGR	EL Produktionsdatum bis: 15.12.2020 Production date to: 15.12.2020
119 BlueTEC (447.701, 447.703, 447.705) 84-140 kW (114-190 PS) OM 651.950	10.2014→		7.00782.12.0	DW-TL	EP
			7.02256.37.0	EUV-WP	EL Produktionsdatum bis: 14.12.2020 Production date to: 14.12.2020
119 BlueTEC 4-matic (447.701, 447.703, 447.705) 84-140 kW (114-190 PS) OM 651.950	12.2014→		7.00782.12.0	DW-TL	EP
			7.02256.37.0	EUV-WP	EL Produktionsdatum bis: 14.12.2020 Production date to: 14.12.2020
119 CDI (447.701, 447.703, 447.705) 84-235 kW (114-320 PS) OM 654.920	03.2019→		7.02256.37.0	EUV-AGR	EL Produktionsdatum bis: 15.12.2020 Production date to: 15.12.2020









					
VITO Mixto (Double Cabin) (W447)					
176					
119 CDI 4-matic (447.701, 447.703, 447.705) 84-235 kW (114-320 PS) OM 654.920	03.2019→		7.02256.37.0	EUV-AGR	EL Produktionsdatum bis: 15.12.2020 Production date to: 15.12.2020
124 CDI (447.701, 447.703, 447.705) 84-235 kW (114-320 PS) OM 654.920	04.2020→12.2020		7.02256.37.0	EUV-AGR	EL Produktionsdatum bis: 15.12.2020 Production date to: 15.12.2020
124 CDI 4-matic (447.701, 447.703, 447.705) 84-235 kW (114-320 PS) OM 654.920	04.2020→12.2020		7.02256.37.0	EUV-AGR	EL Produktionsdatum bis: 15.12.2020 Production date to: 15.12.2020
VITO Tourer (W447)					
177					
114 CDI (447.701, 447.703, 447.705) 84-235 kW (114-320 PS) OM 654.920	03.2019→		7.02256.37.0	EUV-AGR	EL Produktionsdatum bis: 15.12.2020 Production date to: 15.12.2020
114 CDI / 114 BlueTEC (447.701, 447.703, 447.705) 84-140 kW (114-190 PS) OM 651.950	10.2014→		7.00782.12.0	DW-TL	EP
			7.02256.37.0	EUV-WP	EL Produktionsdatum bis: 14.12.2020 Production date to: 14.12.2020
114 CDI / 114 BlueTEC 4-matic (447.701, 447.703,...) 84-140 kW (114-190 PS) OM 651.950	07.2015→		7.00782.12.0	DW-TL	EP
			7.02256.37.0	EUV-WP	EL Produktionsdatum bis: 14.12.2020 Production date to: 14.12.2020
114 CDI 4-matic (447.701, 447.703, 447.705) 84-235 kW (114-320 PS) OM 654.920	03.2019→		7.02256.37.0	EUV-AGR	EL Produktionsdatum bis: 15.12.2020 Production date to: 15.12.2020
116 CDI (447.701, 447.703, 447.705) 84-235 kW (114-320 PS) OM 654.920	03.2019→		7.02256.37.0	EUV-AGR	EL Produktionsdatum bis: 15.12.2020 Production date to: 15.12.2020
			7.00782.12.0	DW-TL	EP
116 CDI / 116 BlueTEC (447.701, 447.703, 447.705) 84-140 kW (114-190 PS) OM 651.950	10.2014→		7.00782.12.0	DW-TL	EP
			7.02256.37.0	EUV-WP	EL Produktionsdatum bis: 14.12.2020 Production date to: 14.12.2020
116 CDI / 116 BlueTEC 4-matic (447.701, 447.703,...) 84-140 kW (114-190 PS) OM 651.950	07.2015→		7.00782.12.0	DW-TL	EP
			7.02256.37.0	EUV-WP	EL Produktionsdatum bis: 14.12.2020 Production date to: 14.12.2020
116 CDI 4-matic (447.701, 447.703, 447.705) 84-235 kW (114-320 PS) OM 654.920	03.2019→		7.02256.37.0	EUV-AGR	EL Produktionsdatum bis: 15.12.2020 Production date to: 15.12.2020
119 CDI (447.701, 447.703, 447.705) 84-235 kW (114-320 PS) OM 654.920	03.2019→		7.02256.37.0	EUV-AGR	EL Produktionsdatum bis: 15.12.2020 Production date to: 15.12.2020
			7.00782.12.0	DW-TL	EP
119 CDI / 119 BlueTEC (447.701, 447.703, 447.705) 84-140 kW (114-190 PS) OM 651.950	10.2014→		7.00782.12.0	DW-TL	EP
			7.02256.37.0	EUV-WP	EL Produktionsdatum bis: 14.12.2020 Production date to: 14.12.2020



















M



















VITO Tourer (W447)						177
119 CDI / 119 BlueTEC 4-matic (447.701, 447.703,... 84-140 kW (114-190 PS) OM 651.950	12.2014→		7.00782.12.0	DW-TL	EP	
			7.02256.37.0	EUV-WP	EL	Produktionsdatum bis: 14.12.2020 Production date to: 14.12.2020
119 CDI 4-matic (447.701, 447.703, 447.705) 84-235 kW (114-320 PS) OM 654.920	03.2019→		7.02256.37.0	EUV-AGR	EL	Produktionsdatum bis: 15.12.2020 Production date to: 15.12.2020
119 Flex (447.703) 115-245 kW (156-333 PS) M 274.920	11.2015→		7.00782.16.0	DW-TL	EP	
			7.02256.37.0	EUV-WP	EL	
			7.04818.04.0	SUV	EL	
124 CDI (447.701, 447.703, 447.705) 84-235 kW (114-320 PS) OM 654.920	04.2020→12.2020		7.02256.37.0	EUV-AGR	EL	Produktionsdatum bis: 15.12.2020 Production date to: 15.12.2020
124 CDI 4-matic (447.701, 447.703, 447.705) 84-235 kW (114-320 PS) OM 654.920	04.2020→12.2020		7.02256.37.0	EUV-AGR	EL	Produktionsdatum bis: 15.12.2020 Production date to: 15.12.2020
2.0 (447.703, 447.705) 115-245 kW (156-333 PS) M 274.920	01.2016→		7.00782.16.0	DW-TL	EP	
			7.02256.37.0	EUV-WP	EL	
			7.04818.04.0	SUV	EL	

M

VITO Van (W447)						178
114 CDI (447.601, 447.603, 447.605) 84-140 kW (114-190 PS) OM 651.950	10.2014→		7.00782.12.0	DW-TL	EP	
			7.02256.37.0	EUV-WP	EL	Produktionsdatum bis: 14.12.2020 Production date to: 14.12.2020
114 CDI (447.601, 447.603, 447.605) 84-235 kW (114-320 PS) OM 654.920	04.2020→		7.02256.37.0	EUV-AGR	EL	Produktionsdatum bis: 15.12.2020 Production date to: 15.12.2020
114 CDI 4x4 (447.601, 447.603, 447.605) 84-140 kW (114-190 PS) OM 651.950	07.2015→		7.00782.12.0	DW-TL	EP	
			7.02256.37.0	EUV-WP	EL	Produktionsdatum bis: 14.12.2020 Production date to: 14.12.2020
114 CDI 4x4 (447.701, 447.703, 447.705) 84-235 kW (114-320 PS) OM 654.920	04.2020→		7.02256.37.0	EUV-AGR	EL	Produktionsdatum bis: 15.12.2020 Production date to: 15.12.2020
116 CDI (447.601, 447.603, 447.605) 84-140 kW (114-190 PS) OM 651.950	10.2014→		7.00782.12.0	DW-TL	EP	
			7.02256.37.0	EUV-WP	EL	Produktionsdatum bis: 14.12.2020 Production date to: 14.12.2020
116 CDI (447.601, 447.603, 447.605) 84-235 kW (114-320 PS) OM 654.920	04.2020→		7.02256.37.0	EUV-AGR	EL	Produktionsdatum bis: 15.12.2020 Production date to: 15.12.2020
116 CDI 4x4 (447.601, 447.603, 447.605) 84-140 kW (114-190 PS) OM 651.950	07.2015→		7.00782.12.0	DW-TL	EP	
			7.02256.37.0	EUV-WP	EL	Produktionsdatum bis: 14.12.2020 Production date to: 14.12.2020
116 CDI 4x4 (447.601, 447.603, 447.605) 84-235 kW (114-320 PS) OM 654.920	04.2020→		7.02256.37.0	EUV-AGR	EL	Produktionsdatum bis: 15.12.2020 Production date to: 15.12.2020





					
VITO Van (W447)					178
119 CDI (447.601, 447.603, 447.605) 84-235 kW (114-320 PS) OM 654.920	04.2020→		7.02256.37.0	EUV-AGR	EL Produktionsdatum bis: 15.12.2020 Production date to: 15.12.2020
119 CDI / BlueTEC (447.601, 447.603, 447.605) 84-140 kW (114-190 PS) OM 651.950	10.2014→		7.00782.12.0	DW-TL	EP
			7.02256.37.0	EUV-WP	EL Produktionsdatum bis: 14.12.2020 Production date to: 14.12.2020
119 CDI / BlueTEC 4x4 (447.601, 447.603, 447.605) 84-140 kW (114-190 PS) OM 651.950	07.2015→		7.00782.12.0	DW-TL	EP
			7.02256.37.0	EUV-WP	EL Produktionsdatum bis: 14.12.2020 Production date to: 14.12.2020
119 CDI 4x4 (447.601, 447.603, 447.605) 84-235 kW (114-320 PS) OM 654.920	04.2020→		7.02256.37.0	EUV-AGR	EL Produktionsdatum bis: 15.12.2020 Production date to: 15.12.2020
2.0 (447.603, 447.605) 115-245 kW (156-333 PS) M 274.920	09.2015→		7.00782.16.0	DW-TL	EP
			7.02256.37.0	EUV-WP	EL
			7.04818.04.0	SUV	EL
VITO Van (W638)					179
113 2.0 (638.014, 638.094) 95 kW (129 PS) M 111.950	03.1997→07.2003		7.02256.37.0	EUV-SL	EL
			7.02256.37.0	EUV-SR	EL
			7.06117.20.0	ZM-NWV	EL
X-CLASS Platform/Chassis (470)					180
X 220 d (470.210) 120 kW (163 PS) OM 699.300	09.2017→		7.01814.22.0	DW-TL	EP
X 250 d 4-matic (470.231) 140 kW (190 PS) OM 699.301	09.2017→		7.01814.22.0	DW-TL	EP
UNIMOG					181
UX 100H,UX 100M 85-90 kW (116-122 PS) OM 602.981	09.1996→		7.02256.37.0	EUV-AGR	EL
VARIO Cab with engine					182
613 D, 614 D (669.599, 669.899) 95 kW (129 PS) OM 900.917	01.2006→		7.21042.01.0	EUV-DS	EL für OE-Nummer: A 001 540 69 97 for OE number: A 001 540 69 97
615 D, 616 D (669.599, 669.899) 115 kW (156 PS) OM 900.918	01.2006→		7.21042.01.0	EUV-DS	EL für OE-Nummer: A 001 540 69 97 for OE number: A 001 540 69 97
618 D (669.599, 669.899) 130 kW (177 PS) OM 900.919	09.2006→		7.21042.01.0	EUV-DS	EL für OE-Nummer: A 001 540 69 97 for OE number: A 001 540 69 97

						
A-CLASS (W177)						1
1.3 A 180 L (177.984) 100-120 kW (136-163 PS) M 282.914	11.2018→		7.04818.04.0	SUV	EL	für OE-Nummer: A 000 153 18 59, A 282 090 02 80 for OE number: A 000 153 18 59, A 282 090 02 80
1.3 A 200 L (177.987) 100-120 kW (136-163 PS) M 282.914	11.2018→		7.04818.04.0	SUV	EL	für OE-Nummer: A 000 153 18 59, A 282 090 02 80 for OE number: A 000 153 18 59, A 282 090 02 80
C-CLASS (W204)						2
C 180 (204.049) 115-137 kW (156-186 PS) M 271.820	08.2013→12.2014		7.00017.03.0	LDRV	EP	 mit Dichtring with O-ring
			7.01870.06.0	SUV	EL	
			7.06117.24.0	ZM-NWV	EL	
C 180 CGI (204.049) 115-137 kW (156-186 PS) M 271.820	11.2012→12.2014		7.00017.03.0	LDRV	EP	
			7.01870.06.0	SUV	EL	
C 180 Kompressor (204.045) 115 kW (156 PS) M 271.910	07.2010→12.2012		7.02256.37.0	EUV-AGK	EL	
			7.02256.37.0	EUV-AGR	EL	
			7.02256.37.0	EUV-AT	EL	
			7.02256.37.0	EUV-DS	EL	
			7.02256.37.0	EUV-KK	EL	
			7.02256.37.0	EUV-SL	EL	
			7.02256.37.0	EUV-SR	EL	
			7.02256.37.0	EUV-VB	EL	
			7.02256.37.0	EUV-WP	EL	
			7.06117.24.0	ZM-NWV	EL	
C 200 CGI (204.048) 135-150 kW (184-204 PS) M 271.860	07.2010→12.2012		7.00017.03.0	LDRV	EP	
			7.01870.06.0	SUV	EL	
C 200 Kompressor (204.041) 135 kW (184 PS) M 271.950	03.2008→12.2009		7.02256.37.0	EUV-AGK	EL	
			7.02256.37.0	EUV-AGR	EL	
			7.02256.37.0	EUV-AT	EL	
			7.02256.37.0	EUV-DS	EL	
			7.02256.37.0	EUV-KK	EL	
			7.02256.37.0	EUV-SL	EL	
			7.02256.37.0	EUV-SR	EL	
			7.02256.37.0	EUV-VB	EL	
			7.02256.37.0	EUV-WP	EL	
			7.06117.24.0	ZM-NWV	EL	
C 230 (204.052) 150 kW (204 PS) M 272.921	05.2008→10.2009		7.22355.01.0	EUV-SR	EL	
			7.06117.60.0	ZM-NWV	EL	
C 260 (204.047) 135-150 kW (184-204 PS) M 271.860	08.2013→12.2014		7.01870.06.0	SUV	EL	

M





C-CLASS (W204) 2

C 260 (204.052) 150 kW (204 PS) M 272.921	01.2009→12.2010		7.22355.01.0 EUV-SR EL	mit Dichtring with O-ring
			7.06117.60.0 ZM-NWV EL	
C 260 CGI (204.047) 135-150 kW (184-204 PS) M 271.860	10.2009→12.2014		7.00017.03.0 LDRV EP	mit Dichtring with O-ring
			7.01870.06.0 SUV EL	
			7.06117.24.0 ZM-NWV EL	
C 280 (204.054) 170-180 kW (231-245 PS) M 272.947	03.2008→01.2009		7.22355.01.0 EUV-SR EL	mit Dichtring with O-ring
			7.02256.37.0 EUV-AGK EL	
			7.02256.37.0 EUV-AGR EL	
			7.02256.37.0 EUV-AT EL	
			7.02256.37.0 EUV-DS EL	
			7.02256.37.0 EUV-KK EL	
			7.02256.37.0 EUV-SL EL	
			7.02256.37.0 EUV-SR EL	
			7.02256.37.0 EUV-VB EL	
			7.02256.37.0 EUV-WP EL	
			7.06117.60.0 ZM-NWV EL	
C 300 (204.054) 170-180 kW (231-245 PS) M 272.947	05.2010→12.2011		7.22355.01.0 EUV-SR EL	mit Dichtring with O-ring
			7.06117.60.0 ZM-NWV EL	
C 300 (204.054) 170-180 kW (231-245 PS) M 272.947	07.2011→12.2014		7.02256.37.0 EUV-AGK EL	mit Dichtring with O-ring
			7.02256.37.0 EUV-AGR EL	
			7.02256.37.0 EUV-AT EL	
			7.02256.37.0 EUV-DS EL	
			7.02256.37.0 EUV-KK EL	
			7.02256.37.0 EUV-SL EL	
			7.02256.37.0 EUV-SR EL	
			7.02256.37.0 EUV-VB EL	
			7.02256.37.0 EUV-WP EL	
			7.06117.60.0 ZM-NWV EL	







M

C-CLASS (W205) 3

C 180 L (205.140) 115 kW (156 PS) M 274.910	10.2014→		7.00782.16.0 DW-TL EP	
			7.04818.04.0 SUV EL	
C 200 (205.042) 115-205 kW (156-279 PS) M 274.920	06.2015→		7.00782.16.0 DW-TL EP	
			7.02256.37.0 EUV-WP EL	
			7.04818.04.0 SUV EL	
C 200 4-matic (205.043) 115-205 kW (156-279 PS) M 274.920	06.2015→		7.00782.16.0 DW-TL EP	
			7.02256.37.0 EUV-WP EL	
			7.04818.04.0 SUV EL	



















C-CLASS (W205) **3**

C 200 L (205.142) 115-205 kW (156-279 PS) M 274.920	08.2014→		7.00782.16.0 DW-TL EP
			7.02256.37.0 EUV-WP EL 7.04818.04.0 SUV EL
C 200 L 4-matic (205.143) 115-205 kW (156-279 PS) M 274.920	04.2015→		7.00782.16.0 DW-TL EP
			7.02256.37.0 EUV-WP EL 7.04818.04.0 SUV EL
C 260 L (205.145) 115-205 kW (156-279 PS) M 274.920	08.2014→12.2015		7.00782.16.0 DW-TL EP
			7.02256.37.0 EUV-WP EL 7.04818.04.0 SUV EL
C 300 (205.048) 115-205 kW (156-279 PS) M 274.920	06.2015→		7.00782.16.0 DW-TL EP
			7.02256.37.0 EUV-WP EL 7.04818.04.0 SUV EL
C 300 L (205.148) 115-205 kW (156-279 PS) M 274.920	06.2015→		7.00782.16.0 DW-TL EP
			7.02256.37.0 EUV-WP EL 7.04818.04.0 SUV EL
C 350 eL (205.147) 115-205 kW (156-279 PS) M 274.920	01.2015→		7.00782.16.0 DW-TL EP
			7.02256.37.0 EUV-WP EL 7.04818.04.0 SUV EL
C 350 eL (205.147) 115-205 kW (156-279 PS) M 274.920	01.2015→		7.00782.16.0 DW-TL EP
			7.02256.37.0 EUV-WP EL

M

E-CLASS (W211) **4**







1.8 E 200 Kompressor (211.041) 135 kW (184 PS) M 271.956	09.2006→12.2012		7.02256.37.0 EUV-AGK EL
			7.02256.37.0 EUV-AGR EL
			7.02256.37.0 EUV-AT EL
			7.02256.37.0 EUV-DS EL
			7.02256.37.0 EUV-KK EL
			7.02256.37.0 EUV-SL EL
			7.02256.37.0 EUV-SR EL
			7.02256.37.0 EUV-VB EL
			7.02256.37.0 EUV-WP EL
1.8 E 200 Kompressor (211.042) 120 kW (163 PS) M 271.941	11.2005→12.2006		7.06117.24.0 ZM-NWV EL  mit Dichtring with O-ring
			7.02256.37.0 EUV-AGK EL
			7.02256.37.0 EUV-AGR EL
			7.02256.37.0 EUV-AT EL
			7.02256.37.0 EUV-DS EL
			7.02256.37.0 EUV-KK EL
			7.02256.37.0 EUV-SL EL

					
E-CLASS (W211)					4
			7.02256.37.0 EUV-SR EL 7.02256.37.0 EUV-VB EL 7.02256.37.0 EUV-WP EL 7.06117.24.0 ZM-NWV EL		mit Dichtring with O-ring
2.5 E 230 (211.052) 150 kW (204 PS) M 272.922	11.2005→12.2009		7.22355.01.0 EUV-SR EL 7.06117.60.0 ZM-NWV EL		mit Dichtring with O-ring
3.0 E 280 (211.054) 170 kW (231 PS) M 272.943	11.2005→12.2009		7.22355.01.0 EUV-SR EL 7.06117.60.0 ZM-NWV EL		mit Dichtring with O-ring
3.5 E 350 (211.056) 200 kW (272 PS) M 272.964	11.2005→12.2009		7.22355.01.0 EUV-SR EL 7.02256.37.0 EUV-AGK EL 7.02256.37.0 EUV-AGR EL 7.02256.37.0 EUV-AT EL 7.02256.37.0 EUV-DS EL 7.02256.37.0 EUV-KK EL 7.02256.37.0 EUV-SL EL 7.02256.37.0 EUV-SR EL 7.02256.37.0 EUV-VB EL 7.02256.37.0 EUV-WP EL 7.06117.60.0 ZM-NWV EL		mit Dichtring with O-ring
E-CLASS (W212)					5
E 180 L (212.133) 115-205 kW (156-279 PS) M 274.920	11.2014→		7.00782.16.0 DW-TL EP 7.02256.37.0 EUV-WP EL 7.04818.04.0 SUV EL		
E 200 L (212.134) 115-205 kW (156-279 PS) M 274.920	06.2014→		7.00782.16.0 DW-TL EP 7.02256.37.0 EUV-WP EL 7.04818.04.0 SUV EL		
E 200 L CGI (212.148) 135-150 kW (184-204 PS) M 271.860	03.2011→12.2012		7.00017.03.0 LDRV EP 7.01870.06.0 SUV EL		
E 260 L (212.136) 115-205 kW (156-279 PS) M 274.920	06.2014→		7.00782.16.0 DW-TL EP 7.02256.37.0 EUV-WP EL 7.04818.04.0 SUV EL		
E 260 L CGI (212.147) 135-150 kW (184-204 PS) M 271.860	06.2010→12.2014		7.02256.37.0 EUV-AGK EL 7.02256.37.0 EUV-AGR EL 7.02256.37.0 EUV-AT EL 7.02256.37.0 EUV-DS EL 7.02256.37.0 EUV-KK EL 7.02256.37.0 EUV-SL EL		

M























E-CLASS (W212) **5**

			7.02256.37.0 EUV-SR EL 7.02256.37.0 EUV-VB EL 7.02256.37.0 EUV-WP EL 7.00017.03.0 LDRV EP 7.01870.06.0 SUV EL 7.06117.24.0 ZM-NWV EL		 mit Dichtring with O-ring
E 300 L (212.154) 170-180 kW (231-245 PS) M 272.952	12.2010→12.2014		7.02256.37.0 EUV-AGK EL		
			7.02256.37.0 EUV-AGR EL		
			7.02256.37.0 EUV-AT EL		
			7.02256.37.0 EUV-DS EL		
			7.02256.37.0 EUV-KK EL		
			7.02256.37.0 EUV-SL EL		
			7.02256.37.0 EUV-SR EL		
			7.02256.37.0 EUV-VB EL		
			7.02256.37.0 EUV-WP EL		
7.06117.60.0 ZM-NWV EL	mit Dichtring with O-ring				
E 320 L (212.162) 200-245 kW (272-333 PS) M 276.820	06.2014→		7.00782.11.0 DW-TL EP		
			7.01870.06.0 SUV EL		
E 320 L 4-matic (212.168) 200-245 kW (272-333 PS) M 276.820	06.2014→		7.00782.11.0 DW-TL EP		
			7.01870.06.0 SUV EL		
E 400 L (212.165) 200-245 kW (272-333 PS) M 276.820	08.2013→12.2014		7.00782.11.0 DW-TL EP		
			7.01870.06.0 SUV EL		
E 400 L 4-matic (212.167) 200-245 kW (272-333 PS) M 276.820	06.2014→		7.00782.11.0 DW-TL EP		
			7.01870.06.0 SUV EL		

M

E-CLASS (W213) **6**

E 200 (213.042) 115-205 kW (156-279 PS) M 274.920	01.2016→		7.00782.16.0 DW-TL EP		
			7.02256.37.0 EUV-WP EL		
			7.04818.04.0 SUV EL		
E 200 4-matic (213.043) 115-205 kW (156-279 PS) M 274.920	11.2016→		7.00782.16.0 DW-TL EP		
			7.02256.37.0 EUV-WP EL		
			7.04818.04.0 SUV EL		
E 200 L (213.142) 115-205 kW (156-279 PS) M 274.920	11.2016→		7.00782.16.0 DW-TL EP		
			7.02256.37.0 EUV-WP EL		
			7.04818.04.0 SUV EL		
E 200 L 4-matic (213.143) 115-205 kW (156-279 PS) M 274.920	11.2016→		7.00782.16.0 DW-TL EP		
			7.02256.37.0 EUV-WP EL		
			7.04818.04.0 SUV EL		

						
E-CLASS (W213)						6
E 300 (213.048) 115-205 kW (156-279 PS) M 274.920		11.2016→	7.00782.16.0	DW-TL	EP	
			7.02256.37.0	EUV-WP	EL	
			7.04818.04.0	SUV	EL	
E 300 L (213.148) 115-205 kW (156-279 PS) M 274.920		08.2016→	7.00782.16.0	DW-TL	EP	
			7.02256.37.0	EUV-WP	EL	
			7.04818.04.0	SUV	EL	
E 300 e L (213.153) 115-205 kW (156-279 PS) M 274.920		11.2019→	7.00782.16.0	DW-TL	EP	
			7.02256.37.0	EUV-WP	EL	
			7.04818.04.0	SUV	EL	
E 320 L 4-matic (213.163) 200 kW (272 PS) M 276.823		11.2016→	7.00782.11.0	DW-TL	EP	
			7.01870.06.0	SUV	EL	
E 350 e L 115-205 kW (156-279 PS) M 274.920		04.2021→	7.00782.16.0	DW-TL	EP	
GLA (H247)						7
GLA 180 (247.784) 100-120 kW (136-163 PS) M 282.914		09.2020→	7.04818.04.0	SUV	EL für OE-Nummer: A 000 153 18 59, A 282 090 02 80 for OE number: A 000 153 18 59, A 282 090 02 80	
			7.04818.04.0	SUV	EL für OE-Nummer: A 000 153 18 59, A 282 090 02 80 for OE number: A 000 153 18 59, A 282 090 02 80	
			7.04818.04.0	SUV	EL für OE-Nummer: A 000 153 18 59, A 282 090 02 80 for OE number: A 000 153 18 59, A 282 090 02 80	
GLA 200 4-matic (247.788) 100-120 kW (136-163 PS) M 282.914		09.2020→	7.04818.04.0	SUV	EL für OE-Nummer: A 000 153 18 59, A 282 090 02 80 for OE number: A 000 153 18 59, A 282 090 02 80	
GLA (X156)						8
200 (156.943) 75-115 kW (102-156 PS) M 270.910		04.2015→12.2019	7.00782.16.0	DW-TL	EP	
			7.01870.06.0	SUV	EL  M 270.910: Fahrgestellnummer bis: 30786355 Vehicle Identification Number to: 30786355 Produktionsdatum bis: 03.08.2015 Production date to: 03.08.2015	
			7.04818.04.0	SUV	EL  M 270.910: Fahrgestellnummer ab: 30786355 Vehicle Identification Number from: 30786355 Produktionsdatum ab: 03.08.2015 Production date from: 03.08.2015	
					 M 270.910: Fahrgestellnummer ab: 10044275 Vehicle Identification Number from: 10044275 Produktionsdatum ab: 22.12.2015 Production date from: 22.12.2015	

M





GLA (X156) **8**















220 4-matic (156.947) 115-160 kW (156-218 PS) M 270.920	04.2015→12.2019		7.00782.16.0	DW-TL	EP	
			7.01870.06.0	SUV	EL	
			7.04818.04.0	SUV	EL	M 270.920: Fahrgestellnummer bis: 10044275 Vehicle Identification Number to: 10044275 Produktionsdatum bis: 22.12.2015 Production date to: 22.12.2015 M 270.920: Fahrgestellnummer bis: 30786355 Vehicle Identification Number to: 30786355 Produktionsdatum bis: 03.08.2015 Production date to: 03.08.2015 M 270.920: Fahrgestellnummer ab: 10044275 Vehicle Identification Number from: 10044275 Produktionsdatum ab: 22.12.2015 Production date from: 22.12.2015 M 270.920: Fahrgestellnummer ab: 30786355 Vehicle Identification Number from: 30786355 Produktionsdatum ab: 03.08.2015 Production date from: 03.08.2015

M













260 4-matic (156.946) 115-160 kW (156-218 PS) M 270.920	04.2015→12.2019		7.00782.16.0	DW-TL	EP	
			7.01870.06.0	SUV	EL	
			7.04818.04.0	SUV	EL	M 270.920: Fahrgestellnummer bis: 10044275 Vehicle Identification Number to: 10044275 Produktionsdatum bis: 22.12.2015 Production date to: 22.12.2015 M 270.920: Fahrgestellnummer bis: 30786355 Vehicle Identification Number to: 30786355 Produktionsdatum bis: 03.08.2015 Production date to: 03.08.2015 M 270.920: Fahrgestellnummer ab: 10044275 Vehicle Identification Number from: 10044275 Produktionsdatum ab: 22.12.2015 Production date from: 22.12.2015 M 270.920: Fahrgestellnummer ab: 30786355 Vehicle Identification Number from: 30786355 Produktionsdatum ab: 03.08.2015 Production date from: 03.08.2015

GLB (X247) **9**

180 (247.684) 100-120 kW (136-163 PS) M 282.914	04.2020→		7.04818.04.0	SUV	EL	für OE-Nummer: A 000 153 18 59, A 282 090 02 80 for OE number: A 000 153 18 59, A 282 090 02 80
200 (247.687) 100-120 kW (136-163 PS) M 282.914	11.2019→		7.04818.04.0	SUV	EL	für OE-Nummer: A 000 153 18 59, A 282 090 02 80 for OE number: A 000 153 18 59, A 282 090 02 80
200 4-matic (247.688) 100-120 kW (136-163 PS) M 282.914	09.2020→		7.04818.04.0	SUV	EL	für OE-Nummer: A 000 153 18 59, A 282 090 02 80 for OE number: A 000 153 18 59, A 282 090 02 80

						
GLC (X253)						10
200 4-matic (253.943) 115-205 kW (156-279 PS) M 274.920	11.2015→		7.00782.16.0	DW-TL	EP	
			7.02256.37.0 7.04818.04.0	EUV-WP SUV	EL EL	
200 L 4-matic (253.143) 115-205 kW (156-279 PS) M 274.920	01.2019→		7.00782.16.0	DW-TL	EP	
			7.02256.37.0 7.04818.04.0	EUV-WP SUV	EL EL	
260 4-matic (253.946) 115-205 kW (156-279 PS) M 274.920	11.2015→		7.00782.16.0	DW-TL	EP	
			7.02256.37.0	EUV-WP	EL	
260 L 4-matic (253.146) 115-205 kW (156-279 PS) M 274.920	10.2018→		7.00782.16.0	DW-TL	EP	
			7.02256.37.0	EUV-WP	EL	
300 4-matic (253.949) 115-205 kW (156-279 PS) M 274.920	11.2015→		7.00782.16.0	DW-TL	EP	
			7.02256.37.0 7.04818.04.0	EUV-WP SUV	EL EL	
300 L 4-matic (253.149) 115-205 kW (156-279 PS) M 274.920	10.2018→		7.00782.16.0	DW-TL	EP	
			7.02256.37.0 7.04818.04.0	EUV-WP SUV	EL EL	
GLK-CLASS (X204)						11
200 (204.934) 115-205 kW (156-279 PS) M 274.920	06.2014→12.2015		7.00782.16.0	DW-TL	EP	
			7.02256.37.0 7.04818.04.0	EUV-WP SUV	EL EL	
260 4-matic (204.937) 115-205 kW (156-279 PS) M 274.920	08.2013→12.2015		7.00782.16.0	DW-TL	EP	
			7.02256.37.0	EUV-WP	EL	
300 4-matic (204.981) 170-180 kW (231-245 PS) M 272.948	04.2012→12.2015		7.02256.37.0	EUV-AGK	EL	
			7.02256.37.0	EUV-AGR	EL	
			7.02256.37.0	EUV-AT	EL	
			7.02256.37.0	EUV-DS	EL	
			7.02256.37.0	EUV-KK	EL	
			7.02256.37.0	EUV-SL	EL	
			7.02256.37.0	EUV-SR	EL	
			7.02256.37.0	EUV-VB	EL	
			7.02256.37.0 7.06117.60.0	EUV-WP ZM-NWV	EL EL	
					mit Dichtring with O-ring	

M

						
VIANO						1
2.5 V6 140 kW (190 PS) M 272.924	01.2010→12.2012		7.22355.01.0	EUV-SR	EL	
			7.02256.37.0	EUV-AGK	EL	
			7.02256.37.0	EUV-AGR	EL	
			7.02256.37.0	EUV-AT	EL	
			7.02256.37.0	EUV-DS	EL	
			7.02256.37.0	EUV-KK	EL	
			7.02256.37.0	EUV-SL	EL	
			7.02256.37.0	EUV-SR	EL	
			7.02256.37.0	EUV-VB	EL	
			7.06117.60.0	ZM-NWV	EL	
3.0 3.0 V6 165 kW (224 PS) M 272.939	04.2013→03.2016		7.22355.01.0	EUV-SR	EL	
			7.06117.60.0	ZM-NWV	EL	
3.5 3.5 V6 190 kW (258 PS) M 272.978	09.2012→03.2016		7.22355.01.0	EUV-SR	EL	
			7.02256.37.0	EUV-AGK	EL	
			7.02256.37.0	EUV-AGR	EL	
			7.02256.37.0	EUV-AT	EL	
			7.02256.37.0	EUV-DS	EL	
			7.02256.37.0	EUV-KK	EL	
			7.02256.37.0	EUV-SL	EL	
			7.02256.37.0	EUV-SR	EL	
			7.02256.37.0	EUV-VB	EL	
			7.06117.60.0	ZM-NWV	EL	
SPRINTER (B906)						2
2.1 311 CDI 110 kW (150 PS) OM 651.955	11.2011→		7.00782.12.0	DW-TL	EP	
			7.02256.37.0	EUV-WP	EL	
V-CLASS (W448)						3
V 260 / V 260 L (448.813, 448.815) 155 kW (211 PS) M 274.920	03.2016→		7.04818.04.0	SUV	EL	
VITO (V639)						4
119 2.5 140 kW (190 PS) M 272.924	01.2010→03.2016		7.22355.01.0	EUV-SR	EL	
			7.02256.37.0	EUV-AGK	EL	
			7.02256.37.0	EUV-AGR	EL	
			7.02256.37.0	EUV-AT	EL	
			7.02256.37.0	EUV-DS	EL	
			7.02256.37.0	EUV-KK	EL	
			7.02256.37.0	EUV-SL	EL	
			7.02256.37.0	EUV-SR	EL	
			7.02256.37.0	EUV-VB	EL	
			7.06117.60.0	ZM-NWV	EL	
122 3.0 165 kW (224 PS) M 272.939	05.2013→03.2016		7.22355.01.0	EUV-SR	EL	

M



























VITO (V639)						4
			7.06117.60.0	ZM-NWV	EL	mit Dichtring with O-ring
2.1 70-120 kW (95-163 PS) OM 651.940	08.2013→03.2016		7.02256.37.0	EUV-WP	EL	
VITO (W448)						5
2.0 (448.705) 155 kW (211 PS) M 274.920	09.2016→		7.04818.04.0	SUV	EL	

M





			 PIERBURG			
COUGAR Coupe						1
2.5 127 kW (173 PS) 96L	09.1998→12.2002		7.02256.46.0	EUV-AGR	EL	
GRAND MARQUIS						2
4.6 142-178 kW (193-242 PS) 99W	09.1997→12.2000		7.02256.46.0	EUV-AGR	EL	
4.6 142-178 kW (193-242 PS) 99W	09.1999→12.2002		7.02256.46.0	EUV-AGR	EL	
4.6 GS 142-178 kW (193-242 PS) 99W	10.1999→12.2002		7.02256.46.0	EUV-AGR	EL	
4.6 LS 142-178 kW (193-242 PS) 99W	10.1999→12.2002		7.02256.46.0	EUV-AGR	EL	
GRAND MARQUIS Saloon						3
4.6 142-178 kW (193-242 PS) 99W	01.2003→12.2005		7.02256.46.0	EUV-AGR	EL	
4.6 Flexfuel 142-178 kW (193-242 PS) 99W	09.2005→12.2011		7.02256.46.0	EUV-AGR	EL	
MARINER						4
3.0 149 kW (203 PS) AJ03	09.2005→12.2006		7.02256.46.0	EUV-AGR	EL	
3.0 149-179 kW (203-243 PS) T30PDED	09.2007→12.2008		7.02256.46.0	EUV-AGR	EL	
3.0	09.2008→12.2011		7.02256.46.0	EUV-AGR	EL	
3.0 4WD 149 kW (203 PS) AJ03	05.2004→12.2007		7.02256.46.0	EUV-AGR	EL	
3.0 AWD 149-179 kW (203-243 PS) T30PDED	09.2007→12.2010		7.02256.46.0	EUV-AGR	EL	
3.0 AWD 149-179 kW (203-243 PS) T30PDED	09.2007→12.2008		7.02256.46.0	EUV-AGR	EL	
3.0 Flex 179 kW (243 PS) 99G	09.2010→12.2011		7.02256.46.0	EUV-AGR	EL	
3.0 Flex AWD 179 kW (243 PS) 99G	09.2010→12.2011		7.02256.46.0	EUV-AGR	EL	
MILAN Saloon						5
2.3 119 kW (162 PS) C23HDEX	09.2005→12.2009		7.06117.55.0	SV-NWV	EH	
2.3 AWD 119 kW (162 PS) C23HDEX	09.2006→12.2009		7.06117.55.0	SV-NWV	EH	
2.5	09.2009→12.2010		7.06117.33.0	SV-NWV	EL	
2.5 116-143 kW (158-194 PS) C25HDEX	09.2010→12.2011		7.06117.33.0	SV-NWV	EL	
MOUNTAINEER						6
4.0 152-157 kW (207-214 PS) V99E	09.1997→12.2001		7.02256.46.0	EUV-AGR	EL	
4.0 152-157 kW (207-214 PS) V99E	10.2000→12.2005		7.02256.46.0	EUV-AGR	EL	
4.0 152-157 kW (207-214 PS) V99E	09.2001→12.2005		7.02256.46.0	EUV-AGR	EL	
4.0 152-157 kW (207-214 PS) V99E	09.2006→12.2010		7.02256.46.0	EUV-AGR	EL	
4.0 AWD 152-157 kW (207-214 PS) V99E	09.1997→12.2001		7.02256.46.0	EUV-AGR	EL	
4.0 AWD 152-157 kW (207-214 PS) V99E	09.2005→12.2010		7.02256.46.0	EUV-AGR	EL	

M

						
MOUNTAINEER						6
4.0 All-wheel Drive 152-157 kW (207-214 PS) V99E	09.2001→12.2005		7.02256.46.0	EUV-AGR	EL	
4.0 Flexfuel 152-157 kW (207-214 PS) V99E	09.2001→12.2005		7.02256.46.0	EUV-AGR	EL	
4.0 Flexfuel All-wheel Drive 152-157 kW (207-214 PS) V99E	09.2001→12.2005		7.02256.46.0	EUV-AGR	EL	
4.6 142-178 kW (193-242 PS) 99W	10.2000→12.2005		7.02256.46.0	EUV-AGR	EL	
4.6 217 kW (295 PS) C46USEM	09.2005→12.2010		7.02256.46.0	EUV-AGR	EL	
4.6 AWD 217 kW (295 PS) C46USEM	09.2005→12.2010		7.02256.46.0	EUV-AGR	EL	
4.6 All-wheel Drive 142-178 kW (193-242 PS) 99W	10.2000→12.2005		7.02256.46.0	EUV-AGR	EL	
5.0 97-104 kW (132-141 PS) V825	09.1996→12.1999		7.02256.46.0	EUV-AGR	EL	
5.0 97-104 kW (132-141 PS) V825	09.1998→12.2001		7.02256.46.0	EUV-AGR	EL	
5.0 AWD 97-104 kW (132-141 PS) V825	09.1996→12.1998		7.02256.46.0	EUV-AGR	EL	
5.0 AWD 97-104 kW (132-141 PS) V825	09.1998→12.2001		7.02256.46.0	EUV-AGR	EL	
MYSTIQUE						7
2.5 127 kW (173 PS) 96L	09.1994→08.2001		7.02256.46.0	EUV-AGR	EL	
SABLE						8
3.0 101-116 kW (137-158 PS) V99U	07.1999→09.2005		7.02256.46.0	EUV-AGR	EL	
3.0	09.1999→09.2005		7.02256.46.0	EUV-AGR	EL	
3.0 Flexfuel 108-116 kW (147-158 PS) 99USFI	09.2000→12.2004		7.02256.46.0	EUV-AGR	EL	
SABLE Estate						9
3.0 108-116 kW (147-158 PS) 99USFI	09.1999→12.2001		7.02256.46.0	EUV-AGR	EL	
3.0	09.1999→12.2004		7.02256.46.0	EUV-AGR	EL	
3.0 Flexfuel 108-116 kW (147-158 PS) 99USFI	09.2000→12.2004		7.02256.46.0	EUV-AGR	EL	

M



MG 6 Hatchback						1
1.8 T 98-125 kW (133-170 PS) 18 K4G	11.2010→	 7.22908.03.0	LDRV	EL		
MG 6 Saloon						2
1.8 T 98-125 kW (133-170 PS) 18 K4G	11.2010→	 7.22908.03.0	LDRV	EL		
MG ZT						3
1.8 T 16V 98-125 kW (133-170 PS) 18 K4G	01.2003→07.2005	 7.22908.03.0	LDRV	EL		
MG ZT- T						4
1.8 T 16V 98-125 kW (133-170 PS) 18 K4G	01.2003→07.2005	 7.22908.03.0	LDRV	EL		

M



GT **1**

1.4 TGI 110-113 kW (150-154 PS) LE2	11.2014->	 7.03351.12.0	LDRV	EP
--	-----------	---	------	----



M



MINI (R50, R53) **1**

Cooper S 120-160 kW (163-218 PS) W11 B16 A	03.2002→09.2006	 7.02318.01.0	EUV-LS	EL
Cooper S 120-160 kW (163-218 PS) W11 B16 A	07.2004→09.2006	 7.02318.01.0	EUV-LS	EL
John Cooper Works 120-160 kW (163-218 PS) W11 B16 A	03.2006→09.2006	 7.02318.01.0	EUV-LS	EL
S Works 120-160 kW (163-218 PS) W11 B16 A	11.2003→06.2005	 7.02318.01.0	EUV-LS	EL
Works 120-160 kW (163-218 PS) W11 B16 A	11.2003→09.2006	 7.02318.01.0	EUV-LS	EL









MINI (R56) **2**

Cooper 55-90 kW (75-122 PS) N12 B16 A, N16 B16 A	09.2006→11.2013	 7.06117.02.0	SV-NWV	EL
Cooper 55-90 kW (75-122 PS) N12 B16 A, N16 B16 A	10.2006→02.2012	 7.06117.02.0	SV-NWV	EL
Cooper 55-90 kW (75-122 PS) N12 B16 A, N16 B16 A	09.2009→11.2013	 7.06117.02.0	SV-NWV	EL
Cooper D 66-82 kW (90-112 PS) N47 C16 A	06.2010→11.2013	 7.02256.27.0	DW-AGR	EP
		7.02318.01.0	EUV-AGR	EL
Cooper D 82-105 kW (112-143 PS) N47 C20 A	02.2011→11.2013	 7.02256.27.0	DW-AGR	EP
		7.02318.01.0	EUV-AGR	EL
Cooper S 120-141 kW (163-192 PS) N14 B16 A, N14 B16 AB	10.2006→02.2010	 7.01777.17.0	DW-TL	EP
		7.01115.08.0	SUV	EL
		7.06117.02.0	SV-NWV	EL
Cooper S 90-160 kW (122-218 PS) N18 B16 A	03.2010→11.2013	 7.01777.17.0	DW-TL	EP
		7.01115.08.0	SUV	EL
		7.06117.02.0	SV-NWV	EL
Cooper S 90-160 kW (122-218 PS) N18 B16 A	03.2010→11.2013	 7.01777.17.0	DW-TL	EP
		7.01115.08.0	SUV	EL
		7.06117.02.0	SV-NWV	EL
Cooper S John Cooper Works 120-141 kW (163-192 PS) N14 B16 A, N14 B16 AB	11.2006→02.2010	 7.06117.02.0	SV-NWV	EL
		7.01777.17.0	DW-TL	EP
Cooper S John Cooper Works 90-160 kW (122-218 PS) N18 B16 A	01.2012→11.2013	 7.01777.17.0	DW-TL	EP
		7.01115.08.0	SUV	EL
		7.06117.02.0	SV-NWV	EL
Cooper SD 82-105 kW (112-143 PS) N47 C20 A	02.2011→11.2013	 7.02256.27.0	DW-AGR	EP
		7.02318.01.0	EUV-AGR	EL
Cooper SD 82-105 kW (112-143 PS) N47 C20 A	02.2011→11.2013	 7.02256.27.0	DW-AGR	EP
		7.02318.01.0	EUV-AGR	EL
		7.01777.17.0	DW-TL	EP
John Cooper Works 141-160 kW (192-218 PS) N14 B16 C	11.2007→11.2013	 7.01777.17.0	DW-TL	EP











M



MINI (R56) 2











			7.01115.08.0	SUV	EL
			7.06117.02.0	SV-NWV	EL
John Cooper Works 155-160 kW (211-218 PS) N18 B16 C	11.2007→11.2013		7.01777.17.0	DW-TL	EP
			7.05367.05.0	SUV	EL
			7.06117.02.0	SV-NWV	EL
John Cooper Works GP 141-160 kW (192-218 PS) N14 B16 C	09.2012→11.2013		7.06117.02.0	SV-NWV	EL
John Cooper Works GP 155-160 kW (211-218 PS) N18 B16 C	09.2012→11.2013		7.01777.17.0	DW-TL	EP
			7.05367.05.0	SUV	EL
			7.06117.02.0	SV-NWV	EL
One 55-70 kW (75-95 PS) N12 B14 A	11.2006→03.2010		7.06117.02.0	SV-NWV	EL
One 55-70 kW (75-95 PS) N12 B14 A	03.2009→03.2010		7.06117.02.0	SV-NWV	EL
One 55-90 kW (75-122 PS) N16 B16 A	03.2010→11.2013		7.06117.02.0	SV-NWV	EL
One 55-90 kW (75-122 PS) N16 B16 A	03.2010→11.2013		7.06117.02.0	SV-NWV	EL
One D 66-82 kW (90-112 PS) N47 C16 A	07.2010→11.2013		7.02256.27.0	DW-AGR	EP
			7.02318.01.0	EUV-AGR	EL
One LPG 55-70 kW (75-95 PS) N12 B14 A	03.2009→03.2010		7.06117.02.0	SV-NWV	EL

MINI CLUBMAN (R55) 3

Cooper 55-90 kW (75-122 PS) N12 B16 A, N16 B16 A	10.2007→12.2013		7.06117.02.0	SV-NWV	EL
Cooper 55-90 kW (75-122 PS) N16 B16 A	03.2010→06.2014		7.06117.02.0	SV-NWV	EL
Cooper 55-90 kW (75-122 PS) N16 B16 A	03.2010→06.2014		7.06117.02.0	SV-NWV	EL
Cooper D 66-82 kW (90-112 PS) N47 C16 A	03.2010→06.2014		7.02318.01.0	EUV-AGR	EL
Cooper D 82-105 kW (112-143 PS) N47 C20 A	02.2011→06.2014		7.02318.01.0	EUV-AGR	EL
Cooper S 120-141 kW (163-192 PS) N14 B16 A	08.2007→07.2010		7.01777.17.0	DW-TL	EP
			7.01115.08.0	SUV	EL
Cooper S 120-141 kW (163-192 PS) N14 B16 AB	08.2007→07.2010		7.01777.17.0	DW-TL	EP
			7.01115.08.0	SUV	EL
			7.06117.02.0	SV-NWV	EL
Cooper S 90-160 kW (122-218 PS) N18 B16 A	10.2007→06.2014		7.01777.17.0	DW-TL	EP
Cooper S 120-141 kW (163-192 PS) N14 B16 A	10.2007→06.2014		7.01777.17.0	DW-TL	EP
			7.01115.08.0	SUV	EL
Cooper S 120-141 kW (163-192 PS) N14 B16 AB	10.2007→06.2014		7.01777.17.0	DW-TL	EP
			7.01115.08.0	SUV	EL



MINI CLUBMAN (R55) 3

			7.06117.02.0	SV-NWV	EL	
Cooper S 90-160 kW (122-218 PS) N18 B16 A	03.2010→06.2014		7.01777.17.0	DW-TL	EP	
			7.01115.08.0	SUV	EL	
			7.06117.02.0	SV-NWV	EL	
Cooper S 90-160 kW (122-218 PS) N18 B16 A	03.2010→06.2014		7.01777.17.0	DW-TL	EP	
			7.01115.08.0	SUV	EL	
			7.06117.02.0	SV-NWV	EL	
Cooper S John Cooper Works 120-141 kW (163-192 PS) N14 B16 AB	10.2008→02.2010		7.01777.17.0	DW-TL	EP	
			7.06117.02.0	SV-NWV	EL	
Cooper SD 82-105 kW (112-143 PS) N47 C20 A	02.2011→06.2014		7.02318.01.0	EUV-AGR	EL	
Cooper SD 82-105 kW (112-143 PS) N47 C20 A	02.2011→06.2014		7.02318.01.0	EUV-AGR	EL	
John Cooper Works 141-160 kW (192-218 PS) N14 B16 C	11.2007→06.2014		7.01777.17.0	DW-TL	EP	
			7.01115.08.0	SUV	EL	
			7.06117.02.0	SV-NWV	EL	
John Cooper Works 155-160 kW (211-218 PS) N18 B16 C	11.2007→06.2014		7.01777.17.0	DW-TL	EP	
			7.05367.05.0	SUV	EL	
			7.06117.02.0	SV-NWV	EL	
One 55-70 kW (75-95 PS) N12 B14 A	03.2009→02.2010		7.06117.02.0	SV-NWV	EL	
One 55-90 kW (75-122 PS) N16 B16 A	03.2010→06.2014		7.06117.02.0	SV-NWV	EL	
One D 66-82 kW (90-112 PS) N47 C16 A	03.2010→06.2014		7.02318.01.0	EUV-AGR	EL	

M

MINI COUNTRYMAN (R60) 4

Cooper 55-90 kW (75-122 PS) N16 B16 A	08.2010→10.2016		7.06117.02.0	SV-NWV	EL	
Cooper 55-90 kW (75-122 PS) N16 B16 A	08.2010→10.2016		7.06117.02.0	SV-NWV	EL	
Cooper 55-90 kW (75-122 PS) N16 B16 A	08.2010→10.2016		7.06117.02.0	SV-NWV	EL	
Cooper ALL4 90-160 kW (122-218 PS) N18 B16 A	11.2012→10.2016		7.06117.02.0	SV-NWV	EL	
Cooper ALL4 55-90 kW (75-122 PS) N16 B16 A	11.2012→10.2016		7.06117.02.0	SV-NWV	EL	
Cooper D 66-82 kW (90-112 PS) N47 C16 A	08.2010→10.2016		7.02256.27.0	DW-TL	EP	07.2014→ Euro 5 Euro 5
			7.02318.01.0	EUV-AGR	EL	
Cooper D 82-105 kW (112-143 PS) N47 C20 A	03.2011→10.2016		7.02256.27.0	DW-AGR	EP	07.2014→ Euro 5 Euro 5
			7.02318.01.0	EUV-AGR	EL	
Cooper D ALL4 66-82 kW (90-112 PS) N47 C16 A	08.2010→10.2016		7.02256.27.0	DW-AGR	EP	07.2014→ Euro 5 Euro 5

























MINI COUNTRYMAN (R60)

4

			7.02318.01.0	EUV-AGR	EL	
Cooper D ALL4 82-105 kW (112-143 PS) N47 C20 A	03.2011→10.2016		7.02256.27.0	DW-AGR	EP	
			7.02318.01.0	EUV-AGR	EL	
Cooper S 90-160 kW (122-218 PS) N18 B16 A	08.2010→10.2016		7.01777.17.0	DW-TL	EP	
			7.01115.08.0	SUV	EL	
			7.06117.02.0	SV-NWV	EL	
Cooper S 90-160 kW (122-218 PS) N18 B16 A	08.2010→10.2016		7.01777.17.0	DW-TL	EP	
			7.01115.08.0	SUV	EL	
			7.06117.02.0	SV-NWV	EL	
Cooper S 90-160 kW (122-218 PS) N18 B16 A	08.2010→10.2016		7.01777.17.0	DW-TL	EP	
			7.01115.08.0	SUV	EL	
			7.06117.02.0	SV-NWV	EL	
Cooper S 90-160 kW (122-218 PS) N18 B16 A	07.2014→10.2016		7.01777.17.0	DW-TL	EP	
			7.01115.08.0	SUV	EL	
			7.06117.02.0	SV-NWV	EL	
Cooper S ALL4 90-160 kW (122-218 PS) N18 B16 A	08.2010→10.2016		7.01777.17.0	DW-TL	EP	
			7.01115.08.0	SUV	EL	
			7.06117.02.0	SV-NWV	EL	
Cooper S ALL4 90-160 kW (122-218 PS) N18 B16 A	08.2010→10.2016		7.01777.17.0	DW-TL	EP	
			7.01115.08.0	SUV	EL	
			7.06117.02.0	SV-NWV	EL	
Cooper S ALL4 90-160 kW (122-218 PS) N18 B16 A	07.2014→10.2016		7.01777.17.0	DW-TL	EP	
			7.01115.08.0	SUV	EL	
			7.06117.02.0	SV-NWV	EL	
Cooper SD 82-105 kW (112-143 PS) N47 C20 A	03.2011→10.2016		7.02256.27.0	DW-AGR	EP	07.2014→ Euro 5 Euro 5
			7.02318.01.0	EUV-AGR	EL	
Cooper SD 82-105 kW (112-143 PS) N47 C20 A	03.2011→10.2016		7.02256.27.0	DW-AGR	EP	07.2014→ Euro 5 Euro 5
			7.02318.01.0	EUV-AGR	EL	
Cooper SD ALL4 82-105 kW (112-143 PS) N47 C20 A	03.2011→10.2016		7.02256.27.0	DW-AGR	EP	07.2014→ Euro 5 Euro 5
			7.02318.01.0	EUV-AGR	EL	
Cooper SD ALL4 82-105 kW (112-143 PS) N47 C20 A	03.2011→10.2016		7.02256.27.0	DW-AGR	EP	07.2014→ Euro 5 Euro 5
			7.02318.01.0	EUV-AGR	EL	
John Cooper Works ALL4 155-160 kW (211-218 PS) N18 B16 C	09.2012→10.2016		7.01777.17.0	DW-TL	EP	
			7.05367.05.0	SUV	EL	
			7.06117.02.0	SV-NWV	EL	





M

						
MINI COUNTRYMAN (R60)						4
John Cooper Works ALL4 155-160 kW (211-218 PS) N18 B16 C	11.2012→10.2016		7.01777.17.0	DW-TL	EP	
			7.05367.05.0	SUV	EL	
			7.06117.02.0	SV-NWV	EL	
One 55-90 kW (75-122 PS) N16 B16 A	08.2010→10.2016		7.06117.02.0	SV-NWV	EL	
One D 66-82 kW (90-112 PS) N47 C16 A	08.2010→10.2016		7.02256.27.0	DW-AGR	EP	07.2014→ Euro 5 Euro 5
			7.02318.01.0	EUV-AGR	EL	
MINI Convertible (R52)						5
Cooper S 120-160 kW (163-218 PS) W11 B16 A	07.2004→11.2007		7.02318.01.0	EUV-LS	EL	
Cooper S 120-160 kW (163-218 PS) W11 B16 A	07.2004→11.2007		7.02318.01.0	EUV-LS	EL	
John Cooper Works 120-160 kW (163-218 PS) W11 B16 A	07.2004→11.2007		7.02318.01.0	EUV-LS	EL	
MINI Convertible (R57)						6
Cooper 55-90 kW (75-122 PS) N12 B16 A, N16 B16 A	12.2008→06.2015		7.06117.02.0	SV-NWV	EL	
Cooper 85-90 kW (116-122 PS) N12 B16 A	12.2008→07.2010		7.06117.02.0	SV-NWV	EL	
Cooper 55-90 kW (75-122 PS) N16 B16 A	03.2010→06.2015		7.06117.02.0	SV-NWV	EL	
Cooper D 66-82 kW (90-112 PS) N47 C16 A	05.2009→11.2013		7.02318.01.0	EUV-AGR	EL	
Cooper D 82-105 kW (112-143 PS) N47 C20 A	02.2011→05.2015		7.02318.01.0	EUV-AGR	EL	
Cooper S 90-160 kW (122-218 PS) N14 B16 A, N18 B16 A	10.2007→06.2015		7.01777.17.0	DW-TL	EP	
			7.01115.08.0	SUV	EL	
			7.06117.02.0	SV-NWV	EL	
Cooper S 120-141 kW (163-192 PS) N14 B16 A	11.2007→12.2008		7.01777.17.0	DW-TL	EP	
			7.01115.08.0	SUV	EL	
			7.06117.02.0	SV-NWV	EL	
Cooper S 120-141 kW (163-192 PS) N14 B16 A, N14 B16 AB	04.2008→07.2010		7.01777.17.0	DW-TL	EP	
			7.01115.08.0	SUV	EL	
			7.06117.02.0	SV-NWV	EL	
Cooper S 120-141 kW (163-192 PS) N14 B16 A, N14 B16 AB	04.2008→07.2010		7.01777.17.0	DW-TL	EP	
			7.01115.08.0	SUV	EL	
			7.06117.02.0	SV-NWV	EL	
Cooper S 90-160 kW (122-218 PS) N18 B16 A	02.2010→06.2015		7.01777.17.0	DW-TL	EP	
			7.01115.08.0	SUV	EL	
			7.06117.02.0	SV-NWV	EL	
Cooper S 90-160 kW (122-218 PS) N18 B16 A	02.2010→06.2015		7.01777.17.0	DW-TL	EP	
			7.01115.08.0	SUV	EL	









M





MINI Convertible (R57) 6

			7.06117.02.0	SV-NWV	EL
Cooper SD 82-105 kW (112-143 PS) N47 C20 A	06.2009→05.2015		7.02318.01.0	EUV-AGR	EL
Cooper SD 82-105 kW (112-143 PS) N47 C20 A	01.2011→05.2015		7.02318.01.0	EUV-AGR	EL
John Cooper Works 141-160 kW (192-218 PS) N14 B16 C	08.2008→05.2015		7.01777.17.0	DW-TL	EP
			7.01115.08.0	SUV	EL
			7.06117.02.0	SV-NWV	EL
John Cooper Works 155-160 kW (211-218 PS) N18 B16 C	08.2008→05.2015		7.05367.05.0	SUV	EL
			7.06117.02.0	SV-NWV	EL
One 55-90 kW (75-122 PS) N16 B16 A	09.2009→06.2015		7.06117.02.0	SV-NWV	EL

MINI Coupe (R58) 7



1.6 Cooper 55-90 kW (75-122 PS) N16 B16 A	10.2014→05.2015		7.06117.02.0	SV-NWV	EL
Cooper 55-90 kW (75-122 PS) N16 B16 A	12.2010→04.2015		7.06117.02.0	SV-NWV	EL
Cooper 55-90 kW (75-122 PS) N16 B16 A	12.2010→04.2015		7.06117.02.0	SV-NWV	EL
Cooper S 90-160 kW (122-218 PS) N18 B16 A	12.2010→04.2015		7.01777.17.0	DW-TL	EP
			7.01115.08.0	SUV	EL
			7.06117.02.0	SV-NWV	EL
Cooper S 90-160 kW (122-218 PS) N18 B16 A	12.2010→04.2015		7.01777.17.0	DW-TL	EP
			7.01115.08.0	SUV	EL
			7.06117.02.0	SV-NWV	EL
Cooper S JCW 90-160 kW (122-218 PS) N18 B16 A	12.2010→04.2015		7.01777.17.0	DW-TL	EP
			7.01115.08.0	SUV	EL
			7.06117.02.0	SV-NWV	EL
Cooper SD 82-105 kW (112-143 PS) N47 C20 A	12.2010→05.2015		7.02256.27.0	DW-AGR	EP
			7.02318.01.0	EUV-AGR	EL
Cooper SD 82-105 kW (112-143 PS) N47 C20 A	12.2010→05.2015		7.02256.27.0	DW-AGR	EP
			7.02318.01.0	EUV-AGR	EL
John Cooper Works 141-160 kW (192-218 PS) N14 B16 C, N18 B16 C	12.2010→05.2015		7.01777.17.0	DW-TL	EP
			7.01115.08.0	SUV	EL
			7.06117.02.0	SV-NWV	EL



















MINI PACEMAN (R61) 8

Cooper 55-90 kW (75-122 PS) N16 B16 A	04.2012→09.2016		7.06117.02.0	SV-NWV	EL
Cooper 55-90 kW (75-122 PS) N16 B16 A	04.2012→09.2016		7.06117.02.0	SV-NWV	EL



MINI PACEMAN (R61) **8**

Cooper ALL4 90-160 kW (122-218 PS) N18 B16 A	11.2012→09.2016		7.01777.17.0	DW-TL	EP	
			7.06117.02.0	SV-NWV	EL	
Cooper ALL4 55-90 kW (75-122 PS) N16 B16 A	07.2013→09.2016		7.06117.02.0	SV-NWV	EL	
Cooper ALL4 55-90 kW (75-122 PS) N16 B16 A	07.2013→09.2016		7.06117.02.0	SV-NWV	EL	
Cooper D 66-82 kW (90-112 PS) N47 C16 A	04.2012→09.2016		7.02256.27.0	DW-AGR	EP	07.2014→ Euro 5 Euro 5
			7.02318.01.0	EUV-AGR	EL	
Cooper D 82-105 kW (112-143 PS) N47 C20 A	07.2012→09.2016		7.02256.27.0	DW-AGR	EP	
			7.02318.01.0	EUV-AGR	EL	
Cooper D ALL4 82-105 kW (112-143 PS) N47 C20 A	03.2012→09.2016		7.02256.27.0	DW-AGR	EP	07.2014→ Euro 5 Euro 5
			7.02318.01.0	EUV-AGR	EL	
Cooper D ALL4 66-82 kW (90-112 PS) N47 C16 A	04.2012→09.2016		7.02256.27.0	DW-AGR	EP	07.2014→ Euro 5 Euro 5
			7.02318.01.0	EUV-AGR	EL	
Cooper S 90-160 kW (122-218 PS) N18 B16 A	11.2012→10.2016		7.01777.17.0	DW-TL	EP	
			7.01115.08.0	SUV	EL	
			7.06117.02.0	SV-NWV	EL	
Cooper S 90-160 kW (122-218 PS) N18 B16 A	01.2014→09.2016		7.01777.17.0	DW-TL	EP	
			7.01115.08.0	SUV	EL	
			7.06117.02.0	SV-NWV	EL	
Cooper S 90-160 kW (122-218 PS) N18 B16 A	07.2014→09.2016		7.01777.17.0	DW-TL	EP	
			7.01115.08.0	SUV	EL	
			7.06117.02.0	SV-NWV	EL	
Cooper S ALL4 90-160 kW (122-218 PS) N18 B16 A	03.2012→09.2016		7.01777.17.0	DW-TL	EP	
			7.01115.08.0	SUV	EL	
			7.06117.02.0	SV-NWV	EL	
Cooper S ALL4 90-160 kW (122-218 PS) N18 B16 A	03.2012→09.2016		7.01777.17.0	DW-TL	EP	
			7.01115.08.0	SUV	EL	
			7.06117.02.0	SV-NWV	EL	
Cooper SD 82-105 kW (112-143 PS) N47 C20 A	03.2012→09.2016		7.02256.27.0	DW-TL	EP	07.2014→ Euro 5 Euro 5
			7.02318.01.0	EUV-AGR	EL	

						
MINI PACEMAN (R61)						
Cooper SD ALL4 82-105 kW (112-143 PS) N47 C20 A	04.2012→09.2016		7.02256.27.0	DW-AGR	EP	07.2014→ Euro 5 Euro 5
			7.02318.01.0	EUV-AGR	EL	
Cooper SD ALL4 82-105 kW (112-143 PS) N47 C20 A	04.2012→09.2016		7.02256.27.0	DW-AGR	EP	07.2014→ Euro 5 Euro 5
			7.02318.01.0	EUV-AGR	EL	
John Cooper Works 155-160 kW (211-218 PS) N18 B16 C	09.2012→09.2016		7.01777.17.0	DW-TL	EP	
			7.05367.05.0	SUV	EL	
			7.06117.02.0	SV-NWV	EL	
John Cooper Works 155-160 kW (211-218 PS) N18 B16 C	03.2013→10.2016		7.01777.17.0	DW-TL	EP	
			7.05367.05.0	SUV	EL	
			7.06117.02.0	SV-NWV	EL	
MINI Roadster (R59)						
Cooper 55-90 kW (75-122 PS) N16 B16 A	11.2011→04.2015		7.06117.02.0	SV-NWV	EL	
			7.06117.02.0	SV-NWV	EL	
Cooper S 90-160 kW (122-218 PS) N18 B16 A	11.2011→04.2015		7.01777.17.0	DW-TL	EP	
			7.01115.08.0	SUV	EL	
			7.06117.02.0	SV-NWV	EL	
Cooper S 90-160 kW (122-218 PS) N18 B16 A	11.2011→04.2015		7.01777.17.0	DW-TL	EP	
			7.01115.08.0	SUV	EL	
			7.06117.02.0	SV-NWV	EL	
Cooper S JCW 90-160 kW (122-218 PS) N18 B16 A	11.2011→04.2015		7.01777.17.0	DW-TL	EP	
			7.01115.08.0	SUV	EL	
			7.06117.02.0	SV-NWV	EL	
Cooper SD 82-105 kW (112-143 PS) N47 C20 A	11.2011→04.2015		7.02256.27.0	DW-AGR	EP	
			7.02318.01.0	EUV-AGR	EL	
Cooper SD 82-105 kW (112-143 PS) N47 C20 A	11.2011→04.2015		7.02256.27.0	DW-AGR	EP	
			7.02318.01.0	EUV-AGR	EL	
John Cooper Works 141-160 kW (192-218 PS) N14 B16 C	11.2011→06.2012		7.01777.17.0	DW-TL	EP	
			7.01115.08.0	SUV	EL	
			7.06117.02.0	SV-NWV	EL	
John Cooper Works 155-160 kW (211-218 PS) N18 B16 C	07.2012→04.2015		7.01777.17.0	DW-TL	EP	
			7.05367.05.0	SUV	EL	
			7.06117.02.0	SV-NWV	EL	

8

9

M



MINI CLUBVAN (R55) 10

Cooper 55-90 kW (75-122 PS) N16 B16 A	12.2012→06.2014	 7.06117.02.0	SV-NWV	EL
Cooper D 66-82 kW (90-112 PS) N47 C16 A	12.2012→06.2014	 7.02318.01.0	EUV-AGR	EL
Cooper D 82-105 kW (112-143 PS) N47 C20 A	12.2012→06.2014	 7.02318.01.0	EUV-AGR	EL
One 55-90 kW (75-122 PS) N16 B16 A	12.2012→06.2014	 7.06117.02.0	SV-NWV	EL









M

















ASX (GA_W_) 1



































1.6 DI-D 84 kW (114 PS) 9HD	07.2015→	 7.01633.06.0	DW-TL	EP
1.6 DI-D 4WD 84 kW (114 PS) 9HD	07.2015→	 7.01633.06.0	DW-TL	EP

Canter (FE5, FE6) VI 2































413 96 kW (131 PS) 4P10-T2	01.2012→	 7.02968.02.0	DW-TL	EP
515, 516 110 kW (150 PS) 4P10-7AT4, 4P10-T4	01.2012→	 7.02968.02.0	DW-TL	EP
615, 616 110 kW (150 PS) 4P10-7AT4, 4P10-T4	01.2012→	 7.02968.02.0	DW-TL	EP
616 110 kW (150 PS) 4P10-7AT4	08.2012→	 7.02968.02.0	DW-TL	EP
6C18 4X4 110 kW (150 PS) 4P10-T4	01.2012→	 7.02968.02.0	DW-TL	EP
715 110 kW (150 PS) 4P10-T4	01.2012→	 7.02968.02.0	DW-TL	EP
815, 816 110 kW (150 PS) 4P10-7AT4, 4P10-T4	01.2012→	 7.02968.02.0	DW-TL	EP
916, 918 129 kW (175 PS) 4P10-7AT6, 4P10-T6	01.2012→	 7.02968.02.0	DW-TL	EP

























						
Centroliner						1
N 4516 199 kW (271 PS) D 2066 LUH 21	08.2006→		7.00380.11.0	LDRV	EP	
N 4522 228 kW (310 PS) D 2066 LUH 22	08.2006→		7.00380.11.0	LDRV	EP	
Cityliner						2
N 1216 HD 294 kW (400 PS) D 2066 LOH 03	09.2006→		7.00380.11.0	LDRV	EP	
N 1217 HDC 324-353 kW (440-480 PS) D 2066 LOH 04, D 2066 LOH 08, D 2676 LOH 02, D 2676 LOH 26	07.2006→		7.00380.11.0	LDRV	EP	
N 1218 HDL 324-353 kW (440-480 PS) D 2066 LOH 04, D 2676 LOH 02, D 2676 LOH 04, D 2676 LOH 27	07.2006→		7.00380.11.0	LDRV	EP	
Skyliner						3
Skyliner 353-371 kW (480-505 PS) D 2676 LOH 02, D 2676 LOH 28	09.2002→		7.00380.11.0	LDRV	EP	
Starliner						4
N 5217 SHD 353-371 kW (480-505 PS) D 2676 LOH 04, D 2676 LOH 28	07.2006→		7.00380.11.0	LDRV	EP	
Tourliner						5
N 2216 SHD 294 kW (400 PS) D 2066 LOH 03	06.2006→		7.00380.11.0	LDRV	EP	
N 2216 SHDL 324 kW (440 PS) D 2066 LOH 04	06.2006→		7.00380.11.0	LDRV	EP	

N

						
ALMERA II (N16)						1
2.2 dCi 81-102 kW (110-139 PS) YD22DDT	09.2003→09.2006		7.00265.02.0	DW-TL	EP  Groß Britannien  Great Britain	
ALMERA II Hatchback (N16)						2
2.2 dCi 81-102 kW (110-139 PS) YD22DDT	09.2003→09.2006		7.00265.02.0	DW-TL	EP  Groß Britannien  Great Britain	
ALMERA TINO (V10)						3
1.8 78-94 kW (106-128 PS) QG18DE	12.1998→02.2003		7.00265.02.0	DW-AGR	EP 02.2003→	
1.8 78-94 kW (106-128 PS) QG18DE	08.2000→02.2006		7.00265.02.0	DW-AGR	EP 02.2003→	
1.8 78-94 kW (106-128 PS) QG18DE	12.2002→02.2006		7.00265.02.0	DW-AGR	EP 02.2003→	
2.2 dCi 84-110 kW (114-150 PS) YD22DDTi	08.2000→02.2006		7.00265.02.0	DW-TL	EP 09.2003→	
2.2 dCi 84-110 kW (114-150 PS) YD22DDTi	08.2000→02.2006		7.00265.02.0	DW-TL	EP 09.2003→	
2.2 dCi 84-110 kW (114-150 PS) YD22DDTi	09.2003→02.2006		7.00265.02.0	DW-TL	EP	
CUBE (Z12)						4
1.5 dCi 48-81 kW (65-110 PS) K9K, K9K 270	03.2010→		7.02256.21.0	DW-TL	EP	
GT-R (R35)						5
NISMO 353-448 kW (480-609 PS) VR38DETT	07.2014→		7.01738.01.0	LDRV	EL	
V6 353-448 kW (480-609 PS) VR38DETT	12.2007→10.2010		7.01738.01.0	LDRV	EL 12.2008→	
V6 353-448 kW (480-609 PS) VR38DETT	09.2010→		7.01738.01.0	LDRV	EL	
V6 353-448 kW (480-609 PS) VR38DETT	10.2010→09.2011		7.01738.01.0	LDRV	EL	
V6 353-448 kW (480-609 PS) VR38DETT	10.2011→		7.01738.01.0	LDRV	EL	
V6 353-448 kW (480-609 PS) VR38DETT	07.2012→		7.01738.01.0	LDRV	EL	
V6 353-448 kW (480-609 PS) VR38DETT	06.2013→		7.01738.01.0	LDRV	EL	
V6 353-448 kW (480-609 PS) VR38DETT	07.2014→		7.01738.01.0	LDRV	EL	
V6 353-448 kW (480-609 PS) VR38DETT	01.2015→		7.01738.01.0	LDRV	EL	
V6 353-448 kW (480-609 PS) VR38DETT	06.2016→		7.01738.01.0	LDRV	EL	
V6 353-448 kW (480-609 PS) VR38DETT	09.2016→		7.01738.01.0	LDRV	EL	
V6 353-448 kW (480-609 PS) VR38DETT	11.2016→		7.01738.01.0	LDRV	EL	
JUKE (F15)						6
1.2 DIG-T 85 kW (116 PS) HRA2DDT	05.2014→		7.08681.15.0	EOV	EH	
			7.01343.04.0	LDRV	EP	
1.5 dCi 81 kW (110 PS) K9K 410, K9K 896	06.2010→		7.02256.21.0	DW-TL	EP  K9K 410, K9K 896: Baujahr bis: 05.2014 Construction year to: 05.2014	

























N

















					
JUKE (F15)					6
1.5 dCi 81 kW (110 PS) K9K 636, K9K 646	06.2010→	 7.01814.12.0	DW-TL	EP	 K9K 636, K9K 646: 10.2013→12.2015
		 7.02256.21.0	DW-TL	EP	 K9K 636, K9K 646: Baujahr bis: 05.2014 Construction year to: 05.2014
MICRA C+C III (K12)					7
1.4 16V 65-72 kW (88-98 PS) CR14DE	08.2005→	 7.06117.14.0	SV-NWV	EH	mit Dichtring with O-ring
MICRA III (K12)					8
1.2 48-81 kW (65-110 PS) CR12DE	10.2003→07.2005	 7.06117.14.0	SV-NWV	EH	mit Dichtring with O-ring
1.2 48-81 kW (65-110 PS) CR12DE	08.2005→06.2010	 7.06117.14.0	SV-NWV	EH	mit Dichtring with O-ring
1.2 48-81 kW (65-110 PS) CR12DE	01.2007→06.2010	 7.06117.14.0	SV-NWV	EH	mit Dichtring with O-ring
1.2 16V 48-81 kW (65-110 PS) CR12DE	01.2003→06.2010	 7.06117.14.0	SV-NWV	EH	mit Dichtring with O-ring
1.2 16V 48-81 kW (65-110 PS) CR12DE	01.2003→06.2010	 7.06117.14.0	SV-NWV	EH	mit Dichtring with O-ring
1.2 LPG 48-81 kW (65-110 PS) CR12DE	10.2002→06.2010	 7.06117.14.0	SV-NWV	EH	mit Dichtring with O-ring
1.4 65-72 kW (88-98 PS) CR14DE	03.2007→06.2010	 7.06117.14.0	SV-NWV	EH	mit Dichtring with O-ring
1.4 16V 65-72 kW (88-98 PS) CR14DE	01.2003→06.2010	 7.06117.14.0	SV-NWV	EH	mit Dichtring with O-ring
1.4 4WD (BNK12) 65-72 kW (88-98 PS) CR14DE	01.2007→06.2010	 7.06117.14.0	SV-NWV	EH	mit Dichtring with O-ring
1.5 dCi 48-50 kW (65-68 PS) K9K 708	06.2005→06.2010	 7.02256.21.0	DW-TL	EP	Baujahr ab: 10.2005 Construction year from: 10.2005 Baujahr bis: 01.2007 Construction year to: 01.2007
1.5 dCi 62-66 kW (84-90 PS) K9K 276	06.2005→06.2010	 7.02256.21.0	DW-TL	EP	Baujahr ab: 10.2005 Construction year from: 10.2005 Baujahr bis: 01.2007 Construction year to: 01.2007
MICRA V (K14)					9
0.9 IG-T 64-66 kW (87-90 PS) HR09DET	12.2016→	 7.08681.15.0	EOV	EH	
		 7.01343.04.0	LDRV	EP	
1.5 DCI 63-66 kW (86-90 PS) K9K 628	12.2016→	 7.01814.12.0	DW-TL	EP	→06.2018
NAVARA (D22)					10
2.8 TDI (D22B) 97-103 kW (132-140 PS) WM28DTI, WM28TI	05.2002→12.2007	 7.03964.01.0	DW-TL	EP	
2.8 TDI 4x4 (D22B) 97-103 kW (132-140 PS) WM28DTI, WM28TI	01.2002→07.2005	 7.03964.01.0	DW-TL	EP	
2.8 TDi (D22B) 97-103 kW (132-140 PS) WM28DTI, WM28TI	05.2002→12.2007	 7.03964.01.0	DW-TL	EP	
2.8 TDi (D22B) 97-103 kW (132-140 PS) WM28DTI	08.2005→09.2008	 7.03964.01.0	DW-TL	EP	
2.8 TDi 4x4 (D22B) 97-103 kW (132-140 PS) WM28DTI	08.2005→09.2008	 7.03964.01.0	DW-TL	EP	

						
NOTE (E11, NE11)						11
1.4 65-72 kW (88-98 PS) CR14DE	03.2006→06.2012		7.06117.14.0	SV-NWV	EH mit Dichtring with O-ring	
1.4 LPG 65-72 kW (88-98 PS) CR14DE	01.2006→08.2013		7.06117.14.0	SV-NWV	EH mit Dichtring with O-ring	
1.5 dCi 47-50 kW (64-68 PS) K9K 700	03.2006→06.2012		7.02256.21.0	DW-TL	EP Baujahr ab: 12.2007 Construction year from: 12.2007 Baujahr bis: 04.2010 Construction year to: 04.2010	
1.5 dCi 62-66 kW (84-90 PS) K9K 276	03.2006→06.2012		7.02256.21.0	DW-TL	EP Baujahr ab: 12.2007 Construction year from: 12.2007 Baujahr bis: 04.2010 Construction year to: 04.2010	
1.5 dCi 76-78 kW (103-106 PS) K9K 288	07.2008→06.2012		7.02256.21.0	DW-TL	EP Baujahr bis: 04.2010 Construction year to: 04.2010	
NOTE (E12)						12
1.5 dCi 63-66 kW (86-90 PS) K9K 608	06.2013→		7.01814.12.0	DW-TL	EP 08.2013→12.2015	
NP300 NAVARA (D40)						13
2.5 D 76-140 kW (103-190 PS) YD25DDTi	09.2008→		7.02212.02.0	DW-TL	EP →01.2010	
2.5 dCi 76-140 kW (103-190 PS) YD25DDTi	07.2005→		7.02212.02.0	DW-TL	EP →01.2010	
2.5 dCi 76-140 kW (103-190 PS) YD25DDTi	12.2005→		7.02212.02.0	DW-TL	EP →01.2010	
2.5 dCi 76-140 kW (103-190 PS) YD25DDTi	10.2006→		7.02212.02.0	DW-TL	EP →01.2010	
2.5 dCi 4WD 76-140 kW (103-190 PS) YD25DDTi	07.2005→		7.02212.02.0	DW-TL	EP →01.2010	
2.5 dCi 4WD 76-140 kW (103-190 PS) YD25DDTi	10.2006→		7.02212.02.0	DW-TL	EP →01.2010	
2.5 dCi 4WD 76-140 kW (103-190 PS) YD25DDTi	01.2007→		7.02212.02.0	DW-TL	EP →01.2010	
2.5 dCi 4WD (D40TT, D40T, D40M, D40BB) 76-140 kW (103-190 PS) YD25DDTi	12.2009→		7.02212.02.0	DW-TL	EP →01.2010	
2.8 TDI, CD, SE, XE, SEL 4x4	08.2005→09.2008		7.03964.01.0	DW-TL	EP	
NP300 NAVARA Pickup (D23)						14
2.3 dCi 116-120 kW (158-163 PS) YS23DDT	01.2015→		7.01814.22.0	DW-TL	EP Produktionsdatum ab: 09.2017 Production date from: 09.2017	
2.3 dCi 140 kW (190 PS) YS23DDTT	10.2015→		7.01814.22.0	DW-TL	EP Produktionsdatum ab: 09.2017 Production date from: 09.2017	
2.3 dCi (D231) 116-120 kW (158-163 PS) YS23DDT	01.2015→		7.01814.22.0	DW-TL	EP Produktionsdatum ab: 09.2017 Production date from: 09.2017	
2.3 dCi 4x4 116-120 kW (158-163 PS) YS23DDT	01.2015→		7.01814.22.0	DW-TL	EP Produktionsdatum ab: 09.2017 Production date from: 09.2017	
2.3 dCi 4x4 (D231) 116-120 kW (158-163 PS) YS23DDT	01.2015→		7.01814.22.0	DW-TL	EP Produktionsdatum ab: 09.2017 Production date from: 09.2017	
2.3 dCi 4x4 (D231) 140 kW (190 PS) YS23DDTT	10.2015→		7.01814.22.0	DW-TL	EP Produktionsdatum ab: 09.2017 Production date from: 09.2017	



















						
PATHFINDER III (R51)						15
2.5 dCi 76-140 kW (103-190 PS) YD25DDTi	01.2005→		7.02212.02.0	DW-TL	EP →01.2010	
2.5 dCi 4WD 76-140 kW (103-190 PS) YD25DDTi	01.2005→		7.02212.02.0	DW-TL	EP →01.2010	
2.5 dCi 4WD 76-140 kW (103-190 PS) YD25DDTi	03.2005→		7.02212.02.0	DW-TL	EP →01.2010	
2.5 dCi 4WD 76-140 kW (103-190 PS) YD25DDTi	10.2006→		7.02212.02.0	DW-TL	EP →01.2010	
PRIMERA (P12)						16
2.2 dCi 81-102 kW (110-139 PS) YD22DDT	04.2003→04.2006		7.00265.02.0	DW-TL	EP	
PRIMERA Estate (WP12)						17
2.2 dCi 81-102 kW (110-139 PS) YD22DDT	04.2003→		7.00265.02.0	DW-TL	EP	
PRIMERA Hatchback (P12)						18
2.2 dCi 81-102 kW (110-139 PS) YD22DDT	04.2003→		7.00265.02.0	DW-TL	EP	
PULSAR Hatchback (C13)						19
1.2 DIG-T 85 kW (116 PS) HRA2DDT	10.2014→		7.08681.15.0	EOV	EH	
			7.01343.04.0	LDRV	EP	
QASHQAI / QASHQAI +2 I (J10, NJ10, JJ10E)						20
1.5 dCi 76-78 kW (103-106 PS) K9K 282, K9K 292	02.2007→12.2013		7.02256.17.0	DW-TL	EP	
			7.02256.21.0	DW-TL	EP  K9K 282, K9K 292: Baujahr bis: 01.2010 Construction year to: 01.2010	
1.5 dCi 76-78 kW (103-106 PS) K9K 282, K9K 292	07.2008→12.2013		7.02256.17.0	DW-TL	EP	
			7.02256.21.0	DW-TL	EP  K9K 282, K9K 292: Baujahr bis: 01.2010 Construction year to: 01.2010	
1.5 dCi 81 kW (110 PS) K9K 430	01.2010→12.2013		7.02256.17.0	DW-TL	EP	
2.0 dCi 110-130 kW (150-177 PS) M9R	02.2007→12.2013		7.02256.17.0	DW-TL	EP Baujahr ab: 01.2010 Construction year from: 01.2010	
2.0 dCi All-wheel Drive 110-130 kW (150-177 PS) M9R	02.2007→12.2013		7.02256.17.0	DW-TL	EP Baujahr ab: 01.2010 Construction year from: 01.2010	
			7.02256.21.0	DW-TL	EP Baujahr bis: 01.2010 Construction year to: 01.2010	
QASHQAI II SUV (J11, J11_)						21
1.2 DIG-T 85 kW (116 PS) HRA2DDT	11.2013→		7.08681.15.0	EOV	EH	
			7.01343.04.0	LDRV	EP	
1.3 DIG-T 103-118 kW (140-160 PS) HR13DDT	08.2018→		7.04818.04.0	SUV	EL	
			7.04818.04.0	SUV	EL	
1.5 dCi 81 kW (110 PS) K9K 636, K9K 646	11.2013→		7.01814.12.0	DW-TL	EP	

N

						
QASHQAI II SUV (J11, J11_)						21
1.6 dCi 70-107 kW (95-146 PS) R9M	11.2013→		7.01814.12.0	DW-TL	EP	10.2014→09.2019
1.6 dCi ALL MODE 4x4-i 70-107 kW (95-146 PS) R9M	11.2013→		7.01814.12.0	DW-TL	EP	10.2014→09.2019
TIIDA Hatchback (C11)						22
1.5 dCi 48-81 kW (65-110 PS) K9K	03.2007→06.2013		7.02256.21.0	DW-TL	EP	Baujahr bis: 03.2010 Construction year to: 03.2010
1.5 dCi 48-81 kW (65-110 PS) K9K, K9K 278	09.2007→12.2011		7.02256.21.0	DW-TL	EP	 K9K, K9K 278: Baujahr bis: 03.2010 Construction year to: 03.2010
TIIDA Saloon (SC11)						23
1.5 dCi 48-81 kW (65-110 PS) K9K, K9K 278	01.2007→12.2012		7.02256.21.0	DW-TL	EP	 K9K, K9K 278: Baujahr bis: 03.2010 Construction year to: 03.2010
1.5 dCi 48-81 kW (65-110 PS) K9K, K9K 278	09.2007→12.2012		7.02256.21.0	DW-TL	EP	 K9K, K9K 278: Baujahr bis: 03.2010 Construction year to: 03.2010
X-TRAIL (T30)						24
2.2 DCi 84-110 kW (114-150 PS) YD22DDTi, YD22ETI	10.2004→01.2013		7.00265.02.0	DW-TL	EP	
2.2 Di 4x4 84-100 kW (114-136 PS) YD22ETI	07.2001→10.2005		7.00265.02.0	DW-TL	EP	09.2003→
2.2 dCi 84-110 kW (114-150 PS) YD22DDTi, YD22ETI	12.2003→01.2013		7.00265.02.0	DW-TL	EP	
2.2 dCi 4x4 84-110 kW (114-150 PS) YD22DDTi, YD22ETI	06.2001→12.2008		7.00265.02.0	DW-TL	EP	 YD22DDTi, YD22ETI: 09.2003→
X-TRAIL (T31)						25
2.0 dCi 4x4 127-130 kW (173-177 PS) M9R 760	06.2007→11.2013		7.02256.17.0	DW-TL	EP	
2.0 dCi 4x4 110-130 kW (150-177 PS) M9R	06.2007→11.2013		7.02256.17.0	DW-TL	EP	
X-TRAIL (T32_)						26
1.3 DIG-T 103-118 kW (140-160 PS) HR13DDT	04.2019→		7.04818.04.0	SUV	EL	
XTERRA (WD22_)						27
2.8 TDI 4WD (WD22B) 97-103 kW (132-140 PS) WM28TI	05.2001→06.2005		7.03964.01.0	DW-TL	EP	
2.8 TDI 4WD (WD22B) 97-103 kW (132-140 PS) WM28DTI, WM28TI	05.2003→08.2008		7.03964.01.0	DW-TL	EP	
2.8 TDI 4x4 (WD22B) 97-103 kW (132-140 PS) WM28DTI	06.2005→08.2008		7.03964.01.0	DW-TL	EP	
INTERSTAR Bus (X70)						28
dCi 100 74-88 kW (101-120 PS) G9U 650	04.2006→03.2011		7.01152.02.0	DW-TL	EP	
			7.02256.19.0	LDRV	EL	
dCi 120 74-88 kW (101-120 PS) G9U 650	09.2006→03.2011		7.01152.02.0	DW-TL	EP	
			7.02256.19.0	LDRV	EL	
dCi 150 88-107 kW (120-146 PS) G9U 632	09.2006→03.2011		7.01152.02.0	DW-TL	EP	
			7.02256.19.0	LDRV	EL	

			 PIERBURG		
INTERSTAR Bus (X70) 28					
dCi 80 60 kW (82 PS) F9Q 772	04.2002→08.2006		7.02256.04.0	DW-AGR	EP
			7.02256.04.0	DW-TL	EP
INTERSTAR Platform/Chassis 29					
dCi 120 74-88 kW (101-120 PS) G9U 650	08.2006→		7.01152.02.0	DW-TL	EP
			7.02256.19.0	LDRV	EL
dCi 150 88-107 kW (120-146 PS) G9U 632	08.2006→		7.01152.02.0	DW-TL	EP
			7.02256.19.0	LDRV	EL
INTERSTAR Van (X70) 30					
dCi 120 74-88 kW (101-120 PS) G9U 650	09.2006→		7.01152.02.0	DW-TL	EP
			7.02256.19.0	LDRV	EL
dCi 150 88-107 kW (120-146 PS) G9U 632	09.2006→		7.01152.02.0	DW-TL	EP
			7.02256.19.0	LDRV	EL
dCi 80 60 kW (82 PS) F9Q 772	04.2002→08.2006		7.02256.04.0	DW-AGR	EP
			7.02256.04.0	DW-TL	EP
KUBISTAR Van (X76) 31					
1.5 dCi 47-48 kW (64-65 PS) K9K 704	08.2003→		7.02256.21.0	DW-TL	EP
1.5 dCi 60 kW (82 PS) K9K 722	08.2003→10.2009		7.02256.21.0	DW-TL	EP
1.5 dCi 42-45 kW (57-61 PS) K9K 710, K9K 714	08.2005→10.2009		7.02256.21.0	DW-TL	EP
NAVARA Platform/Chassis (D23) 32					
2.3 dCi 116-120 kW (158-163 PS) YS23DDT	01.2015→		7.01814.22.0	DW-TL	EP
2.3 dCi 4x4 116-120 kW (158-163 PS) YS23DDT	01.2015→		7.01814.22.0	DW-TL	EP
NP300 NAVARA Platform/Chassis (D40) 33					
2.5 dCi 76-140 kW (103-190 PS) YD25DDTi	08.2008→12.2015		7.02212.02.0	DW-TL	EP
2.5 dCi 4WD 76-140 kW (103-190 PS) YD25DDTi	08.2008→		7.02212.02.0	DW-TL	EP
2.5 dCi 4WD 76-140 kW (103-190 PS) YD25DDTi	08.2008→		7.02212.02.0	DW-TL	EP
NV200 / EVALIA Bus 34					
1.5 dCi 110 (M20, M20M) 81 kW (110 PS) K9K 636, K9K 646	04.2011→		7.01814.12.0	DW-TL	EP
1.5 dCi 85 (M20, M20M, M20K, M20KK) 63 kW (86 PS) K9K 400	07.2010→		7.02256.21.0	DW-TL	EP
			Baujahr bis: 10.2013 Construction year to: 10.2013		

N

						
NV200 Van						35
1.5 dCi 110 (M20, M20M) 81 kW (110 PS) K9K 636, K9K 646	04.2011→		7.01814.12.0	DW-TL	EP	
1.5 dCi 85 (M20, M20M) 63-66 kW (86-90 PS) K9K 400, K9K 608, K9K 628	02.2010→		7.02256.21.0	DW-TL	EP K9K 400, K9K 608, K9K 628: Baujahr ab: 07.2010 Construction year from: 07.2010 Baujahr bis: 10.2013 Construction year to: 10.2013	
NV300 Kombi (X82)						36
1.6 dCi 125 92-118 kW (125-160 PS) R9M 452	09.2016→		7.01814.12.0	DW-TL	EP	
			7.01814.22.0	DW-TL	EP für OE-Nummer: 14956-00Q2B für OE number: 14956-00Q2B	
1.6 dCi 145 92-118 kW (125-160 PS) R9M 452	09.2016→		7.01814.12.0	DW-TL	EP	
			7.01814.22.0	DW-TL	EP für OE-Nummer: 14956-00Q2B für OE number: 14956-00Q2B	
1.6 dci 95 70-89 kW (95-121 PS) R9M 413	09.2016→		7.01814.12.0	DW-TL	EP	
NV300 Platform/Chassis (X82)						37
1.6 dci 125 92-118 kW (125-160 PS) R9M 452	09.2016→		7.01814.12.0	DW-TL	EP	
			7.01814.22.0	DW-TL	EP für OE-Nummer: 14956-00Q2B für OE number: 14956-00Q2B	
1.6 dci 145 92-118 kW (125-160 PS) R9M 452	09.2016→		7.01814.12.0	DW-TL	EP	
			7.01814.22.0	DW-TL	EP für OE-Nummer: 14956-00Q2B für OE number: 14956-00Q2B	
NV300 Van (X82)						38
1.6 dci 120 70-89 kW (95-121 PS) R9M 413	09.2016→		7.01814.12.0	DW-TL	EP	
1.6 dci 125 92-118 kW (125-160 PS) R9M 452	09.2016→		7.01814.12.0	DW-TL	EP	
			7.01814.22.0	DW-TL	EP für OE-Nummer: 14956-00Q2B für OE number: 14956-00Q2B	
1.6 dci 145 92-118 kW (125-160 PS) R9M 452	09.2016→		7.01814.12.0	DW-TL	EP	
			7.01814.22.0	DW-TL	EP für OE-Nummer: 14956-00Q2B für OE number: 14956-00Q2B	
1.6 dci 95 70-89 kW (95-121 PS) R9M 413, R9M 415	09.2016→		7.01814.12.0	DW-TL	EP	
NV400 Platform/Chassis (X62, X62B)						39
dCi 130 RWD 96-120 kW (131-163 PS) M9T 710	06.2016→		7.01814.12.0	DW-TL	EP	
dCi 135 RWD 100-120 kW (136-163 PS) M9T 700	06.2014→06.2016		7.01814.12.0	DW-TL	EP	



N









NV400 Platform/Chassis (X62, X62B) 39

dCi 145 RWD 96-120 kW (131-163 PS) M9T 710	11.2011→06.2016		7.01814.12.0	DW-TL	EP
dCi 165 RWD 100-120 kW (136-163 PS) M9T 700	06.2014→		7.01814.12.0	DW-TL	EP

NV400 Van (X62, X62B) 40

dCi 130 RWD 96-120 kW (131-163 PS) M9T 710	09.2016→		7.01814.12.0	DW-TL	EP
dCi 135 RWD 100-120 kW (136-163 PS) M9T 700	06.2014→09.2016		7.01814.12.0	DW-TL	EP
dCi 165 RWD 100-120 kW (136-163 PS) M9T 700	06.2014→09.2016		7.01814.12.0	DW-TL	EP

PRIMASTAR Bus (X83) 41

dCi 115 84-107 kW (114-146 PS) G9U 630	09.2008→		7.01152.02.0	DW-TL	EP
			7.02256.19.0	LDRV	EL
dCi 120 66-84 kW (90-114 PS) M9R 780, M9R 786	09.2006→		7.02256.19.0	EUV-AGR	EL
dCi 140 99 kW (135 PS) G9U 730	07.2003→		7.02256.04.0	DW-TL	EP
dCi 150 88-107 kW (120-146 PS) G9U 632	09.2006→		7.01152.02.0	DW-TL	EP
dCi 80 60 kW (82 PS) F9Q 762	03.2001→		7.02256.04.0	DW-TL	EP
			7.02256.19.0	EUV-AGR	EL
dCi 90 66 kW (90 PS) M9R 782	09.2006→		7.02256.04.0	DW-TL	EP
			7.02256.19.0	EUV-AGR	EL
dCi 90 66-84 kW (90-114 PS) M9R 786	09.2006→		7.02256.19.0	EUV-AGR	EL





N

PRIMASTAR Platform/Chassis (X83) 42



























2.5 dCi 150 84-107 kW (114-146 PS) G9U 630	04.2006→		7.01152.02.0	DW-TL	EP
			7.02256.19.0	LDRV	EL



























PRIMASTAR Van (X83) 43

1.9 dCi 80 60 kW (82 PS) F9Q 762	09.2002→		7.02256.04.0	DW-TL	EP
2.0 dCi 115 66-84 kW (90-114 PS) M9R 780, M9R 786	09.2006→		7.02256.19.0	EUV-AGR	EL
			7.02256.04.0	DW-TL	EP
2.0 dCi 90 66 kW (90 PS) M9R 782	09.2006→		7.02256.19.0	EUV-AGR	EL
			7.02256.04.0	DW-TL	EP
2.0 dCi 90 66-84 kW (90-114 PS) M9R 786	09.2006→		7.02256.19.0	EUV-AGR	EL
			7.02256.04.0	DW-TL	EP
2.5 dCi 115 84-107 kW (114-146 PS) G9U 630	09.2008→		7.01152.02.0	DW-TL	EP
			7.02256.19.0	LDRV	EL
2.5 dCi 140 99 kW (135 PS) G9U 730	07.2003→		7.02256.04.0	DW-TL	EP
2.5 dCi 150 88-107 kW (120-146 PS) G9U 632	09.2006→		7.01152.02.0	DW-TL	EP

N

			 PIERBURG			
ADAM (M13)						1
1.0 66-77 kW (90-105 PS) B 10 XFL	07.2014→11.2018		7.03351.12.0	LDRV	EP	
			7.03381.14.0	SUV	EL	
1.0 66-77 kW (90-105 PS) D 10 XFL	07.2014→11.2018		7.03351.12.0	LDRV	EP	
			7.03381.14.0	SUV	EL	
1.0 85 kW (115 PS) B 10 XFT	07.2014→11.2018		7.03351.12.0	LDRV	EP	
			7.03381.14.0	SUV	EL	
1.0 85 kW (115 PS) D 10 XFT	07.2014→11.2018		7.03351.12.0	LDRV	EP	
			7.06117.07.0	ZM-NWV	EL	
1.2 51 kW (69 PS) A 12 XEL, B 12 XEL, D 12 XEL	10.2012→02.2019		7.06117.07.0	ZM-NWV	EL	mit Dichtring with O-ring
			7.06117.07.0	ZM-NWV	EL	mit Dichtring with O-ring
1.4 64-66 kW (87-90 PS) A 14 XEL, B 14 XEL, D 14 XEL	10.2012→02.2019		7.06117.07.0	ZM-NWV	EL	mit Dichtring with O-ring
			7.06117.07.0	ZM-NWV	EL	mit Dichtring with O-ring
1.4 74 kW (101 PS) A 14 XER, B 14 XER, D 14 XER	10.2012→02.2019		7.06117.07.0	ZM-NWV	EL	mit Dichtring with O-ring
			7.06117.07.0	ZM-NWV	EL	mit Dichtring with O-ring
1.4 LPG 64-66 kW (87-90 PS) A 14 XEL, B 14 XEL, D 14 XEL	07.2013→11.2018		7.06117.07.0	ZM-NWV	EL	mit Dichtring with O-ring
			7.06117.07.0	ZM-NWV	EL	mit Dichtring with O-ring
1.4 S 110 kW (150 PS) B 14 NEH, D 14 NEH	11.2014→01.2019		7.03833.02.0	EUV-VB	EL	
			7.06117.07.0	ZM-NWV	EL	
AGILA (A) (H00)						2
1.0 (F68) 44 kW (60 PS) Z 10 XEP	08.2003→12.2007		7.02256.28.0	SV-PDA	EP	
			7.02256.28.0	SV-PDA	EP	
1.2 16V Twinport (F68) 55-59 kW (75-80 PS) Z 12 XEP	07.2004→12.2007		7.02256.28.0	SV-PDA	EP	
			7.02256.28.0	SV-PDA	EP	
AGILA (B) (H08)						3
1.3 CDTi (F68) 55 kW (75 PS) D13A	04.2008→04.2010		7.02534.01.0	DW-TL	EP	
AMPERA (R12)						4
EV 150 54 kW (73 PS) A 14 XFL	11.2011→03.2015		7.06117.07.0	ZM-NWV	EL	mit Dichtring with O-ring
ANTARA A (L07)						5
2.0 CDTi 125 kW (170 PS) B 20 DTH	01.2016→		7.08681.02.0	EOV	EH	
			7.02256.44.0	EUV-AGR	EL	
2.0 CDTi 4x4 125 kW (170 PS) B 20 DTH	01.2016→		7.08681.02.0	EOV	EH	
			7.02256.44.0	EUV-AGR	EL	
2.2 CDTi 120-122 kW (163-166 PS) A 22 DM	12.2010→12.2015		7.02256.16.0	EUV-AGR	EL	
			7.02256.16.0	EUV-AGR	EL	
2.2 CDTi 4x4 120-122 kW (163-166 PS) A 22 DM	12.2010→12.2015		7.02256.16.0	EUV-AGR	EL	
			7.02256.16.0	EUV-AGR	EL	
2.2 CDTi 4x4 135 kW (184 PS) A 22 DMH	12.2010→12.2015		7.02256.16.0	EUV-AGR	EL	
			7.06117.05.0	SV-NWV	EH	
2.4 123-126 kW (167-171 PS) A 24 XE	12.2010→		7.06117.05.0	SV-NWV	EH	mit Dichtring with O-ring
			7.06117.06.0	SV-NWV	EH	mit Dichtring with O-ring
2.4 4x4 123-126 kW (167-171 PS) A 24 XE	12.2010→		7.06117.05.0	SV-NWV	EH	mit Dichtring with O-ring
			7.06117.06.0	SV-NWV	EH	mit Dichtring with O-ring















						
ANTARA A (L07)						5
3.0 183-197 kW (249-268 PS) A 30 XH	11.2010→12.2015		7.06117.04.0	SV-NWV	EH mit Wellendichtring With shaft sealing ring	
3.2 V6 167 kW (227 PS) Z 32 SEE	07.2006→12.2011		7.06117.04.0	SV-NWV	EH mit Wellendichtring With shaft sealing ring Fahrgestellnummer ab: 70024581, 93000001, 9B000001 Vehicle Identification Number from: 70024581, 93000001, 9B000001	
ASCONA C (J82)						6
1.6 i (F11, M11, F68, M68) 55-65 kW (75-88 PS) E 16 NZ	09.1987→08.1988		7.05432.00.0	SM	EL mit Dichtring with O-ring	
1.6 i Cat (F11, M11, F68, M68) 55-60 kW (75-82 PS) C 16 LZ, C 16 NZ	09.1986→08.1988		7.05432.00.0	SM	EL mit Dichtring with O-ring	
ASTRA F (T92)						7
1.4 Si (F19, M19) 54-60 kW (73-82 PS) C 14 SE	03.1992→09.1998		7.05432.11.0	SM	EL mit Dichtring with O-ring	
1.4 i (F19, M19) 40-44 kW (54-60 PS) C 14 NZ, X 14 NZ	09.1991→09.1998		7.05432.01.0	SM	EL mit Dichtring with O-ring	
1.4 i 16V (F19, M19) 63-69 kW (86-94 PS) X 14 XE	02.1996→09.1998		7.05432.11.0	SM	EL mit Dichtring with O-ring	
1.6 (F19, M19) 55 kW (75 PS) 16 LZ2, 16 NZR	09.1995→09.1998		7.05432.00.0	SM	EL mit Dichtring with O-ring	
1.6 Si (F19, M19) 74 kW (101 PS) C 16 SE	05.1992→12.1994		7.05432.11.0	SM	EL mit Dichtring with O-ring	
1.6 i (F19, M19) 55-60 kW (75-82 PS) C 16 NZ, X 16 SZR	03.1992→09.1998		7.05432.00.0	SM	EL mit Dichtring with O-ring	
1.6 i (F19, M19) 52 kW (71 PS) X 16 SZ	05.1993→07.1996		7.05432.00.0	SM	EL mit Dichtring with O-ring	
1.6 i 16V (F19, M19) 74 kW (101 PS) X 16 XEL	08.1994→09.1998		7.05432.11.0	SM	EL mit Dichtring with O-ring	
1.8 i (F19, M19) 66 kW (90 PS) C 18 NZ	03.1992→09.1998		7.05432.00.0	SM	EL mit Dichtring with O-ring	
1.8 i 16V (F19, M19) 92 kW (125 PS) C 18 XE	06.1993→10.1994		7.06269.01.0	LLR	EL 	
1.8 i 16V (F19, M19) 85 kW (115-116 PS) C 18 SEL, C 18 XEL, X 18 XE	11.1994→09.1998		7.06269.01.0	LLR	EL 	
2.0 i 16V (F19, M19) 100 kW (136 PS) X 20 XEV	02.1995→09.1998		7.06269.01.0	LLR	EL 	
ASTRA F CLASSIC Estate (T92)						8
1.6 i 16V (F35, M35) 74 kW (101 PS) X 16 XEL	01.1998→01.2005		7.05432.11.0	SM	EL mit Dichtring with O-ring	
ASTRA F CLASSIC Saloon (T92)						9
1.6 i 16V (F19, M19) 74 kW (101 PS) X 16 XEL	01.1998→08.2002		7.05432.11.0	SM	EL mit Dichtring with O-ring	







ASTRA F Convertible (T92) **10**



























1.4 Si 54-60 kW (73-82 PS) C 14 SE	05.1993→03.2001	 7.05432.11.0	SM	EL	mit Dichtring with O-ring
1.4 i 16V 63-69 kW (86-94 PS) X 14 XE	01.1996→03.2001	 7.05432.11.0	SM	EL	mit Dichtring with O-ring
1.6 i 52 kW (71 PS) X 16 SZ	03.1993→08.1996	 7.05432.00.0	SM	EL	mit Dichtring with O-ring
1.6 i 55 kW (75 PS) X 16 SZR	01.1996→03.2001	 7.05432.00.0	SM	EL	mit Dichtring with O-ring
1.8 i 16V 85 kW (116 PS) C 18 XEL, X 18 XE	11.1994→03.2001	 7.06269.01.0	LLR	EL	

ASTRA F Estate (T92) **11**

1.4 Si (F35, M35) 54-60 kW (73-82 PS) C 14 SE	03.1992→01.1998	 7.05432.11.0	SM	EL	mit Dichtring with O-ring
1.4 i (F35, M35) 40-44 kW (54-60 PS) C 14 NZ	09.1991→01.1998	 7.05432.01.0	SM	EL	mit Dichtring with O-ring
1.4 i 16V (F35, M35) 63-69 kW (86-94 PS) X 14 XE	02.1996→01.1998	 7.05432.11.0	SM	EL	mit Dichtring with O-ring
1.6 (F35, M35) 55 kW (75 PS) 16 LZ2, 16 NZR	09.1995→01.1998	 7.05432.00.0	SM	EL	mit Dichtring with O-ring
1.6 Si (F35, M35) 74 kW (101 PS) C 16 SE	03.1992→12.1994	 7.05432.11.0	SM	EL	mit Dichtring with O-ring
1.6 i (F35, M35) 55-60 kW (75-82 PS) C 16 NZ, X 16 SZR	09.1991→01.1998	 7.05432.00.0	SM	EL	mit Dichtring with O-ring
1.6 i (F35, M35) 52 kW (71 PS) X 16 SZ	05.1993→07.1996	 7.05432.00.0	SM	EL	mit Dichtring with O-ring
1.6 i 16V (F35, M35) 74 kW (101 PS) X 16 XEL	08.1994→01.1998	 7.05432.11.0	SM	EL	mit Dichtring with O-ring
1.8 i (F35, M35) 66 kW (90 PS) C 18 NZ	09.1991→01.1998	 7.05432.00.0	SM	EL	mit Dichtring with O-ring
1.8 i 16V (F35, M35) 92 kW (125 PS) C 18 XE	06.1993→01.1998	 7.06269.01.0	LLR	EL	
1.8 i 16V (F35, M35) 85 kW (116 PS) C 18 XEL, X 18 XE	07.1994→01.1998	 7.06269.01.0	LLR	EL	
2.0 i 16V (F35, M35) 100 kW (136 PS) X 20 XEV	02.1995→01.1998	 7.06269.01.0	LLR	EL	







ASTRA F Hatchback (T92) **12**

1.4 Si (F08, M08, F68, M68) 54-60 kW (73-82 PS) C 14 SE	03.1992→01.1998	 7.05432.11.0	SM	EL	mit Dichtring with O-ring
1.4 i (F08, M08, F68, M68) 40-44 kW (54-60 PS) C 14 NZ	09.1991→01.1998	 7.05432.01.0	SM	EL	mit Dichtring with O-ring
1.4 i 16V (F08, M08, F68, M68) 63-69 kW (86-94 PS) X 14 XE	09.1996→02.1998	 7.05432.11.0	SM	EL	mit Dichtring with O-ring
1.6 (F08, M08, F68, M68) 55 kW (75 PS) 16 LZ2, 16 NZR	09.1995→01.1998	 7.05432.00.0	SM	EL	mit Dichtring with O-ring
1.6 Si (F08, M08, F68, M68) 74 kW (101 PS) C 16 SE	03.1992→12.1994	 7.05432.11.0	SM	EL	mit Dichtring with O-ring









						
ASTRA F Hatchback (T92)						12
1.6 i (F08, M08, F68, M68) 55-60 kW (75-82 PS) C 16 NZ, X 16 SZR	09.1991→01.1998		7.05432.00.0	SM	EL	mit Dichtring with O-ring
1.6 i (F08, M08, F68, M68) 52 kW (71 PS) X 16 SZ	05.1993→07.1996		7.05432.00.0	SM	EL	mit Dichtring with O-ring
1.6 i 16V (F08, M08, F68, M68) 74 kW (101 PS) X 16 XEL	08.1994→01.1998		7.05432.11.0	SM	EL	mit Dichtring with O-ring
1.8 i (F08, M08, F68, M68) 66 kW (90 PS) C 18 NZ	09.1991→01.1998		7.05432.00.0	SM	EL	mit Dichtring with O-ring
1.8 i 16V (F08, M08, F68, M68) 92 kW (125 PS) C 18 XE	06.1993→08.1994		7.06269.01.0	LLR	EL	
1.8 i 16V (F08, M08, F68, M68) 85 kW (116 PS) C 18 XEL, X 18 XE	09.1994→01.1998		7.06269.01.0	LLR	EL	
2.0 i 16V (F08, M08, F68, M68) 100 kW (136 PS) X 20 XEV	02.1995→01.1998		7.06269.01.0	LLR	EL	
ASTRA G CLASSIC (T98)						13
1.6 (F08, F48) 74-77 kW (101-105 PS) Z 16 XEP	03.2006→06.2008		7.02256.31.0	SV-PDA	EP	
1.7 CDTI (F08, F48) 59 kW (80 PS) Z 17 DTL	06.2004→07.2009		7.03088.01.0	DW-TL	EP	
			7.02461.01.0	EUV-AGR	EL	
ASTRA G CLASSIC Caravan (F35)						14
1.4 (F35) 66 kW (90 PS) Z 14 XEP	10.2007→07.2009		7.02256.28.0	SV-PDA	EP	
1.6 74-77 kW (101-105 PS) Z 16 XEP	02.2006→07.2009		7.02256.31.0	SV-PDA	EP	
1.7 CDTI 59 kW (80 PS) Z 17 DTL	05.2004→07.2009		7.02461.01.0	EUV-AGR	EL	
ASTRA G Convertible (T98)						15
1.6 (F67) 74-77 kW (101-105 PS) Z 16 XEP	01.2003→10.2005		7.02256.22.0	AKF	EL	für OE-Nummer: 1997319, 58 07 452 for OE number: 1997319, 58 07 452
			7.02256.38.0	AKF	EL	für OE-Nummer: 13105950, 58 07 468 for OE number: 13105950, 58 07 468
			7.02256.31.0	SV-PDA	EP	
1.6 16V (F67) 74-76 kW (101-103 PS) Z 16 XE	03.2001→10.2005		7.02256.22.0	AKF	EL	für OE-Nummer: 1997319, 58 07 452 for OE number: 1997319, 58 07 452
			7.02256.38.0	AKF	EL	für OE-Nummer: 13105950, 58 07 468 for OE number: 13105950, 58 07 468
2.0 16V Turbo (F67) 140-162 kW (190-220 PS) Z 20 LET	11.2002→10.2005		7.01039.03.0	EUV-SR	EL	
			7.01024.02.0	LDRV	EL	
2.0 OPC (F67) 140-162 kW (190-220 PS) Z 20 LET	03.2002→10.2005		7.01039.03.0	EUV-SR	EL	
			7.01024.02.0	LDRV	EL	
2.2 DTI (F67) 86-92 kW (117-125 PS) Y 22 DTR	09.2002→10.2005		7.22138.50.0	EUV-AGR	EL	Fahrgestellnummer ab: 32000001, 35, 36, 38, 3H000001, 4G000001 Vehicle Identification Number from: 32000001, 35, 36, 38, 3H000001, 4G000001



























ASTRA G Coupe (T98) **16**

1.6 16V (F07) 74-76 kW (101-103 PS) Z 16 XE	03.2000→05.2005		7.02256.22.0	AKF	EL	für OE-Nummer: 1997319, 58 07 452 for OE number: 1997319, 58 07 452
			7.02256.38.0	AKF	EL	für OE-Nummer: 13105950, 58 07 468 for OE number: 13105950, 58 07 468
1.6 16V (F07) 74-77 kW (101-105 PS) Z 16 XEP	03.2000→05.2005		7.02256.22.0	AKF	EL	für OE-Nummer: 1997319, 58 07 452 for OE number: 1997319, 58 07 452
			7.02256.38.0	AKF	EL	für OE-Nummer: 13105950, 58 07 468 for OE number: 13105950, 58 07 468
			7.02256.31.0	SV-PDA	EP	
2.0 16V Turbo (F07) 140-162 kW (190-220 PS) Z 20 LET	09.2000→08.2001		7.01039.03.0	EUV-SR	EL	
			7.01024.02.0	LDRV	EL	
2.0 16V Turbo (F07) 140-162 kW (190-220 PS) Z 20 LET	08.2001→05.2005		7.01039.03.0	EUV-SR	EL	
			7.01024.02.0	LDRV	EL	
2.0 16V Turbo (F07) 140-162 kW (190-220 PS) Z 20 LET	11.2002→05.2005		7.01039.03.0	EUV-SR	EL	
			7.01024.02.0	LDRV	EL	
2.2 DTI (F07) 86-92 kW (117-125 PS) Y 22 DTR	09.2002→05.2005		7.22138.50.0	EUV-AGR	EL	Fahrgestellnummer ab: 32000001, 35, 36, 38, 3H000001, 4G000001 Vehicle Identification Number from: 32000001, 35, 36, 38, 3H000001, 4G000001













ASTRA G Estate (T98) **17**

1.4 16V (F35) 63-69 kW (86-94 PS) X 14 XE	06.1998→09.2000		7.02256.38.0	AKF	EL	für OE-Nummer: 13105950, 58 07 468 for OE number: 13105950, 58 07 468
			7.05432.11.0	SM	EL	mit Dichtring with O-ring
1.4 16V (F35) 66 kW (90 PS) Z 14 XE	09.2000→07.2004		7.02256.22.0	AKF	EL	für OE-Nummer: 1997319, 58 07 452 for OE number: 1997319, 58 07 452
			7.02256.38.0	AKF	EL	für OE-Nummer: 13105950, 58 07 468 for OE number: 13105950, 58 07 468
1.6 (F35) 55 kW (75 PS) X 16 SZR	02.1998→09.2000		7.02256.38.0	AKF	EL	für OE-Nummer: 13105950, 58 07 468 for OE number: 13105950, 58 07 468
			7.05432.00.0	SM	EL	mit Dichtring with O-ring
1.6 (F35) 74-77 kW (101-105 PS) Z 16 XEP	12.2002→05.2004		7.02256.22.0	AKF	EL	für OE-Nummer: 1997319, 58 07 452 for OE number: 1997319, 58 07 452
			7.02256.38.0	AKF	EL	für OE-Nummer: 13105950, 58 07 468 for OE number: 13105950, 58 07 468
			7.02256.31.0	SV-PDA	EP	
1.6 16V (F35) 74 kW (101 PS) X 16 XEL	02.1998→08.2000		7.02256.38.0	AKF	EL	für OE-Nummer: 13105950, 58 07 468 for OE number: 13105950, 58 07 468
			7.05432.11.0	SM	EL	mit Dichtring with O-ring
1.6 16V (F35) 74-76 kW (101-103 PS) Z 16 XE	08.2000→07.2004		7.02256.22.0	AKF	EL	für OE-Nummer: 1997319, 58 07 452 for OE number: 1997319, 58 07 452
			7.02256.38.0	AKF	EL	für OE-Nummer: 13105950, 58 07 468 for OE number: 13105950, 58 07 468
1.7 CDTI (F35) 59 kW (80 PS) Z 17 DTL	04.2003→05.2004		7.03088.01.0	DW-TL	EP	
			7.02461.01.0	EUV-AGR	EL	
1.7 DTI 16V (F35) 55 kW (75 PS) Y 17 DT	02.2000→07.2004		7.03085.02.0	DW-AGR	EP	













					
ASTRA G Estate (T98)					17
			7.03088.01.0	DW-TL	EP
2.0 16V (F35) 100 kW (136 PS) X 20 XEV	02.1998→07.2004		7.06269.01.0	LLR	EL 
2.0 DTI 16V (F35) 74 kW (101 PS) Y 20 DTH	08.1999→07.2004		7.22138.50.0	EUV-AGR	EL  ch. 3H000001→
2.0 OPC (F35) 140-162 kW (190-220 PS) Z 20 LET	09.2002→07.2004		7.01039.03.0	EUV-SR	EL
			7.01024.02.0	LDRV	EL
2.0 OPC (F35) 140-162 kW (190-220 PS) Z 20 LET	11.2002→07.2004		7.01039.03.0	EUV-SR	EL
			7.01024.02.0	LDRV	EL
2.2 DTI (F35) 86-92 kW (117-125 PS) Y 22 DTR	09.2002→07.2004		7.22138.50.0	EUV-AGR	EL Fahrgestellnummer ab: 32000001, 35, 36, 38, 3H000001, 4G000001 Vehicle Identification Number from: 32000001, 35, 36, 38, 3H000001, 4G000001
2.2 DTI (F35) 86-92 kW (117-125 PS) Y 22 DTR	09.2002→07.2004		7.22138.50.0	EUV-AGR	EL Fahrgestellnummer ab: 32000001, 35, 36, 38, 3H000001, 4G000001 Vehicle Identification Number from: 32000001, 35, 36, 38, 3H000001, 4G000001
ASTRA G Hatchback (T98)					18
1.4 (F08, F48) 66 kW (90 PS) Z 14 XEP	09.2007→12.2009		7.02256.28.0	SV-PDA	EP
1.4 16V (F08, F48) 63-69 kW (86-94 PS) X 14 XE	02.1998→09.2000		7.02256.38.0	AKF	EL für OE-Nummer: 13105950, 58 07 468 for OE number: 13105950, 58 07 468
			7.05432.11.0	SM	EL mit Dichtring with O-ring
1.4 16V (F08, F48) 66 kW (90 PS) Z 14 XE	09.2000→01.2005		7.02256.22.0	AKF	EL für OE-Nummer: 1997319, 58 07 452 for OE number: 1997319, 58 07 452
			7.02256.38.0	AKF	EL für OE-Nummer: 13105950, 58 07 468 for OE number: 13105950, 58 07 468
1.6 (F08, F48) 55 kW (75 PS) X 16 SZR	02.1998→09.2000		7.02256.38.0	AKF	EL für OE-Nummer: 13105950, 58 07 468 for OE number: 13105950, 58 07 468
			7.05432.00.0	SM	EL mit Dichtring with O-ring
1.6 (F08, F48) 74-77 kW (101-105 PS) Z 16 XEP	11.2002→01.2005		7.02256.22.0	AKF	EL für OE-Nummer: 1997319, 58 07 452 for OE number: 1997319, 58 07 452
			7.02256.38.0	AKF	EL für OE-Nummer: 13105950, 58 07 468 for OE number: 13105950, 58 07 468
			7.02256.31.0	SV-PDA	EP
1.6 16V (F08, F48) 74 kW (101 PS) C 16 SEL, X 16 XEL	02.1998→01.2005		7.02256.38.0	AKF	EL  C 16 SEL, X 16 XEL: für OE-Nummer: 13105950, 58 07 468 for OE number: 13105950, 58 07 468
			7.05432.11.0	SM	EL mit Dichtring with O-ring
1.6 16V (F08, F48) 74-76 kW (101-103 PS) Z 16 XE	08.2000→01.2005		7.02256.22.0	AKF	EL für OE-Nummer: 1997319, 58 07 452 for OE number: 1997319, 58 07 452
			7.02256.38.0	AKF	EL für OE-Nummer: 13105950, 58 07 468 for OE number: 13105950, 58 07 468
1.7 CDTI (F08, F48) 59 kW (80 PS) Z 17 DTL	04.2003→01.2005		7.03088.01.0	DW-TL	EP
			7.02461.01.0	EUV-AGR	EL
1.7 DTI 16V (F08, F48) 55 kW (75 PS) Y 17 DT	02.2000→01.2005		7.03085.02.0	DW-AGR	EP























ASTRA G Hatchback (T98) 18

			PIERBURG		
			7.03088.01.0	DW-TL	EP
2.0 16V (F08, F48) 100 kW (136 PS) X 20 XEV	02.1998→01.2005		7.06269.01.0	LLR	EL 
2.0 16V OPC (F08, F48) 118 kW (160 PS) X 20 XER	11.1999→09.2002		7.06269.01.0	LLR	EL 
2.0 DTI 16V (F08, F48) 74 kW (101 PS) Y 20 DTH	08.1999→01.2005		7.22138.50.0	EUV-AGR	EL  ch. 3H000001→
2.0 OPC (F08, F48) 140-162 kW (190-220 PS) Z 20 LET	09.2002→01.2005		7.01039.03.0	EUV-SR	EL
			7.01024.02.0	LDRV	EL
2.0 OPC (F08, F48) 140-162 kW (190-220 PS) Z 20 LET	11.2002→01.2005		7.01039.03.0	EUV-SR	EL
			7.01024.02.0	LDRV	EL
2.2 DTI (F08, F48) 86-92 kW (117-125 PS) Y 22 DTR	09.2002→01.2005		7.22138.50.0	EUV-AGR	EL Fahrgestellnummer ab: 32000001, 35, 36, 38, 3H000001, 4G000001 Vehicle Identification Number from: 32000001, 35, 36, 38, 3H000001, 4G000001
2.2 DTI (F08, F48) 86-92 kW (117-125 PS) Y 22 DTR	09.2002→01.2005		7.22138.50.0	EUV-AGR	EL Fahrgestellnummer ab: 32000001, 35, 36, 38, 3H000001, 4G000001 Vehicle Identification Number from: 32000001, 35, 36, 38, 3H000001, 4G000001

ASTRA G Saloon (T98) 19

			7.02256.28.0	SV-PDA	EP
1.4 (F69) 66 kW (90 PS) Z 14 XEP	09.2007→12.2009		7.02256.28.0	SV-PDA	EP
1.4 16V (F69) 63-69 kW (86-94 PS) X 14 XE	09.1998→09.2000		7.02256.38.0	AKF	EL für OE-Nummer: 13105950, 58 07 468 for OE number: 13105950, 58 07 468
			7.05432.11.0	SM	EL mit Dichtring with O-ring
1.4 16V (F69) 66 kW (90 PS) Z 14 XE	09.2000→01.2005		7.02256.22.0	AKF	EL für OE-Nummer: 1997319, 58 07 452 for OE number: 1997319, 58 07 452
			7.02256.38.0	AKF	EL für OE-Nummer: 13105950, 58 07 468 for OE number: 13105950, 58 07 468
1.6 (F69) 55 kW (75 PS) X 16 SZR	09.1998→09.2000		7.02256.38.0	AKF	EL für OE-Nummer: 13105950, 58 07 468 for OE number: 13105950, 58 07 468
			7.05432.00.0	SM	EL mit Dichtring with O-ring
1.6 16V (F69) 74 kW (101 PS) X 16 XEL	09.1998→08.2000		7.02256.38.0	AKF	EL für OE-Nummer: 13105950, 58 07 468 for OE number: 13105950, 58 07 468
			7.05432.11.0	SM	EL mit Dichtring with O-ring
1.6 16V (F69) 74-76 kW (101-103 PS) Z 16 XE	08.2000→01.2005		7.02256.22.0	AKF	EL für OE-Nummer: 1997319, 58 07 452 for OE number: 1997319, 58 07 452
			7.02256.38.0	AKF	EL für OE-Nummer: 13105950, 58 07 468 for OE number: 13105950, 58 07 468
1.7 CDTI (F69) 59 kW (80 PS) Z 17 DTL	04.2003→12.2009		7.03088.01.0	DW-TL	EP
			7.02461.01.0	EUV-AGR	EL
1.7 DTI 16V (F69) 55 kW (75 PS) Y 17 DT	02.2000→01.2005		7.03085.02.0	DW-AGR	EP
			7.03088.01.0	DW-TL	EP
2.0 16V (F69) 100 kW (136 PS) X 20 XEV	09.1998→01.2005		7.06269.01.0	LLR	EL 
2.0 DTI 16V (F69) 74 kW (101 PS) Y 20 DTH	08.1999→01.2005		7.22138.50.0	EUV-AGR	EL  ch. 3H000001→

					
ASTRA G Saloon (T98)					19
2.2 DTI (F69) 86-92 kW (117-125 PS) Y 22 DTR	09.2002→01.2005	 7.22138.50.0	EUV-AGR	EL	Fahrgestellnummer ab: 32000001, 35, 36, 38, 3H000001, 4G000001 Vehicle Identification Number from: 32000001, 35, 36, 38, 3H000001, 4G000001
2.2 DTI (F69) 86-92 kW (117-125 PS) Y 22 DTR	09.2002→01.2005	 7.22138.50.0	EUV-AGR	EL	Fahrgestellnummer ab: 32000001, 35, 36, 38, 3H000001, 4G000001 Vehicle Identification Number from: 32000001, 35, 36, 38, 3H000001, 4G000001
ASTRA H (A04)					20
1.2 (L48) 55-59 kW (75-80 PS) Z 12 XEP	08.2005→10.2010	 7.02256.28.0	SV-PDA	EP	
1.3 CDTI (L48) 66-74 kW (90-101 PS) Z 13 DTH	08.2005→10.2010	 7.01420.02.0	DW-TL	EP	Fahrgestellnummer bis: 9B999999, A2, A5, A8, AG Vehicle Identification Number to: 9B999999, A2, A5, A8, AG
		7.03978.01.0	DW-TL	EP	Fahrgestellnummer ab: A2, A5, A8, AG Vehicle Identification Number from: A2, A5, A8, AG Fahrgestellnummer bis: B2, B5, B8, BG Vehicle Identification Number to: B2, B5, B8, BG
		7.04423.01.0	DW-TL	EP	Fahrgestellnummer ab: B2, B5, B8, BG Vehicle Identification Number from: B2, B5, B8, BG
1.4 (L48) 66 kW (90 PS) Z 14 XEP	03.2004→10.2010	 7.02256.28.0	SV-PDA	EP	
1.4 (L48) 55-59 kW (75-80 PS) Z 14 XEL	04.2004→10.2004	 7.02256.28.0	SV-PDA	EP	
1.4 (L48) 55-59 kW (75-80 PS) Z 14 XEL	04.2004→10.2004	 7.02256.28.0	SV-PDA	EP	
1.4 LPG (L48) 66 kW (90 PS) Z 14 XEP	08.2009→10.2010	 7.02256.28.0	SV-PDA	EP	
1.6 (L48) 74-77 kW (101-105 PS) Z 16 XEP	03.2004→10.2010	 7.02256.38.0	AKF	EL	
		7.02256.31.0	SV-PDA	EP	Fahrgestellnummer bis: 72999999, 75999999, 78999999, 7G Vehicle Identification Number to: 72999999, 75999999, 78999999, 7G
1.6 (L48) 77 kW (105 PS) Z 16 XE1	03.2004→10.2010	 7.02256.38.0	AKF	EL	
		7.02256.43.0	EUV-SR	EL	 Z 16 XE1: Fahrgestellnummer ab: 72000001, 75000001, 78000001 Vehicle Identification Number from: 72000001, 75000001, 78000001 Fahrgestellnummer bis: 72999999, 75999999, 78999999 Vehicle Identification Number to: 72999999, 75999999, 78999999  Z 16 XE1: Fahrgestellnummer ab: 82000001, 85000001, 88000001, 8B000001, 8G000001 Vehicle Identification Number from: 82000001, 85000001, 88000001, 8B000001, 8G000001
1.6 (L48) 84-85 kW (114-116 PS) A 16 XER, Z 16 XER	12.2006→05.2014	 7.02256.38.0	AKF	EL	
		7.02256.43.0	EUV-SR	EL	
		7.06117.08.0	SV-NWV	EH	mit Dichtring with O-ring
1.6 Turbo (L48) 132 kW (180 PS) A 16 LET	02.2007→10.2010	 7.03833.02.0	LDRV	EL	

ASTRA H (A04) **20**



















1.6 Turbo (L48) 132 kW (180 PS) Z 16 LET	02.2007→10.2010		7.01039.03.0	EUV-VB	EL	
			7.03833.02.0	LDRV	EL	
1.7 CDTI (L48) 59 kW (80 PS) Z 17 DTL	03.2004→10.2010		7.03088.01.0	DW-TL	EP	
			7.02461.01.0	EUV-LS	EL	
1.7 CDTI (L48) 74 kW (100 PS) Z 17 DTH	03.2004→10.2010		7.03088.01.0	DW-TL	EP	
			7.02461.01.0	EUV-LS	EL	
1.7 CDTI (L48) 81 kW (110 PS) A 17 DTJ, Z 17 DTJ	02.2007→05.2014		7.03085.02.0	DW-TL	EP	
			7.02461.01.0	EUV-LS	EL	
1.7 CDTI (L48) 92 kW (125 PS) A 17 DTR, Z 17 DTR	02.2007→05.2014		7.03085.02.0	DW-TL	EP	
			7.02461.01.0	EUV-LS	EL	
1.8 (L48) 101-103 kW (137-140 PS) A 18 XER	01.2006→10.2010		7.06117.08.0	SV-NWV	EH	mit Dichtring with O-ring
			7.02256.43.0	EUV-SR	EL	
1.8 (L48) 101-103 kW (137-140 PS) Z 18 XER	01.2006→10.2010		7.06117.08.0	SV-NWV	EH	mit Dichtring with O-ring
			7.01420.02.0	DW-TL	EP	
1.9 CDTI (L48) 88 kW (120 PS) Z 19 DT	06.2004→10.2010		7.01420.02.0	DW-TL	EP	
			7.01420.02.0	DW-TL	EP	
1.9 CDTI (L48) 110 kW (150 PS) Z 19 DTH	09.2004→10.2010		7.01420.02.0	DW-TL	EP	
			7.01420.02.0	DW-TL	EP	
1.9 CDTI (L48) 74 kW (101 PS) Z 19 DTL	09.2005→10.2010		7.01420.02.0	DW-TL	EP	
			7.01420.02.0	DW-TL	EP	
1.9 CDTI 16V (L48) 88 kW (120 PS) Z 19 DTJ	04.2004→10.2010		7.01420.02.0	DW-TL	EP	
			7.01024.02.0	LDRV	EL	
2.0 Turbo (L48) 125 kW (170 PS) Z 20 LEL	03.2004→10.2010		7.01024.02.0	LDRV	EL	
			7.01039.03.0	LDRV	EL	
2.0 Turbo (L48) 147 kW (200 PS) Z 20 LER	09.2004→10.2010		7.01024.02.0	LDRV	EL	
			7.01039.03.0	LDRV	EL	
2.0 Turbo (L48) 177 kW (240 PS) Z 20 LEH	03.2005→10.2010		7.01039.03.0	EUV-SR	EL	
			7.01024.02.0	LDRV	EL	

ASTRA H CLASSIC Estate (A04) **21**

1.4 (L35) 66 kW (90 PS) Z 14 XEP	01.2009→		7.02256.28.0	SV-PDA	EP	
			7.03085.02.0	DW-TL	EP	
1.7 CDTI (L35) 92 kW (125 PS) A 17 DTR	01.2009→		7.02461.01.0	EUV-LS	EL	
			7.02461.01.0	EUV-LS	EL	
1.7 CDTI (L35) 92 kW (125 PS) Z 17 DTR	01.2009→		7.02461.01.0	EUV-LS	EL	
			7.03085.02.0	DW-TL	EP	
1.7 CDTi (L35) 81 kW (110 PS) Z 17 DTJ	01.2009→		7.03085.02.0	DW-TL	EP	
			7.02461.01.0	EUV-LS	EL	















ASTRA H CLASSIC Hatchback (A04) **22**

1.3 CDTI (L48) 66-74 kW (90-101 PS) Z 13 DTH	01.2009→		7.04423.01.0	DW-TL	EP	Fahrgestellnummer ab: B2, B5, B8, BG Vehicle Identification Number from: B2, B5, B8, BG
			7.02256.28.0	SV-PDA	EP	
1.4 (L48) 66 kW (90 PS) Z 14 XEP	01.2009→		7.02256.28.0	SV-PDA	EP	
			7.03085.02.0	DW-TL	EP	
1.7 CDTI (L48) 92 kW (125 PS) A 17 DTR	01.2009→		7.03085.02.0	DW-TL	EP	
			7.02461.01.0	EUV-LS	EL	





						
ASTRA H CLASSIC Hatchback (A04)						22
1.7 CDTI (L48) 92 kW (125 PS) Z 17 DTR	01.2009→		7.02461.01.0	EUV-LS	EL	
1.7 CDTI (L48) 81 kW (110 PS) A 17 DTJ, Z 17 DTJ	01.2009→		7.02461.01.0	EUV-LS	EL	
ASTRA H CLASSIC Saloon (A04)						23
1.7 CDTI (L69) 92 kW (125 PS) A 17 DTR, Z 17 DTR	01.2009→		7.02461.01.0	EUV-LS	EL	
1.7 CDTi (L69) 81 kW (110 PS) Z 17 DTJ	01.2009→		7.03085.02.0	DW-TL	EP	
ASTRA H Estate (A04)						24
1.3 CDTI (L35) 66-74 kW (90-101 PS) Z 13 DTH	08.2005→10.2010		7.01420.02.0	DW-TL	EP	Fahrgestellnummer bis: 9B999999, A2, A5, A8, AG Vehicle Identification Number to: 9B999999, A2, A5, A8, AG Fahrgestellnummer ab: A2, A5, A8, AG Vehicle Identification Number from: A2, A5, A8, AG Fahrgestellnummer bis: B2, B5, B8, BG Vehicle Identification Number to: B2, B5, B8, BG Fahrgestellnummer ab: B2, B5, B8, BG Vehicle Identification Number from: B2, B5, B8, BG
			7.03978.01.0	DW-TL	EP	
			7.04423.01.0	DW-TL	EP	
1.4 (L35) 55-59 kW (75-80 PS) Z 14 XEL	08.2004→10.2010		7.02256.28.0	SV-PDA	EP	
1.4 (L35) 66 kW (90 PS) Z 14 XEP	08.2004→10.2010		7.02256.28.0	SV-PDA	EP	
1.4 LPG (L35) 66 kW (90 PS) Z 14 XEP	08.2009→10.2010		7.02256.28.0	SV-PDA	EP	
1.6 (L35) 74-77 kW (101-105 PS) Z 16 XEP	08.2004→10.2010		7.02256.38.0	AKF	EL	Fahrgestellnummer bis: 72999999, 75999999, 78999999, 7G Vehicle Identification Number to: 72999999, 75999999, 78999999, 7G
			7.02256.31.0	SV-PDA	EP	
1.6 (L35) 77 kW (105 PS) Z 16 XE1	08.2004→10.2010		7.02256.38.0	AKF	EL	Z 16 XE1: Fahrgestellnummer ab: 72000001, 75000001, 78000001 Vehicle Identification Number from: 72000001, 75000001, 78000001 Fahrgestellnummer bis: 72999999, 75999999, 78999999 Vehicle Identification Number to: 72999999, 75999999, 78999999 Z 16 XE1: Fahrgestellnummer ab: 82000001, 85000001, 88000001, 8B000001, 8G000001 Vehicle Identification Number from: 82000001, 85000001, 88000001, 8B000001, 8G000001
			7.02256.43.0	EUV-SR	EL	
1.6 (L35) 84-85 kW (114-116 PS) A 16 XER, Z 16 XER	12.2006→05.2014		7.02256.38.0	AKF	EL	mit Dichtring with O-ring
			7.02256.43.0	EUV-SR	EL	
			7.06117.08.0	SV-NWV	EH	
1.6 LPG (L35) 85 kW (116 PS) Z 16 XER	08.2009→10.2010		7.02256.38.0	AKF	EL	mit Dichtring with O-ring
			7.02256.43.0	EUV-SR	EL	
			7.06117.08.0	SV-NWV	EH	













































ASTRA H Estate (A04) **24**

1.6 Turbo (L35) 132 kW (180 PS) A 16 LET	02.2007→10.2010	 7.03833.02.0	LDRV	EL	
1.6 Turbo (L35) 132 kW (180 PS) Z 16 LET	02.2007→10.2010	 7.01039.03.0	EUV-VB	EL	
		7.03833.02.0	LDRV	EL	
1.7 CDTI (L35) 59 kW (80 PS) Z 17 DTL	08.2004→10.2010	 7.03088.01.0	DW-TL	EP	
		7.02461.01.0	EUV-LS	EL	
1.7 CDTI (L35) 74 kW (100 PS) Z 17 DTH	08.2004→10.2010	 7.03088.01.0	DW-TL	EP	
		7.02461.01.0	EUV-LS	EL	
1.7 CDTI (L35) 81 kW (110 PS) A 17 DTJ, Z 17 DTJ	02.2007→05.2014	 7.03085.02.0	DW-TL	EP	
		7.02461.01.0	EUV-LS	EL	
1.7 CDTI (L35) 92 kW (125 PS) A 17 DTR, Z 17 DTR	02.2007→05.2014	 7.03085.02.0	DW-TL	EP	
		7.02461.01.0	EUV-LS	EL	
1.8 (L35) 101-103 kW (137-140 PS) A 18 XER	08.2005→05.2014	 7.06117.08.0	SV-NWV	EH	mit Dichtring with O-ring
1.8 (L35) 101-103 kW (137-140 PS) Z 18 XER	08.2005→05.2014	 7.02256.43.0	EUV-SR	EL	
		7.06117.08.0	SV-NWV	EH	mit Dichtring with O-ring
1.9 CDTI (L35) 110 kW (150 PS) Z 19 DTH	09.2004→10.2010	 7.01420.02.0	DW-TL	EP	
1.9 CDTI (L35) 88 kW (120 PS) Z 19 DT	09.2005→10.2010	 7.01420.02.0	DW-TL	EP	
1.9 CDTI (L35) 74 kW (101 PS) Z 19 DTL	09.2005→10.2010	 7.01420.02.0	DW-TL	EP	
1.9 CDTI 16V (L35) 88 kW (120 PS) Z 19 DTJ	08.2004→10.2010	 7.01420.02.0	DW-TL	EP	
2.0 Turbo (L35) 125 kW (170 PS) Z 20 LEL	08.2004→10.2010	 7.01024.02.0	LDRV	EL	
		7.01039.03.0	LDRV	EL	
2.0 Turbo (L35) 147 kW (200 PS) Z 20 LER	09.2004→10.2010	 7.01024.02.0	LDRV	EL	
		7.01039.03.0	LDRV	EL	

ASTRA H GTC (A04) **25**

1.3 CDTI (L08) 66-74 kW (90-101 PS) Z 13 DTH	04.2005→10.2010	 7.01420.02.0	DW-TL	EP	Fahrgestellnummer bis: 9B999999, A2, A5, A8, AG Vehicle Identification Number to: 9B999999, A2, A5, A8, AG
		7.03978.01.0	DW-TL	EP	Fahrgestellnummer ab: A2, A5, A8, AG Vehicle Identification Number from: A2, A5, A8, AG
		7.04423.01.0	DW-TL	EP	Fahrgestellnummer bis: B2, B5, B8, BG Vehicle Identification Number to: B2, B5, B8, BG
			DW-TL	EP	Fahrgestellnummer ab: B2, B5, B8, BG Vehicle Identification Number from: B2, B5, B8, BG
1.4 (L08) 55-59 kW (75-80 PS) Z 14 XEL	03.2005→10.2010	 7.02256.28.0	SV-PDA	EP	
1.4 (L08) 66 kW (90 PS) Z 14 XEP	03.2005→10.2010	 7.02256.28.0	SV-PDA	EP	
1.6 (L08) 74-77 kW (101-105 PS) Z 16 XEP	03.2005→10.2010	 7.02256.38.0	AKF	EL	

						
ASTRA H GTC (A04)					25	
			7.02256.31.0	SV-PDA	EP	Fahrgestellnummer bis: 72999999, 75999999, 78999999, 7G Vehicle Identification Number to: 72999999, 75999999, 78999999, 7G
1.6 (L08) 77 kW (105 PS) Z 16 XE1	03.2005→10.2010		7.02256.38.0	AKF	EL	 Z 16 XE1: Fahrgestellnummer ab: 72000001, 75000001, 78000001 Vehicle Identification Number from: 72000001, 75000001, 78000001 Fahrgestellnummer bis: 72999999, 75999999, 78999999 Vehicle Identification Number to: 72999999, 75999999, 78999999  Z 16 XE1: Fahrgestellnummer ab: 82000001, 85000001, 88000001, 8B000001, 8G000001 Vehicle Identification Number from: 82000001, 85000001, 88000001, 8B000001, 8G000001
			7.02256.43.0	EUV-SR	EL	
1.6 (L08) 85 kW (116 PS) Z 16 XER	12.2006→10.2010		7.02256.38.0	AKF	EL	mit Dichtring with O-ring
			7.02256.43.0	EUV-SR	EL	
			7.06117.08.0	SV-NWV	EH	
1.6 Turbo (L08) 132 kW (180 PS) A 16 LET	02.2007→10.2010		7.03833.02.0	LDRV	EL	
1.6 Turbo (L08) 132 kW (180 PS) Z 16 LET	02.2007→10.2010		7.01039.03.0	EUV-VB	EL	
			7.03833.02.0	LDRV	EL	
1.7 CDTi (L08) 59 kW (80 PS) Z 17 DTL	03.2005→10.2010		7.03088.01.0	DW-TL	EP	
			7.02461.01.0	EUV-LS	EL	
1.7 CDTi (L08) 81 kW (110 PS) A 17 DTJ	02.2007→10.2010		7.03085.02.0	DW-TL	EP	
			7.02461.01.0	EUV-LS	EL	
1.7 CDTi (L08) 81 kW (110 PS) Z 17 DTJ	02.2007→10.2010		7.02461.01.0	EUV-LS	EL	
			7.02461.01.0	EUV-LS	EL	
1.7 CDTi (L08) 92 kW (125 PS) A 17 DTR	02.2007→10.2010		7.03085.02.0	DW-TL	EP	
			7.02461.01.0	EUV-LS	EL	
1.7 CDTi (L08) 92 kW (125 PS) Z 17 DTR	02.2007→10.2010		7.02461.01.0	EUV-LS	EL	
			7.02461.01.0	EUV-LS	EL	
1.7 CDTi (L08) 74 kW (100 PS) Z 17 DTH	03.2005→10.2010		7.03088.01.0	DW-TL	EP	
			7.02461.01.0	EUV-LS	EL	
1.8 (L08) 101-103 kW (137-140 PS) Z 18 XER	01.2006→10.2010		7.02256.43.0	EUV-SR	EL	mit Dichtring with O-ring
			7.06117.08.0	SV-NWV	EH	
1.9 CDTi (L08) 88 kW (120 PS) Z 19 DT	09.2005→10.2010		7.01420.02.0	DW-TL	EP	
1.9 CDTi (L08) 74 kW (101 PS) Z 19 DTL	01.2006→10.2010		7.01420.02.0	DW-TL	EP	
			7.01420.02.0	DW-TL	EP	
1.9 CDTi (L08) 110 kW (150 PS) Z 19 DTH	03.2005→10.2010		7.01420.02.0	DW-TL	EP	
			7.01420.02.0	DW-TL	EP	
1.9 CDTi 16V (L08) 88 kW (120 PS) Z 19 DTJ	03.2005→10.2010		7.01420.02.0	DW-TL	EP	
			7.01420.02.0	DW-TL	EP	
2.0 Turbo (L08) 147 kW (200 PS) Z 20 LER	03.2005→10.2010		7.01024.02.0	LDRV	EL	
			7.01039.03.0	LDRV	EL	

						
ASTRA H GTC (A04)						25
2.0 Turbo (L08) 125 kW (170 PS) Z 20 LEL	03.2005→10.2010		7.01024.02.0	LDRV	EL	
			7.01039.03.0	LDRV	EL	
2.0 Turbo (L08) 177 kW (240 PS) Z 20 LEH	08.2005→10.2010		7.01039.03.0	EUV-SR	EL	
			7.01024.02.0	LDRV	EL	
ASTRA H Saloon (A04)						26
1.3 CDTi (L69) 66-74 kW (90-101 PS) Z 13 DTH	02.2007→10.2010		7.01420.02.0	DW-TL	EP	Fahrgestellnummer bis: 9B999999, A2, A5, A8, AG Vehicle Identification Number to: 9B999999, A2, A5, A8, AG
			7.03978.01.0	DW-TL	EP	Fahrgestellnummer ab: A2, A5, A8, AG Vehicle Identification Number from: A2, A5, A8, AG
			7.04423.01.0	DW-TL	EP	Fahrgestellnummer bis: B2, B5, B8, BG Vehicle Identification Number to: B2, B5, B8, BG
1.4 (L69) 66 kW (90 PS) Z 14 XEP	02.2007→06.2010		7.02256.28.0	SV-PDA	EP	
1.6 (L69) 85 kW (116 PS) Z 16 XER	02.2007→05.2014		7.02256.38.0	AKF	EL	
			7.02256.43.0	EUV-SR	EL	
			7.06117.08.0	SV-NWV	EH	mit Dichtring with O-ring
1.6 (L69) 74-77 kW (101-105 PS) Z 16 XEP	02.2007→06.2010		7.02256.31.0	SV-PDA	EP	Fahrgestellnummer bis: 72999999, 75999999, 78999999, 7G Vehicle Identification Number to: 72999999, 75999999, 78999999, 7G
1.7 CDTi (L69) 74 kW (100 PS) Z 17 DTH	02.2007→10.2010		7.03088.01.0	DW-TL	EP	
			7.02461.01.0	EUV-LS	EL	
1.7 CDTi (L69) 81 kW (110 PS) Z 17 DTJ	02.2007→05.2014		7.03085.02.0	DW-TL	EP	
			7.02461.01.0	EUV-LS	EL	
1.8 (L69) 101-103 kW (137-140 PS) A 18 XER	02.2007→09.2012		7.06117.08.0	SV-NWV	EH	mit Dichtring with O-ring
1.8 (L69) 101-103 kW (137-140 PS) Z 18 XER	02.2007→09.2012		7.02256.43.0	EUV-SR	EL	
			7.06117.08.0	SV-NWV	EH	mit Dichtring with O-ring
ASTRA H TwinTop (A04)						27
1.4 (L67) 66 kW (90 PS) Z 14 XEP	10.2005→10.2010		7.02256.28.0	SV-PDA	EP	
1.6 (L67) 74-77 kW (101-105 PS) Z 16 XEP	09.2005→10.2010		7.02256.38.0	AKF	EL	
			7.02256.31.0	SV-PDA	EP	Fahrgestellnummer bis: 72999999, 75999999, 78999999, 7G Vehicle Identification Number to: 72999999, 75999999, 78999999, 7G
1.6 (L67) 77 kW (105 PS) Z 16 XE1	09.2005→10.2010		7.02256.38.0	AKF	EL	

ASTRA H TwinTop (A04) **27**















			7.02256.43.0	EUV-SR	EL	Z 16 XE1: Fahrgestellnummer ab: 72000001, 75000001, 78000001 Vehicle Identification Number from: 72000001, 75000001, 78000001 Fahrgestellnummer bis: 72999999, 75999999, 78999999 Vehicle Identification Number to: 72999999, 75999999, 78999999 Z 16 XE1: Fahrgestellnummer ab: 82000001, 85000001, 88000001, 8B000001, 8G000001 Vehicle Identification Number from: 82000001, 85000001, 88000001, 8B000001, 8G000001
1.6 (L67) 85 kW (116 PS) Z 16 XER	12.2006→10.2010		7.02256.38.0	AKF	EL	
			7.02256.43.0 7.06117.08.0	EUV-SR SV-NWV	EL EH	mit Dichtring with O-ring
1.6 Turbo (L67) 132 kW (180 PS) A 16 LET	02.2007→10.2010		7.03833.02.0	LDRV	EL	
1.6 Turbo (L67) 132 kW (180 PS) Z 16 LET	02.2007→10.2010		7.01039.03.0	EUV-VB	EL	
			7.03833.02.0	LDRV	EL	
1.8 (L67) 101-103 kW (137-140 PS) A 18 XER	09.2005→10.2010		7.06117.08.0	SV-NWV	EH	mit Dichtring with O-ring
1.8 (L67) 101-103 kW (137-140 PS) Z 18 XER	09.2005→10.2010		7.02256.43.0	EUV-SR	EL	
			7.06117.08.0	SV-NWV	EH	mit Dichtring with O-ring
1.9 CDTi (L67) 110 kW (150 PS) Z 19 DTH	09.2005→10.2010		7.01420.02.0	DW-TL	EP	
2.0 Turbo (L67) 125 kW (170 PS) Z 20 LEL	09.2005→10.2010		7.01024.02.0	LDRV	EL	
			7.01039.03.0	LDRV	EL	
2.0 Turbo (L67) 147 kW (200 PS) Z 20 LER	09.2005→10.2010		7.01024.02.0	LDRV	EL	
			7.01039.03.0	LDRV	EL	





















ASTRA J (P10) **28**

1.3 CDTi (68) 70 kW (95 PS) A 13 DTE	12.2009→10.2015		7.03073.01.0	DW-TL	EP	
			7.01981.07.0	SV-AGR-K	EP	Fahrgestellnummer bis: B3999999, B8999999, BG999999 Vehicle Identification Number to: B3999999, B8999999, BG999999
1.4 (68) 64 kW (87 PS) A 14 XEL	12.2009→10.2015		7.02256.43.0	EUV-SR	EL	Fahrgestellnummer bis: C0999999, C1999999, C3999999, C8999999, CG999999 Vehicle Identification Number to: C0999999, C1999999, C3999999, C8999999, CG999999
			7.06117.07.0	ZM-NWV	EL	mit Dichtring with O-ring
1.4 (68) 74 kW (101 PS) A 14 XER, B 14 XER	12.2009→10.2015		7.02256.43.0	EUV-SR	EL	A 14 XER, B 14 XER: Fahrgestellnummer bis: C0999999, C1999999, C3999999, C8999999, CG999999 Vehicle Identification Number to: C0999999, C1999999, C3999999, C8999999, CG999999
			7.06117.07.0	ZM-NWV	EL	mit Dichtring with O-ring





ASTRA J (P10) **28**

1.4 LPG (68) 103 kW (140 PS) A 14 NET	01.2012→10.2015		7.03833.02.0	EUV-VB	EL	mit Dichtring with O-ring
			7.06117.07.0	ZM-NWV	EL	
1.4 Turbo (68) 103-110 kW (140-150 PS) A 14 NET, B 14 NET	12.2009→10.2015		7.03833.02.0	EUV-VB	EL	mit Dichtring with O-ring
			7.06117.07.0	ZM-NWV	EL	
1.4 Turbo (68) 88 kW (120 PS) A 14 NEL, B 14 NEL	10.2010→10.2015		7.03833.02.0	EUV-VB	EL	mit Dichtring with O-ring
			7.06117.07.0	ZM-NWV	EL	
1.6 (68) 84-85 kW (114-116 PS) A 16 XER	12.2009→10.2015		7.02256.38.0	AKF	EL	mit Dichtring with O-ring
			7.02256.43.0	EUV-SR	EL	
			7.06117.08.0	SV-NWV	EH	
1.6 (68) 85 kW (116 PS) B 16 XER	12.2009→10.2015		7.02256.43.0	EUV-SR	EL	mit Dichtring with O-ring
			7.06117.08.0	SV-NWV	EH	
1.6 CDTi (68) 81-100 kW (110-136 PS) B 16 DTH	11.2013→10.2015		7.08681.01.0	EOV	EH	Fahrgestellnummer ab: G0000001, G1000001, G8000001, GG000001 Vehicle Identification Number from: G0000001, G1000001, G8000001, GG000001
			7.02256.44.0	EUV-AGR	EL	
1.6 CDTi (68) 81 kW (110 PS) B 16 DTL	02.2014→10.2015		7.08681.01.0	EOV	EH	Fahrgestellnummer ab: G0000001, G1000001, G8000001, GG000001 Vehicle Identification Number from: G0000001, G1000001, G8000001, GG000001
			7.02256.44.0	EUV-AGR	EL	
1.6 SIDI (68) 125 kW (170 PS) A 16 XHT	12.2012→10.2015		7.03351.12.0	LDRV	EP	
1.6 Turbo (68) 132 kW (180 PS) A 16 LET	12.2009→10.2015		7.01039.03.0	EUV-VB	EL	
			7.03833.02.0	LDRV	EL	
1.6 Turbo 4x4 (68) 132 kW (180 PS) A 16 LET	12.2009→10.2015		7.01039.03.0	EUV-VB	EL	
			7.03833.02.0	EUV-VB	EL	
1.7 CDTi (68) 81 kW (110 PS) A 17 DTC, A 17 DTE	09.2009→10.2015		7.03073.01.0	DW-TL	EP	
			7.02461.01.0	EUV-LS	EL	
1.7 CDTi (68) 81 kW (110 PS) A 17 DTJ	09.2009→10.2015		7.03085.02.0	DW-TL	EP	
			7.02461.01.0	EUV-LS	EL	
1.7 CDTi (68) 92 kW (125 PS) A 17 DTR	12.2009→10.2015		7.03085.02.0	DW-TL	EP	
			7.02461.01.0	EUV-LS	EL	
1.7 CDTi (68) 96 kW (131 PS) A 17 DTF, A 17 DTS	07.2011→10.2015		7.03073.01.0	DW-TL	EP	
			7.03085.02.0	DW-TL	EP	
			7.02461.01.0	EUV-LS	EL	
2.0 BiTurbo CDTi (68) 140-143 kW (190-195 PS) A 20 DTR	09.2012→10.2015		7.03978.01.0	DW-TL	EP	für OE-Nummer: 55573362, 55575611, 8 51 017, 8 51 042 for OE number: 55573362, 55575611, 8 51 017, 8 51 042
			7.03460.02.0*	STE	EP	











					
ASTRA J (P10)					28
			↳ 7.03073.01.0	DW-TL	EP
2.0 CDTI (68) 96-121 kW (131-165 PS) A 20 DTH	09.2009→10.2015		7.03978.01.0	DW-TL	EP
2.0 CDTI (68) 96-121 kW (131-165 PS) A 20 DTH	06.2011→10.2015		7.03978.01.0	DW-TL	EP
ASTRA J GTC					29
1.4 (08) 103-110 kW (140-150 PS) A 14 NET, B 14 NET	10.2011→		7.03833.02.0	EUV-VB	EL
			7.06117.07.0	ZM-NWV	EL mit Dichtring with O-ring
1.4 (08) 74 kW (101 PS) A 14 XER	10.2011→10.2015		7.02256.43.0	EUV-SR	EL Fahrgestellnummer bis: C0999999, C1999999, C3999999, C8999999, CG999999 Vehicle Identification Number to: C0999999, C1999999, C3999999, C8999999, CG999999
			7.06117.07.0	ZM-NWV	EL mit Dichtring with O-ring
1.4 (08) 88 kW (120 PS) A 14 NEL, B 14 NEL	10.2011→		7.03833.02.0	EUV-VB	EL
			7.06117.07.0	ZM-NWV	EL mit Dichtring with O-ring
1.6 (08) 132 kW (180 PS) A 16 LET	10.2011→		7.01039.03.0	EUV-VB	EL
			7.03833.02.0	LDRV	EL
1.6 CDTI (08) 81 kW (110 PS) B 16 DTL	07.2014→		7.08681.01.0	EOV	EH Fahrgestellnummer ab: G0000001, G1000001, G8000001, GG000001 Vehicle Identification Number from: G0000001, G1000001, G8000001, GG000001
1.6 CDTI (08) 81-100 kW (110-136 PS) B 16 DTH	07.2014→		7.08681.01.0	EOV	EH Fahrgestellnummer ab: G0000001, G1000001, G8000001, GG000001 Vehicle Identification Number from: G0000001, G1000001, G8000001, GG000001
			7.02256.44.0	EUV-AGR	EL
1.7 CDTI (08) 81 kW (110 PS) A 17 DTC, A 17 DTE	10.2011→10.2015		7.03073.01.0	DW-TL	EP
			7.02461.01.0	EUV-LS	EL
1.7 CDTI (08) 81 kW (110 PS) A 17 DTJ	10.2011→10.2015		7.03085.02.0	DW-TL	EP
			7.02461.01.0	EUV-LS	EL
1.7 CDTI (08) 96 kW (131 PS) A 17 DTF, A 17 DTS	10.2011→10.2015		7.03073.01.0	DW-TL	EP
			7.03085.02.0	DW-TL	EP
			7.02461.01.0	EUV-LS	EL
1.8 (08) 101-103 kW (137-140 PS) A 18 XER	10.2011→10.2015		7.02256.43.0	EUV-SR	EL
			7.06117.08.0	SV-NWV	EH mit Dichtring with O-ring
2.0 (08) 162-206 kW (220-280 PS) A 20 NFT	04.2012→		7.02721.06.0*	EUV-VB	EL mit Halter with holder
			↳ 7.01441.04.0	EUV-VB	EL
			7.06117.05.0	SV-NWV	EH mit Dichtring with O-ring
			7.06117.06.0	SV-NWV	EH mit Dichtring with O-ring
2.0 (08) 191-206 kW (260-280 PS) B 20 NFT	04.2012→		7.02721.06.0*	EUV-VB	EL mit Halter with holder





















ASTRA J GTC **29**

		↳ 7.01441.04.0	EUV-VB	EL	
2.0 BiTurbo CDTI (08) 140-143 kW (190-195 PS) A 20 DTR	10.2012→10.2015	 7.03978.01.0	DW-TL	EP	für OE-Nummer: 55573362, 55575611, 8 51 017, 8 51 042 for OE number: 55573362, 55575611, 8 51 017, 8 51 042
		7.03460.02.0* ↳ 7.03073.01.0	STE DW-TL	EP EP	
2.0 CDTI (08) 96-121 kW (131-165 PS) A 20 DTH	10.2011→10.2015	 7.03978.01.0	DW-TL	EP	

ASTRA J Saloon **30**













1.3 CDTI (69) 70 kW (95 PS) A 13 DTE	06.2012→10.2015	 7.03073.01.0	DW-TL	EP	
		7.01981.07.0	SV-AGR-K	EP	Fahrgestellnummer bis: B3999999, B8999999, BG999999 Vehicle Identification Number to: B3999999, B8999999, BG999999
1.4 64 kW (87 PS) A 14 XEL	01.2014→10.2015	 7.06117.07.0	ZM-NWV	EL	mit Dichtring with O-ring
1.4 (69) 74 kW (101 PS) A 14 XER, B 14 XER	06.2012→10.2015	 7.02256.43.0	EUV-SR	EL	 A 14 XER, B 14 XER: Fahrgestellnummer bis: C0999999, C1999999, C3999999, C8999999, CG999999 Vehicle Identification Number to: C0999999, C1999999, C3999999, C8999999, CG999999
		7.06117.07.0	ZM-NWV	EL	mit Dichtring with O-ring
1.4 LPG (69) 103 kW (140 PS) A 14 NET	07.2014→	 7.03833.02.0	EUV-VB	EL	
		7.06117.07.0	ZM-NWV	EL	mit Dichtring with O-ring
1.4 Turbo (69) 103-110 kW (140-150 PS) A 14 NET, B 14 NET	06.2012→	 7.03833.02.0	EUV-VB	EL	
		7.06117.07.0	ZM-NWV	EL	mit Dichtring with O-ring
1.4 Turbo (69) 88 kW (120 PS) A 14 NEL, B 14 NEL	06.2012→10.2015	 7.03833.02.0	EUV-VB	EL	
		7.06117.07.0	ZM-NWV	EL	mit Dichtring with O-ring
1.6 (69) 84-85 kW (114-116 PS) A 16 XER	06.2012→	 7.02256.38.0	AKF	EL	
		7.02256.43.0	EUV-SR	EL	
		7.06117.08.0	SV-NWV	EH	mit Dichtring with O-ring
1.6 (69) 85 kW (116 PS) B 16 XER	06.2012→	 7.02256.43.0	EUV-SR	EL	
		7.06117.08.0	SV-NWV	EH	mit Dichtring with O-ring
1.6 CDTi (69) 81-100 kW (110-136 PS) B 16 DTH	01.2014→	 7.08681.01.0	EOV	EH	Fahrgestellnummer ab: G0000001, G1000001, G8000001, GG000001 Vehicle Identification Number from: G0000001, G1000001, G8000001, GG000001
		7.02256.44.0	EUV-AGR	EL	
1.6 CDTi (69) 81 kW (110 PS) B 16 DTL	04.2014→	 7.08681.01.0	EOV	EH	Fahrgestellnummer ab: G0000001, G1000001, G8000001, GG000001 Vehicle Identification Number from: G0000001, G1000001, G8000001, GG000001
		7.02256.44.0	EUV-AGR	EL	

					
ASTRA J Saloon					
30					
1.6 Turbo (69) 132 kW (180 PS) A 16 LET	06.2012→		7.01039.03.0	EUV-VB	EL
			7.03833.02.0	LDRV	EL
1.7 CDTI (69) 81 kW (110 PS) A 17 DTC, A 17 DTE	06.2012→10.2015		7.03073.01.0	DW-TL	EP
			7.02461.01.0	EUV-LS	EL
1.7 CDTI (69) 81 kW (110 PS) A 17 DTJ	06.2012→10.2015		7.03085.02.0	DW-TL	EP
			7.02461.01.0	EUV-LS	EL
1.7 CDTI (69) 96 kW (131 PS) A 17 DTF, A 17 DTS	06.2012→10.2015		7.03073.01.0	DW-TL	EP
			7.02461.01.0	EUV-LS	EL
ASTRA J Sports Tourer (P10)					
31					
1.3 CDTI (35) 70 kW (95 PS) A 13 DTE	10.2010→10.2014		7.03073.01.0	DW-TL	EP
			7.01981.07.0	SV-AGR-K	EP Fahrgestellnummer bis: B3999999, B8999999, BG999999 Vehicle Identification Number to: B3999999, B8999999, BG999999
1.4 (35) 74 kW (101 PS) A 14 XER, B 14 XER	10.2010→10.2015		7.02256.43.0	EUV-SR	EL  A 14 XER, B 14 XER: Fahrgestellnummer bis: C0999999, C1999999, C3999999, C8999999, CG999999 Vehicle Identification Number to: C0999999, C1999999, C3999999, C8999999, CG999999
			7.06117.07.0	ZM-NWV	EL mit Dichtring with O-ring
1.4 (35) 64 kW (87 PS) A 14 XEL	10.2010→10.2015		7.02256.43.0	EUV-SR	EL Fahrgestellnummer bis: C0999999, C1999999, C3999999, C8999999, CG999999 Vehicle Identification Number to: C0999999, C1999999, C3999999, C8999999, CG999999
			7.06117.07.0	ZM-NWV	EL mit Dichtring with O-ring
1.4 LPG (35) 103 kW (140 PS) A 14 NET	12.2011→10.2015		7.03833.02.0	EUV-VB	EL
			7.06117.07.0	ZM-NWV	EL mit Dichtring with O-ring
1.4 Turbo (35) 88 kW (120 PS) A 14 NEL, B 14 NEL	10.2010→10.2015		7.03833.02.0	EUV-VB	EL
			7.06117.07.0	ZM-NWV	EL mit Dichtring with O-ring
1.4 Turbo (35) 103-110 kW (140-150 PS) A 14 NET, B 14 NET	10.2010→10.2015		7.03833.02.0	EUV-VB	EL
			7.06117.07.0	ZM-NWV	EL mit Dichtring with O-ring
1.6 (35) 84-85 kW (114-116 PS) A 16 XER	10.2010→10.2015		7.02256.38.0	AKF	EL
			7.02256.43.0	EUV-SR	EL
			7.06117.08.0	SV-NWV	EH mit Dichtring with O-ring
1.6 (35) 85 kW (116 PS) B 16 XER	10.2010→10.2015		7.02256.43.0	EUV-SR	EL
			7.06117.08.0	SV-NWV	EH mit Dichtring with O-ring



























































ASTRA J Sports Tourer (P10) **31**

























1.6 CDTi (35) 81-100 kW (110-136 PS) B 16 DTH	11.2013→10.2015		7.08681.01.0	EOV	EH	Fahrgestellnummer ab: G0000001, G1000001, G8000001, GG000001 Vehicle Identification Number from: G0000001, G1000001, G8000001, GG000001
			7.02256.44.0	EUV-AGR	EL	
1.6 CDTi (35) 81 kW (110 PS) B 16 DTL	02.2014→10.2015		7.08681.01.0	EOV	EH	Fahrgestellnummer ab: G0000001, G1000001, G8000001, GG000001 Vehicle Identification Number from: G0000001, G1000001, G8000001, GG000001
			7.02256.44.0	EUV-AGR	EL	
1.6 Turbo (35) 132 kW (180 PS) A 16 LET	10.2010→10.2015		7.01039.03.0	EUV-VB	EL	
			7.03833.02.0	LDRV	EL	
1.7 CDTi (35) 81 kW (110 PS) A 17 DTC, A 17 DTE	10.2010→10.2015		7.03073.01.0	DW-TL	EP	
			7.02461.01.0	EUV-LS	EL	
1.7 CDTi (35) 81 kW (110 PS) A 17 DTJ	10.2010→10.2015		7.03085.02.0	DW-TL	EP	
			7.02461.01.0	EUV-LS	EL	
1.7 CDTi (35) 92 kW (125 PS) A 17 DTR	10.2010→10.2015		7.03085.02.0	DW-TL	EP	
			7.02461.01.0	EUV-LS	EL	
1.7 CDTi (35) 74 kW (101 PS) A 17 DTL	10.2010→10.2015		7.03085.02.0	DW-TL	EP	
			7.02461.01.0	EUV-LS	EL	
1.7 CDTi (35) 74 kW (101 PS) A 17 DTN	10.2010→10.2015		7.03073.01.0	DW-TL	EP	
			7.03085.02.0	DW-TL	EP	
1.7 CDTi (35) 74 kW (101 PS) A 17 DTF, A 17 DTS	10.2010→10.2015		7.03073.01.0	DW-TL	EP	
			7.03085.02.0	DW-TL	EP	
1.7 CDTi (35) 96 kW (131 PS) A 17 DTF, A 17 DTS	10.2010→10.2015		7.03073.01.0	DW-TL	EP	
			7.03085.02.0	DW-TL	EP	
2.0 BiTurbo CDTi (35) 140-143 kW (190-195 PS) A 20 DTR	09.2012→10.2015		7.03978.01.0	DW-TL	EP	für OE-Nummer: 55573362, 55575611, 8 51 017, 8 51 042 for OE number: 55573362, 55575611, 8 51 017, 8 51 042
			7.03460.02.0* ↳ 7.03073.01.0	STE DW-TL	EP EP	
2.0 CDTi (35) 96-121 kW (131-165 PS) A 20 DTH	10.2010→10.2015		7.03978.01.0	DW-TL	EP	
2.0 CDTi (35) 96-121 kW (131-165 PS) A 20 DTH	08.2011→10.2015		7.03978.01.0	DW-TL	EP	

ASTRA K (B16) **32**

1.0 Turbo (68) 66-77 kW (90-105 PS) B 10 XFL, D 10 XFL	06.2015→		7.03351.12.0	LDRV	EP	
			7.03381.14.0	SUV	EL	
1.0 Turbo (68) 66-77 kW (90-105 PS) D 10 XFL	06.2018→		7.03351.12.0	LDRV	EP	
1.4 CNG (68) 81-112 kW (110-152 PS) B 14 XNT	10.2017→		7.03381.14.0	SUV	EL	

						
ASTRA K (B16)						32
1.4 Turbo (68) 88-92 kW (120-125 PS) B 14 XFL	06.2015→		7.03351.12.0	LDRV	EP	
			7.03381.14.0	SUV	EL	
1.4 Turbo (68) 103-112 kW (140-152 PS) B 14 XFT	06.2015→		7.03351.12.0	LDRV	EP	
			7.03381.14.0	SUV	EL	
1.6 BiTurbo 110 kW (150 PS) D 16 DTR	08.2018→		7.02256.44.0	EUV-AGR	EL	
1.6 CDTi (68) 70-81 kW (95-110 PS) B 16 DTE, B 16 DTU	06.2015→		7.08681.01.0	EOV	EH	
			7.02256.44.0	EUV-AGR	EL	
1.6 CDTi (68) 81-100 kW (110-136 PS) B 16 DTH	06.2015→		7.08681.01.0	EOV	EH	
			7.02256.44.0	EUV-AGR	EL	
1.6 CDTi (68) 70-81 kW (95-110 PS) B 16 DTE	06.2015→		7.08681.01.0	EOV	EH	
			7.02256.44.0	EUV-AGR	EL	
1.6 CDTi (68) 118 kW (160 PS) B 16 DTR	11.2015→		7.08681.01.0	EOV	EH	
			7.02256.44.0	EUV-AGR	EL	
1.6 Turbo (68) 147 kW (200 PS) B 16 SHT	11.2015→		7.03351.12.0	LDRV	EP	
ASTRA K Sports Tourer (B16)						33
1.0 Turbo (35) 66-77 kW (90-105 PS) B 10 XFL, D 10 XFL	11.2015→		7.03351.12.0	LDRV	EP	
			7.03381.14.0	SUV	EL	
1.0 Turbo (35) 66-77 kW (90-105 PS) D 10 XFL	06.2018→		7.03351.12.0	LDRV	EP	
			7.03381.14.0	SUV	EL	
1.4 CNG (35) 81-112 kW (110-152 PS) B 14 XNT	10.2017→		7.03381.14.0	SUV	EL	
1.4 Turbo (35) 88-92 kW (120-125 PS) B 14 XFL	11.2015→		7.03381.14.0	SUV	EL	
			7.03381.14.0	SUV	EL	
1.4 Turbo (35) 103-112 kW (140-152 PS) B 14 XFT	11.2015→		7.03381.14.0	SUV	EL	
			7.03381.14.0	SUV	EL	
1.6 BiTurbo 110 kW (150 PS) D 16 DTR	08.2018→		7.02256.44.0	EUV-AGR	EL	
1.6 CDTi (35) 70-81 kW (95-110 PS) B 16 DTE	11.2015→		7.08681.01.0	EOV	EH	
			7.02256.44.0	EUV-AGR	EL	
1.6 CDTi (35) 70-81 kW (95-110 PS) B 16 DTE, B 16 DTU	11.2015→		7.08681.01.0	EOV	EH	
			7.02256.44.0	EUV-AGR	EL	
1.6 CDTi (35) 81-100 kW (110-136 PS) B 16 DTH	11.2015→		7.08681.01.0	EOV	EH	
			7.02256.44.0	EUV-AGR	EL	
1.6 CDTi (35) 118 kW (160 PS) B 16 DTR	11.2015→		7.08681.01.0	EOV	EH	
			7.02256.44.0	EUV-AGR	EL	

			 PIERBURG		
ASTRA K Sports Tourer (B16)					33
1.6 Turbo (35) 147 kW (200 PS) B 16 SHT	11.2015→		7.02256.44.0 7.03351.12.0	EUV-AGR LDRV	EL EP
CALIBRA A (C89)					34
2.0 i 16V (M07) 100 kW (136 PS) X 20 XEV	02.1994→07.1997		7.06269.01.0	LLR	EL 
2.0 i 16V 4x4 (M07) 100 kW (136 PS) X 20 XEV	02.1994→07.1997		7.06269.01.0	LLR	EL 
CASCADA (W13)					35
1.4 (67) 88 kW (120 PS) A 14 NEL, B 14 NEL	04.2013→04.2018		7.03833.02.0 7.06117.07.0	EUV-VB ZM-NWV	EL EL mit Dichtring with O-ring
1.4 Turbo (67) 103-110 kW (140-150 PS) A 14 NET, B 14 NET	03.2013→04.2018		7.03833.02.0 7.06117.07.0	EUV-VB ZM-NWV	EL EL mit Dichtring with O-ring
1.6 (67) 147 kW (200 PS) A 16 SHT, B 16 SHT	11.2013→04.2018		7.03351.12.0	LDRV	EP
1.6 SIDI (67) 125 kW (170 PS) A 16 XHT	04.2013→04.2019		7.03351.12.0	LDRV	EP
2.0 CDTI (67) 96-121 kW (131-165 PS) A 20 DTH	04.2013→06.2015		7.03978.01.0	DW-TL	EP
2.0 CDTI (67) 140-143 kW (190-195 PS) A 20 DTR	04.2013→06.2015		7.03978.01.0 7.03460.02.0* ↳ 7.01420.02.0 ↳ 7.03073.01.0	DW-TL STE DW-TL DW-TL	EP EP EP für OE-Nummer: 55573362, 55575611, 8 51 017, 8 51 042 for OE number: 55573362, 55575611, 8 51 017, 8 51 042
2.0 CDTI (67) 125 kW (170 PS) B 20 DTH	07.2015→04.2018		7.08681.02.0 7.02256.44.0	EOV EUV-AGR	EH EL
COMBO E Tour / Life (X19)					36
1.2 81 kW (110 PS) D 12 XHL (EB2ADT)	06.2018→		7.08681.09.0	EOV	EH
1.2 96 kW (131 PS) F 12 XHT (EB2ADTS)	07.2019→		7.08681.09.0	EOV	EH
1.5 56 kW (76 PS) D 15 DTL (DV5RE)	06.2018→		7.08681.00.0	EOV	EH
1.5 75 kW (102 PS) D 15 DT (DV5RD)	06.2018→		7.08681.00.0	EOV	EH
1.5 88-96 kW (120-131 PS) D 15 DTH (DV5RC)	06.2018→		7.08681.00.0	EOV	EH
COMBO Tour					37
1.3 CDTI 16V 55 kW (75 PS) Z 13 DTJ	10.2005→12.2011		7.01421.01.0	DW-TL	EP
1.4 66 kW (90 PS) Z 14 XEP	10.2004→12.2011		7.02256.28.0	SV-PDA	EP
1.6 62-69 kW (84-94 PS) Z 16 SE	10.2001→09.2006		7.02256.22.0	AKF	EL
1.6 CNG 69-74 kW (94-101 PS) Z 16 YNG	04.2005→01.2011		7.02256.22.0	AKF	EL

						
COMBO Tour						37
1.6 CNG 69-74 kW (94-101 PS) Z 16 YNG	06.2006→12.2011		7.02256.22.0	AKF	EL	
1.7 CDTI 16V 74 kW (100 PS) Z 17 DTH	07.2004→12.2011		7.02461.01.0	EUV-AGR	EL	
COMBO Tour (X12)						38
1.3 CDTI (C26, D26, E26, C05) 55-70 kW (75-95 PS) A 13 FD	02.2012→		7.01981.07.0	SV-AGR-K	EP	
1.4 (C26, D26, E26, C06) 88 kW (120 PS) A 14 FC	02.2012→		7.01835.06.0	SUV	EL	
1.4 CNG (C26, D26, E26, C05) 88 kW (120 PS) A 14 FC	02.2012→		7.01835.06.0	SUV	EL	
1.6 CDTI (C26, D26, E26, C05) 66-88 kW (90-120 PS) A 16 FDL	02.2012→		7.08681.03.0 7.08681.04.0 7.08681.05.0 7.08681.06.0	SV-HYAT SV-HYAT SV-HYAT SV-HYAT	EH EH EH EH für OE-Nummer: 7 84 068, 95512349 für OE number: 7 84 068, 95512349 für OE-Nummer: 7 84 065, 95512347 für OE number: 7 84 065, 95512347	
CORSA A Hatchback (S83)						39
1.2 i (F08, M08, F68, M68) 33 kW (45 PS) C 12 NZ	09.1989→03.1993		7.05432.01.0	SM	EL mit Dichtring with O-ring	
1.3 i (F08, M08, F68, M68) 44 kW (60 PS) C 13 N	09.1986→09.1990		7.05432.01.0	SM	EL mit Dichtring with O-ring	
1.4 Si (F08, M08, F68, M68) 54-60 kW (73-82 PS) C 14 SE	09.1991→03.1993		7.05432.11.0	SM	EL mit Dichtring with O-ring	
1.4 i (F08, M08, F68, M68) 40-44 kW (54-60 PS) C 14 NZ	01.1985→03.1993		7.05432.01.0	SM	EL mit Dichtring with O-ring	
1.4 i (F08, M08, F68, M68) 40-44 kW (54-60 PS) C 14 NZ	01.1990→03.1993		7.05432.01.0	SM	EL mit Dichtring with O-ring	
1.6 GSI (F08, M08, F68, M68) 74-75 kW (100-102 PS) E 16 SE	05.1988→03.1992		7.05432.11.0	SM	EL mit Dichtring with O-ring	
1.6 GSI (F08, M08, F68, M68) 55-60 kW (75-82 PS) C 16 NZ	09.1988→08.1990		7.05432.00.0	SM	EL mit Dichtring with O-ring	
1.6 GSI (F08, M08, M68, F68) 55-60 kW (75-82 PS) C 16 NZ	09.1988→09.1992		7.05432.00.0	SM	EL mit Dichtring with O-ring	
1.6 GSI Cat (F08, M08, F68, M68) 74 kW (101 PS) C 16 SE	02.1992→03.1993		7.05432.11.0	SM	EL mit Dichtring with O-ring	
CORSA A TR (S83)						40
1.2 i (F11, M11, F19, M19) 33 kW (45 PS) C 12 NZ	09.1989→03.1993		7.05432.01.0	SM	EL mit Dichtring with O-ring	
1.3 (F11, F19, M11, M19) 44 kW (60 PS) C 13 N	09.1985→10.1987		7.05432.01.0	SM	EL mit Dichtring with O-ring	
1.4 i (F11, M11, F19, M19) 40-44 kW (54-60 PS) C 14 NZ	10.1989→03.1993		7.05432.01.0	SM	EL mit Dichtring with O-ring	

O

					
---	---	---	---	--	---



CORSA B (S93) 41

























1.2 i (F08, F68, M68) 33 kW (45 PS) C 12 NZ, X 12 SZ	03.1993→09.2000		7.05432.01.0	SM	EL	mit Dichtring with O-ring
1.2 i (F08, F68, M68) 33 kW (45 PS) 12 NZ	03.1993→09.2000		7.05432.01.0	SM	EL	mit Dichtring with O-ring
1.4 (F08, F68, M68) 54-60 kW (73-82 PS) C 14 SE	04.1993→08.1994		7.05432.11.0	SM	EL	mit Dichtring with O-ring
1.4 Si (F08, F68, M68) 54-60 kW (73-82 PS) C 14 SE	03.1993→09.2000		7.05432.11.0	SM	EL	mit Dichtring with O-ring
1.4 i (F08, F68, M68) 40-44 kW (54-60 PS) C 14 NZ	03.1993→10.1996		7.05432.00.0	SM	EL	mit Dichtring with O-ring für Fahrzeuge mit Automatikgetriebe for vehicles with automatic transmission
			7.05432.01.0	SM	EL	mit Dichtring with O-ring für Fahrzeuge mit Schaltgetriebe for vehicles with manual transmission
1.4 i (F08, F68, M68) 40-44 kW (54-60 PS) C 14 NZ	03.1993→09.2000		7.05432.00.0	SM	EL	mit Dichtring with O-ring für Fahrzeuge mit Automatikgetriebe for vehicles with automatic transmission
			7.05432.01.0	SM	EL	mit Dichtring with O-ring für Fahrzeuge mit Schaltgetriebe for vehicles with manual transmission
1.4 i (F08, F68, M68) 40-44 kW (54-60 PS) X 14 SZ	03.1993→09.2000		7.05432.00.0	SM	EL	mit Dichtring with O-ring
1.4 i (F08, F68, M68) 40-44 kW (54-60 PS) X 14 SZ	10.1996→09.2000		7.05432.00.0	SM	EL	mit Dichtring with O-ring
1.4 i 16V (F08, F68, M68) 63-69 kW (86-94 PS) X 14 XE	09.1994→09.2000		7.05432.11.0	SM	EL	mit Dichtring with O-ring
1.4 i 16V (F08, F68, M68) 63 kW (86 PS) C 14 SEL	08.1997→09.2000		7.05432.11.0	SM	EL	mit Dichtring with O-ring
1.6 GSI 16V (F08, F68, M68) 80 kW (109 PS) C 16 XE	03.1993→09.2000		7.05432.11.0	SM	EL	mit Dichtring with O-ring
1.6 i 16V (F08, F68, M68) 78 kW (106 PS) X 16 XE	09.1994→09.2000		7.05432.11.0	SM	EL	mit Dichtring with O-ring
1.6 i 16V (F08, F68, M68) 74 kW (101 PS) C 16 SEL	08.1997→09.2000		7.05432.11.0	SM	EL	mit Dichtring with O-ring
1.7 D (F08, F68, M68) 42-44 kW (57-60 PS) X 17 D (4EE1)	02.1996→09.2000		7.22138.50.0	EUV-AGR	EL	

CORSA B Estate (S93) 42

1.4 i 16V (F35) 63-69 kW (86-94 PS) X 14 XE	01.1999→12.2002		7.05432.11.0	SM	EL	mit Dichtring with O-ring
--	-----------------	---	---------------------	----	----	------------------------------



CORSA C (X01) 43

1.0 (F08, F68) 44 kW (60 PS) Z 10 XEP	06.2003→12.2009		7.02256.28.0	SV-PDA	EP	
1.2 Twinport (F08, F68) 55-59 kW (75-80 PS) Z 12 XEP	07.2004→12.2009		7.02256.28.0	SV-PDA	EP	

						
CORSA C (X01)						43
1.4 (F08, F68) 66 kW (90 PS) Z 14 XE	09.2000→12.2009		7.02256.22.0	AKF	EL	
1.4 Twinport (F08, F68) 66 kW (90 PS) Z 14 XEP	06.2003→12.2009		7.02256.28.0	SV-PDA	EP	
1.6 (F08, F68) 62-69 kW (84-94 PS) Z 16 SE	09.2000→12.2009		7.02256.22.0	AKF	EL	
1.7 CDTi (F08, F68) 74 kW (100 PS) Z 17 DTH	06.2003→12.2009		7.03088.01.0	DW-TL	EP	
			7.02461.01.0	EUV-AGR	EL	
1.7 DI (F08, F68) 48 kW (65 PS) Y 17 DTL	09.2000→12.2009		7.03085.02.0	DW-AGR	EP	
			7.03088.01.0	DW-TL	EP	
1.7 DTi (F08, F68) 55 kW (75 PS) Y 17 DT	09.2000→12.2009		7.03085.02.0	DW-AGR	EP	
			7.03088.01.0	DW-TL	EP	
CORSA C Saloon (X01)						44
1.7 CDTi 74 kW (100 PS) Z 17 DTH	01.2005→12.2008		7.03088.01.0	DW-TL	EP	
			7.02461.01.0	EUV-AGR	EL	
CORSA CLASSIC Saloon						45
1.4 66 kW (90 PS) Z 14 XEP	07.2000→12.2003		7.02256.28.0	SV-PDA	EP	
CORSA D (S07)						46
1.0 (L08, L68) 44 kW (60 PS) Z 10 XEP	07.2006→12.2010		7.02256.28.0	SV-PDA	EP	
1.0 (L08, L68) 44-48 kW (60-65 PS) A 10 XEP	12.2009→08.2014		7.02256.43.0	EUV-SR	EL	
1.2 (L08, L68) 55-59 kW (75-80 PS) Z 12 XEP	07.2006→08.2014		7.02256.28.0	SV-PDA	EP	
1.2 (L08, L68) 51 kW (69 PS) A 12 XEL	12.2009→08.2014		7.02256.43.0	EUV-SR	EL	
			7.06117.07.0	ZM-NWV	EL	mit Dichtring with O-ring
1.2 (L08, L68) 61-63 kW (83-86 PS) A 12 XER	12.2009→08.2014		7.02256.43.0	EUV-SR	EL	
			7.06117.07.0	ZM-NWV	EL	mit Dichtring with O-ring
1.2 LPG (L08, L68) 55-59 kW (75-80 PS) Z 12 XEP	08.2006→08.2014		7.02256.28.0	SV-PDA	EP	
1.2 LPG (L08, L68) 55-59 kW (75-80 PS) Z 12 XEP	09.2009→12.2011		7.02256.28.0	SV-PDA	EP	
1.2 LPG (L08, L68) 61-63 kW (83-86 PS) A 12 XER	06.2011→08.2014		7.02256.43.0	EUV-SR	EL	
			7.06117.07.0	ZM-NWV	EL	mit Dichtring with O-ring
1.2 LPG (L08, L68) 61-63 kW (83-86 PS) A 12 XER	06.2011→08.2014		7.02256.43.0	EUV-SR	EL	
			7.06117.07.0	ZM-NWV	EL	mit Dichtring with O-ring
1.3 CDTi (L08, L68) 55 kW (75 PS) A 13 DTC	07.2006→08.2014		7.03653.01.0	DW-TL	EP	
			7.01981.07.0	SV-AGR-K	EP	





























CORSA D (S07) **46**

1.3 CDTI (L08, L68) 55 kW (75 PS) Z 13 DTJ	07.2006→08.2014	 7.01420.02.0	DW-TL	EP	für Fahrzeuge mit Diesel-Partikel-Filter (DPF) for vehicles with diesel soot filter
1.3 CDTI (L08, L68) 66-74 kW (90-101 PS) Z 13 DTH	07.2006→06.2011	 7.01420.02.0	DW-TL	EP	
1.3 CDTI (L08, L68) 70 kW (95 PS) A 13 DTE, A 13 DTR, Z 13 DTE	06.2009→08.2014	 7.03653.01.0	DW-TL	EP	
		7.01981.07.0	SV-AGR-K	EP	
1.4 (L08, L68) 66 kW (90 PS) Z 14 XEP	07.2006→08.2014	 7.02256.28.0	SV-PDA	EP	
1.4 (L08, L68) 64 kW (87 PS) A 14 XEL	09.2009→08.2014	 7.02256.43.0	EUV-SR	EL	
		7.06117.07.0	ZM-NWV	EL	mit Dichtring with O-ring
1.4 (L08, L68) 74 kW (101 PS) A 14 XER	12.2009→08.2014	 7.02256.43.0	EUV-SR	EL	
		7.06117.07.0	ZM-NWV	EL	mit Dichtring with O-ring
1.4 (L08, L68) 88 kW (120 PS) A 14 NEL	07.2012→08.2014	 7.03833.02.0	EUV-VB	EL	
		7.06117.07.0	ZM-NWV	EL	mit Dichtring with O-ring
1.4 LPG (L08, L68) 66 kW (90 PS) Z 14 XEP	08.2006→12.2011	 7.02256.28.0	SV-PDA	EP	
1.4 LPG (L08, L68) 64 kW (87 PS) A 14 XEL	09.2009→08.2014	 7.02256.43.0	EUV-SR	EL	
		7.06117.07.0	ZM-NWV	EL	mit Dichtring with O-ring
1.6 Turbo (L08, L68) 141 kW (192 PS) A 16 LER, Z 16 LER	11.2006→08.2014	 7.01039.03.0	EUV-VB	EL	
		7.03833.02.0	EUV-VB	EL	
		7.03833.02.0	LDRV	EL	
1.6 Turbo (L08, L68) 141-152 kW (192-207 PS) B 16 LER	11.2006→08.2014	 7.03833.02.0	EUV-VB	EL	
		7.03833.02.0	LDRV	EL	
1.6 Turbo (L08, L68) 110 kW (150 PS) A 16 LEL, Z 16 LEL	05.2007→08.2014	 7.01039.03.0	EUV-VB	EL	
		7.03833.02.0	EUV-VB	EL	
		7.03833.02.0	LDRV	EL	
1.6 Turbo (L08, L68) 150-155 kW (204-211 PS) A 16 LES	06.2011→08.2014	 7.01039.03.0	EUV-VB	EL	
		7.03833.02.0	EUV-VB	EL	
		7.03833.02.0	LDRV	EL	
1.7 CDTI (L08, L68) 92 kW (125 PS) Z 17 DTR	08.2006→12.2011	 7.03085.02.0	DW-TL	EP	
		7.02461.01.0	EUV-LS	EL	
1.7 CDTI (L08, L68) 96 kW (131 PS) A 17 DTS	12.2009→08.2014	 7.03073.01.0	DW-TL	EP	
		7.03085.02.0	DW-TL	EP	
		7.02461.01.0	EUV-LS	EL	



CORSA E (X15) **47**

1.0 (08, 68) 66-77 kW (90-105 PS) B 10 XFL, F 10 XFL	09.2014→	 7.03351.12.0	LDRV	EP	
		7.03381.14.0	SUV	EL	







						
CORSA E (X15)						47
1.0 (08, 68) 66-77 kW (90-105 PS) D 10 XFL	09.2014→		7.03351.12.0	LDRV	EP	
1.0 (08, 68) 85 kW (115 PS) B 10 XFT	09.2014→		7.03351.12.0	LDRV	EP	
			7.03381.14.0	SUV	EL	
1.2 (08, 68) 51 kW (69 PS) B 12 XEL	09.2014→		7.06117.07.0	ZM-NWV	EL mit Dichtring with O-ring	
1.4 (08, 68) 55 kW (75 PS) B 14 XEJ	09.2014→		7.06117.07.0	ZM-NWV	EL mit Dichtring with O-ring	
1.4 (08, 68) 64-66 kW (87-90 PS) B 14 XEL, D 14 XEL	09.2014→		7.06117.07.0	ZM-NWV	EL mit Dichtring with O-ring	
1.4 LPG (08, 68) 64-66 kW (87-90 PS) B 14 XEL	03.2015→		7.06117.07.0	ZM-NWV	EL mit Dichtring with O-ring	
1.4 LPG (08, 68) 64-66 kW (87-90 PS) B 14 XEL	11.2015→		7.06117.07.0	ZM-NWV	EL mit Dichtring with O-ring	
1.4 Turbo (08, 68) 74 kW (101 PS) B 14 NEJ, D 14 NEJ	09.2014→06.2019		7.03833.02.0	EUV-VB	EL	
			7.06117.07.0	ZM-NWV	EL mit Dichtring with O-ring	
1.4 Turbo (08, 68) 110 kW (150 PS) B 14 NEH, D 14 NEH	03.2015→		7.03833.02.0	EUV-VB	EL	
			7.06117.07.0	ZM-NWV	EL mit Dichtring with O-ring	
1.6 Turbo (08, 68) 152-155 kW (207-211 PS) B 16 LES	03.2015→		7.01039.03.0	EUV-VB	EL	
			7.03833.02.0	LDRV	EL	
CORSA F						48
1.2 (68) 74-81 kW (101-110 PS) F 12 XHL (EB2ADTD)	07.2019→		7.08681.09.0	EOV	EH	
1.2 (68) 96 kW (131 PS) F 12 XHT (EB2ADTS)	07.2019→		7.08681.09.0	EOV	EH	
1.5 (68) 75 kW (102 PS) D 15 DT (DV5RD)	07.2019→		7.08681.00.0	EOV	EH	
CROSSLAND X / CROSSLAND (P17, P2QO)						49
1.2 (75) 81-96 kW (110-131 PS) B 12 XHT (EB2DTS)	03.2017→		7.08681.09.0	EOV	EH	
			7.06117.45.0	SV-NWV	EL	
1.2 (75) 96 kW (131 PS) D 12 XHT (EB2ADTS), F 12 XHT (EB2ADTS)	03.2017→		7.08681.09.0	EOV	EH	
1.2 (75) 60 kW (82 PS) B 12 XE (EB2F)	03.2017→		7.06117.45.0	SV-NWV	EL	
1.2 (75) 81 kW (110 PS) B 12 XHL (EB2DT)	03.2017→		7.08681.09.0	EOV	EH	
			7.06117.45.0	SV-NWV	EL	
1.2 (75) 81 kW (110 PS) D 12 XHL (EB2ADT)	03.2017→		7.08681.09.0	EOV	EH	
1.2 LPG (75) 60 kW (82 PS) B 12 XE (EB2F)	10.2017→		7.06117.45.0	SV-NWV	EL	
1.5 Turbo D (75) 75 kW (102 PS) D 15 DT (DV5RD)	06.2018→		7.08681.00.0	EOV	EH	
1.5 Turbo D (75) 88-96 kW (120-131 PS) D 15 DTH (DV5RC)	08.2018→		7.08681.00.0	EOV	EH	



CROSSLAND X / CROSSLAND (P17, P2QO) **49**

1.6 Turbo D (75) 73 kW (99 PS) B 16 DT (DV6FD)	03.2017→		7.08681.00.0	EOV	EH	
1.6 Turbo D (75) 85-88 kW (116-120 PS) B 16 DTH (DV6FC)	03.2017→		7.08681.00.0	EOV	EH	
1.6 Turbo D (75) 85-88 kW (116-120 PS) B 16 DTH (DV6FC)	08.2017→		7.08681.00.0	EOV	EH	

GRANDLAND X (A18) **50**

















1.2 (75) 81-96 kW (110-131 PS) B 12 XHT (EB2DTS)	06.2017→		7.08681.09.0	EOV	EH	Organisationsnummer ab: 1472089 RPO number from: 1472089
			7.06117.45.0	SV-NWV	EL	Organisationsnummer ab: 1472089 RPO number from: 1472089
1.2 (75) 96 kW (131 PS) D 12 XHT (EB2ADTS)	06.2017→		7.08681.09.0	EOV	EH	Organisationsnummer ab: 1472089, 15468EN RPO number from: 1472089, 15468EN Euro 6d-Temp Euro 6d-Temp
1.5 Turbo D (75) 88-96 kW (120-131 PS) D 15 DTH (DV5RC)	04.2018→		7.08681.00.0	EOV	EH	Organisationsnummer ab: 1472089, 15468EN RPO number from: 1472089, 15468EN
1.5 Turbo D (75) 75 kW (102 PS) D 15 DT (DV5RD)	06.2018→		7.08681.00.0	EOV	EH	Organisationsnummer ab: 1472089, 15468EN RPO number from: 1472089, 15468EN
1.6 Turbo 121 kW (165 PS) A 16 NHT (EP6FDTM)	10.2017→		7.01777.19.0	DW-TL	EP	Organisationsnummer ab: 1472089, 15468EN RPO number from: 1472089, 15468EN für Fahrzeuge mit Automatikgetriebe for vehicles with automatic transmission
			7.01115.08.0	SUV	EL	
			7.06117.45.0	SV-NWV	EL	
1.6 Turbo (75) 133 kW (181 PS) D 16 XHT (EP6FADTXD)	09.2018→		7.01777.19.0	DW-TL	EP	Organisationsnummer ab: 1472089, 15468EN RPO number from: 1472089, 15468EN für Fahrzeuge mit Automatikgetriebe for vehicles with automatic transmission
			7.01115.08.0	SUV	EL	
			7.06117.45.0	SV-NWV	EL	
1.6 Turbo D (75) 85-88 kW (116-120 PS) B 16 DTH (DV6FC)	06.2017→		7.08681.00.0	EOV	EH	Organisationsnummer ab: 1472089 RPO number from: 1472089

GT Convertible (M07) **51**

2.0 (G67) 194 kW (264 PS) Z 20 NHH	06.2007→12.2011		5.02549.03.0*	EUV-VB	EL	mit Halter with holder
			7.01441.04.0	EUV-VB	EL	
			7.06117.05.0	SV-NWV	EH	mit Dichtring with O-ring
			7.06117.06.0	SV-NWV	EH	mit Dichtring with O-ring

















INSIGNIA A (G09) **52**

1.4 (68) 103-110 kW (140-150 PS) A 14 NET, B 14 NET	04.2011→03.2017		7.03833.02.0	EUV-VB	EL	mit Dichtring with O-ring
			7.06117.07.0	ZM-NWV	EL	
1.4 LPG (68) 103-110 kW (140-150 PS) A 14 NET, B 14 NET	07.2012→03.2017		7.03833.02.0	EUV-VB	EL	mit Dichtring with O-ring
			7.06117.07.0	ZM-NWV	EL	





 					
INSIGNIA A (G09)					
1.6 (68) 84-85 kW (114-116 PS) A 16 XER	07.2008→03.2017	 7.02256.38.0	AKF	EL	mit Dichtring with O-ring
		7.02256.43.0	EUV-SR	EL	
		7.06117.08.0	SV-NWV	EH	
1.6 CDTi (68) 88 kW (120 PS) B 16 DTJ	07.2015→03.2017	 7.08681.01.0	EOV	EH	
		7.02256.44.0	EUV-AGR	EL	
1.6 CDTi (68) 81-100 kW (110-136 PS) B 16 DTH	07.2015→03.2017	 7.08681.01.0	EOV	EH	
		7.02256.44.0	EUV-AGR	EL	
1.6 SIDI (68) 125 kW (170 PS) A 16 XHT, B 16 SHL	03.2013→03.2017	 7.03351.12.0	LDRV	EP	
1.6 Turbo (68) 132 kW (180 PS) A 16 LET	07.2008→03.2017	 7.01039.03.0	EUV-VB	EL	mit Dichtring with O-ring
		7.03833.02.0	LDRV	EL	
		7.06117.08.0	SV-NWV	EH	
1.8 (68) 101-103 kW (137-140 PS) A 18 XER	07.2008→03.2017	 7.02256.43.0	EUV-SR	EL	mit Dichtring with O-ring
		7.06117.08.0	SV-NWV	EH	
1.8 (68) 103 kW (140 PS) B 18 XER	07.2008→03.2017	 7.02256.43.0	EUV-SR	EL	
2.0 Biturbo CDTI (68) 140-143 kW (190-195 PS) A 20 DTR	07.2008→12.2011	 7.03978.01.0	DW-TL	EP	für OE-Nummer: 55573362, 55575611, 8 51 017, 8 51 042 for OE number: 55573362, 55575611, 8 51 017, 8 51 042
		7.07400.09.0*	STE	EP	für OE-Nummer: 55567313, 58 51 415 for OE number: 55567313, 58 51 415
		↳ 7.01421.01.0	DW-TL	EP	
		↳ 7.03652.01.0	DW-TL	EP	
		7.07400.10.0*	STE	EP	für OE-Nummer: 55580532, 8 51 070 for OE number: 55580532, 8 51 070
		↳ 7.01421.01.0	DW-TL	EP	
		↳ 7.03652.01.0	DW-TL	EP	
2.0 Biturbo CDTI (68) 140-143 kW (190-195 PS) A 20 DTR	01.2012→03.2017	 7.03978.01.0	DW-TL	EP	für OE-Nummer: 55573362, 55575611, 8 51 017, 8 51 042 for OE number: 55573362, 55575611, 8 51 017, 8 51 042
		7.07400.09.0*	STE	EP	für OE-Nummer: 55567313, 58 51 415 for OE number: 55567313, 58 51 415
		↳ 7.01421.01.0	DW-TL	EP	
		↳ 7.03652.01.0	DW-TL	EP	
		7.07400.10.0*	STE	EP	für OE-Nummer: 55580532, 8 51 070 for OE number: 55580532, 8 51 070
		↳ 7.01421.01.0	DW-TL	EP	
		↳ 7.03652.01.0	DW-TL	EP	
2.0 Biturbo CDTI 4x4 (68) 140-143 kW (190-195 PS) A 20 DTR	05.2009→12.2011	 7.03978.01.0	DW-TL	EP	für OE-Nummer: 55573362, 55575611, 8 51 017, 8 51 042 for OE number: 55573362, 55575611, 8 51 017, 8 51 042
		7.07400.09.0*	STE	EP	für OE-Nummer: 55567313, 58 51 415 for OE number: 55567313, 58 51 415
		↳ 7.01421.01.0	DW-TL	EP	
		↳ 7.03652.01.0	DW-TL	EP	
		7.07400.10.0*	STE	EP	für OE-Nummer: 55580532, 8 51 070 for OE number: 55580532, 8 51 070
		↳ 7.01421.01.0	DW-TL	EP	
↳ 7.03652.01.0	DW-TL	EP			









INSIGNIA A (G09) **52**

2.0 Biturbo CDTI 4x4 (68) 140-143 kW (190-195 PS) A 20 DTR	01.2012→03.2017	 7.03978.01.0	DW-TL	EP	für OE-Nummer: 55573362, 55575611, 8 51 017, 8 51 042 for OE number: 55573362, 55575611, 8 51 017, 8 51 042
		7.07400.09.0*	STE	EP	für OE-Nummer: 55567313, 58 51 415 for OE number: 55567313, 58 51 415
		↳ 7.01421.01.0	DW-TL	EP	
		↳ 7.03652.01.0	DW-TL	EP	
		7.07400.10.0*	STE	EP	für OE-Nummer: 55580532, 8 51 070 for OE number: 55580532, 8 51 070
		↳ 7.01421.01.0 ↳ 7.03652.01.0	DW-TL DW-TL	EP EP	
2.0 CDTI (68) 81 kW (110 PS) A 20 DTC, A 20 DTL	07.2008→03.2017	 7.03978.01.0	DW-TL	EP	
2.0 CDTI (68) 96 kW (131 PS) A 20 DT, A 20 DTJ	07.2008→03.2017	 7.03978.01.0	DW-TL	EP	
2.0 CDTI (68) 96-121 kW (131-165 PS) A 20 DTH	07.2008→03.2017	 7.03978.01.0	DW-TL	EP	
2.0 CDTI (68) 88-103 kW (120-140 PS) A 20 DTE	03.2012→03.2017	 7.03978.01.0	DW-TL	EP	
2.0 CDTI (68) 88-103 kW (120-140 PS) A 20 DTE	06.2013→03.2017	 7.03978.01.0	DW-TL	EP	
2.0 CDTI (68) 96-121 kW (131-165 PS) A 20 DTH	07.2013→03.2017	 7.03978.01.0	DW-TL	EP	
2.0 CDTI (68) 125 kW (170 PS) B 20 DTH	11.2014→03.2017	 7.08681.02.0	EOV	EH	
2.0 CDTI 4x4 (68) 96-121 kW (131-165 PS) A 20 DTH	06.2010→03.2017	 7.02256.44.0	EUV-AGR	EL	
		 7.03978.01.0	DW-TL	EP	
2.0 CDTI 4x4 (68) 96-121 kW (131-165 PS) A 20 DTH	07.2013→03.2017	 7.03978.01.0	DW-TL	EP	
		 7.08681.02.0	EOV	EH	
2.0 CDTI 4x4 (68) 125 kW (170 PS) B 20 DTH	11.2014→03.2017	 7.02256.44.0	EUV-AGR	EL	
		 7.02721.06.0*	EUV-VB	EL	mit Halter with holder
2.0 E85 Turbo (68) 162-206 kW (220-280 PS) A 20 NFT	10.2010→03.2017	↳ 7.01441.04.0	EUV-VB	EL	
		7.06117.05.0	SV-NWV	EH	mit Dichtring with O-ring
		7.06117.06.0	SV-NWV	EH	mit Dichtring with O-ring
2.0 Turbo (68) 162-184 kW (220-250 PS) A 20 NHT	07.2008→03.2017	 5.02549.03.0*	EUV-VB	EL	mit Halter with holder
		↳ 7.01441.04.0	EUV-VB	EL	
		7.03357.04.0	LDRV	EL	
		7.06117.05.0	SV-NWV	EH	mit Dichtring with O-ring
2.0 Turbo (68) 162-184 kW (220-250 PS) A 20 NHT, B 20 NHT	04.2014→03.2017	 7.06117.06.0	SV-NWV	EH	mit Dichtring with O-ring
		 7.03357.04.0	LDRV	EL	













INSIGNIA A (G09)
52

			7.03381.15.0	SUV	EL	
			7.06117.56.0	SV-NWV	EH	mit Dichtring with O-ring
			7.06117.57.0	SV-NWV	EH	mit Dichtring with O-ring
2.0 Turbo 4x4 (68) 162-184 kW (220-250 PS) A 20 NHT	07.2008→03.2017		5.02549.03.0*	EUV-VB	EL	mit Halter with holder
			↳ 7.01441.04.0	EUV-VB	EL	
			7.03357.04.0	LDRV	EL	
			7.06117.05.0	SV-NWV	EH	mit Dichtring with O-ring
			7.06117.06.0	SV-NWV	EH	mit Dichtring with O-ring
2.0 Turbo 4x4 (68) 162-184 kW (220-250 PS) A 20 NHT, B 20 NHT	07.2011→03.2017		7.03357.04.0	LDRV	EL	
			7.03381.15.0	SUV	EL	
			7.06117.56.0	SV-NWV	EH	mit Dichtring with O-ring
			7.06117.57.0	SV-NWV	EH	mit Dichtring with O-ring
2.8 V6 Turbo 4x4 (68) 191 kW (260 PS) A 28 NET	07.2008→03.2017		7.28311.04.0	LDRV	EP	
			7.00175.04.0	SUV	EL	
			7.06117.04.0	SV-NWV	EH	mit Wellendichtring With shaft sealing ring
2.8 V6 Turbo OPC 4x4 (68) 239 kW (325 PS) A 28 NER	07.2009→03.2017		7.28311.04.0	LDRV	EP	
			7.00175.04.0	SUV	EL	
			7.06117.04.0	SV-NWV	EH	mit Wellendichtring With shaft sealing ring
2.8 V6 Turbo OPC 4x4 (68) 239 kW (325 PS) B 28 NER	07.2009→03.2017		7.28311.04.0	LDRV	EP	
			7.00175.04.0	SUV	EL	

O
INSIGNIA A Country Tourer (G09)
53

1.6 CDTi (47) 88 kW (120 PS) B 16 DTJ	07.2015→03.2017		7.08681.01.0	EOV	EH	
1.6 CDTi (47) 81-100 kW (110-136 PS) B 16 DTH	07.2015→03.2017		7.08681.01.0	EOV	EH	
1.6 SIDI (47) 125 kW (170 PS) A 16 XHT, B 16 SHL	07.2014→03.2017		7.03351.12.0	LDRV	EP	
2.0 CDTi (47) 96-121 kW (131-165 PS) A 20 DTH	07.2014→03.2017		7.03978.01.0	DW-TL	EP	
2.0 CDTi (47) 125 kW (170 PS) B 20 DTH	11.2014→03.2017		7.08681.02.0	EOV	EH	
			7.02256.44.0	EUV-AGR	EL	
2.0 CDTi 4x4 (47) 96-121 kW (131-165 PS) A 20 DTH	09.2013→03.2017		7.03978.01.0	DW-TL	EP	
2.0 CDTi 4x4 (47) 140-143 kW (190-195 PS) A 20 DTR	09.2013→03.2017		7.01421.01.0	DW-TL	EP	
			7.03652.01.0	DW-TL	EP	für OE-Nummer: 55573732 für OE number: 55573732











INSIGNIA A Saloon (G09)
54







			↳ 7.01421.01.0 ↳ 7.03652.01.0	DW-TL DW-TL	EP EP	
2.0 Biturbo CDTI (69) 140-143 kW (190-195 PS) A 20 DTR	01.2012→03.2017		7.03978.01.0	DW-TL	EP	für OE-Nummer: 55573362, 55575611, 8 51 017, 8 51 042 for OE number: 55573362, 55575611, 8 51 017, 8 51 042
			7.07400.09.0*	STE	EP	für OE-Nummer: 55567313, 58 51 415 for OE number: 55567313, 58 51 415
			↳ 7.01421.01.0 ↳ 7.03652.01.0	DW-TL DW-TL	EP EP	
			7.07400.10.0*	STE	EP	für OE-Nummer: 55580532, 8 51 070 for OE number: 55580532, 8 51 070
			↳ 7.01421.01.0 ↳ 7.03652.01.0	DW-TL DW-TL	EP EP	
2.0 Biturbo CDTI 4x4 (69) 140-143 kW (190-195 PS) A 20 DTR	07.2008→12.2011		7.03978.01.0	DW-TL	EP	für OE-Nummer: 55573362, 55575611, 8 51 017, 8 51 042 for OE number: 55573362, 55575611, 8 51 017, 8 51 042
			7.07400.09.0*	STE	EP	für OE-Nummer: 55567313, 58 51 415 for OE number: 55567313, 58 51 415
			↳ 7.01421.01.0 ↳ 7.03652.01.0	DW-TL DW-TL	EP EP	
			7.07400.10.0*	STE	EP	für OE-Nummer: 55580532, 8 51 070 for OE number: 55580532, 8 51 070
			↳ 7.01421.01.0 ↳ 7.03652.01.0	DW-TL DW-TL	EP EP	
2.0 Biturbo CDTI 4x4 (69) 140-143 kW (190-195 PS) A 20 DTR	01.2012→03.2017		7.03978.01.0	DW-TL	EP	für OE-Nummer: 55573362, 55575611, 8 51 017, 8 51 042 for OE number: 55573362, 55575611, 8 51 017, 8 51 042
			7.07400.09.0*	STE	EP	für OE-Nummer: 55567313, 58 51 415 for OE number: 55567313, 58 51 415
			↳ 7.01421.01.0 ↳ 7.03652.01.0	DW-TL DW-TL	EP EP	
			7.07400.10.0*	STE	EP	für OE-Nummer: 55580532, 8 51 070 for OE number: 55580532, 8 51 070
			↳ 7.01421.01.0 ↳ 7.03652.01.0	DW-TL DW-TL	EP EP	
2.0 CDTI (69) 81 kW (110 PS) A 20 DTC, A 20 DTL	07.2008→03.2017		7.03978.01.0	DW-TL	EP	
2.0 CDTI (69) 96 kW (131 PS) A 20 DT, A 20 DTJ	07.2008→03.2017		7.03978.01.0	DW-TL	EP	
2.0 CDTI (69) 96-121 kW (131-165 PS) A 20 DTH	07.2008→03.2017		7.03978.01.0	DW-TL	EP	
2.0 CDTI (69) 88-103 kW (120-140 PS) A 20 DTE	03.2012→03.2017		7.03978.01.0	DW-TL	EP	
2.0 CDTI (69) 88-103 kW (120-140 PS) A 20 DTE	06.2013→03.2017		7.03978.01.0	DW-TL	EP	
2.0 CDTI (69) 96-121 kW (131-165 PS) A 20 DTH	07.2013→03.2017		7.03978.01.0	DW-TL	EP	
2.0 CDTI (69) 125 kW (170 PS) B 20 DTH	11.2014→03.2017		7.08681.02.0 7.02256.44.0	EOV EUV-AGR	EH EL	
2.0 CDTI 4x4 (69) 96-121 kW (131-165 PS) A 20 DTH	06.2010→03.2017		7.03978.01.0	DW-TL	EP	

O















INSIGNIA A Saloon (G09) **54**

2.0 CDTI 4x4 (69) 96-121 kW (131-165 PS) A 20 DTH	07.2013→03.2017	 7.03978.01.0	DW-TL	EP	
2.0 CDTI 4x4 (69) 125 kW (170 PS) B 20 DTH	11.2014→03.2017	 7.08681.02.0	EOV	EH	
		7.02256.44.0	EUV-AGR	EL	
2.0 Turbo (69) 162-184 kW (220-250 PS) A 20 NHT	07.2008→03.2017	 5.02549.03.0*	EUV-VB	EL	mit Halter with holder
		↳ 7.01441.04.0	EUV-VB	EL	
		7.03357.04.0	LDRV	EL	
		7.06117.05.0	SV-NWV	EH	mit Dichtring with O-ring
		7.06117.06.0	SV-NWV	EH	mit Dichtring with O-ring
2.0 Turbo (69) 162-184 kW (220-250 PS) A 20 NHT, B 20 NHT	04.2014→03.2017	 7.03357.04.0	LDRV	EL	
		7.03381.15.0	SUV	EL	
		7.06117.56.0	SV-NWV	EH	mit Dichtring with O-ring
		7.06117.57.0	SV-NWV	EH	mit Dichtring with O-ring
2.0 Turbo 4x4 (69) 162-184 kW (220-250 PS) A 20 NHT	07.2008→03.2017	 5.02549.03.0*	EUV-VB	EL	mit Halter with holder
		↳ 7.01441.04.0	EUV-VB	EL	
		7.03357.04.0	LDRV	EL	
		7.06117.05.0	SV-NWV	EH	mit Dichtring with O-ring
		7.06117.06.0	SV-NWV	EH	mit Dichtring with O-ring
2.0 Turbo 4x4 (69) 162-206 kW (220-280 PS) A 20 NFT	07.2011→03.2017	 7.02721.06.0*	EUV-VB	EL	mit Halter with holder
		↳ 7.01441.04.0	EUV-VB	EL	
		7.06117.05.0	SV-NWV	EH	mit Dichtring with O-ring
		7.06117.06.0	SV-NWV	EH	mit Dichtring with O-ring
2.0 Turbo 4x4 (69) 162-184 kW (220-250 PS) A 20 NHT, B 20 NHT	07.2011→03.2017	 7.03357.04.0	LDRV	EL	
		7.03381.15.0	SUV	EL	
		7.06117.56.0	SV-NWV	EH	mit Dichtring with O-ring
		7.06117.57.0	SV-NWV	EH	mit Dichtring with O-ring
2.0 Turbo E85 (69) 162-206 kW (220-280 PS) A 20 NFT	07.2008→03.2017	 7.02721.06.0*	EUV-VB	EL	mit Halter with holder
		↳ 7.01441.04.0	EUV-VB	EL	
		7.06117.05.0	SV-NWV	EH	mit Dichtring with O-ring
		7.06117.06.0	SV-NWV	EH	mit Dichtring with O-ring
2.8 V6 Turbo 4x4 (69) 191 kW (260 PS) A 28 NET	07.2008→03.2017	 7.28311.04.0	LDRV	EP	
		7.00175.04.0	SUV	EL	

					
INSIGNIA A Saloon (G09)					54
			7.06117.04.0	SV-NWV	EH mit Wellendichtring With shaft sealing ring
2.8 V6 Turbo OPC 4x4 (69) 239 kW (325 PS) A 28 NER	07.2009→03.2017		7.28311.04.0	LDRV	EP
			7.00175.04.0 7.06117.04.0	SUV SV-NWV	EL EH mit Wellendichtring With shaft sealing ring
2.8 V6 Turbo OPC 4x4 (69) 239 kW (325 PS) B 28 NER	07.2009→03.2017		7.28311.04.0	LDRV	EP
			7.00175.04.0	SUV	EL
INSIGNIA A Sports Tourer (G09)					55
1.4 (35) 103-110 kW (140-150 PS) A 14 NET, B 14 NET	09.2011→06.2013		7.03833.02.0	EUV-VB	EL
			7.06117.07.0	ZM-NWV	EL mit Dichtring with O-ring
1.4 LPG (35) 103-110 kW (140-150 PS) A 14 NET, B 14 NET	07.2012→06.2013		7.03833.02.0	EUV-VB	EL
			7.06117.07.0	ZM-NWV	EL mit Dichtring with O-ring
1.6 (35) 84-85 kW (114-116 PS) A 16 XER	07.2008→06.2012		7.02256.38.0	AKF	EL
			7.02256.43.0 7.06117.08.0	EUV-SR SV-NWV	EL EH mit Dichtring with O-ring
1.6 CDTi (35) 88 kW (120 PS) B 16 DTJ	07.2015→01.2017		7.08681.01.0	EOV	EH
			7.02256.44.0	EUV-AGR	EL
1.6 CDTi (35) 81-100 kW (110-136 PS) B 16 DTH	07.2015→12.2016		7.08681.01.0	EOV	EH
			7.02256.44.0	EUV-AGR	EL
1.6 SIDI (35) 125 kW (170 PS) A 16 XHT, B 16 SHL	03.2013→11.2014		7.03351.12.0	LDRV	EP
1.6 Turbo (35) 132 kW (180 PS) A 16 LET	01.2009→06.2013		7.01039.03.0	EUV-VB	EL
			7.03833.02.0 7.06117.08.0	LDRV SV-NWV	EL EH mit Dichtring with O-ring
1.8 (35) 101-103 kW (137-140 PS) A 18 XER	07.2008→06.2013		7.02256.43.0	EUV-SR	EL
			7.06117.08.0	SV-NWV	EH mit Dichtring with O-ring
2.0 Biturbo CDTi (35) 140-143 kW (190-195 PS) A 20 DTR	07.2008→03.2017		7.03978.01.0	DW-TL	EP für OE-Nummer: 55573362, 55575611, 8 51 017, 8 51 042 für OE number: 55573362, 55575611, 8 51 017, 8 51 042
			7.07400.09.0*	STE	EP für OE-Nummer: 55567313, 58 51 415 für OE number: 55567313, 58 51 415
			↳ 7.01421.01.0	DW-TL	EP
			↳ 7.03652.01.0	DW-TL	EP
			7.07400.10.0*	STE	EP für OE-Nummer: 55580532, 8 51 070 für OE number: 55580532, 8 51 070
			↳ 7.01421.01.0 ↳ 7.03652.01.0	DW-TL DW-TL	EP EP



INSIGNIA A Sports Tourer (G09) **55**

2.0 Biturbo CDTI (35) 140-143 kW (190-195 PS) A 20 DTR	01.2012→06.2015		7.03978.01.0	DW-TL	EP	für OE-Nummer: 55573362, 55575611, 8 51 017, 8 51 042 for OE number: 55573362, 55575611, 8 51 017, 8 51 042
			7.07400.09.0*	STE	EP	für OE-Nummer: 55567313, 58 51 415 for OE number: 55567313, 58 51 415
			↳ 7.01421.01.0	DW-TL	EP	
			↳ 7.03652.01.0	DW-TL	EP	
			7.07400.10.0*	STE	EP	für OE-Nummer: 55580532, 8 51 070 for OE number: 55580532, 8 51 070
			↳ 7.01421.01.0 ↳ 7.03652.01.0	DW-TL DW-TL	EP EP	
2.0 Biturbo CDTI 4x4 (35) 140-143 kW (190-195 PS) A 20 DTR	07.2008→03.2017		7.03978.01.0	DW-TL	EP	für OE-Nummer: 55573362, 55575611, 8 51 017, 8 51 042 for OE number: 55573362, 55575611, 8 51 017, 8 51 042
			7.07400.09.0*	STE	EP	für OE-Nummer: 55567313, 58 51 415 for OE number: 55567313, 58 51 415
			↳ 7.01421.01.0	DW-TL	EP	
			↳ 7.03652.01.0	DW-TL	EP	
			7.07400.10.0*	STE	EP	für OE-Nummer: 55580532, 8 51 070 for OE number: 55580532, 8 51 070
			↳ 7.01421.01.0 ↳ 7.03652.01.0	DW-TL DW-TL	EP EP	
2.0 Biturbo CDTI 4x4 (35) 140-143 kW (190-195 PS) A 20 DTR	01.2012→06.2015		7.03978.01.0	DW-TL	EP	für OE-Nummer: 55573362, 55575611, 8 51 017, 8 51 042 for OE number: 55573362, 55575611, 8 51 017, 8 51 042
			7.07400.09.0*	STE	EP	für OE-Nummer: 55567313, 58 51 415 for OE number: 55567313, 58 51 415
			↳ 7.01421.01.0	DW-TL	EP	
			↳ 7.03652.01.0	DW-TL	EP	
			7.07400.10.0*	STE	EP	für OE-Nummer: 55580532, 8 51 070 for OE number: 55580532, 8 51 070
			↳ 7.01421.01.0 ↳ 7.03652.01.0	DW-TL DW-TL	EP EP	
2.0 CDTI (35) 81 kW (110 PS) A 20 DTC, A 20 DTL	07.2008→06.2013		7.03978.01.0	DW-TL	EP	
2.0 CDTI (35) 96 kW (131 PS) A 20 DT, A 20 DTJ	07.2008→06.2015		7.03978.01.0	DW-TL	EP	
2.0 CDTI (35) 96-121 kW (131-165 PS) A 20 DTH	07.2008→06.2015		7.03978.01.0	DW-TL	EP	
2.0 CDTI (35) 88-103 kW (120-140 PS) A 20 DTE	03.2012→06.2015		7.03978.01.0	DW-TL	EP	
2.0 CDTI (35) 96-121 kW (131-165 PS) A 20 DTH	07.2013→06.2015		7.03978.01.0	DW-TL	EP	
2.0 CDTI (35) 88-103 kW (120-140 PS) A 20 DTE	07.2013→06.2015		7.03978.01.0	DW-TL	EP	
2.0 CDTI (35) 125 kW (170 PS) B 20 DTH	11.2014→12.2016		7.08681.02.0	EOV	EH	
			7.02256.44.0	EUV-AGR	EL	
2.0 CDTI 4x4 (35) 96-121 kW (131-165 PS) A 20 DTH	06.2010→06.2015		7.03978.01.0	DW-TL	EP	
2.0 CDTI 4x4 (35) 96-121 kW (131-165 PS) A 20 DTH	07.2013→06.2015		7.03978.01.0	DW-TL	EP	

O



INSIGNIA A Sports Tourer (G09)
55

2.0 CDTI 4x4 (35) 125 kW (170 PS) B 20 DTH	11.2014→12.2016		7.08681.02.0	EOV	EH	
			7.02256.44.0	EUV-AGR	EL	
2.0 E85 Turbo (35) 162-206 kW (220-280 PS) A 20 NFT	09.2010→11.2011		7.02721.06.0*	EUV-VB	EL	mit Halter with holder
			↳7.01441.04.0	EUV-VB	EL	
			7.06117.05.0	SV-NWV	EH	mit Dichtring with O-ring
			7.06117.06.0	SV-NWV	EH	mit Dichtring with O-ring
2.0 Turbo (35) 162-184 kW (220-250 PS) A 20 NHT	07.2008→06.2013		5.02549.03.0*	EUV-VB	EL	mit Halter with holder
			↳7.01441.04.0	EUV-VB	EL	
			7.03357.04.0	LDRV	EL	
			7.06117.05.0	SV-NWV	EH	mit Dichtring with O-ring
2.0 Turbo (35) 162-184 kW (220-250 PS) A 20 NHT	04.2014→11.2014		7.03357.04.0	LDRV	EL	
			7.03381.15.0	SUV	EL	
			7.06117.56.0	SV-NWV	EH	mit Dichtring with O-ring
			7.06117.57.0	SV-NWV	EH	mit Dichtring with O-ring
2.0 Turbo (35) 162-184 kW (220-250 PS) B 20 NHT	04.2014→11.2014		7.03357.04.0	LDRV	EL	
			7.06117.56.0	SV-NWV	EH	mit Dichtring with O-ring
			7.06117.57.0	SV-NWV	EH	mit Dichtring with O-ring
2.0 Turbo 4x4 (35) 162-184 kW (220-250 PS) A 20 NHT	07.2008→06.2011		5.02549.03.0*	EUV-VB	EL	mit Halter with holder
			↳7.01441.04.0	EUV-VB	EL	
			7.03357.04.0	LDRV	EL	
			7.06117.05.0	SV-NWV	EH	mit Dichtring with O-ring
2.0 Turbo 4x4 (35) 162-184 kW (220-250 PS) A 20 NHT, B 20 NHT	09.2011→06.2013		7.03357.04.0	LDRV	EL	
			7.03381.15.0	SUV	EL	
			7.06117.56.0	SV-NWV	EH	mit Dichtring with O-ring
			7.06117.57.0	SV-NWV	EH	mit Dichtring with O-ring
2.8 V6 Turbo 4x4 (35) 191 kW (260 PS) A 28 NET	10.2008→06.2013		7.28311.04.0	LDRV	EP	
			7.00175.04.0	SUV	EL	
			7.06117.04.0	SV-NWV	EH	mit Wellendichtring With shaft sealing ring
2.8 V6 Turbo OPC 4x4 (35) 239 kW (325 PS) A 28 NER	07.2009→06.2015		7.28311.04.0	LDRV	EP	







O











INSIGNIA A Sports Tourer (G09) 55

























			7.00175.04.0	SUV	EL	mit Wellendichtring With shaft sealing ring
			7.06117.04.0	SV-NWV	EH	
2.8 V6 Turbo OPC 4x4 (35) 239 kW (325 PS) B 28 NER	07.2009→06.2015		7.28311.04.0	LDRV	EP	
			7.00175.04.0	SUV	EL	

INSIGNIA B Country Tourer (Z18) 56

1.5 (47) 121 kW (165 PS) B 15 SFT, D 15 SFT	06.2017→		7.03381.14.0	SUV	EL	
1.6 Turbo (47) 147 kW (200 PS) D 16 SHT	06.2018→		7.03351.12.0	LDRV	EP	
2.0 4x4 (47) 191-206 kW (260-280 PS) B 20 NFT, D 20 NFT	06.2017→		7.03357.04.0	LDRV	EL	
			7.06117.56.0	SV-NWV	EH	mit Dichtring with O-ring
			7.06117.57.0	SV-NWV	EH	
2.0 CDTi (47) 125 kW (170 PS) D 20 DTH	06.2017→		7.08681.02.0	EOV	EH	
			7.02256.44.0	EUV-AGR	EL	
2.0 CDTi 4x4 (47) 125 kW (170 PS) D 20 DTH	06.2017→		7.08681.02.0	EOV	EH	
			7.02256.44.0	EUV-AGR	EL	
2.0 CDTi 4x4 (47) 154 kW (210 PS) D 20 DTR	01.2018→		7.08681.02.0	EOV	EH	
			7.02256.44.0	EUV-AGR	EL	





INSIGNIA B Grand Sport (Z18) 57

1.5 (68) 103 kW (140 PS) B 15 SFL, D 15 SFL	03.2017→		7.03381.14.0	SUV	EL	
1.5 (68) 121 kW (165 PS) B 15 SFT, D 15 SFT	03.2017→		7.03381.14.0	SUV	EL	
1.6 CDTi (68) 70-81 kW (95-110 PS) B 16 DTE, D 16 DTE, D 16 DTN	03.2017→		7.08681.01.0	EOV	EH	
			7.02256.44.0	EUV-AGR	EL	
1.6 CDTi (68) 81-100 kW (110-136 PS) B 16 DTH, D 16 DTH	03.2017→		7.08681.01.0	EOV	EH	
			7.02256.44.0	EUV-AGR	EL	
1.6 Turbo (68) 147 kW (200 PS) D 16 SHT	06.2018→		7.03351.12.0	LDRV	EP	
2.0 4x4 (68) 191-206 kW (260-280 PS) B 20 NFT, D 20 NFT	03.2017→		7.03357.04.0	LDRV	EL	
			7.06117.56.0	SV-NWV	EH	mit Dichtring with O-ring
			7.06117.57.0	SV-NWV	EH	
2.0 CDTi (68) 125 kW (170 PS) B 20 DTH, D 20 DTH	03.2017→		7.08681.02.0	EOV	EH	
			7.02256.44.0	EUV-AGR	EL	
2.0 CDTi 4x4 (68) 154 kW (210 PS) D 20 DTR	03.2017→		7.08681.02.0	EOV	EH	
			7.02256.44.0	EUV-AGR	EL	





						
INSIGNIA B Grand Sport (Z18)						57
2.0 CDTi 4x4 (68) 125 kW (170 PS) D 20 DTH	03.2017→		7.08681.02.0	EOV	EH	
			7.02256.44.0	EUV-AGR	EL	
INSIGNIA B Sports Tourer (Z18)						58
1.5 (35) 103 kW (140 PS) B 15 SFL, D 15 SFL	03.2017→		7.03381.14.0	SUV	EL	
1.5 (35) 121 kW (165 PS) B 15 SFT, D 15 SFT	03.2017→		7.03381.14.0	SUV	EL	
1.6 CDTi (35) 70-81 kW (95-110 PS) B 16 DTE, D 16 DTE, D 16 DTN	03.2017→		7.08681.01.0	EOV	EH	
			7.02256.44.0	EUV-AGR	EL	
1.6 CDTi (35) 81-100 kW (110-136 PS) B 16 DTH, D 16 DTH	03.2017→		7.08681.01.0	EOV	EH	
			7.02256.44.0	EUV-AGR	EL	
1.6 Turbo (35) 147 kW (200 PS) D 16 SHT	06.2018→		7.03351.12.0	LDRV	EP	
2.0 4x4 (35) 191-206 kW (260-280 PS) B 20 NFT, D 20 NFT	03.2017→		7.03357.04.0	LDRV	EL	
			7.06117.56.0	SV-NWV	EH	mit Dichtring with O-ring
			7.06117.57.0	SV-NWV	EH	mit Dichtring with O-ring
2.0 CDTi (35) 125 kW (170 PS) B 20 DTH	03.2017→		7.02256.44.0	EUV-AGR	EL	
2.0 CDTi (35) 125 kW (170 PS) D 20 DTH	03.2017→		7.08681.02.0	EOV	EH	
			7.02256.44.0	EUV-AGR	EL	
2.0 CDTi 4x4 (35) 154 kW (210 PS) D 20 DTR	03.2017→		7.08681.02.0	EOV	EH	
			7.02256.44.0	EUV-AGR	EL	
2.0 CDTi 4x4 (35) 125 kW (170 PS) D 20 DTH	03.2017→		7.08681.02.0	EOV	EH	
			7.02256.44.0	EUV-AGR	EL	
KADETT E (T85)						59
1.3 i Cat (C19, D19) 44 kW (60 PS) C 13 N	09.1985→08.1991		7.05432.01.0	SM	EL	mit Dichtring with O-ring
1.4 i (C19, D19) 40-44 kW (54-60 PS) C 14 NZ	01.1990→08.1991		7.05432.01.0	SM	EL	mit Dichtring with O-ring
1.6 i (C19, D19) 55-65 kW (75-88 PS) E 16 NZ	09.1986→08.1991		7.05432.00.0	SM	EL	mit Dichtring with O-ring
1.6 i Cat (C19, D19) 55-60 kW (75-82 PS) C 16 LZ, C 16 NZ	09.1986→08.1991		7.05432.00.0	SM	EL	mit Dichtring with O-ring
1.8 i (C19, D19) 66 kW (90 PS) C 18 NZ	08.1989→05.1992		7.05432.00.0	SM	EL	mit Dichtring with O-ring
KADETT E Convertible (T85)						60
1.4 i 40-44 kW (54-60 PS) C 14 NZ	01.1990→08.1991		7.05432.01.0	SM	EL	mit Dichtring with O-ring
1.6 i 55-65 kW (75-88 PS) E 16 NZ	10.1986→02.1993		7.05432.00.0	SM	EL	mit Dichtring with O-ring
1.6 i Cat 55-60 kW (75-82 PS) C 16 LZ, C 16 NZ	10.1987→02.1993		7.05432.00.0	SM	EL	mit Dichtring with O-ring













KADETT E Estate (T85) 61



















1.3 i Cat (C15, C35, D15, D35) 44 kW (60 PS) C 13 N	09.1985→08.1991		7.05432.01.0	SM	EL	mit Dichtring with O-ring
1.4 i (C15, C35, D15, D35) 40-44 kW (54-60 PS) C 14 NZ	01.1990→08.1991		7.05432.01.0	SM	EL	mit Dichtring with O-ring
1.6 i (C15, C35, D15, D35) 55-65 kW (75-88 PS) E 16 NZ	09.1986→08.1991		7.05432.00.0	SM	EL	mit Dichtring with O-ring
1.6 i Cat (C15, C35, D15, D35) 55-60 kW (75-82 PS) C 16 LZ, C 16 NZ	09.1986→08.1991		7.05432.00.0	SM	EL	mit Dichtring with O-ring
1.8 i (C15, C35, D15, D35) 66 kW (90 PS) C 18 NZ	06.1985→08.1991		7.05432.00.0	SM	EL	mit Dichtring with O-ring

KADETT E Hatchback (T85) 62

1.3 i Cat (C08, C48, D08, D48) 44 kW (60 PS) C 13 N	09.1985→08.1991		7.05432.01.0	SM	EL	mit Dichtring with O-ring
1.4 i (C08, C48, D08, D48) 40-44 kW (54-60 PS) C 14 NZ	01.1990→08.1991		7.05432.01.0	SM	EL	mit Dichtring with O-ring
1.6 i (C08, C48, D08, D48) 55-65 kW (75-88 PS) E 16 NZ	09.1986→08.1991		7.05432.00.0	SM	EL	mit Dichtring with O-ring
1.6 i Cat (C08, C48, D08, D48) 55-60 kW (75-82 PS) C 16 LZ, C 16 NZ	09.1986→08.1991		7.05432.00.0	SM	EL	mit Dichtring with O-ring

MERIVA A MPV (X03) 63

1.3 CDTI (E75) 55 kW (75 PS) Z 13 DTJ	09.2003→05.2010		7.01420.02.0	DW-TL	EP	
1.4 16V Twinport (E75) 66 kW (90 PS) Z 14 XEP	07.2004→05.2010		7.02256.28.0	SV-PDA	EP	
1.4 16V Twinport LPG (E75) 66 kW (90 PS) Z 14 XEP	07.2004→05.2010		7.02256.28.0	SV-PDA	EP	
1.6 (E75) 62-69 kW (84-94 PS) Z 16 SE	05.2003→05.2010		7.02256.22.0	AKF	EL	
1.6 (E75) 74-77 kW (101-105 PS) Z 16 XEP	01.2006→05.2010		7.02256.38.0	AKF	EL	
			7.02256.31.0	SV-PDA	EP	
1.6 16V (E75) 74-76 kW (101-103 PS) Z 16 XE	05.2003→01.2006		7.02256.22.0	AKF	EL	
1.6 Turbo (E75) 132 kW (180 PS) Z 16 LET	09.2005→05.2010		7.01039.03.0	EUV-VB	EL	
			7.03833.02.0	LDRV	EL	
1.7 CDTI (E75) 74 kW (101 PS) Z 17 DT	09.2003→05.2010		7.03085.02.0	DW-TL	EP	
			7.02461.01.0	EUV-LS	EL	
1.7 CDTI (E75) 74 kW (100 PS) Z 17 DTH	09.2003→05.2010		7.03088.01.0	DW-TL	EP	
			7.02461.01.0	EUV-AGR	EL	
1.7 CDTI (E75) 92 kW (125 PS) Z 17 DTR	09.2006→05.2010		7.03085.02.0	DW-TL	EP	























					
MERIVA A MPV (X03)					63
1.7 DTI (E75) 55 kW (75 PS) Y 17 DT	09.2003→05.2010		7.02461.01.0 7.03088.01.0	EUV-LS DW-TL	EL EP
MERIVA B MPV (S10)					64
1.3 CDTI (75) 55 kW (75 PS) A 13 DTC	06.2010→10.2013		7.01420.02.0 7.04423.01.0 7.01981.07.0	DW-TL DW-TL SV-AGR-K	EP EP EP →ch. D4167394 Fahrgestellnummer ab: D4167395 Vehicle Identification Number from: D4167395 Fahrgestellnummer ab: D4000001 Vehicle Identification Number from: D4000001 Fahrgestellnummer bis: B4999999 Vehicle Identification Number to: B4999999
1.3 CDTI (75) 70 kW (95 PS) A 13 DTE	06.2010→11.2014		7.01420.02.0 7.04423.01.0 7.01981.07.0	DW-TL DW-TL SV-AGR-K	EP EP EP →ch. D4167394 Fahrgestellnummer ab: D4167395 Vehicle Identification Number from: D4167395 Fahrgestellnummer ab: D4000001 Vehicle Identification Number from: D4000001 Fahrgestellnummer bis: B4999999 Vehicle Identification Number to: B4999999
1.4 (75) 74 kW (101 PS) A 14 XER, B 14 XER	06.2010→03.2017		7.02256.43.0 7.06117.07.0	EUV-SR ZM-NWV	EL EL mit Dichtring with O-ring
1.4 (75) 88 kW (120 PS) A 14 NEL, B 14 NEL	06.2010→03.2017		7.03833.02.0 7.06117.07.0	EUV-VB ZM-NWV	EL EL mit Dichtring with O-ring
1.4 (75) 103-110 kW (140-150 PS) A 14 NET, B 14 NET	06.2010→03.2017		7.03833.02.0 7.06117.07.0	EUV-VB ZM-NWV	EL EL mit Dichtring with O-ring
1.4 LPG (75) 88 kW (120 PS) A 14 NEL, B 14 NEL	06.2011→03.2017		7.03833.02.0 7.06117.07.0	EUV-VB ZM-NWV	EL EL mit Dichtring with O-ring
1.6 CDTI (75) 70 kW (95 PS) B 16 DTC	01.2014→01.2017		7.08681.01.0 7.02256.44.0	EOV EUV-AGR	EH EL Fahrgestellnummer ab: F4000001 Vehicle Identification Number from: F4000001
1.6 CDTI (75) 70-81 kW (95-110 PS) B 16 DTE, B 16 DTL, B 16 DTN	03.2014→03.2017		7.08681.01.0 7.02256.44.0	EOV EUV-AGR	EH EL B 16 DTE, B 16 DTL, B 16 DTN: Fahrgestellnummer ab: F4000001 Vehicle Identification Number from: F4000001
1.6 CDTi (75) 81-100 kW (110-136 PS) B 16 DTH	08.2013→01.2017		7.08681.01.0 7.02256.44.0	EOV EUV-AGR	EH EL Fahrgestellnummer ab: F4000001 Vehicle Identification Number from: F4000001
1.7 CDTI (75) 74 kW (101 PS) A 17 DT	06.2010→01.2017		7.02461.01.0	EUV-LS	EL
1.7 CDTI (75) 81 kW (110 PS) A 17 DTC	06.2010→06.2015		7.03073.01.0 7.03085.02.0 7.02461.01.0	DW-TL DW-TL EUV-AGR	EP EP EL

MERIVA B MPV (S10) 64

1.7 CDTI (75) 81 kW (110 PS) A 17 DTI	06.2010→06.2015	7.03085.02.0	DW-TL	EP	
		7.02461.01.0	EUV-AGR	EL	
1.7 CDTI (75) 96 kW (131 PS) A 17 DTS	06.2010→10.2013	7.03073.01.0	DW-TL	EP	
		7.03085.02.0	DW-TL	EP	
		7.02461.01.0	EUV-AGR	EL	



































MOKKA / MOKKA X (J13) 65

1.4 (_76) 103-110 kW (140-150 PS) A 14 NET, B 14 NET, D 14 NET	04.2013→	7.03833.02.0	EUV-VB	EL	
		7.06117.07.0	ZM-NWV	EL	
1.4 4x4 (_76) 103-110 kW (140-150 PS) A 14 NET, B 14 NET, D 14 NET	06.2012→	7.03833.02.0	EUV-VB	EL	
		7.06117.07.0	ZM-NWV	EL	
1.4 4x4 (_76) 103-112 kW (140-152 PS) B 14 XFT	06.2016→	7.03351.12.0	LDRV	EP	
		7.03381.14.0	SUV	EL	
1.4 LPG (_76) 103-110 kW (140-150 PS) A 14 NET, B 14 NET, D 14 NET	04.2013→	7.03833.02.0	EUV-VB	EL	
		7.06117.07.0	ZM-NWV	EL	
1.6 (_76) 84-85 kW (114-116 PS) A 16 XER	06.2012→	7.02256.38.0	AKF	EL	
		7.02256.43.0	EUV-SR	EL	
		7.06117.08.0	SV-NWV	EH	
1.6 (_76) 85 kW (116 PS) B 16 XER	06.2012→	7.02256.43.0	EUV-SR	EL	
		7.06117.08.0	SV-NWV	EH	
1.6 CDTI (_76) 81-100 kW (110-136 PS) B 16 DTH	01.2015→	7.08681.01.0	EOV	EH	Fahrgestellnummer ab: G4000001, GB000001 Vehicle Identification Number from: G4000001, GB000001
		7.02256.44.0	EUV-AGR	EL	
1.6 CDTI (_76) 99-100 kW (135-136 PS) D 16 DTH	01.2015→	7.02256.44.0	EUV-AGR	EL	
1.6 CDTI (_76) 81 kW (110 PS) B 16 DTN	06.2015→	7.02256.44.0	EUV-AGR	EL	
1.6 CDTI (_76) 81 kW (110 PS) B 16 DTU	06.2015→	7.08681.01.0	EOV	EH	Fahrgestellnummer ab: G4000001, GB000001 Vehicle Identification Number from: G4000001, GB000001
		7.02256.44.0	EUV-AGR	EL	
1.6 CDTI 4x4 (_76) 81-100 kW (110-136 PS) B 16 DTH	01.2015→	7.08681.01.0	EOV	EH	Fahrgestellnummer ab: G4000001, GB000001 Vehicle Identification Number from: G4000001, GB000001
		7.02256.44.0	EUV-AGR	EL	
1.6 CDTI 4x4 (_76) 81 kW (110 PS) D 16 DTN	03.2018→	7.02256.44.0	EUV-AGR	EL	
1.7 CDTI (_76) 96 kW (131 PS) A 17 DTS	06.2012→	7.03073.01.0	DW-TL	EP	
		7.02461.03.0	EUV-AGR	EL	

						
MOKKA / MOKKA X (J13)						65
1.7 CDTI 4x4 (_76) 96 kW (131 PS) A 17 DTS	06.2012→		7.03073.01.0	DW-TL	EP	
			7.02461.03.0	EUV-AGR	EL	
1.8 (_76) 101-103 kW (137-140 PS) A 18 XER	01.2013→		7.02256.43.0	EUV-SR	EL	
			7.06117.08.0	SV-NWV	EH	
1.8 4x4 (_76) 101-103 kW (137-140 PS) A 18 XER	01.2013→		7.02256.43.0	EUV-SR	EL	
			7.06117.08.0	SV-NWV	EH	
OMEGA B (V94)						66
2.0 16V (F69, M69, P69) 100 kW (136 PS) X 20 XEV	03.1994→09.1999		7.06269.01.0	LLR	EL	
2.5 TD (F69, M69, P69) 96 kW (131 PS) X 25 DT, X 25 TD	04.1994→07.2003		7.21903.73.0	DW-AGR	EP	
OMEGA B Estate (V94)						67
2.0 16V (F35, M35, P35) 100 kW (136 PS) X 20 XEV	03.1994→09.1999		7.06269.01.0	LLR	EL	
2.5 TD (F35, M35, P35) 96 kW (131 PS) X 25 DT, X 25 TD	04.1994→07.2001		7.21903.73.0	DW-AGR	EP	
SIGNUM Hatchback (Z03)						68
1.8 (F48) 101-103 kW (137-140 PS) Z 18 XER	09.2005→12.2008		7.02256.43.0	EUV-SR	EL	
			7.06117.08.0	SV-NWV	EH	
1.9 CDTI (F48) 88 kW (120 PS) Z 19 DT	04.2004→02.2008		7.01421.01.0	DW-TL	EP	
1.9 CDTI (F48) 110 kW (150 PS) Z 19 DTH	04.2004→02.2008		7.01421.01.0	DW-TL	EP	
1.9 CDTI (F48) 74 kW (101 PS) Z 19 DTL	08.2005→02.2008		7.01421.01.0	DW-TL	EP	
2.0 Turbo (F48) 129 kW (175 PS) Z 20 NET	05.2003→12.2008		7.00326.03.0	EUV-VB	EL	
			7.00045.00.0*	LDRV	EP	
			↳7.28311.04.0	LDRV	EP	
2.2 DTI (F48) 86-92 kW (117-125 PS) Y 22 DTR	05.2003→04.2004		7.02256.26.0	DW-TL	EP	
			7.22138.50.0	EUV-AGR	EL	
2.8 V6 Turbo (F48) 169 kW (230 PS) Z 28 NEL	09.2005→12.2008		7.00175.04.0	SUV	EL	
			7.06117.04.0	SV-NWV	EH	
2.8 V6 Turbo (F48) 184-206 kW (250-280 PS) Z 28 NET	01.2006→12.2008		7.00175.04.0	SUV	EL	
			7.06117.04.0	SV-NWV	EH	







O

			 PIERBURG			
SPEEDSTER (E01)						69
2.0 Turbo (R97) 140-162 kW (190-220 PS) Z 20 LET	08.2002→08.2006		7.01039.03.0	EUV-SR	EL	
			7.01024.02.0	LDRV	EL	
TIGRA (S93)						70
1.4 16V (F07) 63-69 kW (86-94 PS) X 14 XE	07.1994→12.2000		7.05432.11.0	SM	EL	mit Dichtring with O-ring
1.4 16V (F07) 63-69 kW (86-94 PS) X 14 XE	08.1997→12.2000		7.05432.11.0	SM	EL	mit Dichtring with O-ring
1.6 16V (F07) 78 kW (106 PS) X 16 XE	07.1994→08.1998		7.05432.11.0	SM	EL	mit Dichtring with O-ring
TIGRA TwinTop (X04)						71
1.4 (R97) 66 kW (90 PS) Z 14 XEP	06.2004→12.2010		7.02256.28.0	SV-PDA	EP	
VECTRA A (J89)						72
1.6 (F19, M19) 51-55 kW (69-75 PS) C 16 LZ2	08.1992→07.1993		7.05432.00.0	SM	EL	mit Dichtring with O-ring
1.6 i (F19, M19) 55-65 kW (75-88 PS) C 16 NZ, C 16 NZ2, E 16 NZ	09.1988→11.1995		7.05432.00.0	SM	EL	mit Dichtring with O-ring
1.6 i (F19, M19) 52 kW (71 PS) X 16 SZ	09.1993→11.1995		7.05432.00.0	SM	EL	mit Dichtring with O-ring
1.6 i (F19, M19) 51-55 kW (69-75 PS) 16 LZ2, C 16 LZ2	09.1993→11.1995		7.05432.00.0	SM	EL	mit Dichtring with O-ring
1.8 i Cat (F19, M19) 66 kW (90 PS) C 18 NZ	03.1990→11.1995		7.05432.00.0	SM	EL	mit Dichtring with O-ring
2.0 i 16V (F19, M19) 100 kW (136 PS) X 20 XEV	08.1992→08.1995		7.06269.01.0	LLR	EL	
2.0 i 16V 4x4 (F19, M19) 100 kW (136 PS) X 20 XEV	06.1994→11.1995		7.06269.01.0	LLR	EL	
VECTRA A Hatchback (J89)						73
1.6 (F68, M68) 55-65 kW (75-88 PS) E 16 NZ	08.1988→06.1994		7.05432.00.0	SM	EL	mit Dichtring with O-ring
1.6 (F68, M68) 51-55 kW (69-75 PS) C 16 LZ2	08.1992→07.1993		7.05432.00.0	SM	EL	mit Dichtring with O-ring
1.6 i (F68, M68) 52 kW (71 PS) X 16 SZ	09.1993→11.1995		7.05432.00.0	SM	EL	mit Dichtring with O-ring
1.6 i (F68, M68) 55 kW (75 PS) 16 LZ2	09.1993→11.1995		7.05432.00.0	SM	EL	mit Dichtring with O-ring
1.6 i Cat (F68, M68) 55-60 kW (75-82 PS) C 16 NZ, C 16 NZ2	09.1988→11.1995		7.05432.00.0	SM	EL	mit Dichtring with O-ring
1.8 i Cat (F68, M68) 66 kW (90 PS) C 18 NZ	03.1990→11.1995		7.05432.00.0	SM	EL	mit Dichtring with O-ring
2.0 i 16V (F68, M68) 100 kW (136 PS) X 20 XEV	08.1992→08.1995		7.06269.01.0	LLR	EL	









						
VECTRA B (J96)						74
1.6 i (F19) 55 kW (75 PS) X 16 SZR	10.1995→04.2002		7.05432.00.0	SM	EL	mit Dichtring with O-ring
1.6 i (F19) 55 kW (75 PS) 16 LZ2	10.1995→04.2002		7.05432.00.0	SM	EL	mit Dichtring with O-ring
1.6 i 16V (F19) 74 kW (101 PS) X 16 XEL	10.1995→03.1999		7.05432.11.0	SM	EL	mit Dichtring with O-ring
1.7 TD (F19) 60 kW (82 PS) X 17 DT (TC4EE1)	10.1995→12.1998		7.22138.50.0	EUV-LS	EL	für Fahrzeuge mit Klimaanlage for vehicles with air conditioning
1.8 i 16V (F19) 85 kW (116 PS) X 18 XE	10.1995→09.2000		7.06269.01.0	LLR	EL	
2.0 i 16V (F19) 85-100 kW (116-136 PS) C 20 SEL, X 20 XEV	09.1995→06.2000		7.06269.01.0	LLR	EL	
VECTRA B Estate (J96)						75
1.6 i (F35) 55 kW (75 PS) X 16 SZR	11.1996→06.2000		7.05432.00.0	SM	EL	mit Dichtring with O-ring
1.6 i (F35) 55 kW (75 PS) 16 LZ2	11.1996→06.2000		7.05432.00.0	SM	EL	mit Dichtring with O-ring
1.6 i 16V (F35) 74 kW (101 PS) X 16 XEL	11.1996→03.1999		7.05432.11.0	SM	EL	mit Dichtring with O-ring
1.7 TD (F35) 60 kW (82 PS) X 17 DT (TC4EE1)	11.1996→12.1997		7.22138.50.0	EUV-LS	EL	für Fahrzeuge mit Klimaanlage for vehicles with air conditioning
1.8 i 16V (F35) 85 kW (116 PS) X 18 XE	11.1996→09.2000		7.06269.01.0	LLR	EL	
2.0 i 16V (F35) 85-100 kW (116-136 PS) C 20 SEL, X 20 XEV	11.1996→06.2000		7.06269.01.0	LLR	EL	
VECTRA B Hatchback (J96)						76
1.6 i (F68) 55 kW (75 PS) X 16 SZR	10.1995→07.2003		7.05432.00.0	SM	EL	mit Dichtring with O-ring
1.6 i (F68) 55 kW (75 PS) 16 LZ2	10.1995→07.2003		7.05432.00.0	SM	EL	mit Dichtring with O-ring
1.6 i 16V (F68) 74 kW (101 PS) X 16 XEL	10.1995→03.1999		7.05432.11.0	SM	EL	mit Dichtring with O-ring
1.7 TD (F68) 60 kW (82 PS) X 17 DT (TC4EE1)	10.1995→12.1998		7.22138.50.0	EUV-LS	EL	für Fahrzeuge mit Klimaanlage for vehicles with air conditioning
2.0 i 16V (F68) 85-100 kW (116-136 PS) C 20 SEL, X 20 XEV	09.1995→06.2000		7.06269.01.0	LLR	EL	
VECTRA C (Z02)						77
1.6 (F69) 74-77 kW (101-105 PS) Z 16 XEP	08.2005→08.2008		7.02256.38.0	AKF	EL	
			7.02256.31.0	SV-PDA	EP	
1.8 (F69) 101-103 kW (137-140 PS) Z 18 XER	08.2005→08.2008		7.02256.43.0	EUV-SR	EL	
			7.06117.08.0	SV-NWV	EH	
1.9 CDTI (F69) 88 kW (120 PS) Z 19 DT	04.2004→01.2009		7.01421.01.0	DW-TL	EP	
1.9 CDTI (F69) 110 kW (150 PS) Z 19 DTH	04.2004→08.2008		7.01421.01.0	DW-TL	EP	
1.9 CDTI (F69) 74 kW (101 PS) Z 19 DTL	10.2005→08.2008		7.01421.01.0	DW-TL	EP	
2.0 16V Turbo (F69) 129 kW (175 PS) Z 20 NET	03.2003→08.2008		7.00326.03.0	EUV-VB	EL	
			7.00045.00.0*	LDRV	EP	
			↳7.28311.04.0	LDRV	EP	























VECTRA C (Z02) **77**

2.2 16V (F69) 108 kW (147 PS) Z 22 SE	04.2002→12.2008		7.02256.22.0	AKF	EL	
2.2 DTI 16V (F69) 86-92 kW (117-125 PS) Y 22 DTR	04.2002→07.2004		7.02256.26.0	DW-TL	EP	
			7.22138.50.0	EUV-AGR	EL	
2.2 DTI 16V (F69) 86-92 kW (117-125 PS) Y 22 DTR	04.2002→12.2004		7.02256.26.0	DW-TL	EP	
			7.22138.50.0	EUV-AGR	EL	
2.8 V6 Turbo (F69) 169 kW (230 PS) Z 28 NEL	08.2005→10.2006		7.00175.04.0	SUV	EL	
			7.06117.04.0	SV-NWV	EH	mit Wellendichtring With shaft sealing ring
2.8 V6 Turbo (F69) 184-206 kW (250-280 PS) Z 28 NET	08.2005→09.2006		7.00175.04.0	SUV	EL	
			7.06117.04.0	SV-NWV	EH	mit Wellendichtring With shaft sealing ring
2.8 V6 Turbo (F69) 184-206 kW (250-280 PS) Z 28 NET	08.2005→08.2008		7.00175.04.0	SUV	EL	
			7.06117.04.0	SV-NWV	EH	mit Wellendichtring With shaft sealing ring
2.8 V6 Turbo OPC (F69) 184-206 kW (250-280 PS) Z 28 NET	09.2006→08.2008		7.00175.04.0	SUV	EL	
			7.06117.04.0	SV-NWV	EH	mit Wellendichtring With shaft sealing ring

VECTRA C Estate (Z02) **78**

1.6 (F35) 74-77 kW (101-105 PS) Z 16 XEP	12.2005→08.2008		7.02256.38.0	AKF	EL	
			7.02256.31.0	SV-PDA	EP	
1.8 (F35) 101-103 kW (137-140 PS) Z 18 XER	08.2005→08.2008		7.02256.43.0	EUV-SR	EL	
			7.06117.08.0	SV-NWV	EH	mit Dichtring with O-ring
1.9 CDTI (F35) 88 kW (120 PS) Z 19 DT	04.2004→01.2009		7.01421.01.0	DW-TL	EP	
1.9 CDTI (F35) 110 kW (150 PS) Z 19 DTH	04.2004→08.2008		7.01421.01.0	DW-TL	EP	
1.9 CDTI (F35) 74 kW (101 PS) Z 19 DTL	06.2005→08.2008		7.01421.01.0	DW-TL	EP	
2.0 Turbo (F35) 129 kW (175 PS) Z 20 NET	10.2003→08.2008		7.00326.03.0	EUV-VB	EL	
			7.00045.00.0*	LDRV	EP	
			↳ 7.28311.04.0	LDRV	EP	
2.2 DTI (F35) 86-92 kW (117-125 PS) Y 22 DTR	10.2003→12.2005		7.02256.26.0	DW-TL	EP	
			7.22138.50.0	EUV-AGR	EL	
2.8 V6 Turbo (F35) 169 kW (230 PS) Z 28 NEL	08.2005→10.2008		7.00175.04.0	SUV	EL	
			7.06117.04.0	SV-NWV	EH	mit Wellendichtring With shaft sealing ring
2.8 V6 Turbo (F35) 184-206 kW (250-280 PS) Z 28 NET	08.2005→09.2008		7.00175.04.0	SUV	EL	













					
VECTRA C Estate (Z02)					78
			7.06117.04.0	SV-NWV	EH mit Wellendichtring With shaft sealing ring
2.8 V6 Turbo (F35) 184-206 kW (250-280 PS) Z 28 NET	08.2005→08.2008		7.00175.04.0	SUV	EL
			7.06117.04.0	SV-NWV	EH mit Wellendichtring With shaft sealing ring
2.8 V6 Turbo (F35) 184-206 kW (250-280 PS) Z 28 NET	07.2006→08.2008		7.00175.04.0	SUV	EL
			7.06117.04.0	SV-NWV	EH mit Wellendichtring With shaft sealing ring
VECTRA C GTS (Z02)					79
1.6 (F68) 74-77 kW (101-105 PS) Z 16 XEP	01.2006→08.2008		7.02256.38.0	AKF	EL
			7.02256.31.0	SV-PDA	EP
1.8 (F68) 101-103 kW (137-140 PS) Z 18 XER	08.2005→08.2008		7.02256.43.0	EUV-SR	EL
			7.06117.08.0	SV-NWV	EH mit Dichtring with O-ring
1.9 CDTI (F68) 88 kW (120 PS) Z 19 DT	04.2004→01.2009		7.01421.01.0	DW-TL	EP
1.9 CDTI (F68) 110 kW (150 PS) Z 19 DTH	04.2004→08.2008		7.01421.01.0	DW-TL	EP
1.9 CDTI (F68) 74 kW (101 PS) Z 19 DTL	06.2005→08.2008		7.01421.01.0	DW-TL	EP
2.0 16V Turbo (F68) 129 kW (175 PS) Z 20 NET	03.2003→08.2008		7.00326.03.0	EUV-VB	EL
			7.00045.00.0*	LDRV	EP
			↳ 7.28311.04.0	LDRV	EP
2.2 16V (F68) 108 kW (147 PS) Z 22 SE	08.2002→08.2008		7.02256.22.0	AKF	EL
2.2 DTI 16V (F68) 86-92 kW (117-125 PS) Y 22 DTR	08.2002→07.2006		7.02256.26.0	DW-TL	EP
			7.22138.50.0	EUV-AGR	EL
2.2 DTI 16V (F68) 86-92 kW (117-125 PS) Y 22 DTR	08.2002→06.2008		7.02256.26.0	DW-TL	EP
			7.22138.50.0	EUV-AGR	EL
2.8 V6 Turbo (F68) 169 kW (230 PS) Z 28 NEL	08.2005→08.2008		7.00175.04.0	SUV	EL
			7.06117.04.0	SV-NWV	EH mit Wellendichtring With shaft sealing ring
2.8 V6 Turbo (F68) 184-206 kW (250-280 PS) Z 28 NET	08.2005→09.2008		7.00175.04.0	SUV	EL
			7.06117.04.0	SV-NWV	EH mit Wellendichtring With shaft sealing ring
2.8 V6 Turbo (F68) 184-206 kW (250-280 PS) Z 28 NET	08.2005→08.2008		7.00175.04.0	SUV	EL
			7.06117.04.0	SV-NWV	EH mit Wellendichtring With shaft sealing ring









VECTRA C GTS (Z02) **79**

2.8 V6 Turbo (F68) 184-206 kW (250-280 PS) Z 28 NET	08.2006→08.2008	 7.00175.04.0	SUV	EL	
		7.06117.04.0	SV-NWV	EH	mit Wellendichtring With shaft sealing ring

ZAFIRA / ZAFIRA FAMILY B (A05) **80**

1.6 (M75) 74-77 kW (101-105 PS) Z 16 XEP	07.2005→09.2012	 7.02256.38.0	AKF	EL	
		7.02256.43.0	EUV-SR	EL	 Z 16 XEP: Fahrgestellnummer ab: 72000001, 7G000001 Vehicle Identification Number from: 72000001, 7G000001 Fahrgestellnummer bis: 72999999, 7G999999 Vehicle Identification Number to: 72999999, 7G999999
		7.02256.31.0	SV-PDA	EP	 Z 16 XEP: Fahrgestellnummer ab: 82000001, 8G000001 Vehicle Identification Number from: 82000001, 8G000001 Fahrgestellnummer bis: 72999999, 7G999999 Vehicle Identification Number to: 72999999, 7G999999
1.6 (M75) 77 kW (105 PS) Z 16 XE1	07.2005→09.2012	 7.02256.38.0	AKF	EL	
		7.02256.43.0	EUV-SR	EL	 Z 16 XE1: Fahrgestellnummer ab: 72000001, 7G000001 Vehicle Identification Number from: 72000001, 7G000001 Fahrgestellnummer bis: 72999999, 7G999999 Vehicle Identification Number to: 72999999, 7G999999  Z 16 XE1: Fahrgestellnummer ab: 82000001, 8G000001 Vehicle Identification Number from: 82000001, 8G000001
1.6 (M75) 84-85 kW (114-116 PS) A 16 XER, Z 16 XER	01.2008→04.2015	 7.02256.38.0	AKF	EL	
		7.02256.43.0	EUV-SR	EL	
		7.06117.08.0	SV-NWV	EH	mit Dichtring with O-ring
1.6 CNG Turbo (M75) 110 kW (150 PS) A 16 XNT, Z 16 XNT	04.2010→04.2015	 7.03833.02.0	EUV-VB	EL	
1.7 CDTI (M75) 81 kW (110 PS) A 17 DTJ, Z 17 DTJ	01.2008→04.2015	 7.03085.02.0	DW-TL	EP	
		7.02461.01.0	EUV-LS	EL	
1.7 CDTI (M75) 92 kW (125 PS) A 17 DTR	01.2008→04.2015	 7.03085.02.0	DW-TL	EP	
		7.02461.01.0	EUV-LS	EL	
1.8 (M75) 101-103 kW (137-140 PS) A 18 XER	07.2005→04.2015	 7.06117.08.0	SV-NWV	EH	mit Dichtring with O-ring
		7.02256.43.0	EUV-SR	EL	
1.8 (M75) 101-103 kW (137-140 PS) Z 18 XER	07.2005→04.2015	 7.06117.08.0	SV-NWV	EH	mit Dichtring with O-ring
		7.02256.43.0	EUV-SR	EL	
1.8 (M75) 85-88 kW (116-120 PS) A 18 XEL	06.2013→04.2015	 7.06117.08.0	SV-NWV	EH	mit Dichtring with O-ring

ZAFIRA / ZAFIRA FAMILY B (A05)
80

1.8 LPG (M75) 101-103 kW (137-140 PS) Z 18 XER	07.2009→04.2015		7.02256.43.0	EUV-SR	EL	
			7.06117.08.0	SV-NWV	EH	mit Dichtring with O-ring
1.9 CDTI (M75) 110 kW (150 PS) Z 19 DTH	07.2005→04.2015		7.01420.02.0	DW-TL	EP	
1.9 CDTI (M75) 74 kW (101 PS) Z 19 DTL	07.2005→12.2010		7.01420.02.0	DW-TL	EP	
1.9 CDTI (M75) 88 kW (120 PS) Z 19 DT	07.2005→04.2015		7.01420.02.0	DW-TL	EP	
2.0 (M75) 147 kW (200 PS) Z 20 LER	07.2005→12.2010		7.01024.02.0	LDRV	EL	
			7.01039.03.0	LDRV	EL	
2.0 (M75) 177 kW (240 PS) Z 20 LEH	01.2006→12.2010		7.01024.02.0	LDRV	EL	
			7.01039.03.0	LDRV	EL	

ZAFIRA A MPV (T98)
81



















1.6 16V (F75) 74 kW (101 PS) X 16 XEL	04.1999→09.2000		7.05432.11.0	SM	EL	mit Dichtring with O-ring
2.0 DTI 16V (F75) 74 kW (101 PS) Y 20 DTH	09.2000→06.2005		7.22138.50.0	EUV-AGR	EL	Fahrgestellnummer ab: 32000001, 3H000001, 4G000001 Vehicle Identification Number from: 32000001, 3H000001, 4G000001
			7.01039.03.0	EUV-SR	EL	
2.0 OPC (F75) 140-162 kW (190-220 PS) Z 20 LET	09.2001→06.2005		7.01024.02.0	LDRV	EL	
			7.01039.03.0	EUV-SR	EL	
2.0 OPC (F75) 140-162 kW (190-220 PS) Z 20 LET	11.2002→06.2005		7.01039.03.0	EUV-SR	EL	
			7.01024.02.0	LDRV	EL	
2.2 DTI 16V (F75) 86-92 kW (117-125 PS) Y 22 DTR	01.2002→06.2005		7.22138.50.0	EUV-AGR	EL	Fahrgestellnummer ab: 32000001, 35, 36, 38, 3H000001, 4G000001 Vehicle Identification Number from: 32000001, 35, 36, 38, 3H000001, 4G000001
			7.22138.50.0	EUV-AGR	EL	Fahrgestellnummer ab: 32000001, 35, 36, 38, 3H000001, 4G000001 Vehicle Identification Number from: 32000001, 35, 36, 38, 3H000001, 4G000001

ZAFIRA TOURER C (P12)
82

























1.4 (75) 88 kW (120 PS) A 14 NEL, B 14 NEL	10.2011→		7.03833.02.0	EUV-VB	EL	
			7.06117.07.0	ZM-NWV	EL	mit Dichtring with O-ring
1.4 (75) 103-110 kW (140-150 PS) A 14 NET, B 14 NET	10.2011→		7.03833.02.0	EUV-VB	EL	
			7.06117.07.0	ZM-NWV	EL	mit Dichtring with O-ring
1.4 LPG (75) 103-110 kW (140-150 PS) A 14 NET, B 14 NET	10.2011→		7.03833.02.0	EUV-VB	EL	
			7.06117.07.0	ZM-NWV	EL	mit Dichtring with O-ring
1.6 (75) 125 kW (170 PS) A 16 XHT	12.2012→		7.03351.12.0	LDRV	EP	





































ZAFIRA TOURER C (P12) **82**

























1.6 CDTI (75) 81-100 kW (110-136 PS) B 16 DTH	02.2013→		7.08681.01.0	EOV	EH	 17 A3162915GW5X0583→
			7.02256.44.0	EUV-AGR	EL	
1.6 CDTI (75) 88 kW (120 PS) B 16 DTJ	07.2014→		7.08681.01.0	EOV	EH	 17 A3162915GW5X0583→
			7.02256.44.0	EUV-AGR	EL	
1.6 CDTI (75) 81-100 kW (110-136 PS) B 16 DTH	11.2016→		7.08681.01.0	EOV	EH	 17 A3162915GW5X0583→
			7.02256.44.0	EUV-AGR	EL	
1.6 CDTI (75) 99-100 kW (135-136 PS) D 16 DTH	05.2018→		7.02256.44.0	EUV-AGR	EL	
1.6 CNG (75) 110 kW (150 PS) A 16 XNT, B 16 XNT	10.2011→		7.01039.03.0	EUV-VB	EL	
			7.03833.02.0	EUV-VB	EL	
			7.03833.02.0	LDRV	EL	
1.6 SIDI (75) 147 kW (200 PS) A 16 SHT	07.2013→		7.03351.12.0	LDRV	EP	
1.8 (75) 101-103 kW (137-140 PS) A 18 XER	10.2011→		7.02256.43.0	EUV-SR	EL	
			7.06117.08.0	SV-NWV	EH	mit Dichtring with O-ring
1.8 (75) 85-88 kW (116-120 PS) A 18 XEL	10.2011→		7.02256.43.0	EUV-SR	EL	
			7.06117.08.0	SV-NWV	EH	mit Dichtring with O-ring
2.0 BiTurbo CDTI (75) 140-143 kW (190-195 PS) A 20 DTR	01.2013→		7.03978.01.0	DW-TL	EP	für OE-Nummer: 55573362, 55575611, 8 51 017, 8 51 042 for OE number: 55573362, 55575611, 8 51 017, 8 51 042
			7.03856.02.0* ↳ 7.03073.01.0	STE DW-TL	EP EP	
2.0 CDTi (75) 96-121 kW (131-165 PS) A 20 DTH	10.2011→		7.03855.00.0*	STE	EP	Fahrgestellnummer bis: C2 Vehicle Identification Number to: C2
			↳ 7.03073.01.0	DW-TL	EP	
			7.03855.02.0*	STE	EP	Fahrgestellnummer ab: C2, F1000001 Vehicle Identification Number from: C2, F1000001
			↳ 7.03073.01.0	DW-TL	EP	
2.0 CDTi (75) 96 kW (131 PS) A 20 DT, Y 20 DTJ, Z 20 DTJ	10.2011→		7.03855.00.0*	STE	EP	 A 20 DT, Y 20 DTJ, Z 20 DTJ: Fahrgestellnummer bis: C2 Vehicle Identification Number to: C2
			↳ 7.03073.01.0	DW-TL	EP	
			7.03855.02.0*	STE	EP	 A 20 DT, Y 20 DTJ, Z 20 DTJ: Fahrgestellnummer ab: C2, F1000001 Vehicle Identification Number from: C2, F1000001
			↳ 7.03073.01.0	DW-TL	EP	
2.0 CDTi (75) 81 kW (110 PS) A 20 DTL	10.2011→		7.03855.00.0*	STE	EP	Fahrgestellnummer bis: C2 Vehicle Identification Number to: C2
			↳ 7.03073.01.0	DW-TL	EP	
			7.03855.02.0*	STE	EP	Fahrgestellnummer ab: C2, F1000001 Vehicle Identification Number from: C2, F1000001
			↳ 7.03073.01.0	DW-TL	EP	
2.0 CDTi (75) 125 kW (170 PS) B 20 DTH	01.2015→		7.08681.02.0	EOV	EH	
			7.02256.44.0	EUV-AGR	EL	























O

						
ZAFIRA TOURER C (P12)						82
2.0 CDTi (75) 96 kW (131 PS) B 20 DTJ, D 20 DTJ	06.2016→		7.02256.44.0	EUV-AGR	EL	
2.0 CDTi (75) 125 kW (170 PS) D 20 DTH	05.2018→		7.02256.44.0	EUV-AGR	EL	
ARENA Combi (A97)						83
1.9 D 44 kW (60 PS) F8Q 600, F8Q 606	03.1998→08.2001		7.02256.19.0	EUV-LS	EL	
2.5 D 55-58 kW (75-79 PS) S8U 758, S8U 780, S8U 782	03.1998→08.2001		7.02256.19.0	EUV-AGR	EL	
ARENA Van (TB, TF)						84
1.9 D 44 kW (60 PS) F8Q 600, F8Q 606	03.1998→08.2001		7.02256.19.0	EUV-LS	EL	
2.5 D 55-58 kW (75-79 PS) S8U 758, S8U 780, S8U 782	03.1998→08.2001		7.02256.19.0	EUV-AGR	EL	
ASTRA F Estate Van (T92)						85
1.4 i (F70) 40-44 kW (54-60 PS) C 14 NZ	10.1991→01.1999		7.05432.01.0	SM	EL mit Dichtring with O-ring	
1.6 i (F70) 55-60 kW (75-82 PS) C 16 NZ	10.1991→04.1993		7.05432.00.0	SM	EL mit Dichtring with O-ring	
1.6 i (F70) 52 kW (71 PS) X 16 SZ	02.1993→07.1996		7.05432.00.0	SM	EL mit Dichtring with O-ring	
1.6 i 16V (F70) 74 kW (101 PS) X 16 XEL	08.1994→03.1998		7.05432.11.0	SM	EL mit Dichtring with O-ring	
1.8 i (F70) 66 kW (90 PS) C 18 NZ	06.1993→08.1994		7.05432.00.0	SM	EL mit Dichtring with O-ring	
ASTRA G Estate Van (F70)						86
1.6 (F70) 55 kW (75 PS) X 16 SZR	01.1999→09.2000		7.02256.38.0	AKF	EL für OE-Nummer: 13105950, 58 07 468 for OE number: 13105950, 58 07 468	
			7.05432.00.0	SM	EL mit Dichtring with O-ring	
1.6 (F70) 74-77 kW (101-105 PS) Z 16 XEP	02.2004→11.2004		7.02256.31.0	SV-PDA	EP	
1.7 CDTi (F70) 59 kW (80 PS) Z 17 DTL	07.2003→11.2004		7.03088.01.0	DW-TL	EP	
			7.02461.01.0	EUV-AGR	EL	
1.7 DTI 16V (F70) 55 kW (75 PS) Y 17 DT	02.2000→04.2005		7.03085.02.0	DW-AGR	EP	
			7.03088.01.0	DW-TL	EP	
ASTRA H Estate Van (L70)						87
1.3 CDTi (L70) 66-74 kW (90-101 PS) Z 13 DTH	08.2005→10.2010		7.01420.02.0	DW-TL	EP Fahrgestellnummer bis: 9B999999, A2, A5, A8, AG Vehicle Identification Number to: 9B999999, A2, A5, A8, AG	
			7.04423.01.0	DW-TL	EP Fahrgestellnummer ab: B2, B5, B8, BG Vehicle Identification Number from: B2, B5, B8, BG	
1.4 EcoTec (L70) 66 kW (90 PS) Z 14 XEP	12.2004→12.2012		7.02256.28.0	SV-PDA	EP	
1.6 EcoTec (L70) 74-77 kW (101-105 PS) Z 16 XEP	02.2004→11.2004		7.02256.38.0	AKF	EL	
			7.02256.31.0	SV-PDA	EP Fahrgestellnummer bis: 72999999, 75999999, 78999999, 7G Vehicle Identification Number to: 72999999, 75999999, 78999999, 7G	
1.7 CDTi (L70) 74 kW (100 PS) Z 17 DTH	03.2004→10.2010		7.03088.01.0	DW-TL	EP	
			7.02461.01.0	EUV-LS	EL	

					
ASTRA H Estate Van (L70) 87					
1.7 CDTi (L70) 59 kW (80 PS) Z 17 DTL	12.2004→07.2007		7.03088.01.0	DW-TL	EP
			7.02461.01.0	EUV-LS	EL
1.7 CDTi (L70) 81 kW (110 PS) A 17 DTJ, Z 17 DTJ	02.2007→10.2010		7.03085.02.0	DW-TL	EP
			7.02461.01.0	EUV-LS	EL
1.7 CDTi (L70) 92 kW (125 PS) A 17 DTR, Z 17 DTR	02.2007→10.2010		7.03085.02.0	DW-TL	EP
			7.02461.01.0	EUV-LS	EL
1.9 CDTi (L70) 110 kW (150 PS) Z 19 DTH	09.2004→10.2010		7.01420.02.0	DW-TL	EP
1.9 CDTi (L70) 74 kW (101 PS) Z 19 DTL	08.2005→12.2012		7.01420.02.0	DW-TL	EP
1.9 CDTi (L70) 88 kW (120 PS) Z 19 DT	09.2005→10.2010		7.01420.02.0	DW-TL	EP
1.9 CDTi 16V (L70) 88 kW (120 PS) Z 19 DTJ	08.2004→10.2010		7.01420.02.0	DW-TL	EP
ASTRA J Estate Van (P10) 88					
1.3 CDTi (35) 70 kW (95 PS) A 13 DTE	10.2012→10.2015		7.03073.01.0	DW-TL	EP
			7.01981.07.0	SV-AGR-K	EP Fahrgestellnummer bis: B3999999, B8999999, BG999999 Vehicle Identification Number to: B3999999, B8999999, BG999999
1.7 CDTi (35) 96 kW (131 PS) A 17 DTF, A 17 DTS	10.2012→10.2015		7.03073.01.0	DW-TL	EP
			7.02461.01.0	EUV-LS	EL
ASTRA J Hatchback Van (P10) 89					
1.3 CDTi (68) 70 kW (95 PS) A 13 DTE	05.2013→10.2015		7.03073.01.0	DW-TL	EP
			7.01981.07.0	SV-AGR-K	EP Fahrgestellnummer bis: B3999999, B8999999, BG999999 Vehicle Identification Number to: B3999999, B8999999, BG999999
1.7 CDTi (68) 81 kW (110 PS) A 17 DTC, A 17 DTE	05.2013→10.2015		7.03073.01.0	DW-TL	EP
			7.02461.01.0	EUV-LS	EL
ASTRA K Estate Van 90					
1.0 (35) 66-77 kW (90-105 PS) D 10 XFL	05.2018→		7.03351.12.0	LDRV	EP
COMBO Box Body/MPV 91					
1.3 CDTi 16V 55 kW (75 PS) Z 13 DTJ	10.2005→12.2012		7.01421.01.0	DW-TL	EP
1.4 16V 66 kW (90 PS) Z 14 XEP	08.2005→		7.02256.28.0	SV-PDA	EP
1.6 62-69 kW (84-94 PS) Z 16 SE	10.2001→		7.02256.22.0	AKF	EL
1.6 CNG 16V 69-74 kW (94-101 PS) Z 16 YNG	04.2005→		7.02256.22.0	AKF	EL
1.6 CNG 16V 69-74 kW (94-101 PS) Z 16 YNG	06.2006→		7.02256.22.0	AKF	EL
1.7 CDTi 16V 74 kW (100 PS) Z 17 DTH	12.2004→		7.02461.01.0	EUV-AGR	EL











						
COMBO Box Body/MPV (71_)						92
1.2 33 kW (45 PS) C 12 NZ, X 12 SZ	07.1994→10.2001		7.05432.01.0	SM	EL	mit Dichtring with O-ring
1.4 40-44 kW (54-60 PS) C 14 NZ	07.1994→10.1996		7.05432.00.0	SM	EL	mit Dichtring with O-ring für Fahrzeuge mit Automatikgetriebe for vehicles with automatic transmission
			7.05432.01.0	SM	EL	mit Dichtring with O-ring für Fahrzeuge mit Schaltgetriebe for vehicles with manual transmission
1.4 40-44 kW (54-60 PS) X 14 SZ	10.1996→10.2001		7.05432.00.0	SM	EL	mit Dichtring with O-ring
COMBO Box Body/MPV (X12)						93
1.3 CDTI (B05) 55-70 kW (75-95 PS) A 13 FD	02.2012→		7.01981.07.0	SV-AGR-K	EP	
1.4 (B05) 88 kW (120 PS) A 14 FC	02.2012→		7.01835.06.0	SUV	EL	
1.4 CNG (B05) 88 kW (120 PS) A 14 FC	02.2012→		7.01835.06.0	SUV	EL	
1.6 CDTI (B05) 66-88 kW (90-120 PS) A 16 FDL	02.2012→		7.08681.03.0	SV-HYAT	EH	für OE-Nummer: 7 48 068, 95512349 for OE number: 7 48 068, 95512349
			7.08681.04.0	SV-HYAT	EH	
			7.08681.05.0	SV-HYAT	EH	für OE-Nummer: 7 84 065, 95512347 for OE number: 7 84 065, 95512347
			7.08681.06.0	SV-HYAT	EH	
COMBO Box Body/MPV (X19)						94
1.2 81 kW (110 PS) D 12 XHL (EB2ADT)	02.2019→		7.08681.09.0	EOV	EH	
1.2 96 kW (131 PS) F 12 XHT (EB2ADTS)	09.2019→		7.08681.09.0	EOV	EH	
1.5 D 56 kW (76 PS) D 15 DTL (DV5RE)	08.2018→		7.08681.00.0	EOV	EH	
1.5 D 75 kW (102 PS) D 15 DT (DV5RD)	08.2018→		7.08681.00.0	EOV	EH	
1.5 D 88-96 kW (120-131 PS) D 15 DTH (DV5RC)	08.2018→		7.08681.00.0	EOV	EH	
CORSA A Hatchback Van (S83)						95
1.2 (F08, W5L) 33 kW (45 PS) C 12 NZ	08.1990→07.1994		7.05432.01.0	SM	EL	mit Dichtring with O-ring
CORSA B Hatchback Van (S93)						96
1.2 (F08, W5L) 33 kW (45 PS) C 12 NZ	08.1994→12.2001		7.05432.01.0	SM	EL	mit Dichtring with O-ring
1.4 i (F08, W5L) 40-44 kW (54-60 PS) C 14 NZ	08.1999→09.2000		7.05432.00.0	SM	EL	mit Dichtring with O-ring für Fahrzeuge mit Automatikgetriebe for vehicles with automatic transmission
			7.05432.01.0	SM	EL	mit Dichtring with O-ring für Fahrzeuge mit Schaltgetriebe for vehicles with manual transmission
1.4 i (F08, W5L) 40-44 kW (54-60 PS) X 14 SZ	08.1999→09.2000		7.05432.00.0	SM	EL	mit Dichtring with O-ring
1.7 D (F08, W5L) 42-44 kW (57-60 PS) X 17 D (4EE1)	08.1999→09.2000		7.22138.50.0	EUV-AGR	EL	

						
CORSA C Hatchback Van (X01)						97
1.2 (F08, W5L) 55-59 kW (75-80 PS) Z 12 XEP	07.2005→06.2006		7.02256.28.0	SV-PDA	EP	
1.4 (W5L, F08) 66 kW (90 PS) Z 14 XEP	08.2003→06.2012		7.02256.28.0	SV-PDA	EP	
1.7 CDTi (F08, W5L) 74 kW (100 PS) Z 17 DTH	08.2003→12.2012		7.03088.01.0	DW-TL	EP	
			7.02461.01.0	EUV-AGR	EL	
1.7 DI 16V (F08, W5L) 48 kW (65 PS) Y 17 DTL	09.2000→07.2003		7.03085.02.0	DW-AGR	EP	
			7.03088.01.0	DW-TL	EP	
1.7 DTI 16V (F08, W5L) 55 kW (75 PS) Y 17 DT	09.2000→07.2003		7.03085.02.0	DW-AGR	EP	
			7.03088.01.0	DW-TL	EP	
CORSA D Hatchback Van (S07)						98
1.2 (L08) 55-59 kW (75-80 PS) Z 12 XEP	08.2006→08.2014		7.02256.28.0	SV-PDA	EP	
1.2 (L08) 51 kW (69 PS) A 12 XEL	01.2010→08.2014		7.06117.07.0	ZM-NWV	EL	mit Dichtring with O-ring
1.2 (L08) 61-63 kW (83-86 PS) A 12 XER	06.2010→08.2014		7.06117.07.0	ZM-NWV	EL	mit Dichtring with O-ring
1.3 CDTi (L08) 55 kW (75 PS) A 13 DTC	07.2006→08.2014		7.03653.01.0	DW-TL	EP	
			7.01981.07.0	SV-AGR-K	EP	
1.3 CDTi (L08) 55 kW (75 PS) Z 13 DTJ	07.2006→08.2014		7.01420.02.0	DW-TL	EP	für Fahrzeuge mit Diesel-Partikel-Filter (DPF) for vehicles with diesel soot filter
1.3 CDTi (L08) 66-74 kW (90-101 PS) Z 13 DTH	07.2006→06.2010		7.01420.02.0	DW-TL	EP	
1.3 CDTi (L08) 70 kW (95 PS) A 13 DTE, A 13 DTR, Z 13 DTE	11.2009→08.2014		7.03653.01.0	DW-TL	EP	
			7.01981.07.0	SV-AGR-K	EP	
1.4 (L08) 74 kW (101 PS) A 14 XER	07.2012→08.2014		7.06117.07.0	ZM-NWV	EL	mit Dichtring with O-ring
1.4 (L08) 88 kW (120 PS) A 14 NEL	07.2012→08.2014		7.03833.02.0	EUV-VB	EL	
			7.06117.07.0	ZM-NWV	EL	mit Dichtring with O-ring
1.6 (L08) 141 kW (192 PS) Z 16 LER	07.2012→08.2014		7.01039.03.0	EUV-VB	EL	
			7.03833.02.0	EUV-VB	EL	
			7.03833.02.0	LDRV	EL	
1.7 CDTi (L08) 96 kW (131 PS) A 17 DTS	07.2012→08.2014		7.03073.01.0	DW-TL	EP	
			7.03085.02.0	DW-TL	EP	
CORSA E Hatchback Van (X15)						99
1.2 (08) 51 kW (69 PS) B 12 XEL	01.2015→		7.06117.07.0	ZM-NWV	EL	mit Dichtring with O-ring
1.4 (08) 55 kW (75 PS) B 14 XEJ	09.2014→		7.06117.07.0	ZM-NWV	EL	mit Dichtring with O-ring
1.4 (08) 64-66 kW (87-90 PS) B 14 XEL	09.2014→		7.06117.07.0	ZM-NWV	EL	mit Dichtring with O-ring









						
KADETT E Combo (T85)						100
1.4 i (C25, D25) 40-44 kW (54-60 PS) C 14 NZ	08.1991→07.1994		7.05432.01.0	SM	EL	mit Dichtring with O-ring
1.6 i (C25, D25) 55-60 kW (75-82 PS) C 16 NZ	08.1991→07.1994		7.05432.00.0	SM	EL	mit Dichtring with O-ring
KADETT E Estate Van (T85)						101
1.4 i (C70, D70) 40-44 kW (54-60 PS) C 14 NZ	01.1990→08.1991		7.05432.01.0	SM	EL	mit Dichtring with O-ring
1.6 i (C70, D70) 55-60 kW (75-82 PS) C 16 NZ	08.1989→09.1993		7.05432.00.0	SM	EL	mit Dichtring with O-ring
MERIVA B VAN (S10)						102
1.3 CDTi (75) 70 kW (95 PS) A 13 DTE	01.2013→11.2014		7.01981.07.0	SV-AGR-K	EP	Fahrgestellnummer ab: D4000001 Vehicle Identification Number from: D4000001 Fahrgestellnummer bis: B4999999 Vehicle Identification Number to: B4999999
1.4 ECOTEC (75) 74 kW (101 PS) A 14 XER	01.2013→03.2017		7.06117.07.0	ZM-NWV	EL	mit Dichtring with O-ring
MOVANO B Bus (X62)						103
2.3 CDTi FWD (JV) 74-92 kW (101-125 PS) M9T 670, M9T 676	12.2010→		7.02256.19.0	EUV-AGR	EL	
2.3 CDTi FWD (JV) 92-107 kW (125-146 PS) M9T 678, M9T 680	12.2010→		7.02256.19.0	EUV-AGR	EL	
2.3 CDTi FWD (JV) 100-132 kW (136-179 PS) M9T 716	01.2013→		7.01814.12.0	DW-TL	EP	
2.3 CDTi FWD (JV) 100-132 kW (136-179 PS) M9T 702, M9T 716	05.2014→		7.01814.12.0	DW-TL	EP	
2.3 CDTi FWD (JV) 100-120 kW (136-163 PS) M9T 702	05.2014→		7.01814.12.0	DW-TL	EP	
2.3 CDTi FWD (JV) 107-125 kW (145-170 PS) M9T 706	07.2015→		7.01814.12.0	DW-TL	EP	
2.3 CDTi FWD (JV) 100-132 kW (136-179 PS) M9T 716	08.2019→		7.01814.12.0	DW-TL	EP	
MOVANO B Platform/Chassis (X62)						104
2.3 CDTi FWD (EV, HV, UV) 74-92 kW (101-125 PS) M9T 670, M9T 676	05.2010→		7.02256.19.0	EUV-AGR	EL	
2.3 CDTi FWD (EV, HV, UV) 92-107 kW (125-146 PS) M9T 678, M9T 680	05.2010→		7.02256.19.0	EUV-AGR	EL	
2.3 CDTi FWD (EV, HV, UV) 100-132 kW (136-179 PS) M9T 716	01.2013→		7.01814.12.0	DW-TL	EP	
2.3 CDTi FWD (EV, HV, UV) 100-132 kW (136-179 PS) M9T 702, M9T 716	05.2014→		7.01814.12.0	DW-TL	EP	

























MOVANO B Platform/Chassis (X62) 104

2.3 CDTI FWD (EV, HV, UV) 100-120 kW (136-163 PS) M9T 702	05.2014→		7.01814.12.0	DW-TL	EP
2.3 CDTI FWD (EV, HV, UV) 107-125 kW (145-170 PS) M9T 706	11.2016→		7.01814.12.0	DW-TL	EP
2.3 CDTI FWD (EV, HV, UV) 96 kW (131 PS) M9T 704	11.2016→		7.01814.12.0	DW-TL	EP
2.3 CDTI FWD (EV, HV, UV) 100-132 kW (136-179 PS) M9T 716	08.2019→		7.01814.12.0	DW-TL	EP
2.3 CDTI RWD (EV, HV, UV) 74-92 kW (101-125 PS) M9T 690, M9T 692	05.2010→		7.02256.19.0	EUV-AGR	EL
2.3 CDTI RWD (EV, HV, UV) 74-92 kW (101-125 PS) M9T 692	05.2010→		7.02256.19.0	EUV-AGR	EL
2.3 CDTI RWD (EV, HV, UV) 92-110 kW (125-150 PS) M9T 694, M9T 696, M9T 698	05.2010→		7.02256.19.0	EUV-AGR	EL
2.3 CDTI RWD (EV, HV, UV) 92-110 kW (125-150 PS) M9T 694, M9T 696, M9T 698	01.2013→		7.02256.19.0	EUV-AGR	EL
2.3 CDTI RWD (EV, HV, UV) 100-120 kW (136-163 PS) M9T 700	05.2014→		7.01814.12.0	DW-TL	EP
2.3 CDTI RWD (EV, HV, UV) 100-120 kW (136-163 PS) M9T 700	05.2014→		7.01814.12.0	DW-TL	EP
2.3 CDTI RWD (EV, HV, UV) 96-120 kW (131-163 PS) M9T 710	11.2016→		7.01814.12.0	DW-TL	EP



MOVANO B Van (X62) 105

2.3 CDTI FWD (FV) 74-92 kW (101-125 PS) M9T 670, M9T 676	05.2010→		7.02256.19.0	EUV-AGR	EL
2.3 CDTI FWD (FV) 92-107 kW (125-146 PS) M9T 678, M9T 680	05.2010→		7.02256.19.0	EUV-AGR	EL
2.3 CDTI FWD (FV) 100-132 kW (136-179 PS) M9T 716	01.2013→		7.01814.12.0	DW-TL	EP
2.3 CDTI FWD (FV) 100-132 kW (136-179 PS) M9T 702, M9T 716	05.2014→		7.01814.12.0	DW-TL	EP
2.3 CDTI FWD (FV) 100-120 kW (136-163 PS) M9T 702	05.2014→		7.01814.12.0	DW-TL	EP
2.3 CDTI FWD (FV) 107-125 kW (145-170 PS) M9T 706	11.2016→		7.01814.12.0	DW-TL	EP
2.3 CDTI FWD (FV) 96 kW (131 PS) M9T 704	11.2016→		7.01814.12.0	DW-TL	EP
2.3 CDTI FWD (FV) 100-132 kW (136-179 PS) M9T 716	08.2019→		7.01814.12.0	DW-TL	EP







						
MOVANO B Van (X62)						105
2.3 CDTI RWD (FV) 74-92 kW (101-125 PS) M9T 690, M9T 692	05.2010→		7.02256.19.0	EUV-AGR	EL	
2.3 CDTI RWD (FV) 74-92 kW (101-125 PS) M9T 690	05.2010→		7.02256.19.0	EUV-AGR	EL	
2.3 CDTI RWD (FV) 92-110 kW (125-150 PS) M9T 694, M9T 696, M9T 698	05.2010→		7.02256.19.0	EUV-AGR	EL	
2.3 CDTI RWD (FV) 92-110 kW (125-150 PS) M9T 694, M9T 696, M9T 698	01.2013→		7.02256.19.0	EUV-AGR	EL	
2.3 CDTI RWD (FV) 100-120 kW (136-163 PS) M9T 700	05.2014→		7.01814.12.0	DW-TL	EP	
2.3 CDTI RWD (FV) 100-120 kW (136-163 PS) M9T 700	05.2014→		7.01814.12.0	DW-TL	EP	
2.3 CDTI RWD (FV) 96-120 kW (131-163 PS) M9T 710	11.2016→		7.01814.12.0	DW-TL	EP	
MOVANO Bus (X70)						106
1.9 DTI (JD) 59 kW (80 PS) F9Q 770	09.2000→10.2001		7.02256.04.0	DW-AGR	EP	für Fahrzeuge ohne Klimaanlage for vehicles without air conditioning
1.9 DTI (JD) 60 kW (82 PS) F9Q 772	10.2001→		7.02256.04.0	DW-TL	EP	für Fahrzeuge ohne Klimaanlage for vehicles without air conditioning
2.5 CDTI (JD) 74-107 kW (101-146 PS) G9U 632, G9U 650	08.2006→		7.01152.02.0	DW-TL	EP	
			7.04779.00.0	DW-TL	EP	
			7.02256.19.0	EUV-AGR	EL	
2.5 CDTI (JD) 74-107 kW (101-146 PS) G9U 632, G9U 650	08.2006→		7.01152.02.0	DW-TL	EP	
			7.04779.00.0	DW-TL	EP	
			7.02256.19.0	EUV-AGR	EL	
2.5 CDTI (JD) 74-107 kW (101-146 PS) G9U 650	09.2007→		7.01152.02.0	DW-TL	EP	
			7.04779.00.0	DW-TL	EP	
			7.02256.19.0	EUV-AGR	EL	
2.5 D (JD) 59 kW (80 PS) S8U 772	07.1998→09.2000		7.02256.19.0	EUV-AGR	EL	
2.8 DTI (JD) 84 kW (114 PS) S9W 700, S9W 702	07.1998→10.2001		7.02256.19.0	EUV-LS	EL	
MOVANO Platform/Chassis (X70)						107
2.5 CDTI (ED, HD, UD0, UD4) 74-107 kW (101-146 PS) G9U 632, G9U 650	08.2006→		7.01152.02.0	DW-TL	EP	
			7.04779.00.0	DW-TL	EP	
			7.02256.19.0	EUV-AGR	EL	
2.5 CDTI (ED, HD, UD0, UD4) 74-107 kW (101-146 PS) G9U 632, G9U 650	08.2006→		7.01152.02.0	DW-TL	EP	
			7.04779.00.0	DW-TL	EP	
			7.02256.19.0	EUV-AGR	EL	









MOVANO Platform/Chassis (X70) 107























2.5 CDTI (ED, HD, UD0, UD4) 74-107 kW (101-146 PS) G9U 650	08.2006→		7.01152.02.0	DW-TL	EP	
			7.04779.00.0	DW-TL	EP	
			7.02256.19.0	EUV-AGR	EL	
2.5 D (ED, HD, UD0, UD4) 59 kW (80 PS) S8U 772	07.1998→09.2000		7.02256.19.0	EUV-AGR	EL	
2.8 DTI (ED, HD, UD0, UD4) 84 kW (114 PS) S9W 700, S9W 702	07.1998→10.2001		7.02256.19.0	EUV-LS	EL	

MOVANO Van (X70) 108

1.9 DTI (FD) 59 kW (80 PS) F9Q 770	09.2000→10.2001		7.02256.04.0	DW-AGR	EP	für Fahrzeuge ohne Klimaanlage for vehicles without air conditioning
1.9 DTI (FD) 60 kW (82 PS) F9Q 772	10.2001→		7.02256.04.0	DW-TL	EP	für Fahrzeuge ohne Klimaanlage for vehicles without air conditioning
2.5 CDTI (FD) 74-107 kW (101-146 PS) G9U 632, G9U 650	10.2003→		7.01152.02.0	DW-TL	EP	
			7.04779.00.0	DW-TL	EP	
			7.02256.19.0	EUV-AGR	EL	
2.5 CDTI (FD) 74-107 kW (101-146 PS) G9U 632, G9U 650	10.2003→		7.01152.02.0	DW-TL	EP	
			7.04779.00.0	DW-TL	EP	
			7.02256.19.0	EUV-AGR	EL	
2.5 CDTI (FD) 74-107 kW (101-146 PS) G9U 650	10.2003→		7.01152.02.0	DW-TL	EP	
			7.04779.00.0	DW-TL	EP	
			7.02256.19.0	EUV-AGR	EL	
2.5 D (FD) 59 kW (80 PS) S8U 772	01.1999→09.2000		7.02256.19.0	EUV-AGR	EL	
2.8 DTI (FD) 84 kW (114 PS) S9W 700, S9W 702	01.1999→10.2001		7.02256.19.0	EUV-LS	EL	

VIVARO A Bus (X83) 109

1.9 DI (F7, J7, A07) 59-60 kW (80-82 PS) F9Q 762	08.2001→		7.02256.04.0	DW-TL	EP	
1.9 DTI (F7, J7, A07) 74 kW (101 PS) F9Q 760	08.2001→		7.02256.04.0	DW-TL	EP	
2.0 CDTI (F7, J7, A07) 66-84 kW (90-114 PS) M9R 780, M9R 782	08.2006→		7.02256.04.0	DW-AGR	EP	
			7.02256.04.0	DW-TL	EP	
			7.02256.19.0	EUV-AGR	EL	
2.0 CDTI (F7, J7, A07) 66-84 kW (90-114 PS) M9R 786	08.2006→		7.02256.19.0	EUV-AGR	EL	
2.0 CDTI (F7, J7, A07) 66-84 kW (90-114 PS) M9R 780, M9R 784	08.2006→		7.02256.04.0	DW-AGR	EP	
			7.02256.04.0	DW-TL	EP	
			7.02256.19.0	EUV-AGR	EL	
2.0 CDTI (F7, J7, A07) 66-84 kW (90-114 PS) M9R 786, M9R 788	08.2006→		7.02256.19.0	EUV-AGR	EL	







						
VIVARO A Bus (X83)						109
2.5 CDTI (F7, J7, A07) 84-107 kW (114-146 PS) G9U 630	08.2006→		7.01152.02.0	DW-TL	EP	
			7.04779.00.0	DW-TL	EP	
			7.02256.19.0	EUV-AGR	EL	
2.5 CDTI (F7, J7, A07) 84-107 kW (114-146 PS) G9U 630	08.2006→		7.01152.02.0	DW-TL	EP	
			7.04779.00.0	DW-TL	EP	
			7.02256.19.0	EUV-AGR	EL	
2.5 DTI (F7, J7, A07) 99 kW (135 PS) G9U 730	05.2003→		7.02256.04.0	DW-TL	EP	
VIVARO A Platform/Chassis (X83)						110
1.9 DTI 74 kW (101 PS) F9Q 760	08.2006→		7.02256.04.0	DW-TL	EP	
1.9 Di 59-60 kW (80-82 PS) F9Q 762	08.2001→		7.02256.04.0	DW-TL	EP	
2.0 CDTI 66-84 kW (90-114 PS) M9R 780, M9R 782	01.2006→		7.02256.04.0	DW-AGR	EP	
			7.02256.04.0	DW-TL	EP	
			7.02256.19.0	EUV-AGR	EL	
2.0 CDTI 66-84 kW (90-114 PS) M9R 786	01.2006→		7.02256.19.0	EUV-AGR	EL	
2.0 CDTI 66-84 kW (90-114 PS) M9R 780	08.2006→		7.02256.04.0	DW-AGR	EP	
			7.02256.04.0	DW-TL	EP	
			7.02256.19.0	EUV-AGR	EL	
2.5 CDTI 84-107 kW (114-146 PS) G9U 630	08.2006→		7.01152.02.0	DW-TL	EP	
			7.04779.00.0	DW-TL	EP	
			7.02256.19.0	EUV-AGR	EL	
2.5 CDTI 84-107 kW (114-146 PS) G9U 630	08.2006→		7.01152.02.0	DW-TL	EP	
			7.04779.00.0	DW-TL	EP	
			7.02256.19.0	EUV-AGR	EL	
2.5 DTi 99 kW (135 PS) G9U 730	08.2003→		7.02256.04.0	DW-TL	EP	
VIVARO A Van (X83)						111
1.9 DI (F7) 59-60 kW (80-82 PS) F9Q 762	08.2001→		7.02256.04.0	DW-TL	EP	
1.9 DTI (F7) 74 kW (101 PS) F9Q 760	08.2001→		7.02256.04.0	DW-TL	EP	
2.0 CDTI (F7) 66-84 kW (90-114 PS) M9R 780, M9R 782	08.2006→		7.02256.04.0	DW-AGR	EP	
			7.02256.04.0	DW-TL	EP	
			7.02256.19.0	EUV-AGR	EL	
2.0 CDTI (F7) 66-84 kW (90-114 PS) M9R 786	08.2006→		7.02256.19.0	EUV-AGR	EL	
2.0 CDTI (F7) 66-84 kW (90-114 PS) M9R 780, M9R 784	08.2006→		7.02256.04.0	DW-AGR	EP	
			7.02256.04.0	DW-TL	EP	
			7.02256.19.0	EUV-AGR	EL	





VIVARO A Van (X83) **111**

2.0 CDTI (F7) 66-84 kW (90-114 PS) M9R 786, M9R 788	08.2006→		7.02256.19.0	EUV-AGR	EL	
2.5 CDTI (F7) 84-107 kW (114-146 PS) G9U 630	08.2006→		7.01152.02.0	DW-TL	EP	
			7.04779.00.0	DW-TL	EP	
			7.02256.19.0	EUV-AGR	EL	
2.5 CDTI (F7) 84-107 kW (114-146 PS) G9U 630	08.2006→		7.01152.02.0	DW-TL	EP	
			7.04779.00.0	DW-TL	EP	
			7.02256.19.0	EUV-AGR	EL	
2.5 DTI (F7) 99 kW (135 PS) G9U 730	05.2003→		7.02256.04.0	DW-TL	EP	



VIVARO B Bus (X82) **112**

1.6 CDTI (06) 66-107 kW (90-145 PS) R9M 408, R9M 450	06.2014→		7.01814.12.0	DW-TL	EP	
1.6 CDTI (06) 66-85 kW (90-116 PS) R9M 408	06.2014→		7.01814.12.0	DW-TL	EP	Produktionsdatum ab: 07.10.2014 Production date from: 07.10.2014
			7.01814.22.0	DW-TL	EP	für OE-Nummer: 44 24 170, 95520982 for OE number: 44 24 170, 95520982
1.6 CDTI (06) 85-107 kW (116-145 PS) R9M 450	06.2014→		7.01814.12.0	DW-TL	EP	Produktionsdatum ab: 07.10.2014 Production date from: 07.10.2014
			7.01814.22.0	DW-TL	EP	für OE-Nummer: 44 24 170, 95520982 for OE number: 44 24 170, 95520982
1.6 CDTI (06) 85-107 kW (116-145 PS) R9M 450	06.2014→		7.01814.12.0	DW-TL	EP	Produktionsdatum ab: 07.10.2014 Production date from: 07.10.2014
1.6 CDTI (06) 70-89 kW (95-121 PS) R9M 413	04.2015→		7.01814.12.0	DW-TL	EP	
			7.01814.22.0	DW-TL	EP	für OE-Nummer: 44 24 170, 95520982 for OE number: 44 24 170, 95520982
1.6 CDTI (06) 92-107 kW (125-146 PS) R9M 452	04.2015→		7.01814.12.0	DW-TL	EP	
			7.01814.22.0	DW-TL	EP	für OE-Nummer: 44 24 170, 95520982 for OE number: 44 24 170, 95520982
1.6 CDTI (06) 92-107 kW (125-146 PS) R9M 452	04.2015→		7.01814.12.0	DW-TL	EP	
			7.01814.22.0	DW-TL	EP	für OE-Nummer: 44 24 170, 95520982 for OE number: 44 24 170, 95520982









VIVARO B Platform/Chassis (X82) **113**

1.6 CDTI (03) 66-107 kW (90-145 PS) R9M 408, R9M 450	06.2014→		7.01814.12.0	DW-TL	EP	
1.6 CDTI (03) 85-107 kW (116-145 PS) R9M 450	08.2015→		7.01814.12.0	DW-TL	EP	
			7.01814.22.0	DW-TL	EP	für OE-Nummer: 44 24 170, 95520982 for OE number: 44 24 170, 95520982
1.6 CDTI (03) 85-107 kW (116-145 PS) R9M 450	08.2015→		7.01814.12.0	DW-TL	EP	
			7.01814.22.0	DW-TL	EP	für OE-Nummer: 44 24 170, 95520982 for OE number: 44 24 170, 95520982



VIVARO B Platform/Chassis (X82)
113

1.6 CDTI (03) 92-107 kW (125-146 PS) R9M 452	11.2016→		7.01814.12.0 DW-TL EP	für OE-Nummer: 44 24 170, 95520982 for OE number: 44 24 170, 95520982
			7.01814.22.0 DW-TL EP	
1.6 CDTI (03) 92-107 kW (125-146 PS) R9M 452	11.2016→		7.01814.12.0 DW-TL EP	für OE-Nummer: 44 24 170, 95520982 for OE number: 44 24 170, 95520982
			7.01814.22.0 DW-TL EP	



VIVARO B Van (X82)
114

1.6 CDTI (05) 85-107 kW (116-145 PS) R9M 450	06.2014→		7.01814.12.0 DW-TL EP	Produktionsdatum ab: 07.10.2014 Production date from: 07.10.2014
			7.01814.22.0 DW-TL EP	
1.6 CDTI (05) 66-85 kW (90-116 PS) R9M 408	06.2014→		7.01814.12.0 DW-TL EP	Produktionsdatum ab: 07.10.2014 Production date from: 07.10.2014
			7.01814.22.0 DW-TL EP	
1.6 CDTI (05) 66-107 kW (90-145 PS) R9M 408, R9M 450	06.2014→		7.01814.12.0 DW-TL EP	
			7.01814.22.0 DW-TL EP	
1.6 CDTI (05) 85-107 kW (116-145 PS) R9M 450	06.2014→		7.01814.12.0 DW-TL EP	für OE-Nummer: 44 24 170, 95520982 for OE number: 44 24 170, 95520982
			7.01814.22.0 DW-TL EP	
1.6 CDTI (05) 92-107 kW (125-146 PS) R9M 452	03.2016→		7.01814.12.0 DW-TL EP	für OE-Nummer: 44 24 170, 95520982 for OE number: 44 24 170, 95520982
			7.01814.22.0 DW-TL EP	
1.6 CDTI (05) 92-107 kW (125-146 PS) R9M 452	03.2016→		7.01814.12.0 DW-TL EP	für OE-Nummer: 44 24 170, 95520982 for OE number: 44 24 170, 95520982
			7.01814.22.0 DW-TL EP	
1.6 CDTI (05) 70-89 kW (95-121 PS) R9M 413	03.2016→		7.01814.12.0 DW-TL EP	
			7.01814.22.0 DW-TL EP	
1.6 CDTI (05) 70-89 kW (95-121 PS) R9M 413	08.2016→		7.01814.12.0 DW-TL EP	
			7.01814.22.0 DW-TL EP	

VIVARO C Bus (K0)
115

1.5 75 kW (102 PS) D 15 DT (DV5RUCD)	03.2019→		7.08681.00.0 EOV EH	
			7.08681.00.0 EOV EH	
1.5 88 kW (120 PS) D 15 DTH (DV5RUC)	03.2019→		7.08681.00.0 EOV EH	
			7.08681.00.0 EOV EH	





VIVARO C Van (K0)
116

1.5 75 kW (102 PS) D 15 DT (DV5RUCD)	03.2019→		7.08681.00.0 EOV EH	
			7.08681.00.0 EOV EH	
1.5 88 kW (120 PS) D 15 DTH (DV5RUC)	03.2019→		7.08681.00.0 EOV EH	
			7.08681.00.0 EOV EH	
1.5 4x4 88 kW (120 PS) D 15 DTH (DV5RUC)	03.2019→		7.08681.00.0 EOV EH	
			7.08681.00.0 EOV EH	





ZAFIRA B Box Body/MPV (A05)

117





























1.6 CNG Turbo VAN (M75) 110 kW (150 PS) A 16 XNT, Z 16 XNT	02.2009→04.2015		7.03833.02.0	EUV-VB	EL	
1.7 CDTI VAN (M75) 81 kW (110 PS) A 17 DTJ, Z 17 DTJ	01.2008→04.2015		7.03085.02.0	DW-TL	EP	
1.7 CDTI VAN (M75) 92 kW (125 PS) A 17 DTR	01.2008→04.2015		7.02461.01.0	EUV-LS	EL	
			7.03085.02.0	DW-TL	EP	
1.8 VAN (M75) 101-103 kW (137-140 PS) A 18 XER, Z 18 XER	07.2005→04.2015		7.06117.08.0	SV-NWV	EH	mit Dichtring with O-ring
			7.01024.02.0	LDRV	EL	
2.0 VAN (M75) 147 kW (200 PS) Z 20 LER	07.2005→12.2010		7.01024.02.0	LDRV	EL	
			7.01039.03.0	LDRV	EL	



























ZAFIRA LIFE Bus (K0)

118

1.5 88 kW (120 PS) D 15 DTH (DV5RUC)	03.2019→		7.08681.00.0	EOV	EH	
1.5 75 kW (102 PS) D 15 DT (DV5RUCD)	03.2019→		7.08681.00.0	EOV	EH	

























1007 (KM_)						1
1.4 16V 65 kW (88 PS) KFU (ET3J4)	10.2005→		7.06117.34.0	SV-NWV	EL	mit Dichtring with O-ring
1.4 HDi 50-52 kW (68-70 PS) 8HZ (DV4TD)	04.2005→		7.00964.03.0	DW-AGR	EP	Euro 3 Euro 3
1.6 HDi 80-84 kW (109-114 PS) 9HZ (DV6TED4)	06.2007→		7.00968.04.0	DW-TL	EP	
2008 I (CU_)						2
1.2 THP 110 / PureTech 110 81 kW (110 PS) HNP (EB2ADT)	01.2015→		7.08681.09.0	EOV	EH	Produktionsdatum ab: 05.02.2018 Production date from: 05.02.2018
1.2 THP 110 / PureTech 110 81 kW (110 PS) HNV (EB2DTM), HNZ (EB2DT)	01.2015→		7.08681.09.0	EOV	EH	HNV (EB2DTM), HNZ (EB2DT): Organisationsnummer ab: 1310088 RPO number from: 1310088
			7.06117.45.0	SV-NWV	EL	HNV (EB2DTM), HNZ (EB2DT): Organisationsnummer ab: 1310088 RPO number from: 1310088
1.2 THP 130 / PureTech 130 96 kW (131 PS) HNS (EB2ADTS)	01.2015→		7.08681.09.0	EOV	EH	Produktionsdatum ab: 05.02.2018 Production date from: 05.02.2018
1.2 THP 130 / PureTech 130 96 kW (131 PS) HNY (EB2DTS)	01.2015→		7.08681.09.0	EOV	EH	Produktionsdatum ab: 1310088 Production date from: 1310088
			7.06117.45.0	SV-NWV	EL	Organisationsnummer ab: 1310088 RPO number from: 1310088
1.2 VTi 60-66 kW (82-90 PS) HMZ (EB2), HMZ (EB2F)	03.2013→12.2018		7.06117.45.0	SV-NWV	EL	HMZ (EB2), HMZ (EB2F): Organisationsnummer ab: 1310088 RPO number from: 1310088
1.5 BlueHDI 100 75 kW (102 PS) YHY (DV5RD)	05.2018→		7.08681.00.0	EOV	EH	Produktionsdatum ab: 30.04.2018 Production date from: 30.04.2018
1.6 BlueHDI 100 73-75 kW (99-102 PS) BHY (DV6FD)	01.2015→		7.08681.00.0	EOV	EH	Getriebetyp: BE4R Transmission Type: BE4R Organisationsnummer ab: 15239 RPO number from: 15239
			7.08681.00.0	EOV	EH	Getriebetyp: BE4R Transmission Type: BE4R Organisationsnummer ab: 14448 RPO number from: 14448
1.6 HDi 84-85 kW (114-116 PS) 9HD (DV6C)	03.2013→		7.01633.06.0	DW-TL	EP	
1.6 THP 165 120-127 kW (163-173 PS) 5GY (EP6FDTM)	02.2016→		7.06117.45.0	SV-NWV	EL	Organisationsnummer ab: 14633VG RPO number from: 14633VG für Fahrzeuge mit Automatikgetriebe for vehicles with automatic transmission
			7.06117.45.0	SV-NWV	EL	Organisationsnummer ab: 1310088 RPO number from: 1310088
1.6 VTi 85-90 kW (116-122 PS) 5FS (EP6C)	03.2013→		7.06117.45.0	SV-NWV	EL	Organisationsnummer ab: 1310088 RPO number from: 1310088
2008 II (UD_, US_, UY_, UK_)						3
1.2 PureTech 100 74-75 kW (101-102 PS) HNK (EB2ADTD)	11.2019→		7.08681.09.0	EOV	EH	
1.2 PureTech 130 96 kW (131 PS) HNS (EB2ADTS)	08.2019→		7.08681.09.0	EOV	EH	
1.2 THP / PureTech 155 (USHNNS, URHNNS, UXHNJP, URHNJP,... 114-115 kW (155-156 PS) HNN (EB2ADTX), HNR (EB2ADTXM)	11.2019→		7.08681.09.0	EOV	EH	HNN (EB2ADTX), HNR (EB2ADTXM): für Fahrzeuge mit Automatikgetriebe for vehicles with automatic transmission
			7.08681.00.0	EOV	EH	Organisationsnummer ab: 15736FV RPO number from: 15736FV
1.5 BlueHDI 100 75 kW (102 PS) YHY (DV5RD)	08.2019→		7.08681.00.0	EOV	EH	Organisationsnummer ab: 15736FV RPO number from: 15736FV
1.5 BlueHDI 130 96 kW (131 PS) YHZ (DV5RC)	08.2019→		7.08681.00.0	EOV	EH	Organisationsnummer ab: 15736FV RPO number from: 15736FV

						
205 I Convertible (741B, 20D)						4
1.6 CJ 65-66 kW (88-90 PS) BDY (XU5M3Z)	08.1992→12.1994		7.05432.02.0	SM	EL mit Dichtring with O-ring	
205 II (20A/C)						5
1.6 Aut. 65-71 kW (88-97 PS) BDY (XU5M2Z), BDY (XU5M3Z)	05.1990→09.1998		7.05432.02.0	SM	EL mit Dichtring with O-ring  BDY (XU5M2Z), BDY (XU5M3Z): 01.1992→	
206 CC (2D)						6
1.6 16V 78-90 kW (106-122 PS) NFU (TU5JP4)	09.2000→12.2007		7.02256.05.0	OEL-HV	EH	
2.0 S16 100-105 kW (136-143 PS) RFN (EW10J4)	09.2000→12.2007		7.02256.05.0	OEL-HV	EH	
206 Hatchback (2A/C)						7
1.4 16V 65 kW (88 PS) KFU (ET3J4)	10.2003→02.2008		7.06117.34.0	SV-NWV	EL mit Dichtring with O-ring	
1.4 HDi 50-51 kW (68-69 PS) 8HX (DV4TD)	09.2002→02.2007		7.00964.03.0	DW-AGR	EP ab Euro 4 From Euro 4	
1.4 HDi eco 70 50-52 kW (68-70 PS) 8HX (DV4TD), 8HZ (DV4TD)	09.2001→04.2009		7.00964.03.0	DW-AGR	EP  8HX (DV4TD), 8HZ (DV4TD): ab Euro 4 From Euro 4	
1.6 16V 78-90 kW (106-122 PS) NFU (TU5JP4)	07.2000→04.2009		7.02256.05.0	OEL-HV	EH	
1.6 HDi 110 80-84 kW (109-114 PS) 9HY (DV6TED4), 9HZ (DV6TED4)	05.2004→02.2007		7.00968.04.0	DW-TL	EP	
			7.02256.05.0	OEL-HV	EH	
1.6 i 65-66 kW (88-90 PS) NFZ (TU5JP)	09.1998→12.2000		7.02256.05.0	OEL-HV	EH	
2.0 HDi 90 66 kW (90 PS) RHY (DW10TD)	12.1999→09.2009		7.00964.03.0	DW-AGR	EP Organisationsnummer ab: 09520 RPO number from: 09520	
			7.02256.24.0	DW-AGR	EP →11.2002	
			7.02256.24.0	DW-RK	EP →11.2002	
			7.02256.05.0	OEL-HV	EH	
P 2.0 RC 130-132 kW (177-180 PS) RFK (EW10J4S)	07.2003→12.2007		7.02256.05.0	OEL-HV	EH	
			7.06117.34.0	SV-NWV	EL mit Dichtring with O-ring	
2.0 RC 130-132 kW (177-180 PS) RFK (EW10J4S)	07.2003→02.2007		7.06117.34.0	SV-NWV	EL mit Dichtring with O-ring	
2.0 S16 99 kW (135 PS) RFR (EW10J4)	04.1999→10.2000		7.02256.05.0	OEL-HV	EH	
2.0 S16 100-105 kW (136-143 PS) RFN (EW10J4)	06.1999→12.2007		7.02256.05.0	OEL-HV	EH	
206 SW (2E/K)						8
1.4 16V 65 kW (88 PS) KFU (ET3J4)	10.2003→		7.06117.34.0	SV-NWV	EL mit Dichtring with O-ring	
1.4 HDi 50-51 kW (68-69 PS) 8HX (DV4TD)	07.2002→02.2007		7.00964.03.0	DW-AGR	EP ab Euro 4 From Euro 4	
1.6 16V 78-90 kW (106-122 PS) NFU (TU5JP4)	07.2002→		7.02256.05.0	OEL-HV	EH	
1.6 HDi 110 80-84 kW (109-114 PS) 9HZ (DV6TED4)	05.2004→		7.00968.04.0	DW-TL	EP	
			7.02256.05.0	OEL-HV	EH	
2.0 16V 100-105 kW (136-143 PS) RFN (EW10J4)	07.2002→02.2007		7.02256.05.0	OEL-HV	EH	
2.0 HDi 66 kW (90 PS) RHY (DW10TD)	07.2002→02.2007		7.00964.03.0	DW-AGR	EP Organisationsnummer ab: 09520 RPO number from: 09520	
			7.02256.24.0	DW-AGR	EP →11.2002	

					
206 SW (2E/K)					8
			7.02256.24.0	DW-RK	EP →11.2002
			7.02256.05.0	OEL-HV	EH
206 Saloon					9
1.6 16V 78-90 kW (106-122 PS) NFU (TU5JP4)	03.2007→		7.02256.05.0	OEL-HV	EH
207 (WA_, WC_)					10
1.4 16V 65 kW (88 PS) KFU (ET3J4)	02.2006→10.2013		7.06117.34.0	SV-NWV	EL mit Dichtring with O-ring
1.4 16V 70 kW (95 PS) 8FS (EP3)	06.2007→10.2013		7.06117.45.0	SV-NWV	EL
1.6 16V RC 127 kW (173 PS) 5FY (EP6DTS)	02.2007→12.2012		7.01777.18.0	DW-TL	EP
			7.06117.45.0	SV-NWV	EL
1.6 16V Turbo 110 kW (150 PS) 5FX (EP6DT)	02.2006→10.2013		7.01777.18.0	DW-TL	EP
			7.06117.45.0	SV-NWV	EL
1.6 16V Turbo 115 kW (156 PS) 5FR (EP6DT)	10.2009→12.2012		7.01777.18.0	DW-TL	EP
1.6 16V VTi 85-90 kW (116-122 PS) 5FS (EP6C), 5FW (EP6)	02.2007→12.2012		7.06117.45.0	SV-NWV	EL
1.6 HDi 66-68 kW (90-92 PS) 9HX (DV6ATED4)	02.2006→10.2013		7.00968.04.0	DW-TL	EP
1.6 HDi 80-84 kW (109-114 PS) 9HY (DV6TED4), 9HZ (DV6TED4)	02.2006→10.2013		7.00968.04.0	DW-TL	EP
1.6 HDi 110 82-85 kW (112-116 PS) 9HR (DV6C)	08.2009→12.2012		7.01633.06.0	DW-TL	EP
207 CC (WD_)					11
1.6 16V 85-90 kW (116-122 PS) 5FS (EP6C), 5FW (EP6)	02.2007→10.2013		7.06117.45.0	SV-NWV	EL
1.6 16V Turbo 110 kW (150 PS) 5FX (EP6DT)	02.2007→12.2012		7.01777.18.0	DW-TL	EP
			7.06117.45.0	SV-NWV	EL
1.6 16V Turbo 115 kW (156 PS) 5FR (EP6DT)	10.2009→12.2013		7.01777.18.0	DW-TL	EP
1.6 HDi 80-84 kW (109-114 PS) 9HZ (DV6TED4)	02.2007→01.2015		7.00968.04.0	DW-TL	EP
1.6 HDi 82-85 kW (112-116 PS) 9HR (DV6C)	08.2009→10.2013		7.01633.06.0	DW-TL	EP
207 SW (WK_)					12
1.4 16V 70 kW (95 PS) 8FS (EP3)	06.2007→10.2013		7.06117.45.0	SV-NWV	EL
1.6 16V 85-90 kW (116-122 PS) 5FS (EP6C), 5FW (EP6)	06.2007→10.2013		7.06117.45.0	SV-NWV	EL
1.6 16V RC 127 kW (173 PS) 5FY (EP6DTS)	02.2007→12.2012		7.01777.18.0	DW-TL	EP
			7.06117.45.0	SV-NWV	EL
1.6 16V Turbo 110 kW (150 PS) 5FX (EP6DT)	02.2007→12.2012		7.01777.18.0	DW-TL	EP
			7.06117.45.0	SV-NWV	EL
1.6 HDi 80-84 kW (109-114 PS) 9HZ (DV6TED4)	06.2007→12.2012		7.00968.04.0	DW-TL	EP
1.6 HDi 82-85 kW (112-116 PS) 9HR (DV6C)	08.2009→10.2013		7.01633.06.0	DW-TL	EP



208 I (CA_, CC_) 13

1.0 50 kW (68 PS) ZMZ (EB0)	03.2012→	 7.06117.45.0	SV-NWV	EL	
1.2 PureTech 82 60-66 kW (82-90 PS) HMZ (EB2F)	03.2018→	 7.06117.45.0	SV-NWV	EL	
1.2 THP 110 81 kW (110 PS) HNP (EB2ADT)	01.2013→	 7.08681.09.0	EOV	EH	
1.2 THP 110 81 kW (110 PS) HNV (EB2DTM), HNZ (EB2DT)	01.2013→	 7.08681.09.0	EOV	EH	
		 7.06117.45.0	SV-NWV	EL	
1.2 VTI 82 60-66 kW (82-90 PS) HMZ (EB2), HMZ (EB2F)	03.2012→	 7.06117.45.0	SV-NWV	EL	
1.2 VTi 68 / PureTech 68 50 kW (68 PS) HMP (EB2FB)	08.2016→	 7.06117.45.0	SV-NWV	EL	
1.4 GPL 70 kW (95 PS) EP3C	10.2013→	 7.06117.45.0	SV-NWV	EL	für Fahrzeuge mit Schaltgetriebe for vehicles with manual transmission
1.4 VTi 70 kW (95 PS) EP3C	03.2012→	 7.06117.45.0	SV-NWV	EL	für Fahrzeuge mit Schaltgetriebe for vehicles with manual transmission
1.5 BlueHDi 100 75 kW (102 PS) YHY (DV5RD)	05.2018→	 7.08681.00.0	EOV	EH	
1.6 115 kW (156 PS) 5FV (EP6CDT)	03.2012→	 7.01777.18.0	DW-TL	EP	
		 7.01115.08.0	SUV	EL	
		 7.06117.45.0	SV-NWV	EL	für Fahrzeuge mit Schaltgetriebe for vehicles with manual transmission
1.6 85-90 kW (116-122 PS) 5FS (EP6C)	03.2012→	 7.06117.45.0	SV-NWV	EL	
1.6 BlueHDi 100 73-75 kW (99-102 PS) BHY (DV6FD)	01.2015→	 7.08681.00.0	EOV	EH	Getriebetyp: BE4R Transmission Type: BE4R Organisationsnummer ab: 14938 RPO number from: 14938
1.6 GTi 147 kW (200 PS) 5FU (EP6CDTX)	08.2012→	 7.01777.19.0	DW-TL	EP	für Fahrzeuge mit Schaltgetriebe for vehicles with manual transmission
		 7.01115.08.0	SUV	EL	
		 7.06117.45.0	SV-NWV	EL	für Fahrzeuge mit Schaltgetriebe for vehicles with manual transmission
1.6 GTi 153 kW (208 PS) 5GR (EP6FDTX)	10.2014→	 7.01777.19.0	DW-TL	EP	für Fahrzeuge mit Schaltgetriebe for vehicles with manual transmission
		 7.01115.08.0	SUV	EL	
		 7.06117.45.0	SV-NWV	EL	für Fahrzeuge mit Schaltgetriebe for vehicles with manual transmission
1.6 HDi 84-85 kW (114-116 PS) 9HD (DV6C)	03.2012→	 7.01633.06.0	DW-TL	EP	
1.6 HDi / BlueHDi 75 55 kW (75 PS) BHW (DV6FE)	01.2013→	 7.08681.00.0	EOV	EH	Getriebetyp: BE4R Transmission Type: BE4R Organisationsnummer ab: 14938 RPO number from: 14938
1.6 THP 165 120-127 kW (163-173 PS) 5GZ (EP6FDT)	03.2015→	 7.01777.19.0	DW-TL	EP	für Fahrzeuge mit Schaltgetriebe for vehicles with manual transmission
		 7.01115.08.0	SUV	EL	
		7.06117.45.0	SV-NWV	EL	für Fahrzeuge mit Schaltgetriebe for vehicles with manual transmission
1.6 e-HDi 82-85 kW (112-116 PS) 9HR (DV6C)	07.2015→	7.01633.06.0	DW-TL	EP	













P





208 II (UB_, UP_, UW_, UJ_) 14























1.2 PureTech 100 74 kW (101 PS) HNK (EB2ADT)	06.2019→	 7.08681.09.0	EOV	EH	Organisationsnummer ab: 1542776 RPO number from: 1542776
1.2 PureTech 130 96 kW (131 PS) HNS (EB2ADTS)	06.2019→	 7.08681.09.0	EOV	EH	Organisationsnummer ab: 1542776 RPO number from: 1542776
1.5 BlueHDI 100 75 kW (102 PS) YHY (DV5RD)	06.2019→	 7.08681.00.0	EOV	EH	Organisationsnummer ab: 1542776 RPO number from: 1542776
1.5 BlueHDI 130 96 kW (131 PS) YHZ (DV5RC)	09.2019→	 7.08681.00.0	EOV	EH	Organisationsnummer ab: 1542776 RPO number from: 1542776















3008 MPV (0U_) 15

1.2 96 kW (131 PS) HNY (EB2DTS)	01.2015→08.2016	 7.08681.09.0	EOV	EH	
		7.06117.45.0	SV-NWV	EL	
1.6 BlueHdI 120 85-88 kW (116-120 PS) BHZ (DV6FC)	05.2014→08.2016	 7.08681.00.0	EOV	EH	Organisationsnummer ab: 14420 RPO number from: 14420
1.6 HDi 82-85 kW (112-116 PS) 9HR (DV6C)	12.2009→08.2016	 7.01633.06.0	DW-TL	EP	
1.6 HDi 84 kW (114 PS) 9HD (DV6CTED)	03.2013→08.2016	 7.01633.06.0	DW-TL	EP	
1.6 HDi 115 / BlueHdI 115 82-85 kW (112-116 PS) 9HC (DV6C)	02.2013→08.2016	 7.01633.06.0	DW-TL	EP	
1.6 HDi 115 / BlueHdI 115 85-88 kW (116-120 PS) BHX (DV6FC)	02.2013→08.2016	 7.08681.00.0	EOV	EH	Organisationsnummer ab: 14420 RPO number from: 14420
1.6 THP 110 kW (150 PS) 5FE (EP6CDTM), 5FE (EP6CDTMD)	06.2009→08.2016	 7.01777.18.0	DW-TL	EP	
		7.01115.08.0	SUV	EL	
1.6 THP 110 kW (150 PS) 5FX (EP6DT)	06.2009→08.2016	 7.01777.18.0	DW-TL	EP	
		7.01115.08.0	SUV	EL	
		7.06117.45.0	SV-NWV	EL	für Fahrzeuge mit Schaltgetriebe for vehicles with manual transmission
1.6 THP 115 kW (156 PS) 5FV (EP6CDT)	06.2009→08.2016	 7.01777.18.0	DW-TL	EP	
		7.01115.08.0	SUV	EL	
		7.06117.45.0	SV-NWV	EL	
1.6 THP 115-127 kW (156-173 PS) 5FM (EP6CDTM)	09.2010→08.2016	 7.01777.18.0	DW-TL	EP	
		7.01115.08.0	SUV	EL	
		7.06117.45.0	SV-NWV	EL	für Fahrzeuge mit Automatikgetriebe for vehicles with automatic transmission
1.6 Turbo 120-127 kW (163-173 PS) 5GZ (EP6FDT)	05.2014→08.2016	 7.01777.19.0	DW-TL	EP	für Fahrzeuge mit Automatikgetriebe for vehicles with automatic transmission
		7.01115.08.0	SUV	EL	
		7.06117.45.0	SV-NWV	EL	für Fahrzeuge mit Automatikgetriebe for vehicles with automatic transmission
1.6 VTi 85-90 kW (116-122 PS) 5FS (EP6C), 5FW (EP6)	06.2009→08.2016	 7.06117.45.0	SV-NWV	EL	

3008 SUV (MC_, MR_, MJ_, M4_) 16





1.2 THP/ PureTech 130 96 kW (131 PS) HNS (EB2ADTS)	05.2016→	 7.08681.09.0	EOV	EH	
1.2 THP/ PureTech 130 96 kW (131 PS) HNY (EB2DTS)	05.2016→	 7.08681.09.0	EOV	EH	

					
3008 SUV (MC_, MR_, MJ_, M4_)					16
			7.06117.45.0	SV-NWV	EL
1.5 BlueHDi 130 96 kW (131 PS) YHZ (DV5RC)	02.2018→		7.08681.00.0	EOV	EH
1.6 BlueHDi 100 73-75 kW (99-102 PS) BHY (DV6FD)	11.2016→		7.08681.00.0	EOV	EH
1.6 BlueHDi 115 85-88 kW (116-120 PS) BHX (DV6FC)	11.2016→		7.08681.00.0	EOV	EH Getriebetyp: AT63, ML6C Transmission Type: AT63, ML6C
1.6 BlueHDi 120 85-88 kW (116-120 PS) BHZ (DV6FC)	05.2016→		7.08681.00.0	EOV	EH Getriebetyp: AT63, ML6C Transmission Type: AT63, ML6C
1.6 PureTech 180 133 kW (181 PS) 5GF (EP6FADTXD)	07.2018→		7.06117.45.0	SV-NWV	EL für Fahrzeuge mit Automatikgetriebe for vehicles with automatic transmission
1.6 THP 150 110-112 kW (150-152 PS) 5GX (EP6FDTMD)	11.2017→		7.01777.18.0	DW-TL	EP
			7.06117.45.0	SV-NWV	EL für Fahrzeuge mit Automatikgetriebe for vehicles with automatic transmission
1.6 THP 165 120-127 kW (163-173 PS) 5GZ (EP6FDT)	05.2016→		7.01777.18.0	DW-TL	EP
			7.01777.19.0	DW-TL	EP für Fahrzeuge mit Automatikgetriebe for vehicles with automatic transmission
			7.01115.08.0	SUV	EL
			7.06117.45.0	SV-NWV	EL für Fahrzeuge mit Automatikgetriebe for vehicles with automatic transmission
301					17
1.2 VTi 82 60-66 kW (82-90 PS) HMZ (EB2F)	12.2014→		7.06117.45.0	SV-NWV	EL
1.5 BlueHDI 100 75 kW (102 PS) YHY (DV5RD)	05.2018→		7.08681.00.0	EOV	EH
306 (7B, N3, N5)					18
1.4 SL 55-58 kW (75-79 PS) KDX (TU3MC)	06.1994→05.2001		7.05432.04.0	SM	EL mit Dichtring with O-ring Vergasertyp: Solex Carburettor Type: Solex
1.6 SR 65-66 kW (88-90 PS) NFZ (TU5JP)	06.1994→10.2000		7.02256.05.0	OEL-HV	EH
1.8 74-77 kW (101-105 PS) LFZ (XU7JP)	06.1994→05.2001		7.02256.05.0	OEL-HV	EH
			7.05432.02.0	SM	EL mit Dichtring with O-ring
1.8 16V 76-86 kW (103-117 PS) LFY (XU7JP4)	03.1997→05.2001		7.02256.05.0	OEL-HV	EH
			7.05432.06.0	SM	EL mit Dichtring with O-ring für OE-Nummer: 1920 4X for OE number: 1920 4X
1.8 16V 76-86 kW (103-117 PS) LFY (XU7JP4)	03.1997→07.2001		7.05432.06.0	SM	EL mit Dichtring with O-ring für OE-Nummer: 1920 4X for OE number: 1920 4X
1.8 16V 76-86 kW (103-117 PS) LFY (XU7JP4)	07.1997→08.1999		7.05432.06.0	SM	EL mit Dichtring with O-ring für OE-Nummer: 1920 4X for OE number: 1920 4X
1.8 16V 76-86 kW (103-117 PS) LFY (XU7JP4)	10.1999→10.2003		7.05432.06.0	SM	EL mit Dichtring with O-ring für OE-Nummer: 1920 4X for OE number: 1920 4X

















						
306 (7B, N3, N5)						18
1.8 ST 74-77 kW (101-105 PS) LFZ (XU7JP)	06.1994→05.2001		7.02256.05.0	OEL-HV	EH	mit Dichtring with O-ring
			7.05432.02.0	SM	EL	
1.9 D 51 kW (69 PS) WJY (DW8B)	12.1999→05.2001		7.02256.24.0	DW-RK	EP	
2.0 89-96 kW (121-131 PS) RFX (XU10J2)	11.1995→06.1997		7.05432.02.0	SM	EL	mit Dichtring with O-ring
2.0 97-100 kW (132-136 PS) RFV (XU10J4R)	03.1997→05.2001		7.02256.05.0	OEL-HV	EH	
2.0 HDI 90 66 kW (90 PS) RHY (DW10TD)	06.1999→12.2001		7.02256.24.0	DW-AGR	EP	
			7.02256.24.0	DW-RK	EP	
2.0 S16 110-112 kW (150-152 PS) RFY (XU10J4Z)	06.1994→05.2001		7.02256.05.0	OEL-HV	EH	
2.0 S16 110-116 kW (150-155 PS) RFT (XU10J4)	06.1994→05.2001		7.02256.05.0	OEL-HV	EH	
2.0 ST 89-96 kW (121-131 PS) RFX (XU10J2)	07.1994→05.2001		7.05432.02.0	SM	EL	mit Dichtring with O-ring
306 Break (7E, N3, N5)						19
1.6 65-66 kW (88-90 PS) NFZ (TU5JP)	03.1997→10.2000		7.02256.05.0	OEL-HV	EH	
1.6 72 kW (98 PS) NFT (TU5JP)	10.2000→04.2002		7.02256.05.0	OEL-HV	EH	
1.8 74-77 kW (101-105 PS) LFZ (XU7JP)	03.1997→04.2002		7.02256.05.0	OEL-HV	EH	mit Dichtring with O-ring
			7.05432.02.0	SM	EL	
1.8 16V 76-86 kW (103-117 PS) LFY (XU7JP4)	03.1997→04.2002		7.02256.05.0	OEL-HV	EH	mit Dichtring with O-ring für OE-Nummer: 1920 4X for OE number: 1920 4X
			7.05432.06.0	SM	EL	
1.8 16V 76-86 kW (103-117 PS) LFY (XU7JP4)	03.1997→07.2001		7.05432.06.0	SM	EL	mit Dichtring with O-ring für OE-Nummer: 1920 4X for OE number: 1920 4X
1.9 D 51 kW (69 PS) WJY (DW8B)	12.1999→04.2002		7.02256.24.0	DW-RK	EP	
2.0 97-100 kW (132-136 PS) RFV (XU10J4R)	03.1997→04.2002		7.02256.05.0	OEL-HV	EH	
2.0 HDI 90 66 kW (90 PS) RHY (DW10TD)	06.1999→04.2002		7.02256.24.0	DW-AGR	EP	
			7.02256.24.0	DW-RK	EP	
306 Convertible (7D, N3, N5)						20
1.6 65-66 kW (88-90 PS) NFZ (TU5JP)	04.1996→10.2000		7.02256.05.0	OEL-HV	EH	
1.6 72 kW (98 PS) NFT (TU5JP)	10.2000→04.2002		7.02256.05.0	OEL-HV	EH	
1.8 74-77 kW (101-105 PS) L6A (XU7JP), LFZ (XU7JP)	03.1994→04.2002		7.02256.05.0	OEL-HV	EH	mit Dichtring with O-ring
			7.05432.02.0	SM	EL	
1.8 74-77 kW (101-105 PS) LFZ (XU7JP)	05.1997→04.1999		7.05432.02.0	SM	EL	mit Dichtring with O-ring
1.8 16V 76-86 kW (103-117 PS) LFY (XU7JP4)	05.1997→04.2002		7.02256.05.0	OEL-HV	EH	



















306 Convertible (7D, N3, N5) 20

			7.05432.06.0	SM	EL	mit Dichtring with O-ring für OE-Nummer: 1920 4X for OE number: 1920 4X
2.0 89-96 kW (121-131 PS) RFX (XU10J2)	01.1994→06.1997		7.05432.02.0	SM	EL	mit Dichtring with O-ring
2.0 89-96 kW (121-131 PS) RFX (XU10J2)	03.1994→04.2002		7.05432.02.0	SM	EL	mit Dichtring with O-ring
2.0 89-96 kW (121-131 PS) RFX (XU10J2)	02.1995→11.1997		7.05432.02.0	SM	EL	mit Dichtring with O-ring
2.0 16V 97-100 kW (132-136 PS) RFV (XU10J4R)	03.1997→04.2002		7.02256.05.0	OEL-HV	EH	

306 Hatchback (7A, 7C, N3, N5) 21

1.4 55-58 kW (75-79 PS) KDX (TU3MC)	04.1993→07.2001		7.05432.04.0	SM	EL	mit Dichtring with O-ring Vergasertyp: Solex Carburettor Type: Solex
1.6 65-66 kW (88-90 PS) NFZ (TU5JP)	05.1993→10.2000		7.02256.05.0	OEL-HV	EH	
1.6 65-66 kW (88-90 PS) NFZ (TU5JP)	07.2000→05.2001		7.02256.05.0	OEL-HV	EH	
1.6 72 kW (98 PS) NFT (TU5JP)	10.2000→05.2001		7.02256.05.0	OEL-HV	EH	
1.8 74-77 kW (101-105 PS) LFZ (XU7JP)	05.1993→05.2001		7.02256.05.0	OEL-HV	EH	
			7.05432.02.0	SM	EL	mit Dichtring with O-ring
1.8 16V 76-86 kW (103-117 PS) LFY (XU7JP4)	03.1997→05.2001		7.02256.05.0	OEL-HV	EH	
			7.05432.06.0	SM	EL	mit Dichtring with O-ring für OE-Nummer: 1920 4X for OE number: 1920 4X
1.8 16V 76-86 kW (103-117 PS) LFY (XU7JP4)	03.1997→10.2003		7.05432.06.0	SM	EL	mit Dichtring with O-ring für OE-Nummer: 1920 4X for OE number: 1920 4X
1.8 16V 76-86 kW (103-117 PS) LFY (XU7JP4)	07.1997→10.2000		7.05432.06.0	SM	EL	mit Dichtring with O-ring für OE-Nummer: 1920 4X for OE number: 1920 4X
1.9 D 51 kW (69 PS) WJY (DW8B)	12.1999→05.2001		7.02256.24.0	DW-RK	EP	
2.0 89-96 kW (121-131 PS) RFX (XU10J2)	01.1994→12.1999		7.05432.02.0	SM	EL	mit Dichtring with O-ring
2.0 16V 97-100 kW (132-136 PS) RFV (XU10J4R)	03.1997→05.2001		7.02256.05.0	OEL-HV	EH	
2.0 HDI 90 66 kW (90 PS) RHY (DW10TD)	06.1999→12.2002		7.02256.24.0	DW-AGR	EP	
			7.02256.24.0	DW-RK	EP	
2.0 S16 110-112 kW (150-152 PS) RFY (XU10J4Z)	05.1993→05.2001		7.02256.05.0	OEL-HV	EH	
2.0 S16 110-116 kW (150-155 PS) RFT (XU10J4), RFY (XU10J4Z)	06.1994→05.2001		7.02256.05.0	OEL-HV	EH	
2.0 S16 120-124 kW (163-169 PS) RFS (XU10J4RS)	06.1996→05.2001		7.02256.05.0	OEL-HV	EH	
2.0 XSi 89-96 kW (121-131 PS) RFX (XU10J2)	05.1993→05.2001		7.05432.02.0	SM	EL	mit Dichtring with O-ring











P





















					
307 (3A/C)					22
1.4 16V 65 kW (88 PS) KFU (ET3J4)	11.2003→07.2007		7.06117.34.0	SV-NWV	EL mit Dichtring with O-ring
1.4 HDi 50-52 kW (68-70 PS) 8HZ (DV4TD)	10.2001→06.2005		7.00964.03.0	DW-AGR	EP
1.6 HDi 66-68 kW (90-92 PS) 9HX (DV6ATED4)	04.2005→03.2009		7.00968.04.0	DW-TL	EP
1.6 HDi 110 80-84 kW (109-114 PS) 9HY (DV6TED4), 9HZ (DV6TED4)	02.2004→03.2009		7.00968.04.0	DW-TL	EP
2.0 16V 103-111 kW (140-151 PS) RFJ (EW10A)	03.2005→11.2007		7.06117.34.0	SV-NWV	EL mit Dichtring with O-ring Organisationsnummer bis: 10919 RPO number to: 10919 Euro3/Euro4 Euro3/Euro4
2.0 16V 130-132 kW (177-180 PS) RFK (EW10J4S)	06.2005→11.2007		7.06117.34.0	SV-NWV	EL mit Dichtring with O-ring
2.0 HDi 110 79 kW (107 PS) RHS (DW10ATED)	08.2000→03.2007		7.00964.03.0	DW-AGR	EP für Fahrzeuge mit Diesel-Partikel-Filter (DPF) for vehicles with diesel soot filter
			7.00964.03.0	DW-RK	EP für Fahrzeuge mit Diesel-Partikel-Filter (DPF) for vehicles with diesel soot filter
			7.00964.03.0	DW-TL	EP für Fahrzeuge mit Diesel-Partikel-Filter (DPF) for vehicles with diesel soot filter
2.0 HDi 135 100-103 kW (136-140 PS) RHR (DW10BTED4)	10.2003→11.2007		7.00612.01.0	DW-TL	EP 05.2005→01.2006 Schaltgetriebe Manual Transmission Organisationsnummer bis: 10673 RPO number to: 10673 für Fahrzeuge mit Diesel-Partikel-Filter (DPF) for vehicles with diesel soot filter
			7.01632.02.0	DW-RK	EP  RHR (DW10BTED4): Getriebeautomatik 6 Gang 6-Speed Automatic Transmission für Fahrzeuge mit Diesel-Partikel-Filter (DPF) for vehicles with diesel soot filter
			7.01632.02.0	DW-TL	EP  RHR (DW10BTED4): Schaltgetriebe Manual Transmission Organisationsnummer ab: 10674 RPO number from: 10674 für Fahrzeuge mit Diesel-Partikel-Filter (DPF) for vehicles with diesel soot filter Herstellerausschluss: Delphi Manufacturer Exclusion: Delphi
			7.01633.04.0	DW-TL	EP Schaltgetriebe Manual Transmission für Fahrzeuge mit Diesel-Partikel-Filter (DPF) for vehicles with diesel soot filter Herstellerausschluss: Delphi Manufacturer Exclusion: Delphi
2.0 HDi 90 66 kW (90 PS) RHY (DW10TD)	08.2000→03.2007		7.00964.03.0	DW-AGR	EP ab Euro 4 From Euro 4
			7.00964.03.0	DW-RK	EP ab Euro 4 From Euro 4

















307 Break (3E) 23

1.4 16V 65 kW (88 PS) KFU (ET3J4)	11.2003→07.2007	 7.06117.34.0	SV-NWV	EL	mit Dichtring with O-ring	
1.4 HDi 50-52 kW (68-70 PS) 8HZ (DV4TD)	03.2002→06.2005	 7.00964.03.0	DW-AGR	EP		
1.6 HDi 110 80-84 kW (109-114 PS) 9HY (DV6TED4), 9HZ (DV6TED4)	02.2004→04.2008	 7.00968.04.0	DW-TL	EP		
2.0 16V 103-111 kW (140-151 PS) RFJ (EW10A)	03.2005→04.2008	 7.06117.34.0	SV-NWV	EL	mit Dichtring with O-ring Fahrgestellnummer bis: 10919 Vehicle Identification Number to: 10919 Euro3/Euro4 Euro3/Euro4	
2.0 16V 130-132 kW (177-180 PS) RFK (EW10J4S)	06.2005→04.2008	 7.06117.34.0	SV-NWV	EL	mit Dichtring with O-ring	
2.0 HDi 110 79 kW (107 PS) RHS (DW10ATED)	03.2002→12.2009	 7.00964.03.0	DW-AGR	EP	für Fahrzeuge mit Diesel-Partikel-Filter (DPF) for vehicles with diesel soot filter	
		7.00964.03.0	DW-RK	EP	für Fahrzeuge mit Diesel-Partikel-Filter (DPF) for vehicles with diesel soot filter	
		7.00964.03.0	DW-TL	EP	für Fahrzeuge mit Diesel-Partikel-Filter (DPF) for vehicles with diesel soot filter	
2.0 HDi 90 66 kW (90 PS) RHY (DW10TD)	03.2002→04.2008	 7.00964.03.0	DW-AGR	EP	ab Euro 4 From Euro 4	
		7.00964.03.0	DW-RK	EP	ab Euro 4 From Euro 4	
2.0 HDi 135 100-103 kW (136-140 PS) RHR (DW10BTED4)	02.2004→04.2008	 7.00612.01.0	DW-TL	EP	05.2005→01.2006 Schaltgetriebe Manual Transmission Organisationsnummer bis: 10673 RPO number to: 10673 für Fahrzeuge mit Diesel-Partikel-Filter (DPF) for vehicles with diesel soot filter	
			7.01632.02.0	DW-RK	EP	 RHR (DW10BTED4): Schaltgetriebe Manual Transmission Organisationsnummer ab: 10674 RPO number from: 10674 für Fahrzeuge mit Diesel-Partikel-Filter (DPF) for vehicles with diesel soot filter Herstellerausschluss: Delphi Manufacturer Exclusion: Delphi  RHR (DW10BTED4): Getriebeautomatik 6 Gang 6-Speed Automatic Transmission Organisationsnummer ab: 10674 RPO number from: 10674 für Fahrzeuge mit Diesel-Partikel-Filter (DPF) for vehicles with diesel soot filter
			7.01632.02.0	DW-TL	EP	Schaltgetriebe Manual Transmission Organisationsnummer ab: 10674 RPO number from: 10674 für Fahrzeuge mit Diesel-Partikel-Filter (DPF) for vehicles with diesel soot filter
		7.01633.04.0	DW-TL	EP	Schaltgetriebe Manual Transmission für Fahrzeuge mit Diesel-Partikel-Filter (DPF) for vehicles with diesel soot filter	

						
307 CC (3B)						24
2.0 16V 130-132 kW (177-180 PS) RFK (EW10J4S)	10.2003→04.2009		7.06117.34.0	SV-NWV	EL mit Dichtring with O-ring	
2.0 16V 103-111 kW (140-151 PS) RFJ (EW10A)	12.2004→04.2009		7.06117.34.0	SV-NWV	EL mit Dichtring with O-ring  RFJ (EW10A): Organisationsnummer bis: 10702 RPO number to: 10702 Euro 4 (D4) Euro 4 (D4)  RFJ (EW10A): Euro 3 (D4) Euro 3 (D4)	
2.0 16V 130-132 kW (177-180 PS) RFK (EW10J4S)	04.2005→06.2009		7.06117.34.0	SV-NWV	EL mit Dichtring with O-ring	
2.0 16V 103-111 kW (140-151 PS) RFJ (EW10A)	10.2005→04.2009		7.06117.34.0	SV-NWV	EL mit Dichtring with O-ring  RFJ (EW10A): Organisationsnummer bis: 10702 RPO number to: 10702 Euro 4 (D4) Euro 4 (D4)  RFJ (EW10A): Euro 3 (D3) Euro 3 (D3)	
2.0 HDi 135 100-103 kW (136-140 PS) RHR (DW10BTED4)	06.2005→04.2009		7.00612.01.0	DW-TL	EP →01.2006 Schaltgetriebe Manual Transmission Organisationsnummer bis: 10673 RPO number to: 10673 für Fahrzeuge mit Diesel-Partikel-Filter (DPF) for vehicles with diesel soot filter	
			7.01632.02.0	DW-RK	EP  RHR (DW10BTED4): Schaltgetriebe Manual Transmission Organisationsnummer ab: 10674 RPO number from: 10674 für Fahrzeuge mit Diesel-Partikel-Filter (DPF) for vehicles with diesel soot filter Herstellerausschluss: Delphi Manufacturer Exclusion: Delphi  RHR (DW10BTED4): Getriebeautomatik 6 Gang 6-Speed Automatic Transmission für Fahrzeuge mit Diesel-Partikel-Filter (DPF) for vehicles with diesel soot filter	
			7.01632.02.0	DW-TL	EP Schaltgetriebe Manual Transmission Organisationsnummer ab: 10674 RPO number from: 10674 für Fahrzeuge mit Diesel-Partikel-Filter (DPF) for vehicles with diesel soot filter Herstellerausschluss: Delphi Manufacturer Exclusion: Delphi	
			7.01633.04.0	DW-TL	EP Schaltgetriebe Manual Transmission für Fahrzeuge mit Diesel-Partikel-Filter (DPF) for vehicles with diesel soot filter	
307 SW (3H)						25
1.4 16V 65 kW (88 PS) KFU (ET3J4)	11.2003→07.2007		7.06117.34.0	SV-NWV	EL mit Dichtring with O-ring	
1.6 HDI 110 80-84 kW (109-114 PS) 9HY (DV6TED4), 9HZ (DV6TED4)	11.2003→12.2007		7.00968.04.0	DW-TL	EP	
1.6 HDI 90 66-68 kW (90-92 PS) 9HX (DV6ATED4)	04.2005→04.2008		7.00968.04.0	DW-TL	EP	







307 SW (3H) **25**











<p>2.0 16V 103-111 kW (140-151 PS) RFJ (EW10A)</p>	<p>03.2005→04.2008</p>	<p>7.06117.34.0</p> 	<p>SV-NWV</p>	<p>EL mit Dichtring with O-ring Organisationsnummer bis: 10919 RPO number to: 10919 Euro3/Euro4 Euro3/Euro4</p>
<p>2.0 16V 103-111 kW (140-151 PS) RFJ (EW10A)</p>	<p>10.2005→12.2009</p>	<p>7.06117.34.0</p> 	<p>SV-NWV</p>	<p>EL mit Dichtring with O-ring Organisationsnummer bis: 10919 RPO number to: 10919 Euro3/Euro4 Euro3/Euro4</p>
<p>2.0 HDI 110 79 kW (107 PS) RHS (DW10ATED)</p>	<p>03.2002→12.2009</p>	<p>7.00964.03.0</p> 	<p>DW-AGR</p>	<p>EP für Fahrzeuge mit Diesel-Partikel-Filter (DPF) for vehicles with diesel soot filter</p>
<p>2.0 HDI 90 66 kW (90 PS) RHY (DW10TD)</p>	<p>03.2002→04.2008</p>	<p>7.00964.03.0</p> 	<p>DW-RK</p>	<p>EP für Fahrzeuge mit Diesel-Partikel-Filter (DPF) for vehicles with diesel soot filter</p>
<p>2.0 HDi 90 66 kW (90 PS) RHY (DW10TD)</p>	<p>03.2002→04.2008</p>	<p>7.00964.03.0</p> 	<p>DW-AGR</p>	<p>EP ab Euro 4 From Euro 4</p>
<p>2.0 HDi 135 100-103 kW (136-140 PS) RHR (DW10BTED4)</p>	<p>02.2004→04.2008</p>	<p>7.00612.01.0</p> 	<p>DW-TL</p>	<p>EP 05.2005→01.2006 Schaltgetriebe Manual Transmission Organisationsnummer bis: 10673 RPO number to: 10673 für Fahrzeuge mit Diesel-Partikel-Filter (DPF) for vehicles with diesel soot filter</p>
<p>2.0 HDi 135 100-103 kW (136-140 PS) RHR (DW10BTED4)</p>	<p>02.2004→04.2008</p>	<p>7.01632.02.0</p> 	<p>DW-RK</p>	<p>EP  RHR (DW10BTED4): Getriebeautomatik 6 Gang 6-Speed Automatic Transmission für Fahrzeuge mit Diesel-Partikel-Filter (DPF) for vehicles with diesel soot filter</p>
<p>2.0 HDi 135 100-103 kW (136-140 PS) RHR (DW10BTED4)</p>	<p>02.2004→04.2008</p>	<p>7.01632.02.0</p> 	<p>DW-TL</p>	<p>EP  RHR (DW10BTED4): Schaltgetriebe Manual Transmission Organisationsnummer ab: 10674 RPO number from: 10674 für Fahrzeuge mit Diesel-Partikel-Filter (DPF) for vehicles with diesel soot filter Herstellerausschluss: Delphi Manufacturer Exclusion: Delphi</p>
<p>2.0 HDi 135 100-103 kW (136-140 PS) RHR (DW10BTED4)</p>	<p>02.2004→04.2008</p>	<p>7.01632.02.0</p> 	<p>DW-TL</p>	<p>EP Schaltgetriebe Manual Transmission Organisationsnummer ab: 10674 RPO number from: 10674 für Fahrzeuge mit Diesel-Partikel-Filter (DPF) for vehicles with diesel soot filter Herstellerausschluss: Delphi Manufacturer Exclusion: Delphi</p>
<p>2.0 HDi 135 100-103 kW (136-140 PS) RHR (DW10BTED4)</p>	<p>02.2004→04.2008</p>	<p>7.01633.04.0</p> 	<p>DW-TL</p>	<p>EP Schaltgetriebe Manual Transmission für Fahrzeuge mit Diesel-Partikel-Filter (DPF) for vehicles with diesel soot filter</p>
<p>2.0 HDi 135 100-103 kW (136-140 PS) RHR (DW10BTED4)</p>	<p>02.2004→04.2008</p>	<p>7.01633.04.0</p> 	<p>DW-TL</p>	<p>EP Schaltgetriebe Manual Transmission für Fahrzeuge mit Diesel-Partikel-Filter (DPF) for vehicles with diesel soot filter</p>

P





307 Saloon **26**

2.0 103-111 kW (140-151 PS) RFJ (EW10A)	03.2004→04.2009	 7.06117.34.0	SV-NWV	EL	mit Dichtring with O-ring  RFJ (EW10A): Organisationsnummer bis: 10702 RPO number to: 10702 Euro 4 (D4) Euro 4 (D4)  RFJ (EW10A): Euro 3 (D3) Euro 3 (D3)
2.0 HDi 79-80 kW (107-109 PS) RHZ (DW10ATED)	09.2006→03.2012	 7.02256.23.0	DW-AGR	EP	für OE-Nummer: 1628 HC for OE number: 1628 HC
		7.02256.24.0	DW-AGR	EP	für OE-Nummer: 1628 LQ for OE number: 1628 LQ
		7.02256.24.0	DW-TL	EP	für OE-Nummer: 1628 LQ for OE number: 1628 LQ
2.0 HDi 66 kW (90 PS) RHY (DW10TD)	09.2006→10.2010	 7.00964.03.0	DW-AGR	EP	ab Euro 4 From Euro 4
		7.00964.03.0	DW-RK	EP	ab Euro 4 From Euro 4

308 CC (4B_) **27**













1.6 16V 110 kW (150 PS) 5FX (EP6DT)	06.2009→12.2014	 7.01777.18.0	DW-TL	EP	
		7.01115.08.0	SUV	EL	
		7.06117.45.0	SV-NWV	EL	
1.6 16V 81-88 kW (110-120 PS) EP6	06.2009→12.2014	 7.06117.45.0	SV-NWV	EL	
1.6 16V 115 kW (156 PS) 5FV (EP6CDT)	06.2009→12.2014	 7.01777.18.0	DW-TL	EP	
		7.01115.08.0	SUV	EL	
		7.06117.45.0	SV-NWV	EL	
1.6 16V 103 kW (140 PS) 5FT (EP6DT)	06.2009→12.2014	 7.01777.18.0	DW-TL	EP	
		7.01115.08.0	SUV	EL	
		7.06117.45.0	SV-NWV	EL	
1.6 HDi 80-84 kW (109-114 PS) 9HZ (DV6TED4)	02.2009→05.2012	 7.00968.04.0	DW-TL	EP	
1.6 HDi 82-85 kW (112-116 PS) 9HR (DV6C)	06.2009→12.2014	 7.01633.06.0	DW-TL	EP	
1.6 HDi 84-85 kW (114-116 PS) 9HD (DV6C)	03.2013→12.2014	 7.01633.06.0	DW-TL	EP	
1.6 THP 147-150 kW (200-204 PS) EP6CDTX	10.2010→12.2014	 7.01777.19.0	DW-TL	EP	
		7.01115.08.0	SUV	EL	
		7.06117.45.0	SV-NWV	EL	
1.6 THP 115-127 kW (156-173 PS) 5FM (EP6CDTM)	08.2012→12.2014	 7.01777.18.0	DW-TL	EP	
		7.01115.08.0	SUV	EL	
		7.06117.45.0	SV-NWV	EL	für Fahrzeuge mit Automatikgetriebe for vehicles with automatic transmission
2.0 HDi 100-103 kW (136-140 PS) RHR (DW10BTED4)	04.2009→12.2014	 7.01633.04.0	DW-TL	EP	für Fahrzeuge mit Diesel-Partikel-Filter (DPF) for vehicles with diesel soot filter

308 I (4A_, 4C_) **28**







1.4 16V 70 kW (95 PS) 8FS (EP3)	09.2007→10.2014	 7.06117.45.0	SV-NWV	EL	
1.4 16V 72 kW (98 PS) 8FR (EP3)	12.2009→10.2014	 7.06117.45.0	SV-NWV	EL	
1.6 115-127 kW (156-173 PS) 5FM (EP6CDTM)	09.2009→12.2010	 7.01777.18.0	DW-TL	EP	



308 I (4A_, 4C_) 28

			7.01115.08.0 7.06117.45.0	SUV SV-NWV	EL EL	für Fahrzeuge mit Automatikgetriebe for vehicles with automatic transmission
1.6 16V 88 kW (120 PS) 5FW (EP6)	09.2007→10.2014		7.06117.45.0	SV-NWV	EL	
1.6 16V 110 kW (150 PS) 5FX (EP6DT)	09.2007→10.2014		7.01777.18.0	DW-TL	EP	
			7.01115.08.0 7.06117.45.0	SUV SV-NWV	EL EL	
1.6 16V 103 kW (140 PS) 5FT (EP6DT)	09.2007→10.2014		7.01777.18.0	DW-TL	EP	
			7.01115.08.0 7.06117.45.0	SUV SV-NWV	EL EL	
1.6 16V 127 kW (173 PS) 5FY (EP6DTS)	03.2008→10.2014		7.01777.18.0	DW-TL	EP	
			7.01115.08.0 7.06117.45.0	SUV SV-NWV	EL EL	
1.6 GTi 147-150 kW (200-204 PS) EP6CDTX	07.2010→10.2014		7.01777.19.0	DW-TL	EP	
			7.01115.08.0 7.06117.45.0	SUV SV-NWV	EL EL	
1.6 HDi 66-68 kW (90-92 PS) 9HV (DV6TED4B), 9HV (DV6TED4BU), 9HX (DV6ATED4)	09.2007→10.2014		7.00968.04.0	DW-TL	EP	
1.6 HDi 80-84 kW (109-114 PS) 9HZ (DV6TED4)	09.2007→10.2014		7.00968.04.0	DW-TL	EP	
1.6 HDi 82-85 kW (112-116 PS) 9HR (DV6C)	12.2009→10.2014		7.01633.06.0	DW-TL	EP	
1.6 HDi 82-85 kW (114-116 PS) 9HD (DV6C), 9HG (DV6C M)	03.2013→10.2014		7.01633.06.0	DW-TL	EP	
1.6 THP 16V 115 kW (156 PS) 5FV (EP6CDT)	10.2009→10.2014		7.01777.18.0	DW-TL	EP	
			7.01115.08.0 7.06117.45.0	SUV SV-NWV	EL EL	
2.0 HDi 100-103 kW (136-140 PS) RHR (DW10BTED4)	09.2007→10.2014		7.01633.04.0	DW-TL	EP	für Fahrzeuge mit Diesel-Partikel-Filter (DPF) for vehicles with diesel soot filter
2.0 HDi 100-103 kW (136-140 PS) RHR (DW10BTED4)	07.2010→12.2012		7.01633.04.0	DW-TL	EP	für Fahrzeuge mit Diesel-Partikel-Filter (DPF) for vehicles with diesel soot filter

308 II (LB_, LP_, LW_, LH_, L3_) 29

1.2 THP 110 81 kW (110 PS) HNP (EB2ADT)	11.2013→		7.08681.09.0	EOV	EH	
1.2 THP 110 81 kW (110 PS) HNV (EB2DTM), HNZ (EB2DT)	11.2013→		7.08681.09.0	EOV	EH	
			7.06117.45.0	SV-NWV	EL	
1.2 THP 130 96 kW (131 PS) HNY (EB2DTS)	11.2013→		7.08681.09.0	EOV	EH	
			7.06117.45.0	SV-NWV	EL	
1.2 VTi 72 60-66 kW (82-90 PS) HMZ (EB2F)	09.2013→		7.06117.45.0	SV-NWV	EL	
1.5 BlueHDi 100 75 kW (102 PS) YHY (DV5RD)	05.2018→		7.08681.00.0	EOV	EH	
1.5 BlueHDi 130 96 kW (131 PS) YHZ (DV5RC)	06.2017→		7.08681.00.0	EOV	EH	



308 II (LB_, LP_, LW_, LH_, L3_) 29

1.6 BlueHDi 120 85-88 kW (116-120 PS) BHZ (DV6FC)	11.2013→	7.08681.00.0	EOV	EH	BHZ (DV6FC): Getriebetyp: ML6C Transmission Type: ML6C Organisationsnummer ab: 14329 RPO number from: 14329 BHZ (DV6FC): Getriebetyp: AT63 Transmission Type: AT63 Organisationsnummer ab: 14420 RPO number from: 14420
1.6 GTi 184 kW (250 PS) 5GP (EP6FDTR)	08.2015→	7.01777.19.0 7.01115.08.0 7.06117.45.0	DW-TL	EP	
1.6 GTi (L35GNH) 200 kW (272 PS) 5GN (EP6FDTR)	06.2015→	7.01777.19.0 7.01115.08.0 7.06117.45.0	DW-TL	EP	
1.6 HDi / BlueHDi 115 82-85 kW (112-116 PS) 9HC (DV6C)	09.2013→	7.01633.06.0	DW-TL	EP	
1.6 HDi / BlueHDi 115 85-88 kW (116-120 PS) BHZ (DV6FC)	09.2013→	7.08681.00.0	EOV	EH	BHZ (DV6FC): Getriebetyp: AT63 Transmission Type: AT63 Organisationsnummer ab: 14420 RPO number from: 14420 BHZ (DV6FC): Getriebetyp: ML6C Transmission Type: ML6C Organisationsnummer ab: 14329 RPO number from: 14329
1.6 PureTech 225 165 kW (224 PS) GGR (EP6FADTX)	01.2018→	7.06117.45.0	SV-NWV	EL	für Fahrzeuge mit Automatikgetriebe for vehicles with automatic transmission
1.6 THP 115 kW (156 PS) 5FV (EP6CDT)	09.2013→	7.01777.18.0 7.01115.08.0 7.06117.45.0	DW-TL	EP	
1.6 THP 125 92 kW (125 PS) 5FA (EP6CDT)	09.2013→	7.01777.18.0 7.01115.08.0 7.06117.45.0	DW-TL	EP	
				EL	für Fahrzeuge mit Schaltgetriebe for vehicles with manual transmission

P

308 SW I (4E_, 4H_) 30

1.4 16V 70 kW (95 PS) 8FS (EP3)	09.2007→10.2014	7.06117.45.0	SV-NWV	EL	
1.4 16V 72 kW (98 PS) 8FR (EP3)	12.2009→10.2014	7.06117.45.0	SV-NWV	EL	
1.6 16V 88 kW (120 PS) 5FW (EP6)	09.2007→10.2014	7.06117.45.0	SV-NWV	EL	
1.6 16V 110 kW (150 PS) 5FX (EP6DT)	09.2007→10.2014	7.01777.18.0 7.01115.08.0 7.06117.45.0	DW-TL	EP	
1.6 16V 103 kW (140 PS) 5FT (EP6DT)	09.2007→10.2014	7.01777.18.0 7.01115.08.0 7.06117.45.0	DW-TL	EP	
1.6 16V 127 kW (173 PS) 5FY (EP6DTS)	03.2008→10.2014	7.01777.18.0 7.01115.08.0 7.06117.45.0	DW-TL	EP	
1.6 HDi 66-68 kW (90-92 PS) 9HX (DV6ATED4)	09.2007→10.2014	7.00968.04.0	DW-TL	EP	



308 SW I (4E_, 4H_)					30
1.6 HDi 80-84 kW (109-114 PS) 9HZ (DV6TED4)	09.2007→10.2014		7.00968.04.0	DW-TL	EP
1.6 HDi 82-85 kW (112-116 PS) 9HR (DV6C)	12.2009→10.2014		7.01633.06.0	DW-TL	EP
1.6 HDi 84-85 kW (114-116 PS) 9HD (DV6C)	03.2013→10.2014		7.01633.06.0	DW-TL	EP
1.6 THP 16V 115 kW (156 PS) 5FV (EP6CDT)	10.2009→10.2014		7.01777.18.0	DW-TL	EP
			7.01115.08.0	SUV	EL
			7.06117.45.0	SV-NWV	EL
2.0 HDi 100-103 kW (136-140 PS) RHR (DW10BTED4)	09.2007→12.2012		7.01633.04.0	DW-TL	EP für Fahrzeuge mit Diesel-Partikel-Filter (DPF) for vehicles with diesel soot filter
2.0 HDi 100-103 kW (136-140 PS) RHR (DW10BTED4)	09.2007→10.2014		7.01633.04.0	DW-TL	EP für Fahrzeuge mit Diesel-Partikel-Filter (DPF) for vehicles with diesel soot filter
308 SW II (LC_, LJ_, LR_, LX_, L4_)					31
1.2 THP 110 81 kW (110 PS) HNZ (EB2DT)	03.2014→		7.08681.09.0	EOV	EH
			7.06117.45.0	SV-NWV	EL
1.2 THP 130 96 kW (131 PS) HNY (EB2DTS)	03.2014→		7.08681.09.0	EOV	EH
			7.06117.45.0	SV-NWV	EL
1.5 BlueHDi 100 75 kW (102 PS) YHY (DV5RD)	04.2018→		7.08681.00.0	EOV	EH
1.5 BlueHDi 130 96 kW (131 PS) YHZ (DV5RC)	06.2017→		7.08681.00.0	EOV	EH
1.6 BlueHDi 120 85-88 kW (116-120 PS) BHZ (DV6FC)	03.2014→		7.08681.00.0	EOV	EH BHZ (DV6FC): Getriebetyp: AT63 Transmission Type: AT63 Organisationsnummer ab: 14420 RPO number from: 14420 BHZ (DV6FC): Getriebetyp: ML6C Transmission Type: ML6C Organisationsnummer ab: 14329 RPO number from: 14329
1.6 GT 205 151 kW (205 PS) 5GT (EP6FDTX)	02.2015→		7.01777.19.0	DW-TL	EP für Fahrzeuge mit Schaltgetriebe for vehicles with manual transmission
			7.01115.08.0	SUV	EL
			7.06117.45.0	SV-NWV	EL für Fahrzeuge mit Schaltgetriebe for vehicles with manual transmission
1.6 HDi / BlueHDi 115 82-85 kW (112-116 PS) 9HC (DV6C)	03.2014→		7.01633.06.0	DW-TL	EP
1.6 HDi / BlueHDi 115 85-88 kW (116-120 PS) BHZ (DV6FC)	03.2014→		7.08681.00.0	EOV	EH BHZ (DV6FC): Getriebetyp: AT63 Transmission Type: AT63 Organisationsnummer ab: 14420 RPO number from: 14420 BHZ (DV6FC): Getriebetyp: ML6C Transmission Type: ML6C Organisationsnummer ab: 14329 RPO number from: 14329
1.6 THP 125 92 kW (125 PS) 5FA (EP6CDT)	03.2014→		7.01777.18.0	DW-TL	EP
			7.01115.08.0	SUV	EL
			7.06117.45.0	SV-NWV	EL für Fahrzeuge mit Schaltgetriebe for vehicles with manual transmission
1.6 THP 155 115 kW (156 PS) 5FV (EP6CDT)	03.2014→		7.01777.18.0	DW-TL	EP
			7.01115.08.0	SUV	EL
			7.06117.45.0	SV-NWV	EL für Fahrzeuge mit Schaltgetriebe for vehicles with manual transmission

P





						
309 II (3C, 3A)						32
1.6 65-71 kW (88-97 PS) BDY (XU5M2Z), BDY (XU5M3Z)	07.1989→12.1993		7.05432.02.0	SM	EL mit Dichtring with O-ring  BDY (XU5M2Z), BDY (XU5M3Z): 01.1992→	
4008						33
1.6 HDi 84-85 kW (114-116 PS) 9HD (DV6C)	05.2012→		7.01633.06.0	DW-TL	EP	
1.6 HDi AWC 84-85 kW (114-116 PS) 9HD (DV6C)	05.2012→		7.01633.06.0	DW-TL	EP	
1.6 HDi AWC 82-85 kW (112-116 PS) 9HC (DV6C)	05.2012→		7.01633.06.0	DW-TL	EP	
405 I (15B)						34
1.6 65-71 kW (88-97 PS) BDY (XU5M2Z), BDZ (XU5M)	07.1987→12.1992		7.05432.02.0	SM	EL mit Dichtring with O-ring  BDY (XU5M2Z), BDZ (XU5M): 01.1992→	
1.6 65-69 kW (88-94 PS) BDZ (XU5M)	10.1989→12.1992		7.05432.02.0	SM	EL mit Dichtring with O-ring 01.1992→	
1.6 4x4 65-69 kW (88-94 PS) BDZ (XU5M)	04.1988→07.1992		7.05432.02.0	SM	EL mit Dichtring with O-ring 01.1992→	
405 I Break (15E)						35
1.6 65-71 kW (88-97 PS) BDY (XU5M2Z), BDY (XU5M3Z), BDZ (XU5M)	10.1988→08.1992		7.05432.02.0	SM	EL mit Dichtring with O-ring  BDY (XU5M2Z), BDY (XU5M3Z), BDZ (XU5M): 01.1992→	
1.6 SRi 4x4 65-69 kW (88-94 PS) BDZ (XU5M)	04.1988→07.1992		7.05432.02.0	SM	EL mit Dichtring with O-ring 01.1992→	
405 II (4B)						36
1.6 65-71 kW (88-97 PS) BDY (XU5M2Z), BDY (XU5M3Z), BDZ (XU5M), BFZ (XU5JP)	08.1992→10.1995		7.05432.02.0	SM	EL mit Dichtring with O-ring für OE-Nummer: 1920 N1 for OE number: 1920 N1	
1.6 65-68 kW (88-92 PS) BFZ (XU5JP)	08.1992→08.1994		7.05432.02.0	SM	EL mit Dichtring with O-ring für OE-Nummer: 1920 N1 for OE number: 1920 N1	
1.6 65-68 kW (88-92 PS) BFZ (XU5JP)	08.1992→05.1997		7.05432.02.0	SM	EL mit Dichtring with O-ring für OE-Nummer: 1920 N1 for OE number: 1920 N1	
2.0 89-96 kW (121-131 PS) RFX (XU10J2)	08.1992→10.1995		7.05432.02.0	SM	EL mit Dichtring with O-ring	
2.0 T 16 X4 144 kW (196 PS) RGZ (XU10J4TE/Z)	08.1992→10.1995		7.05432.02.0	SM	EL mit Dichtring with O-ring	
2.0 X4 89-96 kW (121-131 PS) RFX (XU10J2)	08.1992→10.1995		7.05432.02.0	SM	EL mit Dichtring with O-ring	
405 II Break (4E)						37
1.6 65-71 kW (88-97 PS) BDY (XU5M2Z), BDY (XU5M3Z), BFZ (XU5JP)	08.1992→10.1996		7.05432.02.0	SM	EL mit Dichtring with O-ring für OE-Nummer: 1920 N1 for OE number: 1920 N1	
1.6 65-68 kW (88-92 PS) BFZ (XU5JP)	08.1992→08.1994		7.05432.02.0	SM	EL mit Dichtring with O-ring	
2.0 89-96 kW (121-131 PS) RFX (XU10J2)	08.1992→10.1996		7.05432.02.0	SM	EL mit Dichtring with O-ring	





405 II Break (4E) **37**

2.0 4x4 89-96 kW (121-131 PS) RFX (XU10J2)	08.1992→10.1996	 7.05432.02.0	SM	EL	mit Dichtring with O-ring
2.0 4x4 144 kW (196 PS) RGZ (XU10J4TE/Z)	08.1992→12.1995	 7.05432.02.0	SM	EL	mit Dichtring with O-ring

406 (8B) **38**

1.6 65-68 kW (88-92 PS) BFZ (XU5JP)	11.1995→05.2004	 7.02256.05.0	OEL-HV	EH	mit Dichtring with O-ring
		7.05432.02.0	SM	EL	
1.8 74 kW (101 PS) L6A (XU7JP)	10.1996→03.1999	 7.05432.02.0	SM	EL	mit Dichtring with O-ring
1.8 66 kW (90 PS) LFX (XU7JB)	05.1997→05.2004	 7.02256.05.0	OEL-HV	EH	mit Dichtring with O-ring
		7.05432.06.0	SM	EL	
1.8 16V 76-86 kW (103-117 PS) LFY (XU7JP4)	11.1995→10.2000	 7.02256.05.0	OEL-HV	EH	mit Dichtring with O-ring für OE-Nummer: 1920 4X for OE number: 1920 4X
		7.05432.06.0	SM	EL	
1.8 16V 85 kW (116 PS) 6FZ (EW7J4)	10.2000→05.2004	 7.02256.05.0	OEL-HV	EH	
2.0 16V 97-100 kW (132-136 PS) RFV (XU10J4R)	11.1995→05.2004	 7.02256.05.0	OEL-HV	EH	
2.0 16V 99 kW (135 PS) RFR (EW10J4)	01.1999→08.2000	 7.02256.05.0	OEL-HV	EH	
2.0 16V 100-105 kW (136-143 PS) RFN (EW10J4)	08.2000→06.2004	 7.02256.05.0	OEL-HV	EH	
2.0 HDI 110 79-80 kW (107-109 PS) RHZ (DW10ATED)	06.1998→08.2001	 7.02256.23.0	DW-AGR	EP	
		7.02256.24.0	DW-AGR	EP	
		7.02256.24.0	DW-RK	EP	
		7.02256.24.0	DW-TL	EP	
		7.02256.05.0	OEL-HV	EH	
2.0 HDI 90 66 kW (90 PS) RHY (DW10TD)	02.1999→05.2004	 7.02256.23.0	DW-AGR	EP	für OE-Nummer: 1628 HC for OE number: 1628 HC
		7.02256.24.0	DW-AGR	EP	für OE-Nummer: 1628 LQ for OE number: 1628 LQ
		7.02256.05.0	OEL-HV	EH	
2.0 HDi 110 79-80 kW (107-109 PS) RHS (DW10ATED), RHZ (DW10ATED)	08.2001→05.2004	 7.02256.23.0	DW-AGR	EP	
		7.02256.24.0	DW-AGR	EP	
		7.02256.24.0	DW-RK	EP	
		7.02256.24.0	DW-TL	EP	
2.2 HDi 98 kW (133 PS) 4HX (DW12TED4)	03.2000→05.2004	 7.02256.24.0	DW-RK	EP	für OE-Nummer: 1628 LQ for OE number: 1628 LQ
		7.02256.23.0	DW-TL	EP	
		7.02256.05.0	OEL-HV	EH	





















406 Break (8E/F) **39**

1.8 74 kW (101 PS) L6A (XU7JP)	10.1996→03.1999	 7.05432.02.0	SM	EL	mit Dichtring with O-ring
1.8 66 kW (90 PS) LFX (XU7JB)	05.1997→10.2004	 7.02256.05.0	OEL-HV	EH	mit Dichtring with O-ring
		7.05432.06.0	SM	EL	

P







406 Break (8E/F) 39

1.8 16V 76-86 kW (103-117 PS) LFY (XU7JP4)	10.1996→10.2000	 7.02256.05.0	OEL-HV	EH	mit Dichtring with O-ring für OE-Nummer: 1920 4X for OE number: 1920 4X
		 7.05432.06.0	SM	EL	
1.8 16V 85 kW (116 PS) 6FZ (EW7J4)	10.2000→10.2004	 7.02256.05.0	OEL-HV	EH	
2.0 16V 97-100 kW (132-136 PS) RFV (XU10J4R)	10.1996→10.2004	 7.02256.05.0	OEL-HV	EH	
2.0 16V 99 kW (135 PS) RFR (EW10J4)	01.1999→10.2000	 7.02256.05.0	OEL-HV	EH	
2.0 16V 100-105 kW (136-143 PS) RFN (EW10J4)	10.2000→10.2004	 7.02256.05.0	OEL-HV	EH	
2.0 HDi 110 79-80 kW (107-109 PS) RHZ (DW10ATED)	02.1999→04.2004	 7.02256.23.0	DW-AGR	EP	
		 7.02256.24.0	DW-AGR	EP	
		 7.02256.24.0	DW-RK	EP	
		 7.02256.24.0	DW-TL	EP	
2.0 HDi 90 66 kW (90 PS) RHY (DW10TD)	02.1999→10.2004	 7.02256.23.0	DW-AGR	EP	für OE-Nummer: 1628 HC for OE number: 1628 HC
		 7.02256.24.0	DW-AGR	EP	für OE-Nummer: 1628 LQ for OE number: 1628 LQ
		 7.02256.05.0	OEL-HV	EH	
2.0 HDi 110 79-80 kW (107-109 PS) RHS (DW10ATED), RHZ (DW10ATED)	08.2001→10.2004	 7.02256.23.0	DW-AGR	EP	
		 7.02256.24.0	DW-AGR	EP	
		 7.02256.24.0	DW-RK	EP	
		 7.02256.24.0	DW-TL	EP	
2.2 HDi 98 kW (133 PS) 4HX (DW12TED4)	03.2000→10.2004	 7.02256.24.0	DW-RK	EP	für OE-Nummer: 1628 LQ for OE number: 1628 LQ
		 7.02256.23.0	DW-TL	EP	
		 7.02256.05.0	OEL-HV	EH	

406 Coupe (8C) 40



















2.0 16V 97-100 kW (132-136 PS) RFV (XU10J4R)	03.1997→12.2004	 7.02256.05.0	OEL-HV	EH	
2.0 16V 99 kW (135 PS) RFR (EW10J4)	01.1999→10.2000	 7.02256.05.0	OEL-HV	EH	
2.0 16V 97-100 kW (132-136 PS) RFV (XU10J4R)	04.1999→09.2004	 7.02256.05.0	OEL-HV	EH	
2.0 16V 97-105 kW (132-143 PS) RFN (EW10J4), RFV (XU10J4R)	10.2000→12.2004	 7.02256.05.0	OEL-HV	EH	
2.2 HDi 98 kW (133 PS) 4HX (DW12TED4)	03.2000→12.2004	 7.02256.24.0	DW-RK	EP	für OE-Nummer: 1628 LQ for OE number: 1628 LQ
		 7.02256.23.0	DW-TL	EP	
		 7.02256.05.0	OEL-HV	EH	

407 (6D_) 41

1.6 HDi 110 80-84 kW (109-114 PS) 9HZ (DV6TED4)	05.2004→12.2010	 7.00968.04.0	DW-TL	EP	
		 7.02256.05.0	OEL-HV	EH	
1.8 85 kW (116 PS) 6FZ (EW7J4)	03.2004→07.2005	 7.02256.05.0	OEL-HV	EH	
1.8 16V 92 kW (125 PS) 6FY (EW7A)	08.2005→12.2010	 7.02256.05.0	OEL-HV	EH	
2.0 100-105 kW (136-143 PS) RFN (EW10J4)	03.2004→07.2005	 7.02256.05.0	OEL-HV	EH	









407 (6D_) **41**

<p>2.0 16V 103-111 kW (140-151 PS) RFJ (EW10A)</p>	<p>09.2005→12.2010</p>	<p> 7.02256.05.0 7.06117.34.0</p>	<p>OEL-HV EH SV-NWV EL</p>	<p>mit Dichtring with O-ring Organisationsnummer bis: 10919 RPO number to: 10919</p>
<p>2.0 Bioflex 103-111 kW (140-151 PS) RFJ (EW10A)</p>	<p>09.2007→02.2011</p>	<p> 7.02256.05.0</p>	<p>OEL-HV EH</p>	
<p>2.0 HDi 93 kW (126 PS) RHL (DW10BTED4)</p>	<p>11.2004→10.2007</p>	<p> 7.00612.01.0</p>	<p>DW-TL EP</p>	<p> RHL (DW10BTED4): Schaltgetriebe Manual Transmission  RHL (DW10BTED4): →02.2006 Getriebeautomatik 6 Gang 6-Speed Automatic Transmission Organisationsnummer bis: 10702 RPO number to: 10702</p>
<p>2.0 HDi 100-103 kW (136-140 PS) RHR (DW10BTED4)</p>	<p>06.2009→12.2010</p>	<p> 7.01632.02.0 7.00612.01.0 7.02256.05.0</p>	<p>DW-RK EP DW-TL EP OEL-HV EH</p>	<p> RHR (DW10BTED4): Schaltgetriebe Manual Transmission Organisationsnummer ab: 10780 RPO number from: 10780 Organisationsnummer bis: 10765 RPO number to: 10765 Herstellereinschränkung: Delphi Manufacturer Restriction: Delphi  RHR (DW10BTED4): Getriebeautomatik 6 Gang 6-Speed Automatic Transmission Organisationsnummer ab: 10703 RPO number from: 10703</p>
<p>2.0 HDi 120 kW (163 PS) RHH (DW10CTED4)</p>	<p>06.2009→12.2010</p>	<p> 7.02256.05.0</p>	<p>OEL-HV EH</p>	
<p>2.0 HDi 135 100-103 kW (136-140 PS) RHR (DW10BTED4)</p>	<p>05.2004→10.2010</p>	<p> 7.01632.02.0 7.00612.01.0 7.01633.04.0 7.02256.05.0</p>	<p>DW-RK EP DW-TL EP DW-TL EP OEL-HV EH</p>	<p> RHR (DW10BTED4): Schaltgetriebe Manual Transmission Organisationsnummer ab: 10780 RPO number from: 10780 Organisationsnummer bis: 10765 RPO number to: 10765 Herstellereinschränkung: Delphi Manufacturer Restriction: Delphi  RHR (DW10BTED4): Getriebeautomatik 6 Gang 6-Speed Automatic Transmission Organisationsnummer ab: 10703 RPO number from: 10703  RHR (DW10BTED4): Schaltgetriebe Manual Transmission  RHR (DW10BTED4): →02.2006 Getriebeautomatik 6 Gang 6-Speed Automatic Transmission Organisationsnummer bis: 10702 RPO number to: 10702</p>
<p>2.2 116 kW (158 PS) 3FZ (EW12J4)</p>	<p>03.2004→10.2006</p>	<p> 7.02256.05.0</p>	<p>OEL-HV EH</p>	
<p>2.2 16V 120 kW (163 PS) 3FY (EW12J4)</p>	<p>08.2005→12.2010</p>	<p> 7.02256.05.0</p>	<p>OEL-HV EH</p>	
<p>2.2 HDi 120 kW (163 PS) 4HP (DW12BTED4)</p>	<p>03.2006→12.2010</p>	<p> 7.01633.04.0</p>	<p>DW-TL EP</p>	<p>für Fahrzeuge mit Diesel-Partikel-Filter (DPF) for vehicles with diesel soot filter</p>
<p>2.2 HDi 170 125 kW (170 PS) 4HT (DW12BTED4)</p>	<p>03.2006→12.2010</p>	<p> 7.01633.04.0</p>	<p>DW-TL EP</p>	<p>für Fahrzeuge mit Diesel-Partikel-Filter (DPF) for vehicles with diesel soot filter</p>













P



407 Coupe (6C_) 42

2.0 HDi 100-103 kW (136-140 PS) RHR (DW10BTED4)	10.2005→		7.01632.02.0	DW-RK	EP	 RHR (DW10BTED4): Schaltgetriebe Manual Transmission Organisationsnummer ab: 10780 RPO number from: 10780 Organisationsnummer bis: 10765 RPO number to: 10765 Herstellereinschränkung: Delphi Manufacturer Restriction: Delphi  RHR (DW10BTED4): Getriebeautomatik 6 Gang 6-Speed Automatic Transmission Organisationsnummer ab: 10703 RPO number from: 10703
			7.00612.01.0	DW-TL	EP	 RHR (DW10BTED4): Schaltgetriebe Manual Transmission  RHR (DW10BTED4): →02.2006 Getriebeautomatik 6 Gang 6-Speed Automatic Transmission Organisationsnummer bis: 10702 RPO number to: 10702
			7.01633.04.0	DW-TL	EP	
			7.02256.05.0	OEL-HV	EH	
2.0 HDi 120 kW (163 PS) RHH (DW10CTED4)	06.2009→		7.02256.05.0	OEL-HV	EH	
2.2 16V 120 kW (163 PS) 3FY (EW12J4)	10.2005→		7.02256.05.0	OEL-HV	EH	











407 SW (6E_) 43

1.6 HDi 110 80-84 kW (109-114 PS) 9HZ (DV6TED4)	05.2004→12.2010		7.00968.04.0	DW-TL	EP	
			7.02256.05.0	OEL-HV	EH	
1.8 85 kW (116 PS) 6FZ (EW7J4)	05.2004→07.2005		7.02256.05.0	OEL-HV	EH	
1.8 16V 92 kW (125 PS) 6FY (EW7A)	08.2005→12.2010		7.02256.05.0	OEL-HV	EH	
2.0 100-105 kW (136-143 PS) RFN (EW10J4)	05.2004→07.2005		7.02256.05.0	OEL-HV	EH	
2.0 16V 103-111 kW (140-151 PS) RFJ (EW10A)	08.2005→12.2010		7.02256.05.0	OEL-HV	EH	
			7.06117.34.0	SV-NWV	EL	mit Dichtring with O-ring Organisationsnummer bis: 10919 RPO number to: 10919
2.0 Bioflex 103-111 kW (140-151 PS) RFJ (EW10A)	01.2008→12.2010		7.02256.05.0	OEL-HV	EH	
2.0 Flex 103-111 kW (140-151 PS) RFJ (EW10A)	10.2005→02.2011		7.06117.34.0	SV-NWV	EL	mit Dichtring with O-ring Organisationsnummer bis: 10919 RPO number to: 10919
2.0 HDi 93 kW (126 PS) RHL (DW10BTED4)	11.2004→10.2007		7.00612.01.0	DW-TL	EP	 RHL (DW10BTED4): Schaltgetriebe Manual Transmission  RHL (DW10BTED4): →02.2006 Getriebeautomatik 6 Gang 6-Speed Automatic Transmission Organisationsnummer bis: 10702 RPO number to: 10702
2.0 HDi 100-103 kW (136-140 PS) RHR (DW10BTED4)	08.2008→12.2010		7.01632.02.0	DW-RK	EP	 RHR (DW10BTED4): Schaltgetriebe Manual Transmission Herstellereinschränkung: Delphi Manufacturer Restriction: Delphi  RHR (DW10BTED4): Getriebeautomatik 6 Gang 6-Speed Automatic Transmission

P











407 SW (6E_) **43**

			7.00612.01.0	DW-TL	EP	Schaltgetriebe Manual Transmission
			7.01633.04.0	DW-TL	EP	
			7.02256.05.0	OEL-HV	EH	
2.0 HDi 120 kW (163 PS) RHH (DW10CTED4)	06.2009→12.2010		7.02256.05.0	OEL-HV	EH	
2.0 HDi 135 100-103 kW (136-140 PS) RHR (DW10BTED4)	07.2004→12.2010		7.01632.02.0	DW-RK	EP	 RHR (DW10BTED4): Schaltgetriebe Manual Transmission Organisationsnummer ab: 10780 RPO number from: 10780 Organisationsnummer bis: 10765 RPO number to: 10765 Herstellereinschränkung: Delphi Manufacturer Restriction: Delphi  RHR (DW10BTED4): Getriebeautomatik 6 Gang 6-Speed Automatic Transmission Organisationsnummer ab: 10703 RPO number from: 10703
			7.00612.01.0	DW-TL	EP	 RHR (DW10BTED4): Schaltgetriebe Manual Transmission  RHR (DW10BTED4): →02.2006 Getriebeautomatik 6 Gang 6-Speed Automatic Transmission Organisationsnummer bis: 10702 RPO number to: 10702
			7.01633.04.0	DW-TL	EP	
			7.02256.05.0	OEL-HV	EH	
2.2 116 kW (158 PS) 3FZ (EW12J4)	05.2004→07.2005		7.02256.05.0	OEL-HV	EH	
2.2 16V 120 kW (163 PS) 3FY (EW12J4)	08.2005→12.2010		7.02256.05.0	OEL-HV	EH	
2.2 HDi 120 kW (163 PS) 4HP (DW12BTED4)	06.2008→12.2010		7.01633.04.0	DW-TL	EP	für Fahrzeuge mit Diesel-Partikel-Filter (DPF) for vehicles with diesel soot filter
2.2 HDi 170 125 kW (170 PS) 4HT (DW12BTED4)	03.2006→12.2010		7.01633.04.0	DW-TL	EP	für Fahrzeuge mit Diesel-Partikel-Filter (DPF) for vehicles with diesel soot filter

P

5008 (0U_, 0E_) **44**













1.2 96 kW (131 PS) HNY (EB2DTS)	01.2015→03.2017		7.08681.09.0	EOV	EH	
			7.06117.45.0	SV-NWV	EL	
1.6 16V 85-90 kW (116-122 PS) 5FS (EP6C), 5FW (EP6)	09.2009→03.2017		7.06117.45.0	SV-NWV	EL	für Fahrzeuge mit Schaltgetriebe for vehicles with manual transmission
1.6 16V 115 kW (156 PS) 5FV (EP6CDT)	09.2009→03.2017		7.01777.18.0	DW-TL	EP	
			7.01115.08.0	SUV	EL	
			7.06117.45.0	SV-NWV	EL	
1.6 BlueHDi 120 85-88 kW (116-120 PS) BHZ (DV6FC)	05.2014→03.2017		7.08681.00.0	EOV	EH	Organisationsnummer ab: 14420 RPO number from: 14420
1.6 HDi 82-85 kW (112-116 PS) 9HR (DV6C)	08.2010→03.2017		7.01633.06.0	DW-TL	EP	
1.6 HDi 84-85 kW (114-116 PS) 9HD (DV6C)	03.2013→03.2017		7.01633.06.0	DW-TL	EP	
1.6 THP 163 120-127 kW (163-173 PS) 5GZ (EP6FDT)	02.2012→03.2017		7.01777.19.0	DW-TL	EP	für Fahrzeuge mit Automatikgetriebe for vehicles with automatic transmission
			7.01115.08.0	SUV	EL	
1.6 THP 165 120-127 kW (163-173 PS) 5GZ (EP6FDT)	02.2012→03.2017		7.01777.19.0	DW-TL	EP	für Fahrzeuge mit Automatikgetriebe for vehicles with automatic transmission





5008 (0U_, 0E_) 44

		7.01115.08.0	SUV	EL	für Fahrzeuge mit Automatikgetriebe for vehicles with automatic transmission
		7.06117.45.0	SV-NWV	EL	

5008 II (MC_, MJ_, MR_, M4_) 45







1.2 (MRHNYH, MRHNYW, MRHNSJ) 96 kW (131 PS) HNS (EB2ADTS)	12.2016→	 7.08681.09.0	EOV	EH	 HNS (EB2ADTS): Organisationsnummer ab: 14500CJ, 1533889 RPO number from: 14500CJ, 1533889 Euro 6d-Temp Euro 6d-Temp  HNS (EB2ADTS): Organisationsnummer ab: 14500CJ, 15575CJ, 1566689, 1588389 RPO number from: 14500CJ, 15575CJ, 1566689, 1588389 Euro 6d Euro 6d
1.2 (MRHNYH, MRHNYW, MRHNSJ) 96 kW (131 PS) HNY (EB2DTS)	12.2016→	 7.08681.09.0	EOV	EH	Organisationsnummer ab: 14500CJ, 1533889 RPO number from: 14500CJ, 1533889
				EL	Organisationsnummer ab: 14500CJ, 1533889 RPO number from: 14500CJ, 1533889
1.5 BlueHDi 130 96 kW (131 PS) YHZ (DV5RC)	02.2018→	 7.08681.00.0	EOV	EH	
1.6 110-112 kW (150-152 PS) 5GX (EP6FDTMD)	07.2018→	 7.01777.18.0	DW-TL	EP	
				EL	Organisationsnummer ab: 14500CJ, 1533889 RPO number from: 14500CJ, 1533889 für Fahrzeuge mit Automatikgetriebe for vehicles with automatic transmission
1.6 BlueHDi 100 73-75 kW (99-102 PS) BHY (DV6FD)	12.2016→	 7.08681.00.0	EOV	EH	
1.6 BlueHDi 115 85-88 kW (116-120 PS) BHX (DV6FC)	12.2016→	 7.08681.00.0	EOV	EH	
1.6 BlueHDi 120 85-88 kW (116-120 PS) BHZ (DV6FC)	12.2016→	 7.08681.00.0	EOV	EH	
1.6 PureTech 180 133 kW (181 PS) 5GF (EP6FADTXD)	07.2018→	 7.06117.45.0	SV-NWV	EL	Organisationsnummer ab: 14500CJ, 1533889 RPO number from: 14500CJ, 1533889 für Fahrzeuge mit Automatikgetriebe for vehicles with automatic transmission
				EL	
1.6 THP 165 120-127 kW (163-173 PS) 5GY (EP6FDTM)	12.2016→	 7.01777.19.0	DW-TL	EP	für Fahrzeuge mit Automatikgetriebe for vehicles with automatic transmission
				EL	
1.6 THP 165 120-127 kW (163-173 PS) 5GZ (EP6FDT)	12.2016→	 7.01777.19.0	DW-TL	EP	für Fahrzeuge mit Automatikgetriebe for vehicles with automatic transmission
				EL	
				EL	für Fahrzeuge mit Automatikgetriebe for vehicles with automatic transmission
		7.01115.08.0	SUV	EL	
		7.06117.45.0	SV-NWV	EL	

508 I (8D_) 46



1.6 BlueHDi 120 85-88 kW (116-120 PS) BHZ (DV6FC)	03.2014→12.2018	 7.08681.00.0	EOV	EH	Organisationsnummer ab: 14420 RPO number from: 14420
1.6 HDi 82-85 kW (112-116 PS) 9HL (DV6C), 9HR (DV6C)	11.2010→12.2018	 7.01633.06.0	DW-TL	EP	









508 I (8D_) **46**

1.6 HDi 84 kW (114 PS) 9HD (DV6CTED)	02.2012→12.2018	 7.01633.06.0	DW-TL	EP	
1.6 HDi 85-88 kW (116-120 PS) BHX (DV6FC)	09.2014→12.2018	 7.08681.00.0	EOV	EH	Organisationsnummer ab: 14420 RPO number from: 14420
1.6 THP 115 kW (156 PS) 5FV (EP6CDT)	11.2010→12.2018	 7.01777.18.0	DW-TL	EP	
		7.01115.08.0	SUV	EL	
		7.06117.45.0	SV-NWV	EL	
1.6 THP 110 kW (150 PS) 5FN (EP6CDT)	11.2010→12.2018	 7.01777.18.0	DW-TL	EP	
		7.01115.08.0	SUV	EL	
1.6 THP 120-127 kW (163-173 PS) 5GZ (EP6FDT)	09.2011→12.2018	 7.01777.19.0	DW-TL	EP	
		7.01115.08.0	SUV	EL	
		7.06117.45.0	SV-NWV	EL	
1.6 THP 120-127 kW (163-173 PS) 5GZ (EP6FDT)	01.2012→12.2018	 7.01777.19.0	DW-TL	EP	
		7.01115.08.0	SUV	EL	
1.6 VTi 85-90 kW (116-122 PS) 5FS (EP6C)	11.2010→12.2018	 7.06117.45.0	SV-NWV	EL	

508 II (FB_, FH_, F3_) **47**



1.5 BlueHDi 130 (FBYHZJ, FBYHZR) 96 kW (131 PS) YHZ (DV5RC)	10.2018→	 7.08681.00.0	EOV	EH	
1.6 PureTech 180 (F35GFR) 133 kW (181 PS) 5GF (EP6FADTXD)	10.2018→	 7.06117.45.0	SV-NWV	EL	für Fahrzeuge mit Automatikgetriebe for vehicles with automatic transmission
1.6 PureTech 225 (F35GGR) 162-165 kW (220-225 PS) 5GG (EP6FADTX)	10.2018→	 7.06117.45.0	SV-NWV	EL	für Fahrzeuge mit Automatikgetriebe for vehicles with automatic transmission
1.6 THP 150 (F35GXV) 110-112 kW (150-152 PS) 5GX (EP6FDTMD)	09.2018→	 7.01777.19.0	DW-TL	EP	
1.6 THP 165 (F35GYV) 120-127 kW (163-173 PS) 5GY (EP6FDTM)	09.2018→	 7.01777.19.0	DW-TL	EP	
		7.01115.08.0	SUV	EL	
PureTech 130 (FBHNSR) 96 kW (131 PS) HNS (EB2ADTS)	06.2020→	 7.08681.09.0	EOV	EH	Euro 6d Euro 6d

508 SW I (8E_) **48**

1.6 120-127 kW (163-173 PS) 5GZ (EP6FDT)	02.2012→12.2018	 7.01777.19.0	DW-TL	EP	
		7.01115.08.0	SUV	EL	
		7.06117.45.0	SV-NWV	EL	
1.6 BlueHDi 120 85-88 kW (116-120 PS) BHZ (DV6FC)	03.2014→12.2018	 7.08681.00.0	EOV	EH	Organisationsnummer ab: 14420 RPO number from: 14420
1.6 HDi 82-85 kW (112-116 PS) 9HL (DV6C), 9HR (DV6C)	11.2010→12.2018	 7.01633.06.0	DW-TL	EP	
1.6 HDi 82-85 kW (112-116 PS) 9HL (DV6C), 9HR (DV6C)	02.2012→12.2018	 7.01633.06.0	DW-TL	EP	
1.6 HDi 85-88 kW (116-120 PS) BHX (DV6FC)	09.2014→12.2018	 7.08681.00.0	EOV	EH	Organisationsnummer ab: 14420 RPO number from: 14420
1.6 THP 115 kW (156 PS) 5FV (EP6CDT)	11.2010→12.2018	 7.01777.18.0	DW-TL	EP	
		7.01115.08.0	SUV	EL	







508 SW I (8E_) 48

1.6 THP 110 kW (150 PS) 5FE (EP6CDTM), 5FN (EP6CDT)	11.2010→12.2018	 7.06117.45.0	SV-NWV	EL	
		 7.01777.18.0	DW-TL	EP	
1.6 VTi 85-90 kW (116-122 PS) 5FS (EP6C)	11.2010→12.2018	 7.06117.45.0	SV-NWV	EL	





508 SW II (FC_, FJ_, F4_) 49

1.5 BlueHDi 130 96 kW (131 PS) YHZ (DV5RC)	09.2018→	 7.08681.00.0	EOV	EH	
1.6 PureTech 180 133 kW (181 PS) GFR (EP6FADTXD)	09.2018→	 7.06117.45.0	SV-NWV	EL	für Fahrzeuge mit Automatikgetriebe for vehicles with automatic transmission
1.6 PureTech 225 (F45GGR) 165 kW (224 PS) GCR (EP6FADTX)	09.2018→	 7.06117.45.0	SV-NWV	EL	für Fahrzeuge mit Automatikgetriebe for vehicles with automatic transmission
PureTech 130 96 kW (131 PS) HNS (EB2ADTS)	06.2020→	 7.08681.09.0	EOV	EH	Euro 6d Euro 6d

607 (9D, 9U) 50

2.0 HDI 79-80 kW (107-109 PS) RHZ (DW10ATED)	05.2000→09.2005	 7.02256.23.0	DW-AGR	EP	
		7.02256.23.0	DW-TL	EP	
		7.02256.24.0	DW-RK	EP	
		7.02256.24.0	DW-TL	EP	
2.0 HDI 100-103 kW (136-140 PS) RHR (DW10BTED4)	09.2005→07.2011	 7.00968.04.0	DW-TL	EP	
		7.01633.04.0	DW-TL	EP	Organisationsnummer ab: 10738 RPO number from: 10738 für Fahrzeuge mit Diesel-Partikel-Filter (DPF) for vehicles with diesel soot filter
2.0 HDi 79 kW (107 PS) RHS (DW10ATED)	03.2001→09.2004	 7.02256.23.0	DW-AGR	EP	
		7.02256.23.0	DW-TL	EP	
		7.02256.24.0	DW-RK	EP	
		7.02256.24.0	DW-TL	EP	
2.2 HDi 98 kW (133 PS) 4HX (DW12TED4)	02.2000→02.2006	 7.02256.24.0	DW-AGR	EP	
		7.02256.23.0	DW-TL	EP	
2.2 HDi 125 kW (170 PS) 4HT (DW12BTED4)	05.2006→06.2010	 7.01633.04.0	DW-TL	EP	für Fahrzeuge mit Diesel-Partikel-Filter (DPF) for vehicles with diesel soot filter

806 (221) 51









1.8 73 kW (99 PS) LFW (XU7JP)	07.1995→08.2002	 7.02256.05.0	OEL-HV	EH	
		7.05432.02.0	SM	EL	mit Dichtring with O-ring
2.0 89-90 kW (121-123 PS) RFU (XU10J2)	06.1994→08.2002	 7.02256.05.0	OEL-HV	EH	
		7.05432.02.0	SM	EL	mit Dichtring with O-ring
2.0 16V 97-100 kW (132-136 PS) RFV (XU10J4R)	05.1998→09.2000	 7.02256.05.0	OEL-HV	EH	
2.0 16V 100-105 kW (136-143 PS) RFN (EW10J4)	09.2000→08.2002	 7.02256.05.0	OEL-HV	EH	
2.0 HDI 79-80 kW (107-109 PS) RHZ (DW10ATED)	08.1999→08.2002	 7.02256.24.0	DW-AGR	EP	
		7.02256.24.0	DW-TL	EP	
		7.02256.05.0	OEL-HV	EH	



806 (221) **51**

2.0 HDi 16V 79-80 kW (107-109 PS) RHW (DW10ATED4)	08.1999→08.2002		7.02256.24.0	DW-AGR	EP	
		7.02256.24.0	DW-RK	EP		
		7.02256.24.0	DW-TL	EP		
		7.02256.05.0	OEL-HV	EH		



807 (EB_) **52**

2.0 16V 103-111 kW (140-151 PS) RFJ (EW10A)	09.2005→		7.06117.34.0	SV-NWV	EL	mit Dichtring with O-ring Organisationsnummer bis: 10919 RPO number to: 10919
2.0 HDi 100-103 kW (136-140 PS) RHR (DW10BTED4)	06.2006→		7.01632.02.0	DW-RK	EP	Organisationsnummer bis: 10990 RPO number to: 10990
			7.01633.04.0	DW-TL	EP	für Fahrzeuge mit Diesel-Partikel-Filter (DPF) for vehicles with diesel soot filter
2.0 HDi 79-80 kW (107-109 PS) RHM (DW10ATED4), RHT (DW10ATED4), RHW (DW10ATED4)	06.2002→05.2006		7.02256.23.0	DW-RK	EP	
			7.02256.23.0	DW-TL	EP	
			7.02256.24.0	DW-AGR	EP	
			7.02256.24.0	DW-TL	EP	
2.0 HDi 79-80 kW (107-109 PS) RHW (DW10ATED4)	04.2004→		7.02256.23.0	DW-RK	EP	für OE-Nummer: 1628 HC for OE number: 1628 HC
			7.02256.23.0	DW-TL	EP	für OE-Nummer: 1628 HC for OE number: 1628 HC
			7.02256.24.0	DW-AGR	EP	für OE-Nummer: 1628 LQ for OE number: 1628 LQ
			7.02256.24.0	DW-TL	EP	für OE-Nummer: 1628 LQ for OE number: 1628 LQ
2.0 HDi 79-88 kW (107-120 PS) RHK (DW10UTED4)	02.2006→		7.01632.02.0	DW-RK	EP	Organisationsnummer bis: 10990 RPO number to: 10990
			7.01633.04.0	DW-TL	EP	Organisationsnummer bis: 11381 RPO number to: 11381
2.2 HDi 94-100 kW (128-136 PS) 4HW (DW12TED4)	04.2004→05.2006		7.02256.23.0	DW-RK	EP	
2.2 HDi 125 kW (170 PS) 4HT (DW12BTED4)	06.2006→		7.01633.04.0	DW-TL	EP	für Fahrzeuge mit Diesel-Partikel-Filter (DPF) for vehicles with diesel soot filter
2.2 HDi 120 kW (163 PS) 4HR (DW12BTED4)	06.2006→		7.01633.04.0	DW-TL	EP	für Fahrzeuge mit Diesel-Partikel-Filter (DPF) for vehicles with diesel soot filter







BIPPER TEPEE **53**

1.3 HDi 75 55 kW (75 PS) FHZ (F13DTE5)	10.2010→		7.03003.01.0	DW-TL	EP	für OE-Nummer: 2574 24 for OE number: 2574 24
			7.01981.07.0	SV-AGR-K	EP	
			7.08681.03.0	SV-HYAT	EH	
			7.08681.04.0	SV-HYAT	EH	
			7.08681.05.0	SV-HYAT	EH	
			7.08681.06.0	SV-HYAT	EH	











PARTNER MPV (5_, G_) **54**

1.6 HDi 75 55 kW (75 PS) 9HW (DV6BTED4)	08.2005→07.2008		7.00968.04.0	DW-TL	EP	
1.6 HDi 90 66-68 kW (90-92 PS) 9HX (DV6ATED4)	08.2005→12.2015		7.00968.04.0	DW-TL	EP	
1.8 66 kW (90 PS) LFX (XU7JB)	05.1997→12.2002		7.05432.06.0	SM	EL	mit Dichtring with O-ring















PARTNER MPV (5_, G_)
54

1.9 D 51 kW (69 PS) WJY (DW8B)	01.1999→07.2008	 7.02256.24.0	DW-RK	EP	
1.9 D 4x4 51 kW (69 PS) WJY (DW8B)	04.2004→08.2005	 7.02256.24.0	DW-RK	EP	
2.0 HDi 66 kW (90 PS) RHY (DW10TD)	02.2000→07.2008	 7.02256.24.0	DW-AGR	EP	
2.0 HDi 4x4 66 kW (90 PS) RHY (DW10TD)	04.2004→08.2005	 7.02256.24.0	DW-RK	EP	
		 7.02256.24.0	DW-AGR	EP	
		 7.02256.24.0	DW-RK	EP	























PARTNER TEPEE
55



















1.2 THP 81 kW (110 PS) HNZ (EB2DT)	02.2016→	 7.08681.09.0	EOV	EH	
		 7.06117.45.0	SV-NWV	EL	
1.6 BlueHDi 100 73-75 kW (99-102 PS) BHY (DV6FD)	12.2014→	 7.08681.00.0	EOV	EH	Organisationsnummer ab: 14420 RPO number from: 14420
		 7.08681.00.0	EOV	EH	Organisationsnummer ab: 14420 RPO number from: 14420
1.6 HDi 80-84 kW (109-114 PS) 9HZ (DV6TED4)	04.2008→	 7.00968.04.0	DW-TL	EP	
1.6 HDi 82-85 kW (112-116 PS) 9HL (DV6C)	08.2010→	 7.01633.06.0	DW-TL	EP	
1.6 HDi 82-85 kW (112-116 PS) 9HL (DV6C)	03.2013→	 7.01633.06.0	DW-TL	EP	
1.6 HDi / BlueHDi 75 55 kW (75 PS) BHW (DV6FE)	06.2008→12.2018	 7.08681.00.0	EOV	EH	Organisationsnummer ab: 14420 RPO number from: 14420
		 7.00968.04.0	DW-TL	EP	
1.6 VTi 85-90 kW (116-122 PS) 5FS (EP6C)	09.2009→04.2016	 7.06117.45.0	SV-NWV	EL	
1.6 VTi 72 kW (98 PS) 5FK (EP6CB)	08.2010→	 7.06117.45.0	SV-NWV	EL	

























RCZ
56

1.6 16V 115 kW (156 PS) 5FV (EP6CDT)	03.2010→12.2015	 7.01777.18.0	DW-TL	EP	
		 7.01115.08.0	SUV	EL	
		 7.06117.45.0	SV-NWV	EL	
1.6 16V 147-150 kW (200-204 PS) EP6CDTX	06.2010→12.2015	 7.01777.19.0	DW-TL	EP	
		 7.01115.08.0	SUV	EL	
		 7.06117.45.0	SV-NWV	EL	
1.6 16V 147-150 kW (200-204 PS) EP6CDTX	06.2010→12.2015	 7.01777.19.0	DW-TL	EP	
		 7.01115.08.0	SUV	EL	
		 7.01777.18.0	DW-TL	EP	
1.6 16V 115-127 kW (156-173 PS) 5FM (EP6CDTM)	01.2011→12.2015	 7.01115.08.0	SUV	EL	
		 7.06117.45.0	SV-NWV	EL	für Fahrzeuge mit Automatikgetriebe for vehicles with automatic transmission
		 7.01777.18.0	DW-TL	EP	
1.6 THP 150 110 kW (150 PS) 5FE (EP6CDTMD)	03.2011→12.2015	 7.01115.08.0	SUV	EL	
		 7.06117.45.0	SV-NWV	EL	für Fahrzeuge mit Automatikgetriebe for vehicles with automatic transmission
		7.01777.18.0	DW-TL	EP	

P









					
RCZ 56					
1.6 THP 270 199 kW (270 PS) 5FG (EP6CDTR)	06.2013→12.2015		7.01777.19.0 7.01115.08.0 7.06117.45.0	DW-TL SUV SV-NWV	EP EL EL
RIFTER 57					
1.2 PureTech 110 81 kW (110 PS) HNP (EB2ADT)	09.2018→		7.08681.09.0	EOV	EH  HNP (EB2ADT): Euro 6d-Temp Euro 6d-Temp  HNP (EB2ADT): Organisationsnummer ab: 15575 RPO number from: 15575 Euro 6d Euro 6d
1.2 PureTech 130 96 kW (131 PS) HNS (EB2ADTS)	07.2019→		7.08681.09.0	EOV	EH Organisationsnummer ab: 15575 RPO number from: 15575 Euro 6d Euro 6d
1.5 BlueHDi 100 75 kW (102 PS) YHY (DV5RD)	09.2018→		7.08681.00.0	EOV	EH
1.5 BlueHDi 130 96 kW (131 PS) YHZ (DV5RC)	09.2018→		7.08681.00.0	EOV	EH
1.5 BlueHDi 75 (ECYHW) 55 kW (75 PS) YHW (DV5RE)	09.2018→		7.08681.00.0	EOV	EH
206 Van 58					
1.4 HDi 50-52 kW (68-70 PS) 8HX (DV4TD), 8HZ (DV4TD)	09.2001→03.2009		7.00964.03.0	DW-AGR	EP  8HX (DV4TD), 8HZ (DV4TD): ab Euro 4 From Euro 4
207 Hatchback Van (WA_, WC_) 59					
1.6 HDi 66-68 kW (90-92 PS) 9HX (DV6ATED4)	04.2007→10.2012		7.00968.04.0	DW-TL	EP
306 Estate Van (N_, 7_) 60					
1.9 D 51 kW (69 PS) WJY (DW8B)	02.1999→08.2002		7.02256.24.0	DW-RK	EP
2.0 HDi 66 kW (90 PS) RHY (DW10TD)	08.1998→06.2000		7.02256.24.0	DW-AGR	EP
			7.02256.24.0	DW-RK	EP
306 Hatchback Van 61					
1.9 D 51 kW (69 PS) WJY (DW8B)	02.1999→08.2001		7.02256.24.0	DW-RK	EP
307 SW Estate Van (3E_, 3H_) 62					
1.4 HDi 50-52 kW (68-70 PS) 8HZ (DV4TD)	04.2002→06.2005		7.00964.03.0	DW-AGR	EP
2.0 HDi 79-80 kW (107-109 PS) RHZ (DW10ATED)	01.2003→12.2009		7.02256.23.0	DW-AGR	EP für OE-Nummer: 1628 HC for OE number: 1628 HC
			7.02256.24.0	DW-AGR	EP für OE-Nummer: 1628 LQ for OE number: 1628 LQ
			7.02256.24.0	DW-TL	EP für OE-Nummer: 1628 LQ for OE number: 1628 LQ
2.0 HDi 66 kW (90 PS) RHY (DW10TD)	04.2003→04.2008		7.00964.03.0	DW-AGR	EP ab Euro 4 From Euro 4
			7.00964.03.0	DW-RK	EP ab Euro 4 From Euro 4

						
307 SW Estate Van (3E_, 3H_) 62						
2.0 HDi 100-103 kW (136-140 PS) RHR (DW10BTED4)	04.2004→11.2007		7.00612.01.0	DW-TL	EP	05.2005→01.2006 Schaltgetriebe Manual Transmission Organisationsnummer bis: 10673 RPO number to: 10673 für Fahrzeuge mit Diesel-Partikel-Filter (DPF) for vehicles with diesel soot filter
			7.01633.04.0	DW-TL	EP	Schaltgetriebe Manual Transmission für Fahrzeuge mit Diesel-Partikel-Filter (DPF) for vehicles with diesel soot filter
308 Hatchback Van (LB_) 63						
1.6 e-HDi 115 (LB9HCG) 82-85 kW (112-116 PS) 9HC (DV6C)	03.2015→		7.01633.06.0	DW-TL	EP	
407 SW Estate Van (6E_) 64						
2.0 HDi 100-103 kW (136-140 PS) RHR (DW10BTED4)	06.2009→12.2010		7.01632.02.0	DW-RK	EP	 RHR (DW10BTED4): Schaltgetriebe Manual Transmission Herstellereinschränkung: Delphi Manufacturer Restriction: Delphi
			7.00612.01.0	DW-TL	EP	 RHR (DW10BTED4): Getriebeautomatik 6 Gang 6-Speed Automatic Transmission
			7.01633.04.0	DW-TL	EP	Schaltgetriebe Manual Transmission
508 SW Estate Van (8E_) 65						
1.6 HDi 82-85 kW (112-116 PS) 9HL (DV6C)	03.2013→12.2018		7.01633.06.0	DW-TL	EP	
BIPPER (AA_) 66						
1.3 HDi 75 55 kW (75 PS) FHZ (F13DTE5)	10.2010→		7.03003.01.0	DW-TL	EP	
			7.01981.07.0	SV-AGR-K	EP	
			7.08681.03.0	SV-HYAT	EH	für OE-Nummer: 2574 24 for OE number: 2574 24
			7.08681.04.0	SV-HYAT	EH	
			7.08681.05.0	SV-HYAT	EH	für OE-Nummer: 2574 22 for OE number: 2574 22
7.08681.06.0	SV-HYAT	EH				
BOXER Bus 67						
3.0 HDi 160 115-130 kW (156-177 PS) F1CE0481D (F30DT)	04.2006→		7.02256.03.0	DW-AGR	EP	
BOXER Bus (230P) 68						
2.0 i 80 kW (109 PS) RFW (XU10J2)	03.1994→04.2002		7.05432.02.0	SM	EL	mit Dichtring with O-ring
2.0 i 4x4 80 kW (109 PS) RFW (XU10J2)	08.1996→04.2002		7.05432.02.0	SM	EL	mit Dichtring with O-ring
2.8 D 64 kW (87 PS) 8140.63 (F28D)	01.1999→02.2002		7.02256.03.0	DW-AGR	EP	
2.8 HDi 92-94 kW (125-128 PS) 8140.43S (F28DTCR)	11.2000→04.2002		7.02256.03.0	DW-AGR	EP	
2.8 HDi 92-94 kW (125-128 PS) 8140.43S (F28DTCR)	10.2000→11.2001		7.02256.03.0	DW-AGR	EP	







						
BOXER Bus (230P)						68
2.8 HDi 4x4 92-94 kW (125-128 PS) 8140.43S (F28DTCR)	10.2000→04.2002		7.02256.03.0	DW-AGR	EP	
2.8 HDi All-wheel Drive 92-94 kW (125-128 PS) 8140.43S (F28DTCR)	10.2000→11.2001		7.02256.03.0	DW-AGR	EP	
BOXER Bus (244, Z_)						69
2.0 HDi 62 kW (84 PS) RHV (DW10TD)	04.2002→		7.02256.23.0	DW-AGR	EP	
			7.02256.24.0	DW-AGR	EP	
			7.02256.24.0	DW-RK	EP	
2.0 HDi 62 kW (84 PS) RHV (DW10UTD)	04.2002→		7.02256.23.0	DW-AGR	EP	
2.2 HDi 74 kW (101 PS) 4HY (DW12UTED)	04.2002→		7.02256.23.0	DW-AGR	EP	
			7.02256.24.0	DW-TL	EP	
2.8 HDi 92-94 kW (125-128 PS) 8140.43S (F28DTCR)	04.2002→		7.02256.03.0	DW-AGR	EP	
2.8 HDi 4x4 92-94 kW (125-128 PS) 8140.43S (F28DTCR)	04.2002→		7.02256.03.0	DW-AGR	EP	
BOXER Platform/Chassis						70
3.0 HDi 160 115-130 kW (156-177 PS) F1CE0481D (F30DT)	04.2006→		7.02256.03.0	DW-AGR	EP	
BOXER Platform/Chassis (244)						71
2.0 HDi 62 kW (84 PS) RHV (DW10TD), RHV (DW10UTD)	04.2002→		7.02256.23.0	DW-AGR	EP	
			7.02256.24.0	DW-AGR	EP	
			7.02256.24.0	DW-RK	EP	
2.2 HDi 74 kW (101 PS) 4HY (DW12UTED)	04.2002→		7.02256.23.0	DW-AGR	EP	
			7.02256.24.0	DW-TL	EP	
2.8 HDi 92-94 kW (125-128 PS) 8140.43S (F28DTCR)	04.2002→		7.02256.03.0	DW-AGR	EP	
2.8 HDi 4x4 92-94 kW (125-128 PS) 8140.43S (F28DTCR)	04.2002→		7.02256.03.0	DW-AGR	EP	
BOXER Platform/Chassis (ZCT_)						72
2.0 i 80 kW (109 PS) RFW (XU10J2)	06.1994→04.2002		7.05432.02.0	SM	EL mit Dichtring with O-ring	
2.8 D 64 kW (87 PS) 8140.63 (F28D)	01.1999→02.2002		7.02256.03.0	DW-AGR	EP	
2.8 HDi 92-94 kW (125-128 PS) 8140.43S (F28DTCR)	11.2000→04.2002		7.02256.03.0	DW-AGR	EP	
2.8 HDi 92-94 kW (125-128 PS) 8140.43S (F28DTCR)	10.2000→11.2001		7.02256.03.0	DW-AGR	EP	
2.8 HDi All-wheel Drive 92-94 kW (125-128 PS) 8140.43S (F28DTCR)	10.2000→11.2001		7.02256.03.0	DW-AGR	EP	
BOXER Van						73
3.0 HDi 160 115-130 kW (156-177 PS) F1CE0481D (F30DT)	04.2006→		7.02256.03.0	DW-AGR	EP	









BOXER Van (230L) 74

2.0 4x4 80 kW (109 PS) RFW (XU10J2)	03.1996→09.1998	 7.05432.02.0	SM	EL	mit Dichtring with O-ring
2.0 HDI 62 kW (84 PS) RHV (DW10UTD)	08.2001→04.2002	 7.02256.23.0	DW-AGR	EP	
2.0 i 80 kW (109 PS) RFW (XU10J2)	06.1994→04.2002	 7.05432.02.0	SM	EL	mit Dichtring with O-ring
2.8 D 64 kW (87 PS) 8140.63 (F28D)	01.1999→02.2002	 7.02256.03.0	DW-AGR	EP	
2.8 HDI 92-94 kW (125-128 PS) 8140.43S (F28DTCR)	11.2000→04.2002	 7.02256.03.0	DW-AGR	EP	
2.8 HDi 92-94 kW (125-128 PS) 8140.43S (F28DTCR)	10.2000→11.2001	 7.02256.03.0	DW-AGR	EP	
2.8 HDi 4x4 92-94 kW (125-128 PS) 8140.43S (F28DTCR)	10.2000→11.2001	 7.02256.03.0	DW-AGR	EP	
2.8 HDi 4x4 92-94 kW (125-128 PS) 8140.43S (F28DTCR)	10.2000→04.2002	 7.02256.03.0	DW-AGR	EP	



























BOXER Van (244) 75



















2.0 HDi 62 kW (84 PS) RHV (DW10TD)	04.2002→	 7.02256.23.0	DW-AGR	EP	
		7.02256.24.0	DW-AGR	EP	
		7.02256.24.0	DW-RK	EP	
2.0 HDi 62 kW (84 PS) RHV (DW10UTD)	04.2002→	 7.02256.23.0	DW-AGR	EP	
		7.02256.23.0	DW-AGR	EP	
2.2 HDi 74 kW (101 PS) 4HY (DW12UTED)	04.2002→	 7.02256.23.0	DW-AGR	EP	
		7.02256.24.0	DW-TL	EP	
2.8 HDi 92-94 kW (125-128 PS) 8140.43S (F28DTCR)	04.2002→	 7.02256.03.0	DW-AGR	EP	
2.8 HDi 92-94 kW (125-128 PS) 8140.43S (F28DTCR)	09.2005→09.2009	 7.02256.03.0	DW-AGR	EP	
2.8 HDi 4x4 92-94 kW (125-128 PS) 8140.43S (F28DTCR)	04.2002→	 7.02256.03.0	DW-AGR	EP	

EXPERT (224_) 76









1.6 58 kW (79 PS) 222A2 (1580 SPI)	02.1996→09.2000	 7.02256.05.0	OEL-HV	EH	
1.8 74-77 kW (101-105 PS) LFZ (XU7JP)	10.1996→09.2000	 7.02256.05.0	OEL-HV	EH	
		7.05432.02.0	SM	EL	mit Dichtring with O-ring
1.9 D 51 kW (69 PS) WJY (DW8B)	12.2003→12.2006	 7.02256.23.0	DW-RK	EP	Organisationsnummer ab: 09857 RPO number from: 09857 Produktionsdatum ab: 04.11.2003 Production date from: 04.11.2003
2.0 100-105 kW (136-143 PS) RFN (EW10J4)	07.2000→12.2006	 7.02256.05.0	OEL-HV	EH	
2.0 HDI 79-80 kW (107-109 PS) RHZ (DW10ATED)	07.2000→12.2006	 7.02256.24.0	DW-AGR	EP	
		7.02256.24.0	DW-TL	EP	
		7.02256.05.0	OEL-HV	EH	
2.0 HDI 80 kW (109 PS) RHZ (DW10BTED), RHZ (DW10BTED+), RHZ (DW10CTED)	07.2000→12.2006	 7.02256.05.0	OEL-HV	EH	
2.0 HDI 16V 79-80 kW (107-109 PS) RHW (DW10ATED4)	07.2000→12.2006	 7.02256.24.0	DW-AGR	EP	
		7.02256.24.0	DW-TL	EP	
		7.02256.05.0	OEL-HV	EH	

			 PIERBURG		
EXPERT (224_)					76
2.0 HDi 69 kW (94 PS) RHX (DW10BTED)	10.2000→10.2006		7.02256.24.0	DW-AGR	EP
			7.02256.24.0	DW-TL	EP
			7.02256.05.0	OEL-HV	EH
EXPERT Bus (V_)					77
1.5 BlueHDi 100 75 kW (102 PS) YHR (DV5RUCd)	06.2018→		7.08681.00.0	EOV	EH
					Produktionsdatum ab: 08.10.2018 Production date from: 08.10.2018
1.5 BlueHDi 120 88 kW (120 PS) YHV (DV5RUC)	06.2018→		7.08681.00.0	EOV	EH
EXPERT Platform/Chassis					78
2.0 HDi 120 79-88 kW (107-120 PS) RHK (DW10UTED4)	01.2007→		7.01633.04.0	DW-TL	EP
					Organisationsnummer bis: 11381 RPO number to: 11381
2.0 HDi 140 100-103 kW (136-140 PS) RHR (DW10BTED4)	01.2007→		7.01633.04.0	DW-TL	EP
					Organisationsnummer bis: 11381 RPO number to: 11381 für Fahrzeuge mit Diesel-Partikel-Filter (DPF) for vehicles with diesel soot filter
EXPERT Platform/Chassis (223)					79
1.6 58 kW (79 PS) 222A2 (1580 SPI)	02.1996→09.2000		7.02256.05.0	OEL-HV	EH
1.9 D 51 kW (69 PS) WJY (DW8B)	06.1998→09.2001		7.02256.23.0	DW-RK	EP
			7.02256.24.0	DW-RK	EP
			7.02256.24.0	DW-AGR	EP
2.0 HDi 69 kW (94 PS) RHX (DW10BTED)	10.2000→10.2006		7.02256.24.0	DW-AGR	EP
			7.02256.24.0	DW-TL	EP
2.0 HDi 79-80 kW (107-109 PS) RHW (DW10ATED4)	10.2000→10.2006		7.02256.24.0	DW-AGR	EP
			7.02256.24.0	DW-TL	EP
			7.02256.05.0	OEL-HV	EH
EXPERT Van (222)					80
1.6 58 kW (79 PS) 222A2 (1580 SPI)	02.1996→09.2000		7.02256.05.0	OEL-HV	EH
1.8 74-77 kW (101-105 PS) LFZ (XU7JP)	10.1996→09.2000		7.02256.05.0	OEL-HV	EH
			7.05432.02.0	SM	EL
					mit Dichtring with O-ring
1.9 D 70 51 kW (69 PS) WJY (DW8B)	12.1998→12.2006		7.02256.24.0	DW-RK	EP
			7.02256.23.0	DW-RK	EP
					→11.2003
					Organisationsnummer ab: 09857 RPO number from: 09857 Produktionsdatum ab: 04.11.2003 Production date from: 04.11.2003
2.0 100-105 kW (136-143 PS) RFN (EW10J4)	09.2002→12.2006		7.02256.05.0	OEL-HV	EH
2.0 HDi 69 kW (94 PS) RHX (DW10BTED)	07.2000→12.2006		7.02256.24.0	DW-AGR	EP
			7.02256.24.0	DW-TL	EP
			7.02256.05.0	OEL-HV	EH
2.0 HDi 79-80 kW (107-109 PS) RHZ (DW10ATED)	07.2000→12.2006		7.02256.24.0	DW-AGR	EP
			7.02256.24.0	DW-TL	EP
			7.02256.05.0	OEL-HV	EH
2.0 HDi 80 kW (109 PS) RHZ (DW10BTED), RHZ (DW10BTED+), RHZ (DW10CTED)	07.2000→12.2006		7.02256.05.0	OEL-HV	EH

						
EXPERT Van (222)						80
2.0 HDI 79-80 kW (107-109 PS) RHW (DW10ATED4)	07.2000→12.2006		7.02256.24.0	DW-AGR	EP	
			7.02256.24.0	DW-TL	EP	
			7.02256.05.0	OEL-HV	EH	
EXPERT Van (VF3A_, VF3U_, VF3X_)						81
2.0 16V 103-111 kW (140-151 PS) RFH (EW10A), RFJ (EW10A)	01.2007→		7.02256.05.0	OEL-HV	EH	
2.0 HDi 120 79-88 kW (107-120 PS) RHK (DW10UTED4)	01.2007→		7.01633.04.0	DW-TL	EP	Organisationsnummer bis: 11381 RPO number to: 11381
2.0 HDi 140 100-103 kW (136-140 PS) RHR (DW10BTED4)	01.2007→		7.01633.04.0	DW-TL	EP	Organisationsnummer bis: 11381 RPO number to: 11381 für Fahrzeuge mit Diesel-Partikel-Filter (DPF) for vehicles with diesel soot filter
EXPERT Van (V_)						82
1.5 BlueHDi 100 75 kW (102 PS) YHR (DV5RUCd)	06.2018→		7.08681.00.0	EOV	EH	Produktionsdatum ab: 08.10.2018 Production date from: 08.10.2018
1.5 BlueHDi 120 88 kW (120 PS) YHV (DV5RUC)	06.2018→		7.08681.00.0	EOV	EH	
PARTNER Box Body/MPV						83
1.2 THP 81 kW (110 PS) HNZ (EB2DT)	02.2016→		7.08681.09.0	EOV	EH	
			7.06117.45.0	SV-NWV	EL	
1.6 72 kW (98 PS) 5FK (EP6CB)	11.2010→		7.06117.45.0	SV-NWV	EL	
1.6 BlueHDi 100 73-75 kW (99-102 PS) BHY (DV6FD)	04.2015→		7.08681.00.0	EOV	EH	Organisationsnummer ab: 14420 RPO number from: 14420
1.6 HDi 55 kW (75 PS) 9HT (DV6BTED4), 9HT (DV6BUTED4), 9HW (DV6BTED4)	04.2008→		7.00968.04.0	DW-TL	EP	
1.6 HDi 80-84 kW (109-114 PS) 9HZ (DV6TED4)	04.2008→		7.00968.04.0	DW-TL	EP	
1.6 HDi 82-85 kW (112-116 PS) 9HL (DV6C)	08.2010→		7.01633.06.0	DW-TL	EP	
1.6 HDi 82-85 kW (112-116 PS) 9HL (DV6C)	03.2013→		7.01633.06.0	DW-TL	EP	
1.6 HDi / BlueHDi 75 55 kW (75 PS) BHW (DV6FE)	07.2011→		7.08681.00.0	EOV	EH	Organisationsnummer ab: 14420 RPO number from: 14420
1.6 HDi 16V 66 kW (90 PS) 9HS (DV6TED4BU), 9HX (DV6AUTED4)	04.2008→		7.00968.04.0	DW-TL	EP	
1.6 HDi 16V 4x4 66-68 kW (90-92 PS) 9HS (DV6TED4BU), 9HX (DV6ATED4)	04.2012→		7.00968.04.0	DW-TL	EP	
PARTNER Box Body/MPV (5_, G_)						84
1.6 HDi 75 55 kW (75 PS) 9HW (DV6BTED4)	08.2005→07.2008		7.00968.04.0	DW-TL	EP	
1.6 HDi 90 66-68 kW (90-92 PS) 9HX (DV6ATED4)	08.2005→12.2015		7.00968.04.0	DW-TL	EP	
1.8 66 kW (90 PS) LFX (XU7JB)	03.1997→08.2000		7.05432.06.0	SM	EL	mit Dichtring with O-ring
1.9 D 51 kW (69 PS) WJY (DW8B)	06.1996→12.2015		7.02256.24.0	DW-RK	EP	
1.9 D 4x4 51 kW (69 PS) WJY (DW8B)	04.2004→07.2011		7.02256.24.0	DW-RK	EP	

			 PIERBURG		
PARTNER Box Body/MPV (5_, G_) 84					
2.0 HDi 66 kW (90 PS) RHY (DW10TD)	04.2000→07.2008		7.02256.24.0	DW-AGR	EP
			7.02256.24.0	DW-RK	EP
2.0 HDi 4x4 66 kW (90 PS) RHY (DW10TD)	04.2004→08.2005		7.02256.24.0	DW-AGR	EP
			7.02256.24.0	DW-RK	EP
PARTNER Box Body/MPV (K9) 85					
1.2 PureTech 110 81 kW (110 PS) HNP (EB2ADT)	07.2019→		7.08681.09.0	EOV	EH  HNP (EB2ADT): Euro 6d-Temp Euro 6d-Temp  HNP (EB2ADT): Organisationsnummer ab: 15575 RPO number from: 15575 Euro 6d Euro 6d
1.2 PureTech 130 96 kW (131 PS) HNS (EB2ADTS)	07.2019→		7.08681.09.0	EOV	EH Organisationsnummer ab: 15575 RPO number from: 15575 Euro 6d Euro 6d
1.5 BlueHDI 130 96 kW (131 PS) YHZ (DV5RC)	09.2018→		7.08681.00.0	EOV	EH
PARTNER Platform/Chassis 86					
1.6 HDi 55 kW (75 PS) 9HT (DV6BTED4)	01.2009→		7.00968.04.0	DW-TL	EP
1.6 HDi 16V 66-68 kW (90-92 PS) 9HX (DV6ATED4)	01.2009→		7.00968.04.0	DW-TL	EP
PARTNER Platform/Chassis (5_, G_) 87					
1.9 D 51 kW (69 PS) WJY (DW8B)	01.1999→07.2008		7.02256.24.0	DW-RK	EP
TRAVELLER Bus (V_) 88					
1.5 BlueHDI 100 75 kW (102 PS) YHR (DV5RUCd)	06.2018→		7.08681.00.0	EOV	EH
1.5 BlueHDI 120 88 kW (120 PS) YHV (DV5RUC)	06.2018→		7.08681.00.0	EOV	EH Produktionsdatum ab: 02.07.2018 Production date from: 02.07.2018

P

					
3008					
1.6 THP 120 kW (163 PS) 5F06 10FJBZ (EP6CDTM)	01.2013→12.2014	 7.01115.08.0	SUV	EL	1
408					
1.6 THP 120-123 kW (163-167 PS) 5G02 10UF01 (EP6FDTM)	08.2014→	 7.01115.08.0	SUV	EL	2
508					
1.6 THP 120-123 kW (163-167 PS) 5G02 10UF01 (EP6FDTM)	01.2015→	 7.01115.08.0	SUV	EL	3

































POLESTAR 1 (P)

























1

<p>PHEV AWD 227 kW (309 PS) B 4204 T22</p>	<p>03.2018→</p>	<p> 7.05367.05.0</p>	<p>SUV EL</p>	
<p>PHEV AWD 227 kW (309 PS) B 4204 T22</p>	<p>10.2019→</p>	<p> 7.05367.05.0</p>	<p>SUV EL</p>	

P

						
G5 Coupe						1
2.2 116 kW (158 PS) LAP	09.2008→12.2010		7.06117.05.0	SV-NWV	EH	mit Dichtring with O-ring
			7.06117.06.0	SV-NWV	EH	mit Dichtring with O-ring
2.4 123-132 kW (167-180 PS) LE5	01.2007→12.2008		7.06117.05.0	SV-NWV	EH	mit Dichtring with O-ring
			7.06117.06.0	SV-NWV	EH	mit Dichtring with O-ring
G5 Saloon						2
2.2 116 kW (158 PS) LAP	09.2008→12.2010		7.06117.05.0	SV-NWV	EH	mit Dichtring with O-ring
			7.06117.06.0	SV-NWV	EH	mit Dichtring with O-ring
2.4 123-132 kW (167-180 PS) LE5	01.2007→12.2008		7.06117.05.0	SV-NWV	EH	mit Dichtring with O-ring
			7.06117.06.0	SV-NWV	EH	mit Dichtring with O-ring
G6						3
2.4 123-132 kW (167-180 PS) LE5	09.2007→12.2010		7.06117.05.0	SV-NWV	EH	mit Dichtring with O-ring
			7.06117.06.0	SV-NWV	EH	mit Dichtring with O-ring
2.4 Flexfuel 122-136 kW (166-185 PS) LE9	09.2009→12.2010		7.06117.05.0	SV-NWV	EH	mit Dichtring with O-ring
			7.06117.06.0	SV-NWV	EH	mit Dichtring with O-ring
3.6 147-197 kW (200-268 PS) LY7	09.2007→12.2009		7.06117.04.0	SV-NWV	EH	mit Wellendichtring With shaft sealing ring 2007 2007 2009 2009
G6 Coupe						4
3.6 147-197 kW (200-268 PS) LY7	09.2006→12.2009		7.06117.04.0	SV-NWV	EH	mit Wellendichtring With shaft sealing ring 2007 2007 2009 2009
G8 Saloon						5
3.6 147-197 kW (200-268 PS) LY7	09.2008→12.2009		7.06117.04.0	SV-NWV	EH	mit Wellendichtring With shaft sealing ring 2008 2008 2009 2009
PURSUIT Saloon						6
2.4 123-132 kW (167-180 PS) LE5	09.2005→12.2006		7.06117.05.0	SV-NWV	EH	mit Dichtring with O-ring
			7.06117.06.0	SV-NWV	EH	mit Dichtring with O-ring
SOLSTICE Convertible						7
2.0 194 kW (264 PS) LNF	09.2006→12.2009		5.02549.03.0*	EUV-VB	EL	mit Halter with holder 2007 2007 2010 2010
			↳7.01441.04.0	EUV-VB	EL	

					
SOLSTICE Convertible					7
			7.06117.05.0	SV-NWV	EH mit Dichtring with O-ring
			7.06117.06.0	SV-NWV	EH mit Dichtring with O-ring
2.4 VVTi 123-132 kW (167-180 PS) LE5	03.2005→12.2009		7.06117.05.0	SV-NWV	EH mit Dichtring with O-ring
			7.06117.06.0	SV-NWV	EH mit Dichtring with O-ring
SOLSTICE Coupe					8
2.0 194 kW (264 PS) LNF	09.2008→12.2009		5.02549.03.0*	EUV-VB	EL mit Halter with holder 2007 2007 2010 2010
			↳ 7.01441.04.0	EUV-VB	EL
			7.06117.05.0	SV-NWV	EH mit Dichtring with O-ring
			7.06117.06.0	SV-NWV	EH mit Dichtring with O-ring
2.4 VVTi 123-132 kW (167-180 PS) LE5	09.2005→12.2007		7.06117.05.0	SV-NWV	EH mit Dichtring with O-ring
			7.06117.06.0	SV-NWV	EH mit Dichtring with O-ring
TORRENT					9
3.6 147-197 kW (200-268 PS) LY7	09.2007→12.2009		7.06117.04.0	SV-NWV	EH mit Wellendichtring With shaft sealing ring 2008 2008 2009 2009
3.6 AWD 147-197 kW (200-268 PS) LY7	09.2007→12.2009		7.06117.04.0	SV-NWV	EH mit Wellendichtring With shaft sealing ring 2008 2008 2009 2009

						
718 BOXSTER (982)						1
2.0 184 kW (250 PS) MDD.PA	04.2016→		7.04638.01.0	DW-TL	EP	
2.0 (982320, 982321) 220 kW (300 PS) MDD.PB	04.2016→		7.04638.01.0	DW-TL	EP	
2.5 GTS (982340, 982341) 269 kW (365 PS) MDJ.UA, MDJ.UB	10.2017→		7.04638.01.0	DW-TL	EP	
2.5 S (982330, 982331) 257 kW (350 PS) MDD.NC	04.2016→		7.04638.01.0	DW-TL	EP	
718 CAYMAN (982)						2
2.0 184 kW (250 PS) MDD.PA	04.2016→		7.04638.01.0	DW-TL	EP	
2.0 (982120, 982121) 220 kW (300 PS) MDD.PB	04.2016→		7.04638.01.0	DW-TL	EP	
2.5 GTS (982140, 982141) 269 kW (365 PS) MDJ.UA, MDJ.UB	10.2017→		7.04638.01.0	DW-TL	EP	
S 2.5 (982130, 982131) 257 kW (350 PS) MDD.NC	04.2016→		7.04638.01.0	DW-TL	EP	
911 (993)						3
3.6 Carrera 4 210 kW (285-286 PS) M 64.21, M 64.23	08.1995→09.1997		7.22280.02.0	EUV-SR	EL	
3.6 Turbo 4 298-300 kW (405-408 PS) M 64.60	03.1995→09.1997		7.22280.02.0	EUV-SL	EL	
3.6 Turbo GT2 316 kW (430 PS) M 64.60R	03.1995→09.1997		7.22280.02.0	EUV-SL	EL	
3.6 Turbo GT2 4 316 kW (430 PS) M 64.60R	08.1995→09.1997		7.22280.02.0	EUV-SL	EL	
3.8 Carrera RS 221 kW (300 PS) M 64.20	06.1995→09.1997		7.22280.02.0	EUV-SR	EL	
911 (996)						4
3.4 Carrera 221 kW (301 PS) M 96.01, M 96.04	09.1997→09.2001		7.22098.04.0	AKF	EL	
			7.22280.02.0	EUV-LS	EL	
			7.22280.02.0	EUV-SL	EL	
3.4 Carrera 221-235 kW (301-320 PS) M 96.02	05.2001→08.2005		7.22098.04.0	AKF	EL	
					für OE-Nummer: 996 605 201 01 for OE number: 996 605 201 01	
3.4 Carrera 4 221 kW (301 PS) M 96.01	09.1997→09.2001		7.22098.04.0	AKF	EL	
					für OE-Nummer: 996 605 201 01 for OE number: 996 605 201 01	
3.4 Carrera 4 221 kW (301 PS) M 96.04	09.1997→09.2001		7.22098.04.0	AKF	EL	
			7.22280.02.0	EUV-SL	EL	
			7.22280.02.0	EUV-LS	EL	
3.4 Carrera 4 221-235 kW (301-320 PS) M 96.02	05.2001→08.2005		7.22098.04.0	AKF	EL	
					für OE-Nummer: 996 605 201 01 for OE number: 996 605 201 01	
			7.22280.02.0	EUV-LS	EL	
3.6 Carrera 235-254 kW (320-345 PS) M 96.03	10.2001→08.2005		7.22098.04.0	AKF	EL	
					für OE-Nummer: 996 605 201 01 for OE number: 996 605 201 01	
			7.22280.02.0	EUV-LS	EL	





P



911 (996) **4**

3.6 Carrera 4 235-254 kW (320-345 PS) M 96.03	10.2001→08.2005		7.22098.04.0	AKF	EL	für OE-Nummer: 996 605 201 01 for OE number: 996 605 201 01	
			7.22280.02.0	EUV-LS	EL		
3.6 Carrera 4S 235-254 kW (320-345 PS) M 96.03	02.2003→08.2005		7.22098.04.0	AKF	EL	für OE-Nummer: 996 605 201 01 for OE number: 996 605 201 01	
			7.22280.02.0	EUV-LS	EL		
3.6 Carrera S 235-254 kW (320-345 PS) M 96.03	02.2003→08.2005		7.22098.04.0	AKF	EL	für OE-Nummer: 996 605 201 01 for OE number: 996 605 201 01	
			7.22280.02.0	EUV-LS	EL		
3.6 GT2 309-355 kW (420-483 PS) M 96.70	04.2001→08.2005		7.22098.04.0	AKF	EL	für OE-Nummer: 996 605 201 01 for OE number: 996 605 201 01	
			7.22892.02.0	AKF	EL		für OE-Nummer: 996 605 213 01 for OE number: 996 605 213 01
			7.22687.39.0	EUV-LS	EL		
			7.22908.03.0	LDRV	EL		
3.6 GT2 309-355 kW (420-483 PS) M 96.70	10.2003→08.2005		7.22098.04.0	AKF	EL	für OE-Nummer: 996 605 201 01 for OE number: 996 605 201 01	
			7.22892.02.0	AKF	EL		für OE-Nummer: 996 605 213 01 for OE number: 996 605 213 01
			7.22687.39.0	EUV-LS	EL		
			7.22908.03.0	LDRV	EL		
3.6 GT3 265 kW (360 PS) M 96.76	03.1999→08.2005		7.22280.02.0	EUV-LS	EL		
3.6 GT3 280-283 kW (381-385 PS) M 96.79	03.2003→08.2005		7.22280.02.0	EUV-LS	EL		
			7.22687.39.0	EUV-LS	EL		
3.6 S 309-355 kW (420-483 PS) M 96.70	08.2004→08.2005		7.22098.04.0	AKF	EL	für OE-Nummer: 996 605 201 01 for OE number: 996 605 201 01	
			7.22892.02.0	AKF	EL		für OE-Nummer: 996 605 213 01 for OE number: 996 605 213 01
3.6 Turbo 4 309-355 kW (420-483 PS) M 96.70	06.2000→08.2005		7.22098.04.0	AKF	EL	für OE-Nummer: 996 605 201 01 for OE number: 996 605 201 01	
			7.22892.02.0	AKF	EL		für OE-Nummer: 996 605 213 01 for OE number: 996 605 213 01
			7.22687.39.0	EUV-LS	EL		
			7.22280.02.0	EUV-SL	EL		
3.6 Turbo 4S 309-355 kW (420-483 PS) M 96.70	02.2003→08.2005		7.22098.04.0	AKF	EL	für OE-Nummer: 996 605 201 01 for OE number: 996 605 201 01	
			7.22892.02.0	AKF	EL		für OE-Nummer: 996 605 213 01 for OE number: 996 605 213 01
			7.22687.39.0	EUV-LS	EL		
			7.22908.03.0	LDRV	EL		

911 (997) **5**

3.6 Carrera 235-242 kW (320-329 PS) M 96.05	07.2004→12.2008		7.22280.02.0	EUV-LS	EL	
3.6 Carrera 254 kW (345 PS) MA1.02	06.2008→12.2011		7.22280.02.0	EUV-LS	EL	
3.6 Carrera 4 235-242 kW (320-329 PS) M 96.05	07.2004→12.2008		7.22280.02.0	EUV-LS	EL	
3.6 Carrera 4 254 kW (345 PS) MA1.02	06.2008→12.2012		7.22280.02.0	EUV-LS	EL	



911 (997) 5

3.6 GT3 305 kW (415 PS) M 97.76	03.2006→12.2009	7.22280.02.0	EUV-SR	EL	
3.6 Turbo 353-462 kW (480-628 PS) M 97.70	03.2006→12.2009	7.22687.39.0	EUV-LS	EL	
3.8 Carrera 4S 261-264 kW (355-359 PS) M 97.01	07.2004→12.2008	7.22280.02.0	EUV-LS	EL	
3.8 Carrera 4S 280 kW (381 PS) M 97.01S	08.2005→12.2008	7.22280.02.0	EUV-LS	EL	
3.8 Carrera 4S 261-264 kW (355-359 PS) M 97.01	09.2005→12.2008	7.22280.02.0	EUV-LS	EL	
3.8 Carrera 4S 283-304 kW (385-413 PS) MA1.01	06.2008→12.2012	7.22280.02.0	EUV-LS	EL	
3.8 Carrera 4S / 4 GTS 283-304 kW (385-413 PS) MA1.01	06.2009→12.2012	7.22280.02.0	EUV-LS	EL	
3.8 Carrera S 261-264 kW (355-359 PS) M 97.01	07.2004→12.2008	7.22280.02.0	EUV-LS	EL	
3.8 Carrera S 280 kW (381 PS) M 97.01S	08.2005→12.2008	7.22280.02.0	EUV-LS	EL	
3.8 Carrera S 283-304 kW (385-413 PS) MA1.01	06.2008→12.2011	7.22280.02.0	EUV-LS	EL	
3.8 Carrera S / GTS 283-304 kW (385-413 PS) MA1.01	06.2009→12.2011	7.22280.02.0	EUV-AGK	EL	für Fahrzeuge mit Sport-Endschalldämpfer for vehicles with sport end silencer
3.8 GT3 320 kW (435 PS) M 97.77	05.2009→12.2011	7.22280.02.0	EUV-SR	EL	
3.8 GT3 RS 331 kW (450 PS) M 97.77R	08.2009→12.2011	7.22280.02.0	EUV-SR	EL	
4.0 GT3 RS 368 kW (500 PS) M 97.74	07.2011→12.2012	7.22280.02.0	EUV-SR	EL	

911 Convertible (993) 6

3.6 Carrera 210 kW (285-286 PS) M 64.21, M 64.24	08.1995→09.1997	7.22280.02.0	EUV-SR	EL	
--	-----------------	---------------------	--------	----	--

911 Convertible (996) 7

3.4 Carrera 221 kW (301 PS) M 96.01, M 96.04	02.1998→09.2001	7.22098.04.0	AKF	EL	M 96.01, M 96.04: für OE-Nummer: 996 605 201 01 for OE number: 996 605 201 01
		7.22280.02.0	EUV-LS	EL	
		7.22280.02.0	EUV-SL	EL	
3.4 Carrera 221-235 kW (301-320 PS) M 96.02	05.2001→08.2005	7.22098.04.0	AKF	EL	für OE-Nummer: 996 605 201 01 for OE number: 996 605 201 01
3.4 Carrera 4 221-235 kW (301-320 PS) M 96.02, M 96.04	02.1998→09.2001	7.22098.04.0	AKF	EL	M 96.02, M 96.04: für OE-Nummer: 996 605 201 01 for OE number: 996 605 201 01
		7.22280.02.0	EUV-LS	EL	
		7.22280.02.0	EUV-SL	EL	
3.4 Carrera 4 221-235 kW (301-320 PS) M 96.02	05.2001→08.2005	7.22098.04.0	AKF	EL	für OE-Nummer: 996 605 201 01 for OE number: 996 605 201 01
		7.22280.02.0	EUV-LS	EL	

















911 Convertible (996) **7**

3.6 Carrera 235-254 kW (320-345 PS) M 96.03	10.2001→08.2005		7.22098.04.0	AKF	EL	für OE-Nummer: 996 605 201 01 for OE number: 996 605 201 01	
			7.22280.02.0	EUV-SL	EL		
3.6 Carrera 4 235-254 kW (320-345 PS) M 96.03	10.2001→08.2005		7.22098.04.0	AKF	EL	für OE-Nummer: 996 605 201 01 for OE number: 996 605 201 01	
			7.22280.02.0	EUV-SL	EL		
3.6 Carrera 4S 235-254 kW (320-345 PS) M 96.03	06.2002→08.2005		7.22098.04.0	AKF	EL	für OE-Nummer: 996 605 201 01 for OE number: 996 605 201 01	
			7.22280.02.0	EUV-SL	EL		
3.6 Carrera S 235-254 kW (320-345 PS) M 96.03	06.2002→08.2005		7.22098.04.0	AKF	EL	für OE-Nummer: 996 605 201 01 for OE number: 996 605 201 01	
			7.22280.02.0	EUV-LS	EL		
3.6 S 309-355 kW (420-483 PS) M 96.70	08.2004→08.2005		7.22098.04.0	AKF	EL	für OE-Nummer: 996 605 201 01 for OE number: 996 605 201 01	
			7.22892.02.0	AKF	EL		für OE-Nummer: 996 605 213 01 for OE number: 996 605 213 01
3.6 Turbo 4 309-355 kW (420-483 PS) M 96.70	10.2003→08.2005		7.22098.04.0	AKF	EL	für OE-Nummer: 996 605 201 01 for OE number: 996 605 201 01	
			7.22892.02.0	AKF	EL		für OE-Nummer: 996 605 213 01 for OE number: 996 605 213 01
			7.22687.39.0	EUV-LS	EL		
			7.22908.03.0	LDRV	EL		
3.6 Turbo 4S 309-355 kW (420-483 PS) M 96.70	10.2003→08.2005		7.22098.04.0	AKF	EL	für OE-Nummer: 996 605 201 01 for OE number: 996 605 201 01	
			7.22892.02.0	AKF	EL		für OE-Nummer: 996 605 213 01 for OE number: 996 605 213 01
			7.22687.39.0	EUV-LS	EL		
			7.22908.03.0	LDRV	EL		























P























911 Convertible (997) **8**

3.6 Carrera 235-242 kW (320-329 PS) M 96.05	04.2005→12.2008		7.22280.02.0	EUV-LS	EL	
3.6 Carrera 254 kW (345 PS) MA1.02	06.2008→12.2011		7.22280.02.0	EUV-LS	EL	
3.6 Carrera 4 235-242 kW (320-329 PS) M 96.05	04.2005→12.2008		7.22280.02.0	EUV-LS	EL	
3.6 Carrera 4 254 kW (345 PS) MA1.02	06.2008→12.2012		7.22280.02.0	EUV-LS	EL	
3.6 Turbo 353-462 kW (480-628 PS) M 97.70	09.2007→12.2009		7.22687.39.0	EUV-LS	EL	
3.8 Carrera 4S 261-264 kW (355-359 PS) M 97.01	04.2005→12.2008		7.22280.02.0	EUV-LS	EL	
3.8 Carrera 4S 261-264 kW (355-359 PS) M 97.01	04.2005→12.2010		7.22280.02.0	EUV-LS	EL	
3.8 Carrera 4S 280 kW (381 PS) M 97.01S	08.2005→12.2008		7.22280.02.0	EUV-LS	EL	
3.8 Carrera 4S 283-304 kW (385-413 PS) MA1.01	06.2008→12.2012		7.22280.02.0	EUV-LS	EL	

						
911 Convertible (1997)						8
3.8 Carrera 4S / 4 GTS 283-304 kW (385-413 PS) MA1.01	06.2009→12.2012		7.22280.02.0	EUV-LS	EL	
3.8 Carrera S 261-264 kW (355-359 PS) M 97.01	04.2005→12.2008		7.22280.02.0	EUV-LS	EL	
3.8 Carrera S 280 kW (381 PS) M 97.01S	08.2005→12.2008		7.22280.02.0	EUV-LS	EL	
3.8 Carrera S 283-304 kW (385-413 PS) MA1.01	06.2008→12.2011		7.22280.02.0	EUV-LS	EL	
3.8 Carrera S / GTS 283-304 kW (385-413 PS) MA1.01	06.2009→12.2011		7.22280.02.0	EUV-AGK	EL	für Fahrzeuge mit Sport-Endschalldämpfer for vehicles with sport end silencer
911 Targa (1996)						9
3.6 235-254 kW (320-345 PS) M 96.03	12.2001→08.2005		7.22098.04.0	AKF	EL	für OE-Nummer: 996 605 201 01 for OE number: 996 605 201 01
			7.22280.02.0	EUV-LS	EL	
911 Targa (1997)						10
3.6 Carrera 4 235-242 kW (320-329 PS) M 96.05	07.2006→12.2008		7.22280.02.0	EUV-LS	EL	
3.6 Carrera 4 254 kW (345 PS) MA1.02	10.2008→12.2012		7.22280.02.0	EUV-LS	EL	
3.8 Carrera 4S 261-264 kW (355-359 PS) M 97.01	07.2006→12.2008		7.22280.02.0	EUV-LS	EL	
3.8 Carrera 4S 283-304 kW (385-413 PS) MA1.01	10.2008→12.2012		7.22280.02.0	EUV-LS	EL	
BOXSTER (1981)						11
2.7 155-205 kW (211-279 PS) MA1.22	04.2012→		7.22280.02.0	EUV-AGK	EL	für Fahrzeuge mit Sport-Endschalldämpfer for vehicles with sport end silencer
2.7 155-205 kW (211-279 PS) MA1.22	04.2012→		7.22280.02.0	EUV-AGK	EL	für Fahrzeuge mit Sport-Endschalldämpfer for vehicles with sport end silencer
GTS 3.4 232-246 kW (316-334 PS) MA1.23	02.2014→		7.22280.02.0	EUV-AGK	EL	für Fahrzeuge mit Sport-Endschalldämpfer for vehicles with sport end silencer
S 3.4 232-246 kW (316-334 PS) MA1.23	04.2012→		7.22280.02.0	EUV-AGK	EL	für Fahrzeuge mit Sport-Endschalldämpfer for vehicles with sport end silencer
BOXSTER (1986)						12
2.5 150 kW (204 PS) M 96.20	09.1996→08.1999		7.22098.04.0	AKF	EL	für OE-Nummer: 996 605 201 01 for OE number: 996 605 201 01
			7.22280.02.0	EUV-SL	EL	
2.7 155-162 kW (218-220 PS) M 96.22	06.1999→12.2002		7.22098.04.0	AKF	EL	für OE-Nummer: 996 605 201 01 for OE number: 996 605 201 01
2.7 155-162 kW (218-220 PS) M 96.22	08.1999→07.2002		7.22098.04.0	AKF	EL	für OE-Nummer: 996 605 201 01 for OE number: 996 605 201 01
			7.22280.02.0	EUV-SL	EL	
2.7 168 kW (228 PS) M 96.23	07.2002→12.2004		7.22098.04.0	AKF	EL	für OE-Nummer: 996 605 201 01 for OE number: 996 605 201 01
			7.22280.02.0	EUV-SL	EL	
S 3.2 185 kW (252 PS) M 96.21	08.1999→07.2002		7.22098.04.0	AKF	EL	für OE-Nummer: 996 605 201 01 for OE number: 996 605 201 01
			7.22280.02.0	EUV-SL	EL	

P





					
BOXSTER (986)					12
S 3.2 191-196 kW (260-267 PS) M 96.24	07.2002→12.2004	 7.22098.04.0	AKF	EL	für OE-Nummer: 996 605 201 01 for OE number: 996 605 201 01
		7.22280.02.0	EUV-SL	EL	
S 3.2 191-196 kW (260-267 PS) M 96.24	01.2004→12.2004	 7.22098.04.0	AKF	EL	für OE-Nummer: 996 605 201 01 for OE number: 996 605 201 01
		7.22280.02.0	EUV-SL	EL	
BOXSTER (987)					13
2.7 179-180 kW (143-245 PS) M 97.20	07.2006→12.2009	 7.22280.02.0	EUV-SL	EL	
2.9 155-195 kW (211-265 PS) MA1.20	06.2009→03.2012	 7.22280.02.0	EUV-LS	EL	
S 3.2 191-206 kW (260-280 PS) M 96.26	11.2004→12.2006	 7.22280.02.0	EUV-SL	EL	
S 3.4 217 kW (295 PS) M 97.21	07.2006→12.2009	 7.22280.02.0	EUV-SL	EL	
S 3.4 223 kW (303 PS) M 97.22	08.2008→12.2009	 7.22280.02.0	EUV-SL	EL	
S 3.4 228-246 kW (310-335 PS) MA1.21	06.2009→12.2011	 7.22280.02.0	EUV-LS	EL	
CARRERA GT (980)					14
5.7 450 kW (612 PS) M 80.01	07.2003→12.2006	 7.22280.02.0	EUV-SL	EL	
CAYENNE (92A)					15
3.0 Diesel 176 kW (239 PS) M 05.9E	06.2010→	 7.02256.00.0	EUV-AGR	EP	für Getriebeautomatik 8 Gang for 8-speed automatic transmission
		7.02256.00.0	EUV-RK	EP	für Getriebeautomatik 8 Gang for 8-speed automatic transmission
		7.02256.41.0	SV-KK	EL	für Fahrzeuge mit Standheizung for vehicles with parking heater
3.0 Diesel 176-245 kW (239-333 PS) MCN.RB	06.2010→	 7.02256.41.0	SV-KK	EL	für Fahrzeuge mit Standheizung for vehicles with parking heater
P 3.0 Diesel 155 kW (211 PS) MCR.CB, MCV.VC	06.2010→	 7.02256.00.0	EUV-AGR	EP	
		7.28098.04.0	EUV-ML	EL	 MCR.CB, MCV.VC: für Fahrzeuge mit Start-Stopp-Funktion, für Fahrzeuge mit Bremsenergieerückgewinnung for vehicles with start-stop function, for vehicles with brake energy recovery
		7.02256.41.0	SV-KK	EL	 MCR.CB, MCV.VC: für Fahrzeuge mit Standheizung for vehicles with parking heater
3.0 Diesel 180 kW (245 PS) MCR.CA	06.2011→	 7.02256.00.0	EUV-AGR	EP	
		7.28098.04.0	EUV-ML	EL	für Fahrzeuge mit Start-Stopp-Funktion, für Fahrzeuge mit Bremsenergieerückgewinnung for vehicles with start-stop function, for vehicles with brake energy recovery
		7.02256.41.0	SV-KK	EL	für Fahrzeuge mit Standheizung for vehicles with parking heater
3.0 Diesel 184 kW (250 PS) MCV.VB	08.2014→	 7.02256.00.0	EUV-AGR	EP	
		7.28098.04.0	EUV-ML	EL	für Fahrzeuge mit Start-Stopp-Funktion, für Fahrzeuge mit Bremsenergieerückgewinnung for vehicles with start-stop function, for vehicles with brake energy recovery
		7.02256.41.0	SV-KK	EL	für Fahrzeuge mit Standheizung for vehicles with parking heater

					
CAYENNE (92A)					
3.0 Diesel 176-245 kW (239-333 PS) MCN.RB	09.2014→		7.02256.00.0	EUV-AGR	EP
			7.02256.41.0	SV-KK	EL für Fahrzeuge mit Standheizung for vehicles with parking heater
3.0 Diesel 193 kW (262 PS) MCV.VA	10.2014→		7.02256.00.0	EUV-AGR	EP
			7.28098.04.0	EUV-ML	EL für Fahrzeuge mit Start-Stopp-Funktion, für Fahrzeuge mit Bremsenergieerückgewinnung for vehicles with start-stop function, for vehicles with brake energy recovery
			7.02256.41.0	SV-KK	EL für Fahrzeuge mit Standheizung for vehicles with parking heater
3.0 S 245 kW (333 PS) M 06.EC, MCJ.T	04.2011→		7.02256.00.0	EUV-RK	EP
			7.02256.41.0	SV-KK	EL  M 06.EC, MCJ.T: für Fahrzeuge mit Standheizung for vehicles with parking heater
			7.06117.47.0	SV-NWV	EH mit Dichtring with O-ring
3.0 S E-Hybrid 245-248 kW (333-337 PS) M 06.EC, MCG.E, MCG.EA, MCG.FA	06.2010→		7.02256.00.0	EUV-RK	EP
			7.02256.41.0	SV-KK	EL  M 06.EC, MCG.E, MCG.EA, MCG.FA: für Fahrzeuge mit Standheizung for vehicles with parking heater
			7.06117.47.0	SV-NWV	EH mit Dichtring with O-ring
3.0 S E-Hybrid 245-248 kW (333-337 PS) M 06.EC, MCG.E, MCG.EA, MCG.FA	10.2014→		7.02256.41.0	SV-KK	EL  M 06.EC, MCG.E, MCG.EA, MCG.FA: für Fahrzeuge mit Standheizung for vehicles with parking heater
			7.06117.47.0	SV-NWV	EH mit Dichtring with O-ring
3.6 220-224 kW (300-305 PS) M 55.02, MCE.YA	06.2010→		7.02256.00.0	EUV-RK	EP  M 55.02, MCE.YA: für Getriebeautomatik 8 Gang for 8-speed automatic transmission
			7.02256.41.0	SV-KK	EL  M 55.02, MCE.YA: für Fahrzeuge mit Standheizung for vehicles with parking heater
3.6 220-224 kW (300-305 PS) MCE.YA	01.2016→		7.02256.00.0	EUV-RK	EP für Getriebeautomatik 8 Gang for 8-speed automatic transmission
3.6 GTS 324-328 kW (440-446 PS) MCX.ZA	02.2015→		7.04638.01.0	DW-TL	EP
			7.22687.51.0	LDRV	EL
3.6 S 309-313 kW (420-426 PS) MCU.RA	10.2014→		7.04638.01.0	DW-TL	EP
			7.22687.51.0	LDRV	EL
4.2 S Diesel 281 kW (382 PS) MCU.DB	10.2012→		7.02256.00.0	EUV-AGR	EP
			7.02256.41.0	SV-KK	EL für Fahrzeuge mit Standheizung for vehicles with parking heater
4.2 S Diesel 283 kW (385 PS) MCU.DC	10.2014→		7.02256.00.0	EUV-AGR	EP
			7.02256.41.0	SV-KK	EL für Fahrzeuge mit Standheizung for vehicles with parking heater
4.8 GTS 294-309 kW (400-420 PS) M 48.02	06.2012→		7.02256.00.0	EUV-SR	EP
			7.22280.02.0	EUV-SR	EL

P





CAYENNE (92A) 15

			7.02256.41.0	SV-KK	EL	für Fahrzeuge mit Standheizung for vehicles with parking heater
4.8 S 294-309 kW (400-420 PS) M 48.02	06.2010→		7.02256.00.0	EUV-SR	EP	
			7.22280.02.0	EUV-SR	EL	
			7.02256.41.0	SV-KK	EL	für Fahrzeuge mit Standheizung for vehicles with parking heater
4.8 Turbo 368-410 kW (500-550 PS) M 48.52	06.2010→		7.02256.00.0	EUV-SR	EP	
			7.22908.03.0	LDRV	EL	
			7.02256.41.0	SV-KK	EL	für Fahrzeuge mit Standheizung for vehicles with parking heater
4.8 Turbo 368-410 kW (500-550 PS) M 48.52	06.2010→		7.02256.00.0	EUV-SR	EP	
			7.22908.03.0	LDRV	EL	
			7.02256.41.0	SV-KK	EL	für Fahrzeuge mit Standheizung for vehicles with parking heater
4.8 Turbo 382 kW (520 PS) MCF.TB	10.2014→		7.02256.00.0	EUV-SR	EP	
			7.22908.03.0	LDRV	EL	
			7.02256.41.0	SV-KK	EL	für Fahrzeuge mit Standheizung for vehicles with parking heater
4.8 Turbo S 368-410 kW (500-550 PS) M 48.52	10.2012→		7.22280.02.0	EUV-LS	EL	
			7.02256.00.0	EUV-SR	EP	
			7.22908.03.0	LDRV	EL	
			7.02256.41.0	SV-KK	EL	für Fahrzeuge mit Standheizung for vehicles with parking heater
4.8 Turbo S 419 kW (570 PS) MCY.XA	01.2015→		7.02256.00.0	EUV-SR	EP	
			7.22908.03.0	LDRV	EL	
			7.02256.41.0	SV-KK	EL	für Fahrzeuge mit Standheizung for vehicles with parking heater











P

CAYENNE (9PA) 16

























3.0 TDI 176 kW (239 PS) M 05.9D	02.2009→09.2010		7.02256.00.0	EUV-AGR	EP	
			7.02256.41.0	SV-KK	EL	für Fahrzeuge mit Standheizung for vehicles with parking heater
3.2 177-184 kW (241-250 PS) M02.2Y	08.2003→09.2007		7.02256.00.0	EUV-SR	EP	
			7.02256.41.0	SV-KK	EL	für Fahrzeuge mit Standheizung for vehicles with parking heater
3.2 177-184 kW (241-250 PS) M02.2Y	10.2003→09.2007		7.02256.00.0	EUV-SR	EP	
			7.02256.41.0	SV-KK	EL	Fahrgestellnummer ab: 9P6LA 01563, 9P6LA 41357, 9P6LA 80631 Vehicle Identification Number from: 9P6LA 01563, 9P6LA 41357, 9P6LA 80631 für Fahrzeuge mit Standheizung for vehicles with parking heater
			7.02256.42.0	SV-KK	EL	Fahrgestellnummer bis: 9P6LA 01562, 9P6LA 41356, 9P6LA 80630 Vehicle Identification Number to: 9P6LA 01562, 9P6LA 41356, 9P6LA 80630 für Fahrzeuge mit Standheizung for vehicles with parking heater



























CAYENNE (9PA) 16

3.6 213 kW (290 PS) M 55.01	02.2007→09.2010	 7.02256.41.0	SV-KK	EL	für Fahrzeuge mit Standheizung for vehicles with parking heater
GTS 4.8 283-298 kW (385-405 PS) M 48.01	10.2007→09.2010	 7.22280.02.0	EUV-SR	EL	
		7.02256.41.0	SV-KK	EL	für Fahrzeuge mit Standheizung for vehicles with parking heater
S 4.5	09.2002→12.2006	 7.02256.41.0	SV-KK	EL	
S 4.5 250 kW (340 PS) M 48.00	09.2002→09.2007	7.02256.41.0	SV-KK	EL	Fahrgestellnummer ab: 9P6LA 01563, 9P6LA 41357, 9P6LA 80631 Vehicle Identification Number from: 9P6LA 01563, 9P6LA 41357, 9P6LA 80631 für Fahrzeuge mit Standheizung for vehicles with parking heater
		 7.02256.42.0	SV-KK	EL	Fahrgestellnummer bis: 9P6LA 01562, 9P6LA 41356, 9P6LA 80630 Vehicle Identification Number to: 9P6LA 01562, 9P6LA 41356, 9P6LA 80630 für Fahrzeuge mit Standheizung for vehicles with parking heater
S 4.8 283-298 kW (385-405 PS) M 48.01	02.2007→09.2010	 7.22280.02.0	EUV-SR	EL	
		7.02256.41.0	SV-KK	EL	für Fahrzeuge mit Standheizung for vehicles with parking heater
Turbo 4.5 331 kW (450 PS) M 48.50	09.2002→09.2007	 7.22908.03.0	LDRV	EL	
		7.02256.41.0	SV-KK	EL	Fahrgestellnummer ab: 9P6LA 01563, 9P6LA 41357, 9P6LA 80631 Vehicle Identification Number from: 9P6LA 01563, 9P6LA 41357, 9P6LA 80631 für Fahrzeuge mit Standheizung for vehicles with parking heater
		7.02256.42.0	SV-KK	EL	Fahrgestellnummer bis: 9P6LA 01562, 9P6LA 41356, 9P6LA 80630 Vehicle Identification Number to: 9P6LA 01562, 9P6LA 41356, 9P6LA 80630 für Fahrzeuge mit Standheizung for vehicles with parking heater
Turbo 4.8 368-404 kW (500-550 PS) M 48.51	09.2007→12.2009	 7.22908.03.0	LDRV	EL	
Turbo S 4.5 383 kW (521 PS) M 48.50T	03.2006→09.2007	 7.02256.41.0	SV-KK	EL	für Fahrzeuge mit Standheizung for vehicles with parking heater
Turbo S 4.8 368-404 kW (500-550 PS) M 48.51	02.2007→09.2010	 7.22908.03.0	LDRV	EL	
		7.02256.41.0	SV-KK	EL	für Fahrzeuge mit Standheizung for vehicles with parking heater
Turbo S 4.8 368-404 kW (500-550 PS) M 48.51	02.2007→09.2010	 7.22908.03.0	LDRV	EL	
		7.02256.41.0	SV-KK	EL	für Fahrzeuge mit Standheizung for vehicles with parking heater
Turbo S 4.8 368-404 kW (500-550 PS) M 48.51	08.2008→09.2010	 7.22908.03.0	LDRV	EL	
		7.02256.41.0	SV-KK	EL	für Fahrzeuge mit Standheizung for vehicles with parking heater







P

			 PIERBURG			
CAYMAN (981)						17
2.7 155-205 kW (211-279 PS) MA1.22	03.2013→		7.22280.02.0	EUV-AGK	EL	für Fahrzeuge ohne Sport-Endschalldämpfer for vehicles without sport rear silencer
S 3.4 232-246 kW (316-334 PS) MA1.23	03.2013→		7.22280.02.0	EUV-LS	EL	
CAYMAN (987)						18
2.7 179-180 kW (143-245 PS) M 97.20	07.2006→12.2009		7.22280.02.0	EUV-SL	EL	
2.9 155-195 kW (211-265 PS) MA1.20	02.2009→12.2012		7.22280.02.0	EUV-LS	EL	
R 3.4 228-246 kW (310-335 PS) MA1.21	11.2010→12.2012		7.22280.02.0	EUV-LS	EL	
S 3.4 Sport 223 kW (303 PS) M 97.22	08.2008→12.2012		7.22280.02.0	EUV-SL	EL	
S 3.4 217 kW (295 PS) M 97.21	11.2005→12.2009		7.22280.02.0	EUV-SL	EL	
S 3.4 228-246 kW (310-335 PS) MA1.21	02.2009→06.2013		7.22280.02.0	EUV-LS	EL	
MACAN (95B)						19
2.0 174 kW (237 PS) MCN.CC, MCY.NA	07.2014→09.2018		7.06117.26.0	ZM-NWV	EL	
2.0 185 kW (252 PS) MCY.NB, MCY.PA	10.2015→		7.06117.26.0	ZM-NWV	EL	
3.0 GTS 265 kW (360 PS) MDC.NA	10.2015→09.2018		7.04638.01.0	DW-TL	EP	
			7.22687.51.0	LDRV	EL	
			7.02256.41.0	SV-KK	EL	für Fahrzeuge mit Standheizung for vehicles with parking heater
3.0 S 250 kW (340 PS) MCT.MA	02.2014→09.2018		7.04638.01.0	DW-TL	EP	
			7.22687.51.0	LDRV	EL	
			7.02256.41.0	SV-KK	EL	für Fahrzeuge mit Standheizung for vehicles with parking heater
3.0 S Diesel 180 kW (245 PS) MCD.UD	02.2014→09.2018		7.02256.00.0	EUV-AGR	EP	
			7.02256.41.0	SV-KK	EL	für Fahrzeuge mit Standheizung for vehicles with parking heater
3.0 S Diesel 190 kW (258 PS) MCT.BA	02.2014→09.2018		7.02256.00.0	EUV-AGR	EP	
			7.02256.41.0	SV-KK	EL	für Fahrzeuge mit Standheizung for vehicles with parking heater
3.0 S Diesel 155 kW (211 PS) MCT.BB	02.2014→09.2018		7.02256.00.0	EUV-AGR	EP	
			7.02256.41.0	SV-KK	EL	für Fahrzeuge mit Standheizung for vehicles with parking heater
3.0 S Diesel 184 kW (250 PS) MCT.BC	02.2014→09.2018		7.02256.00.0	EUV-AGR	EP	
			7.02256.41.0	SV-KK	EL	für Fahrzeuge mit Standheizung for vehicles with parking heater
3.6 Turbo 294 kW (400 PS) MCT.LA	02.2014→09.2018		7.04638.01.0	DW-TL	EP	
			7.22687.51.0	LDRV	EL	
			7.02256.41.0	SV-KK	EL	für Fahrzeuge mit Standheizung for vehicles with parking heater
PANAMERA (970)						20
3.0 4S 309 kW (420 PS) MCW.DA	07.2013→10.2016		7.04638.01.0	DW-TL	EP	
			7.22280.02.0	EUV-LS	EL	
			7.22687.51.0	LDRV	EL	

					
PANAMERA (970)					
3.0 4S 235 kW (320 PS) MCW.FA	10.2013→10.2016		7.04638.01.0	DW-TL	EP
			7.22687.51.0	LDRV	EL
3.0 D 184 kW (250 PS) MCR.CC	08.2011→07.2013		7.02256.00.0	EUV-AGR	EP
			7.28098.16.0	EUV-BKV	EL
3.0 D 155 kW (211 PS) MCR.CB	08.2011→07.2013		7.02256.00.0	EUV-AGR	EP
			7.28098.16.0	EUV-BKV	EL
3.0 D 221 kW (300 PS) MCW.JA	07.2013→10.2016		7.02256.00.0	EUV-AGR	EP
3.0 S 309 kW (420 PS) MCW.DA	07.2013→10.2016		7.04638.01.0	DW-TL	EP
			7.22280.02.0	EUV-LS	EL
			7.22687.51.0	LDRV	EL
3.0 S 235 kW (320 PS) MCW.FA	10.2013→10.2016		7.04638.01.0	DW-TL	EP
			7.22687.51.0	LDRV	EL
3.0 S E-Hybrid 245-248 kW (333-337 PS) MCG.EA, MCG.FA	03.2011→07.2013		7.03280.04.0	EUV-KK	EL
			7.06117.47.0	SV-NWV	EH mit Dichtring with O-ring
3.0 S E-Hybrid 245-248 kW (333-337 PS) MCG.EA, MCG.FA	03.2011→07.2013		7.03280.04.0	EUV-KK	EL  MCG.EA, MCG.FA: für OE-Nummer: 06H 906 283 B for OE number: 06H 906 283 B
			7.06117.47.0	SV-NWV	EH mit Dichtring with O-ring
3.0 S E-Hybrid 245-248 kW (333-337 PS) MCG.FA	01.2012→10.2016		7.06117.47.0	SV-NWV	EH mit Dichtring with O-ring
3.0 S E-Hybrid 245-248 kW (333-337 PS) MCG.EA, MCG.FA	07.2013→10.2016		7.03280.04.0	EUV-KK	EL  MCG.EA, MCG.FA: für OE-Nummer: 06H 906 283 B for OE number: 06H 906 283 B
			7.06117.47.0	SV-NWV	EH mit Dichtring with O-ring
3.6 220 kW (300 PS) M 46.20	05.2010→07.2013		7.22280.02.0	EUV-SR	EL
3.6 228 kW (310 PS) MCW.AA, MCX.NA	07.2013→10.2016		7.22280.02.0	EUV-SR	EL
3.6 4 220 kW (300 PS) M 46.40	05.2010→07.2013		7.22280.02.0	EUV-SR	EL
3.6 4 228 kW (310 PS) MCW.AA, MCX.NA	07.2013→10.2016		7.22280.02.0	EUV-SR	EL
4.8 294-302 kW (400-411 PS) M 48.20	09.2009→07.2013		7.22280.02.0	EUV-SR	EL
4.8 4S 294-328 kW (400-446 PS) M 48.40	09.2009→07.2013		7.22280.02.0	EUV-SR	EL
4.8 4S 294-328 kW (400-446 PS) M 48.40	09.2009→07.2013		7.22280.02.0	EUV-SR	EL
4.8 GTS 294-328 kW (400-446 PS) M 48.40	01.2012→12.2015		7.22280.02.0	EUV-SR	EL
4.8 GTS 294-328 kW (400-446 PS) M 48.40	09.2012→07.2013		7.22280.02.0	EUV-SR	EL
4.8 GTS 294-328 kW (400-446 PS) M 48.40	01.2013→10.2016		7.22280.02.0	EUV-SR	EL
4.8 GTS 324 kW (440 PS) MCX.PA, MCX.RA	07.2013→10.2016		7.22280.02.0	EUV-SR	EL



PANAMERA (970) **20**















4.8 S 294-302 kW (400-411 PS) M 48.20	09.2009→07.2013		7.22280.02.0	EUV-SR	EL	
4.8 Turbo 368-425 kW (500-578 PS) M 48.70	09.2009→07.2013		7.22687.39.0	EUV-LS	EL	
			7.22908.03.0	LDRV	EL	
4.8 Turbo 368-425 kW (500-578 PS) M 48.70	08.2010→07.2013		7.22687.39.0	EUV-LS	EL	
			7.22908.03.0	LDRV	EL	
4.8 Turbo 382 kW (520 PS) MCW.BA	07.2013→10.2016		7.22280.02.0	EUV-LS	EL	für Fahrzeuge mit Sport-Endschalldämpfer for vehicles with sport end silencer
			7.22687.39.0	EUV-LS	EL	
			7.22908.03.0	LDRV	EL	
4.8 Turbo S 368-425 kW (500-578 PS) M 48.70	05.2011→07.2013		7.22687.39.0	EUV-LS	EL	
			7.22908.03.0	LDRV	EL	
4.8 Turbo S 419 kW (570 PS) MCW.CA	07.2013→10.2016		7.22687.39.0	EUV-LS	EL	
			7.22908.03.0	LDRV	EL	
4.8 Turbo S 368-425 kW (500-578 PS) M 48.70	01.2014→10.2016		7.22687.39.0	EUV-LS	EL	
			7.22908.03.0	LDRV	EL	

























PANAMERA (971) **21**























4.0 GTS (97ADG1) 338 kW (460 PS) CVDD	01.2018→		7.03280.04.0	EUV-KK	EL	
4.0 S 4 Diesel (97ADD1) 310 kW (422 PS) MDB.UC	05.2016→		7.02256.00.0	EUV-AGR	EP	
4.0 Turbo (97AFF1, 97BFF1) 404 kW (550 PS) MCV.DA	05.2016→		7.03280.04.0	EUV-KK	EL	
4.0 Turbo S E-Hybrid (97AFH1, 97BFH1) 404 kW (550 PS) MCV.DA	05.2017→		7.03280.04.0	EUV-KK	EL	
4.0 Turbo S E-Hybrid (97AFH1, 97BFH1) 404 kW (550 PS) MCV.DA	05.2017→		7.03280.04.0	EUV-KK	EL	

PANAMERA Sport Turismo (971) **22**

4.0 GTS (97CDG1) 338 kW (460 PS) CVDD	01.2018→		7.03280.04.0	EUV-KK	EL	
4.0 S 4 Diesel (97CDD1) 310 kW (422 PS) MDB.UC	05.2017→		7.02256.00.0	EUV-AGR	EP	
4.0 Turbo (97CFF1) 404 kW (550 PS) MCV.DA	05.2017→		7.03280.04.0	EUV-KK	EL	
4.0 Turbo S E-Hybrid (97CFH1) 404 kW (550 PS) MCV.DA	05.2017→		7.03280.04.0	EUV-KK	EL	
4.0 Turbo S E-Hybrid (97CFH1) 404 kW (550 PS) MCV.DA	05.2017→		7.03280.04.0	EUV-KK	EL	

					
G-MODELL (W461)					
290 GD Turbodiesel (461.335, 461.336) 88 kW (120 PS) OM 602.983	04.1997→12.2001		7.02256.37.0	EUV-AGR	EL
G-MODELL (W463)					
G 320 (V6) (463.232, 463.233) 158 kW (215 PS) M 112.945	04.1997→11.2000		7.02256.37.0	EUV-SL	EL
			7.22355.01.0	EUV-SR	EL
G 500 (463.240, 463.241) 218 kW (296 PS) M 113.962	12.1997→11.2000		7.02256.37.0	EUV-SL	EL
			7.22355.01.0	EUV-SR	EL
G 55 AMG (463.240, 463.241) 260 kW (354 PS) M 113.982	04.1999→03.2001		7.02256.37.0	EUV-SL	EL
			7.22355.01.0	EUV-SR	EL
G-MODELL Cabrio (W463)					
G 320 (V6) (463.209) 158 kW (215 PS) M 112.945	05.1997→11.2000		7.02256.37.0	EUV-SL	EL
			7.22355.01.0	EUV-SR	EL
G 500 (463.206) 218 kW (296 PS) M 113.962	01.1998→11.2000		7.02256.37.0	EUV-SL	EL
			7.22355.01.0	EUV-SR	EL
G 55 AMG (463.206) 260 kW (354 PS) M 113.982	07.1999→11.2000		7.02256.37.0	EUV-SL	EL
			7.22355.01.0	EUV-SR	EL
G-MODELL Van (W461)					
290 GD Turbodiesel (461.326) 88 kW (120 PS) OM 602.983	04.1997→12.2001		7.02256.37.0	EUV-AGR	EL

						
ALASKAN						1
2.3 dCi 163 4x4 (U3MB) 120-140 kW (163-190 PS) M9T 260	09.2017→		7.01814.22.0	DW-TL	EP	
2.3 dCi 190 4x4 (U3MD) 120-140 kW (163-190 PS) M9T 260	09.2017→		7.01814.22.0	DW-TL	EP	
AVANTIME (DE0_)						2
2.2 dCi (DE01) 110 kW (150 PS) G9T 712	05.2002→05.2003		7.02256.19.0	EUV-LS	EL	
1.9 dTi 72 kW (98 PS) F9Q 722	09.2001→12.2003		7.02256.04.0	DW-AGR	EP	
CAPTUR I (J5_, H5_)						3
0.9 TCe 90 66 kW (90 PS) H4B 400	06.2013→		7.08681.15.0	EOV	EH	
			7.01343.04.0	LDRV	EP	
1.2 T 83-88 kW (113-120 PS) H5F 403	06.2013→		7.08681.15.0	EOV	EH	
			7.01343.04.0	LDRV	EP	
1.2 T 83-88 kW (113-120 PS) H5F 403	06.2015→		7.08681.15.0	EOV	EH	
			7.01343.04.0	LDRV	EP	
1.2 TCe (J5AU) 74-97 kW (101-132 PS) H5F 408	02.2018→		7.01343.04.0	LDRV	EP	
			7.01343.04.0	LDRV	EP	
1.2 TCe 120 83-88 kW (113-120 PS) H5F 403	06.2013→		7.08681.15.0	EOV	EH	
			7.01343.04.0	LDRV	EP	
1.2 TCe 120 74-97 kW (101-132 PS) H5F 408, H5F 412	01.2016→		7.08681.15.0	EOV	EH	
			7.01343.04.0	LDRV	EP	
			7.02476.09.0	SUV	EL	
1.3 TCe 130 (J5NJ) 85-120 kW (115-163 PS) H5H 450	03.2018→		7.04818.04.0	SUV	EL	
			7.04818.04.0	SUV	EL	
1.3 TCe 150 (J5NK) 85-120 kW (115-163 PS) H5H 450	03.2018→		7.04818.04.0	SUV	EL	
			7.04818.04.0	SUV	EL	
1.5 dCi (J5MW) 60-66 kW (82-90 PS) K9K 830	06.2013→		7.01814.12.0	DW-TL	EP	
1.5 dCi 110 70-81 kW (95-110 PS) K9K 646	01.2015→		7.01814.12.0	DW-TL	EP	
1.5 dCi 90 55-66 kW (75-90 PS) K9K 608, K9K 609, K9K 628, K9K 629, K9K 838	06.2013→		7.01814.12.0	DW-TL	EP	
<div style="display: flex; justify-content: space-between;"> Produktionsdatum bis: 20.12.2015 Production date to: 20.12.2015  K9K 608, K9K 609, K9K 628, K9K 629: Produktionsdatum bis: 20.12.2015 Production date to: 20.12.2015 </div>						
CAPTUR II						4
TCe 130 (HFMF) 75-120 kW (102-163 PS) H5H 470	01.2020→		7.04818.04.0	SUV	EL	
TCe 155 (HFMN) 75-120 kW (102-163 PS) H5H 470	01.2020→		7.04818.04.0	SUV	EL	











						
CLIO II (BB_, CB_)						5
1.5 dCi (B/CB3M) 47 kW (64 PS) K9K 740	06.2005→12.2010		7.02256.21.0	DW-TL	EP	
1.5 dCi (BB3N, CB3N) 60-62 kW (82-84 PS) K9K 718	02.2007→06.2009		7.02256.21.0	DW-TL	EP	
1.6 16V (BB01, BB0H, BB0T, BB14, BB1D, BB1R, BB2KL, BB3G... 55-86 kW (75-117 PS) K4M 708, K4M 740, K4M 742, K4M 743, K4M 744, K4M 745, K4M 748	09.1998→04.2005		7.02256.05.0	OEL-HV	EH	
1.9 D (B/CB0E) 47-48 kW (64-65 PS) F8Q 630	09.1998→05.2005		7.02256.19.0	EUV-AGR	EL	
1.9 D (B/CB0J) 47-48 kW (64-65 PS) F8Q 630	02.2000→05.2001		7.02256.19.0	EUV-AGR	EL	
1.9 dTi (B/CB0U) 59 kW (80 PS) F9Q 780	12.1999→05.2005		7.02256.04.0	DW-AGR	EP	
2.0 16V Sport 124-132 kW (168-180 PS) F4R 738	01.2004→04.2005		7.02256.05.0	OEL-HV	EH	
2.0 16V Sport (CB0M) 124-126 kW (169-172 PS) F4R 730, F4R 736	02.2000→06.2009		7.02256.05.0	OEL-HV	EH	
CLIO III (BR0/1, CR0/1)						6
1.5 dCi (BR0H, CR0H, CR1S, BR1S) 78 kW (106 PS) K9K 764	06.2005→12.2014		7.02256.21.0	DW-TL	EP	Produktionsdatum bis: 06.04.2010 Production date to: 06.04.2010
1.5 dCi (BR1C, CR1C) 63-76 kW (86-103 PS) K9K 772	06.2005→12.2012		7.02256.21.0	DW-TL	EP	Produktionsdatum bis: 06.04.2010 Production date to: 06.04.2010
1.6 16V (BR05, BR0B, BR0Y, BR15, BR1J, BR1M, BR1Y, CR0B,... 82 kW (112 PS) K4M 800, K4M 801	06.2005→12.2014		7.02256.05.0	OEL-HV	EH	
1.6 16V (BR09, BR0T, CR09, CR0T) 65 kW (88 PS) K4M 804	06.2005→10.2007		7.02256.05.0	OEL-HV	EH	
			7.06117.39.0	SV-NWV	EL	
1.6 16V GT (BR10, CR10) 94-98 kW (128-133 PS) K4M 862	06.2009→12.2014		7.02256.05.0	OEL-HV	EH	
			7.06117.39.0	SV-NWV	EL	
2.0 16V (BR0C, BR0K, CR0C, CR0K) 102 kW (138 PS) M4R 700, M4R 701	09.2006→12.2014		7.02256.05.0	OEL-HV	EH	
CLIO III Grandtour (KR0/1_)						7
1.5 dCi (KR0H, KR1S) 78 kW (106 PS) K9K 764	02.2008→12.2012		7.02256.21.0	DW-TL	EP	Produktionsdatum bis: 06.04.2010 Production date to: 06.04.2010
1.5 dCi (KR1C, KR1N) 63-76 kW (86-103 PS) K9K 772	11.2007→12.2012		7.02256.21.0	DW-TL	EP	Produktionsdatum bis: 06.04.2010 Production date to: 06.04.2010
1.6 16V (KR0B) 82 kW (112 PS) K4M 800, K4M 801	11.2007→12.2012		7.02256.05.0	OEL-HV	EH	
			7.06117.39.0	SV-NWV	EL	







CLIO III Grandtour (KR0/1_) 7

1.6 16V (KR10) 94-98 kW (128-133 PS) K4M 862	11.2007→12.2012		7.02256.05.0	OEL-HV	EH	
			7.06117.39.0	SV-NWV	EL	



























CLIO IV (BH_) 8

0.9 TCe 75 (BHNP) 56-66 kW (76-90 PS) H4B 408	05.2018→		7.01343.04.0	LDRV	EP	
0.9 TCe 90 56-66 kW (76-90 PS) H4B 408	11.2012→		7.01343.04.0	LDRV	EP	
0.9 TCe 90 66 kW (90 PS) H4B 400	11.2012→		7.08681.15.0	EOV	EH	
			7.01343.04.0	LDRV	EP	
0.9 TCe 90 LPG 66 kW (90 PS) H4B 410	06.2016→		7.01343.04.0	LDRV	EP	
1.2 TCe 120 (BHAU) 74-97 kW (101-132 PS) H5F 408	01.2016→		7.01343.04.0	LDRV	EP	
			7.02476.09.0	SUV	EL	
1.2 TCe 120 (BHAU) 84-97 kW (115-132 PS) H5F 412	01.2016→		7.08681.15.0	EOV	EH	
			7.01343.04.0	LDRV	EP	
			7.02476.09.0	SUV	EL	
1.2 TCe 120 (BHM0) 83-88 kW (113-120 PS) H5F 403	03.2013→		7.08681.15.0	EOV	EH	
			7.01343.04.0	LDRV	EP	
1.5 dCi (BHM6) 60-62 kW (82-84 PS) K9K 838	11.2012→		7.01814.12.0	DW-TL	EP	
1.5 dCi (BHMW) 60-66 kW (82-90 PS) K9K 830	11.2012→		7.01814.12.0	DW-TL	EP	
1.5 dCi 75 55-66 kW (75-90 PS) K9K 628	11.2012→		7.01814.12.0	DW-TL	EP	Produktionsdatum bis: 20.12.2015 Production date to: 20.12.2015
1.5 dCi 90 55-66 kW (75-90 PS) K9K 608, K9K 628	11.2012→		7.01814.12.0	DW-TL	EP	K9K 608, K9K 628: Produktionsdatum bis: 20.12.2015 Production date to: 20.12.2015

CLIO IV Grandtour (KH_) 9





0.9 TCe 75 (KHNP) 56-66 kW (76-90 PS) H4B 408	08.2018→		7.01343.04.0	LDRV	EP	
0.9 TCe 90 56-66 kW (76-90 PS) H4B 408	01.2013→		7.01343.04.0	LDRV	EP	
0.9 TCe 90 66 kW (90 PS) H4B 400	01.2013→		7.08681.15.0	EOV	EH	
			7.01343.04.0	LDRV	EP	
1.2 TCe 120 (KHAU) 74-97 kW (101-132 PS) H5F 408	01.2016→		7.01343.04.0	LDRV	EP	
			7.02476.09.0	SUV	EL	
1.2 TCe 120 (KHAU) 84-97 kW (115-132 PS) H5F 412	01.2016→		7.08681.15.0	EOV	EH	
			7.01343.04.0	LDRV	EP	
			7.02476.09.0	SUV	EL	

R



						
CLIO IV Grandtour (KH_)						9
1.2 TCe 120 (KHM0) 83-88 kW (113-120 PS) H5F 403	03.2013→		7.08681.15.0	EOV	EH	
			7.01343.04.0	LDRV	EP	
1.5 dCi 75 55-66 kW (75-90 PS) K9K 628	01.2013→		7.01814.12.0	DW-TL	EP	Produktionsdatum bis: 20.12.2015 Production date to: 20.12.2015
1.5 dCi 90 (KHN3, KHN4) 55-66 kW (75-90 PS) K9K 608, K9K 628, K9K 629, K9K 638	01.2013→		7.01814.12.0	DW-TL	EP	
DUSTER (HS_)						10
2.0 98-109 kW (133-148 PS) F4R 402, F4R 404	01.2011→		7.06117.15.0	SV-NWV	EH	mit Wellendichtring With shaft sealing ring
2.0 98-109 kW (133-148 PS) F4R 402, F4R 403	10.2011→		7.06117.15.0	SV-NWV	EH	mit Wellendichtring With shaft sealing ring
2.0 98-109 kW (133-148 PS) F4R 403, F4R 405	02.2012→		7.06117.15.0	SV-NWV	EH	mit Wellendichtring With shaft sealing ring
2.0 4x4 99-109 kW (135-148 PS) F4R 400, F4R 402	01.2011→		7.06117.15.0	SV-NWV	EH	mit Wellendichtring With shaft sealing ring
2.0 4x4 98-109 kW (133-148 PS) F4R 402, F4R 403	10.2011→		7.06117.15.0	SV-NWV	EH	mit Wellendichtring With shaft sealing ring
2.0 Flex 98-109 kW (133-148 PS) F4R 402, F4R 403	01.2016→03.2020		7.06117.15.0	SV-NWV	EH	mit Wellendichtring With shaft sealing ring
2.0 Flex 4x4 99-109 kW (135-148 PS) F4R 400, F4R 402, F4R 408	11.2013→		7.06117.15.0	SV-NWV	EH	mit Wellendichtring With shaft sealing ring
2.0 Flex 4x4 98-109 kW (133-148 PS) F4R 402, F4R 403	01.2016→		7.06117.15.0	SV-NWV	EH	mit Wellendichtring With shaft sealing ring
2.0 Hi-Flex 98-109 kW (133-148 PS) F4R 402, F4R 403, F4R 404, F4R 405	01.2011→12.2015		7.06117.15.0	SV-NWV	EH	mit Wellendichtring With shaft sealing ring
2.0 Hi-Flex 4x4 99-109 kW (135-148 PS) F4R 400, F4R 402, F4R 408	01.2011→12.2015		7.06117.15.0	SV-NWV	EH	mit Wellendichtring With shaft sealing ring
ESPACE III (JE0_)						11
1.9 dTi (JE0M) 72 kW (98 PS) F9Q 722	02.1999→10.2002		7.02256.04.0	DW-AGR	EP	
2.0 (JE0A) 84 kW (114 PS) F3R 728, F3R 729, F3R 742, F3R 768, F3R 769	11.1996→10.2000		7.06269.07.0	LLR	EL	
2.2 dCi (JE0K) 85-95 kW (115-130 PS) G9T 710	10.2000→10.2002		7.02256.04.0	DW-TL	EP	
			7.02256.19.0	EUV-LS	EL	→06.2001
2.2 dCi (JE0S) 85-95 kW (115-130 PS) G9T 710	07.2000→10.2002		7.02256.04.0	DW-TL	EP	
			7.02256.19.0	EUV-LS	EL	→06.2001
ESPACE IV (JK0/1_)						12
1.9 dCi (JK0U) 85-88 kW (115-120 PS) F9Q 820	04.2003→02.2005		7.01152.02.0	DW-TL	EP	
			7.02256.19.0	LDRV	EL	
1.9 dCi (JK0U, JK0G) 85-88 kW (115-120 PS) F9Q 820	11.2002→		7.01152.02.0	DW-TL	EP	

















ESPACE IV (JK0/1_) **12**

		7.02256.19.0	LDRV	EL	
2.0 dCi (JK01, JK02, JK1J, JK1K, JK1H) 96-110 kW (131-150 PS) M9R 740, M9R 750	01.2006→	 7.02256.15.0	DW-TL	EP	
		7.02256.19.0	EUV-AGR	EL	
2.0 dCi (JK03, JK04, JK1C, JK1G, JK1J, JK1K) 96-127 kW (131-173 PS) M9R 760, M9R 761, M9R 762, M9R 763	01.2006→	 7.02256.15.0	DW-TL	EP	
		7.02256.19.0	EUV-AGR	EL	
2.2 dCi (JK07) 102 kW (139 PS) G9T 645	02.2006→	 7.01152.02.0	DW-TL	EP	
		7.02256.19.0	EUV-AGR	EL	
2.2 dCi (JK0H) 110 kW (150 PS) G9T 742, G9T 743	11.2002→08.2006	 7.01152.02.0	DW-TL	EP	
		7.02256.19.0	EUV-AGR	EL	

ESPACE V (JR_) **13**

1.6 dCi 130 96 kW (130 PS) R9M 409	06.2015→	 7.01814.12.0	DW-TL	EP	
1.6 dCi 160 92-120 kW (125-163 PS) R9M 452	06.2015→	 7.01814.22.0	DW-TL	EP	für OE-Nummer: 14 95 667 40R for OE number: 14 95 667 40R

FLUENCE (L3_) **14**











1.5 dCi (L30A) 60-66 kW (82-90 PS) K9K 830	02.2010→	 7.02256.21.0	DW-TL	EP	Produktionsdatum bis: 17.04.2012 Production date to: 17.04.2012
1.5 dCi (L30B) 78 kW (106 PS) K9K 832	02.2010→	 7.02256.21.0	DW-TL	EP	Produktionsdatum bis: 04.10.2010 Production date to: 04.10.2010
1.5 dCi (L30D, L30L, L306, L33F, L33L, L33M, L33V, L33W) 66-81 kW (90-110 PS) K9K 656, K9K 657	02.2010→	 7.01814.12.0	DW-TL	EP	 K9K 656, K9K 657: Produktionsdatum bis: 11.05.2017 Production date to: 11.05.2017
1.5 dCi (L30D, L30L, L306, L33F, L33L, L33M, L33V, L33W) 78-81 kW (106-110 PS) K9K 836, K9K 837	02.2010→	 7.02256.21.0	DW-TL	EP	 K9K 836, K9K 837: Produktionsdatum bis: 04.10.2010 Production date to: 04.10.2010
1.5 dCi (L30S) 66 kW (90 PS) K9K 834	02.2010→	 7.02256.21.0	DW-TL	EP	Produktionsdatum bis: 04.10.2010 Production date to: 04.10.2010
1.6 16V 78-86 kW (106-116 PS) K4M 838	02.2010→	 7.06117.39.0	SV-NWV	EL	
1.6 16V (L301, L30F, L30P, L30R) 78-86 kW (106-116 PS) K4M 838, K4M 839	02.2010→	 7.06117.39.0	SV-NWV	EL	
1.6 16V (L304, L305, L30H) 78-86 kW (106-116 PS) K4M 838	02.2010→	 7.06117.39.0	SV-NWV	EL	
1.6 LPG 16V 81 kW (110 PS) K4M 839	01.2012→	 7.06117.39.0	SV-NWV	EL	
1.6 dCi 96 kW (130 PS) R9M 402	07.2014→	 7.01814.12.0	DW-TL	EP	Produktionsdatum ab: 07.10.2014 Production date from: 07.10.2014
2.0 132-140 kW (180-190 PS) F4R 872	02.2011→11.2014	 7.01343.04.0	LDRV	EP	
		7.06117.15.0	SV-NWV	EH	mit Wellendichtring With shaft sealing ring
2.0 132-140 kW (180-190 PS) F4R 872	01.2013→	 7.01343.04.0	LDRV	EP	

R















GRAND SCÉNIC II (JM0/1_)

15























1.5 dCi 74-78 kW (103-106 PS) K9K 734	06.2006→11.2008		7.02256.21.0	DW-TL	EP	
1.5 dCi (JM02, JM13) 74-78 kW (101-106 PS) K9K 728	04.2004→11.2008		7.02256.21.0	DW-TL	EP	
1.5 dCi (JM1E) 78 kW (106 PS) K9K 732	05.2005→01.2009		7.02256.21.0	DW-TL	EP	
1.6 81-83 kW (110-113 PS) K4M 761, K4M 782	04.2004→08.2006		7.06117.39.0	SV-NWV	EL	
1.6 77 kW (105 PS) K4M 788	06.2006→11.2008		7.02256.05.0	OEL-HV	EH	
1.6 82 kW (112 PS) K4M 812	06.2006→11.2008		7.06117.39.0	SV-NWV	EL	
1.6 Flex 81-85 kW (110-116 PS) K4M 766	06.2006→06.2009		7.06117.39.0	SV-NWV	EL	Produktionsdatum ab: 07.02.2008 Production date from: 07.02.2008
1.9 dCi 72-97 kW (98-132 PS) F9Q 803, F9Q 804, F9Q 812	05.2005→01.2009		7.01152.02.0	DW-TL	EP	
1.9 dCi (JM0G, JM12, JM1G, JM2C) 85-88 kW (116-120 PS) F9Q 812	04.2004→05.2006		7.01152.02.0	DW-TL	EP	
			7.02256.19.0	LDRV	EL	
1.9 dCi (JM14) 81-96 kW (110-131 PS) F9Q 816, F9Q 818, F9Q EE 804, F9Q J 803	04.2004→02.2008		7.01152.02.0	DW-TL	EP	
2.0 dCi (JM1K) 110 kW (150 PS) M9R 700, M9R 721, M9R 722	09.2005→11.2008		7.02256.15.0	DW-TL	EP	
			7.02256.19.0	EUV-AGR	EL	

GRAND SCÉNIC III (JZ0/1_)

16





1.2 TCe 84-85 kW (114-116 PS) H5F 400	04.2012→		7.08681.15.0	EOV	EH	
			7.01343.04.0	LDRV	EP	
1.2 TCe 74-97 kW (101-132 PS) H5F 408	07.2014→		7.01343.04.0	LDRV	EP	
			7.02476.09.0	SUV	EL	
1.2 TCe (JZ16) 97 kW (132 PS) H5F 404	01.2013→		7.08681.15.0	EOV	EH	
			7.01343.04.0	LDRV	EP	
1.4 16V (JZ0F) 96 kW (131 PS) H4J 700	02.2009→		7.01343.04.0	LDRV	EP	
1.5 dCi 78 kW (106 PS) K9K 832	02.2009→		7.02256.21.0	DW-TL	EP	Produktionsdatum bis: 06.04.2010 Production date to: 06.04.2010
1.5 dCi 78-81 kW (106-110 PS) K9K 836, K9K 837	04.2009→		7.02256.21.0	DW-TL	EP	 K9K 836, K9K 837: Produktionsdatum bis: 06.04.2010 Production date to: 06.04.2010
1.5 dCi 81 kW (110 PS) K9K 636	04.2009→		7.01814.12.0	DW-TL	EP	Produktionsdatum bis: 20.12.2015 Production date to: 20.12.2015
1.5 dCi 70-81 kW (95-110 PS) K9K 846	11.2010→		7.01814.12.0	DW-TL	EP	Produktionsdatum bis: 20.12.2015 Production date to: 20.12.2015
1.6 16V (JZ0U) 81-85 kW (110-116 PS) K4M 858	02.2009→		7.06117.39.0	SV-NWV	EL	
1.6 dCi (JZ00, JZ12) 96 kW (130 PS) R9M 402, R9M 404, R9M 414	04.2011→		7.01814.12.0	DW-TL	EP	
2.0 dCi (JZ0L) 118-120 kW (160-163 PS) M9R 610	04.2009→		7.02256.15.0	DW-TL	EP	
			7.02256.19.0	EUV-AGR	EL	

R













					
GRAND SCÉNIC III (JZ0/1_) 16					
2.0 dCi (JZ0Y) 110 kW (150 PS) M9R 615	02.2009→		7.02256.15.0	DW-TL	EP
			7.02256.19.0	EUV-AGR	EL
GRAND SCÉNIC IV (R9_) 17					
1.2 TCe 115 74-97 kW (101-132 PS) H5F 408	09.2016→		7.08681.15.0	EOV	EH
			7.01343.04.0	LDRV	EP
			7.02476.09.0	SUV	EL
1.2 TCe 130 74-97 kW (101-132 PS) H5F 408	09.2016→		7.08681.15.0	EOV	EH
			7.01343.04.0	LDRV	EP
			7.02476.09.0	SUV	EL
1.3 TCe 115 (R9N9) 75-120 kW (102-163 PS) H5H 450, H5H 470	01.2018→		7.04818.04.0	SUV	EL
1.3 TCe 140 75-120 kW (102-163 PS) H5H 450, H5H 470	01.2018→		7.04818.04.0	SUV	EL
1.3 TCe 160 85-120 kW (115-163 PS) H5H 450	01.2018→		7.04818.04.0	SUV	EL
1.3 TCe 160 (R9NC) 75-120 kW (102-163 PS) H5H 470	09.2018→		7.04818.04.0	SUV	EL
1.6 dCi 130 96 kW (130 PS) R9M 409	09.2016→		7.01814.12.0	DW-TL	EP
1.6 dCi 160 92-120 kW (125-163 PS) R9M 452	09.2016→		7.01814.22.0	DW-TL	EP für OE-Nummer: 14 95 667 40R for OE number: 14 95 667 40R
KADJAR (HA_, HL_) 18					
1.2 TCe 130 74-97 kW (101-132 PS) H5F 408	06.2015→		7.08681.15.0	EOV	EH
			7.01343.04.0	LDRV	EP
			7.02476.09.0	SUV	EL
1.3 TCe 140 75-120 kW (102-163 PS) H5H 470	08.2018→		7.04818.04.0	SUV	EL
1.3 TCe 160 (HLNC) 75-120 kW (102-163 PS) H5H 470	08.2018→		7.04818.04.0	SUV	EL
1.5 dCi 110 (HLA3) 67-81 kW (91-110 PS) K9K 646, K9K 647	06.2015→		7.01814.12.0	DW-TL	EP  K9K 646, K9K 647: Produktionsdatum bis: 20.12.2015 Production date to: 20.12.2015
1.6 dCi 130 4x4 96 kW (130 PS) R9M 414	06.2015→		7.01814.12.0	DW-TL	EP
KANGOO (KC0/1_) 19					
1.5 dCi 60-62 kW (82-84 PS) K9K 718	06.2005→		7.02256.21.0	DW-TL	EP Produktionsdatum bis: 02.09.2009 Production date to: 02.09.2009
1.6 16V 69-82 kW (94-112 PS) K4M 706, K4M 730, K4M 750, K4M 752, K4M 753	06.2001→		7.02256.05.0	OEL-HV	EH
1.6 16V 4x4 (KC0P, KC0S, KC0L) 70 kW (95 PS) K4M 750, K4M 752, K4M 753	10.2001→		7.02256.05.0	OEL-HV	EH





KANGOO (KC0/1_) 19

1.6 16V bivalent 60-81 kW (82-106 PS) K4M 850	06.2005→		7.02256.05.0	OEL-HV	EH	
1.9 dTi (KC0U) 59 kW (80 PS) F9Q 780	02.2000→		7.02256.04.0	DW-AGR	EP	
D 55 1.9 (KC0D) 40-48 kW (54-65 PS) F8Q 662	03.1998→		7.02256.19.0	EUV-AGR	EL	
D 65 1.9 (KC0E, KC02, KC0J, KC0N) 47-48 kW (64-65 PS) F8Q 630	03.1998→06.2001		7.02256.19.0	EUV-AGR	EL	

KANGOO / GRAND KANGOO (KW0/1_) 20

1.2 TCe 115 (KW02, KW14) 74-97 kW (101-132 PS) H5F 408, H5F 412	07.2013→		7.08681.15.0	EOV	EH	
			7.01343.04.0	LDRV	EP	
			7.02476.09.0	SUV	EL	
1.2 TCe 115 (KW02, KW14) 84-85 kW (114-116 PS) H5F 400	07.2013→		7.08681.15.0	EOV	EH	
			7.01343.04.0	LDRV	EP	
1.5 dCi 76-81 kW (103-110 PS) K9K 804	02.2008→		7.02256.21.0	DW-TL	EP	Produktionsdatum bis: 06.04.2010 Production date to: 06.04.2010
1.5 dCi 105 (KW0F) 76 kW (103 PS) K9K 806	02.2008→		7.02256.21.0	DW-TL	EP	Produktionsdatum bis: 06.04.2010 Production date to: 06.04.2010
1.5 dCi 110 (KW06, KW12) 67-81 kW (91-110 PS) K9K 636, K9K 646, K9K 647	03.2013→		7.01814.12.0	DW-TL	EP	 K9K 636, K9K 646, K9K 647: Produktionsdatum bis: 20.12.2015 Production date to: 20.12.2015
1.5 dCi 70 (KW0V, KW0A) 50-63 kW (68-86 PS) K9K 802	02.2008→		7.02256.21.0	DW-TL	EP	Produktionsdatum bis: 06.04.2010 Production date to: 06.04.2010
1.5 dCi 75 (KW07, KW10, KW04) 55-66 kW (75-90 PS) K9K 608, K9K 628	11.2012→		7.01814.12.0	DW-TL	EP	 K9K 608, K9K 628: Produktionsdatum bis: 20.12.2015 Production date to: 20.12.2015
1.5 dCi 85 (KW0K, KW0L, KW0B) 50-66 kW (68-90 PS) K9K 802, K9K 812	02.2008→		7.02256.21.0	DW-TL	EP	 K9K 802, K9K 812: Produktionsdatum bis: 06.04.2010 Production date to: 06.04.2010
1.5 dCi 90 (KW05, KW08, KW0G, KW11) 55-66 kW (75-90 PS) K9K 608, K9K 628	06.2008→		7.01814.12.0	DW-TL	EP	 K9K 608, K9K 628: Produktionsdatum bis: 20.12.2015 Production date to: 20.12.2015
1.5 dCi 90 (KW05, KW08, KW0G, KW11) 55-66 kW (75-90 PS) K9K 808	06.2008→		7.02256.21.0	DW-TL	EP	Produktionsdatum bis: 06.04.2010 Production date to: 06.04.2010









KANGOO BE BOP (KW0/1_) 21

1.5 dCi 76-81 kW (103-110 PS) K9K 804	06.2009→		7.02256.21.0	DW-TL	EP	Produktionsdatum bis: 06.04.2010 Production date to: 06.04.2010
1.5 dCi (KW0F) 76 kW (103 PS) K9K 806	02.2009→12.2012		7.02256.21.0	DW-TL	EP	Produktionsdatum bis: 06.04.2010 Production date to: 06.04.2010
1.5 dCi (KW0G) 55-66 kW (75-90 PS) K9K 808	06.2009→12.2012		7.02256.21.0	DW-TL	EP	Produktionsdatum bis: 06.04.2010 Production date to: 06.04.2010



R





KOLEOS I (HY_) 22

2.0 dCi 110-127 kW (150-173 PS) M9R 865	07.2013→		7.02256.17.0	DW-TL	EP	
2.0 dCi (HY0K) 110-127 kW (150-173 PS) M9R 855, M9R 856, M9R 862, M9R 865, M9R 866	09.2008→		7.02256.17.0	DW-TL	EP	 M9R 855, M9R 856, M9R 862, M9R 865, M9R 866: Produktionsdatum ab: 08.02.2011 Production date from: 08.02.2011
2.0 dCi 4x4 127-130 kW (173-177 PS) M9R 830	09.2008→03.2013		7.02256.17.0	DW-TL	EP	Produktionsdatum ab: 08.02.2011 Production date from: 08.02.2011
2.0 dCi 4x4 (HY0B) 127-130 kW (173-177 PS) M9R 830	09.2008→		7.02256.15.0	DW-TL	EP	
			7.02256.17.0	DW-TL	EP	Produktionsdatum ab: 08.02.2011 Production date from: 08.02.2011
			7.02256.19.0	EUV-AGR	EL	
2.0 dCi 4x4 (HY0K) 110 kW (150 PS) M9R 832	09.2008→		7.02256.15.0	DW-TL	EP	
			7.02256.17.0	DW-TL	EP	Produktionsdatum ab: 08.02.2011 Production date from: 08.02.2011
			7.02256.19.0	EUV-AGR	EL	
2.0 dCi 4x4 (HY0K) 110-127 kW (150-173 PS) M9R 833, M9R 834, M9R 835, M9R 836, M9R 838, M9R 850, M9R 855, M9R 856, M9R 862, M9R 865, M9R 866	09.2008→		7.02256.17.0	DW-TL	EP	 M9R 833, M9R 834, M9R 835, M9R 836, M9R 838, M9R 850, M9R 855, M9R 856, M9R 862, M9R 865, M9R 866: Produktionsdatum ab: 08.02.2011 Production date from: 08.02.2011

KOLEOS II (HC_) 23

1.3 TCe 160 75-120 kW (102-163 PS) H5H 470	07.2020→		7.04818.04.0	SUV	EL	
1.6 dCi 130 96 kW (130 PS) R9M 409, R9M 414	08.2016→		7.01814.12.0	DW-TL	EP	

LAGUNA Coupe (DT0/1) 24

1.5 dCi 70-81 kW (95-110 PS) K9K 846	03.2012→12.2015		7.01814.12.0	DW-TL	EP	Produktionsdatum bis: 20.12.2015 Production date to: 20.12.2015
2.0 dCi (DT01, DT08, DT09, DT0K, DT12, DT1C, DT1D, DT1M,...) 96-110 kW (131-150 PS) M9R 802, M9R 805	09.2008→12.2015		7.02256.15.0	DW-TL	EP	
			7.02256.19.0	EUV-AGR	EL	
2.0 dCi (DT0M, DT0N, DT0S, DT19, DT1F) 127 kW (173 PS) M9R 800, M9R 809	09.2008→12.2015		7.02256.15.0	DW-TL	EP	
			7.02256.19.0	EUV-AGR	EL	









LAGUNA I (B56_, 556_) 25

1.6 16V (B568, B561) 79 kW (107 PS) K4M 720, K4M 724	11.1997→03.2001		7.02256.05.0	OEL-HV	EH	
1.8 69-70 kW (94-95 PS) F3P 676	06.1995→06.1998		7.06269.07.0	LLR	EL	
1.8 69 kW (94 PS) F3P 674	06.1995→02.2001		7.06269.07.0	LLR	EL	
1.8 (B56S/T/0) 66 kW (90 PS) F3P 670	08.1995→03.2001		7.06269.07.0	LLR	EL	
1.8 16V (B563, B564) 85-89 kW (116-121 PS) F4P 760, F4P 770	04.1998→03.2001		7.02256.05.0	OEL-HV	EH	







LAGUNA I (B56_, 556_) 25

1.9 dCi (B56W) 79 kW (107 PS) F9Q 718	09.1999→03.2001	 7.02256.04.0	DW-TL	EP	
1.9 dTi (B56J) 72-75 kW (98-102 PS) F9Q 710, F9Q 716, F9Q 717	10.1997→03.2001	 7.02256.04.0	DW-AGR	EP	
2.0 102 kW (139 PS) N7Q 700, N7Q 704	06.1995→02.2001	 7.06269.09.0	LLR	EL	
2.0 83-84 kW (113-114 PS) F3R 722	06.1995→02.2001	 7.02256.05.0	OEL-HV	EH	
2.0 84 kW (114 PS) F3R 768	06.1995→02.2001	 7.06269.07.0	LLR	EL	
		7.02256.05.0	OEL-HV	EH	
2.0 80-85 kW (109-116 PS) F3R 611	03.1999→03.2001	 7.06269.07.0	LLR	EL	
		7.02256.05.0	OEL-HV	EH	
2.0 (B56C/H/N) 83-84 kW (113-114 PS) F3R 722, F3R 723	12.1993→03.2001	 7.02256.05.0	OEL-HV	EH	
2.0 16V (B56D/M) 102 kW (139 PS) N7Q 700, N7Q 704	08.1995→03.2001	 7.06269.09.0	LLR	EL	

LAGUNA I Grandtour (K56_) 26

1.8 (K56S/T/0) 66 kW (90 PS) F3P 670	09.1995→03.2001	 7.06269.07.0	LLR	EL	
1.9 dCi (K56W) 79 kW (107 PS) F9Q 718	09.1999→03.2001	 7.02256.04.0	DW-TL	EP	
1.9 dTi (K56J) 72-75 kW (98-102 PS) F9Q 710, F9Q 716, F9Q 717	10.1997→03.2001	 7.02256.04.0	DW-AGR	EP	
2.0 84 kW (114 PS) F3R 728, F3R 768	10.1998→01.2001	 7.06269.07.0	LLR	EL	
		7.02256.05.0	OEL-HV	EH	
2.0 (K56C/H) 83-84 kW (113-114 PS) F3R 722, F3R 723	09.1995→03.2001	 7.02256.05.0	OEL-HV	EH	
2.0 16V (K56D/M) 102 kW (139 PS) N7Q 700, N7Q 704	09.1995→03.2001	 7.06269.09.0	LLR	EL	

LAGUNA II (BG0/1_) 27





1.6 16V (BG0A, BG0L) 76-79 kW (103-107 PS) K4M 710, K4M 714	03.2001→05.2005	 7.02256.05.0	OEL-HV	EH	
1.6 16V (BG1G, BG1H) 82 kW (112 PS) K4M 716	02.2005→08.2007	 7.02256.05.0	OEL-HV	EH	
		7.06117.39.0	SV-NWV	EL	
1.9 dCi (BG0E) 74-77 kW (101-105 PS) F9Q 752	06.2001→05.2005	 7.02256.04.0	DW-TL	EP	
1.9 dCi 74-79 kW (101-107 PS) F9Q 754	03.2001→09.2007	 7.02256.04.0	DW-TL	EP	
		7.02256.19.0	EUV-LS	EL	
1.9 dCi 85-92 kW (115-125 PS) F9Q 750	09.2005→12.2007	 7.01152.02.0	DW-TL	EP	
1.9 dCi (BG05) 66-68 kW (90-92 PS) F9Q 664	03.2004→05.2005	 7.01152.02.0	DW-TL	EP	
		7.02256.04.0	DW-TL	EP	



LAGUNA II (BG0/1_) **27**

1.9 dCi (BG08, BG0G) 81-88 kW (110-120 PS) F9Q 650, F9Q 670, F9Q 674	03.2001→09.2007		7.01152.02.0	DW-TL	EP	
			7.02256.19.0	EUV-LS	EL	
1.9 dCi (BG08, BG0G) 85-92 kW (115-125 PS) F9Q 750	03.2001→09.2007		7.02256.04.0	DW-TL	EP	→08.2003
			7.01152.02.0	DW-TL	EP	Produktionsdatum ab: 19.08.2003 Production date from: 19.08.2003
			7.02256.19.0	EUV-LS	EL	
1.9 dCi (BG0R) 74-79 kW (101-107 PS) F9Q 754	10.2001→05.2005		7.02256.04.0	DW-TL	EP	
1.9 dCi (BG12) 81-96 kW (110-130 PS) F9Q 750, F9Q 758, F9Q 759	09.2005→12.2007		7.01152.02.0	DW-TL	EP	
			7.02256.19.0	EUV-LS	EL	
1.9 dCi (BG1A, BG1V) 81-96 kW (110-130 PS) F9Q 758, F9Q 759	05.2005→08.2007		7.01152.02.0	DW-TL	EP	
			7.02256.19.0	EUV-LS	EL	
1.9 dCi (BG1A, BG1W) 81-96 kW (110-130 PS) F9Q 674, F9Q 758	01.2005→08.2007		7.01152.02.0	DW-TL	EP	
			7.02256.04.0	DW-TL	EP	
2.0 dCi (BG14, BG1S) 96-127 kW (131-173 PS) M9R 760	01.2006→08.2007		7.02256.15.0	DW-TL	EP	
			7.02256.19.0	EUV-AGR	EL	
2.0 dCi (BG1T) 96-110 kW (131-150 PS) M9R 740	08.2005→08.2006		7.02256.15.0	DW-TL	EP	
			7.02256.19.0	EUV-AGR	EL	
2.2 dCi 83-110 kW (113-150 PS) G9T 600, G9T 605, G9T 706, G9T 707	05.2005→08.2007		7.01152.02.0	DW-TL	EP	
			7.02256.19.0	EUV-AGR	EL	
			7.02256.19.0	EUV-SR	EL	
2.2 dCi (BG09) 83-102 kW (113-139 PS) G9T 600	04.2004→10.2005		7.01152.02.0	DW-TL	EP	
			7.02256.19.0	EUV-AGR	EL	
2.2 dCi (BG0F) 83-110 kW (113-150 PS) G9T 700	10.2001→08.2006		7.01152.02.0	DW-TL	EP	
			7.02256.19.0	EUV-SR	EL	
2.2 dCi (BG0F) 83-110 kW (113-150 PS) G9T 702	10.2001→08.2006		7.01152.02.0	DW-TL	EP	
			7.02256.19.0	EUV-SR	EL	

LAGUNA II Grandtour (KG0/1_) **28**

1.6 16V 82 kW (112 PS) K4M 716	02.2005→08.2007		7.06117.39.0	SV-NWV	EL	
1.9 dCi (KG0E) 74-77 kW (101-105 PS) F9Q 752	06.2001→05.2005		7.02256.04.0	DW-TL	EP	
			7.02256.19.0	EUV-LS	EL	
1.9 dCi 74-79 kW (101-107 PS) F9Q 754	03.2001→12.2007		7.02256.04.0	DW-TL	EP	
			7.02256.19.0	EUV-LS	EL	
1.9 dCi 66-68 kW (90-92 PS) F9Q 664	08.2003→09.2007		7.01152.02.0	DW-TL	EP	



LAGUNA II Grandtour (KG0/1_) 28



1.9 dCi 85-92 kW (115-125 PS) F9Q 750	09.2005→12.2007		7.01152.02.0	DW-TL	EP	
1.9 dCi (KG05) 66-68 kW (90-92 PS) F9Q 664	03.2004→05.2005		7.01152.02.0	DW-TL	EP	
			7.02256.19.0	EUV-LS	EL	
1.9 dCi (KG0E, KG0R) 74-77 kW (101-105 PS) F9Q 752	10.2001→05.2005		7.02256.04.0	DW-TL	EP	
1.9 dCi (KG0G) 81-88 kW (110-120 PS) F9Q 670, F9Q 674	03.2001→09.2007		7.01152.02.0	DW-TL	EP	
			7.02256.19.0	EUV-LS	EL	
1.9 dCi (KG0G) 85-92 kW (115-125 PS) F9Q 750	03.2001→09.2007		7.02256.04.0	DW-TL	EP	→08.2003
			7.01152.02.0	DW-TL	EP	Produktionsdatum ab: 19.08.2003 Production date from: 19.08.2003
			7.02256.19.0	EUV-LS	EL	
1.9 dCi (KG12) 81-96 kW (110-130 PS) F9Q 758, F9Q 759	08.2005→09.2007		7.01152.02.0	DW-TL	EP	
1.9 dCi (KG1A, KG1W) 81-88 kW (110-120 PS) F9Q 674	01.2005→12.2007		7.01152.02.0	DW-TL	EP	
			7.02256.19.0	EUV-LS	EL	
1.9 dCi (KG1A, KG1W) 81-96 kW (110-130 PS) F9Q 758	01.2005→12.2007		7.01152.02.0	DW-TL	EP	
1.9 dCi (KG1V) 81-96 kW (110-130 PS) F9Q 758, F9Q 759	05.2005→12.2007		7.01152.02.0	DW-TL	EP	
			7.02256.19.0	EUV-LS	EL	
2.0 dCi (KG1S) 96-127 kW (131-173 PS) M9R 760	01.2006→12.2007		7.02256.15.0	DW-TL	EP	
			7.02256.19.0	EUV-AGR	EL	
2.0 dCi (KG1T) 96-110 kW (131-150 PS) M9R 740	08.2005→08.2006		7.02256.15.0	DW-TL	EP	
			7.02256.19.0	EUV-AGR	EL	
2.2 dCi 83-110 kW (113-150 PS) G9T 600, G9T 706, G9T 707	05.2005→12.2007		7.01152.02.0	DW-TL	EP	
			7.02256.19.0	EUV-AGR	EL	
			7.02256.19.0	EUV-SR	EL	
2.2 dCi (KG09) 83-102 kW (113-139 PS) G9T 600	04.2004→10.2005		7.01152.02.0	DW-TL	EP	
			7.02256.19.0	EUV-SR	EL	
2.2 dCi (KG0F) 83-110 kW (113-150 PS) G9T 702	10.2001→08.2006		7.01152.02.0	DW-TL	EP	
			7.02256.19.0	EUV-SR	EL	

LAGUNA III (BT0/1) 29







1.5 dCi (BT00, BT0A, BT0T, BT1J) 76-81 kW (103-110 PS) K9K 780, K9K 782	10.2007→12.2015		7.02256.21.0	DW-TL	EP	 K9K 780, K9K 782: Produktionsdatum bis: 06.04.2010 Production date to: 06.04.2010
1.6 16V (BT04, BT0D, BT0U) 81 kW (110 PS) K4M 824	10.2007→12.2015		7.06117.39.0	SV-NWV	EL	



LAGUNA III (BT0/1) 29



2.0 dCi (BT01, BT08, BT09, BT0E, BT0K, BT12, BT1C, BT1D,....) 96-110 kW (131-150 PS) M9R 802, M9R 805	10.2007→12.2015		7.02256.15.0	DW-TL	EP	
			7.02256.19.0	EUV-AGR	EL	
2.0 dCi (BT07, BT0J, BT14, BT1A, BT1S) 96-110 kW (131-150 PS) M9R 742, M9R 744, M9R 802	10.2007→12.2015		7.02256.15.0	DW-TL	EP	
			7.02256.19.0	EUV-AGR	EL	
2.0 dCi (BT0M, BT0N, BT0S, BT19, BT1F) 127 kW (173 PS) M9R 800, M9R 809	01.2008→12.2015		7.02256.15.0	DW-TL	EP	
			7.02256.19.0	EUV-AGR	EL	
2.0 dCi GT (BT11, BT1E, BT1N) 127-132 kW (173-180 PS) M9R 816	03.2008→12.2015		7.02256.15.0	DW-TL	EP	
			7.02256.19.0	EUV-AGR	EL	
3.0 dCi (BT03, BT13) 173-195 kW (235-265 PS) V9X 891	09.2008→12.2015		7.02256.15.0	DW-TL	EP	
			7.02256.19.0	EUV-AGR	EL	

LAGUNA III Grandtour (KT0/1) 30

1.5 dCi (KT0A) 70-81 kW (95-110 PS) K9K 846	10.2007→12.2015		7.01814.12.0	DW-TL	EP	Produktionsdatum bis: 20.12.2015 Production date to: 20.12.2015
			7.02256.21.0	DW-TL	EP	 K9K 780, K9K 782: Produktionsdatum bis: 06.04.2010 Production date to: 06.04.2010
1.6 16V (KT0D) 81 kW (110 PS) K4M 824	10.2007→12.2015		7.06117.39.0	SV-NWV	EL	
			7.02256.15.0	DW-TL	EP	
2.0 dCi (KT01, KT08, KT09, KT0K, KT12, KT1D, KT1W) 96-110 kW (131-150 PS) M9R 802, M9R 805	10.2007→12.2015		7.02256.15.0	DW-TL	EP	
			7.02256.19.0	EUV-AGR	EL	
2.0 dCi (KT07, KT0J, KT14, KT1A, KT1S) 96-110 kW (131-150 PS) M9R 742, M9R 744, M9R 802	10.2007→12.2015		7.02256.15.0	DW-TL	EP	
			7.02256.19.0	EUV-AGR	EL	
2.0 dCi (KT0M, KT0N, KT0S, KT19, KT1F) 127 kW (173 PS) M9R 800, M9R 809	01.2008→12.2015		7.02256.15.0	DW-TL	EP	
			7.02256.19.0	EUV-AGR	EL	
2.0 dCi GT (KT11, KT1E, KT1N) 127-132 kW (173-180 PS) M9R 816	03.2008→12.2015		7.02256.15.0	DW-TL	EP	
			7.02256.19.0	EUV-AGR	EL	























R

LODGY (JS_) 31

























1.5 dCi 60-66 kW (82-90 PS) K9K 830	01.2015→		7.01814.12.0	DW-TL	EP	
			7.01814.12.0	DW-TL	EP	
1.5 dCi 70-81 kW (95-110 PS) K9K 846	04.2015→12.2019		7.01814.12.0	DW-TL	EP	Produktionsdatum bis: 20.12.2015 Production date to: 20.12.2015

LOGAN I (LS_) 32

1.5 dCi 63 kW (86 PS) K9K 796	02.2008→06.2015		7.02256.21.0	DW-TL	EP	Produktionsdatum bis: 02.09.2009 Production date to: 02.09.2009

					
LOGAN I Estate (KS_)					33
1.5 dCi 63 kW (86 PS) K9K 796	02.2008→06.2015		7.02256.21.0	DW-TL EP	Produktionsdatum bis: 02.09.2009 Production date to: 02.09.2009
MEGANE CC (EZ0/1_)					34
1.2 TCe 84-85 kW (114-116 PS) H5F 400	09.2012→08.2015		7.08681.15.0	EOV EH	
			7.01343.04.0	LDRV EP	
1.2 TCe (EZ16) 97 kW (132 PS) H5F 404	01.2013→		7.08681.15.0	EOV EH	
			7.01343.04.0	LDRV EP	
1.4 TCe (EZ0F, EZ1V) 96 kW (131 PS) H4J 700	06.2010→		7.01343.04.0	LDRV EP	
1.6 16V (EZ0U, EZ1U) 81-85 kW (110-116 PS) K4M 858	06.2010→		7.06117.39.0	SV-NWV EL	
1.6 dCi (EZ00) 96 kW (130 PS) R9M 402	04.2011→		7.01814.12.0	DW-TL EP	
2.0 TCe (EZ1T) 132-140 kW (180-190 PS) F4R 870, F4R 872	06.2010→		7.01343.04.0	LDRV EP	
			7.06117.15.0	SV-NWV EH	mit Wellendichtring With shaft sealing ring
2.0 dCi (EZ0L) 118-120 kW (160-163 PS) M9R 610	06.2010→		7.02256.15.0	DW-TL EP	
			7.02256.19.0	EUV-AGR EL	
MEGANE GRANDTOUR					35
2.0i 80-85 kW (109-115 PS) F3R 750, F3R 751, F3R 752, F3R 791, F3R 796, F3R 797, F3R 798	03.1999→08.2003		7.02256.05.0	OEL-HV EH	
MEGANE I (BA0/1_)					36
1.6 16V (BA04, BA0B, BA11, BA1J, BA16, BA19, BA1K, BA1V,... 69-85 kW (94-116 PS) K4M 700, K4M 701, K4M 706, K4M 708, K4M 709	03.1999→08.2002		7.02256.05.0	OEL-HV EH	
1.9 dCi (BA05, BA1F) 74-77 kW (101-105 PS) F9Q 732, F9Q 733	02.2001→08.2003		7.02256.04.0	DW-TL EP	
1.9 dTi (BA08, BA0N) 72 kW (98 PS) F9Q 731, F9Q 734, F9Q 736	03.1997→02.2001		7.02256.04.0	DW-AGR EP	
2.0 i 80-85 kW (109-115 PS) F3R 750, F3R 751	03.1999→08.2003		7.06269.07.0	LLR EL	⊗
			7.02256.05.0	OEL-HV EH	
2.0 i (BA0G) 80-85 kW (109-115 PS) F3R 750, F3R 751	01.1996→08.2003		7.06269.07.0	LLR EL	⊗
			7.02256.05.0	OEL-HV EH	
MEGANE I Cabriolet (EA0/1_)					37
1.6 16V (EA04, EA0B, EA11, EA1J) 75-85 kW (102-116 PS) K4M 700, K4M 701, K4M 708, K4M 709	03.1999→07.2003		7.02256.05.0	OEL-HV EH	
2.0 (EA0G) 80-85 kW (109-115 PS) F3R 750, F3R 798	04.1997→08.2003		7.06269.07.0	LLR EL	⊗
			7.02256.05.0	OEL-HV EH	

R

			 PIERBURG		
MEGANE I Cabriolet (EA0/1_) 37					
2.0 i (EA0G) 80-85 kW (109-115 PS) F3R 791, F3R 796	03.1999→08.2003		7.06269.07.0	LLR	EL 
			7.02256.05.0	OEL-HV	EH
MEGANE I Classic (LA0/1_) 38					
1.6 16V (LA00, LA04, LA0B, LA11, LA16, LA19, LA1J, LA1K,...) 69-85 kW (94-116 PS) K4M 700, K4M 701, K4M 706, K4M 708, K4M 709	03.1999→07.2003		7.02256.05.0	OEL-HV	EH
1.9 dCi (LA05, LA1F) 74-77 kW (101-105 PS) F9Q 732, F9Q 733	02.2001→08.2003		7.02256.04.0	DW-TL	EP
1.9 dTi (LA08, LA0N) 72 kW (98 PS) F9Q 731, F9Q 734, F9Q 736	03.1997→02.2001		7.02256.04.0	DW-AGR	EP
2.0 i (LA07, LA0G) 80-85 kW (109-115 PS) F3R 750, F3R 751, F3R 752, F3R 791, F3R 796, F3R 797, F3R 798	09.1996→08.2003		7.06269.07.0	LLR	EL 
			7.02256.05.0	OEL-HV	EH
2.0 i (LA0G) 80-85 kW (109-115 PS) F3R 750, F3R 751, F3R 752, F3R 791, F3R 796, F3R 797, F3R 798	03.1999→08.2003		7.06269.07.0	LLR	EL 
			7.02256.05.0	OEL-HV	EH
MEGANE I Coach (DA0/1_) 39					
1.6 16V (DA0B, DA04, DA11) 75-85 kW (102-116 PS) K4M 700, K4M 701, K4M 708, K4M 709	03.1999→07.2003		7.02256.05.0	OEL-HV	EH
1.9 dCi (DA05, DA1F) 74-77 kW (101-105 PS) F9Q 732, F9Q 733	02.2001→08.2003		7.02256.04.0	DW-TL	EP
1.9 dTi (DA0N) 72 kW (98 PS) F9Q 731, F9Q 734, F9Q 736	03.1997→02.2001		7.02256.04.0	DW-AGR	EP
2.0 i 80-85 kW (109-115 PS) F3R 791, F3R 796	03.1999→08.2003		7.06269.07.0	LLR	EL 
			7.02256.05.0	OEL-HV	EH
2.0 i (DA0G) 80-85 kW (109-115 PS) F3R 750, F3R 751, F3R 798	03.1996→08.2003		7.06269.07.0	LLR	EL 
			7.02256.05.0	OEL-HV	EH
MEGANE I Grandtour (KA0/1_) 40					
1.6 16V (KA0B, KA04, KA11) 75-85 kW (102-116 PS) K4M 700, K4M 701, K4M 708, K4M 709, K4M 712	03.1999→08.2003		7.02256.05.0	OEL-HV	EH
1.9 D (KA0J, KA0R) 47 kW (64 PS) F8Q 790	04.1999→08.2003		7.02256.19.0	EUV-LS	EL
1.9 dTi (KA0N) 72 kW (98 PS) F9Q 731, F9Q 736	03.1999→02.2001		7.02256.04.0	DW-AGR	EP

R



MEGANE II (BM0/1_, CM0/1_)

41

1.5 dCi (BM02, BM13, BM2A, CM02, CM13) 74-78 kW (101-106 PS) K9K 728, K9K 729	10.2003→02.2008		7.02256.21.0	DW-TL	EP
1.5 dCi (BM16, CM16) 74-78 kW (103-106 PS) K9K 734	01.2007→03.2009		7.02256.21.0	DW-TL	EP
1.5 dCi (BM1E, CM1E) 78 kW (106 PS) K9K 732	05.2005→06.2008		7.02256.21.0	DW-TL	EP
1.5 dCi (BM1F, CM1F) 63 kW (86 PS) K9K 724	05.2005→02.2008		7.02256.21.0	DW-TL	EP
1.6 77 kW (105 PS) K4M 788	06.2005→02.2008		7.02256.05.0	OEL-HV	EH
1.6 16V 81-83 kW (110-113 PS) K4M 760, K4M 812, K4M 813	01.2006→06.2008		7.02256.05.0	OEL-HV	EH
1.6 16V (BM0C, CM0C) 81-83 kW (110-113 PS) K4M 760	11.2002→02.2008		7.02256.05.0	OEL-HV	EH
			7.06117.39.0	SV-NWV	EL
1.9 dCi 66-75 kW (90-102 PS) F9Q 808	11.2002→12.2005		7.01152.02.0	DW-TL	EP
			7.02256.19.0	EUV-LS	EL
1.9 dCi 81-97 kW (110-132 PS) F9Q 804, F9Q 816, F9Q 818	11.2002→02.2008		7.01152.02.0	DW-TL	EP
1.9 dCi 66-75 kW (90-102 PS) F9Q 808	03.2004→08.2006		7.01152.02.0	DW-TL	EP
			7.02256.19.0	EUV-LS	EL
1.9 dCi 72-97 kW (98-132 PS) F9Q 803, F9Q 804, F9Q 816, F9Q 818	05.2005→12.2009		7.01152.02.0	DW-TL	EP
			7.01152.02.0	DW-TL	EP
1.9 dCi 81-97 kW (110-132 PS) F9Q 804, F9Q 818	05.2005→02.2008		7.01152.02.0	DW-TL	EP
			7.02256.19.0	EUV-LS	EL
1.9 dCi (BM0G, CM0G) 88 kW (120 PS) F9Q 800	11.2002→02.2008		7.01152.02.0	DW-TL	EP
			7.02256.19.0	EUV-LS	EL
2.0 dCi 127 kW (173 PS) M9R 724	01.2007→02.2008		7.02256.15.0	DW-TL	EP
			7.02256.19.0	EUV-AGR	EL
2.0 dCi (BM1K, CM1K) 110 kW (150 PS) M9R 700, M9R 722	09.2005→02.2008		7.02256.15.0	DW-TL	EP
			7.02256.19.0	EUV-AGR	EL

R

MEGANE II Coupé-Cabriolet (EM0/1_)

42

1.5 dCi (EM16) 74-78 kW (103-106 PS) K9K 734	01.2007→06.2009		7.02256.21.0	DW-TL	EP
1.5 dCi (EM1E) 78 kW (106 PS) K9K 732	03.2006→01.2009		7.02256.21.0	DW-TL	EP
1.6 81-83 kW (110-113 PS) K4M 760, K4M 761	09.2003→03.2009		7.02256.05.0	OEL-HV	EH
			7.06117.39.0	SV-NWV	EL
1.6 16V 81-83 kW (110-113 PS) K4M 760, K4M 761, K4M 812, K4M 813	01.2006→06.2008		7.02256.05.0	OEL-HV	EH
			7.02256.05.0	OEL-HV	EH

MEGANE II Coupé-Cabriolet (EM0/1_)
42

			7.06117.39.0	SV-NWV	EL
1.9 dCi 88 kW (120 PS) F9Q 800	09.2003→03.2009		7.01152.02.0	DW-TL	EP
			7.02256.19.0	EUV-LS	EL
1.9 dCi 81-97 kW (110-132 PS) F9Q 804, F9Q 816, F9Q 818	09.2003→03.2009		7.01152.02.0	DW-TL	EP
1.9 dCi 72-97 kW (98-132 PS) F9Q 803, F9Q 804	05.2005→02.2007		7.01152.02.0	DW-TL	EP
1.9 dCi 81-97 kW (110-132 PS) F9Q 804, F9Q 816, F9Q 818	05.2005→03.2009		7.01152.02.0	DW-TL	EP
2.0 dCi 110 kW (150 PS) M9R 700, M9R 722	09.2005→03.2009		7.02256.15.0	DW-TL	EP
			7.02256.19.0	EUV-AGR	EL

MEGANE II Estate (KM0/1_)
43

















1.5 dCi (KM02, KM13) 74-78 kW (101-106 PS) K9K 728, K9K 729	02.2004→03.2006		7.02256.21.0	DW-TL	EP
1.5 dCi (KM16) 74-78 kW (103-106 PS) K9K 734	01.2007→07.2009		7.02256.21.0	DW-TL	EP
1.5 dCi (KM16, KM1E) 78 kW (106 PS) K9K 732	05.2005→06.2008		7.02256.21.0	DW-TL	EP
1.5 dCi (KM1F) 63 kW (86 PS) K9K 724	05.2005→07.2009		7.02256.21.0	DW-TL	EP
1.6 81-83 kW (110-113 PS) K4M 760, K4M 761	08.2003→07.2009		7.02256.05.0	OEL-HV	EH
			7.06117.39.0	SV-NWV	EL
1.6 16V 81-83 kW (110-113 PS) K4M 760, K4M 761, K4M 812, K4M 813	01.2006→08.2009		7.02256.05.0	OEL-HV	EH
			7.06117.39.0	SV-NWV	EL
1.6 LPG 16V 81-83 kW (110-113 PS) K4M 760	01.2006→08.2009		7.06117.39.0	SV-NWV	EL
1.9 dCi 66-75 kW (90-102 PS) F9Q 808	03.2004→02.2007		7.01152.02.0	DW-TL	EP
			7.02256.19.0	EUV-LS	EL
1.9 dCi 66-75 kW (90-102 PS) F9Q 808	04.2004→12.2005		7.01152.02.0	DW-TL	EP
			7.02256.19.0	EUV-LS	EL
1.9 dCi 81-96 kW (110-131 PS) F9Q 818	05.2005→07.2009		7.01152.02.0	DW-TL	EP
1.9 dCi 72-97 kW (98-132 PS) F9Q 803, F9Q 804	05.2005→07.2009		7.01152.02.0	DW-TL	EP
1.9 dCi 81-97 kW (110-132 PS) F9Q 804, F9Q 818	05.2005→07.2009		7.01152.02.0	DW-TL	EP
1.9 dCi (KMRG, KM1G, KM0G, KM2C) 88 kW (120 PS) F9Q 800	08.2003→07.2009		7.01152.02.0	DW-TL	EP
			7.02256.19.0	EUV-LS	EL
2.0 dCi 110 kW (150 PS) M9R 700, M9R 722	09.2005→07.2009		7.02256.15.0	DW-TL	EP
			7.02256.19.0	EUV-AGR	EL

R



MEGANE II Saloon (LM0/1_)

44

1.5 dCi (LM02, LM13, LM2A) 74-78 kW (101-106 PS) K9K 728, K9K 729	02.2004→12.2010		7.02256.21.0	DW-TL	EP	 K9K 728, K9K 729: Produktionsdatum bis: 06.04.2010 Production date to: 06.04.2010
1.5 dCi (LM16) 74-78 kW (103-106 PS) K9K 734	10.2003→12.2010		7.02256.21.0	DW-TL	EP	Produktionsdatum bis: 06.04.2010 Production date to: 06.04.2010
1.5 dCi (LM1E) 78 kW (106 PS) K9K 732	05.2005→12.2010		7.02256.21.0	DW-TL	EP	Produktionsdatum bis: 06.04.2010 Production date to: 06.04.2010
1.5 dCi (LM1F) 63 kW (86 PS) K9K 724	05.2005→12.2010		7.02256.21.0	DW-TL	EP	Produktionsdatum bis: 06.04.2010 Production date to: 06.04.2010
1.6 81-83 kW (110-113 PS) K4M 760, K4M 761	09.2003→		7.02256.05.0	OEL-HV	EH	
			7.06117.39.0	SV-NWV	EL	
1.6 75 kW (102 PS) K4M 768	09.2003→		7.02256.05.0	OEL-HV	EH	
1.6 81-83 kW (110-113 PS) K4M 760, K4M 761	09.2003→11.2008		7.06117.39.0	SV-NWV	EL	
1.6 77-81 kW (105-110 PS) K4M 762	05.2005→		7.02256.05.0	OEL-HV	EH	
1.6 82 kW (112 PS) K4M 812	09.2007→12.2010		7.06117.39.0	SV-NWV	EL	
1.6 16V (LM1R, LM0C) 81-83 kW (110-113 PS) K4M 760, K4M 761, K4M 812, K4M 813	01.2006→		7.02256.05.0	OEL-HV	EH	
			7.06117.39.0	SV-NWV	EL	
1.9 dCi 66-75 kW (90-102 PS) F9Q 808	09.2003→12.2005		7.01152.02.0	DW-TL	EP	
			7.02256.19.0	EUV-LS	EL	
1.9 dCi 66-75 kW (90-102 PS) F9Q 808	03.2004→		7.01152.02.0	DW-TL	EP	
			7.02256.19.0	EUV-LS	EL	
1.9 dCi 72-97 kW (98-132 PS) F9Q 803, F9Q 804	05.2005→		7.01152.02.0	DW-TL	EP	
1.9 dCi (LM0G, LM1G, LM2C) 88 kW (120 PS) F9Q 800	09.2003→		7.01152.02.0	DW-TL	EP	
			7.02256.19.0	EUV-LS	EL	
1.9 dCi (LM14, LM1D) 72-97 kW (98-132 PS) F9Q 803, F9Q 804, F9Q 816, F9Q 818	05.2005→		7.01152.02.0	DW-TL	EP	
2.0 dCi 110 kW (150 PS) M9R 700, M9R 722	09.2005→		7.02256.15.0	DW-TL	EP	
			7.02256.19.0	EUV-AGR	EL	

R











MEGANE III Coupe (DZ0/1_)

45



























1.2 TCe (DZ16, DZ28) 84-97 kW (115-132 PS) H5F 412	01.2013→08.2015		7.01343.04.0	LDRV	EP	
			7.02476.09.0	SUV	EL	
1.2 TCe (DZ16, DZ28) 97 kW (132 PS) H5F 404	01.2013→08.2015		7.08681.15.0	EOV	EH	
			7.01343.04.0	LDRV	EP	
1.2 TCe (DZ16, DZ28) 97 kW (132 PS) H5F 405	01.2013→08.2015		7.01343.04.0	LDRV	EP	



MEGANE III Coupe (DZ0/1_) 45

1.2 TCe (DZ2B, DZ11) 74-97 kW (101-132 PS) H5F 408	03.2012→08.2015		7.01343.04.0	LDRV	EP	
			7.02476.09.0	SUV	EL	
1.2 TCe (DZ2B, DZ11) 84-85 kW (114-116 PS) H5F 400	03.2012→08.2015		7.08681.15.0	EOV	EH	
			7.01343.04.0	LDRV	EP	
1.4 TCe (DZ0F, DZ1V) 96 kW (131 PS) H4J 700	04.2009→		7.01343.04.0	LDRV	EP	
1.5 dCi 70-81 kW (95-110 PS) K9K 846	07.2014→		7.01814.12.0	DW-TL	EP	Produktionsdatum bis: 20.12.2015 Production date to: 20.12.2015
1.5 dCi (DZ09, DZ0D, DZ1F, DZ1G) 70-81 kW (95-110 PS) K9K 636, K9K 846	02.2009→08.2015		7.01814.12.0	DW-TL	EP	 K9K 636, K9K 846: Produktionsdatum bis: 20.12.2015 Production date to: 20.12.2015
1.5 dCi (DZ09, DZ0D, DZ1F, DZ1G) 78-81 kW (106-110 PS) K9K 836, K9K 837	02.2009→08.2015		7.02256.21.0	DW-TL	EP	 K9K 836, K9K 837: Produktionsdatum bis: 06.04.2010 Production date to: 06.04.2010
1.5 dCi (DZ0B) 78 kW (106 PS) K9K 832	02.2009→		7.02256.21.0	DW-TL	EP	Produktionsdatum bis: 06.04.2010 Production date to: 06.04.2010
1.5 dCi (DZ0C, DZ1A) 66 kW (90 PS) K9K 834	11.2008→08.2015		7.02256.21.0	DW-TL	EP	Produktionsdatum bis: 06.04.2010 Production date to: 06.04.2010
1.6 16V (DZ0U, DZ1B, DZ1H) 81-85 kW (110-116 PS) K4M 858	11.2008→08.2015		7.06117.39.0	SV-NWV	EL	
1.6 dCi (DZ00) 96 kW (130 PS) R9M 402	04.2011→08.2015		7.01814.12.0	DW-TL	EP	
2.0 R.S. 162-202 kW (220-275 PS) F4R 874	11.2008→		7.01343.04.0	LDRV	EP	
			7.06117.15.0	SV-NWV	EH	mit Wellendichtring With shaft sealing ring
2.0 R.S. 162-202 kW (220-275 PS) F4R 874	07.2014→		7.01343.04.0	LDRV	EP	
			7.06117.15.0	SV-NWV	EH	mit Wellendichtring With shaft sealing ring
2.0 TCe 132-140 kW (180-190 PS) F4R 872	06.2012→		7.01343.04.0	LDRV	EP	
			7.06117.15.0	SV-NWV	EH	mit Wellendichtring With shaft sealing ring
2.0 TCe (DZ0K) 132 kW (180 PS) F4R 870	11.2008→08.2015		7.01343.04.0	LDRV	EP	
			7.06117.15.0	SV-NWV	EH	mit Wellendichtring With shaft sealing ring
2.0 TCe (DZ1N) 162-202 kW (220-275 PS) F4R 874	05.2009→		7.01343.04.0	LDRV	EP	
			7.06117.15.0	SV-NWV	EH	mit Wellendichtring With shaft sealing ring
2.0 TCe 220 162-202 kW (220-275 PS) F4R 874	11.2013→		7.01343.04.0	LDRV	EP	
			7.06117.15.0	SV-NWV	EH	mit Wellendichtring With shaft sealing ring
2.0 dCi (DZ0L) 118-120 kW (160-163 PS) M9R 610	04.2009→08.2015		7.02256.15.0	DW-TL	EP	
			7.02256.19.0	EUV-AGR	EL	

R

						
MEGANE III Coupe (DZ0/1_)						45
2.0 dCi (DZ0Y) 110 kW (150 PS) M9R 615	04.2009→		7.02256.15.0	DW-TL	EP	
			7.02256.19.0	EUV-AGR	EL	
MEGANE III Grandtour (KZ0/1)						46
1.2 TCe (KZ16, KZ28) 84-97 kW (115-132 PS) H5F 405, H5F 412	01.2013→		7.01343.04.0	LDRV	EP	
1.2 TCe (KZ16, KZ28) 97 kW (132 PS) H5F 404	01.2013→		7.08681.15.0	EOV	EH	
			7.01343.04.0	LDRV	EP	
1.2 TCe (KZ2B, KZ11) 74-97 kW (101-132 PS) H5F 408	03.2012→		7.01343.04.0	LDRV	EP	
1.2 TCe (KZ2B, KZ11) 84-85 kW (114-116 PS) H5F 400	03.2012→		7.08681.15.0	EOV	EH	
			7.01343.04.0	LDRV	EP	
1.4 TCe (KZ0F, KZ1V) 96 kW (131 PS) H4J 700	05.2009→		7.01343.04.0	LDRV	EP	
1.5 dCi 70-81 kW (95-110 PS) K9K 846	11.2013→		7.01814.12.0	DW-TL	EP	Produktionsdatum bis: 20.12.2015 Production date to: 20.12.2015
1.5 dCi (KZ09, KZ0D, KZ1G) 70-81 kW (95-110 PS) K9K 636, K9K 846	02.2009→		7.01814.12.0	DW-TL	EP	 K9K 636, K9K 846: Produktionsdatum bis: 20.12.2015 Production date to: 20.12.2015
1.5 dCi (KZ09, KZ0D, KZ1G) 78-81 kW (106-110 PS) K9K 836, K9K 837	02.2009→		7.02256.21.0	DW-TL	EP	 K9K 836, K9K 837: Produktionsdatum bis: 06.04.2010 Production date to: 06.04.2010
1.5 dCi (KZ0C, KZ1A) 66 kW (90 PS) K9K 834	05.2009→		7.02256.21.0	DW-TL	EP	Produktionsdatum bis: 06.04.2010 Production date to: 06.04.2010
1.5 dCi (KZ1M, KZ1W) 70-81 kW (95-110 PS) K9K 846	02.2009→		7.01814.12.0	DW-TL	EP	Produktionsdatum bis: 20.12.2015 Production date to: 20.12.2015
1.5 dCi (KZ1M, KZ1W) 78-81 kW (106-110 PS) K9K 832, K9K 836	02.2009→		7.02256.21.0	DW-TL	EP	 K9K 832, K9K 836: Produktionsdatum bis: 06.04.2010 Production date to: 06.04.2010
1.6 16V (KZ0U, KZ1B, KZ1U) 81-85 kW (110-116 PS) K4M 858	05.2009→		7.06117.39.0	SV-NWV	EL	
1.6 dCi (KZ00, KZ12, KZ13) 96 kW (130 PS) R9M 402, R9M 404, R9M 414	04.2011→		7.01814.12.0	DW-TL	EP	
2.0 TCe 132-140 kW (180-190 PS) F4R 872	09.2012→		7.01343.04.0	LDRV	EP	
			7.06117.15.0	SV-NWV	EH	mit Wellendichtring With shaft sealing ring
2.0 TCe 162-202 kW (220-275 PS) F4R 874	09.2012→		7.01343.04.0	LDRV	EP	
			7.06117.15.0	SV-NWV	EH	mit Wellendichtring With shaft sealing ring
2.0 TCe (KZ0K, KZ1T) 132-140 kW (180-190 PS) F4R 870, F4R 872	11.2008→		7.01343.04.0	LDRV	EP	
			7.06117.15.0	SV-NWV	EH	mit Wellendichtring With shaft sealing ring

























MEGANE III Grandtour (KZ0/1) **46**

2.0 dCi (KZ0L) 118-120 kW (160-163 PS) M9R 610	04.2009→		7.02256.15.0	DW-TL	EP	
			7.02256.19.0	EUV-AGR	EL	

MEGANE III Hatchback (BZ0/1_, B3_) **47**













1.2 TCe (BZ16, BZ28) 84-97 kW (115-132 PS) H5F 405, H5F 412	01.2013→		7.01343.04.0	LDRV	EP	
1.2 TCe (BZ16, BZ28) 97 kW (132 PS) H5F 404	01.2013→		7.08681.15.0	EOV	EH	
			7.01343.04.0	LDRV	EP	
1.2 TCe (BZ2B, BZ11) 74-97 kW (101-132 PS) H5F 408	03.2012→08.2015		7.01343.04.0	LDRV	EP	
1.2 TCe (BZ2B, BZ11) 84-85 kW (114-116 PS) H5F 400	03.2012→08.2015		7.08681.15.0	EOV	EH	
			7.01343.04.0	LDRV	EP	
1.4 TCe (BZ0F, BZ1V) 96 kW (131 PS) H4J 700	04.2009→		7.01343.04.0	LDRV	EP	
1.5 dCi 78 kW (106 PS) K9K 832	02.2009→		7.02256.21.0	DW-TL	EP	Produktionsdatum bis: 06.04.2010 Production date to: 06.04.2010
1.5 dCi (BZ09, BZ0D, BZ1W, BZ29) 70-81 kW (95-110 PS) K9K 636, K9K 846	02.2009→		7.01814.12.0	DW-TL	EP	K9K 636, K9K 846: Produktionsdatum bis: 20.12.2015 Production date to: 20.12.2015
1.5 dCi (BZ09, BZ0D, BZ1W, BZ29) 78-81 kW (106-110 PS) K9K 836, K9K 837	02.2009→		7.02256.21.0	DW-TL	EP	K9K 836, K9K 837: Produktionsdatum bis: 06.04.2010 Production date to: 06.04.2010
1.5 dCi (BZ0C) 66 kW (90 PS) K9K 834	11.2008→08.2015		7.02256.21.0	DW-TL	EP	Produktionsdatum bis: 06.04.2010 Production date to: 06.04.2010
1.5 dCi (BZ1G, BZ1W, BZ0R) 70-81 kW (95-110 PS) K9K 846	11.2013→08.2015		7.01814.12.0	DW-TL	EP	Produktionsdatum bis: 20.12.2015 Production date to: 20.12.2015
1.6 16V 81-85 kW (110-116 PS) K4M 858	11.2008→		7.06117.39.0	SV-NWV	EL	
1.6 16V (BZ1B, BZ1H) 81-85 kW (110-116 PS) K4M 858	11.2008→		7.06117.39.0	SV-NWV	EL	
1.6 dCi (BZ00, BZ12) 96 kW (130 PS) R9M 402, R9M 404	04.2011→08.2015		7.01814.12.0	DW-TL	EP	
2.0 R.S. 162-202 kW (220-275 PS) F4R 874	06.2014→		7.01343.04.0	LDRV	EP	
			7.06117.15.0	SV-NWV	EH	
2.0 TCe 132-140 kW (180-190 PS) F4R 872	06.2012→		7.01343.04.0	LDRV	EP	
			7.06117.15.0	SV-NWV	EH	
2.0 TCe (BZ0K) 132 kW (180 PS) F4R 870	11.2008→08.2015		7.01343.04.0	LDRV	EP	
			7.06117.15.0	SV-NWV	EH	
2.0 TCe 220 162-202 kW (220-275 PS) F4R 874	11.2013→		7.01343.04.0	LDRV	EP	
			7.06117.15.0	SV-NWV	EH	

R

					
MEGANE III Hatchback (BZ0/1_, B3_)					
47					
2.0 dCi (BZ0L) 118-120 kW (160-163 PS) M9R 610	04.2009→08.2015		7.02256.15.0	DW-TL	EP
			7.02256.19.0	EUV-AGR	EL
MEGANE IV GRAND COUPE					
48					
1.2 TCe 130 74-97 kW (101-132 PS) H5F 408	10.2016→		7.08681.15.0	EOV	EH
			7.01343.04.0	LDRV	EP
			7.02476.09.0	SUV	EL
1.3 TCe 115 (LVN9) 75-120 kW (102-163 PS) H5H 450, H5H 470	01.2018→		7.04818.04.0	SUV	EL
1.3 TCe 140 (LVNB) 75-120 kW (102-163 PS) H5H 450, H5H 470	01.2018→		7.04818.04.0	SUV	EL
1.5 dCi 90 (LVA1) 66-81 kW (90-110 PS) K9K 656	10.2016→		7.01814.12.0	DW-TL	EP
					Produktionsdatum ab: 13.05.2017 Production date from: 13.05.2017
MEGANE IV Grandtour (K9A/M/N_)					
49					
1.2 TCe 100 74-97 kW (101-132 PS) H5F 408	04.2016→		7.08681.15.0	EOV	EH
			7.01343.04.0	LDRV	EP
			7.02476.09.0	SUV	EL
1.2 TCe 130 (K9MR) 74-97 kW (101-132 PS) H5F 408	04.2016→		7.08681.15.0	EOV	EH
			7.01343.04.0	LDRV	EP
			7.02476.09.0	SUV	EL
1.3 TCe 100 (K9N8) 75-120 kW (102-163 PS) H5H 470	08.2018→		7.04818.04.0	SUV	EL
1.3 TCe 115 (K9N9) 75-120 kW (102-163 PS) H5H 450, H5H 470	01.2018→		7.04818.04.0	SUV	EL
1.3 TCe 140 (K9NB) 75-120 kW (102-163 PS) H5H 450, H5H 470	01.2018→		7.04818.04.0	SUV	EL
1.3 TCe 160 (K9NC) 75-120 kW (102-163 PS) H5H 450, H5H 470	01.2018→		7.04818.04.0	SUV	EL
1.3 TCe 160 (K9NC) 75-120 kW (102-163 PS) H5H 470	07.2018→		7.04818.04.0	SUV	EL
1.5 dCi 110 66-81 kW (90-110 PS) K9K 656, K9K 657	04.2016→		7.01814.12.0	DW-TL	EP
					 K9K 656, K9K 657: Produktionsdatum ab: 13.05.2017 Production date from: 13.05.2017
1.5 dCi 90 66-81 kW (90-110 PS) K9K 656	04.2016→		7.01814.12.0	DW-TL	EP
					Produktionsdatum ab: 13.05.2017 Production date from: 13.05.2017
1.6 dCi 130 96 kW (130 PS) R9M 409	04.2016→		7.01814.12.0	DW-TL	EP
1.6 dCi 165 92-120 kW (125-163 PS) R9M 452	04.2016→		7.01814.22.0	DW-TL	EP
					für OE-Nummer: 14 95 667 40R for OE number: 14 95 667 40R































MEGANE IV Hatchback (B9A/M/N_) **50**

1.2 TCe 100 (B9MS) 74-97 kW (101-132 PS) H5F 408	11.2015→		7.08681.15.0	EOV	EH	
			7.01343.04.0 7.02476.09.0	LDRV SUV	EP EL	
1.2 TCe 130 (B9MR) 74-97 kW (101-132 PS) H5F 408	11.2015→		7.08681.15.0	EOV	EH	
			7.01343.04.0 7.02476.09.0	LDRV SUV	EP EL	
1.3 TCe 100 (B9N8) 75-120 kW (102-163 PS) H5H 470	08.2018→		7.04818.04.0	SUV	EL	
1.3 TCe 115 (B9N9) 75-120 kW (102-163 PS) H5H 450, H5H 470	01.2018→		7.04818.04.0	SUV	EL	
1.3 TCe 140 (B9NB) 75-120 kW (102-163 PS) H5H 450, H5H 470	01.2018→		7.04818.04.0	SUV	EL	
1.3 TCe 160 (B9NC) 75-120 kW (102-163 PS) H5H 450, H5H 470	01.2018→		7.04818.04.0	SUV	EL	
1.3 TCe 160 (B9NC) 75-120 kW (102-163 PS) H5H 470	11.2018→		7.04818.04.0	SUV	EL	
1.5 dCi 110 (B9A3) 66-81 kW (90-110 PS) K9K 646, K9K 656, K9K 657	11.2015→		7.01814.12.0	DW-TL	EP	 K9K 646: Produktionsdatum bis: 20.12.2015 Production date to: 20.12.2015  K9K 656, K9K 657: Produktionsdatum ab: 13.05.2017 Production date from: 13.05.2017
1.5 dCi 90 (B9A1) 66-81 kW (90-110 PS) K9K 656	11.2015→		7.01814.12.0	DW-TL	EP	Produktionsdatum ab: 13.05.2017 Production date from: 13.05.2017
1.6 dCi 130 (B9A4) 96 kW (130 PS) R9M 409	11.2015→		7.01814.12.0	DW-TL	EP	
1.6 dCi 165 92-120 kW (125-163 PS) R9M 452	11.2015→		7.01814.22.0	DW-TL	EP	für OE-Nummer: 14 95 667 40R for OE number: 14 95 667 40R

R MEGANE Scenic (JA0/1_) **51**











1.6 16V (JA0B, JA04, JA11) 75-85 kW (102-116 PS) K4M 700, K4M 701, K4M 704, K4M 708	04.1998→10.1999		7.02256.05.0	OEL-HV	EH	
1.9 D (JA0J) 47 kW (64 PS) F8Q 790	03.1997→09.1999		7.02256.19.0	EUV-LS	EL	
1.9 dTi (JA0N) 72 kW (98 PS) F9Q 734	04.1997→09.1999		7.02256.04.0	DW-AGR	EP	
2.0 RXE 4x4 80-85 kW (109-115 PS) F3R 750	05.1997→10.1999		7.06269.07.0	LLR	EL	
2.0 i (JA02, JA0G) 80-85 kW (109-115 PS) F3R 796	01.1999→09.1999		7.06269.07.0	LLR	EL	
2.0 i (JA0G) 80-85 kW (109-115 PS) F3R 750, F3R 751	01.1997→09.1999		7.06269.07.0	LLR	EL	

						
MODUS / GRAND MODUS (F/JP0_)						52
1.5 dCi (JP02) 63-76 kW (86-103 PS) K9K 772	05.2007→		7.02256.21.0	DW-TL	EP	Produktionsdatum bis: 04.06.2010 Production date to: 04.06.2010
1.6 (JP03, JP0B, JP0U, JP0Y, JP1G) 82 kW (112 PS) K4M 790, K4M 791, K4M 800, K4M 801	12.2004→		7.06117.39.0	SV-NWV	EL	
1.6 (JP0L, JP0V) 65 kW (88 PS) K4M 794	12.2004→		7.06117.39.0	SV-NWV	EL	
SAFRANE I (B54_)						53
2.0 12V (B542, B54E) 97-99 kW (132-135 PS) J7R 734, J7R 735	04.1992→07.1996		7.06269.09.0	LLR	EL	
2.2 (B543) 101 kW (137 PS) J7T 760, J7T 761	04.1992→07.1996		7.06269.09.0	LLR	EL	
SAFRANE II (B54_)						54
2.0 16V (B54L) 100 kW (136 PS) N7Q 710, N7Q 711	07.1996→12.2000		7.06269.09.0	LLR	EL	
SANDERO/STEPWAY II (B8_)						55
1.5 dCi 60-66 kW (82-90 PS) K9K 830	12.2013→		7.01814.12.0	DW-TL	EP	
SCÉNIC I MPV (JA0/1_, FA0_)						56
1.6 75-85 kW (102-116 PS) K4M 708, K4M 709	03.2001→08.2003		7.02256.05.0	OEL-HV	EH	
1.8 16V (JA12, JA1R, JA1M, JA1A) 85 kW (115 PS) F4P 720, F4P 722	01.2001→08.2003		7.02256.05.0	OEL-HV	EH	
1.8 4x4 85 kW (115 PS) F4P 722	07.2000→04.2001		7.02256.05.0	OEL-HV	EH	
1.9 D (JA0J, FA0J) 47 kW (64 PS) F8Q 790	09.1999→03.2001		7.02256.19.0	EUV-LS	EL	
1.9 dCi (JA05, JA1F) 74-77 kW (101-105 PS) F9Q 732, F9Q 733	09.1999→08.2003		7.02256.04.0	DW-TL	EP	
1.9 dCi RX4 75 kW (102 PS) F9Q 740	11.2000→08.2003		7.02256.04.0	DW-TL	EP	
1.9 dTi (JA0N) 72 kW (98 PS) F9Q 731, F9Q 734, F9Q 736	09.1999→08.2003		7.02256.04.0	DW-AGR	EP	
SCÉNIC II (JM0/1_)						57
1.5 dCi (JM02, JM13) 74-78 kW (101-106 PS) K9K 728, K9K 729	11.2003→08.2005		7.02256.21.0	DW-TL	EP	
1.5 dCi (JM16) 74-78 kW (101-106 PS) K9K 728, K9K 734	01.2007→11.2008		7.02256.21.0	DW-TL	EP	
1.5 dCi (JM1E, JM16) 74-78 kW (103-106 PS) K9K 732, K9K 734	05.2005→11.2008		7.02256.21.0	DW-TL	EP	
1.5 dCi (JM1F) 63 kW (86 PS) K9K 724	05.2005→11.2008		7.02256.21.0	DW-TL	EP	
1.6 (JM0C, JM0J, JM1B) 81-83 kW (110-113 PS) K4M 761, K4M 782	06.2003→10.2006		7.02256.05.0	OEL-HV	EH	
1.6 16V (JM1R) 69-82 kW (94-112 PS) K4M 706	10.2005→11.2008		7.06117.39.0 7.02256.05.0	SV-NWV OEL-HV	EL EH	













R

























SCÉNIC II (JM0/1_) 57

1.6 16V (JM1R) 81-85 kW (110-116 PS) K4M 766, K4M 812, K4M 813	10.2005→11.2008		7.02256.05.0	OEL-HV	EH	
			7.06117.39.0	SV-NWV	EL	Produktionsdatum ab: 07.02.2008 Production date from: 07.02.2008
1.6 Hi-Flex 81-85 kW (110-116 PS) K4M 766	03.2005→07.2010		7.06117.39.0	SV-NWV	EL	Produktionsdatum ab: 07.02.2008 Production date from: 07.02.2008
1.9 D 85-96 kW (116-131 PS) F9Q 812, F9Q J 803	06.2006→11.2008		7.01152.02.0	DW-TL	EP	
1.9 dCi 81-97 kW (110-132 PS) F9Q 804	06.2003→11.2008		7.01152.02.0	DW-TL	EP	
1.9 dCi 72-96 kW (98-131 PS) F9Q 803	04.2004→10.2008		7.01152.02.0	DW-TL	EP	
1.9 dCi (JM0G, JM12, JM1G, JM2C) 85-88 kW (116-120 PS) F9Q 812	06.2003→05.2006		7.01152.02.0	DW-TL	EP	
			7.02256.19.0	LDRV	EL	
1.9 dCi (JM14) 81-97 kW (110-132 PS) F9Q 804, F9Q 816, F9Q 818, F9Q J 803	05.2005→11.2008		7.01152.02.0	DW-TL	EP	
1.9 dCi (JM15) 81-97 kW (110-132 PS) F9Q 804	05.2005→11.2008		7.01152.02.0	DW-TL	EP	
1.9 dCi 130 81-97 kW (110-132 PS) F9Q 804	10.2005→12.2009		7.01152.02.0	DW-TL	EP	
2.0 dCi (JM1K) 110 kW (150 PS) M9R 700, M9R 721, M9R 722	09.2005→11.2008		7.02256.15.0	DW-TL	EP	
			7.02256.19.0	EUV-AGR	EL	





















SCÉNIC III (JZ0/1_) 58

1.2 TCe 84-85 kW (114-116 PS) H5F 400	04.2012→		7.08681.15.0	EOV	EH	
			7.01343.04.0	LDRV	EP	
1.2 TCe (JZ16) 74-97 kW (101-132 PS) H5F 404, H5F 408	01.2013→		7.08681.15.0	EOV	EH	
			7.01343.04.0	LDRV	EP	
1.4 16V (JZ0F, JZ1V) 96 kW (131 PS) H4J 700	02.2009→		7.01343.04.0	LDRV	EP	
1.5 dCi 78 kW (106 PS) K9K 832	02.2009→		7.02256.21.0	DW-TL	EP	Produktionsdatum bis: 06.04.2010 Production date to: 06.04.2010
1.5 dCi 66-81 kW (90-110 PS) K9K 636, K9K 656, K9K 657	04.2009→		7.01814.12.0	DW-TL	EP	 K9K 636: Produktionsdatum bis: 20.12.2015 Production date to: 20.12.2015
						 K9K 656, K9K 657: Produktionsdatum bis: 03.04.2017 Production date to: 03.04.2017
1.5 dCi 78-81 kW (106-110 PS) K9K 836, K9K 837	04.2009→		7.02256.21.0	DW-TL	EP	 K9K 836, K9K 837: Produktionsdatum bis: 06.04.2010 Production date to: 06.04.2010
1.5 dCi (JZ02, JZ0R) 70-81 kW (95-110 PS) K9K 846	11.2010→		7.01814.12.0	DW-TL	EP	Produktionsdatum bis: 20.12.2015 Production date to: 20.12.2015
1.6 16V (JZ0U, JZ1B) 81-85 kW (110-116 PS) K4M 858	02.2009→		7.06117.39.0	SV-NWV	EL	
1.6 dCi (JZ00, JZ12) 96 kW (130 PS) R9M 402, R9M 404, R9M 414	04.2011→		7.01814.12.0	DW-TL	EP	























R

					
SCÉNIC III (JZ0/1_) 58					
2.0 dCi (JZ0L) 118-120 kW (160-163 PS) M9R 610	04.2009→		7.02256.15.0	DW-TL	EP
			7.02256.19.0	EUV-AGR	EL
2.0 dCi (JZ0Y, JZ26) 110 kW (150 PS) M9R 615	02.2009→		7.02256.15.0	DW-TL	EP
			7.02256.19.0	EUV-AGR	EL
SCÉNIC IV (J9_) 59					
1.2 TCe 115 74-97 kW (101-132 PS) H5F 408	09.2016→		7.08681.15.0	EOV	EH
			7.01343.04.0	LDRV	EP
1.2 TCe 130 74-97 kW (101-132 PS) H5F 408	09.2016→		7.08681.15.0	EOV	EH
			7.01343.04.0	LDRV	EP
1.3 TCe 115 (J9N9) 75-120 kW (102-163 PS) H5H 450, H5H 470	01.2018→		7.04818.04.0	SUV	EL
			7.04818.04.0	SUV	EL
1.3 TCe 140 75-120 kW (102-163 PS) H5H 450, H5H 470	01.2018→		7.04818.04.0	SUV	EL
			7.04818.04.0	SUV	EL
1.3 TCe 160 85-120 kW (115-163 PS) H5H 450	01.2018→		7.04818.04.0	SUV	EL
			7.04818.04.0	SUV	EL
1.3 TCe 160 (J9NC) 75-120 kW (102-163 PS) H5H 470	09.2018→		7.04818.04.0	SUV	EL
			7.04818.04.0	SUV	EL
1.6 dCi 130 96 kW (130 PS) R9M 409	09.2016→		7.01814.12.0	DW-TL	EP
			7.01814.22.0	DW-TL	EP
1.6 dCi 160 92-120 kW (125-163 PS) R9M 452	09.2016→		7.01814.12.0	DW-TL	EP
			7.01814.22.0	DW-TL	EP
TALISMAN (LP_) 60					
1.3 TCe 160 (LPNC) 75-120 kW (102-163 PS) H5H 470	01.2019→		7.04818.04.0	SUV	EL
			7.04818.04.0	SUV	EL
1.5 dCi 110 67-81 kW (91-110 PS) K9K 646, K9K 647	11.2015→		7.01814.12.0	DW-TL	EP
			7.01814.12.0	DW-TL	EP
1.6 dCi 130 96 kW (130 PS) R9M 409	11.2015→		7.01814.12.0	DW-TL	EP
			7.01814.12.0	DW-TL	EP
1.6 dCi 160 92-120 kW (125-163 PS) R9M 452, R9M 453	06.2015→		7.01814.12.0	DW-TL	EP
			7.01814.22.0	DW-TL	EP
TALISMAN Grandtour (KP_) 61					
1.3 TCe 160 (KPNC) 75-120 kW (102-163 PS) H5H 470	01.2019→		7.04818.04.0	SUV	EL
			7.04818.04.0	SUV	EL
1.6 dCi 130 96 kW (130 PS) R9M 409	03.2016→		7.01814.12.0	DW-TL	EP
			7.01814.12.0	DW-TL	EP

R

					
TALISMAN Grandtour (KP_) 61					
1.6 dCi 160 92-120 kW (125-163 PS) R9M 452, R9M 453	03.2016→		7.01814.12.0	DW-TL	EP
			7.01814.22.0	DW-TL	EP  R9M 452, R9M 453: für OE-Nummer: 14 95 667 40R for OE number: 14 95 667 40R
THALIA I (LB_) 62					
1.5 dCi 60-62 kW (82-84 PS) K9K 718	06.2001→02.2009		7.02256.21.0	DW-TL	EP
1.5 dCi 47 kW (64 PS) K9K 740	06.2005→		7.02256.21.0	DW-TL	EP
THALIA II (LU_) 63					
1.5 dCi 60-62 kW (82-84 PS) K9K 718	09.2008→		7.02256.21.0	DW-TL	EP Produktionsdatum bis: 02.09.2009 Production date to: 02.09.2009
1.5 dCi 47 kW (64 PS) K9K 740	09.2008→		7.02256.21.0	DW-TL	EP
TWINGO II (CN0_) 64					
1.5 dCi (CN0E) 47 kW (64 PS) K9K 740	03.2007→09.2014		7.02256.21.0	DW-TL	EP
1.5 dCi (CN0U) 60-62 kW (82-84 PS) K9K 718	04.2008→09.2014		7.02256.21.0	DW-TL	EP Produktionsdatum bis: 02.09.2009 Production date to: 02.09.2009
1.6 RS (CN0N, CN0R, CN0S) 98 kW (133 PS) K4M 854	05.2008→09.2014		7.06117.39.0	SV-NWV	EL
TWINGO III (BCM_) 65					
0.9 TCe 110 66-80 kW (90-109 PS) H4B 401	11.2016→		7.08681.15.0	EOV	EH
0.9 TCe 90 66-80 kW (90-109 PS) H4B 401	09.2014→		7.08681.15.0	EOV	EH
1.0 SCe 70 51-52 kW (69-71 PS) H4D 400	09.2014→		7.08681.15.0	EOV	EH
VEL SATIS (BJ0_) 66					
2.0 dCi (BJ03) 96-127 kW (131-173 PS) M9R 760	08.2005→		7.02256.15.0	DW-TL	EP
			7.02256.19.0	EUV-AGR	EL
2.0 dCi (BJ03, BJ0B) 96-127 kW (131-173 PS) M9R 760, M9R 762, M9R 763	01.2006→		7.02256.15.0	DW-TL	EP
			7.02256.19.0	EUV-AGR	EL
2.2 dCi (BJ0E, BJ0F) 83-110 kW (113-150 PS) G9T 702, G9T 703	06.2002→08.2009		7.01152.02.0	DW-TL	EP
			7.02256.19.0	EUV-LS	EL
2.2 dCi (BJ0E, BJ0F, BJ0G, BJ0H) 78-110 kW (106-150 PS) G9T 600, G9T 606, G9T 607, G9T 702	09.2004→		7.01152.02.0	DW-TL	EP
			7.02256.19.0 7.02256.19.0	EUV-AGR EUV-LS	EL EL
2.2 dCi (BJ0E, BJ0F, BJ0G, BJ0H) 83-110 kW (113-150 PS) G9T 700	09.2004→		7.01152.02.0	DW-TL	EP
2.2 dCi (BJ0H) 83-102 kW (113-139 PS) G9T 600	04.2004→		7.01152.02.0	DW-TL	EP

R

						
VEL SATIS (BJ0_)						66
2.2 dCi (BJ0H) 83-110 kW (113-150 PS) G9T 702	04.2004→		7.02256.19.0 7.01152.02.0	EUV-AGR DW-TL	EL EP	
2.2 dCi (BJ0M) 83-110 kW (113-150 PS) G9T 700, G9T 702	12.2004→		7.01152.02.0	DW-TL	EP	
WIND (E4M_)						67
1.6 (E4MB, E4MC) 98 kW (133 PS) K4M 854	07.2010→		7.06117.39.0	SV-NWV	EL	
CLIO II Hatchback Van (SB0/1/2_)						68
1.9 D (SB0E) 47-48 kW (64-65 PS) F8Q 630	09.1998→		7.02256.19.0	EUV-AGR	EL	
1.9 DTi (SB0U) 59 kW (80 PS) F9Q 780	02.2000→05.2001		7.02256.04.0	DW-AGR	EP	
CLIO III Hatchback Van (SB_, SR_)						69
1.5 dCi 78 kW (106 PS) K9K 764	10.2005→10.2007		7.02256.21.0	DW-TL	EP	
CLIO IV Hatchback Van (BH_)						70
0.9 TCe 90 56-66 kW (76-90 PS) H4B 400, H4B 408	01.2014→		7.08681.15.0 7.01343.04.0	EOV LDRV	EH EP	
0.9 TCe 90 LPG (BHM1) 66 kW (90 PS) H4B 410	08.2015→		7.01343.04.0	LDRV	EP	
1.5 dCi 90 (BHAJ) 55-66 kW (75-90 PS) K9K 608, K9K 628, K9K 629	01.2014→		7.01814.12.0	DW-TL	EP	
DOKKER						71
1.5 dCi 55-66 kW (75-90 PS) K9K 612	12.2013→		7.01814.12.0	DW-TL	EP	Produktionsdatum bis: 20.12.2015 Production date to: 20.12.2015
KANGOO Express (FC0/1_)						72
1.5 dCi (FC1G) 60-62 kW (82-84 PS) K9K 718	06.2005→		7.02256.21.0	DW-TL	EP	Produktionsdatum bis: 02.09.2009 Production date to: 02.09.2009
1.6 16V 69-82 kW (94-112 PS) K4M 706, K4M 752	10.2001→		7.02256.05.0	OEL-HV	EH	
1.6 16V 4x4 (FC0L, FC0P, FC0S) 70 kW (95 PS) K4M 750, K4M 752, K4M 753	10.2001→		7.02256.05.0	OEL-HV	EH	
1.9 dTi (FC0U) 59 kW (80 PS) F9Q 780	02.2000→		7.02256.04.0	DW-AGR	EP	
D 55 1.9 (FC0D) 40-48 kW (54-65 PS) F8Q 662	03.1998→		7.02256.19.0	EUV-AGR	EL	
D 65 1.9 (FC0E, FC02, FC0J, FC0N) 47-48 kW (64-65 PS) F8Q 630	03.1998→		7.02256.19.0	EUV-AGR	EL	
KANGOO Express (FW0/1_)						73
1.2 TCe 115 (FW02, FW14) 74-97 kW (101-132 PS) H5F 408, H5F 412	07.2013→		7.08681.15.0 7.01343.04.0 7.02476.09.0	EOV LDRV SUV	EH EP EL	





KANGOO Express (FW0/1_) 73

1.2 TCe 115 (FW02, FW14) 84-85 kW (114-116 PS) H5F 400	07.2013→		7.08681.15.0	EOV	EH	
			7.01343.04.0	LDRV	EP	
1.5 dCi 105 (FW0F) 76 kW (103 PS) K9K 806	02.2008→		7.02256.21.0	DW-TL	EP	Produktionsdatum bis: 06.04.2010 Production date to: 06.04.2010
1.5 dCi 110 (FW06, FW12) 67-81 kW (91-110 PS) K9K 636, K9K 646, K9K 647	09.2013→		7.01814.12.0	DW-TL	EP	 K9K 636, K9K 646, K9K 647: Produktionsdatum bis: 20.12.2015 Production date to: 20.12.2015
1.5 dCi 75 (FW07, FW10, FW04) 55-66 kW (75-90 PS) K9K 608, K9K 628	09.2010→		7.01814.12.0	DW-TL	EP	 K9K 608, K9K 628: Produktionsdatum bis: 20.12.2015 Production date to: 20.12.2015
1.5 dCi 85 (FW0K, FW0L, FW0B) 50-66 kW (68-90 PS) K9K 802, K9K 812	02.2008→		7.02256.21.0	DW-TL	EP	 K9K 802, K9K 812: Produktionsdatum bis: 06.04.2010 Production date to: 06.04.2010
1.5 dCi 90 (FW0G, FW05, FW08, FW11) 55-66 kW (75-90 PS) K9K 608, K9K 628	06.2009→		7.01814.12.0	DW-TL	EP	 K9K 608, K9K 628: Produktionsdatum bis: 20.12.2015 Production date to: 20.12.2015
1.5 dCi 90 (FW0G, FW05, FW08, FW11) 55-66 kW (75-90 PS) K9K 808	06.2009→		7.02256.21.0	DW-TL	EP	Produktionsdatum bis: 06.04.2010 Production date to: 06.04.2010

MASTER II Bus (JD) 74

1.9 dTi 59 kW (80 PS) F9Q 770	09.2000→		7.02256.04.0	DW-AGR	EP	
2.5 D 59 kW (80 PS) S8U 770	07.1998→01.2001		7.02256.19.0	EUV-LS	EL	
2.5 dCi 74-88 kW (101-120 PS) G9U 650	08.2006→		7.02256.19.0	LDRV	EL	
2.5 dCi 88-107 kW (120-146 PS) G9U 632	08.2006→		7.01152.02.0	DW-TL	EP	
			7.02256.19.0	LDRV	EL	

MASTER II Platform/Chassis (ED/HD/UD) 75

2.5 D 59 kW (80 PS) S8U 770	07.1998→01.2001		7.02256.19.0	EUV-LS	EL	
2.5 dCi 74-88 kW (101-120 PS) G9U 650	08.2006→		7.02256.19.0	LDRV	EL	
2.5 dCi 88-107 kW (120-146 PS) G9U 632	08.2006→		7.01152.02.0	DW-TL	EP	
			7.02256.19.0	LDRV	EL	

MASTER II Van (FD) 76

1.9 dTi 59 kW (80 PS) F9Q 770	09.2000→		7.02256.04.0	DW-AGR	EP	
2.5 D 59 kW (80 PS) S8U 770	07.1998→01.2001		7.02256.19.0	EUV-LS	EL	
2.5 dCi 74-88 kW (101-120 PS) G9U 650	08.2006→01.2010		7.02256.19.0	LDRV	EL	
2.5 dCi 74-88 kW (101-120 PS) G9U 650	08.2006→		7.02256.19.0	LDRV	EL	
2.5 dCi 88-107 kW (120-146 PS) G9U 632	08.2006→		7.01152.02.0	DW-TL	EP	
			7.02256.19.0	LDRV	EL	

R

MASTER III Bus (JV)
77

2.3 dCi 110 FWD (JV0R, JV0W) 81-96 kW (110-131 PS) M9T 704	09.2014→		7.01814.12.0	DW-TL	EP
2.3 dCi 135 FWD (JV0N, JV08) 96-132 kW (136-179 PS) M9T 702, M9T 716	07.2014→		7.01814.12.0	DW-TL	EP
2.3 dCi 145 FWD (JV0F, JV0S, JV0T) 107-125 kW (145-170 PS) M9T 706, M9T 708	02.2011→		7.01814.12.0	DW-TL	EP
2.3 dCi 150 FWD (JV0F, JV03) 100-132 kW (136-179 PS) M9T 716	03.2020→		7.01814.12.0	DW-TL	EP
2.3 dCi 165 FWD (JV0P, JV0U) 96-120 kW (136-163 PS) M9T 702, M9T 708	07.2014→		7.01814.12.0	DW-TL	EP
2.3 dCi 170 FWD (JV0L) 107-125 kW (145-170 PS) M9T 706	07.2015→		7.01814.12.0	DW-TL	EP
2.3 dCi 180 FWD (JV04) 100-132 kW (136-179 PS) M9T 716	01.2020→		7.01814.12.0	DW-TL	EP

MASTER III Platform/Chassis (EV, HV, UV)
78



2.3 dCi 110 FWD (EV0R, EV0W, HV0R, HV0W, UV0R, UV0W) 81-96 kW (110-131 PS) M9T 704	09.2014→		7.01814.12.0	DW-TL	EP
2.3 dCi 130 FWD (EV0Y, HV0Y, UV0M, UV0Y) 81-96 kW (110-131 PS) M9T 704	03.2012→		7.01814.12.0	DW-TL	EP
2.3 dCi 130 RWD (HV01, HV10, HV11, HV12, UV01, UV10,...) 96-120 kW (131-163 PS) M9T 710	07.2016→		7.01814.12.0	DW-TL	EP
2.3 dCi 135 FWD (EV0N, HV0N, UV0N, EV08, HV08, UV08) 96-132 kW (136-179 PS) M9T 702, M9T 716	07.2014→		7.01814.12.0	DW-TL	EP
2.3 dCi 135 RWD (HV0N, UV0N) 100-120 kW (136-163 PS) M9T 700	07.2014→		7.01814.12.0	DW-TL	EP
2.3 dCi 145 FWD (EV0E, EV0F, HV0E, HV0F, UV0E, UV0F,...) 107-125 kW (145-170 PS) M9T 706, M9T 708	02.2010→		7.01814.12.0	DW-TL	EP
2.3 dCi 145 RWD (UV0F, UV0E, HV0E, HV0F, HV0T, HV10,...) 96-120 kW (131-163 PS) M9T 710	02.2010→		7.01814.12.0	DW-TL	EP
2.3 dCi 150 FWD (EV0F, HV0F, UV0F, EV03, HV03, UV03) 100-132 kW (136-179 PS) M9T 716	07.2019→		7.01814.12.0	DW-TL	EP
2.3 dCi 165 FWD (EV0P, EV0U, EV11, EV12, HV0P, HV0U,...) 96-120 kW (136-163 PS) M9T 702, M9T 708	07.2014→		7.01814.12.0	DW-TL	EP

R



MASTER III Platform/Chassis (EV, HV, UV)

78

























2.3 dCi 165 RWD (HV0P, HV0U, HV10, HV12, UV0P, UV0U,...) 96-120 kW (131-163 PS) M9T 700, M9T 710	07.2014→		7.01814.12.0	DW-TL	EP
2.3 dCi 170 FWD (EV0L, HV0L, UV0L) 107-125 kW (145-170 PS) M9T 706	06.2016→		7.01814.12.0	DW-TL	EP
2.3 dCi 180 FWD (EV04, HV04, UV04) 100-132 kW (136-179 PS) M9T 716	07.2019→		7.01814.12.0	DW-TL	EP

MASTER III Van (FV)

79

2.3 dCi 100 FWD (FV0A, FV0B, FV0G, FV0K, FV0H) 74-92 kW (101-125 PS) M9T 670, M9T 676	02.2010→		7.02256.15.0	DW-TL	EP
			7.02256.19.0	EUV-AGR	EL
2.3 dCi 110 FWD (FV0R, FV0W) 81-96 kW (110-131 PS) M9T 704	09.2014→		7.01814.12.0	DW-TL	EP
2.3 dCi 125 FWD (FV0C, FV0D, FV0G, FV0H, FV0J, FV0K) 74-92 kW (101-125 PS) M9T 670, M9T 676	02.2010→		7.02256.15.0	DW-TL	EP
			7.02256.19.0	EUV-AGR	EL
2.3 dCi 125 RWD (FV0C, FV0D, FV0H, FV0J, FV0A, FV0K) 74-96 kW (101-130 PS) M9T 690, M9T 692	02.2010→		7.02256.15.0	DW-TL	EP
			7.02256.19.0	EUV-AGR	EL
2.3 dCi 130 FWD (FV0M, FV0Y) 81-120 kW (110-163 PS) M9T 704, M9T 710	06.2016→		7.01814.12.0	DW-TL	EP
2.3 dCi 130 RWD (FV01, FV10, FV11, FV12) 96-120 kW (131-163 PS) M9T 710	03.2012→		7.01814.12.0	DW-TL	EP
2.3 dCi 135 FWD (FV0N, FV08) 96-132 kW (136-179 PS) M9T 702, M9T 716	07.2014→		7.01814.12.0	DW-TL	EP
2.3 dCi 135 RWD (FV0N) 100-120 kW (136-163 PS) M9T 700	07.2014→		7.01814.12.0	DW-TL	EP
2.3 dCi 145 FWD (FV0E, FV0F, FV0H, FV02, FV0M, FV0S,...) 107-125 kW (145-170 PS) M9T 706, M9T 708	02.2010→		7.01814.12.0	DW-TL	EP
2.3 dCi 145 RWD (FV0E, FV0F, FV0T, FV10, FV12) 92-110 kW (125-150 PS) M9T 698	02.2010→		7.02256.15.0	DW-TL	EP
			7.02256.19.0	EUV-AGR	EL
2.3 dCi 145 RWD (FV0E, FV0F, FV0T, FV10, FV12) 96-120 kW (131-163 PS) M9T 710	02.2010→		7.01814.12.0	DW-TL	EP
2.3 dCi 150 FWD (FV0F, FV03) 100-132 kW (136-179 PS) M9T 716	07.2019→		7.01814.12.0	DW-TL	EP







R

						
MASTER III Van (FV)						79
2.3 dCi 165 FWD (FV0P, FV0U, FV11, FV12) 96-120 kW (136-163 PS) M9T 702, M9T 708	07.2014→		7.01814.12.0	DW-TL	EP	
2.3 dCi 165 RWD (FV0P, FV0U, FV10, FV12) 96-120 kW (131-163 PS) M9T 700, M9T 710	07.2014→		7.01814.12.0	DW-TL	EP	
2.3 dCi 170 FWD (FV0L) 107-125 kW (145-170 PS) M9T 706	07.2015→		7.01814.12.0	DW-TL	EP	
2.3 dCi 180 FWD (FV04) 100-132 kW (136-179 PS) M9T 716	07.2019→		7.01814.12.0	DW-TL	EP	
MEGANE II Estate Van (KM_)						80
1.5 dCi (KM02) 74-78 kW (101-106 PS) K9K 728	08.2003→07.2009		7.02256.21.0	DW-TL	EP	
1.5 dCi (KM1E) 78 kW (106 PS) K9K 732	08.2003→07.2009		7.02256.21.0	DW-TL	EP	
1.5 dCi (KM1F) 63 kW (86 PS) K9K 724	05.2005→07.2009		7.02256.21.0	DW-TL	EP	
MEGANE II Hatchback Van (KM0/2_)						81
1.5 dCi 74-78 kW (101-106 PS) K9K 728	08.2003→02.2008		7.02256.21.0	DW-TL	EP	
1.5 dCi 63 kW (86 PS) K9K 724	04.2005→02.2008		7.02256.21.0	DW-TL	EP	
1.5 dCi 78 kW (106 PS) K9K 732	05.2005→02.2008		7.02256.21.0	DW-TL	EP	
1.5 dCi 74-78 kW (103-106 PS) K9K 734	01.2007→03.2009		7.02256.21.0	DW-TL	EP	
MEGANE III Combi Van (KZ0/1)						82
1.5 dCi 78-81 kW (106-110 PS) K9K 836, K9K 837	01.2009→08.2015		7.02256.21.0	DW-TL	EP	 K9K 836, K9K 837: Produktionsdatum bis: 06.04.2010 Production date to: 06.04.2010
MEGANE III Hatchback Van (BZ_)						83
1.5 dCi (BZ0C, BZ1A) 66 kW (90 PS) K9K 834	11.2008→08.2015		7.02256.21.0	DW-TL	EP	Produktionsdatum bis: 06.04.2010 Production date to: 06.04.2010
1.5 dCi (BZ0D, BZ1G, BZ1F, BZ1M, BZ1W, BZ0R, BZ10) 70-81 kW (95-110 PS) K9K 846	02.2009→08.2015		7.01814.12.0	DW-TL	EP	
1.5 dCi (BZ0D, BZ1G, BZ1F, BZ1M, BZ1W, BZ0R, BZ10) 78-81 kW (106-110 PS) K9K 836	02.2009→08.2015		7.02256.21.0	DW-TL	EP	Produktionsdatum bis: 06.04.2010 Production date to: 06.04.2010
TRAFIC Bus (TXW)						84
1.9 D 44 kW (60 PS) F8Q 606	06.1997→03.2001		7.02256.19.0	EUV-LS	EL	
TRAFIC II Bus (JL)						85
1.9 dCi 100 (JL0C) 60-75 kW (82-102 PS) F9Q 760	03.2001→		7.02256.04.0	DW-TL	EP	
1.9 dCi 80 (JL0B) 60 kW (82 PS) F9Q 762	03.2001→		7.02256.04.0	DW-TL	EP	







R

					
---	---	---	---	--	---





TRAFIC II Bus (JL)	85
---------------------------	-----------





















1.9 dCi 60 kW (82 PS) F9Q 762	04.2001→07.2003		7.02256.04.0	DW-TL	EP
2.0 dCi 115 66-84 kW (90-114 PS) M9R 780, M9R 782, M9R 786	08.2006→		7.02256.04.0	DW-TL	EP
			7.02256.19.0	EUV-AGR	EL
2.0 dCi 90 66-84 kW (90-114 PS) M9R 782	08.2006→		7.02256.04.0	DW-TL	EP
			7.02256.19.0	EUV-AGR	EL
2.5 dCi 115 84-107 kW (114-146 PS) G9U 630	02.2008→		7.01152.02.0	DW-TL	EP
2.5 dCi 135 (JL0D) 99 kW (135 PS) G9U 730	05.2003→		7.02256.04.0	DW-TL	EP
2.5 dCi 145 (JL0J) 84-107 kW (114-146 PS) G9U 630	08.2006→		7.01152.02.0	DW-TL	EP
			7.02256.19.0	LDRV	EL

TRAFIC II Platform/Chassis (EL)	86
--	-----------

1.9 dCi 100 (EL0C) 60-75 kW (82-102 PS) F9Q 760	03.2001→		7.02256.04.0	DW-TL	EP
1.9 dCi 80 (EL0B) 60 kW (82 PS) F9Q 762	03.2001→		7.02256.04.0	DW-TL	EP
2.0 dCi 115 (EL0H) 66-84 kW (90-114 PS) M9R 780, M9R 782, M9R 786	08.2006→		7.02256.04.0	DW-TL	EP
			7.02256.19.0	EUV-AGR	EL
2.0 dCi 90 (EL0H) 66-84 kW (90-114 PS) M9R 780, M9R 782	08.2006→		7.02256.04.0	DW-TL	EP
			7.02256.19.0	EUV-AGR	EL
2.5 dCi 84-107 kW (114-146 PS) G9U 630	08.2007→		7.01152.02.0	DW-TL	EP
			7.02256.19.0	LDRV	EL
2.5 dCi 135 (EL0D) 99 kW (135 PS) G9U 730	03.2001→		7.02256.04.0	DW-TL	EP
2.5 dCi 145 (EL0J) 84-107 kW (114-146 PS) G9U 630	08.2006→		7.01152.02.0	DW-TL	EP
			7.02256.19.0	LDRV	EL

TRAFIC II Van (FL)	87
---------------------------	-----------

1.9 dCi 100 (FL0C) 60-75 kW (82-102 PS) F9Q 760	03.2001→		7.02256.04.0	DW-TL	EP
1.9 dCi 80 (FL0B) 60 kW (82 PS) F9Q 762	03.2001→		7.02256.04.0	DW-TL	EP
2.0 dCi 115 (FL01, FLOU) 66-84 kW (90-114 PS) M9R 780, M9R 782, M9R 786	08.2006→		7.02256.04.0	DW-TL	EP
			7.02256.19.0	EUV-AGR	EL
2.0 dCi 90 (FL0H) 66-84 kW (90-114 PS) M9R 780, M9R 782	08.2006→		7.02256.04.0	DW-TL	EP
			7.02256.19.0	EUV-AGR	EL
2.0 dCi 90 (FL0H) 66-84 kW (90-114 PS) M9R 786	08.2006→		7.02256.19.0	EUV-AGR	EL

						
TRAFIC II Van (FL)						87
2.5 dCi 84-107 kW (114-146 PS) G9U 630	08.2007→		7.01152.02.0	DW-TL	EP	
2.5 dCi 135 (FL0D) 99 kW (135 PS) G9U 730	05.2003→		7.02256.04.0	DW-TL	EP	
2.5 dCi 145 (FL0J) 84-107 kW (114-146 PS) G9U 630	08.2006→		7.01152.02.0	DW-TL	EP	
			7.02256.19.0	LDRV	EL	
TRAFIC III Bus (JG_)						88
1.6 dCi 115 (JGMD) 66-85 kW (90-116 PS) R9M 408	05.2014→		7.01814.12.0	DW-TL	EP	Produktionsdatum ab: 07.10.2014 Production date from: 07.10.2014
1.6 dCi 120 (JGMB) 88-107 kW (120-145 PS) R9M 450	05.2014→		7.01814.12.0	DW-TL	EP	Produktionsdatum ab: 07.10.2014 Production date from: 07.10.2014
			7.01814.22.0	DW-TL	EP	für OE-Nummer: 14 95 667 40R for OE number: 14 95 667 40R
1.6 dCi 120 (JGMS) 70-89 kW (95-121 PS) R9M 415	01.2019→		7.01814.12.0	DW-TL	EP	
1.6 dCi 125 (JGMH) 92-120 kW (125-163 PS) R9M 452	07.2015→		7.01814.12.0	DW-TL	EP	
			7.01814.22.0	DW-TL	EP	für OE-Nummer: 14 95 667 40R for OE number: 14 95 667 40R
1.6 dCi 140 (JGMA) 88-107 kW (120-145 PS) R9M 450	05.2014→		7.01814.12.0	DW-TL	EP	Produktionsdatum ab: 07.10.2014 Production date from: 07.10.2014
			7.01814.22.0	DW-TL	EP	für OE-Nummer: 14 95 667 40R for OE number: 14 95 667 40R
1.6 dCi 145 (JGMG) 92-120 kW (125-163 PS) R9M 452	07.2015→		7.01814.12.0	DW-TL	EP	
			7.01814.22.0	DW-TL	EP	für OE-Nummer: 14 95 667 40R for OE number: 14 95 667 40R
1.6 dCi 90 (JGME) 66-85 kW (90-116 PS) R9M 408	05.2014→		7.01814.12.0	DW-TL	EP	Produktionsdatum ab: 07.10.2014 Production date from: 07.10.2014
1.6 dCi 95 (JGMR, JGMJ) 70-89 kW (95-121 PS) R9M 413, R9M 415	07.2015→		7.01814.12.0	DW-TL	EP	
TRAFIC III Platform/Chassis (EG_)						89
1.6 dCi 120 (EGMB) 88-107 kW (120-145 PS) R9M 450	06.2014→		7.01814.12.0	DW-TL	EP	Produktionsdatum ab: 07.10.2014 Production date from: 07.10.2014
			7.01814.22.0	DW-TL	EP	für OE-Nummer: 14 95 667 40R for OE number: 14 95 667 40R
1.6 dCi 125 (EGMH) 92-120 kW (125-163 PS) R9M 452	07.2015→		7.01814.12.0	DW-TL	EP	
			7.01814.22.0	DW-TL	EP	für OE-Nummer: 14 95 667 40R for OE number: 14 95 667 40R
1.6 dCi 140 (EGMA) 88-107 kW (120-145 PS) R9M 450	06.2014→		7.01814.12.0	DW-TL	EP	Produktionsdatum ab: 07.10.2014 Production date from: 07.10.2014
			7.01814.22.0	DW-TL	EP	für OE-Nummer: 14 95 667 40R for OE number: 14 95 667 40R









R



TRAFIC III Platform/Chassis (EG_) 89

1.6 dCi 145 (EGMG) 92-120 kW (125-163 PS) R9M 452	07.2015→		7.01814.12.0	DW-TL	EP	für OE-Nummer: 14 95 667 40R for OE number: 14 95 667 40R
			7.01814.22.0	DW-TL	EP	

TRAFIC III Van (FG_) 90

1.6 dCi 115 (FGMD) 66-85 kW (90-116 PS) R9M 408	05.2014→		7.01814.12.0	DW-TL	EP	Produktionsdatum ab: 07.10.2014 Production date from: 07.10.2014
1.6 dCi 120 (FGMB) 88-107 kW (120-145 PS) R9M 450	05.2014→		7.01814.12.0	DW-TL	EP	Produktionsdatum ab: 07.10.2014 Production date from: 07.10.2014
			7.01814.22.0	DW-TL	EP	für OE-Nummer: 14 95 667 40R for OE number: 14 95 667 40R
1.6 dCi 120 (FGMK) 70-89 kW (95-121 PS) R9M 413	07.2015→		7.01814.12.0	DW-TL	EP	
1.6 dCi 125 (FGMH) 92-120 kW (125-163 PS) R9M 452	07.2015→		7.01814.12.0	DW-TL	EP	
			7.01814.22.0	DW-TL	EP	für OE-Nummer: 14 95 667 40R for OE number: 14 95 667 40R
1.6 dCi 140 (FGMA) 88-107 kW (120-145 PS) R9M 450	05.2014→		7.01814.12.0	DW-TL	EP	Produktionsdatum ab: 07.10.2014 Production date from: 07.10.2014
			7.01814.22.0	DW-TL	EP	für OE-Nummer: 14 95 667 40R for OE number: 14 95 667 40R
1.6 dCi 145 (FGMG) 92-120 kW (125-163 PS) R9M 452	07.2015→		7.01814.12.0	DW-TL	EP	
			7.01814.22.0	DW-TL	EP	für OE-Nummer: 14 95 667 40R for OE number: 14 95 667 40R
1.6 dCi 90 (FGME) 66-85 kW (90-116 PS) R9M 408	05.2014→		7.01814.12.0	DW-TL	EP	Produktionsdatum ab: 07.10.2014 Production date from: 07.10.2014
1.6 dCi 95 (FGMJ, FGMR) 70-89 kW (95-121 PS) R9M 413, R9M 415	07.2015→		7.01814.12.0	DW-TL	EP	

TRAFIC Platform/Chassis (PXX) 91

2.5 D 55 kW (75 PS) S8U 780	05.1998→03.2001		7.02256.19.0	EUV-AGR	EL	
--------------------------------	-----------------	---	--------------	---------	----	--

TRAFIC Van (TXX) 92



















1.9 D 44 kW (60 PS) F8Q 606	06.1997→01.1999		7.02256.19.0	EUV-LS	EL	
--------------------------------	-----------------	---	--------------	--------	----	--

R



950						1
2.0 108-113 kW (147-154 PS) LTD	07.2012→12.2015		7.06117.05.0	SV-NWV	EH	mit Dichtring with O-ring
			7.06117.06.0	SV-NWV	EH	mit Dichtring with O-ring
2.4 TGI 137 kW (186 PS) LAF	07.2012→12.2015		7.06117.05.0	SV-NWV	EH	mit Dichtring with O-ring
			7.06117.06.0	SV-NWV	EH	mit Dichtring with O-ring
3.0 V6 TGI 190 kW (258 PS) LFW	07.2012→12.2015		7.06117.04.0	SV-NWV	EH	mit Wellendichtring With shaft sealing ring

R

						
CULLINAN (RR31)						1
V12 420-441 kW (571-600 PS) N74 B68 A	08.2018→		7.04216.05.0	SUV	EL	mit Dichtring with O-ring
			7.06117.36.0	SV-NWV	EL	
V12 420-441 kW (571-600 PS) N74 B68 A	08.2019→		7.04216.05.0	SUV	EL	mit Dichtring with O-ring
			7.06117.36.0	SV-NWV	EL	
DAWN (RR6)						2
6.6 V12 419-465 kW (570-632 PS) N74 B66 A	01.2016→		7.00887.21.0	DW-TL	EP	mit Dichtring with O-ring
V12 419-465 kW (570-632 PS) N74 B66 A	02.2016→		7.00887.21.0	DW-TL	EP	
			7.02318.01.0 7.06117.36.0	EUV-AGK SV-NWV	EL EL	
V12 419-465 kW (570-632 PS) N74 B66 A	07.2017→		7.00887.21.0	DW-TL	EP	
			7.02318.01.0	EUV-AGK	EL	
			7.06117.36.0	SV-NWV	EL	
GHOST I (RR4)						3
EWB 6.6 419-465 kW (570-632 PS) N74 B66 A	09.2009→		7.00887.21.0	DW-TL	EP	mit Dichtring with O-ring
V-Specification 419-465 kW (570-632 PS) N74 B66 A	01.2014→06.2014		7.00887.21.0	DW-TL	EP	
			7.02318.01.0 7.06117.36.0	EUV-AGK SV-NWV	EL EL	
V12 419-465 kW (570-632 PS) N74 B66 A	12.2009→03.2020		7.00887.21.0	DW-TL	EP	
			7.02318.01.0	EUV-AGK	EL	
			7.06117.36.0	SV-NWV	EL	
V12 419-465 kW (570-632 PS) N74 B66 A	03.2016→03.2020		7.00887.21.0	DW-TL	EP	
			7.02318.01.0	EUV-AGK	EL	
			7.06117.36.0	SV-NWV	EL	
GHOST II (RR21)						4
V12 420-441 kW (571-600 PS) N74 B68 A	08.2020→		7.04216.05.0	SUV	EL	mit Dichtring with O-ring
			7.06117.36.0	SV-NWV	EL	
GHOST II Extended Wheelbase (RR22)						5
V12 420-441 kW (571-600 PS) N74 B68 A	08.2020→		7.04216.05.0	SUV	EL	mit Dichtring with O-ring
			7.06117.36.0	SV-NWV	EL	
PHANTOM VII (RR1)						6
V12 338 kW (460 PS) N73 B68 A	01.2003→07.2017		7.06117.00.0	SV-NWV	EL	mit Dichtring with O-ring
PHANTOM VII Coupe (RR3)						7
6.75 V12 338 kW (460 PS) N73 B68 A	06.2008→07.2017		7.06117.00.0	SV-NWV	EL	mit Dichtring with O-ring

R



PHANTOM VII Drophead Coupe (RR2)

8

6.75 V12 338 kW (460 PS) N73 B68 A	06.2007→07.2017	 7.06117.00.0	SV-NWV	EL	mit Dichtring with O-ring
--	-----------------	---	--------	----	------------------------------



PHANTOM VIII (RR11, RR12)

9

V12, V12 EWB 420-441 kW (571-600 PS) N74 B68 A	09.2017→	 7.04216.05.0	SUV	EL	
		7.06117.36.0	SV-NWV	EL	mit Dichtring with O-ring



WRAITH (RR5)

10

























6.6 V12 419-465 kW (570-632 PS) N74 B66 A	01.2016→	 7.00887.21.0	DW-TL	EP	
V12 419-465 kW (570-632 PS) N74 B66 A	08.2013→	 7.00887.21.0	DW-TL	EP	
		7.02318.01.0	EUV-AGK	EL	
		7.06117.36.0	SV-NWV	EL	mit Dichtring with O-ring
V12 419-465 kW (570-632 PS) N74 B66 A	07.2019→	 7.02318.01.0	EUV-AGK	EL	
		7.06117.36.0	SV-NWV	EL	mit Dichtring with O-ring

R











75 (RJ)						1
1.8 Turbo 110 kW (150 PS) 18 K4G	05.2003→05.2005	 7.22908.03.0	LDRV	EL		
75 I Tourer (RJ)						2
1.8 Turbo 110 kW (150 PS) 18 K4G	05.2003→05.2005	 7.22908.03.0	LDRV	EL		

R

					
9-3 (YS3D)					
1					
2.0 Turbo 151 kW (205 PS) B205R	10.1999→09.2002		7.22593.03.0	AKF	EL
2.2 TiD 85-92 kW (115-125 PS) D223L	02.1998→11.2000		7.22138.50.0	EUV-SR	EL Fahrgestellnummer ab: 41019993 Vehicle Identification Number from: 41019993
2.2 TiD 85-92 kW (115-125 PS) D223L	11.2000→09.2002		7.22138.50.0	EUV-SR	EL Fahrgestellnummer ab: 41019993 Vehicle Identification Number from: 41019993
9-3 (YS3F, E79, D79, D75)					
2					
1.9 TTiD 96-132 kW (130-180 PS) A 19 DTR	12.2007→02.2015		7.03652.01.0	DW-TL	EP für OE-Nummer: 55573732 for OE number: 55573732
1.9 TTiD 96-132 kW (130-180 PS) A 19 DTR	12.2007→02.2015		7.03652.01.0	DW-TL	EP für OE-Nummer: 55573732 for OE number: 55573732
1.9 TTiD 96-132 kW (130-180 PS) A 19 DTR, Z 19 DTR	12.2007→02.2015		7.03652.01.0	DW-TL	EP  A 19 DTR, Z 19 DTR: für OE-Nummer: 55573732 for OE number: 55573732
2.0 Turbo XWD 145-185 kW (197-252 PS) B207R	01.2008→02.2015		7.00326.03.0	EUV-VB	EL
2.0 t 145-185 kW (197-252 PS) B207R	09.2002→02.2015		7.00326.03.0	EUV-VB	EL
2.0 t 129-143 kW (175-194 PS) B207L	09.2002→02.2015		7.00326.03.0	EUV-VB	EL
2.0 t 162-164 kW (220-223 PS) A 20 NFT	01.2011→02.2015		7.06117.05.0	SV-NWV	EH mit Dichtring with O-ring
			7.06117.06.0	SV-NWV	EH mit Dichtring with O-ring
2.0 t Bio Power 162-164 kW (220-223 PS) A 20 NFT	01.2011→02.2015		7.06117.05.0	SV-NWV	EH mit Dichtring with O-ring
			7.06117.06.0	SV-NWV	EH mit Dichtring with O-ring
2.0 t BioPower 145-185 kW (197-252 PS) B207R	09.2002→02.2015		7.00326.03.0	EUV-VB	EL
2.0 t BioPower 129-143 kW (175-194 PS) B207L	01.2007→02.2015		7.00326.03.0	EUV-VB	EL
2.0 t BioPower XWD 162-164 kW (220-223 PS) A 20 NFT	01.2008→02.2015		7.06117.05.0	SV-NWV	EH mit Dichtring with O-ring
			7.06117.06.0	SV-NWV	EH mit Dichtring with O-ring
2.0 t XWD 162-164 kW (220-223 PS) A 20 NFT	01.2008→02.2015		7.06117.05.0	SV-NWV	EH mit Dichtring with O-ring
			7.06117.06.0	SV-NWV	EH mit Dichtring with O-ring
2.2 TiD 85-92 kW (115-125 PS) D223L	09.2002→02.2015		7.22138.50.0	EUV-SR	EL Fahrgestellnummer ab: 41019993 Vehicle Identification Number from: 41019993
2.8 169-203 kW (230-276 PS) B284L	09.2005→12.2009		7.00175.04.0	SUV	EL
			7.06117.04.0	SV-NWV	EH mit Wellendichtring With shaft sealing ring 2006 2006 2010 2010



9-3 (YS3F, E79, D79, D75) 2









2.8 Turbo V6 169-239 kW (230-325 PS) LP9	03.2005→02.2015	 7.06117.04.0	SV-NWV	EH	mit Wellendichtring With shaft sealing ring 2006 2006 2010 2010
2.8 Turbo V6 169-239 kW (230-325 PS) LP9	03.2005→02.2015	 7.06117.04.0	SV-NWV	EH	mit Wellendichtring With shaft sealing ring 2006 2006 2010 2010
2.8 Turbo V6 169-203 kW (230-276 PS) B284L	12.2007→02.2015	 7.00175.04.0	SUV	EL	
		 7.06117.04.0	SV-NWV	EH	mit Wellendichtring With shaft sealing ring 2006 2006 2010 2010
2.8 Turbo V6 169-203 kW (230-276 PS) B284L	04.2008→02.2015	 7.00175.04.0	SUV	EL	
		 7.06117.04.0	SV-NWV	EH	mit Wellendichtring With shaft sealing ring 2006 2006 2010 2010
2.8 Turbo V6 203-206 kW (276-280 PS) B284R	05.2008→02.2015	 7.00175.04.0	SUV	EL	
2.8 Turbo V6 XWD 203-206 kW (276-280 PS) B284R	05.2008→12.2011	 7.00175.04.0	SUV	EL	
		 7.06117.04.0	SV-NWV	EH	mit Wellendichtring With shaft sealing ring 2006 2006 2010 2010

9-3 Cabriolet (YS3D) 3

2.0 Turbo 151 kW (205 PS) B205R	10.1999→08.2003	 7.22593.03.0	AKF	EL	
---	-----------------	---	-----	----	--

S













9-3 Convertible (YS3F) 4

1.9 TTI d 96-132 kW (130-180 PS) A 19 DTR	12.2007→02.2015	 7.03652.01.0	DW-TL	EP	für OE-Nummer: 55573732 for OE number: 55573732
1.9 TTI d 96-132 kW (130-180 PS) A 19 DTR	12.2007→02.2015	 7.03652.01.0	DW-TL	EP	für OE-Nummer: 55573732 for OE number: 55573732
1.9 TTI d 96-132 kW (130-180 PS) A 19 DTR, Z 19 DTR	12.2007→02.2015	 7.03652.01.0	DW-TL	EP	 A 19 DTR, Z 19 DTR: für OE-Nummer: 55573732 for OE number: 55573732
2.0 t 129-143 kW (175-194 PS) B207L	08.2003→02.2015	 7.00326.03.0	EUV-VB	EL	
2.0 t 145-185 kW (197-252 PS) B207R	08.2003→02.2015	 7.00326.03.0	EUV-VB	EL	
2.0 t 162-164 kW (220-223 PS) A 20 NFT	01.2011→02.2015	 7.06117.05.0	SV-NWV	EH	mit Dichtring with O-ring
		 7.06117.06.0	SV-NWV	EH	mit Dichtring with O-ring























 					
9-3 Convertible (YS3F)					4
2.0 t BioPower 129-143 kW (175-194 PS) B207L	01.2007→02.2015	 7.00326.03.0	EUV-VB	EL	
2.0 t BioPower 162-164 kW (220-223 PS) A 20 NFT	01.2011→02.2015	 7.06117.05.0	SV-NWV	EH	mit Dichtring with O-ring
		7.06117.06.0	SV-NWV	EH	mit Dichtring with O-ring
2.8 169-203 kW (230-276 PS) B284L	09.2005→12.2009	 7.00175.04.0	SUV	EL	
		7.06117.04.0	SV-NWV	EH	mit Wellendichtring With shaft sealing ring 2006 2006 2010 2010
2.8 Turbo V6 169-239 kW (230-325 PS) LP9	02.2006→02.2015	 7.06117.04.0	SV-NWV	EH	mit Wellendichtring With shaft sealing ring 2006 2006 2010 2010
		7.06117.04.0	SV-NWV	EH	mit Wellendichtring With shaft sealing ring 2006 2006 2010 2010
2.8 Turbo V6 169-239 kW (230-325 PS) LP9	02.2006→02.2015	 7.06117.04.0	SV-NWV	EH	mit Wellendichtring With shaft sealing ring 2006 2006 2010 2010
		7.06117.04.0	SV-NWV	EH	mit Wellendichtring With shaft sealing ring 2006 2006 2010 2010
2.8 Turbo V6 169-203 kW (230-276 PS) B284L	12.2007→02.2015	 7.00175.04.0	SUV	EL	
		7.06117.04.0	SV-NWV	EH	mit Wellendichtring With shaft sealing ring 2006 2006 2010 2010
2.8 Turbo V6 203-206 kW (276-280 PS) B284R	02.2009→02.2015	 7.00175.04.0	SUV	EL	
		7.06117.04.0	SV-NWV	EH	mit Wellendichtring With shaft sealing ring 2006 2006 2010 2010
2.8 Turbo V6 203-206 kW (276-280 PS) B284R	02.2009→02.2015	 7.00175.04.0	SUV	EL	
		7.06117.04.0	SV-NWV	EH	mit Wellendichtring With shaft sealing ring 2006 2006 2010 2010
9-3 Estate (E50)					5
1.9 TTiD 96-132 kW (130-180 PS) A 19 DTR	12.2007→02.2015	 7.03652.01.0	DW-TL	EP	für OE-Nummer: 55573732 for OE number: 55573732
1.9 TTiD 96-132 kW (130-180 PS) A 19 DTR	12.2007→02.2015	 7.03652.01.0	DW-TL	EP	für OE-Nummer: 55573732 for OE number: 55573732
1.9 TTiD 129-132 kW (175-180 PS) Z 19 DTR	12.2007→02.2015	 7.03652.01.0	DW-TL	EP	für OE-Nummer: 55573732 for OE number: 55573732
2.0 t 129-143 kW (175-194 PS) B207L	03.2005→02.2015	 7.00326.03.0	EUV-VB	EL	



9-3 Estate (E50) **5**

2.0 t 145-185 kW (197-252 PS) B207R	03.2005→02.2015	 7.00326.03.0	EUV-VB	EL	
2.0 t 162-164 kW (220-223 PS) A 20 NFT	01.2011→02.2015	 7.06117.05.0	SV-NWV	EH	mit Dichtring with O-ring
		7.06117.06.0	SV-NWV	EH	mit Dichtring with O-ring
2.0 t BioPower 129-143 kW (175-194 PS) B207L	01.2007→02.2015	 7.00326.03.0	EUV-VB	EL	
2.0 t BioPower 162-164 kW (220-223 PS) A 20 NFT	01.2011→02.2015	 7.06117.05.0	SV-NWV	EH	mit Dichtring with O-ring
		7.06117.06.0	SV-NWV	EH	mit Dichtring with O-ring
2.0 t BioPower XWD 162-164 kW (220-223 PS) A 20 NFT	01.2011→02.2015	 7.06117.05.0	SV-NWV	EH	mit Dichtring with O-ring
		7.06117.06.0	SV-NWV	EH	mit Dichtring with O-ring
2.0 t XWD 145-185 kW (197-252 PS) B207R	06.2008→02.2015	 7.00326.03.0	EUV-VB	EL	
2.0 t XWD 162-164 kW (220-223 PS) A 20 NFT	01.2011→02.2015	 7.06117.05.0	SV-NWV	EH	mit Dichtring with O-ring
		7.06117.06.0	SV-NWV	EH	mit Dichtring with O-ring
2.8 Turbo V6 169-203 kW (230-276 PS) B284L	03.2005→02.2015	 7.00175.04.0	SUV	EL	
2.8 Turbo V6 169-239 kW (230-325 PS) LP9	03.2005→02.2015	 7.06117.04.0	SV-NWV	EH	mit Wellendichtring With shaft sealing ring 2006 2006 2010 2010
		7.00175.04.0	SUV	EL	
2.8 Turbo V6 169-203 kW (230-276 PS) B284L	12.2007→02.2015	 7.00175.04.0	SUV	EL	
		7.06117.04.0	SV-NWV	EH	mit Wellendichtring With shaft sealing ring 2006 2006 2010 2010
2.8 Turbo V6 203-206 kW (276-280 PS) B284R	05.2008→02.2015	 7.00175.04.0	SUV	EL	
		7.06117.04.0	SV-NWV	EH	mit Wellendichtring With shaft sealing ring 2006 2006 2010 2010
2.8 Turbo V6 203-206 kW (276-280 PS) B284R	05.2008→02.2015	 7.00175.04.0	SUV	EL	
2.8 Turbo V6 XWD 203-206 kW (276-280 PS) B284R	05.2008→12.2011	 7.00175.04.0	SUV	EL	

S







						
9-3 Estate (E50)						5
			7.06117.04.0	SV-NWV	EH mit Wellendichtring With shaft sealing ring 2006 2006 2010 2010	
2.8 XWD 169-203 kW (230-276 PS) B284L	09.2007→12.2009		7.00175.04.0	SUV	EL	
			7.06117.04.0	SV-NWV	EH mit Wellendichtring With shaft sealing ring 2006 2006 2010 2010	
9-3X (YS3)						6
1.9 TTiD AWD 96-132 kW (130-180 PS) A 19 DTR, Z 19 DTR	02.2009→12.2012		7.03652.01.0	DW-TL	EP  A 19 DTR, Z 19 DTR: für OE-Nummer: 55573732 for OE number: 55573732	
2.0 t XWD 145-185 kW (197-252 PS) B207R	02.2009→02.2015		7.00326.03.0	EUV-VB	EL	
9-4X						7
2.8 Turbo XWD 224 kW (305 PS) LAU	02.2011→12.2011		7.00175.04.0	SUV	EL	
9-5 (YS3E)						8
2.3 Turbo 152-224 kW (207-305 PS) B235R	10.1999→09.2001		7.22593.03.0	AKF	EL	
2.3 Turbo 152-224 kW (207-305 PS) B235R	09.2001→12.2009		7.22593.03.0	AKF	EL	
2.3 Turbo 149-184 kW (203-250 PS) B235L	07.2003→12.2009		7.22593.03.0	AKF	EL	
2.3 Turbo 152-224 kW (207-305 PS) B235R	11.2005→12.2009		7.22593.03.0	AKF	EL	
2.3 Turbo 152-224 kW (207-305 PS) B235R	04.2008→12.2009		7.22593.03.0	AKF	EL	
2.3 t 125-136 kW (170-185 PS) B235E	09.1997→12.2009		7.22593.03.0	AKF	EL	
2.3 t 125-136 kW (170-185 PS) B235E	01.2001→12.2009		7.22593.03.0	AKF	EL	
3.0 TiD 130 kW (177 PS) D308L	07.2001→12.2009		7.22593.03.0	AKF	EL	
9-5 (YS3G)						9
1.6 Turbo 132 kW (180 PS) A 16 LET	05.2010→01.2012		7.01039.03.0	EUV-VB	EL	
2.0 162-164 kW (220-223 PS) A 20 NFT	09.2010→01.2012		7.06117.05.0	SV-NWV	EH mit Dichtring with O-ring	
			7.06117.06.0	SV-NWV	EH mit Dichtring with O-ring	
2.0 Turbo 162 kW (220 PS) A 20 NHT	05.2010→01.2012		7.06117.05.0	SV-NWV	EH mit Dichtring with O-ring	
			7.06117.06.0	SV-NWV	EH mit Dichtring with O-ring	
2.0 Turbo XWD 162 kW (220 PS) A 20 NHT	05.2010→01.2012		7.06117.05.0	SV-NWV	EH mit Dichtring with O-ring	



9-5 (YS3G) 9

			7.06117.06.0	SV-NWV	EH	mit Dichtring with O-ring
2.0 t BioPower 162-164 kW (220-223 PS) A 20 NFT	05.2010→01.2012		7.06117.05.0	SV-NWV	EH	mit Dichtring with O-ring
			7.06117.06.0	SV-NWV	EH	mit Dichtring with O-ring
2.0 t BioPower XWD 162 kW (220 PS) A 20 NHT	05.2010→01.2012		7.06117.05.0	SV-NWV	EH	mit Dichtring with O-ring
			7.06117.06.0	SV-NWV	EH	mit Dichtring with O-ring
2.8 AWD 221-224 kW (301-305 PS) A 28 NER	05.2010→01.2012		7.06117.04.0	SV-NWV	EH	mit Wellendichtring With shaft sealing ring 2010 2010
2.8 Turbo V6 XWD 221-224 kW (301-305 PS) A 28 NER	05.2010→01.2012		7.00175.04.0	SUV	EL	
			7.06117.04.0	SV-NWV	EH	mit Wellendichtring With shaft sealing ring 2010 2010

9-5 Estate (YS3E) 10

2.3 Turbo 152-224 kW (207-305 PS) B235R	10.1999→09.2001		7.22593.03.0	AKF	EL	
2.3 Turbo 152-224 kW (207-305 PS) B235R	09.2001→12.2009		7.22593.03.0	AKF	EL	
2.3 Turbo 149-184 kW (203-250 PS) B235L	07.2003→12.2009		7.22593.03.0	AKF	EL	
2.3 Turbo 152-224 kW (207-305 PS) B235R	01.2006→12.2009		7.22593.03.0	AKF	EL	
2.3 t 125-136 kW (170-185 PS) B235E	10.1998→12.2009		7.22593.03.0	AKF	EL	
2.3 t 125-136 kW (170-185 PS) B235E	01.2001→12.2009		7.22593.03.0	AKF	EL	
3.0 TiD 130 kW (177 PS) D308L	07.2001→12.2009		7.22593.03.0	AKF	EL	

S

FR-S Coupe
1
2.0 S 149 kW (203 PS)
 FA20D

09.2012->





















7.06117.41.0

ZM-NWV

EL

 mit Dichtring
 with O-ring
 Produktionsdatum bis: 02.2015
 Production date to: 02.2015





S

					
ALHAMBRA (710, 711)					
1.4 TSI 110 kW (150 PS) CAVA, CTHA	06.2010→		7.02588.04.0	LDRV	EL
			7.04247.02.0	SUV	EL
			7.02256.40.0	SV-KK	EL
CAVA, CTHA: für Fahrzeuge mit Standheizung for vehicles with parking heater					
1.4 TSI 110 kW (150 PS) CNWB	06.2010→		7.02588.04.0	LDRV	EL
			7.04247.02.0	SUV	EL
			7.02256.40.0	SV-KK	EL
für Fahrzeuge mit Standheizung for vehicles with parking heater					
1.4 TSI 110 kW (150 PS) CZDA	05.2015→		7.02256.41.0	SV-KK	EL
			7.06117.48.0	SV-NWV	EL
			für Fahrzeuge mit Standheizung for vehicles with parking heater		
1.4 TSI 110 kW (150 PS) DJKA	05.2015→		7.02256.41.0	SV-KK	EL
für Fahrzeuge mit Standheizung for vehicles with parking heater					
1.8 TSI 118 kW (160 PS) CDAA	11.2012→		7.22880.01.0	EUV-SR	EL
			7.00470.07.0	LDRV	EL
			7.01830.13.0	SUV	EL
			7.02256.40.0	SV-KK	EL
für Fahrzeuge mit Standheizung for vehicles with parking heater					
2.0 TDI 103 kW (140 PS) CFFB	06.2010→		7.00868.02.0	DW-TL	EP
			7.02256.00.0	EUV-AGR	EP
			7.02256.40.0	SV-KK	EL
für Fahrzeuge mit Standheizung for vehicles with parking heater					
2.0 TDI 125 kW (170 PS) CFGB	06.2010→02.2013		7.00868.02.0	DW-TL	EP
			7.02256.00.0	EUV-AGR	EP
			7.02256.40.0	SV-KK	EL
für Fahrzeuge mit Standheizung for vehicles with parking heater					
2.0 TDI 100 kW (136 PS) CFFA	06.2010→05.2011		7.00868.02.0	DW-TL	EP
			7.02256.00.0	EUV-AGR	EP
			7.02256.40.0	SV-KK	EL
für Fahrzeuge mit Standheizung for vehicles with parking heater					
2.0 TDI 85 kW (116 PS) CFFE	05.2011→		7.02256.00.0	EUV-AGR	EP
			7.02256.40.0	SV-KK	EL
für Fahrzeuge mit Standheizung for vehicles with parking heater					
2.0 TDI 130 kW (177 PS) CFGC	11.2012→		7.02256.00.0	EUV-AGR	EP
			7.02256.40.0	SV-KK	EL
für Fahrzeuge mit Standheizung for vehicles with parking heater					
2.0 TDI 110 kW (150 PS) CUVC, DFLA, DLTA	05.2015→		7.02256.41.0	SV-KK	EL
			CUVC, DFLA, DLTA: für Fahrzeuge mit Standheizung for vehicles with parking heater		
2.0 TDI 135 kW (184 PS) CUWA, DFMA	05.2015→		7.02256.41.0	SV-KK	EL
			CUWA, DFMA: für Fahrzeuge mit Standheizung for vehicles with parking heater		
2.0 TDI 4Drive 103 kW (140 PS) CFFB	05.2011→		7.00868.02.0	DW-TL	EP
			7.02256.00.0	EUV-AGR	EP
			7.02256.40.0	SV-KK	EL
für Fahrzeuge mit Standheizung for vehicles with parking heater					
2.0 TDI 4Drive 110 kW (150 PS) CUVC, DFLA	05.2015→		7.02256.41.0	SV-KK	EL
			CUVC, DFLA: für Fahrzeuge mit Standheizung for vehicles with parking heater		









S



ALHAMBRA (710, 711) 1









2.0 TDI 4Drive 135 kW (184 PS) DFMA	05.2016→	 7.02256.41.0	SV-KK	EL	für Fahrzeuge mit Standheizung for vehicles with parking heater
2.0 TDi 4Drive 130 kW (177 PS) DLUB	11.2018→	 7.02256.41.0	SV-KK	EL	für Fahrzeuge mit Standheizung for vehicles with parking heater
2.0 TSI 147 kW (200 PS) CCZA	11.2010→05.2012	 7.22880.01.0	EUV-SR	EL	06.2011→ für OE-Nummer: 06H 145 713 T, 06J 145 722 B for OE number: 06H 145 713 T, 06J 145 722 B
		7.00470.07.0	LDRV	EL	
		7.02901.05.0	SUV	EL	
		7.01830.13.0	SUV	EL	
2.0 TSI 162 kW (220 PS) DEDA	05.2015→	 7.02256.18.0	EUV-SR	EP	für Fahrzeuge mit Standheizung for vehicles with parking heater
		7.02256.41.0	SV-KK	EL	
		7.06117.26.0	ZM-NWV	EL	

ALHAMBRA (7V8, 7V9) 2









1.8 T 20V 110 kW (150 PS) AWC	08.2000→03.2010	 7.28098.04.0	EUV-KA	EL	für Fahrzeuge mit Standheizung for vehicles with parking heater
1.9 TDI 66 kW (90 PS) 1Z, AHU	04.1996→03.2010	 7.21903.70.0	DW-AGR	EP	
		7.21895.55.0	LDRV	EL	
1.9 TDI 81 kW (110 PS) AFN, AVG	08.1996→06.2000	 7.21903.70.0	DW-AGR	EP	
		7.21903.75.0	DW-TL	EP	
1.9 TDI 85 kW (115 PS) AUY, BVK	06.2000→03.2010	 7.02183.01.0	DW-AGR	EP	AUY, BVK: für Fahrzeuge mit Standheizung for vehicles with parking heater
		7.02184.01.0	DW-TL	EP	
		7.02256.00.0	EUV-AGR	EP	
		7.28098.04.0	EUV-KA	EL	
1.9 TDI 66 kW (90 PS) ANU	08.2000→03.2010	 7.02183.01.0	DW-AGR	EP	für Fahrzeuge mit Standheizung for vehicles with parking heater
		7.02256.00.0	EUV-AGR	EP	
		7.28098.04.0	EUV-KA	EL	
1.9 TDI 96-112 kW (130-152 PS) ASZ	11.2002→11.2008	 7.02183.01.0	DW-AGR	EP	für Fahrzeuge mit Standheizung for vehicles with parking heater
		7.02184.01.0	DW-TL	EP	
		7.02256.00.0	EUV-AGR	EP	
		7.28098.04.0	EUV-KA	EL	
1.9 TDI 110 kW (150 PS) BTB	05.2005→05.2007	 7.02183.01.0	DW-AGR	EP	für Fahrzeuge mit Standheizung for vehicles with parking heater
		7.02184.01.0	DW-TL	EP	
		7.02256.00.0	EUV-AGR	EP	
		7.28098.04.0	EUV-KA	EL	
1.9 TDI 4motion 85 kW (115 PS) AUY, BVK	06.2000→03.2010	 7.02183.01.0	DW-AGR	EP	
		7.02184.01.0	DW-TL	EP	
		7.02256.00.0	EUV-AGR	EP	









ALHAMBRA (7V8, 7V9) 2

		 PIERBURG			
		7.28098.04.0	EUV-KA	EL	 AUY, BVK: für Fahrzeuge mit Standheizung for vehicles with parking heater
2.0 TDI 103 kW (140 PS) BRT	11.2005→03.2010	 7.00868.02.0	DW-TL	EP	
		7.28098.04.0	EUV-KA	EL	für Fahrzeuge mit Standheizung for vehicles with parking heater
2.0 i 85 kW (115 PS) ADY	04.1996→08.2000	 7.21483.54.0	EUV-AGR	EL	
2.0 i 85 kW (115 PS) ATM	08.2000→03.2010	 7.28098.04.0	EUV-KA	EL	für Fahrzeuge mit Standheizung for vehicles with parking heater
2.8 V6 150 kW (204 PS) AYL	06.2000→03.2010	 7.28098.04.0	EUV-KA	EL	für OE-Nummer: 037 906 283 D for OE number: 037 906 283 D für Fahrzeuge mit Standheizung for vehicles with parking heater
		7.02256.00.0	EUV-SL	EP	
		7.02256.00.0	EUV-SR	EP	
		7.06117.44.0	SV-NWV	EL	mit Dichtring with O-ring Einlassseite Intake Side
2.8 V6 4motion 150 kW (204 PS) AYL	06.2000→03.2010	 7.28098.04.0	EUV-KA	EL	für OE-Nummer: 037 906 283 D for OE number: 037 906 283 D für Fahrzeuge mit Standheizung for vehicles with parking heater
		7.02256.00.0	EUV-SL	EP	
		7.02256.00.0	EUV-SR	EP	
		7.06117.44.0	SV-NWV	EL	mit Dichtring with O-ring Einlassseite Intake Side





ALTEA (5P1) 3

1.2 TSI 77 kW (105 PS) CBZB	04.2010→	 7.22880.01.0	EUV-KK	EL	
1.4 TSI 92 kW (125 PS) CAXC	11.2007→	 7.00415.07.0	SUV	EL	Produktionsdatum bis: 12.11.2008 Production date to: 12.11.2008
		7.01830.13.0	SUV	EL	
		7.06117.54.0	SV-NWV	EL	
1.6 75 kW (102 PS) BGU, BSE, BSF, CCSA	03.2004→	 7.10014.00.0	AKF	EL	
		7.22880.01.0	EUV-SR	EL	
1.6 LPG 75 kW (102 PS) CHGA	09.2009→	 7.10014.00.0	AKF	EL	
		7.22880.01.0	EUV-SR	EL	
1.6 TDI 77 kW (105 PS) CAYC	10.2009→	 7.02256.00.0	EUV-AGR	EP	
1.6 TDI 66 kW (90 PS) CAYB	11.2010→	 7.02256.00.0	EUV-AGR	EP	
1.8 TFSI 118 kW (160 PS) BYT, BZB	01.2007→	 7.00470.07.0	LDRV	EL	
		7.00415.07.0	SUV	EL	
		7.06117.26.0	ZM-NWV	EL	
1.8 TFSI 118 kW (160 PS) CDAA	01.2007→	 7.22880.01.0	EUV-SR	EL	Fahrgestellnummer ab: 1P-6-000 001 Vehicle Identification Number from: 1P-6-000 001
		7.00470.07.0	LDRV	EL	
		7.01830.13.0	SUV	EL	
		7.06117.26.0	ZM-NWV	EL	
1.9 TDI 77 kW (105 PS) BLS	04.2004→	 7.00868.02.0	DW-TL	EP	

ALTEA (5P1) **3**

			7.02256.00.0	EUV-AGR	EP	
2.0 FSI 110 kW (150 PS) BLR, BLY, BVY, BVZ	05.2004→03.2009		7.22880.01.0	EUV-SR	EL	
			7.06117.37.0	SV-NWV	EL	
2.0 TDI 103 kW (140 PS) BMM	11.2005→		7.00868.02.0	DW-TL	EP	
			7.02256.00.0	EUV-AGR	EP	
2.0 TDI 125 kW (170 PS) BMN, CEGA	03.2006→		7.00868.02.0	DW-TL	EP	
			7.02256.00.0	EUV-AGR	EP	
2.0 TDI 16V 103 kW (140 PS) CFHC	03.2004→		7.02256.00.0	EUV-AGR	EP	
2.0 TFSI 147 kW (200 PS) BWA	04.2006→05.2009		7.00470.07.0	LDRV	EL	
			7.00415.07.0	SUV	EL	
			7.01830.13.0	SUV	EL	
			7.06117.46.0	SV-NWV	EH	mit Dichtring with O-ring













ALTEA XL (5P5, 5P8) **4**

1.2 TSI 77 kW (105 PS) CBZB	04.2010→		7.22880.01.0	EUV-KK	EL	
1.4 TSI 92 kW (125 PS) CAXC	11.2007→		7.00415.07.0	SUV	EL	Produktionsdatum bis: 12.11.2008 Production date to: 12.11.2008
			7.01830.13.0	SUV	EL	
			7.06117.54.0	SV-NWV	EL	
1.6 75 kW (102 PS) BGU	10.2006→		7.22880.01.0	EUV-SR	EL	
1.6 75 kW (102 PS) BSE, BSF, CCSA	10.2006→		7.10014.00.0	AKF	EL	
			7.22880.01.0	EUV-SR	EL	
1.6 LPG 75 kW (102 PS) CHGA	09.2009→		7.10014.00.0	AKF	EL	
			7.22880.01.0	EUV-SR	EL	
1.6 Multifuel 75 kW (102 PS) BSE, BSF	10.2006→11.2010		7.22880.01.0	EUV-SR	EL	
1.6 Multifuel 75 kW (102 PS) CCSA	10.2006→11.2010		7.10014.00.0	AKF	EL	
			7.22880.01.0	EUV-SR	EL	
1.6 TDI 77 kW (105 PS) CAYC	10.2009→		7.02256.00.0	EUV-AGR	EP	
1.6 TDI 66 kW (90 PS) CAYB	11.2010→		7.02256.00.0	EUV-AGR	EP	
1.8 TFSI 118 kW (160 PS) BYT, BZB	01.2007→		7.00470.07.0	LDRV	EL	
			7.00415.07.0	SUV	EL	
			7.06117.26.0	ZM-NWV	EL	
1.8 TFSI 118 kW (160 PS) CDAA	01.2007→		7.22880.01.0	EUV-SR	EL	Fahrgestellnummer ab: 1P-6-000 001 Vehicle Identification Number from: 1P-6-000 001
			7.00470.07.0	LDRV	EL	
			7.01830.13.0	SUV	EL	
			7.06117.26.0	ZM-NWV	EL	
1.9 TDI 77 kW (105 PS) BLS	10.2006→12.2010		7.00868.02.0	DW-TL	EP	
			7.02256.00.0	EUV-AGR	EP	
1.9 TDI 4x4 77 kW (105 PS) BLS	06.2009→12.2010		7.00868.02.0	DW-TL	EP	

S





ALTEA XL (5P5, 5P8) **4**



			7.02256.00.0	EUV-AGR	EP	
2.0 FSI 110 kW (150 PS) BVY, BVZ	10.2006→03.2009		7.22880.01.0	EUV-SR	EL	
			7.06117.37.0	SV-NWV	EL	
2.0 TDI 103 kW (140 PS) BMM	10.2006→		7.00868.02.0	DW-TL	EP	
			7.02256.00.0	EUV-AGR	EP	
2.0 TDI 125 kW (170 PS) BMN, CEGA	06.2007→05.2009		7.00868.02.0	DW-TL	EP	
			7.02256.00.0	EUV-AGR	EP	
2.0 TDI 16V 103 kW (140 PS) CFHC	10.2006→		7.02256.00.0	EUV-AGR	EP	
2.0 TDI 16V 4x4 103 kW (140 PS) CFHC	10.2010→		7.02256.00.0	EUV-AGR	EP	
2.0 TDI 4x4 125 kW (170 PS) BMN, CEGA	06.2007→05.2009		7.00868.02.0	DW-TL	EP	
			7.02256.00.0	EUV-AGR	EP	
2.0 TDI 4x4 125 kW (170 PS) CFJA	06.2007→05.2009		7.02256.00.0	EUV-AGR	EP	
2.0 TDI 4x4 103 kW (140 PS) BMM	06.2007→		7.00868.02.0	DW-TL	EP	
			7.02256.00.0	EUV-AGR	EP	
2.0 TFSI 147 kW (200 PS) BWA	10.2006→05.2009		7.00470.07.0	LDRV	EL	mit Dichtring with O-ring
			7.00415.07.0	SUV	EL	
			7.01830.13.0	SUV	EL	
			7.06117.46.0	SV-NWV	EH	
2.0 TFSI 155 kW (211 PS) CCZB	05.2009→		7.06117.26.0	ZM-NWV	EL	
2.0 TFSI 4x4 147 kW (200 PS) BWA	06.2007→05.2009		7.00470.07.0	LDRV	EL	mit Dichtring with O-ring
			7.00415.07.0	SUV	EL	
			7.01830.13.0	SUV	EL	
			7.06117.46.0	SV-NWV	EH	
2.0 TFSI 4x4 155 kW (211 PS) CCZB	05.2009→		7.22880.01.0	EUV-SR	EL	
			7.00470.07.0	LDRV	EL	
			7.01830.13.0	SUV	EL	
			7.06117.26.0	ZM-NWV	EL	





























S

ARONA (KJ7) **5**

1.0 TGi 66 kW (90 PS) DBYA	11.2018→		7.06117.48.0	SV-NWV	EL	
1.0 TSI 70 kW (95 PS) CHZL, DKLA	07.2017→		7.06117.48.0	SV-NWV	EL	
1.0 TSI 85 kW (115 PS) CHZJ, DKJA, DKRF	07.2017→		7.06117.48.0	SV-NWV	EL	













AROSA (6H1) **6**

1.4 TDI 55 kW (75 PS) AMF	01.2000→06.2004		7.21903.70.0	DW-AGR	EP	
			7.21895.55.0	LDRV	EL	
1.7 SDI 44 kW (60 PS) AKU	08.1997→06.2004		7.21903.75.0	DW-TL	EP	









						
ATECA (KH7, KHP)						7
1.0 TSI 85 kW (115 PS) CHZJ, DKRF	05.2016→		7.06117.48.0	SV-NWV	EL	
1.4 TSI 4Drive 110 kW (150 PS) CZEA	06.2016→		7.06117.48.0	SV-NWV	EL	
2.0 TDI 81 kW (110 PS) CRVA	10.2016→		7.02256.00.0	EUV-AGR	EP Euro 4	
2.0 TDI 105 kW (143 PS) CRVC	10.2016→		7.02256.00.0	EUV-AGR	EP Euro 4	
2.0 TSI 4Drive 140 kW (190 PS) CZPB, DKZA	05.2017→		7.02901.05.0	SUV	EL  CZPB, DKZA: →07.2019	
CORDOBA (6K1, 6K2)						8
1.4 i 16V 74 kW (101 PS) AFH	09.1996→10.2002		7.21483.54.0	EUV-AGR	EL	
1.6 i 74-76 kW (101-103 PS) AEH, AFT, AKL	07.1996→10.2002		7.22402.03.0	EUV-SR	EL	
1.6 i 74 kW (100-101 PS) APF, AUR	07.1996→10.2002		7.22880.01.0	EUV-SR	EL  APF, AUR: Fahrgestellnummer ab: 6K-X-400 000 Vehicle Identification Number from: 6K-X-400 000	
1.8 T 20V Cupra 115-132 kW (156-179 PS) AQX, AYP	07.2000→10.2002		7.21895.55.0	LDRV	EL	
1.9 SDI 47 kW (64 PS) AEY	08.1996→06.1999		7.21903.70.0	DW-AGR	EP	
			7.21895.55.0	LDRV	EL	
1.9 SDI 50 kW (68 PS) AGP, AQM	06.1999→10.2002		7.21903.70.0	DW-AGR	EP	
1.9 TDI 66 kW (90 PS) 1Z, AHU	08.1996→10.2002		7.21903.70.0	DW-AGR	EP	
			7.21895.55.0	LDRV	EL	
1.9 TDI 66 kW (90 PS) AGR	08.1996→10.2002		7.21903.70.0	DW-AGR	EP	
			7.02256.00.0	EUV-AGR	EP  ch. 6K-X-400 000→ch. 6K-X-499 99  130 439→	
			7.21895.55.0	LDRV	EL	
1.9 TDI 66 kW (90 PS) ALH	08.1996→10.2002		7.21903.75.0	DW-AGR	EP 01.1999→	
			7.21903.70.0	DW-AGR	EP	
1.9 TDI 81 kW (110 PS) AFN, ASV	03.1997→10.2002		7.21903.70.0	DW-AGR	EP	
			7.21903.75.0	DW-AGR	EP	
CORDOBA (6L2)						9
1.4 TDI 59 kW (80 PS) BMS	06.2005→11.2009		7.00868.02.0	DW-TL	EP	
1.6 16V 77 kW (105 PS) BTS	11.2006→11.2009		7.06117.54.0	SV-NWV	EL	
1.9 SDI 47 kW (64 PS) ASY	09.2002→11.2009		7.02183.01.0	DW-AGR	EP	
1.9 TDI 74 kW (101 PS) BMT	09.2002→11.2009		7.00868.02.0	DW-TL	EP	
			7.02256.00.0	EUV-AGR	EP	



CORDOBA Vario (6K5) **10**

1.6 i 74-76 kW (101-103 PS) AEH, AFT, AKL	09.1996→12.2002	 7.22402.03.0	EUV-SR	EL	
1.6 i 74 kW (100-101 PS) APF, AUR	09.1996→12.2002	 7.22880.01.0	EUV-SR	EL	 APF, AUR: Fahrgestellnummer ab: 6K-X-400 000 Vehicle Identification Number from: 6K-X-400 000
1.9 SDI 47 kW (64 PS) AEY	09.1996→06.1999	 7.21903.70.0	DW-AGR	EP	
		7.21895.55.0	LDRV	EL	
1.9 SDI 50 kW (68 PS) AGP, AQM	06.1999→12.2002	 7.21903.70.0	DW-AGR	EP	
1.9 TDI 66 kW (90 PS) 1Z, AHU	08.1996→12.2002	 7.21903.70.0	DW-AGR	EP	
		7.21895.55.0	LDRV	EL	
1.9 TDI 66 kW (90 PS) AGR	08.1996→12.2002	 7.21903.70.0	DW-AGR	EP	
		7.02256.00.0	EUV-AGR	EP	 ch. 6K-X-400 000→ch. 6K-X-499 999  130 439→
		7.21895.55.0	LDRV	EL	
1.9 TDI 66 kW (90 PS) ALH	08.1996→12.2002	 7.21903.75.0	DW-AGR	EP	01.1999→
		7.21903.70.0	DW-AGR	EP	
1.9 TDI 81 kW (110 PS) AFN	07.1997→12.2002	 7.21903.70.0	DW-AGR	EP	
		7.21903.75.0	DW-AGR	EP	
1.9 TDI 81 kW (110 PS) ASV	07.1997→12.2002	 7.21903.70.0	DW-AGR	EP	

EXEO (3R2) **11**









1.6 75 kW (102 PS) ALZ	03.2009→09.2010	 7.10014.00.0	AKF	EL	
		7.22880.01.0	EUV-SR	EL	
1.8 T 110 kW (150 PS) CFMA	12.2008→05.2010	 7.01805.01.0	EUV-SR	EL	
1.8 TSI 118 kW (160 PS) CDHB	05.2010→05.2013	 7.22880.01.0	EUV-SR	EL	
		7.00470.07.0	LDRV	EL	
		7.01830.13.0	SUV	EL	
		7.06117.26.0	ZM-NWV	EL	
1.8 TSI 88 kW (120 PS) CDHA	09.2010→05.2013	 7.22880.01.0	EUV-SR	EL	
		7.00470.07.0	LDRV	EL	
		7.01830.13.0	SUV	EL	
		7.06117.26.0	ZM-NWV	EL	
2.0 TDI 105 kW (143 PS) CAGA, CJCA	12.2008→05.2013	 7.02256.00.0	EUV-AGR	EP	
2.0 TDI 88 kW (120 PS) CAGC, CJCC	12.2008→05.2013	 7.02256.00.0	EUV-AGR	EP	
2.0 TDI 125 kW (170 PS) CAHA, CGLB	02.2009→05.2013	 7.02256.00.0	EUV-AGR	EP	
2.0 TFSI 147 kW (200 PS) BWE	03.2009→05.2013	 7.00470.07.0	LDRV	EL	
		7.01830.13.0	SUV	EL	
		7.06117.46.0	SV-NWV	EH	mit Dichtring with O-ring
2.0 TFSI 155 kW (211 PS) CDND	05.2010→05.2013	 7.22880.01.0	EUV-SR	EL	
		7.00470.07.0	LDRV	EL	

S











EXEO (3R2) 11

		7.02901.05.0	SUV	EL	06.2011→
		7.06117.26.0	ZM-NWV	EL	

EXEO ST (3R5) 12







































1.6 75 kW (102 PS) ALZ	06.2009→09.2010	 7.10014.00.0	AKF	EL	
		7.22880.01.0	EUV-SR	EL	
1.8 T 110 kW (150 PS) CFMA	06.2009→05.2010	 7.01805.01.0	EUV-SR	EL	
1.8 TSI 118 kW (160 PS) CDHB	05.2010→05.2013	 7.22880.01.0	EUV-SR	EL	
		7.00470.07.0	LDRV	EL	
		7.01830.13.0	SUV	EL	
		7.06117.26.0	ZM-NWV	EL	
1.8 TSI 88 kW (120 PS) CDHA	09.2010→05.2013	 7.22880.01.0	EUV-SR	EL	
		7.00470.07.0	LDRV	EL	
		7.01830.13.0	SUV	EL	
		7.06117.26.0	ZM-NWV	EL	
2.0 TDI 105 kW (143 PS) CAGA, CJCA	05.2009→05.2013	 7.02256.00.0	EUV-AGR	EP	
2.0 TDI 125 kW (170 PS) CAHA, CGLB	05.2009→05.2013	 7.02256.00.0	EUV-AGR	EP	
2.0 TDI 88 kW (120 PS) CAGC, CJCC	07.2009→05.2013	 7.02256.00.0	EUV-AGR	EP	
2.0 TFSI 147 kW (200 PS) BWE	06.2009→05.2013	 7.00470.07.0	LDRV	EL	
		7.01830.13.0	SUV	EL	
		7.06117.46.0	SV-NWV	EH	mit Dichtring with O-ring
2.0 TFSI 155 kW (211 PS) CDND	05.2010→05.2013	 7.22880.01.0	EUV-SR	EL	
		7.00470.07.0	LDRV	EL	
		7.02901.05.0	SUV	EL	06.2011→
		7.06117.26.0	ZM-NWV	EL	

IBIZA II (6K1) 13

1.4 i 16V 74 kW (101 PS) AFH	06.1997→02.2002	 7.21483.54.0	EUV-AGR	EL	
1.6 i 74-76 kW (101-103 PS) AEH, AFT, AKL	04.1996→02.2002	 7.22402.03.0	EUV-SR	EL	
1.6 i 74 kW (100-101 PS) APF, AUR	04.1996→02.2002	 7.22880.01.0	EUV-SR	EL	 APF, AUR: Fahrgestellnummer ab: 6K-X-400 000 Vehicle Identification Number from: 6K-X-400 000
1.8 T 20V Cupra 115-132 kW (156-179 PS) AQX, AYP	07.2000→02.2002	 7.21895.55.0	LDRV	EL	
1.8 T 20V Cupra R 115-132 kW (156-179 PS) AYP	07.2000→02.2002	 7.21895.55.0	LDRV	EL	
1.9 SDI 47 kW (64 PS) AEY	08.1996→08.1999	 7.21903.70.0	DW-AGR	EP	
		7.21895.55.0	LDRV	EL	
1.9 SDI 50 kW (68 PS) AGP, AQM	08.1999→02.2002	 7.21903.70.0	DW-AGR	EP	
1.9 TDI 66 kW (90 PS) 1Z, AHU	08.1996→02.2002	 7.21903.70.0	DW-AGR	EP	
		7.21895.55.0	LDRV	EL	

S

IBIZA II (6K1)					13
1.9 TDI 66 kW (90 PS) AGR	08.1996→02.2002		7.02256.00.0	EUV-AGR EP	ch. 6K-X-400 000→ch. 6K-X-499 99 130 439→
			7.21895.55.0	LDRV EL	
1.9 TDI 66 kW (90 PS) ALH	08.1996→02.2002		7.21903.75.0	DW-AGR EP	
			7.21895.55.0	LDRV EL	
1.9 TDI 81 kW (110 PS) AFN, ASV	02.1997→02.2002		7.21903.70.0	DW-AGR EP	
			7.21903.75.0	DW-AGR EP	
IBIZA III (6L1)					14
1.4 TDI 59 kW (80 PS) BMS	06.2005→11.2009		7.00868.02.0	DW-TL EP	
1.6 16V 77 kW (105 PS) BTS	11.2006→11.2009		7.06117.54.0	SV-NWV EL	
1.8 T Cupra R 132 kW (180 PS) BBU, BLZ	01.2004→02.2008		7.01037.02.0	EUV-SL EL	
1.8 T FR 110 kW (150 PS) BJX, BKV	12.2003→05.2008		7.01037.02.0	EUV-SL EL	
1.9 SDI 47 kW (64 PS) ASY	02.2002→12.2005		7.02183.01.0	DW-AGR EP	
1.9 TDI 74 kW (101 PS) BMT	02.2002→11.2009		7.00868.02.0	DW-TL EP	
IBIZA IV (6J5, 6P1)					15
1.0 55 kW (75 PS) CHYB	05.2015→06.2017		7.06117.48.0	SV-NWV EL	
1.0 TSI 70 kW (95 PS) CHZB	05.2015→06.2017		7.06117.48.0	SV-NWV EL	
1.0 TSI 81 kW (110 PS) CHZC	05.2015→06.2017		7.06117.48.0	SV-NWV EL	
1.2 TDI 55 kW (75 PS) CFWA	06.2010→03.2012		7.22880.01.0	EUV-AGR EL	Fahrgestellnummer ab: 6J-9-000 001 Vehicle Identification Number from: 6J-9-000 001
1.2 TSI 77 kW (105 PS) CBZB	09.2010→03.2012		7.22880.01.0	EUV-KK EL	Fahrgestellnummer ab: 6J-9-000 001 Vehicle Identification Number from: 6J-9-000 001
1.2 TSI 63 kW (86 PS) CBZA	08.2012→05.2015		7.22880.01.0	EUV-KK EL	
1.4 TDI 59 kW (80 PS) BMS	07.2008→06.2010		7.00868.02.0	DW-TL EP	
1.4 TSI 110 kW (150 PS) CAVF	06.2009→05.2015		7.02588.04.0	LDRV EL	ch. 6J-9-000 001→
			7.04247.02.0	SUV EL	ch. 6J-9-000 001→
			7.06117.54.0	SV-NWV EL	Fahrgestellnummer ab: 6J-9-000 001 Vehicle Identification Number from: 6J-9-000 001
1.4 TSI 110 kW (150 PS) CNUB, CTHF, CTJB	06.2009→05.2015		7.02588.04.0	LDRV EL	
			7.04247.02.0	SUV EL	
1.4 TSI 103 kW (140 PS) CPTA	10.2013→05.2015		7.06117.48.0	SV-NWV EL	
1.4 TSI 110 kW (150 PS) CZEA	11.2015→06.2017		7.06117.48.0	SV-NWV EL	
1.6 77 kW (105 PS) BTS	05.2008→03.2012		7.06117.54.0	SV-NWV EL	Fahrgestellnummer ab: 6J-9-000 001 Vehicle Identification Number from: 6J-9-000 001
1.6 TDI 66 kW (90 PS) CAYB	05.2009→05.2015		7.02256.00.0	EUV-AGR EP	ch. 6J-9-000 001→

















						
IBIZA IV (6J5, 6P1)						15
1.6 TDI 77 kW (105 PS) CAYC, CLNA	05.2009→05.2015		7.02256.00.0	EUV-AGR	EP  CAYC, CLNA:  ch. 6J-9-000 001→	
1.9 TDI 77 kW (105 PS) BLS	03.2008→06.2010		7.00868.02.0	DW-TL	EP	
			7.02256.00.0	EUV-AGR	EP  ch. 6J-9-000 001→	
1.9 TDI 66 kW (90 PS) BXJ	07.2008→06.2010		7.00868.02.0	DW-TL	EP  ch. 6J-9-000 001→	
			7.02256.00.0	EUV-AGR	EP  ch. 6J-9-000 001→	
2.0 TDI 105 kW (143 PS) CFHD	01.2010→05.2015		7.02256.00.0	EUV-AGR	EP  ch. 6J-9-000 001→	
IBIZA IV SC (6J1, 6P5)						16
1.0 55 kW (75 PS) CHYB	05.2015→12.2016		7.06117.48.0	SV-NWV	EL	
1.0 TSI 70 kW (95 PS) CHZB	05.2015→12.2016		7.06117.48.0	SV-NWV	EL	
1.0 TSI 81 kW (110 PS) CHZC	05.2015→12.2016		7.06117.48.0	SV-NWV	EL	
1.2 TDI 55 kW (75 PS) CFWA	05.2010→05.2015		7.22880.01.0	EUV-AGR	EL Fahrgestellnummer ab: 6J-9-000 001 Vehicle Identification Number from: 6J-9-000 001	
1.2 TSI 77 kW (105 PS) CBZB	09.2010→05.2015		7.22880.01.0	EUV-KK	EL Fahrgestellnummer ab: 6J-9-000 001 Vehicle Identification Number from: 6J-9-000 001	
1.2 TSI 63 kW (86 PS) CBZA	08.2012→05.2015		7.22880.01.0	EUV-KK	EL	
1.4 TDI 59 kW (80 PS) BMS	07.2008→06.2010		7.00868.02.0	DW-TL	EP	
1.4 TSI 110 kW (150 PS) CAVF	01.2009→05.2015		7.02588.04.0	LDRV	EL  ch. 6J-9-000 001→	
			7.04247.02.0	SUV	EL  ch. 6J-9-000 001→	
			7.06117.54.0	SV-NWV	EL Fahrgestellnummer ab: 6J-9-000 001 Vehicle Identification Number from: 6J-9-000 001	
1.4 TSI 110 kW (150 PS) CNUB, CTHF, CTJB	01.2009→05.2015		7.02588.04.0	LDRV	EL	
			7.04247.02.0	SUV	EL	
1.4 TSI 103 kW (140 PS) CPTA	10.2013→05.2015		7.06117.48.0	SV-NWV	EL	
1.4 TSI 110 kW (150 PS) CZEA	11.2015→12.2016		7.06117.48.0	SV-NWV	EL	
1.4 TSI Cupra 132 kW (180 PS) CAVE	06.2009→05.2015		7.02588.04.0	LDRV	EL	
			7.04247.02.0	SUV	EL  ch. 6J-9-000 001→	
			7.06117.54.0	SV-NWV	EL Fahrgestellnummer ab: 6J-9-000 001 Vehicle Identification Number from: 6J-9-000 001	
1.4 TSI Cupra 132 kW (180 PS) CTHE, CTJC	06.2009→05.2015		7.02588.04.0	LDRV	EL	
			7.04247.02.0	SUV	EL	
1.6 77 kW (105 PS) BTS	07.2008→05.2015		7.06117.54.0	SV-NWV	EL Fahrgestellnummer ab: 6J-9-000 001 Vehicle Identification Number from: 6J-9-000 001	
1.6 TDI 66 kW (90 PS) CAYB	05.2009→05.2015		7.02256.00.0	EUV-AGR	EP  ch. 6J-9-000 001→	
1.6 TDI 77 kW (105 PS) CAYC	05.2009→05.2015		7.02256.00.0	EUV-AGR	EP  ch. 6J-9-000 001→	
1.8 TSI Cupra 141 kW (192 PS) DAJA	11.2015→12.2016		7.02256.18.0	EUV-SR	EP	
			7.02901.05.0	SUV	EL	



IBIZA IV SC (6J1, 6P5) 16

			7.06117.26.0	ZM-NWV	EL	
1.9 TDI 66 kW (90 PS) BXJ	06.2008→06.2010		7.00868.02.0	DW-TL	EP	 ch. 6J-9-000 001→
			7.02256.00.0	EUV-AGR	EP	 ch. 6J-9-000 001→
1.9 TDI 77 kW (105 PS) BLS	07.2008→06.2010		7.00868.02.0	DW-TL	EP	
			7.02256.00.0	EUV-AGR	EP	 ch. 6J-9-000 001→
2.0 TDI 105 kW (143 PS) CFHD	01.2010→05.2015		7.02256.00.0	EUV-AGR	EP	 ch. 6J-9-000 001→

IBIZA IV ST (6J8, 6P8) 17

1.0 55 kW (75 PS) CHYB	05.2015→07.2016		7.06117.48.0	SV-NWV	EL	
1.0 TSI 70 kW (95 PS) CHZB	05.2015→07.2016		7.06117.48.0	SV-NWV	EL	
1.0 TSI 81 kW (110 PS) CHZC	05.2015→07.2016		7.06117.48.0	SV-NWV	EL	
1.2 TDI 55 kW (75 PS) CFWA	04.2010→05.2015		7.22880.01.0	EUV-AGR	EL	Fahrgestellnummer ab: 6J-9-000 001 Vehicle Identification Number from: 6J-9-000 001
1.2 TSI 77 kW (105 PS) CBZB	09.2010→05.2015		7.22880.01.0	EUV-KK	EL	Fahrgestellnummer ab: 6J-9-000 001 Vehicle Identification Number from: 6J-9-000 001
1.2 TSI 63 kW (86 PS) CBZA	09.2012→05.2015		7.22880.01.0	EUV-KK	EL	
1.4 TSI 110 kW (150 PS) CAVF	02.2012→05.2015		7.02588.04.0	LDRV	EL	
			7.04247.02.0	SUV	EL	 ch. 6J-9-000 001→
			7.06117.54.0	SV-NWV	EL	Fahrgestellnummer ab: 6J-9-000 001 Vehicle Identification Number from: 6J-9-000 001
1.4 TSI 110 kW (150 PS) CNUB, CTHF, CTJB	02.2012→05.2015		7.02588.04.0	LDRV	EL	
			7.04247.02.0	SUV	EL	
1.4 TSI 103 kW (140 PS) CPTA	10.2013→05.2015		7.06117.48.0	SV-NWV	EL	
1.4 TSI 110 kW (150 PS) CZEA	11.2015→07.2016		7.06117.48.0	SV-NWV	EL	
1.6 77 kW (105 PS) BTS	02.2012→05.2015		7.06117.54.0	SV-NWV	EL	Fahrgestellnummer ab: 6J-9-000 001 Vehicle Identification Number from: 6J-9-000 001
1.6 TDI 66 kW (90 PS) CAYB	03.2010→05.2015		7.02256.00.0	EUV-AGR	EP	 ch. 6J-9-000 001→
1.6 TDI 77 kW (105 PS) CAYC, CLNA	03.2010→05.2015		7.02256.00.0	EUV-AGR	EP	 CAYC, CLNA:  ch. 6J-9-000 001→













IBIZA V (KJ1) 18

1.0 55 kW (75 PS) CHYB	01.2017→		7.06117.48.0	SV-NWV	EL	
1.0 48 kW (65 PS) CHYC	07.2017→		7.06117.48.0	SV-NWV	EL	
1.0 TGI 66 kW (90 PS) DBYA	11.2017→		7.06117.48.0	SV-NWV	EL	
1.0 TSI 70 kW (95 PS) CHZL, DKLA	01.2017→		7.06117.48.0	SV-NWV	EL	
1.0 TSI 85 kW (115 PS) CHZJ, DKJA, DKRF	01.2017→		7.06117.48.0	SV-NWV	EL	
1.5 TSI 110 kW (150 PS) DADA	07.2017→		7.06117.48.0	SV-NWV	EL	















 				
LEON (1M1)				
19				
1.4 16V 55 kW (75 PS) AHW	11.1999→06.2006	 7.21483.54.0	EUV-AGR	EL
1.6 74-76 kW (101-103 PS) AEH, AKL	11.1999→06.2006	 7.22402.03.0	EUV-SR	EL
1.6 75 kW (102 PS) BFQ	10.2005→06.2006	 7.22880.01.0	EUV-SR	EL
1.8 20V 92 kW (125 PS) AGN	11.1999→06.2006	 7.02461.01.0	EUV-SR	EL
		7.28098.04.0	EUV-SR	EL Fahrgestellnummer ab: 1M-1-025 001 Vehicle Identification Number from: 1M-1-025 001
1.8 20V 92 kW (125 PS) APG	11.1999→06.2006	 7.02256.00.0	EUV-SL	EP
		7.02461.01.0	EUV-SR	EL
		7.28098.04.0	EUV-SR	EL Fahrgestellnummer ab: 1M-1-025 001 Vehicle Identification Number from: 1M-1-025 001
1.8 20V T 132 kW (180 PS) APP, AUQ	11.1999→06.2006	 7.22687.49.0	EUV-DR	EP
		7.22687.39.0	EUV-LS	EL
		7.01805.01.0	EUV-SR	EL
1.8 20V T 4 132 kW (180 PS) AJQ	11.1999→06.2006	 7.22687.49.0	EUV-DR	EP
		7.22687.39.0	EUV-LS	EL
1.8 20V T 4 132 kW (180 PS) ARY	03.2000→06.2006	 7.22687.49.0	EUV-DR	EP
		7.22687.39.0	EUV-LS	EL
		7.01805.01.0	EUV-SR	EL
1.8 T Cupra R 154 kW (209 PS) AMK	02.2002→06.2006	 7.22687.49.0	EUV-DR	EP
		7.22687.39.0	EUV-LS	EL
1.8 T Cupra R 165 kW (225 PS) BAM	07.2003→06.2006	 7.22687.49.0	EUV-DR	EP
		7.22687.39.0	EUV-LS	EL
1.9 SDI 50 kW (68 PS) AQM	11.1999→06.2006	 7.02183.01.0	DW-AGR	EP  ch. 1M-Y-000 001→
		7.21903.70.0	DW-AGR	EP Fahrgestellnummer bis: 1M-X-025 000 Vehicle Identification Number to: 1M-X-025 000
1.9 TDI 66 kW (90 PS) AGR	11.1999→06.2006	 7.02183.01.0	DW-AGR	EP  ch. 1M-Y-000 001→
		7.21903.70.0	DW-AGR	EP Fahrgestellnummer bis: 1M-X-025 000 Vehicle Identification Number to: 1M-X-025 000
		7.02256.00.0	EUV-AGR	EP  ch. 1M-Y-000 001→
		7.01037.02.0	LDRV	EL  ch. 1M-Y-000 001→
		7.21895.55.0	LDRV	EL Fahrgestellnummer bis: 1M-X-025 000 Vehicle Identification Number to: 1M-X-025 000
1.9 TDI 66 kW (90 PS) ALH	11.1999→06.2006	 7.02183.01.0	DW-AGR	EP  ch. 1M-Y-000 001→
		7.21903.70.0	DW-AGR	EP Fahrgestellnummer bis: 1M-X-025 000 Vehicle Identification Number to: 1M-X-025 000
		7.02184.01.0	DW-TL	EP  ch. 1M-Y-000 001→
		7.21903.75.0	DW-TL	EP  →ch. 1M-X-025 000
		7.02256.00.0	EUV-AGR	EP  ch. 1M-Y-000 001→
1.9 TDI 81 kW (110 PS) AHF, ASV	11.1999→06.2006	 7.02183.01.0	DW-AGR	EP  AHF, ASV:  ch. 1M-Y-000 001→



LEON (1M1) **19**

			7.21903.70.0	DW-AGR	EP	 AHF, ASV: Fahrgestellnummer bis: 1M-X-025 000 Vehicle Identification Number to: 1M-X-025 000
			7.02184.01.0	DW-TL	EP	 AHF, ASV:  ch. 1M-Y-000 001→
			7.21903.75.0	DW-TL	EP	 AHF, ASV:  →ch. 1M-X-025 000
			7.02256.00.0	EUV-AGR	EP	 AHF, ASV:  ch. 1M-Y-000 001→
1.9 TDI 110 kW (150 PS) ARL	09.2000→06.2006		7.02183.01.0	DW-AGR	EP	
			7.00868.02.0	DW-TL	EP	
			7.02256.00.0	EUV-AGR	EP	
1.9 TDI 96-112 kW (130-152 PS) ASZ	05.2003→06.2006		7.02183.01.0	DW-AGR	EP	
			7.00868.02.0	DW-TL	EP	
			7.02256.00.0	EUV-AGR	EP	
1.9 TDI 74 kW (100 PS) AXR	10.2005→06.2006		7.02183.01.0	DW-AGR	EP	
			7.00868.02.0	DW-TL	EP	
			7.02256.00.0	EUV-AGR	EP	
1.9 TDI Syncro 110 kW (150 PS) ARL	05.2002→06.2006		7.02183.01.0	DW-AGR	EP	
			7.00868.02.0	DW-TL	EP	
			7.02256.00.0	EUV-AGR	EP	
2.8 150 kW (204 PS) BDE	05.2002→06.2004		7.02256.00.0	EUV-SL	EP	
			7.02256.00.0	EUV-SR	EP	
2.8 Cupra 4 150 kW (204 PS) AUE	02.2001→06.2006		7.02256.00.0	EUV-SL	EP	
			7.02256.00.0	EUV-SR	EP	

LEON (1P1) **20**

1.2 TSI 77 kW (105 PS) CBZB	02.2010→12.2012		7.22880.01.0	EUV-KK	EL	Fahrgestellnummer ab: 1P-6-000 001 Vehicle Identification Number from: 1P-6-000 001
1.4 TSI 92 kW (125 PS) CAXC	11.2007→12.2012		7.01830.13.0	SUV	EL	
			7.06117.54.0	SV-NWV	EL	Fahrgestellnummer ab: 1P-6-000 001 Vehicle Identification Number from: 1P-6-000 001
1.6 75 kW (102 PS) BSE, BSF, CCSA	07.2005→12.2012		7.10014.00.0	AKF	EL	 BSE, BSF, CCSA:  ch. 1P-6-000 001→
			7.22880.01.0	EUV-SR	EL	 BSE, BSF, CCSA: Fahrgestellnummer ab: 1P-6-000 001 Vehicle Identification Number from: 1P-6-000 001
1.6 LPG 75 kW (102 PS) CHGA	12.2009→12.2012		7.10014.00.0	AKF	EL	 ch. 1P-6-000 001→
			7.22880.01.0	EUV-SR	EL	Fahrgestellnummer ab: 1P-6-000 001 Vehicle Identification Number from: 1P-6-000 001
1.6 MultiFuel 75 kW (102 PS) BSE	07.2005→08.2013		7.10014.00.0	AKF	EL	 ch. 1P-6-000 001→
			7.22880.01.0	EUV-SR	EL	Fahrgestellnummer ab: 1P-6-000 001 Vehicle Identification Number from: 1P-6-000 001
1.6 MultiFuel 75 kW (102 PS) CCSA, CMXA	07.2005→08.2013		7.22880.01.0	EUV-SR	EL	
1.6 TDI 77 kW (105 PS) CAYC	02.2010→12.2012		7.02256.00.0	EUV-AGR	EP	 ch. 1P-6-000 001→
1.6 TDI 66 kW (90 PS) CAYB	11.2010→12.2012		7.02256.00.0	EUV-AGR	EP	

					
LEON (1P1)					
1.8 TSI 118 kW (160 PS) BZB	06.2007→12.2012		7.00470.07.0	LDRV	EL  ch. 1P-6-000 001→
			7.00415.07.0	SUV	EL Fahrgestellnummer ab: 1P-6-000 001 Vehicle Identification Number from: 1P-6-000 001
			7.06117.26.0	ZM-NWV	EL Fahrgestellnummer ab: 1P-6-000 001 Vehicle Identification Number from: 1P-6-000 001
1.8 TSI 118 kW (160 PS) CDA A	06.2007→12.2012		7.22880.01.0	EUV-SR	EL Fahrgestellnummer ab: 1P-6-000 001 Vehicle Identification Number from: 1P-6-000 001
			7.00470.07.0	LDRV	EL  ch. 1P-6-000 001→
			7.01830.13.0	SUV	EL
			7.06117.26.0	ZM-NWV	EL Fahrgestellnummer ab: 1P-6-000 001 Vehicle Identification Number from: 1P-6-000 001
1.9 TDI 77 kW (105 PS) BLS	07.2005→12.2010		7.00868.02.0	DW-TL	EP
			7.02256.00.0	EUV-AGR	EP  ch. 1P-6-000 001→
2.0 Cupra R 195 kW (265 PS) CDLA	09.2009→12.2012		7.00470.07.0	LDRV	EL  ch. 1P-6-000 001→
			7.00415.07.0	SUV	EL Fahrgestellnummer ab: 1P-6-000 001 Vehicle Identification Number from: 1P-6-000 001
			7.01830.13.0	SUV	EL
			7.06117.46.0	SV-NWV	EH mit Dichtring with O-ring Fahrgestellnummer ab: 1P-6-000 001 Vehicle Identification Number from: 1P-6-000 001
2.0 FSI 110 kW (150 PS) BLR, BLY, BVY, BVZ	07.2005→05.2010		7.22880.01.0	EUV-SR	EL  BLR, BLY, BVY, BVZ: Fahrgestellnummer ab: 1P-6-000 001 Vehicle Identification Number from: 1P-6-000 001
			7.06117.37.0	SV-NWV	EL  BLR, BLY, BVY, BVZ: Fahrgestellnummer ab: 1P-6-000 001 Vehicle Identification Number from: 1P-6-000 001
2.0 TDI 103 kW (140 PS) BMM	10.2005→10.2010		7.00868.02.0	DW-TL	EP
			7.02256.00.0	EUV-AGR	EP  ch. 1P-6-000 001→
2.0 TDI 125 kW (170 PS) BMN, CEGA	05.2006→12.2012		7.00868.02.0	DW-TL	EP  ch. 1P-6-000 001→
			7.02256.00.0	EUV-AGR	EP  BMN, CEGA:  ch. 1P-6-000 001→
2.0 TDI 125 kW (170 PS) CFJA	05.2006→12.2012		7.02256.00.0	EUV-AGR	EP
2.0 TDI 16V 103 kW (140 PS) CFHC, CLCB	07.2005→12.2012		7.02256.00.0	EUV-AGR	EP
2.0 TFSI 147 kW (200 PS) BWA	05.2005→03.2009		7.00470.07.0	LDRV	EL  ch. 1P-6-000 001→
			7.00415.07.0	SUV	EL Fahrgestellnummer ab: 1P-6-000 001 Vehicle Identification Number from: 1P-6-000 001
			7.01830.13.0	SUV	EL
			7.06117.46.0	SV-NWV	EH mit Dichtring with O-ring Fahrgestellnummer ab: 1P-6-000 001 Vehicle Identification Number from: 1P-6-000 001
2.0 TFSI 177 kW (240 PS) BWJ	11.2006→05.2011		7.00470.07.0	LDRV	EL  ch. 1P-6-000 001→











20
S























LEON (1P1) **20**

			7.00415.07.0	SUV	EL	Fahrgestellnummer ab: 1P-6-000 001 Vehicle Identification Number from: 1P-6-000 001
			7.06117.46.0	SV-NWV	EH	mit Dichtring with O-ring Fahrgestellnummer ab: 1P-6-000 001 Vehicle Identification Number from: 1P-6-000 001
2.0 TFSI 177 kW (240 PS) CDLD	11.2006→05.2011		7.00470.07.0	LDRV	EL	 ch. 1P-6-000 001→
			7.00415.07.0	SUV	EL	Fahrgestellnummer ab: 1P-6-000 001 Vehicle Identification Number from: 1P-6-000 001
			7.01830.13.0	SUV	EL	
			7.06117.46.0	SV-NWV	EH	mit Dichtring with O-ring Fahrgestellnummer ab: 1P-6-000 001 Vehicle Identification Number from: 1P-6-000 001
2.0 TFSI 155 kW (211 PS) CCZB	06.2009→12.2012		7.22880.01.0	EUV-SR	EL	 ch. 1P-6-000 001→
			7.00470.07.0	LDRV	EL	 ch. 1P-6-000 001→
			7.00415.07.0	SUV	EL	Fahrgestellnummer ab: 1P-6-000 001 Vehicle Identification Number from: 1P-6-000 001
			7.01830.13.0	SUV	EL	
			7.06117.26.0	ZM-NWV	EL	Fahrgestellnummer ab: 1P-6-000 001 Vehicle Identification Number from: 1P-6-000 001

LEON (5F1) **21**

1.0 TSI 85 kW (115 PS) CHZD, DKRF	05.2015→		7.06117.48.0	SV-NWV	EL	Fahrgestellnummer ab: 5F-D-000 001 Vehicle Identification Number from: 5F-D-000 001 Produktionsdatum ab: 13.05.2013 Production date from: 13.05.2013
1.0 TSi 63 kW (86 PS) DKLB	09.2018→		7.06117.48.0	SV-NWV	EL	
1.2 TSI 63 kW (86 PS) CJZB	12.2012→		7.06117.48.0	SV-NWV	EL	Fahrgestellnummer ab: 5F-D-000 001 Vehicle Identification Number from: 5F-D-000 001 Produktionsdatum bis: 04.11.2013 Production date to: 04.11.2013
1.2 TSI 77 kW (105 PS) CJZA	01.2013→		7.06117.48.0	SV-NWV	EL	Fahrgestellnummer ab: 5F-D-000 001 Vehicle Identification Number from: 5F-D-000 001 Produktionsdatum bis: 04.11.2013 Production date to: 04.11.2013
1.4 TGI 81 kW (110 PS) CPWA	02.2013→		7.06117.48.0	SV-NWV	EL	Fahrgestellnummer ab: 5F-D-000 001 Vehicle Identification Number from: 5F-D-000 001
1.4 TSI 103 kW (140 PS) CHPA, CPTA	09.2012→		7.06117.48.0	SV-NWV	EL	 CHPA: Fahrgestellnummer ab: 5F-D-000 001 Vehicle Identification Number from: 5F-D-000 001  CPTA: Fahrgestellnummer ab: 5F-D-000 001 Vehicle Identification Number from: 5F-D-000 001 Produktionsdatum bis: 12.05.2013 Production date to: 12.05.2013
1.4 TSI 90 kW (122 PS) CMBA, CXSA	11.2012→		7.06117.48.0	SV-NWV	EL	 CMBA, CXSA: Fahrgestellnummer ab: 5F-D-000 001 Vehicle Identification Number from: 5F-D-000 001















S

					
LEON (5F1)					21
1.4 TSI 92 kW (125 PS) CZCA	05.2014→		7.06117.48.0	SV-NWV	EL Fahrgestellnummer ab: 5F-D-000 001 Vehicle Identification Number from: 5F-D-000 001 Produktionsdatum ab: 13.05.2013 Production date from: 13.05.2013
1.4 TSI 110 kW (150 PS) CZDA, CZEA	05.2014→		7.06117.48.0	SV-NWV	EL  CZDA, CZEA: Fahrgestellnummer ab: 5F-D-000 001 Vehicle Identification Number from: 5F-D-000 001 Produktionsdatum ab: 13.05.2013 Production date from: 13.05.2013
1.8 TSI 132 kW (180 PS) CJSA	02.2013→		7.03280.04.0 7.02901.05.0 7.06117.26.0	EUV-SR SUV ZM-NWV	EL Fahrgestellnummer ab: 5F-D-000 001 Vehicle Identification Number from: 5F-D-000 001 EL Fahrgestellnummer ab: 5F-D-000 001 Vehicle Identification Number from: 5F-D-000 001
2.0 Cupra 206 kW (280 PS) CJXA	10.2013→		7.03280.04.0 7.02901.05.0 7.06117.26.0	EUV-SR SUV ZM-NWV	EL Fahrgestellnummer ab: 5F-D-000 001 Vehicle Identification Number from: 5F-D-000 001 für OE-Nummer: 06H 906 283 B for OE number: 06H 906 283 B EL Fahrgestellnummer ab: 5F-D-000 001 Vehicle Identification Number from: 5F-D-000 001
2.0 Cupra 195 kW (265 PS) CJXE	10.2013→		7.03280.04.0 7.02901.05.0 7.06117.26.0	EUV-SR SUV ZM-NWV	EL Fahrgestellnummer ab: 5F-D-000 001 Vehicle Identification Number from: 5F-D-000 001 für OE-Nummer: 06H 906 283 B for OE number: 06H 906 283 B EL Fahrgestellnummer ab: 5F-D-000 001 Vehicle Identification Number from: 5F-D-000 001
2.0 Cupra 213 kW (290 PS) CJXH	10.2015→		7.02256.18.0 7.03280.04.0 7.02901.05.0 7.06117.26.0	EUV-SR EUV-SR SUV ZM-NWV	EP EL Fahrgestellnummer ab: 5F-D-000 001 Vehicle Identification Number from: 5F-D-000 001 für OE-Nummer: 06H 906 283 B for OE number: 06H 906 283 B EL EL
2.0 Cupra 213 kW (290 PS) DNUC	10.2015→		7.02256.18.0 7.02901.05.0 7.06117.26.0	EUV-SR SUV ZM-NWV	EP EL EL
2.0 Cupra 221 kW (300 PS) CJXC	01.2017→		7.02256.18.0 7.02901.05.0 7.06117.26.0	EUV-SR SUV ZM-NWV	EP EL EL
2.0 Cupra R 228 kW (310 PS) CJXG	11.2017→		7.02256.18.0 7.02901.05.0 7.06117.26.0	EUV-SR SUV ZM-NWV	EP EL EL
2.0 TDI 105 kW (143 PS) CRVC	05.2013→		7.02256.00.0	EUV-AGR	EP  ch. 5F-D-000 001→
2.0 TDI 81 kW (110 PS) CRVA	05.2013→		7.02256.00.0	EUV-AGR	EP  ch. 5F-D-000 001→
2.0 TSI 140 kW (190 PS) DKZA	09.2018→		7.02901.05.0	SUV	EL

S







LEON SC (5F5) **22**

1.0 TSI 85 kW (115 PS) CHZD	05.2015→08.2018	 7.06117.48.0	SV-NWV	EL	Fahrgestellnummer ab: 5F-D-000 001 Vehicle Identification Number from: 5F-D-000 001 Produktionsdatum ab: 13.05.2013 Production date from: 13.05.2013	
1.2 TSI 63 kW (86 PS) CJZB	01.2013→08.2018	 7.06117.48.0	SV-NWV	EL	Fahrgestellnummer ab: 5F-D-000 001 Vehicle Identification Number from: 5F-D-000 001 Produktionsdatum bis: 04.11.2013 Production date to: 04.11.2013	
1.2 TSI 77 kW (105 PS) CJZA	02.2013→04.2014	 7.06117.48.0	SV-NWV	EL	Fahrgestellnummer ab: 5F-D-000 001 Vehicle Identification Number from: 5F-D-000 001 Produktionsdatum bis: 04.11.2013 Production date to: 04.11.2013	
1.4 TSI 90 kW (122 PS) CMBA, CXSA	02.2013→06.2015	 7.06117.48.0	SV-NWV	EL	 CMBA, CXSA: Fahrgestellnummer ab: 5F-D-000 001 Vehicle Identification Number from: 5F-D-000 001	
1.4 TSI 103 kW (140 PS) CHPA, CPTA	02.2013→11.2016	 7.06117.48.0	SV-NWV	EL	 CHPA: Fahrgestellnummer ab: 5F-D-000 001 Vehicle Identification Number from: 5F-D-000 001  CPTA: Fahrgestellnummer ab: 5F-D-000 001 Vehicle Identification Number from: 5F-D-000 001 Produktionsdatum bis: 12.05.2013 Production date to: 12.05.2013	
1.4 TSI 92 kW (125 PS) CZCA	05.2014→08.2018	 7.06117.48.0	SV-NWV	EL	Fahrgestellnummer ab: 5F-D-000 001 Vehicle Identification Number from: 5F-D-000 001 Produktionsdatum ab: 13.05.2013 Production date from: 13.05.2013	
1.4 TSI 110 kW (150 PS) CZEA	05.2014→08.2018	 7.06117.48.0	SV-NWV	EL	Fahrgestellnummer ab: 5F-D-000 001 Vehicle Identification Number from: 5F-D-000 001 Produktionsdatum ab: 13.05.2013 Production date from: 13.05.2013	
1.8 TSI 132 kW (180 PS) CJSA	02.2013→08.2018	 7.03280.04.0	EUV-SR	EL	Fahrgestellnummer ab: 5F-D-000 001 Vehicle Identification Number from: 5F-D-000 001	
			7.06117.26.0	ZM-NWV	EL	Fahrgestellnummer ab: 5F-D-000 001 Vehicle Identification Number from: 5F-D-000 001
2.0 Cupra 195 kW (265 PS) CJXE	10.2013→11.2016	 7.03280.04.0	EUV-SR	EL	Fahrgestellnummer ab: 5F-D-000 001 Vehicle Identification Number from: 5F-D-000 001 für OE-Nummer: 06H 906 283 B for OE number: 06H 906 283 B	
			7.02901.05.0	SUV	EL	
			7.06117.26.0	ZM-NWV	EL	Fahrgestellnummer ab: 5F-D-000 001 Vehicle Identification Number from: 5F-D-000 001
2.0 Cupra 206 kW (280 PS) CJXA	10.2013→11.2016	 7.03280.04.0	EUV-SR	EL	Fahrgestellnummer ab: 5F-D-000 001 Vehicle Identification Number from: 5F-D-000 001 für OE-Nummer: 06H 906 283 B for OE number: 06H 906 283 B	
			7.02901.05.0	SUV	EL	
			7.06117.26.0	ZM-NWV	EL	Fahrgestellnummer ab: 5F-D-000 001 Vehicle Identification Number from: 5F-D-000 001
2.0 Cupra 213 kW (290 PS) CJXH	10.2015→11.2016	 7.02256.18.0	EUV-SR	EP		





S

					
---	---	---	---	--	---

LEON SC (5F5) **22**















		7.03280.04.0	EUV-SR	EL	Fahrgestellnummer ab: 5F-D-000 001 Vehicle Identification Number from: 5F-D-000 001 für OE-Nummer: 06H 906 283 B for OE number: 06H 906 283 B
		7.02901.05.0	SUV	EL	
		7.06117.26.0	ZM-NWV	EL	
2.0 Cupra 221 kW (300 PS) CJXC	01.2017→08.2018	 7.02256.18.0	EUV-SR	EP	
		7.02901.05.0	SUV	EL	
		7.06117.26.0	ZM-NWV	EL	
2.0 TDI 81 kW (110 PS) CRVA	02.2013→	 7.02256.00.0	EUV-AGR	EP	 ch. 5F-D-000 001→
2.0 TDI 105 kW (143 PS) CRVC	05.2013→	 7.02256.00.0	EUV-AGR	EP	 ch. 5F-D-000 001→

LEON ST (5F8) **23**

1.0 TSi 85 kW (115 PS) CHZD, DKRF	05.2015→	 7.06117.48.0	SV-NWV	EL	Fahrgestellnummer ab: 5F-D-000 001 Vehicle Identification Number from: 5F-D-000 001 Produktionsdatum ab: 13.05.2013 Production date from: 13.05.2013
1.0 TSi 63 kW (86 PS) DKLB	09.2018→	 7.06117.48.0	SV-NWV	EL	
1.2 TSi 77 kW (105 PS) CJZA	08.2013→	 7.06117.48.0	SV-NWV	EL	Fahrgestellnummer ab: 5F-D-000 001 Vehicle Identification Number from: 5F-D-000 001 Produktionsdatum bis: 04.11.2013 Production date to: 04.11.2013
1.2 TSi 63 kW (86 PS) CJZB	11.2013→	 7.06117.48.0	SV-NWV	EL	Fahrgestellnummer ab: 5F-D-000 001 Vehicle Identification Number from: 5F-D-000 001 Produktionsdatum bis: 04.11.2013 Production date to: 04.11.2013
1.4 TGI 81 kW (110 PS) CPWA	10.2013→	 7.06117.48.0	SV-NWV	EL	Fahrgestellnummer ab: 5F-D-000 001 Vehicle Identification Number from: 5F-D-000 001
1.4 TSi 90 kW (122 PS) CMBA, CXSA	09.2012→	 7.06117.48.0	SV-NWV	EL	 CMBA, CXSA: Fahrgestellnummer ab: 5F-D-000 001 Vehicle Identification Number from: 5F-D-000 001
1.4 TSi 103 kW (140 PS) CHPA, CPTA	10.2013→	 7.06117.48.0	SV-NWV	EL	 CHPA: Fahrgestellnummer ab: 5F-D-000 001 Vehicle Identification Number from: 5F-D-000 001  CPTA: Fahrgestellnummer ab: 5F-D-000 001 Vehicle Identification Number from: 5F-D-000 001 Produktionsdatum bis: 12.05.2013 Production date to: 12.05.2013
1.4 TSi 92 kW (125 PS) CZCA	05.2014→	 7.06117.48.0	SV-NWV	EL	Fahrgestellnummer ab: 5F-D-000 001 Vehicle Identification Number from: 5F-D-000 001 Produktionsdatum ab: 13.05.2013 Production date from: 13.05.2013
1.4 TSi 110 kW (150 PS) CZEA	05.2014→	 7.06117.48.0	SV-NWV	EL	Fahrgestellnummer ab: 5F-D-000 001 Vehicle Identification Number from: 5F-D-000 001 Produktionsdatum ab: 13.05.2013 Production date from: 13.05.2013
1.8 TSi 132 kW (180 PS) CJSA	10.2013→	 7.03280.04.0	EUV-SR	EL	Fahrgestellnummer ab: 5F-D-000 001 Vehicle Identification Number from: 5F-D-000 001
		7.02901.05.0	SUV	EL	



LEON ST (5F8) **23**

			7.06117.26.0	ZM-NWV	EL	Fahrgestellnummer ab: 5F-D-000 001 Vehicle Identification Number from: 5F-D-000 001
1.8 TSI 4Drive 132 kW (180 PS) CJSA, CJSB	11.2014→		7.03280.04.0	EUV-SR	EL	 CJSA, CJSB: Fahrgestellnummer ab: 5F-D-000 001 Vehicle Identification Number from: 5F-D-000 001
			7.02901.05.0	SUV	EL	
			7.06117.26.0	ZM-NWV	EL	 CJSA, CJSB: Fahrgestellnummer ab: 5F-D-000 001 Vehicle Identification Number from: 5F-D-000 001
2.0 Cupra 195 kW (265 PS) CJXE	10.2013→		7.03280.04.0	EUV-SR	EL	Fahrgestellnummer ab: 5F-D-000 001 Vehicle Identification Number from: 5F-D-000 001 für OE-Nummer: 06H 906 283 B for OE number: 06H 906 283 B
			7.02901.05.0	SUV	EL	
			7.06117.26.0	ZM-NWV	EL	Fahrgestellnummer ab: 5F-D-000 001 Vehicle Identification Number from: 5F-D-000 001
2.0 Cupra 206 kW (280 PS) CJXA	10.2013→		7.03280.04.0	EUV-SR	EL	Fahrgestellnummer ab: 5F-D-000 001 Vehicle Identification Number from: 5F-D-000 001 für OE-Nummer: 06H 906 283 B for OE number: 06H 906 283 B
			7.02901.05.0	SUV	EL	
			7.06117.26.0	ZM-NWV	EL	Fahrgestellnummer ab: 5F-D-000 001 Vehicle Identification Number from: 5F-D-000 001
2.0 Cupra 213 kW (290 PS) CJXH	10.2015→		7.02256.18.0	EUV-SR	EP	
			7.03280.04.0	EUV-SR	EL	Fahrgestellnummer ab: 5F-D-000 001 Vehicle Identification Number from: 5F-D-000 001 für OE-Nummer: 06H 906 283 B for OE number: 06H 906 283 B
			7.02901.05.0	SUV	EL	
			7.06117.26.0	ZM-NWV	EL	
2.0 Cupra 213 kW (290 PS) DNUC	10.2015→		7.02901.05.0	SUV	EL	
			7.06117.26.0	ZM-NWV	EL	
2.0 Cupra 221 kW (300 PS) CJXC	11.2016→		7.02256.18.0	EUV-SR	EP	
			7.02901.05.0	SUV	EL	
			7.06117.26.0	ZM-NWV	EL	
2.0 Cupra 4Drive 221 kW (300 PS) CJXC, DNUC	11.2016→		7.02256.18.0	EUV-SR	EP	
			7.02901.05.0	SUV	EL	
			7.06117.26.0	ZM-NWV	EL	
2.0 TDI 105 kW (143 PS) CRVC	10.2013→		7.02256.00.0	EUV-AGR	EP	 ch. 5F-D-000 001→
2.0 TDI 81 kW (110 PS) CRVA	11.2013→		7.02256.00.0	EUV-AGR	EP	 ch. 5F-D-000 001→
2.0 TSI 140 kW (190 PS) DKZA	09.2018→		7.02901.05.0	SUV	EL	
2.0 TSI 4Drive 140 kW (190 PS) DKZA	09.2018→		7.02901.05.0	SUV	EL	































S

Mii (KF1, KE1)						24
1.0 44 kW (60 PS) CHYA	10.2011→07.2019		7.06117.48.0	SV-NWV	EL	
1.0 55 kW (75 PS) CHYB	10.2011→07.2019		7.06117.48.0	SV-NWV	EL	
1.0 EcoFuel 50 kW (68 PS) CPGA	10.2012→07.2019		7.06117.48.0	SV-NWV	EL	
TARRACO (KN2)						25
1.4 TSI 110 kW (150 PS) CZDA	09.2018→		7.06117.48.0	SV-NWV	EL	
2.0 TSI 4Drive 140 kW (190 PS) DKZA	11.2018→		7.02901.05.0	SUV	EL	→07.2019
TOLEDO I (1L2)						26
1.6 i 52-55 kW (71-75 PS) 1F	05.1991→12.1993		7.01805.01.0	EUV-LS	EL	
1.6 i 52-55 kW (71-75 PS) 1F	01.1993→03.1999		7.01805.01.0	EUV-LS	EL	
1.8 i 65 kW (88 PS) RP	05.1991→12.1996		7.01805.01.0	EUV-LS	EL	
1.8 i 66 kW (90 PS) ABS, ADZ	11.1993→12.1996		7.01805.01.0	EUV-SR	EL	
1.9 TDI 66 kW (90 PS) 1Z, AHU	08.1995→03.1999		7.21903.70.0	DW-AGR	EP	
1.9 TDI 81 kW (110 PS) AFN	11.1996→03.1999		7.21895.55.0	LDRV	EL	
			7.21903.70.0	DW-AGR	EP	
			7.21903.75.0	DW-TL	EP	
TOLEDO II (1M2)						27
1.4 16V 55 kW (75 PS) AHW	01.2000→05.2002		7.21483.54.0	EUV-AGR	EL	
1.6 74-76 kW (101-103 PS) AEH, AKL	10.1998→07.2004		7.22402.03.0	EUV-SR	EL	
1.8 20V 92 kW (125 PS) AGN	10.1998→07.2004		7.02461.01.0	EUV-SR	EL	
			7.28098.04.0	EUV-SR	EL	Fahrgestellnummer ab: 1M-1-025 001 Vehicle Identification Number from: 1M-1-025 001
1.8 20V 92 kW (125 PS) APG	05.1999→07.2004		7.02256.00.0	EUV-SL	EP	ch. 1M-X-000 001→ch. 1M-X-025 000
			7.02461.01.0	EUV-SR	EL	
			7.28098.04.0	EUV-SR	EL	Fahrgestellnummer ab: 1M-1-025 001 Vehicle Identification Number from: 1M-1-025 001
1.8 20VT 132 kW (180 PS) APP, ARY, AUQ	09.2000→07.2004		7.22687.49.0	EUV-DR	EP	APP: Fahrgestellnummer ab: 1M-X-000 001 Vehicle Identification Number from: 1M-X-000 001 Fahrgestellnummer bis: 1M-X-025 000 Vehicle Identification Number to: 1M-X-025 000
			7.22687.39.0	EUV-LS	EL	ARY, AUQ: Fahrgestellnummer ab: 1M-X-000 001 Vehicle Identification Number from: 1M-X-000 001
			7.01805.01.0	EUV-SR	EL	APP, ARY, AUQ: ch. 1M-X-000 001→
1.9 TDI 81 kW (110 PS) AHF, ASV	10.1998→07.2004		7.02183.01.0	DW-AGR	EP	AHF, ASV: ch. 1M-Y-000 001→

S



















































TOLEDO II (1M2) **27**

			7.21903.70.0	DW-AGR	EP	 AHF, ASV: Fahrgestellnummer bis: 1M-X-025 000 Vehicle Identification Number to: 1M-X-025 000
			7.02184.01.0	DW-TL	EP	 AHF, ASV:  ch. 1M-Y-000 001→
			7.21903.75.0	DW-TL	EP	 AHF, ASV:  →ch. 1M-X-025 000
			7.02256.00.0	EUV-AGR	EP	 AHF, ASV:  ch. 1M-Y-000 001→
1.9 TDI 66 kW (90 PS) AGR	03.1999→07.2004		7.02183.01.0	DW-AGR	EP	 ch. 1M-Y-000 001→
			7.21903.70.0	DW-AGR	EP	Fahrgestellnummer bis: 1M-X-025 000 Vehicle Identification Number to: 1M-X-025 000
			7.02256.00.0	EUV-AGR	EP	 ch. 1M-Y-000 001→
			7.01037.02.0	LDRV	EL	 ch. 1M-Y-000 001→
			7.21895.55.0	LDRV	EL	 →ch. 1M-X-025 000
1.9 TDI 66 kW (90 PS) ALH	04.1999→07.2004		7.02183.01.0	DW-AGR	EP	 ch. 1M-Y-000 001→
			7.21903.70.0	DW-AGR	EP	Fahrgestellnummer bis: 1M-X-025 000 Vehicle Identification Number to: 1M-X-025 000
			7.02184.01.0	DW-TL	EP	 ch. 1M-Y-000 001→
			7.21903.75.0	DW-TL	EP	 →ch. 1M-X-025 000
			7.02256.00.0	EUV-AGR	EP	 ch. 1M-Y-000 001→
1.9 TDI 110 kW (150 PS) ARL	10.2000→07.2004		7.02183.01.0	DW-AGR	EP	
			7.00868.02.0	DW-TL	EP	
			7.02256.00.0	EUV-AGR	EP	 ch. 1M-X-000 001→ch. 1M-X-025 000
1.9 TDI 96-112 kW (130-152 PS) ASZ	05.2003→05.2006		7.02183.01.0	DW-AGR	EP	
			7.00868.02.0	DW-TL	EP	
			7.02256.00.0	EUV-AGR	EP	
1.9 TDI 74 kW (100 PS) AXR	08.2005→05.2006		7.00868.02.0	DW-TL	EP	
			7.02256.00.0	EUV-AGR	EP	
1.9 TDI 4Drive 110 kW (150 PS) ARL	10.2000→10.2005		7.02183.01.0	DW-AGR	EP	
			7.00868.02.0	DW-TL	EP	
2.3 V5 110 kW (150 PS) AGZ	10.1998→11.2000		7.02256.00.0	EUV-SL	EP	 ch. 1M-Y-000 001→
			7.02256.00.0	EUV-SR	EP	 ch. 1M-Y-000 001→
2.3 V5 20V 125 kW (170 PS) AQN	09.2000→11.2003		7.02256.00.0	EUV-SL	EP	 ch. 1M-X-000 001→ch. 1M-X-025 000
			7.02256.00.0	EUV-SR	EP	 ch. 1M-X-000 001→ch. 1M-X-025 000
2.8 150 kW (204 PS) AUE	10.2000→07.2001		7.02256.00.0	EUV-SL	EP	 ch. 1M-X-000 001→ch. 1M-X-025 000
			7.02256.00.0	EUV-SR	EP	 ch. 1M-X-000 001→ch. 1M-X-025 000



TOLEDO III (5P2) **28**































1.4 TSI 92 kW (125 PS) CAXC	11.2007→05.2009		7.00415.07.0	SUV	EL	
			7.06117.54.0	SV-NWV	EL	
1.6 75 kW (102 PS) BGU, BSE, BSF, CCSA	10.2004→05.2009		7.10014.00.0	AKF	EL	
			7.22880.01.0	EUV-SR	EL	
1.8 TFSI 118 kW (160 PS) BYT, BZB	01.2007→05.2009		7.00470.07.0	LDRV	EL	
			7.00415.07.0	SUV	EL	

						
TOLEDO III (5P2)						28
1.8 TFSI 118 kW (160 PS) CDAА	01.2007→05.2009		7.06117.26.0	ZM-NWV	EL	
			7.22880.01.0	EUV-SR	EL	
			7.00470.07.0	LDRV	EL	
			7.01830.13.0	SUV	EL	
1.9 TDI 77 kW (105 PS) BLS	10.2004→05.2009		7.06117.26.0	ZM-NWV	EL	
			7.00868.02.0	DW-TL	EP	
			7.02256.00.0	EUV-AGR	EP	
2.0 FSI 110 kW (150 PS) BLR, BLY, BVY, BVZ	10.2004→05.2009		7.22880.01.0	EUV-SR	EL	
			7.06117.37.0	SV-NWV	EL	
2.0 TDI 103 kW (140 PS) BMM	11.2005→05.2009		7.00868.02.0	DW-TL	EP	
			7.02256.00.0	EUV-AGR	EP	
2.0 TDI 125 kW (170 PS) BMN, CEGA	01.2006→05.2009		7.00868.02.0	DW-TL	EP	
			7.02256.00.0	EUV-AGR	EP	
2.0 TFSI 147 kW (200 PS) BWA	11.2005→05.2009		7.00470.07.0	LDRV	EL	
			7.00415.07.0	SUV	EL	
			7.01830.13.0	SUV	EL	
			7.06117.46.0	SV-NWV	EH	
TOLEDO III (5P_)						29
1.4 TFSI 16V 92 kW (125 PS) CAXC	11.2007→05.2009		7.01830.13.0	SUV	EL	
TOLEDO IV (KG3)						30
1.2 TSI 63 kW (86 PS) CBZA	07.2012→06.2015		7.22880.01.0	EUV-KK	EL	
1.2 TSI 77 kW (105 PS) CBZB	07.2012→06.2015		7.22880.01.0	EUV-KK	EL	
1.2 TSI 66 kW (90 PS) CJZC	05.2015→05.2017		7.06117.48.0	SV-NWV	EL	
1.2 TSI 81 kW (110 PS) CJZD	05.2015→05.2017		7.06117.48.0	SV-NWV	EL	
1.4 TSI 90 kW (122 PS) CAXA	07.2012→06.2015		7.01830.13.0	SUV	EL	
			7.06117.54.0	SV-NWV	EL	
1.4 TSI 92 kW (125 PS) CZCA	05.2015→04.2019		7.06117.48.0	SV-NWV	EL	
1.6 77 kW (105 PS) CFNA	07.2013→06.2015		7.06117.54.0	SV-NWV	EL	
1.6 81 kW (110 PS) CWVA	05.2015→04.2019		7.06117.48.0	SV-NWV	EL	
1.6 TDI 77 kW (105 PS) CAYC, CLNA	07.2012→06.2015		7.02256.00.0	EUV-AGR	EP	
1.6 TDI 66 kW (90 PS) CAYB	06.2013→06.2015		7.02256.00.0	EUV-AGR	EP	
ALHAMBRA VAN (7V8, 7V9)						31
1.9 TDI 96-112 kW (130-152 PS) ASZ	11.2002→11.2008		7.28098.04.0	EUV-KA	EL	für Fahrzeuge mit Standheizung for vehicles with parking heater
1.9 TDI 4motion 85 kW (115 PS) AUY, BVK	06.2002→05.2008		7.28098.04.0	EUV-KA	EL	 AUY, BVK: für Fahrzeuge mit Standheizung for vehicles with parking heater
2.0 85 kW (115 PS) ADY	03.1996→07.2000		7.21483.54.0	EUV-AGR	EL	

			 PIERBURG		
ALHAMBRA VAN (7V8, 7V9) 31					
2.0 85 kW (115 PS) ATM	06.2000→03.2010	 7.28098.04.0	EUV-KA	EL	Baujahr ab: 01.2001 Construction year from: 01.2001 für Fahrzeuge mit Standheizung for vehicles with parking heater
TDI 66 kW (90 PS) 1Z, AHU	03.1996→05.2000	 7.21903.70.0 7.21895.55.0	DW-AGR LDRV	EP EL	
TDI 81 kW (110 PS) AFN	09.1997→02.2002	 7.21903.70.0	DW-AGR	EP	
TDI 66 kW (90 PS) ANU	06.2000→03.2010	 7.28098.04.0	EUV-KA	EL	für Fahrzeuge mit Standheizung for vehicles with parking heater
TDI 85 kW (115 PS) AUY, BVK	06.2000→03.2010	 7.28098.04.0	EUV-KA	EL	 AUY, BVK: für Fahrzeuge mit Standheizung for vehicles with parking heater
CORDOBA VARIO Estate Van (6K5) 32					
1.9 TDI 81 kW (110 PS) ASV	08.2000→12.2002	 7.21903.70.0	DW-AGR	EP	
IBIZA IV Hatchback Van (6J1) 33					
1.2 TDI 55 kW (75 PS) CFWA	05.2010→05.2015	 7.22880.01.0	EUV-AGR	EL	Fahrgestellnummer ab: 6J-9-000 001 Vehicle Identification Number from: 6J-9-000 001
INCA (6K9) 34					
1.7 D 42 kW (57 PS) AHB	09.1996→06.2003	 7.21903.70.0 7.21895.55.0	DW-AGR LDRV	EP EL	
1.9 SDI 47 kW (64 PS) AEY	11.1995→09.2000	 7.21903.70.0 7.21895.55.0	DW-AGR LDRV	EP EL	
1.9 SDI 47 kW (64 PS) AYQ	09.2000→06.2003	 7.21903.70.0	DW-AGR	EP	
LEON Hatchback Van (5F1) 35					
1.8 TFSI 132 kW (180 PS) CJSA	02.2013→	 7.03280.04.0 7.02901.05.0 7.06117.26.0	EUV-SR SUV ZM-NWV	EL EL EL	Fahrgestellnummer ab: 5F-D-000 001 Vehicle Identification Number from: 5F-D-000 001 Fahrgestellnummer ab: 5F-D-000 001 Vehicle Identification Number from: 5F-D-000 001
2.0 Cupra 213 kW (290 PS) CJXH	09.2015→10.2016	 7.03280.04.0 7.02901.05.0 7.06117.26.0	EUV-SR SUV ZM-NWV	EL EL EL	Fahrgestellnummer ab: 5F-D-000 001 Vehicle Identification Number from: 5F-D-000 001 für OE-Nummer: 06H 906 283 B for OE number: 06H 906 283 B
2.0 Cupra 221 kW (300 PS) CJXC	01.2017→	 7.02901.05.0 7.06117.26.0	SUV ZM-NWV	EL EL	
LEON ST Estate Van (5F8) 36					
1.8 TFSI 132 kW (180 PS) CJSA	10.2013→	 7.03280.04.0 7.02901.05.0 7.06117.26.0	EUV-SR SUV ZM-NWV	EL EL EL	Fahrgestellnummer ab: 5F-D-000 001 Vehicle Identification Number from: 5F-D-000 001 Fahrgestellnummer ab: 5F-D-000 001 Vehicle Identification Number from: 5F-D-000 001

LEON ST Estate Van (5F8) 36

2.0 Cupra 206 kW (280 PS) CJXA	10.2013->	  7.03280.04.0 7.02901.05.0 7.06117.26.0	EUV-SR SUV ZM-NWV	EL EL EL	Fahrgestellnummer ab: 5F-D-000 001 Vehicle Identification Number from: 5F-D-000 001 für OE-Nummer: 06H 906 283 B for OE number: 06H 906 283 B Fahrgestellnummer ab: 5F-D-000 001 Vehicle Identification Number from: 5F-D-000 001
2.0 Cupra 221 kW (300 PS) CJXC	11.2016->	 7.02901.05.0 7.06117.26.0	SUV ZM-NWV	EL EL	
2.0 Cupra 4Drive 221 kW (300 PS) CJXC	11.2016->	 7.02901.05.0 7.06117.26.0	SUV ZM-NWV	EL EL	



			 PIERBURG			
CITIGO (NF1)						1
1.0 44 kW (60 PS) CHYA	10.2011→08.2019		7.06117.48.0	SV-NWV	EL	
1.0 55 kW (75 PS) CHYB	10.2011→08.2019		7.06117.48.0	SV-NWV	EL	
1.0 CNG 50 kW (68 PS) CPGA	11.2012→08.2019		7.06117.48.0	SV-NWV	EL	
FABIA I (6Y2)						2
1.9 SDI 47 kW (64 PS) ASY	12.1999→03.2008		7.02183.01.0	DW-AGR	EP	
1.9 TDI 74 kW (100 PS) ATD	01.2000→03.2008		7.02183.01.0	DW-AGR	EP	
			7.02184.01.0	DW-TL	EP	
			7.02256.00.0	EUV-AGR	EP	
FABIA I Combi (6Y5)						3
1.9 SDI 47 kW (64 PS) ASY	04.2000→12.2007		7.02183.01.0	DW-AGR	EP	
1.9 TDI 74 kW (100 PS) ATD	04.2000→12.2007		7.02183.01.0	DW-AGR	EP	
			7.02184.01.0	DW-TL	EP	
			7.02256.00.0	EUV-AGR	EP	
FABIA I Saloon (6Y3)						4
1.9 SDI 47 kW (64 PS) ASY	11.1999→12.2007		7.02183.01.0	DW-AGR	EP	
1.9 TDI 74 kW (100 PS) ATD	01.2000→12.2007		7.02183.01.0	DW-AGR	EP	
			7.02184.01.0	DW-TL	EP	
			7.02256.00.0	EUV-AGR	EP	
FABIA II (542)						5
1.2 TDI 55 kW (75 PS) CFWA	05.2010→12.2014		7.22880.01.0	EUV-AGR	EL	
1.2 TSI 77 kW (105 PS) CBZB	03.2010→12.2014		7.22880.01.0	EUV-KK	EL	
1.2 TSI 63 kW (86 PS) CBZA	03.2010→12.2014		7.22880.01.0	EUV-KK	EL	
1.4 TDI 59 kW (80 PS) BMS	01.2007→03.2010		7.00868.02.0	DW-TL	EP  ch. 5J-7-000 001→	
1.4 TSI RS 132 kW (180 PS) CAVE, CTHE	05.2010→12.2014		7.02588.04.0	LDRV	EL	
			7.04247.02.0	SUV	EL	
1.6 77 kW (105 PS) BTS, CFNA	04.2007→12.2014		7.06117.54.0	SV-NWV	EL Fahrgestellnummer ab: 5J-7-000 001 Vehicle Identification Number from: 5J-7-000 001	
1.6 TDI 66 kW (90 PS) CAYB	03.2010→12.2014		7.02256.00.0	EUV-AGR	EP	
1.6 TDI 77 kW (105 PS) CAYC	03.2010→12.2014		7.02256.00.0	EUV-AGR	EP	
1.6 TDI 55 kW (75 PS) CAYA	04.2010→12.2014		7.02256.00.0	EUV-AGR	EP	
1.9 TDI 77 kW (105 PS) BLS	04.2007→03.2010		7.00868.02.0	DW-TL	EP  ch. 5J-7-000 001→	
			7.02256.00.0	EUV-AGR	EP  ch. 5J-7-000 001→	
FABIA II Combi (545)						6
1.2 TDI 55 kW (75 PS) CFWA	05.2010→12.2014		7.22880.01.0	EUV-AGR	EL	
1.2 TSI 77 kW (105 PS) CBZB	03.2010→12.2014		7.22880.01.0	EUV-KK	EL	

S

FABIA II Combi (545) 6

1.2 TSI 63 kW (86 PS) CBZA	03.2010→12.2014	 7.22880.01.0	EUV-KK	EL	
1.4 TDI 59 kW (80 PS) BMS	10.2007→03.2010	 7.00868.02.0	DW-TL	EP	 ch. 5J-7-000 001→
1.4 TSI RS 132 kW (180 PS) CAVE, CTHE	05.2010→12.2014	 7.02588.04.0	LDRV	EL	
		7.04247.02.0	SUV	EL	
1.6 77 kW (105 PS) BTS, CFNA	10.2007→12.2014	 7.06117.54.0	SV-NWV	EL	Fahrgestellnummer ab: 5J-7-000 001 Vehicle Identification Number from: 5J-7-000 001
1.6 TDI 66 kW (90 PS) CAYB	03.2010→12.2014	 7.02256.00.0	EUV-AGR	EP	
1.6 TDI 77 kW (105 PS) CAYC	03.2010→12.2014	 7.02256.00.0	EUV-AGR	EP	
1.6 TDI 55 kW (75 PS) CAYA	04.2010→12.2014	 7.02256.00.0	EUV-AGR	EP	
1.9 TDI 77 kW (105 PS) BLS	10.2007→03.2010	 7.00868.02.0	DW-TL	EP	 ch. 5J-7-000 001→
		7.02256.00.0	EUV-AGR	EP	 ch. 5J-7-000 001→

FABIA III (NJ3) 7



1.0 44 kW (60 PS) CHYA, CHYE	08.2014→	 7.06117.48.0	SV-NWV	EL	 CHYA, CHYE: Fahrgestellnummer ab: NJ-F-000 001 Vehicle Identification Number from: NJ-F-000 001
1.0 55 kW (75 PS) CHYB	08.2014→	 7.06117.48.0	SV-NWV	EL	Fahrgestellnummer ab: NJ-F-000 001 Vehicle Identification Number from: NJ-F-000 001
1.0 TSI 70 kW (95 PS) DKLD	08.2014→	 7.06117.48.0	SV-NWV	EL	Fahrgestellnummer ab: NJ-F-000 001 Vehicle Identification Number from: NJ-F-000 001
1.0 TSI 81 kW (110 PS) DKRC	08.2014→	 7.06117.48.0	SV-NWV	EL	Fahrgestellnummer ab: NJ-F-000 001 Vehicle Identification Number from: NJ-F-000 001
1.2 TSI 66 kW (90 PS) CJZC	08.2014→	 7.06117.48.0	SV-NWV	EL	Fahrgestellnummer ab: NJ-F-000 001 Vehicle Identification Number from: NJ-F-000 001 für OE-Nummer: 04E 906 455 D for OE number: 04E 906 455 D
1.2 TSI 81 kW (110 PS) CJZD	08.2014→	 7.06117.48.0	SV-NWV	EL	Fahrgestellnummer ab: NJ-F-000 001 Vehicle Identification Number from: NJ-F-000 001 für OE-Nummer: 04E 906 455 D for OE number: 04E 906 455 D
1.6 81 kW (110 PS) CWVA	01.2015→	 7.06117.48.0	SV-NWV	EL	Fahrgestellnummer ab: NJ-F-000 001 Vehicle Identification Number from: NJ-F-000 001 für OE-Nummer: 04E 906 455 D for OE number: 04E 906 455 D

FABIA III Estate (NJ5) 8



1.0 55 kW (75 PS) CHYB	10.2014→	 7.06117.48.0	SV-NWV	EL	Fahrgestellnummer ab: NJ-F-000 001 Vehicle Identification Number from: NJ-F-000 001
1.0 44 kW (60 PS) CHYA, CHYE	10.2014→	 7.06117.48.0	SV-NWV	EL	 CHYA, CHYE: Fahrgestellnummer ab: NJ-F-000 001 Vehicle Identification Number from: NJ-F-000 001
1.0 TSI 70 kW (95 PS) DKLD	08.2014→	 7.06117.48.0	SV-NWV	EL	Fahrgestellnummer ab: NJ-F-000 001 Vehicle Identification Number from: NJ-F-000 001
1.0 TSI 81 kW (110 PS) DKRC	08.2014→	 7.06117.48.0	SV-NWV	EL	Fahrgestellnummer ab: NJ-F-000 001 Vehicle Identification Number from: NJ-F-000 001





FABIA III Estate (NJ5) 8

1.2 TSI 66 kW (90 PS) CJZC	10.2014→		7.06117.48.0	SV-NWV	EL	Fahrgestellnummer ab: NJ-F-000 001 Vehicle Identification Number from: NJ-F-000 001 für OE-Nummer: 04E 906 455 D for OE number: 04E 906 455 D
1.2 TSI 81 kW (110 PS) CJZD	10.2014→		7.06117.48.0	SV-NWV	EL	Fahrgestellnummer ab: NJ-F-000 001 Vehicle Identification Number from: NJ-F-000 001 für OE-Nummer: 04E 906 455 D for OE number: 04E 906 455 D
1.6 81 kW (110 PS) CWVA	01.2015→		7.06117.48.0	SV-NWV	EL	Fahrgestellnummer ab: NJ-F-000 001 Vehicle Identification Number from: NJ-F-000 001 für OE-Nummer: 04E 906 455 D for OE number: 04E 906 455 D

KAMIQ (NW4) 9

1.0 TGI CNG 66 kW (90 PS) DBYA	11.2019→		7.06117.48.0	SV-NWV	EL	
1.0 TSI 70 kW (95 PS) DKLA	07.2019→		7.06117.48.0	SV-NWV	EL	
1.0 TSI 85 kW (115 PS) DKRF	07.2019→		7.06117.48.0	SV-NWV	EL	

KAROQ (NU7) 10

1.0 TSI 85 kW (115 PS) CHZJ, DKRF	07.2017→		7.06117.48.0	SV-NWV	EL	
2.0 TDI 4x4 105 kW (143 PS) CRVC	07.2018→		7.02256.00.0	EUV-AGR	EP	Euro 4 Euro 4
2.0 TSI 4x4 140 kW (190 PS) DKZA	04.2019→		7.02901.05.0	SUV	EL	

KODIAQ (NS7, NV7) 11

1.4 TSI 92 kW (125 PS) CZCA	10.2016→		7.06117.48.0	SV-NWV	EL	
1.4 TSI 110 kW (150 PS) CZDA, CZEA	10.2016→		7.06117.48.0	SV-NWV	EL	
1.4 TSI 4x4 110 kW (150 PS) CZDA, CZEA	10.2016→		7.06117.48.0	SV-NWV	EL	
2.0 TSI 4x4 132 kW (180 PS) CZPA	10.2016→		7.02256.18.0	EUV-SR	EP	Produktionsdatum bis: 12.12.2016 Production date to: 12.12.2016
2.0 TSI 4x4 140 kW (190 PS) DKZA	02.2019→		7.02256.18.0	EUV-SR	EP	Produktionsdatum bis: 12.12.2016 Production date to: 12.12.2016
			7.02901.05.0	SUV	EL	

S





OCTAVIA I (1U2) 12

1.6 74 kW (101 PS) AEH, AKL	02.1997→12.2007		7.22402.03.0	EUV-SR	EL	
1.6 75 kW (102 PS) AVU, BFQ	11.2000→12.2010		7.22880.01.0	EUV-SR	EL	
1.8 92 kW (125 PS) AGN	09.1996→07.2000		7.02461.01.0	EUV-SR	EL	 ch. 1U-W-000 001→
1.8 T 110 kW (150 PS) ARX, ARZ, AUM	08.1997→12.2010		7.22687.49.0	EUV-DR	EP	
			7.22687.39.0	EUV-LS	EL	
			7.01805.01.0	EUV-SR	EL	
1.8 T 4x4 110 kW (150 PS) ARX	05.2001→05.2006		7.22687.49.0	EUV-DR	EP	
			7.22687.39.0	EUV-LS	EL	
			7.01805.01.0	EUV-SR	EL	

OCTAVIA I (1U2) **12**

1.9 SDI 50 kW (68 PS) AGP	06.1997→12.2003	 7.02183.01.0	DW-AGR	EP	 ch. 1U-Y-208 701→
		7.21903.70.0	DW-AGR	EP	Fahrgestellnummer bis: 1U-X-208 700 Vehicle Identification Number to: 1U-X-208 700
1.9 SDI 50 kW (68 PS) AQM	06.1997→12.2003	 7.02183.01.0	DW-AGR	EP	
1.9 TDI 66 kW (90 PS) AGR	09.1996→03.2010	 7.02183.01.0	DW-AGR	EP	 ch. 1U-Y-208 701→
		7.21903.70.0	DW-AGR	EP	Fahrgestellnummer bis: 1U-X-208 700 Vehicle Identification Number to: 1U-X-208 700
		7.02256.00.0	EUV-AGR	EP	 ch. 1U-X-208 701→
		7.01037.02.0	LDRV	EL	Fahrgestellnummer ab: 1U-X-232 430, 1U-X8208 718 Vehicle Identification Number from: 1U-X-232 430, 1U-X8208 718
1.9 TDI 66 kW (90 PS) ALH	09.1996→03.2010	 7.02183.01.0	DW-AGR	EP	
		7.02184.01.0	DW-TL	EP	
		7.02256.00.0	EUV-AGR	EP	
1.9 TDI 81 kW (110 PS) AHF, ASV	08.1997→01.2006	 7.02183.01.0	DW-AGR	EP	 AHF, ASV:  ch. 1U-Y-208 701→
		7.21903.70.0	DW-AGR	EP	 AHF, ASV:  →ch. 1U-X-208 700
		7.02184.01.0	DW-TL	EP	 AHF, ASV:  ch. 1U-Y-208 701→
		7.21903.75.0	DW-TL	EP	 AHF, ASV:  →ch. 1U-X-208 700
		7.02256.00.0	EUV-AGR	EP	 AHF, ASV:  ch. 1U-Y-208 701→
1.9 TDI 96 kW (130 PS) ASZ	01.2003→09.2004	 7.02183.01.0	DW-AGR	EP	
		7.00868.02.0	DW-TL	EP	
		7.02256.00.0	EUV-AGR	EP	
1.9 TDI 74 kW (100 PS) AXR	10.2005→12.2010	 7.02183.01.0	DW-AGR	EP	
		7.00868.02.0	DW-TL	EP	
		7.02256.00.0	EUV-AGR	EP	
2.0 85 kW (116 PS) AQY	04.1999→05.2007	 7.02256.00.0	EUV-SL	EP	Fahrgestellnummer bis: 1U-Y-433 000, 1U-Y8308 000 Vehicle Identification Number to: 1U-Y-433 000, 1U-Y8308 000
2.0 85 kW (116 PS) AZJ	04.1999→05.2007	 7.22880.01.0	EUV-SR	EL	
RS 1.8 T 132 kW (180 PS) AUQ	05.2001→01.2006	 7.22687.49.0	EUV-DR	EP	
		7.22687.39.0	EUV-LS	EL	
		7.01805.01.0	EUV-SR	EL	

























OCTAVIA I Combi (1U5) **13**

1.6 74 kW (101 PS) AEH, AKL	07.1998→12.2007	 7.22402.03.0	EUV-SR	EL	
1.6 75 kW (102 PS) AVU, BFQ	09.2000→12.2010	 7.22880.01.0	EUV-SR	EL	
1.8 20V 92 kW (125 PS) AGN	07.1998→07.2000	 7.02461.01.0	EUV-SR	EL	 ch. 1U-W-000 001→
1.8 T 110 kW (150 PS) ARX, ARZ, AUM	07.1998→12.2010	 7.22687.49.0	EUV-DR	EP	
		7.22687.39.0	EUV-LS	EL	
		7.01805.01.0	EUV-SR	EL	

S



OCTAVIA I Combi (1U5) **13**

1.8 T 4x4 110 kW (150 PS) ARX	05.2001→05.2006	 7.22687.49.0	EUV-DR	EP	
		7.22687.39.0 7.01805.01.0	EUV-LS EUV-SR	EL EL	
1.9 SDI 50 kW (68 PS) AGP	07.1998→12.2003	 7.02183.01.0	DW-AGR	EP	 ch. 1U-Y-208 701→
		7.21903.70.0	DW-AGR	EP	Fahrgestellnummer bis: 1U-X-208 700 Vehicle Identification Number to: 1U-X-208 700
1.9 SDI 50 kW (68 PS) AQM	07.1998→12.2003	 7.02183.01.0	DW-AGR	EP	
1.9 TDI 66 kW (90 PS) AGR	07.1998→03.2010	 7.02183.01.0	DW-AGR	EP	 ch. 1U-Y-208 701→
		7.21903.70.0	DW-AGR	EP	Fahrgestellnummer bis: 1U-X-208 700 Vehicle Identification Number to: 1U-X-208 700
		7.02256.00.0 7.01037.02.0	EUV-AGR LDRV	EP EL	 ch. 1U-X-208 701→ Fahrgestellnummer ab: 1U-X-232 430, 1U-X8208 718 Vehicle Identification Number from: 1U-X-232 430, 1U-X8208 718
		7.21895.55.0	LDRV	EL	Fahrgestellnummer bis: 1U-X-232 429 Vehicle Identification Number to: 1U-X-232 429
1.9 TDI 66 kW (90 PS) ALH	07.1998→03.2010	 7.02183.01.0	DW-AGR	EP	
		7.02184.01.0 7.02256.00.0	DW-TL EUV-AGR	EP EP	
		 7.02183.01.0	DW-AGR	EP	 AHF, ASV:  ch. 1U-Y-208 701→
1.9 TDI 81 kW (110 PS) AHF, ASV	07.1998→01.2006	7.21903.70.0	DW-AGR	EP	 AHF, ASV: Fahrgestellnummer bis: 1U-X-208 700 Vehicle Identification Number to: 1U-X-208 700
		7.02184.01.0	DW-TL	EP	 AHF, ASV:  ch. 1U-Y-208 701→
		7.21903.75.0	DW-TL	EP	 AHF, ASV:  →ch. 1U-X-208 700
		7.02256.00.0	EUV-AGR	EP	 AHF, ASV:  ch. 1U-Y-208 701→
1.9 TDI 74 kW (100 PS) AXR	08.2000→12.2010	 7.02183.01.0	DW-AGR	EP	
		7.00868.02.0 7.02256.00.0	DW-TL EUV-AGR	EP EP	
		 7.02183.01.0	DW-AGR	EP	
1.9 TDI 96 kW (130 PS) ASZ	01.2003→09.2004	7.00868.02.0 7.02256.00.0	DW-TL EUV-AGR	EP EP	
		 7.02183.01.0	DW-AGR	EP	
		7.21903.70.0	DW-AGR	EP	 ch. 1U-Y-208 701→
1.9 TDI 4x4 66 kW (90 PS) AGR	11.1999→02.2006	7.02183.01.0	DW-AGR	EP	 ch. 1U-Y-208 701→
		7.21903.70.0	DW-AGR	EP	Fahrgestellnummer bis: 1U-X-208 700 Vehicle Identification Number to: 1U-X-208 700
		7.02256.00.0 7.01037.02.0	EUV-AGR LDRV	EP EL	 ch. 1U-X-208 701→ Fahrgestellnummer ab: 1U-X-232 430, 1U-X8208 718 Vehicle Identification Number from: 1U-X-232 430, 1U-X8208 718
		7.21895.55.0	LDRV	EL	Fahrgestellnummer bis: 1U-X-232 429 Vehicle Identification Number to: 1U-X-232 429
1.9 TDI 4x4 74 kW (100 PS) ATD	09.2000→01.2006	 7.02183.01.0	DW-AGR	EP	
		7.02184.01.0	DW-TL	EP	

S

OCTAVIA I Combi (1U5) **13**

		7.02256.00.0	EUV-AGR	EP	
2.0 85 kW (116 PS) AQY	04.1999→05.2007	7.02256.00.0	EUV-SL	EP	Fahrgestellnummer bis: 1U-Y-433 000, 1U-Y8308 000 Vehicle Identification Number to: 1U-Y-433 000, 1U-Y8308 000
2.0 85 kW (116 PS) AZJ	04.1999→05.2007	7.22880.01.0	EUV-SR	EL	
2.0 4x4 85 kW (116 PS) AZJ	08.2000→09.2004	7.22880.01.0	EUV-SR	EL	
RS 1.8 T 132 kW (180 PS) AUQ	08.2002→01.2006	7.22687.49.0	EUV-DR	EP	
		7.22687.39.0	EUV-LS	EL	
		7.01805.01.0	EUV-SR	EL	

OCTAVIA II (1Z3) **14**

1.2 TSI 77 kW (105 PS) CBZB	02.2010→06.2013	7.22880.01.0	EUV-KK	EL	Fahrgestellnummer ab: 1Z-9-000 001 Vehicle Identification Number from: 1Z-9-000 001
		7.02256.40.0	SV-KK	EL	ch. 1Z-9-000 001→ für Fahrzeuge mit Standheizung for vehicles with parking heater
1.4 55 kW (75 PS) BCA	05.2004→05.2006	7.02256.40.0	SV-KK	EL	ch. 1Z-4-000 001→ für Fahrzeuge mit Standheizung for vehicles with parking heater
1.4 59 kW (80 PS) BUD, CGGA	06.2004→04.2013	7.02256.40.0	SV-KK	EL	BUD: ch. 1Z-4-000 001→ für Fahrzeuge mit Standheizung for vehicles with parking heater CGGA: ch. 1Z-9-000 001→ für Fahrzeuge mit Standheizung for vehicles with parking heater
1.4 TSI 90 kW (122 PS) CAXA	11.2008→06.2013	7.00470.07.0	LDRV	EL	ch. 1Z-9-000 001→
		7.01830.13.0	SUV	EL	
		7.02256.40.0	SV-KK	EL	ch. 1Z-9-000 001→ für Fahrzeuge mit Standheizung for vehicles with parking heater
		7.06117.54.0	SV-NWV	EL	Fahrgestellnummer ab: 1Z-9-000 001 Vehicle Identification Number from: 1Z-9-000 001
1.6 75 kW (102 PS) BGU, BSE, BSF, CCSA, CMXA	06.2004→06.2013	7.10014.00.0	AKF	EL	BGU, BSE, BSF, CCSA: ch. 1Z-4-000 001→
		7.22880.01.0	EUV-SR	EL	CMXA: ch. 1Z-9-000 001→
		7.02256.40.0	SV-KK	EL	BGU, BSE, BSF, CCSA: Fahrgestellnummer ab: 1Z-4-000 001 Vehicle Identification Number from: 1Z-4-000 001 CMXA: Fahrgestellnummer ab: 1Z-9-000 001 Vehicle Identification Number from: 1Z-9-000 001
			SV-KK	EL	BGU, BSE, BSF, CCSA: ch. 1Z-4-000 001→ für Fahrzeuge mit Standheizung for vehicles with parking heater CMXA: ch. 1Z-9-000 001→ für Fahrzeuge mit Standheizung for vehicles with parking heater
1.6 FSI 85 kW (115 PS) BLF	02.2004→10.2008	7.10014.00.0	AKF	EL	ch. 1Z-4-000 001→
		7.22880.01.0	EUV-SR	EL	Fahrgestellnummer ab: 1Z-4-000 001 Vehicle Identification Number from: 1Z-4-000 001
		7.02256.40.0	SV-KK	EL	ch. 1Z-4-000 001→ für Fahrzeuge mit Standheizung for vehicles with parking heater

























S



OCTAVIA II (1Z3) **14**

		7.06117.54.0	SV-NWV	EL	Fahrgestellnummer ab: 1Z-4-000 001 Vehicle Identification Number from: 1Z-4-000 001
1.6 LPG 75 kW (102 PS) BSE	08.2009→11.2012	7.22880.01.0	EUV-SR	EL	Fahrgestellnummer ab: 1Z-9-000 001 Vehicle Identification Number from: 1Z-9-000 001
1.6 LPG 75 kW (102 PS) CHGA	08.2009→11.2012	7.10014.00.0	AKF	EL	ch. 1Z-9-000 001→
		7.22880.01.0	EUV-SR	EL	Fahrgestellnummer ab: 1Z-9-000 001 Vehicle Identification Number from: 1Z-9-000 001
		7.02256.40.0	SV-KK	EL	ch. 1Z-9-000 001→ für Fahrzeuge mit Standheizung for vehicles with parking heater
1.6 MultiFuel 75 kW (102 PS) CCSA, CMXA	01.2008→06.2013	7.10014.00.0	AKF	EL	CCSA: ch. 1Z-4-000 001→ CMXA: ch. 1Z-9-000 001→
		7.22880.01.0	EUV-SR	EL	CCSA: Fahrgestellnummer ab: 1Z-4-000 001 Vehicle Identification Number from: 1Z-4-000 001 CMXA: Fahrgestellnummer ab: 1Z-9-000 001 Vehicle Identification Number from: 1Z-9-000 001
		7.02256.40.0	SV-KK	EL	CCSA: ch. 1Z-4-000 001→ für Fahrzeuge mit Standheizung for vehicles with parking heater CMXA: ch. 1Z-9-000 001→ für Fahrzeuge mit Standheizung for vehicles with parking heater
1.6 TDI 77 kW (105 PS) CAYC	06.2009→04.2013	7.02256.00.0	EUV-AGR	EP	ch. 1Z-9-000 001→
		7.02256.40.0	SV-KK	EL	ch. 1Z-9-000 001→ für Fahrzeuge mit Standheizung for vehicles with parking heater
1.8 TSI 118 kW (160 PS) BZB	06.2007→04.2013	7.00470.07.0	LDRV	EL	ch. 1Z-4-000 001→
		7.00415.07.0	SUV	EL	Fahrgestellnummer ab: 1Z-4-000 001 Vehicle Identification Number from: 1Z-4-000 001 Fahrgestellnummer bis: 1Z-82243 043, 1Z-88039 031, 1Z-8A156 460, 1Z-8B159 878, 1Z-8C013 425, 1Z-8D150 073, 1Z-8K155 440, 1Z-8S151 374 Vehicle Identification Number to: 1Z-82243 043, 1Z-88039 031, 1Z-8A156 460, 1Z-8B159 878, 1Z-8C013 425, 1Z-8D150 073, 1Z-8K155 440, 1Z-8S151 374
		7.01830.13.0	SUV	EL	
		7.02256.40.0	SV-KK	EL	ch. 1Z-4-000 001→ für Fahrzeuge mit Standheizung for vehicles with parking heater
1.8 TSI 118 kW (160 PS) CDAA	06.2007→04.2013	7.06117.26.0	ZM-NWV	EL	Fahrgestellnummer ab: 1Z-4-000 001 Vehicle Identification Number from: 1Z-4-000 001
		7.22880.01.0	EUV-SR	EL	Fahrgestellnummer ab: 1Z-9-000 001 Vehicle Identification Number from: 1Z-9-000 001
		7.00470.07.0	LDRV	EL	ch. 1Z-9-000 001→
		7.01830.13.0	SUV	EL	
		7.02256.40.0	SV-KK	EL	ch. 1Z-9-000 001→ für Fahrzeuge mit Standheizung for vehicles with parking heater

OCTAVIA II (1Z3) **14**

		 PIERBURG			
		7.06117.26.0	ZM-NWV	EL	Fahrgestellnummer ab: 1Z-9-000 001 Vehicle Identification Number from: 1Z-9-000 001
1.8 TSI 112 kW (152 PS) CDAB	03.2009→06.2013	 7.22880.01.0	EUV-SR	EL	Fahrgestellnummer ab: 1Z-9-000 001 Vehicle Identification Number from: 1Z-9-000 001
		7.00470.07.0	LDRV	EL	 ch. 1Z-9-000 001→
		7.01830.13.0	SUV	EL	
		7.02256.40.0	SV-KK	EL	 ch. 1Z-9-000 001→ für Fahrzeuge mit Standheizung for vehicles with parking heater
		7.06117.26.0	ZM-NWV	EL	Fahrgestellnummer ab: 1Z-9-000 001 Vehicle Identification Number from: 1Z-9-000 001
1.9 TDI 77 kW (105 PS) BJB, BKC, BXE	06.2004→12.2010	 7.02256.40.0	SV-KK	EL	 BJB, BKC, BXE:  ch. 1Z-4-000 001→ für Fahrzeuge mit Standheizung for vehicles with parking heater
1.9 TDI 77 kW (105 PS) BLS	06.2004→12.2010	 7.00868.02.0	DW-TL	EP	 ch. 1Z-4-000 001→
		7.02256.00.0	EUV-AGR	EP	 ch. 1Z-4-000 001→
		7.02256.40.0	SV-KK	EL	 ch. 1Z-4-000 001→ für Fahrzeuge mit Standheizung for vehicles with parking heater
2.0 FSI 110 kW (150 PS) BLR, BLY, BVY, BVZ	11.2004→10.2008	 7.22880.01.0	EUV-SR	EL	 BLR, BLY, BVY, BVZ: Fahrgestellnummer ab: 1Z-4-000 001 Vehicle Identification Number from: 1Z-4-000 001
		7.02256.40.0	SV-KK	EL	 BLR, BLY, BVY, BVZ:  ch. 1Z-4-000 001→ für Fahrzeuge mit Standheizung for vehicles with parking heater
		7.06117.37.0	SV-NWV	EL	 BLR, BLY, BVY, BVZ: Fahrgestellnummer ab: 1Z-4-000 001 Vehicle Identification Number from: 1Z-4-000 001
2.0 RS 147 kW (200 PS) BWA	10.2005→02.2013	 7.00470.07.0	LDRV	EL	 ch. 1Z-4-000 001→
		7.00415.07.0	SUV	EL	Fahrgestellnummer ab: 1Z-4-000 001 Vehicle Identification Number from: 1Z-4-000 001 Fahrgestellnummer bis: 1Z-82243 043, 1Z-88039 031, 1Z-8A156 460, 1Z-8B159 878, 1Z-8C013 425, 1Z-8D150 073, 1Z-8K155 440, 1Z-8S151 374 Vehicle Identification Number to: 1Z-82243 043, 1Z-88039 031, 1Z-8A156 460, 1Z-8B159 878, 1Z-8C013 425, 1Z-8D150 073, 1Z-8K155 440, 1Z-8S151 374
		7.01830.13.0	SUV	EL	
		7.02256.40.0	SV-KK	EL	 ch. 1Z-4-000 001→ für Fahrzeuge mit Standheizung for vehicles with parking heater
		7.06117.46.0	SV-NWV	EH	mit Dichtring with O-ring Fahrgestellnummer ab: 1Z-4-000 001 Vehicle Identification Number from: 1Z-4-000 001
2.0 RS 147 kW (200 PS) CCZA	10.2005→02.2013	 7.22880.01.0	EUV-SR	EL	Fahrgestellnummer ab: 1Z-9-000 001 Vehicle Identification Number from: 1Z-9-000 001
		7.00470.07.0	LDRV	EL	 ch. 1Z-9-000 001→
		7.02901.05.0	SUV	EL	05.2011→,  ch. 1Z-9-000 001→

S

OCTAVIA II (1Z3) 14

			7.00415.07.0	SUV	EL	Fahrgestellnummer ab: 1Z-9-000 001 Vehicle Identification Number from: 1Z-9-000 001 Produktionsdatum bis: 16.05.2011 Production date to: 16.05.2011
			7.02256.40.0	SV-KK	EL	ch. 1Z-9-000 001→ für Fahrzeuge mit Standheizung for vehicles with parking heater
			7.06117.26.0	ZM-NWV	EL	Fahrgestellnummer ab: 1Z-9-000 001 Vehicle Identification Number from: 1Z-9-000 001
2.0 TDI 103 kW (140 PS) BMM	11.2005→05.2010		7.00868.02.0	DW-TL	EP	
			7.02256.00.0	EUV-AGR	EP	ch. 1Z-4-000 001→
			7.02256.40.0	SV-KK	EL	ch. 1Z-4-000 001→ für Fahrzeuge mit Standheizung for vehicles with parking heater
2.0 TDI 81 kW (110 PS) CFHF, CLCA	03.2010→06.2013		7.02256.00.0	EUV-AGR	EP	CFHF, CLCA: ch. 1Z-9-000 001→
2.0 TDI 16V 103 kW (140 PS) BKD	02.2004→04.2013		7.02256.40.0	SV-KK	EL	ch. 1Z-4-000 001→ für Fahrzeuge mit Standheizung for vehicles with parking heater
2.0 TDI 16V 103 kW (140 PS) CFHC, CLCB	02.2004→04.2013		7.02256.00.0	EUV-AGR	EP	CFHC, CLCB: ch. 1Z-9-000 001→
			7.02256.40.0	SV-KK	EL	CFHC, CLCB: ch. 1Z-9-000 001→ für Fahrzeuge mit Standheizung for vehicles with parking heater
2.0 TDI RS 125 kW (170 PS) BMN, CEGA	04.2006→02.2013		7.00868.02.0	DW-TL	EP	ch. 1Z-4-000 001→
			7.02256.00.0	EUV-AGR	EP	BMN, CEGA: ch. 1Z-4-000 001→
			7.02256.40.0	SV-KK	EL	BMN, CEGA: ch. 1Z-4-000 001→ für Fahrzeuge mit Standheizung for vehicles with parking heater

OCTAVIA II Combi (1Z5) 15

1.2 TSI 77 kW (105 PS) CBZB	02.2010→04.2013		7.22880.01.0	EUV-KK	EL	Fahrgestellnummer ab: 1Z-9-000 001 Vehicle Identification Number from: 1Z-9-000 001
			7.02256.40.0	SV-KK	EL	ch. 1Z-9-000 001→ für Fahrzeuge mit Standheizung for vehicles with parking heater
1.4 55 kW (75 PS) BCA	05.2004→05.2006		7.02256.40.0	SV-KK	EL	ch. 1Z-4-000 001→ für Fahrzeuge mit Standheizung for vehicles with parking heater
1.4 59 kW (80 PS) BUD, CGGA	05.2006→06.2013		7.02256.40.0	SV-KK	EL	BUD: ch. 1Z-4-000 001→ für Fahrzeuge mit Standheizung for vehicles with parking heater CGGA: ch. 1Z-9-000 001→ für Fahrzeuge mit Standheizung for vehicles with parking heater
1.4 TSI 90 kW (122 PS) CAXA	11.2008→06.2013		7.00470.07.0	LDRV	EL	ch. 1Z-9-000 001→
			7.01830.13.0	SUV	EL	
			7.02256.40.0	SV-KK	EL	ch. 1Z-9-000 001→ für Fahrzeuge mit Standheizung for vehicles with parking heater
			7.06117.54.0	SV-NWV	EL	Fahrgestellnummer ab: 1Z-9-000 001 Vehicle Identification Number from: 1Z-9-000 001
1.6 75 kW (102 PS) BGU, BSE, BSF, CCSA, CMXA	09.2004→06.2013		7.10014.00.0	AKF	EL	BGU, BSE, BSF, CCSA: ch. 1Z-4-000-001→ CMXA: ch. 1Z-9-000-001→















OCTAVIA II Combi (1Z5) **15**

			7.22880.01.0	EUV-SR	EL	BGU, BSE, BSF, CCSA: Fahrgestellnummer ab: 1Z-4-000 001 Vehicle Identification Number from: 1Z-4-000 001 CMXA: Fahrgestellnummer ab: 1Z-9-000 001 Vehicle Identification Number from: 1Z-9-000 001
			7.02256.40.0	SV-KK	EL	BGU, BSE, BSF, CCSA: ch. 1Z-4-000 001→ für Fahrzeuge mit Standheizung for vehicles with parking heater CMXA: ch. 1Z-9-000 001→ für Fahrzeuge mit Standheizung for vehicles with parking heater
1.6 FSI 85 kW (115 PS) BLF	02.2004→10.2008		7.10014.00.0	AKF	EL	ch. 1Z-4-000 001→
			7.22880.01.0	EUV-SR	EL	Fahrgestellnummer ab: 1Z-4-000 001 Vehicle Identification Number from: 1Z-4-000 001
			7.02256.40.0	SV-KK	EL	ch. 1Z-4-000 001→ für Fahrzeuge mit Standheizung for vehicles with parking heater
			7.06117.54.0	SV-NWV	EL	Fahrgestellnummer ab: 1Z-4-000 001 Vehicle Identification Number from: 1Z-4-000 001
1.6 LPG 75 kW (102 PS) CHGA	08.2009→11.2012		7.10014.00.0	AKF	EL	ch. 1Z-9-000 001→
			7.22880.01.0	EUV-SR	EL	Fahrgestellnummer ab: 1Z-9-000 001 Vehicle Identification Number from: 1Z-9-000 001
			7.02256.40.0	SV-KK	EL	ch. 1Z-9-000 001→ für Fahrzeuge mit Standheizung for vehicles with parking heater
1.6 MultiFuel 75 kW (102 PS) CCSA, CMXA	01.2008→06.2013		7.10014.00.0	AKF	EL	CCSA: ch. 1Z-4-000 001→ CMXA: ch. 1Z-9-000 001→
			7.22880.01.0	EUV-SR	EL	CCSA: Fahrgestellnummer ab: 1Z-4-000 001 Vehicle Identification Number from: 1Z-4-000 001 CMXA: Fahrgestellnummer ab: 1Z-9-000 001 Vehicle Identification Number from: 1Z-9-000 001
			7.02256.40.0	SV-KK	EL	CCSA: ch. 1Z-4-000 001→ für Fahrzeuge mit Standheizung for vehicles with parking heater CMXA: ch. 1Z-9-000 001→ für Fahrzeuge mit Standheizung for vehicles with parking heater
1.6 TDI 77 kW (105 PS) CAYC	06.2009→04.2013		7.02256.00.0	EUV-AGR	EP	ch. 1Z-9-000 001→
			7.02256.40.0	SV-KK	EL	ch. 1Z-9-000 001→ für Fahrzeuge mit Standheizung for vehicles with parking heater
1.6 TDI 4x4 77 kW (105 PS) CAYC	06.2009→02.2013		7.02256.00.0	EUV-AGR	EP	ch. 1Z-9-000 001→
			7.02256.40.0	SV-KK	EL	ch. 1Z-9-000 001→ für Fahrzeuge mit Standheizung for vehicles with parking heater
1.8 TSI 118 kW (160 PS) BZB	06.2007→04.2013		7.00470.07.0	LDRV	EL	ch. 1Z-4-000 001→

































S



OCTAVIA II Combi (1Z5) **15**

			7.00415.07.0	SUV	EL	Fahrgestellnummer ab: 1Z-4-000 001 Vehicle Identification Number from: 1Z-4-000 001 Fahrgestellnummer bis: 1Z-82243 043, 1Z-88039 031, 1Z-8A156 460, 1Z-8B159 878, 1Z-8C013 425, 1Z-8D150 073, 1Z-8K155 440, 1Z-8S151 374 Vehicle Identification Number to: 1Z-82243 043, 1Z-88039 031, 1Z-8A156 460, 1Z-8B159 878, 1Z-8C013 425, 1Z-8D150 073, 1Z-8K155 440, 1Z-8S151 374
			7.01830.13.0	SUV	EL	
			7.02256.40.0	SV-KK	EL	 ch. 1Z-4-000 001→ für Fahrzeuge mit Standheizung for vehicles with parking heater
			7.06117.26.0	ZM-NWV	EL	Fahrgestellnummer ab: 1Z-4-000 001 Vehicle Identification Number from: 1Z-4-000 001
1.8 TSI 118 kW (160 PS) CDAA	06.2007→04.2013		7.22880.01.0	EUV-SR	EL	Fahrgestellnummer ab: 1Z-9-000 001 Vehicle Identification Number from: 1Z-9-000 001
			7.00470.07.0	LDRV	EL	 ch. 1Z-9-000 001→
			7.01830.13.0	SUV	EL	
			7.02256.40.0	SV-KK	EL	 ch. 1Z-9-000 001→ für Fahrzeuge mit Standheizung for vehicles with parking heater
			7.06117.26.0	ZM-NWV	EL	Fahrgestellnummer ab: 1Z-9-000 001 Vehicle Identification Number from: 1Z-9-000 001
1.8 TSI 112 kW (152 PS) CDAB	03.2009→06.2013		7.22880.01.0	EUV-SR	EL	Fahrgestellnummer ab: 1Z-9-000 001 Vehicle Identification Number from: 1Z-9-000 001
			7.00470.07.0	LDRV	EL	 ch. 1Z-9-000 001→
			7.01830.13.0	SUV	EL	
			7.02256.40.0	SV-KK	EL	 ch. 1Z-9-000 001→ für Fahrzeuge mit Standheizung for vehicles with parking heater
			7.06117.26.0	ZM-NWV	EL	Fahrgestellnummer ab: 1Z-9-000 001 Vehicle Identification Number from: 1Z-9-000 001
1.8 TSI 4x4 118 kW (160 PS) CDAA	11.2008→02.2013		7.22880.01.0	EUV-SR	EL	Fahrgestellnummer ab: 1Z-9-000 001 Vehicle Identification Number from: 1Z-9-000 001
			7.00470.07.0	LDRV	EL	 ch. 1Z-9-000 001→
			7.01830.13.0	SUV	EL	
			7.02256.40.0	SV-KK	EL	 ch. 1Z-9-000 001→ für Fahrzeuge mit Standheizung for vehicles with parking heater
			7.06117.26.0	ZM-NWV	EL	Fahrgestellnummer ab: 1Z-9-000 001 Vehicle Identification Number from: 1Z-9-000 001
1.8 TSI 4x4 112 kW (152 PS) CDAB	03.2009→02.2013		7.22880.01.0	EUV-SR	EL	Fahrgestellnummer ab: 1Z-9-000 001 Vehicle Identification Number from: 1Z-9-000 001
			7.00470.07.0	LDRV	EL	 ch. 1Z-9-000 001→
			7.01830.13.0	SUV	EL	
			7.02256.40.0	SV-KK	EL	 ch. 1Z-9-000 001→ für Fahrzeuge mit Standheizung for vehicles with parking heater
			7.06117.26.0	ZM-NWV	EL	Fahrgestellnummer ab: 1Z-9-000 001 Vehicle Identification Number from: 1Z-9-000 001

































S

					
OCTAVIA II Combi (1Z5)					
1.9 TDI 77 kW (105 PS) BJB, BKC, BXE	09.2004→12.2010		7.02256.40.0	SV-KK	EL  BJB, BKC, BXE: für Fahrzeuge mit Standheizung for vehicles with parking heater
			7.00868.02.0	DW-TL	EP  ch. 1Z-4-000 001→
1.9 TDI 77 kW (105 PS) BLS	09.2004→12.2010		7.02256.00.0	EUV-AGR	EP  ch. 1Z-4-000 001→
			7.02256.40.0	SV-KK	EL  ch. 1Z-4-000 001→ für Fahrzeuge mit Standheizung for vehicles with parking heater
			7.02256.40.0	SV-KK	EL  BKC, BXE:  ch. 1Z-4-000 001→ für Fahrzeuge mit Standheizung for vehicles with parking heater
1.9 TDI 4x4 77 kW (105 PS) BLS	11.2004→12.2010		7.00868.02.0	DW-TL	EP  ch. 1Z-4-000 001→
			7.02256.00.0	EUV-AGR	EP  ch. 1Z-4-000 001→
			7.02256.40.0	SV-KK	EL  ch. 1Z-4-000 001→ für Fahrzeuge mit Standheizung for vehicles with parking heater
2.0 FSI 110 kW (150 PS) BLR, BLY, BVY, BVZ	11.2004→10.2008		7.22880.01.0	EUV-SR	EL  BLR, BLY, BVY, BVZ: Fahrgestellnummer ab: 1Z-4-000 001 Vehicle Identification Number from: 1Z-4-000 001
			7.02256.40.0	SV-KK	EL  BLR, BLY, BVY, BVZ:  ch. 1Z-4-000 001→ für Fahrzeuge mit Standheizung for vehicles with parking heater
			7.06117.37.0	SV-NWV	EL  BLR, BLY, BVY, BVZ: Fahrgestellnummer ab: 1Z-4-000 001 Vehicle Identification Number from: 1Z-4-000 001
2.0 FSI 4x4 110 kW (150 PS) BLX, BVX	11.2004→04.2009		7.22880.01.0	EUV-SR	EL  BLX, BVX: Fahrgestellnummer ab: 1Z-4-000 001 Vehicle Identification Number from: 1Z-4-000 001
			7.02256.40.0	SV-KK	EL  BLX, BVX:  ch. 1Z-4-000 001→ für Fahrzeuge mit Standheizung for vehicles with parking heater
			7.06117.37.0	SV-NWV	EL  BLX, BVX, BVX: Fahrgestellnummer ab: 1Z-4-000 001 Vehicle Identification Number from: 1Z-4-000 001
2.0 FSI 4x4 110 kW (150 PS) BLY	11.2004→04.2009		7.22880.01.0	EUV-SR	EL Fahrgestellnummer ab: 1Z-4-000 001 Vehicle Identification Number from: 1Z-4-000 001
2.0 RS 147 kW (200 PS) BWA	10.2005→02.2013		7.00470.07.0	LDRV	EL  ch. 1Z-4-000 001→
			7.00415.07.0	SUV	EL Fahrgestellnummer ab: 1Z-4-000 001 Vehicle Identification Number from: 1Z-4-000 001 Fahrgestellnummer bis: 1Z-82243 043, 1Z-88039 031, 1Z-8A156 460, 1Z-8B159 878, 1Z-8C013 425, 1Z-8D150 073, 1Z-8K155 440, 1Z-8S151 374 Vehicle Identification Number to: 1Z-82243 043, 1Z-88039 031, 1Z-8A156 460, 1Z-8B159 878, 1Z-8C013 425, 1Z-8D150 073, 1Z-8K155 440, 1Z-8S151 374
			7.01830.13.0	SUV	EL
			7.02256.40.0	SV-KK	EL  ch. 1Z-4-000 001→ für Fahrzeuge mit Standheizung for vehicles with parking heater

15
S















OCTAVIA II Combi (1Z5) **15**

			7.06117.46.0	SV-NWV	EH	mit Dichtring with O-ring Fahrgestellnummer ab: 1Z-4-000 001 Vehicle Identification Number from: 1Z-4-000 001
2.0 RS 147 kW (200 PS) CCZA	10.2005→02.2013		7.22880.01.0	EUV-SR	EL	Fahrgestellnummer ab: 1Z-9-000 001 Vehicle Identification Number from: 1Z-9-000 001
			7.00470.07.0	LDRV	EL	 ch. 1Z-9-000 001→
			7.02901.05.0	SUV	EL	05.2011→,  ch. 1Z-9-000 001→
			7.00415.07.0	SUV	EL	Fahrgestellnummer ab: 1Z-9-000 001 Vehicle Identification Number from: 1Z-9-000 001 Produktionsdatum bis: 16.05.2011 Production date to: 16.05.2011
			7.02256.40.0	SV-KK	EL	 ch. 1Z-9-000 001→ für Fahrzeuge mit Standheizung for vehicles with parking heater
2.0 TDI 103 kW (140 PS) BMM	11.2005→05.2010		7.00868.02.0	DW-TL	EP	
			7.02256.00.0 7.02256.40.0	EUV-AGR SV-KK	EP EL	 ch. 1Z-4-000 001→  ch. 1Z-4-000 001→ für Fahrzeuge mit Standheizung for vehicles with parking heater
2.0 TDI 81 kW (110 PS) CFHF, CLCA	03.2010→06.2013		7.02256.00.0	EUV-AGR	EP	 CFHF, CLCA:  ch. 1Z-9-000 001→
2.0 TDI 16V 103 kW (140 PS) BKD	02.2004→05.2013		7.02256.40.0	SV-KK	EL	 ch. 1Z-4-000 001→ für Fahrzeuge mit Standheizung for vehicles with parking heater
2.0 TDI 16V 103 kW (140 PS) CFHC, CLCB	02.2004→05.2013		7.02256.00.0	EUV-AGR	EP	 CFHC, CLCB:  ch. 1Z-9-000 001→
			7.02256.40.0	SV-KK	EL	 CFHC, CLCB:  ch. 1Z-9-000 001→ für Fahrzeuge mit Standheizung for vehicles with parking heater
2.0 TDI 16V 100 kW (136 PS) AZV	02.2004→05.2010		7.02256.40.0	SV-KK	EL	 ch. 1Z-4-000 001→ für Fahrzeuge mit Standheizung for vehicles with parking heater
2.0 TDI 16V 4x4 103 kW (140 PS) CFHC	05.2010→02.2013		7.02256.00.0	EUV-AGR	EP	 ch. 1Z-9-000 001→
			7.02256.40.0	SV-KK	EL	 ch. 1Z-9-000 001→ für Fahrzeuge mit Standheizung for vehicles with parking heater
2.0 TDI 4x4 103 kW (140 PS) BMM	07.2006→05.2010		7.00868.02.0	DW-TL	EP	
			7.02256.00.0	EUV-AGR	EP	 ch. 1Z-4-000 001→
			7.02256.40.0	SV-KK	EL	 ch. 1Z-4-000 001→ für Fahrzeuge mit Standheizung for vehicles with parking heater
2.0 TDI 4x4 81 kW (110 PS) CFHF	05.2011→02.2013		7.02256.00.0	EUV-AGR	EP	 ch. 1Z-9-000 001→
2.0 TDI RS 125 kW (170 PS) BMN, CEGA	04.2006→02.2013		7.00868.02.0	DW-TL	EP	 ch. 1Z-4-000 001→
			7.02256.00.0	EUV-AGR	EP	 BMN, CEGA:  ch. 1Z-4-000 001→
			7.02256.40.0	SV-KK	EL	 BMN, CEGA:  ch. 1Z-4-000 001→ für Fahrzeuge mit Standheizung for vehicles with parking heater

S

OCTAVIA III (5E3, NL3, NR3) 16





1.0 TSI 85 kW (115 PS) CHZD	05.2016→	 7.06117.48.0	SV-NWV	EL	Fahrgestellnummer ab: NE-D-000 001 Vehicle Identification Number from: NE-D-000 001 Produktionsdatum ab: 13.05.2013 Production date from: 13.05.2013
1.2 TSI 63 kW (86 PS) CJZB, CYVA	11.2012→	 7.06117.48.0	SV-NWV	EL	 CJZB: Fahrgestellnummer ab: NE-D-000 001 Vehicle Identification Number from: NE-D-000 001 Produktionsdatum bis: 29.07.2013 Production date to: 29.07.2013  CYVA: für OE-Nummer: 04E 906 455 D for OE number: 04E 906 455 D
1.2 TSI 77 kW (105 PS) CJZA	11.2012→	 7.06117.48.0	SV-NWV	EL	Fahrgestellnummer ab: NE-D-000 001 Vehicle Identification Number from: NE-D-000 001 Produktionsdatum bis: 29.07.2013 Production date to: 29.07.2013
1.4 TSI 103 kW (140 PS) CHPA	11.2012→	 7.06117.48.0	SV-NWV	EL	Fahrgestellnummer ab: NE-D-000 001 Vehicle Identification Number from: NE-D-000 001
1.4 TSI 110 kW (150 PS) CZDA	08.2014→	 7.06117.48.0	SV-NWV	EL	Fahrgestellnummer ab: NE-D-000 001 Vehicle Identification Number from: NE-D-000 001 Produktionsdatum ab: 13.05.2013 Production date from: 13.05.2013
1.4 TSI G-TEC 81 kW (110 PS) CPWA	11.2013→	 7.06117.48.0	SV-NWV	EL	Fahrgestellnummer ab: NE-D-000 001 Vehicle Identification Number from: NE-D-000 001 Produktionsdatum ab: 13.05.2013 Production date from: 13.05.2013
1.6 81 kW (110 PS) CWVA	01.2014→	 7.06117.48.0	SV-NWV	EL	für OE-Nummer: 04E 906 455 D for OE number: 04E 906 455 D
1.8 TSI 132 kW (180 PS) CJSA	11.2012→	 7.03280.04.0	EUV-SR	EL	Fahrgestellnummer ab: NE-D-000 001 Vehicle Identification Number from: NE-D-000 001
			SUV ZM-NWV	EL	Fahrgestellnummer ab: 5E-D-000 001 Vehicle Identification Number from: 5E-D-000 001
1.8 TSI 4x4 132 kW (180 PS) CJSB	09.2014→	 7.03280.04.0	EUV-SR	EL	Fahrgestellnummer ab: NE-D-000 001 Vehicle Identification Number from: NE-D-000 001
			ZM-NWV	EL	Fahrgestellnummer ab: 5E-D-000 001 Vehicle Identification Number from: 5E-D-000 001
2.0 TDI 105 kW (143 PS) CRVC	11.2012→	 7.02256.00.0	EUV-AGR	EP	 ch. NE-D-000 001→ Euro 4 Euro 4
2.0 TSI RS 162 kW (220 PS) CHHB	05.2013→	 7.02901.05.0	SUV	EL	
			ZM-NWV	EL	Fahrgestellnummer ab: 5E-D-000 001 Vehicle Identification Number from: 5E-D-000 001
2.0 TSI RS 169 kW (230 PS) CHHA	05.2015→	 7.02901.05.0	SUV	EL	
			ZM-NWV	EL	Fahrgestellnummer ab: 5E-D-000 001 Vehicle Identification Number from: 5E-D-000 001
2.0 TSI RS 180 kW (245 PS) DKTB, DLBA	02.2017→	 7.06117.26.0	ZM-NWV	EL	

S































OCTAVIA III Combi (5E5, 5E6)

17













1.0 TSI 85 kW (115 PS) CHZD	05.2016→	 7.06117.48.0	SV-NWV	EL	Fahrgestellnummer ab: NE-D-000 001 Vehicle Identification Number from: NE-D-000 001 Produktionsdatum ab: 13.05.2013 Production date from: 13.05.2013
1.2 TSI 63 kW (86 PS) CJZB, CYVA	11.2012→	 7.06117.48.0	SV-NWV	EL	 CJZB: Fahrgestellnummer ab: NE-D-000 001 Vehicle Identification Number from: NE-D-000 001 Produktionsdatum bis: 29.07.2013 Production date to: 29.07.2013  CYVA: für OE-Nummer: 04E 906 455 D for OE number: 04E 906 455 D
1.2 TSI 77 kW (105 PS) CJZA	11.2012→	 7.06117.48.0	SV-NWV	EL	Fahrgestellnummer ab: NE-D-000 001 Vehicle Identification Number from: NE-D-000 001 Produktionsdatum bis: 29.07.2013 Production date to: 29.07.2013
1.4 TSI 103 kW (140 PS) CHPA	11.2012→	 7.06117.48.0	SV-NWV	EL	Fahrgestellnummer ab: NE-D-000 001 Vehicle Identification Number from: NE-D-000 001
1.4 TSI 110 kW (150 PS) CZDA	08.2014→	 7.06117.48.0	SV-NWV	EL	Fahrgestellnummer ab: NE-D-000 001 Vehicle Identification Number from: NE-D-000 001 Produktionsdatum ab: 13.05.2013 Production date from: 13.05.2013
1.4 TSI G-TEC 81 kW (110 PS) CPWA	11.2013→	 7.06117.48.0	SV-NWV	EL	Fahrgestellnummer ab: NE-D-000 001 Vehicle Identification Number from: NE-D-000 001 Produktionsdatum ab: 13.05.2013 Production date from: 13.05.2013
1.6 81 kW (110 PS) CWVA	01.2014→	 7.06117.48.0	SV-NWV	EL	für OE-Nummer: 04E 906 455 D for OE number: 04E 906 455 D
1.8 TSI 132 kW (180 PS) CJSA, CJSB	11.2012→	 7.03280.04.0	EUV-SR	EL	 CJSA, CJSB: Fahrgestellnummer ab: NE-D-000 001 Vehicle Identification Number from: NE-D-000 001
			SUV ZM-NWV	EL	 CJSA, CJSB: Fahrgestellnummer ab: 5E-D-000 001 Vehicle Identification Number from: 5E-D-000 001
1.8 TSI 4x4 132 kW (180 PS) CJSB	11.2012→	 7.03280.04.0	EUV-SR	EL	Fahrgestellnummer ab: NE-D-000 001 Vehicle Identification Number from: NE-D-000 001
			ZM-NWV	EL	Fahrgestellnummer ab: 5E-D-000 001 Vehicle Identification Number from: 5E-D-000 001
2.0 TDI 105 kW (143 PS) CRVC	11.2012→	 7.02256.00.0	EUV-AGR	EP	 ch. NE-D-000 001→ Euro 4 Euro 4
2.0 TSI RS 162 kW (220 PS) CHHB	11.2012→	 7.02901.05.0	SUV	EL	
			ZM-NWV	EL	Fahrgestellnummer ab: 5E-D-000 001 Vehicle Identification Number from: 5E-D-000 001
2.0 TSI RS 169 kW (230 PS) CHHA	05.2015→	 7.02901.05.0	SUV	EL	
			ZM-NWV	EL	Fahrgestellnummer ab: 5E-D-000 001 Vehicle Identification Number from: 5E-D-000 001
2.0 TSI RS 180 kW (245 PS) DKTB, DLBA	02.2017→	 7.06117.26.0	ZM-NWV	EL	

S

						
OCTAVIA IV (NX3)						18
2.0 TDI 105 kW (143 PS) CRVC	06.2020→		7.02256.00.0	EUV-AGR	EP  ch. NX-L-000 001→ Euro 4 Euro 4	
2.0 TSI RS 180 kW (245 PS) DLBA	03.2020→		7.06117.26.0	ZM-NWV	EL Fahrgestellnummer ab: NX-L--000 001 Vehicle Identification Number from: NX-L--000 001	
OCTAVIA IV Combi (NX5)						19
2.0 TDI 105 kW (143 PS) CRVC	06.2020→		7.02256.00.0	EUV-AGR	EP  ch. NX-L-000 001→ Euro 4 Euro 4	
2.0 TSI RS 180 kW (245 PS) DLBA	03.2020→		7.06117.26.0	ZM-NWV	EL Fahrgestellnummer ab: NX-L--000 001 Vehicle Identification Number from: NX-L--000 001	
RAPID (NA2)						20
1.5 TDI 77 kW (105 PS) CWXB	01.2014→08.2016		7.02256.00.0	EUV-AGR	EP	
1.5 TDI 81 kW (110 PS) CWXC	09.2016→10.2019		7.02256.00.0	EUV-AGR	EP	
1.6 TDI 77 kW (105 PS) CLNA	10.2011→12.2013		7.02256.00.0	EUV-AGR	EP	
RAPID (NH3)						21
1.0 TSI 70 kW (95 PS) CHZB, DKLD	06.2017→12.2019		7.06117.48.0	SV-NWV	EL	
1.0 TSI 81 kW (110 PS) CHZC, DKRC	06.2017→12.2019		7.06117.48.0	SV-NWV	EL	
1.2 LPG 63 kW (86 PS) CBZA	07.2012→05.2015		7.22880.01.0	EUV-KK	EL	
1.2 TSI 63 kW (86 PS) CBZA	07.2012→05.2015		7.22880.01.0	EUV-KK	EL	
1.2 TSI 77 kW (105 PS) CBZB	07.2012→05.2015		7.22880.01.0	EUV-KK	EL	
1.2 TSI 66 kW (90 PS) CJZC	05.2015→12.2019		7.06117.48.0	SV-NWV	EL für OE-Nummer: 04E 906 455 D for OE number: 04E 906 455 D	
1.2 TSI 81 kW (110 PS) CJZD	05.2015→12.2019		7.06117.48.0	SV-NWV	EL für OE-Nummer: 04E 906 455 D for OE number: 04E 906 455 D	
1.4 TSI 90 kW (122 PS) CAXA	07.2012→06.2015		7.00470.07.0	LDRV	EL	
			7.01830.13.0	SUV	EL	
			7.06117.48.0	SV-NWV	EL für OE-Nummer: 04E 906 455 D for OE number: 04E 906 455 D	
1.4 TSI 92 kW (125 PS) CZCA	05.2015→12.2019		7.06117.48.0	SV-NWV	EL für OE-Nummer: 03C 906 455 A for OE number: 03C 906 455 A	
			7.06117.54.0	SV-NWV	EL für OE-Nummer: 04E 906 455 D for OE number: 04E 906 455 D	
1.6 77 kW (105 PS) CFNA	07.2012→06.2015		7.06117.48.0	SV-NWV	EL für OE-Nummer: 04E 906 455 D for OE number: 04E 906 455 D	
			7.06117.54.0	SV-NWV	EL für OE-Nummer: 03C 906 455 A for OE number: 03C 906 455 A	
1.6 81 kW (110 PS) CWVA	05.2015→12.2019		7.06117.48.0	SV-NWV	EL für OE-Nummer: 04E 906 455 D for OE number: 04E 906 455 D Produktionsdatum bis: 31.12.2019 Production date to: 31.12.2019	
1.6 SRE 66 kW (90 PS) CWVB	06.2015→12.2019		7.06117.48.0	SV-NWV	EL für OE-Nummer: 04E 906 455 D for OE number: 04E 906 455 D Produktionsdatum bis: 31.12.2019 Production date to: 31.12.2019	
1.6 TDI 77 kW (105 PS) CAYC, CLNA	07.2012→12.2019		7.02256.00.0	EUV-AGR	EP	
1.6 TDI 66 kW (90 PS) CAYB	08.2013→05.2015		7.02256.00.0	EUV-AGR	EP	































RAPID Spaceback (NH1) **22**

1.0 TSI 70 kW (95 PS) CHZB, DKLD	06.2017→12.2019	 7.06117.48.0	SV-NWV	EL	
1.0 TSI 81 kW (110 PS) CHZC, DKRC	06.2017→12.2019	 7.06117.48.0	SV-NWV	EL	
1.2 LPG 63 kW (86 PS) CBZA	07.2012→05.2015	 7.22880.01.0	EUV-KK	EL	
1.2 TSI 63 kW (86 PS) CBZA	07.2012→05.2015	 7.22880.01.0	EUV-KK	EL	
1.2 TSI 77 kW (105 PS) CBZB	07.2012→05.2015	 7.22880.01.0	EUV-KK	EL	
1.2 TSI 66 kW (90 PS) CJZC	05.2015→12.2019	 7.06117.48.0	SV-NWV	EL	für OE-Nummer: 04E 906 455 D for OE number: 04E 906 455 D
1.2 TSI 81 kW (110 PS) CJZD	05.2015→12.2019	 7.06117.48.0	SV-NWV	EL	für OE-Nummer: 04E 906 455 D for OE number: 04E 906 455 D
1.4 TSI 90 kW (122 PS) CAXA	07.2012→06.2015	 7.00470.07.0	LDRV	EL	
		7.01830.13.0	SUV	EL	
		7.06117.48.0	SV-NWV	EL	für OE-Nummer: 04E 906 455 D for OE number: 04E 906 455 D
		7.06117.54.0	SV-NWV	EL	für OE-Nummer: 03C 906 455 A for OE number: 03C 906 455 A
1.4 TSI 92 kW (125 PS) CZCA	05.2015→12.2019	 7.06117.48.0	SV-NWV	EL	für OE-Nummer: 04E 906 455 D for OE number: 04E 906 455 D
1.6 77 kW (105 PS) CFNA	07.2012→06.2015	 7.06117.48.0	SV-NWV	EL	für OE-Nummer: 04E 906 455 D for OE number: 04E 906 455 D
		7.06117.54.0	SV-NWV	EL	für OE-Nummer: 03C 906 455 A for OE number: 03C 906 455 A
1.6 SRE 81 kW (110 PS) CWVA	05.2015→12.2019	 7.06117.48.0	SV-NWV	EL	für OE-Nummer: 04E 906 455 D for OE number: 04E 906 455 D Produktionsdatum bis: 31.12.2019 Production date to: 31.12.2019
1.6 TDI 77 kW (105 PS) CAYC, CLNA	07.2012→12.2019	 7.02256.00.0	EUV-AGR	EP	
1.6 TDI 66 kW (90 PS) CAYB	08.2013→05.2015	 7.02256.00.0	EUV-AGR	EP	

ROOMSTER (5J7) **23**

















1.2 TDI 55 kW (75 PS) CFWA	03.2010→05.2015	 7.22880.01.0	EUV-AGR	EL	
1.2 TSI 77 kW (105 PS) CBZB	03.2010→05.2015	 7.22880.01.0	EUV-KK	EL	
1.2 TSI 63 kW (86 PS) CBZA	03.2010→05.2015	 7.22880.01.0	EUV-KK	EL	
1.4 TDI 59 kW (80 PS) BMS	09.2006→03.2010	 7.00868.02.0	DW-TL	EP	
1.6 77 kW (105 PS) BTS, CFNA	09.2006→05.2015	 7.06117.54.0	SV-NWV	EL	
1.6 LPG 77 kW (105 PS) BTS	06.2006→07.2010	 7.06117.54.0	SV-NWV	EL	
1.6 TDI 66 kW (90 PS) CAYB	03.2010→05.2015	 7.02256.00.0	EUV-AGR	EP	
1.6 TDI 77 kW (105 PS) CAYC	03.2010→05.2015	 7.02256.00.0	EUV-AGR	EP	
1.9 TDI 77 kW (105 PS) BLS	09.2006→03.2010	 7.00868.02.0	DW-TL	EP	
		7.02256.00.0	EUV-AGR	EP	









































S



























						
SCALA (NW1)						24
1.0 TGI CNG 66 kW (90 PS) DBYA	11.2019→		7.06117.48.0	SV-NWV	EL	
1.0 TSI 85 kW (115 PS) DKRF	02.2019→		7.06117.48.0	SV-NWV	EL	
1.0 TSI 70 kW (95 PS) DKLA	02.2019→		7.06117.48.0	SV-NWV	EL	
SUPERB I (3U4)						25
1.8 T 110 kW (150 PS) AWT	12.2001→03.2008		7.01805.01.0	EUV-SR	EL	
			7.21895.55.0	LDRV	EL	Fahrgestellnummer ab: 3U-39018402 Vehicle Identification Number from: 3U-39018402
1.9 TDI 96 kW (130 PS) AVF, AWX	12.2001→03.2008		7.02183.01.0	DW-AGR	EP	
			7.02184.01.0	DW-TL	EP	
1.9 TDI 74 kW (101 PS) AVB	08.2002→10.2005		7.02183.01.0	DW-AGR	EP	
			7.02184.01.0	DW-TL	EP	
			7.21903.70.0	DW-TL	EP	für OE-Nummer: 1H0 906 627 für OE number: 1H0 906 627
1.9 TDI 77 kW (105 PS) BSV	10.2005→05.2007		7.02183.01.0	DW-AGR	EP	
			7.22903.28.0	DW-TL	EP	
1.9 TDI 85 kW (115 PS) BPZ	01.2007→03.2008		7.02183.01.0	DW-AGR	EP	
			7.22903.28.0	DW-TL	EP	
2.0 85 kW (115 PS) AZM	12.2001→03.2008		7.22880.01.0	EUV-SR	EL	
2.0 TDI 103 kW (140 PS) BSS	10.2005→03.2008		7.02183.01.0	DW-AGR	EP	
			7.02184.01.0	DW-TL	EP	
2.5 TDI 114 kW (155 PS) AYM	12.2001→08.2003		7.22903.34.0	DW-AGR	EP	Fahrgestellnummer ab: 3U-29007 041 Vehicle Identification Number from: 3U-29007 041
			7.00868.02.0	DW-TL	EP	
2.5 TDI 120 kW (163 PS) BDG	06.2003→03.2008		7.22903.34.0	DW-AGR	EP	Fahrgestellnummer ab: 3U-29007 041 Vehicle Identification Number from: 3U-29007 041
			7.00868.02.0	DW-TL	EP	
2.8 V6 142 kW (193 PS) AMX	12.2001→03.2008		7.01805.01.0	EUV-SR	EL	
2.8 V6 140 kW (190 PS) BBG	06.2002→03.2008		7.01805.01.0	EUV-SR	EL	
SUPERB II (3T4)						26
1.4 TSI 92 kW (125 PS) CAXC	07.2008→05.2015		7.00470.07.0	LDRV	EL	 ch. 3T-8-000 001→
			7.01830.13.0	SUV	EL	
			7.02256.40.0	SV-KK	EL	 ch. 3T-8-000 001→ für Fahrzeuge mit Standheizung for vehicles with parking heater
1.6 TDI 77 kW (105 PS) CAYC	09.2010→05.2015		7.02256.00.0	EUV-AGR	EP	 ch. 3T-8-000 001→
			7.02256.40.0	SV-KK	EL	 ch. 3T-8-000 001→ für Fahrzeuge mit Standheizung for vehicles with parking heater
1.8 TSI 118 kW (160 PS) BZB	03.2008→05.2015		7.00470.07.0	LDRV	EL	 ch. 3T-8-000 001→



SUPERB II (3T4) **26**

			7.00415.07.0	SUV	EL	Fahrgestellnummer ab: 3T-8-000 001 Vehicle Identification Number from: 3T-8-000 001 Produktionsdatum bis: 30.10.2008 Production date to: 30.10.2008
			7.01830.13.0	SUV	EL	
			7.02256.40.0	SV-KK	EL	 ch. 3T-8-000 001→ für Fahrzeuge mit Standheizung for vehicles with parking heater
			7.06117.26.0	ZM-NWV	EL	Fahrgestellnummer ab: 3T-8-000 001 Vehicle Identification Number from: 3T-8-000 001
1.8 TSI 118 kW (160 PS) CDAA	03.2008→05.2015		7.22880.01.0	EUV-SR	EL	Fahrgestellnummer ab: 3T-8-000 001 Vehicle Identification Number from: 3T-8-000 001
			7.00470.07.0	LDRV	EL	 ch. 3T-8-000 001→
			7.01830.13.0	SUV	EL	
			7.02256.40.0	SV-KK	EL	 ch. 3T-8-000 001→ für Fahrzeuge mit Standheizung for vehicles with parking heater
			7.06117.26.0	ZM-NWV	EL	Fahrgestellnummer ab: 3T-8-000 001 Vehicle Identification Number from: 3T-8-000 001
1.8 TSI 112 kW (152 PS) CDAB	03.2009→05.2015		7.22880.01.0	EUV-SR	EL	Fahrgestellnummer ab: 3T-8-000 001 Vehicle Identification Number from: 3T-8-000 001
			7.00470.07.0	LDRV	EL	 ch. 3T-8-000 001→
			7.01830.13.0	SUV	EL	
			7.02256.40.0	SV-KK	EL	 ch. 3T-8-000 001→ für Fahrzeuge mit Standheizung for vehicles with parking heater
			7.06117.26.0	ZM-NWV	EL	Fahrgestellnummer ab: 3T-8-000 001 Vehicle Identification Number from: 3T-8-000 001
1.8 TSI 4x4 118 kW (160 PS) CDAA	11.2008→05.2015		7.22880.01.0	EUV-SR	EL	Fahrgestellnummer ab: 3T-8-000 001 Vehicle Identification Number from: 3T-8-000 001
			7.00470.07.0	LDRV	EL	 ch. 3T-8-000 001→
			7.01830.13.0	SUV	EL	
			7.02256.40.0	SV-KK	EL	 ch. 3T-8-000 001→ für Fahrzeuge mit Standheizung for vehicles with parking heater
			7.06117.26.0	ZM-NWV	EL	Fahrgestellnummer ab: 3T-8-000 001 Vehicle Identification Number from: 3T-8-000 001
1.8 TSI 4x4 112 kW (152 PS) CDAB	03.2009→05.2015		7.22880.01.0	EUV-SR	EL	Fahrgestellnummer ab: 3T-8-000 001 Vehicle Identification Number from: 3T-8-000 001
			7.00470.07.0	LDRV	EL	 ch. 3T-8-000 001→
			7.01830.13.0	SUV	EL	
			7.02256.40.0	SV-KK	EL	 ch. 3T-8-000 001→ für Fahrzeuge mit Standheizung for vehicles with parking heater
			7.06117.26.0	ZM-NWV	EL	Fahrgestellnummer ab: 3T-8-000 001 Vehicle Identification Number from: 3T-8-000 001
1.9 TDI 77 kW (105 PS) BLS	03.2008→11.2010		7.02183.01.0	DW-AGR	EP	
			7.00868.02.0	DW-TL	EP	 ch. 3T-8-000 001→
			7.02256.00.0	EUV-AGR	EP	 ch. 3T-8-000 001→
			7.02256.40.0	SV-KK	EL	 ch. 3T-8-000 001→ für Fahrzeuge mit Standheizung for vehicles with parking heater

					
SUPERB II (3T4)					
26					
1.9 TDI 77 kW (105 PS) BXE	03.2008→11.2010		7.02183.01.0	DW-AGR	EP
			7.02256.40.0	SV-KK	EL  ch. 3T-8-000 001→ für Fahrzeuge mit Standheizung for vehicles with parking heater
2.0 TDI 103 kW (140 PS) BMP	03.2008→05.2010		7.00868.02.0	DW-TL	EP  ch. 3T-8-000 001→
			7.02256.00.0	EUV-AGR	EP  ch. 3T-8-000 001→
			7.02256.40.0	SV-KK	EL
2.0 TDI 125 kW (170 PS) CBBB	07.2008→05.2015		7.00868.02.0	DW-TL	EP  ch. 3T-8-000 001→
			7.02256.00.0	EUV-AGR	EP  ch. 3T-8-000 001→
			7.02256.40.0	SV-KK	EL  ch. 3T-8-000 001→ für Fahrzeuge mit Standheizung for vehicles with parking heater
2.0 TDI 125 kW (170 PS) CFGB	07.2008→05.2015		7.02256.00.0	EUV-AGR	EP  ch. 3T-8-000 001→
			7.02256.40.0	SV-KK	EL  ch. 3T-8-000 001→ für Fahrzeuge mit Standheizung for vehicles with parking heater
2.0 TDI 16V 103 kW (140 PS) BKD	01.2009→05.2015		7.02256.40.0	SV-KK	EL  ch. 3T-8-000 001→ für Fahrzeuge mit Standheizung for vehicles with parking heater
			7.02256.00.0	EUV-AGR	EP  CFFB, CLJA:  ch. 3T-8-000 001→
2.0 TDI 16V 103 kW (140 PS) CFFB, CLJA	01.2009→05.2015		7.02256.40.0	SV-KK	EL  CFFB, CLJA:  ch. 3T-8-000 001→ für Fahrzeuge mit Standheizung for vehicles with parking heater
			7.02256.00.0	EUV-AGR	EP  ch. 3T-8-000 001→
2.0 TDI 16V 4x4 103 kW (140 PS) CFFB	11.2010→05.2015		7.02256.00.0	EUV-AGR	EP  ch. 3T-8-000 001→
			7.02256.40.0	SV-KK	EL  ch. 3T-8-000 001→ für Fahrzeuge mit Standheizung for vehicles with parking heater
2.0 TDI 4x4 125 kW (170 PS) CBBB	09.2008→05.2015		7.00868.02.0	DW-TL	EP  ch. 3T-8-000 001→
			7.02256.00.0	EUV-AGR	EP  ch. 3T-8-000 001→
			7.02256.40.0	SV-KK	EL  ch. 3T-8-000 001→ für Fahrzeuge mit Standheizung for vehicles with parking heater
2.0 TDI 4x4 125 kW (170 PS) CFGB	09.2008→05.2015		7.02256.00.0	EUV-AGR	EP  ch. 3T-8-000 001→
			7.02256.40.0	SV-KK	EL  ch. 3T-8-000 001→ für Fahrzeuge mit Standheizung for vehicles with parking heater
2.0 TSI 147 kW (200 PS) CCZA	05.2010→05.2015		7.22880.01.0	EUV-SR	EL Fahrgestellnummer ab: 3T-8-000 001 Vehicle Identification Number from: 3T-8-000 001
			7.00470.07.0	LDRV	EL  ch. 3T-8-000 001→
			7.02901.05.0	SUV	EL 05.2011→,  ch. 3T-8-000 001→
			7.00415.07.0	SUV	EL Fahrgestellnummer ab: 3T-8-000 001 Vehicle Identification Number from: 3T-8-000 001 Produktionsdatum bis: 16.05.2011 Production date to: 16.05.2011
			7.02256.40.0	SV-KK	EL  ch. 3T-8-000 001→ für Fahrzeuge mit Standheizung for vehicles with parking heater
			7.06117.26.0	ZM-NWV	EL Fahrgestellnummer ab: 3T-8-000 001 Vehicle Identification Number from: 3T-8-000 001

			 PIERBURG		
SUPERB II (3T4)					26
3.6 FSI 4x4 191 kW (260 PS) CDVA	11.2008→05.2015		7.02256.40.0	SV-KK	EL  ch. 3T-8-000 001→ für Fahrzeuge mit Standheizung for vehicles with parking heater
			7.06117.37.0	SV-NWV	EL Fahrgestellnummer ab: 3T-8-000 001 Vehicle Identification Number from: 3T-8-000 001
SUPERB II Estate (3T5)					27
1.4 TSI 92 kW (125 PS) CAXC	10.2009→05.2015		7.00470.07.0	LDRV	EL  ch. 3T-8-000 001→
			7.01830.13.0	SUV	EL
			7.02256.40.0	SV-KK	EL  ch. 3T-8-000 001→ für Fahrzeuge mit Standheizung for vehicles with parking heater
1.6 TDI 77 kW (105 PS) CAYC	09.2010→05.2015		7.02256.00.0	EUV-AGR	EP  ch. 3T-8-000 001→
			7.02256.40.0	SV-KK	EL  ch. 3T-8-000 001→ für Fahrzeuge mit Standheizung for vehicles with parking heater
1.8 TSI 112 kW (152 PS) CDAB	10.2009→05.2015		7.22880.01.0	EUV-SR	EL Fahrgestellnummer ab: 3T-8-000 001 Vehicle Identification Number from: 3T-8-000 001
			7.00470.07.0	LDRV	EL  ch. 3T-8-000 001→
			7.01830.13.0	SUV	EL
			7.02256.40.0	SV-KK	EL  ch. 3T-8-000 001→ für Fahrzeuge mit Standheizung for vehicles with parking heater
			7.06117.26.0	ZM-NWV	EL Fahrgestellnummer ab: 3T-8-000 001 Vehicle Identification Number from: 3T-8-000 001
1.8 TSI 118 kW (160 PS) CDAA	10.2009→05.2015		7.22880.01.0	EUV-SR	EL Fahrgestellnummer ab: 3T-8-000 001 Vehicle Identification Number from: 3T-8-000 001
			7.00470.07.0	LDRV	EL  ch. 3T-8-000 001→
			7.01830.13.0	SUV	EL
			7.02256.40.0	SV-KK	EL  ch. 3T-8-000 001→ für Fahrzeuge mit Standheizung for vehicles with parking heater
			7.06117.26.0	ZM-NWV	EL Fahrgestellnummer ab: 3T-8-000 001 Vehicle Identification Number from: 3T-8-000 001
1.8 TSI 4x4 112 kW (152 PS) CDAB	10.2009→05.2015		7.22880.01.0	EUV-SR	EL Fahrgestellnummer ab: 3T-8-000 001 Vehicle Identification Number from: 3T-8-000 001
			7.00470.07.0	LDRV	EL  ch. 3T-8-000 001→
			7.01830.13.0	SUV	EL
			7.02256.40.0	SV-KK	EL  ch. 3T-8-000 001→ für Fahrzeuge mit Standheizung for vehicles with parking heater
			7.06117.26.0	ZM-NWV	EL Fahrgestellnummer ab: 3T-8-000 001 Vehicle Identification Number from: 3T-8-000 001
1.8 TSI 4x4 118 kW (160 PS) CDAA	10.2009→05.2015		7.22880.01.0	EUV-SR	EL Fahrgestellnummer ab: 3T-8-000 001 Vehicle Identification Number from: 3T-8-000 001
			7.00470.07.0	LDRV	EL  ch. 3T-8-000 001→
			7.01830.13.0	SUV	EL
			7.02256.40.0	SV-KK	EL  ch. 3T-8-000 001→ für Fahrzeuge mit Standheizung for vehicles with parking heater
			7.06117.26.0	ZM-NWV	EL Fahrgestellnummer ab: 3T-8-000 001 Vehicle Identification Number from: 3T-8-000 001



S

					
SUPERB II Estate (3T5)					
1.9 TDI 77 kW (105 PS) BLS	10.2009→11.2010		7.02183.01.0	DW-AGR	EP
			7.00868.02.0	DW-TL	EP
			7.02256.00.0	EUV-AGR	EP
			7.02256.40.0	SV-KK	EL
 ch. 3T-8-000-001→  ch. 3T-8-000 001→  ch. 3T-8-000 001→ für Fahrzeuge mit Standheizung for vehicles with parking heater					
1.9 TDI 77 kW (105 PS) BXE	10.2009→11.2010		7.02183.01.0	DW-AGR	EP
			7.02256.40.0	SV-KK	EL
 ch. 3T-8-000 001→ für Fahrzeuge mit Standheizung for vehicles with parking heater					
2.0 TDI 125 kW (170 PS) CBBB	10.2009→05.2015		7.00868.02.0	DW-TL	EP
			7.02256.00.0	EUV-AGR	EP
			7.02256.40.0	SV-KK	EL
 ch. 3T-8-000 001→  ch. 3T-8-000 001→  ch. 3T-8-000 001→ für Fahrzeuge mit Standheizung for vehicles with parking heater					
2.0 TDI 125 kW (170 PS) CFGB	10.2009→05.2015		7.02256.00.0	EUV-AGR	EP
			7.02256.40.0	SV-KK	EL
 ch. 3T-8-000 001→  ch. 3T-8-000 001→ für Fahrzeuge mit Standheizung for vehicles with parking heater					
2.0 TDI 103 kW (140 PS) BMP	10.2009→03.2010		7.00868.02.0	DW-TL	EP
			7.02256.00.0	EUV-AGR	EP
 ch. 3T-8-000 001→					
2.0 TDI 16V 103 kW (140 PS) BKD	10.2009→05.2015		7.02256.40.0	SV-KK	EL
 ch. 3T-8-000 001→ für Fahrzeuge mit Standheizung for vehicles with parking heater					
2.0 TDI 16V 103 kW (140 PS) CFFB, CLJA	10.2009→05.2015		7.02256.00.0	EUV-AGR	EP
			7.02256.40.0	SV-KK	EL
 CFFB, CLJA:  ch. 3T-8-000 001→  CFFB, CLJA:  ch. 3T-8-000 001→ für Fahrzeuge mit Standheizung for vehicles with parking heater					
2.0 TDI 16V 4x4 103 kW (140 PS) CFFB	11.2010→05.2015		7.02256.00.0	EUV-AGR	EP
			7.02256.40.0	SV-KK	EL
 ch. 3T-8-000 001→  ch. 3T-8-000 001→ für Fahrzeuge mit Standheizung for vehicles with parking heater					
2.0 TDI 4x4 125 kW (170 PS) CBBB	10.2009→05.2015		7.00868.02.0	DW-TL	EP
			7.02256.00.0	EUV-AGR	EP
			7.02256.40.0	SV-KK	EL
 ch. 3T-8-000 001→  ch. 3T-8-000 001→  ch. 3T-8-000 001→ für Fahrzeuge mit Standheizung for vehicles with parking heater					
2.0 TDI 4x4 125 kW (170 PS) CFGB	10.2009→05.2015		7.02256.00.0	EUV-AGR	EP
			7.02256.40.0	SV-KK	EL
 ch. 3T-8-000 001→  ch. 3T-8-000 001→ für Fahrzeuge mit Standheizung for vehicles with parking heater					
2.0 TSI 147 kW (200 PS) CCZA	05.2010→05.2015		7.22880.01.0	EUV-SR	EL
			7.00470.07.0	LDRV	EL
			7.02901.05.0	SUV	EL
			7.00415.07.0	SUV	EL
Fahrgestellnummer ab: 3T-8-000 001 Vehicle Identification Number from: 3T-8-000 001  ch. 3T-8-000 001→ 05.2011→,  ch. 3T-8-000 001→ Fahrgestellnummer ab: 3T-8-000 001 Vehicle Identification Number from: 3T-8-000 001 Produktionsdatum bis: 16.05.2011 Production date to: 16.05.2011					











S



SUPERB II Estate (3T5) 27



















			7.02256.40.0	SV-KK	EL  ch. 3T-8-000 001→ für Fahrzeuge mit Standheizung for vehicles with parking heater
			7.06117.26.0	ZM-NWV	EL Fahrgestellnummer ab: 3T-8-000 001 Vehicle Identification Number from: 3T-8-000 001
3.6 V6 4x4 191 kW (260 PS) CDVA	10.2009→05.2015		7.02256.40.0	SV-KK	EL  ch. 3T-8-000 001→ für Fahrzeuge mit Standheizung for vehicles with parking heater
			7.06117.37.0	SV-NWV	EL Fahrgestellnummer ab: 3T-8-000 001 Vehicle Identification Number from: 3T-8-000 001























SUPERB III (3V3) 28













1.4 TSI 92 kW (125 PS) CZCA	03.2015→		7.06117.48.0	SV-NWV	EL Fahrgestellnummer ab: NP-F7000 001 Vehicle Identification Number from: NP-F7000 001
1.4 TSI 110 kW (150 PS) CZDA, CZEA	03.2015→		7.06117.48.0	SV-NWV	EL  CZDA, CZEA: Fahrgestellnummer ab: NP-F7000 001 Vehicle Identification Number from: NP-F7000 001
1.4 TSI 4x4 110 kW (150 PS) CZEA	03.2015→		7.06117.48.0	SV-NWV	EL Fahrgestellnummer ab: NP-F7000 001 Vehicle Identification Number from: NP-F7000 001
1.4 TSI iV 115 kW (156 PS) DGEB	08.2019→		7.06117.48.0	SV-NWV	EL Fahrgestellnummer ab: NP-F7000 001 Vehicle Identification Number from: NP-F7000 001
1.8 TSI 132 kW (180 PS) CJSA	03.2015→		7.03280.04.0	EUV-SR	EL Fahrgestellnummer ab: NP-F7000 001 Vehicle Identification Number from: NP-F7000 001
			7.02901.05.0	SUV	EL
			7.06117.26.0	ZM-NWV	EL Fahrgestellnummer ab: NP-F7000 001 Vehicle Identification Number from: NP-F7000 001
1.8 TSI 132 kW (180 PS) CJSC	03.2015→		7.03280.04.0	EUV-SR	EL Fahrgestellnummer ab: NP-F7000 001 Vehicle Identification Number from: NP-F7000 001
			7.06117.26.0	ZM-NWV	EL Fahrgestellnummer ab: NP-F7000 001 Vehicle Identification Number from: NP-F7000 001
2.0 TSI 162 kW (220 PS) CHHB	03.2015→		7.02901.05.0	SUV	EL
			7.06117.26.0	ZM-NWV	EL Fahrgestellnummer ab: NP-F7000 001 Vehicle Identification Number from: NP-F7000 001
2.0 TSI 4x4 206 kW (280 PS) CJXA	03.2015→		7.06117.26.0	ZM-NWV	EL Fahrgestellnummer ab: NP-F7000 001 Vehicle Identification Number from: NP-F7000 001
2.0 TSI 4x4 200 kW (272 PS) DNUA	03.2015→		7.06117.26.0	ZM-NWV	EL Fahrgestellnummer ab: NP-F7000 001 Vehicle Identification Number from: NP-F7000 001

SUPERB III Estate (3V5) 29

1.4 TSI 92 kW (125 PS) CZCA	03.2015→		7.06117.48.0	SV-NWV	EL Fahrgestellnummer ab: NP-F7000 001 Vehicle Identification Number from: NP-F7000 001
1.4 TSI 110 kW (150 PS) CZDA, CZEA	03.2015→		7.06117.48.0	SV-NWV	EL  CZDA, CZEA: Fahrgestellnummer ab: NP-F7000 001 Vehicle Identification Number from: NP-F7000 001
1.4 TSI 4x4 110 kW (150 PS) CZEA	03.2015→		7.06117.48.0	SV-NWV	EL Fahrgestellnummer ab: NP-F7000 001 Vehicle Identification Number from: NP-F7000 001
1.4 TSI iV 115 kW (156 PS) DGEB	08.2019→		7.06117.48.0	SV-NWV	EL Fahrgestellnummer ab: NP-F7000 001 Vehicle Identification Number from: NP-F7000 001

						
SUPERB III Estate (3V5)						29
1.8 TSI 132 kW (180 PS) CJSA	03.2015→		7.03280.04.0	EUV-SR	EL	Fahrgestellnummer ab: NP-F7000 001 Vehicle Identification Number from: NP-F7000 001
			7.02901.05.0	SUV	EL	
			7.06117.26.0	ZM-NWV	EL	Fahrgestellnummer ab: NP-F7000 001 Vehicle Identification Number from: NP-F7000 001
1.8 TSI 132 kW (180 PS) CJSC	03.2015→		7.03280.04.0	EUV-SR	EL	Fahrgestellnummer ab: NP-F7000 001 Vehicle Identification Number from: NP-F7000 001
			7.06117.26.0	ZM-NWV	EL	Fahrgestellnummer ab: NP-F7000 001 Vehicle Identification Number from: NP-F7000 001
2.0 TSI 162 kW (220 PS) CHHB	03.2015→		7.02901.05.0	SUV	EL	
			7.06117.26.0	ZM-NWV	EL	Fahrgestellnummer ab: NP-F7000 001 Vehicle Identification Number from: NP-F7000 001
2.0 TSI 4x4 206 kW (280 PS) CJXA	03.2015→		7.06117.26.0	ZM-NWV	EL	Fahrgestellnummer ab: NP-F7000 001 Vehicle Identification Number from: NP-F7000 001
2.0 TSI 4x4 200 kW (272 PS) DNUA	03.2015→		7.06117.26.0	ZM-NWV	EL	Fahrgestellnummer ab: NP-F7000 001 Vehicle Identification Number from: NP-F7000 001
YETI (5L)						30
1.2 TSI 77 kW (105 PS) CBZB	09.2009→05.2015		7.22880.01.0	EUV-KK	EL	
			7.02256.40.0	SV-KK	EL	für Fahrzeuge mit Standheizung for vehicles with parking heater
1.4 TSI 90 kW (122 PS) CAXA	06.2010→05.2015		7.00470.07.0	LDRV	EL	
			7.01830.13.0	SUV	EL	
			7.02256.40.0	SV-KK	EL	für Fahrzeuge mit Standheizung for vehicles with parking heater
			7.06117.54.0	SV-NWV	EL	
1.4 TSI 92 kW (125 PS) CZCA	05.2015→12.2017		7.06117.48.0	SV-NWV	EL	
1.6 81 kW (110 PS) CWVA	04.2014→12.2017		7.02256.40.0	SV-KK	EL	für Fahrzeuge mit Standheizung for vehicles with parking heater
1.6 TDI 77 kW (105 PS) CAYC	11.2010→05.2015		7.02256.00.0	EUV-AGR	EP	
			7.02256.40.0	SV-KK	EL	für Fahrzeuge mit Standheizung for vehicles with parking heater
1.8 TSI 4x4 118 kW (160 PS) CDA A	05.2009→12.2017		7.03280.04.0	EUV-SR	EL	Produktionsdatum ab: 29.08.2016 Production date from: 29.08.2016
			7.22880.01.0	EUV-SR	EL	
			7.00470.07.0	LDRV	EL	
			7.01830.13.0	SUV	EL	
			7.02256.40.0	SV-KK	EL	für Fahrzeuge mit Standheizung for vehicles with parking heater
			7.06117.26.0	ZM-NWV	EL	
1.8 TSI 4x4 112 kW (152 PS) CDAB	11.2009→12.2017		7.03280.04.0	EUV-SR	EL	Produktionsdatum ab: 29.08.2016 Production date from: 29.08.2016
			7.22880.01.0	EUV-SR	EL	
			7.00470.07.0	LDRV	EL	
			7.01830.13.0	SUV	EL	
			7.02256.40.0	SV-KK	EL	für Fahrzeuge mit Standheizung for vehicles with parking heater
			7.06117.26.0	ZM-NWV	EL	
2.0 TDI 81 kW (110 PS) CFHA, CLCA	11.2009→12.2017		7.02256.00.0	EUV-AGR	EP	

					
YETI (5L)					30
			7.02256.40.0	SV-KK	EL  CFHA, CLCA: für Fahrzeuge mit Standheizung for vehicles with parking heater
2.0 TDI 103 kW (140 PS) CFHC	11.2011→12.2017		7.02256.00.0	EUV-AGR	EP
			7.02256.40.0	SV-KK	EL für Fahrzeuge mit Standheizung for vehicles with parking heater
2.0 TDI 4x4 103 kW (140 PS) CBDB	05.2009→12.2017		7.00868.02.0	DW-TL	EP
			7.02256.00.0	EUV-AGR	EP
			7.02256.40.0	SV-KK	EL für Fahrzeuge mit Standheizung for vehicles with parking heater
2.0 TDI 4x4 103 kW (140 PS) CFHC, CLCB	05.2009→12.2017		7.02256.00.0	EUV-AGR	EP
			7.02256.40.0	SV-KK	EL  CFHC, CLCB: für Fahrzeuge mit Standheizung for vehicles with parking heater
2.0 TDI 4x4 81 kW (110 PS) CFHF	11.2009→12.2017		7.02256.00.0	EUV-AGR	EP
			7.02256.40.0	SV-KK	EL für Fahrzeuge mit Standheizung for vehicles with parking heater
2.0 TDI 4x4 125 kW (170 PS) CEGA	11.2009→05.2015		7.00868.02.0	DW-TL	EP
			7.02256.00.0	EUV-AGR	EP
			7.02256.40.0	SV-KK	EL für Fahrzeuge mit Standheizung for vehicles with parking heater
2.0 TDI 4x4 125 kW (170 PS) CFJA	11.2009→05.2015		7.02256.00.0	EUV-AGR	EP
			7.02256.40.0	SV-KK	EL für Fahrzeuge mit Standheizung for vehicles with parking heater
FABIA I Praktik (6Y5)					31
1.9 SDI 47 kW (64 PS) ASY	05.2003→12.2007		7.02183.01.0	DW-AGR	EP
1.9 TDI 74 kW (100 PS) ATD	01.2000→12.2007		7.02184.01.0	DW-TL	EP
OCTAVIA I Estate Van (1U5)					32
1.9 D 50 kW (68 PS) AQM	08.2000→12.2003		7.02183.01.0	DW-AGR	EP
1.9 TDI 66 kW (90 PS) ALH	08.2000→03.2010		7.02183.01.0	DW-AGR	EP
			7.02184.01.0	DW-TL	EP
S ROOMSTER Praktik (5J)					33
1.2 TDI 55 kW (75 PS) CFWA	03.2010→05.2015		7.22880.01.0	EUV-AGR	EL
1.2 TSI 63 kW (86 PS) CBZA	03.2010→05.2015		7.22880.01.0	EUV-KK	EL
1.4 TDI 59 kW (80 PS) BMS	03.2007→03.2010		7.00868.02.0	DW-TL	EP
1.6 TDI 66 kW (90 PS) CAYB	03.2010→05.2015		7.02256.00.0	EUV-AGR	EP

					
OCTAVIA Hatchback (913)					
1					
1.4 TSi 96 kW (131 PS) CFBA	04.2010→12.2014		7.02901.05.0	SUV	EL
1.8 TSI 118 kW (160 PS) BYJ	06.2007→03.2014		7.06117.26.0	ZM-NWV	EL
2.0 TSI 147 kW (200 PS) CGMA	04.2010→12.2013		7.22880.01.0	EUV-AGK	EL
			7.22880.01.0	EUV-AGR	EL
			7.22880.01.0	EUV-KK	EL
			7.22880.01.0	EUV-LS	EL
			7.22880.01.0	EUV-ML	EL
			7.22880.01.0	EUV-SL	EL
			7.22880.01.0	EUV-SR	EL
			7.02901.05.0	SUV	EL
SUPERB (374)					
2					
1.4 TSi 96 kW (131 PS) CFBA	04.2010→01.2015		7.02901.05.0	SUV	EL
1.8 TSI 118 kW (160 PS) CEAA	08.2009→12.2015		7.22880.01.0	EUV-AGK	EL
			7.22880.01.0	EUV-AGR	EL
			7.22880.01.0	EUV-KK	EL
			7.22880.01.0	EUV-LS	EL
			7.22880.01.0	EUV-ML	EL
			7.22880.01.0	EUV-SL	EL
			7.22880.01.0	EUV-SR	EL
			7.02901.05.0	SUV	EL
2.0 TSI 147 kW (200 PS) CGMA	08.2009→12.2013		7.22880.01.0	EUV-AGK	EL
			7.22880.01.0	EUV-AGR	EL
			7.22880.01.0	EUV-KK	EL
			7.22880.01.0	EUV-LS	EL
			7.22880.01.0	EUV-ML	EL
			7.22880.01.0	EUV-SL	EL
			7.22880.01.0	EUV-SR	EL
			7.02901.05.0	SUV	EL
YETI (0Y6, 0Y7)					
3					
1.8 TSi 4x4 118 kW (160 PS) CEAA	11.2013→		7.22880.01.0	EUV-AGK	EL
			7.22880.01.0	EUV-AGR	EL
			7.22880.01.0	EUV-KK	EL
			7.22880.01.0	EUV-LS	EL
			7.22880.01.0	EUV-ML	EL
			7.22880.01.0	EUV-SL	EL
			7.22880.01.0	EUV-SR	EL
			7.02901.05.0	SUV	EL

S



FORFOUR (454) 1

1.5 CDI (454.000) 50-70 kW (58-95 PS) OM 639.939	09.2004→06.2006		7.00782.04.0	DW-TL	EP	für Fahrzeuge ohne Diesel-Partikel-Filter (DPF) for vehicles without diesel soot filter
1.5 CDI (454.001) 50-70 kW (58-95 PS) OM 639.939	09.2004→06.2006		7.00782.04.0	DW-TL	EP	für Fahrzeuge ohne Diesel-Partikel-Filter (DPF) for vehicles without diesel soot filter

FORFOUR Hatchback (453) 2

0.9 (453.044, 453.053) 61-80 kW (83-109 PS) M 281.910	11.2014→		7.08681.15.0	EOV	EH	
0.9 Brabus (453.062) 61-80 kW (83-109 PS) M 281.910	07.2016→		7.08681.15.0	EOV	EH	
1.0 (453.041) 45-52 kW (60-71 PS) M 281.920	11.2014→		7.08681.15.0	EOV	EH	
1.0 (453.042, 453.043) 45-52 kW (60-71 PS) M 281.920	07.2014→		7.08681.15.0	EOV	EH	

FORTWO Cabrio (451) 3

0.8 CDi (451.400) 33 kW (45 PS) OM 660.950	01.2007→		7.00782.04.0	DW-TL	EP	
0.8 CDi (451.401) 40 kW (54 PS) OM 660.951	08.2009→		7.00782.04.0	DW-TL	EP	
1.0 (451.431, 451.480) 45-52 kW (61-71 PS) M 132.910	01.2007→		7.02256.37.0	EUV-SL	EL	USA, Kanada USA, Kanada
1.0 Brabus (451.433) 62-75 kW (84-102 PS) M 132.930	01.2008→		7.02256.37.0	EUV-SL	EL	USA, Kanada USA, Kanada
1.0 Turbo (451.432) 62-75 kW (84-102 PS) M 132.930	01.2007→		7.02256.37.0	EUV-SL	EL	USA, Kanada USA, Kanada
1.0 Turbo Brabus (451.433) 62-75 kW (84-102 PS) M 132.930	07.2010→		7.02256.37.0	EUV-SL	EL	USA, Kanada USA, Kanada

FORTWO Convertible (453) 4

0.9 (453.444, 453.453) 61-80 kW (83-109 PS) M 281.910	09.2015→		7.08681.15.0	EOV	EH	
			7.02256.37.0	EUV-SL	EL	
0.9 Brabus (453.462) 61-80 kW (83-109 PS) M 281.910	07.2016→		7.08681.15.0	EOV	EH	
1.0 (453.442, 453.443) 45-52 kW (60-71 PS) M 281.920	09.2015→		7.08681.15.0	EOV	EH	

FORTWO Coupe (451) 5

0.8 CDi (451.300) 33 kW (45 PS) OM 660.950	01.2007→		7.00782.04.0	DW-TL	EP	
0.8 CDi (451.301) 40 kW (54 PS) OM 660.951	08.2009→		7.00782.04.0	DW-TL	EP	
1.0 (451.330, 451.334) 45-52 kW (61-71 PS) M 132.910	01.2007→		7.02256.37.0	EUV-SL	EL	USA, Kanada USA, Kanada
1.0 (451.331, 451.380) 45-52 kW (61-71 PS) M 132.910	01.2007→		7.02256.37.0	EUV-SL	EL	USA, Kanada USA, Kanada

S

FORTWO Coupe (451)
5

1.0 Brabus (451.333) 62-75 kW (84-102 PS) M 132.930	01.2008->	 7.02256.37.0	EUV-SL	EL	USA, Kanada USA, Kanada
1.0 Turbo (451.332) 62-75 kW (84-102 PS) M 132.930	01.2007->	 7.02256.37.0	EUV-SL	EL	USA, Kanada USA, Kanada
1.0 Turbo Brabus (451.333) 62-75 kW (84-102 PS) M 132.930	07.2010->	 7.02256.37.0	EUV-SL	EL	USA, Kanada USA, Kanada

FORTWO Coupe (453)
6

0.9 (453.344, 453.353) 61-80 kW (83-109 PS) M 281.910	09.2014->	 7.08681.15.0	EOV	EH	
		 7.02256.37.0	EUV-SL	EL	
0.9 Brabus (453.362) 61-80 kW (83-109 PS) M 281.910	07.2016->	 7.08681.15.0	EOV	EH	
1.0 (453.341) 45-52 kW (60-71 PS) M 281.920	11.2014->	 7.08681.15.0	EOV	EH	
1.0 (453.342, 453.343) 45-52 kW (60-71 PS) M 281.920	07.2014->	 7.08681.15.0	EOV	EH	







KORANDO (KJ) 1

2.0 93-94 kW (126-128 PS) E20	05.1997→10.2002	 7.21071.50.0	EUV-LS	EP	
2.3 103-110 kW (140-150 PS) E23M161	01.1999→11.2006	 7.21071.50.0	EUV-LS	EP	Produktionsdatum bis: 23.09.2005 Production date to: 23.09.2005
2.3 TDiC 4x4 74 kW (101 PS) OM661LA	07.1998→11.2006	 7.21071.50.0	EUV-AGR	EP	Produktionsdatum bis: 28.12.2000 Production date to: 28.12.2000
2.9 TD 88 kW (120 PS) MB-OM 662 LA	04.1998→11.2006	 7.21071.50.0	EUV-AGR	EP	Produktionsdatum bis: 28.12.2000 Production date to: 28.12.2000
3.2 162 kW (220 PS) M 104.992	06.1997→11.2006	 7.21071.50.0	EUV-LS	EP	Produktionsdatum bis: 23.09.2005 Production date to: 23.09.2005
3.2 154-156 kW (209-212 PS) M 104.995	01.1999→02.2000	 7.21071.50.0	EUV-LS	EP	
3.2 (KJ) 154-156 kW (209-212 PS) M 104.995	12.1996→11.2002	 7.21071.50.0	EUV-LS	EP	Produktionsdatum bis: 28.12.2000 Production date to: 28.12.2000

KORANDO Cabrio (KJ) 2

2.3 103-110 kW (140-150 PS) E23M161	11.1997→02.2000	 7.21071.50.0	EUV-LS	EP	
2.3 103-110 kW (140-150 PS) E23M161	02.1999→11.2006	 7.21071.50.0	EUV-LS	EP	Produktionsdatum bis: 23.09.2005 Production date to: 23.09.2005
2.9 TD 88-108 kW (120-147 PS) OM662LA	04.1998→02.2000	 7.21071.50.0	EUV-AGR	EP	
3.2 162 kW (220 PS) M 104.992	06.1997→11.2006	 7.21071.50.0	EUV-LS	EP	Produktionsdatum bis: 23.09.2005 Production date to: 23.09.2005
3.2 154-156 kW (209-212 PS) M 104.995	01.1999→11.2002	 7.21071.50.0	EUV-LS	EP	
3.2 4x4 154-162 kW (209-220 PS) M162E32	06.1997→11.2002	 7.21071.50.0	EUV-LS	EP	





















MUSSO (FJ) 3

2.0 93-94 kW (126-128 PS) E20	10.1996→05.2005	 7.21071.50.0	EUV-LS	EP	Produktionsdatum bis: 19.11.2000 Production date to: 19.11.2000
2.3 TDiC All-wheel Drive 74 kW (101 PS) OM661LA	05.1997→10.2003	 7.21071.50.0	EUV-AGR	EP	Produktionsdatum bis: 20.11.2000 Production date to: 20.11.2000
2.9 TD 88-108 kW (120-147 PS) OM662LA	04.1998→12.2005	 7.21071.50.0	EUV-AGR	EP	Produktionsdatum bis: 20.11.2000 Production date to: 20.11.2000
2.9 TD 88-108 kW (120-147 PS) OM662LA	04.1998→09.2007	 7.21071.50.0	EUV-AGR	EP	Produktionsdatum bis: 20.11.2000 Production date to: 20.11.2000
3.2 162 kW (220 PS) M 104.992	06.1996→09.2004	 7.21071.50.0	EUV-LS	EP	





















S































						
BRZ						1
2.0 147 kW (200 PS) FA20D	06.2012→		7.06117.41.0	ZM-NWV	EL	mit Dichtring with O-ring Produktionsdatum bis: 22.02.2015 Production date to: 22.02.2015
FORESTER (SJ_)						2
2.0 BiFuel AWD (S13, SJ5) 110-114 kW (150-155 PS) FB20B	03.2013→		7.06117.41.0	ZM-NWV	EL	mit Dichtring with O-ring
2.0 XT AWD 177-200 kW (253-272 PS) FA20F	03.2013→		7.06117.41.0	ZM-NWV	EL	mit Dichtring with O-ring Produktionsdatum bis: 22.02.2015 Production date to: 22.02.2015
2.0 XT AWD (SJG) 177-221 kW (240-300 PS) FA20	03.2013→		7.06117.41.0	ZM-NWV	EL	mit Dichtring with O-ring Produktionsdatum bis: 22.02.2015 Production date to: 22.02.2015
2.0 i AWD 110-120 kW (150-163 PS) FB20	03.2013→		7.06117.41.0	ZM-NWV	EL	mit Dichtring with O-ring
2.5 AWD (SJ9) 125-130 kW (170-177 PS) FB25	11.2012→		7.06117.41.0	ZM-NWV	EL	mit Dichtring with O-ring
IMPREZA Hatchback (GP_)						3
1.6 i AWD 84 kW (114 PS) FB16B	06.2012→		7.06117.41.0	ZM-NWV	EL	mit Dichtring with O-ring
2.0 AWD (GP7) 110-120 kW (150-163 PS) FB20	01.2012→		7.06117.41.0	ZM-NWV	EL	mit Dichtring with O-ring
IMPREZA Hatchback (GT_)						4
1.6 i (GT3) 84-85 kW (114-116 PS) FB16A	07.2017→		7.06117.41.0	ZM-NWV	EL	mit Dichtring with O-ring
2.0 i AWD (GT7) 107-120 kW (145-163 PS) FB20C	10.2016→		7.06117.41.0	ZM-NWV	EL	mit Dichtring with O-ring
IMPREZA Saloon (GJ_)						5
1.6 AWD 84-85 kW (114-116 PS) FB16A, FB16B	06.2012→09.2016		7.06117.41.0	ZM-NWV	EL	mit Dichtring with O-ring
2.0 AWD (GJ7) 110-114 kW (150-155 PS) FB20B	07.2011→		7.06117.41.0	ZM-NWV	EL	mit Dichtring with O-ring
LEGACY V (BM)						6
2.5 i AWD (BMM) 125-130 kW (170-177 PS) FB25, FB25A, FB25B	07.2012→12.2014		7.06117.41.0	ZM-NWV	EL	mit Dichtring with O-ring
LEGACY V Estate (BR)						7
2.5 CNG AWD 127 kW (173 PS) FB25B	04.2013→12.2014		7.06117.41.0	ZM-NWV	EL	mit Dichtring with O-ring
2.5 i AWD (BRM) 125-130 kW (170-177 PS) FB25	07.2012→12.2014		7.06117.41.0	ZM-NWV	EL	mit Dichtring with O-ring
LEGACY VI (BN, BS)						8
2.0 DIT AWD 177-221 kW (240-300 PS) FA20	11.2015→		7.06117.41.0	ZM-NWV	EL	mit Dichtring with O-ring Produktionsdatum bis: 22.02.2015 Production date to: 22.02.2015
2.5 i AWD (BN9) 125-130 kW (170-177 PS) FB25	01.2015→		7.06117.41.0	ZM-NWV	EL	mit Dichtring with O-ring

S

						
LEVORG						9
2.0 AWD 177-221 kW (240-300 PS) FA20	03.2015→		7.06117.41.0	ZM-NWV	EL mit Dichtring with O-ring Produktionsdatum bis: 22.02.2015 Production date to: 22.02.2015	
2.0 AWD 177-221 kW (240-300 PS) FA20	05.2016→		7.06117.41.0	ZM-NWV	EL mit Dichtring with O-ring Produktionsdatum bis: 22.02.2015 Production date to: 22.02.2015	
OUTBACK (BR)						10
2.5 BiFuel AWD 127 kW (173 PS) FB25B	01.2013→12.2014		7.06117.41.0	ZM-NWV	EL mit Dichtring with O-ring	
2.5 CNG AWD 127 kW (173 PS) FB25B	06.2014→12.2014		7.06117.41.0	ZM-NWV	EL mit Dichtring with O-ring	
2.5 i AWD 127 kW (173 PS) FB25B	01.2013→		7.06117.41.0	ZM-NWV	EL mit Dichtring with O-ring	
OUTBACK (BS)						11
2.5 AWD 127 kW (173 PS) FB25A	10.2014→		7.06117.41.0	ZM-NWV	EL mit Dichtring with O-ring	
2.5 AWD (BS9) 125-130 kW (170-177 PS) FB25	03.2015→		7.06117.41.0	ZM-NWV	EL mit Dichtring with O-ring	
WRX Saloon (GJ)						12
2.0 AWD (GK6, GK8) 177-200 kW (253-272 PS) FA20E, FA20F	09.2013→		7.06117.41.0	ZM-NWV	EL mit Dichtring with O-ring  FA20E, FA20F: Produktionsdatum bis: 22.02.2015 Production date to: 22.02.2015	
XV (GT)						13
1.6 i AWD (GT3) 84-85 kW (114-116 PS) FB16A	08.2017→		7.06117.41.0	ZM-NWV	EL mit Dichtring with O-ring	
2.0 i AWD (GT7) 107-120 kW (145-163 PS) FB20C	04.2017→		7.06117.41.0	ZM-NWV	EL mit Dichtring with O-ring	
XV (_GP_)						14
1.6 BiFuel AWD (G33GP, GP3) 84 kW (114 PS) FB16B	03.2012→		7.06117.41.0	ZM-NWV	EL mit Dichtring with O-ring	
1.6 i AWD (GP3, G33GP) 84-85 kW (114-116 PS) FB16A, FB16B	03.2012→		7.06117.41.0	ZM-NWV	EL mit Dichtring with O-ring	
2.0 BiFuel AWD (G33GP, GP7) 110-114 kW (150-155 PS) FB20B	03.2012→		7.06117.41.0	ZM-NWV	EL mit Dichtring with O-ring	
2.0 i AWD (GP7, G33GP) 110-114 kW (150-155 PS) FB20B	03.2012→		7.06117.41.0	ZM-NWV	EL mit Dichtring with O-ring	







S

						
LIANA (ER, RH_)						1
1.4 DDiS (RH 414D) 66 kW (90 PS) 8HY	04.2004→		7.02256.24.0	DW-AGR	EP	
			7.02256.24.0	DW-TL	EP	
LIANA Hatchback						2
1.4 DDiS 66 kW (90 PS) 8HY	04.2004→12.2007		7.02256.24.0	DW-AGR	EP	
			7.02256.24.0	DW-TL	EP	
SPLASH (EX)						3
1.3 CDTi (A5B 413D) 55 kW (75 PS) D13A	01.2008→		7.02534.01.0	DW-TL	EP	für Fahrzeuge mit Diesel-Partikel-Filter (DPF) for vehicles with diesel soot filter
SWIFT III (MZ, EZ)						4
1.3 DDiS (RS 413D) 55 kW (75 PS) D13A	08.2005→		7.02534.01.0	DW-TL	EP	für Fahrzeuge mit Diesel-Partikel-Filter (DPF) for vehicles with diesel soot filter
SWIFT IV (FZ, NZ)						5
1.3 DDiS (AZG 413D) 55 kW (75 PS) D13A	10.2010→		7.02534.01.0	DW-TL	EP	
1.3 DDiS (AZG 413D) 55 kW (75 PS) D13AA	10.2010→		7.02534.01.0	DW-TL	EP	
			7.01981.07.0	SV-AGR-K	EP	
SX4 (EY, GY)						6
1.9 DDiS (RW 419D) 88 kW (120 PS) D19AA	06.2006→		7.02534.01.0	DW-TL	EP	
1.9 DDiS 4x4 (RW 419D) 88 kW (120 PS) D19AA	06.2006→		7.02534.01.0	DW-TL	EP	
2.0 DDiS (RW 420D) 99 kW (135 PS) D20AA	07.2009→		7.02534.01.0	DW-TL	EP	
2.0 DDiS 4x4 (RW 420D) 99 kW (135 PS) D20AA	07.2009→		7.02534.01.0	DW-TL	EP	
SX4 S-CROSS (JY)						7
1.6 DDiS (AKK 416D) 88 kW (120 PS) D16AA	08.2013→		7.02534.01.0	DW-TL	EP	Euro 5 Euro 5
1.6 DDiS AllGrip (AKK 416D) 88 kW (120 PS) D16AA	08.2013→		7.02534.01.0	DW-TL	EP	Euro 5 Euro 5
WAGON R Hatchback						8
1.0 44 kW (60 PS) Z 10 XEP	06.2004→08.2005		7.02256.28.0	SV-PDA	EP	
1.2 59 kW (80 PS) Z 12 XEP	06.2004→08.2005		7.02256.28.0	SV-PDA	EP	
WAGON R+ Hatchback (MM)						9
1.2 (RB 412) 59 kW (80 PS) Z 12 XEP	01.2005→12.2008		7.02256.28.0	SV-PDA	EP	

						
AURIS (_E15_)						1
2.0 D-4D (ADE150_) 91-93 kW (124-126 PS) 1AD-FTV	10.2006→09.2012		7.00513.10.0	DW-TL	EP	
			7.03584.01.0	EUV-AGR	EL	
2.2 D (ADE157_, ADE151_) 100-130 kW (136-177 PS) 2AD-FHV	11.2006→09.2012		7.00513.10.0	DW-TL	EP	
			7.03584.01.0	EUV-AGR	EL	
AURIS (_E18_)						2
1.2 (NRE185_) 85-96 kW (116-131 PS) 8NR-FTS	03.2015→12.2018		7.00513.19.0	DW-TL	EP	 8NR-FTS:  Japan  Japan  8NR-FTS: Fahrgestellnummer ab: E001001 Vehicle Identification Number from: E001001 Fahrgestellnummer bis: E056438 Vehicle Identification Number to: E056438  Europa  Europe Produktionsdatum bis: 05.2018 Production date to: 05.2018
			7.03584.01.0	EUV-AGR	EL	
2.0 D-4D (ADE186_) 91-93 kW (124-126 PS) 1AD-FTV	10.2012→04.2015		7.03584.01.0	EUV-AGR	EL	 Europa  Europe
AURIS Estate (_E18_)						3
1.2 (NRE185_) 85-96 kW (116-131 PS) 8NR-FTS	03.2015→12.2018		7.00513.19.0	DW-TL	EP	 8NR-FTS: Fahrgestellnummer ab: E001001 Vehicle Identification Number from: E001001 Fahrgestellnummer bis: E056438 Vehicle Identification Number to: E056438  Europa  Europe Produktionsdatum bis: 05.2018 Production date to: 05.2018  8NR-FTS:  Japan  Japan
			7.03584.01.0	EUV-AGR	EL	
2.0 D-4D (ADE186_) 91-93 kW (124-126 PS) 1AD-FTV	07.2013→04.2015		7.03584.01.0	EUV-AGR	EL	 Europa  Europe
AVENSIS (_T25_)						4
2.0 D-4D (ADT250_) 91-93 kW (124-126 PS) 1AD-FTV	03.2006→11.2008		7.00513.10.0	DW-TL	EP	
			7.00513.10.0	DW-TL	EP	
2.2 D-4D (ADT251_) 98-110 kW (133-150 PS) 2AD-FTV	10.2005→11.2008		7.00513.10.0	DW-TL	EP	
2.2 D-CAT (ADT251_) 100-130 kW (136-177 PS) 2AD-FHV	07.2005→11.2008		7.00513.10.0	DW-TL	EP	
			7.03584.01.0	EUV-AGR	EL	









AVENSIS Estate (_T25_) 5

2.0 D-4D (ADT250_) 91-93 kW (124-126 PS) 1AD-FTV	03.2006→11.2008		7.00513.10.0 DW-TL EP	
			7.03584.01.0 EUV-AGR EL	09.2006→  Europa  Europe
2.2 D-4D (ADT251_) 98-110 kW (133-150 PS) 2AD-FTV	10.2005→11.2008		7.00513.10.0 DW-TL EP	
			7.03584.01.0 EUV-AGR EL	
2.2 D-CAT (ADT251_) 100-130 kW (136-177 PS) 2AD-FHV	07.2005→11.2008		7.00513.10.0 DW-TL EP	
			7.03584.01.0 EUV-AGR EL	 Europa  Europe

AVENSIS Estate (_T27_) 6

2.0 D-4D (ADT270_) 91-93 kW (124-126 PS) 1AD-FTV	02.2009→10.2018		7.00513.10.0 DW-TL EP	
			7.03584.01.0 EUV-AGR EL	08.2012→  Europa  Europe
2.0 D-4D (ADT270_) 91-93 kW (124-126 PS) 1AD-FTV	11.2011→10.2018		7.00513.10.0 DW-TL EP	
			7.03584.01.0 EUV-AGR EL	08.2012→  Europa  Europe
2.2 D-4D (ADT271_) 98-110 kW (133-150 PS) 2AD-FTV	02.2009→10.2018		7.00513.10.0 DW-TL EP	
			7.03584.01.0 EUV-AGR EL	
2.2 D-4D (ADT271_) 100-130 kW (136-177 PS) 2AD-FHV	02.2009→10.2018		7.00513.10.0 DW-TL EP	
			7.03584.01.0 EUV-AGR EL	 2AD-FHV:  Europa  Europa  2AD-FHV:  Europa  Europa
2.2 D-4D (ADT271_) 100-130 kW (136-177 PS) 2AD-FHV	02.2009→10.2018		7.00513.10.0 DW-TL EP	
			7.03584.01.0 EUV-AGR EL	 Europa  Europe

AVENSIS Saloon (_T25_) 7

2.0 D-4D (ADT250_) 91-93 kW (124-126 PS) 1AD-FTV	03.2006→10.2008		7.00513.10.0 DW-TL EP	
			7.03584.01.0 EUV-AGR EL	09.2006→  Europa  Europe
2.2 D-4D (ADT251_) 98-110 kW (133-150 PS) 2AD-FTV	10.2005→11.2008		7.00513.10.0 DW-TL EP	
			7.03584.01.0 EUV-AGR EL	
2.2 D-CAT (ADT251_) 100-130 kW (136-177 PS) 2AD-FHV	07.2005→11.2008		7.00513.10.0 DW-TL EP	
			7.03584.01.0 EUV-AGR EL	 Europa  Europe

T



AVENSIS Saloon (_T27_) **8**



2.0 D-4D (ADT270_) 91-93 kW (124-126 PS) 1AD-FTV	11.2008→10.2018		7.00513.10.0	DW-TL	EP	
			7.03584.01.0	EUV-AGR	EL	
2.0 D-4D (ADT270_) 91-93 kW (124-126 PS) 1AD-FTV	11.2011→10.2018		7.00513.10.0	DW-TL	EP	08.2012→ 🇪🇺 Europa 🇪🇺 Europe
			7.03584.01.0	EUV-AGR	EL	
2.2 D-4D (ADT271_) 98-130 kW (133-177 PS) 2AD-FHV, 2AD-FTV	11.2008→10.2018		7.00513.10.0	DW-TL	EP	🇪🇺 2AD-FHV, 2AD-FTV: 🇪🇺 Europa 🇪🇺 Europe
			7.03584.01.0	EUV-AGR	EL	
2.2 D-4D (ADT271_) 100-130 kW (136-177 PS) 2AD-FHV	11.2008→10.2018		7.00513.10.0	DW-TL	EP	🇪🇺 Europa 🇪🇺 Europe
			7.03584.01.0	EUV-AGR	EL	

C-HR (_X1_) **9**

1.2 (NGX10_) 85-96 kW (116-131 PS) 8NR-FTS	10.2016→		7.00513.19.0	DW-TL	EP	<p>🇪🇺 8NR-FTS: Fahrgestellnummer ab: R000501 Vehicle Identification Number from: R000501 Fahrgestellnummer bis: R043929 Vehicle Identification Number to: R043929 🇪🇺 Europa 🇪🇺 Europe Produktionsdatum bis: 05.2018 Production date to: 05.2018 🇷🇺 8NR-FTS: 🇷🇺 Russland 🇷🇺 Russia Produktionsdatum bis: 09.2019 Production date to: 09.2019 🇯🇵 8NR-FTS: 🇯🇵 Japan 🇯🇵 Japan Produktionsdatum bis: 10.2019 Production date to: 10.2019</p>
--	----------	---	--------------	-------	----	---

T



C-HR (_X1_) 9

1.2 4WD (NGX50) 85-96 kW (116-131 PS) 8NR-FTS	10.2016→	7.00513.19.0 	DW-TL	EP	8NR-FTS: Fahrgestellnummer ab: R000501 Vehicle Identification Number from: R000501 Fahrgestellnummer bis: R011857 Vehicle Identification Number to: R011857 Europa Europe Produktionsdatum bis: 05.2018 Production date to: 05.2018 8NR-FTS: Russland Russia Produktionsdatum bis: 09.2019 Production date to: 09.2019 8NR-FTS: Japan Japan Produktionsdatum bis: 10.2019 Production date to: 10.2019
1.2 4WD (NGX50_) 85-96 kW (116-131 PS) 8NR-FTS	10.2016→	7.00513.19.0 	DW-TL	EP	8NR-FTS: Fahrgestellnummer ab: R000501 Vehicle Identification Number from: R000501 Fahrgestellnummer bis: R011857 Vehicle Identification Number to: R011857 Europa Europe Produktionsdatum bis: 05.2018 Production date to: 05.2018 8NR-FTS: Russland Russia Produktionsdatum bis: 09.2019 Production date to: 09.2019 8NR-FTS: Japan Japan Produktionsdatum bis: 10.2019 Production date to: 10.2019

COROLLA Saloon (_E15_) 10































2.0 D-4D (ADE150) 91-93 kW (124-126 PS) 1AD-FTV	11.2006→07.2014	7.00513.10.0  7.03584.01.0	DW-TL	EP	02.2008→06.2013 Europa Europe
--	-----------------	---	-------	----	-------------------------------------

COROLLA Verso (ZER_, ZZE12_, R1_) 11











































2.2 D-4D (AUR10_) 100-130 kW (136-177 PS) 2AD-FHV	10.2005→03.2009	7.00513.10.0  7.03584.01.0	DW-TL	EP	
2.2 D-4D (AUR10_) 98-110 kW (133-150 PS) 2AD-FTV	10.2005→03.2009		DW-TL	EP	

CROWN (_S21_) 12

2.0 VVT-iW (ARS210) 170-180 kW (231-245 PS) 8AR-FTS	10.2015→	7.00513.19.0  7.04654.10.0	DW-TL	EP	Japan Japan Produktionsdatum bis: 04.2018 Production date to: 04.2018 Japan Japan Produktionsdatum bis: 04.2018 Production date to: 04.2018
--	----------	---	-------	----	--

					
CROWN (_S22_) 13					
2.0 (ARS220) 170-180 kW (231-245 PS) 8AR-FTS	07.2018→		7.00513.19.0	DW-TL	EP  Japan  Japan
			7.04654.10.0	SUV	EL  Japan  Japan
GT 86 Coupe (ZN6_) 14					
2.0 (ZN6AC_, ZN6BC_) 147-153 kW (200-208 PS) 4U-GSE	03.2012→		7.06117.41.0	ZM-NWV	EL mit Dichtring with O-ring Produktionsdatum bis: 02.2015 Production date to: 02.2015
HARRIER (_U6_) 15					
2.0 (ASU60_) 170-180 kW (231-245 PS) 8AR-FTS	06.2017→		7.00513.19.0	DW-TL	EP
			7.04654.10.0	SUV	EL
2.0 4WD (ASU65_) 170-180 kW (231-245 PS) 8AR-FTS	06.2017→		7.00513.19.0	DW-TL	EP
			7.04654.10.0	SUV	EL
PROACE CITY VERSO MPV 16					
1.2 VVT-i 110 (BKYNM) 81 kW (110 PS) EB2ADT	10.2019→		7.08681.09.0	EOV	EH
1.2 VVT-i 130 (BKYNP) 96 kW (131 PS) EB2ADTS	10.2019→		7.08681.09.0	EOV	EH
1.5 D-4D 100 (BKYMD) 75 kW (102 PS) DV5RD	10.2019→		7.08681.00.0	EOV	EH
1.5 D-4D 130 (BKYMA) 96 kW (131 PS) DV5RC	10.2019→		7.08681.00.0	EOV	EH
RAV 4 III (_A3_) 17					
2.2 D (ALA35_) 98-130 kW (133-177 PS) 2AD-FHV, 2AD-FTV	12.2008→06.2013		7.03584.01.0	EUV-AGR	EL
2.2 D 4WD (ALA30) 98-110 kW (133-150 PS) 2AD-FTV	11.2005→12.2010		7.00513.10.0	DW-TL	EP
2.2 D 4WD (ALA30_) 98-110 kW (133-150 PS) 2AD-FTV	02.2006→12.2012		7.00513.10.0	DW-TL	EP
2.2 D 4WD (ALA30_) 100-130 kW (136-177 PS) 2AD-FHV	02.2006→06.2013		7.00513.10.0	DW-TL	EP
			7.03584.01.0	EUV-AGR	EL →12.2012
2.2 D 4WD (ALA30_) 98-130 kW (133-177 PS) 2AD-FHV, 2AD-FTV	12.2008→06.2013		7.00513.10.0	DW-TL	EP
			7.03584.01.0	EUV-AGR	EL  2AD-FHV, 2AD-FTV: 12.2012→
RAV 4 IV (_A4_) 18					
2.0 D (ALA40_) 91-93 kW (124-126 PS) 1AD-FTV	12.2012→11.2018		7.03584.01.0	EUV-AGR	EL →10.2015  Europa  Europe
2.0 D 4WD (ALA41_) 91-93 kW (124-126 PS) 1AD-FTV	01.2013→11.2018		7.03584.01.0	EUV-AGR	EL 11.2013→10.2015  Europa  Europe

T

						
RAV 4 IV (_A4_)						18
2.2 D 4WD (ALA49) 98-130 kW (133-177 PS) 2AD-FHV, 2AD-FTV	12.2012→		7.03584.01.0	EUV-AGR	EL	 2AD-FHV, 2AD-FTV: →10.2015  Europa  Europe  2AD-FHV, 2AD-FTV: 10.2015→
2.2 D 4WD (ALA49) 100-130 kW (136-177 PS) 2AD-FHV	12.2012→		7.03584.01.0	EUV-AGR	EL	 2AD-FHV: →10.2015  Europa  Europe  2AD-FHV: 10.2015→
VERSO (_R2_)						19
2.0 D-4D (AUR20_) 91-93 kW (124-126 PS) 1AD-FTV	04.2009→08.2018		7.03584.01.0	EUV-AGR	EL	 Europa  Europe
2.0 D-4D (AUR20_) 91-93 kW (124-126 PS) 1AD-FTV	11.2012→08.2018		7.03584.01.0	EUV-AGR	EL	 Europa  Europe
2.2 D-4D (AUR21) 100-130 kW (136-177 PS) 2AD-FHV	04.2009→08.2018		7.03584.01.0	EUV-AGR	EL	 Europa  Europe
2.2 D-4D (AUR21_) 100-130 kW (136-177 PS) 2AD-FHV	04.2009→08.2018		7.03584.01.0	EUV-AGR	EL	 Europa  Europe
2.2 D-CAT (AUR21_) 100-130 kW (136-177 PS) 2AD-FHV	04.2009→08.2018		7.03584.01.0	EUV-AGR	EL	 Europa  Europe
PROACE Bus (MDZ_)						20
1.5 D4d (MDZ1) 88 kW (120 PS) 5WZ-HV (DV5RUC)	08.2018→		7.08681.00.0	EOV	EH	
1.5 D4d (MDZ8) 75 kW (102 PS) 5WZ-TV (DV5RUCD)	08.2018→		7.08681.00.0	EOV	EH	
PROACE CITY Box Body/MPV						21
1.2 VVT-i 110 (BPZNN) 81 kW (110 PS) EB2ADT	10.2019→		7.08681.09.0	EOV	EH	
1.2 VVT-i 130 (BPZNP) 96 kW (131 PS) EB2ADTS	10.2019→		7.08681.09.0	EOV	EH	
1.5 D-4D 100 (BPZMD) 75 kW (102 PS) DV5RD	10.2019→		7.08681.00.0	EOV	EH	
1.5 D-4D 130 (BPZMA) 96 kW (131 PS) DV5RC	10.2019→		7.08681.00.0	EOV	EH	
1.5 D-4D 75 (BPZMJ) 55 kW (75 PS) DV5RE	10.2019→		7.08681.00.0	EOV	EH	
PROACE VERSO Bus (MPY_)						22
1.5 D4d (MPY1) 88 kW (120 PS) 5WZ-HV (DV5RUC)	06.2018→		7.08681.00.0	EOV	EH	
1.5 D4d (MPY8) 75 kW (102 PS) 5WZ-TV (DV5RUCD)	06.2018→		7.08681.00.0	EOV	EH	
PROACE Van (MDZ_)						23
1.5 D4d (MDZ1) 88 kW (120 PS) 5WZ-HV (DV5RUC)	05.2019→		7.08681.00.0	EOV	EH	
1.5 D4d (MDZ8) 75 kW (102 PS) 5WZ-TV (DV5RUCD)	05.2019→		7.08681.00.0	EOV	EH	



T































CROWN ROYAL (_S21_)						1
2.0 T (ARS212) 173 kW (235 PS) 8AR-FTS	08.2015→		7.00513.19.0	DW-TL	EP	Produktionsdatum bis: 10.2019 Production date to: 10.2019
			7.04654.10.0	SUV	EL	Produktionsdatum bis: 10.2019 Production date to: 10.2019

T











HIGHLANDER (_U5_)
1

2.0 T (ASU50) 162 kW (220 PS) 8AR-FTS	03.2015->		7.00513.19.0 DW-TL EP
			7.04654.10.0 SUV EL
2.0 T All-wheel Drive (ASU55) 162 kW (220 PS) 8AR-FTS	03.2015->		7.00513.19.0 DW-TL EP
			7.04654.10.0 SUV EL















						
ADAM (M13)						1
1.0 85 kW (116 PS) B 10 XFT	07.2014→11.2018		7.03351.12.0	LDRV	EP	
			7.03381.14.0	SUV	EL	
1.0 85 kW (115 PS) D 10 XFT	07.2014→11.2018		7.03351.12.0	LDRV	EP	
1.2 51 kW (69 PS) A 12 XEL, B 12 XEL, D 12 XEL	10.2012→04.2019		7.06117.07.0	ZM-NWV	EL	mit Dichtring with O-ring
1.4 64-66 kW (87-90 PS) A 14 XEL, B 14 XEL	10.2012→02.2019		7.06117.07.0	ZM-NWV	EL	mit Dichtring with O-ring
1.4 55-74 kW (75-101 PS) A 14 XER, B 14 XER	10.2012→02.2019		7.06117.07.0	ZM-NWV	EL	mit Dichtring with O-ring
1.4 S 110 kW (150 PS) B 14 NEH	11.2014→01.2019		7.03833.02.0	EUV-VB	EL	
			7.06117.07.0	ZM-NWV	EL	mit Dichtring with O-ring
AGILA Mk I (A) (H00)						2
1.0 12V 44 kW (60 PS) Z 10 XEP	02.2000→11.2006		7.02256.28.0	SV-PDA	EP	
1.2 16V Twinport 59 kW (80 PS) Z 12 XEP	07.2004→11.2006		7.02256.28.0	SV-PDA	EP	
AGILA Mk II (B) (H08)						3
1.3 CDTI 55 kW (75 PS) D13A	01.2008→11.2014		7.02534.01.0	DW-TL	EP	
AMPERA (R12)						4
EV 150 (D1JOI) 63 kW (86 PS) A 14 XFL	03.2012→		7.06117.07.0	ZM-NWV	EL	mit Dichtring with O-ring
ANTARA A (L07)						5
2.4 123-126 kW (167-171 PS) A 24 XE	12.2010→04.2015		7.06117.05.0	SV-NWV	EH	mit Dichtring with O-ring
			7.06117.06.0	SV-NWV	EH	mit Dichtring with O-ring
2.4 4x4 123-126 kW (167-171 PS) A 24 XE	12.2010→04.2015		7.06117.05.0	SV-NWV	EH	mit Dichtring with O-ring
			7.06117.06.0	SV-NWV	EH	mit Dichtring with O-ring
ASTRA Mk II Hatchback (T85)						6
1.4 i 44 kW (60 PS) C 14 NZ	01.1990→08.1991		7.05432.01.0	SM	EL	mit Dichtring with O-ring
ASTRA Mk III (F) Convertible (T92)						7
1.6 i 52 kW (71 PS) X 16 SZ	03.1993→08.1996		7.05432.00.0	SM	EL	mit Dichtring with O-ring
1.6 i 55 kW (75 PS) X 16 SZR	01.1996→03.2001		7.02256.38.0	AKF	EL	für OE-Nummer: 13105950, 58 07 468 for OE number: 13105950, 58 07 468
			7.05432.00.0	SM	EL	mit Dichtring with O-ring
1.8 92 kW (125 PS) C 18 XE	09.1994→08.1996		7.06269.01.0	LLR	EL	
1.8 16V 85 kW (116 PS) C 18 XEL, X 18 XE	11.1994→03.2001		7.06269.01.0	LLR	EL	
1.8 i (F08) 66 kW (90 PS) C 18 NZ	09.1991→02.1998		7.05432.00.0	SM	EL	mit Dichtring with O-ring
ASTRA Mk III (F) Estate (T92)						8
1.4 i 60 kW (82 PS) C 14 SE	03.1991→02.1998		7.05432.11.0	SM	EL	mit Dichtring with O-ring
1.4 i 44 kW (60 PS) C 14 NZ	09.1991→02.1998		7.05432.01.0	SM	EL	mit Dichtring with O-ring

V









ASTRA Mk III (F) Estate (T92)
8

1.4 i 16V 66 kW (90 PS) X 14 XE	02.1996→01.1998		7.05432.11.0	SM	EL	mit Dichtring with O-ring
1.6 Si 74 kW (101 PS) C 16 SE	03.1991→12.1994		7.05432.11.0	SM	EL	mit Dichtring with O-ring
1.6 i 55-61 kW (75-83 PS) C 16 NZ, X 16 SZR	09.1991→12.1998		7.05432.00.0	SM	EL	mit Dichtring with O-ring
1.6 i 52 kW (71 PS) X 16 SZ	07.1994→02.1998		7.05432.00.0	SM	EL	mit Dichtring with O-ring
1.6 i 16V 74 kW (101 PS) X 16 XEL	01.1994→02.1998		7.05432.11.0	SM	EL	mit Dichtring with O-ring
1.8 i 66 kW (90 PS) C 18 NZ	09.1991→02.1998		7.05432.00.0	SM	EL	mit Dichtring with O-ring
1.8 i 16V 92 kW (125 PS) C 18 XE	09.1994→02.1998		7.06269.01.0	LLR	EL	
1.8 i 16V 85 kW (116 PS) C 18 XEL	09.1994→02.1998		7.06269.01.0	LLR	EL	
2.0 i 16V 100 kW (136 PS) X 20 XEV	01.1994→02.1998		7.06269.01.0	LLR	EL	



























ASTRA Mk III (F) Hatchback (T92)
9

1.4 i 44 kW (60 PS) C 14 NZ	09.1991→02.1998		7.05432.01.0	SM	EL	mit Dichtring with O-ring
1.4 i 60 kW (82 PS) C 14 SE	03.1992→02.1998		7.05432.11.0	SM	EL	mit Dichtring with O-ring
1.4 i 16V 66 kW (90 PS) X 14 XE	02.1996→02.1998		7.05432.11.0	SM	EL	mit Dichtring with O-ring
1.6 i 55-61 kW (75-83 PS) C 16 NZ	09.1991→02.1998		7.05432.00.0	SM	EL	mit Dichtring with O-ring
1.6 i 74 kW (101 PS) C 16 SE	03.1992→02.1998		7.05432.11.0	SM	EL	mit Dichtring with O-ring
1.6 i 52 kW (71 PS) X 16 SZ	02.1993→12.1996		7.05432.00.0	SM	EL	mit Dichtring with O-ring
1.6 i 16V 74 kW (101 PS) X 16 XEL	01.1994→02.1998		7.05432.11.0	SM	EL	mit Dichtring with O-ring
1.8 i 66 kW (90 PS) C 18 NZ	09.1991→02.1998		7.05432.00.0	SM	EL	mit Dichtring with O-ring
1.8 i 16V 92 kW (125 PS) C 18 XE	09.1994→02.1998		7.06269.01.0	LLR	EL	
1.8 i 16V 85 kW (116 PS) C 18 XEL	09.1994→02.1998		7.06269.01.0	LLR	EL	
2.0 i 16V 100 kW (136 PS) X 20 XEV	01.1994→02.1998		7.06269.01.0	LLR	EL	



ASTRA Mk III (F) Saloon (T92)
10

1.4 i 44 kW (60 PS) C 14 NZ	04.1992→09.1998		7.05432.01.0	SM	EL	mit Dichtring with O-ring
1.4 i 60 kW (82 PS) C 14 SE	04.1992→09.1998		7.05432.11.0	SM	EL	mit Dichtring with O-ring
1.4 i 16V 66 kW (90 PS) X 14 XE	02.1996→09.1998		7.05432.11.0	SM	EL	mit Dichtring with O-ring
1.6 i 55-61 kW (75-83 PS) C 16 NZ, X 16 SZR	03.1992→09.1998		7.05432.00.0	SM	EL	mit Dichtring with O-ring
1.6 i 74 kW (101 PS) C 16 SE	05.1992→12.1994		7.05432.11.0	SM	EL	mit Dichtring with O-ring
1.6 i 52 kW (71 PS) X 16 SZ	08.1994→07.1996		7.05432.00.0	SM	EL	mit Dichtring with O-ring
1.6 i 16V 74 kW (101 PS) X 16 XEL	08.1994→09.1998		7.05432.11.0	SM	EL	mit Dichtring with O-ring
1.8 i 66 kW (90 PS) C 18 NZ	03.1992→09.1998		7.05432.00.0	SM	EL	mit Dichtring with O-ring









V

						
ASTRA Mk III (F) Saloon (T92)						10
1.8 i 16V 92 kW (125 PS) C 18 XE	06.1993→10.1994		7.06269.01.0	LLR	EL 	
1.8 i 16V 85 kW (116 PS) C 18 XEL	01.1994→12.1996		7.06269.01.0	LLR	EL 	
2.0 i 16V 100 kW (136 PS) X 20 XEV	02.1995→09.1998		7.06269.01.0	LLR	EL 	
ASTRA Mk IV (G) Convertible (T98)						11
1.6 16V 63-74 kW (85-101 PS) Z 16 XE	03.2001→10.2005		7.02256.22.0	AKF	EL für OE-Nummer: 1997319, 58 07 452 for OE number: 1997319, 58 07 452	
			7.02256.38.0	AKF	EL für OE-Nummer: 13105950, 58 07 468 for OE number: 13105950, 58 07 468	
1.6 16V 74-77 kW (101-105 PS) Z 16 XEP	03.2003→10.2005		7.02256.31.0	SV-PDA	EP	
2.0 140-162 kW (190-220 PS) Z 20 LET	09.2002→10.2005		7.01039.03.0	EUV-SR	EL	
			7.01024.02.0	LDRV	EL	
2.0 Turbo 140-162 kW (190-220 PS) Z 20 LET	03.2002→10.2005		7.01039.03.0	EUV-SR	EL	
			7.01024.02.0	LDRV	EL	
ASTRA Mk IV (G) Coupe (T98)						12
1.6 16V 74-77 kW (101-105 PS) Z 16 XEP	03.2000→08.2005		7.02256.31.0	SV-PDA	EP	
2.0 16V Turbo 140-162 kW (190-220 PS) Z 20 LET	09.2000→08.2005		7.01039.03.0	EUV-SR	EL	
			7.01024.02.0	LDRV	EL	
ASTRA Mk IV (G) Estate (T98)						13
1.4 16V 66 kW (90 PS) X 14 XE	02.1998→05.2005		7.02256.38.0	AKF	EL für OE-Nummer: 13105950, 58 07 468 for OE number: 13105950, 58 07 468	
			7.05432.11.0	SM	EL mit Dichtring with O-ring	
1.4 16V 66 kW (90 PS) Z 14 XE	02.1998→05.2005		7.02256.22.0	AKF	EL für OE-Nummer: 1997319, 58 07 452 for OE number: 1997319, 58 07 452	
			7.02256.38.0	AKF	EL für OE-Nummer: 13105950, 58 07 468 for OE number: 13105950, 58 07 468	
1.6 55 kW (75 PS) X 16 SZR	03.1998→04.2004		7.02256.38.0	AKF	EL für OE-Nummer: 13105950, 58 07 468 for OE number: 13105950, 58 07 468	
			7.05432.00.0	SM	EL mit Dichtring with O-ring	
1.6 74-77 kW (101-105 PS) Z 16 XEP	12.2002→05.2005		7.02256.31.0	SV-PDA	EP	
1.6 16V 63-74 kW (85-101 PS) Z 16 XE	03.1998→04.2004		7.02256.22.0	AKF	EL für OE-Nummer: 1997319, 58 07 452 for OE number: 1997319, 58 07 452	
			7.02256.38.0	AKF	EL für OE-Nummer: 13105950, 58 07 468 for OE number: 13105950, 58 07 468	
1.6 16V 74 kW (101 PS) X 16 XEL	03.1998→04.2004		7.02256.38.0	AKF	EL für OE-Nummer: 13105950, 58 07 468 for OE number: 13105950, 58 07 468	
			7.05432.11.0	SM	EL mit Dichtring with O-ring	
1.6 Dualfuel 55 kW (75 PS) X 16 SZR	02.1998→12.2000		7.05432.00.0	SM	EL mit Dichtring with O-ring	
1.7 CDTI 16V 59 kW (80 PS) Z 17 DTL	04.2003→05.2005		7.03088.01.0	DW-TL	EP	
			7.02461.01.0	EUV-AGR	EL	
1.7 DTI 16V 55 kW (75 PS) Y 17 DT	02.2000→05.2005		7.03085.02.0	DW-AGR	EP	



ASTRA Mk IV (G) Estate (T98) 13

2.0 DTI 16V 74 kW (101 PS) Y 20 DTH	03.1998→04.2004	 7.03088.01.0	DW-TL	EP	
		 7.22138.50.0	EUV-AGR	EL	 ch. 32000001→

ASTRA Mk IV (G) Hatchback (T98) 14









1.4 16V (F08, F48) 66 kW (90 PS) X 14 XE	02.1998→05.2005	 7.02256.38.0	AKF	EL	für OE-Nummer: 13105950, 58 07 468 for OE number: 13105950, 58 07 468
		7.05432.11.0	SM	EL	mit Dichtring with O-ring
1.4 16V (F08, F48) 66 kW (90 PS) Z 14 XE	02.1998→05.2005	 7.02256.22.0	AKF	EL	für OE-Nummer: 1997319, 58 07 452 for OE number: 1997319, 58 07 452
		7.02256.38.0	AKF	EL	für OE-Nummer: 13105950, 58 07 468 for OE number: 13105950, 58 07 468
1.6 (F08, F48) 55 kW (75 PS) X 16 SZR	02.1998→09.2000	 7.02256.38.0	AKF	EL	für OE-Nummer: 13105950, 58 07 468 for OE number: 13105950, 58 07 468
		7.05432.00.0	SM	EL	mit Dichtring with O-ring
1.6 (F08, F48) 74-77 kW (101-105 PS) Z 16 XEP	12.2002→05.2005	 7.02256.31.0	SV-PDA	EP	
1.6 16V (F08, F48) 63-74 kW (85-101 PS) Z 16 XE	02.1998→05.2005	 7.02256.22.0	AKF	EL	für OE-Nummer: 1997319, 58 07 452 for OE number: 1997319, 58 07 452
		7.02256.38.0	AKF	EL	für OE-Nummer: 13105950, 58 07 468 for OE number: 13105950, 58 07 468
1.6 16V (F08, F48) 74 kW (101 PS) X 16 XEL	02.1998→05.2005	 7.02256.38.0	AKF	EL	für OE-Nummer: 13105950, 58 07 468 for OE number: 13105950, 58 07 468
		7.05432.11.0	SM	EL	mit Dichtring with O-ring
1.6 Dualfuel (F08, F48) 55 kW (75 PS) X 16 SZR	02.1998→12.2000	 7.05432.00.0	SM	EL	mit Dichtring with O-ring
1.7 CDTI 16V (F08, F48) 59 kW (80 PS) Z 17 DTL	04.2003→05.2005	 7.02461.01.0	EUV-AGR	EL	
1.7 DTI 16V (F08, F48) 55 kW (75 PS) Y 17 DT	02.2000→05.2005	 7.03085.02.0	DW-AGR	EP	
		7.03088.01.0	DW-TL	EP	
2.0 (F08) 140-162 kW (190-220 PS) Z 20 LET	08.2002→05.2005	 7.01039.03.0	EUV-SR	EL	
		7.01024.02.0	LDRV	EL	
2.0 16V (F08) 100 kW (136 PS) X 20 XEV	02.1998→05.2005	 7.06269.01.0	LLR	EL	
2.0 DTI 16V (F48) 74 kW (101 PS) Y 20 DTH	08.1999→05.2005	 7.22138.50.0	EUV-AGR	EL	 ch. 32000001→
		 7.01039.03.0	EUV-SR	EL	
2.0 SRI Turbo (F08) 140-162 kW (190-220 PS) Z 20 LET	11.2001→05.2005	 7.01039.03.0	EUV-SR	EL	
		7.01024.02.0	LDRV	EL	

ASTRA Mk IV (G) Saloon (T98) 15









1.4 16V 66 kW (90 PS) X 14 XE	09.1998→05.2005	 7.02256.38.0	AKF	EL	für OE-Nummer: 13105950, 58 07 468 for OE number: 13105950, 58 07 468
		7.05432.11.0	SM	EL	mit Dichtring with O-ring
1.4 16V 66 kW (90 PS) Z 14 XE	09.1998→05.2005	 7.02256.22.0	AKF	EL	für OE-Nummer: 1997319, 58 07 452 for OE number: 1997319, 58 07 452
		7.02256.38.0	AKF	EL	für OE-Nummer: 13105950, 58 07 468 for OE number: 13105950, 58 07 468



ASTRA Mk IV (G) Saloon (T98) 15













1.6 55 kW (75 PS) X 16 SZR	09.1998→09.2000	 7.02256.38.0	AKF	EL	für OE-Nummer: 13105950, 58 07 468 for OE number: 13105950, 58 07 468
		7.05432.00.0	SM	EL	mit Dichtring with O-ring
1.6 16V 63-74 kW (85-101 PS) Z 16 XE	09.1998→05.2005	 7.02256.22.0	AKF	EL	für OE-Nummer: 1997319, 58 07 452 for OE number: 1997319, 58 07 452
		7.02256.38.0	AKF	EL	für OE-Nummer: 13105950, 58 07 468 for OE number: 13105950, 58 07 468
1.6 16V 74 kW (101 PS) X 16 XEL	09.1998→05.2005	 7.02256.38.0	AKF	EL	für OE-Nummer: 13105950, 58 07 468 for OE number: 13105950, 58 07 468
		7.05432.11.0	SM	EL	mit Dichtring with O-ring
1.7 CDTI 16V 59 kW (80 PS) Z 17 DTL	04.2003→05.2005	 7.03088.01.0	DW-TL	EP	
		7.02461.01.0	EUV-AGR	EL	
1.7 DTI 16V 55 kW (75 PS) Y 17 DT	02.2000→05.2005	 7.03085.02.0	DW-AGR	EP	
		7.03088.01.0	DW-TL	EP	
2.0 16V 100 kW (136 PS) X 20 XEV	09.1998→05.2005	 7.06269.01.0	LLR	EL	
		7.22138.50.0	EUV-AGR	EL	 ch. 32000001→

ASTRA Mk V (H) (A04) 16

















1.3 CDTI (L48) 66-74 kW (90-101 PS) Z 13 DTH	01.2004→05.2009	 7.01420.02.0	DW-TL	EP	Fahrgestellnummer bis: 9B999999, A2, A5, A8, AG Vehicle Identification Number to: 9B999999, A2, A5, A8, AG
		7.03978.01.0	DW-TL	EP	Fahrgestellnummer ab: A2, A5, A8, AG Vehicle Identification Number from: A2, A5, A8, AG
		7.04423.01.0	DW-TL	EP	Fahrgestellnummer bis: B2, B5, B8, BG Vehicle Identification Number to: B2, B5, B8, BG
1.4 (L48) 66 kW (90 PS) Z 14 XEP	01.2004→05.2009	 7.02256.28.0	SV-PDA	EP	
		7.02256.31.0	SV-PDA	EP	Fahrgestellnummer bis: 72999999, 75999999, 78999999, 7G Vehicle Identification Number to: 72999999, 75999999, 78999999, 7G
1.6 (L48) 74-77 kW (101-105 PS) Z 16 XEP	01.2004→05.2009	 7.02256.38.0	AKF	EL	
		7.02256.31.0	SV-PDA	EP	Fahrgestellnummer bis: 72999999, 75999999, 78999999, 7G Vehicle Identification Number to: 72999999, 75999999, 78999999, 7G
		7.02256.43.0	EUV-SR	EL	
1.6 (L48) 85 kW (116 PS) Z 16 XER	01.2004→05.2009	 7.02256.38.0	AKF	EL	
		7.06117.08.0	SV-NWV	EH	mit Dichtring with O-ring
1.6 Turbo (L48) 132 kW (180 PS) A 16 LET, Z 16 LET	09.2006→09.2009	 7.03833.02.0	LDRV	EL	
		7.03088.01.0	DW-TL	EP	
1.7 CDTI (L48) 59 kW (80 PS) Z 17 DTL	01.2004→05.2009	 7.03088.01.0	DW-TL	EP	
		7.02461.01.0	EUV-LS	EL	
1.7 CDTI (L48) 74 kW (100 PS) Z 17 DTH	01.2004→05.2009	 7.03088.01.0	DW-TL	EP	
		7.02461.01.0	EUV-LS	EL	
1.7 CDTi (L48) 81 kW (110 PS) A 17 DTJ, Z 17 DTJ	01.2004→03.2011	 7.03085.02.0	DW-TL	EP	
		7.02461.01.0	EUV-LS	EL	

V

ASTRA Mk V (H) (A04) 16

1.8 (L48) 103 kW (140 PS) A 18 XER	01.2004→05.2009	 7.06117.08.0	SV-NWV	EH	mit Dichtring with O-ring
1.8 (L48) 103 kW (140 PS) Z 18 XER	01.2004→05.2009	 7.02256.43.0	EUV-SR	EL	
		 7.06117.08.0	SV-NWV	EH	mit Dichtring with O-ring
1.9 CDTi (L48) 110 kW (150 PS) Z 19 DTH	01.2004→05.2009	 7.01420.02.0	DW-TL	EP	
1.9 CDTi (L48) 88 kW (120 PS) Z 19 DT	01.2004→05.2009	 7.01420.02.0	DW-TL	EP	
1.9 CDTi 16V (L48) 88 kW (120 PS) Z 19 DTJ	01.2004→05.2009	 7.01420.02.0	DW-TL	EP	
2.0 Turbo (L48) 125 kW (170 PS) Z 20 LEL	01.2004→05.2009	 7.01024.02.0	LDRV	EL	
		 7.01039.03.0	LDRV	EL	
2.0 Turbo (L48) 147 kW (200 PS) Z 20 LER	01.2004→05.2009	 7.01024.02.0	LDRV	EL	
		 7.01039.03.0	LDRV	EL	
2.0 Turbo (L48) 176-177 kW (240-241 PS) Z 20 LEH	01.2004→05.2009	 7.01024.02.0	LDRV	EL	
		 7.01039.03.0	LDRV	EL	









ASTRA Mk V (H) Estate (A04) 17

1.3 CDTi (L35) 66-74 kW (90-101 PS) Z 13 DTH	08.2004→03.2009	 7.01420.02.0	DW-TL	EP	Fahrgestellnummer bis: 9B999999, A2, A5, A8, AG Vehicle Identification Number to: 9B999999, A2, A5, A8, AG
		 7.03978.01.0	DW-TL	EP	Fahrgestellnummer ab: A2, A5, A8, AG Vehicle Identification Number from: A2, A5, A8, AG
		 7.04423.01.0	DW-TL	EP	Fahrgestellnummer bis: B2, B5, B8, BG Vehicle Identification Number to: B2, B5, B8, BG
1.4 (L35) 66 kW (90 PS) Z 14 XEP	08.2004→03.2009	 7.02256.28.0	SV-PDA	EP	
1.6 (L35) 74-77 kW (101-105 PS) Z 16 XEP	08.2004→03.2009	 7.02256.38.0	AKF	EL	
		 7.02256.31.0	SV-PDA	EP	Fahrgestellnummer bis: 72999999, 75999999, 78999999, 7G Vehicle Identification Number to: 72999999, 75999999, 78999999, 7G
1.6 (L35) 132 kW (180 PS) A 16 LET	08.2004→03.2009	 7.03833.02.0	LDRV	EL	
1.6 (L35) 132 kW (180 PS) Z 16 LET	08.2004→03.2009	 7.01039.03.0	EUV-VB	EL	
		 7.03833.02.0	LDRV	EL	
1.6 (L35) 85 kW (116 PS) Z 16 XER	08.2004→03.2011	 7.02256.38.0	AKF	EL	
		 7.02256.43.0	EUV-SR	EL	
		 7.06117.08.0	SV-NWV	EH	mit Dichtring with O-ring
1.7 CDTi (L35) 59 kW (80 PS) Z 17 DTL	08.2004→05.2009	 7.03088.01.0	DW-TL	EP	
		 7.02461.01.0	EUV-LS	EL	
1.7 CDTi (L35) 74 kW (100 PS) Z 17 DTH	08.2004→03.2009	 7.03088.01.0	DW-TL	EP	
		 7.02461.01.0	EUV-LS	EL	









V



ASTRA Mk V (H) Estate (A04) **17**

1.7 CDTi (L35) 81 kW (110 PS) A 17 DTJ, Z 17 DTJ	08.2004→10.2012	 7.03085.02.0	DW-TL	EP	
		7.02461.01.0	EUV-LS	EL	
1.8 (L35) 103 kW (140 PS) A 18 XER	12.2005→10.2010	 7.06117.08.0	SV-NWV	EH	mit Dichtring with O-ring
1.8 (L35) 103 kW (140 PS) Z 18 XER	12.2005→10.2010	 7.02256.43.0	EUV-SR	EL	
		7.06117.08.0	SV-NWV	EH	mit Dichtring with O-ring
1.9 CDTi (L35) 88 kW (120 PS) Z 19 DT	08.2004→03.2009	 7.01420.02.0	DW-TL	EP	
1.9 CDTi (L35) 110 kW (150 PS) Z 19 DTH	08.2004→03.2009	 7.01420.02.0	DW-TL	EP	
1.9 CDTi 16V (L35) 88 kW (120 PS) Z 19 DTJ	08.2004→03.2009	 7.01420.02.0	DW-TL	EP	
2.0 Turbo (L35) 125 kW (170 PS) Z 20 LEL	08.2004→10.2010	 7.01024.02.0	LDRV	EL	
		7.01039.03.0	LDRV	EL	
2.0 Turbo (L35) 147 kW (200 PS) Z 20 LER	08.2004→10.2010	 7.01024.02.0	LDRV	EL	
		7.01039.03.0	LDRV	EL	

ASTRA Mk V (H) Sport Hatch (A04) **18**

1.3 CDTi (L08) 66-74 kW (90-101 PS) Z 13 DTH	04.2005→11.2010	 7.01420.02.0	DW-TL	EP	Fahrgestellnummer bis: 9B999999, A2, A5, A8, AG Vehicle Identification Number to: 9B999999, A2, A5, A8, AG Fahrgestellnummer ab: A2, A5, A8, AG Vehicle Identification Number from: A2, A5, A8, AG Fahrgestellnummer bis: B2, B5, B8, BG Vehicle Identification Number to: B2, B5, B8, BG Fahrgestellnummer ab: B2, B5, B8, BG Vehicle Identification Number from: B2, B5, B8, BG
		7.03978.01.0	DW-TL	EP	
		7.04423.01.0	DW-TL	EP	
1.4 i 16V (L08) 66 kW (90 PS) Z 14 XEP	03.2005→11.2010	 7.02256.28.0	SV-PDA	EP	
1.6 (L08) 74-77 kW (101-105 PS) Z 16 XEP	02.2005→11.2010	 7.02256.38.0	AKF	EL	
		7.02256.31.0	SV-PDA	EP	Fahrgestellnummer bis: 72999999, 75999999, 78999999, 7G Vehicle Identification Number to: 72999999, 75999999, 78999999, 7G
1.6 (L08) 132 kW (180 PS) A 16 LET	10.2006→11.2010	 7.03833.02.0	LDRV	EL	
1.6 (L08) 132 kW (180 PS) Z 16 LET	10.2006→11.2010	 7.01039.03.0	EUV-VB	EL	
		7.03833.02.0	LDRV	EL	
1.6 i 16V (L08) 85 kW (116 PS) Z 16 XER	12.2006→11.2010	 7.02256.38.0	AKF	EL	mit Dichtring with O-ring
		7.02256.43.0	EUV-SR	EL	
		7.06117.08.0	SV-NWV	EH	
1.7 CDTi (L08) 74 kW (100 PS) Z 17 DTH	02.2005→11.2010	 7.03088.01.0	DW-TL	EP	
		7.02461.01.0	EUV-LS	EL	
1.7 CDTi (L08) 81 kW (110 PS) A 17 DTJ	02.2007→11.2009	 7.03085.02.0	DW-TL	EP	
		7.02461.01.0	EUV-LS	EL	

V



ASTRA Mk V (H) Sport Hatch (A04) 18

1.7 CDTi (L08) 81 kW (110 PS) Z 17 DTJ	02.2007→11.2009	7.02461.01.0	EUV-LS	EL	
1.8 i 16V (L08) 103 kW (140 PS) A 18 XER	03.2007→11.2010	7.06117.08.0	SV-NWV	EH	mit Dichtring with O-ring
1.8 i 16V (L08) 103 kW (140 PS) Z 18 XER	03.2007→11.2010	7.02256.43.0	EUV-SR	EL	
		7.06117.08.0	SV-NWV	EH	mit Dichtring with O-ring
1.9 CDTi (L08) 88 kW (120 PS) Z 19 DT	02.2005→11.2010	7.01420.02.0	DW-TL	EP	
1.9 CDTi (L08) 110 kW (150 PS) Z 19 DTH	02.2005→11.2010	7.01420.02.0	DW-TL	EP	
1.9 CDTi (L08) 74 kW (100 PS) Z 19 DTL	08.2005→11.2010	7.01420.02.0	DW-TL	EP	
2.0 Turbo (L08) 125 kW (170 PS) Z 20 LEL	02.2005→11.2010	7.01024.02.0	LDRV	EL	
		7.01039.03.0	LDRV	EL	
2.0 VXR (L08) 176-177 kW (240-241 PS) Z 20 LEH	02.2009→11.2010	7.01024.02.0	LDRV	EL	
		7.01039.03.0	LDRV	EL	

ASTRA Mk V (H) TwinTop (A04) 19

1.6 (L67) 74-77 kW (101-105 PS) Z 16 XEP	09.2005→11.2010	7.02256.38.0	AKF	EL	
		7.02256.31.0	SV-PDA	EP	Fahrgestellnummer bis: 72999999, 75999999, 78999999, 7G Vehicle Identification Number to: 72999999, 75999999, 78999999, 7G
1.6 i 16V (L67) 85 kW (116 PS) A 16 XER	10.2006→08.2011	7.02256.43.0	EUV-SR	EL	
1.6 i 16V (L67) 85 kW (116 PS) Z 16 XER	10.2006→08.2011	7.02256.43.0	EUV-SR	EL	
		7.06117.08.0	SV-NWV	EH	mit Dichtring with O-ring
1.8 (L67) 103 kW (140 PS) Z 18 XER	05.2008→11.2010	7.02256.43.0	EUV-SR	EL	
		7.06117.08.0	SV-NWV	EH	mit Dichtring with O-ring
1.9 CDTi (L67) 110 kW (150 PS) Z 19 DTH	01.2006→11.2010	7.01420.02.0	DW-TL	EP	
2.0 (L67) 125 kW (170 PS) Z 20 LEL	02.2006→11.2010	7.01024.02.0	LDRV	EL	
		7.01039.03.0	LDRV	EL	
2.0 Turbo (L67) 147 kW (200 PS) Z 20 LER	01.2006→11.2010	7.01024.02.0	LDRV	EL	
		7.01039.03.0	LDRV	EL	

















ASTRA Mk VI (J) (P10) 20

1.3 CDTi 70 kW (95 PS) A 13 DTE	12.2009→10.2015	7.03073.01.0	DW-TL	EP	
		7.01981.07.0	SV-AGR-K	EP	Fahrgestellnummer bis: B3999999, B8999999, BG999999 Vehicle Identification Number to: B3999999, B8999999, BG999999
1.4 55-74 kW (75-101 PS) A 14 XER, B 14 XER	12.2009→10.2015	7.02256.43.0	EUV-SR	EL	A 14 XER, B 14 XER: Fahrgestellnummer bis: C0999999, C1999999, C3999999, C8999999, CG999999 Vehicle Identification Number to: C0999999, C1999999, C3999999, C8999999, CG999999







ASTRA Mk VI (J) (P10) **20**

		 PIERBURG			
		7.06117.07.0	ZM-NWV	EL	mit Dichtring with O-ring
1.4 64 kW (87 PS) A 14 XEL	12.2009→10.2015	 7.02256.43.0	EUV-SR	EL	Fahrgestellnummer bis: C0999999, C1999999, C3999999, C8999999, CG999999 Vehicle Identification Number to: C0999999, C1999999, C3999999, C8999999, CG999999
		7.06117.07.0	ZM-NWV	EL	mit Dichtring with O-ring
1.4 Turbo 103-110 kW (140-150 PS) A 14 NET, B 14 NET, D 14 NET	12.2009→10.2015	 7.03833.02.0	EUV-VB	EL	
		7.06117.07.0	ZM-NWV	EL	mit Dichtring with O-ring
1.4 Turbo 88 kW (120 PS) A 14 NEL	08.2010→10.2015	 7.03833.02.0	EUV-VB	EL	
		7.06117.07.0	ZM-NWV	EL	mit Dichtring with O-ring
1.6 85 kW (116 PS) A 16 XER	12.2009→10.2015	 7.02256.38.0	AKF	EL	
		7.02256.43.0	EUV-SR	EL	
		7.06117.08.0	SV-NWV	EH	mit Dichtring with O-ring
1.6 85 kW (116 PS) B 16 XER	12.2009→10.2015	 7.02256.43.0	EUV-SR	EL	
		7.06117.08.0	SV-NWV	EH	mit Dichtring with O-ring
1.6 CDTi 81 kW (110 PS) B 16 DTL	11.2013→10.2015	 7.08681.01.0	EOV	EH	Fahrgestellnummer ab: G0000001, G1000001, G8000001, GG000001 Vehicle Identification Number from: G0000001, G1000001, G8000001, GG000001
		7.02256.44.0	EUV-AGR	EL	
1.6 CDTi 88-100 kW (120-136 PS) B 16 DTH	11.2013→10.2015	 7.08681.01.0	EOV	EH	Fahrgestellnummer ab: G0000001, G1000001, G8000001, GG000001 Vehicle Identification Number from: G0000001, G1000001, G8000001, GG000001
		7.02256.44.0	EUV-AGR	EL	
1.6 Turbo 132 kW (180 PS) A 16 LET	12.2009→10.2015	 7.01039.03.0	EUV-VB	EL	
		7.03833.02.0	LDRV	EL	
1.7 CDTi 74 kW (101 PS) A 17 DTL	10.2010→10.2015	 7.03085.02.0	DW-TL	EP	
		7.02461.01.0	EUV-LS	EL	
1.7 CDTi 81 kW (110 PS) A 17 DTC, A 17 DTE	12.2009→10.2015	 7.03073.01.0	DW-TL	EP	
		7.02461.01.0	EUV-LS	EL	
1.7 CDTi 81 kW (110 PS) A 17 DTJ	12.2009→10.2015	 7.03085.02.0	DW-TL	EP	
		7.02461.01.0	EUV-LS	EL	
1.7 CDTi 92 kW (125 PS) A 17 DTR	12.2009→10.2015	 7.03085.02.0	DW-TL	EP	
		7.02461.01.0	EUV-LS	EL	
1.7 CDTi 96 kW (131 PS) A 17 DTF, A 17 DTS	06.2011→10.2015	 7.03073.01.0	DW-TL	EP	
		7.03085.02.0	DW-TL	EP	
		7.02461.01.0	EUV-LS	EL	









V



ASTRA Mk VI (J) (P10) 20

2.0 BiTurbo CDTi 140-143 kW (190-194 PS) A 20 DTR	12.2012→10.2015		7.03978.01.0	DW-TL	EP	für OE-Nummer: 55573362, 55575611, 8 51 017, 8 51 042 for OE number: 55573362, 55575611, 8 51 017, 8 51 042
			7.03460.02.0* ↳7.03073.01.0	STE DW-TL	EP EP	
2.0 CDTi 118-121 kW (160-165 PS) A 20 DTH	12.2009→06.2011		7.03978.01.0	DW-TL	EP	
2.0 CDTi 118-121 kW (160-165 PS) A 20 DTH	08.2011→10.2015		7.03978.01.0	DW-TL	EP	







ASTRA Mk VI (J) Estate (P10) 21

1.3 CDTi 70 kW (95 PS) A 13 DTE	10.2010→10.2015		7.03073.01.0	DW-TL	EP	Fahrgestellnummer bis: B3999999, B8999999, BG999999 Vehicle Identification Number to: B3999999, B8999999, BG999999
			7.01981.07.0	SV-AGR-K	EP	
1.4 55-74 kW (75-101 PS) A 14 XER, B 14 XER	10.2010→10.2015		7.02256.43.0	EUV-SR	EL	A 14 XER, B 14 XER: Fahrgestellnummer bis: C0999999, C1999999, C3999999, C8999999, CG999999 Vehicle Identification Number to: C0999999, C1999999, C3999999, C8999999, CG999999
			7.06117.07.0	ZM-NWV	EL	
1.4 64 kW (87 PS) A 14 XEL	10.2010→10.2015		7.02256.43.0	EUV-SR	EL	Fahrgestellnummer bis: C0999999, C1999999, C3999999, C8999999, CG999999 Vehicle Identification Number to: C0999999, C1999999, C3999999, C8999999, CG999999
			7.06117.07.0	ZM-NWV	EL	
1.4 Turbo 103 kW (140 PS) A 14 NET	10.2010→10.2015		7.03833.02.0	EUV-VB	EL	mit Dichtring with O-ring
			7.06117.07.0	ZM-NWV	EL	
1.6 85 kW (116 PS) A 16 XER	10.2010→10.2015		7.02256.38.0	AKF	EL	mit Dichtring with O-ring
			7.02256.43.0	EUV-SR	EL	
			7.06117.08.0	SV-NWV	EH	
1.6 85 kW (116 PS) B 16 XER	10.2010→10.2015		7.02256.43.0	EUV-SR	EL	mit Dichtring with O-ring
			7.06117.08.0	SV-NWV	EH	
1.6 CDTi 88-100 kW (120-136 PS) B 16 DTH	01.2014→10.2015		7.08681.01.0	EOV	EH	Fahrgestellnummer ab: G0000001, G1000001, G8000001, GG000001 Vehicle Identification Number from: G0000001, G1000001, G8000001, GG000001
			7.02256.44.0	EUV-AGR	EL	
1.6 CDTi 81 kW (110 PS) B 16 DTL	01.2014→10.2015		7.08681.01.0	EOV	EH	Fahrgestellnummer ab: G0000001, G1000001, G8000001, GG000001 Vehicle Identification Number from: G0000001, G1000001, G8000001, GG000001
			7.02256.44.0	EUV-AGR	EL	
1.6 Turbo 132 kW (180 PS) A 16 LET	10.2010→10.2015		7.01039.03.0	EUV-VB	EL	
			7.03833.02.0	EUV-VB	EL	































ASTRA Mk VI (J) Estate (P10) **21**

1.7 CDTi 81 kW (110 PS) A 17 DTC, A 17 DTE	10.2010→10.2015		7.03073.01.0	DW-TL	EP	
			7.03085.02.0	DW-TL	EP	
			7.02461.01.0	EUV-LS	EL	
1.7 CDTi 81 kW (110 PS) A 17 DTJ	10.2010→10.2015		7.02461.01.0	EUV-LS	EL	
1.7 CDTi 92 kW (125 PS) A 17 DTR	10.2010→10.2015		7.03085.02.0	DW-TL	EP	
			7.02461.01.0	EUV-LS	EL	
1.7 CDTi 96 kW (131 PS) A 17 DTF, A 17 DTS	06.2011→10.2015		7.03073.01.0	DW-TL	EP	
			7.03085.02.0	DW-TL	EP	
			7.02461.01.0	EUV-LS	EL	
2.0 BiTurbo CDTi 140-143 kW (190-194 PS) A 20 DTR	12.2012→10.2015		7.03978.01.0	DW-TL	EP	für OE-Nummer: 55573362, 55575611, 8 51 017, 8 51 042 for OE number: 55573362, 55575611, 8 51 017, 8 51 042
			7.03460.02.0*	STE	EP	
			↳ 7.03073.01.0	DW-TL	EP	
2.0 CDTi 118-121 kW (160-165 PS) A 20 DTH	10.2010→06.2011		7.03978.01.0	DW-TL	EP	
2.0 CDTi 118-121 kW (160-165 PS) A 20 DTH	08.2011→10.2015		7.03978.01.0	DW-TL	EP	

ASTRA Mk VI (J) GTC (P10) **22**

1.4 74-88 kW (101-120 PS) A 14 NEL, B 14 NEL	10.2011→10.2015		7.03833.02.0	EUV-VB	EL	
			7.06117.07.0	ZM-NWV	EL	mit Dichtring with O-ring
1.4 74 kW (101 PS) A 14 XER	10.2011→10.2015		7.02256.43.0	EUV-SR	EL	Fahrgestellnummer bis: C0999999, C1999999, C3999999, C8999999, CG999999 Vehicle Identification Number to: C0999999, C1999999, C3999999, C8999999, CG999999
			7.06117.07.0	ZM-NWV	EL	mit Dichtring with O-ring
1.4 103-110 kW (140-150 PS) A 14 NET, B 14 NET	10.2011→10.2015		7.03833.02.0	EUV-VB	EL	
			7.06117.07.0	ZM-NWV	EL	mit Dichtring with O-ring
1.6 132 kW (180 PS) A 16 LET	10.2011→10.2015		7.01039.03.0	EUV-VB	EL	
			7.03833.02.0	EUV-VB	EL	
1.6 CDTi 81 kW (110 PS) B 16 DTL	07.2014→10.2015		7.08681.01.0	EOV	EH	Fahrgestellnummer ab: G0000001, G1000001, G8000001, GG000001 Vehicle Identification Number from: G0000001, G1000001, G8000001, GG000001
1.6 CDTi 88-100 kW (120-136 PS) B 16 DTH	07.2014→10.2015		7.08681.01.0	EOV	EH	Fahrgestellnummer ab: G0000001, G1000001, G8000001, GG000001 Vehicle Identification Number from: G0000001, G1000001, G8000001, GG000001
			7.02256.44.0	EUV-AGR	EL	
1.7 CDTi 81 kW (110 PS) A 17 DTC, A 17 DTE	10.2011→10.2015		7.03073.01.0	DW-TL	EP	
			7.03085.02.0	DW-TL	EP	
			7.02461.01.0	EUV-LS	EL	
1.7 CDTi 81 kW (110 PS) A 17 DTJ	10.2011→10.2015		7.02461.01.0	EUV-LS	EL	





V

						
ASTRA Mk VI (J) GTC (P10)						22
1.7 CDTi 96 kW (131 PS) A 17 DTF, A 17 DTS	10.2011→10.2015		7.03073.01.0	DW-TL	EP	
			7.03085.02.0	DW-TL	EP	
			7.02461.01.0	EUV-LS	EL	
2.0 BiTurbo CDTi 140-143 kW (190-194 PS) A 20 DTR	12.2012→10.2015		7.03978.01.0	DW-TL	EP	für OE-Nummer: 55573362, 55575611, 8 51 017, 8 51 042 for OE number: 55573362, 55575611, 8 51 017, 8 51 042
			7.03460.02.0* ↳7.03073.01.0	STE DW-TL	EP EP	
2.0 CDTi 118-121 kW (160-165 PS) A 20 DTH	10.2011→10.2015		7.03978.01.0	DW-TL	EP	
2.0 VXR 162-206 kW (220-280 PS) A 20 NFT, B 20 NFT	04.2012→10.2015		7.02721.06.0*	EUV-VB	EL	mit Halter with holder
			↳7.01441.04.0	EUV-VB	EL	
			7.06117.05.0	SV-NWV	EH	mit Dichtring with O-ring
			7.06117.06.0	SV-NWV	EH	mit Dichtring with O-ring
ASTRA Mk VI (J) Saloon (P10)						23
1.3 CDTi 70 kW (95 PS) A 13 DTE	06.2012→10.2015		7.03073.01.0	DW-TL	EP	
			7.01981.07.0	SV-AGR-K	EP	
1.4 74 kW (101 PS) A 14 XER	06.2012→10.2015		7.02256.43.0	EUV-SR	EL	Fahrgestellnummer bis: C0999999, C1999999, C3999999, C8999999, CG999999 Vehicle Identification Number to: C0999999, C1999999, C3999999, C8999999, CG999999
			7.06117.07.0	ZM-NWV	EL	mit Dichtring with O-ring
1.4 Turbo 103 kW (140 PS) A 14 NET	06.2012→10.2015		7.03833.02.0	EUV-VB	EL	
			7.06117.07.0	ZM-NWV	EL	
1.6 85 kW (116 PS) A 16 XER	06.2012→10.2015		7.02256.38.0	AKF	EL	
			7.02256.43.0	EUV-SR	EL	
			7.06117.08.0	SV-NWV	EH	
1.6 Turbo 132 kW (180 PS) A 16 LET	06.2012→10.2015		7.01039.03.0	EUV-VB	EL	
			7.03833.02.0	EUV-VB	EL	
1.7 CDTi 81 kW (110 PS) A 17 DTC, A 17 DTE	06.2012→10.2015		7.03073.01.0	DW-TL	EP	
			7.03085.02.0	DW-TL	EP	
			7.02461.01.0	EUV-LS	EL	
1.7 CDTi 81 kW (110 PS) A 17 DTJ	06.2012→10.2015		7.02461.01.0	EUV-LS	EL	
1.7 CDTi 96 kW (131 PS) A 17 DTF, A 17 DTS	06.2012→10.2015		7.03073.01.0	DW-TL	EP	
			7.03085.02.0	DW-TL	EP	
			7.02461.01.0	EUV-LS	EL	
ASTRA Mk VII (K) (B16)						24
1.0 66-77 kW (90-105 PS) B 10 XFL, D 10 XFL	07.2015→		7.03351.12.0	LDRV	EP	
			7.03381.14.0	SUV	EL	

V







ASTRA Mk VII (K) (B16) **24**

1.4 Turbo 88-92 kW (120-125 PS) B 14 XFL	07.2015→		7.03381.14.0	SUV	EL	
1.4 Turbo 103-112 kW (140-152 PS) B 14 XFT	07.2015→		7.03381.14.0	SUV	EL	
1.6 BiTurbo 110 kW (150 PS) D 16 DTR	08.2018→		7.02256.44.0	EUV-AGR	EL	
1.6 CDTi 70-81 kW (95-110 PS) B 16 DTE, B 16 DTU	07.2015→		7.08681.01.0	EOV	EH	
			7.02256.44.0	EUV-AGR	EL	
1.6 CDTi 88-100 kW (120-136 PS) B 16 DTH	07.2015→		7.08681.01.0	EOV	EH	
			7.02256.44.0	EUV-AGR	EL	
1.6 CDTi 70-81 kW (95-110 PS) B 16 DTE	07.2015→		7.08681.01.0	EOV	EH	
1.6 CDTi 118 kW (160 PS) B 16 DTR	11.2015→		7.08681.01.0	EOV	EH	
			7.02256.44.0	EUV-AGR	EL	

ASTRA Mk VII (K) Estate (B16) **25**

1.0 66-77 kW (90-105 PS) B 10 XFL, D 10 XFL	11.2015→		7.03351.12.0	LDRV	EP	
			7.03381.14.0	SUV	EL	
1.4 Turbo 88-92 kW (120-125 PS) B 14 XFL	11.2015→		7.03381.14.0	SUV	EL	
1.4 Turbo 103-112 kW (140-152 PS) B 14 XFT	11.2015→		7.03381.14.0	SUV	EL	
1.6 BiTurbo 110 kW (150 PS) D 16 DTR	08.2018→		7.02256.44.0	EUV-AGR	EL	
1.6 CDTi 70-81 kW (95-110 PS) B 16 DTE, B 16 DTU	07.2015→		7.08681.01.0	EOV	EH	
			7.02256.44.0	EUV-AGR	EL	
1.6 CDTi 88-100 kW (120-136 PS) B 16 DTH	11.2015→		7.08681.01.0	EOV	EH	
			7.02256.44.0	EUV-AGR	EL	
1.6 CDTi 118 kW (160 PS) B 16 DTR	11.2015→		7.08681.01.0	EOV	EH	
			7.02256.44.0	EUV-AGR	EL	
1.6 CDTi 70-81 kW (95-110 PS) B 16 DTE	11.2015→		7.08681.01.0	EOV	EH	































CALIBRA (C89) **26**

2.0 i 16V 100 kW (136 PS) X 20 XEV	06.1990→07.1997		7.06269.01.0	LLR	EL	
2.0 i 16V 4x4 100 kW (136 PS) X 20 XEV	02.1994→07.1997		7.06269.01.0	LLR	EL	

CASCADA Convertible (W13) **27**







1.4 103-110 kW (140-150 PS) A 14 NET, B 14 NET	02.2013→		7.03833.02.0	EUV-VB	EL	
			7.06117.07.0	ZM-NWV	EL	mit Dichtring with O-ring
1.6 125 kW (170 PS) A 16 XHT	02.2013→		7.03351.12.0	LDRV	EP	
1.6 147 kW (200 PS) A 16 SHT	11.2013→		7.03351.12.0	LDRV	EP	
2.0 CDTi 118-121 kW (160-165 PS) A 20 DTH	02.2013→		7.03978.01.0	DW-TL	EP	

V







						
CASCADA Convertible (W13)						27
2.0 CDTI 140-143 kW (190-194 PS) A 20 DTR	02.2013→		7.03978.01.0	DW-TL	EP	für OE-Nummer: 55573362, 55575611, 8 51 017, 8 51 042 for OE number: 55573362, 55575611, 8 51 017, 8 51 042
			7.03460.02.0*	STE	EP	
			↳7.01420.02.0	DW-TL	EP	
			↳7.03073.01.0	DW-TL	EP	
2.0 CDTI 125 kW (170 PS) B 20 DTH	07.2015→		7.08681.02.0	EOV	EH	
			7.02256.44.0	EUV-AGR	EL	
CAVALIER Mk II Saloon (J82)						28
1.6 i 55-61 kW (75-83 PS) E 16 NZ	08.1986→08.1988		7.05432.00.0	SM	EL	mit Dichtring with O-ring
1.6 i Cat 55-61 kW (75-83 PS) C 16 LZ, C 16 NZ	08.1986→08.1988		7.05432.00.0	SM	EL	mit Dichtring with O-ring
CAVALIER Mk III Hatchback (J89)						29
1.6 i 52 kW (71 PS) X 16 SZ	09.1993→11.1995		7.05432.00.0	SM	EL	mit Dichtring with O-ring
1.8 66 kW (90 PS) C 18 NZ	09.1988→10.1990		7.05432.00.0	SM	EL	mit Dichtring with O-ring
1.8 i Cat 66 kW (90 PS) C 18 NZ	03.1990→11.1995		7.05432.00.0	SM	EL	mit Dichtring with O-ring
2.0 i 16V 100 kW (136 PS) X 20 XEV	09.1992→08.1995		7.06269.01.0	LLR	EL	
CAVALIER Mk III Saloon (J89)						30
1.6 i 52 kW (71 PS) X 16 SZ	09.1993→11.1995		7.05432.00.0	SM	EL	mit Dichtring with O-ring
1.8 66 kW (90 PS) C 18 NZ	09.1988→08.1995		7.05432.00.0	SM	EL	mit Dichtring with O-ring
1.8 i Cat 66 kW (90 PS) C 18 NZ	03.1990→11.1995		7.05432.00.0	SM	EL	mit Dichtring with O-ring
2.0 SRi 16V 100 kW (136 PS) X 20 XEV	09.1992→08.1995		7.06269.01.0	LLR	EL	
COMBO Mk IV (E) Life (X19)						31
1.2 81 kW (110 PS) D 12 XHL (EB2ADT)	06.2018→		7.08681.09.0	EOV	EH	
1.2 96 kW (131 PS) F 12 XHT (EB2ADTS)	07.2019→		7.08681.09.0	EOV	EH	
1.5 75 kW (102 PS) D 15 DT (DV5RD)	06.2018→		7.08681.00.0	EOV	EH	
1.5 88-96 kW (120-131 PS) D 15 DTH (DV5RC)	06.2018→		7.08681.00.0	EOV	EH	
COMBO TOUR Mk II (C) (F25)						32
1.3 CDTI 16V 51-55 kW (69-75 PS) Z 13 DTJ	07.2006→02.2012		7.01421.01.0	DW-TL	EP	
1.4 66 kW (90 PS) Z 14 XEP	10.2004→09.2010		7.02256.28.0	SV-PDA	EP	
1.6 62-64 kW (84-87 PS) Z 16 SE	10.2001→06.2004		7.02256.22.0	AKF	EL	
1.6 CNG 69-74 kW (94-101 PS) Z 16 YNG	04.2005→02.2012		7.02256.22.0	AKF	EL	
1.6 CNG 69-74 kW (94-101 PS) Z 16 YNG	06.2006→09.2010		7.02256.22.0	AKF	EL	
1.7 CDTI 16V 74 kW (100 PS) Z 17 DTH	12.2004→09.2010		7.02461.01.0	EUV-AGR	EL	







CORSA Mk I (B) (S93) 33

1.2 i 33 kW (45 PS) C 12 NZ, X 12 SZ	03.1993→09.2000	 7.05432.01.0	SM	EL	mit Dichtring with O-ring
1.4 i 40-44 kW (54-60 PS) X 14 SZ	03.1993→09.2000	 7.05432.00.0	SM	EL	mit Dichtring with O-ring
1.4 i 44 kW (60 PS) C 14 NZ	03.1993→09.2000	 7.05432.00.0	SM	EL	mit Dichtring with O-ring für Fahrzeuge mit Automatikgetriebe for vehicles with automatic transmission
		7.05432.01.0	SM	EL	mit Dichtring with O-ring für Fahrzeuge mit Schaltgetriebe for vehicles with manual transmission
1.4 i 16V 66 kW (90 PS) X 14 XE	09.1994→09.2000	 7.05432.11.0	SM	EL	mit Dichtring with O-ring
1.4 i S 60 kW (82 PS) C 14 SE	03.1993→09.2000	 7.05432.11.0	SM	EL	mit Dichtring with O-ring
1.6 GSI 16V 78-80 kW (106-109 PS) C 16 XE	03.1993→09.2000	 7.05432.11.0	SM	EL	mit Dichtring with O-ring
1.6 i 16V 78-80 kW (106-109 PS) X 16 XE	09.1994→09.2000	 7.05432.11.0	SM	EL	mit Dichtring with O-ring

CORSA Mk II (C) (X01) 34

1.0 12V (F08, F68) 44 kW (60 PS) Z 10 XEP	11.2003→10.2006	 7.02256.28.0	SV-PDA	EP	
1.2 Twinport (F08, F68) 59 kW (80 PS) Z 12 XEP	07.2004→10.2006	 7.02256.28.0	SV-PDA	EP	
1.4 16V (F08, F68) 66 kW (90 PS) Z 14 XE	09.2000→10.2006	 7.02256.22.0	AKF	EL	
1.4 Twinport (F08, F68) 66 kW (90 PS) Z 14 XEP	06.2003→10.2006	 7.02256.28.0	SV-PDA	EP	
1.7 CDTI 16V (F08, F68) 74 kW (100 PS) Z 17 DTH	08.2000→09.2006	 7.03088.01.0	DW-TL	EP	
		7.02461.01.0	EUV-AGR	EL	
1.7 DI 16V (F08, F68) 48 kW (65 PS) Y 17 DTL	08.2000→09.2006	 7.03085.02.0	DW-AGR	EP	
		7.03088.01.0	DW-TL	EP	
1.7 DTI 16V (F08, F68) 55 kW (75 PS) Y 17 DT	08.2000→09.2006	 7.03085.02.0	DW-AGR	EP	
		7.03088.01.0	DW-TL	EP	



























CORSA Mk III (D) (S07) 35





















1.0 (L08) 44 kW (60 PS) Z 10 XEP	08.2006→08.2014	 7.02256.28.0	SV-PDA	EP	
1.0 i 12V (L08) 44-48 kW (60-65 PS) A 10 XEP	01.2010→08.2014	 7.02256.43.0	EUV-SR	EL	
		 7.02256.28.0	SV-PDA	EP	
1.2 (L08) 59 kW (80 PS) Z 12 XEP	08.2006→08.2014	 7.02256.43.0	EUV-SR	EL	
1.2 (L08) 51 kW (69 PS) A 12 XEL	06.2010→08.2014	 7.06117.07.0	ZM-NWV	EL	mit Dichtring with O-ring
		 7.02256.28.0	SV-PDA	EP	

V

					
CORSA Mk III (D) (S07)					
1.2 LPG (L08) 61-63 kW (83-86 PS) A 12 XER	08.2011→08.2014		7.02256.43.0	EUV-SR	EL
			7.06117.07.0	ZM-NWV	EL mit Dichtring with O-ring
1.2 i 16V (L08) 61-63 kW (83-86 PS) A 12 XER	12.2009→08.2014		7.02256.43.0	EUV-SR	EL
			7.06117.07.0	ZM-NWV	EL mit Dichtring with O-ring
1.3 CDTI (L08) 51-55 kW (69-75 PS) Z 13 DTJ	08.2006→08.2014		7.01420.02.0	DW-TL	EP für Fahrzeuge mit Diesel-Partikel-Filter (DPF) for vehicles with diesel soot filter
1.3 CDTI (L08) 55 kW (75 PS) A 13 DTC	08.2006→08.2014		7.03653.01.0	DW-TL	EP
			7.01981.07.0	SV-AGR-K	EP
1.3 CDTI (L08) 66-74 kW (90-101 PS) Z 13 DTH	08.2006→08.2014		7.01420.02.0	DW-TL	EP
1.3 CDTI (L08) 70 kW (95 PS) A 13 DTE, A 13 DTR, Z 13 DTE	07.2010→08.2014		7.03653.01.0	DW-TL	EP
			7.01981.07.0	SV-AGR-K	EP
1.4 (L08) 66 kW (90 PS) Z 14 XEP	08.2006→08.2014		7.02256.28.0	SV-PDA	EP
1.4 (L08) 74 kW (101 PS) A 14 XER	01.2010→08.2014		7.02256.43.0	EUV-SR	EL
			7.06117.07.0	ZM-NWV	EL mit Dichtring with O-ring
1.4 (L08) 88 kW (120 PS) A 14 NEL	08.2012→08.2014		7.03833.02.0	EUV-VB	EL
			7.06117.07.0	ZM-NWV	EL mit Dichtring with O-ring
1.4 LPG (L08) 66 kW (90 PS) Z 14 XEP	07.2006→08.2014		7.02256.28.0	SV-PDA	EP
1.6 SRi (L08) 110 kW (150 PS) A 16 LEL, Z 16 LEL	05.2007→08.2014		7.01039.03.0	EUV-VB	EL
			7.03833.02.0	EUV-VB	EL
			7.03833.02.0	LDRV	EL
1.6 VXR (L08) 141-150 kW (192-204 PS) A 16 LER, Z 16 LER	11.2006→08.2014		7.01039.03.0	EUV-VB	EL
			7.03833.02.0	EUV-VB	EL
			7.03833.02.0	LDRV	EL
1.6 VXR (L08) 141-151 kW (192-205 PS) B 16 LER	11.2006→08.2014		7.03833.02.0	EUV-VB	EL
			7.03833.02.0	LDRV	EL
			7.03833.02.0	LDRV	EL
1.6 VXR (L08) 150-155 kW (204-211 PS) A 16 LES	06.2011→08.2014		7.03833.02.0	EUV-VB	EL
			7.03833.02.0	LDRV	EL
1.6 VXR (L08) 150-155 kW (204-211 PS) A 16 LES	06.2011→03.2012		7.03833.02.0	EUV-VB	EL
			7.03833.02.0	LDRV	EL
1.6 VXR (L08) 150-155 kW (204-211 PS) A 16 LES	06.2011→08.2014		7.03833.02.0	EUV-VB	EL
			7.03833.02.0	LDRV	EL

V











					
CORSA Mk III (D) (S07)					35
1.7 CDTI (L08) 92 kW (125 PS) Z 17 DTR	11.2006→08.2014		7.03085.02.0	DW-TL	EP
			7.02461.01.0	EUV-LS	EL
1.7 CDTI (L08) 96 kW (131 PS) A 17 DTS	03.2007→08.2014		7.03073.01.0	DW-TL	EP
			7.03085.02.0	DW-TL	EP
CORSA Mk IV (E) (X15)					36
1.0 66-77 kW (90-105 PS) B 10 XFL, F 10 XFL	08.2014→		7.03351.12.0	LDRV	EP
			7.03381.14.0	SUV	EL
1.0 66-77 kW (90-105 PS) D 10 XFL	08.2014→		7.03351.12.0	LDRV	EP
1.0 85 kW (116 PS) B 10 XFT	08.2014→		7.03351.12.0	LDRV	EP
			7.03381.14.0	SUV	EL
1.2 51 kW (69 PS) B 12 XEL	08.2014→		7.06117.07.0	ZM-NWV	EL mit Dichtring with O-ring
1.4 74 kW (101 PS) B 14 NEJ, D 14 NEJ	08.2014→		7.03833.02.0	EUV-VB	EL
			7.06117.07.0	ZM-NWV	EL mit Dichtring with O-ring
1.4 64-66 kW (87-90 PS) B 14 XEL, D 14 XEL	08.2014→		7.06117.07.0	ZM-NWV	EL mit Dichtring with O-ring
1.4 55-66 kW (75-90 PS) B 14 XEJ	09.2014→		7.06117.07.0	ZM-NWV	EL mit Dichtring with O-ring
1.4 110 kW (150 PS) B 14 NEH	07.2015→		7.03833.02.0	EUV-VB	EL
			7.06117.07.0	ZM-NWV	EL mit Dichtring with O-ring
1.6 VXR 151-155 kW (205-211 PS) B 16 LES	04.2015→		7.01039.03.0	EUV-VB	EL
			7.03833.02.0	LDRV	EL
CORSA Mk V (F)					37
1.2 74-81 kW (101-110 PS) F 12 XHL (EB2ADTD)	07.2019→		7.08681.09.0	EOV	EH
1.5 75 kW (102 PS) D 15 DT (DV5RD)	07.2019→		7.08681.00.0	EOV	EH
CROSSLAND X (P17)					38
1.2 (75) 55-60 kW (75-82 PS) B 12 XE (EB2F)	03.2017→		7.06117.45.0	SV-NWV	EL
1.2 (75) 81 kW (110 PS) B 12 XHL (EB2DT)	03.2017→		7.08681.09.0	EOV	EH
			7.06117.45.0	SV-NWV	EL
1.2 (75) 81 kW (110 PS) D 12 XHL (EB2ADT)	03.2017→		7.08681.09.0	EOV	EH
1.2 (75) 81-96 kW (110-131 PS) B 12 XHT (EB2DTS)	03.2017→		7.08681.09.0	EOV	EH
			7.06117.45.0	SV-NWV	EL
1.2 (75) 96 kW (131 PS) D 12 XHT (EB2ADTS)	03.2017→		7.08681.09.0	EOV	EH
1.5 Turbo D (75) 75 kW (102 PS) D 15 DT (DV5RD)	06.2018→		7.08681.00.0	EOV	EH
1.6 Turbo D (75) 73 kW (99 PS) B 16 DT (DV6FD)	03.2017→		7.08681.00.0	EOV	EH
1.6 Turbo D (75) 85-88 kW (116-120 PS) B 16 DTH (DV6FC)	03.2017→		7.08681.00.0	EOV	EH

						
GRANDLAND X (A18)						39
1.2 Turbo (75) 81-96 kW (110-131 PS) B 12 XHT (EB2DTS)	06.2017→		7.08681.09.0	EOV	EH	Organisationsnummer ab: 1472089 RPO number from: 1472089
			7.06117.45.0	SV-NWV	EL	Organisationsnummer ab: 1472089 RPO number from: 1472089
1.2 Turbo (75) 96 kW (131 PS) D 12 XHT (EB2ADTS)	06.2017→		7.08681.09.0	EOV	EH	Organisationsnummer ab: 1472089, 15468EN RPO number from: 1472089, 15468EN Euro 6d-Temp Euro 6d-Temp
1.5 Turbo D (75) 88-96 kW (120-131 PS) D 15 DTH (DV5RC)	04.2018→		7.08681.00.0	EOV	EH	Organisationsnummer ab: 1472089, 15468EN RPO number from: 1472089, 15468EN
1.6 Turbo D (75) 85-88 kW (116-120 PS) B 16 DTH (DV6FC)	06.2017→		7.08681.00.0	EOV	EH	Organisationsnummer ab: 1472089 RPO number from: 1472089
INSIGNIA Mk I (A) Country Tourer (G09)						40
1.6 CDTI (47) 88-100 kW (120-136 PS) B 16 DTH	07.2015→05.2017		7.08681.01.0	EOV	EH	
2.0 Biturbo CDTI 4x4 (47) 140-143 kW (190-194 PS) A 20 DTR	09.2013→05.2017		7.01421.01.0	DW-TL	EP	
			7.03652.01.0	DW-TL	EP	für OE-Nummer: 55573732 for OE number: 55573732
			7.03978.01.0	DW-TL	EP	für OE-Nummer: 55573362, 55575611, 8 51 017, 8 51 042 for OE number: 55573362, 55575611, 8 51 017, 8 51 042
2.0 CDTI (47) 118-121 kW (160-165 PS) A 20 DTH	07.2013→05.2017		7.03978.01.0	DW-TL	EP	
2.0 CDTI (47) 118-121 kW (160-165 PS) A 20 DTH	07.2013→05.2017		7.03978.01.0	DW-TL	EP	
2.0 CDTI (47) 125 kW (170 PS) B 20 DTH	11.2014→05.2017		7.08681.02.0	EOV	EH	
			7.02256.44.0	EUV-AGR	EL	
2.0 CDTI 4x4 (47) 125 kW (170 PS) B 20 DTH	11.2014→05.2017		7.08681.02.0	EOV	EH	
			7.02256.44.0	EUV-AGR	EL	
INSIGNIA Mk I (A) Hatchback (G09)						41
1.4 (68) 103-110 kW (140-150 PS) A 14 NET, B 14 NET	04.2011→05.2017		7.03833.02.0	EUV-VB	EL	
			7.06117.07.0	ZM-NWV	EL	mit Dichtring with O-ring
1.4 LPG (68) 103 kW (140 PS) A 14 NET	07.2012→05.2017		7.03833.02.0	EUV-VB	EL	
			7.06117.07.0	ZM-NWV	EL	mit Dichtring with O-ring
1.6 85 kW (116 PS) A 16 XER	07.2008→07.2012		7.02256.43.0	EUV-SR	EL	
			7.06117.08.0	SV-NWV	EH	mit Dichtring with O-ring
1.6 CDTI (68) 88-100 kW (120-136 PS) B 16 DTH	07.2015→05.2017		7.08681.01.0	EOV	EH	
			7.02256.44.0	EUV-AGR	EL	
1.6 Turbo (68) 132 kW (180 PS) A 16 LET	01.2009→05.2017		7.01039.03.0	EUV-VB	EL	











INSIGNIA Mk I (A) Hatchback (G09)

41

			7.03833.02.0 7.06117.08.0	LDRV SV-NWV	EL EH	mit Dichtring with O-ring
1.8 (68) 103 kW (140 PS) A 18 XER, B 18 XER	07.2008→05.2017		7.02256.43.0 7.06117.08.0	EUV-SR SV-NWV	EL EH	mit Dichtring with O-ring
2.0 Biturbo CDTI (68) 140-143 kW (190-194 PS) A 20 DTR	03.2012→05.2017		7.03978.01.0 7.07400.09.0* ↳ 7.01421.01.0 ↳ 7.03652.01.0 7.07400.10.0* ↳ 7.01421.01.0 ↳ 7.03652.01.0	DW-TL STE DW-TL DW-TL STE DW-TL DW-TL	EP EP EP EP EP EP	für OE-Nummer: 55573362, 55575611, 8 51 017, 8 51 042 for OE number: 55573362, 55575611, 8 51 017, 8 51 042 für OE-Nummer: 55567313, 58 51 415 for OE number: 55567313, 58 51 415 für OE-Nummer: 55580532, 8 51 070 for OE number: 55580532, 8 51 070
2.0 Biturbo CDTI 4x4 (68) 140-143 kW (190-194 PS) A 20 DTR	03.2012→05.2017		7.03978.01.0 7.07400.09.0* ↳ 7.01421.01.0 ↳ 7.03652.01.0 7.07400.10.0* ↳ 7.01421.01.0 ↳ 7.03652.01.0	DW-TL STE DW-TL DW-TL STE DW-TL DW-TL	EP EP EP EP EP EP	für OE-Nummer: 55573362, 55575611, 8 51 017, 8 51 042 for OE number: 55573362, 55575611, 8 51 017, 8 51 042 für OE-Nummer: 55567313, 58 51 415 for OE number: 55567313, 58 51 415 für OE-Nummer: 55580532, 8 51 070 for OE number: 55580532, 8 51 070
2.0 CDTI (68) 81 kW (110 PS) A 20 DTC	07.2008→05.2017		7.03978.01.0	DW-TL	EP	
2.0 CDTI (68) 96 kW (131 PS) A 20 DT, A 20 DTJ	07.2008→12.2014		7.03978.01.0	DW-TL	EP	
2.0 CDTI (68) 118-121 kW (160-165 PS) A 20 DTH	07.2008→05.2017		7.03978.01.0	DW-TL	EP	
2.0 CDTI (68) 140-143 kW (190-194 PS) A 20 DTR	10.2008→05.2017		7.03978.01.0 7.07400.09.0* ↳ 7.01421.01.0 ↳ 7.03652.01.0 7.07400.10.0* ↳ 7.01421.01.0 ↳ 7.03652.01.0	DW-TL STE DW-TL DW-TL STE DW-TL DW-TL	EP EP EP EP EP EP	für OE-Nummer: 55573362, 55575611, 8 51 017, 8 51 042 for OE number: 55573362, 55575611, 8 51 017, 8 51 042 für OE-Nummer: 55567313, 58 51 415 for OE number: 55567313, 58 51 415 für OE-Nummer: 55580532, 8 51 070 for OE number: 55580532, 8 51 070
V 2.0 CDTI (68) 88-103 kW (120-140 PS) A 20 DTE	03.2012→03.2016		7.03978.01.0	DW-TL	EP	
2.0 CDTI (68) 118-121 kW (160-165 PS) A 20 DTH	07.2013→05.2017		7.03978.01.0	DW-TL	EP	
2.0 CDTI (68) 88-103 kW (120-140 PS) A 20 DTE	07.2013→05.2017		7.03978.01.0	DW-TL	EP	
2.0 CDTI (68) 125 kW (170 PS) B 20 DTH	11.2014→05.2017		7.08681.02.0	EOV	EH	



INSIGNIA Mk I (A) Hatchback (G09) 41

		7.02256.44.0	EUV-AGR	EL	
2.0 CDTI 4x4 (68) 118-121 kW (160-165 PS) A 20 DTH	07.2008→05.2017	 7.03978.01.0	DW-TL	EP	
2.0 CDTI 4x4 (68) 140-143 kW (190-194 PS) A 20 DTR	05.2009→05.2017	 7.03978.01.0	DW-TL	EP	für OE-Nummer: 55573362, 55575611, 8 51 017, 8 51 042 for OE number: 55573362, 55575611, 8 51 017, 8 51 042
		7.07400.09.0*	STE	EP	für OE-Nummer: 55567313, 58 51 415 for OE number: 55567313, 58 51 415
		↳ 7.01421.01.0	DW-TL	EP	
		↳ 7.03652.01.0	DW-TL	EP	
		7.07400.10.0*	STE	EP	für OE-Nummer: 55580532, 8 51 070 for OE number: 55580532, 8 51 070
		↳ 7.01421.01.0	DW-TL	EP	
		↳ 7.03652.01.0	DW-TL	EP	
2.0 CDTI 4x4 (68) 125 kW (170 PS) B 20 DTH	11.2014→05.2017	 7.08681.02.0	EOV	EH	
		7.02256.44.0	EUV-AGR	EL	
2.0 Turbo (68) 162-206 kW (220-280 PS) A 20 NFT	07.2008→05.2017	 7.02721.06.0*	EUV-VB	EL	mit Halter with holder
		↳ 7.01441.04.0	EUV-VB	EL	
		7.06117.05.0	SV-NWV	EH	mit Dichtring with O-ring
		7.06117.06.0	SV-NWV	EH	mit Dichtring with O-ring
2.0 Turbo (68) 162-184 kW (220-250 PS) A 20 NHT	07.2008→05.2017	 5.02549.03.0*	EUV-VB	EL	mit Halter with holder
		↳ 7.01441.04.0	EUV-VB	EL	
		7.03357.04.0	LDRV	EL	
		7.06117.05.0	SV-NWV	EH	mit Dichtring with O-ring
		7.06117.06.0	SV-NWV	EH	mit Dichtring with O-ring
2.0 Turbo (68) 162-184 kW (220-250 PS) A 20 NHT, B 20 NHT	07.2011→05.2017	 7.03357.04.0	LDRV	EL	
		7.03381.15.0	SUV	EL	
		7.06117.56.0	SV-NWV	EH	mit Dichtring with O-ring
		7.06117.57.0	SV-NWV	EH	mit Dichtring with O-ring
2.0 Turbo 4x4 (68) 162-184 kW (220-250 PS) A 20 NHT	07.2008→05.2017	 5.02549.03.0*	EUV-VB	EL	mit Halter with holder
		↳ 7.01441.04.0	EUV-VB	EL	
		7.03357.04.0	LDRV	EL	
		7.06117.05.0	SV-NWV	EH	mit Dichtring with O-ring
		7.06117.06.0	SV-NWV	EH	mit Dichtring with O-ring
2.8 V6 Turbo 4x4 (68) 191 kW (260 PS) A 28 NET	07.2008→05.2017	 7.28311.04.0	LDRV	EP	
		7.00175.04.0	SUV	EL	
		7.06117.04.0	SV-NWV	EH	mit Wellendichtring With shaft sealing ring
2.8 VXR (68) 239 kW (325 PS) A 28 NER	07.2009→05.2017	 7.28311.04.0	LDRV	EP	









V



INSIGNIA Mk I (A) Hatchback (G09) 41

			7.00175.04.0	SUV	EL	mit Wellendichtring With shaft sealing ring
			7.06117.04.0	SV-NWV	EH	
2.8 VXR (68) 239 kW (325 PS) B 28 NER	07.2009→05.2017		7.28311.04.0	LDRV	EP	
			7.00175.04.0	SUV	EL	











INSIGNIA Mk I (A) Saloon (G09) 42

1.4 (69) 103 kW (140 PS) A 14 NET	04.2011→05.2017		7.03833.02.0	EUV-VB	EL	mit Dichtring with O-ring
			7.06117.07.0	ZM-NWV	EL	
1.4 LPG (69) 103 kW (140 PS) A 14 NET	07.2012→05.2017		7.03833.02.0	EUV-VB	EL	mit Dichtring with O-ring
			7.06117.07.0	ZM-NWV	EL	
1.6 85 kW (116 PS) A 16 XER	07.2008→07.2012		7.02256.43.0	EUV-SR	EL	mit Dichtring with O-ring
			7.06117.08.0	SV-NWV	EH	
1.6 CDTi (69) 88-100 kW (120-136 PS) B 16 DTH	07.2015→05.2017		7.08681.01.0	EOV	EH	
			7.02256.44.0	EUV-AGR	EL	
1.6 Turbo (69) 132 kW (180 PS) A 16 LET	01.2009→05.2017		7.01039.03.0	EUV-VB	EL	mit Dichtring with O-ring
			7.03833.02.0	LDRV	EL	
			7.06117.08.0	SV-NWV	EH	
1.8 (69) 103 kW (140 PS) A 18 XER	07.2008→05.2017		7.02256.43.0	EUV-SR	EL	mit Dichtring with O-ring
			7.06117.08.0	SV-NWV	EH	
2.0 Biturbo CDTI (69) 140-143 kW (190-194 PS) A 20 DTR	03.2012→05.2017		7.03978.01.0	DW-TL	EP	für OE-Nummer: 55573362, 55575611, 8 51 017, 8 51 042 for OE number: 55573362, 55575611, 8 51 017, 8 51 042
			7.07400.09.0*	STE	EP	für OE-Nummer: 55567313, 58 51 415 for OE number: 55567313, 58 51 415
			↳ 7.01421.01.0	DW-TL	EP	
			↳ 7.03652.01.0	DW-TL	EP	
			7.07400.10.0*	STE	EP	für OE-Nummer: 55580532, 8 51 070 for OE number: 55580532, 8 51 070
			↳ 7.01421.01.0	DW-TL	EP	
			↳ 7.03652.01.0	DW-TL	EP	
2.0 Biturbo CDTI 4x4 (69) 140-143 kW (190-194 PS) A 20 DTR	03.2012→05.2017		7.03978.01.0	DW-TL	EP	für OE-Nummer: 55573362, 55575611, 8 51 017, 8 51 042 for OE number: 55573362, 55575611, 8 51 017, 8 51 042
			7.07400.09.0*	STE	EP	für OE-Nummer: 55567313, 58 51 415 for OE number: 55567313, 58 51 415
			↳ 7.01421.01.0	DW-TL	EP	
			↳ 7.03652.01.0	DW-TL	EP	
			7.07400.10.0*	STE	EP	für OE-Nummer: 55580532, 8 51 070 for OE number: 55580532, 8 51 070
			↳ 7.01421.01.0	DW-TL	EP	
			↳ 7.03652.01.0	DW-TL	EP	
2.0 CDTI (69) 96 kW (131 PS) A 20 DT, A 20 DTJ	07.2008→12.2014		7.03978.01.0	DW-TL	EP	

V







INSIGNIA Mk I (A) Saloon (G09) 42

2.0 CDTI (69) 118-121 kW (160-165 PS) A 20 DTH	07.2008→05.2017	 7.03978.01.0	DW-TL	EP	
2.0 CDTI (69) 140-143 kW (190-194 PS) A 20 DTR	11.2008→05.2017	 7.03978.01.0 7.07400.09.0* ↳ 7.01421.01.0 ↳ 7.03652.01.0 7.07400.10.0* ↳ 7.01421.01.0 ↳ 7.03652.01.0	DW-TL STE DW-TL DW-TL STE DW-TL DW-TL	EP EP EP EP EP EP EP	für OE-Nummer: 55573362, 55575611, 8 51 017, 8 51 042 for OE number: 55573362, 55575611, 8 51 017, 8 51 042 für OE-Nummer: 55567313, 58 51 415 for OE number: 55567313, 58 51 415 für OE-Nummer: 55580532, 8 51 070 for OE number: 55580532, 8 51 070
2.0 CDTI (69) 118-121 kW (160-165 PS) A 20 DTH	07.2013→05.2017	 7.03978.01.0	DW-TL	EP	
2.0 CDTI (69) 88-103 kW (120-140 PS) A 20 DTE	07.2013→05.2017	 7.03978.01.0	DW-TL	EP	
2.0 CDTI (69) 125 kW (170 PS) B 20 DTH	11.2014→05.2017	 7.08681.02.0 7.02256.44.0	EOV EUV-AGR	EH EL	
2.0 CDTI 4x4 (69) 118-121 kW (160-165 PS) A 20 DTH	07.2008→05.2017	 7.03978.01.0	DW-TL	EP	
2.0 CDTI 4x4 (69) 140-143 kW (190-194 PS) A 20 DTR	05.2009→05.2017	 7.03978.01.0 7.07400.09.0* ↳ 7.01421.01.0 ↳ 7.03652.01.0 7.07400.10.0* ↳ 7.01421.01.0 ↳ 7.03652.01.0	DW-TL STE DW-TL DW-TL STE DW-TL DW-TL	EP EP EP EP EP EP EP	für OE-Nummer: 55573362, 55575611, 8 51 017, 8 51 042 for OE number: 55573362, 55575611, 8 51 017, 8 51 042 für OE-Nummer: 55567313, 58 51 415 for OE number: 55567313, 58 51 415 für OE-Nummer: 55580532, 8 51 070 for OE number: 55580532, 8 51 070
2.0 CDTI 4x4 (69) 125 kW (170 PS) B 20 DTH	11.2014→05.2017	 7.08681.02.0 7.02256.44.0	EOV EUV-AGR	EH EL	
2.0 Turbo (69) 162-206 kW (220-280 PS) A 20 NFT	07.2008→05.2017	 7.02721.06.0* ↳ 7.01441.04.0 7.06117.05.0 7.06117.06.0	EUV-VB EUV-VB SV-NWV SV-NWV	EL EL EH EH	mit Halter with holder mit Dichtring with O-ring mit Dichtring with O-ring
2.0 Turbo (69) 162-184 kW (220-250 PS) A 20 NHT	07.2008→05.2017	 5.02549.03.0* ↳ 7.01441.04.0 7.03357.04.0 7.06117.05.0 7.06117.06.0	EUV-VB EUV-VB LDRV SV-NWV SV-NWV	EL EL EL EH EH	mit Halter with holder mit Dichtring with O-ring mit Dichtring with O-ring











INSIGNIA Mk I (A) Saloon (G09) 42

2.0 Turbo (69) 162-184 kW (220-250 PS) A 20 NHT, B 20 NHT	09.2011→05.2017		7.03357.04.0	LDRV	EL	mit Dichtring with O-ring
			7.03381.15.0	SUV	EL	
			7.06117.56.0	SV-NWV	EH	
2.0 Turbo 4x4 (69) 162-184 kW (220-250 PS) A 20 NHT	07.2008→05.2017		7.06117.57.0	SV-NWV	EH	mit Dichtring with O-ring
			5.02549.03.0*	EUV-VB	EL	mit Halter with holder
			↳ 7.01441.04.0	EUV-VB	EL	
2.0 Turbo 4x4 (69) 162-184 kW (220-250 PS) A 20 NHT	09.2011→05.2017		7.03357.04.0	LDRV	EL	mit Dichtring with O-ring
			7.03381.15.0	SUV	EL	
			7.06117.56.0	SV-NWV	EH	
2.8 V6 Turbo 4x4 (69) 191 kW (260 PS) A 28 NET	07.2008→05.2017		7.06117.06.0	SV-NWV	EH	mit Dichtring with O-ring
			7.28311.04.0	LDRV	EP	
			7.00175.04.0	SUV	EL	
2.8 VXR (69) 239 kW (325 PS) A 28 NER	07.2009→05.2017		7.06117.04.0	SV-NWV	EH	mit Wellendichtring With shaft sealing ring
			7.00175.04.0	SUV	EL	
			7.28311.04.0	LDRV	EP	











INSIGNIA Mk I (A) Sports Tourer (G09) 43

1.4 (35) 103-110 kW (140-150 PS) A 14 NET, B 14 NET	04.2011→05.2017		7.03833.02.0	EUV-VB	EL	mit Dichtring with O-ring
			7.06117.07.0	ZM-NWV	EL	
1.4 LPG (35) 103 kW (140 PS) A 14 NET	07.2012→05.2017		7.03833.02.0	EUV-VB	EL	mit Dichtring with O-ring
			7.06117.07.0	ZM-NWV	EL	
1.6 85 kW (116 PS) A 16 XER	07.2008→07.2012		7.02256.43.0	EUV-SR	EL	mit Dichtring with O-ring
			7.06117.08.0	SV-NWV	EH	
1.6 CDTI (35) 88-100 kW (120-136 PS) B 16 DTH	07.2015→05.2017		7.08681.01.0	EOV	EH	
			7.02256.44.0	EUV-AGR	EL	
1.6 Turbo (35) 132 kW (180 PS) A 16 LET	01.2009→05.2017		7.01039.03.0	EUV-VB	EL	mit Dichtring with O-ring
			7.03833.02.0	LDRV	EL	
			7.06117.08.0	SV-NWV	EH	
1.8 (35) 103 kW (140 PS) A 18 XER	07.2008→05.2017		7.02256.43.0	EUV-SR	EL	



INSIGNIA Mk I (A) Sports Tourer (G09)











43

		7.06117.08.0	SV-NWV	EH	mit Dichtring with O-ring
2.0 Biturbo CDTI (35) 140-143 kW (190-194 PS) A 20 DTR	03.2012→05.2017	 7.03978.01.0	DW-TL	EP	für OE-Nummer: 55573362, 55575611, 8 51 017, 8 51 042 for OE number: 55573362, 55575611, 8 51 017, 8 51 042
		7.07400.09.0*	STE	EP	für OE-Nummer: 55567313, 58 51 415 for OE number: 55567313, 58 51 415
		↳ 7.01421.01.0	DW-TL	EP	
		↳ 7.03652.01.0	DW-TL	EP	
		7.07400.10.0*	STE	EP	für OE-Nummer: 55580532, 8 51 070 for OE number: 55580532, 8 51 070
		↳ 7.01421.01.0	DW-TL	EP	
		↳ 7.03652.01.0	DW-TL	EP	
2.0 Biturbo CDTI 4x4 (35) 140-143 kW (190-194 PS) A 20 DTR	03.2012→05.2017	 7.03978.01.0	DW-TL	EP	für OE-Nummer: 55573362, 55575611, 8 51 017, 8 51 042 for OE number: 55573362, 55575611, 8 51 017, 8 51 042
		7.07400.09.0*	STE	EP	für OE-Nummer: 55567313, 58 51 415 for OE number: 55567313, 58 51 415
		↳ 7.01421.01.0	DW-TL	EP	
		↳ 7.03652.01.0	DW-TL	EP	
		7.07400.10.0*	STE	EP	für OE-Nummer: 55580532, 8 51 070 for OE number: 55580532, 8 51 070
		↳ 7.01421.01.0	DW-TL	EP	
		↳ 7.03652.01.0	DW-TL	EP	
2.0 CDTI (35) 81 kW (110 PS) A 20 DTC	07.2008→05.2017	 7.03978.01.0	DW-TL	EP	
2.0 CDTI (35) 96 kW (131 PS) A 20 DT, A 20 DTJ	07.2008→12.2014	 7.03978.01.0	DW-TL	EP	
2.0 CDTI (35) 118-121 kW (160-165 PS) A 20 DTH	07.2008→05.2017	 7.03978.01.0	DW-TL	EP	
2.0 CDTI (35) 140-143 kW (190-194 PS) A 20 DTR	11.2008→05.2017	 7.03978.01.0	DW-TL	EP	für OE-Nummer: 55573362, 55575611, 8 51 017, 8 51 042 for OE number: 55573362, 55575611, 8 51 017, 8 51 042
		7.07400.09.0*	STE	EP	für OE-Nummer: 55567313, 58 51 415 for OE number: 55567313, 58 51 415
		↳ 7.01421.01.0	DW-TL	EP	
		↳ 7.03652.01.0	DW-TL	EP	
		7.07400.10.0*	STE	EP	für OE-Nummer: 55580532, 8 51 070 for OE number: 55580532, 8 51 070
		↳ 7.01421.01.0	DW-TL	EP	
		↳ 7.03652.01.0	DW-TL	EP	
2.0 CDTI (35) 88-103 kW (120-140 PS) A 20 DTE	03.2012→03.2016	 7.03978.01.0	DW-TL	EP	
2.0 CDTI (35) 88-103 kW (120-140 PS) A 20 DTE	07.2013→05.2017	 7.03978.01.0	DW-TL	EP	
2.0 CDTI (35) 118-121 kW (160-165 PS) A 20 DTH	07.2013→05.2017	 7.03978.01.0	DW-TL	EP	
2.0 CDTI (35) 125 kW (170 PS) B 20 DTH	11.2014→05.2017	 7.08681.02.0	EOV	EH	
		7.02256.44.0	EUV-AGR	EL	
2.0 CDTI 4x4 (35) 118-121 kW (160-165 PS) A 20 DTH	07.2008→05.2017	 7.03978.01.0	DW-TL	EP	

























V



INSIGNIA Mk I (A) Sports Tourer (G09) 43





2.0 CDTI 4x4 (35) 140-143 kW (190-194 PS) A 20 DTR	05.2009→05.2017		7.03978.01.0	DW-TL	EP	für OE-Nummer: 55573362, 55575611, 8 51 017, 8 51 042 for OE number: 55573362, 55575611, 8 51 017, 8 51 042
			7.07400.09.0*	STE	EP	für OE-Nummer: 55567313, 58 51 415 for OE number: 55567313, 58 51 415
			↳ 7.01421.01.0	DW-TL	EP	
			↳ 7.03652.01.0	DW-TL	EP	
			7.07400.10.0*	STE	EP	für OE-Nummer: 55580532, 8 51 070 for OE number: 55580532, 8 51 070
			↳ 7.01421.01.0 ↳ 7.03652.01.0	DW-TL DW-TL	EP EP	
2.0 CDTI 4x4 (35) 125 kW (170 PS) B 20 DTH	11.2014→05.2017		7.08681.02.0	EOV	EH	
			7.02256.44.0	EUV-AGR	EL	
2.0 Turbo (35) 162-206 kW (220-280 PS) A 20 NFT	07.2008→05.2017		7.02721.06.0*	EUV-VB	EL	mit Halter with holder
			↳ 7.01441.04.0	EUV-VB	EL	
			7.06117.05.0	SV-NWV	EH	mit Dichtring with O-ring
2.0 Turbo (35) 162-184 kW (220-250 PS) A 20 NHT	07.2008→05.2017		5.02549.03.0*	EUV-VB	EL	mit Halter with holder
			↳ 7.01441.04.0	EUV-VB	EL	
			7.03357.04.0	LDRV	EL	
			7.06117.05.0	SV-NWV	EH	mit Dichtring with O-ring
2.0 Turbo (35) 162-184 kW (220-250 PS) A 20 NHT, B 20 NHT	07.2011→05.2017		7.06117.06.0	SV-NWV	EH	mit Dichtring with O-ring
			7.03357.04.0	LDRV	EL	
			7.03381.15.0	SUV	EL	
2.0 Turbo (35) 162-184 kW (220-250 PS) A 20 NHT, B 20 NHT	07.2011→05.2017		7.06117.56.0	SV-NWV	EH	mit Dichtring with O-ring
			7.06117.57.0	SV-NWV	EH	mit Dichtring with O-ring
			7.06117.05.0	SV-NWV	EH	mit Dichtring with O-ring
2.0 Turbo 4x4 (35) 162-184 kW (220-250 PS) A 20 NHT	07.2008→05.2017		5.02549.03.0*	EUV-VB	EL	mit Halter with holder
			↳ 7.01441.04.0	EUV-VB	EL	
			7.03357.04.0	LDRV	EL	
			7.06117.05.0	SV-NWV	EH	mit Dichtring with O-ring
2.8 V6 Turbo (35) 191 kW (260 PS) A 28 NET	08.2008→05.2017		7.06117.06.0	SV-NWV	EH	mit Dichtring with O-ring
			7.28311.04.0	LDRV	EP	
			7.00175.04.0	SUV	EL	
2.8 VXR (35) 239 kW (325 PS) A 28 NER	07.2009→05.2017		7.06117.04.0	SV-NWV	EH	mit Wellendichtring With shaft sealing ring
			7.28311.04.0	LDRV	EP	
2.8 VXR (35) 239 kW (325 PS) A 28 NER	07.2009→05.2017		7.00175.04.0	SUV	EL	
			7.06117.04.0	SV-NWV	EH	mit Wellendichtring With shaft sealing ring
			7.28311.04.0	LDRV	EP	

V









						
INSIGNIA Mk II (B) Country Tourer (Z18)						44
2.0 D (47) 125 kW (170 PS) D 20 DTH	03.2017→		7.08681.02.0	EOV	EH	
			7.02256.44.0	EUV-AGR	EL	
2.0 D 4x4 (47) 154 kW (209 PS) D 20 DTR	07.2017→		7.08681.02.0	EOV	EH	
			7.02256.44.0	EUV-AGR	EL	
2.0 D 4x4 (47) 125 kW (170 PS) B 20 DTH	09.2017→		7.02256.44.0	EUV-AGR	EL	
2.0 D 4x4 (47) 125 kW (170 PS) D 20 DTH	09.2017→		7.08681.02.0	EOV	EH	
			7.02256.44.0	EUV-AGR	EL	
INSIGNIA Mk II (B) Hatchback (Z18)						45
1.5 (68) 103 kW (140 PS) B 15 SFL, D 15 SFL	03.2017→		7.03381.14.0	SUV	EL	
1.5 (68) 121 kW (165 PS) B 15 SFT, D 15 SFT	03.2017→		7.03381.14.0	SUV	EL	
1.6 D (68) 70-81 kW (95-110 PS) B 16 DTE, D 16 DTE, D 16 DTN	03.2017→		7.08681.01.0	EOV	EH	
			7.02256.44.0	EUV-AGR	EL	
1.6 D (68) 88-100 kW (120-136 PS) B 16 DTH, D 16 DTH	03.2017→		7.08681.01.0	EOV	EH	
			7.02256.44.0	EUV-AGR	EL	
1.6 Turbo (68) 147 kW (200 PS) D 16 SHT	06.2018→		7.03351.12.0	LDRV	EP	
2.0 4x4 (68) 191-206 kW (260-280 PS) B 20 NFT	03.2017→		7.03357.04.0	LDRV	EL	
			7.06117.56.0	SV-NWV	EH mit Dichtring with O-ring	
			7.06117.57.0	SV-NWV	EH mit Dichtring with O-ring	
2.0 D (68) 125 kW (170 PS) B 20 DTH	03.2017→		7.02256.44.0	EUV-AGR	EL	
2.0 D (68) 125 kW (170 PS) D 20 DTH	03.2017→		7.08681.02.0	EOV	EH	
			7.02256.44.0	EUV-AGR	EL	
2.0 D 4x4 (68) 154 kW (209 PS) D 20 DTR	07.2017→		7.08681.02.0	EOV	EH	
			7.02256.44.0	EUV-AGR	EL	
INSIGNIA Mk II (B) Sports Tourer (Z18)						46
1.5 (35) 103 kW (140 PS) B 15 SFL, D 15 SFL	03.2017→		7.03381.14.0	SUV	EL	
1.5 (35) 121 kW (165 PS) B 15 SFT, D 15 SFT	03.2017→		7.03381.14.0	SUV	EL	
1.6 D (35) 70-81 kW (95-110 PS) B 16 DTE, D 16 DTE, D 16 DTN	03.2017→		7.08681.01.0	EOV	EH	
			7.02256.44.0	EUV-AGR	EL	
1.6 D (35) 88-100 kW (120-136 PS) B 16 DTH, D 16 DTH	03.2017→		7.08681.01.0	EOV	EH	
			7.02256.44.0	EUV-AGR	EL	
1.6 Turbo (35) 147 kW (200 PS) D 16 SHT	06.2018→		7.03351.12.0	LDRV	EP	
2.0 4x4 (35) 191-206 kW (260-280 PS) B 20 NFT	03.2017→		7.03357.04.0	LDRV	EL	
			7.06117.56.0	SV-NWV	EH mit Dichtring with O-ring	









INSIGNIA Mk II (B) Sports Tourer (Z18) 46

			7.06117.57.0	SV-NWV	EH	mit Dichtring with O-ring
2.0 D (35) 125 kW (170 PS) B 20 DTH	03.2017→		7.02256.44.0	EUV-AGR	EL	
2.0 D (35) 125 kW (170 PS) D 20 DTH	03.2017→		7.08681.02.0	EOV	EH	
			7.02256.44.0	EUV-AGR	EL	
2.0 D 4x4 (35) 154 kW (209 PS) D 20 DTR	07.2017→		7.08681.02.0	EOV	EH	
			7.02256.44.0	EUV-AGR	EL	

MERIVA A (X03) 47











1.3 CDTi 51-55 kW (69-75 PS) Z 13 DTJ	01.2003→10.2009		7.01420.02.0	DW-TL	EP	
1.4 16V Twinport 66 kW (90 PS) Z 14 XEP	01.2003→06.2010		7.02256.28.0	SV-PDA	EP	
1.6 Turbo 132 kW (180 PS) Z 16 LET	05.2006→06.2010		7.01039.03.0	EUV-VB	EL	
			7.03833.02.0	LDRV	EL	
1.6 i 62-64 kW (84-87 PS) Z 16 SE	01.2003→06.2010		7.02256.22.0	AKF	EL	
1.6 i 16V 63-74 kW (85-101 PS) Z 16 XE	01.2003→09.2005		7.02256.22.0	AKF	EL	
1.6 i 16V Twinport 74-77 kW (101-105 PS) Z 16 XEP	05.2003→06.2010		7.02256.38.0	AKF	EL	
			7.02256.31.0	SV-PDA	EP	
1.7 CDTi 74 kW (100 PS) Z 17 DTH	09.2003→08.2005		7.03088.01.0	DW-TL	EP	
			7.02461.01.0	EUV-AGR	EL	
1.7 DTi 55 kW (75 PS) Y 17 DT	06.2003→06.2010		7.03088.01.0	DW-TL	EP	

MERIVA Mk II (B) (S10) 48

1.3 CDTi 55 kW (75 PS) A 13 DTC	06.2010→		7.01420.02.0	DW-TL	EP	 →ch. D4167394
			7.04423.01.0	DW-TL	EP	Fahrgestellnummer ab: D4167395 Vehicle Identification Number from: D4167395
			7.01981.07.0	SV-AGR-K	EP	Fahrgestellnummer ab: D4000001 Vehicle Identification Number from: D4000001 Fahrgestellnummer bis: B4999999 Vehicle Identification Number to: B4999999
1.3 CDTi 70 kW (95 PS) A 13 DTE	06.2010→		7.01420.02.0	DW-TL	EP	 →ch. D4167394
			7.04423.01.0	DW-TL	EP	Fahrgestellnummer ab: D4167395 Vehicle Identification Number from: D4167395
			7.01981.07.0	SV-AGR-K	EP	Fahrgestellnummer ab: D4000001 Vehicle Identification Number from: D4000001 Fahrgestellnummer bis: B4999999 Vehicle Identification Number to: B4999999
1.4 55-74 kW (75-101 PS) A 14 XER, B 14 XER	06.2010→		7.02256.43.0	EUV-SR	EL	
			7.06117.07.0	ZM-NWV	EL	mit Dichtring with O-ring
1.4 74-88 kW (101-120 PS) A 14 NEL, B 14 NEL	06.2010→		7.03833.02.0	EUV-VB	EL	

V

MERIVA Mk II (B) (S10) 48

			7.06117.07.0	ZM-NWV	EL	mit Dichtring with O-ring
1.4 103-110 kW (140-150 PS) A 14 NET, B 14 NET	06.2010→		7.03833.02.0	EUV-VB	EL	
			7.06117.07.0	ZM-NWV	EL	mit Dichtring with O-ring
1.4 LPG 88 kW (120 PS) A 14 NEL	06.2011→		7.03833.02.0	EUV-VB	EL	
			7.06117.07.0	ZM-NWV	EL	mit Dichtring with O-ring
1.6 CDTi 70 kW (95 PS) B 16 DTC	01.2014→		7.08681.01.0	EOV	EH	Fahrgestellnummer ab: F4000001 Vehicle Identification Number from: F4000001
			7.02256.44.0	EUV-AGR	EL	
1.6 CDTi 88-100 kW (120-136 PS) B 16 DTH	08.2013→		7.08681.01.0	EOV	EH	Fahrgestellnummer ab: F4000001 Vehicle Identification Number from: F4000001
			7.02256.44.0	EUV-AGR	EL	
1.6 CDTi 70-81 kW (95-110 PS) B 16 DTE, B 16 DTL, B 16 DTN	07.2014→		7.08681.01.0	EOV	EH	 B 16 DTE, B 16 DTL, B 16 DTN: Fahrgestellnummer ab: F4000001 Vehicle Identification Number from: F4000001
			7.02256.44.0	EUV-AGR	EL	
1.7 CDTi 74 kW (101 PS) A 17 DT	06.2010→		7.03085.02.0	DW-TL	EP	
			7.02461.01.0	EUV-LS	EL	
1.7 CDTi 96 kW (131 PS) A 17 DTS	06.2010→		7.03073.01.0	DW-TL	EP	
			7.03085.02.0	DW-TL	EP	
1.7 CDTi 81 kW (110 PS) A 17 DTC	06.2010→		7.03073.01.0	DW-TL	EP	
			7.03085.02.0	DW-TL	EP	
1.7 CDTi 81 kW (110 PS) A 17 DTI	06.2010→		7.03085.02.0	DW-TL	EP	
			7.02461.01.0	EUV-AGR	EL	

MOKKA 49































1.8i 16V 103 kW (140 PS) A 18 XER	10.2012→		7.06117.08.0	SV-NWV	EH	mit Dichtring with O-ring
---	----------	---	---------------------	--------	----	------------------------------

MOKKA / MOKKA X (J13) 50

1.4 103-110 kW (140-150 PS) A 14 NET, B 14 NET, D 14 NET	04.2013→		7.03833.02.0	EUV-VB	EL	
			7.06117.07.0	ZM-NWV	EL	mit Dichtring with O-ring
1.4 4x4 103-110 kW (140-150 PS) A 14 NET, B 14 NET, D 14 NET	06.2012→		7.03833.02.0	EUV-VB	EL	
			7.06117.07.0	ZM-NWV	EL	mit Dichtring with O-ring
1.4 4x4 103-112 kW (140-152 PS) B 14 XFT	06.2016→		7.03351.12.0	LDRV	EP	
			7.03381.14.0	SUV	EL	
1.6 85 kW (116 PS) A 16 XER	06.2012→		7.02256.38.0	AKF	EL	
			7.02256.43.0	EUV-SR	EL	
1.6 85 kW (116 PS) B 16 XER	06.2012→		7.06117.08.0	SV-NWV	EH	mit Dichtring with O-ring
			7.02256.43.0	EUV-SR	EL	













MOKKA / MOKKA X (J13)					50
			7.06117.08.0	SV-NWV	EH mit Dichtring with O-ring
1.6 CDTi 81 kW (110 PS) B 16 DTN, B 16 DTU	06.2015→		7.08681.01.0	EOV	EH B 16 DTN, B 16 DTU: Fahrgestellnummer ab: G4000001, GB000001 Vehicle Identification Number from: G4000001, GB000001
			7.02256.44.0	EUV-AGR	EL
1.6 CDTi 88-100 kW (120-136 PS) B 16 DTH	01.2015→		7.08681.01.0	EOV	EH Fahrgestellnummer ab: G4000001, GB000001 Vehicle Identification Number from: G4000001, GB000001
			7.02256.44.0	EUV-AGR	EL
1.6 CDTi 4x4 88-100 kW (120-136 PS) B 16 DTH	01.2015→		7.08681.01.0	EOV	EH Fahrgestellnummer ab: G4000001, GB000001 Vehicle Identification Number from: G4000001, GB000001
1.7 CDTi 96 kW (131 PS) A 17 DTS	06.2012→		7.03073.01.0	DW-TL	EP
			7.02461.03.0	EUV-AGR	EL
1.7 CDTi 4x4 96 kW (131 PS) A 17 DTS	06.2012→		7.03073.01.0	DW-TL	EP
			7.02461.03.0	EUV-AGR	EL
NOVA Hatchback (S83)					51
1.2 33 kW (45 PS) C 12 NZ	09.1989→03.1993		7.05432.01.0	SM	EL mit Dichtring with O-ring
1.4 i 44 kW (60 PS) C 14 NZ	01.1990→03.1993		7.05432.01.0	SM	EL mit Dichtring with O-ring
1.4 i S 60 kW (82 PS) C 14 SE	09.1991→03.1993		7.05432.11.0	SM	EL mit Dichtring with O-ring
1.6 GSI 60-74 kW (81-101 PS) E 16 SE	05.1988→03.1992		7.05432.11.0	SM	EL mit Dichtring with O-ring
1.6 GSI Cat 74 kW (101 PS) C 16 SE	02.1992→03.1993		7.05432.11.0	SM	EL mit Dichtring with O-ring
NOVA Saloon (S83)					52
1.2 33 kW (45 PS) C 12 NZ	02.1992→12.1993		7.05432.01.0	SM	EL mit Dichtring with O-ring
1.4 60 kW (82 PS) C 14 SE	09.1990→08.1992		7.05432.11.0	SM	EL mit Dichtring with O-ring
1.4 44 kW (60 PS) C 14 NZ	10.1990→08.1992		7.05432.01.0	SM	EL mit Dichtring with O-ring
OMEGA (B) Estate (V94)					53
2.0 16V 100 kW (136 PS) X 20 XEV	03.1994→07.2001		7.06269.01.0	LLR	EL
2.5 TD 96 kW (131 PS) X 25 DT, X 25 TD	04.1994→07.2001		7.21903.73.0	DW-AGR	EP
OMEGA (B) Saloon (V94)					54
2.0 16V 100 kW (136 PS) X 20 XEV	03.1994→07.2001		7.06269.01.0	LLR	EL
2.5 TD 96 kW (131 PS) X 25 DT, X 25 TD	04.1994→07.2001		7.21903.73.0	DW-AGR	EP
SIGNUM (Z03)					55
1.8 103 kW (140 PS) Z 18 XER	08.2005→05.2008		7.02256.43.0	EUV-SR	EL
			7.06117.08.0	SV-NWV	EH mit Dichtring with O-ring
1.9 CDTi 88 kW (120 PS) Z 19 DT	04.2004→03.2008		7.01421.01.0	DW-TL	EP







						
SIGNUM (Z03)						55
1.9 CDTI 16V 110 kW (150 PS) Z 19 DTH	04.2004→03.2008		7.01421.01.0	DW-TL	EP	
2.0 i Turbo 129 kW (175 PS) Z 20 NET	03.2003→10.2008		7.00326.03.0	EUV-VB	EL	
			7.00045.00.0*	LDRV	EP	
			↳ 7.28311.04.0	LDRV	EP	
2.2 DTI 92 kW (125 PS) Y 22 DTR	05.2003→05.2008		7.02256.26.0	DW-TL	EP	
			7.22138.50.0	EUV-AGR	EL	
2.8 V6 Turbo 169 kW (230 PS) Z 28 NEL	07.2005→05.2008		7.00175.04.0	SUV	EL	
			7.06117.04.0	SV-NWV	EH	mit Wellendichtring With shaft sealing ring
2.8 V6 Turbo 184-206 kW (250-280 PS) Z 28 NET	05.2007→10.2008		7.00175.04.0	SUV	EL	
			7.06117.04.0	SV-NWV	EH	mit Wellendichtring With shaft sealing ring
TIGRA Mk I (S93)						56
1.4 16V 66 kW (90 PS) X 14 XE	07.1994→12.2000		7.05432.11.0	SM	EL	mit Dichtring with O-ring
1.6 16V 78-80 kW (106-109 PS) X 16 XE	07.1994→12.2000		7.05432.11.0	SM	EL	mit Dichtring with O-ring
TIGRA TwinTop (X04)						57
1.4 66 kW (90 PS) Z 14 XEP	06.2004→08.2009		7.02256.28.0	SV-PDA	EP	
VECTRA (B) Estate (J96)						58
2.0 i 16V (F35) 100 kW (136 PS) X 20 XEV	10.1995→01.2001		7.06269.01.0	LLR	EL	
VECTRA (B) Hatchback (J96)						59
1.6 i (F68) 55 kW (75 PS) X 16 SZR	08.1995→10.2001		7.05432.00.0	SM	EL	mit Dichtring with O-ring
1.6 i 16V (F68) 74 kW (101 PS) X 16 XEL	08.1995→10.2001		7.05432.11.0	SM	EL	mit Dichtring with O-ring
1.7 TD (F68) 60 kW (82 PS) X17TD	10.1995→11.1996		7.22138.50.0	EUV-LS	EL	für Fahrzeuge mit Klimaanlage for vehicles with air conditioning
2.0 i 16V (F68) 100 kW (136 PS) X 20 XEV	10.1995→01.2001		7.06269.01.0	LLR	EL	
VECTRA (B) Saloon (J96)						60
1.6 i (F19) 55 kW (75 PS) X 16 SZR	08.1995→10.2001		7.05432.00.0	SM	EL	mit Dichtring with O-ring
1.6 i 16V (F19) 74 kW (101 PS) X 16 XEL	08.1995→10.2001		7.05432.11.0	SM	EL	mit Dichtring with O-ring
1.8 i 16V (F19) 85 kW (116 PS) X 18 XE	10.1995→09.2000		7.06269.01.0	LLR	EL	
2.0 i 16V (F19) 100 kW (136 PS) X 20 XEV	10.1995→01.2001		7.06269.01.0	LLR	EL	
VECTRA Mk II (C) (Z02)						61
1.8 103 kW (140 PS) Z 18 XER	01.2006→07.2008		7.02256.43.0	EUV-SR	EL	
			7.06117.08.0	SV-NWV	EH	mit Dichtring with O-ring
1.9 CDTI 88 kW (120 PS) Z 19 DT	04.2002→09.2008		7.01421.01.0	DW-TL	EP	
1.9 CDTI 16V 110 kW (150 PS) Z 19 DTH	04.2004→08.2008		7.01421.01.0	DW-TL	EP	

V





VECTRA Mk II (C) (Z02)						61
2.0 16V Turbo 129 kW (175 PS) Z 20 NET	01.2000→10.2008		7.00326.03.0	EUV-VB	EL	
			7.00045.00.0* ↳ 7.28311.04.0	LDRV LDRV	EP EP	
2.2 16V 106-108 kW (144-147 PS) Z 22 SE	01.2002→10.2008		7.02256.22.0	AKF	EL	
2.2 DTI 16V 92 kW (125 PS) Y 22 DTR	04.2002→10.2008		7.02256.26.0	DW-TL	EP	
			7.22138.50.0	EUV-AGR	EL	

VECTRA Mk II (C) Estate (Z02)						62
1.8 103 kW (140 PS) Z 18 XER	01.2006→07.2008		7.02256.43.0	EUV-SR	EL	mit Dichtring with O-ring
			7.06117.08.0	SV-NWV	EH	
1.9 CDTI 88 kW (120 PS) Z 19 DT	04.2004→07.2008		7.01421.01.0	DW-TL	EP	
1.9 CDTI 16V 110 kW (150 PS) Z 19 DTH	04.2004→05.2009		7.01421.01.0	DW-TL	EP	
2.0 16V Turbo 129 kW (175 PS) Z 20 NET	10.2003→07.2008		7.00326.03.0	EUV-VB	EL	
			7.00045.00.0* ↳ 7.28311.04.0	LDRV LDRV	EP EP	
2.2 DTI 16V 92 kW (125 PS) Y 22 DTR	10.2003→07.2008		7.02256.26.0	DW-TL	EP	
			7.22138.50.0	EUV-AGR	EL	
2.8 V6 Turbo 169 kW (230 PS) Z 28 NEL	08.2005→05.2009		7.00175.04.0	SUV	EL	mit Wellendichtring With shaft sealing ring
			7.06117.04.0	SV-NWV	EH	
2.8 V6 Turbo 184-206 kW (250-280 PS) Z 28 NET	08.2006→05.2009		7.00175.04.0	SUV	EL	mit Wellendichtring With shaft sealing ring
			7.06117.04.0	SV-NWV	EH	
2.8 V6 Turbo 184-206 kW (250-280 PS) Z 28 NET	10.2006→05.2009		7.00175.04.0	SUV	EL	mit Wellendichtring With shaft sealing ring
			7.06117.04.0	SV-NWV	EH	

VECTRA Mk II (C) GTS (Z02)						63
1.8 103 kW (140 PS) Z 18 XER	01.2006→07.2008		7.02256.43.0	EUV-SR	EL	mit Dichtring with O-ring
			7.06117.08.0	SV-NWV	EH	
1.9 CDTI 88 kW (120 PS) Z 19 DT	08.2002→07.2008		7.01421.01.0	DW-TL	EP	
1.9 CDTI 16V 110 kW (150 PS) Z 19 DTH	04.2004→07.2008		7.01421.01.0	DW-TL	EP	
2.0 16V Turbo 129 kW (175 PS) Z 20 NET	03.2003→07.2008		7.00326.03.0	EUV-VB	EL	
			7.00045.00.0* ↳ 7.28311.04.0	LDRV LDRV	EP EP	
2.2 16V 106-108 kW (144-147 PS) Z 22 SE	08.2002→07.2008		7.02256.22.0	AKF	EL	
2.2 DTI 16V 92 kW (125 PS) Y 22 DTR	08.2002→07.2008		7.02256.26.0	DW-TL	EP	
			7.22138.50.0	EUV-AGR	EL	













V

						
VECTRA Mk II (C) GTS (Z02)						63
2.8 V6 Turbo 169 kW (230 PS) Z 28 NEL	08.2005→05.2009		7.00175.04.0	SUV	EL	mit Wellendichtring With shaft sealing ring
			7.06117.04.0	SV-NWV	EH	
2.8 V6 Turbo 184-206 kW (250-280 PS) Z 28 NET	08.2005→08.2006		7.00175.04.0	SUV	EL	mit Wellendichtring With shaft sealing ring
			7.06117.04.0	SV-NWV	EH	
2.8 V6 Turbo 184-206 kW (250-280 PS) Z 28 NET	02.2006→05.2009		7.00175.04.0	SUV	EL	mit Wellendichtring With shaft sealing ring
			7.06117.04.0	SV-NWV	EH	
2.8 V6 Turbo 184-206 kW (250-280 PS) Z 28 NET	10.2006→05.2009		7.00175.04.0	SUV	EL	mit Wellendichtring With shaft sealing ring
			7.06117.04.0	SV-NWV	EH	
VX220 Convertible (E01)						64
2.0 VXR 140-162 kW (190-220 PS) Z 20 LET	10.2003→07.2005		7.01039.03.0	EUV-SR	EL	
			7.01024.02.0	LDRV	EL	
2.0 i Turbo 140-162 kW (190-220 PS) Z 20 LET	03.2001→07.2005		7.01039.03.0	EUV-SR	EL	
			7.01024.02.0	LDRV	EL	
ZAFIRA A (T98)						65
1.6 16V 74 kW (101 PS) X 16 XEL	04.1999→08.2005		7.05432.11.0	SM	EL	mit Dichtring with O-ring
2.0 140-162 kW (190-220 PS) Z 20 LET	06.2002→06.2005		7.01039.03.0	EUV-SR	EL	
			7.01024.02.0	LDRV	EL	
2.0 DTI 16V 74 kW (101 PS) Y 20 DTH	04.1999→08.2005		7.22138.50.0	EUV-AGR	EL	Fahrgestellnummer ab: 32000001, 3H000001, 4G000001 Vehicle Identification Number from: 32000001, 3H000001, 4G000001
2.0 GSI Turbo 140-162 kW (190-220 PS) Z 20 LET	09.2001→06.2005		7.01039.03.0	EUV-SR	EL	
			7.01024.02.0	LDRV	EL	
ZAFIRA Mk II						66
2.0i Turbo 16V 140-162 kW (190-220 PS) Z 20 LET	09.2001→		7.01024.02.0	LDRV	EL	
ZAFIRA Mk II (B) (A05)						67
1.6 74-77 kW (101-105 PS) Z 16 XEP	07.2005→11.2014		7.02256.38.0	AKF	EL	 Z 16 XEP: Fahrgestellnummer ab: 72000001, 7G000001 Vehicle Identification Number from: 72000001, 7G000001 Fahrgestellnummer bis: 72999999, 7G999999 Vehicle Identification Number to: 72999999, 7G999999  Z 16 XEP: Fahrgestellnummer ab: 82000001, 8G000001 Vehicle Identification Number from: 82000001, 8G000001
			7.02256.43.0	EUV-SR	EL	

V



ZAFIRA Mk II (B) (A05) **67**

			7.02256.31.0	SV-PDA	EP	Fahrgestellnummer bis: 72999999, 7G999999 Vehicle Identification Number to: 72999999, 7G999999
1.6 77 kW (105 PS) Z 16 XE1	07.2005→11.2014		7.02256.38.0	AKF	EL	 Z 16 XE1: Fahrgestellnummer ab: 72000001, 7G000001 Vehicle Identification Number from: 72000001, 7G000001 Fahrgestellnummer bis: 72999999, 7G999999 Vehicle Identification Number to: 72999999, 7G999999  Z 16 XE1: Fahrgestellnummer ab: 82000001, 8G000001 Vehicle Identification Number from: 82000001, 8G000001
			7.02256.43.0	EUV-SR	EL	
1.6 85 kW (116 PS) A 16 XER, Z 16 XER	12.2007→11.2014		7.02256.38.0	AKF	EL	mit Dichtring with O-ring
			7.02256.43.0	EUV-SR	EL	
			7.06117.08.0	SV-NWV	EH	
1.7 CDTI 92 kW (125 PS) A 17 DTR	01.2008→11.2014		7.03085.02.0	DW-TL	EP	
			7.02461.01.0	EUV-LS	EL	
1.7 CDTI 81 kW (110 PS) A 17 DTJ, Z 17 DTJ	04.2009→11.2014		7.03085.02.0	DW-TL	EP	
			7.02461.01.0	EUV-LS	EL	
1.8 103 kW (140 PS) A 18 XER	04.2005→11.2014		7.06117.08.0	SV-NWV	EH	mit Dichtring with O-ring
			7.02256.43.0	EUV-SR	EL	mit Dichtring with O-ring
1.8 103 kW (140 PS) Z 18 XER	04.2005→11.2014		7.06117.08.0	SV-NWV	EH	
1.8 85-88 kW (116-120 PS) A 18 XEL	04.2013→11.2014		7.06117.08.0	SV-NWV	EH	mit Dichtring with O-ring
			7.01420.02.0	DW-TL	EP	
1.9 CDTI 88 kW (120 PS) Z 19 DT	07.2005→11.2014		7.01420.02.0	DW-TL	EP	
			7.01420.02.0	DW-TL	EP	
2.0 147 kW (200 PS) Z 20 LER	07.2005→11.2014		7.01024.02.0	LDRV	EL	
			7.01039.03.0	LDRV	EL	
2.0 176-177 kW (240-241 PS) Z 20 LEH	01.2006→11.2014		7.01024.02.0	LDRV	EL	
			7.01039.03.0	LDRV	EL	

ZAFIRA Mk III (P12) **68**



1.4 (75) 88 kW (120 PS) A 14 NEL	10.2011→08.2018		7.03833.02.0	EUV-VB	EL	mit Dichtring with O-ring
			7.06117.07.0	ZM-NWV	EL	
1.4 (75) 103-110 kW (140-150 PS) A 14 NET, B 14 NET	10.2011→08.2018		7.03833.02.0	EUV-VB	EL	mit Dichtring with O-ring
			7.06117.07.0	ZM-NWV	EL	
1.6 CDTi (75) 88-100 kW (120-136 PS) B 16 DTH	03.2013→08.2018		7.08681.01.0	EOV	EH	 17 A3162915GW5X0583→
			7.02256.44.0	EUV-AGR	EL	

ZAFIRA Mk III (P12)					68
1.6 CDTi (75) 88-100 kW (120-136 PS) B 16 DTH	10.2016→08.2018	7.08681.01.0	EOV	EH	17 A3162915GW5X0583→
1.6 CNG (75) 110 kW (150 PS) A 16 XNT	10.2011→08.2018	7.01039.03.0	EUV-VB	EL	
1.8 (75) 85-88 kW (116-120 PS) A 18 XEL	10.2011→08.2018	7.03833.02.0	EUV-VB	EL	
		7.02256.43.0	EUV-SR	EL	
1.8 (75) 103 kW (140 PS) A 18 XER	10.2011→08.2018	7.06117.08.0	SV-NWV	EH	mit Dichtring with O-ring
		7.02256.43.0	EUV-SR	EL	
2.0 BiTurbo CDTi (75) 140-143 kW (190-194 PS) A 20 DTR	11.2012→08.2018	7.03978.01.0	DW-TL	EP	für OE-Nummer: 55573362, 55575611, 8 51 017, 8 51 042 for OE number: 55573362, 55575611, 8 51 017, 8 51 042
		7.03856.02.0* ↳ 7.03073.01.0	STE DW-TL	EP EP	
2.0 CDTi (75) 81 kW (110 PS) A 20 DTL	10.2011→08.2018	7.03855.00.0*	STE	EP	Fahrgestellnummer bis: C2 Vehicle Identification Number to: C2
		↳ 7.03073.01.0	DW-TL	EP	
		7.03855.02.0*	STE	EP	Fahrgestellnummer ab: C2, F1000001 Vehicle Identification Number from: C2, F1000001
		↳ 7.03073.01.0	DW-TL	EP	
2.0 CDTi (75) 96 kW (131 PS) A 20 DT, Y 20 DTJ, Z 20 DTJ	10.2011→08.2018	7.03855.00.0*	STE	EP	A 20 DT, Y 20 DTJ, Z 20 DTJ: Fahrgestellnummer bis: C2 Vehicle Identification Number to: C2
		↳ 7.03073.01.0	DW-TL	EP	
		7.03855.02.0*	STE	EP	A 20 DT, Y 20 DTJ, Z 20 DTJ: Fahrgestellnummer ab: C2, F1000001 Vehicle Identification Number from: C2, F1000001
		↳ 7.03073.01.0	DW-TL	EP	
2.0 CDTi (75) 118-121 kW (160-165 PS) A 20 DTH	10.2011→08.2018	7.03855.00.0*	STE	EP	Fahrgestellnummer bis: C2 Vehicle Identification Number to: C2
		↳ 7.03073.01.0	DW-TL	EP	
		7.03855.02.0*	STE	EP	Fahrgestellnummer ab: C2, F1000001 Vehicle Identification Number from: C2, F1000001
		↳ 7.03073.01.0	DW-TL	EP	
2.0 CDTi (75) 125 kW (170 PS) B 20 DTH	01.2015→08.2018	7.08681.02.0	EOV	EH	
		7.02256.44.0	EUV-AGR	EL	
ARENA Combi (A97)					69
1.9 D 44 kW (60 PS) F8Q 600, F8Q 606	03.1998→08.2001	7.02256.19.0	EUV-LS	EL	
2.5 D 55-58 kW (75-79 PS) S8U 758, S8U 780, S8U 782	03.1998→08.2001	7.02256.19.0	EUV-AGR	EL	
ARENA Van (A97)					70
1.9 D 44 kW (60 PS) F8Q 600, F8Q 606	03.1998→08.2001	7.02256.19.0	EUV-LS	EL	
2.5 D 55-58 kW (75-79 PS) S8U 758, S8U 780, S8U 782	03.1998→08.2001	7.02256.19.0	EUV-AGR	EL	







V













ASTRAVAN Mk III (F) Estate Van (T92) 71

1.4 i (F70) 44 kW (60 PS) C 14 NZ	09.1991→08.1995	 7.05432.01.0	SM	EL	mit Dichtring with O-ring
1.6 i (F70) 55-61 kW (75-83 PS) C 16 NZ	10.1991→08.1998	 7.05432.00.0	SM	EL	mit Dichtring with O-ring
1.6 i (F70) 52 kW (71 PS) X 16 SZ	09.1994→08.1996	 7.05432.00.0	SM	EL	mit Dichtring with O-ring























ASTRAVAN Mk IV (G) Estate Van (T98) 72

1.6 Dualfuel 55 kW (75 PS) X 16 SZR	02.1998→12.2000	 7.05432.00.0	SM	EL	mit Dichtring with O-ring
1.6 i 55 kW (75 PS) X 16 SZR	08.1998→09.2000	 7.02256.38.0	AKF	EL	für OE-Nummer: 13105950, 58 07 468 for OE number: 13105950, 58 07 468
		7.05432.00.0	SM	EL	mit Dichtring with O-ring
1.7 CDTi 59 kW (80 PS) Z 17 DTL	07.2003→08.2006	 7.03088.01.0	DW-TL	EP	
		7.02461.01.0	EUV-AGR	EL	
1.7 DTi 16V 55 kW (75 PS) Y 17 DT	04.2001→08.2006	 7.03085.02.0	DW-AGR	EP	
		7.03088.01.0	DW-TL	EP	
2.0 DTi 74 kW (101 PS) Y 20 DTH	04.2004→08.2006	 7.22138.50.0	EUV-AGR	EL	 ch. 32000001→





ASTRAVAN Mk V (H) Estate Van (A04) 73

























1.3 CDTi 66-74 kW (90-101 PS) Z 13 DTH	08.2005→	 7.01420.02.0	DW-TL	EP	Fahrgestellnummer bis: 9B999999, A2, A5, A8, AG
		7.04423.01.0	DW-TL	EP	Fahrgestellnummer ab: B2, B5, B8, BG Vehicle Identification Number from: B2, B5, B8, BG
1.4 i 66 kW (90 PS) Z 14 XEP	03.2005→	 7.02256.28.0	SV-PDA	EP	
1.6 74-77 kW (101-105 PS) Z 16 XEP	03.2005→	 7.02256.38.0	AKF	EL	
		7.02256.31.0	SV-PDA	EP	Fahrgestellnummer bis: 72999999, 75999999, 78999999, 7G Vehicle Identification Number to: 72999999, 75999999, 78999999, 7G
1.6 77 kW (105 PS) Z 16 XE1	03.2005→	 7.02256.38.0	AKF	EL	
1.7 CDTi 74 kW (100 PS) Z 17 DTH	03.2005→11.2011	 7.03088.01.0	DW-TL	EP	
		7.02461.01.0	EUV-LS	EL	
1.7 CDTi 59 kW (80 PS) Z 17 DTL	03.2005→07.2006	 7.03088.01.0	DW-TL	EP	
		7.02461.01.0	EUV-LS	EL	
1.7 CDTi 81 kW (110 PS) A 17 DTJ, Z 17 DTJ	06.2011→12.2013	 7.02461.01.0	EUV-LS	EL	
1.7 CDTi 92 kW (125 PS) A 17 DTR, Z 17 DTR	11.2011→	 7.02461.01.0	EUV-LS	EL	
1.9 CDTi 88 kW (120 PS) Z 19 DT	03.2005→11.2011	 7.01420.02.0	DW-TL	EP	
1.9 CDTi 110 kW (150 PS) Z 19 DTH	03.2005→11.2011	 7.01420.02.0	DW-TL	EP	

V

						
COMBO Mk I (B) (S93)						74
1.4 44 kW (60 PS) C 14 NZ	07.1994→10.2001		7.05432.00.0	SM	EL	mit Dichtring with O-ring für Fahrzeuge mit Automatikgetriebe for vehicles with automatic transmission
			7.05432.01.0	SM	EL	mit Dichtring with O-ring für Fahrzeuge mit Schaltgetriebe for vehicles with manual transmission
COMBO Mk II (C) Box Body/MPV (F25)						75
1.3 CDTI 16V 51-55 kW (69-75 PS) Z 13 DTJ	10.2005→11.2011		7.01421.01.0	DW-TL	EP	
1.4 i 16V 66 kW (90 PS) Z 14 XEP	01.2004→11.2011		7.02256.28.0	SV-PDA	EP	
1.6 62-64 kW (84-87 PS) Z 16 SE	09.2001→10.2004		7.02256.22.0	AKF	EL	
1.6 62-64 kW (84-87 PS) Z 16 SE	10.2001→11.2011		7.02256.22.0	AKF	EL	
1.6 CNG 16V 69-74 kW (94-101 PS) Z 16 YNG	04.2005→02.2012		7.02256.22.0	AKF	EL	
1.6 CNG 16V 69-74 kW (94-101 PS) Z 16 YNG	06.2006→02.2012		7.02256.22.0	AKF	EL	
1.7 CDTI 16V 74 kW (100 PS) Z 17 DTH	12.2004→11.2011		7.02461.01.0	EUV-AGR	EL	
COMBO Mk III (D) Box Body/MPV (X12)						76
1.6 CDTi 66-88 kW (90-120 PS) A 16 FDL	11.2011→		7.08681.03.0	SV-HYAT	EH	für OE-Nummer: 7 84 068, 95512349 for OE number: 7 84 068, 95512349
			7.08681.04.0	SV-HYAT	EH	
			7.08681.05.0	SV-HYAT	EH	für OE-Nummer: 7 84 065, 95512347 for OE number: 7 84 065, 95512347
			7.08681.06.0	SV-HYAT	EH	
COMBO Mk IV (E) Box Body/MPV						77
1.2 81 kW (110 PS) D 12 XHL (EB2ADT)	02.2019→		7.08681.09.0	EOV	EH	
1.5 D 75 kW (102 PS) D 15 DT (DV5RD)	08.2018→		7.08681.00.0	EOV	EH	
CORSAVAN Mk I (B) Hatchback Van (S93)						78
1.4 i 44 kW (60 PS) C 14 NZ	01.1994→09.2000		7.05432.00.0	SM	EL	mit Dichtring with O-ring für Fahrzeuge mit Automatikgetriebe for vehicles with automatic transmission
			7.05432.01.0	SM	EL	mit Dichtring with O-ring für Fahrzeuge mit Schaltgetriebe for vehicles with manual transmission
CORSAVAN Mk II (C) Hatchback Van (X01)						79
1.2 16V (F08) 59 kW (80 PS) Z 12 XEP	07.2004→11.2006		7.02256.28.0	SV-PDA	EP	
1.2 16V Dualfuel (F08) 59 kW (80 PS) Z 12 XEP	07.2004→12.2005		7.02256.28.0	SV-PDA	EP	
1.4 (F08) 66 kW (90 PS) Z 14 XEP	11.2003→06.2006		7.02256.28.0	SV-PDA	EP	
1.7 DI 16V (F08) 48 kW (65 PS) Y 17 DTL	09.2000→06.2006		7.03085.02.0	DW-AGR	EP	
			7.03088.01.0	DW-TL	EP	

V



			 PIERBURG		
CORSAVAN Mk II (C) Hatchback Van (X01) 79					
1.7 DTI 16V (F08) 55 kW (75 PS) Y 17 DT	09.2000→06.2006		7.03085.02.0	DW-AGR	EP
			7.03088.01.0	DW-TL	EP
CORSAVAN Mk III (D) Hatchback Van (S07) 80					
1.2 59 kW (80 PS) Z 12 XEP	07.2009→		7.02256.28.0	SV-PDA	EP
1.2 51 kW (69 PS) A 12 XEL	01.2010→		7.06117.07.0	ZM-NWV	EL mit Dichtring with O-ring
1.3 CDTI 70 kW (95 PS) A 13 DTE, A 13 DTR, Z 13 DTE	07.2006→		7.03653.01.0	DW-TL	EP
			7.01981.07.0	SV-AGR-K	EP
1.3 CDTI 51-55 kW (69-75 PS) Z 13 DTJ	07.2006→		7.01420.02.0	DW-TL	EP
1.3 CDTI 55 kW (75 PS) A 13 DTC	07.2006→		7.03653.01.0	DW-TL	EP
			7.01981.07.0	SV-AGR-K	EP
1.3 CDTI 66-74 kW (90-101 PS) Z 13 DTH	07.2006→		7.01420.02.0	DW-TL	EP
CORSAVAN Mk IV (E) Hatchback Van (X15) 81					
1.2 51 kW (69 PS) B 12 XEL	10.2014→		7.06117.07.0	ZM-NWV	EL mit Dichtring with O-ring
MOVANO Mk I (A) Chassis/Cab (X70) 82					
2.5 CDTI (ED, UD0) 74-107 kW (101-146 PS) G9U 632, G9U 650	08.2006→05.2010		7.01152.02.0	DW-TL	EP
2.5 CDTI (ED, UD0) 74-107 kW (101-146 PS) G9U 632, G9U 650	08.2006→05.2010		7.01152.02.0	DW-TL	EP
2.5 CDTI (UD0, ED) 74-107 kW (101-146 PS) G9U 650	10.2006→12.2010		7.01152.02.0	DW-TL	EP
2.8 DTI (UD0, ED, HD) 84 kW (114 PS) S9W 702	10.1998→10.2001		7.02256.19.0	EUV-LS	EL
MOVANO Mk I (A) Combi (X70) 83					
2.5 CDTI (JD) 74-107 kW (101-146 PS) G9U 650	10.2001→08.2009		7.01152.02.0	DW-TL	EP
2.5 CDTI (JD) 74-107 kW (101-146 PS) G9U 632, G9U 650	02.2003→08.2009		7.01152.02.0	DW-TL	EP
2.5 CDTI (JD) 88-107 kW (120-146 PS) G9U 632	08.2006→05.2010		7.01152.02.0	DW-TL	EP
2.8 DTI (JD) 84 kW (114 PS) S9W 702	10.1998→10.2001		7.02256.19.0	EUV-LS	EL
V MOVANO Mk I (A) Van (X70) 84					
2.5 CDTI (FD) 88-107 kW (120-146 PS) G9U 632	08.2006→05.2010		7.01152.02.0	DW-TL	EP
2.5 CDTI (FD) 74-107 kW (101-146 PS) G9U 632, G9U 650	08.2006→05.2010		7.01152.02.0	DW-TL	EP

						
MOVANO Mk I (A) Van (X70)						84
2.5 CDTI (FD) 74-107 kW (101-146 PS) G9U 650	10.2006→12.2010		7.01152.02.0	DW-TL	EP	
2.8 TDI (FD) 84 kW (114 PS) S9W 702	10.1998→10.2001		7.02256.19.0	EUV-LS	EL	
MOVANO Mk II (B) Chassis/Cab (X62)						85
2.3 CDTI FWD (HV, EV, UV) 100-132 kW (136-179 PS) M9T 716	08.2019→		7.01814.12.0	DW-TL	EP	
2.3 CDTI FWD (HV, UV) 100-132 kW (136-179 PS) M9T 716	08.2019→		7.01814.12.0	DW-TL	EP	
2.3 CDTI FWD (UV, HV) 74-92 kW (101-125 PS) M9T 670, M9T 676	05.2010→		7.02256.19.0	EUV-AGR	EL	
2.3 CDTI FWD (UV, HV) 100-132 kW (136-179 PS) M9T 702, M9T 716	05.2014→		7.01814.12.0	DW-TL	EP	
2.3 CDTI FWD (UV, HV) 107-125 kW (145-170 PS) M9T 706	11.2016→		7.01814.12.0	DW-TL	EP	
2.3 CDTI FWD (UV, HV, EV) 74-107 kW (101-146 PS) M9T 670, M9T 676, M9T 680	05.2010→		7.02256.19.0	EUV-AGR	EL	
2.3 CDTI FWD (UV, HV, EV) 92-107 kW (125-146 PS) M9T 678, M9T 680	05.2010→		7.02256.19.0	EUV-AGR	EL	
2.3 CDTI FWD (UV, HV, EV) 96 kW (131 PS) M9T 704	10.2016→		7.01814.12.0	DW-TL	EP	
2.3 CDTI RWD (UV, HV) 100-120 kW (136-163 PS) M9T 700	05.2014→		7.01814.12.0	DW-TL	EP	
2.3 CDTI RWD (UV, HV) 100-120 kW (136-163 PS) M9T 700	05.2014→		7.01814.12.0	DW-TL	EP	
2.3 CDTI RWD (UV, HV) 96-120 kW (131-163 PS) M9T 710	10.2016→		7.01814.12.0	DW-TL	EP	
2.3 CDTI RWD (UV, HV, EV) 74-92 kW (101-125 PS) M9T 690, M9T 692	07.2010→		7.02256.19.0	EUV-AGR	EL	
2.3 CDTI RWD (UV, HV, EV) 107-110 kW (146-150 PS) M9T 694	07.2010→		7.02256.19.0	EUV-AGR	EL	
MOVANO Mk II (B) Combi (X62)						86
2.3 CDTI FWD (JV) 74-92 kW (101-125 PS) M9T 670, M9T 676	05.2010→		7.02256.19.0	EUV-AGR	EL	
2.3 CDTI FWD (JV) 74-107 kW (101-146 PS) M9T 670, M9T 676, M9T 680	05.2010→		7.02256.19.0	EUV-AGR	EL	
2.3 CDTI FWD (JV) 92-107 kW (125-146 PS) M9T 678, M9T 680	05.2010→		7.02256.19.0	EUV-AGR	EL	
2.3 CDTI FWD (JV) 100-120 kW (136-163 PS) M9T 702	05.2014→		7.01814.12.0	DW-TL	EP	















V







MOVANO Mk II (B) Combi (X62) 86



























2.3 CDTI FWD (JV) 100-120 kW (136-163 PS) M9T 702	05.2014→		7.01814.12.0	DW-TL	EP
2.3 CDTI FWD (JV) 107-125 kW (145-170 PS) M9T 706	07.2015→		7.01814.12.0	DW-TL	EP

MOVANO Mk II (B) VAN (X62) 87

2.3 CDTI FWD (FV) 74-92 kW (101-125 PS) M9T 670, M9T 676	05.2010→		7.02256.19.0	EUV-AGR	EL
2.3 CDTI FWD (FV) 74-107 kW (101-146 PS) M9T 670, M9T 676, M9T 680	05.2010→		7.02256.19.0	EUV-AGR	EL
2.3 CDTI FWD (FV) 92-107 kW (125-146 PS) M9T 678, M9T 680	05.2010→		7.02256.19.0	EUV-AGR	EL
2.3 CDTI FWD (FV) 100-132 kW (136-179 PS) M9T 702, M9T 716	05.2014→		7.01814.12.0	DW-TL	EP
2.3 CDTI FWD (FV) 100-120 kW (136-163 PS) M9T 700	05.2014→		7.01814.12.0	DW-TL	EP
2.3 CDTI FWD (FV) 96 kW (131 PS) M9T 704	10.2016→		7.01814.12.0	DW-TL	EP
2.3 CDTI FWD (FV) 107-125 kW (145-170 PS) M9T 706	11.2016→		7.01814.12.0	DW-TL	EP
2.3 CDTI FWD (FV) 100-132 kW (136-179 PS) M9T 716	08.2019→		7.01814.12.0	DW-TL	EP
2.3 CDTI FWD (FV) 100-132 kW (136-179 PS) M9T 716	08.2019→		7.01814.12.0	DW-TL	EP
2.3 CDTI RWD (FV) 74-92 kW (101-125 PS) M9T 690, M9T 692	05.2010→		7.02256.19.0	EUV-AGR	EL
2.3 CDTI RWD (FV) 107-110 kW (146-150 PS) M9T 694	05.2010→		7.02256.19.0	EUV-AGR	EL
2.3 CDTI RWD (FV) 100-120 kW (136-163 PS) M9T 700	05.2014→		7.01814.12.0	DW-TL	EP
2.3 CDTI RWD (FV) 100-120 kW (136-163 PS) M9T 700, M9T 702	05.2014→		7.01814.12.0	DW-TL	EP
2.3 CDTI RWD (FV) 96-120 kW (131-163 PS) M9T 710	10.2016→		7.01814.12.0	DW-TL	EP

V VIVARO A Bus (X83) 88

1.9 DI 59-60 kW (80-82 PS) F9Q 762	08.2001→12.2006		7.02256.04.0	DW-TL	EP
1.9 DTI 74 kW (101 PS) F9Q 760	08.2001→12.2006		7.02256.04.0	DW-TL	EP
2.0 CDTI 66-84 kW (90-114 PS) M9R 780, M9R 782	01.2006→07.2014		7.02256.04.0	DW-AGR	EP
			7.02256.04.0	DW-TL	EP
			7.02256.19.0	EUV-AGR	EL
2.0 CDTI 66-84 kW (90-114 PS) M9R 786	01.2006→07.2014		7.02256.19.0	EUV-AGR	EL

						
VIVARO A Bus (X83)						88
2.0 CDTI 66-84 kW (90-114 PS) M9R 780, M9R 784	08.2006→07.2014		7.02256.04.0	DW-AGR	EP	
			7.02256.04.0	DW-TL	EP	
			7.02256.19.0	EUV-AGR	EL	
2.0 CDTI 66-84 kW (90-114 PS) M9R 786, M9R 788	08.2006→07.2014		7.02256.19.0	EUV-AGR	EL	
2.5 CDTI 84-107 kW (114-146 PS) G9U 630	01.2006→07.2014		7.01152.02.0	DW-TL	EP	
2.5 CDTI 84-107 kW (114-146 PS) G9U 630	08.2006→07.2014		7.01152.02.0	DW-TL	EP	
2.5 DTI 99 kW (135 PS) G9U 730	07.2003→07.2014		7.02256.04.0	DW-TL	EP	
VIVARO A Platform/Chassis (X83)						89
2.0 CDTI 66-84 kW (90-114 PS) M9R 780, M9R 782	01.2006→07.2014		7.02256.04.0	DW-AGR	EP	
			7.02256.04.0	DW-TL	EP	
			7.02256.19.0	EUV-AGR	EL	
2.0 CDTI 66-84 kW (90-114 PS) M9R 786	01.2006→07.2014		7.02256.19.0	EUV-AGR	EL	
2.0 CDTI 66-84 kW (90-114 PS) M9R 780	08.2006→07.2014		7.02256.04.0	DW-AGR	EP	
			7.02256.04.0	DW-TL	EP	
			7.02256.19.0	EUV-AGR	EL	
2.0 CDTI 84 kW (114 PS) M9R 788	08.2006→07.2014		7.02256.19.0	EUV-AGR	EL	
2.5 CDTI 99 kW (135 PS) G9U 730	04.2003→07.2006		7.02256.04.0	DW-TL	EP	
2.5 CDTI 84-107 kW (114-146 PS) G9U 630	08.2006→07.2014		7.01152.02.0	DW-TL	EP	
2.5 CDTI 84-107 kW (114-146 PS) G9U 630	08.2006→07.2014		7.01152.02.0	DW-TL	EP	
VIVARO A Van (X83)						90
1.9 DI 59-60 kW (80-82 PS) F9Q 762	08.2001→12.2006		7.02256.04.0	DW-TL	EP	
1.9 DTI 74 kW (101 PS) F9Q 760	08.2001→12.2006		7.02256.04.0	DW-TL	EP	
2.0 CDTI 66-84 kW (90-114 PS) M9R 780, M9R 782	01.2006→07.2014		7.02256.04.0	DW-AGR	EP	
			7.02256.04.0	DW-TL	EP	
			7.02256.19.0	EUV-AGR	EL	
2.0 CDTI 66-84 kW (90-114 PS) M9R 786	01.2006→07.2014		7.02256.19.0	EUV-AGR	EL	
2.0 CDTI 66-84 kW (90-114 PS) M9R 780	08.2006→07.2014		7.02256.04.0	DW-AGR	EP	
			7.02256.04.0	DW-TL	EP	
			7.02256.19.0	EUV-AGR	EL	
2.0 CDTI 84 kW (114 PS) M9R 788	08.2006→07.2014		7.02256.19.0	EUV-AGR	EL	
2.5 CDTI 84-107 kW (114-146 PS) G9U 630	08.2006→07.2014		7.01152.02.0	DW-TL	EP	
			7.04779.00.0	DW-TL	EP	
			7.02256.19.0	EUV-AGR	EL	
2.5 CDTI 84-107 kW (114-146 PS) G9U 630	08.2006→08.2008		7.01152.02.0	DW-TL	EP	
2.5 DTI 99 kW (135 PS) G9U 730	07.2003→07.2014		7.02256.04.0	DW-TL	EP	

V

VIVARO B Bus (X82) 91

1.6 CDTi 66-85 kW (90-116 PS) R9M 408	05.2014→	7.01814.12.0	DW-TL	EP	Produktionsdatum ab: 07.10.2014 Production date from: 07.10.2014
1.6 CDTi 66-85 kW (90-116 PS) R9M 408	05.2014→	7.01814.12.0	DW-TL	EP	Produktionsdatum ab: 07.10.2014 Production date from: 07.10.2014
1.6 CDTi 85-107 kW (116-146 PS) R9M 450	05.2014→	7.01814.12.0	DW-TL	EP	Produktionsdatum ab: 07.10.2014 Production date from: 07.10.2014
		7.01814.22.0	DW-TL	EP	für OE-Nummer: 44 24 170, 95520982 for OE number: 44 24 170, 95520982
1.6 CDTi 85-107 kW (116-146 PS) R9M 450	06.2014→	7.01814.12.0	DW-TL	EP	Produktionsdatum ab: 07.10.2014 Production date from: 07.10.2014
		7.01814.22.0	DW-TL	EP	für OE-Nummer: 44 24 170, 95520982 for OE number: 44 24 170, 95520982
1.6 CDTi 85-107 kW (116-146 PS) R9M 450	08.2016→	7.01814.12.0	DW-TL	EP	für OE-Nummer: 44 24 170, 95520982 for OE number: 44 24 170, 95520982
		7.01814.22.0	DW-TL	EP	
1.6 CDTi 70-89 kW (95-121 PS) R9M 413	08.2016→	7.01814.12.0	DW-TL	EP	

VIVARO B Platform/Chassis (X82) 92





1.6 CDTi 85-107 kW (116-146 PS) R9M 450	08.2016→	7.01814.12.0	DW-TL	EP	für OE-Nummer: 44 24 170, 95520982 for OE number: 44 24 170, 95520982
		7.01814.22.0	DW-TL	EP	
1.6 CDTi 66-85 kW (90-116 PS) R9M 408	05.2014→	7.01814.12.0	DW-TL	EP	Produktionsdatum ab: 07.10.2014 Production date from: 07.10.2014
1.6 CDTi 85-107 kW (116-146 PS) R9M 450	05.2014→	7.01814.12.0	DW-TL	EP	Produktionsdatum ab: 07.10.2014 Production date from: 07.10.2014
		7.01814.22.0	DW-TL	EP	für OE-Nummer: 44 24 170, 95520982 for OE number: 44 24 170, 95520982
1.6 CDTi 85-107 kW (116-146 PS) R9M 450	05.2014→	7.01814.12.0	DW-TL	EP	Produktionsdatum ab: 07.10.2014 Production date from: 07.10.2014
		7.01814.22.0	DW-TL	EP	für OE-Nummer: 44 24 170, 95520982 for OE number: 44 24 170, 95520982
1.6 CDTi 85-107 kW (116-146 PS) R9M 450	08.2016→	7.01814.12.0	DW-TL	EP	für OE-Nummer: 44 24 170, 95520982 for OE number: 44 24 170, 95520982
		7.01814.22.0	DW-TL	EP	

VIVARO B Van (X82) 93

1.6 CDTi 85-107 kW (116-146 PS) R9M 450	05.2014→	7.01814.12.0	DW-TL	EP	Produktionsdatum ab: 07.10.2014 Production date from: 07.10.2014
		7.01814.22.0	DW-TL	EP	für OE-Nummer: 44 24 170, 95520982 for OE number: 44 24 170, 95520982
1.6 CDTi 66-85 kW (90-116 PS) R9M 408	05.2014→	7.01814.12.0	DW-TL	EP	Produktionsdatum ab: 07.10.2014 Production date from: 07.10.2014
1.6 CDTi 66-85 kW (90-116 PS) R9M 408	05.2014→	7.01814.12.0	DW-TL	EP	Produktionsdatum ab: 07.10.2014 Production date from: 07.10.2014
1.6 CDTi 85-107 kW (116-146 PS) R9M 450	05.2014→	7.01814.12.0	DW-TL	EP	Produktionsdatum ab: 07.10.2014 Production date from: 07.10.2014
		7.01814.22.0	DW-TL	EP	für OE-Nummer: 44 24 170, 95520982 for OE number: 44 24 170, 95520982
1.6 CDTi 85-107 kW (116-146 PS) R9M 450	08.2016→	7.01814.12.0	DW-TL	EP	für OE-Nummer: 44 24 170, 95520982 for OE number: 44 24 170, 95520982
		7.01814.22.0	DW-TL	EP	
1.6 CDTi 85-107 kW (116-146 PS) R9M 450	08.2016→	7.01814.12.0	DW-TL	EP	für OE-Nummer: 44 24 170, 95520982 for OE number: 44 24 170, 95520982
		7.01814.22.0	DW-TL	EP	
1.6 CDTi 70-89 kW (95-121 PS) R9M 413	08.2016→	7.01814.12.0	DW-TL	EP	

V



VIVARO C Van (K0)						94
1.5 75 kW (102 PS) D 15 DT (DV5RUCD)	03.2019->	 7.08681.00.0	EOV	EH		
1.5 88 kW (120 PS) D 15 DTH (DV5RUC)	03.2019->	 7.08681.00.0	EOV	EH		
VIVARO LIFE Bus (K0)						95
1.5 88 kW (120 PS) D 15 DTH (DV5RUC)	03.2019->	 7.08681.00.0	EOV	EH		
1.5 75 kW (102 PS) D 15 DT (DV5RUCD)	03.2019->	 7.08681.00.0	EOV	EH		





DUMMY

1













DUMMY 68-74 kW (92-100 PS)
R 754 EU4 (56C)



7.01010.03.0

DW-AGR

EP

					
AMAROK (2HA, 2HB, S1B, S6B, S7A, S7B)					
2.0 BiTDI 120 kW (163 PS) CDCA	09.2010→08.2012		7.02256.00.0	EUV-AGR	EP
2.0 BiTDI 132 kW (180 PS) CNEA, CSHA	11.2011→		7.02256.00.0 7.02256.41.0	EUV-KK SV-KK	EP EL
CNEA, CSHA: für Fahrzeuge mit Standheizung for vehicles with parking heater					
2.0 BiTDI 4motion 120 kW (163 PS) CDCA	09.2010→08.2012		7.02256.00.0	EUV-AGR	EP
2.0 BiTDI 4motion 132 kW (180 PS) CNEA, CSHA	11.2011→		7.02256.00.0 7.02256.41.0	EUV-KK SV-KK	EP EL
CNEA, CSHA: 01.2013→ für Fahrzeuge mit Standheizung for vehicles with parking heater					
2.0 TDI 90 kW (122 PS) CDBA, CNFA	09.2010→10.2013		7.02256.00.0 7.02256.00.0 7.02256.41.0	EUV-AGR EUV-KK SV-KK	EP EP EL
CDBA, CNFA: für Fahrzeuge mit Standheizung for vehicles with parking heater					
2.0 TDI 103 kW (140 PS) CNFB	07.2012→10.2016		7.02256.00.0 7.02256.41.0	EUV-AGR SV-KK	EP EL
01.2013→ für Fahrzeuge mit Standheizung for vehicles with parking heater					
2.0 TDI 4motion 90 kW (122 PS) CDBA, CNFA	09.2010→10.2013		7.02256.00.0 7.02256.00.0	EUV-AGR EUV-KK	EP EP
2.0 TDI 4motion 103 kW (140 PS) CNFB	06.2012→10.2016		7.02256.00.0 7.02256.41.0	EUV-AGR SV-KK	EP EL
01.2013→ für Fahrzeuge mit Standheizung for vehicles with parking heater					
2.0 TSI 118 kW (160 PS) CFPA	12.2010→10.2016		7.03280.04.0 7.22880.01.0 7.00470.07.0 7.02901.05.0 7.02256.41.0	EUV-SR EUV-SR LDRV SUV SV-KK	EL EL EL EL EL
01.2013→ für Fahrzeuge mit Standheizung for vehicles with parking heater					
2.0 TSI 4motion 118 kW (160 PS) CFPA	09.2011→10.2016		7.03280.04.0 7.22880.01.0 7.00470.07.0 7.02901.05.0 7.02256.41.0	EUV-SR EUV-SR LDRV SUV SV-KK	EL EL EL EL EL
01.2013→ für Fahrzeuge mit Standheizung for vehicles with parking heater					
3.0 TDI 120 kW (163 PS) DDXA	06.2016→		7.02256.00.0 7.03280.04.0 7.02256.41.0	EUV-AGR EUV-AGR SV-KK	EP EL EL
Produktionsdatum bis: 03.10.2016 Production date to: 03.10.2016					
3.0 TDI 4motion 165 kW (224 PS) DDXC	06.2016→		7.02256.00.0 7.03280.04.0	EUV-AGR EUV-AGR	EP EL
Produktionsdatum bis: 03.10.2016 Production date to: 03.10.2016					



AMAROK (2HA, 2HB, S1B, S6B, S7A, S7B) **1**

			7.02256.41.0	SV-KK	EL	für Fahrzeuge mit Standheizung for vehicles with parking heater
3.0 TDI 4motion 150 kW (204 PS) DDXB	06.2016→		7.02256.00.0	EUV-AGR	EP	Produktionsdatum bis: 03.10.2016 Production date to: 03.10.2016
			7.03280.04.0	EUV-AGR	EL	
			7.02256.41.0	SV-KK	EL	für Fahrzeuge mit Standheizung for vehicles with parking heater
3.0 TDI 4motion 120 kW (163 PS) DDXA	06.2016→		7.02256.00.0	EUV-AGR	EP	Produktionsdatum bis: 03.10.2016 Production date to: 03.10.2016
			7.03280.04.0	EUV-AGR	EL	
			7.02256.41.0	SV-KK	EL	für Fahrzeuge mit Standheizung for vehicles with parking heater
3.0 TDI 4motion 190 kW (258 PS) DDXE	05.2018→		7.03280.04.0	EUV-AGR	EL	
			7.02256.41.0	SV-KK	EL	für Fahrzeuge mit Standheizung for vehicles with parking heater



AMEO (631) **2**

1.0 56 kW (76 PS) CHYD	09.2018→04.2020		7.06117.48.0	SV-NWV	EL	
1.5 TDI 81 kW (110 PS) CWXC	08.2016→04.2020		7.02256.00.0	EUV-AGR	EP	





ARTEON (3H7, 3H8) **3**

2.0 TDI 130 kW (177 PS) CRGA	11.2017→07.2020		7.02256.00.0	EUV-AGR	EP	
2.0 TSI 140 kW (190 PS) CZPB, DKZA	05.2017→		7.02901.05.0	SUV	EL	→07.2018
2.0 TSI 4motion 206 kW (280 PS) DJHC	04.2017→06.2020		7.02901.05.0	SUV	EL	
			7.06117.26.0	ZM-NWV	EL	
2.0 TSI 4motion 200 kW (272 PS) DLRB, DNUA	04.2018→		7.02901.05.0	SUV	EL	
			7.06117.26.0	ZM-NWV	EL	

























ARTEON SHOOTING BRAKE (3H9) **4**

2.0 TSI 4motion 206 kW (280 PS) DJHC	06.2020→		7.06117.26.0	ZM-NWV	EL	
2.0 TSi 4motion 200 kW (272 PS) DLRB	09.2020→		7.06117.26.0	ZM-NWV	EL	

ATLAS (CA1) **5**











2.0 TSI 175 kW (238 PS) DCGA	07.2017→		7.02901.05.0	SUV	EL	01.2020→
			7.06117.26.0	ZM-NWV	EL	
2.0 TSI 4motion 162 kW (220 PS) CXDA	12.2017→		7.02901.05.0	SUV	EL	
			7.02256.41.0	SV-KK	EL	für Fahrzeuge mit Standheizung for vehicles with parking heater
			7.06117.26.0	ZM-NWV	EL	
3.6 FSI 206-209 kW (280-284 PS) CDVC	12.2016→		7.03280.04.0	EUV-KK	EL	
			7.06117.37.0	SV-NWV	EL	
3.6 FSI 4motion 206-209 kW (280-284 PS) CDVC	12.2016→		7.03280.04.0	EUV-KK	EL	
			7.06117.37.0	SV-NWV	EL	
3.6 FSi 4motion 183 kW (249 PS) CDVD	01.2019→		7.03280.04.0	EUV-KK	EL	

V

					
ATLAS (CA1)					5
			7.02256.41.0	SV-KK	EL für Fahrzeuge mit Standheizung for vehicles with parking heater
			7.06117.37.0	SV-NWV	EL
ATLAS CROSS SPORT (CMC)					6
2.0 TSI 175 kW (238 PS) DCGA	08.2019→		7.06117.26.0	ZM-NWV	EL
2.0 TSI 4motion 175 kW (238 PS) DCGA	08.2019→		7.06117.26.0	ZM-NWV	EL
3.6 FSI 206-209 kW (280-284 PS) CDVC	08.2019→		7.03280.04.0	EUV-KK	EL
			7.06117.37.0	SV-NWV	EL
3.6 FSI 4motion 206-209 kW (280-284 PS) CDVC	08.2019→		7.03280.04.0	EUV-KK	EL
			7.06117.37.0	SV-NWV	EL
BEETLE (5C1, 5C2)					7
1.2 TSI 77 kW (105 PS) CBZB	07.2011→07.2019		7.22880.01.0	EUV-KK	EL
1.4 TSI 118 kW (160 PS) CAVD, CNWA, CTHD, CTKA	10.2011→07.2016		7.02588.04.0	LDRV	EL
			7.04247.02.0	SUV	EL
			7.06117.54.0	SV-NWV	EL
1.4 TSI 110 kW (150 PS) CZDA	12.2014→07.2019		7.06117.48.0	SV-NWV	EL
1.6 TDI 77 kW (105 PS) CAYC	10.2011→07.2016		7.02256.00.0	EUV-AGR	EP
1.8 TSI 125 kW (170 PS) CPKA, CPRA	12.2013→07.2017		7.02901.05.0	SUV	EL
			7.06117.26.0	ZM-NWV	EL
2.0 TDI 103-104 kW (140-141 PS) CJAA	04.2011→07.2016		7.00868.02.0	DW-TL	EP
2.0 TDI 103 kW (140 PS) CFFB	04.2012→07.2016		7.02256.00.0	EUV-AGR	EP
2.0 TSI 147-157 kW (200-213 PS) CBFA, CCTA, CCZA	04.2011→07.2016		7.22880.01.0	EUV-SR	EL
			7.00470.07.0	LDRV	EL
			7.02901.05.0	SUV	EL
			7.06117.26.0	ZM-NWV	EL
2.0 TSI 155 kW (211 PS) CPLA, CPPA	12.2013→07.2019		7.02256.18.0	EUV-SR	EP  CPLA, CPPA: für OE-Nummer: 06H 906 283 F for OE number: 06H 906 283 F
			7.02901.05.0	SUV	EL
			7.06117.26.0	ZM-NWV	EL
2.0 TSI 162 kW (220 PS) CULC	12.2014→09.2018		7.02256.18.0	EUV-SR	EP
			7.02901.05.0	SUV	EL
			7.06117.26.0	ZM-NWV	EL Produktionsdatum ab: 07.05.2017 Production date from: 07.05.2017
2.0 TSI 130 kW (177 PS) DDSA	07.2017→07.2019		7.02901.05.0	SUV	EL
BEETLE Convertible (5C7, 5C8)					8
1.2 TSI 77 kW (105 PS) CBZB	12.2011→07.2019		7.22880.01.0	EUV-KK	EL
1.4 TSI 118 kW (160 PS) CAVD, CNWA, CTHD, CTKA	12.2011→07.2016		7.02588.04.0	LDRV	EL
			7.04247.02.0	SUV	EL
			7.06117.54.0	SV-NWV	EL











BEETLE Convertible (5C7, 5C8) **8**

1.4 TSI 110 kW (150 PS) CZDA	12.2014→09.2018	 7.06117.48.0	SV-NWV	EL	
1.6 TDI 77 kW (105 PS) CAYC	12.2011→07.2016	 7.02256.00.0	EUV-AGR	EP	
1.8 TSI 125 kW (170 PS) CPKA, CPRA	12.2013→12.2016	 7.02901.05.0	SUV	EL	
		7.06117.26.0	ZM-NWV	EL	
2.0 TDI 103 kW (140 PS) CFFB	04.2012→07.2016	 7.02256.00.0	EUV-AGR	EP	
2.0 TDI 103-104 kW (140-141 PS) CJAA	04.2012→07.2016	 7.00868.02.0	DW-TL	EP	
2.0 TSI 147-157 kW (200-213 PS) CBFA, CCTA, CCZA	12.2011→07.2016	 7.22880.01.0	EUV-SR	EL	
		7.00470.07.0	LDRV	EL	
		7.02901.05.0	SUV	EL	
		7.06117.26.0	ZM-NWV	EL	
2.0 TSI 155 kW (211 PS) CPLA, CPPA	12.2012→07.2019	 7.02256.18.0	EUV-SR	EP	 CPLA, CPPA: für OE-Nummer: 06H 906 283 F for OE number: 06H 906 283 F
		7.02901.05.0	SUV	EL	
		7.06117.26.0	ZM-NWV	EL	
2.0 TSI 147-157 kW (200-213 PS) CBFA, CCTA	01.2013→07.2016	 7.22880.01.0	EUV-SR	EL	
		7.00470.07.0	LDRV	EL	
		7.06117.26.0	ZM-NWV	EL	
2.0 TSI 162 kW (220 PS) CULC	12.2014→09.2018	 7.02256.18.0	EUV-SR	EP	Produktionsdatum ab: 07.05.2017 Production date from: 07.05.2017
		7.02901.05.0	SUV	EL	
		7.06117.26.0	ZM-NWV	EL	
2.0 TSI 130 kW (177 PS) DDSA	07.2017→07.2019	 7.02901.05.0	SUV	EL	

BORA (1J2/1J6) **9**

2.0 TSI 16V 85-157 kW (116-213 PS) BPY, BWA, CBFA, CCTA, CFEA	06.2005→12.2009	 7.01830.13.0	SUV	EL	
--	-----------------	---	-----	----	--

BORA I (1J2) **10**

1.4 16V 55 kW (75 PS) AHW, AKQ	03.2000→05.2005	 7.21483.54.0	EUV-AGR	EL	
1.6 65-76 kW (100-103 PS) AEH, AKL, APF	10.1998→05.2005	 7.22402.03.0	EUV-SR	EL	
		 7.22880.01.0	EUV-SR	EL	
1.6 FSI 81 kW (110 PS) BAD	01.2002→05.2005	 7.10014.00.0	AKF	EL	
		7.28098.04.0	EUV-SR	EL	
1.8 92 kW (125 PS) AGN	10.1998→05.2005	 7.02461.01.0	EUV-SR	EL	 →ch. 1J-1W270 000
		7.28098.04.0	EUV-SR	EL	Fahrgestellnummer ab: 1J-1D231 001, 1J-1W270 001 Vehicle Identification Number from: 1J-1D231 001, 1J-1W270 001
1.8 4motion 92 kW (125 PS) AGN	02.1999→05.2005	 7.02461.01.0	EUV-SR	EL	 →ch. 1J-1W270 000
		7.28098.04.0	EUV-SR	EL	Fahrgestellnummer ab: 1J-1D231 001, 1J-1W270 001 Vehicle Identification Number from: 1J-1D231 001, 1J-1W270 001

























V

BORA I (1J2)					
10					
1.8 T 110 kW (150 PS) AUM	05.2000→05.2005		7.22687.49.0	EUV-DR	EP
			7.22687.39.0 7.01805.01.0	EUV-LS EUV-SR	EL EL
1.8 T 132-142 kW (180-193 PS) AUQ	03.2002→05.2005		7.22687.49.0	EUV-DR	EP
			7.22687.39.0 7.01805.01.0	EUV-LS EUV-SR	EL EL
1.8 T 132 kW (180 PS) AWP	03.2002→05.2005		7.22687.49.0	EUV-DR	EP
			7.01805.01.0	EUV-SR	EL
1.9 SDI 50 kW (68 PS) AGP, AQM	10.1998→05.2005		7.02183.01.0	DW-AGR	EP AGP, AQM: ch. 1J-Y-000 001→
			7.21903.70.0	DW-AGR	EP AGP, AQM: Fahrgestellnummer bis: 1J-X-999 000 Vehicle Identification Number to: 1J-X-999 000
1.9 TDI 66 kW (90 PS) AGR	10.1998→05.2005		7.02183.01.0	DW-AGR	EP ch. 1J-Y-000 001→
			7.21903.70.0	DW-AGR	EP Fahrgestellnummer bis: 1J-X-999 000 Vehicle Identification Number to: 1J-X-999 000
			7.02256.00.0	EUV-AGR	EP
			7.01037.02.0	LDRV	EL ch. 1J-Y-000 001→
			7.21895.55.0	LDRV	EL Fahrgestellnummer bis: 1J-X-999 000 Vehicle Identification Number to: 1J-X-999 000
1.9 TDI 66-67 kW (90-91 PS) ALH	10.1998→05.2005		7.02183.01.0	DW-AGR	EP ch. 1J-Y-000 001→
			7.21903.70.0	DW-AGR	EP Fahrgestellnummer bis: 1J-X-999 000 Vehicle Identification Number to: 1J-X-999 000
			7.02184.01.0	DW-TL	EP ch. 1J-Y-000 001→
			7.21903.75.0	DW-TL	EP →ch. 1J-X-999 000
			7.02256.00.0	EUV-AGR	EP
1.9 TDI 81 kW (110 PS) AHF, ASV	10.1998→06.2001		7.02183.01.0	DW-AGR	EP AHF, ASV: ch. 1J-Y-000 001→
			7.21903.70.0	DW-AGR	EP AHF, ASV: Fahrgestellnummer bis: 1J-X-999 000 Vehicle Identification Number to: 1J-X-999 000
			7.02184.01.0	DW-TL	EP AHF, ASV: ch. 1J-Y-000 001→
			7.21903.75.0	DW-TL	EP AHF, ASV: →ch. 1J-X-999 000
			7.02256.00.0	EUV-AGR	EP
1.9 TDI 85 kW (115 PS) AJM, AUY	12.1998→01.2002		7.02183.01.0	DW-AGR	EP AJM, AUY: ch. 1J-Y-000 001→
			7.21903.70.0	DW-AGR	EP AJM, AUY: Fahrgestellnummer bis: 1J-X-999 000 Vehicle Identification Number to: 1J-X-999 000
			7.02184.01.0 7.21903.75.0	DW-TL DW-TL	EP AJM, AUY: ch. 1J-Y-000 001→ EP AJM, AUY: →ch. 1J-X-999 000
1.9 TDI 110 kW (150 PS) ARL	05.2000→05.2005		7.02183.01.0	DW-AGR	EP
			7.00868.02.0 7.02256.00.0	DW-TL EUV-AGR	EP EP
1.9 TDI 74 kW (101 PS) ATD	09.2000→05.2005		7.02183.01.0	DW-AGR	EP ch. 1J-Y-000 001→

V



BORA I (1J2) **10**



























			7.21903.70.0	DW-AGR	EP	Fahrgestellnummer bis: 1J-X-999 000 Vehicle Identification Number to: 1J-X-999 000
			7.02184.01.0	DW-TL	EP	 ch. 1J-Y-000 001→
			7.21903.75.0	DW-TL	EP	 →ch. 1J-X-999 000
			7.02256.00.0	EUV-AGR	EP	
1.9 TDI 74 kW (101 PS) AXR	09.2000→05.2005		7.02183.01.0	DW-AGR	EP	
			7.00868.02.0	DW-TL	EP	
			7.02256.00.0	EUV-AGR	EP	
1.9 TDI 96 kW (130 PS) ASZ	11.2000→05.2005		7.02183.01.0	DW-AGR	EP	
			7.00868.02.0	DW-TL	EP	
			7.02256.00.0	EUV-AGR	EP	
1.9 TDI 4motion 66 kW (90 PS) AGR	11.1998→04.2002		7.02183.01.0	DW-AGR	EP	 ch. 1J-Y-000 001→
			7.21903.70.0	DW-AGR	EP	Fahrgestellnummer bis: 1J-X-999 000 Vehicle Identification Number to: 1J-X-999 000
			7.02256.00.0	EUV-AGR	EP	
			7.01037.02.0	LDRV	EL	 ch. 1J-Y-000 001→
			7.21895.55.0	LDRV	EL	Fahrgestellnummer bis: 1J-X-999 000 Vehicle Identification Number to: 1J-X-999 000
1.9 TDI 4motion 85 kW (115 PS) AJM, AUY	02.1999→06.2001		7.02183.01.0	DW-AGR	EP	 AJM, AUY:  ch. 1J-Y-000 001→
			7.21903.70.0	DW-AGR	EP	 AJM, AUY: Fahrgestellnummer bis: 1J-X-999 000 Vehicle Identification Number to: 1J-X-999 000
			7.02184.01.0	DW-TL	EP	 AJM, AUY:  ch. 1J-Y-000 001→
			7.21903.75.0	DW-TL	EP	 AJM, AUY:  →ch. 1J-X-999 000
1.9 TDI 4motion 110 kW (150 PS) ARL	05.2000→05.2005		7.02183.01.0	DW-AGR	EP	
			7.00868.02.0	DW-TL	EP	
			7.02256.00.0	EUV-AGR	EP	
1.9 TDI 4motion 74 kW (101 PS) ATD	09.2000→05.2005		7.02183.01.0	DW-AGR	EP	 ch. 1J-Y-000 001→
			7.21903.70.0	DW-AGR	EP	Fahrgestellnummer bis: 1J-X-999 000 Vehicle Identification Number to: 1J-X-999 000
			7.02184.01.0	DW-TL	EP	 ch. 1J-Y-000 001→
			7.21903.75.0	DW-TL	EP	 →ch. 1J-X-999 000
			7.02256.00.0	EUV-AGR	EP	
1.9 TDI 4motion 96 kW (130 PS) ASZ	11.2000→05.2005		7.02183.01.0	DW-AGR	EP	
			7.00868.02.0	DW-TL	EP	
			7.02256.00.0	EUV-AGR	EP	
2.0 85 kW (115 PS) AZJ	10.1998→12.2013		7.22880.01.0	EUV-SR	EL	
2.0 4motion 85 kW (115 PS) AZJ	04.2000→05.2005		7.22880.01.0	EUV-SR	EL	
2.3 V5 125 kW (170 PS) AQN	10.2000→05.2005		7.06117.44.0	SV-NWV	EL	mit Dichtring with O-ring Einlassseite Intake Side

BORA I (1J2)					10
2.3 V5 4motion 125 kW (170 PS) AQN	10.2000→05.2005		7.06117.44.0	SV-NWV	EL mit Dichtring with O-ring Einlassseite Intake Side
2.8 V6 4motion 150 kW (204 PS) BDE	03.1999→05.2005		7.06117.44.0	SV-NWV	EL mit Dichtring with O-ring Einlassseite Intake Side
BORA Variant (1J6)					11
1.4 16V 55 kW (75 PS) AHW, AKQ	09.2001→05.2005		7.21483.54.0	EUV-AGR	EL
1.6 65-76 kW (100-103 PS) AEH, AKL, APF	05.1999→05.2005		7.22402.03.0	EUV-SR	EL
1.6 75 kW (102 PS) AVU, BFQ	08.2000→05.2005		7.22880.01.0	EUV-SR	EL
1.6 FSI 81 kW (110 PS) BAD	01.2002→05.2005		7.10014.00.0	AKF	EL
1.8 4motion 92 kW (125 PS) AGN	05.1999→05.2005		7.28098.04.0	EUV-SR	EL
			7.02461.01.0	EUV-SR	EL →ch. 1J-1W270 000
1.8 T 110 kW (150 PS) AUM	05.2000→05.2005		7.22687.49.0	EUV-DR	EP
			7.22687.39.0	EUV-LS	EL
1.8 T 132-142 kW (180-193 PS) AUQ	05.2002→05.2005		7.01805.01.0	EUV-SR	EL
			7.22687.49.0	EUV-DR	EP
			7.22687.39.0	EUV-LS	EL
1.8 T 132 kW (180 PS) AWP	05.2002→05.2005		7.01805.01.0	EUV-SR	EL
			7.22687.49.0	EUV-DR	EP
			7.22687.39.0	EUV-LS	EL
1.9 TDI 85 kW (115 PS) AJM, AUY	05.1999→06.2001		7.02183.01.0	DW-AGR	EP AJM, AUY: ch. 1J-Y-000 001→
			7.21903.70.0	DW-AGR	EP AJM, AUY: Fahrgestellnummer bis: 1J-X-999 000 Vehicle Identification Number to: 1J-X-999 000
			7.02184.01.0	DW-TL	EP AJM, AUY: ch. 1J-Y-000 001→
			7.21903.75.0	DW-TL	EP AJM, AUY: →ch. 1J-X-999 000
1.9 TDI 81 kW (110 PS) AHF, ASV	05.1999→06.2001		7.02183.01.0	DW-AGR	EP AHF, ASV: ch. 1J-Y-000 001→
			7.21903.70.0	DW-AGR	EP AHF, ASV: Fahrgestellnummer bis: 1J-X-999 000 Vehicle Identification Number to: 1J-X-999 000
			7.02184.01.0	DW-TL	EP AHF, ASV: ch. 1J-Y-000 001→
			7.21903.75.0	DW-TL	EP AHF, ASV: →ch. 1J-X-999 000
			7.02256.00.0	EUV-AGR	EP
			7.02183.01.0	DW-AGR	EP ch. 1J-Y-000 001→
1.9 TDI 74 kW (101 PS) ATD	09.2000→05.2005		7.21903.70.0	DW-AGR	EP Fahrgestellnummer bis: 1J-X-999 000 Vehicle Identification Number to: 1J-X-999 000
			7.02184.01.0	DW-TL	EP ch. 1J-Y-000 001→
			7.21903.75.0	DW-TL	EP →ch. 1J-X-999 000
			7.02256.00.0	EUV-AGR	EP
			7.02183.01.0	DW-AGR	EP

































BORA Variant (1J6) **11**

1.9 TDI 74 kW (101 PS) AXR	09.2000→05.2005		7.02183.01.0	DW-AGR	EP	
			7.00868.02.0	DW-TL	EP	
			7.02256.00.0	EUV-AGR	EP	
1.9 TDI 96 kW (130 PS) ASZ	11.2000→05.2005		7.02183.01.0	DW-AGR	EP	
			7.00868.02.0	DW-TL	EP	
			7.02256.00.0	EUV-AGR	EP	
1.9 TDI 110 kW (150 PS) ARL	05.2001→05.2005		7.02183.01.0	DW-AGR	EP	
			7.00868.02.0	DW-TL	EP	
			7.02256.00.0	EUV-AGR	EP	
1.9 TDI 66 kW (90 PS) AGR	07.2004→05.2005		7.02183.01.0	DW-AGR	EP	 ch. 1J-Y-000 001→
			7.21903.70.0	DW-AGR	EP	Fahrgestellnummer bis: 1J-X-999 000 Vehicle Identification Number to: 1J-X-999 000
			7.02256.00.0	EUV-AGR	EP	
			7.01037.02.0	LDRV	EL	 ch. 1J-Y-000 001→
			7.21895.55.0	LDRV	EL	Fahrgestellnummer bis: 1J-X-999 000 Vehicle Identification Number to: 1J-X-999 000
1.9 TDI 66-67 kW (90-91 PS) ALH	07.2004→05.2005		7.02183.01.0	DW-AGR	EP	 ch. 1J-Y-000 001→
			7.21903.70.0	DW-AGR	EP	Fahrgestellnummer bis: 1J-X-999 000 Vehicle Identification Number to: 1J-X-999 000
			7.02184.01.0	DW-TL	EP	 ch. 1J-Y-000 001→
			7.21903.75.0	DW-TL	EP	 →ch. 1J-X-999 000
			7.02256.00.0	EUV-AGR	EP	
1.9 TDI 4motion 85 kW (115 PS) AJM, AUY	05.1999→06.2001		7.02183.01.0	DW-AGR	EP	 AJM, AUY:  ch. 1J-Y-000 001→
			7.21903.70.0	DW-AGR	EP	 AJM, AUY: Fahrgestellnummer bis: 1J-X-999 000 Vehicle Identification Number to: 1J-X-999 000
			7.02184.01.0	DW-TL	EP	 AJM, AUY:  ch. 1J-Y-000 001→
			7.21903.75.0	DW-TL	EP	 AJM, AUY:  →ch. 1J-X-999 000
1.9 TDI 4motion 74 kW (101 PS) ATD	09.2000→05.2005		7.02183.01.0	DW-AGR	EP	 ch. 1J-Y-000 001→
			7.21903.70.0	DW-AGR	EP	Fahrgestellnummer bis: 1J-X-999 000 Vehicle Identification Number to: 1J-X-999 000
			7.02184.01.0	DW-TL	EP	 ch. 1J-Y-000 001→
			7.21903.75.0	DW-TL	EP	 →ch. 1J-X-999 000
			7.02256.00.0	EUV-AGR	EP	
1.9 TDI 4motion 96 kW (130 PS) ASZ	11.2000→05.2005		7.02183.01.0	DW-AGR	EP	
			7.00868.02.0	DW-TL	EP	
			7.02256.00.0	EUV-AGR	EP	
1.9 TDI 4motion 110 kW (150 PS) ARL	05.2001→05.2005		7.02183.01.0	DW-AGR	EP	
			7.00868.02.0	DW-TL	EP	
			7.02256.00.0	EUV-AGR	EP	
2.0 85 kW (115 PS) AZJ	05.1999→05.2005		7.22880.01.0	EUV-SR	EL	
2.0 4motion 85 kW (115 PS) AZJ	04.2000→05.2005		7.22880.01.0	EUV-SR	EL	

V

						
BORA Variant (1J6)						11
2.3 V5 125 kW (170 PS) AQN	10.2000→05.2005		7.06117.44.0	SV-NWV	EL mit Dichtring with O-ring Einlassseite Intake Side	
2.3 V5 4motion 125 kW (170 PS) AQN	10.2000→05.2005		7.06117.44.0	SV-NWV	EL mit Dichtring with O-ring Einlassseite Intake Side	
2.8 V6 4motion 150 kW (204 PS) BDE	05.1999→05.2005		7.06117.44.0	SV-NWV	EL mit Dichtring with O-ring Einlassseite Intake Side	
CADDY ALLTRACK MPV (SAB)						12
1.0 TSI 75 kW (102 PS) CHZG	11.2015→		7.06117.48.0	SV-NWV	EL	
1.0 TSI 62 kW (84 PS) DKRD	11.2018→		7.06117.48.0	SV-NWV	EL	
1.4 TGI CNG 81 kW (110 PS) CPWA	06.2015→		7.06117.48.0	SV-NWV	EL für OE-Nummer: 04E 906 455 D for OE number: 04E 906 455 D	
1.4 TSI 92 kW (125 PS) CZCB	05.2015→		7.06117.48.0	SV-NWV	EL	
1.4 TSI 96 kW (131 PS) DJKD	07.2018→		7.06117.48.0	SV-NWV	EL	
1.6 TDI 55 kW (75 PS) CAYE	05.2015→11.2017		7.02256.00.0	EUV-AGR	EP  ch. 2K-B-200 001→	
1.6 TDI 75 kW (102 PS) CAYD	05.2015→		7.02256.00.0	EUV-AGR	EP	
2.0 TDI 103 kW (140 PS) CFHC	05.2015→		7.02256.00.0	EUV-AGR	EP	
2.0 TDI 81 kW (110 PS) CLCA	05.2015→		7.02256.00.0	EUV-AGR	EP	
2.0 TDI 4motion 81 kW (110 PS) CFHF	05.2015→05.2016		7.02256.00.0	EUV-AGR	EP	
2.0 TDI 4motion 103 kW (140 PS) CFHC	05.2015→		7.02256.00.0	EUV-AGR	EP	
CADDY II MPV (9K9B)						13
1.7 SDI 42 kW (57 PS) AHB	07.1996→09.2000		7.21903.70.0	DW-AGR	EP	
			7.21895.55.0	EUV-LS	EL	
1.9 SDI 47-48 kW (64-65 PS) AEY	11.1995→01.2004		7.21903.70.0	DW-AGR	EP	
			7.21895.55.0	EUV-LS	EL	
1.9 SDI 47 kW (64 PS) AYQ	11.1995→01.2004		7.21903.70.0	DW-AGR	EP	
1.9 TDI 66-67 kW (90-91 PS) 1Z, AHU, ALE	10.1996→01.2004		7.21903.70.0	DW-AGR	EP	
			7.21895.55.0	LDRV	EL	
1.9 TDI 66-67 kW (90-91 PS) ALH	10.1996→01.2004		7.21903.75.0	DW-AGR	EP	
			7.21903.70.0	DW-TL	EP	
CADDY III MPV (2KB, 2KJ, 2CB, 2CJ)						14
1.2 TSI 63 kW (86 PS) CBZA	09.2010→05.2015		7.22880.01.0	EUV-KK	EL	
1.2 TSI 77 kW (105 PS) CBZB	09.2010→05.2015		7.22880.01.0	EUV-KK	EL	
1.6 75 kW (102 PS) BGU	04.2004→05.2015		7.10014.00.0	AKF	EL	
			7.22880.01.0	EUV-SR	EL	

V



CADDY III MPV (2KB, 2KJ, 2CB, 2CJ)

14

1.6 75 kW (102 PS) BSE, BSF	04.2004→05.2015	7.10014.00.0	AKF	EL	BSE, BSF: für Fahrzeuge mit Standheizung for vehicles with parking heater
		7.22880.01.0	EUV-SR	EL	
		7.02256.40.0	SV-KK	EL	
1.6 BiFuel 75 kW (102 PS) CHGA	05.2011→05.2015	7.10014.00.0	AKF	EL	ch. 2K-B-200 001→
		7.22880.01.0	EUV-SR	EL	
1.6 TDI 55 kW (75 PS) CAYE	08.2010→05.2015	7.02256.00.0	EUV-AGR	EP	ch. 2K-B-200 001→
1.6 TDI 75 kW (102 PS) CAYD	08.2010→05.2015	7.02256.00.0	EUV-AGR	EP	ch. 2K-B-200 001→
1.9 TDI 77 kW (105 PS) BJB	04.2004→08.2010	7.02256.41.0	SV-KK	EL	für Fahrzeuge mit Standheizung for vehicles with parking heater
1.9 TDI 77 kW (105 PS) BLS	04.2004→08.2010	7.00868.02.0	DW-TL	EP	
		7.02256.00.0	EUV-AGR	EP	
1.9 TDI 55 kW (75 PS) BSU	09.2005→08.2010	7.00868.02.0	DW-TL	EP	
		7.02256.00.0	EUV-AGR	EP	
1.9 TDI 4motion 77 kW (105 PS) BLS	05.2008→08.2010	7.00868.02.0	DW-TL	EP	
		7.02256.00.0	EUV-AGR	EP	
2.0 SDI 51 kW (70 PS) BDJ, BST	03.2004→08.2010	7.00580.01.0	DW-AGR	EP	BDJ, BST: für Fahrzeuge mit Standheizung for vehicles with parking heater
		7.02256.40.0	SV-KK	EL	
2.0 TDI 103 kW (140 PS) BMM	09.2007→08.2010	7.00868.02.0	DW-TL	EP	
		7.02256.00.0	EUV-AGR	EP	
2.0 TDI 81 kW (110 PS) CLCA	08.2010→05.2015	7.02256.00.0	EUV-AGR	EP	
2.0 TDI 16V 103 kW (140 PS) CFHC, CLCB	11.2010→05.2015	7.02256.00.0	EUV-AGR	EP	
2.0 TDI 16V 4motion 103 kW (140 PS) CFHC	11.2010→05.2015	7.02256.00.0	EUV-AGR	EP	
2.0 TDI 4motion 81 kW (110 PS) CFHF	08.2010→05.2015	7.02256.00.0	EUV-AGR	EP	ch. 2K-B-200 001→



























CADDY IV MPV (SAB, SAJ)

15

1.0 TSI 75 kW (102 PS) CHZG, DKRE	11.2015→09.2020	7.06117.48.0	SV-NWV	EL	
1.0 TSI 62 kW (84 PS) DKRD	11.2018→07.2019	7.06117.48.0	SV-NWV	EL	
1.4 TGI CNG 81 kW (110 PS) CPWA	06.2015→09.2020	7.06117.48.0	SV-NWV	EL	für OE-Nummer: 04E 906 455 D for OE number: 04E 906 455 D
1.4 TSI 92 kW (125 PS) CZCB	05.2015→09.2020	7.06117.48.0	SV-NWV	EL	
1.4 TSI 96 kW (131 PS) DJKD	07.2018→09.2020	7.06117.48.0	SV-NWV	EL	
1.6 TDI 55 kW (75 PS) CAYE	05.2015→11.2017	7.02256.00.0	EUV-AGR	EP	ch. 2K-B-200 001→
1.6 TDI 75 kW (102 PS) CAYD	05.2015→09.2020	7.02256.00.0	EUV-AGR	EP	
2.0 TDI 103 kW (140 PS) CFHC, CLCB	05.2015→09.2020	7.02256.00.0	EUV-AGR	EP	

V











CADDY IV MPV (SAB, SAJ)						15
2.0 TDI 81 kW (110 PS) CLCA	09.2015→09.2020	 7.02256.00.0	EUV-AGR	EP		
2.0 TDI 4motion 81 kW (110 PS) CFHF, CLCA	05.2015→09.2020	 7.02256.00.0	EUV-AGR	EP		
2.0 TDI 4motion 103 kW (140 PS) CFHC	05.2015→09.2020	 7.02256.00.0	EUV-AGR	EP		
CC B7 (358)						16
1.4 TSI 118 kW (160 PS) CTHD	11.2011→12.2016	 7.02588.04.0	LDRV	EL	 ch. 3C-C-700 001→	
		7.04247.02.0	SUV	EL	 ch. 3C-C-700 001→	
		7.06117.54.0	SV-NWV	EL	Fahrgestellnummer ab: 3C-C-700 001 Vehicle Identification Number from: 3C-C-700 001	
1.4 TSI MultiFuel 118 kW (160 PS) CKMA	11.2011→12.2016	 7.02588.04.0	LDRV	EL	 ch. 3C-C-700 001→	
		7.04247.02.0	SUV	EL	 ch. 3C-C-700 001→	
		7.06117.54.0	SV-NWV	EL	Fahrgestellnummer ab: 3C-C-700 001 Vehicle Identification Number from: 3C-C-700 001	
1.8 TSI 118 kW (160 PS) CDA A	11.2011→12.2016	 7.03280.04.0	EUV-SR	EL	Fahrgestellnummer ab: 3C-C-700 001 Vehicle Identification Number from: 3C-C-700 001	
		7.00470.07.0	LDRV	EL	 ch. 3C-C-700 001→	
		7.01830.13.0	SUV	EL		
		7.06117.26.0	ZM-NWV	EL	 ch. 3C-C-700 001→	
1.8 TSI 112 kW (152 PS) CDAB	11.2011→12.2016	 7.03280.04.0	EUV-SR	EL	Fahrgestellnummer ab: 3C-C-700 001 Vehicle Identification Number from: 3C-C-700 001	
		7.22880.01.0	EUV-SR	EL	Fahrgestellnummer ab: 3C-C-700 001 Vehicle Identification Number from: 3C-C-700 001	
		7.00470.07.0	LDRV	EL	 ch. 3C-B-200 001→	
		7.01830.13.0	SUV	EL		
7.06117.26.0	ZM-NWV	EL	Fahrgestellnummer ab: 3C-C-700 001 Vehicle Identification Number from: 3C-C-700 001			
2.0 TDI 100 kW (136 PS) CFFA	11.2011→12.2016	 7.02256.00.0	EUV-AGR	EP	 ch. 3C-C-700 001→	
2.0 TDI 125 kW (170 PS) CFGB, CLLA	11.2011→12.2016	 7.02256.00.0	EUV-AGR	EP		
2.0 TDI 103 kW (140 PS) CFFB	11.2011→12.2016	 7.02256.00.0	EUV-AGR	EP		
2.0 TDI 130 kW (177 PS) CFG C	12.2012→12.2016	 7.02256.00.0	EUV-AGR	EP		
2.0 TDI 4motion 103 kW (140 PS) CFFB	11.2011→12.2016	 7.02256.00.0	EUV-AGR	EP		
2.0 TDI 4motion 125 kW (170 PS) CFGB	11.2011→01.2013	 7.02256.00.0	EUV-AGR	EP		
2.0 TDI 4motion 130 kW (177 PS) CFG C	12.2012→12.2016	 7.02256.00.0	EUV-AGR	EP		
2.0 TSI 147-157 kW (200-213 PS) CBFA, CCTA	11.2011→12.2016	 7.03280.04.0	EUV-SR	EL	 CBFA, CCTA: Fahrgestellnummer ab: 3C-C-700 001 Vehicle Identification Number from: 3C-C-700 001	
		7.22880.01.0	EUV-SR	EL	 CBFA, CCTA: Fahrgestellnummer ab: 3C-C-700 001 Vehicle Identification Number from: 3C-C-700 001	
		7.00470.07.0	LDRV	EL	 CBFA, CCTA:	
		7.02901.05.0	SUV	EL	 ch. 3C-C-700 001→	

V











CC B7 (358) **16**

			7.06117.26.0	ZM-NWV	EL	 CBFA, CCTA:  ch. 3C-C-700 001→
2.0 TSI 155 kW (211 PS) CCZB	11.2011→12.2016		7.03280.04.0	EUV-SR	EL	Fahrgestellnummer ab: 3C-C-700 001 Vehicle Identification Number from: 3C-C-700 001
			7.22880.01.0	EUV-SR	EL	Fahrgestellnummer ab: 3C-C-700 001 Vehicle Identification Number from: 3C-C-700 001
			7.00470.07.0	LDRV	EL	 ch. 3C-C-700 001→
			7.02901.05.0	SUV	EL	 ch. 3C-C-700 001→
			7.06117.26.0	ZM-NWV	EL	Fahrgestellnummer ab: 3C-C-700 001 Vehicle Identification Number from: 3C-C-700 001
3.6 FSI 4motion 206 kW (280 PS) CNNA	11.2011→12.2016		7.06117.37.0	SV-NWV	EL	Fahrgestellnummer ab: 3C-C-700 001 Vehicle Identification Number from: 3C-C-700 001
3.6 FSI 4motion 220 kW (300 PS) BWS	11.2011→12.2016		7.02256.40.0	SV-KK	EL	 ch. 3C-C-700 001→ für Fahrzeuge mit Standheizung for vehicles with parking heater
			7.06117.37.0	SV-NWV	EL	Fahrgestellnummer ab: 3C-C-700 001 Vehicle Identification Number from: 3C-C-700 001

CITI GOLF **17**













1.6 53-60 kW (72-82 PS) HM	06.1996→12.1999		7.01805.01.0	EUV-LS	EL	
--------------------------------------	-----------------	--	---------------------	--------	----	--

EOS (1F7, 1F8) **18**

1.4 TSI 90 kW (122 PS) CAXA	11.2007→08.2015		7.01830.13.0	SUV	EL	
			7.02901.05.0	SUV	EL	
			7.02256.40.0	SV-KK	EL	für Fahrzeuge mit Standheizung for vehicles with parking heater
			7.06117.54.0	SV-NWV	EL	
1.4 TSI 118 kW (160 PS) CAVD	05.2008→08.2015		7.02588.04.0	LDRV	EL	
			7.04247.02.0	SUV	EL	
			7.02256.40.0	SV-KK	EL	für Fahrzeuge mit Standheizung for vehicles with parking heater
			7.06117.54.0	SV-NWV	EL	
1.4 TSI 118 kW (160 PS) CTHD	05.2008→08.2015		7.02588.04.0	LDRV	EL	 ch. 1F-B-006 377→
			7.04247.02.0	SUV	EL	 ch. 1F-B-006 377→
			7.06117.54.0	SV-NWV	EL	Fahrgestellnummer ab: 1F-B-006 377 Vehicle Identification Number from: 1F-B-006 377
1.6 FSI 85 kW (115 PS) BLF	06.2006→05.2008		7.10014.00.0	AKF	EL	
			7.22880.01.0	EUV-SR	EL	
			7.02256.40.0	SV-KK	EL	für Fahrzeuge mit Standheizung for vehicles with parking heater
			7.06117.54.0	SV-NWV	EL	
2.0 FSI 110 kW (150 PS) BVY, BVZ	03.2006→05.2008		7.22880.01.0	EUV-SR	EL	
			7.02256.40.0	SV-KK	EL	 BVY, BVZ: für Fahrzeuge mit Standheizung for vehicles with parking heater
			7.06117.37.0	SV-NWV	EL	
2.0 TDI 103 kW (140 PS) BMM	06.2006→05.2008		7.00868.02.0	DW-TL	EP	
			7.02256.00.0	EUV-AGR	EP	
			7.02256.40.0	SV-KK	EL	für Fahrzeuge mit Standheizung for vehicles with parking heater











EOS (1F7, 1F8) 18

2.0 TDI 100 kW (136 PS) CFFA	11.2010→08.2015	 7.00868.02.0	DW-TL	EP	
		7.02256.00.0	EUV-AGR	EP	 ch. 1F-B-006 377→
2.0 TDI 16V 103 kW (140 PS) CBAB	05.2008→08.2015	 7.00868.02.0	DW-TL	EP	
		7.02256.00.0	EUV-AGR	EP	
		7.02256.40.0	SV-KK	EL	für Fahrzeuge mit Standheizung for vehicles with parking heater
2.0 TDI 16V 103 kW (140 PS) CFFB	05.2008→08.2015	 7.00868.02.0	DW-TL	EP	
		7.02256.00.0	EUV-AGR	EP	 ch. 1F-B-006 377→
2.0 TFSI 147 kW (200 PS) BPY, BWA	03.2006→08.2015	 7.00470.07.0	LDRV	EL	
		7.01830.13.0	SUV	EL	
		7.02901.05.0	SUV	EL	
		7.02256.40.0	SV-KK	EL	 BPY, BWA: für Fahrzeuge mit Standheizung for vehicles with parking heater
		7.06117.46.0	SV-NWV	EH	mit Dichtring with O-ring
2.0 TFSI 147 kW (200 PS) CAWB	03.2006→08.2015	 7.03280.04.0	EUV-SR	EL	Baujahr ab: 01.2009 Construction year from: 01.2009
		7.22880.01.0	EUV-SR	EL	
		7.00470.07.0	LDRV	EL	
		7.02256.40.0	SV-KK	EL	für Fahrzeuge mit Standheizung for vehicles with parking heater
		7.06117.26.0	ZM-NWV	EL	
2.0 TFSI 147-157 kW (200-213 PS) CBFA	03.2006→08.2015	 7.03280.04.0	EUV-SR	EL	Baujahr ab: 01.2009 Construction year from: 01.2009
		7.22880.01.0	EUV-SR	EL	Fahrgestellnummer ab: 1F-B-006 377 Vehicle Identification Number from: 1F-B-006 377
		7.00470.07.0	LDRV	EL	
		7.02901.05.0	SUV	EL	für OE-Nummer: 06J 145 713 F, 06J 145 713 FX, 06J 145 713 K, 06J 145 713 KX, 06J 145 713 T, 06J 145 713 TX, 06J 145 722 B, 06J 145 722 BX for OE number: 06J 145 713 F, 06J 145 713 FX, 06J 145 713 K, 06J 145 713 KX, 06J 145 713 T, 06J 145 713 TX, 06J 145 722 B, 06J 145 722 BX
		7.06117.26.0	ZM-NWV	EL	 ch. 1F-B-006 377→
2.0 TFSI 147-157 kW (200-213 PS) CCTA	03.2006→08.2015	 7.03280.04.0	EUV-SR	EL	Baujahr ab: 01.2009 Construction year from: 01.2009
		7.00470.07.0	LDRV	EL	
		7.02901.05.0	SUV	EL	für OE-Nummer: 06J 145 713 F, 06J 145 713 FX, 06J 145 713 K, 06J 145 713 KX, 06J 145 713 T, 06J 145 713 TX, 06J 145 722 B, 06J 145 722 BX for OE number: 06J 145 713 F, 06J 145 713 FX, 06J 145 713 K, 06J 145 713 KX, 06J 145 713 T, 06J 145 713 TX, 06J 145 722 B, 06J 145 722 BX
		7.02256.40.0	SV-KK	EL	für Fahrzeuge mit Standheizung for vehicles with parking heater
		7.06117.26.0	ZM-NWV	EL	
2.0 TFSI 147 kW (200 PS) CCZA	03.2006→08.2015	 7.03280.04.0	EUV-SR	EL	Baujahr ab: 01.2009 Construction year from: 01.2009
		7.22880.01.0	EUV-SR	EL	
		7.00470.07.0	LDRV	EL	
		7.02901.05.0	SUV	EL	 ch. 1F-B-006 377→



EOS (1F7, 1F8) 18

			7.02256.40.0	SV-KK	EL	für Fahrzeuge mit Standheizung for vehicles with parking heater
			7.06117.26.0	ZM-NWV	EL	
2.0 TSI 155 kW (211 PS) CCZB	11.2009→08.2015		7.03280.04.0	EUV-SR	EL	
			7.22880.01.0	EUV-SR	EL	
			7.00470.07.0	LDRV	EL	
			7.02901.05.0	SUV	EL	 ch. 1F-B-006 377→ für OE-Nummer: 06J 145 713 F, 06J 145 713 FX, 06J 145 713 K, 06J 145 713 KX, 06J 145 713 T, 06J 145 713 TX, 06J 145 722 B, 06J 145 722 BX for OE number: 06J 145 713 F, 06J 145 713 FX, 06J 145 713 K, 06J 145 713 KX, 06J 145 713 T, 06J 145 713 TX, 06J 145 722 B, 06J 145 722 BX
			7.02256.40.0	SV-KK	EL	für Fahrzeuge mit Standheizung for vehicles with parking heater
			7.06117.26.0	ZM-NWV	EL	
3.2 V6 184 kW (250 PS) BUB	06.2006→05.2009		7.10014.00.0	AKF	EL	
			7.02256.00.0	EUV-AGK	EP	
			7.02256.40.0	SV-KK	EL	für Fahrzeuge mit Standheizung for vehicles with parking heater
			7.06117.37.0	SV-NWV	EL	 ch. 1F-8-000 000→
			7.06117.43.0	SV-NWV	EL	mit Dichtring with O-ring  →ch. 1F-7-060 000 Auslassseite Exhaust Side
			7.06117.44.0	SV-NWV	EL	mit Dichtring with O-ring  →ch. 1F-7-060 000 Einlassseite Intake Side
3.2 V6 184 kW (250 PS) CBRA	06.2006→05.2009		7.06117.37.0	SV-NWV	EL	
3.6 V6 191 kW (260 PS) CDVA	05.2009→11.2010		7.02256.00.0	EUV-AGK	EP	
			7.02256.40.0	SV-KK	EL	für Fahrzeuge mit Standheizung for vehicles with parking heater
			7.06117.37.0	SV-NWV	EL	



























FOX Hatchback (5Z1, 5Z3, 5Z4) 19

1.9 D 47 kW (64 PS) ASY	12.2007→12.2009		7.02183.01.0	DW-AGR	EP	■ Afrika ■ Africa
-----------------------------------	-----------------	---	---------------------	--------	----	----------------------

GOLF ALLTRACK VII Variant (BA5, BV5) 20

1.8 TSI 4motion 132 kW (180 PS) CJSB	12.2014→		7.03280.04.0	EUV-SR	EL	Baujahr ab: 01.2017 Construction year from: 01.2017
			7.06117.26.0	ZM-NWV	EL	Fahrgestellnummer ab: AU-E-500 001 Vehicle Identification Number from: AU-E-500 001
1.8 TSI 4motion 125 kW (170 PS) CXBB	08.2016→		7.06117.26.0	ZM-NWV	EL	Fahrgestellnummer ab: AU-GM500001 Vehicle Identification Number from: AU-GM500001
TSI 132 kW (180 PS) CJSB	02.2019→		7.03280.04.0	EUV-SR	EL	

V





						
GOLF II (19E, 1G1)						21
1.8 i Cat 65-66 kW (88-90 PS) RP	08.1987→10.1991		7.01805.01.0	EUV-LS	EL	
1.8 i Cat Syncro 65-66 kW (88-90 PS) RP	08.1987→10.1991		7.01805.01.0	EUV-LS	EL	
GOLF III (1H1)						22
1.6 74 kW (101 PS) AEK	07.1995→12.1995		7.21483.54.0	EUV-AGR	EL	
1.6 74 kW (101 PS) AFT, AKS	12.1995→08.1997		7.22402.03.0	EUV-SR	EL	
1.9 SDI 47-48 kW (64-65 PS) AEY	04.1997→08.1997		7.21903.70.0	DW-AGR	EP	
1.9 TDI 66-67 kW (90-91 PS) 1Z, AHU, ALE	08.1993→08.1997		7.21895.55.0	LDRV	EL	
			7.21903.70.0	DW-AGR	EP	
1.9 TDI 81 kW (110 PS) AFN	04.1996→08.1997		7.21903.70.0	DW-AGR	EP	
			7.21903.75.0	DW-TL	EP	
1.9 TDI Syncro (1HX1) 66-67 kW (90-91 PS) 1Z, AHU, ALE	08.1995→08.1997		7.21903.70.0	DW-AGR	EP	
			7.21895.55.0	LDRV	EL	
2.0 81-87 kW (110-117 PS) ABA	11.1991→08.1997		7.21483.54.0	EUV-AGR	EL  →ch. 1H-V-999 000  Mexico, Kanada  Mexico, Kanada	
GOLF III Cabriolet (1E7)						23
1.6 74 kW (101 PS) AEK	10.1994→12.1995		7.21483.54.0	EUV-AGR	EL	
1.6 74 kW (101 PS) AFT, AKS	12.1995→02.1998		7.22402.03.0	EUV-SR	EL	
1.9 TDI 66-67 kW (90-91 PS) 1Z, AHU, ALE	08.1995→05.1998		7.21903.70.0	DW-AGR	EP	
			7.21895.55.0	LDRV	EL	
1.9 TDI 81 kW (110 PS) AFN	07.1996→05.1998		7.21903.70.0	DW-AGR	EP	
			7.21903.75.0	DW-TL	EP	
GOLF III Variant (1H5)						24
1.6 74 kW (101 PS) AEK	07.1994→12.1995		7.21483.54.0	EUV-AGR	EL	
1.6 74 kW (101 PS) AFT, AKS	01.1996→04.1999		7.22402.03.0	EUV-SR	EL	
1.9 SDI 47-48 kW (64-65 PS) AEY	04.1997→04.1999		7.21903.70.0	DW-AGR	EP	
			7.21895.55.0	LDRV	EL	
1.9 TDI 66-67 kW (90-91 PS) 1Z, AHU, ALE	03.1994→04.1999		7.21903.70.0	DW-AGR	EP	
			7.21895.55.0	LDRV	EL	
1.9 TDI 81 kW (110 PS) AFN	04.1996→04.1999		7.21903.70.0	DW-AGR	EP	
			7.21903.75.0	DW-TL	EP	



GOLF III Variant (1H5) 24

1.9 TDI Syncro 66-67 kW (90-91 PS) 1Z, AHU, ALE	07.1995→04.1999		7.21903.70.0	DW-AGR	EP	
			7.21895.55.0	LDRV	EL	



































GOLF IV (1J1) 25

1.4 16V 55 kW (75 PS) AHW, AKQ	10.1997→05.2004		7.21483.54.0	EUV-AGR	EL	 AHW, AKQ: Fahrgestellnummer ab: 1J-W-000 001 Vehicle Identification Number from: 1J-W-000 001
			7.22402.03.0	EUV-SR	EL	
1.6 65-76 kW (100-103 PS) AEH, AKL, APF	08.1997→05.2004		7.22402.03.0	EUV-SR	EL	
1.6 75 kW (102 PS) AVU, BFQ	08.2000→06.2005		7.22880.01.0	EUV-SR	EL	 ch. 1J-W-000 001→
			7.10014.00.0	AKF	EL	
1.6 FSI 81 kW (110 PS) BAD	01.2002→06.2005		7.10014.00.0	AKF	EL	
			7.28098.04.0	EUV-SR	EL	
1.8 92 kW (125 PS) AGN	08.1997→06.2005		7.02461.01.0	EUV-SR	EL	 ch. 1J-W-000 001→ch. 1J-1D231 000
			7.28098.04.0	EUV-SR	EL	Fahrgestellnummer ab: 1J-1B073 001, 1J-1D231 001, 1J-1P137 001, 1J-1U045 001, 1J-1W270 001 Vehicle Identification Number from: 1J-1B073 001, 1J-1D231 001, 1J-1P137 001, 1J-1U045 001, 1J-1W270 001
1.8 4motion 92 kW (125 PS) AGN	05.1998→06.2005		7.02461.01.0	EUV-SR	EL	 ch. 1J-W-000 001→ch. 1J-1D231 000
			7.28098.04.0	EUV-SR	EL	Fahrgestellnummer ab: 1J-1B073 001, 1J-1D231 001, 1J-1P137 001, 1J-1U045 001, 1J-1W270 001 Vehicle Identification Number from: 1J-1B073 001, 1J-1D231 001, 1J-1P137 001, 1J-1U045 001, 1J-1W270 001
1.8 T 110 kW (150 PS) ARZ, AUM	08.1997→06.2005		7.22687.49.0	EUV-DR	EP	 ARZ, AUM: Fahrgestellnummer ab: 1J-W-000 001 Vehicle Identification Number from: 1J-W-000 001
			7.22687.39.0	EUV-LS	EL	 ARZ, AUM:  ch. 1J-W-000 001→
			7.01805.01.0	EUV-SR	EL	
1.8 T GTI 132-142 kW (180-193 PS) AUQ	08.2001→06.2005		7.22687.39.0	EUV-LS	EL	
			7.01805.01.0	EUV-SR	EL	
1.9 SDI 50 kW (68 PS) AGP, AQM	08.1997→06.2005		7.02183.01.0	DW-AGR	EP	 AGP, AQM:  ch. 1J-Y-000 001→
			7.21903.70.0	DW-AGR	EP	 AGP, AQM: Fahrgestellnummer bis: 1J-X-999 000 Vehicle Identification Number to: 1J-X-999 000
1.9 TDI 81 kW (110 PS) AHF, ASV	08.1997→05.2004		7.02183.01.0	DW-AGR	EP	 AHF, ASV:  ch. 1J-Y-000 001→
			7.21903.70.0	DW-AGR	EP	 AHF, ASV: Fahrgestellnummer bis: 1J-X-999 000 Vehicle Identification Number to: 1J-X-999 000
			7.02184.01.0	DW-TL	EP	 AHF, ASV:  ch. 1J-Y-000 001→
			7.21903.75.0	DW-TL	EP	 AHF, ASV:  →ch. 1J-X-999 000
			7.02256.00.0	EUV-AGR	EP	
1.9 TDI 66 kW (90 PS) AGR	10.1997→05.2004		7.02183.01.0	DW-AGR	EP	 ch. 1J-Y-000 001→
			7.21903.70.0	DW-AGR	EP	Fahrgestellnummer bis: 1J-X-999 000 Vehicle Identification Number to: 1J-X-999 000

V





















GOLF IV (1J1) 25

			7.02256.00.0 7.01037.02.0 7.21895.55.0	EUV-AGR LDRV LDRV	EP EL EL	  ch. 1J-Y-000 001→ Fahrgestellnummer bis: 1J-X-999 000 Vehicle Identification Number to: 1J-X-999 000
1.9 TDI 66-67 kW (90-91 PS) ALH	10.1997→05.2004		7.02183.01.0 7.21903.70.0 7.02184.01.0 7.21903.75.0 7.02256.00.0	DW-AGR DW-AGR DW-TL DW-TL EUV-AGR	EP EP EP EP EP	 ch. 1J-Y-000 001→ Fahrgestellnummer bis: 1J-X-999 000 Vehicle Identification Number to: 1J-X-999 000  ch. 1J-Y-000 001→  →ch. 1J-X-999 000
1.9 TDI 85 kW (115 PS) AJM, AUY	12.1998→06.2001		7.02183.01.0 7.21903.70.0 7.02184.01.0 7.21903.75.0	DW-AGR DW-AGR DW-TL DW-TL	EP EP EP EP	 AJM, AUY:  ch. 1J-Y-000 001→  AJM, AUY: Fahrgestellnummer bis: 1J-X-999 000 Vehicle Identification Number to: 1J-X-999 000  AJM, AUY:  ch. 1J-Y-000 001→  AJM, AUY:  →ch. 1J-X-999 000
1.9 TDI 110 kW (150 PS) ARL	05.2000→06.2005		7.02183.01.0 7.00868.02.0 7.02256.00.0	DW-AGR DW-TL EUV-AGR	EP EP EP	 ch. 1J-W-000 001→
1.9 TDI 74 kW (101 PS) ATD	09.2000→06.2005		7.02183.01.0 7.21903.70.0 7.02184.01.0 7.21903.75.0 7.02256.00.0	DW-AGR DW-AGR DW-TL DW-TL EUV-AGR	EP EP EP EP EP	 ch. 1J-Y-000 001→ Fahrgestellnummer bis: 1J-X-999 000 Vehicle Identification Number to: 1J-X-999 000  ch. 1J-Y-000 001→  →ch. 1J-X-999 000
1.9 TDI 74 kW (101 PS) AXR	09.2000→06.2005		7.02183.01.0 7.00868.02.0 7.02256.00.0	DW-AGR DW-TL EUV-AGR	EP EP EP	 ch. 1J-Y-000 001→
1.9 TDI 96 kW (130 PS) ASZ	11.2000→06.2005		7.02183.01.0 7.00868.02.0 7.02256.00.0	DW-AGR DW-TL EUV-AGR	EP EP EP	 ch. 1J-W-000 001→
1.9 TDI 4motion 66 kW (90 PS) AGR	07.1998→04.2002		7.02183.01.0 7.21903.70.0 7.02256.00.0 7.01037.02.0 7.21895.55.0	DW-AGR DW-AGR EUV-AGR LDRV LDRV	EP EP EP EL EL	 ch. 1J-Y-000 001→ Fahrgestellnummer bis: 1J-X-999 000 Vehicle Identification Number to: 1J-X-999 000  ch. 1J-Y-000 001→ Fahrgestellnummer bis: 1J-X-999 000 Vehicle Identification Number to: 1J-X-999 000
1.9 TDI 4motion 85 kW (115 PS) AJM, AUY	09.1999→06.2001		7.02183.01.0 7.21903.70.0 7.02184.01.0 7.21903.75.0	DW-AGR DW-AGR DW-TL DW-TL	EP EP EP EP	 AJM, AUY:  ch. 1J-Y-000 001→  AJM, AUY: Fahrgestellnummer bis: 1J-X-999 000 Vehicle Identification Number to: 1J-X-999 000  AJM, AUY:  ch. 1J-Y-000 001→  AJM, AUY:  →ch. 1J-X-999 000







GOLF IV (1J1) **25**

1.9 TDI 4motion 110 kW (150 PS) ARL	02.2000→06.2005	 7.02183.01.0	DW-AGR	EP	 ch. 1J-W-000 001→
		7.00868.02.0	DW-TL	EP	
		7.02256.00.0	EUV-AGR	EP	
1.9 TDI 4motion 74 kW (101 PS) ATD	09.2000→06.2005	 7.02183.01.0	DW-AGR	EP	 ch. 1J-Y-000 001→
		7.21903.70.0	DW-AGR	EP	Fahrgestellnummer bis: 1J-X-999 000 Vehicle Identification Number to: 1J-X-999 000
		7.02184.01.0	DW-TL	EP	 ch. 1J-Y-000 001→
		7.21903.75.0	DW-TL	EP	 →ch. 1J-X-999 000
		7.02256.00.0	EUV-AGR	EP	
1.9 TDI 4motion 96 kW (130 PS) ASZ	11.2000→06.2005	 7.02183.01.0	DW-AGR	EP	 ch. 1J-W-000 001→
		7.00868.02.0	DW-TL	EP	
		7.02256.00.0	EUV-AGR	EP	
2.0 85 kW (115 PS) AZJ	07.1998→05.2004	 7.22880.01.0	EUV-SR	EL	
2.0 4motion 85 kW (115 PS) AZJ	10.2000→06.2005	 7.22880.01.0	EUV-SR	EL	
2.0 BiFuel 85 kW (116 PS) BEH	05.2002→05.2003	 7.22880.01.0	EUV-SR	EL	
2.3 V5 125 kW (170 PS) AQN	10.2000→06.2005	 7.06117.44.0	SV-NWV	EL	mit Dichtring with O-ring  ch. 1J-W-000 001→ Einlassseite Intake Side
		 7.06117.44.0	SV-NWV	EL	mit Dichtring with O-ring  ch. 1J-W-000 001→ Einlassseite Intake Side
2.8 VR6 4motion 150 kW (204 PS) BDE	03.1999→06.2005	 7.06117.44.0	SV-NWV	EL	mit Dichtring with O-ring Einlassseite Intake Side
3.2 R32 4motion 177 kW (241 PS) BFH	09.2002→06.2005	 7.02256.00.0	EUV-AGK	EP	
		7.06117.43.0	SV-NWV	EL	mit Dichtring with O-ring Auslassseite Exhaust Side
		7.06117.44.0	SV-NWV	EL	mit Dichtring with O-ring Einlassseite Intake Side
3.2 R32 4motion 177 kW (241 PS) BML	09.2002→06.2005	 7.06117.43.0	SV-NWV	EL	mit Dichtring with O-ring Auslassseite Exhaust Side
		7.06117.44.0	SV-NWV	EL	mit Dichtring with O-ring Einlassseite Intake Side



















V

GOLF IV Cabriolet (1E7) **26**

1.6 74 kW (101 PS) AFT, AKS	06.1998→06.2002	 7.22402.03.0	EUV-SR	EL	
1.9 TDI 66-67 kW (90-91 PS) AHU, ALE	06.1998→06.2002	 7.21903.70.0	DW-AGR	EP	
1.9 TDI 81 kW (110 PS) AFN, AVG	06.1998→06.2002	 7.21903.70.0	DW-AGR	EP	
		7.21903.75.0	DW-TL	EP	



GOLF IV Variant (1J5) 27







1.4 16V 55 kW (75 PS) AHW, AKQ	05.1999→06.2006	 7.21483.54.0	EUV-AGR	EL	 AHW, AKQ: Fahrgestellnummer ab: 1J-W-000 001 Vehicle Identification Number from: 1J-W-000 001
1.6 65-76 kW (100-103 PS) AEH, AKL, APF	05.1999→04.2002	 7.22402.03.0	EUV-SR	EL	
1.6 75 kW (102 PS) AVU, BFQ	08.2000→06.2006	 7.22880.01.0	EUV-SR	EL	Fahrgestellnummer ab: 1J-W-000 001 Vehicle Identification Number from: 1J-W-000 001
1.6 FSI 81 kW (110 PS) BAD	01.2002→06.2006	 7.10014.00.0	AKF	EL	
1.6 FSi 85 kW (115 PS) BAG	10.2003→07.2004	 7.10014.00.0	AKF	EL	 ch. 1K-4-000 001→
		7.22880.01.0	EUV-SR	EL	Fahrgestellnummer ab: 1K-4-000 001 Vehicle Identification Number from: 1K-4-000 001
1.8 4motion 92 kW (125 PS) AGN	05.1999→06.2006	 7.02461.01.0	EUV-SR	EL	 ch. 1J-W-000 001→ch. 1J-1D231 000
		7.28098.04.0	EUV-SR	EL	Fahrgestellnummer ab: 1J-1B073 001, 1J-1D231 001, 1J-1P137 001, 1J-1U045 001, 1J-1W270 001 Vehicle Identification Number from: 1J-1B073 001, 1J-1D231 001, 1J-1P137 001, 1J-1U045 001, 1J-1W270 001
1.8 T 110 kW (150 PS) ARZ, AUM	05.2000→06.2006	 7.22687.49.0	EUV-DR	EP	 ARZ, AUM: Fahrgestellnummer ab: 1J-W-000 001 Vehicle Identification Number from: 1J-W-000 001
		7.22687.39.0	EUV-LS	EL	 ARZ, AUM:  ch. 1J-W-000 001→
		7.01805.01.0	EUV-SR	EL	
1.8 T 132-142 kW (180-193 PS) AUQ	05.2002→06.2006	 7.22687.39.0	EUV-LS	EL	
		7.01805.01.0	EUV-SR	EL	
1.9 SDI 50 kW (68 PS) AGP, AQM	05.1999→06.2006	 7.02183.01.0	DW-AGR	EP	 AGP, AQM:  ch. 1J-Y-000 001→
		7.21903.70.0	DW-AGR	EP	 AGP, AQM: Fahrgestellnummer bis: 1J-X-999 000 Vehicle Identification Number to: 1J-X-999 000
1.9 TDI 66 kW (90 PS) AGR	05.1999→05.2006	 7.02183.01.0	DW-AGR	EP	 ch. 1J-Y-000 001→
		7.21903.70.0	DW-AGR	EP	Fahrgestellnummer bis: 1J-X-999 000 Vehicle Identification Number to: 1J-X-999 000
		7.02256.00.0	EUV-AGR	EP	
		7.01037.02.0	LDRV	EL	 ch. 1J-Y-000 001→
		7.21895.55.0	LDRV	EL	Fahrgestellnummer bis: 1J-X-999 000 Vehicle Identification Number to: 1J-X-999 000
1.9 TDI 66-67 kW (90-91 PS) ALH	05.1999→05.2006	 7.02183.01.0	DW-AGR	EP	 ch. 1J-Y-000 001→
		7.21903.70.0	DW-AGR	EP	Fahrgestellnummer bis: 1J-X-999 000 Vehicle Identification Number to: 1J-X-999 000
		7.02184.01.0	DW-TL	EP	 ch. 1J-Y-000 001→
		7.21903.75.0	DW-TL	EP	 →ch. 1J-X-999 000
1.9 TDI 81 kW (110 PS) AHF, ASV	05.1999→06.2001	 7.02183.01.0	DW-AGR	EP	 AHF, ASV:  ch. 1J-Y-000 001→

V













GOLF IV Variant (1J5)













27

			7.21903.70.0	DW-AGR	EP	 AHF, ASV: Fahrgestellnummer bis: 1J-X-999 000 Vehicle Identification Number to: 1J-X-999 000
			7.02184.01.0	DW-TL	EP	 AHF, ASV:  ch. 1J-Y-000 001→
			7.21903.75.0	DW-TL	EP	 AHF, ASV:  →ch. 1J-X-999 000
			7.02256.00.0	EUV-AGR	EP	
1.9 TDI 85 kW (115 PS) AJM, AUY	08.1999→06.2001		7.02183.01.0	DW-AGR	EP	 AJM, AUY:  ch. 1J-Y-000 001→
			7.21903.70.0	DW-AGR	EP	 AJM, AUY: Fahrgestellnummer bis: 1J-X-999 000 Vehicle Identification Number to: 1J-X-999 000
			7.02184.01.0	DW-TL	EP	 AJM, AUY:  ch. 1J-Y-000 001→
			7.21903.75.0	DW-TL	EP	 AJM, AUY:  →ch. 1J-X-999 000
1.9 TDI 74 kW (101 PS) ATD	09.2000→06.2006		7.02183.01.0	DW-AGR	EP	 ch. 1J-Y-000 001→
			7.21903.70.0	DW-AGR	EP	Fahrgestellnummer bis: 1J-X-999 000 Vehicle Identification Number to: 1J-X-999 000
			7.02184.01.0	DW-TL	EP	 ch. 1J-Y-000 001→
			7.21903.75.0	DW-TL	EP	 →ch. 1J-X-999 000
			7.02256.00.0	EUV-AGR	EP	
1.9 TDI 74 kW (101 PS) AXR	09.2000→06.2006		7.02183.01.0	DW-AGR	EP	 ch. 1J-Y-000 001→
			7.00868.02.0	DW-TL	EP	
			7.02256.00.0	EUV-AGR	EP	
1.9 TDI 96 kW (130 PS) ASZ	11.2000→06.2006		7.02183.01.0	DW-AGR	EP	 ch. 1J-W-000 001→
			7.00868.02.0	DW-TL	EP	
			7.02256.00.0	EUV-AGR	EP	
1.9 TDI 110 kW (150 PS) ARL	06.2001→06.2006		7.02183.01.0	DW-AGR	EP	
			7.00868.02.0	DW-TL	EP	
			7.02256.00.0	EUV-AGR	EP	
1.9 TDI 4motion 66 kW (90 PS) AGR	05.1999→04.2002		7.02183.01.0	DW-AGR	EP	 ch. 1J-Y-000 001→
			7.21903.70.0	DW-AGR	EP	Fahrgestellnummer bis: 1J-X-999 000 Vehicle Identification Number to: 1J-X-999 000
			7.02256.00.0	EUV-AGR	EP	
			7.01037.02.0	LDRV	EL	 ch. 1J-Y-000 001→
			7.21895.55.0	LDRV	EL	Fahrgestellnummer bis: 1J-X-999 000 Vehicle Identification Number to: 1J-X-999 000
1.9 TDI 4motion 85 kW (115 PS) AJM	05.1999→06.2001		7.02183.01.0	DW-AGR	EP	 ch. 1J-Y-000 001→
			7.21903.70.0	DW-AGR	EP	Fahrgestellnummer bis: 1J-X-999 000 Vehicle Identification Number to: 1J-X-999 000
			7.02184.01.0	DW-TL	EP	 ch. 1J-Y-000 001→
			7.21903.75.0	DW-TL	EP	 →ch. 1J-X-999 000
1.9 TDI 4motion 74 kW (101 PS) ATD	09.2000→06.2006		7.02183.01.0	DW-AGR	EP	 ch. 1J-Y-000 001→
			7.21903.70.0	DW-AGR	EP	Fahrgestellnummer bis: 1J-X-999 000 Vehicle Identification Number to: 1J-X-999 000
			7.02184.01.0	DW-TL	EP	 ch. 1J-Y-000 001→
			7.21903.75.0	DW-TL	EP	 →ch. 1J-X-999 000
			7.02256.00.0	EUV-AGR	EP	

V























GOLF IV Variant (1J5)						27
1.9 TDI 4motion 96 kW (130 PS) ASZ	11.2000→06.2006		7.02183.01.0	DW-AGR	EP	 ch. 1J-W-000 001→
			7.00868.02.0	DW-TL	EP	
			7.02256.00.0	EUV-AGR	EP	
1.9 TDI 4motion 110 kW (150 PS) ARL	05.2002→06.2005		7.02183.01.0	DW-AGR	EP	
			7.00868.02.0	DW-TL	EP	
			7.02256.00.0	EUV-AGR	EP	
2.0 85 kW (115 PS) AZJ	05.1999→06.2006		7.22880.01.0	EUV-SR	EL	
2.0 4motion 85 kW (115 PS) AZJ	10.2000→06.2006		7.22880.01.0	EUV-SR	EL	
2.0 Bi-Fuel 85 kW (116 PS) BEH	02.2002→06.2006		7.22880.01.0	EUV-SR	EL	
2.3 V5 125 kW (170 PS) AQN	10.2000→06.2006		7.06117.44.0	SV-NWV	EL	mit Dichtring with O-ring  ch. 1J-W-000 001→ Einlassseite Intake Side
2.3 V5 4motion 125 kW (170 PS) AQN	10.2000→06.2006		7.06117.44.0	SV-NWV	EL	mit Dichtring with O-ring  ch. 1J-W-000 001→ Einlassseite Intake Side
2.8 V6 4motion 150 kW (204 PS) BDE	05.1999→06.2006		7.06117.44.0	SV-NWV	EL	mit Dichtring with O-ring Einlassseite Intake Side

GOLF PLUS V (5M1, 521)						28	
1.2 TSI 77 kW (105 PS) CBZB	11.2009→12.2013		7.22880.01.0	EUV-KK	EL	Fahrgestellnummer ab: 1K-9-900 001 Vehicle Identification Number from: 1K-9-900 001	
			7.02256.40.0	SV-KK	EL		 ch. 1K-9-900 001→ für Fahrzeuge mit Standheizung for vehicles with parking heater
1.2 TSI 63 kW (86 PS) CBZA	05.2010→12.2013		7.22880.01.0	EUV-KK	EL	Fahrgestellnummer ab: 1K-9-900 001 Vehicle Identification Number from: 1K-9-900 001	
			7.02256.40.0	SV-KK	EL		 ch. 1K-9-900 001→ für Fahrzeuge mit Standheizung for vehicles with parking heater
1.4 16V 55 kW (75 PS) BCA	01.2005→11.2006		7.02256.40.0	SV-KK	EL	für Fahrzeuge mit Standheizung for vehicles with parking heater	
1.4 16V 59-60 kW (80-82 PS) BUD, CGGA	05.2006→12.2013		7.02256.40.0	SV-KK	EL	 BUD: für Fahrzeuge mit Standheizung for vehicles with parking heater  CGGA:  ch. 1K-9-900 001→ für Fahrzeuge mit Standheizung for vehicles with parking heater	
1.4 FSI 66 kW (90 PS) BLN	07.2005→11.2006		7.10014.00.0	AKF	EL		
1.4 TSI 103 kW (140 PS) BMY	05.2006→06.2008		7.01044.03.0	EUV-SR	EL		
			7.00470.07.0	LDRV	EL		für OE-Nummer: 06F 906 283 F for OE number: 06F 906 283 F
			7.02588.04.0	LDRV	EL		für OE-Nummer: 03C 906 283 B for OE number: 03C 906 283 B
			7.04247.02.0	SUV	EL		
			7.02256.40.0	SV-KK	EL		für Fahrzeuge mit Standheizung for vehicles with parking heater
			7.06117.54.0	SV-NWV	EL		
1.4 TSI 125 kW (170 PS) BLG	05.2006→06.2008		7.01044.03.0	EUV-SR	EL		

V





























GOLF PLUS V (5M1, 521) 28

			7.00470.07.0	LDRV	EL	für OE-Nummer: 06F 906 283 F for OE number: 06F 906 283 F
			7.02588.04.0	LDRV	EL	für OE-Nummer: 03C 906 283 B for OE number: 03C 906 283 B
			7.04247.02.0	SUV	EL	
			7.02256.40.0	SV-KK	EL	für Fahrzeuge mit Standheizung for vehicles with parking heater
			7.06117.54.0	SV-NWV	EL	
1.4 TSI 90 kW (122 PS) CAXA	06.2007→12.2013		7.00415.07.0	SUV	EL	Produktionsdatum bis: 11.11.2008 Production date to: 11.11.2008
			7.01830.13.0	SUV	EL	
			7.02256.40.0	SV-KK	EL	für Fahrzeuge mit Standheizung for vehicles with parking heater
			7.06117.54.0	SV-NWV	EL	
1.4 TSI 118 kW (160 PS) CAVD, CNWA	06.2008→12.2013		7.02588.04.0	LDRV	EL	 ch. 1K-9-900 001→
			7.04247.02.0	SUV	EL	 ch. 1K-9-900 001→
			7.02256.40.0	SV-KK	EL	 CAVD: für Fahrzeuge mit Standheizung for vehicles with parking heater  CNWA:  ch. 1K-9-900 001→ für Fahrzeuge mit Standheizung for vehicles with parking heater
			7.06117.54.0	SV-NWV	EL	Fahrgestellnummer ab: 1K-9-900 001 Vehicle Identification Number from: 1K-9-900 001
1.6 75 kW (102 PS) BSE, BSF, CCSA, CMXA	05.2005→12.2013		7.10014.00.0	AKF	EL	 ch. 1K-9-900 001→
			7.22880.01.0	EUV-SR	EL	 CCSA, CMXA: Fahrgestellnummer ab: 1K-9-900 001 Vehicle Identification Number from: 1K-9-900 001
			7.02256.40.0	SV-KK	EL	 BSE, BSF, CCSA: für Fahrzeuge mit Standheizung for vehicles with parking heater  CMXA:  ch. 1K-9-900 001→ für Fahrzeuge mit Standheizung for vehicles with parking heater
1.6 BiFuel 75 kW (102 PS) CHGA	05.2009→12.2013		7.10014.00.0	AKF	EL	 ch. 1K-9-900 001→
			7.22880.01.0	EUV-SR	EL	Fahrgestellnummer ab: 1K-9-900 001 Vehicle Identification Number from: 1K-9-900 001
			7.02256.40.0	SV-KK	EL	 ch. 1K-9-900 001→ für Fahrzeuge mit Standheizung for vehicles with parking heater
1.6 FSI 85 kW (115 PS) BLF	12.2004→05.2008		7.10014.00.0	AKF	EL	
			7.02256.40.0	SV-KK	EL	für Fahrzeuge mit Standheizung for vehicles with parking heater
			7.06117.54.0	SV-NWV	EL	
1.6 MultiFuel 75 kW (102 PS) CCSA, CMXA	11.2007→12.2013		7.10014.00.0	AKF	EL	 ch. 1K-9-900 001→
			7.22880.01.0	EUV-SR	EL	 CCSA, CMXA: Fahrgestellnummer ab: 1K-9-900 001 Vehicle Identification Number from: 1K-9-900 001
			7.02256.40.0	SV-KK	EL	 CCSA: für Fahrzeuge mit Standheizung for vehicles with parking heater  CMXA:  ch. 1K-9-900 001→ für Fahrzeuge mit Standheizung for vehicles with parking heater



GOLF PLUS V (5M1, 521) **28**

1.6 TDI 66 kW (90 PS) CAYB	02.2009→12.2013	 7.02256.00.0	EUV-AGR	EP	 ch. 1K-9-900 001→
		7.02256.40.0	SV-KK	EL	 ch. 1K-9-900 001→ für Fahrzeuge mit Standheizung for vehicles with parking heater
1.6 TDI 77 kW (105 PS) CAYC	03.2009→12.2013	 7.02256.00.0	EUV-AGR	EP	 ch. 1K-9-900 001→
		7.02256.40.0	SV-KK	EL	 ch. 1K-9-900 001→ für Fahrzeuge mit Standheizung for vehicles with parking heater
1.9 TDI 77 kW (105 PS) BKC, BXE	01.2005→01.2009	 7.02256.40.0	SV-KK	EL	 BKC, BXE: für Fahrzeuge mit Standheizung for vehicles with parking heater
1.9 TDI 77 kW (105 PS) BLS	01.2005→01.2009	 7.00868.02.0	DW-TL	EP	
		7.02256.00.0	EUV-AGR	EP	
		7.02256.40.0	SV-KK	EL	für Fahrzeuge mit Standheizung for vehicles with parking heater
1.9 TDI 66 kW (90 PS) BRU, BXF	05.2005→12.2008	 7.02256.40.0	SV-KK	EL	 BRU, BXF: für Fahrzeuge mit Standheizung for vehicles with parking heater
1.9 TDI 66 kW (90 PS) BXJ	05.2005→12.2008	 7.00868.02.0	DW-TL	EP	
		7.02256.00.0	EUV-AGR	EP	
		7.02256.40.0	SV-KK	EL	für Fahrzeuge mit Standheizung for vehicles with parking heater
2.0 FSI 110 kW (150 PS) BLR, BLY	05.2005→06.2008	 7.22880.01.0	EUV-SR	EL	
		7.06117.37.0	SV-NWV	EL	
2.0 FSI 110 kW (150 PS) BVY, BVZ	05.2005→06.2008	 7.22880.01.0	EUV-SR	EL	
		7.02256.40.0	SV-KK	EL	 BVY, BVZ: für Fahrzeuge mit Standheizung for vehicles with parking heater
		7.06117.37.0	SV-NWV	EL	
2.0 TDI 100 kW (136 PS) AZV, CFHB	05.2005→12.2013	 7.02256.40.0	SV-KK	EL	 AZV: für Fahrzeuge mit Standheizung for vehicles with parking heater  CFHB:  ch. 1K-9-900 001→ für Fahrzeuge mit Standheizung for vehicles with parking heater
		7.00868.02.0	DW-TL	EP	
2.0 TDI 100 kW (136 PS) CBDA	05.2005→12.2013	 7.00868.02.0	DW-TL	EP	
		7.02256.00.0	EUV-AGR	EP	 ch. 1K-9-900 001→
		7.02256.40.0	SV-KK	EL	 ch. 1K-9-900 001→ für Fahrzeuge mit Standheizung for vehicles with parking heater
2.0 TDI 103 kW (140 PS) BMM	12.2005→05.2011	 7.00868.02.0	DW-TL	EP	
		7.02256.00.0	EUV-AGR	EP	
		7.02256.40.0	SV-KK	EL	für Fahrzeuge mit Standheizung for vehicles with parking heater
2.0 TDI 81 kW (110 PS) CBDC	01.2009→12.2013	 7.00868.02.0	DW-TL	EP	 ch. 1K-9-400 001→
		7.02256.00.0	EUV-AGR	EP	 ch. 1K-9-900 001→
		7.02256.40.0	SV-KK	EL	 ch. 1K-9-900 001→ für Fahrzeuge mit Standheizung for vehicles with parking heater
2.0 TDI 81 kW (110 PS) CLCA	01.2009→12.2013	 7.02256.00.0	EUV-AGR	EP	 ch. 1K-9-900 001→
		7.02256.40.0	SV-KK	EL	 ch. 1K-9-900 001→ für Fahrzeuge mit Standheizung for vehicles with parking heater

V





















GOLF PLUS V (5M1, 521) 28

2.0 TDI 16V 103 kW (140 PS) BKD	01.2005→12.2013	 7.02256.40.0	SV-KK	EL	für Fahrzeuge mit Standheizung for vehicles with parking heater
2.0 TDI 16V 103 kW (140 PS) CBDB	01.2005→12.2013	 7.00868.02.0 7.02256.00.0 7.02256.40.0	DW-TL EUV-AGR SV-KK	EP EP EL	 ch. 1K-9-900 001→  ch. 1K-9-900 001→ für Fahrzeuge mit Standheizung for vehicles with parking heater
2.0 TDI 16V 103 kW (140 PS) CFHC	01.2005→12.2013	 7.02256.00.0 7.02256.40.0	EUV-AGR SV-KK	EP EL	 ch. 1K-9-900 001→  ch. 1K-9-900 001→ für Fahrzeuge mit Standheizung for vehicles with parking heater







































GOLF SPORTSVAN VII (AM1, AN1) 29

1.0 TSI 85 kW (115 PS) CHZD, DKRF	05.2015→	 7.06117.48.0	SV-NWV	EL	
1.0 TSI 63 kW (86 PS) CHZK, DKLB	05.2017→	 7.06117.48.0	SV-NWV	EL	
1.0 TSI 81 kW (110 PS) CHZC	05.2017→	 7.06117.48.0	SV-NWV	EL	
1.4 TSI 110 kW (150 PS) CZDA	02.2014→	 7.06117.48.0	SV-NWV	EL	
1.4 TSI 92 kW (125 PS) CZCA	04.2014→	 7.06117.48.0	SV-NWV	EL	
1.4 TSI MultiFuel 92 kW (125 PS) CPVB	04.2014→	 7.06117.48.0	SV-NWV	EL	
2.0 TDI 81 kW (110 PS) CRVA	05.2014→11.2017	 7.02256.00.0	EUV-AGR	EP	

GOLF V (1K1) 30

1.4 16V 55 kW (75 PS) BCA	10.2003→05.2006	 7.02256.40.0	SV-KK	EL	 ch. 1K-4-000 001→ für Fahrzeuge mit Standheizung for vehicles with parking heater
1.4 16V 59-60 kW (80-82 PS) BUD	05.2006→11.2008	 7.02256.40.0	SV-KK	EL	 ch. 1K-6-000 001→ für Fahrzeuge mit Standheizung for vehicles with parking heater
1.4 FSI 66 kW (90 PS) BKG, BLN	10.2003→07.2006	 7.10014.00.0 7.22880.01.0 7.02256.40.0	AKF EUV-SR SV-KK	EL EL EL	 BKG, BLN:  ch. 1K-4-000 001→  BKG:  ch. 1K-4-000 001→  BLN: Fahrgestellnummer ab: 1K-4-000 001 Vehicle Identification Number from: 1K-4-000 001  BKG, BLN:  ch. 1K-4-000 001→ für Fahrzeuge mit Standheizung for vehicles with parking heater
1.4 TSI 125 kW (170 PS) BLG	11.2005→11.2008	 7.01044.03.0 7.02588.04.0 7.00470.07.0 7.04247.02.0 7.02256.40.0 7.06117.54.0	EUV-SR LDRV LDRV SUV SV-KK SV-NWV	EL EL EL EL EL EL	 ch. 1K-6-000 001→  ch. 1K-6-000 001→ für OE-Nummer: 03C 906 283 B for OE number: 03C 906 283 B für OE-Nummer: 06F 906 283 F for OE number: 06F 906 283 F  ch. 1K-6-000 001→  ch. 1K-6-000 001→ für Fahrzeuge mit Standheizung for vehicles with parking heater Fahrgestellnummer ab: 1K-6-000 001 Vehicle Identification Number from: 1K-6-000 001
1.4 TSI 103 kW (140 PS) BMY	05.2006→11.2008	 7.01044.03.0	EUV-SR	EL	 ch. 1K-6-000 001→































V

					
GOLF V (1K1)					30
			7.02588.04.0	LDRV	EL  ch. 1K-6-000 001→ für OE-Nummer: 03C 906 283 B for OE number: 03C 906 283 B
			7.00470.07.0	LDRV	EL für OE-Nummer: 06F 906 283 F for OE number: 06F 906 283 F
			7.04247.02.0	SUV	EL  ch. 1K-6-000 001→
			7.02256.40.0	SV-KK	EL  ch. 1K-6-000 001→ für Fahrzeuge mit Standheizung for vehicles with parking heater
			7.06117.54.0	SV-NWV	EL Fahrgestellnummer ab: 1K-6-000 001 Vehicle Identification Number from: 1K-6-000 001
1.4 TSI 90 kW (122 PS) CAXA	05.2007→11.2008		7.00415.07.0	SUV	EL Produktionsdatum bis: 11.11.2008 Production date to: 11.11.2008
			7.01830.13.0	SUV	EL
			7.02256.40.0	SV-KK	EL für Fahrzeuge mit Standheizung for vehicles with parking heater
			7.06117.54.0	SV-NWV	EL
1.6 75 kW (102 PS) BGU, BSE, BSF	01.2004→11.2008		7.10014.00.0	AKF	EL  BGU:  ch. 1K-4-000 001→  BSE, BSF:  ch. 1K-6-000 001→
			7.22880.01.0	EUV-SR	EL  BGU: Fahrgestellnummer ab: 1K-4-000 001 Vehicle Identification Number from: 1K-4-000 001  BSE, BSF: Fahrgestellnummer ab: 1K-6-000 001 Vehicle Identification Number from: 1K-6-000 001
			7.02256.40.0	SV-KK	EL  BGU:  ch. 1K-4-000 001→ für Fahrzeuge mit Standheizung for vehicles with parking heater  BSE, BSF:  ch. 1K-6-000 001→ für Fahrzeuge mit Standheizung for vehicles with parking heater
1.6 75 kW (102 PS) CCSA	01.2004→11.2008		7.10014.00.0	AKF	EL  ch. 1K-9-400 001→
1.6 FSI 85 kW (115 PS) BAG, BLF, BLP	10.2003→07.2008		7.10014.00.0	AKF	EL  BAG, BLF, BLP:  ch. 1K-4-000 001→
			7.22880.01.0	EUV-SR	EL  BAG, BLF, BLP: Fahrgestellnummer ab: 1K-4-000 001 Vehicle Identification Number from: 1K-4-000 001
			7.02256.40.0	SV-KK	EL  BAG, BLF, BLP:  ch. 1K-4-000 001→ für Fahrzeuge mit Standheizung for vehicles with parking heater
			7.06117.54.0	SV-NWV	EL  BAG, BLF, BLP: Fahrgestellnummer ab: 1K-4-000 001 Vehicle Identification Number from: 1K-4-000 001
1.6 MultiFuel 75 kW (102 PS) CCSA	10.2007→11.2008		7.10014.00.0	AKF	EL  ch. 1K-9-400 001→
			7.22880.01.0	EUV-SR	EL
			7.02256.40.0	SV-KK	EL für Fahrzeuge mit Standheizung for vehicles with parking heater
1.9 TDI 77 kW (105 PS) BKC, BXE	10.2003→11.2008		7.02256.40.0	SV-KK	EL  BKC:  ch. 1K-4-000 001→ für Fahrzeuge mit Standheizung for vehicles with parking heater  BXE:  ch. 1K-6-000 001→ für Fahrzeuge mit Standheizung for vehicles with parking heater
1.9 TDI 77 kW (105 PS) BLS	10.2003→11.2008		7.00868.02.0	DW-TL	EP
			7.02256.00.0	EUV-AGR	EP

V



















GOLF V (1K1) **30**

		7.02256.40.0	SV-KK	EL	 ch. 1K-6-000 001→ für Fahrzeuge mit Standheizung for vehicles with parking heater
1.9 TDI 66 kW (90 PS) BRU, BXF	05.2004→11.2008	 7.02256.40.0	SV-KK	EL	 BRU:  ch. 1K-4-000 001→ für Fahrzeuge mit Standheizung for vehicles with parking heater  BXF:  ch. 1K-6-000 001→ für Fahrzeuge mit Standheizung for vehicles with parking heater
1.9 TDI 66 kW (90 PS) BXJ	05.2004→11.2008	 7.00868.02.0 7.02256.00.0 7.02256.40.0	DW-TL EUV-AGR SV-KK	EP EP EL	für Fahrzeuge mit Standheizung for vehicles with parking heater
1.9 TDI 4motion 77 kW (105 PS) BKC, BXE	08.2004→11.2008	 7.02256.40.0	SV-KK	EL	 BKC:  ch. 1K-4-000 001→ für Fahrzeuge mit Standheizung for vehicles with parking heater  BXE:  ch. 1K-6-000 001→ für Fahrzeuge mit Standheizung for vehicles with parking heater
1.9 TDI 4motion 77 kW (105 PS) BLS	08.2004→11.2008	 7.00868.02.0 7.02256.00.0 7.02256.40.0	DW-TL EUV-AGR SV-KK	EP EP EL	 ch. 1K-6-000 001→ für Fahrzeuge mit Standheizung for vehicles with parking heater
2.0 85 kW (116 PS) BHY	01.2005→11.2008	 7.02256.40.0	SV-KK	EL	 ch. 1K-4-000 001→ für Fahrzeuge mit Standheizung for vehicles with parking heater
2.0 FSI 110 kW (150 PS) AXW, BLR, BLX, BLY, BVX, BVY, BVZ	01.2004→11.2008	 7.22880.01.0 7.02256.40.0 7.06117.37.0	EUV-SR SV-KK SV-NWV	EL EL EL	 AXW, BLR, BLX, BLY: Fahrgestellnummer ab: 1K-4-000 001 Vehicle Identification Number from: 1K-4-000 001  BVX, BVY, BVZ: Fahrgestellnummer ab: 1K-6-000 001 Vehicle Identification Number from: 1K-6-000 001  ch. 1K-4-000 001→ für Fahrzeuge mit Standheizung for vehicles with parking heater  BVX, BVY, BVZ:  ch. 1K-6-000 001→ für Fahrzeuge mit Standheizung for vehicles with parking heater  AXW, BLR, BLX, BLY, BVZ: Fahrgestellnummer ab: 1K-4-000 001 Vehicle Identification Number from: 1K-4-000 001  BVX, BVY: Fahrgestellnummer ab: 1K-6-000 001 Vehicle Identification Number from: 1K-6-000 001
2.0 FSI 4motion 110 kW (150 PS) BLX, BVX	08.2004→11.2008	 7.22880.01.0 7.02256.40.0	EUV-SR SV-KK	EL EL	 BLX: Fahrgestellnummer ab: 1K-4-000 001 Vehicle Identification Number from: 1K-4-000 001  BVX: Fahrgestellnummer ab: 1K-6-000 001 Vehicle Identification Number from: 1K-6-000 001  BLX:  ch. 1K-4-000 001→ für Fahrzeuge mit Standheizung for vehicles with parking heater  BVX:  ch. 1K-6-000 001→ für Fahrzeuge mit Standheizung for vehicles with parking heater

V





















GOLF V (1K1) **30**

			7.06117.37.0	SV-NWV	EL	 BLX: Fahrgestellnummer ab: 1K-4-000 001 Vehicle Identification Number from: 1K-4-000 001  BVX: Fahrgestellnummer ab: 1K-6-000 001 Vehicle Identification Number from: 1K-6-000 001
2.0 GTI 147 kW (200 PS) AXX	10.2004→02.2009		7.00470.07.0	LDRV	EL	 ch. 1K-4-000 001→
			7.01830.13.0	SUV	EL	
			7.06117.46.0	SV-NWV	EH	mit Dichtring with O-ring Fahrgestellnummer ab: 1K-4-000 001 Vehicle Identification Number from: 1K-4-000 001
2.0 GTI 147 kW (200 PS) BPY, BWA	10.2004→02.2009		7.00470.07.0	LDRV	EL	 BPY, BWA:  ch. 1K-6-000 001→
			7.01830.13.0	SUV	EL	
			7.02256.40.0	SV-KK	EL	 BPY, BWA:  ch. 1K-6-000 001→ für Fahrzeuge mit Standheizung for vehicles with parking heater
			7.06117.46.0	SV-NWV	EH	mit Dichtring with O-ring  BPY, BWA: Fahrgestellnummer ab: 1K-6-000 001 Vehicle Identification Number from: 1K-6-000 001
2.0 GTI 147 kW (200 PS) CAWB	10.2004→02.2009		7.03280.04.0	EUV-SR	EL	Baujahr ab: 01.2008 Construction year from: 01.2008
			7.22880.01.0	EUV-SR	EL	
			7.00470.07.0	LDRV	EL	
			7.01830.13.0	SUV	EL	
			7.02256.40.0	SV-KK	EL	für Fahrzeuge mit Standheizung for vehicles with parking heater
			7.06117.26.0	ZM-NWV	EL	
2.0 GTI 147-157 kW (200-213 PS) CBFA	10.2004→02.2009		7.03280.04.0	EUV-SR	EL	Baujahr ab: 01.2008 Construction year from: 01.2008
			7.22880.01.0	EUV-SR	EL	Fahrgestellnummer ab: 1K-9-400 001 Vehicle Identification Number from: 1K-9-400 001
			7.00470.07.0	LDRV	EL	 ch. 1K-9-400 001→
			7.02901.05.0	SUV	EL	für OE-Nummer: 06H 145 710 C, 06J 145 713 F for OE number: 06H 145 710 C, 06J 145 713 F
			7.02256.40.0	SV-KK	EL	 ch. 1K-9-400 001→ für Fahrzeuge mit Standheizung for vehicles with parking heater
2.0 GTI 147-157 kW (200-213 PS) CCTA	10.2004→02.2009		7.03280.04.0	EUV-SR	EL	Baujahr ab: 01.2008 Construction year from: 01.2008
			7.01830.13.0	SUV	EL	
			7.06117.26.0	ZM-NWV	EL	
2.0 GTI 169 kW (230 PS) BYD	09.2006→12.2008		7.00470.07.0	LDRV	EL	 ch. 1K-6-000 001→
			7.00415.07.0	SUV	EL	Fahrgestellnummer ab: 1K-6-000 001 Vehicle Identification Number from: 1K-6-000 001 Produktionsdatum bis: 11.11.2008 Production date to: 11.11.2008
			7.01830.13.0	SUV	EL	





GOLF V (1K1) 30



















			7.02256.40.0	SV-KK	EL	 ch. 1K-6-000 001→ für Fahrzeuge mit Standheizung for vehicles with parking heater
			7.06117.46.0	SV-NWV	EH	mit Dichtring with O-ring Fahrgestellnummer ab: 1K-6-000 001 Vehicle Identification Number from: 1K-6-000 001
2.0 SDI 55 kW (75 PS) BDK	01.2004→11.2008		7.00580.01.0	DW-AGR	EP	
			7.02256.40.0	SV-KK	EL	 ch. 1K-4-000 001→ für Fahrzeuge mit Standheizung for vehicles with parking heater
2.0 TDI 100 kW (136 PS) AZV	10.2003→11.2008		7.02256.40.0	SV-KK	EL	 ch. 1K-4-000 001→ für Fahrzeuge mit Standheizung for vehicles with parking heater
2.0 TDI 103 kW (140 PS) BMM	12.2004→11.2008		7.00868.02.0	DW-TL	EP	
			7.02256.00.0	EUV-AGR	EP	
			7.02256.40.0	SV-KK	EL	 ch. 1K-4-000 001→ für Fahrzeuge mit Standheizung for vehicles with parking heater
2.0 TDI 125 kW (170 PS) BMN	11.2005→11.2008		7.00868.02.0	DW-TL	EP	
			7.02256.00.0	EUV-AGR	EP	
			7.02256.40.0	SV-KK	EL	 ch. 1K-6-000 001→ für Fahrzeuge mit Standheizung for vehicles with parking heater
2.0 TDI 16V 103 kW (140 PS) BKD	10.2003→11.2008		7.02256.40.0	SV-KK	EL	 ch. 1K-4-000 001→ für Fahrzeuge mit Standheizung for vehicles with parking heater
2.0 TDI 16V 4motion 103 kW (140 PS) BKD	08.2004→11.2008		7.02256.40.0	SV-KK	EL	 ch. 1K-4-000 001→ für Fahrzeuge mit Standheizung for vehicles with parking heater
2.0 TDI 4motion 103 kW (140 PS) BMM	01.2007→11.2008		7.00868.02.0	DW-TL	EP	
			7.02256.00.0	EUV-AGR	EP	
			7.02256.40.0	SV-KK	EL	 ch. 1K-4-000 001→ für Fahrzeuge mit Standheizung for vehicles with parking heater
3.2 R32 4motion 184 kW (250 PS) BUB	11.2005→11.2008		7.10014.00.0	AKF	EL	 ch. 1K-6-000 001→
			7.28098.04.0	EUV-AGK	EL	Fahrgestellnummer ab: 1K-6-000 001 Vehicle Identification Number from: 1K-6-000 001
			7.06117.43.0	SV-NWV	EL	mit Dichtring with O-ring  ch. 1K-6-000 001→ch. 1K-8-400 0 00 für OE-Nummer: 066 906 455 B, 066 906 455 E, 066 906 455 H for OE number: 066 906 455 B, 066 906 455 E, 066 906 455 H Auslassseite Exhaust Side



GOLF V (1K1) 30

		7.06117.44.0	SV-NWV	EL	mit Dichtring with O-ring  ch. 1K-6-000 001→ch. 1K-8-400 000 für OE-Nummer: 066 906 455, 066 906 455 C, 066 906 455 F for OE number: 066 906 455, 066 906 455 C, 066 906 455 F Einlassseite Intake Side
		7.06117.37.0	SV-NWV	EL	für OE-Nummer: 03H 906 455, 06F 109 257 B for OE number: 03H 906 455, 06F 109 257 B















GOLF V Variant (1K5) 31

1.4 59-60 kW (80-82 PS) BUD	06.2007→07.2009	 7.02256.40.0	SV-KK	EL	 ch. 1K-6-000 001→ für Fahrzeuge mit Standheizung for vehicles with parking heater
1.4 TSI 103 kW (140 PS) BMY	06.2007→07.2009	 7.01044.03.0	EUV-SR	EL	 ch. 1K-6-000 001→
		7.02588.04.0	LDRV	EL	 ch. 1K-6-000 001→ für OE-Nummer: 03C 906 283 B for OE number: 03C 906 283 B
		7.00470.07.0	LDRV	EL	für OE-Nummer: 06F 906 283 F for OE number: 06F 906 283 F
		7.04247.02.0	SUV	EL	 ch. 1K-6-000 001→
		7.02256.40.0	SV-KK	EL	 ch. 1K-6-000 001→ für Fahrzeuge mit Standheizung for vehicles with parking heater
1.4 TSI 90 kW (122 PS) CAXA	06.2007→07.2009	 7.00415.07.0	SUV	EL	Fahrgestellnummer bis: 1K-9-295 790 Vehicle Identification Number to: 1K-9-295 790
		7.01830.13.0	SUV	EL	
		7.02256.40.0	SV-KK	EL	für Fahrzeuge mit Standheizung for vehicles with parking heater
		7.06117.54.0	SV-NWV	EL	
1.4 TSI 125 kW (170 PS) BLG	06.2007→07.2009	 7.01044.03.0	EUV-SR	EL	 ch. 1K-6-000 001→
		7.02588.04.0	LDRV	EL	 ch. 1K-6-000 001→ für OE-Nummer: 03C 906 283 B for OE number: 03C 906 283 B
		7.00470.07.0	LDRV	EL	für OE-Nummer: 06F 906 283 F for OE number: 06F 906 283 F
		7.04247.02.0	SUV	EL	 ch. 1K-6-000 001→
		7.02256.40.0	SV-KK	EL	 ch. 1K-6-000 001→ für Fahrzeuge mit Standheizung for vehicles with parking heater
1.4 TSI 118 kW (160 PS) CAVD	07.2008→07.2009	 7.02588.04.0	LDRV	EL	
		7.04247.02.0	SUV	EL	
		7.02256.40.0	SV-KK	EL	für Fahrzeuge mit Standheizung for vehicles with parking heater
1.6 75 kW (102 PS) BSE, BSF	06.2007→07.2009	 7.06117.54.0	SV-NWV	EL	
		 7.10014.00.0	AKF	EL	 BSE, BSF:  ch. 1K-6-000 001→

V









GOLF V Variant (1K5) **31**





			7.22880.01.0	EUV-SR	EL	 BSE, BSF: Fahrgestellnummer ab: 1K-6-000 001 Vehicle Identification Number from: 1K-6-000 001
			7.02256.40.0	SV-KK	EL	 BSE, BSF:  ch. 1K-6-000 001→ für Fahrzeuge mit Standheizung for vehicles with parking heater
1.6 75 kW (102 PS) CCSA	06.2007→07.2009		7.10014.00.0	AKF	EL	
			7.22880.01.0	EUV-SR	EL	
1.6 MultiFuel 75 kW (102 PS) CCSA	11.2007→07.2009		7.10014.00.0	AKF	EL	
			7.22880.01.0	EUV-SR	EL	
			7.02256.40.0	SV-KK	EL	für Fahrzeuge mit Standheizung for vehicles with parking heater
1.9 TDI 77 kW (105 PS) BLS	06.2007→07.2009		7.00868.02.0	DW-TL	EP	
			7.02256.00.0	EUV-AGR	EP	
			7.02256.40.0	SV-KK	EL	 ch. 1K-6-000 001→ für Fahrzeuge mit Standheizung for vehicles with parking heater
1.9 TDI 77 kW (105 PS) BXE	06.2007→07.2009		7.02256.40.0	SV-KK	EL	 ch. 1K-6-000 001→ für Fahrzeuge mit Standheizung for vehicles with parking heater
1.9 TDI 4motion 77 kW (105 PS) BLS	01.2008→07.2009		7.00868.02.0	DW-TL	EP	
			7.02256.00.0	EUV-AGR	EP	
			7.02256.40.0	SV-KK	EL	 ch. 1K-6-000 001→ für Fahrzeuge mit Standheizung for vehicles with parking heater
2.0 147 kW (200 PS) BWA	06.2007→07.2009		7.00470.07.0	LDRV	EL	 ch. 1K-6-000 001→
			7.00415.07.0	SUV	EL	Fahrgestellnummer bis: 1K-9-295 790 Vehicle Identification Number to: 1K-9-295 790
			7.01830.13.0	SUV	EL	
			7.02256.40.0	SV-KK	EL	 ch. 1K-6-000 001→ für Fahrzeuge mit Standheizung for vehicles with parking heater
			7.06117.46.0	SV-NWV	EH	mit Dichtring with O-ring Fahrgestellnummer ab: 1K-6-000 001 Vehicle Identification Number from: 1K-6-000 001 Fahrgestellnummer bis: 1K-9-304 948 Vehicle Identification Number to: 1K-9-304 948
2.0 147 kW (200 PS) CAWB	06.2007→07.2009		7.03280.04.0	EUV-SR	EL	
			7.22880.01.0	EUV-SR	EL	
			7.00470.07.0	LDRV	EL	
			7.01830.13.0	SUV	EL	
			7.02901.05.0	SUV	EL	für OE-Nummer: 06J 145 713 F, 06J 145 713 FX, 06J 145 713 K, 06J 145 713 KX, 06J 145 713 T, 06J 145 713 TX, 06J 145 722 B, 06J 145 722 BX for OE number: 06J 145 713 F, 06J 145 713 FX, 06J 145 713 K, 06J 145 713 KX, 06J 145 713 T, 06J 145 713 TX, 06J 145 722 B, 06J 145 722 BX
			7.02256.40.0	SV-KK	EL	für Fahrzeuge mit Standheizung for vehicles with parking heater
			7.06117.26.0	ZM-NWV	EL	



GOLF V Variant (1K5) 31





















2.0 147-157 kW (200-213 PS) CBFA	06.2007→07.2009		7.03280.04.0	EUV-SR	EL	Fahrgestellnummer ab: 1K-9-400 001 Vehicle Identification Number from: 1K-9-400 001	
			7.01830.13.0	SUV	EL		
2.0 147-157 kW (200-213 PS) CCTA	06.2007→07.2009		7.03280.04.0	EUV-SR	EL	Fahrgestellnummer bis: 1K-9-295 790 Vehicle Identification Number to: 1K-9-295 790 für OE-Nummer: 06J 145 713 F, 06J 145 713 FX, 06J 145 713 K, 06J 145 713 KX, 06J 145 713 T, 06J 145 713 TX, 06J 145 722 B, 06J 145 722 BX for OE number: 06J 145 713 F, 06J 145 713 FX, 06J 145 713 K, 06J 145 713 KX, 06J 145 713 T, 06J 145 713 TX, 06J 145 722 B, 06J 145 722 BX	
			7.22880.01.0	EUV-SR	EL		🇰🇷 Korea (Republik) 🇰🇷 Korea (Republik)
			7.00470.07.0	LDRV	EL		
			7.00415.07.0	SUV	EL		
			7.01830.13.0	SUV	EL		
			7.02901.05.0	SUV	EL		
2.0 TDI 103 kW (140 PS) BMM	06.2007→07.2009		7.00868.02.0	DW-TL	EP	🚗 ch. 1K-4-000 001→ für Fahrzeuge mit Standheizung for vehicles with parking heater	
			7.02256.00.0	EUV-AGR	EP		
			7.02256.40.0	SV-KK	EL		
2.0 TDI 100 kW (136 PS) AZV	06.2007→07.2009		7.02256.40.0	SV-KK	EL	🚗 ch. 1K-4-000 001→ für Fahrzeuge mit Standheizung for vehicles with parking heater	
2.0 TDI 16V 103 kW (140 PS) BKD	06.2007→07.2009		7.02256.40.0	SV-KK	EL	🚗 ch. 1K-4-000 001→ für Fahrzeuge mit Standheizung for vehicles with parking heater	
2.0 TDI 16V 103 kW (140 PS) CBDB	06.2007→07.2009		7.00868.02.0	DW-TL	EP		
			7.02256.00.0	EUV-AGR	EP		

GOLF VI (5K1) 32

1.2 TSI 77 kW (105 PS) CBZB	11.2008→11.2012		7.22880.01.0	EUV-KK	EL	Fahrgestellnummer ab: 1K-9-400 001 Vehicle Identification Number from: 1K-9-400 001
			7.02256.40.0	SV-KK	EL	
1.2 TSI 63 kW (86 PS) CBZA	05.2010→11.2012		7.22880.01.0	EUV-KK	EL	Fahrgestellnummer ab: 1K-9-400 001 Vehicle Identification Number from: 1K-9-400 001
			7.02256.40.0	SV-KK	EL	
1.4 59 kW (80 PS) CGGA	10.2008→11.2012		7.02256.40.0	SV-KK	EL	🚗 ch. 1K-9-400 001→ für Fahrzeuge mit Standheizung for vehicles with parking heater
1.4 TSI 90 kW (122 PS) CAXA	10.2008→11.2012		7.01830.13.0	SUV	EL	🚗 ch. 1K-9-400 001→ für Fahrzeuge mit Standheizung for vehicles with parking heater
			7.02256.40.0	SV-KK	EL	
			7.06117.54.0	SV-NWV	EL	
1.4 TSI 118 kW (160 PS) CAVD, CNWA, CTHD	10.2008→11.2012		7.02588.04.0	LDRV	EL	

















GOLF VI (5K1) **32**

			<p>7.04247.02.0 SUV EL</p> <p>7.02256.40.0 SV-KK EL</p> <p>7.06117.54.0 SV-NWV EL</p>		<p>CAVD, CNWA:  ch. 1K-9-400 001→ für Fahrzeuge mit Standheizung for vehicles with parking heater</p> <p>CTHD: für Fahrzeuge mit Standheizung for vehicles with parking heater</p> <p>Fahrgestellnummer ab: 1K-9-400 001 Vehicle Identification Number from: 1K-9-400 001</p>
<p>1.6 75 kW (102 PS) BSE, BSF, CCSA, CMXA</p>	10.2008→11.2012	 <p>7.10014.00.0 AKF EL</p> <p>7.22880.01.0 EUV-SR EL</p> <p>7.02256.40.0 SV-KK EL</p>	<p>BSE, BSF:  ch. 1K-6-000 001→</p> <p>CCSA, CMXA:  ch. 1K-9-400 001→</p> <p>CCSA, CMXA: Fahrgestellnummer ab: 1K-9-400 001 Vehicle Identification Number from: 1K-9-400 001</p> <p>BSE, BSF, CCSA, CMXA:  ch. 1K-9-400 001→ für Fahrzeuge mit Standheizung for vehicles with parking heater</p>		
<p>1.6 BiFuel 75 kW (102 PS) CHGA</p>	03.2009→11.2012	 <p>7.10014.00.0 AKF EL</p> <p>7.22880.01.0 EUV-SR EL</p> <p>7.02256.40.0 SV-KK EL</p>	<p> ch. 1K-9-400 001→</p> <p>Fahrgestellnummer ab: 1K-9-400 001 Vehicle Identification Number from: 1K-9-400 001</p> <p> ch. 1K-9-400 001→ für Fahrzeuge mit Standheizung for vehicles with parking heater</p>		
<p>1.6 MultiFuel 75 kW (102 PS) CCSA, CMXA</p>	10.2008→11.2012	 <p>7.10014.00.0 AKF EL</p> <p>7.22880.01.0 EUV-SR EL</p> <p>7.02256.40.0 SV-KK EL</p>	<p>CCSA, CMXA:  ch. 1K-9-400 001→</p> <p>Fahrgestellnummer ab: 1K-9-400 001 Vehicle Identification Number from: 1K-9-400 001</p> <p>CCSA, CMXA:  ch. 1K-9-400 001→ für Fahrzeuge mit Standheizung for vehicles with parking heater</p>		
<p>1.6 TDI 77 kW (105 PS) CAYC</p>	02.2009→11.2012	 <p>7.02256.00.0 EUV-AGR EP</p> <p>7.02256.40.0 SV-KK EL</p>	<p> ch. 1K-9-400 001→ für Fahrzeuge mit Standheizung for vehicles with parking heater</p>		
<p>1.6 TDI 66 kW (90 PS) CAYB</p>	02.2009→11.2012	 <p>7.02256.00.0 EUV-AGR EP</p> <p>7.02256.40.0 SV-KK EL</p>	<p> ch. 1K-9-400 001→ für Fahrzeuge mit Standheizung for vehicles with parking heater</p>		
<p>1.8 TSI 118 kW (160 PS) CDAA</p>	06.2009→01.2011	 <p>7.03280.04.0 EUV-SR EL</p> <p>7.22880.01.0 EUV-SR EL</p> <p>7.00470.07.0 LDRV EL</p> <p>7.02256.40.0 SV-KK EL</p> <p>7.06117.26.0 ZM-NWV EL</p>	<p>Fahrgestellnummer ab: 1K-9-400 001 Vehicle Identification Number from: 1K-9-400 001</p> <p>Fahrgestellnummer ab: 1K-9-400 001 Vehicle Identification Number from: 1K-9-400 001</p> <p> ch. 1K-9-400 001→</p> <p> ch. 1K-9-400 001→ für Fahrzeuge mit Standheizung for vehicles with parking heater</p> <p> ch. 1K-9-400 001→</p>		
<p>2.0 GTI 147-157 kW (200-213 PS) CBFA, CCTA</p>	01.2010→02.2014	 <p>7.03280.04.0 EUV-SR EL</p>	<p>CBFA, CCTA: Fahrgestellnummer ab: 1K-9-400 001 Vehicle Identification Number from: 1K-9-400 001</p>		

















GOLF VI (5K1) **32**

			7.22880.01.0	EUV-SR	EL	Fahrgestellnummer ab: 1K-9-400 001 Vehicle Identification Number from: 1K-9-400 001
			7.00470.07.0	LDRV	EL	 CBFA, CCTA:  ch. 1K-9-400 001→
			7.02901.05.0	SUV	EL	 CBFA, CCTA: für OE-Nummer: 06J 145 713 F, 06J 145 713 FX, 06J 145 713 K, 06J 145 713 KX, 06J 145 713 T, 06J 145 713 TX, 06J 145 722 B, 06J 145 722 BX for OE number: 06J 145 713 F, 06J 145 713 FX, 06J 145 713 K, 06J 145 713 KX, 06J 145 713 T, 06J 145 713 TX, 06J 145 722 B, 06J 145 722 BX
			7.06117.26.0	ZM-NWV	EL	
2.0 GTi 155 kW (211 PS) CCZB	04.2009→11.2012		7.03280.04.0	EUV-SR	EL	Fahrgestellnummer ab: 1K-9-400 001 Vehicle Identification Number from: 1K-9-400 001
			7.22880.01.0	EUV-SR	EL	Fahrgestellnummer ab: 1K-9-400 001 Vehicle Identification Number from: 1K-9-400 001
			7.00470.07.0	LDRV	EL	 ch. 1K-9-400 001→
			7.02901.05.0	SUV	EL	für OE-Nummer: 06J 145 713 F, 06J 145 713 FX, 06J 145 713 K, 06J 145 713 KX, 06J 145 713 T, 06J 145 713 TX, 06J 145 722 B, 06J 145 722 BX for OE number: 06J 145 713 F, 06J 145 713 FX, 06J 145 713 K, 06J 145 713 KX, 06J 145 713 T, 06J 145 713 TX, 06J 145 722 B, 06J 145 722 BX
			7.02256.40.0	SV-KK	EL	 ch. 1K-9-400 001→ für Fahrzeuge mit Standheizung for vehicles with parking heater
			7.06117.26.0	ZM-NWV	EL	Fahrgestellnummer ab: 1K-9-400 001 Vehicle Identification Number from: 1K-9-400 001
2.0 GTi 147-157 kW (200-213 PS) CBFA, CCTA, CCZA	06.2009→11.2013		7.03280.04.0	EUV-SR	EL	 CBFA, CCTA, CCZA: Fahrgestellnummer ab: 1K-9-400 001 Vehicle Identification Number from: 1K-9-400 001
			7.22880.01.0	EUV-SR	EL	 CBFA, CCTA, CCZA: Fahrgestellnummer ab: 1K-9-400 001 Vehicle Identification Number from: 1K-9-400 001
			7.00470.07.0	LDRV	EL	
			7.02901.05.0	SUV	EL	 CBFA, CCTA: für OE-Nummer: 06J 145 713 F, 06J 145 713 FX, 06J 145 713 K, 06J 145 713 KX, 06J 145 713 T, 06J 145 713 TX, 06J 145 722 B, 06J 145 722 BX for OE number: 06J 145 713 F, 06J 145 713 FX, 06J 145 713 K, 06J 145 713 KX, 06J 145 713 T, 06J 145 713 TX, 06J 145 722 B, 06J 145 722 BX
			7.06117.26.0	ZM-NWV	EL	 CBFA, CCTA: Fahrgestellnummer ab: 1K-9-400 001 Vehicle Identification Number from: 1K-9-400 001
2.0 GTi 173 kW (235 PS) CDLG	05.2011→11.2012		7.01830.13.0	SUV	EL	
			7.02256.40.0	SV-KK	EL	für Fahrzeuge mit Standheizung for vehicles with parking heater
			7.06117.46.0	SV-NWV	EH	mit Dichtring with O-ring
2.0 R 4motion 188 kW (256 PS) CDLC	11.2009→11.2013		7.28098.04.0	EUV-AGK	EL	Fahrgestellnummer ab: 1K-9-400 001 Vehicle Identification Number from: 1K-9-400 001
			7.00470.07.0	LDRV	EL	 ch. 1K-9-400 001→

















GOLF VI (5K1) **32**









			<p>7.01830.13.0 SUV EL</p> <p>7.02256.40.0 SV-KK EL  ch. 1K-9-400 001→ für Fahrzeuge mit Standheizung for vehicles with parking heater</p> <p>7.06117.46.0 SV-NWV EH mit Dichtring with O-ring Fahrgestellnummer ab: 1K-9-400 001 Vehicle Identification Number from: 1K-9-400 001</p>
2.0 R 4motion 188-191 kW (256-260 PS) CRZA	11.2009→11.2013	 7.28098.04.0	<p>EUV-AGK EL</p> <p>7.01830.13.0 SUV EL</p> <p>7.02256.40.0 SV-KK EL für Fahrzeuge mit Standheizung for vehicles with parking heater</p> <p>7.06117.46.0 SV-NWV EH mit Dichtring with O-ring</p>
2.0 R 4motion 199 kW (270 PS) CDLF	11.2009→11.2012	 7.28098.04.0	<p>EUV-AGK EL Fahrgestellnummer ab: 1K-9-400 001 Vehicle Identification Number from: 1K-9-400 001</p> <p>7.00470.07.0 LDRV EL  ch. 1K-9-400 001→</p> <p>7.01830.13.0 SUV EL</p> <p>7.02256.40.0 SV-KK EL  ch. 1K-9-400 001→ für Fahrzeuge mit Standheizung for vehicles with parking heater</p> <p>7.06117.46.0 SV-NWV EH mit Dichtring with O-ring Fahrgestellnummer ab: 1K-9-400 001 Vehicle Identification Number from: 1K-9-400 001</p>
2.0 TDI 103 kW (140 PS) CBAB	10.2008→05.2013	 7.00868.02.0	<p>DW-TL EP</p> <p>7.02256.00.0 EUV-AGR EP</p> <p>7.02256.40.0 SV-KK EL  ch. 1K-9-400 001→ für Fahrzeuge mit Standheizung for vehicles with parking heater</p>
2.0 TDI 103 kW (140 PS) CFFB	10.2008→05.2013	 7.02256.00.0	<p>EUV-AGR EP</p> <p>7.02256.40.0 SV-KK EL  ch. 1K-9-400 001→ für Fahrzeuge mit Standheizung for vehicles with parking heater</p>
2.0 TDI 103-104 kW (140-141 PS) CJAA	10.2008→05.2013	 7.00868.02.0	<p>DW-TL EP</p> <p>7.02256.40.0 SV-KK EL  ch. 1K-9-400 001→ für Fahrzeuge mit Standheizung for vehicles with parking heater</p>
2.0 TDI 81 kW (110 PS) CBDC	10.2008→11.2012	 7.00868.02.0	<p>DW-TL EP</p> <p>7.02256.00.0 EUV-AGR EP</p> <p>7.02256.40.0 SV-KK EL für Fahrzeuge mit Standheizung for vehicles with parking heater</p>
V 2.0 TDI 81 kW (110 PS) CLCA	10.2008→11.2012	 7.02256.00.0	<p>EUV-AGR EP</p> <p>7.02256.40.0 SV-KK EL  ch. 1K-9-400 001→ für Fahrzeuge mit Standheizung for vehicles with parking heater</p>
2.0 TDI 100 kW (136 PS) CBAA	10.2008→11.2012	 7.00868.02.0	<p>DW-TL EP</p> <p>7.02256.00.0 EUV-AGR EP</p> <p>7.02256.40.0 SV-KK EL  ch. 1K-9-400 001→ für Fahrzeuge mit Standheizung for vehicles with parking heater</p>



GOLF VI (5K1) 32

2.0 TDI 100 kW (136 PS) CFFA	10.2008→11.2012		7.02256.00.0	EUV-AGR	EP	 ch. 1K-9-400 001→ für Fahrzeuge mit Standheizung for vehicles with parking heater
			7.02256.40.0	SV-KK	EL	
2.0 TDI 125 kW (170 PS) CBBB	04.2009→11.2012		7.00868.02.0	DW-TL	EP	 ch. 1K-9-400 001→ für Fahrzeuge mit Standheizung for vehicles with parking heater
			7.02256.00.0	EUV-AGR	EP	
			7.02256.40.0	SV-KK	EL	
2.0 TDI 125 kW (170 PS) CFGB	04.2009→11.2012		7.02256.00.0	EUV-AGR	EP	 ch. 1K-9-400 001→ für Fahrzeuge mit Standheizung for vehicles with parking heater
			7.02256.40.0	SV-KK	EL	
2.0 TDI 4motion 103 kW (140 PS) CBAB	05.2009→11.2012		7.00868.02.0	DW-TL	EP	 ch. 1K-9-400 001→ für Fahrzeuge mit Standheizung for vehicles with parking heater
			7.02256.00.0	EUV-AGR	EP	
			7.02256.40.0	SV-KK	EL	
2.0 TDI 4motion 103 kW (140 PS) CFFB	05.2009→11.2012		7.02256.00.0	EUV-AGR	EP	 ch. 1K-9-400 001→ für Fahrzeuge mit Standheizung for vehicles with parking heater
			7.02256.40.0	SV-KK	EL	
2.0 TFSI 4motion 188-191 kW (256-260 PS) CRZA	09.2011→11.2013		7.28098.04.0	EUV-AGK	EL	mit Dichtring with O-ring
			7.01830.13.0	SUV	EL	
			7.06117.46.0	SV-NWV	EH	
2.5 112-127 kW (152-173 PS) CBTA, CBUA	07.2009→05.2013		7.02256.40.0	SV-KK	EL	 CBTA, CBUA:  ch. 1K-9-400 001→ für Fahrzeuge mit Standheizung for vehicles with parking heater













GOLF VI Convertible (517) 33

1.2 TSI 77 kW (105 PS) CBZB	03.2011→05.2016		7.22880.01.0	EUV-KK	EL	 ch. 1K-9-400 001→ für Fahrzeuge mit Standheizung for vehicles with parking heater
			7.02256.40.0	SV-KK	EL	
1.2 TSI 16V 77 kW (105 PS) CYVD	11.2013→05.2016		7.06117.48.0	SV-NWV	EL	
1.4 TSI 118 kW (160 PS) CAVD, CTHD	03.2011→05.2016		7.02588.04.0	LDRV	EL	 CAVD:  ch. 1K-9-400 001→ für Fahrzeuge mit Standheizung for vehicles with parking heater  CTHD: für Fahrzeuge mit Standheizung for vehicles with parking heater
			7.04247.02.0	SUV	EL	
			7.02256.40.0	SV-KK	EL	
			7.06117.54.0	SV-NWV	EL	
1.4 TSI 118 kW (160 PS) CNWA, CTKA	03.2011→05.2016		7.02588.04.0	LDRV	EL	
			7.04247.02.0	SUV	EL	









GOLF VI Convertible (517) **33**

			7.02256.40.0	SV-KK	EL	 CNWA:  ch. 1K-9-400 001→ für Fahrzeuge mit Standheizung for vehicles with parking heater  CTKA: für Fahrzeuge mit Standheizung for vehicles with parking heater
1.4 TSI 90 kW (122 PS) CAXA	11.2011→05.2016		7.01830.13.0	SUV	EL	
			7.02256.40.0	SV-KK	EL	 ch. 1K-9-400 001→ für Fahrzeuge mit Standheizung for vehicles with parking heater
1.4 TSI 92 kW (125 PS) CZCA	11.2013→05.2016		7.06117.48.0	SV-NWV	EL	
1.4 TSI 110 kW (150 PS) CZDA	11.2013→05.2016		7.06117.48.0	SV-NWV	EL	
1.6 TDI 77 kW (105 PS) CAYC	03.2011→05.2016		7.02256.00.0	EUV-AGR	EP	
			7.02256.40.0	SV-KK	EL	 ch. 1K-9-400 001→ für Fahrzeuge mit Standheizung for vehicles with parking heater
2.0 GTI 155 kW (211 PS) CCZB	05.2012→05.2016		7.03280.04.0	EUV-SR	EL	
			7.22880.01.0	EUV-SR	EL	
			7.00470.07.0	LDRV	EL	
			7.02901.05.0	SUV	EL	
			7.06117.26.0	ZM-NWV	EL	
2.0 R 195 kW (265 PS) CDLA	01.2013→05.2016		7.02256.00.0	EUV-AGR	EP	
			7.00470.07.0	LDRV	EL	
			7.06117.46.0	SV-NWV	EH	mit Dichtring with O-ring
2.0 TDI 103 kW (140 PS) CFHC	11.2011→05.2016		7.02256.00.0	EUV-AGR	EP	
			7.02256.40.0	SV-KK	EL	für Fahrzeuge mit Standheizung for vehicles with parking heater
2.0 TSI 162 kW (220 PS) CULC	11.2013→05.2016		7.02256.18.0	EUV-SR	EP	
			7.02901.05.0	SUV	EL	
			7.06117.26.0	ZM-NWV	EL	

















GOLF VI Variant (AJ5) **34**

1.2 TSI 77 kW (105 PS) CBZB	07.2009→07.2013		7.22880.01.0	EUV-KK	EL	
			7.02256.40.0	SV-KK	EL	 ch. 1K-9-400 001→ für Fahrzeuge mit Standheizung for vehicles with parking heater
1.2 TSI 63 kW (86 PS) CBZA	07.2010→07.2013		7.22880.01.0	EUV-KK	EL	Fahrgestellnummer ab: 1K-9-400 001 Vehicle Identification Number from: 1K-9-400 001
			7.02256.40.0	SV-KK	EL	 ch. 1K-9-400 001→ für Fahrzeuge mit Standheizung for vehicles with parking heater
1.4 59 kW (80 PS) CGGA	07.2009→07.2013		7.02256.40.0	SV-KK	EL	 ch. 1K-9-400 001→ für Fahrzeuge mit Standheizung for vehicles with parking heater
1.4 TSI 90 kW (122 PS) CAXA	07.2009→07.2013		7.01830.13.0	SUV	EL	
			7.02256.40.0	SV-KK	EL	 ch. 1K-9-400 001→ für Fahrzeuge mit Standheizung for vehicles with parking heater
			7.06117.54.0	SV-NWV	EL	

V



GOLF VI Variant (AJ5) 34

1.4 TSI 118 kW (160 PS) CAVD, CNWA, CTKA	07.2009→07.2013	 7.02588.04.0	LDRV	EL	 CAVD, CNWA:  ch. 1K-9-400 001→ für Fahrzeuge mit Standheizung for vehicles with parking heater  CTKA: für Fahrzeuge mit Standheizung for vehicles with parking heater
		7.04247.02.0	SUV	EL	
		7.02256.40.0	SV-KK	EL	
1.4 TSI 118 kW (160 PS) CTHD	07.2009→07.2013	 7.02588.04.0	LDRV	EL	für Fahrzeuge mit Standheizung for vehicles with parking heater
		7.04247.02.0	SUV	EL	
		7.02256.40.0	SV-KK	EL	
1.6 75 kW (102 PS) BSE, BSF, CCSA	07.2009→07.2013	 7.10014.00.0	AKF	EL	 BSE, BSF:  ch. 1K-6-000 001→
		7.22880.01.0	EUV-SR	EL	
		7.02256.40.0	SV-KK	EL	
1.6 BiFuel 75 kW (102 PS) BSF	07.2009→12.2010	 7.22880.01.0	EUV-SR	EL	Fahrgestellnummer ab: 1K-9-400 001 Vehicle Identification Number from: 1K-9-400 001
		7.22880.01.0	EUV-SR	EL	
		7.02256.40.0	SV-KK	EL	
1.6 MultiFuel 75 kW (102 PS) CMXA	07.2010→07.2013	 7.22880.01.0	EUV-SR	EL	Fahrgestellnummer ab: 1K-9-400 001 Vehicle Identification Number from: 1K-9-400 001
		7.02256.40.0	SV-KK	EL	
		7.02256.40.0	SV-KK	EL	
1.6 TDI 77 kW (105 PS) CAYC	07.2009→07.2013	 7.02256.00.0	EUV-AGR	EP	 ch. 1K-9-400 001→ für Fahrzeuge mit Standheizung for vehicles with parking heater
		7.02256.40.0	SV-KK	EL	
		7.02256.40.0	SV-KK	EL	
1.6 TDI 66 kW (90 PS) CAYB	12.2009→07.2013	 7.02256.00.0	EUV-AGR	EP	 ch. 1K-9-400 001→ für Fahrzeuge mit Standheizung for vehicles with parking heater
		7.02256.40.0	SV-KK	EL	
		7.02256.40.0	SV-KK	EL	
1.6 TDI 4motion 77 kW (105 PS) CAYC	07.2009→07.2013	 7.02256.00.0	EUV-AGR	EP	 ch. 1K-9-400 001→ für Fahrzeuge mit Standheizung for vehicles with parking heater
		7.02256.40.0	SV-KK	EL	
		7.02256.40.0	SV-KK	EL	
2.0 TDI 103 kW (140 PS) CBDB	07.2009→07.2013	 7.00868.02.0	DW-TL	EP	 ch. 1K-9-400 001→ für Fahrzeuge mit Standheizung for vehicles with parking heater
		7.02256.00.0	EUV-AGR	EP	
		7.02256.40.0	SV-KK	EL	
2.0 TDI 103 kW (140 PS) CFHC	07.2009→07.2013	 7.02256.00.0	EUV-AGR	EP	für Fahrzeuge mit Standheizung for vehicles with parking heater
		7.02256.40.0	SV-KK	EL	
		7.02256.40.0	SV-KK	EL	
2.0 TDI 103-104 kW (140-141 PS) CJAA	07.2009→07.2013	 7.00868.02.0	DW-TL	EP	 ch. 1K-9-400 001→ für Fahrzeuge mit Standheizung for vehicles with parking heater
		7.02256.00.0	EUV-AGR	EP	
		7.02256.40.0	SV-KK	EL	















GOLF VI Variant (AJ5) 34

2.0 TDI 100 kW (136 PS) CBDA	07.2009→07.2013		7.00868.02.0	DW-TL	EP	für Fahrzeuge mit Standheizung for vehicles with parking heater
			7.02256.00.0 7.02256.40.0	EUV-AGR SV-KK	EP EL	
2.0 TDI 100 kW (136 PS) CFHB	07.2009→07.2013		7.02256.40.0	SV-KK	EL	für Fahrzeuge mit Standheizung for vehicles with parking heater
2.0 TDI 81 kW (110 PS) CLCA	01.2010→07.2013		7.02256.00.0	EUV-AGR	EP	 ch. 1K-9-400 001→ für Fahrzeuge mit Standheizung for vehicles with parking heater
			7.02256.40.0	SV-KK	EL	
2.0 TSI 147 kW (200 PS) CCZA	07.2009→07.2013		7.22880.01.0	EUV-SR	EL	für Fahrzeuge mit Standheizung for vehicles with parking heater
			7.00470.07.0	LDRV	EL	
			7.02256.40.0	SV-KK	EL	
			7.06117.26.0	ZM-NWV	EL	













GOLF VII (5G1, BQ1, BE1, BE2) 35

1.0 TSI 85 kW (115 PS) CHZD, DKRF	05.2015→		7.06117.48.0	SV-NWV	EL	 CHZD: Fahrgestellnummer ab: AU-D-000 001 Vehicle Identification Number from: AU-D-000 001 Produktionsdatum ab: 13.05.2013 Production date from: 13.05.2013  DKRF: Fahrgestellnummer ab: AU-HJ400001, AU-HP300001, AU-HR400001, AU-HW300001, AU-HW850001 Vehicle Identification Number from: AU-HJ400001, AU-HP300001, AU-HR400001, AU-HW300001, AU-HW850001
1.0 TSI 81 kW (110 PS) CHZC	11.2016→		7.06117.48.0	SV-NWV	EL	Fahrgestellnummer ab: AU-HJ400001, AU-HP300001, AU-HR400001, AU-HW300001, AU-HW850001 Vehicle Identification Number from: AU-HJ400001, AU-HP300001, AU-HR400001, AU-HW300001, AU-HW850001
1.0 TSI 63 kW (86 PS) CHZK, DKLB	01.2017→07.2018		7.06117.48.0	SV-NWV	EL	 CHZK, DKLB: Fahrgestellnummer ab: AU-HJ400001, AU-HP300001, AU-HR400001, AU-HW300001, AU-HW850001 Vehicle Identification Number from: AU-HJ400001, AU-HP300001, AU-HR400001, AU-HW300001, AU-HW850001
1.2 TSI 63 kW (86 PS) CJZB	08.2012→		7.06117.48.0	SV-NWV	EL	Fahrgestellnummer ab: AU-D-000 001 Vehicle Identification Number from: AU-D-000 001 Produktionsdatum bis: 29.07.2013 Production date to: 29.07.2013
1.2 TSI 77 kW (105 PS) CJZA	11.2012→		7.06117.48.0	SV-NWV	EL	Fahrgestellnummer ab: AU-D-000 001 Vehicle Identification Number from: AU-D-000 001 Produktionsdatum bis: 29.07.2013 Production date to: 29.07.2013
1.4 GTE Hybrid 110 kW (150 PS) CUKB	05.2014→		7.02256.41.0	SV-KK	EL	 ch. AU-D-000 001→ für OE-Nummer: 1T0 820 036 D for OE number: 1T0 820 036 D
			7.06117.48.0	SV-NWV	EL	

V











GOLF VII (5G1, BQ1, BE1, BE2) **35**

1.4 TGI CNG 81 kW (110 PS) CPWA	06.2013→	 7.06117.48.0	SV-NWV	EL	Fahrgestellnummer ab: AU-D-000 001 Vehicle Identification Number from: AU-D-000 001 Produktionsdatum ab: 13.05.2013 Production date from: 13.05.2013
1.4 TSI 103 kW (140 PS) CHPA, CPTA	08.2012→	 7.06117.48.0	SV-NWV	EL	 CHPA, CPTA: Fahrgestellnummer ab: AU-D-000 001 Vehicle Identification Number from: AU-D-000 001
1.4 TSI 90 kW (122 PS) CMBA, CXSA	11.2012→	 7.06117.48.0	SV-NWV	EL	 CMBA, CXSA: Fahrgestellnummer ab: AU-D-000 001 Vehicle Identification Number from: AU-D-000 001
1.4 TSI 110 kW (150 PS) CZDA, CZEA	05.2014→	 7.06117.48.0	SV-NWV	EL	 CZDA, CZEA: Fahrgestellnummer ab: AU-D-000 001 Vehicle Identification Number from: AU-D-000 001 Produktionsdatum ab: 13.05.2013 Production date from: 13.05.2013
1.4 TSI 92 kW (125 PS) CZCA	05.2014→	 7.06117.48.0	SV-NWV	EL	Fahrgestellnummer ab: AU-D-000 001 Vehicle Identification Number from: AU-D-000 001 Produktionsdatum ab: 13.05.2013 Production date from: 13.05.2013
1.4 TSI MultiFuel 90 kW (122 PS) CPVA	04.2013→	 7.06117.48.0	SV-NWV	EL	Fahrgestellnummer ab: AU-D-000 001 Vehicle Identification Number from: AU-D-000 001
1.4 TSI MultiFuel 92 kW (125 PS) CPVB	12.2013→	 7.06117.48.0	SV-NWV	EL	Fahrgestellnummer ab: AU-D-000 001 Vehicle Identification Number from: AU-D-000 001 Produktionsdatum ab: 13.05.2013 Production date from: 13.05.2013
1.8 TSI 125 kW (170 PS) CNSA, CNSB, CXBA, CXBB	07.2013→	 7.02901.05.0	SUV	EL	 CNSA, CNSB, CXBA, CXBB: 01.2016→
			ZM-NWV	EL	 CNSA, CNSB, CXBA, CXBB: Fahrgestellnummer ab: AU-GM000001 Vehicle Identification Number from: AU-GM000001
2.0 GTI 162 kW (220 PS) CHHB, CXDA	04.2013→	 7.02256.18.0	EUV-SR	EP	 CHHB, CXDA: Fahrgestellnummer ab: AU-D-000 001 Vehicle Identification Number from: AU-D-000 001 für OE-Nummer: 06H 906 283 F for OE number: 06H 906 283 F
			SUV ZM-NWV	EL EL	 CHHB, CXDA: Fahrgestellnummer ab: AU-D-000 001 Vehicle Identification Number from: AU-D-000 001
2.0 GTI 162 kW (220 PS) CXCB	04.2013→	 7.06117.26.0	ZM-NWV	EL	Fahrgestellnummer ab: AU-GM000001 Vehicle Identification Number from: AU-GM000001
2.0 GTI 169 kW (230 PS) CHHA	04.2013→	 7.02256.18.0	EUV-SR	EP	Fahrgestellnummer ab: AU-D-000 001 Vehicle Identification Number from: AU-D-000 001 für OE-Nummer: 06H 906 283 F for OE number: 06H 906 283 F
			SUV ZM-NWV	EL EL	Fahrgestellnummer ab: AU-D-000 001 Vehicle Identification Number from: AU-D-000 001
2.0 GTI 155 kW (211 PS) CNTA	11.2013→	 7.02256.18.0	EUV-SR	EP	Fahrgestellnummer ab: AU-D-000 001 Vehicle Identification Number from: AU-D-000 001 für OE-Nummer: 06H 906 283 F for OE number: 06H 906 283 F
		 7.02901.05.0	SUV	EL	



















GOLF VII (5G1, BQ1, BE1, BE2) **35**





			7.06117.26.0	ZM-NWV	EL	Fahrgestellnummer ab: AU-D-000 001 Vehicle Identification Number from: AU-D-000 001
2.0 GTI 155 kW (211 PS) CXCA	11.2013→		7.02901.05.0 7.06117.26.0	SUV ZM-NWV	EL EL	Fahrgestellnummer ab: AU-GM000001 Vehicle Identification Number from: AU-GM000001
2.0 GTI 180 kW (245 PS) DKTB, DLBA	03.2017→		7.06117.26.0	ZM-NWV	EL	Fahrgestellnummer ab: AU-HJ400001, AU-HP300001, AU-HR400001, AU-HW300001, AU-HW850001 Vehicle Identification Number from: AU-HJ400001, AU-HP300001, AU-HR400001, AU-HW300001, AU-HW850001
2.0 GTI 170 kW (231 PS) DKFA	09.2018→		7.06117.26.0	ZM-NWV	EL	
2.0 GTI Clubsport 195 kW (265 PS) CJXE	02.2016→03.2017		7.02256.18.0 7.02901.05.0 7.06117.26.0	EUV-SR SUV ZM-NWV	EP EL EL	Fahrgestellnummer ab: AU-D-000 001 Vehicle Identification Number from: AU-D-000 001 für OE-Nummer: 06H 906 283 F for OE number: 06H 906 283 F Fahrgestellnummer ab: AU-D-000 001 Vehicle Identification Number from: AU-D-000 001
2.0 GTI Clubsport S 228 kW (310 PS) CJXG	09.2016→		7.02256.18.0 7.02901.05.0 7.06117.26.0	EUV-SR SUV ZM-NWV	EP EL EL	Fahrgestellnummer ab: AU-D-000 001 Vehicle Identification Number from: AU-D-000 001 für OE-Nummer: 06H 906 283 F for OE number: 06H 906 283 F Fahrgestellnummer ab: AU-D-000 001 Vehicle Identification Number from: AU-D-000 001
2.0 GTI TCR 213 kW (290 PS) CJXH, DNUC	11.2018→		7.06117.26.0	ZM-NWV	EL	
2.0 R 360S 4motion 221-265 kW (300-360 PS) CJXC	09.2016→		7.02901.05.0 7.06117.26.0	SUV ZM-NWV	EL EL	Fahrgestellnummer ab: AU-E-500 001 Vehicle Identification Number from: AU-E-500 001
2.0 R 4motion 206 kW (280 PS) CJXB	11.2013→		7.02256.18.0 7.02901.05.0 7.06117.26.0	EUV-SR SUV ZM-NWV	EP EL EL	Fahrgestellnummer ab: AU-D-000 001 Vehicle Identification Number from: AU-D-000 001 für OE-Nummer: 06H 906 283 F for OE number: 06H 906 283 F Fahrgestellnummer ab: AU-D-000 001 Vehicle Identification Number from: AU-D-000 001
V 2.0 R 4motion 221-265 kW (300-360 PS) CJXC	11.2013→		7.02256.18.0 7.02901.05.0 7.06117.26.0	EUV-SR SUV ZM-NWV	EP EL EL	Fahrgestellnummer ab: AU-D-000 001 Vehicle Identification Number from: AU-D-000 001 für OE-Nummer: 06H 906 283 F for OE number: 06H 906 283 F Fahrgestellnummer ab: AU-D-000 001 Vehicle Identification Number from: AU-D-000 001



GOLF VII (5G1, BQ1, BE1, BE2) 35

2.0 R 4motion 215 kW (292 PS) CYFB	11.2014→	 7.02256.18.0  7.02901.05.0 7.06117.26.0	EUV-SR SUV ZM-NWV	EP EL EL	Fahrgestellnummer ab: AU-D-000 001 Vehicle Identification Number from: AU-D-000 001 für OE-Nummer: 06H 906 283 F for OE number: 06H 906 283 F Fahrgestellnummer ab: AU-D-000 001 Vehicle Identification Number from: AU-D-000 001
2.0 R 4motion 228 kW (310 PS) CJXG	12.2016→	 7.02256.18.0 7.02901.05.0 7.06117.26.0	EUV-SR SUV ZM-NWV	EP EL EL	Fahrgestellnummer ab: AU-D-000 001 Vehicle Identification Number from: AU-D-000 001 für OE-Nummer: 06H 906 283 F for OE number: 06H 906 283 F Fahrgestellnummer ab: AU-D-000 001 Vehicle Identification Number from: AU-D-000 001
2.0 R 4motion 228 kW (310 PS) DJHA	12.2016→	 7.06117.26.0	ZM-NWV	EL	Fahrgestellnummer ab: AU-HJ400001, AU-HP300001, AU-HR400001, AU-HW300001, AU-HW850001 Vehicle Identification Number from: AU-HJ400001, AU-HP300001, AU-HR400001, AU-HW300001, AU-HW850001
2.0 R 4motion 213 kW (290 PS) CJXD	12.2016→	 7.02901.05.0 7.06117.26.0	SUV ZM-NWV	EL EL	Fahrgestellnummer ab: AU-HJ400001, AU-HP300001, AU-HR400001, AU-HW300001, AU-HW850001 Vehicle Identification Number from: AU-HJ400001, AU-HP300001, AU-HR400001, AU-HW300001, AU-HW850001
2.0 R 4motion 213 kW (290 PS) DJHB, DNUC	12.2016→	 7.06117.26.0	ZM-NWV	EL	 DJHB: Fahrgestellnummer ab: AU-HJ400001, AU-HP300001, AU-HR400001, AU-HW300001, AU-HW850001 Vehicle Identification Number from: AU-HJ400001, AU-HP300001, AU-HR400001, AU-HW300001, AU-HW850001  DNUC: Produktionsdatum ab: 08.01.2018 Production date from: 08.01.2018
2.0 TDI 105 kW (143 PS) CRVC	08.2012→	 7.02256.00.0	EUV-AGR	EP	 ch. AU-D-000 001→
2.0 TDI 81 kW (110 PS) CRVA	11.2012→	 7.02256.00.0	EUV-AGR	EP	 ch. AU-D-000 001→
e-Golf 85 kW (115 PS) EAGA	03.2014→02.2017	 7.02256.41.0	SV-KK	EL	für Fahrzeuge mit Standheizung for vehicles with parking heater
e-Golf 100 kW (136 PS) EAZA, EBSA	12.2016→	 7.02256.41.0	SV-KK	EL	 EAZA, EBSA: für Fahrzeuge mit Standheizung for vehicles with parking heater

GOLF VII Variant (BA5, BV5) 36

















1.0 TSI 85 kW (115 PS) CHZD, DKRF	05.2015→03.2017	 7.06117.48.0 	SV-NWV	EL	 CHZD: Fahrgestellnummer ab: AU-E-500 001 Vehicle Identification Number from: AU-E-500 001  DKRF: Fahrgestellnummer ab: AU-HP750001 Vehicle Identification Number from: AU-HP750001
1.0 TSI 81 kW (110 PS) CHZC	11.2016→	 7.06117.48.0	SV-NWV	EL	Fahrgestellnummer ab: AU-HP750001 Vehicle Identification Number from: AU-HP750001





GOLF VII Variant (BA5, BV5)

36

1.0 TSI 63 kW (86 PS) CHZK	01.2017→07.2018	 7.06117.48.0	SV-NWV	EL	Fahrgestellnummer ab: AU-HP750001 Vehicle Identification Number from: AU-HP750001
1.2 TSI 63 kW (86 PS) CJZB	05.2013→03.2017	 7.06117.48.0	SV-NWV	EL	Fahrgestellnummer ab: AU-E-500 001 Vehicle Identification Number from: AU-E-500 001 Produktionsdatum bis: 29.07.2013 Production date to: 29.07.2013
1.2 TSI 77 kW (105 PS) CJZA	05.2013→	 7.06117.48.0	SV-NWV	EL	Fahrgestellnummer ab: AU-E-500 001 Vehicle Identification Number from: AU-E-500 001 Produktionsdatum bis: 29.07.2013 Production date to: 29.07.2013
1.4 Flex 110 kW (150 PS) CWLA	06.2015→	 7.06117.48.0	SV-NWV	EL	Fahrgestellnummer ab: AU-GM500001 Vehicle Identification Number from: AU-GM500001
1.4 TGI CNG 81 kW (110 PS) CPWA	09.2013→	 7.06117.48.0	SV-NWV	EL	Fahrgestellnummer ab: AU-E-500 001 Vehicle Identification Number from: AU-E-500 001
1.4 TSI 103 kW (140 PS) CHPA	05.2013→03.2017	 7.06117.48.0	SV-NWV	EL	Fahrgestellnummer ab: AU-E-500 001 Vehicle Identification Number from: AU-E-500 001
1.4 TSI 90 kW (122 PS) CXSA	05.2013→	 7.06117.48.0	SV-NWV	EL	Fahrgestellnummer ab: AU-E-500 001 Vehicle Identification Number from: AU-E-500 001
1.4 TSI 92 kW (125 PS) CZCA, CZDD	05.2014→03.2017	 7.06117.48.0	SV-NWV	EL	 CZCA, CZDD: Fahrgestellnummer ab: AU-E-500 001 Vehicle Identification Number from: AU-E-500 001
1.4 TSI 110 kW (150 PS) CHPB, CZDA	05.2014→	 7.06117.48.0	SV-NWV	EL	 CHPB, CZDA: Fahrgestellnummer ab: AU-E-500 001 Vehicle Identification Number from: AU-E-500 001
1.4 TSI MultiFuel 90 kW (122 PS) CPVA	04.2013→03.2017	 7.06117.48.0	SV-NWV	EL	Fahrgestellnummer ab: AU-E-500 001 Vehicle Identification Number from: AU-E-500 001
1.4 TSI MultiFuel 92 kW (125 PS) CPVB	05.2014→03.2017	 7.06117.48.0	SV-NWV	EL	Fahrgestellnummer ab: AU-E-500 001 Vehicle Identification Number from: AU-E-500 001
1.6 81 kW (110 PS) CWVA	05.2014→03.2017	 7.06117.48.0	SV-NWV	EL	Fahrgestellnummer ab: AU-GM500001 Vehicle Identification Number from: AU-GM500001
1.8 TSI 125 kW (170 PS) CNSA, CNSB	07.2013→	 7.02901.05.0	SUV	EL	 CNSA, CNSB: 01.2016→
1.8 TSI 125 kW (170 PS) CXBA, CXBB	07.2013→	 7.02901.05.0	SUV	EL	 CXBA, CXBB: 01.2016→
		7.06117.26.0	ZM-NWV	EL	 CXBA, CXBB: Fahrgestellnummer ab: AU-GM500001 Vehicle Identification Number from: AU-GM500001
1.8 TSI 4motion 132 kW (180 PS) CJSB	11.2016→	 7.03280.04.0	EUV-SR	EL	
		7.02901.05.0	SUV	EL	
		7.06117.26.0	ZM-NWV	EL	Fahrgestellnummer ab: AU-E-500 001 Vehicle Identification Number from: AU-E-500 001
1.8 TSI 4motion 125 kW (170 PS) CXBA, CXBB	07.2017→	 7.02901.05.0	SUV	EL	
		7.06117.26.0	ZM-NWV	EL	 CXBA, CXBB: Fahrgestellnummer ab: AU-GM500001 Vehicle Identification Number from: AU-GM500001
2.0 R 360S 4motion 221-265 kW (300-360 PS) CJXC	09.2016→	 7.02901.05.0	SUV	EL	

V



GOLF VII Variant (BA5, BV5) 36

			7.06117.26.0	ZM-NWV	EL	Fahrgestellnummer ab: AU-E-500 001 Vehicle Identification Number from: AU-E-500 001
2.0 R 4motion 206 kW (280 PS) CJXB	03.2015→03.2017		7.02256.18.0	EUV-SR	EP	Fahrgestellnummer ab: AU-E-500 001 Vehicle Identification Number from: AU-E-500 001
			7.02901.05.0	SUV	EL	
			7.06117.26.0	ZM-NWV	EL	Fahrgestellnummer ab: AU-E-500 001 Vehicle Identification Number from: AU-E-500 001
2.0 R 4motion 221-265 kW (300-360 PS) CJXC	03.2015→03.2017		7.02256.18.0	EUV-SR	EP	Fahrgestellnummer ab: AU-E-500 001 Vehicle Identification Number from: AU-E-500 001
			7.02901.05.0	SUV	EL	
			7.06117.26.0	ZM-NWV	EL	Fahrgestellnummer ab: AU-E-500 001 Vehicle Identification Number from: AU-E-500 001
2.0 R 4motion 221 kW (300 PS) DNUÉ	03.2015→03.2017		7.06117.26.0	ZM-NWV	EL	Produktionsdatum ab: 08.01.2018 Production date from: 08.01.2018
2.0 R 4motion 228 kW (310 PS) CJXG	12.2016→		7.02901.05.0	SUV	EL	
			7.06117.26.0	ZM-NWV	EL	Fahrgestellnummer ab: AU-E-500 001 Vehicle Identification Number from: AU-E-500 001
2.0 R 4motion 228 kW (310 PS) DJHA	12.2016→		7.06117.26.0	ZM-NWV	EL	Fahrgestellnummer ab: AU-HP750001 Vehicle Identification Number from: AU-HP750001
2.0 R 4motion 213 kW (290 PS) CJXD	12.2016→07.2018		7.02901.05.0	SUV	EL	
			7.06117.26.0	ZM-NWV	EL	Fahrgestellnummer ab: AU-HP750001 Vehicle Identification Number from: AU-HP750001
2.0 R 4motion 213 kW (290 PS) DJHB, DNUC	12.2016→07.2018		7.06117.26.0	ZM-NWV	EL	Fahrgestellnummer ab: AU-HP750001 Vehicle Identification Number from: AU-HP750001
2.0 TDI 81 kW (110 PS) CRVA	05.2013→03.2017		7.02256.00.0	EUV-AGR	EP	ch. AU-D-000 001→

JETTA II (19E, 1G2, 165) 37

1.8 Cat 65-66 kW (88-90 PS) RP	08.1987→10.1991		7.01805.01.0	EUV-LS	EL	
1.8 Syncro 65-66 kW (88-90 PS) RP	08.1987→12.1988		7.01805.01.0	EUV-LS	EL	

JETTA III (1K2) 38

1.4 TSI 103 kW (140 PS) BMY	07.2006→10.2010		7.01044.03.0	EUV-SR	EL	
			7.00470.07.0	LDRV	EL	für OE-Nummer: 06F 906 283 F for OE number: 06F 906 283 F
			7.01830.13.0	SUV	EL	
			7.04247.02.0	SUV	EL	
			7.02256.40.0	SV-KK	EL	für Fahrzeuge mit Standheizung for vehicles with parking heater
1.4 TSI 125 kW (170 PS) BLG	07.2006→10.2010		7.06117.54.0	SV-NWV	EL	
			7.01044.03.0	EUV-SR	EL	
			7.00470.07.0	LDRV	EL	für OE-Nummer: 06F 906 283 F for OE number: 06F 906 283 F
			7.01830.13.0	SUV	EL	
			7.04247.02.0	SUV	EL	
7.02256.40.0	SV-KK	EL	für Fahrzeuge mit Standheizung for vehicles with parking heater			
7.06117.54.0	SV-NWV	EL				



















JETTA III (1K2) **38**

1.4 TSI 90 kW (122 PS) CAXA	05.2007→10.2010		7.00415.07.0	SUV	EL	2008 2008 für Fahrzeuge mit Standheizung for vehicles with parking heater
			7.01830.13.0	SUV	EL	
			7.02256.40.0	SV-KK	EL	
			7.06117.54.0	SV-NWV	EL	
1.4 TSI 118 kW (160 PS) CAVD	07.2008→10.2010		7.02588.04.0	LDRV	EL	 ch. 16-B-000 001→ für Fahrzeuge mit Standheizung for vehicles with parking heater
			7.04247.02.0	SUV	EL	
			7.01830.13.0	SUV	EL	
			7.02256.40.0	SV-KK	EL	
1.6 75 kW (102 PS) BSE, BSF	09.2004→10.2010		7.10014.00.0	AKF	EL	 BSE, BSF: für Fahrzeuge mit Standheizung for vehicles with parking heater
			7.22880.01.0	EUV-SR	EL	
			7.02256.40.0	SV-KK	EL	
1.6 75 kW (102 PS) CCSA	09.2004→10.2010		7.10014.00.0	AKF	EL	
			7.22880.01.0	EUV-SR	EL	
1.6 FSI 85 kW (115 PS) BLF	09.2005→10.2010		7.10014.00.0	AKF	EL	für Fahrzeuge mit Standheizung for vehicles with parking heater
			7.22880.01.0	EUV-SR	EL	
			7.02256.40.0	SV-KK	EL	
			7.06117.54.0	SV-NWV	EL	
1.6 MultiFuel 75 kW (102 PS) CCSA	01.2008→10.2010		7.10014.00.0	AKF	EL	für Fahrzeuge mit Standheizung for vehicles with parking heater
			7.22880.01.0	EUV-SR	EL	
			7.02256.40.0	SV-KK	EL	
1.6 TDI 77 kW (105 PS) CAYC	06.2009→10.2010		7.02256.00.0	EUV-AGR	EP	für Fahrzeuge mit Standheizung for vehicles with parking heater
			7.02256.40.0	SV-KK	EL	
1.6 TDI 66 kW (90 PS) CAYB	12.2009→10.2010		7.02256.00.0	EUV-AGR	EP	für Fahrzeuge mit Standheizung for vehicles with parking heater
			7.02256.40.0	SV-KK	EL	
1.9 TDI 77 kW (105 PS) BKC, BXE	08.2005→10.2010		7.02256.40.0	SV-KK	EL	 BKC, BXE: für Fahrzeuge mit Standheizung for vehicles with parking heater
1.9 TDI 77 kW (105 PS) BLS	08.2005→10.2010		7.00868.02.0	DW-TL	EP	für Fahrzeuge mit Standheizung for vehicles with parking heater
			7.02256.00.0	EUV-AGR	EP	
			7.02256.40.0	SV-KK	EL	
2.0 FSI 110 kW (150 PS) BLR, BLY, BVY, BVZ	08.2005→10.2010		7.22880.01.0	EUV-SR	EL	 BLR, BLY, BVY, BVZ: für Fahrzeuge mit Standheizung for vehicles with parking heater
			7.02256.40.0	SV-KK	EL	
			7.06117.37.0	SV-NWV	EL	
2.0 TDI 100 kW (136 PS) AZV	09.2005→10.2010		7.02256.40.0	SV-KK	EL	für Fahrzeuge mit Standheizung for vehicles with parking heater
2.0 TDI 100 kW (136 PS) CBDA	09.2005→10.2010		7.00868.02.0	DW-TL	EP	
			7.02256.00.0	EUV-AGR	EP	

V









JETTA III (1K2) 38

		 PIERBURG			
		7.02256.40.0	SV-KK	EL	für Fahrzeuge mit Standheizung for vehicles with parking heater
2.0 TDI 103 kW (140 PS) BMM	10.2005→10.2010	 7.00868.02.0	DW-TL	EP	
		7.02256.00.0	EUV-AGR	EP	
		7.02256.40.0	SV-KK	EL	für Fahrzeuge mit Standheizung for vehicles with parking heater
2.0 TDI 125 kW (170 PS) BMN	10.2006→10.2010	 7.00868.02.0	DW-TL	EP	
		7.02256.00.0	EUV-AGR	EP	
		7.02256.40.0	SV-KK	EL	für Fahrzeuge mit Standheizung for vehicles with parking heater
2.0 TDI 125 kW (170 PS) CEGA	10.2006→10.2010	 7.00868.02.0	DW-TL	EP	
		7.02256.00.0	EUV-AGR	EP	
2.0 TDI 16V 103 kW (140 PS) BKD	08.2005→10.2010	 7.02256.40.0	SV-KK	EL	für Fahrzeuge mit Standheizung for vehicles with parking heater
2.0 TDI 16V 103 kW (140 PS) CBDB	08.2005→10.2010	 7.00868.02.0	DW-TL	EP	
		7.02256.00.0	EUV-AGR	EP	
		7.02256.40.0	SV-KK	EL	für Fahrzeuge mit Standheizung for vehicles with parking heater
2.0 TDI 16V 103-104 kW (140-141 PS) CJAA	08.2005→10.2010	 7.00868.02.0	DW-TL	EP	
2.0 TFSI 147 kW (200 PS) AXX	10.2005→10.2010	 7.01830.13.0	SUV	EL	
		7.06117.46.0	SV-NWV	EH	mit Dichtring with O-ring Südafrika South Africa
2.0 TFSI 147 kW (200 PS) BPY	10.2005→10.2010	 7.00470.07.0	LDRV	EL	
		7.00415.07.0	SUV	EL	
		7.02256.40.0	SV-KK	EL	für Fahrzeuge mit Standheizung for vehicles with parking heater
		7.06117.46.0	SV-NWV	EH	mit Dichtring with O-ring
2.0 TFSI 147 kW (200 PS) BWA	10.2005→10.2010	 7.00470.07.0	LDRV	EL	 →ch. 1K-9-109 650
		7.00415.07.0	SUV	EL	2008
		7.01830.13.0	SUV	EL	2008
		7.02256.40.0	SV-KK	EL	für Fahrzeuge mit Standheizung for vehicles with parking heater
		7.06117.46.0	SV-NWV	EH	mit Dichtring with O-ring
2.0 TFSI 147 kW (200 PS) CAWB	10.2005→10.2010	 7.22880.01.0	EUV-SR	EL	
		7.00470.07.0	LDRV	EL	
		7.01830.13.0	SUV	EL	
		7.02256.40.0	SV-KK	EL	für Fahrzeuge mit Standheizung for vehicles with parking heater
		7.06117.26.0	ZM-NWV	EL	
2.0 TFSI 147-157 kW (200-213 PS) CBFA	10.2005→10.2010	 7.22880.01.0	EUV-SR	EL	Fahrgestellnummer ab: 16-B-000 001 Vehicle Identification Number from: 16-B-000 001

















JETTA III (1K2) **38**

			7.02901.05.0	SUV	EL	 ch. 16-B-000 001→ für OE-Nummer: 06H 145 710 C, 06J 145 713 F for OE number: 06H 145 710 C, 06J 145 713 F
2.0 TFSI 147-157 kW (200-213 PS) CCTA	10.2005→10.2010		7.22880.01.0	EUV-SR	EL	für Fahrzeuge mit Standheizung for vehicles with parking heater ■■ Korea (Republik) ■■ Korea (Republic)
			7.00415.07.0	SUV	EL	
			7.01830.13.0	SUV	EL	
			7.02256.40.0	SV-KK	EL	
2.0 TFSI 125 kW (170 PS) CAWA	07.2008→10.2010		7.22880.01.0	EUV-SR	EL	für Fahrzeuge mit Standheizung for vehicles with parking heater ■■ Südafrika ■■ South Africa
			7.00470.07.0	LDRV	EL	
			7.01830.13.0	SUV	EL	
			7.02256.40.0	SV-KK	EL	
2.5 110-112 kW (150-152 PS) BGP, BTK	01.2006→10.2010		7.02256.40.0	SV-KK	EL	 BGP, BTK: für Fahrzeuge mit Standheizung for vehicles with parking heater
			7.06117.26.0	ZM-NWV	EL	■■ Südafrika ■■ South Africa
2.5 125 kW (170 PS) CCCA	07.2008→10.2010		7.02256.40.0	SV-KK	EL	für Fahrzeuge mit Standheizung for vehicles with parking heater

JETTA IV (162, 163, AV3, AV2) **39**

1.2 TSI 77 kW (105 PS) CBZB	10.2010→		7.22880.01.0	EUV-KK	EL	Fahrgestellnummer ab: 16-B-000 001 Vehicle Identification Number from: 16-B-000 001
1.4 TSI 118 kW (160 PS) CAVD, CTHD	04.2011→		7.02588.04.0	LDRV	EL	 ch. 16-B-000 001→
			7.04247.02.0	SUV	EL	 CAVD, CTHD:  ch. 16-B-000 001→
			7.01830.13.0	SUV	EL	
			7.06117.54.0	SV-NWV	EL	 CAVD, CTHD: Fahrgestellnummer ab: 16-B-000 001 Vehicle Identification Number from: 16-B-000 001 ■■ Europa ■■ Europe  CTHD: Fahrgestellnummer ab: 16-EL000 001 Vehicle Identification Number from: 16-EL000 001 ■■ Malaysia ■■ Malaysia
1.4 TSI 110 kW (150 PS) CAVA, CTHA	04.2011→07.2014		7.02588.04.0	LDRV	EL	 CAVA, CTHA:  ch. 16-B-000 001→
			7.04247.02.0	SUV	EL	 CAVA, CTHA:  ch. 16-B-000 001→
			7.01830.13.0	SUV	EL	

V

























JETTA IV (162, 163, AV3, AV2) **39**





























		7.06117.54.0	SV-NWV	EL	<ul style="list-style-type: none"> CAVA: Fahrgestellnummer ab: 16-B-000 001 Vehicle Identification Number from: 16-B-000 001 CTHA: Fahrgestellnummer ab: 16-B-000 001 Vehicle Identification Number from: 16-B-000 001 Europa Europe CTHA: Fahrgestellnummer ab: 16-DN900 001 Vehicle Identification Number from: 16-DN900 001 Russland Russia
1.4 TSI 90 kW (122 PS) CAXA, CMSB	05.2011→	7.01830.13.0	SUV	EL	
		7.06117.54.0	SV-NWV	EL	<ul style="list-style-type: none"> CAXA: Fahrgestellnummer ab: 16-B-000 001 Vehicle Identification Number from: 16-B-000 001 Europa Europe CAXA: Fahrgestellnummer ab: 16-DN900 001 Vehicle Identification Number from: 16-DN900 001 Russland Russia CMSB: Fahrgestellnummer ab: 16-B-000 001 Vehicle Identification Number from: 16-B-000 001
1.4 TSI 92 kW (125 PS) CZCA	08.2014→	7.06117.48.0	SV-NWV	EL	<ul style="list-style-type: none"> CZCA: Fahrgestellnummer ab: 16-F-000 001 Vehicle Identification Number from: 16-F-000 001 Europa Europe CZCA: Fahrgestellnummer ab: 16-FN000 001 Vehicle Identification Number from: 16-FN000 001 Russland Russia
1.4 TSI 110 kW (150 PS) CZDA, CZTA	08.2014→	7.06117.48.0	SV-NWV	EL	<ul style="list-style-type: none"> CZDA: Fahrgestellnummer ab: 16-FL000 001 Vehicle Identification Number from: 16-FL000 001 Malaysia Malaysia CZDA: Fahrgestellnummer ab: 16-F-000 001 Vehicle Identification Number from: 16-F-000 001 Europa Europe CZDA: Fahrgestellnummer ab: 16-FN000 001 Vehicle Identification Number from: 16-FN000 001 Russland Russia CZTA: Fahrgestellnummer ab: 16-F-000 001 Vehicle Identification Number from: 16-F-000 001

















JETTA IV (162, 163, AV3, AV2) **39**

1.4 TSI Hybrid 110 kW (150 PS) CNLA, CRJA	04.2011→	 7.06117.48.0	SV-NWV	EL	 CNLA, CRJA: Fahrgestellnummer ab: 16-B-000 001 Vehicle Identification Number from: 16-B-000 001
1.6 77 kW (105 PS) CFNA	12.2011→	 7.06117.54.0	SV-NWV	EL	Fahrgestellnummer ab: 16-FN000 001 Vehicle Identification Number from: 16-FN000 001 # Russland # Russia
1.6 63 kW (86 PS) CFNB	03.2013→	 7.06117.54.0	SV-NWV	EL	Fahrgestellnummer ab: 16-FN000 001 Vehicle Identification Number from: 16-FN000 001 # Russland # Russia
1.6 TDI 77 kW (105 PS) CAYC	04.2010→07.2015	 7.02256.00.0	EUV-AGR	EP	
1.8 TSI 125 kW (170 PS) CPKA, CPRA	07.2014→	 7.02256.18.0	EUV-SR	EP	 CPKA, CPRA: Fahrgestellnummer ab: 16-B-000 001 Vehicle Identification Number from: 16-B-000 001 für OE-Nummer: 06H 906 283 F for OE number: 06H 906 283 F
			SUV	EL	
			ZM-NWV	EL	 CPKA, CPRA: Fahrgestellnummer ab: 16-B-000 001 Vehicle Identification Number from: 16-B-000 001
2.0 TDI 81 kW (110 PS) CLCA	10.2010→	 7.02256.00.0	EUV-AGR	EP	 ch. 16-B-000 001→
2.0 TDI 103 kW (140 PS) CFFB, CFHC, CLCB	02.2011→	 7.02256.00.0	EUV-AGR	EP	 CFFB, CFHC, CLCB:  ch. 16-B-000 001→
2.0 TDI 103-104 kW (140-141 PS) CJAA	02.2011→	 7.00868.02.0	DW-TL	EP	
2.0 TSI 147-157 kW (200-213 PS) CBFA, CCZA	12.2010→	 7.22880.01.0	EUV-SR	EL	 CBFA, CCZA: Fahrgestellnummer ab: 16-B-000 001 Vehicle Identification Number from: 16-B-000 001
			LDRV	EL	 CBFA, CCZA:  ch. 16-B-000 001→
			SUV	EL	 ch. 16-B-000 001→ für OE-Nummer: 06H 145 713 FX, 06J 145 713 F for OE number: 06H 145 713 FX, 06J 145 713 F
			ZM-NWV	EL	 CBFA, CCZA: Fahrgestellnummer ab: 16-B-000 001 Vehicle Identification Number from: 16-B-000 001 Produktionsdatum bis: 30.06.2014 Production date to: 30.06.2014
2.0 TSI 147-157 kW (200-213 PS) CCTA	12.2010→	 7.22880.01.0	EUV-SR	EL	
			LDRV	EL	 ch. 16-B-000 001→
			SUV	EL	
			SUV	EL	für OE-Nummer: 06J 145 713 K, 06J 145 713 KX, 06J 145 713 T, 06J 145 713 TX, 06J 145 722 B, 06J 145 722 BX for OE number: 06J 145 713 K, 06J 145 713 KX, 06J 145 713 T, 06J 145 713 TX, 06J 145 722 B, 06J 145 722 BX
			ZM-NWV	EL	Fahrgestellnummer ab: 16-B-000 001 Vehicle Identification Number from: 16-B-000 001 Produktionsdatum bis: 30.06.2014 Production date to: 30.06.2014



						
JETTA IV (162, 163, AV3, AV2)						39
2.0 TSI 155 kW (211 PS) CPLA, CPPA	12.2012→12.2017		7.02256.18.0	EUV-SR	EP	 CPLA, CPPA: Fahrgestellnummer ab: 16-B-000 001 Vehicle Identification Number from: 16-B-000 001 für OE-Nummer: 06H 906 283 F for OE number: 06H 906 283 F
			7.02901.05.0 7.06117.26.0	SUV ZM-NWV	EL EL	 CPLA, CPPA: Fahrgestellnummer ab: 16-B-000 001 Vehicle Identification Number from: 16-B-000 001
JETTA IV (1J5)						40
1.9 SDI 50 kW (68 PS) AQM	02.2002→		7.21903.70.0	DW-AGR	EP	 China  China
JETTA VII Saloon (BU3)						41
1.4 TSI 110 kW (150 PS) CWLA, CZDA, DGXA, DJXA	12.2017→		7.06117.48.0	SV-NWV	EL	
2.0 GLI 170 kW (231 PS) DKFA	12.2018→		7.06117.26.0	ZM-NWV	EL	
250 TSI Total Flex 110 kW (150 PS) CWLA	05.2018→		7.06117.48.0	SV-NWV	EL	
350 TSI 169 kW (230 PS) CXDB	12.2018→		7.06117.26.0	ZM-NWV	EL	
LUPO I (6X1, 6E1)						42
1.2 TDI 3L 45 kW (61 PS) ANY, AYZ	07.1999→07.2005		7.21903.70.0	DW-AGR	EP	
			7.21903.75.0	DW-TL	EP	
1.4 16V 55 kW (75 PS) AHW, AKQ	09.1998→07.2005		7.21483.54.0	EUV-AGR	EL	
1.4 FSI 77 kW (105 PS) ARR	02.2001→07.2005		7.28098.04.0	EUV-SR	EL	
1.4 TDI 55 kW (75 PS) AMF	01.1999→07.2005		7.21903.70.0	DW-AGR	EP	
			7.21895.55.0	LDRV	EL	
1.7 SDI 44 kW (60 PS) AKU	09.1998→07.2005		7.21903.75.0	DW-TL	EP	
MAGOTAN (3C) (VRC)						43
1.8 TFSI 16V	04.2007→		7.01830.13.0	SUV	EL	
2.0 TFSI 16V 147 kW (200 PS) CBL	12.2007→		7.01830.13.0	SUV	EL	
NEW BEETLE (9C1, 1C1)						44
1.6 74 kW (101 PS) AWH	10.1999→09.2000		7.22402.03.0	EUV-SR	EL	
1.6 75 kW (102 PS) AYD, BFS	06.2000→09.2010		7.22402.03.0	EUV-SR	EL	
1.8 T 110 kW (150 PS) APH, AVC	10.1999→10.2000		7.21895.55.0	EUV-SL	EL	
1.8 T 110 kW (150 PS) BKF	10.1999→09.2010		7.01037.02.0	EUV-SL	EL	
			7.01037.02.0	LDRV	EL	
1.8 T 110 kW (150 PS) AWU, AWV	06.2000→09.2010		7.21895.55.0	EUV-SL	EL	
			7.01037.02.0	EUV-SL	EL	
			7.01037.02.0	LDRV	EL	



NEW BEETLE (9C1, 1C1) **44**



1.8 T 132 kW (180 PS) AWP, BNU	11.2001→06.2005	 7.01037.02.0	EUV-SL	EL	
		7.01037.02.0	LDRV	EL	
1.9 TDI 66-67 kW (90-91 PS) ALH	01.1998→06.2004	 7.02183.01.0	DW-AGR	EP	 ch. 9C-Y-600 001→
		7.21903.70.0	DW-AGR	EP	Fahrgestellnummer bis: 1C-X-499 000 Vehicle Identification Number to: 1C-X-499 000
		7.02184.01.0	DW-TL	EP	 ch. 9C-Y-600 001→
		7.21903.75.0	DW-TL	EP	 →ch. 1C-X-499 000
		7.02256.00.0	EUV-AGR	EP	
1.9 TDI 74 kW (101 PS) ATD	06.2001→09.2010	 7.02183.01.0	DW-AGR	EP	
		7.00868.02.0	DW-TL	EP	
		7.02184.01.0	DW-TL	EP	
		7.02256.00.0	EUV-AGR	EP	
1.9 TDI 74 kW (101 PS) BEW	07.2005→12.2006	 7.00868.02.0	DW-TL	EP	 ch. 1C-9-500 001→
		7.02184.01.0	DW-TL	EP	 ch. 1C-9-500 001→
		7.02256.00.0	EUV-AGR	EP	
		7.28098.04.0	EUV-AGR	EL	für OE-Nummer: 037 906 283 D for OE number: 037 906 283 D
1.9 TDI 77 kW (105 PS) BSW	07.2005→09.2010	 7.02183.01.0	DW-AGR	EP	
		7.02184.01.0	DW-TL	EP	
		7.00868.02.0	DW-TL	EP	
2.0 85 kW (115 PS) AZJ	01.1998→09.2010	 7.22880.01.0	EUV-SR	EL	
		7.02256.00.0	EUV-AGR	EP	
		7.02256.00.0	EUV-AGR	EP	
3.2 RSI 4motion (1C9) 165 kW (224 PS) AXJ	04.2000→05.2001	 7.02256.00.0	EUV-AGK	EP	

NEW BEETLE Convertible (1Y7) **45**











1.6 75 kW (102 PS) BFS	01.2003→09.2010	 7.22402.03.0	EUV-SR	EL	
1.8 T 110 kW (150 PS) AWU, AWW	01.2003→09.2010	 7.21895.55.0	EUV-SL	EL	
		7.01037.02.0	EUV-SL	EL	
		7.01037.02.0	LDRV	EL	
1.8 T 110 kW (150 PS) BKF	01.2003→09.2010	 7.01037.02.0	EUV-SL	EL	
		7.01037.02.0	LDRV	EL	
1.9 TDI 66-67 kW (90-91 PS) ALH	09.2002→06.2004	 7.02183.01.0	DW-AGR	EP	
		7.02256.00.0	EUV-AGR	EP	
1.9 TDI 74 kW (101 PS) AXR	06.2003→09.2010	 7.02183.01.0	DW-AGR	EP	
		7.00868.02.0	DW-TL	EP	
		7.02256.00.0	EUV-AGR	EP	
1.9 TDI 74 kW (101 PS) BEW	06.2003→09.2010	 7.00868.02.0	DW-TL	EP	
		7.02256.00.0	EUV-AGR	EP	
		7.28098.04.0	EUV-AGR	EL	
1.9 TDI 77 kW (105 PS) BSW	07.2005→09.2010	 7.02183.01.0	DW-AGR	EP	



NEW BEETLE Convertible (1Y7) **45**

		7.02184.01.0	DW-TL	EP	 ch. 9C-9-550 001→
		7.00868.02.0	DW-TL	EP	
		7.02256.00.0	EUV-AGR	EP	
2.0 85 kW (115 PS) AZJ, BDC, BGD	09.2002→10.2010	 7.22880.01.0	EUV-SR	EL	 BDC, BGD: PKW, Cabriolet/ Passenger car, cabriolet

PASSAT ALLTRACK B7 (365) **46**

1.8 TSI 112 kW (152 PS) CDAB	01.2012→12.2014	 7.03280.04.0	EUV-SR	EL	Fahrgestellnummer ab: 3C-B-200 001 Vehicle Identification Number from: 3C-B-200 001	
		7.22880.01.0	EUV-SR	EL		
		7.00470.07.0	LDRV	EL		
		7.01830.13.0	SUV	EL		
		7.02256.40.0	SV-KK	EL		 ch. 3C-B-200 001→ für Fahrzeuge mit Standheizung for vehicles with parking heater
1.8 TSI 118 kW (160 PS) CDAA	01.2012→12.2014	 7.03280.04.0	EUV-SR	EL	Fahrgestellnummer ab: 3C-B-200 001 Vehicle Identification Number from: 3C-B-200 001	
		7.22880.01.0	EUV-SR	EL		
		7.00470.07.0	LDRV	EL		
		7.01830.13.0	SUV	EL		
		7.02256.40.0	SV-KK	EL		 ch. 3C-B-200 001→ für Fahrzeuge mit Standheizung for vehicles with parking heater
2.0 TDI 103 kW (140 PS) CFFB	01.2012→12.2014	 7.00868.02.0	DW-TL	EP		
2.0 TDI 4motion 103 kW (140 PS) CFFB	01.2012→12.2014	 7.00868.02.0	DW-TL	EP		
2.0 TDI 4motion 125 kW (170 PS) CFGB	01.2012→12.2014	 7.00868.02.0	DW-TL	EP		
2.0 TDI 4motion 130 kW (177 PS) CFGC	01.2013→12.2014	 7.00868.02.0	DW-TL	EP		
2.0 TSI 4motion 155 kW (211 PS) CCZB	01.2012→12.2014	 7.03280.04.0	EUV-SR	EL	Fahrgestellnummer ab: 3C-B-200 001 Vehicle Identification Number from: 3C-B-200 001	
		7.22880.01.0	EUV-SR	EL		Fahrgestellnummer ab: 3C-B-200 001 Vehicle Identification Number from: 3C-B-200 001
		7.00470.07.0	LDRV	EL		
		7.02901.05.0	SUV	EL		
		7.01830.13.0	SUV	EL		 ch. 3C-B-200 001→ für Fahrzeuge mit Standheizung for vehicles with parking heater
7.02256.40.0	SV-KK	EL				
		7.06117.26.0	ZM-NWV	EL	Fahrgestellnummer ab: 3C-B-200 001 Vehicle Identification Number from: 3C-B-200 001	



PASSAT ALLTRACK B8 Variant (3G5, CB5)						47
1.4 TSI 4motion 110 kW (150 PS) CZEA	05.2015→		7.06117.48.0	SV-NWV	EL Fahrgestellnummer ab: 3C-F-200 001 Vehicle Identification Number from: 3C-F-200 001	
2.0 TSI 4motion 162 kW (220 PS) CHHB	07.2015→		7.02256.18.0	EUV-SR	EP Fahrgestellnummer ab: 3C-F-200 001 Vehicle Identification Number from: 3C-F-200 001 für OE-Nummer: 06H 906 283 F for OE number: 06H 906 283 F	
			7.06117.26.0	ZM-NWV	EL Fahrgestellnummer ab: 3C-F-200 001 Vehicle Identification Number from: 3C-F-200 001	
2.0 TSI 4motion 200 kW (272 PS) DNUA	08.2018→		7.02256.18.0	EUV-SR	EP Fahrgestellnummer ab: 3C-F-200 001 Vehicle Identification Number from: 3C-F-200 001 für OE-Nummer: 06H 906 283 F for OE number: 06H 906 283 F	
			7.06117.26.0	ZM-NWV	EL	
PASSAT B2 (32B)						48
1.3 44 kW (60 PS) EP	08.1980→07.1986		7.01805.01.0	EUV-LS	EL	
PASSAT B2 Saloon (32B)						49
1.6 55 kW (75 PS) JU	08.1984→07.1986		7.01805.01.0	EUV-LS	EL	
PASSAT B2 Variant (33B)						50
1.3 44 kW (60 PS) EP	08.1980→07.1986		7.01805.01.0	EUV-LS	EL	
1.6 55 kW (75 PS) JU	08.1983→07.1986		7.01805.01.0	EUV-LS	EL	
PASSAT B3/B4 (3A2, 35I)						51
1.6 55 kW (75 PS) 1F	08.1988→07.1990		7.01805.01.0	EUV-LS	EL	
1.6 74 kW (101 PS) AEK	10.1994→12.1995		7.21483.54.0	EUV-AGR	EL ☛ Mexico ☛ Mexico	
			7.21483.54.0	EUV-AGR	EL ☛ Mexico ☛ Mexico	
1.6 74 kW (101 PS) AFT	12.1995→08.1996		7.22402.03.0	EUV-SR	EL	
			7.01805.01.0	EUV-LS	EL	
1.8 65-66 kW (88-90 PS) RP	02.1988→07.1991		7.01805.01.0	EUV-LS	EL	
1.9 TDI 66-67 kW (90-91 PS) 1Z, AHU	10.1993→08.1996		7.21903.70.0	DW-AGR	EP	
			7.21903.70.0	DW-TL	EP für OE-Nummer: 1H0 906 627 for OE number: 1H0 906 627	
			7.21895.55.0	LDRV	EL Fahrgestellnummer ab: 3B-V-000 001 Vehicle Identification Number from: 3B-V-000 001	
1.9 TDI 81 kW (110 PS) AFN	03.1996→08.1996		7.21903.70.0	DW-AGR	EP	
			7.21903.70.0	DW-TL	EP für OE-Nummer: 1H0 906 627 for OE number: 1H0 906 627	
			7.21903.75.0	DW-TL	EP	
2.8 VR6 120-128 kW (163-174 PS) AAA	06.1991→08.1996		7.21483.54.0	EUV-AGR	EL ☛ Mexico ☛ Mexico	
PASSAT B3/B4 Variant (3A5, 35I)						52
1.6 55 kW (75 PS) 1F	04.1988→07.1991		7.01805.01.0	EUV-LS	EL	
1.6 74 kW (101 PS) AEK	07.1994→12.1995		7.21483.54.0	EUV-AGR	EL ☛ Mexico ☛ Mexico	
			7.21483.54.0	EUV-AGR	EL ☛ Mexico ☛ Mexico	



















PASSAT B3/B4 Variant (3A5, 35I)

52

			7.22402.03.0	EUV-SR	EL	
1.8 65-66 kW (88-90 PS) RP	02.1988→07.1991		7.01805.01.0	EUV-LS	EL	
1.9 TDI 66-67 kW (90-91 PS) 1Z, AHU	10.1993→05.1997		7.21903.70.0	DW-AGR	EP	
			7.21903.70.0	DW-TL	EP	für OE-Nummer: 1H0 906 627 for OE number: 1H0 906 627
			7.21895.55.0	LDRV	EL	Fahrgestellnummer ab: 3B-V-000 001 Vehicle Identification Number from: 3B-V-000 001
1.9 TDI 81 kW (110 PS) AFN	03.1996→05.1997		7.21903.70.0	DW-AGR	EP	
			7.21903.70.0	DW-TL	EP	für OE-Nummer: 1H0 906 627 for OE number: 1H0 906 627
			7.21903.75.0	DW-TL	EP	
2.8 VR6 120-128 kW (163-174 PS) AAA	06.1991→05.1997		7.21483.54.0	EUV-AGR	EL	 Mexico  Mexico
2.9 VR6 Syncro 135-140 kW (184-190 PS) ABV	01.1994→05.1997		7.21483.54.0	EUV-AGR	EL	Fahrgestellnummer bis: 3A-V-015 000 Vehicle Identification Number to: 3A-V-015 000

PASSAT B5 (3B2)



















53

1.6 74 kW (101 PS) AHL, ANA, ARM	10.1996→11.2000		7.22402.03.0	EUV-SR	EL	 AHL, ANA, ARM: Fahrgestellnummer ab: 3B-V-000 001 Vehicle Identification Number from: 3B-V-000 001
1.8 92 kW (125 PS) ADR	10.1996→11.2000		7.01805.01.0	EUV-SR	EL	
			7.22402.03.0	EUV-SR	EL	
1.8 92 kW (125 PS) APT, ARG	01.1999→11.2000		7.22402.03.0	EUV-SR	EL	
1.8 Syncro/4motion 92 kW (125 PS) ADR	12.1996→08.2000		7.01805.01.0	EUV-SR	EL	
			7.22402.03.0	EUV-SR	EL	
1.8 Syncro/4motion 92 kW (125 PS) APT, ARG	01.1999→08.2000		7.22402.03.0	EUV-SR	EL	
1.8 T 110 kW (150 PS) ANB, APU	01.1999→11.2000		7.01805.01.0	EUV-LS	EL	
1.9 TDI 66 kW (90 PS) AHH	10.1996→11.2000		7.21903.75.0	DW-TL	EP	 ch. 3B-V-000 001→
			7.21903.70.0	DW-AGR	EP	
			7.21903.70.0	DW-TL	EP	für OE-Nummer: 1H0 906 627 for OE number: 1H0 906 627
1.9 TDI 66-67 kW (90-91 PS) AHU	10.1996→11.2000		7.21903.70.0	DW-AGR	EP	
			7.21903.70.0	DW-TL	EP	für OE-Nummer: 1H0 906 627 for OE number: 1H0 906 627
			7.21895.55.0	LDRV	EL	Fahrgestellnummer ab: 3B-V-000 001 Vehicle Identification Number from: 3B-V-000 001
1.9 TDI 81 kW (110 PS) AFN, AVG	10.1996→11.2000		7.21903.75.0	DW-TL	EP	 ch. 3B-V-000 001→
			7.21903.70.0	DW-AGR	EP	
			7.21903.70.0	DW-TL	EP	 AFN, AVG: für OE-Nummer: 1H0 906 627 for OE number: 1H0 906 627
1.9 TDI 85 kW (115 PS) AJM, ATJ	08.1998→11.2000		7.21903.75.0	DW-TL	EP	 AJM, ATJ:  ch. 3B-V-000 001→
			7.21903.70.0	DW-AGR	EP	

V









PASSAT B5 (3B2) **53**

		 PIERBURG		
		7.21903.70.0	DW-TL	EP  AJM, ATJ: für OE-Nummer: 1H0 906 627 for OE number: 1H0 906 627
1.9 TDI 74 kW (101 PS) AVB	02.2000→11.2000	 7.21903.75.0	DW-TL	EP  ch. 3B-V-000 001→
		7.02184.01.0	DW-TL	EP
		7.21903.70.0	DW-TL	EP für OE-Nummer: 1H0 906 627 for OE number: 1H0 906 627
1.9 TDI 4motion 85 kW (115 PS) ATJ	01.2000→11.2000	 7.21903.75.0	DW-TL	EP  ch. 3B-V-000 001→
		7.21903.70.0	DW-AGR	EP
		7.21903.70.0	DW-TL	EP für OE-Nummer: 1H0 906 627 for OE number: 1H0 906 627
1.9 TDI Syncro/4motion 81 kW (110 PS) AFN, AVG	06.1997→08.2000	 7.21903.75.0	DW-TL	EP  ch. 3B-V-000 001→
		7.21903.70.0	DW-AGR	EP
		7.21903.70.0	DW-TL	EP  AFN, AVG: für OE-Nummer: 1H0 906 627 for OE number: 1H0 906 627
2.5 TDI 110 kW (150 PS) AFB, AKN	07.1998→11.2000	 7.00868.02.0	DW-TL	EP
2.5 TDI Syncro/4motion 110 kW (150 PS) AFB, AKN	12.1998→11.2000	 7.00868.02.0	DW-TL	EP
2.8 V6 142 kW (193 PS) ACK, APR, AQD	08.1996→11.2000	 7.01805.01.0	EUV-SR	EL
2.8 V6 132 kW (180 PS) AGE	05.1997→09.1999	 7.01805.01.0	EUV-SR	EL
2.8 V6 140 kW (190 PS) ATX, BBG	09.1999→11.2000	 7.01805.01.0	EUV-SR	EL
2.8 V6 4motion 140 kW (190 PS) ATX	09.1999→11.2000	 7.01805.01.0	EUV-SR	EL
2.8 V6 Syncro/4motion 142 kW (193 PS) ACK, APR, AQD	10.1996→11.2000	 7.01805.01.0	EUV-SR	EL

PASSAT B5 GP (3BG) **54**

2.5 TDI 110 kW (150 PS) AKN	10.2000→05.2003	 7.00868.02.0	DW-TL	EP
---------------------------------------	-----------------	---	-------	----



















PASSAT B5 Variant (3B5) **55**

1.6 74 kW (101 PS) AHL, ANA, ARM	06.1997→11.2000	 7.22402.03.0	EUV-SR	EL  AHL, ANA, ARM: Fahrgestellnummer ab: 3B-V-000 001 Vehicle Identification Number from: 3B-V-000 001
1.8 92 kW (125 PS) ADR	06.1997→11.2000	 7.01805.01.0	EUV-SR	EL
		7.22402.03.0	EUV-SR	EL
1.8 92 kW (125 PS) APT, ARG	01.1999→11.2000	 7.22402.03.0	EUV-SR	EL
1.8 Syncro/4motion 92 kW (125 PS) ADR	06.1997→11.2000	 7.01805.01.0	EUV-SR	EL
		7.22402.03.0	EUV-SR	EL
1.8 Syncro/4motion 92 kW (125 PS) APT, ARG	01.1999→11.2000	 7.22402.03.0	EUV-SR	EL
1.8 T 110 kW (150 PS) ANB, APU	05.1997→11.2000	 7.01805.01.0	EUV-LS	EL

V





PASSAT B5 Variant (3B5) **55**

1.9 TDI 66 kW (90 PS) AHH	06.1997→11.2000	 7.21903.75.0	DW-TL	EP	 ch. 3B-V-000 001→ für OE-Nummer: 1H0 906 627 für OE number: 1H0 906 627
		7.21903.70.0	DW-AGR	EP	
		7.21903.70.0	DW-TL	EP	
1.9 TDI 66-67 kW (90-91 PS) AHU	06.1997→11.2000	 7.21903.70.0	DW-AGR	EP	für OE-Nummer: 1H0 906 627 für OE number: 1H0 906 627 Fahrgestellnummer ab: 3B-V-000 001 Vehicle Identification Number from: 3B-V-000 001
		7.21903.70.0	DW-TL	EP	
		7.21895.55.0	LDRV	EL	
1.9 TDI 81 kW (110 PS) AFN, AVG	06.1997→11.2000	 7.21903.75.0	DW-TL	EP	 ch. 3B-V-000 001→ AFN, AVG: für OE-Nummer: 1H0 906 627 für OE number: 1H0 906 627
		7.21903.70.0	DW-AGR	EP	
		7.21903.70.0	DW-TL	EP	
1.9 TDI 85 kW (115 PS) AJM, ATJ	08.1998→11.2000	 7.21903.75.0	DW-TL	EP	 ch. 3B-V-000 001→ AJM, ATJ: für OE-Nummer: 1H0 906 627 für OE number: 1H0 906 627
		7.21903.70.0	DW-AGR	EP	
		7.21903.70.0	DW-TL	EP	
1.9 TDI 74 kW (101 PS) AVB	02.2000→11.2000	 7.21903.75.0	DW-TL	EP	 ch. 3B-V-000 001→ für OE-Nummer: 1H0 906 627 für OE number: 1H0 906 627
		7.02184.01.0	DW-TL	EP	
		7.21903.70.0	DW-TL	EP	
1.9 TDI 4motion 85 kW (115 PS) AJM	08.1999→11.2000	 7.21903.70.0	DW-AGR	EP	für OE-Nummer: 1H0 906 627 für OE number: 1H0 906 627
		7.21903.70.0	DW-TL	EP	
1.9 TDI 4motion 85 kW (115 PS) ATJ	08.1999→11.2000	 7.21903.75.0	DW-TL	EP	 ch. 3B-V-000 001→ für OE-Nummer: 1H0 906 627 für OE number: 1H0 906 627
		7.21903.70.0	DW-AGR	EP	
		7.21903.70.0	DW-TL	EP	
1.9 TDI Syncro/4motion 81 kW (110 PS) AFN, AVG	06.1997→08.2000	 7.21903.75.0	DW-TL	EP	 ch. 3B-V-000 001→ AFN, AVG: für OE-Nummer: 1H0 906 627 für OE number: 1H0 906 627
		7.21903.70.0	DW-AGR	EP	
		7.21903.70.0	DW-TL	EP	
2.5 TDI 110 kW (150 PS) AFB, AKN	07.1998→11.2000	 7.00868.02.0	DW-TL	EP	
2.5 TDI Syncro/4motion 110 kW (150 PS) AFB, AKN	12.1998→11.2000	 7.00868.02.0	DW-TL	EP	
2.8 Syncro 132 kW (180 PS) AGE	05.1997→09.1999	 7.01805.01.0	EUV-SR	EL	
2.8 V6 142 kW (193 PS) ACK, APR, AQD	06.1997→11.2000	 7.01805.01.0	EUV-SR	EL	
2.8 V6 132 kW (180 PS) AGE	09.1997→09.1999	 7.01805.01.0	EUV-SR	EL	
2.8 V6 140 kW (190 PS) ATX	09.1999→11.2000	 7.01805.01.0	EUV-SR	EL	























PASSAT B5 Variant (3B5) 55

2.8 V6 4motion 140 kW (190 PS) ATX	09.1999→11.2000	 7.01805.01.0	EUV-SR	EL	
2.8 V6 Syncro/4motion 142 kW (193 PS) ACK, APR, AQD	06.1997→11.2000	 7.01805.01.0	EUV-SR	EL	







PASSAT B5.5 (3B3) 56

1.6 75 kW (102 PS) ALZ	11.2000→05.2005	 7.10014.00.0 7.22880.01.0	AKF	EL	
1.8 T 125 kW (170 PS) AWM	02.2001→11.2005	 7.01805.01.0	EUV-SR	EL	
1.8 T 20V 110 kW (150 PS) AWT	11.2000→05.2005	 7.01805.01.0	EUV-LS	EL	
1.8 T 4motion 125 kW (170 PS) AWM	11.2003→05.2005	 7.01805.01.0	EUV-SR	EL	
1.9 TDI 74 kW (101 PS) AVB	11.2000→05.2005	 7.02183.01.0 7.21903.75.0 7.02184.01.0 7.21903.70.0	DW-AGR	EP	 ch. 3B-V-000 001→ für OE-Nummer: 1H0 906 627 for OE number: 1H0 906 627
1.9 TDI 96 kW (130 PS) AVF, AWX	11.2000→05.2005	 7.02183.01.0 7.21903.70.0 7.02184.01.0	DW-AGR	EP	
1.9 TDI 4motion 96 kW (130 PS) AVF	11.2000→05.2005	 7.02183.01.0 7.21903.70.0 7.02184.01.0	DW-AGR	EP	
2.0 85 kW (116 PS) AZM	11.2000→05.2005	 7.22880.01.0	EUV-SR	EL	
2.0 96 kW (130 PS) ALT	11.2001→05.2005	 7.10014.00.0 7.22880.01.0	AKF	EL	
2.0 4motion 85 kW (116 PS) AZM	11.2000→05.2005	 7.22880.01.0	EUV-SR	EL	
2.0 TDI 100 kW (136 PS) BGW	12.2003→05.2005	 7.02183.01.0 7.02184.01.0	DW-AGR	EP	
2.0 TDI 100 kW (136 PS) BHW	12.2003→05.2005	 7.02184.01.0	DW-TL	EP	
2.3 V5 125 kW (170 PS) AZX	11.2000→05.2005	 7.06117.44.0	SV-NWV	EL	mit Dichtring with O-ring Einlassseite Intake Side
2.3 V5 4motion 125 kW (170 PS) AZX	11.2000→05.2005	 7.06117.44.0	SV-NWV	EL	mit Dichtring with O-ring Einlassseite Intake Side
2.5 TDI 110 kW (150 PS) AKN	11.2000→05.2005	 7.22903.34.0 7.00868.02.0	DW-AGR	EP	Fahrgestellnummer ab: 3B-2-000 001 Vehicle Identification Number from: 3B-2-000 001
2.5 TDI 120 kW (163 PS) BDG	05.2003→05.2005	 7.22903.34.0 7.00868.02.0	DW-AGR	EP	
2.5 TDI 4motion 110 kW (150 PS) AFB	11.2000→05.2005	 7.00868.02.0	DW-TL	EP	

















V



PASSAT B5.5 (3B3) 56

2.5 TDI 4motion 110 kW (150 PS) AKN	11.2000→05.2005		7.22903.34.0	DW-AGR	EP	Fahrgestellnummer ab: 3B-2-000 001 Vehicle Identification Number from: 3B-2-000 001
			7.00868.02.0	DW-TL	EP	
2.5 TDI 4motion 132 kW (180 PS) BAU, BDH	01.2003→05.2005		7.22903.34.0	DW-AGR	EP	
			7.00868.02.0	DW-TL	EP	
2.8 140 kW (190 PS) BBG	10.2000→05.2005		7.01805.01.0	EUV-SR	EL	
2.8 142 kW (193 PS) AMX, ATQ	05.2002→05.2003		7.01805.01.0	EUV-SR	EL	
2.8 4motion 140 kW (190 PS) BBG	10.2000→05.2005		7.01805.01.0	EUV-SR	EL	
2.8 4motion 142 kW (193 PS) AMX, ATQ	11.2000→05.2005		7.01805.01.0	EUV-SR	EL	
4.0 W8 4motion 202 kW (275 PS) BDN, BDP	09.2001→09.2004		7.22880.01.0	EUV-ML	EL	











PASSAT B5.5 Variant (3B6) 57

1.6 75 kW (102 PS) ALZ	11.2000→05.2005		7.10014.00.0	AKF	EL	
			7.22880.01.0	EUV-SR	EL	
1.8 4motion 125 kW (170 PS) AWM	11.2003→05.2005		7.01805.01.0	EUV-SR	EL	
1.8 T 125 kW (170 PS) AWM	05.2002→08.2005		7.01805.01.0	EUV-SR	EL	
1.8 T 20V 110 kW (150 PS) AWT	11.2000→05.2005		7.01805.01.0	EUV-LS	EL	 Mexico  Mexico
1.9 TDI 74 kW (101 PS) AVB	11.2000→05.2005		7.02183.01.0	DW-AGR	EP	für OE-Nummer: 1J0 906 627, 1K0 906 627 D for OE number: 1J0 906 627, 1K0 906 627 D
			7.21903.75.0	DW-TL	EP	 ch. 3B-V-000 001→
			7.02184.01.0	DW-TL	EP	
			7.21903.70.0	DW-TL	EP	für OE-Nummer: 1H0 906 627 for OE number: 1H0 906 627
1.9 TDI 96 kW (130 PS) AVF, AWX	11.2000→05.2005		7.02183.01.0	DW-AGR	EP	
			7.21903.70.0	DW-AGR	EP	
			7.02184.01.0	DW-TL	EP	
1.9 TDI 4motion 96 kW (130 PS) AVF	11.2000→05.2005		7.02183.01.0	DW-AGR	EP	
			7.21903.70.0	DW-AGR	EP	
			7.02184.01.0	DW-TL	EP	
2.0 85 kW (116 PS) AZM	11.2000→05.2005		7.22880.01.0	EUV-SR	EL	
2.0 96 kW (130 PS) ALT	11.2001→05.2005		7.10014.00.0	AKF	EL	
			7.22880.01.0	EUV-SR	EL	
2.0 4motion 85 kW (116 PS) AZM	11.2000→05.2005		7.22880.01.0	EUV-SR	EL	
2.0 TDI 100 kW (136 PS) BGW	12.2003→05.2005		7.02183.01.0	DW-AGR	EP	
			7.02184.01.0	DW-TL	EP	
2.0 TDI 100 kW (136 PS) BHW	12.2003→05.2005		7.02184.01.0	DW-TL	EP	
2.3 VR5 125 kW (170 PS) AZX	11.2000→05.2005		7.06117.44.0	SV-NWV	EL	mit Dichtring with O-ring Einlassseite Intake Side











PASSAT B5.5 Variant (3B6) 57















2.3 VR5 4motion 125 kW (170 PS) AZX	11.2000→05.2005	 7.06117.44.0	SV-NWV	EL	mit Dichtring with O-ring Einlassseite Intake Side
2.5 TDI 110 kW (150 PS) AKN	11.2000→05.2005	 7.22903.34.0	DW-AGR	EP	Fahrgestellnummer ab: 3B-2-000 001 Vehicle Identification Number from: 3B-2-000 001
		7.00868.02.0	DW-TL	EP	
2.5 TDI 120 kW (163 PS) BDG	05.2003→05.2005	 7.22903.34.0	DW-AGR	EP	
		7.00868.02.0	DW-TL	EP	
2.5 TDI 4motion 110 kW (150 PS) AKN	11.2000→05.2005	 7.22903.34.0	DW-AGR	EP	Fahrgestellnummer ab: 3B-2-000 001 Vehicle Identification Number from: 3B-2-000 001
		7.00868.02.0	DW-TL	EP	
2.5 TDI 4motion 132 kW (180 PS) BAU, BDH	01.2003→05.2005	 7.22903.34.0	DW-AGR	EP	
		7.00868.02.0	DW-TL	EP	
2.8 142 kW (193 PS) ATQ	10.2000→08.2005	 7.01805.01.0	EUV-SR	EL	
2.8 140 kW (190 PS) BBG	10.2000→05.2005	 7.01805.01.0	EUV-SR	EL	
2.8 4motion 140 kW (190 PS) BBG	10.2000→05.2005	 7.01805.01.0	EUV-SR	EL	
2.8 4motion 142 kW (193 PS) AMX, ATQ	11.2000→05.2005	 7.01805.01.0	EUV-SR	EL	
4.0 W8 4motion 202 kW (275 PS) BDN, BDP	09.2001→09.2004	 7.22880.01.0	EUV-ML	EL	

PASSAT B6 (3C2) 58

1.4 TSI 90 kW (122 PS) CAXA	05.2007→07.2010	 7.01830.13.0	SUV	EL	für Fahrzeuge mit Standheizung for vehicles with parking heater
		7.02901.05.0	SUV	EL	
		7.02256.40.0	SV-KK	EL	
		7.06117.54.0	SV-NWV	EL	
1.4 TSI EcoFuel 110 kW (150 PS) CDGA	01.2009→07.2010	 7.02588.04.0	LDRV	EL	für Fahrzeuge mit Standheizung for vehicles with parking heater
		7.04247.02.0	SUV	EL	
		7.02256.40.0	SV-KK	EL	
1.6 75 kW (102 PS) BSE, BSF	05.2005→07.2010	 7.10014.00.0	AKF	EL	BSE, BSF: für Fahrzeuge mit Standheizung for vehicles with parking heater
		7.22880.01.0	EUV-SR	EL	
		7.02256.40.0	SV-KK	EL	
1.6 FSI 85 kW (115 PS) BLF	03.2005→06.2008	 7.10014.00.0	AKF	EL	für Fahrzeuge mit Standheizung for vehicles with parking heater
		7.22880.01.0	EUV-SR	EL	
		7.02256.40.0	SV-KK	EL	
1.6 TDI 77 kW (105 PS) CAYC	08.2009→07.2010	 7.02256.00.0	EUV-AGR	EP	für Fahrzeuge mit Standheizung for vehicles with parking heater
		7.02256.40.0	SV-KK	EL	
1.8 TSI 118 kW (160 PS) BZB	05.2007→07.2010	 7.03280.04.0	EUV-SR	EL	



















PASSAT B6 (3C2) 58

			7.00415.07.0	SUV	EL	2008 2008
			7.01830.13.0	SUV	EL	
			7.02256.40.0	SV-KK	EL	für Fahrzeuge mit Standheizung for vehicles with parking heater
			7.06117.26.0	ZM-NWV	EL	
1.8 TSI 118 kW (160 PS) CDA A	05.2007→07.2010		7.03280.04.0	EUV-SR	EL	
			7.00470.07.0	LDRV	EL	
			7.01830.13.0	SUV	EL	
			7.02256.40.0	SV-KK	EL	für Fahrzeuge mit Standheizung for vehicles with parking heater
			7.06117.26.0	ZM-NWV	EL	
1.8 TSI 112 kW (152 PS) CDAB	11.2009→07.2010		7.03280.04.0	EUV-SR	EL	
			7.00470.07.0	LDRV	EL	
			7.01830.13.0	SUV	EL	
			7.06117.26.0	ZM-NWV	EL	
1.8 TSI 112 kW (152 PS) CGYA	11.2009→07.2010		7.03280.04.0	EUV-SR	EL	
			7.22880.01.0	EUV-SR	EL	 →ch. 3C-B-050 000
			7.00470.07.0	LDRV	EL	
			7.01830.13.0	SUV	EL	
			7.02256.40.0	SV-KK	EL	für Fahrzeuge mit Standheizung for vehicles with parking heater
			7.06117.26.0	ZM-NWV	EL	
1.9 TDI 77 kW (105 PS) BKC, BXE	03.2005→07.2010		7.02256.40.0	SV-KK	EL	 BKC, BXE: für Fahrzeuge mit Standheizung for vehicles with parking heater
1.9 TDI 77 kW (105 PS) BLS	03.2005→07.2010		7.00868.02.0	DW-TL	EP	
			7.02256.00.0	EUV-AGR	EP	
			7.02256.40.0	SV-KK	EL	für Fahrzeuge mit Standheizung for vehicles with parking heater
2.0 BlueTDI 105 kW (143 PS) CBAC	01.2009→11.2010		7.00868.02.0	DW-TL	EP	
			7.02256.00.0	EUV-AGR	EP	
			7.02256.40.0	SV-KK	EL	für Fahrzeuge mit Standheizung for vehicles with parking heater
2.0 FSI 110 kW (150 PS) BLR, BLY, BVY, BVZ	03.2005→07.2010		7.22880.01.0	EUV-SR	EL	
			7.02256.40.0	SV-KK	EL	 BLR, BLY, BVY, BVZ: für Fahrzeuge mit Standheizung for vehicles with parking heater
			7.06117.37.0	SV-NWV	EL	
2.0 FSI 147 kW (200 PS) AXX	07.2005→07.2010		7.00470.07.0	LDRV	EL	
			7.01830.13.0	SUV	EL	
			7.06117.46.0	SV-NWV	EH	mit Dichtring with O-ring
2.0 FSI 147 kW (200 PS) BPY, BWA	07.2005→07.2010		7.00470.07.0	LDRV	EL	
			7.01830.13.0	SUV	EL	
			7.02256.40.0	SV-KK	EL	 BPY, BWA: für Fahrzeuge mit Standheizung for vehicles with parking heater
			7.06117.46.0	SV-NWV	EH	mit Dichtring with O-ring
2.0 FSI 147-157 kW (200-213 PS) CAWB, CCTA	07.2005→07.2010		7.03280.04.0	EUV-SR	EL	 CAWB, CCTA: Baujahr ab: 01.2008 Construction year from: 01.2008





PASSAT B6 (3C2) **58**

			<p>7.22880.01.0 EUV-SR EL</p> <p>7.00470.07.0 LDRV EL</p> <p>7.02901.05.0 SUV EL</p>	<p>EL  CAWB, CCTA: →ch. 3C-B-050 000</p> <p>EL  CAWB: für OE-Nummer: 06J 145 713 K, 06J 145 713 KX, 06J 145 713 T, 06J 145 713 TX, 06J 145 722 B, 06J 145 722 BX for OE number: 06J 145 713 K, 06J 145 713 KX, 06J 145 713 T, 06J 145 713 TX, 06J 145 722 B, 06J 145 722 BX</p> <p>EL  CCTA:  ch. 3C-C-700 001→ für OE-Nummer: 06J 145 713 K, 06J 145 713 KX, 06J 145 713 T, 06J 145 713 TX, 06J 145 722 B, 06J 145 722 BX for OE number: 06J 145 713 K, 06J 145 713 KX, 06J 145 713 T, 06J 145 713 TX, 06J 145 722 B, 06J 145 722 BX</p> <p>EL  CAWB, CCTA: für Fahrzeuge mit Standheizung for vehicles with parking heater</p>
2.0 FSI 147-157 kW (200-213 PS) CBFA	07.2005→07.2010		<p>7.22880.01.0 EUV-SR EL</p> <p>7.00470.07.0 LDRV EL</p> <p>7.02901.05.0 SUV EL</p>	<p>EL PKW, Coupe/ Passenger car, coupé</p> <p>EL  →ch. 3C-B-050 000</p> <p>EL  ch. 3C-C-700 001→ für OE-Nummer: 06J 145 713 K, 06J 145 713 KX, 06J 145 713 T, 06J 145 713 TX, 06J 145 722 B, 06J 145 722 BX for OE number: 06J 145 713 K, 06J 145 713 KX, 06J 145 713 T, 06J 145 713 TX, 06J 145 722 B, 06J 145 722 BX</p>
2.0 FSI 147 kW (200 PS) CCZA	07.2005→07.2010		<p>7.03280.04.0 EUV-SR EL</p> <p>7.22880.01.0 EUV-SR EL</p> <p>7.00470.07.0 LDRV EL</p> <p>7.02256.40.0 SV-KK EL</p> <p>7.06117.26.0 ZM-NWV EL</p>	<p>EL Baujahr ab: 01.2008 Construction year from: 01.2008</p> <p>EL  →ch. 3C-B-050 000</p> <p>EL für Fahrzeuge mit Standheizung for vehicles with parking heater</p>
2.0 FSI 125 kW (170 PS) CCTB	08.2007→07.2010		<p>7.03280.04.0 EUV-SR EL</p> <p>7.22880.01.0 EUV-SR EL</p> <p>7.00470.07.0 LDRV EL</p> <p>7.01830.13.0 SUV EL</p> <p>7.02901.05.0 SUV EL</p> <p>7.02256.40.0 SV-KK EL</p> <p>7.06117.26.0 ZM-NWV EL</p>	<p>EL  →ch. 3C-B-050 000</p> <p>EL für Fahrzeuge mit Standheizung for vehicles with parking heater</p>
2.0 FSI 4motion 110 kW (150 PS) BLX, BLY, BVX	09.2005→07.2010		<p>7.22880.01.0 EUV-SR EL</p> <p>7.02256.40.0 SV-KK EL</p> <p>7.06117.37.0 SV-NWV EL</p>	<p>EL  BLX, BLY, BVX: für Fahrzeuge mit Standheizung for vehicles with parking heater</p>
2.0 TDI 103 kW (140 PS) BMP	03.2005→05.2009		<p>7.00868.02.0 DW-TL EP</p> <p>7.02256.00.0 EUV-AGR EP</p> <p>7.02256.40.0 SV-KK EL</p>	<p>EL für Fahrzeuge mit Standheizung for vehicles with parking heater</p>
2.0 TDI 100 kW (136 PS) BMA	03.2005→11.2010		<p>7.00868.02.0 DW-TL EP</p> <p>7.02256.00.0 EUV-AGR EP</p>	

V



















PASSAT B6 (3C2) **58**

			7.28098.04.0	EUV-AGR	EL	Fahrgestellnummer ab: 3C-7-000 001 Vehicle Identification Number from: 3C-7-000 001
			7.02256.40.0	SV-KK	EL	für Fahrzeuge mit Standheizung for vehicles with parking heater
2.0 TDI 100 kW (136 PS) CBAA	03.2005→11.2010		7.00868.02.0	DW-TL	EP	
			7.02256.00.0	EUV-AGR	EP	
			7.02256.40.0	SV-KK	EL	für Fahrzeuge mit Standheizung for vehicles with parking heater
2.0 TDI 125 kW (170 PS) BMR, CBBB	08.2005→07.2010		7.00868.02.0	DW-TL	EP	
			7.02256.00.0	EUV-AGR	EP	
			7.02256.40.0	SV-KK	EL	 BMR, CBBB: für Fahrzeuge mit Standheizung for vehicles with parking heater
2.0 TDI 90 kW (122 PS) BVE	08.2005→07.2006		7.00868.02.0	DW-TL	EP	
			7.02256.00.0	EUV-AGR	EP	 ch. 3C-7-000 001→
			7.28098.04.0	EUV-AGR	EL	Fahrgestellnummer ab: 3C-7-000 001 Vehicle Identification Number from: 3C-7-000 001
			7.02256.40.0	SV-KK	EL	für Fahrzeuge mit Standheizung for vehicles with parking heater
2.0 TDI 120 kW (163 PS) BUZ	08.2005→05.2009		7.00868.02.0	DW-TL	EP	
			7.02256.00.0	EUV-AGR	EP	
			7.02256.40.0	SV-KK	EL	für Fahrzeuge mit Standheizung for vehicles with parking heater
2.0 TDI 88 kW (120 PS) BWV	11.2005→05.2007		7.00868.02.0	DW-TL	EP	
			7.02256.00.0	EUV-AGR	EP	 ch. 3C-7-000 001→
			7.28098.04.0	EUV-AGR	EL	Fahrgestellnummer ab: 3C-7-000 001 Vehicle Identification Number from: 3C-7-000 001
			7.02256.40.0	SV-KK	EL	für Fahrzeuge mit Standheizung for vehicles with parking heater
2.0 TDI 81 kW (110 PS) CBDC	11.2008→07.2010		7.00868.02.0	DW-TL	EP	
			7.02256.00.0	EUV-AGR	EP	
			7.02256.40.0	SV-KK	EL	für Fahrzeuge mit Standheizung for vehicles with parking heater
2.0 TDI 16V 103 kW (140 PS) BKP	03.2005→07.2010		7.00868.02.0	DW-TL	EP	
			7.02256.00.0	EUV-AGR	EP	 ch. 3C-7-000 001→
			7.28098.04.0	EUV-AGR	EL	Fahrgestellnummer ab: 3C-7-000 001 Vehicle Identification Number from: 3C-7-000 001
			7.02256.40.0	SV-KK	EL	für Fahrzeuge mit Standheizung for vehicles with parking heater
2.0 TDI 16V 103 kW (140 PS) CBAB	03.2005→07.2010		7.00868.02.0	DW-TL	EP	
			7.02256.00.0	EUV-AGR	EP	
			7.02256.40.0	SV-KK	EL	für Fahrzeuge mit Standheizung for vehicles with parking heater
2.0 TDI 16V 4motion 103 kW (140 PS) BKP	03.2005→08.2010		7.00868.02.0	DW-TL	EP	
			7.02256.00.0	EUV-AGR	EP	 ch. 3C-7-000 001→
			7.28098.04.0	EUV-AGR	EL	Fahrgestellnummer ab: 3C-7-000 001 Vehicle Identification Number from: 3C-7-000 001

V



PASSAT B6 (3C2) **58**

			7.02256.40.0	SV-KK	EL	für Fahrzeuge mit Standheizung for vehicles with parking heater
2.0 TDI 16V 4motion 103 kW (140 PS) CBAB	03.2005→08.2010		7.00868.02.0	DW-TL	EP	
			7.02256.00.0 7.02256.40.0	EUV-AGR SV-KK	EP EL	für Fahrzeuge mit Standheizung for vehicles with parking heater
2.0 TDI 4motion 103 kW (140 PS) BMP	03.2005→05.2009		7.00868.02.0	DW-TL	EP	
			7.02256.00.0	EUV-AGR	EP	
2.0 TDI 4motion 125 kW (170 PS) CBBB	05.2009→07.2010		7.00868.02.0	DW-TL	EP	
			7.02256.00.0 7.02256.40.0	EUV-AGR SV-KK	EP EL	für Fahrzeuge mit Standheizung for vehicles with parking heater
3.2 FSI 4motion 184 kW (250 PS) AXZ	11.2005→07.2010		7.02256.40.0	SV-KK	EL	für Fahrzeuge mit Standheizung for vehicles with parking heater
			7.06117.37.0	SV-NWV	EL	 ch. 3C-7-120 001→
			7.06117.43.0	SV-NWV	EL	mit Dichtring with O-ring  →ch. 3C-7-120 000 Auslassseite Exhaust Side nur in Verbindung mit: 066 109 210 R only in connection with: 066 109 210 R
			7.06117.44.0	SV-NWV	EL	mit Dichtring with O-ring  →ch. 3C-7-120 000 Einlassseite Intake Side
3.6 FSI 206 kW (280 PS) BLV	06.2005→07.2010		7.06117.37.0	SV-NWV	EL	 ch. 3C-7-120 001→
			7.06117.43.0	SV-NWV	EL	mit Dichtring with O-ring  →ch. 3C-7-120 000 Auslassseite Exhaust Side nur in Verbindung mit: 066 109 210 R only in connection with: 066 109 210 R
			7.06117.44.0	SV-NWV	EL	mit Dichtring with O-ring  →ch. 3C-7-120 000 Einlassseite Intake Side
3.6 FSI 4motion 206 kW (280 PS) BLV	09.2005→07.2010		7.06117.37.0	SV-NWV	EL	 ch. 3C-7-120 001→
			7.06117.43.0	SV-NWV	EL	mit Dichtring with O-ring  →ch. 3C-7-120 000 Auslassseite Exhaust Side nur in Verbindung mit: 066 109 210 R only in connection with: 066 109 210 R
			7.06117.44.0	SV-NWV	EL	mit Dichtring with O-ring  →ch. 3C-7-120 000 Einlassseite Intake Side
3.6 R36 4motion 220 kW (300 PS) BWS	04.2007→07.2010		7.02256.40.0	SV-KK	EL	für Fahrzeuge mit Standheizung for vehicles with parking heater
			7.06117.37.0	SV-NWV	EL	













PASSAT B6 Variant (3C5) 59

1.4 TSI 90 kW (122 PS) CAXA	05.2007→11.2010		7.01830.13.0	SUV	EL	für Fahrzeuge mit Standheizung for vehicles with parking heater
			7.02901.05.0	SUV	EL	
			7.02256.40.0	SV-KK	EL	
			7.06117.54.0	SV-NWV	EL	
1.4 TSI EcoFuel 110 kW (150 PS) CDGA	01.2009→11.2010		7.02588.04.0	LDRV	EL	für Fahrzeuge mit Standheizung for vehicles with parking heater
			7.04247.02.0	SUV	EL	
			7.02256.40.0	SV-KK	EL	
1.6 75 kW (102 PS) BSE, BSF	08.2005→11.2010		7.10014.00.0	AKF	EL	BSE, BSF: für Fahrzeuge mit Standheizung for vehicles with parking heater
			7.22880.01.0	EUV-SR	EL	
			7.02256.40.0	SV-KK	EL	
1.6 FSI 85 kW (115 PS) BLF	08.2005→06.2008		7.10014.00.0	AKF	EL	für Fahrzeuge mit Standheizung for vehicles with parking heater
			7.22880.01.0	EUV-SR	EL	
			7.02256.40.0	SV-KK	EL	
1.6 TDI 77 kW (105 PS) CAYC	08.2009→11.2010		7.02256.00.0	EUV-AGR	EP	für Fahrzeuge mit Standheizung for vehicles with parking heater
			7.02256.40.0	SV-KK	EL	
1.8 TSI 118 kW (160 PS) BZB	05.2007→10.2011		7.03280.04.0	EUV-SR	EL	→ch. 3C-B-050 000 2008 2008
			7.22880.01.0	EUV-SR	EL	
			7.00470.07.0	LDRV	EL	
			7.00415.07.0	SUV	EL	
			7.01830.13.0	SUV	EL	
			7.02901.05.0	SUV	EL	
1.8 TSI 118 kW (160 PS) CDAA	05.2007→10.2011		7.03280.04.0	EUV-SR	EL	
			7.00470.07.0	LDRV	EL	
			7.01830.13.0	SUV	EL	
1.8 TSI 112 kW (152 PS) CDAB	11.2009→11.2010		7.03280.04.0	EUV-SR	EL	
			7.00470.07.0	LDRV	EL	
			7.01830.13.0	SUV	EL	
1.8 TSI 112 kW (152 PS) CGYA	11.2009→11.2010		7.03280.04.0	EUV-SR	EL	→ch. 3C-B-050 000
			7.22880.01.0	EUV-SR	EL	
			7.00470.07.0	LDRV	EL	
1.8 TSI 112 kW (152 PS) CGYA	11.2009→11.2010		7.01830.13.0	SUV	EL	für Fahrzeuge mit Standheizung for vehicles with parking heater
			7.02256.40.0	SV-KK	EL	
			7.06117.26.0	ZM-NWV	EL	
1.9 TDI 77 kW (105 PS) BKC, BXE	08.2005→11.2010		7.02256.40.0	SV-KK	EL	BKC, BXE: für Fahrzeuge mit Standheizung for vehicles with parking heater







PASSAT B6 Variant (3C5) **59**

1.9 TDI 77 kW (105 PS) BLS	08.2005→11.2010		7.00868.02.0	DW-TL	EP	für Fahrzeuge mit Standheizung for vehicles with parking heater
			7.02256.00.0	EUV-AGR	EP	
			7.02256.40.0	SV-KK	EL	
2.0 BlueTDI 105 kW (143 PS) CBAC	01.2009→11.2010		7.00868.02.0	DW-TL	EP	für Fahrzeuge mit Standheizung for vehicles with parking heater
			7.02256.00.0	EUV-AGR	EP	
			7.02256.40.0	SV-KK	EL	
2.0 FSI 110 kW (150 PS) BLR, BLY, BVY, BVZ	08.2005→11.2010		7.22880.01.0	EUV-SR	EL	 BLR, BLY, BVY, BVZ: für Fahrzeuge mit Standheizung for vehicles with parking heater
			7.02256.40.0	SV-KK	EL	
			7.06117.37.0	SV-NWV	EL	
2.0 FSI 147 kW (200 PS) AXX	08.2005→11.2010		7.00470.07.0	LDRV	EL	mit Dichtring with O-ring
			7.01830.13.0	SUV	EL	
			7.06117.46.0	SV-NWV	EH	
2.0 FSI 147 kW (200 PS) BPY, BWA	08.2005→11.2010		7.00470.07.0	LDRV	EL	 BPY, BWA: für Fahrzeuge mit Standheizung for vehicles with parking heater
			7.01830.13.0	SUV	EL	
			7.02256.40.0	SV-KK	EL	
			7.06117.46.0	SV-NWV	EH	
2.0 FSI 147-157 kW (200-213 PS) CAWB, CCTA, CCZA	08.2005→11.2010		7.03280.04.0	EUV-SR	EL	 CAWB, CCTA, CCZA: Baujahr ab: 01.2008 Construction year from: 01.2008
			7.22880.01.0	EUV-SR	EL	
			7.00470.07.0	LDRV	EL	
			7.02901.05.0	SUV	EL	
			7.02256.40.0	SV-KK	EL	
			7.06117.26.0	ZM-NWV	EL	
2.0 FSI 147-157 kW (200-213 PS) CBFA	08.2005→11.2010		7.22880.01.0	EUV-SR	EL	PKW, Coupe/ Passenger car, coupé
			7.00470.07.0	LDRV	EL	
			7.02901.05.0	SUV	EL	

V



















PASSAT B6 Variant (3C5) **59**

2.0 FSI 4motion 110 kW (150 PS) BLX, BLY, BVX	09.2005→11.2010		7.22880.01.0	EUV-SR	EL	 BLX, BLY, BVX: für Fahrzeuge mit Standheizung for vehicles with parking heater
			7.02256.40.0	SV-KK	EL	
			7.06117.37.0	SV-NWV	EL	
2.0 TDI 90 kW (122 PS) BVE	08.2005→02.2006		7.00868.02.0	DW-TL	EP	Fahrgestellnummer ab: 3C-7-000 001 Vehicle Identification Number from: 3C-7-000 001
			7.28098.04.0	EUV-AGR	EL	
			7.02256.40.0	SV-KK	EL	
2.0 TDI 100 kW (136 PS) BMA	08.2005→11.2010		7.00868.02.0	DW-TL	EP	 ch. 3C-7-000 001→ Fahrgestellnummer ab: 3C-7-000 001 Vehicle Identification Number from: 3C-7-000 001
			7.02256.00.0	EUV-AGR	EP	
			7.28098.04.0	EUV-AGR	EL	
2.0 TDI 100 kW (136 PS) CBAA	08.2005→11.2010		7.00868.02.0	DW-TL	EP	für Fahrzeuge mit Standheizung for vehicles with parking heater
			7.02256.00.0	EUV-AGR	EP	
			7.02256.40.0	SV-KK	EL	
2.0 TDI 125 kW (170 PS) BMR, CBBB	08.2005→11.2010		7.00868.02.0	DW-TL	EP	 BMR, CBBB: für Fahrzeuge mit Standheizung for vehicles with parking heater
			7.02256.00.0	EUV-AGR	EP	
			7.02256.40.0	SV-KK	EL	
2.0 TDI 103 kW (140 PS) BMP	08.2005→05.2009		7.00868.02.0	DW-TL	EP	für Fahrzeuge mit Standheizung for vehicles with parking heater
			7.02256.00.0	EUV-AGR	EP	
			7.02256.40.0	SV-KK	EL	
2.0 TDI 120 kW (163 PS) BUZ	08.2005→05.2009		7.00868.02.0	DW-TL	EP	für Fahrzeuge mit Standheizung for vehicles with parking heater
			7.02256.00.0	EUV-AGR	EP	
			7.02256.40.0	SV-KK	EL	
2.0 TDI 88 kW (120 PS) BWV	11.2005→05.2007		7.00868.02.0	DW-TL	EP	 ch. 3C-7-000 001→ Fahrgestellnummer ab: 3C-7-000 001 Vehicle Identification Number from: 3C-7-000 001
			7.02256.00.0	EUV-AGR	EP	
			7.28098.04.0	EUV-AGR	EL	
2.0 TDI 81 kW (110 PS) CBDC	11.2008→11.2010		7.00868.02.0	DW-TL	EP	für Fahrzeuge mit Standheizung for vehicles with parking heater
			7.02256.00.0	EUV-AGR	EP	
			7.02256.40.0	SV-KK	EL	
2.0 TDI 16V 103 kW (140 PS) BKP	08.2005→11.2010		7.00868.02.0	DW-TL	EP	 ch. 3C-7-000 001→ Fahrgestellnummer ab: 3C-7-000 001 Vehicle Identification Number from: 3C-7-000 001
			7.02256.00.0	EUV-AGR	EP	
			7.28098.04.0	EUV-AGR	EL	





PASSAT B6 Variant (3C5) 59

















			7.02256.40.0	SV-KK	EL	für Fahrzeuge mit Standheizung for vehicles with parking heater
2.0 TDI 16V 103 kW (140 PS) CBAB	08.2005→11.2010		7.00868.02.0	DW-TL	EP	
			7.02256.00.0	EUV-AGR	EP	
			7.02256.40.0	SV-KK	EL	für Fahrzeuge mit Standheizung for vehicles with parking heater
2.0 TDI 16V 4motion 103 kW (140 PS) BKP	08.2005→11.2010		7.00868.02.0	DW-TL	EP	
			7.02256.00.0	EUV-AGR	EP	 ch. 3C-7-000 001→
			7.28098.04.0	EUV-AGR	EL	Fahrgestellnummer ab: 3C-7-000 001 Vehicle Identification Number from: 3C-7-000 001
			7.02256.40.0	SV-KK	EL	für Fahrzeuge mit Standheizung for vehicles with parking heater
2.0 TDI 16V 4motion 103 kW (140 PS) CBAB	08.2005→11.2010		7.00868.02.0	DW-TL	EP	
			7.02256.00.0	EUV-AGR	EP	
			7.02256.40.0	SV-KK	EL	für Fahrzeuge mit Standheizung for vehicles with parking heater
2.0 TDI 4motion 103 kW (140 PS) BMP	08.2005→05.2009		7.00868.02.0	DW-TL	EP	
			7.02256.00.0	EUV-AGR	EP	
			7.02256.40.0	SV-KK	EL	für Fahrzeuge mit Standheizung for vehicles with parking heater
2.0 TDI 4motion 125 kW (170 PS) CBBB	05.2009→11.2010		7.00868.02.0	DW-TL	EP	
			7.02256.00.0	EUV-AGR	EP	
			7.02256.40.0	SV-KK	EL	für Fahrzeuge mit Standheizung for vehicles with parking heater
			7.02256.40.0	SV-KK	EL	für Fahrzeuge mit Standheizung for vehicles with parking heater
3.2 FSI 4motion 184 kW (250 PS) AXZ	11.2005→11.2010		7.02256.40.0	SV-KK	EL	für Fahrzeuge mit Standheizung for vehicles with parking heater
			7.06117.37.0	SV-NWV	EL	 ch. 3C-7-120 001→
			7.06117.43.0	SV-NWV	EL	mit Dichtring with O-ring  →ch. 3C-7-120 000 Auslassseite Exhaust Side nur in Verbindung mit: 066 109 210 R only in connection with: 066 109 210 R
			7.06117.44.0	SV-NWV	EL	mit Dichtring with O-ring  →ch. 3C-7-120 000 Einlassseite Intake Side
			7.06117.44.0	SV-NWV	EL	 ch. 3C-7-120 001→
3.6 FSI 206 kW (280 PS) BLV	09.2005→11.2010		7.06117.37.0	SV-NWV	EL	 ch. 3C-7-120 001→
			7.06117.43.0	SV-NWV	EL	mit Dichtring with O-ring  →ch. 3C-7-120 000 Auslassseite Exhaust Side nur in Verbindung mit: 066 109 210 R only in connection with: 066 109 210 R
			7.06117.44.0	SV-NWV	EL	mit Dichtring with O-ring  →ch. 3C-7-120 000 Einlassseite Intake Side
			7.06117.37.0	SV-NWV	EL	 ch. 3C-7-120 001→



PASSAT B6 Variant (3C5) 59





























			7.06117.43.0	SV-NWV	EL	mit Dichtring with O-ring  →ch. 3C-7-120 000 Auslasseite Exhaust Side nur in Verbindung mit: 066 109 210 R only in connection with: 066 109 210 R
			7.06117.44.0	SV-NWV	EL	mit Dichtring with O-ring  →ch. 3C-7-120 000 Einlassseite Intake Side
3.6 R36 4motion 220 kW (300 PS) BWS	04.2007→11.2010		7.02256.40.0	SV-KK	EL	für Fahrzeuge mit Standheizung for vehicles with parking heater
			7.06117.37.0	SV-NWV	EL	

PASSAT B7 (362) 60

1.4 TSI 90 kW (122 PS) CAXA	08.2010→12.2014		7.01830.13.0	SUV	EL	
			7.02256.40.0	SV-KK	EL	 ch. 3C-B-200 001→ für Fahrzeuge mit Standheizung for vehicles with parking heater
			7.06117.54.0	SV-NWV	EL	Fahrgestellnummer ab: 3C-B-200 001 Vehicle Identification Number from: 3C-B-200 001
1.4 TSI 118 kW (160 PS) CTHD	11.2012→12.2014		7.02588.04.0	LDRV	EL	 ch. 3C-B-200 001→
			7.04247.02.0	SUV	EL	 ch. 3C-B-200 001→
			7.02256.40.0	SV-KK	EL	 ch. 3C-B-200 001→ für Fahrzeuge mit Standheizung for vehicles with parking heater
			7.06117.54.0	SV-NWV	EL	Fahrgestellnummer ab: 3C-B-200 001 Vehicle Identification Number from: 3C-B-200 001
1.4 TSI EcoFuel 110 kW (150 PS) CDGA	08.2010→12.2014		7.02588.04.0	LDRV	EL	
			7.04247.02.0	SUV	EL	
			7.02256.40.0	SV-KK	EL	 ch. 3C-B-200 001→ für Fahrzeuge mit Standheizung for vehicles with parking heater
			7.06117.54.0	SV-NWV	EL	Fahrgestellnummer ab: 3C-B-200 001 Vehicle Identification Number from: 3C-B-200 001
1.4 TSI MultiFuel 118 kW (160 PS) CKMA	11.2010→12.2014		7.02588.04.0	LDRV	EL	 ch. 3C-B-200 001→
			7.04247.02.0	SUV	EL	 ch. 3C-B-200 001→
			7.02256.40.0	SV-KK	EL	 ch. 3C-B-200 001→ für Fahrzeuge mit Standheizung for vehicles with parking heater
			7.06117.54.0	SV-NWV	EL	Fahrgestellnummer ab: 3C-B-200 001 Vehicle Identification Number from: 3C-B-200 001
1.6 TDI 77 kW (105 PS) CAYC	08.2010→12.2014		7.02256.00.0	EUV-AGR	EP	
1.8 TSI 118 kW (160 PS) CDA A	08.2010→12.2014		7.03280.04.0	EUV-SR	EL	
			7.22880.01.0	EUV-SR	EL	
			7.00470.07.0	LDRV	EL	
			7.01830.13.0	SUV	EL	
			7.02256.40.0	SV-KK	EL	 ch. 3C-B-200 001→ für Fahrzeuge mit Standheizung for vehicles with parking heater
			7.06117.26.0	ZM-NWV	EL	 ch. 3C-B-200 001→

V

















PASSAT B7 (362)					60
1.8 TSI 112 kW (152 PS) CDAB	02.2011→12.2014		7.03280.04.0	EUV-SR	EL
			7.22880.01.0	EUV-SR	EL
			7.00470.07.0	LDRV	EL
			7.01830.13.0	SUV	EL
			7.02256.40.0	SV-KK	EL
					ch. 3C-B-200 001→ für Fahrzeuge mit Standheizung for vehicles with parking heater Fahrgestellnummer ab: 3C-B-200 001 Vehicle Identification Number from: 3C-B-200 001
2.0 TDI 103 kW (140 PS) CFFB	08.2010→12.2014		7.00868.02.0	DW-TL	EP
			7.02256.00.0	EUV-AGR	EP
2.0 TDI 125 kW (170 PS) CFGB, CLLA	08.2010→12.2014		7.00868.02.0	DW-TL	EP
			7.02256.00.0	EUV-AGR	EP
2.0 TDI 100 kW (136 PS) CFFA	08.2010→12.2014		7.00868.02.0	DW-TL	EP
			7.02256.00.0	EUV-AGR	EP
2.0 TDI 130 kW (177 PS) CFGC	12.2012→12.2014		7.00868.02.0	DW-TL	EP
			7.02256.00.0	EUV-AGR	EP
2.0 TDI 4motion 103 kW (140 PS) CFFB	08.2010→12.2014		7.00868.02.0	DW-TL	EP
			7.02256.00.0	EUV-AGR	EP
2.0 TDI 4motion 125 kW (170 PS) CFGB	08.2010→01.2013		7.00868.02.0	DW-TL	EP
			7.02256.00.0	EUV-AGR	EP
2.0 TDI 4motion 130 kW (177 PS) CFGC	01.2013→12.2014		7.00868.02.0	DW-TL	EP
			7.02256.00.0	EUV-AGR	EP
2.0 TSI 155 kW (211 PS) CCZB	11.2010→12.2014		7.03280.04.0	EUV-SR	EL
			7.22880.01.0	EUV-SR	EL
			7.00470.07.0	LDRV	EL
			7.02901.05.0	SUV	EL
			7.01830.13.0	SUV	EL
			7.02256.40.0	SV-KK	EL
			7.06117.26.0	ZM-NWV	EL
					Fahrgestellnummer ab: 3C-B-200 001 Vehicle Identification Number from: 3C-B-200 001 ch. 3C-B-200 001→ für OE-Nummer: 06J 145 713 K, 06J 145 713 KX, 06J 145 713 T, 06J 145 713 TX, 06J 145 722 B, 06J 145 722 BX for OE number: 06J 145 713 K, 06J 145 713 KX, 06J 145 713 T, 06J 145 713 TX, 06J 145 722 B, 06J 145 722 BX ch. 3C-B-200 001→ für Fahrzeuge mit Standheizung for vehicles with parking heater Fahrgestellnummer ab: 3C-B-200 001 Vehicle Identification Number from: 3C-B-200 001
3.6 FSI 4motion 220 kW (300 PS) BWS	01.2011→12.2014		7.02256.40.0	SV-KK	EL
			7.06117.37.0	SV-NWV	EL
					Fahrgestellnummer ab: 3C-B-200 001 Vehicle Identification Number from: 3C-B-200 001

					
PASSAT B7 (A32, A33)					
61					
1.8 TSI 125 kW (170 PS) CPKA, CPRA	06.2013→		7.02901.05.0	SUV	EL
			7.06117.26.0	ZM-NWV	EL
					 CPKA, CPRA: Fahrgestellnummer ab: A3-DC000 001 Vehicle Identification Number from: A3-DC000 001
2.0 TDI 103 kW (140 PS) CFFB, CKRA	04.2011→06.2015		7.02256.00.0	EUV-AGR	EP
					 CFFB:  ch. 3C-B-200 001→  CKRA:  ch. A3-DC000 001→
3.6 FSI 206-209 kW (280-284 PS) CDVB	04.2011→09.2015		7.06117.37.0	SV-NWV	EL
					Fahrgestellnummer ab: A3-DC000 001 Vehicle Identification Number from: A3-DC000 001
3.6 FSI 206-209 kW (280-284 PS) CDVB	04.2011→		7.06117.37.0	SV-NWV	EL
					Fahrgestellnummer ab: A3-DC000 001 Vehicle Identification Number from: A3-DC000 001
PASSAT B7 Variant (365)					
62					
1.4 TSI 90 kW (122 PS) CAXA	08.2010→12.2014		7.01830.13.0	SUV	EL
			7.02256.40.0	SV-KK	EL
			7.06117.54.0	SV-NWV	EL
					 ch. 3C-B-200 001→ für Fahrzeuge mit Standheizung for vehicles with parking heater
					Fahrgestellnummer ab: 3C-B-200 001 Vehicle Identification Number from: 3C-B-200 001
1.4 TSI 118 kW (160 PS) CTHD	11.2012→12.2014		7.02588.04.0	LDRV	EL
			7.04247.02.0	SUV	EL
			7.02256.40.0	SV-KK	EL
			7.06117.54.0	SV-NWV	EL
					 ch. 3C-B-200 001→  ch. 3C-B-200 001→ für Fahrzeuge mit Standheizung for vehicles with parking heater
					Fahrgestellnummer ab: 3C-B-200 001 Vehicle Identification Number from: 3C-B-200 001
1.4 TSI EcoFuel 110 kW (150 PS) CDGA	08.2010→12.2014		7.02588.04.0	LDRV	EL
			7.04247.02.0	SUV	EL
			7.02256.40.0	SV-KK	EL
			7.06117.54.0	SV-NWV	EL
					 ch. 3C-B-200 001→ für Fahrzeuge mit Standheizung for vehicles with parking heater
					Fahrgestellnummer ab: 3C-B-200 001 Vehicle Identification Number from: 3C-B-200 001
1.4 TSI MultiFuel 118 kW (160 PS) CKMA	11.2010→12.2014		7.02588.04.0	LDRV	EL
			7.04247.02.0	SUV	EL
			7.02256.40.0	SV-KK	EL
			7.06117.54.0	SV-NWV	EL
					 ch. 3C-B-200 001→  ch. 3C-B-200 001→ für Fahrzeuge mit Standheizung for vehicles with parking heater
					Fahrgestellnummer ab: 3C-B-200 001 Vehicle Identification Number from: 3C-B-200 001
1.6 TDI 77 kW (105 PS) CAYC	08.2010→12.2014		7.02256.00.0	EUV-AGR	EP
					 ch. 3C-B-200 001→
1.8 TSI 118 kW (160 PS) CDA A	08.2010→12.2014		7.03280.04.0	EUV-SR	EL
			7.22880.01.0	EUV-SR	EL
			7.00470.07.0	LDRV	EL
			7.01830.13.0	SUV	EL
			7.02256.40.0	SV-KK	EL
			7.06117.26.0	ZM-NWV	EL
					 ch. 3C-B-200 001→ für Fahrzeuge mit Standheizung for vehicles with parking heater
					Fahrgestellnummer ab: 3C-B-200 001 Vehicle Identification Number from: 3C-B-200 001

V



























PASSAT B7 Variant (365) **62**







1.8 TSI 112 kW (152 PS) CDAB	02.2011→12.2014	 7.03280.04.0	EUV-SR	EL	 ch. 3C-B-200 001→ für Fahrzeuge mit Standheizung for vehicles with parking heater Fahrgestellnummer ab: 3C-B-200 001 Vehicle Identification Number from: 3C-B-200 001
		7.22880.01.0	EUV-SR	EL	
		7.00470.07.0	LDRV	EL	
		7.01830.13.0	SUV	EL	
		7.02256.40.0	SV-KK	EL	
2.0 TDI 103 kW (140 PS) CFFB	08.2010→12.2014	 7.00868.02.0	DW-TL	EP	 ch. 3C-B-200 001→
		7.02256.00.0	EUV-AGR	EP	
2.0 TDI 125 kW (170 PS) CFGB, CLLA	08.2010→12.2014	 7.00868.02.0	DW-TL	EP	
		7.02256.00.0	EUV-AGR	EP	
2.0 TDI 100 kW (136 PS) CFFA	08.2010→12.2014	 7.00868.02.0	DW-TL	EP	
		7.02256.00.0	EUV-AGR	EP	
2.0 TDI 130 kW (177 PS) CFGC	12.2012→12.2014	 7.00868.02.0	DW-TL	EP	
		7.02256.00.0	EUV-AGR	EP	
2.0 TDI 4motion 103 kW (140 PS) CFFB	08.2010→12.2014	 7.00868.02.0	DW-TL	EP	 ch. 3C-B-200 001→
		7.02256.00.0	EUV-AGR	EP	
2.0 TDI 4motion 125 kW (170 PS) CFGB	08.2010→01.2013	 7.00868.02.0	DW-TL	EP	
		7.02256.00.0	EUV-AGR	EP	
2.0 TDI 4motion 130 kW (177 PS) CFGC	01.2013→12.2014	 7.00868.02.0	DW-TL	EP	
		7.02256.00.0	EUV-AGR	EP	
2.0 TSI 155 kW (211 PS) CCZB	11.2010→12.2015	 7.03280.04.0	EUV-SR	EL	Fahrgestellnummer ab: 3C-B-200 001 Vehicle Identification Number from: 3C-B-200 001  ch. 3C-B-200 001→ für OE-Nummer: 06J 145 713 K, 06J 145 713 TX, 06J 145 713 KX, 06J 145 713 T, 06J 145 713 TX, 06J 145 722 B, 06J 145 722 BX for OE number: 06J 145 713 K, 06J 145 713 KX, 06J 145 713 T, 06J 145 713 TX, 06J 145 722 B, 06J 145 722 BX  ch. 3C-B-200 001→ für Fahrzeuge mit Standheizung for vehicles with parking heater Fahrgestellnummer ab: 3C-B-200 001 Vehicle Identification Number from: 3C-B-200 001
		7.22880.01.0	EUV-SR	EL	
		7.00470.07.0	LDRV	EL	
		7.02901.05.0	SUV	EL	
		7.01830.13.0	SUV	EL	
		7.02256.40.0	SV-KK	EL	
		7.06117.26.0	ZM-NWV	EL	
3.6 FSI 4motion 220 kW (300 PS) BWS	01.2011→12.2014	 7.02256.40.0	SV-KK	EL	 ch. 3C-B-200 001→ für Fahrzeuge mit Standheizung for vehicles with parking heater Fahrgestellnummer ab: 3C-B-200 001 Vehicle Identification Number from: 3C-B-200 001
		7.06117.37.0	SV-NWV	EL	



PASSAT B8 (3G2, CB2) 63











1.4 GTE Hybrid 115 kW (156 PS) CUKC, DGEB	06.2015→11.2018	 7.02256.41.0	SV-KK	EL  CUKC, DGEB: ch. 3C-F-200 001→ für Fahrzeuge mit Standheizung for vehicles with parking heater
		 7.06117.48.0	SV-NWV	EL  CUKC, DGEB: Fahrgestellnummer ab: 3C-F-200 001 Vehicle Identification Number from: 3C-F-200 001
1.4 TSI 110 kW (150 PS) CZDA, CZEA	11.2014→	 7.06117.48.0	SV-NWV	EL  CZDA, CZEA: Fahrgestellnummer ab: 3C-F-200 001 Vehicle Identification Number from: 3C-F-200 001
1.4 TSI 92 kW (125 PS) CZCA	11.2014→	 7.06117.48.0	SV-NWV	EL Fahrgestellnummer ab: 3C-F-200 001 Vehicle Identification Number from: 3C-F-200 001
1.4 TSI 4motion 110 kW (150 PS) CZEA	02.2015→	 7.06117.48.0	SV-NWV	EL Fahrgestellnummer ab: 3C-F-200 001 Vehicle Identification Number from: 3C-F-200 001
1.8 TSI 132 kW (180 PS) CJSA, CJSC	02.2015→	 7.03280.04.0	EUV-SR	EL  CJSA, CJSC: Fahrgestellnummer ab: 3C-F-200 001 Vehicle Identification Number from: 3C-F-200 001
		 7.02901.05.0	SUV	EL  CJSA, CJSC: →01.2019
		 7.06117.26.0	ZM-NWV	EL  CJSA, CJSC: Fahrgestellnummer ab: 3C-F-200 001 Vehicle Identification Number from: 3C-F-200 001
2.0 TSI 162 kW (220 PS) CHHB, CXDA	02.2015→	 7.02256.18.0	EUV-SR	EP  CHHB, CXDA: Fahrgestellnummer ab: 3C-F-200 001 Vehicle Identification Number from: 3C-F-200 001 für OE-Nummer: 06H 906 283 F for OE number: 06H 906 283 F
		 7.02901.05.0	SUV	EL  CHHB, CXDA: →02.2019
		 7.06117.26.0	ZM-NWV	EL  CHHB, CXDA: Fahrgestellnummer ab: 3C-F-200 001 Vehicle Identification Number from: 3C-F-200 001
2.0 TSI 4motion 206 kW (280 PS) CJXA	05.2015→	 7.02256.18.0	EUV-SR	EP Fahrgestellnummer ab: 3C-F-200 001 Vehicle Identification Number from: 3C-F-200 001 für OE-Nummer: 06H 906 283 F for OE number: 06H 906 283 F
		 7.02901.05.0  7.06117.26.0	SUV ZM-NWV	EL →02.2019 EL Fahrgestellnummer ab: 3C-F-200 001 Vehicle Identification Number from: 3C-F-200 001
2.0 TSI 4motion 200 kW (272 PS) DNUA	09.2018→	 7.02256.18.0	EUV-SR	EP Fahrgestellnummer ab: 3C-F-200 001 Vehicle Identification Number from: 3C-F-200 001 für OE-Nummer: 06H 906 283 F for OE number: 06H 906 283 F
		 7.06117.26.0	ZM-NWV	EL

PASSAT B8 Variant (3G5, CB5) 64





1.4 GTE Hybrid 115 kW (156 PS) CUKC, DGEB	06.2015→	 7.02256.41.0	SV-KK	EL  CUKC, DGEB: ch. 3C-F-200 001→ für Fahrzeuge mit Standheizung for vehicles with parking heater
		 7.06117.48.0	SV-NWV	EL  CUKC, DGEB: Fahrgestellnummer ab: 3C-F-200 001 Vehicle Identification Number from: 3C-F-200 001
1.4 TSI 110 kW (150 PS) CZDA, CZEA	11.2014→	 7.06117.48.0	SV-NWV	EL  CZDA, CZEA: Fahrgestellnummer ab: 3C-F-200 001 Vehicle Identification Number from: 3C-F-200 001



PASSAT B8 Variant (3G5, CB5) 64

1.4 TSI 92 kW (125 PS) CZCA	11.2014→	 7.06117.48.0	SV-NWV	EL	Fahrgestellnummer ab: 3C-F-200 001 Vehicle Identification Number from: 3C-F-200 001
1.4 TSI 4motion 110 kW (150 PS) CZEA	02.2015→	 7.06117.48.0	SV-NWV	EL	Fahrgestellnummer ab: 3C-F-200 001 Vehicle Identification Number from: 3C-F-200 001
1.8 TSI 132 kW (180 PS) CJSA, CJSC	02.2015→	 7.03280.04.0	EUV-SR	EL	 CJSA, CJSC: Fahrgestellnummer ab: 3C-F-200 001 Vehicle Identification Number from: 3C-F-200 001
		7.02901.05.0	SUV	EL	 CJSA, CJSC: →01.2019
		7.06117.26.0	ZM-NWV	EL	 CJSA, CJSC:  ch. 3C-F-200 001→
2.0 TSI 162 kW (220 PS) CHHB, CXDA	08.2014→	 7.02256.18.0	EUV-SR	EP	 CHHB, CXDA: Fahrgestellnummer ab: 3C-F-200 001 Vehicle Identification Number from: 3C-F-200 001 für OE-Nummer: 06H 906 283 F for OE number: 06H 906 283 F
		7.02901.05.0	SUV	EL	 CHHB, CXDA: →02.2019
		7.06117.26.0	ZM-NWV	EL	 CHHB, CXDA: Fahrgestellnummer ab: 3C-F-200 001 Vehicle Identification Number from: 3C-F-200 001
2.0 TSI 4motion 206 kW (280 PS) CJXA	05.2015→	 7.02256.18.0	EUV-SR	EP	Fahrgestellnummer ab: 3C-F-200 001 Vehicle Identification Number from: 3C-F-200 001 für OE-Nummer: 06H 906 283 F for OE number: 06H 906 283 F
		7.02901.05.0	SUV	EL	→02.2019
		7.06117.26.0	ZM-NWV	EL	Fahrgestellnummer ab: 3C-F-200 001 Vehicle Identification Number from: 3C-F-200 001
2.0 TSI 4motion 200 kW (272 PS) DNUA	09.2018→	 7.02256.18.0	EUV-SR	EP	Fahrgestellnummer ab: 3C-F-200 001 Vehicle Identification Number from: 3C-F-200 001 für OE-Nummer: 06H 906 283 F for OE number: 06H 906 283 F
		7.06117.26.0	ZM-NWV	EL	















PASSAT CC B6 (357) 65

1.4 TSI MultiFuel 118 kW (160 PS) CKMA	01.2011→01.2012	 7.02588.04.0	LDRV	EL	
		7.04247.02.0	SUV	EL	 ch. 3C-C-700 001→
		7.02256.40.0	SV-KK	EL	für Fahrzeuge mit Standheizung for vehicles with parking heater
1.8 TSI 118 kW (160 PS) BZB	06.2008→01.2012	 7.03280.04.0	EUV-SR	EL	
		7.00470.07.0	LDRV	EL	
		7.01830.13.0	SUV	EL	
		7.02256.40.0	SV-KK	EL	für Fahrzeuge mit Standheizung for vehicles with parking heater
1.8 TSI 118 kW (160 PS) CDA A	06.2008→01.2012	 7.06117.26.0	ZM-NWV	EL	
		7.03280.04.0	EUV-SR	EL	
		7.22880.01.0	EUV-SR	EL	Fahrgestellnummer ab: 3C-C-700 001 Vehicle Identification Number from: 3C-C-700 001
		7.00470.07.0	LDRV	EL	
		7.01830.13.0	SUV	EL	
7.02256.40.0	SV-KK	EL	für Fahrzeuge mit Standheizung for vehicles with parking heater		
7.06117.26.0	ZM-NWV	EL			

V



PASSAT CC B6 (357) 65

1.8 TSI 112 kW (152 PS) CDAB	11.2008→05.2010	 7.03280.04.0	EUV-SR	EL	Fahrgestellnummer ab: 3C-C-700 001 Vehicle Identification Number from: 3C-C-700 001 für Fahrzeuge mit Standheizung for vehicles with parking heater
		7.22880.01.0	EUV-SR	EL	
		7.00470.07.0	LDRV	EL	
		7.01830.13.0	SUV	EL	
		7.02256.40.0	SV-KK	EL	
1.8 TSI 112 kW (152 PS) CGYA	11.2008→05.2010	 7.03280.04.0	EUV-SR	EL	für Fahrzeuge mit Standheizung for vehicles with parking heater
		7.00470.07.0	LDRV	EL	
		7.01830.13.0	SUV	EL	
		7.02256.40.0	SV-KK	EL	
		7.06117.26.0	ZM-NWV	EL	
2.0 BlueTDI 105 kW (143 PS) CBAC	05.2009→11.2010	 7.00868.02.0	DW-TL	EP	
		7.02256.00.0	EUV-AGR	EP	
2.0 TDI 103 kW (140 PS) CBAB	06.2008→01.2012	 7.00868.02.0	DW-TL	EP	
		7.02256.00.0	EUV-AGR	EP	
2.0 TDI 103 kW (140 PS) CFFB	06.2008→01.2012	 7.02256.00.0	EUV-AGR	EP	
		7.02256.00.0	EUV-AGR	EP	
2.0 TDI 125 kW (170 PS) CBBB	06.2008→01.2012	 7.00868.02.0	DW-TL	EP	
		7.02256.00.0	EUV-AGR	EP	
2.0 TDI 125 kW (170 PS) CFGB, CLLA	06.2008→01.2012	 7.02256.00.0	EUV-AGR	EP	
		7.02256.00.0	EUV-AGR	EP	
2.0 TDI 100 kW (136 PS) CBAA	06.2008→05.2011	 7.00868.02.0	DW-TL	EP	
		7.02256.00.0	EUV-AGR	EP	
2.0 TDI 100 kW (136 PS) CFFA	06.2008→05.2011	 7.02256.00.0	EUV-AGR	EP	
		7.02256.00.0	EUV-AGR	EP	
2.0 TDI 4motion 103 kW (140 PS) CBAB	08.2009→01.2012	 7.00868.02.0	DW-TL	EP	
		7.02256.00.0	EUV-AGR	EP	
2.0 TDI 4motion 103 kW (140 PS) CFFB	08.2009→01.2012	 7.02256.00.0	EUV-AGR	EP	
		7.02256.00.0	EUV-AGR	EP	
2.0 TDI 4motion 125 kW (170 PS) CBBB	11.2009→01.2012	 7.00868.02.0	DW-TL	EP	
		7.02256.00.0	EUV-AGR	EP	
2.0 TDI 4motion 125 kW (170 PS) CFGB	11.2009→01.2012	 7.02256.00.0	EUV-AGR	EP	
		7.02256.00.0	EUV-AGR	EP	
2.0 TSI 147 kW (200 PS) CAWB, CCZA	06.2008→01.2012	 7.03280.04.0	EUV-SR	EL	für Fahrzeuge mit Standheizung for vehicles with parking heater
		7.00470.07.0	LDRV	EL	
		7.02901.05.0	SUV	EL	
		7.02256.40.0	SV-KK	EL	
		7.06117.26.0	ZM-NWV	EL	
2.0 TSI 147-157 kW (200-213 PS) CBFA, CCTA	06.2008→01.2012	 7.03280.04.0	EUV-SR	EL	für Fahrzeuge mit Standheizung for vehicles with parking heater
		7.22880.01.0	EUV-SR	EL	



































PASSAT CC B6 (357) 65

			7.00470.07.0 7.02901.05.0 7.02256.40.0	LDRV SUV SV-KK	EL EL EL	CBFA, CCTA: für Fahrzeuge mit Standheizung for vehicles with parking heater
			7.06117.26.0	ZM-NWV	EL	
2.0 TSI 155 kW (211 PS) CCZB	11.2010→01.2012		7.03280.04.0	EUV-SR	EL	Fahrgestellnummer ab: 3C-C-700 001 Vehicle Identification Number from: 3C-C-700 001 ch. 3C-C-700 001→ für Fahrzeuge mit Standheizung for vehicles with parking heater
			7.22880.01.0	EUV-SR	EL	
			7.00470.07.0 7.02901.05.0 7.02256.40.0	LDRV SUV SV-KK	EL EL EL	
			7.06117.26.0	ZM-NWV	EL	
3.6 FSI 206 kW (280 PS) BLV, CNNA	06.2008→01.2012		7.06117.37.0	SV-NWV	EL	
3.6 FSI 4motion 220 kW (300 PS) BWS	02.2008→12.2011		7.02256.40.0	SV-KK	EL	für Fahrzeuge mit Standheizung for vehicles with parking heater
			7.06117.37.0	SV-NWV	EL	
3.6 FSI 4motion 206 kW (280 PS) BLV, CNNA	06.2008→01.2012		7.02256.40.0	SV-KK	EL	BLV, CNNA: für Fahrzeuge mit Standheizung for vehicles with parking heater
			7.06117.37.0	SV-NWV	EL	

PHAETON (3D1, 3D2, 3D3, 3D4, 3D6, 3D7, 3D8, 3D9) 66



3.0 V6 184 kW (250 PS) CPFA	04.2012→03.2016		7.28098.04.0	EUV-ML	EL	
			7.06117.37.0	SV-NWV	EL	
3.0 V6 TDI 4motion 165 kW (224 PS) BMK	09.2004→05.2007		7.01019.01.0	DW-AGR	EP	
			7.02256.00.0	EUV-AGR	EP	
			7.28098.04.0	EUV-ML	EL	
3.0 V6 TDI 4motion 171 kW (233 PS) CARA	06.2007→11.2008		7.02256.00.0	EUV-AGR	EP	
			7.28098.04.0	EUV-ML	EL	
3.0 V6 TDI 4motion 176 kW (239 PS) CARB	11.2008→03.2016		7.02256.00.0	EUV-AGR	EP	
3.0 V6 TDI 4motion 176 kW (240 PS) CEXA	11.2008→03.2016		7.02256.00.0	EUV-AGR	EP	
			7.28098.04.0	EUV-ML	EL	
3.0 V6 TDI 4motion 180 kW (245 PS) CEXB	11.2013→03.2016		7.02256.00.0	EUV-AGR	EP	
			7.28098.04.0	EUV-ML	EL	
3.2 V6 177 kW (241 PS) AYT, BKL	04.2002→05.2005		7.28098.04.0	EUV-ML	EL	
3.2 V6 4motion 177 kW (241 PS) BKL, BRK	02.2004→11.2008		7.28098.04.0	EUV-ML	EL	
3.6 V6 4motion 206 kW (280 PS) CHNA, CMVA	11.2008→03.2016		7.28098.04.0	EUV-ML	EL	Fahrgestellnummer ab: 3D-9-100 001 Vehicle Identification Number from: 3D-9-100 001

V



















						
PHAETON (3D1, 3D2, 3D3, 3D4, 3D6, 3D7, 3D8, 3D9)					66	
			7.06117.37.0	SV-NWV	EL	Fahrgestellnummer ab: 3D-9-100 001 Vehicle Identification Number from: 3D-9-100 001
4.2 V8 4motion 246 kW (335 PS) BGH, BGJ	05.2003→03.2016		7.28098.04.0	EUV-ML	EL	
			7.22687.50.0	EUV-SR	EP	
5.0 V10 TDI 4motion 230 kW (313 PS) AJS	11.2002→10.2006		7.00580.01.0	DW-AGR	EP	
			7.02256.00.0	EUV-AGR	EP	
			7.28098.04.0	EUV-ML	EL	
6.0 W12 4motion 309 kW (420 PS) BAN	04.2002→12.2005		7.28098.04.0	EUV-ML	EL	
			7.22880.01.0	EUV-SL	EL	
6.0 W12 4motion 331 kW (450 PS) BRN, BTT	05.2005→03.2016		7.28098.04.0	EUV-ML	EL	
POLO (6N2)					67	
1.4 16V 55 kW (75 PS) AHW	10.1999→09.2001		7.21483.54.0	EUV-AGR	EL	Fahrgestellnummer ab: 6N-YD000 001 Vehicle Identification Number from: 6N-YD000 001
1.4 TDI 55 kW (75 PS) AMF	10.1999→09.2001		7.21903.70.0	DW-AGR	EP	Fahrgestellnummer ab: 6N-YD000 001 Vehicle Identification Number from: 6N-YD000 001
			7.21895.55.0	LDRV	EL	Fahrgestellnummer ab: 6N-YD000 001 Vehicle Identification Number from: 6N-YD000 001
1.7 SDI 44 kW (60 PS) AKU	10.1999→09.2001		7.21903.75.0	DW-TL	EP	
1.9 SDI 47 kW (64 PS) ASX	10.1999→09.2001		7.21903.75.0	DW-TL	EP	 ch. 6N-YD000 001→
POLO (9N_)					68	
1.4 FSI 63 kW (86 PS) AXU	02.2002→07.2006		7.10014.00.0	AKF	EL	 ch. 9N-2-000 001→
			7.22880.01.0	EUV-SR	EL	Fahrgestellnummer ab: 9N-2-000 001 Vehicle Identification Number from: 9N-2-000 001
1.4 TDI 55 kW (75 PS) AMF	10.2001→06.2005		7.21903.70.0	DW-AGR	EP	Fahrgestellnummer ab: 6N-YD000 001 Vehicle Identification Number from: 6N-YD000 001
			7.21895.55.0	LDRV	EL	
1.4 TDI 59 kW (80 PS) BMS	04.2005→11.2009		7.00868.02.0	DW-TL	EP	 ch. 9N-5-500 001→
1.4 TDI 51 kW (70 PS) BWB	04.2005→11.2009		7.00868.02.0	DW-TL	EP	 ch. 9N-5-500 001→
1.6 16V 77 kW (105 PS) BTS	05.2006→11.2009		7.06117.54.0	SV-NWV	EL	Fahrgestellnummer ab: 9N-5-500 001 Vehicle Identification Number from: 9N-5-500 001
1.8 GTI 110 kW (150 PS) BJX	09.2005→11.2009		7.01037.02.0	EUV-SL	EL	
1.8 GTi Cup Edition 132 kW (180 PS) BBU	05.2006→11.2009		7.01037.02.0	EUV-SL	EL	
1.9 SDI 47 kW (64 PS) ASY	10.2001→11.2009		7.02183.01.0	DW-AGR	EP	 ch. 9N-2-000 001→
1.9 TDI 74 kW (101 PS) BMT	10.2001→11.2009		7.00868.02.0	DW-TL	EP	 ch. 9N-5-500 001→
			7.02256.00.0	EUV-AGR	EP	 ch. 9N-5-500 000→



POLO III (6N1) **69**

100 1.4 16V 74 kW (100 PS) AFH	04.1996→10.1999	 7.21483.54.0	EUV-AGR	EL	
60 1.7 SDI 44 kW (60 PS) AKU	08.1997→10.1999	 7.21903.75.0	DW-TL	EP	

POLO III CLASSIC (6V2) **70**

1.9 SDI 47-48 kW (64-65 PS) AEY	06.1996→09.2001	 7.21903.70.0	DW-AGR	EP	
		7.21895.55.0	LDRV	EL	
1.9 TDI 66-67 kW (90-91 PS) AHU	01.1997→08.1999	 7.21903.70.0	DW-AGR	EP	Fahrgestellnummer ab: 6K-Y-502 795 Vehicle Identification Number from: 6K-Y-502 795
		7.21895.55.0	LDRV	EL	
100 1.6 65-76 kW (100-103 PS) AEH, AFT, AKL	12.1995→09.2001	 7.22402.03.0	EUV-SR	EL	 AEH, AKL: Fahrgestellnummer ab: 6K-Y-502 795 Vehicle Identification Number from: 6K-Y-502 795
100 1.6 74 kW (101 PS) APF, AUR	12.1995→09.2001	 7.22880.01.0	EUV-SR	EL	 APF, AUR: Fahrgestellnummer ab: 6K-Y-502 795 Vehicle Identification Number from: 6K-Y-502 795
110 1.9 TDI 81 kW (110 PS) AFN, ASV	06.1998→01.2002	 7.21903.75.0	DW-AGR	EP	 ch. 6K-Y-502 795→
		7.21903.70.0	DW-AGR	EP	 AFN: ab Achslast [t]: 6K-Y-502 795 from Axle Load [t]: 6K-Y-502 795  ASV: Fahrgestellnummer ab: 6K-Y-502 795 Vehicle Identification Number from: 6K-Y-502 795
57 1.7 SDI 42 kW (57 PS) AKW	07.1997→09.2001	 7.21903.70.0	DW-AGR	EP	Fahrgestellnummer ab: 6K-Y-502 795 Vehicle Identification Number from: 6K-Y-502 795
		7.21895.55.0	LDRV	EL	
64 1.9 SDI 47-48 kW (64-65 PS) AEY	12.1995→08.1999	 7.21903.70.0	DW-AGR	EP	
		7.21895.55.0	LDRV	EL	
68 1.9 SDI 50 kW (68 PS) AGP, AQM	08.1999→01.2002	 7.21903.70.0	DW-AGR	EP	 AGP, AQM: Fahrgestellnummer ab: 6K-Y-502 795 Vehicle Identification Number from: 6K-Y-502 795
90 1.9 TDI 66 kW (90 PS) AGR	09.1996→09.2001	 7.21903.70.0	DW-AGR	EP	Fahrgestellnummer ab: 6K-Y-502 795 Vehicle Identification Number from: 6K-Y-502 795
		7.02256.00.0	EUV-AGR	EP	 ch. 6K-Y-502 795→
		7.21895.55.0	LDRV	EL	Fahrgestellnummer ab: 6K-Y-502 795 Vehicle Identification Number from: 6K-Y-502 795
90 1.9 TDI 66-67 kW (90-91 PS) AHU, ALE	01.1997→09.2001	 7.21903.70.0	DW-AGR	EP	 AHU, ALE: Fahrgestellnummer ab: 6K-Y-502 795 Vehicle Identification Number from: 6K-Y-502 795
		7.21895.55.0	LDRV	EL	
90 1.9 TDI 66-67 kW (90-91 PS) ALH	08.1997→09.2001	 7.21903.70.0	DW-AGR	EP	Fahrgestellnummer ab: 6K-Y-502 795 Vehicle Identification Number from: 6K-Y-502 795



POLO IV Saloon (9A4, 9A2, 9N2, 9A6) **71**

1.9 SDI 47 kW (64 PS) ASY	11.2003→04.2012	 7.02183.01.0	DW-AGR	EP	
-------------------------------------	-----------------	---	--------	----	--





























V



POLO IV Saloon (9N4) 72



1.4 TDi 55 kW (75 PS) AMF	01.2003→12.2007	 7.21895.55.0	LDRV	EL	Fahrgestellnummer ab: 6N-YD000 001 Vehicle Identification Number from: 6N-YD000 001
1.6 77 kW (105 PS) BTS	01.2007→12.2010	 7.06117.54.0	SV-NWV	EL	Fahrgestellnummer ab: 9N-5-500 001 Vehicle Identification Number from: 9N-5-500 001
1.6 Classic 74 kW (101 PS) BCD	09.2004→12.2006	 7.22880.01.0	EUV-SR	EL	

POLO V (6R1, 6C1) 73

1.0 44 kW (60 PS) CHYA	01.2014→	 7.06117.48.0	SV-NWV	EL	Fahrgestellnummer ab: 6R-F-000 001 Vehicle Identification Number from: 6R-F-000 001
1.0 55 kW (75 PS) CHYB	01.2014→	 7.06117.48.0	SV-NWV	EL	Fahrgestellnummer ab: 6R-F-000 001 Vehicle Identification Number from: 6R-F-000 001
1.0 TSI 70 kW (95 PS) CHZB	11.2014→	 7.06117.48.0	SV-NWV	EL	Fahrgestellnummer ab: 6R-F-000 001 Vehicle Identification Number from: 6R-F-000 001
1.2 51 kW (70 PS) CGPA	06.2009→	 7.22880.01.0	EUV-KK	EL	 ch. 6R-D-000 001→
1.2 55 kW (75 PS) CJLA	08.2011→	 7.22880.01.0	EUV-AGR	EL	Fahrgestellnummer ab: 6K-Y-502 795 Vehicle Identification Number from: 6K-Y-502 795 ▣▣ Indien ▣▣ India
1.2 TDi 55 kW (75 PS) CFWA	10.2009→	 7.22880.01.0	EUV-AGR	EL	Fahrgestellnummer ab: 60-AT000 001 Vehicle Identification Number from: 60-AT000 001 ▣▣ Indien ▣▣ India
1.2 TSi 77 kW (105 PS) CBZB	11.2009→	 7.22880.01.0	EUV-KK	EL	Fahrgestellnummer ab: 60-AT000 001 Vehicle Identification Number from: 60-AT000 001 ▣▣ Indien ▣▣ India
1.2 TSi 66 kW (90 PS) CBZC	05.2011→05.2014	 7.22880.01.0	EUV-KK	EL	Fahrgestellnummer ab: 6R-A-000 001 Vehicle Identification Number from: 6R-A-000 001
1.4 GTI 132 kW (180 PS) CAVE, CTHE	05.2010→	 7.02588.04.0	LDRV	EL	 CAVE, CTHE:  ch. 6R-A-000 001→
		7.04247.02.0	SUV	EL	 CAVE:  ch. 6R-A-000 001→  CTHE:  ch. 6R-D-000 001→
		7.06117.54.0	SV-NWV	EL	 CAVE: Fahrgestellnummer ab: 6R-A-000 001 Vehicle Identification Number from: 6R-A-000 001  CTHE: Fahrgestellnummer ab: 6R-D-000 001 Vehicle Identification Number from: 6R-D-000 001
1.4 TSi 103 kW (140 PS) CPTA	10.2012→05.2014	 7.06117.48.0	SV-NWV	EL	Fahrgestellnummer ab: 6R-D-000 001 Vehicle Identification Number from: 6R-D-000 001
1.4 TSi 110 kW (150 PS) CZEA	05.2014→10.2017	 7.06117.48.0	SV-NWV	EL	Fahrgestellnummer ab: 6R-F-000 001 Vehicle Identification Number from: 6R-F-000 001
1.5 TDi 66 kW (90 PS) CWXA	07.2014→03.2020	 7.02256.00.0	EUV-AGR	EP	 ch. 60-FT000 001→
1.5 TDi GT 77 kW (105 PS) CWXB	04.2014→	 7.02256.00.0	EUV-AGR	EP	 ch. 60-FT000 001→
1.5 TDi GT 81 kW (110 PS) CWXC	04.2017→03.2020	 7.02256.00.0	EUV-AGR	EP	 ch. 60-FT000 001→
1.6 TDi 55 kW (75 PS) CAYA	06.2009→	 7.02256.00.0	EUV-AGR	EP	 ch. 6R-A-000 001→









POLO V (6R1, 6C1)						73
1.6 TDI 66 kW (90 PS) CAYB	06.2009→		7.02256.00.0	EUV-AGR	EP ch. 6R-A-000 001→	
1.6 TDI 77 kW (105 PS) CAYC, CLNA	06.2009→		7.02256.00.0	EUV-AGR	EP CAYC, CLNA: ch. 6R-A-000 001→	
1.8 GTI 141-169 kW (192-230 PS) DAJA, DAJB	11.2014→		7.02256.18.0	EUV-SR	EP DAJA, DAJB: Fahrgestellnummer ab: 6R-F-000 001 Vehicle Identification Number from: 6R-F-000 001	
			7.02901.05.0	SUV	EL	
			7.06117.26.0	ZM-NWV	EL DAJA, DAJB: Fahrgestellnummer ab: 6R-F-000 001 Vehicle Identification Number from: 6R-F-000 001	
1.8 GTI 230 141-169 kW (192-230 PS) DAJA	04.2016→		7.06117.26.0	ZM-NWV	EL Fahrgestellnummer ab: 6R-F-000 001 Vehicle Identification Number from: 6R-F-000 001	
2.0 R WRC 162 kW (220 PS) CDLJ	08.2013→05.2014		7.00470.07.0	LDRV	EL ch. 6R-D-000 001→	
			7.01830.13.0	SUV	EL	
POLO V Saloon (602, 604, 612, 614)						74
1.4 TSi 92 kW (125 PS) CZCA	05.2016→		7.06117.48.0	SV-NWV	EL Fahrgestellnummer ab: 61-F-000 001 Vehicle Identification Number from: 61-F-000 001 ■ Russland ■ Russia	
POLO VI (AW1, BZ1)						75
1.0 55 kW (75 PS) CHYB	06.2017→		7.06117.48.0	SV-NWV	EL Fahrgestellnummer ab: AW-J-000 001 Vehicle Identification Number from: AW-J-000 001	
1.0 48 kW (65 PS) CHYC	08.2017→		7.06117.48.0	SV-NWV	EL Fahrgestellnummer ab: AW-J-000 001 Vehicle Identification Number from: AW-J-000 001	
1.0 TGI 66 kW (90 PS) DBYA	09.2017→		7.06117.48.0	SV-NWV	EL Fahrgestellnummer ab: AW-J-000 001 Vehicle Identification Number from: AW-J-000 001	
1.0 TSI 70 kW (95 PS) CHZL, DKLA	06.2017→		7.06117.48.0	SV-NWV	EL CHZL, DKLA: Fahrgestellnummer ab: AW-J-000 001 Vehicle Identification Number from: AW-J-000 001	
1.0 TSI 85 kW (115 PS) CHZJ, DKJA, DKRF	09.2017→		7.06117.48.0	SV-NWV	EL CHZJ, DKJA, DKRF: Fahrgestellnummer ab: AW-J-000 001 Vehicle Identification Number from: AW-J-000 001	
POLO Variant (6V5)						76
1.6 65-76 kW (100-103 PS) AEH, AFT, AKL 1.6 74 kW (101 PS) APF, AUR	05.1997→09.2001		7.22402.03.0	EUV-SR	EL	
			7.22880.01.0	EUV-AGK	EL	
			7.22880.01.0	EUV-AGR	EL	
			7.22880.01.0	EUV-KK	EL	
			7.22880.01.0	EUV-LS	EL	
			7.22880.01.0	EUV-ML	EL	
			7.22880.01.0	EUV-SL	EL	
1.7 SDI 42 kW (57 PS) AKW	08.1997→09.2001		7.21903.70.0	DW-AGR	EP	
			7.21895.55.0	LDRV	EL	
1.9 SDI 47-48 kW (64-65 PS) AEY	06.1997→09.2001		7.21903.70.0	DW-AGR	EP	
			7.21895.55.0	LDRV	EL	





						
POLO Variant (6V5)						76
1.9 SDI 50 kW (68 PS) AGP, AQM	08.1999→09.2001		7.21903.70.0	DW-AGR	EP  AGP, AQM: ch. 6K-Y-502 795→	
1.9 TDI 66 kW (90 PS) AGR	05.1997→09.2001		7.02256.00.0	EUV-AGR	EP  ch. 6K-Y-502 795→	
			7.21895.55.0	LDRV	EL Fahrgestellnummer ab: 6K-Y-502 795 Vehicle Identification Number from: 6K-Y-502 795	
1.9 TDI 66-67 kW (90-91 PS) AHU, ALE	05.1997→09.2001		7.21903.70.0	DW-AGR	EP	
			7.21895.55.0	LDRV	EL	
1.9 TDI 66-67 kW (90-91 PS) ALH	08.1997→09.2001		7.21903.70.0	DW-AGR	EP  ch. 6K-Y-502 795→	
			7.21903.75.0	DW-AGR	EP  ch. 6K-Y-502 795→	
1.9 TDI 81 kW (110 PS) AFN, ASV	06.1998→09.2001		7.21903.70.0	DW-AGR	EP  ch. 6K-Y-502 795→	
			7.21903.75.0	DW-AGR	EP  ch. 6K-Y-502 795→	
SAGITAR (VRC)						77
1.8i TFSI 16V	01.2008→		7.01830.13.0	SUV	EL	
SCIROCCO III (137, 138)						78
1.4 TSI 118 kW (160 PS) CAVD, CNWA, CTHD, CTKA	05.2008→11.2017		7.02588.04.0	LDRV	EL	
			7.04247.02.0	SUV	EL	
			7.06117.54.0	SV-NWV	EL	
1.4 TSI 90 kW (122 PS) CAXA, CMSB	08.2008→11.2017		7.01830.13.0	SUV	EL	
			7.06117.54.0	SV-NWV	EL	
1.4 TSI 92 kW (125 PS) CZCA	11.2013→11.2017		7.06117.48.0	SV-NWV	EL	
1.4 TSI 110 kW (150 PS) CZDA	07.2015→11.2017		7.06117.48.0	SV-NWV	EL	
1.4 TSI 96 kW (130 PS) CZDC	07.2015→11.2017		7.06117.48.0	SV-NWV	EL	
2.0 R 188 kW (256 PS) CDLC	11.2009→11.2017		7.02256.00.0	EUV-AGK	EP	
			7.00470.07.0	LDRV	EL	
			7.01830.13.0	SUV	EL	
2.0 R 195 kW (265 PS) CDLA	11.2009→11.2017		7.06117.46.0	SV-NWV	EH mit Dichtring with O-ring	
			7.02256.00.0	EUV-AGK	EP	
2.0 R 206 kW (280 PS) CDLK	05.2014→11.2017		7.00470.07.0	LDRV	EL	
			7.06117.46.0	SV-NWV	EH mit Dichtring with O-ring	
			7.02256.00.0	EUV-AGK	EP	
2.0 TDI 103 kW (140 PS) CBDB	08.2008→11.2017		7.00470.07.0	LDRV	EL	
			7.01830.13.0	SUV	EL	
			7.06117.46.0	SV-NWV	EH mit Dichtring with O-ring	
2.0 TDI 103 kW (140 PS) CFHC	08.2008→11.2017		7.00868.02.0	DW-TL	EP	
			7.02256.00.0	EUV-AGR	EP	
2.0 TDI 125 kW (170 PS) CBBB	05.2009→11.2017		7.02256.00.0	EUV-AGR	EP	
			7.00868.02.0	DW-TL	EP	



SCIROCCO III (137, 138) 78















2.0 TDI 125 kW (170 PS) CFGB	05.2009→11.2017		7.02256.00.0	EUV-AGR	EP	
2.0 TDI 100 kW (136 PS) CFHB	11.2010→11.2017		7.02256.00.0	EUV-AGR	EP	
2.0 TDI 130 kW (177 PS) CFGC	01.2013→11.2017		7.02256.00.0	EUV-AGR	EP	
2.0 TSI 147 kW (200 PS) CAWB	05.2008→11.2009		7.03280.04.0	EUV-SR	EL	für OE-Nummer: 06J 145 713 K, 06J 145 713 KX, 06J 145 713 T, 06J 145 713 TX, 06J 145 722 B, 06J 145 722 BX for OE number: 06J 145 713 K, 06J 145 713 KX, 06J 145 713 T, 06J 145 713 TX, 06J 145 722 B, 06J 145 722 BX
7.22880.01.0			EUV-SR	EL		
7.00470.07.0			LDRV	EL		
7.01830.13.0			SUV	EL		
7.02901.05.0			SUV	EL		
7.06117.26.0	ZM-NWV	EL				
2.0 TSI 155 kW (211 PS) CCZB	11.2009→11.2017		7.03280.04.0	EUV-SR	EL	für OE-Nummer: 06J 145 713 K, 06J 145 713 KX, 06J 145 713 T, 06J 145 713 TX, 06J 145 722 B, 06J 145 722 BX for OE number: 06J 145 713 K, 06J 145 713 KX, 06J 145 713 T, 06J 145 713 TX, 06J 145 722 B, 06J 145 722 BX
7.22880.01.0			EUV-SR	EL		
7.00470.07.0			LDRV	EL		
7.02901.05.0			SUV	EL		
7.06117.26.0			ZM-NWV	EL		
2.0 TSI 132 kW (180 PS) CULA	11.2013→11.2017		7.02256.18.0	EUV-SR	EP	
7.06117.26.0			ZM-NWV	EL		
2.0 TSI 162 kW (220 PS) CULC	11.2013→11.2017		7.02256.18.0	EUV-SR	EP	
7.02901.05.0			SUV	EL		
7.06117.26.0			ZM-NWV	EL		

SHARAN (7M8, 7M9, 7M6) 79

1.8 T 20V 110 kW (150 PS) AWC	04.2000→03.2010		7.28098.04.0	EUV-KA	EL	für Fahrzeuge mit Standheizung for vehicles with parking heater
1.9 TDI 66-67 kW (90-91 PS) 1Z, AHU	09.1995→03.2010		7.21903.70.0	DW-AGR	EP	
			7.21895.55.0	LDRV	EL	
1.9 TDI 81 kW (110 PS) AFN, AVG	09.1996→04.2000		7.21903.70.0	DW-AGR	EP	
			7.21903.75.0	DW-TL	EP	
1.9 TDI 66 kW (90 PS) ANU	09.1999→03.2010		7.02183.01.0	DW-AGR	EP	01.2001→
			7.21903.70.0	DW-AGR	EP	für Fahrzeuge mit Standheizung for vehicles with parking heater
			7.02256.00.0	EUV-AGR	EP	
			7.28098.04.0	EUV-KA	EL	
			7.01037.02.0	LDRV	EL	
7.21895.55.0	LDRV	EL				
1.9 TDI 85 kW (115 PS) AUY, BVK	04.2000→03.2010		7.02183.01.0	DW-AGR	EP	01.2001→
			7.02184.01.0	DW-TL	EP	
			7.02256.00.0	EUV-AGR	EP	



SHARAN (7M8, 7M9, 7M6) 79

			7.28098.04.0	EUV-KA	EL	 AUY, BVK: für Fahrzeuge mit Standheizung for vehicles with parking heater
1.9 TDI 96 kW (130 PS) ASZ	11.2002→03.2010		7.02183.01.0	DW-AGR	EP	für Fahrzeuge mit Standheizung for vehicles with parking heater
			7.02184.01.0	DW-TL	EP	
			7.02256.00.0	EUV-AGR	EP	
			7.28098.04.0	EUV-KA	EL	
1.9 TDI 110 kW (150 PS) BTB	06.2005→03.2010		7.02183.01.0	DW-AGR	EP	für Fahrzeuge mit Standheizung for vehicles with parking heater
			7.02184.01.0	DW-TL	EP	
			7.02256.00.0	EUV-AGR	EP	
			7.28098.04.0	EUV-KA	EL	
1.9 TDI 4motion 85 kW (115 PS) AU Y	04.2000→03.2010		7.02183.01.0	DW-AGR	EP	01.2001→ für Fahrzeuge mit Standheizung for vehicles with parking heater
			7.02184.01.0	DW-TL	EP	
			7.02256.00.0	EUV-AGR	EP	
			7.28098.04.0	EUV-KA	EL	
2.0 85 kW (115 PS) ADY	09.1995→04.2000		7.21483.54.0	EUV-AGR	EL	
2.0 85 kW (115 PS) ATM	04.2000→03.2010		7.28098.04.0	EUV-KA	EL	für Fahrzeuge mit Standheizung for vehicles with parking heater
2.0 LPG 85 kW (115 PS) ATM	04.2006→03.2010		7.28098.04.0	EUV-KA	EL	für Fahrzeuge mit Standheizung for vehicles with parking heater
2.0 TDI 100 kW (136 PS) BVH	11.2005→03.2010		7.00868.02.0	DW-TL	EP	für Fahrzeuge mit Standheizung for vehicles with parking heater
			7.28098.04.0	EUV-KA	EL	
2.0 TDI 103 kW (140 PS) BRT	11.2005→03.2010		7.00868.02.0	DW-TL	EP	für Fahrzeuge mit Standheizung for vehicles with parking heater
			7.28098.04.0	EUV-KA	EL	
2.8 V6 24V 150 kW (204 PS) AYL	04.2000→03.2010		7.28098.04.0	EUV-KA	EL	für OE-Nummer: 037 906 283 D for OE number: 037 906 283 D für Fahrzeuge mit Standheizung for vehicles with parking heater
			7.06117.44.0	SV-NWV	EL	mit Dichtring with O-ring Einlassseite Intake Side
2.8 V6 24V 4motion 150 kW (204 PS) AYL	04.2000→03.2010		7.28098.04.0	EUV-KA	EL	für OE-Nummer: 037 906 283 D for OE number: 037 906 283 D für Fahrzeuge mit Standheizung for vehicles with parking heater
			7.06117.44.0	SV-NWV	EL	mit Dichtring with O-ring Einlassseite Intake Side
2.8 VR6 120-128 kW (163-174 PS) AAA, AMY	09.1995→04.2000		7.21483.54.0	EUV-AGR	EL	
2.8 VR6 Syncro 120-128 kW (163-174 PS) AAA, AMY	11.1996→04.2000		7.21483.54.0	EUV-AGR	EL	

SHARAN (7N1, 7N2) 80





















1.4 TSI 110 kW (150 PS) CAVA, CTHA	05.2010→		7.02588.04.0	LDRV	EL	
			7.04247.02.0	SUV	EL	



SHARAN (7N1, 7N2) 80

			7.02256.40.0	SV-KK	EL	CAVA, CTHA: für Fahrzeuge mit Standheizung for vehicles with parking heater
			7.06117.54.0	SV-NWV	EL	
1.4 TSI 110 kW (150 PS) CNWB	05.2010→		7.02588.04.0	LDRV	EL	
			7.04247.02.0	SUV	EL	
1.4 TSI 110 kW (150 PS) CZDA, DJKA	05.2015→		7.02256.41.0	SV-KK	EL	CZDA, DJKA: ch. 7N-G-200 001→ für Fahrzeuge mit Standheizung for vehicles with parking heater
			7.06117.48.0	SV-NWV	EL	CZDA, DJKA: Fahrgestellnummer ab: 7N-G-200 001 Vehicle Identification Number from: 7N-G-200 001
1.8 TSI 118 kW (160 PS) CDAA	11.2011→		7.03280.04.0	EUV-SR	EL	
			7.22880.01.0	EUV-SR	EL	
			7.00470.07.0	LDRV	EL	
			7.01830.13.0	SUV	EL	
			7.02256.40.0	SV-KK	EL	für Fahrzeuge mit Standheizung for vehicles with parking heater
			7.06117.26.0	ZM-NWV	EL	
2.0 TDI 103 kW (140 PS) CFFB	05.2010→		7.02256.00.0	EUV-AGR	EP	
			7.02256.40.0	SV-KK	EL	für Fahrzeuge mit Standheizung for vehicles with parking heater
2.0 TDI 100 kW (136 PS) CFFA	05.2010→		7.02256.00.0	EUV-AGR	EP	
			7.02256.40.0	SV-KK	EL	für Fahrzeuge mit Standheizung for vehicles with parking heater
2.0 TDI 125 kW (170 PS) CFGB	08.2010→		7.02256.00.0	EUV-AGR	EP	
			7.02256.40.0	SV-KK	EL	für Fahrzeuge mit Standheizung for vehicles with parking heater
2.0 TDI 85 kW (115 PS) CFFE	05.2011→07.2019		7.02256.00.0	EUV-AGR	EP	
			7.02256.40.0	SV-KK	EL	für Fahrzeuge mit Standheizung for vehicles with parking heater
2.0 TDI 85 kW (115 PS) CUVA, DFLD	05.2011→07.2019		7.02256.41.0	SV-KK	EL	CUVA, DFLD: ch. 7N-G-200 001→ für Fahrzeuge mit Standheizung for vehicles with parking heater
2.0 TDI 130 kW (177 PS) CFGC	01.2013→11.2015		7.02256.00.0	EUV-AGR	EP	
			7.02256.40.0	SV-KK	EL	für Fahrzeuge mit Standheizung for vehicles with parking heater
2.0 TDI 110 kW (150 PS) CUVC, DFLA, DLTA	05.2015→11.2015		7.02256.41.0	SV-KK	EL	CUVC, DFLA, DLTA: ch. 7N-G-200 001→ für Fahrzeuge mit Standheizung for vehicles with parking heater
2.0 TDI 135 kW (184 PS) CUWA, DFMA	05.2015→		7.02256.41.0	SV-KK	EL	CUWA, DFMA: ch. 7N-G-200 001→ für Fahrzeuge mit Standheizung for vehicles with parking heater
2.0 TDI 4motion 103 kW (140 PS) CFFB	05.2011→11.2015		7.02256.00.0	EUV-AGR	EP	
			7.02256.40.0	SV-KK	EL	für Fahrzeuge mit Standheizung for vehicles with parking heater
2.0 TSI 147 kW (200 PS) CCZA	12.2010→		7.03280.04.0	EUV-SR	EL	
			7.22880.01.0	EUV-SR	EL	





V

						
SHARAN (7N1, 7N2)						80
			7.00470.07.0 7.02901.05.0	LDRV SUV	EL EL	für OE-Nummer: 06J 145 713 K, 06J 145 713 KX, 06J 145 713 T, 06J 145 713 TX, 06J 145 722 B, 06J 145 722 BX für OE number: 06J 145 713 K, 06J 145 713 KX, 06J 145 713 T, 06J 145 713 TX, 06J 145 722 B, 06J 145 722 BX für Fahrzeuge mit Standheizung for vehicles with parking heater
			7.02256.40.0	SV-KK	EL	
			7.06117.26.0	ZM-NWV	EL	
2.0 TSI 162 kW (220 PS) DEDA	05.2015→		7.02256.18.0	EUV-SR	EP	
			7.02901.05.0 7.02256.41.0	SUV SV-KK	EL EL	Fahrgestellnummer ab: 7N-G-200 001 Vehicle Identification Number from: 7N-G-200 001 Produktionsdatum bis: 18.05.2018 Production date to: 18.05.2018  ch. 7N-G-200 001→ für Fahrzeuge mit Standheizung for vehicles with parking heater
			7.06117.26.0	ZM-NWV	EL	
SURAN (5Z)						81
1.9 SDI 47 kW (64 PS) ASY	09.2007→		7.02183.01.0	DW-AGR	EP	
T-CROSS (C11)						82
1.0 TSi 70 kW (95 PS) CHZL, DKLA	12.2018→		7.06117.48.0	SV-NWV	EL	
1.0 TSi 85 kW (115 PS) DKJA, DKRF	12.2018→		7.06117.48.0	SV-NWV	EL	
T-ROC (A11)						83
1.0 TSi 85 kW (115 PS) CHZJ, DKRF	07.2017→		7.06117.48.0	SV-NWV	EL	
2.0 R 4motion 221 kW (300 PS) DNUE	09.2019→		7.06117.26.0	ZM-NWV	EL	
2.0 TSi 4motion 140 kW (190 PS) CZPB	07.2017→		7.02901.05.0	SUV	EL	
T-ROC Convertible (AC7)						84
1.0 TSi 85 kW (115 PS) DKRF	12.2019→		7.06117.48.0	SV-NWV	EL	
TIGUAN (5N_)						85
1.4 TSi 110 kW (150 PS) CAVA, CTHA	05.2008→07.2018		7.02588.04.0 7.04247.02.0 7.06117.54.0	LDRV SUV SV-NWV	EL EL EL	01.2012→
1.4 TSi 90 kW (122 PS) CAXA	08.2010→07.2018		7.01830.13.0 7.06117.54.0	SUV SV-NWV	EL EL	
1.4 TSi 118 kW (160 PS) CAVD	05.2011→07.2018		7.02588.04.0 7.04247.02.0 7.06117.54.0	LDRV SUV SV-NWV	EL EL EL	
1.4 TSi 118 kW (160 PS) CTHD	05.2011→07.2018		7.04247.02.0 7.06117.54.0	SUV SV-NWV	EL EL	
1.4 TSi 92 kW (125 PS) CZDB	05.2015→07.2018		7.06117.48.0	SV-NWV	EL	

V





TIGUAN (5N_) 85











1.4 TSI 110 kW (150 PS) CZDA	05.2015→07.2018	 7.06117.48.0	SV-NWV	EL	
1.4 TSI 4motion 110 kW (150 PS) BWK	09.2007→07.2018	 7.01044.03.0	EUV-SR	EL	
		7.02588.04.0	LDRV	EL	
		7.04247.02.0	SUV	EL	
1.4 TSI 4motion 110 kW (150 PS) CAVA, CTHA	09.2007→07.2018	 7.06117.54.0	SV-NWV	EL	01.2012→
		7.02588.04.0	LDRV	EL	
		7.04247.02.0	SUV	EL	
1.4 TSI 4motion 118 kW (160 PS) CAVD, CTHD	05.2011→07.2018	 7.06117.54.0	SV-NWV	EL	
		7.02588.04.0	LDRV	EL	
		7.04247.02.0	SUV	EL	
2.0 TDI 103 kW (140 PS) CBAB, CFFB	03.2008→07.2018	 7.00868.02.0	DW-TL	EP	
		7.02256.00.0	EUV-AGR	EP	
2.0 TDI 81 kW (110 PS) CFFD	05.2010→07.2018	 7.02256.00.0	EUV-AGR	EP	
		7.00868.02.0	DW-TL	EP	
2.0 TDI 4motion 103 kW (140 PS) CBAB, CFFB, CLJA	09.2007→07.2018	 7.00868.02.0	DW-TL	EP	
		7.02256.00.0	EUV-AGR	EP	
		7.00868.02.0	DW-TL	EP	
2.0 TDI 4motion 125 kW (170 PS) CBBB, CFGB	09.2007→07.2018	 7.00868.02.0	DW-TL	EP	
		7.02256.00.0	EUV-AGR	EP	
		7.00868.02.0	DW-TL	EP	
2.0 TDI 4motion 100 kW (136 PS) CBAA, CFFA	11.2007→07.2018	 7.00868.02.0	DW-TL	EP	
		7.02256.00.0	EUV-AGR	EP	
		7.00868.02.0	DW-TL	EP	
2.0 TDI 4motion 120 kW (163 PS) CBBA	02.2008→08.2009	 7.00868.02.0	DW-TL	EP	
		7.02256.00.0	EUV-AGR	EP	
		7.00868.02.0	DW-TL	EP	
2.0 TDI 4motion 130 kW (177 PS) CFGC	11.2012→07.2018	 7.00868.02.0	DW-TL	EP	
		7.02256.00.0	EUV-AGR	EP	
		7.03280.04.0	EUV-SR	EL	
		7.22880.01.0	EUV-SR	EL	
2.0 TFSI 147-157 kW (200-213 PS) CAWB, CCTA	11.2007→07.2018	 7.00470.07.0	LDRV	EL	
		7.02901.05.0	SUV	EL	
		7.06117.26.0	ZM-NWV	EL	
		7.03280.04.0	EUV-SR	EL	
		7.22880.01.0	EUV-SR	EL	
2.0 TFSI 4motion 147-157 kW (200-213 PS) CAWB, CCTA, CCZA	09.2007→07.2018	 7.00470.07.0	LDRV	EL	
		7.02901.05.0	SUV	EL	
		7.06117.26.0	ZM-NWV	EL	
		7.03280.04.0	EUV-SR	EL	
		7.22880.01.0	EUV-SR	EL	
2.0 TFSI 4motion 125 kW (170 PS) CAWA	09.2007→07.2018	 7.01830.13.0	SUV	EL	
		7.02901.05.0	SUV	EL	
		7.06117.26.0	ZM-NWV	EL	
		7.03280.04.0	EUV-SR	EL	
		7.22880.01.0	EUV-SR	EL	
2.0 TFSI 4motion 125 kW (170 PS) CCTB	09.2007→07.2018	 7.03280.04.0	EUV-SR	EL	
		7.03280.04.0	EUV-SR	EL	



TIGUAN (5N_) 85

2.0 TFSI 4motion 125 kW (170 PS) CCZC	09.2007→07.2018		7.03280.04.0	EUV-SR	EL
			7.22880.01.0	EUV-SR	EL
			7.00470.07.0	LDRV	EL
			7.02901.05.0	SUV	EL
2.0 TSI 4motion 132 kW (180 PS) CCZD	05.2011→07.2018		7.03280.04.0	EUV-SR	EL
			7.22880.01.0	EUV-SR	EL
			7.00470.07.0	LDRV	EL
			7.06117.26.0	ZM-NWV	EL
2.0 TSI 4motion 155 kW (211 PS) CCZB	05.2011→07.2018		7.03280.04.0	EUV-SR	EL
			7.00470.07.0	LDRV	EL
			7.02901.05.0	SUV	EL
			7.06117.26.0	ZM-NWV	EL

TIGUAN (AD1, AX1) 86

1.4 TSI 92 kW (125 PS) CZCA	01.2016→07.2018		7.06117.48.0	SV-NWV	EL	Fahrgestellnummer ab: WVGZZZ5NZZG-000001 Vehicle Identification Number from: WVGZZZ5NZZG-000001
1.4 TSI 110 kW (150 PS) CZDA, CZIA, DJVA	01.2016→07.2018		7.06117.48.0	SV-NWV	EL	 CZDA, CZIA, DJVA: Fahrgestellnummer ab: WVGZZZ5NZZG-000001 Vehicle Identification Number from: WVGZZZ5NZZG-000001
1.4 TSI 4motion 110 kW (150 PS) CZDA, CZIA	05.2016→07.2018		7.06117.48.0	SV-NWV	EL	 CZDA, CZIA: Fahrgestellnummer ab: WVGZZZ5NZZG-000001 Vehicle Identification Number from: WVGZZZ5NZZG-000001
2.0 TDI 4motion 110 kW (150 PS) DBGC	01.2016→07.2020		7.02256.00.0	EUV-AGR	EP	 ch. WVGZZZ5NZZG-00000→ch. A D1*** Euro 4 Euro 4
2.0 TDI 4motion 105 kW (143 PS) CRFD	06.2016→07.2020		7.02256.00.0	EUV-AGR	EP	 ch. WVGZZZ5NZZG-00000→ch. A D1*** Euro 4 Euro 4
2.0 TSI 4motion 132 kW (180 PS) CZPA	01.2016→		7.02256.18.0	EUV-SR	EP	Fahrgestellnummer ab: WVGZZZ5NZZG-000001 Vehicle Identification Number from: WVGZZZ5NZZG-000001 Fahrgestellnummer bis: AD1*** Vehicle Identification Number to: AD1*** für OE-Nummer: 06H 906 283 F for OE number: 06H 906 283 F
			7.02901.05.0	SUV	EL	
2.0 TSI 4motion 162 kW (220 PS) CHHB	06.2016→		7.02256.18.0	EUV-SR	EP	Fahrgestellnummer ab: WVGZZZ5NZZG-000001 Vehicle Identification Number from: WVGZZZ5NZZG-000001 Fahrgestellnummer bis: AD1*** Vehicle Identification Number to: AD1*** für OE-Nummer: 06H 906 283 F for OE number: 06H 906 283 F
			7.02901.05.0	SUV	EL	
			7.06117.26.0	ZM-NWV	EL	





















TIGUAN (AD1, AX1) 86

2.0 TSI 4motion 169 kW (230 PS) DKTA	09.2018→07.2020		7.02256.18.0	EUV-SR	EP	Fahrgestellnummer ab: WVGZZZ5NZG-000001 Vehicle Identification Number from: WVGZZZ5NZG-000001 Fahrgestellnummer bis: AD1*** Vehicle Identification Number to: AD1*** für OE-Nummer: 06H 906 283 F for OE number: 06H 906 283 F
			7.02901.05.0	SUV	EL	
2.0 TSI 4motion 140 kW (190 PS) DKZA	09.2018→		7.02256.18.0	EUV-SR	EP	Fahrgestellnummer ab: WVGZZZ5NZG-000001 Vehicle Identification Number from: WVGZZZ5NZG-000001 Fahrgestellnummer bis: AD1*** Vehicle Identification Number to: AD1*** für OE-Nummer: 06H 906 283 F for OE number: 06H 906 283 F
			7.02901.05.0	SUV	EL	

TIGUAN ALLSPACE (BW2) 87

1.4 TSI 110 kW (150 PS) CZDA, CZEA	06.2017→09.2018		7.06117.48.0	SV-NWV	EL	
1.4 TSI E100 Flex 110 kW (150 PS) CWLA	07.2017→		7.06117.48.0	SV-NWV	EL	
2.0 TDI 4motion 110 kW (150 PS) DBGC	06.2017→		7.02256.00.0	EUV-AGR	EP	 ch. WVGZZZ5NZG-00000→ch. A D1*** Euro 4 Euro 4
2.0 TSI 137 kW (186 PS) DGUA	04.2017→		7.02901.05.0	SUV	EL	
2.0 TSI 4motion 132 kW (180 PS) DGVA	03.2017→		7.02901.05.0	SUV	EL	
2.0 TSI 4motion 137 kW (186 PS) DGUA	04.2017→		7.02901.05.0	SUV	EL	
2.0 TSI 4motion 162 kW (220 PS) CXDA	07.2017→		7.02901.05.0	SUV	EL	
			7.06117.26.0	ZM-NWV	EL	
2.0 TSI 4motion 162 kW (220 PS) DNJA	07.2017→		7.06117.26.0	ZM-NWV	EL	
2.0 TSI 4motion 169 kW (230 PS) DKTA	09.2018→		7.02901.05.0	SUV	EL	
2.0 TSI 4motion 140 kW (190 PS) DNLA	09.2018→		7.02901.05.0	SUV	EL	

































TOUAREG (7LA, 7L6, 7L7) 88

2.5 R5 TDI 128 kW (174 PS) BAC	01.2003→05.2010		7.00580.01.0	DW-AGR	EP	 ch. 7L-6-020 001→  →ch. 7L-6-020 000 für Fahrzeuge mit Standheizung for vehicles with parking heater
			7.02184.01.0	DW-TL	EP	
			7.02256.00.0	EUV-AGR	EP	
			7.02256.41.0	SV-KK	EL	
			7.02256.42.0	SV-KK	EL	
2.5 R5 TDI 128 kW (174 PS) BPE	01.2003→05.2010		7.02184.01.0	DW-TL	EP	 ch. 7L-6-020 001→
			7.02256.00.0	EUV-AGR	EP	
			7.02256.41.0	SV-KK	EL	
2.5 R5 TDI 120 kW (163 PS) BLK	08.2003→05.2010		7.00580.01.0	DW-AGR	EP	
			7.02184.01.0	DW-TL	EP	
			7.02256.00.0	EUV-AGR	EP	

V



























TOUAREG (7LA, 7L6, 7L7) **88**

			7.02256.41.0 7.02256.42.0	SV-KK SV-KK	EL EL	 ch. 7L-6-020 001→  →ch. 7L-6-020 000 für Fahrzeuge mit Standheizung for vehicles with parking heater
2.5 R5 TDI 120 kW (163 PS) BPD	08.2003→05.2010		7.02184.01.0 7.02256.00.0 7.02256.41.0	DW-TL EUV-AGR SV-KK	EP EP EL	 ch. 7L-6-020 001→
3.0 TDI 155 kW (211 PS) BUN	04.2006→05.2010		7.01019.01.0 7.02256.00.0 7.02256.41.0	DW-AGR EUV-AGR SV-KK	EP EP EL	 ch. 7L-6-020 001→
3.0 TDI 155 kW (211 PS) CASB	04.2006→05.2010		7.02256.00.0 7.02256.41.0	EUV-AGR SV-KK	EP EL	 ch. 7L6***→  ch. 7L6***→
3.0 V6 TDI 165 kW (224 PS) BKS	11.2004→05.2010		7.01019.01.0 7.02256.00.0 7.02256.41.0 7.02256.42.0	DW-AGR EUV-AGR SV-KK SV-KK	EP EP EL EL	 ch. 7L-6-020 001→  →ch. 7L-6-020 000 für Fahrzeuge mit Standheizung for vehicles with parking heater
3.0 V6 TDI 165 kW (224 PS) CATA	11.2004→05.2010		7.02256.00.0 7.02256.41.0	EUV-AGR SV-KK	EP EL	 ch. 7L6***→  ch. 7L6***→
3.0 V6 TDI 176 kW (240 PS) CASA, CASC	11.2007→05.2010		7.02256.00.0 7.02256.41.0	EUV-AGR SV-KK	EP EL	 CASA, CASC:  ch. 7L6***→
3.2 V6 162 kW (220 PS) AZZ, BKJ	10.2002→11.2006		7.02256.42.0 7.06117.43.0 7.06117.44.0	SV-KK SV-NWV SV-NWV	EL EL EL	 AZZ, BKJ: für Fahrzeuge mit Standheizung for vehicles with parking heater mit Dichtring with O-ring  AZZ, BKJ: Auslasseite Exhaust Side mit Dichtring with O-ring  AZZ, BKJ: Einlasseite Intake Side
3.2 V6 162-177 kW (220-241 PS) BMV, BMX, BRJ	10.2002→11.2006		7.02256.41.0 7.02256.42.0 7.06117.43.0 7.06117.44.0	SV-KK SV-KK SV-NWV SV-NWV	EL EL EL EL	 BMV, BMX, BRJ:  ch. 7L-6-020-001→  BMV, BMX, BRJ:  →ch. 7L-6-020 000 für Fahrzeuge mit Standheizung for vehicles with parking heater mit Dichtring with O-ring  BMV, BMX, BRJ: Auslasseite Exhaust Side mit Dichtring with O-ring  BMV, BMX, BRJ: Einlasseite Intake Side
3.2 V6 162-177 kW (220-241 PS) BMV	11.2004→11.2006		7.02256.41.0 7.02256.42.0 7.06117.43.0	SV-KK SV-KK SV-NWV	EL EL EL	 ch. 7L-6-020-001→  →ch. 7L-6-020 000 für Fahrzeuge mit Standheizung for vehicles with parking heater mit Dichtring with O-ring Auslasseite Exhaust Side







TOUAREG (7LA, 7L6, 7L7) **88**













			7.06117.44.0	SV-NWV	EL	mit Dichtring with O-ring Einlassseite Intake Side
3.6 V6 FSI 206 kW (280 PS) BHK	10.2005→05.2010		7.02256.41.0	SV-KK	EL	 ch. 7L-6-020 001→
			7.02256.42.0	SV-KK	EL	 →ch. 7L-6-020 000 für Fahrzeuge mit Standheizung for vehicles with parking heater
			7.06117.37.0	SV-NWV	EL	 ch. 7L6***→ Fahrgestellnummer bis: 7L-8-090 000 Vehicle Identification Number to: 7L-8-090 000
			7.06117.43.0	SV-NWV	EL	mit Dichtring with O-ring Auslassseite Exhaust Side
			7.06117.44.0	SV-NWV	EL	mit Dichtring with O-ring Einlassseite Intake Side
4.2 V8 228 kW (310 PS) AXQ	12.2002→11.2006		7.02256.41.0	SV-KK	EL	 ch. 7L-6-020 001→
			7.02256.42.0	SV-KK	EL	 →ch. 7L-6-020 000 für Fahrzeuge mit Standheizung for vehicles with parking heater
4.2 V8 FSI 231-257 kW (314-350 PS) BAR	06.2006→05.2010		7.22880.01.0	EUV-SL	EL	☐☐ Mexico ☐☐ Mexico
			7.02256.41.0	SV-KK	EL	 ch. 7L-6-020 001→
5.0 R50 TDI 230-257 kW (313-350 PS) CBWA	08.2007→05.2010		7.02256.00.0	EUV-AGR	EP	 ch. 7L6***→
			7.02256.41.0	SV-KK	EL	 ch. 7L6***→
5.0 V10 TDI 230 kW (313 PS) AYH	10.2002→05.2010		7.02183.01.0	DW-AGR	EP	
			7.02256.41.0	SV-KK	EL	 ch. 7L-6-020 001→
			7.02256.42.0	SV-KK	EL	 →ch. 7L-6-020 000 für Fahrzeuge mit Standheizung for vehicles with parking heater
5.0 V10 TDI 230 kW (313 PS) BLE	10.2002→05.2010		7.02256.00.0	EUV-AGR	EP	
			7.02256.41.0	SV-KK	EL	 ch. 7L-6-020 001→
			7.02256.42.0	SV-KK	EL	 →ch. 7L-6-020 000 für Fahrzeuge mit Standheizung for vehicles with parking heater
5.0 V10 TDI 230 kW (313 PS) BWF	10.2002→05.2010		7.02256.41.0	SV-KK	EL	 ch. 7L6***→
6.0 W12 331 kW (450 PS) BJN	08.2004→05.2010		7.02256.41.0	SV-KK	EL	 ch. 7L-6-020 001→
			7.02256.42.0	SV-KK	EL	 →ch. 7L-6-020 000 für Fahrzeuge mit Standheizung for vehicles with parking heater
6.0 W12 331 kW (450 PS) CFRA	08.2004→05.2010		7.02256.41.0	SV-KK	EL	 ch. 7L6***→

TOUAREG (7P5, 7P6) **89**

3.0 V6 TDI 150 kW (204 PS) CASD	01.2010→03.2018		7.02256.00.0	EUV-AGR	EP	
			7.02256.41.0	SV-KK	EL	für Fahrzeuge mit Standheizung for vehicles with parking heater
3.0 V6 TDI 150 kW (204 PS) CJMA, CVWA	01.2010→03.2018		7.02256.00.0	EUV-AGR	EP	







TOUAREG (7P5, 7P6) **89**

			7.28098.04.0	EUV-ML	EL	 CJMA, CVWA: für Fahrzeuge mit Start-Stopp-Funktion, für Fahrzeuge mit Bremsenergieerückgewinnung for vehicles with start-stop function, for vehicles with brake energy recovery
			7.02256.41.0	SV-KK	EL	 CJMA, CVWA: für Fahrzeuge mit Standheizung for vehicles with parking heater
3.0 V6 TDI 150 kW (204 PS) CRCD	01.2010→03.2018		7.02256.00.0	EUV-AGR	EP	
			7.28098.04.0	EUV-ML	EL	für Fahrzeuge mit Start-Stopp-Funktion, für Fahrzeuge mit Bremsenergieerückgewinnung for vehicles with start-stop function, for vehicles with brake energy recovery
3.0 V6 TDI 176 kW (240 PS) CASA, CNRB	01.2010→03.2018		7.02256.00.0	EUV-AGR	EP	
			7.02256.41.0	SV-KK	EL	 CASA, CNRB: für Fahrzeuge mit Standheizung for vehicles with parking heater
3.0 V6 TDI 165 kW (224 PS) CATA	06.2010→03.2018		7.02256.00.0	EUV-AGR	EP	
			7.02256.41.0	SV-KK	EL	für Fahrzeuge mit Standheizung for vehicles with parking heater
3.0 V6 TDI 180 kW (245 PS) CJGD	05.2011→03.2018		7.02256.41.0	SV-KK	EL	für Fahrzeuge mit Standheizung for vehicles with parking heater
3.0 V6 TDI 180 kW (245 PS) CRCA	05.2011→03.2018		7.02256.00.0	EUV-AGR	EP	
			7.28098.04.0	EUV-ML	EL	für Fahrzeuge mit Start-Stopp-Funktion, für Fahrzeuge mit Bremsenergieerückgewinnung for vehicles with start-stop function, for vehicles with brake energy recovery
			7.02256.41.0	SV-KK	EL	für Fahrzeuge mit Standheizung for vehicles with parking heater
3.0 V6 TDI 193 kW (262 PS) CVVA	09.2014→03.2018		7.02256.00.0	EUV-AGR	EP	
			7.28098.04.0	EUV-ML	EL	für Fahrzeuge mit Start-Stopp-Funktion, für Fahrzeuge mit Bremsenergieerückgewinnung for vehicles with start-stop function, for vehicles with brake energy recovery
3.0 V6 TSI 213 kW (290 PS) CJTA	08.2010→03.2018		7.22880.01.0	EUV-KK	EL	
			7.22880.01.0	EUV-SL	EL	
			7.28098.15.0	EUV-SR	EL	
			7.02256.41.0	SV-KK	EL	für Fahrzeuge mit Standheizung for vehicles with parking heater
			7.06117.47.0	SV-NWV	EH	mit Dichtring with O-ring
3.0 V6 TSI 235 kW (320 PS) CYJA	01.2015→03.2018		7.22880.01.0	EUV-SL	EL	
			7.28098.15.0	EUV-SR	EL	
			7.06117.47.0	SV-NWV	EH	mit Dichtring with O-ring
3.0 V6 TSI Hybrid 245-283 kW (333-385 PS) CGEA, CGFA	04.2010→03.2018		7.02256.00.0	EUV-KK	EP	 CGEA, CGFA: für OE-Nummer: 1K0 906 283 A for OE number: 1K0 906 283 A
			7.22880.01.0	EUV-KK	EL	
			7.22880.01.0	EUV-SL	EL	
			7.28098.15.0	EUV-SR	EL	







TOUAREG (7P5, 7P6) 89

			7.02256.41.0	SV-KK	EL	CGEA, CGFA: für Fahrzeuge mit Standheizung for vehicles with parking heater mit Dichtring with O-ring
			7.06117.47.0	SV-NWV	EH	
3.0 V6 TSI Hybrid 245-283 kW (333-385 PS) CGFA	09.2010→03.2018		7.02256.00.0	EUV-KK	EP	für OE-Nummer: 1K0 906 283 A for OE number: 1K0 906 283 A mit Dichtring with O-ring
			7.22880.01.0	EUV-KK	EL	
			7.22880.01.0	EUV-SL	EL	
			7.28098.15.0	EUV-SR	EL	
			7.06117.47.0	SV-NWV	EH	
3.6 V6 FSI 206 kW (280 PS) CGRA	04.2010→03.2018		7.03280.04.0	EUV-KK	EL	für Fahrzeuge mit Standheizung for vehicles with parking heater
			7.22880.01.0	EUV-KK	EL	
			7.02256.00.0	EUV-SR	EP	
			7.02256.41.0	SV-KK	EL	
			7.06117.37.0	SV-NWV	EL	
3.6 V6 FSI 183 kW (249 PS) CMTA	08.2010→03.2018		7.02256.00.0	EUV-SR	EP	für Fahrzeuge mit Standheizung for vehicles with parking heater
			7.02256.41.0	SV-KK	EL	
			7.06117.37.0	SV-NWV	EL	
			7.02256.00.0	EUV-SR	EP	
4.2 V8 FSI 265 kW (360 PS) CGNA	01.2011→03.2018		7.02256.00.0	EUV-RK	EP	für Fahrzeuge mit Standheizung for vehicles with parking heater
			7.03280.04.0	EUV-SR	EL	
			7.22880.01.0	EUV-KK	EL	
			7.22880.01.0	EUV-SL	EL	
			7.22880.01.0	EUV-SR	EL	
			7.02256.41.0	SV-KK	EL	
4.2 V8 TDI 250 kW (340 PS) CKDA	01.2010→03.2018		7.02256.00.0	EUV-AGR	EP	für Fahrzeuge mit Standheizung for vehicles with parking heater
			7.22880.01.0	EUV-KK	EL	
			7.02256.41.0	SV-KK	EL	

TOUAREG (CR7) 90

2.0 TFSi 4motion 183 kW (249 PS) CYRC	05.2018→		7.22880.01.0	EUV-LS	EL	Fahrgestellnummer ab: CR-J-000 001 Vehicle Identification Number from: CR-J-000 001
			7.02901.05.0	SUV	EL	
			7.06117.26.0	ZM-NWV	EL	
2.0 TSI 4motion 180 kW (245 PS) DMFA	08.2018→11.2020		7.22880.01.0	EUV-LS	EL	Fahrgestellnummer ab: CR-J-000 001 Vehicle Identification Number from: CR-J-000 001
			7.02901.05.0	SUV	EL	
			7.06117.26.0	ZM-NWV	EL	
2.0 TSI 4motion 180 kW (245 PS) DNEA	08.2018→11.2020		7.22880.01.0	EUV-LS	EL	Fahrgestellnummer ab: CR-J-000 001 Vehicle Identification Number from: CR-J-000 001
			7.06117.26.0	ZM-NWV	EL	



TOUAREG (CR7) 90





















2.0 TSI 4motion 185 kW (252 PS) CYRB	09.2018→	 7.22880.01.0	EUV-LS	EL	Fahrgestellnummer ab: CR-J-000 001 Vehicle Identification Number from: CR-J-000 001
		7.02901.05.0	SUV	EL	
		7.06117.26.0	ZM-NWV	EL	Fahrgestellnummer ab: CR-J-000 001 Vehicle Identification Number from: CR-J-000 001
3.0 TDI 190 kW (258 PS) CVMC	11.2017→	 7.02256.00.0	EUV-AGR	EP	 ch. CR-J-000 001→
		7.03280.04.0	EUV-AGR	EL	Fahrgestellnummer ab: CR-J-000 001 Vehicle Identification Number from: CR-J-000 001
		7.22880.01.0	EUV-LS	EL	Fahrgestellnummer ab: CR-J-000 001 Vehicle Identification Number from: CR-J-000 001
3.0 TDI 4motion 210 kW (286 PS) DENA	11.2017→	 7.02256.00.0	EUV-AGR	EP	 ch. CR-J-000 001→
		7.03280.04.0	EUV-AGR	EL	Fahrgestellnummer ab: CR-J-000 001 Vehicle Identification Number from: CR-J-000 001
		7.22880.01.0	EUV-LS	EL	Fahrgestellnummer ab: CR-J-000 001 Vehicle Identification Number from: CR-J-000 001
3.0 TDI 4motion 183 kW (249 PS) CVMD	01.2018→	 7.02256.00.0	EUV-AGR	EP	 ch. CR-J-000 001→
		7.03280.04.0	EUV-AGR	EL	Fahrgestellnummer ab: CR-J-000 001 Vehicle Identification Number from: CR-J-000 001
		7.22880.01.0	EUV-LS	EL	Fahrgestellnummer ab: CR-J-000 001 Vehicle Identification Number from: CR-J-000 001
3.0 TDI 4motion 170 kW (231 PS) DEND	05.2018→	 7.02256.00.0	EUV-AGR	EP	 ch. CR-J-000 001→
		7.03280.04.0	EUV-AGR	EL	Fahrgestellnummer ab: CR-J-000 001 Vehicle Identification Number from: CR-J-000 001
		7.22880.01.0	EUV-LS	EL	Fahrgestellnummer ab: CR-J-000 001 Vehicle Identification Number from: CR-J-000 001
3.0 TSI 4motion 250 kW (340 PS) DCBE	03.2018→	 7.22880.01.0	EUV-KK	EL	Fahrgestellnummer ab: CR-J-000 001 Vehicle Identification Number from: CR-J-000 001 Produktionsdatum bis: 27.07.2020 Production date to: 27.07.2020
4.0 V8 TDI 4motion 310 kW (421 PS) DMVB	06.2019→	 7.02256.00.0	EUV-AGR	EP	 ch. CR-J-000 001→
eHybrid 4motion 185 kW (252 PS) DFKA	11.2020→	 7.06117.26.0	ZM-NWV	EL	Fahrgestellnummer ab: CR-J-000 001 Vehicle Identification Number from: CR-J-000 001
eHybrid 4motion 185 kW (252 PS) DFKA	11.2020→	 7.06117.26.0	ZM-NWV	EL	Fahrgestellnummer ab: CR-J-000 001 Vehicle Identification Number from: CR-J-000 001

TOURAN (1T1, 1T2) 91

1.4 TSI 103 kW (140 PS) BMY	02.2006→05.2010	 7.01044.03.0	EUV-SR	EL	
		7.00470.07.0	LDRV	EL	 BMY: →10.2008  BMY: 11.2008→05.2009 für Fahrzeuge mit Automatikgetriebe for vehicles with automatic transmission
		7.02588.04.0	LDRV	EL	 BMY: 11.2008→05.2009 für Fahrzeuge mit Schaltgetriebe for vehicles with manual transmission  BMY: 06.2009→











TOURAN (1T1, 1T2) **91**

			<p>7.04247.02.0 SUV EL</p> <p>7.02256.40.0 SV-KK EL</p> <p>7.06117.54.0 SV-NWV EL</p>		<p>für Fahrzeuge mit Standheizung for vehicles with parking heater</p>
<p>1.4 TSI 103 kW (140 PS) CAVC</p>	<p>02.2006→05.2010</p>		<p>7.00470.07.0 LDRV EL</p>	 CAVC: 11.2008→05.2009 für Fahrzeuge mit Automatikgetriebe for vehicles with automatic transmission  CAVC: →10.2008  CAVC: 11.2008→05.2009 für Fahrzeuge mit Schaltgetriebe for vehicles with manual transmission  CAVC: 06.2009→	
			<p>7.02588.04.0 LDRV EL</p>		
			<p>7.04247.02.0 SUV EL</p> <p>7.02256.40.0 SV-KK EL</p>		
			<p>7.06117.54.0 SV-NWV EL</p>		
<p>1.4 TSI 125 kW (170 PS) BLG</p>	<p>11.2006→05.2010</p>		<p>7.01044.03.0 EUV-SR EL</p>	 BLG: →10.2008  BLG: 11.2008→05.2009 für Fahrzeuge mit Automatikgetriebe for vehicles with automatic transmission  BLG: 06.2009→  BLG: 11.2008→05.2009 für Fahrzeuge mit Schaltgetriebe for vehicles with manual transmission	
			<p>7.00470.07.0 LDRV EL</p>		
			<p>7.02588.04.0 LDRV EL</p>		
			<p>7.04247.02.0 SUV EL</p> <p>7.02256.40.0 SV-KK EL</p>		
<p>1.4 TSI 125 kW (170 PS) CAVB</p>	<p>11.2006→05.2010</p>		<p>7.00470.07.0 LDRV EL</p>	 CAVB: →10.2008  CAVB: 11.2008→05.2009 für Fahrzeuge mit Automatikgetriebe for vehicles with automatic transmission  CAVB: 06.2009→  CAVB: 11.2008→05.2009 für Fahrzeuge mit Schaltgetriebe for vehicles with manual transmission	
			<p>7.02588.04.0 LDRV EL</p>		
			<p>7.04247.02.0 SUV EL</p> <p>7.06117.54.0 SV-NWV EL</p>		
<p>1.4 TSI EcoFuel 110 kW (150 PS) CDGA</p>	<p>05.2009→05.2010</p>		<p>7.02588.04.0 LDRV EL</p>	<p>für Fahrzeuge mit Standheizung for vehicles with parking heater</p>	
			<p>7.04247.02.0 SUV EL</p> <p>7.02256.40.0 SV-KK EL</p>		
			<p>7.06117.54.0 SV-NWV EL</p>		
<p>1.6 75 kW (102 PS) BGU, BSE, BSF</p>	<p>07.2003→05.2010</p>		<p>7.10014.00.0 AKF EL</p>	<p> BGU, BSE, BSF: für Fahrzeuge mit Standheizung for vehicles with parking heater</p>	
			<p>7.22880.01.0 EUV-SR EL</p>		
			<p>7.02256.40.0 SV-KK EL</p>		
<p>1.6 BiFuel 75 kW (102 PS) BSF</p>	<p>11.2006→05.2010</p>		<p>7.22880.01.0 EUV-SR EL</p>		
<p>1.6 FSI 85 kW (115 PS) BAG, BLF, BLP</p>	<p>02.2003→01.2007</p>		<p>7.10014.00.0 AKF EL</p>	<p> BAG, BLF, BLP: für Fahrzeuge mit Standheizung for vehicles with parking heater</p>	
			<p>7.22880.01.0 EUV-SR EL</p>		
			<p>7.02256.40.0 SV-KK EL</p>		
			<p>7.06117.54.0 SV-NWV EL</p>		

V



TOURAN (1T1, 1T2) 91

1.9 TDI 74 kW (100 PS) AVQ	02.2003→05.2004	 7.02256.41.0	SV-KK	EL	für Fahrzeuge mit Standheizung for vehicles with parking heater
1.9 TDI 77 kW (105 PS) BKC, BXE	08.2003→05.2010	 7.02256.41.0	SV-KK	EL	 BKC, BXE: für Fahrzeuge mit Standheizung for vehicles with parking heater
1.9 TDI 77 kW (105 PS) BLS	08.2003→05.2010	 7.00868.02.0 7.02256.00.0 7.02256.41.0	DW-TL EUV-AGR SV-KK	EP EP EL	für Fahrzeuge mit Standheizung for vehicles with parking heater
1.9 TDI 66 kW (90 PS) BRU, BXF	11.2004→05.2010	 7.02256.41.0	SV-KK	EL	 BRU, BXF: für Fahrzeuge mit Standheizung for vehicles with parking heater
1.9 TDI 66 kW (90 PS) BXJ	11.2004→05.2010	 7.00868.02.0 7.02256.00.0 7.02256.41.0	DW-TL EUV-AGR SV-KK	EP EP EL	für Fahrzeuge mit Standheizung for vehicles with parking heater
2.0 EcoFuel 80 kW (109 PS) BSX	02.2006→05.2009	 7.02256.40.0	SV-KK	EL	für Fahrzeuge mit Standheizung for vehicles with parking heater
2.0 FSI 110 kW (150 PS) AXW, BLR, BLX, BLY, BVY, BVZ	10.2003→01.2007	 7.22880.01.0 7.02256.40.0 7.06117.37.0	EUV-SR SV-KK SV-NWV	EL EL EL	 AXW, BLR, BLX, BLY, BVY, BVZ: für Fahrzeuge mit Standheizung for vehicles with parking heater
2.0 TDI 100 kW (136 PS) AZV	02.2003→05.2010	 7.02256.41.0	SV-KK	EL	für Fahrzeuge mit Standheizung for vehicles with parking heater
2.0 TDI 125 kW (170 PS) BMN	12.2005→05.2010	 7.00868.02.0 7.02256.00.0 7.02256.41.0	DW-TL EUV-AGR SV-KK	EP EP EL	für Fahrzeuge mit Standheizung for vehicles with parking heater
2.0 TDI 125 kW (170 PS) CFJA	12.2005→05.2010	 7.00868.02.0 7.02256.00.0	DW-TL EUV-AGR	EP EP	
2.0 TDI 103 kW (140 PS) BMM	12.2005→05.2010	 7.00868.02.0 7.02256.00.0 7.02256.41.0	DW-TL EUV-AGR SV-KK	EP EP EL	für Fahrzeuge mit Standheizung for vehicles with parking heater
2.0 TDI 16V 103 kW (140 PS) BKD	08.2003→05.2010	 7.02256.41.0	SV-KK	EL	für Fahrzeuge mit Standheizung for vehicles with parking heater

TOURAN (1T3) 92

1.2 TSI 77 kW (105 PS) CBZB	05.2010→05.2015	 7.22880.01.0 7.02256.40.0	EUV-KK SV-KK	EL EL	für Fahrzeuge mit Standheizung for vehicles with parking heater
1.4 TSI 103 kW (140 PS) CAVC, CTHC	05.2010→05.2015	 7.02588.04.0 7.04247.02.0 7.02256.40.0 7.06117.54.0	LDRV SUV SV-KK SV-NWV	EL EL EL EL	 CAVC, CTHC: für Fahrzeuge mit Standheizung for vehicles with parking heater
1.4 TSI 125 kW (170 PS) CAVB, CTHB	05.2010→05.2015	 7.02588.04.0 7.04247.02.0	LDRV SUV	EL EL	

V



TOURAN (1T3)

92

			7.02256.40.0	SV-KK	EL	CAVB, CTHB: für Fahrzeuge mit Standheizung for vehicles with parking heater
			7.06117.54.0	SV-NWV	EL	
1.4 TSI EcoFuel 110 kW (150 PS) CDGA	05.2010→05.2015		7.02588.04.0	LDRV	EL	für Fahrzeuge mit Standheizung for vehicles with parking heater
			7.04247.02.0	SUV	EL	
			7.02256.40.0	SV-KK	EL	
			7.06117.54.0	SV-NWV	EL	
1.6 TDI 66 kW (90 PS) CAYB	05.2010→05.2015		7.02256.00.0	EUV-AGR	EP	für Fahrzeuge mit Standheizung for vehicles with parking heater
			7.02256.41.0	SV-KK	EL	
1.6 TDI 77 kW (105 PS) CAYC	05.2010→05.2015		7.02256.00.0	EUV-AGR	EP	für Fahrzeuge mit Standheizung for vehicles with parking heater
			7.02256.41.0	SV-KK	EL	
2.0 TDI 125 kW (170 PS) CFJA	05.2010→01.2013		7.02256.00.0	EUV-AGR	EP	für Fahrzeuge mit Standheizung for vehicles with parking heater
			7.02256.41.0	SV-KK	EL	
2.0 TDI 103 kW (140 PS) CFHC	05.2010→05.2015		7.02256.00.0	EUV-AGR	EP	für Fahrzeuge mit Standheizung for vehicles with parking heater
			7.02256.41.0	SV-KK	EL	
2.0 TDI 81 kW (110 PS) CFHF, CLCA	11.2010→05.2015		7.02256.00.0	EUV-AGR	EP	CFHF, CLCA: für Fahrzeuge mit Standheizung for vehicles with parking heater
			7.02256.41.0	SV-KK	EL	
2.0 TDI 130 kW (177 PS) CFJB	01.2013→05.2015		7.02256.00.0	EUV-AGR	EP	für Fahrzeuge mit Standheizung for vehicles with parking heater
			7.02256.41.0	SV-KK	EL	

TOURAN (5T1)

























93

1.0 TSI 85 kW (116 PS) DKRB	12.2018→		7.06117.48.0	SV-NWV	EL	
1.4 TSI 110 kW (150 PS) CZDA	05.2015→		7.06117.48.0	SV-NWV	EL	
1.8 TSI 132 kW (180 PS) CJSA	11.2015→		7.03280.04.0	EUV-SR	EL	
			7.02901.05.0	SUV	EL	
			7.06117.26.0	ZM-NWV	EL	
2.0 TDI 110 kW (150 PS) DFEA, DFGA	05.2015→		7.02256.00.0	EUV-AGR	EP	
2.0 TDI 81 kW (110 PS) CRVA, CYKB, DFEB, DFGB	11.2015→07.2019		7.02256.00.0	EUV-AGR	EP	
2.0 TDI 140 kW (190 PS) DFHA	11.2015→07.2019		7.02256.00.0	EUV-AGR	EP	
2.0 TDI 85 kW (115 PS) DFGC	02.2019→		7.02256.00.0	EUV-AGR	EP	

UP! (121, 122, BL1, BL2, BL3, 123)











94

1.0 44 kW (60 PS) CHYA, DAFA	08.2011→08.2020		7.06117.48.0	SV-NWV	EL	
1.0 55 kW (75 PS) CHYB	08.2011→11.2019		7.06117.48.0	SV-NWV	EL	
1.0 EcoFuel 50 kW (68 PS) CPGA	11.2012→08.2020		7.06117.48.0	SV-NWV	EL	

						
UP! (121, 122, BL1, BL2, BL3, 123)						94
1.0 GTI 85 kW (115 PS) DKRA	11.2017→08.2020		7.06117.48.0	SV-NWV	EL	
1.0 TSI 66 kW (90 PS) CHZA, DKLC	05.2016→09.2018		7.06117.48.0	SV-NWV	EL	
VENTO (1H2)						95
1.6 74 kW (101 PS) AFT	12.1995→09.1998		7.22402.03.0	EUV-SR	EL	
1.9 SDI 47-48 kW (64-65 PS) AEY	04.1997→09.1998		7.21903.70.0	DW-AGR	EP	
			7.21895.55.0	LDRV	EL	
1.9 TDI 66-67 kW (90-91 PS) 1Z, AHU, ALE	09.1993→09.1998		7.21903.70.0	DW-AGR	EP	
			7.21895.55.0	LDRV	EL	
1.9 TDI 81 kW (110 PS) AFN	04.1996→09.1998		7.21903.70.0	DW-AGR	EP	
			7.21903.75.0	DW-TL	EP	
AMAROK Platform/Chassis (S1B, S6B, S7B)						96
2.0 BiTDI 132 kW (180 PS) CNEA, CSHA	09.2011→07.2019		7.02256.00.0	EUV-KK	EP	
			7.02256.41.0	SV-KK	EL  CNEA, CSHA: 01.2013→ für Fahrzeuge mit Standheizung for vehicles with parking heater	
2.0 BiTDI 4motion 132 kW (180 PS) CNEA, CSHA	09.2011→07.2019		7.02256.00.0	EUV-KK	EP	
			7.02256.41.0	SV-KK	EL  CNEA, CSHA: 01.2013→ für Fahrzeuge mit Standheizung for vehicles with parking heater	
2.0 TDI 90 kW (122 PS) CDBA, CNFA	09.2011→10.2013		7.02256.00.0	EUV-AGR	EP	
			7.02256.00.0	EUV-KK	EP	
2.0 TDI 103 kW (140 PS) CNFB	09.2011→10.2016		7.02256.00.0	EUV-AGR	EP	
			7.02256.41.0	SV-KK	EL 01.2013→ für Fahrzeuge mit Standheizung for vehicles with parking heater	
2.0 TDI 120 kW (163 PS) CDCA	09.2011→08.2012		7.02256.00.0	EUV-AGR	EP	
2.0 TDI 4motion 120 kW (163 PS) CDCA	09.2011→08.2012		7.02256.00.0	EUV-AGR	EP	
2.0 TDI 4motion 103 kW (140 PS) CNFB	09.2011→10.2016		7.02256.00.0	EUV-AGR	EP	
			7.02256.41.0	SV-KK	EL 01.2013→ für Fahrzeuge mit Standheizung for vehicles with parking heater	
2.0 TSI 118 kW (160 PS) CFPA	09.2011→10.2016		7.03280.04.0	EUV-SR	EL	
			7.00470.07.0	LDRV	EL	
			7.02901.05.0	SUV	EL	
			7.02256.41.0	SV-KK	EL 01.2013→ für Fahrzeuge mit Standheizung for vehicles with parking heater	
3.0 TDI 4motion 150 kW (204 PS) DDXB	06.2016→		7.02256.00.0	EUV-AGR	EP Produktionsdatum bis: 03.10.2016 Production date to: 03.10.2016	
			7.02256.41.0	SV-KK	EL für Fahrzeuge mit Standheizung for vehicles with parking heater	
3.0 TDI 4motion 190 kW (258 PS) DDXE	05.2018→		7.02256.41.0	SV-KK	EL für Fahrzeuge mit Standheizung for vehicles with parking heater	















CADDY ALLTRACK Box Body/MPV (SAA) 97

1.0 TSI 75 kW (102 PS) CHZG	11.2015→		7.06117.48.0	SV-NWV	EL	
1.4 TGI CNG 81 kW (110 PS) CPWA	06.2015→		7.06117.48.0	SV-NWV	EL	für OE-Nummer: 04E 906 455 D for OE number: 04E 906 455 D
1.4 TSI 92 kW (125 PS) CZCB	05.2015→		7.06117.48.0	SV-NWV	EL	
1.4 TSI 96 kW (131 PS) DJKD	06.2019→		7.06117.48.0	SV-NWV	EL	
1.6 TDI 55 kW (75 PS) CAYE	05.2015→11.2017		7.02256.00.0	EUV-AGR	EP	 ch. 2K-B-200 001→
1.6 TDI 75 kW (102 PS) CAYD	05.2015→		7.02256.00.0	EUV-AGR	EP	
2.0 TDI 103 kW (140 PS) CFHC, CLCB	05.2015→		7.02256.00.0	EUV-AGR	EP	
2.0 TDI 4motion 103 kW (140 PS) CFHC	05.2015→		7.02256.00.0	EUV-AGR	EP	
2.0 TDI 4motion 81 kW (110 PS) CFHF	05.2015→05.2016		7.02256.00.0	EUV-AGR	EP	

CADDY II Box Body/MPV (9K9A) 98



















1.7 SDI 42 kW (57 PS) AHB	07.1996→09.2000		7.21903.70.0	DW-AGR	EP	
			7.21895.55.0	EUV-LS	EL	
1.9 SDI 47-48 kW (64-65 PS) AEY	11.1995→01.2004		7.21903.70.0	DW-AGR	EP	
			7.21895.55.0	EUV-LS	EL	
1.9 SDI 47 kW (64 PS) AYQ	11.1995→01.2004		7.21903.70.0	DW-AGR	EP	
1.9 TDI 66-67 kW (90-91 PS) 1Z, AHU, ALE	09.1996→01.2004		7.21903.70.0	DW-AGR	EP	
			7.21895.55.0	LDRV	EL	
1.9 TDI 66-67 kW (90-91 PS) ALH	09.1996→01.2004		7.21903.75.0	DW-AGR	EP	
			7.21903.70.0	DW-TL	EP	

CADDY III Box Body/MPV (2KA, 2KH, 2CA, 2CH) 99











1.2 TSI 63 kW (86 PS) CBZA	09.2010→05.2015		7.22880.01.0	EUV-KK	EL	
1.2 TSI 77 kW (105 PS) CBZB	09.2010→05.2015		7.22880.01.0	EUV-KK	EL	
1.6 75 kW (102 PS) BGU	04.2004→05.2015		7.10014.00.0	AKF	EL	
			7.22880.01.0	EUV-SR	EL	
1.6 75 kW (102 PS) BSE, BSF	04.2004→05.2015		7.10014.00.0	AKF	EL	
			7.22880.01.0	EUV-SR	EL	
			7.02256.40.0	SV-KK	EL	 BSE, BSF: für Fahrzeuge mit Standheizung for vehicles with parking heater
V 1.6 BiFuel 75 kW (102 PS) CHGA	05.2011→05.2015		7.10014.00.0	AKF	EL	 ch. 2K-B-200 001→
			7.22880.01.0	EUV-SR	EL	
1.6 TDI 55 kW (75 PS) CAYE	08.2010→05.2015		7.02256.00.0	EUV-AGR	EP	 ch. 2K-B-200 001→
1.6 TDI 75 kW (102 PS) CAYD	08.2010→05.2015		7.02256.00.0	EUV-AGR	EP	 ch. 2K-B-200 001→
1.9 TDI 77 kW (105 PS) BJB	04.2004→08.2010		7.02256.41.0	SV-KK	EL	für Fahrzeuge mit Standheizung for vehicles with parking heater
1.9 TDI 77 kW (105 PS) BLS	04.2004→08.2010		7.00868.02.0	DW-TL	EP	



CADDY III Box Body/MPV (2KA, 2KH, 2CA, 2CH) 99

			7.02256.00.0	EUV-AGR	EP	
1.9 TDI 55 kW (75 PS) BSU	09.2005→08.2010		7.00868.02.0	DW-TL	EP	
			7.02256.00.0	EUV-AGR	EP	
1.9 TDI 4motion 77 kW (105 PS) BLS	11.2008→08.2010		7.00868.02.0	DW-TL	EP	
			7.02256.00.0	EUV-AGR	EP	
2.0 SDI 51 kW (70 PS) BDJ, BST	03.2004→08.2010		7.00580.01.0	DW-AGR	EP	
			7.02256.40.0	SV-KK	EL	 BDJ, BST: für Fahrzeuge mit Standheizung for vehicles with parking heater
2.0 TDI 103 kW (140 PS) BMM	09.2007→08.2010		7.00868.02.0	DW-TL	EP	
			7.02256.00.0	EUV-AGR	EP	
2.0 TDI 81 kW (110 PS) CLCA	08.2010→05.2015		7.02256.00.0	EUV-AGR	EP	
2.0 TDI 62 kW (85 PS) CFHE	11.2010→05.2015		7.02256.00.0	EUV-AGR	EP	
2.0 TDI 16V 103 kW (140 PS) CFHC, CLCB	11.2010→05.2015		7.02256.00.0	EUV-AGR	EP	
2.0 TDI 16V 4motion 103 kW (140 PS) CFHC	11.2010→05.2015		7.02256.00.0	EUV-AGR	EP	 ch. 2K-B-200 001→
2.0 TDI 4motion 81 kW (110 PS) CFHF	08.2010→05.2015		7.02256.00.0	EUV-AGR	EP	 ch. 2K-B-200 001→
2.0 TDI 4motion 62 kW (85 PS) CFHE	12.2010→05.2015		7.02256.00.0	EUV-AGR	EP	

CADDY IV Box Body/MPV (SAA, SAH) 100









1.0 TSI 75 kW (102 PS) CHZG, DKRE	11.2015→09.2020		7.06117.48.0	SV-NWV	EL	
1.4 TGI CNG 81 kW (110 PS) CPWA	06.2015→09.2020		7.06117.48.0	SV-NWV	EL	für OE-Nummer: 04E 906 455 D for OE number: 04E 906 455 D
1.4 TSI 92 kW (125 PS) CZCB	05.2015→09.2020		7.06117.48.0	SV-NWV	EL	
1.4 TSI 96 kW (131 PS) DJKD	06.2019→09.2020		7.06117.48.0	SV-NWV	EL	
1.6 TDI 55 kW (75 PS) CAYE	05.2015→11.2017		7.02256.00.0	EUV-AGR	EP	
1.6 TDI 75 kW (102 PS) CAYD	05.2015→09.2020		7.02256.00.0	EUV-AGR	EP	
2.0 TDI 103 kW (140 PS) CFHC, CLCB	05.2015→09.2020		7.02256.00.0	EUV-AGR	EP	
2.0 TDI 81 kW (110 PS) CLCA	09.2015→09.2020		7.02256.00.0	EUV-AGR	EP	
2.0 TDI 4motion 81 kW (110 PS) CFHF, CLCA	05.2015→09.2020		7.02256.00.0	EUV-AGR	EP	
2.0 TDI 4motion 103 kW (140 PS) CFHC	05.2015→09.2020		7.02256.00.0	EUV-AGR	EP	

CRAFTER 30-35 Bus (2E_) 101











2.0 TDI 80 kW (109 PS) CKTB	05.2011→12.2016		7.00868.02.0	DW-TL	EP	
			7.02256.00.0	EUV-AGR	EP	
2.0 TDI 100 kW (136 PS) CKTC	05.2011→12.2016		7.00868.02.0	DW-TL	EP	
			7.02256.00.0	EUV-AGR	EP	
2.0 TDI 120 kW (163 PS) CKUB, CSNA	07.2011→12.2016		7.00868.02.0	DW-TL	EP	

































CRAFTER 30-35 Bus (2E_) **101**

			7.02256.00.0	EUV-AGR	EP
2.0 TDI 105 kW (142 PS) CKUC	10.2011→12.2016		7.00868.02.0	DW-TL	EP
			7.02256.00.0	EUV-AGR	EP
2.0 TDI 84 kW (114 PS) CSLB	11.2013→12.2016		7.00868.02.0	DW-TL	EP
			7.02256.00.0	EUV-AGR	EP
2.0 TDI 80 kW (109 PS) CSLA	11.2015→12.2016		7.02256.00.0	EUV-AGR	EP
2.0 TDI 4motion 120 kW (163 PS) CKUB, CSNA	11.2011→12.2016		7.00868.02.0	DW-TL	EP
			7.02256.00.0	EUV-AGR	EP
2.5 TDI 65 kW (88 PS) BJJ, CEBA	04.2006→07.2011		7.00868.02.0	DW-TL	EP
			7.00470.07.0	LDRV	EL
2.5 TDI 80 kW (109 PS) BJK, CEBB	04.2006→05.2013		7.00868.02.0	DW-TL	EP
			7.00470.07.0	LDRV	EL
2.5 TDI 100 kW (136 PS) BJL, CECA	04.2006→05.2013		7.00868.02.0	DW-TL	EP
			7.00470.07.0	LDRV	EL
2.5 TDI 120 kW (163 PS) BJM, CECB	04.2006→07.2011		7.00868.02.0	DW-TL	EP
			7.00470.07.0	LDRV	EL

CRAFTER 30-50 Platform/Chassis (2F_) **102**

2.0 TDI 80 kW (109 PS) CKTB	05.2011→12.2016		7.00868.02.0	DW-TL	EP
			7.02256.00.0	EUV-AGR	EP
2.0 TDI 80 kW (109 PS) CSLA	05.2011→12.2016		7.02256.00.0	EUV-AGR	EP
2.0 TDI 100 kW (136 PS) CKTC	05.2011→12.2016		7.00868.02.0	DW-TL	EP
			7.02256.00.0	EUV-AGR	EP
2.0 TDI 120 kW (163 PS) CKUB, CSNA	07.2011→12.2016		7.00868.02.0	DW-TL	EP
			7.02256.00.0	EUV-AGR	EP
2.0 TDI 105 kW (142 PS) CKUC	10.2011→12.2016		7.00868.02.0	DW-TL	EP
			7.02256.00.0	EUV-AGR	EP
2.0 TDI 84 kW (114 PS) CSLB	11.2013→12.2016		7.00868.02.0	DW-TL	EP
			7.02256.00.0	EUV-AGR	EP
2.0 TDI 103 kW (140 PS) CSLC	11.2015→12.2016		7.00868.02.0	DW-TL	EP
			7.02256.00.0	EUV-AGR	EP
2.0 TDI 4motion 120 kW (163 PS) CKUB, CSNA	11.2011→12.2016		7.00868.02.0	DW-TL	EP
			7.02256.00.0	EUV-AGR	EP
2.5 TDI 65 kW (88 PS) BJJ, CEBA	04.2006→07.2011		7.00868.02.0	DW-TL	EP
			7.00470.07.0	LDRV	EL
2.5 TDI 80 kW (109 PS) BJK, CEBB	04.2006→05.2013		7.00868.02.0	DW-TL	EP
			7.00470.07.0	LDRV	EL
2.5 TDI 100 kW (136 PS) BJL, CECA	04.2006→05.2013		7.00868.02.0	DW-TL	EP
			7.00470.07.0	LDRV	EL





















V

					
CRAFTER 30-50 Platform/Chassis (2F_)					
102					
2.5 TDI 120 kW (163 PS) BJM, CECB	04.2006→07.2011		7.00868.02.0	DW-TL	EP
			7.00470.07.0	LDRV	EL
CRAFTER 30-50 Van (2E_)					
103					
2.0 TDI 80 kW (109 PS) CKTB	05.2011→12.2016		7.00868.02.0	DW-TL	EP
			7.02256.00.0	EUV-AGR	EP
2.0 TDI 80 kW (109 PS) CSLA	05.2011→12.2016		7.02256.00.0	EUV-AGR	EP
2.0 TDI 100 kW (136 PS) CKTC	05.2011→12.2016		7.00868.02.0	DW-TL	EP
			7.02256.00.0	EUV-AGR	EP
2.0 TDI 120 kW (163 PS) CKUB, CSNA	07.2011→12.2016		7.00868.02.0	DW-TL	EP
			7.02256.00.0	EUV-AGR	EP
2.0 TDI 105 kW (142 PS) CKUC	10.2011→12.2016		7.00868.02.0	DW-TL	EP
			7.02256.00.0	EUV-AGR	EP
2.0 TDI 84 kW (114 PS) CSLB	11.2013→12.2016		7.00868.02.0	DW-TL	EP
			7.02256.00.0	EUV-AGR	EP
2.0 TDI 103 kW (140 PS) CSLC	11.2015→12.2016		7.00868.02.0	DW-TL	EP
			7.02256.00.0	EUV-AGR	EP
2.0 TDI 4motion 120 kW (163 PS) CKUB, CSNA	07.2011→12.2016		7.00868.02.0	DW-TL	EP
			7.02256.00.0	EUV-AGR	EP
2.5 TDI 65 kW (88 PS) BJJ, CEBA	04.2006→07.2011		7.00868.02.0	DW-TL	EP
			7.00470.07.0	LDRV	EL
2.5 TDI 80 kW (109 PS) BJK, CEBB	04.2006→05.2013		7.00868.02.0	DW-TL	EP
			7.00470.07.0	LDRV	EL
2.5 TDI 100 kW (136 PS) BJL, CECA	04.2006→05.2013		7.00868.02.0	DW-TL	EP
			7.00470.07.0	LDRV	EL
2.5 TDI 120 kW (163 PS) BJM, CECB	04.2006→07.2011		7.00868.02.0	DW-TL	EP
			7.00470.07.0	LDRV	EL
CRAFTER Bus (SYI, SYJ)					
104					
2.0 TDI 103 kW (140 PS) DAUA	09.2016→		7.02256.41.0	SV-KK	EL für Fahrzeuge mit Standheizung for vehicles with parking heater
2.0 TDI 130 kW (177 PS) DAVA	09.2016→		7.02256.00.0	EUV-AGR	EP  DAVA:  ch. SZ-H-000 001→  DAVA:  ch. SY-H-000 001→
			7.02256.41.0	SV-KK	EL für Fahrzeuge mit Standheizung for vehicles with parking heater
2.0 TDI 75 kW (102 PS) DAUB	10.2016→		7.02256.41.0	SV-KK	EL für Fahrzeuge mit Standheizung for vehicles with parking heater
2.0 TDI 4motion 130 kW (177 PS) DAVA	03.2017→		7.02256.00.0	EUV-AGR	EP  DAVA:  ch. SZ-H-000 001→  DAVA:  ch. SZ-H-000 001→
			7.02256.41.0	SV-KK	EL für Fahrzeuge mit Standheizung for vehicles with parking heater
2.0 TDI 4motion 103 kW (140 PS) DAUA	04.2017→		7.02256.41.0	SV-KK	EL für Fahrzeuge mit Standheizung for vehicles with parking heater





















V



CRAFTER Platform/Chassis (SZ_) 105

2.0 TDI 75 kW (102 PS) DAUB	11.2016→	 7.02256.41.0	SV-KK	EL	für Fahrzeuge mit Standheizung for vehicles with parking heater
2.0 TDI 103 kW (140 PS) DAUA	11.2016→	 7.02256.41.0	SV-KK	EL	für Fahrzeuge mit Standheizung for vehicles with parking heater
2.0 TDI 130 kW (177 PS) DAVA	11.2016→	 7.02256.00.0	EUV-AGR	EP	 DAVA:  ch. SZ-H-000 001→  DAVA:  ch. SY-H-000 001→
		7.02256.41.0	SV-KK	EL	für Fahrzeuge mit Standheizung for vehicles with parking heater
2.0 TDI 4motion 130 kW (177 PS) DAVA	03.2017→	 7.02256.00.0	EUV-AGR	EP	 DAVA:  ch. SZ-H-000 001→  DAVA:  ch. SY-H-000 001→
		7.02256.41.0	SV-KK	EL	für Fahrzeuge mit Standheizung for vehicles with parking heater
2.0 TDI 4motion 103 kW (140 PS) DAUA	11.2017→	 7.02256.41.0	SV-KK	EL	für Fahrzeuge mit Standheizung for vehicles with parking heater
2.0 TDI RWD 80 kW (109 PS) DASC	11.2016→	 7.02256.41.0	SV-KK	EL	für Fahrzeuge mit Standheizung for vehicles with parking heater
2.0 TDI RWD 130 kW (177 PS) DAWA	07.2017→	 7.02256.00.0	EUV-AGR	EP	 DAWA:  ch. SZ-H-000 001→  DAWA:  ch. SY-H-000 001→
		7.02256.41.0	SV-KK	EL	für Fahrzeuge mit Standheizung for vehicles with parking heater
2.0 TDI RWD 90 kW (122 PS) DASA	08.2017→	 7.02256.41.0	SV-KK	EL	für Fahrzeuge mit Standheizung for vehicles with parking heater
2.0 TDI RWD 103 kW (140 PS) DASB	11.2017→	 7.02256.41.0	SV-KK	EL	für Fahrzeuge mit Standheizung for vehicles with parking heater

CRAFTER Van (SY_, SX_) 106

2.0 TDI 103 kW (140 PS) DAUA	09.2016→	 7.02256.41.0	SV-KK	EL	für Fahrzeuge mit Standheizung for vehicles with parking heater
2.0 TDI 130 kW (177 PS) DAVA	09.2016→	 7.02256.00.0	EUV-AGR	EP	 DAVA:  ch. SY-H-000 001→  DAVA:  ch. SZ-H-000 001→
		7.02256.41.0	SV-KK	EL	für Fahrzeuge mit Standheizung for vehicles with parking heater
2.0 TDI 75 kW (102 PS) DAUB	10.2016→	 7.02256.41.0	SV-KK	EL	für Fahrzeuge mit Standheizung for vehicles with parking heater
2.0 TDI 4motion 130 kW (177 PS) DAVA	03.2017→	 7.02256.00.0	EUV-AGR	EP	 DAVA:  ch. SZ-H-000 001→  DAVA:  ch. SY-H-000 001→
		7.02256.41.0	SV-KK	EL	für Fahrzeuge mit Standheizung for vehicles with parking heater
2.0 TDI 4motion 103 kW (140 PS) DAUA	04.2017→	 7.02256.41.0	SV-KK	EL	für Fahrzeuge mit Standheizung for vehicles with parking heater
2.0 TDI RWD 130 kW (177 PS) DAWA	05.2017→	 7.02256.00.0	EUV-AGR	EP	 DAWA:  ch. SZ-H-000 001→  DAWA:  ch. SY-H-000 001→
		7.02256.41.0	SV-KK	EL	für Fahrzeuge mit Standheizung for vehicles with parking heater
2.0 TDI RWD 80 kW (109 PS) DASC	05.2017→	 7.02256.41.0	SV-KK	EL	für Fahrzeuge mit Standheizung for vehicles with parking heater
2.0 TDI RWD 90 kW (122 PS) DASA	08.2017→	 7.02256.41.0	SV-KK	EL	für Fahrzeuge mit Standheizung for vehicles with parking heater
2.0 TDI RWD 103 kW (140 PS) DASB	10.2017→	 7.02256.41.0	SV-KK	EL	für Fahrzeuge mit Standheizung for vehicles with parking heater

































V

GOLF II Van (19E, 1G1) 107

1.8 i 65-66 kW (88-90 PS) RP	08.1987→07.1991	 7.01805.01.0	EUV-LS	EL	
--	-----------------	---	--------	----	--

GOLF III Van (1H1) 108









1.9 SDI 47-48 kW (64-65 PS) AEY	08.1995→09.1997	 7.21903.70.0	DW-AGR	EP	
		7.21895.55.0	LDRV	EL	

						
GOLF III Van (1H1)						108
1.9 TDI 66 kW (90 PS) 1Z	08.1991→09.1997		7.21903.70.0	DW-AGR	EP	Fahrgestellnummer ab: 1H-N-000 001 Vehicle Identification Number from: 1H-N-000 001
			7.21895.55.0	LDRV	EL	
GOLF IV Van (1J1)						109
1.9 SDI 50 kW (68 PS) AQM	11.1998→05.2004		7.02183.01.0	DW-AGR	EP	 ch. 1-Y-000 001→
			7.21903.70.0	DW-AGR	EP	Fahrgestellnummer bis: 1J-X-999 000 Vehicle Identification Number to: 1J-X-999 000
1.9 TDI 81 kW (110 PS) AHF	10.1997→05.2004		7.02183.01.0	DW-AGR	EP	 ch. 1-Y-000 001→
			7.21903.70.0	DW-AGR	EP	Fahrgestellnummer bis: 1J-X-999 000 Vehicle Identification Number to: 1J-X-999 000
			7.21903.75.0	DW-TL	EP	 →ch. 1J-X-999 000
			7.02256.00.0	EUV-AGR	EP	
1.9 TDI 66 kW (90 PS) AGR	05.2000→09.2002		7.02183.01.0	DW-AGR	EP	 ch. 1-Y-000 001→
			7.21903.70.0	DW-AGR	EP	Fahrgestellnummer bis: 1J-X-999 000 Vehicle Identification Number to: 1J-X-999 000
			7.02256.00.0	EUV-AGR	EP	
			7.01037.02.0	LDRV	EL	 ch. 1J-Y-000 001→
1.9 TDI 96 kW (130 PS) ASZ	04.2001→05.2004		7.02183.01.0	DW-AGR	EP	
			7.00868.02.0	DW-TL	EP	
			7.02256.00.0	EUV-AGR	EP	
1.9 TDI 4motion 85 kW (115 PS) AUY	01.2000→04.2001		7.21903.70.0	DW-AGR	EP	Fahrgestellnummer bis: 1J-X-999 000 Vehicle Identification Number to: 1J-X-999 000
			7.21903.75.0	DW-TL	EP	 →ch. 1J-X-999 000
GOLF PLUS Van (521)						110
1.2 TSi 77 kW (105 PS) CBZB	11.2009→08.2014		7.22880.01.0	EUV-KK	EL	Fahrgestellnummer ab: 1K-9-900 001 Vehicle Identification Number from: 1K-9-900 001
1.4 TSi 118 kW (160 PS) CAVD	01.2009→09.2012		7.02588.04.0	LDRV	EL	 ch. 1K-9-900 001→
			7.04247.02.0	SUV	EL	
1.4 TSi 90 kW (122 PS) CAXA	01.2009→08.2014		7.00415.07.0	SUV	EL	Produktionsdatum bis: 11.11.2008 Production date to: 11.11.2008
1.6 TDi 66 kW (90 PS) CAYB	02.2009→08.2014		7.02256.00.0	EUV-AGR	EP	 ch. 1K-9-900 001→
1.6 TDi 77 kW (105 PS) CAYC	02.2009→08.2014		7.02256.00.0	EUV-AGR	EP	 ch. 1K-9-900 001→
2.0 TDi 103 kW (140 PS) CFHC	11.2009→08.2014		7.02256.00.0	EUV-AGR	EP	 ch. 1K-9-900 001→
GOLF VAN IV Variant (1J5)						111
1.9 SDI 50 kW (68 PS) AQM	05.1999→05.2006		7.02183.01.0	DW-AGR	EP	 ch. 1-Y-000 001→
			7.21903.70.0	DW-AGR	EP	Fahrgestellnummer bis: 1J-X-999 000 Vehicle Identification Number to: 1J-X-999 000
1.9 TDI 66 kW (90 PS) AGR	05.1999→05.2006		7.02183.01.0	DW-AGR	EP	 ch. 1-Y-000 001→





V



GOLF VAN IV Variant (1J5) **111**













			7.21903.70.0	DW-AGR	EP	Fahrgestellnummer bis: 1J-X-999 000 Vehicle Identification Number to: 1J-X-999 000
			7.02256.00.0	EUV-AGR	EP	
			7.01037.02.0	LDRV	EL	 ch. 1J-Y-000 001→
			7.21895.55.0	LDRV	EL	Fahrgestellnummer bis: 1J-X-999 000 Vehicle Identification Number to: 1J-X-999 000
1.9 TDI 66-67 kW (90-91 PS) ALH	05.1999→05.2006		7.02183.01.0	DW-AGR	EP	 ch. 1-Y-000 001→
			7.21903.70.0	DW-AGR	EP	Fahrgestellnummer bis: 1J-X-999 000 Vehicle Identification Number to: 1J-X-999 000
			7.02184.01.0	DW-TL	EP	 ch. 1J-Y-000 001→
			7.21903.75.0	DW-TL	EP	 →ch. 1J-X-999 000
			7.02256.00.0	EUV-AGR	EP	
1.9 TDI 81 kW (110 PS) AHF, ASV	05.1999→05.2006		7.02183.01.0	DW-AGR	EP	 AHF, ASV:  ch. 1-Y-000 001→
			7.21903.70.0	DW-AGR	EP	 AHF, ASV: Fahrgestellnummer bis: 1J-X-999 000 Vehicle Identification Number to: 1J-X-999 000
			7.02184.01.0	DW-TL	EP	
			7.21903.75.0	DW-TL	EP	 AHF, ASV:  →ch. 1J-X-999 000
			7.02256.00.0	EUV-AGR	EP	
1.9 TDI 85 kW (115 PS) AJM	05.1999→04.2002		7.21903.70.0	DW-AGR	EP	Fahrgestellnummer bis: 1J-X-999 000 Vehicle Identification Number to: 1J-X-999 000
			7.02184.01.0	DW-TL	EP	 ch. 1J-Y-000 001→
			7.21903.75.0	DW-TL	EP	 →ch. 1J-X-999 000
1.9 TDI 74 kW (101 PS) ATD	02.2000→06.2006		7.02183.01.0	DW-AGR	EP	 ch. 1-Y-000 001→
			7.21903.70.0	DW-AGR	EP	Fahrgestellnummer bis: 1J-X-999 000 Vehicle Identification Number to: 1J-X-999 000
			7.02184.01.0	DW-TL	EP	 ch. 1J-Y-000 001→
			7.21903.75.0	DW-TL	EP	 →ch. 1J-X-999 000
			7.02256.00.0	EUV-AGR	EP	
1.9 TDI 74 kW (101 PS) AXR	02.2000→06.2006		7.02183.01.0	DW-AGR	EP	
			7.00868.02.0	DW-TL	EP	
			7.02256.00.0	EUV-AGR	EP	
1.9 TDI 96 kW (130 PS) ASZ	04.2001→05.2006		7.02256.00.0	EUV-AGR	EP	

GOLF VAN VI Variant (AJ5) **112**



1.2 TSi 77 kW (105 PS) CBZB	09.2009→05.2014		7.22880.01.0	EUV-KK	EL	Fahrgestellnummer ab: 1K-9-400 001 Vehicle Identification Number from: 1K-9-400 001
1.4 TSi 118 kW (160 PS) CAVD	07.2009→10.2012		7.04247.02.0	SUV	EL	
1.6 TDi 66 kW (90 PS) CAYB	12.2009→10.2012		7.02256.00.0	EUV-AGR	EP	
1.6 TDi BlueMotion 77 kW (105 PS) CAYC	07.2009→05.2014		7.02256.00.0	EUV-AGR	EP	
2.0 TDi 103 kW (140 PS) CBDB	07.2009→05.2014		7.00868.02.0	DW-TL	EP	
			7.02256.00.0	EUV-AGR	EP	
2.0 TDi 103 kW (140 PS) CFHC	07.2009→05.2014		7.02256.00.0	EUV-AGR	EP	





GOLF VI Van (5K1_) 113

1.2 TSi 63 kW (86 PS) CBZA	05.2010→11.2012		7.22880.01.0	EUV-KK	EL	Fahrgestellnummer ab: 1K-9-400 001 Vehicle Identification Number from: 1K-9-400 001
1.2 TSi BlueMotion 77 kW (105 PS) CBZB	05.2009→11.2012		7.22880.01.0	EUV-KK	EL	Fahrgestellnummer ab: 1K-9-400 001 Vehicle Identification Number from: 1K-9-400 001
1.4 TSi 118 kW (160 PS) CAVD	10.2008→11.2012		7.02588.04.0	LDRV	EL	
			7.04247.02.0	SUV	EL	
1.6 TDi 66 kW (90 PS) CAYB	02.2009→11.2012		7.02256.00.0	EUV-AGR	EP	
1.6 TDi BlueMotion 77 kW (105 PS) CAYC	05.2009→11.2012		7.02256.00.0	EUV-AGR	EP	
2.0 GTi 155 kW (211 PS) CCZB	02.2009→11.2012		7.03280.04.0	EUV-SR	EL	Fahrgestellnummer ab: 1K-9-400 001 Vehicle Identification Number from: 1K-9-400 001
			7.22880.01.0	EUV-SR	EL	Fahrgestellnummer ab: 1K-9-400 001 Vehicle Identification Number from: 1K-9-400 001
			7.00470.07.0	LDRV	EL	 ch. 1K-9-400 001→
			7.02901.05.0	SUV	EL	für OE-Nummer: 06J 145 713 F, 06J 145 713 FX, 06J 145 713 K, 06J 145 713 KX, 06J 145 713 T, 06J 145 713 TX, 06J 145 722 B, 06J 145 722 BX for OE number: 06J 145 713 F, 06J 145 713 FX, 06J 145 713 K, 06J 145 713 KX, 06J 145 713 T, 06J 145 713 TX, 06J 145 722 B, 06J 145 722 BX
			7.06117.26.0	ZM-NWV	EL	Fahrgestellnummer ab: 1K-9-400 001 Vehicle Identification Number from: 1K-9-400 001
2.0 TDi 103 kW (140 PS) CFFB	09.2009→11.2012		7.02256.00.0	EUV-AGR	EP	
2.0 TDi 103-104 kW (140-141 PS) CJAA	09.2009→11.2012		7.00868.02.0	DW-TL	EP	
2.0 TDi 125 kW (170 PS) CFGB	05.2010→11.2012		7.02256.00.0	EUV-AGR	EP	
2.0 TSi R 4motion 199 kW (270 PS) CDLF	11.2009→11.2012		7.28098.04.0	EUV-AGK	EL	Fahrgestellnummer ab: 1K-9-400 001 Vehicle Identification Number from: 1K-9-400 001
			7.00470.07.0	LDRV	EL	 ch. 1K-9-400 001→

GOLF VII Van (5G1) 114

2.0 GTi 162 kW (220 PS) CHHB	04.2013→		7.02901.05.0	SUV	EL	
			7.06117.26.0	ZM-NWV	EL	Fahrgestellnummer ab: AU-D-000 001 Vehicle Identification Number from: AU-D-000 001
2.0 GTi 169 kW (230 PS) CHHA	04.2015→		7.02901.05.0	SUV	EL	
			7.06117.26.0	ZM-NWV	EL	Fahrgestellnummer ab: AU-D-000 001 Vehicle Identification Number from: AU-D-000 001

GOLF Van III Variant (1H5) 115

1.9 SDI 47-48 kW (64-65 PS) AEY	07.1995→02.1999		7.21903.70.0	DW-AGR	EP	
			7.21895.55.0	LDRV	EL	
1.9 TDI 66-67 kW (90-91 PS) 1Z, AHU	08.1993→12.1999		7.21903.70.0	DW-AGR	EP	







GOLF Van III Variant (1H5) 115

			7.21895.55.0	LDRV	EL	Fahrgestellnummer ab: 1H-N-000 001 Vehicle Identification Number from: 1H-N-000 001
1.9 TDI 81 kW (110 PS) AFN	05.1996→02.1999		7.21903.70.0	DW-AGR	EP	
			7.21903.75.0	DW-TL	EP	

GRAND CALIFORNIA Camper (SCB, SCC) 116

2.0 TDI 130 kW (177 PS) DAVA	04.2019→		7.02256.00.0	EUV-AGR	EP	
2.0 TDI 4motion 130 kW (177 PS) DAVA	04.2019→		7.02256.00.0	EUV-AGR	EP	

LOAD UP (121, 122, BL1, BL2) 117

1.0 44 kW (60 PS) CHYA, DAFA	12.2014→11.2019		7.06117.48.0	SV-NWV	EL	
1.0 BlueMotion 55 kW (75 PS) CHYB	05.2016→11.2019		7.06117.48.0	SV-NWV	EL	
1.0 EcoFuel 50 kW (68 PS) CPGA	12.2014→08.2020		7.06117.48.0	SV-NWV	EL	
1.0 TSi BlueMotion 66 kW (90 PS) CHZA	05.2016→09.2018		7.06117.48.0	SV-NWV	EL	

LT 28-35 II Bus (2DB, 2DE, 2DK) 118

2.3 105 kW (143 PS) AGL	05.1996→07.2006		7.21071.50.0	EUV-DS	EP	
2.5 SDI 55 kW (75 PS) AGX	07.1996→07.2006		7.21903.70.0	DW-AGR	EP	
			7.21071.50.0	EUV-DS	EP	
			7.21895.55.0	LDRV	EL	
2.5 TDI 75 kW (102 PS) AHD	05.1996→08.1999		7.21903.70.0	DW-AGR	EP	Fahrgestellnummer bis: 2D-1-014 000 Vehicle Identification Number to: 2D-1-014 000
			7.21071.50.0	EUV-DS	EP	
			7.21895.55.0	LDRV	EL	
2.5 TDI 66 kW (90 PS) APA	05.1999→07.2006		7.02183.01.0	DW-AGR	EP	 ch. 2D-1-014 001→
			7.21903.70.0	DW-AGR	EP	Fahrgestellnummer bis: 2D-1-014 000 Vehicle Identification Number to: 2D-1-014 000
			7.21071.50.0	EUV-DS	EP	
			7.21895.55.0	LDRV	EL	
2.5 TDI 80 kW (109 PS) ANJ	05.1999→07.2006		7.02183.01.0	DW-AGR	EP	 ch. 2D-1-014 001→
			7.21903.70.0	DW-AGR	EP	Fahrgestellnummer bis: 2D-1-014 001 Vehicle Identification Number to: 2D-1-014 001
			7.02184.01.0	DW-TL	EP	 ch. 2D-1-014 001→
			7.21903.75.0	DW-TL	EP	 →ch. 2D-1-014 000
			7.02256.00.0	EUV-AGR	EP	
			7.21071.50.0	EUV-DS	EP	
			7.21895.55.0	LDRV	EL	
2.5 TDI 80 kW (109 PS) AVR	05.1999→07.2006		7.02183.01.0	DW-AGR	EP	 ch. 2D-1-014 001→
			7.21903.70.0	DW-AGR	EP	Fahrgestellnummer bis: 2D-1-014 001 Vehicle Identification Number to: 2D-1-014 001
			7.02184.01.0	DW-TL	EP	 ch. 2D-1-014 001→
			7.21903.75.0	DW-TL	EP	 →ch. 2D-1-014 000
			7.02256.00.0	EUV-AGR	EP	
			7.21071.50.0	EUV-DS	EP	

V



LT 28-35 II Bus (2DB, 2DE, 2DK) 118

2.5 TDI 61 kW (83 PS) BBE	05.2001→07.2006		7.02183.01.0	DW-AGR	EP	ch. 2D-1-014 001→
			7.02256.00.0	EUV-AGR	EP	
			7.21071.50.0	EUV-DS	EP	
			7.21895.55.0	LDRV	EL	
2.5 TDI 70 kW (95 PS) BBF	05.2001→07.2006		7.02183.01.0	DW-AGR	EP	ch. 2D-1-014 001→
			7.21903.70.0	DW-AGR	EP	
			7.02256.00.0	EUV-AGR	EP	
			7.21071.50.0	EUV-DS	EP	
2.8 TDI 92 kW (125 PS) AGK	07.1997→05.2003		7.21071.50.0	EUV-DS	EP	
			7.21071.50.0	EUV-DS	EP	
				EUV-DS	EP	
				EUV-DS	EP	
2.8 TDI 96 kW (130 PS) ATA	01.1999→01.2002		7.21071.50.0	EUV-DS	EP	
			7.21071.50.0	EUV-DS	EP	
2.8 TDI 116 kW (158 PS) AUH	05.2001→06.2006		7.02184.01.0	DW-TL	EP	
			7.02256.00.0	EUV-AGR	EP	
			7.21071.50.0	EUV-DS	EP	
2.8 TDI 116 kW (158 PS) BCQ	05.2001→06.2006		7.02183.01.0	DW-AGR	EP	
			7.02184.01.0	DW-TL	EP	
			7.02256.00.0	EUV-AGR	EP	
			7.21071.50.0	EUV-DS	EP	









LT 28-46 II Platform/Chassis (2DC, 2DF, 2DG, 2DL, 2DM) 119

2.3 105 kW (143 PS) AGL	06.1996→07.2006		7.21071.50.0	EUV-DS	EP			
2.5 SDI 55 kW (75 PS) AGX	09.1996→07.2006		7.21903.70.0	DW-AGR	EP			
			7.21071.50.0	EUV-DS	EP			
			7.21895.55.0	LDRV	EL			
2.5 TDI 75 kW (102 PS) AHD	06.1996→08.1999		7.21903.70.0	DW-AGR	EP	Fahrgestellnummer bis: 2D-1-014 000 Vehicle Identification Number to: 2D-1-014 000		
			7.21071.50.0	EUV-DS	EP			
			7.21895.55.0	LDRV	EL			
2.5 TDI 66 kW (90 PS) APA	05.1999→07.2006		7.02183.01.0	DW-AGR	EP	ch. 2D-1-014 001→		
			7.21903.70.0	DW-AGR	EP		Fahrgestellnummer bis: 2D-1-014 000 Vehicle Identification Number to: 2D-1-014 000	
			7.21071.50.0	EUV-DS	EP			
			7.21895.55.0	LDRV	EL			
2.5 TDI 80 kW (109 PS) ANJ	05.1999→07.2006		7.02183.01.0	DW-AGR	EP	ch. 2D-1-014 001→		
			7.21903.70.0	DW-AGR	EP		Fahrgestellnummer bis: 2D-1-014 001 Vehicle Identification Number to: 2D-1-014 001	
			7.02184.01.0	DW-TL	EP			ch. 2D-1-014 001→
			7.21903.75.0	DW-TL	EP			
			7.02256.00.0	EUV-AGR	EP			
			7.21071.50.0	EUV-DS	EP			
			7.21895.55.0	LDRV	EL			
2.5 TDI 80 kW (109 PS) AVR	05.1999→07.2006		7.02183.01.0	DW-AGR	EP	ch. 2D-1-014 001→		
			7.21903.70.0	DW-AGR	EP		Fahrgestellnummer bis: 2D-1-014 001 Vehicle Identification Number to: 2D-1-014 001	

















LT 28-46 II Platform/Chassis (2DC, 2DF, 2DG, 2DL, 2DM) 119

			7.02184.01.0	DW-TL	EP	 ch. 2D-1-014 001→
			7.21903.75.0	DW-TL	EP	 →ch. 2D-1-014 000
			7.02256.00.0	EUV-AGR	EP	
			7.21071.50.0	EUV-DS	EP	
2.5 TDI 61 kW (83 PS) BBE	05.2001→07.2006		7.02183.01.0	DW-AGR	EP	 ch. 2D-1-014 001→
			7.02256.00.0	EUV-AGR	EP	
			7.21071.50.0	EUV-DS	EP	
			7.21895.55.0	LDRV	EL	
2.5 TDI 70 kW (95 PS) BBF	05.2001→07.2006		7.02183.01.0	DW-AGR	EP	 ch. 2D-1-014 001→
			7.21903.70.0	DW-AGR	EP	
			7.02256.00.0	EUV-AGR	EP	
			7.21071.50.0	EUV-DS	EP	
			7.21895.55.0	LDRV	EL	
2.8 TDI 92 kW (125 PS) AGK	07.1997→01.2002		7.21071.50.0	EUV-DS	EP	
2.8 TDI 96 kW (130 PS) ATA	01.1999→07.2006		7.21071.50.0	EUV-DS	EP	
2.8 TDI 116 kW (158 PS) AUH	04.2002→07.2006		7.02184.01.0	DW-TL	EP	
			7.02256.00.0	EUV-AGR	EP	
			7.21071.50.0	EUV-DS	EP	









LT 28-46 II Van (2DA, 2DD, 2DH) 120

2.3 105 kW (143 PS) AGL	05.1996→07.2006		7.21071.50.0	EUV-DS	EP	
2.5 SDI 55 kW (75 PS) AGX	09.1996→07.2006		7.21903.70.0	DW-AGR	EP	
			7.21071.50.0	EUV-DS	EP	
			7.21895.55.0	LDRV	EL	
2.5 TDI 75 kW (102 PS) AHD	05.1996→08.1999		7.21903.70.0	DW-AGR	EP	Fahrgestellnummer bis: 2D-1-014 000 Vehicle Identification Number to: 2D-1-014 000
			7.21071.50.0	EUV-DS	EP	
			7.21895.55.0	LDRV	EL	
2.5 TDI 66 kW (90 PS) APA	05.1999→07.2006		7.02183.01.0	DW-AGR	EP	 ch. 2D-1-014 001→
			7.21903.70.0	DW-AGR	EP	Fahrgestellnummer bis: 2D-1-014 000 Vehicle Identification Number to: 2D-1-014 000
			7.21071.50.0	EUV-DS	EP	
			7.21895.55.0	LDRV	EL	
2.5 TDI 80 kW (109 PS) ANJ	05.1999→07.2006		7.02183.01.0	DW-AGR	EP	 ch. 2D-1-014 001→
			7.21903.70.0	DW-AGR	EP	Fahrgestellnummer bis: 2D-1-014 001 Vehicle Identification Number to: 2D-1-014 001
			7.02184.01.0	DW-TL	EP	 ch. 2D-1-014 001→
			7.21903.75.0	DW-TL	EP	 →ch. 2D-1-014 000
			7.02256.00.0	EUV-AGR	EP	
			7.21071.50.0	EUV-DS	EP	
			7.21895.55.0	LDRV	EL	
2.5 TDI 80 kW (109 PS) AVR	05.1999→07.2006		7.02183.01.0	DW-AGR	EP	 ch. 2D-1-014 001→
			7.21903.70.0	DW-AGR	EP	Fahrgestellnummer bis: 2D-1-014 001 Vehicle Identification Number to: 2D-1-014 001
			7.02184.01.0	DW-TL	EP	 ch. 2D-1-014 001→





V



LT 28-46 II Van (2DA, 2DD, 2DH) 120

			7.21903.75.0	DW-TL	EP	 →ch. 2D-1-014 000
			7.02256.00.0	EUV-AGR	EP	
			7.21071.50.0	EUV-DS	EP	
2.5 TDI 61 kW (83 PS) BBE	05.2001→07.2006		7.02183.01.0	DW-AGR	EP	 ch. 2D-1-014 001→
			7.02256.00.0	EUV-AGR	EP	
			7.21071.50.0	EUV-DS	EP	
			7.21895.55.0	LDRV	EL	
2.5 TDI 70 kW (95 PS) BBF	05.2001→07.2006		7.02183.01.0	DW-AGR	EP	 ch. 2D-1-014 001→
			7.21903.70.0	DW-AGR	EP	
			7.02256.00.0	EUV-AGR	EP	
			7.21071.50.0	EUV-DS	EP	
			7.21895.55.0	LDRV	EL	
2.8 TDI 92 kW (125 PS) AGK	07.1997→01.2002		7.21071.50.0	EUV-DS	EP	
2.8 TDI 96 kW (130 PS) ATA	01.1999→07.2006		7.21071.50.0	EUV-DS	EP	
2.8 TDI 116 kW (158 PS) AUH	04.2002→07.2006		7.02184.01.0	DW-TL	EP	
			7.02256.00.0	EUV-AGR	EP	
			7.21071.50.0	EUV-DS	EP	
2.8 TDI 116 kW (158 PS) BCQ	04.2002→07.2006		7.02183.01.0	DW-AGR	EP	
			7.02184.01.0	DW-TL	EP	
			7.02256.00.0	EUV-AGR	EP	
			7.21071.50.0	EUV-DS	EP	

















MULTIVAN V (7HM, 7HN, 7HF, 7EF, 7EM, 7EN) 121

1.9 TDI 77 kW (105 PS) AXB	04.2003→11.2009		7.00580.01.0	DW-AGR	EP	Fahrgestellnummer ab: 7H-4-082 001, 7J-4-033 001 Vehicle Identification Number from: 7H-4-082 001, 7J-4-033 001 für Fahrzeuge mit Standheizung, für Fahrzeuge mit Schaltgetriebe for vehicles with parking heater, for vehicles with manual transmission
			7.00868.02.0	DW-TL	EP	
			7.02256.00.0	EUV-AGR	EP	
			7.02256.42.0	SV-KK	EL	
1.9 TDI 63 kW (85 PS) AXC	04.2003→11.2009		7.00580.01.0	DW-AGR	EP	Fahrgestellnummer ab: 7H-4-082 001, 7J-4-033 001 Vehicle Identification Number from: 7H-4-082 001, 7J-4-033 001 für Fahrzeuge mit Standheizung, für Fahrzeuge mit Schaltgetriebe for vehicles with parking heater, for vehicles with manual transmission
			7.00868.02.0	DW-TL	EP	
			7.02256.00.0	EUV-AGR	EP	
			7.02256.42.0	SV-KK	EL	
1.9 TDI 62 kW (84 PS) BRR	01.2006→11.2009		7.00868.02.0	DW-TL	EP	für Fahrzeuge mit Standheizung for vehicles with parking heater
			7.02256.42.0	SV-KK	EL	
1.9 TDI 75 kW (102 PS) BRS	06.2006→11.2009		7.00868.02.0	DW-TL	EP	für Fahrzeuge mit Standheizung for vehicles with parking heater
			7.02256.42.0	SV-KK	EL	





MULTIVAN V (7HM, 7HN, 7HF, 7EF, 7EM, 7EN) 121

2.0 85 kW (115 PS) AXA	11.2003→08.2015		7.10014.00.0	AKF	EL  ch. 7H-3-000 001→
			7.02256.41.0	SV-KK	EL Fahrgestellnummer ab: 7H-A-200 001, 7J-A-200 001 Vehicle Identification Number from: 7H-A-200 001, 7J-A-200 001 für Fahrzeuge mit Schaltgetriebe for vehicles with manual transmission für heiße Klimazonen for hot climate zones
			7.02256.42.0	SV-KK	EL für Fahrzeuge mit Standheizung, für Fahrzeuge mit Schaltgetriebe for vehicles with parking heater, for vehicles with manual transmission
2.0 BiTDI 132 kW (180 PS) CFCA	09.2009→08.2015		7.02256.00.0	EUV-AGR	EP  ch. 7H-A-200 001→
			7.02256.41.0	SV-KK	EL Fahrgestellnummer ab: 7H-A-200 001, 7J-A-200 001 Vehicle Identification Number from: 7H-A-200 001, 7J-A-200 001
2.0 BiTDI 4motion 132 kW (180 PS) CFCA	09.2009→08.2015		7.02256.00.0	EUV-AGR	EP  ch. 7H-A-200 001→
			7.28098.04.0	EUV-DS	EL  ch. 7H-A-200 001→
			7.02256.41.0	SV-KK	EL Fahrgestellnummer ab: 7H-A-200 001, 7J-A-200 001 Vehicle Identification Number from: 7H-A-200 001, 7J-A-200 001
2.0 TDI 62 kW (84 PS) CAAA	09.2009→08.2015		7.02256.41.0	SV-KK	EL Fahrgestellnummer ab: 7H-A-200 001, 7J-A-200 001 Vehicle Identification Number from: 7H-A-200 001, 7J-A-200 001 für Fahrzeuge mit Schaltgetriebe for vehicles with manual transmission
2.0 TDI 75 kW (102 PS) CAAB	09.2009→08.2015		7.02256.00.0	EUV-AGR	EP
			7.02256.41.0	SV-KK	EL Fahrgestellnummer ab: 7H-A-200 001, 7J-A-200 001 Vehicle Identification Number from: 7H-A-200 001, 7J-A-200 001 für Fahrzeuge mit Schaltgetriebe for vehicles with manual transmission
2.0 TDI 103 kW (140 PS) CAAC, CCHA	09.2009→08.2015		7.02256.00.0	EUV-AGR	EP
			7.02256.41.0	SV-KK	EL  CAAC: Fahrgestellnummer ab: 7H-A-200 001, 7J-A-200 001 Vehicle Identification Number from: 7H-A-200 001, 7J-A-200 001  CCHA: Fahrgestellnummer ab: 7H-A-200 001 Vehicle Identification Number from: 7H-A-200 001
2.0 TDI 100 kW (136 PS) CAAE	05.2010→08.2015		7.02256.41.0	SV-KK	EL Fahrgestellnummer ab: 7H-A-200 001, 7J-A-200 001 Vehicle Identification Number from: 7H-A-200 001, 7J-A-200 001
2.0 TDI 100 kW (136 PS) CCHB	05.2010→08.2015		7.02256.00.0	EUV-AGR	EP  ch. 7H-A-200 001→
			7.02256.41.0	SV-KK	EL  ch. 7H-A-200 001→
2.0 TDI 84 kW (114 PS) CAAD	05.2011→08.2015		7.02256.41.0	SV-KK	EL Fahrgestellnummer ab: 7H-C-000 001, 7J-C-000 001 Vehicle Identification Number from: 7H-C-000 001, 7J-C-000 001 für Fahrzeuge mit Schaltgetriebe for vehicles with manual transmission

V













MULTIVAN V (7HM, 7HN, 7HF, 7EF, 7EM, 7EN) 121

2.0 TDI 4motion 103 kW (140 PS) CAAC, CCHA	09.2009→08.2015		7.02256.00.0	EUV-AGR	EP	 CAAC, CCHA:  ch. 7H-A-200 001→  CAAC: Fahrgestellnummer ab: 7H-A-200 001, 7J-A-200 001 Vehicle Identification Number from: 7H-A-200 001, 7J-A-200 001  CCHA:  ch. 7H-A-200 001→
			7.28098.04.0	EUV-DS	EL	
			7.02256.41.0	SV-KK	EL	
2.0 TDI 4motion 100 kW (136 PS) CAAE	05.2010→08.2015		7.28098.04.0	EUV-DS	EL	 ch. 7H-A-200 001→ Fahrgestellnummer ab: 7H-A-200 001, 7J-A-200 001 Vehicle Identification Number from: 7H-A-200 001, 7J-A-200 001
			7.02256.41.0	SV-KK	EL	
2.0 TDI 4motion 100 kW (136 PS) CCHB	05.2010→08.2015		7.02256.00.0	EUV-AGR	EP	 ch. 7H-A-200 001→  ch. 7H-A-200 001→  ch. 7H-A-200 001→
			7.28098.04.0	EUV-DS	EL	
			7.02256.41.0	SV-KK	EL	
2.0 TSI 150 kW (204 PS) CJKA	05.2011→08.2015		7.03280.04.0	EUV-SR	EL	 ch. 7H-C-000 001→
			7.02901.05.0	SUV	EL	
			7.02256.41.0	SV-KK	EL	
			7.06117.26.0	ZM-NWV	EL	
2.0 TSI 110 kW (150 PS) CJKB	07.2012→08.2015		7.03280.04.0	EUV-SR	EL	Fahrgestellnummer ab: 7H-C-000 001, 7J-C-000 001 Vehicle Identification Number from: 7H-C-000 001, 7J-C-000 001
			7.02901.05.0	SUV	EL	
			7.02256.41.0	SV-KK	EL	
			7.06117.26.0	ZM-NWV	EL	
2.0 TSI 4motion 150 kW (204 PS) CJKA	07.2011→08.2015		7.28098.04.0	EUV-DS	EL	Fahrgestellnummer ab: 7H-A-200 001 Vehicle Identification Number from: 7H-A-200 001  ch. 7H-C-000 001→
			7.03280.04.0	EUV-SR	EL	
			7.02901.05.0	SUV	EL	
			7.02256.41.0	SV-KK	EL	
			7.06117.26.0	ZM-NWV	EL	
2.5 TDI 96 kW (130 PS) AXD	04.2003→11.2009		7.00580.01.0	DW-AGR	EP	für Fahrzeuge mit Standheizung for vehicles with parking heater
			7.00868.02.0	DW-TL	EP	
			7.02256.00.0	EUV-AGR	EP	
			7.02256.42.0	SV-KK	EL	
2.5 TDI 96 kW (130 PS) BNZ	04.2003→11.2009		7.00868.02.0	DW-TL	EP	für Fahrzeuge mit Standheizung for vehicles with parking heater
			7.02256.00.0	EUV-AGR	EP	
			7.02256.42.0	SV-KK	EL	
2.5 TDI 96-128 kW (131-174 PS) AXE	04.2003→11.2009		7.00580.01.0	DW-AGR	EP	für Fahrzeuge mit Standheizung for vehicles with parking heater
			7.00868.02.0	DW-TL	EP	
			7.02256.00.0	EUV-AGR	EP	
			7.02256.42.0	SV-KK	EL	
2.5 TDI 128 kW (174 PS) BPC	04.2003→11.2009		7.00868.02.0	DW-TL	EP	
			7.02256.00.0	EUV-AGR	EP	





MULTIVAN V (7HM, 7HN, 7HF, 7EF, 7EM, 7EN) 121

			7.02256.42.0	SV-KK	EL	für Fahrzeuge mit Standheizung for vehicles with parking heater
2.5 TDI 120 kW (163 PS) BLJ	11.2003→11.2009		7.00580.01.0	DW-AGR	EP	für Fahrzeuge mit Standheizung, für Fahrzeuge mit Schaltgetriebe for vehicles with parking heater, for vehicles with manual transmission
			7.00868.02.0	DW-TL	EP	
			7.02256.42.0	SV-KK	EL	
2.5 TDI 4motion 96 kW (130 PS) AXD	07.2004→11.2009		7.00580.01.0	DW-AGR	EP	für Fahrzeuge mit Standheizung for vehicles with parking heater
			7.00868.02.0	DW-TL	EP	
			7.02256.00.0	EUV-AGR	EP	
			7.28098.04.0	EUV-DS	EL	
			7.02256.42.0	SV-KK	EL	
2.5 TDI 4motion 96 kW (130 PS) BNZ	07.2004→11.2009		7.00868.02.0	DW-TL	EP	für Fahrzeuge mit Standheizung for vehicles with parking heater
			7.02256.00.0	EUV-AGR	EP	
			7.28098.04.0	EUV-DS	EL	
			7.02256.42.0	SV-KK	EL	
2.5 TDI 4motion 96-128 kW (131-174 PS) AXE	07.2004→11.2009		7.00580.01.0	DW-AGR	EP	für Fahrzeuge mit Standheizung for vehicles with parking heater
			7.00868.02.0	DW-TL	EP	
			7.02256.00.0	EUV-AGR	EP	
			7.28098.04.0	EUV-DS	EL	
			7.02256.42.0	SV-KK	EL	
2.5 TDI 4motion 128 kW (174 PS) BPC	07.2004→11.2009		7.00868.02.0	DW-TL	EP	für Fahrzeuge mit Standheizung for vehicles with parking heater
			7.02256.00.0	EUV-AGR	EP	
			7.28098.04.0	EUV-DS	EL	
			7.02256.42.0	SV-KK	EL	
3.2 V6 170 kW (231 PS) BDL	02.2004→06.2004		7.02256.42.0	SV-KK	EL	für Fahrzeuge mit Standheizung for vehicles with parking heater
			7.06117.43.0	SV-NWV	EL	mit Dichtring with O-ring  ch. 7H-3-000 001→ch. 7H-3-001 0 00 Auslassseite Exhaust Side
			7.06117.44.0	SV-NWV	EL	mit Dichtring with O-ring  ch. 7H-3-000 001→ch. 7H-3-001 0 00 Einlassseite Intake Side
3.2 V6 173 kW (235 PS) BKK, CFLA	02.2004→12.2009		7.02256.42.0	SV-KK	EL	 BKK, CFLA: für Fahrzeuge mit Standheizung for vehicles with parking heater

V



MULTIVAN V (7HM, 7HN, 7HF, 7EF, 7EM, 7EN) 121

			7.06117.43.0	SV-NWV	EL	mit Dichtring with O-ring BKK: ch. 7H-3-000 001→ch. 7H-9-200 000 Auslasseite Exhaust Side CFLA: ch. 7H-9-000 001→ch. 7H-9-200 000 Auslasseite Exhaust Side
			7.06117.44.0	SV-NWV	EL	mit Dichtring with O-ring BKK: ch. 7H-3-000 001→ch. 7H-9-200 000 Einlassseite Intake Side CFLA: ch. 7H-9-000 001→ch. 7H-9-200 000 Einlassseite Intake Side
3.2 V6 4motion 173 kW (235 PS) BKK	07.2004→12.2009		7.28098.04.0	EUV-DS	EL	
			7.02256.42.0	SV-KK	EL	für Fahrzeuge mit Standheizung for vehicles with parking heater
			7.06117.43.0	SV-NWV	EL	mit Dichtring with O-ring ch. 7H-3-000 001→ch. 7H-9-200 000 Auslasseite Exhaust Side
			7.06117.44.0	SV-NWV	EL	mit Dichtring with O-ring ch. 7H-3-000 001→ch. 7H-9-200 000 Einlassseite Intake Side
3.2 V6 4motion 173 kW (235 PS) CFLA	05.2008→12.2009		7.02256.42.0	SV-KK	EL	für Fahrzeuge mit Standheizung for vehicles with parking heater
			7.06117.43.0	SV-NWV	EL	mit Dichtring with O-ring ch. 7H-9-000 001→ch. 7H-9-200 000 Auslasseite Exhaust Side
			7.06117.44.0	SV-NWV	EL	mit Dichtring with O-ring ch. 7H-9-000 001→ch. 7H-9-200 000 Einlassseite Intake Side

















MULTIVAN VI (SGF, SGM, SGN, SHM, SHN) 122

2.0 TDI 75 kW (102 PS) CAAB	04.2015→		7.02184.01.0	DW-TL	EP	
			7.02256.00.0	EUV-AGR	EP	
			7.02256.41.0	SV-KK	EL	ch. 7H-G-000 001→ für Fahrzeuge mit Schaltgetriebe for vehicles with manual transmission
2.0 TDI 75 kW (102 PS) CXGB	04.2015→		7.02184.01.0	DW-TL	EP	
2.0 TDI 103 kW (140 PS) CAAC	04.2015→		7.02184.01.0	DW-TL	EP	
			7.02256.00.0	EUV-AGR	EP	









MULTIVAN VI (SGF, SGM, SGN, SHM, SHN) 122

			7.02256.41.0	SV-KK	EL	Fahrgestellnummer ab: 7H-G-000 001, 7J-G-000 001 Vehicle Identification Number from: 7H-G-000 001, 7J-G-000 001
2.0 TDI 110 kW (150 PS) CXFA, CXHA	04.2015→		7.00868.02.0	DW-TL	EP	
			7.02184.01.0	DW-TL	EP	
			7.02256.00.0	EUV-AGR	EP	
2.0 TDI 132 kW (180 PS) CFCA	04.2015→		7.02256.00.0	EUV-AGR	EP	
			7.02256.41.0	SV-KK	EL	Fahrgestellnummer ab: 7H-G-000 001, 7J-G-000 001 Vehicle Identification Number from: 7H-G-000 001, 7J-G-000 001
2.0 TDI 150 kW (204 PS) CXEB	06.2015→		7.02184.01.0	DW-TL	EP	
			7.02256.00.0	EUV-AGR	EP	
2.0 TDI 84 kW (114 PS) CXHB	05.2016→		7.02184.01.0	DW-TL	EP	
			7.02256.00.0	EUV-AGR	EP	
2.0 TDI 146 kW (199 PS) CXEC	11.2018→		7.00868.02.0	DW-TL	EP	
			7.02184.01.0	DW-TL	EP	
			7.02256.00.0	EUV-AGR	EP	
			7.02256.41.0	SV-KK	EL	01.2020→ für Fahrzeuge mit Standheizung for vehicles with parking heater
2.0 TDI 81 kW (110 PS) CXHC	07.2019→		7.02256.00.0	EUV-AGR	EP	
			7.02256.41.0	SV-KK	EL	Fahrgestellnummer ab: 7H-L-000 001, 7J-L-000 001 Vehicle Identification Number from: 7H-L-000 001, 7J-L-000 001 für Fahrzeuge mit Standheizung for vehicles with parking heater
2.0 TDI 4motion 103 kW (140 PS) CAAC	06.2015→		7.02184.01.0	DW-TL	EP	
			7.02256.00.0	EUV-AGR	EP	
			7.28098.04.0	EUV-DS	EL	 ch. 7H-G-000 001→
			7.02256.41.0	SV-KK	EL	Fahrgestellnummer ab: 7H-G-000 001, 7J-G-000 001 Vehicle Identification Number from: 7H-G-000 001, 7J-G-000 001
2.0 TDI 4motion 132 kW (180 PS) CFCA	06.2015→		7.02256.00.0	EUV-AGR	EP	
			7.28098.04.0	EUV-DS	EL	 ch. 7H-G-000 001→
			7.02256.41.0	SV-KK	EL	Fahrgestellnummer ab: 7H-G-000 001, 7J-G-000 001 Vehicle Identification Number from: 7H-G-000 001, 7J-G-000 001
2.0 TDI 4motion 150 kW (204 PS) CXEB	06.2015→		7.02184.01.0	DW-TL	EP	
			7.28098.04.0	EUV-DS	EL	 ch. 7H-G-000 001→
2.0 TDI 4motion 110 kW (150 PS) CXFA, CXHA	08.2015→		7.00868.02.0	DW-TL	EP	
			7.02184.01.0	DW-TL	EP	
			7.02256.00.0	EUV-AGR	EP	
			7.28098.04.0	EUV-DS	EL	 CXFA, CXHA:  ch. 7H-G-000 001→
2.0 TDI 4motion 146 kW (199 PS) CXEC	12.2018→		7.00868.02.0	DW-TL	EP	

V



MULTIVAN VI (SGF, SGM, SGN, SHM, SHN) 122

			7.02184.01.0 7.02256.00.0 7.02256.41.0	DW-TL EUV-AGR SV-KK	EP EP EL	01.2020→ für Fahrzeuge mit Standheizung for vehicles with parking heater
2.0 TSI 110 kW (150 PS) CJKB	04.2015→		7.03280.04.0 7.02901.05.0 7.02256.41.0 7.06117.26.0	EUV-SR SUV SV-KK ZM-NWV	EL EL EL EL	Fahrgestellnummer ab: 7H-G-000 001, 7J-G-000 001 Vehicle Identification Number from: 7H-G-000 001, 7J-G-000 001
2.0 TSI 150 kW (204 PS) CJKA	04.2015→		7.03280.04.0 7.02901.05.0 7.02256.41.0 7.06117.26.0	EUV-SR SUV SV-KK ZM-NWV	EL EL EL EL	Fahrgestellnummer ab: 7H-G-000 001, 7J-G-000 001 Vehicle Identification Number from: 7H-G-000 001, 7J-G-000 001
2.0 TSI 4motion 150 kW (204 PS) CJKA	06.2015→		7.28098.04.0 7.03280.04.0 7.02901.05.0 7.02256.41.0 7.06117.26.0	EUV-DS EUV-SR SUV SV-KK ZM-NWV	EL EL EL EL EL	 ch. 7H-G-000 001→  ch. 7H-C-000 001→ Fahrgestellnummer ab: 7H-G-000 001, 7J-G-000 001 Vehicle Identification Number from: 7H-G-000 001, 7J-G-000 001

PASSAT B7 Estate Van (365) 123

1.6 TDi BlueMotion 77 kW (105 PS) CAYC	08.2010→12.2014		7.02256.00.0	EUV-AGR	EP	
1.8 TFSi 118 kW (160 PS) CDA A	08.2010→12.2014		7.03280.04.0 7.22880.01.0 7.06117.26.0	EUV-SR EUV-SR ZM-NWV	EL EL EL	Fahrgestellnummer ab: 3C-B-200 001 Vehicle Identification Number from: 3C-B-200 001 Fahrgestellnummer ab: 3C-B-200 001 Vehicle Identification Number from: 3C-B-200 001
2.0 TDi BlueMotion 103 kW (140 PS) CFFB	08.2010→12.2014		7.02256.00.0	EUV-AGR	EP	 ch. 3C-B-200 001→
2.0 TDi BlueMotion 125 kW (170 PS) CFG B, CLLA	08.2010→12.2014		7.02256.00.0	EUV-AGR	EP	
2.0 TFSi 155 kW (211 PS) CCZ B	11.2010→12.2014		7.03280.04.0 7.22880.01.0 7.06117.26.0	EUV-SR EUV-SR ZM-NWV	EL EL EL	Fahrgestellnummer ab: 3C-B-200 001 Vehicle Identification Number from: 3C-B-200 001 Fahrgestellnummer ab: 3C-B-200 001 Vehicle Identification Number from: 3C-B-200 001
3.6 FSi 4motion 220 kW (300 PS) BWS	01.2011→12.2014		7.06117.37.0	SV-NWV	EL	Fahrgestellnummer ab: 3C-B-200 001 Vehicle Identification Number from: 3C-B-200 001









POLO Van (6R) **124**

1.2 TDi BlueMotion 55 kW (75 PS) CFWA	10.2009→05.2014	 7.22880.01.0	EUV-AGR	EL	Fahrgestellnummer ab: 60-AT000 001 Vehicle Identification Number from: 60-AT000 001 ■ Indien ■ India
1.2 TSi 66 kW (90 PS) CBZC	05.2011→05.2014	 7.22880.01.0	EUV-KK	EL	Fahrgestellnummer ab: 6R-A-000 001 Vehicle Identification Number from: 6R-A-000 001
1.2 TSi BlueMotion 77 kW (105 PS) CBZB	11.2009→05.2014	 7.22880.01.0	EUV-KK	EL	Fahrgestellnummer ab: 60-AT000 001 Vehicle Identification Number from: 60-AT000 001 ■ Indien ■ India
1.4 GTi 132 kW (180 PS) CAVE	05.2010→05.2014	 7.02588.04.0	LDRV	EL	Fahrgestellnummer ab: 6R-A-000 001, 6R-D-000 001 Vehicle Identification Number from: 6R-A-000 001, 6R-D-000 001
1.6 TDi 55 kW (75 PS) CAYA	06.2009→05.2014	 7.04247.02.0	SUV	EL	 ch. 6R-A-000 001→
1.6 TDi 55 kW (75 PS) CAYA	06.2009→05.2014	 7.02256.00.0	EUV-AGR	EP	 ch. 6R-A-000 001→
1.6 TDi 77 kW (105 PS) CAYC	06.2009→05.2014	 7.02256.00.0	EUV-AGR	EP	 ch. 6R-A-000 001→
1.6 TDi BlueMotion 66 kW (90 PS) CAYB	06.2009→05.2014	 7.02256.00.0	EUV-AGR	EP	 ch. 6R-A-000 001→





POLO Van Estate Van (6V5) **125**

1.9 SDI 47-48 kW (64-65 PS) AEY	05.1996→08.1996	 7.21895.55.0	LDRV	EL	
---	-----------------	---	------	----	--

SCIROCCO Van (137) **126**

1.4 TSi 118 kW (160 PS) CAVD	06.2008→05.2014	 7.02588.04.0	LDRV	EL	
		7.04247.02.0	SUV	EL	
2.0 TDi 103 kW (140 PS) CBDB	08.2008→05.2014	 7.00868.02.0	DW-TL	EP	
		7.02256.00.0	EUV-AGR	EP	
2.0 TDi 103 kW (140 PS) CFHC	08.2008→05.2014	 7.02256.00.0	EUV-AGR	EP	
2.0 TDi 125 kW (170 PS) CBBB	05.2009→05.2014	 7.00868.02.0	DW-TL	EP	
		7.02256.00.0	EUV-AGR	EP	
2.0 TDi 125 kW (170 PS) CFGB	05.2009→05.2014	 7.02256.00.0	EUV-AGR	EP	
2.0 TFSi 155 kW (211 PS) CCZB	11.2009→05.2014	 7.03280.04.0	EUV-SR	EL	
		7.22880.01.0	EUV-SR	EL	
		7.00470.07.0	LDRV	EL	
		7.06117.26.0	ZM-NWV	EL	

SHARAN VAN (7M_) **127**

1.9 TDI (7M6, 7M9) 85 kW (115 PS) AUY	04.2000→03.2010	 7.02256.00.0	EUV-AGR	EP	
		7.28098.04.0	EUV-KA	EL	für Fahrzeuge mit Standheizung for vehicles with parking heater
1.9 TDI (7M8) 81 kW (110 PS) AFN	09.1996→05.2003	 7.21903.70.0	DW-AGR	EP	
1.9 TDI (7M8, 7M9) 66-67 kW (90-91 PS) AHU	09.1996→05.2000	 7.21903.70.0	DW-AGR	EP	
		7.21895.55.0	LDRV	EL	
1.9 TDI (7M8, 7M9) 66 kW (90 PS) ANU	06.2000→05.2003	 7.21903.70.0	DW-AGR	EP	



SHARAN VAN (7M_)

127

			7.02256.00.0	EUV-AGR	EP	Baujahr ab: 01.2000 Construction year from: 01.2000 für Fahrzeuge mit Standheizung for vehicles with parking heater
			7.28098.04.0	EUV-KA	EL	
			7.21895.55.0	LDRV	EL	
1.9 TDI (7M9) 96 kW (130 PS) ASZ	11.2002→05.2003		7.02256.00.0	EUV-AGR	EP	
			7.28098.04.0	EUV-KA	EL	für Fahrzeuge mit Standheizung for vehicles with parking heater
2.0 (7M8, 7M9) 85 kW (115 PS) ADY	09.1996→05.2000		7.21483.54.0	EUV-AGR	EL	
2.0 (7M8, 7M9) 85 kW (115 PS) ATM	06.2000→07.2002		7.28098.04.0	EUV-KA	EL	Baujahr ab: 01.2001 Construction year from: 01.2001 für Fahrzeuge mit Standheizung for vehicles with parking heater
2.8 VR6 (7M8) 120-128 kW (163-174 PS) AAA	09.1996→04.2000		7.21483.54.0	EUV-AGR	EL	
2.8 VR6 (7M9) 150 kW (204 PS) AYL	08.2001→05.2003		7.28098.04.0	EUV-KA	EL	für Fahrzeuge mit Standheizung for vehicles with parking heater





SHARAN VAN (7N1, 7N2)

128





















2.0 TDI 100 kW (136 PS) CFFA	05.2010→05.2011		7.02256.00.0	EUV-AGR	EP	
2.0 TDI 103 kW (140 PS) CFFB	05.2010→11.2015		7.02256.00.0	EUV-AGR	EP	
2.0 TDI 125 kW (170 PS) CFGB	08.2010→01.2013		7.02256.00.0	EUV-AGR	EP	
2.0 TDI 85 kW (115 PS) CFFE	05.2011→11.2015		7.02256.00.0	EUV-AGR	EP	
2.0 TSI 147 kW (200 PS) CCZA	12.2010→11.2015		7.03280.04.0	EUV-SR	EL	
			7.22880.01.0	EUV-SR	EL	
			7.06117.26.0	ZM-NWV	EL	

TIGUAN VAN (5N_)

129

2.0 TDI (5N1) 81 kW (110 PS) CFFD	05.2010→07.2011		7.02256.00.0	EUV-AGR	EP	
2.0 TDI (5N1, 5N2) 103 kW (140 PS) CFFB	11.2009→07.2018		7.02256.00.0	EUV-AGR	EP	
2.0 TDI 4motion (5N1, 5N2) 103 kW (140 PS) CBAB, CFFB, CLJA	11.2007→07.2018		7.02256.00.0	EUV-AGR	EP	
2.0 TDI 4motion (5N1, 5N2) 125 kW (170 PS) CFGB	05.2010→05.2013		7.02256.00.0	EUV-AGR	EP	
2.0 TDI 4motion (5N2) 130 kW (177 PS) CFGC	11.2012→07.2018		7.02256.00.0	EUV-AGR	EP	
2.0 TSI 4motion (5N1) 125 kW (170 PS) CCZC	11.2009→05.2011		7.03280.04.0	EUV-SR	EL	
			7.22880.01.0	EUV-SR	EL	
			7.06117.26.0	ZM-NWV	EL	
2.0 TSI 4motion (5N1) 147 kW (200 PS) CCZA	11.2009→05.2011		7.03280.04.0	EUV-SR	EL	
			7.22880.01.0	EUV-SR	EL	
			7.06117.26.0	ZM-NWV	EL	

V

					
TIGUAN VAN (5N_)					129
2.0 TSI 4motion (5N2) 155 kW (211 PS) CCZB	05.2011→07.2018		7.03280.04.0	EUV-SR	EL
			7.06117.26.0	ZM-NWV	EL
TOUAREG VAN (7P5)					130
3.0 TDI 4motion 180 kW (245 PS) CRCA	05.2011→12.2014		7.02256.00.0	EUV-AGR	EP
			7.28098.04.0	EUV-ML	EL
für Fahrzeuge mit Start-Stopp-Funktion, für Fahrzeuge mit Bremsenergieerückgewinnung for vehicles with start-stop function, for vehicles with brake energy recovery					
TOURAN VAN (1T1, 1T2)					131
1.9 TDI 66 kW (90 PS) BXJ	11.2004→05.2010		7.02256.00.0	EUV-AGR	EP
2.0 FSI 110 kW (150 PS) BLR, BLX, BLY, BVY, BVZ	05.2004→01.2007		7.22880.01.0	EUV-SR	EL
			7.06117.37.0	SV-NWV	EL
2.0 TDi 103 kW (140 PS) BMM	12.2005→05.2010		7.02256.00.0	EUV-AGR	EP
FSI 85 kW (115 PS) BAG, BLF, BLP	02.2003→11.2006		7.22880.01.0	EUV-SR	EL
TOURAN VAN (1T3)					132
1.6 TDI 66 kW (90 PS) CAYB	05.2010→05.2015		7.02256.00.0	EUV-AGR	EP
1.6 TDI 77 kW (105 PS) CAYC	05.2010→05.2015		7.02256.00.0	EUV-AGR	EP
2.0 TDI 103 kW (140 PS) CFHC	05.2010→05.2015		7.02256.00.0	EUV-AGR	EP
2.0 TDi 125 kW (170 PS) CFJA	05.2010→01.2013		7.02256.00.0	EUV-AGR	EP
TRANSPORTER / CARAVELLE VI Bus (SGB, SGG, SGJ, SGC, SHB, SHJ)					133
2.0 TDI 62 kW (84 PS) CAAA	04.2015→		7.00868.02.0	DW-TL	EP
			7.02256.00.0	EUV-AGR	EP
			7.02256.41.0	SV-KK	EL
Fahrgestellnummer ab: 7H-G-000 001, 7J-G-000 001 Vehicle Identification Number from: 7H-G-000 001, 7J-G-000 001 für Fahrzeuge mit Schaltgetriebe for vehicles with manual transmission					
2.0 TDI 62 kW (84 PS) CXGA	04.2015→		7.00868.02.0	DW-TL	EP
			7.02256.00.0	EUV-AGR	EP
2.0 TDI 75 kW (102 PS) CAAB	04.2015→		7.00868.02.0	DW-TL	EP
			7.02184.01.0	DW-TL	EP
			7.02256.00.0	EUV-AGR	EP
			7.02256.41.0	SV-KK	EL
Fahrgestellnummer ab: 7H-G-000 001, 7J-G-000 001 Vehicle Identification Number from: 7H-G-000 001, 7J-G-000 001 für Fahrzeuge mit Schaltgetriebe for vehicles with manual transmission					
2.0 TDI 75 kW (102 PS) CXGB	04.2015→		7.00868.02.0	DW-TL	EP
			7.02184.01.0	DW-TL	EP
			7.02256.00.0	EUV-AGR	EP















TRANSPORTER / CARAVELLE VI Bus (SGB, SGG, SGJ, SGC, SHB, SHJ) 133

2.0 TDI 103 kW (140 PS) CAAC	04.2015→		7.00868.02.0	DW-TL	EP	Fahrgestellnummer ab: 7H-G-000 001, 7J-G-000 001 Vehicle Identification Number from: 7H-G-000 001, 7J-G-000 001
			7.02184.01.0	DW-TL	EP	
			7.02256.00.0	EUV-AGR	EP	
			7.02256.41.0	SV-KK	EL	
2.0 TDI 110 kW (150 PS) CXFA, CXHA	04.2015→		7.00868.02.0	DW-TL	EP	
			7.02184.01.0	DW-TL	EP	
			7.02256.00.0	EUV-AGR	EP	
2.0 TDI 132 kW (180 PS) CFCA	04.2015→		7.00868.02.0	DW-TL	EP	Fahrgestellnummer ab: 7H-G-000 001, 7J-G-000 001 Vehicle Identification Number from: 7H-G-000 001, 7J-G-000 001
			7.02256.00.0	EUV-AGR	EP	
			7.02256.41.0	SV-KK	EL	
2.0 TDI 150 kW (204 PS) CXEB	06.2015→		7.00868.02.0	DW-TL	EP	
			7.02184.01.0	DW-TL	EP	
			7.02256.00.0	EUV-AGR	EP	
2.0 TDI 84 kW (114 PS) CXHB	05.2016→		7.00868.02.0	DW-TL	EP	
			7.02184.01.0	DW-TL	EP	
			7.02256.00.0	EUV-AGR	EP	
2.0 TDI 146 kW (199 PS) CXEC	11.2018→		7.00868.02.0	DW-TL	EP	Fahrgestellnummer ab: 7H-L-000 001, 7J-L-000 001 Vehicle Identification Number from: 7H-L-000 001, 7J-L-000 001 für Fahrzeuge mit Standheizung for vehicles with parking heater
			7.02184.01.0	DW-TL	EP	
			7.02256.00.0	EUV-AGR	EP	
			7.02256.41.0	SV-KK	EL	
2.0 TDI 81 kW (110 PS) CXHC	07.2019→		7.02256.00.0	EUV-AGR	EP	Fahrgestellnummer ab: 7H-L-000 001, 7J-L-000 001 Vehicle Identification Number from: 7H-L-000 001, 7J-L-000 001 für Fahrzeuge mit Standheizung for vehicles with parking heater
			7.02256.41.0	SV-KK	EL	
2.0 TDI 66 kW (90 PS) CXGD	10.2019→		7.02256.00.0	EUV-AGR	EP	Fahrgestellnummer ab: 7H-L-000 001, 7J-L-000 001 Vehicle Identification Number from: 7H-L-000 001, 7J-L-000 001 für Fahrzeuge mit Standheizung for vehicles with parking heater
			7.02256.41.0	SV-KK	EL	
2.0 TDI 4motion 103 kW (140 PS) CAAC	06.2015→		7.00868.02.0	DW-TL	EP	Fahrgestellnummer ab: 7H-G-000 001, 7J-G-000 001 Vehicle Identification Number from: 7H-G-000 001, 7J-G-000 001
			7.02184.01.0	DW-TL	EP	
			7.02256.00.0	EUV-AGR	EP	
			7.28098.04.0	EUV-DS	EL	
			7.02256.41.0	SV-KK	EL	





TRANSPORTER / CARAVELLE VI Bus (SGB, SGG, SGJ, SGC, SHB, SHJ) 133































2.0 TDI 4motion 132 kW (180 PS) CFCA	06.2015→		7.00868.02.0	DW-TL	EP	 ch. 7H-G-000 001→ Fahrgestellnummer ab: 7H-G-000 001, 7J-G-000 001 Vehicle Identification Number from: 7H-G-000 001, 7J-G-000 001
			7.02256.00.0	EUV-AGR	EP	
			7.28098.04.0	EUV-DS	EL	
			7.02256.41.0	SV-KK	EL	
2.0 TDI 4motion 150 kW (204 PS) CXEB	06.2015→		7.00868.02.0	DW-TL	EP	 ch. 7H-G-000 001→
			7.02184.01.0	DW-TL	EP	
			7.02256.00.0	EUV-AGR	EP	
			7.28098.04.0	EUV-DS	EL	
2.0 TDI 4motion 110 kW (150 PS) CXFA, CXHA	08.2015→		7.00868.02.0	DW-TL	EP	 CXFA, CXHA:  ch. 7H-G-000 001→
			7.02184.01.0	DW-TL	EP	
			7.02256.00.0	EUV-AGR	EP	
			7.28098.04.0	EUV-DS	EL	
2.0 TDI 4motion 146 kW (199 PS) CXEC	08.2018→		7.00868.02.0	DW-TL	EP	Fahrgestellnummer ab: 7H-L-000 001, 7J-L-000 001 Vehicle Identification Number from: 7H-L-000 001, 7J-L-000 001 für Fahrzeuge mit Standheizung for vehicles with parking heater
			7.02184.01.0	DW-TL	EP	
			7.02256.00.0	EUV-AGR	EP	
			7.02256.41.0	SV-KK	EL	
2.0 TSI 110 kW (150 PS) CJKB	04.2015→		7.03280.04.0	EUV-SR	EL	Fahrgestellnummer ab: 7H-G-000 001, 7J-G-000 001 Vehicle Identification Number from: 7H-G-000 001, 7J-G-000 001
			7.02901.05.0	SUV	EL	
			7.02256.41.0	SV-KK	EL	
			7.06117.26.0	ZM-NWV	EL	
2.0 TSI 150 kW (204 PS) CJKA	04.2015→		7.03280.04.0	EUV-SR	EL	Fahrgestellnummer ab: 7H-G-000 001, 7J-G-000 001 Vehicle Identification Number from: 7H-G-000 001, 7J-G-000 001
			7.02901.05.0	SUV	EL	
			7.02256.41.0	SV-KK	EL	
			7.06117.26.0	ZM-NWV	EL	
2.0 TSI 4motion 150 kW (204 PS) CJKA	06.2015→		7.28098.04.0	EUV-DS	EL	 ch. 7H-G-000 001→ Fahrgestellnummer ab: 7H-G-000 001, 7J-G-000 001 Vehicle Identification Number from: 7H-G-000 001, 7J-G-000 001
			7.03280.04.0	EUV-SR	EL	
			7.02901.05.0	SUV	EL	
			7.02256.41.0	SV-KK	EL	
			7.06117.26.0	ZM-NWV	EL	

TRANSPORTER IV Bus (70B, 70C, 7DB, 7DK, 70J, 70K, 7DC, 7DJ) 134

1.9 TD 50 kW (68 PS) ABL	10.1992→04.2003		7.02256.06.0	SV-KK	EL	 ch. 70-Y-015 001→
2.0 62 kW (84 PS) AAC	09.1990→04.2003		7.02256.06.0	SV-KK	EL	 ch. 70-Y-015 001→



TRANSPORTER IV Bus (70B, 70C, 7DB, 7DK, 70J, 70K, 7DC, 7DJ) 134

2.5 81 kW (110 PS) AEU	09.1990→06.2003	 7.02256.06.0	SV-KK	EL	 ch. 70-Y-015 001→
2.5 81-85 kW (110-115 PS) AET	08.1996→04.2003	 7.21483.54.0	EUV-AGR	EL	
		7.02256.06.0	SV-KK	EL	 ch. 70-Y-015 001→
2.5 85 kW (115 PS) APL	05.1999→04.2003	 7.02256.06.0	SV-KK	EL	 ch. 70-Y-015 001→
2.5 Syncro 81 kW (110 PS) AEU	08.1992→04.2003	 7.02256.06.0	SV-KK	EL	 ch. 70-Y-015 001→
2.5 Syncro 81-85 kW (110-115 PS) AET	08.1996→04.2003	 7.21483.54.0	EUV-AGR	EL	Fahrgestellnummer ab: 70-T-200 001 Vehicle Identification Number from: 70-T-200 001
		7.02256.06.0	SV-KK	EL	 ch. 70-Y-015 001→
2.5 Syncro 85 kW (115 PS) APL	05.1999→04.2003	 7.02256.06.0	SV-KK	EL	 ch. 70-Y-015 001→
2.5 TDI 75 kW (102 PS) ACV, AUF, AYC	09.1995→04.2003	 7.21903.70.0	DW-AGR	EP	
		7.02256.06.0	SV-KK	EL	 ACV, AYC:  ch. 70-Y-015 001→  AUF:  ch. 70-Y-015 001→ Automatikgetriebe Automatic Transmission
2.5 TDI 65 kW (88 PS) AJT, AYY	05.1998→04.2003	 7.21903.70.0	DW-AGR	EP	
		7.02256.06.0	SV-KK	EL	 AJT, AYY:  ch. 70-Y-015 001→
2.5 TDI 111 kW (151 PS) AHY, AXG	05.1998→04.2003	 7.21903.70.0	DW-AGR	EP	
		7.21903.75.0	DW-TL	EP	
		7.02256.06.0	SV-KK	EL	 AHY, AXG:  ch. 70-Y-015 001→
2.5 TDI Syncro 75 kW (102 PS) ACV	01.1996→04.2003	 7.21903.70.0	DW-AGR	EP	
		7.02256.06.0	SV-KK	EL	 ch. 70-Y-015 001→
2.5 TDI Syncro 75 kW (102 PS) AXL	01.1996→04.2003	 7.21903.75.0	DW-TL	EP	 ch. 70-T-200 001→
2.8 VR 6 103 kW (140 PS) AES	11.1995→04.2000	 7.21483.54.0	EUV-AGR	EL	Fahrgestellnummer ab: 70-T-200 001 Vehicle Identification Number from: 70-T-200 001
		7.02256.06.0	SV-KK	EL	 ch. 70-Y-015 001→
2.8 VR6 150 kW (204 PS) AMV	04.2000→04.2003	 7.28098.04.0	EUV-SR	EL	
		7.02256.06.0	SV-KK	EL	
		7.06117.44.0	SV-NWV	EL	mit Dichtung with O-ring Einlassseite Intake Side

























TRANSPORTER IV Platform/Chassis (70E, 70L, 70M, 7DE, 7DL, 7D) 135

1.9 TD 50 kW (68 PS) ABL	10.1992→04.2003	 7.02256.06.0	SV-KK	EL	 ch. 70-Y-015 001→
2.0 62 kW (84 PS) AAC	07.1990→04.2003	 7.02256.06.0	SV-KK	EL	 ch. 70-Y-015 001→
2.5 81 kW (110 PS) AEU	11.1990→04.2003	 7.02256.06.0	SV-KK	EL	 ch. 70-Y-015 001→
2.5 81-85 kW (110-115 PS) AET	08.1996→04.2003	 7.21483.54.0	EUV-AGR	EL	
		7.02256.06.0	SV-KK	EL	 ch. 70-Y-015 001→
2.5 85 kW (115 PS) APL	05.1999→04.2003	 7.02256.06.0	SV-KK	EL	 ch. 70-Y-015 001→
2.5 Syncro 81-85 kW (110-115 PS) AET	08.1996→04.2003	 7.21483.54.0	EUV-AGR	EL	Fahrgestellnummer ab: 70-T-200 001 Vehicle Identification Number from: 70-T-200 001
		7.02256.06.0	SV-KK	EL	 ch. 70-Y-015 001→

































TRANSPORTER IV Plattform/Chassis (70E, 70L, 70M, 7DE, 7DL, 7D) 135

















2.5 Syncro 81 kW (110 PS) AEU	06.1997→11.2001	 7.02256.06.0	SV-KK	EL	 ch. 70-Y-015 001→
2.5 Syncro 85 kW (115 PS) APL	05.1999→04.2003	 7.02256.06.0	SV-KK	EL	 ch. 70-Y-015 001→
2.5 TDI 75 kW (102 PS) ACV, AUF, AYC	09.1995→04.2003	 7.21903.70.0	DW-AGR	EP	 ACV, AYC:  ch. 70-Y-015 001→  AUF:  ch. 70-Y-015 001→ Automatikgetriebe Automatic Transmission
		 7.02256.06.0	SV-KK	EL	
2.5 TDI 65 kW (88 PS) AJT, AYY	05.1998→04.2003	 7.21903.70.0	DW-AGR	EP	 AJT, AYY:  ch. 70-Y-015 001→
		 7.02256.06.0	SV-KK	EL	
2.5 TDI Syncro 75 kW (102 PS) ACV	05.1998→04.2003	 7.21903.70.0	DW-AGR	EP	 ch. 70-Y-015 001→
		 7.02256.06.0	SV-KK	EL	
2.5 TDI Syncro 75 kW (102 PS) AXL	05.1998→04.2003	 7.21903.75.0	DW-TL	EP	 ch. 70-T-200 001→
2.8 103 kW (140 PS) AES	05.1996→05.2000	 7.21483.54.0	EUV-AGR	EL	Fahrgestellnummer ab: 70-T-200 001 Vehicle Identification Number from: 70-T-200 001
		 7.02256.06.0	SV-KK	EL	
2.8 VR6 150 kW (204 PS) AMV	06.2000→04.2003	 7.28098.04.0	EUV-SR	EL	mit Dichtring with O-ring Einlassseite Intake Side
		 7.02256.06.0	SV-KK	EL	
		 7.06117.44.0	SV-NWV	EL	

TRANSPORTER IV Van (70A, 70H, 7DA, 7DH) 136















1.9 TD 50 kW (68 PS) ABL	10.1992→04.2003	 7.02256.06.0	SV-KK	EL	 ch. 70-Y-015 001→
2.0 62 kW (84 PS) AAC	07.1990→04.2003	 7.02256.06.0	SV-KK	EL	 ch. 70-Y-015 001→
2.5 81 kW (110 PS) AEU	11.1990→04.2003	 7.02256.06.0	SV-KK	EL	 ch. 70-Y-015 001→
2.5 81-85 kW (110-115 PS) AET	08.1996→04.2003	 7.21483.54.0	EUV-AGR	EL	 ch. 70-Y-015 001→
		 7.02256.06.0	SV-KK	EL	
2.5 85 kW (115 PS) APL	05.1999→04.2003	 7.02256.06.0	SV-KK	EL	 ch. 70-Y-015 001→
2.5 Syncro 81-85 kW (110-115 PS) AET	08.1996→04.2003	 7.21483.54.0	EUV-AGR	EL	Fahrgestellnummer ab: 70-T-200 001 Vehicle Identification Number from: 70-T-200 001
		 7.02256.06.0	SV-KK	EL	
2.5 Syncro 81 kW (110 PS) AEU	06.1997→11.2001	 7.02256.06.0	SV-KK	EL	 ch. 70-Y-015 001→
2.5 Syncro 85 kW (115 PS) APL	05.1999→04.2003	 7.02256.06.0	SV-KK	EL	 ch. 70-Y-015 001→
2.5 TDI 75 kW (102 PS) ACV, AUF, AYC	09.1995→04.2003	 7.21903.70.0	DW-AGR	EP	 ACV, AYC:  ch. 70-Y-015 001→  AUF:  ch. 70-Y-015 001→ Automatikgetriebe Automatic Transmission
		 7.02256.06.0	SV-KK	EL	
2.5 TDI 65 kW (88 PS) AJT, AYY	12.1998→04.2003	 7.21903.70.0	DW-AGR	EP	 AJT, AYY:  ch. 70-Y-015 001→
		 7.02256.06.0	SV-KK	EL	
2.5 TDI 111 kW (151 PS) AHY	09.2000→04.2003	 7.21903.70.0	DW-AGR	EP	



TRANSPORTER IV Van (70A, 70H, 7DA, 7DH) 136

2.5 TDI 111 kW (151 PS) AXG	09.2000→04.2003	 7.21903.75.0	DW-TL	EP	
		 7.21903.70.0	DW-AGR	EP	
2.5 TDI Syncro 75 kW (102 PS) ACV	09.1995→04.2003	 7.21903.75.0	DW-TL	EP	 ch. 70-Y-015 001→
		 7.02256.06.0	SV-KK	EL	
2.5 TDI Syncro 75 kW (102 PS) AXL	09.1995→04.2003	 7.21903.70.0	DW-AGR	EP	 ch. 70-Y-015 001→
		 7.02256.06.0	SV-KK	EL	
2.8 VR6 103 kW (140 PS) AES	05.1996→05.2000	 7.21903.75.0	DW-TL	EP	 ch. 70-T-200 001→
		 7.21483.54.0	EUV-AGR	EL	
2.8 VR6 150 kW (204 PS) AMV	06.2000→04.2003	 7.21483.54.0	EUV-AGR	EL	Fahrgestellnummer ab: 70-T-200 001 Vehicle Identification Number from: 70-T-200 001
		 7.02256.06.0	SV-KK	EL	
		 7.28098.04.0	EUV-SR	EL	
		 7.02256.06.0	SV-KK	EL	 ch. 70-Y-015 001→
		 7.06117.44.0	SV-NWV	EL	
					mit Dichtring with O-ring Einlassseite Intake Side







TRANSPORTER V Bus (7HB, 7HJ, 7EB, 7EJ, 7EF, 7EG, 7HF, 7EC) 137

1.9 TDI 63 kW (85 PS) AXC	04.2003→11.2009	 7.00580.01.0	DW-AGR	EP	Fahrgestellnummer ab: 7H-4-082 001, 7J-4-033 001 Vehicle Identification Number from: 7H-4-082 001, 7J-4-033 001 für Fahrzeuge mit Standheizung, für Fahrzeuge mit Schaltgetriebe for vehicles with parking heater, for vehicles with manual transmission
		 7.00868.02.0	DW-TL	EP	
		 7.02256.00.0	EUV-AGR	EP	
		 7.02256.42.0	SV-KK	EL	
1.9 TDI 77 kW (105 PS) AXB	04.2003→11.2009	 7.00580.01.0	DW-AGR	EP	Fahrgestellnummer ab: 7H-4-082 001, 7J-4-033 001 Vehicle Identification Number from: 7H-4-082 001, 7J-4-033 001 für Fahrzeuge mit Standheizung, für Fahrzeuge mit Schaltgetriebe for vehicles with parking heater, for vehicles with manual transmission
		 7.00868.02.0	DW-TL	EP	
		 7.02256.00.0	EUV-AGR	EP	
		 7.02256.42.0	SV-KK	EL	
1.9 TDI 62 kW (84 PS) BRR	01.2006→11.2009	 7.00868.02.0	DW-TL	EP	
		 7.02256.42.0	SV-KK	EL	
1.9 TDI 75 kW (102 PS) BRS	06.2006→11.2009	 7.00868.02.0	DW-TL	EP	
		 7.02256.42.0	SV-KK	EL	
2.0 85 kW (115 PS) AXA	11.2003→08.2015	 7.10014.00.0	AKF	EL	 ch. 7H-3-000 001→

V

























TRANSPORTER V Bus (7HB, 7HJ, 7EB, 7EJ, 7EF, 7EG, 7HF, 7EC) 137

			7.02256.41.0	SV-KK	EL	Fahrgestellnummer ab: 7H-A-200 001, 7J-A-200 001 Vehicle Identification Number from: 7H-A-200 001, 7J-A-200 001 für Fahrzeuge mit Schaltgetriebe for vehicles with manual transmission für heiße Klimazonen for hot climate zones
			7.02256.42.0	SV-KK	EL	für Fahrzeuge mit Standheizung, für Fahrzeuge mit Schaltgetriebe for vehicles with parking heater, for vehicles with manual transmission
2.0 BiTDI 132 kW (180 PS) CFCA	09.2009→08.2015		7.00868.02.0	DW-TL	EP	Fahrgestellnummer ab: 7H-A-200 001, 7J-A-200 001 Vehicle Identification Number from: 7H-A-200 001, 7J-A-200 001
			7.02256.00.0	EUV-AGR	EP	
			7.02256.41.0	SV-KK	EL	
2.0 BiTDI 4motion 132 kW (180 PS) CFCA	09.2009→08.2015		7.00868.02.0	DW-TL	EP	Fahrgestellnummer ab: 7H-A-200 001 Vehicle Identification Number from: 7H-A-200 001 Fahrgestellnummer ab: 7H-A-200 001, 7J-A-200 001 Vehicle Identification Number from: 7H-A-200 001, 7J-A-200 001
			7.02256.00.0	EUV-AGR	EP	
			7.28098.04.0	EUV-DS	EL	
			7.02256.41.0	SV-KK	EL	
2.0 CNG 85 kW (115 PS) AXA	01.2006→08.2015		7.02256.41.0	SV-KK	EL	Fahrgestellnummer ab: 7H-A-200 001, 7J-A-200 001 Vehicle Identification Number from: 7H-A-200 001, 7J-A-200 001 für Fahrzeuge mit Schaltgetriebe for vehicles with manual transmission für heiße Klimazonen for hot climate zones
2.0 TDI 62 kW (84 PS) CAAA	09.2009→08.2015		7.00868.02.0	DW-TL	EP	Fahrgestellnummer ab: 7H-A-200 001, 7J-A-200 001 Vehicle Identification Number from: 7H-A-200 001, 7J-A-200 001 für Fahrzeuge mit Schaltgetriebe for vehicles with manual transmission
			7.02256.00.0	EUV-AGR	EP	
			7.02256.41.0	SV-KK	EL	
2.0 TDI 75 kW (102 PS) CAAB	09.2009→08.2015		7.00868.02.0	DW-TL	EP	Fahrgestellnummer ab: 7H-A-200 001, 7J-A-200 001 Vehicle Identification Number from: 7H-A-200 001, 7J-A-200 001 für Fahrzeuge mit Schaltgetriebe for vehicles with manual transmission
			7.02256.00.0	EUV-AGR	EP	
			7.02256.41.0	SV-KK	EL	
2.0 TDI 103 kW (140 PS) CAAC, CCHA	09.2009→08.2015		7.00868.02.0	DW-TL	EP	
			7.02256.00.0	EUV-AGR	EP	

V







TRANSPORTER V Bus (7HB, 7HJ, 7EB, 7EJ, 7EF, 7EG, 7HF, 7EC) 137

			7.02256.41.0	SV-KK	EL	 CAAC: Fahrgestellnummer ab: 7H-A-200 001, 7J-A-200 001 Vehicle Identification Number from: 7H-A-200 001, 7J-A-200 001  CCHA: Fahrgestellnummer ab: 7H-A-200 001 Vehicle Identification Number from: 7H-A-200 001
2.0 TDI 100 kW (136 PS) CAAE, CCHB	05.2010→08.2015		7.00868.02.0	DW-TL	EP	 CAAE: Fahrgestellnummer ab: 7H-A-200 001, 7J-A-200 001 Vehicle Identification Number from: 7H-A-200 001, 7J-A-200 001  CCHB:  ch. 7H-A-200 001→
			7.02256.00.0	EUV-AGR	EP	
			7.02256.41.0	SV-KK	EL	
2.0 TDI 84 kW (114 PS) CAAD	05.2011→08.2015		7.02256.00.0	EUV-AGR	EP	Fahrgestellnummer ab: 7H-C-000 001, 7J-C-000 001 Vehicle Identification Number from: 7H-C-000 001, 7J-C-000 001 für Fahrzeuge mit Schaltgetriebe for vehicles with manual transmission
			7.02256.41.0	SV-KK	EL	
2.0 TDI 4motion 103 kW (140 PS) CAAC, CCHA	09.2009→08.2015		7.00868.02.0	DW-TL	EP	 CAAC, CCHA:  ch. 7H-A-200 001→  CAAC: Fahrgestellnummer ab: 7H-A-200 001, 7J-A-200 001 Vehicle Identification Number from: 7H-A-200 001, 7J-A-200 001  CCHA: Fahrgestellnummer ab: 7H-A-200 001 Vehicle Identification Number from: 7H-A-200 001
			7.02256.00.0	EUV-AGR	EP	
			7.28098.04.0	EUV-DS	EL	
			7.02256.41.0	SV-KK	EL	
2.0 TDI 4motion 100 kW (136 PS) CAAE, CCHB	05.2010→08.2015		7.00868.02.0	DW-TL	EP	 CAAE, CCHB:  ch. 7H-A-200 001→  CAAE: Fahrgestellnummer ab: 7H-A-200 001, 7J-A-200 001 Vehicle Identification Number from: 7H-A-200 001, 7J-A-200 001  CCHB:  ch. 7H-A-200 001→
			7.02256.00.0	EUV-AGR	EP	
			7.28098.04.0	EUV-DS	EL	
			7.02256.41.0	SV-KK	EL	
2.0 TSI 150 kW (204 PS) CJKA	05.2011→08.2015		7.03280.04.0	EUV-SR	EL	 ch. 7H-C-000 001→
			7.02901.05.0	SUV	EL	
			7.02256.41.0	SV-KK	EL	
			7.06117.26.0	ZM-NWV	EL	
2.0 TSI 110 kW (150 PS) CJKB	07.2012→08.2015		7.03280.04.0	EUV-SR	EL	Fahrgestellnummer ab: 7H-C-000 001, 7J-C-000 001 Vehicle Identification Number from: 7H-C-000 001, 7J-C-000 001
			7.02901.05.0	SUV	EL	
			7.02256.41.0	SV-KK	EL	
2.0 TSI 4motion 150 kW (204 PS) CJKA	07.2011→08.2015		7.06117.26.0	ZM-NWV	EL	Fahrgestellnummer ab: 7H-A-200 001 Vehicle Identification Number from: 7H-A-200 001
			7.28098.04.0	EUV-DS	EL	
			7.03280.04.0	EUV-SR	EL	



















TRANSPORTER V Bus (7HB, 7HJ, 7EB, 7EJ, 7EF, 7EG, 7HF, 7EC) **137**

			7.02901.05.0 7.02256.41.0 7.06117.26.0	SUV SV-KK ZM-NWV	EL EL EL	 ch. 7H-C-000 001→
2.5 TDI 96 kW (130 PS) AXD	04.2003→11.2009		7.00580.01.0 7.00868.02.0 7.02256.00.0 7.02256.42.0	DW-AGR DW-TL EUV-AGR SV-KK	EP EP EP EL	für Fahrzeuge mit Standheizung for vehicles with parking heater
2.5 TDI 96-128 kW (131-174 PS) AXE	04.2003→11.2009		7.00868.02.0 7.02256.00.0	DW-TL EUV-AGR	EP EP	
2.5 TDI 96 kW (130 PS) BNZ	04.2003→11.2009		7.00868.02.0 7.02256.00.0 7.02256.42.0	DW-TL EUV-AGR SV-KK	EP EP EL	für Fahrzeuge mit Standheizung for vehicles with parking heater
2.5 TDI 96-128 kW (131-174 PS) AXE	04.2003→11.2009		7.00580.01.0 7.00868.02.0 7.02256.00.0 7.02256.42.0	DW-AGR DW-TL EUV-AGR SV-KK	EP EP EP EL	für Fahrzeuge mit Standheizung for vehicles with parking heater
2.5 TDI 128 kW (174 PS) BPC	04.2003→11.2009		7.00868.02.0 7.02256.00.0 7.02256.42.0	DW-TL EUV-AGR SV-KK	EP EP EL	für Fahrzeuge mit Standheizung for vehicles with parking heater
2.5 TDI 4motion 96 kW (130 PS) AXD	07.2004→11.2009		7.00580.01.0 7.00868.02.0 7.02256.00.0 7.28098.04.0 7.02256.42.0	DW-AGR DW-TL EUV-AGR EUV-DS SV-KK	EP EP EP EL EL	für Fahrzeuge mit Standheizung for vehicles with parking heater
2.5 TDI 4motion 96 kW (130 PS) BNZ	07.2004→11.2009		7.00868.02.0 7.02256.00.0 7.28098.04.0 7.02256.42.0	DW-TL EUV-AGR EUV-DS SV-KK	EP EP EL EL	für Fahrzeuge mit Standheizung for vehicles with parking heater
2.5 TDI 4motion 96-128 kW (131-174 PS) AXE	07.2004→11.2009		7.00580.01.0 7.00868.02.0 7.02256.00.0 7.28098.04.0 7.02256.42.0	DW-AGR DW-TL EUV-AGR EUV-DS SV-KK	EP EP EP EL EL	für Fahrzeuge mit Standheizung for vehicles with parking heater
2.5 TDI 4motion 128 kW (174 PS) BPC	07.2004→11.2009		7.00868.02.0 7.02256.00.0 7.28098.04.0 7.02256.42.0	DW-TL EUV-AGR EUV-DS SV-KK	EP EP EL EL	für Fahrzeuge mit Standheizung for vehicles with parking heater
2.5 TDi 120 kW (163 PS) BLJ	11.2003→11.2009		7.00580.01.0 7.00868.02.0 7.02256.00.0	DW-AGR DW-TL EUV-AGR	EP EP EP	





TRANSPORTER V Bus (7HB, 7HJ, 7EB, 7EJ, 7EF, 7EG, 7HF, 7EC) **137**

			7.02256.42.0	SV-KK	EL	für Fahrzeuge mit Standheizung, für Fahrzeuge mit Schaltgetriebe for vehicles with parking heater, for vehicles with manual transmission
3.2 V6 170 kW (231 PS) BDL	02.2004→06.2004		7.02256.42.0	SV-KK	EL	für Fahrzeuge mit Standheizung for vehicles with parking heater
			7.06117.43.0	SV-NWV	EL	mit Dichtring with O-ring  ch. 7H-3-000 001→ch. 7H-3-001 000 Auslassseite Exhaust Side
			7.06117.44.0	SV-NWV	EL	mit Dichtring with O-ring  ch. 7H-3-000 001→ch. 7H-3-001 000 Einlassseite Intake Side
3.2 V6 173 kW (235 PS) BKK, CFLA	02.2004→11.2009		7.02256.42.0	SV-KK	EL	 BKK, CFLA: für Fahrzeuge mit Standheizung for vehicles with parking heater
			7.06117.43.0	SV-NWV	EL	mit Dichtring with O-ring  BKK:  ch. 7H-3-000 001→ch. 7H-9-200 000 Auslassseite Exhaust Side
			7.06117.44.0	SV-NWV	EL	mit Dichtring with O-ring  CFLA:  ch. 7H-9-000 001→ch. 7H-9-200 000 Auslassseite Exhaust Side
3.2 V6 4motion 173 kW (235 PS) BKK	11.2003→12.2009		7.28098.04.0	EUV-DS	EL	
			7.02256.42.0	SV-KK	EL	für Fahrzeuge mit Standheizung for vehicles with parking heater
			7.06117.43.0	SV-NWV	EL	mit Dichtring with O-ring  ch. 7H-3-000 001→ch. 7H-9-200 000 Auslassseite Exhaust Side
3.2 V6 4motion 170 kW (231 PS) BDL	11.2003→11.2009		7.28098.04.0	EUV-DS	EL	
			7.06117.44.0	SV-NWV	EL	mit Dichtring with O-ring  ch. 7H-3-000 001→ch. 7H-9-200 000 Einlassseite Intake Side
			7.02256.42.0	SV-KK	EL	für Fahrzeuge mit Standheizung for vehicles with parking heater
3.2 V6 4motion 173 kW (235 PS) CFLA	05.2008→12.2009		7.02256.42.0	SV-KK	EL	für Fahrzeuge mit Standheizung for vehicles with parking heater











TRANSPORTER V Bus (7HB, 7HJ, 7EB, 7EJ, 7EF, 7EG, 7HF, 7EC) 137

		7.06117.43.0	SV-NWV	EL	mit Dichtring with O-ring  ch. 7H-9-000 001→ch. 7H-9-200 000 Auslasseite Exhaust Side
		7.06117.44.0	SV-NWV	EL	mit Dichtring with O-ring  ch. 7H-9-000 001→ch. 7H-9-200 000 Einlassseite Intake Side













TRANSPORTER V Platform/Chassis (7JD, 7JE, 7JL, 7JY, 7JZ, 7FD) 138

1.9 TDI 63 kW (85 PS) AXC	04.2003→11.2009	 7.00580.01.0	DW-AGR	EP	Fahrgestellnummer ab: 7H-4-082 001, 7J-4-033 001 Vehicle Identification Number from: 7H-4-082 001, 7J-4-033 001 für Fahrzeuge mit Standheizung, für Fahrzeuge mit Schaltgetriebe for vehicles with parking heater, for vehicles with manual transmission
		7.00868.02.0	DW-TL	EP	
		7.02256.00.0	EUV-AGR	EP	
		7.02256.42.0	SV-KK	EL	
1.9 TDI 77 kW (105 PS) AXB	04.2003→11.2009	 7.00580.01.0	DW-AGR	EP	Fahrgestellnummer ab: 7H-4-082 001, 7J-4-033 001 Vehicle Identification Number from: 7H-4-082 001, 7J-4-033 001 für Fahrzeuge mit Standheizung, für Fahrzeuge mit Schaltgetriebe for vehicles with parking heater, for vehicles with manual transmission
		7.00868.02.0	DW-TL	EP	
		7.02256.00.0	EUV-AGR	EP	
		7.02256.42.0	SV-KK	EL	
1.9 TDI 62 kW (84 PS) BRR	01.2006→11.2009	 7.00868.02.0	DW-TL	EP	für Fahrzeuge mit Standheizung for vehicles with parking heater
		7.02256.42.0	SV-KK	EL	
1.9 TDI 75 kW (102 PS) BRS	06.2006→11.2009	 7.00868.02.0	DW-TL	EP	für Fahrzeuge mit Standheizung for vehicles with parking heater
		7.02256.42.0	SV-KK	EL	
2.0 85 kW (115 PS) AXA	11.2003→05.2013	 7.10014.00.0	AKF	EL	 ch. 7J-3-000 001→
		7.02256.41.0	SV-KK	EL	Fahrgestellnummer ab: 7H-A-200 001, 7J-A-200 001 Vehicle Identification Number from: 7H-A-200 001, 7J-A-200 001 für Fahrzeuge mit Schaltgetriebe for vehicles with manual transmission für heiße Klimazonen for hot climate zones
		7.02256.42.0	SV-KK	EL	für Fahrzeuge mit Standheizung, für Fahrzeuge mit Schaltgetriebe for vehicles with parking heater, for vehicles with manual transmission
2.0 BiTDI 132 kW (180 PS) CFCA	09.2009→08.2015	 7.00868.02.0	DW-TL	EP	
		7.02256.00.0	EUV-AGR	EP	

V

















TRANSPORTER V Platform/Chassis (7JD, 7JE, 7JL, 7JY, 7JZ, 7FD) 138

		 PIERBURG			
		7.02256.41.0	SV-KK	EL	Fahrgestellnummer ab: 7H-A-200 001, 7J-A-200 001 Vehicle Identification Number from: 7H-A-200 001, 7J-A-200 001
2.0 BiTDI 4motion 132 kW (180 PS) CFCA	09.2009→08.2015	 7.00868.02.0	DW-TL	EP	
		7.02256.00.0	EUV-AGR	EP	
		7.28098.04.0	EUV-DS	EL	 ch. 7J-A-200 001→
		7.02256.41.0	SV-KK	EL	Fahrgestellnummer ab: 7H-A-200 001, 7J-A-200 001 Vehicle Identification Number from: 7H-A-200 001, 7J-A-200 001
2.0 TDI 62 kW (84 PS) CAAA	09.2009→08.2015	 7.00868.02.0	DW-TL	EP	
		7.02256.00.0	EUV-AGR	EP	
		7.02256.41.0	SV-KK	EL	Fahrgestellnummer ab: 7H-A-200 001, 7J-A-200 001 Vehicle Identification Number from: 7H-A-200 001, 7J-A-200 001 für Fahrzeuge mit Schaltgetriebe für vehicles with manual transmission
2.0 TDI 75 kW (102 PS) CAAB	09.2009→08.2015	 7.00868.02.0	DW-TL	EP	
		7.02256.41.0	SV-KK	EL	Fahrgestellnummer ab: 7H-A-200 001, 7J-A-200 001 Vehicle Identification Number from: 7H-A-200 001, 7J-A-200 001 für Fahrzeuge mit Schaltgetriebe für vehicles with manual transmission
2.0 TDI 103 kW (140 PS) CAAC	09.2009→08.2015	 7.00868.02.0	DW-TL	EP	
		7.02256.00.0	EUV-AGR	EP	
		7.02256.41.0	SV-KK	EL	Fahrgestellnummer ab: 7H-A-200 001, 7J-A-200 001 Vehicle Identification Number from: 7H-A-200 001, 7J-A-200 001
2.0 TDI 103 kW (140 PS) CCHA	09.2009→08.2015	 7.00868.02.0	DW-TL	EP	
		7.02256.00.0	EUV-AGR	EP	
2.0 TDI 100 kW (136 PS) CAAE	05.2010→08.2015	 7.00868.02.0	DW-TL	EP	
		7.02256.00.0	EUV-AGR	EP	
		7.02256.41.0	SV-KK	EL	Fahrgestellnummer ab: 7H-A-200 001, 7J-A-200 001 Vehicle Identification Number from: 7H-A-200 001, 7J-A-200 001
2.0 TDI 84 kW (114 PS) CAAD	05.2011→08.2015	 7.02256.00.0	EUV-AGR	EP	
		7.02256.41.0	SV-KK	EL	Fahrgestellnummer ab: 7H-C-000 001, 7J-C-000 001 Vehicle Identification Number from: 7H-C-000 001, 7J-C-000 001 für Fahrzeuge mit Schaltgetriebe für vehicles with manual transmission
2.0 TDI 4motion 103 kW (140 PS) CAAC	09.2009→08.2015	 7.00868.02.0	DW-TL	EP	
		7.02256.00.0	EUV-AGR	EP	
		7.28098.04.0	EUV-DS	EL	 ch. 7J-A-200 001→
		7.02256.41.0	SV-KK	EL	Fahrgestellnummer ab: 7H-A-200 001, 7J-A-200 001 Vehicle Identification Number from: 7H-A-200 001, 7J-A-200 001

V











TRANSPORTER V Platform/Chassis (7JD, 7JE, 7JL, 7JY, 7JZ, 7FD) 138

2.0 TDI 4motion 103 kW (140 PS) CCHA	09.2009→08.2015		7.00868.02.0	DW-TL	EP	
			7.02256.00.0	EUV-AGR	EP	
2.0 TDI 4motion 100 kW (136 PS) CAAE, CCHB	05.2010→08.2015		7.00868.02.0	DW-TL	EP	 CAAE:  ch. 7J-A-200 001→  CCHB:  ch. 7J-C-000 001→  CAAE: Fahrgestellnummer ab: 7H-A-200 001, 7J-A-200 001 Vehicle Identification Number from: 7H-A-200 001, 7J-A-200 001  CCHB: Fahrgestellnummer ab: 7H-A-200 001 Vehicle Identification Number from: 7H-A-200 001
			7.02256.00.0	EUV-AGR	EP	
			7.28098.04.0	EUV-DS	EL	
			7.02256.41.0	SV-KK	EL	
2.0 TSI 110 kW (150 PS) CJKB	07.2012→08.2015		7.03280.04.0	EUV-SR	EL	Fahrgestellnummer ab: 7H-C-000 001, 7J-C-000 001 Vehicle Identification Number from: 7H-C-000 001, 7J-C-000 001
			7.02901.05.0	SUV	EL	
			7.02256.41.0	SV-KK	EL	
			7.06117.26.0	ZM-NWV	EL	
2.5 TDI 96 kW (130 PS) AXD	04.2003→11.2009		7.00580.01.0	DW-AGR	EP	für Fahrzeuge mit Standheizung for vehicles with parking heater
			7.00868.02.0	DW-TL	EP	
			7.02256.00.0	EUV-AGR	EP	
			7.02256.42.0	SV-KK	EL	
2.5 TDI 96 kW (130 PS) BNZ	04.2003→11.2009		7.00868.02.0	DW-TL	EP	für Fahrzeuge mit Standheizung for vehicles with parking heater
			7.02256.00.0	EUV-AGR	EP	
			7.02256.42.0	SV-KK	EL	
2.5 TDI 96-128 kW (131-174 PS) AXE	04.2003→11.2009		7.00580.01.0	DW-AGR	EP	für Fahrzeuge mit Standheizung for vehicles with parking heater
			7.00868.02.0	DW-TL	EP	
			7.02256.00.0	EUV-AGR	EP	
			7.02256.42.0	SV-KK	EL	
2.5 TDI 128 kW (174 PS) BPC	04.2003→11.2009		7.00868.02.0	DW-TL	EP	für Fahrzeuge mit Standheizung for vehicles with parking heater
			7.02256.00.0	EUV-AGR	EP	
			7.02256.42.0	SV-KK	EL	
2.5 TDI 4motion 96-128 kW (131-174 PS) AXE	04.2004→11.2009		7.00580.01.0	DW-AGR	EP	für Fahrzeuge mit Standheizung for vehicles with parking heater
			7.00868.02.0	DW-TL	EP	
			7.02256.00.0	EUV-AGR	EP	
			7.28098.04.0	EUV-DS	EL	
			7.02256.42.0	SV-KK	EL	
2.5 TDI 4motion 128 kW (174 PS) BPC	04.2004→11.2009		7.00868.02.0	DW-TL	EP	für Fahrzeuge mit Standheizung for vehicles with parking heater
			7.02256.00.0	EUV-AGR	EP	
			7.28098.04.0	EUV-DS	EL	
			7.02256.42.0	SV-KK	EL	



V



TRANSPORTER V Platform/Chassis (7JD, 7JE, 7JL, 7JY, 7JZ, 7FD) 138

2.5 TDI 4motion 96 kW (130 PS) AXD	07.2004→11.2009		7.00580.01.0	DW-AGR	EP	für Fahrzeuge mit Standheizung for vehicles with parking heater	
			7.00868.02.0	DW-TL	EP		
			7.02256.00.0	EUV-AGR	EP		
			7.28098.04.0	EUV-DS	EL		
2.5 TDI 4motion 96 kW (130 PS) BNZ	07.2004→11.2009		7.00868.02.0	DW-TL	EP	für Fahrzeuge mit Standheizung for vehicles with parking heater	
			7.02256.00.0	EUV-AGR	EP		
			7.28098.04.0	EUV-DS	EL		
			7.02256.42.0	SV-KK	EL		
3.2 4motion 170 kW (231 PS) BDL	11.2003→11.2009		7.28098.04.0	EUV-DS	EL	mit Dichtring with O-ring  ch. 7J-3-000 001→ch. 7J-9-020 000 Auslasseite Exhaust Side	
			7.06117.43.0	SV-NWV	EL		
			7.06117.44.0	SV-NWV	EL		mit Dichtring with O-ring  ch. 7J-3-000 001→ch. 7J-9-020 000 Einlasseite Intake Side
3.2 V6 173 kW (235 PS) BKK	08.2003→05.2006		7.02256.42.0	SV-KK	EL	für Fahrzeuge mit Standheizung for vehicles with parking heater	
3.2 V6 170 kW (231 PS) BDL	02.2004→11.2009		7.02256.42.0	SV-KK	EL	für Fahrzeuge mit Standheizung for vehicles with parking heater	
			7.06117.43.0	SV-NWV	EL	mit Dichtring with O-ring  ch. 7J-3-000 001→ch. 7J-9-020 000 Auslasseite Exhaust Side	
			7.06117.44.0	SV-NWV	EL	mit Dichtring with O-ring  ch. 7J-3-000 001→ch. 7J-9-020 000 Einlasseite Intake Side	











TRANSPORTER V Van (7HA, 7HH, 7EA, 7EH) 139

1.9 TDI 63 kW (85 PS) AXC	04.2003→11.2009		7.00580.01.0	DW-AGR	EP	Fahrgestellnummer ab: 7H-4-082 001, 7J-4-033 001 Vehicle Identification Number from: 7H-4-082 001, 7J-4-033 001 für Fahrzeuge mit Standheizung, für Fahrzeuge mit Schaltgetriebe for vehicles with parking heater, for vehicles with manual transmission
			7.00868.02.0	DW-TL	EP	
			7.02256.00.0	EUV-AGR	EP	
			7.02256.42.0	SV-KK	EL	
1.9 TDI 77 kW (105 PS) AXB	04.2003→11.2009		7.00580.01.0	DW-AGR	EP	
			7.00868.02.0	DW-TL	EP	
			7.02256.00.0	EUV-AGR	EP	

V























TRANSPORTER V Van (7HA, 7HH, 7EA, 7EH) 139

			7.02256.42.0	SV-KK	EL	Fahrgestellnummer ab: 7H-4-082 001, 7J-4-033 001 Vehicle Identification Number from: 7H-4-082 001, 7J-4-033 001 für Fahrzeuge mit Standheizung, für Fahrzeuge mit Schaltgetriebe for vehicles with parking heater, for vehicles with manual transmission
1.9 TDI 62 kW (84 PS) BRR	01.2006→11.2009		7.00868.02.0	DW-TL	EP	
			7.02256.42.0	SV-KK	EL	für Fahrzeuge mit Standheizung for vehicles with parking heater
1.9 TDI 75 kW (102 PS) BRS	06.2006→11.2009		7.00868.02.0	DW-TL	EP	
			7.02256.42.0	SV-KK	EL	für Fahrzeuge mit Standheizung for vehicles with parking heater
2.0 85 kW (115 PS) AXA	11.2003→08.2015		7.10014.00.0	AKF	EL	 ch. 7H-3-000 001→
			7.02256.41.0	SV-KK	EL	Fahrgestellnummer ab: 7H-A-200 001, 7J-A-200 001 Vehicle Identification Number from: 7H-A-200 001, 7J-A-200 001 für Fahrzeuge mit Schaltgetriebe for vehicles with manual transmission für heiße Klimazonen for hot climate zones
			7.02256.42.0	SV-KK	EL	für Fahrzeuge mit Standheizung, für Fahrzeuge mit Schaltgetriebe for vehicles with parking heater, for vehicles with manual transmission
2.0 BiFuel 85 kW (115 PS) AXA	05.2011→08.2015		7.10014.00.0	AKF	EL	 ch. 7H-3-000 001→
			7.02256.41.0	SV-KK	EL	Fahrgestellnummer ab: 7H-A-200 001, 7J-A-200 001 Vehicle Identification Number from: 7H-A-200 001, 7J-A-200 001 für Fahrzeuge mit Schaltgetriebe for vehicles with manual transmission für heiße Klimazonen for hot climate zones
2.0 BiTDI 132 kW (180 PS) CFCA	09.2009→08.2015		7.00868.02.0	DW-TL	EP	
			7.02256.00.0	EUV-AGR	EP	
			7.02256.41.0	SV-KK	EL	Fahrgestellnummer ab: 7H-A-200 001, 7J-A-200 001 Vehicle Identification Number from: 7H-A-200 001, 7J-A-200 001
2.0 BiTDI 4motion 132 kW (180 PS) CFCA	09.2009→08.2015		7.00868.02.0	DW-TL	EP	
			7.02256.00.0	EUV-AGR	EP	
			7.28098.04.0	EUV-DS	EL	 ch. 7H-A-200 001→
			7.02256.41.0	SV-KK	EL	Fahrgestellnummer ab: 7H-A-200 001, 7J-A-200 001 Vehicle Identification Number from: 7H-A-200 001, 7J-A-200 001
2.0 TDI 62 kW (84 PS) CAAA	09.2009→08.2015		7.00868.02.0	DW-TL	EP	
			7.02256.00.0	EUV-AGR	EP	
			7.02256.41.0	SV-KK	EL	Fahrgestellnummer ab: 7H-A-200 001, 7J-A-200 001 Vehicle Identification Number from: 7H-A-200 001, 7J-A-200 001 für Fahrzeuge mit Schaltgetriebe for vehicles with manual transmission

V



TRANSPORTER V Van (7HA, 7HH, 7EA, 7EH) 139

2.0 TDI 75 kW (102 PS) CAAB	09.2009→08.2015	 7.00868.02.0 7.02256.00.0 7.02256.41.0	DW-TL EP EUV-AGR EP SV-KK EL	Fahrgestellnummer ab: 7H-A-200 001, 7J-A-200 001 Vehicle Identification Number from: 7H-A-200 001, 7J-A-200 001 für Fahrzeuge mit Schaltgetriebe für vehicles with manual transmission
2.0 TDI 103 kW (140 PS) CAAC, CCHA	09.2009→08.2015	 7.00868.02.0 7.02256.00.0 7.02256.41.0	DW-TL EP EUV-AGR EP SV-KK EL	 CAAC: Fahrgestellnummer ab: 7H-A-200 001, 7J-A-200 001 Vehicle Identification Number from: 7H-A-200 001, 7J-A-200 001  CCHA: Fahrgestellnummer ab: 7H-A-200 001 Vehicle Identification Number from: 7H-A-200 001
2.0 TDI 100 kW (136 PS) CAAE, CCHB	05.2010→08.2015	 7.00868.02.0 7.02256.00.0 7.02256.41.0	DW-TL EP EUV-AGR EP SV-KK EL	 CAAE: Fahrgestellnummer ab: 7H-A-200 001, 7J-A-200 001 Vehicle Identification Number from: 7H-A-200 001, 7J-A-200 001  CCHB: Fahrgestellnummer ab: 7H-A-200 001 Vehicle Identification Number from: 7H-A-200 001
2.0 TDI 84 kW (114 PS) CAAD	05.2011→08.2015	 7.02256.00.0 7.02256.41.0	EUV-AGR EP SV-KK EL	Fahrgestellnummer ab: 7H-C-000 001, 7J-C-000 001 Vehicle Identification Number from: 7H-C-000 001, 7J-C-000 001 für Fahrzeuge mit Schaltgetriebe für vehicles with manual transmission
2.0 TDI 4motion 103 kW (140 PS) CAAC, CCHA	09.2009→08.2015	 7.00868.02.0 7.02256.00.0 7.28098.04.0 7.02256.41.0	DW-TL EP EUV-AGR EP EUV-DS EL SV-KK EL	 CAAC, CCHA:  ch. 7H-A-200 001→  CAAC: Fahrgestellnummer ab: 7H-A-200 001, 7J-A-200 001 Vehicle Identification Number from: 7H-A-200 001, 7J-A-200 001  CCHA:  ch. 7H-A-200 001→
2.0 TDI 4motion 100 kW (136 PS) CAAE, CCHB	05.2010→08.2015	 7.00868.02.0 7.02256.00.0 7.28098.04.0 7.02256.41.0	DW-TL EP EUV-AGR EP EUV-DS EL SV-KK EL	 CAAE, CCHB:  ch. 7H-A-200 001→  CAAE: Fahrgestellnummer ab: 7H-A-200 001, 7J-A-200 001 Vehicle Identification Number from: 7H-A-200 001, 7J-A-200 001  CCHB: Fahrgestellnummer ab: 7H-A-200 001 Vehicle Identification Number from: 7H-A-200 001
2.0 TSI 150 kW (204 PS) CJKA	05.2011→08.2015	 7.03280.04.0 7.02901.05.0	EUV-SR EL SUV EL	





TRANSPORTER V Van (7HA, 7HH, 7EA, 7EH)













139

			7.02256.41.0	SV-KK	EL	ch. 7H-C-000 001→
			7.06117.26.0	ZM-NWV	EL	
2.0 TSI 110 kW (150 PS) CJKB	07.2012→08.2015		7.03280.04.0	EUV-SR	EL	Fahrgestellnummer ab: 7H-C-000 001, 7J-C-000 001 Vehicle Identification Number from: 7H-C-000 001, 7J-C-000 001
			7.02901.05.0	SUV	EL	
			7.02256.41.0	SV-KK	EL	
			7.06117.26.0	ZM-NWV	EL	
2.0 TSI 4motion 150 kW (204 PS) CJKA	07.2011→08.2015		7.28098.04.0	EUV-DS	EL	Fahrgestellnummer ab: 7H-A-200 001 Vehicle Identification Number from: 7H-A-200 001
			7.03280.04.0	EUV-SR	EL	
			7.02901.05.0	SUV	EL	
			7.02256.41.0	SV-KK	EL	
			7.06117.26.0	ZM-NWV	EL	
2.5 TDI 96 kW (130 PS) AXD	04.2003→11.2009		7.00580.01.0	DW-AGR	EP	für Fahrzeuge mit Standheizung for vehicles with parking heater
			7.00868.02.0	DW-TL	EP	
			7.02256.00.0	EUV-AGR	EP	
			7.02256.42.0	SV-KK	EL	
2.5 TDI 96 kW (130 PS) BNZ	04.2003→11.2009		7.00868.02.0	DW-TL	EP	für Fahrzeuge mit Standheizung for vehicles with parking heater
			7.02256.00.0	EUV-AGR	EP	
			7.02256.42.0	SV-KK	EL	
2.5 TDI 96-128 kW (131-174 PS) AXE	04.2003→11.2009		7.00580.01.0	DW-AGR	EP	für Fahrzeuge mit Standheizung for vehicles with parking heater
			7.00868.02.0	DW-TL	EP	
			7.02256.00.0	EUV-AGR	EP	
			7.02256.42.0	SV-KK	EL	
2.5 TDI 128 kW (174 PS) BPC	04.2003→11.2009		7.00868.02.0	DW-TL	EP	für Fahrzeuge mit Standheizung for vehicles with parking heater
			7.02256.00.0	EUV-AGR	EP	
			7.02256.42.0	SV-KK	EL	
2.5 TDI 4motion 96 kW (130 PS) AXD	07.2004→11.2009		7.00580.01.0	DW-AGR	EP	für Fahrzeuge mit Standheizung for vehicles with parking heater
			7.00868.02.0	DW-TL	EP	
			7.02256.00.0	EUV-AGR	EP	
			7.28098.04.0	EUV-DS	EL	
			7.02256.42.0	SV-KK	EL	
2.5 TDI 4motion 96 kW (130 PS) BNZ	07.2004→11.2009		7.00868.02.0	DW-TL	EP	für Fahrzeuge mit Standheizung for vehicles with parking heater
			7.02256.00.0	EUV-AGR	EP	
			7.28098.04.0	EUV-DS	EL	
			7.02256.42.0	SV-KK	EL	
2.5 TDI 4motion 96-128 kW (131-174 PS) AXE	07.2004→11.2009		7.00580.01.0	DW-AGR	EP	
			7.00868.02.0	DW-TL	EP	
			7.02256.00.0	EUV-AGR	EP	
			7.28098.04.0	EUV-DS	EL	

V











TRANSPORTER V Van (7HA, 7HH, 7EA, 7EH) 139

			7.02256.42.0	SV-KK	EL	für Fahrzeuge mit Standheizung for vehicles with parking heater
2.5 TDI 4motion 128 kW (174 PS) BPC	07.2004→11.2009		7.00868.02.0	DW-TL	EP	
			7.02256.00.0	EUV-AGR	EP	
			7.28098.04.0	EUV-DS	EL	
			7.02256.42.0	SV-KK	EL	für Fahrzeuge mit Standheizung for vehicles with parking heater
3.2 4motion 173 kW (235 PS) BKK	11.2003→11.2009		7.28098.04.0	EUV-DS	EL	
			7.02256.42.0	SV-KK	EL	für Fahrzeuge mit Standheizung for vehicles with parking heater
			7.06117.43.0	SV-NWV	EL	mit Dichtring with O-ring  ch. 7H-3-000 001→ch. 7H-9-200 000 Auslasseite Exhaust Side
			7.06117.44.0	SV-NWV	EL	mit Dichtring with O-ring  ch. 7H-3-000 001→ch. 7H-9-200 000 Einlassseite Intake Side
3.2 4motion 173 kW (235 PS) CFLA	11.2003→11.2009		7.02256.42.0	SV-KK	EL	für Fahrzeuge mit Standheizung for vehicles with parking heater
			7.06117.43.0	SV-NWV	EL	mit Dichtring with O-ring  ch. 7H-9-000 001→ch. 7H-9-200 000 Auslasseite Exhaust Side
			7.06117.44.0	SV-NWV	EL	mit Dichtring with O-ring  ch. 7H-9-000 001→ch. 7H-9-200 000 Einlassseite Intake Side
3.2 V6 170 kW (231 PS) BDL	04.2003→06.2005		7.02256.42.0	SV-KK	EL	für Fahrzeuge mit Standheizung for vehicles with parking heater
			7.06117.43.0	SV-NWV	EL	mit Dichtring with O-ring  ch. 7H-3-000 001→ch. 7H-3-001 000 Auslasseite Exhaust Side
			7.06117.44.0	SV-NWV	EL	mit Dichtring with O-ring  ch. 7H-3-000 001→ch. 7H-3-001 000 Einlassseite Intake Side
3.2 V6 173 kW (235 PS) BKK, CFLA	02.2004→11.2009		7.02256.42.0	SV-KK	EL	 BKK, CFLA: für Fahrzeuge mit Standheizung for vehicles with parking heater











TRANSPORTER V Van (7HA, 7HH, 7EA, 7EH) 139

			7.06117.43.0	SV-NWV	EL	mit Dichtring with O-ring  BKK:  ch. 7H-3-000 001→ch. 7H-9-200 000 Auslassseite Exhaust Side  CFLA:  ch. 7H-9-000 001→ch. 7H-9-200 000 Auslassseite Exhaust Side
			7.06117.44.0	SV-NWV	EL	mit Dichtring with O-ring  BKK:  ch. 7H-3-000 001→ch. 7H-9-200 000 Einlassseite Intake Side  CFLA:  ch. 7H-9-000 001→ch. 7H-9-200 000 Einlassseite Intake Side

TRANSPORTER VI Platform/Chassis (SFD, SFE, SFL, SFZ, SJD, SJ) 140

2.0 TDI 62 kW (84 PS) CAAA	04.2015→06.2016		7.00868.02.0	DW-TL	EP	Fahrgestellnummer ab: 7H-G-000 001, 7J-G-000 001 Vehicle Identification Number from: 7H-G-000 001, 7J-G-000 001 für Fahrzeuge mit Standheizung for vehicles with parking heater
			7.02256.00.0	EUV-AGR	EP	
			7.02256.41.0	SV-KK	EL	
2.0 TDI 62 kW (84 PS) CXGA	04.2015→06.2016		7.00868.02.0	DW-TL	EP	
7.02256.00.0	EUV-AGR	EP				
2.0 TDI 75 kW (102 PS) CAAB	04.2015→		7.00868.02.0	DW-TL	EP	
7.02184.01.0	DW-TL		EP			
7.02256.00.0	EUV-AGR		EP			
7.02256.41.0	SV-KK		EL			
2.0 TDI 75 kW (102 PS) CXGB	04.2015→		7.00868.02.0	DW-TL	EP	
7.02184.01.0	DW-TL		EP			
7.02256.00.0	EUV-AGR		EP			
2.0 TDI 103 kW (140 PS) CAAC	04.2015→		7.00868.02.0	DW-TL	EP	Fahrgestellnummer ab: 7H-G-000 001, 7J-G-000 001 Vehicle Identification Number from: 7H-G-000 001, 7J-G-000 001
			7.02184.01.0	DW-TL	EP	
			7.02256.00.0	EUV-AGR	EP	
7.02256.41.0	SV-KK	EL				
2.0 TDI 132 kW (180 PS) CFCA	04.2015→		7.00868.02.0	DW-TL	EP	
			7.02256.00.0	EUV-AGR	EP	

V



TRANSPORTER VI Platform/Chassis (SFD, SFE, SFL, SFZ, SJD, SJ) 140

			7.02256.41.0	SV-KK	EL	Fahrgestellnummer ab: 7H-G-000 001, 7J-G-000 001 Vehicle Identification Number from: 7H-G-000 001, 7J-G-000 001
2.0 TDI 110 kW (150 PS) CXHA	08.2015→		7.00868.02.0	DW-TL	EP	
			7.02184.01.0	DW-TL	EP	
			7.02256.00.0	EUV-AGR	EP	
2.0 TDI 84 kW (114 PS) CXHB	05.2016→		7.02184.01.0	DW-TL	EP	
			7.02256.00.0	EUV-AGR	EP	
			7.02184.01.0	DW-TL	EP	
2.0 TDI 150 kW (204 PS) CXEB	05.2016→		7.02184.01.0	DW-TL	EP	
			7.02256.00.0	EUV-AGR	EP	
			7.02184.01.0	DW-TL	EP	
2.0 TDI 81 kW (110 PS) CXHC	07.2019→		7.02256.00.0	EUV-AGR	EP	
			7.02256.41.0	SV-KK	EL	Fahrgestellnummer ab: 7H-L-000 001, 7J-L-000 001 Vehicle Identification Number from: 7H-L-000 001, 7J-L-000 001 für Fahrzeuge mit Standheizung for vehicles with parking heater
			7.02256.00.0	EUV-AGR	EP	
2.0 TDI 146 kW (199 PS) CXEC	08.2019→		7.02256.00.0	EUV-AGR	EP	
			7.02256.41.0	SV-KK	EL	Fahrgestellnummer ab: 7H-L-000 001, 7J-L-000 001 Vehicle Identification Number from: 7H-L-000 001, 7J-L-000 001 für Fahrzeuge mit Standheizung for vehicles with parking heater
			7.02256.00.0	EUV-AGR	EP	
2.0 TDI 66 kW (90 PS) CXGD	10.2019→		7.02256.00.0	EUV-AGR	EP	
			7.02256.41.0	SV-KK	EL	Fahrgestellnummer ab: 7H-L-000 001, 7J-L-000 001 Vehicle Identification Number from: 7H-L-000 001, 7J-L-000 001 für Fahrzeuge mit Standheizung for vehicles with parking heater
			7.02256.00.0	EUV-AGR	EP	
2.0 TDI 4motion 103 kW (140 PS) CAAC	06.2015→		7.00868.02.0	DW-TL	EP	
			7.02184.01.0	DW-TL	EP	
			7.02256.00.0	EUV-AGR	EP	
			7.28098.04.0	EUV-DS	EL	 ch. 7J-G-000 001→
			7.02256.41.0	SV-KK	EL	Fahrgestellnummer ab: 7H-G-000 001, 7J-G-000 001 Vehicle Identification Number from: 7H-G-000 001, 7J-G-000 001
2.0 TDI 4motion 132 kW (180 PS) CFCA	06.2015→		7.00868.02.0	DW-TL	EP	
			7.02256.00.0	EUV-AGR	EP	
			7.28098.04.0	EUV-DS	EL	 ch. 7J-G-000 001→
			7.02256.41.0	SV-KK	EL	Fahrgestellnummer ab: 7H-G-000 001, 7J-G-000 001 Vehicle Identification Number from: 7H-G-000 001, 7J-G-000 001
2.0 TDI 4motion 110 kW (150 PS) CXHA	05.2016→		7.00868.02.0	DW-TL	EP	
			7.02184.01.0	DW-TL	EP	
			7.02256.00.0	EUV-AGR	EP	
			7.28098.04.0	EUV-DS	EL	 ch. 7J-G-000 001→
2.0 TDI 4motion 150 kW (204 PS) CXEB	05.2016→		7.02184.01.0	DW-TL	EP	





TRANSPORTER VI Platform/Chassis (SFD, SFE, SFL, SFZ, SJD, SJ) 140

			7.02256.00.0	EUV-AGR	EP	
			7.28098.04.0	EUV-DS	EL	ch. 7J-G-000 001→
2.0 TDI 4motion 146 kW (199 PS) CXEC	08.2019→		7.02256.00.0	EUV-AGR	EP	
			7.02256.41.0	SV-KK	EL	Fahrgestellnummer ab: 7H-L-000 001, 7J-L-000 001 Vehicle Identification Number from: 7H-L-000 001, 7J-L-000 001 für Fahrzeuge mit Standheizung for vehicles with parking heater
2.0 TSI 110 kW (150 PS) CJKB	04.2015→		7.03280.04.0	EUV-SR	EL	
			7.02901.05.0	SUV	EL	
			7.02256.41.0	SV-KK	EL	Fahrgestellnummer ab: 7H-G-000 001, 7J-G-000 001 Vehicle Identification Number from: 7H-G-000 001, 7J-G-000 001
			7.06117.26.0	ZM-NWV	EL	

TRANSPORTER VI Van (SGA, SGH, SHA, SHH) 141

2.0 TDI 62 kW (84 PS) CAAA	04.2015→06.2016		7.00868.02.0	DW-TL	EP	
			7.02256.00.0	EUV-AGR	EP	
			7.02256.41.0	SV-KK	EL	Fahrgestellnummer ab: 7H-G-000 001, 7J-G-000 001 Vehicle Identification Number from: 7H-G-000 001, 7J-G-000 001 für Fahrzeuge mit Schaltgetriebe for vehicles with manual transmission
2.0 TDI 62 kW (84 PS) CXGA	04.2015→06.2016		7.00868.02.0	DW-TL	EP	
			7.02256.00.0	EUV-AGR	EP	
2.0 TDI 75 kW (102 PS) CAAB	04.2015→		7.00868.02.0	DW-TL	EP	
			7.02184.01.0	DW-TL	EP	
			7.02256.00.0	EUV-AGR	EP	
			7.02256.41.0	SV-KK	EL	Fahrgestellnummer ab: 7H-G-000 001, 7J-G-000 001 Vehicle Identification Number from: 7H-G-000 001, 7J-G-000 001 für Fahrzeuge mit Schaltgetriebe for vehicles with manual transmission
2.0 TDI 75 kW (102 PS) CXGB	04.2015→		7.00868.02.0	DW-TL	EP	
			7.02184.01.0	DW-TL	EP	
			7.02256.00.0	EUV-AGR	EP	
2.0 TDI 103 kW (140 PS) CAAC	04.2015→		7.00868.02.0	DW-TL	EP	
			7.02184.01.0	DW-TL	EP	
			7.02256.00.0	EUV-AGR	EP	
			7.02256.41.0	SV-KK	EL	Fahrgestellnummer ab: 7H-G-000 001, 7J-G-000 001 Vehicle Identification Number from: 7H-G-000 001, 7J-G-000 001
2.0 TDI 110 kW (150 PS) CXFA, CXHA	04.2015→		7.00868.02.0	DW-TL	EP	
			7.02184.01.0	DW-TL	EP	
			7.02256.00.0	EUV-AGR	EP	
2.0 TDI 132 kW (180 PS) CFCA	04.2015→		7.00868.02.0	DW-TL	EP	
			7.02256.00.0	EUV-AGR	EP	

V











TRANSPORTER VI Van (SGA, SGH, SHA, SHH) 141

			7.02256.41.0	SV-KK	EL	Fahrgestellnummer ab: 7H-G-000 001, 7J-G-000 001 Vehicle Identification Number from: 7H-G-000 001, 7J-G-000 001
2.0 TDI 150 kW (204 PS) CXEB	06.2015→		7.02184.01.0	DW-TL	EP	
			7.02256.00.0	EUV-AGR	EP	
2.0 TDI 84 kW (114 PS) CXHB	05.2016→		7.02184.01.0	DW-TL	EP	
			7.02256.00.0	EUV-AGR	EP	
2.0 TDI 146 kW (199 PS) CXEC	08.2018→		7.02256.00.0	EUV-AGR	EP	
			7.02256.41.0	SV-KK	EL	Fahrgestellnummer ab: 7H-L-000 001, 7J-L-000 001 Vehicle Identification Number from: 7H-L-000 001, 7J-L-000 001 für Fahrzeuge mit Standheizung for vehicles with parking heater
2.0 TDI 81 kW (110 PS) CXHC	07.2019→		7.02256.00.0	EUV-AGR	EP	
			7.02256.41.0	SV-KK	EL	Fahrgestellnummer ab: 7H-L-000 001, 7J-L-000 001 Vehicle Identification Number from: 7H-L-000 001, 7J-L-000 001 für Fahrzeuge mit Standheizung for vehicles with parking heater
2.0 TDI 66 kW (90 PS) CXGD	10.2019→		7.02256.00.0	EUV-AGR	EP	
			7.02256.41.0	SV-KK	EL	Fahrgestellnummer ab: 7H-L-000 001, 7J-L-000 001 Vehicle Identification Number from: 7H-L-000 001, 7J-L-000 001 für Fahrzeuge mit Standheizung for vehicles with parking heater
2.0 TDI 4motion 103 kW (140 PS) CAAC	06.2015→		7.00868.02.0	DW-TL	EP	
			7.02184.01.0	DW-TL	EP	
			7.02256.00.0	EUV-AGR	EP	
			7.28098.04.0	EUV-DS	EL	 ch. 7H-G-000 001→
			7.02256.41.0	SV-KK	EL	Fahrgestellnummer ab: 7H-G-000 001, 7J-G-000 001 Vehicle Identification Number from: 7H-G-000 001, 7J-G-000 001
2.0 TDI 4motion 132 kW (180 PS) CFCA	06.2015→		7.00868.02.0	DW-TL	EP	
			7.02256.00.0	EUV-AGR	EP	
			7.28098.04.0	EUV-DS	EL	 ch. 7H-G-000 001→
			7.02256.41.0	SV-KK	EL	Fahrgestellnummer ab: 7H-G-000 001, 7J-G-000 001 Vehicle Identification Number from: 7H-G-000 001, 7J-G-000 001
2.0 TDI 4motion 150 kW (204 PS) CXEB	06.2015→		7.02184.01.0	DW-TL	EP	
			7.02256.00.0	EUV-AGR	EP	
			7.28098.04.0	EUV-DS	EL	 ch. 7H-G-000 001→
2.0 TDI 4motion 110 kW (150 PS) CXFA, CXHA	08.2015→		7.00868.02.0	DW-TL	EP	
			7.02184.01.0	DW-TL	EP	
			7.02256.00.0	EUV-AGR	EP	
			7.28098.04.0	EUV-DS	EL	 CXFA, CXHA: ch. 7H-G-000 001→

V



TRANSPORTER VI Van (SGA, SGH, SHA, SHH)						141
2.0 TDI 4motion 146 kW (199 PS) CXEC	08.2018→		7.02256.00.0	EUV-AGR	EP	Fahrgestellnummer ab: 7H-L-000 001, 7J-L-000 001 Vehicle Identification Number from: 7H-L-000 001, 7J-L-000 001 für Fahrzeuge mit Standheizung for vehicles with parking heater
			7.02256.41.0	SV-KK	EL	
2.0 TSI 110 kW (150 PS) CJKB	04.2015→		7.03280.04.0	EUV-SR	EL	Fahrgestellnummer ab: 7H-G-000 001, 7J-G-000 001 Vehicle Identification Number from: 7H-G-000 001, 7J-G-000 001
			7.02901.05.0	SUV	EL	
			7.02256.41.0	SV-KK	EL	
2.0 TSI 150 kW (204 PS) CJKA	04.2015→		7.03280.04.0	EUV-SR	EL	Fahrgestellnummer ab: 7H-G-000 001, 7J-G-000 001 Vehicle Identification Number from: 7H-G-000 001, 7J-G-000 001
			7.02901.05.0	SUV	EL	
			7.02256.41.0	SV-KK	EL	
2.0 TSI 4motion 150 kW (204 PS) CJKA	06.2015→		7.28098.04.0	EUV-DS	EL	 ch. 7H-G-000 001→ Fahrgestellnummer ab: 7H-G-000 001, 7J-G-000 001 Vehicle Identification Number from: 7H-G-000 001, 7J-G-000 001
			7.03280.04.0	EUV-SR	EL	
			7.02901.05.0	SUV	EL	
			7.02256.41.0	SV-KK	EL	
			7.06117.26.0	ZM-NWV	EL	

ENGINE						142
ENGINE 58 kW (79 PS) AFD	04.1994→		7.21903.70.0	DW-AGR	EP	
ENGINE 63 kW (86 PS) AVM	11.2000→		7.02183.01.0	DW-AGR	EP	
			7.02184.01.0	DW-TL	EP	
ENGINE 54 kW (73 PS) BMF	05.2004→		7.06117.43.0	SV-NWV	EL	mit Dichtring with O-ring Auslassseite Exhaust Side
			7.06117.44.0	SV-NWV	EL	mit Dichtring with O-ring Einlassseite Intake Side
ENGINE 55 kW (75 PS) CBJA	05.2007→		7.00580.01.0	DW-AGR	EP	
			7.02183.01.0	DW-AGR	EP	
			7.00868.02.0	DW-TL	EP	
			7.02184.01.0	DW-TL	EP	









V

960 (964)						1
2.9 132-150 kW (180-204 PS) B 6304 FS, B 6304 GS	08.1990→07.1994		7.22240.15.0	EUV-SL	EL B 6304 FS, B 6304 GS: 1998 1998	
C30 (533)						2
1.6 D 80-81 kW (109-110 PS) D 4164 T	10.2006→12.2012		7.00968.04.0	DW-TL	EP	
1.6 D2 84 kW (114 PS) D 4162 T	10.2010→12.2012		7.07400.04.0*	STE	EP für Fahrzeuge mit Schaltgetriebe for vehicles with manual transmission	
			↳7.01633.06.0	DW-TL	EP	
			7.07400.05.0*	STE	EP für Fahrzeuge mit Automatikgetriebe for vehicles with automatic transmission	
↳7.01633.06.0	DW-TL	EP				
1.8 92 kW (125 PS) B 4184 S11	10.2006→12.2012		7.02256.48.0	STE	EP	
1.8 FlexFuel 92 kW (125 PS) B 4184 S8	01.2007→12.2012		7.02256.48.0	STE	EP	
2.0 107 kW (146 PS) B 4204 S3	10.2006→12.2012		7.02256.48.0	STE	EP	
2.0 D 100 kW (136 PS) D 4204 T	10.2006→12.2012		7.01771.01.0	DW-RK	EP	
			7.01771.01.0	DW-TL	EP	
2.0 FlexFuel 107 kW (146 PS) B 4204 S4	01.2010→12.2012		7.02256.48.0	STE	EP	
D3 110 kW (150 PS) D 5204 T5	10.2010→12.2012		7.02325.05.0	DW-TL	EP	
			7.02613.02.0	EUV-AGR	EP	
D4 130 kW (177 PS) D 5204 T	10.2010→12.2012		7.02325.05.0	DW-TL	EP	
			7.02613.02.0	EUV-AGR	EP	
D5 132 kW (180 PS) D 5244 T13, D 5244 T8	10.2006→12.2012		7.00515.04.0	EUV-AGR	EP	
D5 120 kW (163 PS) D 5244 T9	10.2006→12.2012		7.00515.04.0	EUV-AGR	EP	
T5 162 kW (220 PS) B 5254 T3	10.2006→12.2012		7.28197.16.0	LDRV	EL	
T5 169-184 kW (230-250 PS) B 5254 T7	03.2007→12.2012		7.28197.16.0	LDRV	EL	
C70 I Convertible (873)						3
2.0 132 kW (180 PS) B 5204 T2	03.1998→10.2005		7.22517.04.0	AKF	EL Europa Europe 2000 2000 2001 2001	
			7.22240.13.0	LDRV	EL 01.2003→	
			7.22240.09.0	LDRV	EL Produktionsdatum bis: 31.12.1999 Production date to: 31.12.1999	
2.0 T 166 kW (226 PS) B 5204 T3	03.1998→10.2005		7.22517.04.0	AKF	EL Europa Europe 2000 2000 2001 2001	
			7.22240.13.0	LDRV	EL 01.2003→	
			7.22240.09.0	LDRV	EL Produktionsdatum bis: 31.12.1999 Production date to: 31.12.1999	

V



C70 I Convertible (873) **3**

2.0 T 120 kW (163 PS) B 5204 T4	03.2000→10.2005	 PIERBURG  7.22517.04.0	AKF LDRV	EL EL	■■ Europa ■■ Europe 2000 2000 2001 2001 01.2003→
2.3 147-184 kW (239-250 PS) B 5234 T3	09.2002→12.2003	 7.22240.13.0	LDRV	EL	01.2003→
2.3 T5 147-184 kW (239-250 PS) B 5234 T3	03.1998→10.2005	 7.28194.01.0 7.22517.04.0 7.22240.13.0 7.22240.09.0	AKF AKF LDRV LDRV	EL EL EL EL	01.1999→ ■■ Europa ■■ Europe 2000 2000 2002 2002 01.2003→ Produktionsdatum bis: 31.12.1999 Production date to: 31.12.1999
2.3 T5 180 kW (245 PS) B 5234 T9	07.2002→10.2005	 7.22517.04.0 7.22240.13.0	AKF LDRV	EL EL	■■ Europa ■■ Europe 2000 2000 2002 2002 01.2003→
2.4 121-125 kW (165-170 PS) B 5254 S	06.1998→10.2005	 7.22517.06.0 7.28194.01.0	AKF AKF	EL EL	→12.1999
2.4 T 142 kW (193 PS) B 5244 T	03.1998→10.2005	 7.22517.04.0 7.22240.13.0 7.22240.09.0	AKF LDRV LDRV	EL EL EL	■■ Europa ■■ Europe 2000 2000 2002 2002 01.2003→ Produktionsdatum bis: 31.12.1999 Production date to: 31.12.1999
2.4 T 142 kW (193 PS) B 5254 T	03.1998→10.2005	 7.28194.01.0 7.22517.04.0 7.22240.13.0 7.22240.09.0	AKF AKF LDRV LDRV	EL EL EL EL	01.1999→ ■■ Europa ■■ Europe 2000 2000 2002 2002 01.2003→ Produktionsdatum bis: 31.12.1999 Production date to: 31.12.1999
2.4 T 147 kW (200 PS) B 5244 T7	07.2002→10.2005	 7.22517.04.0 7.22240.13.0	AKF LDRV	EL EL	■■ Europa ■■ Europe 2000 2000 2002 2002 01.2003→

V

C70 I Coupe (872) 4

2.0 132 kW (180 PS) B 5204 T2	03.1997→09.2002	 7.22517.04.0	AKF	EL	 Europa  Europe 2000 2000 2001 2001
		 7.22240.09.0	LDRV	EL	Produktionsdatum bis: 31.12.1999 Production date to: 31.12.1999
2.0 T 166 kW (226 PS) B 5204 T3	03.1997→09.2002	 7.22517.04.0	AKF	EL	 Europa  Europe 2000 2000 2001 2001
		 7.22240.09.0	LDRV	EL	Produktionsdatum bis: 31.12.1999 Production date to: 31.12.1999
2.0 T 120 kW (163 PS) B 5204 T4	03.2000→09.2002	 7.22517.04.0	AKF	EL	 Europa  Europe 2000 2000 2001 2001
2.3 T-5 147-184 kW (239-250 PS) B 5234 T3	03.1997→09.2002	 7.22517.04.0	AKF	EL	 Europa  Europe 2000 2000 2002 2002
		 7.22240.09.0	LDRV	EL	Produktionsdatum bis: 31.12.1999 Production date to: 31.12.1999
2.4 121-125 kW (165-170 PS) B 5254 S	03.1999→09.2002	 7.22517.06.0	AKF	EL	→12.1999
		 7.28194.01.0	AKF	EL	
2.4 125 kW (170 PS) B 5244 S	05.1999→09.2002	 7.22517.06.0	AKF	EL	→12.1999
		 7.22517.04.0	AKF	EL	 Europa  Europe 2000 2000 2002 2002
2.4 121-125 kW (165-170 PS) B 5254 S	11.1999→09.2002	 7.22517.04.0	AKF	EL	 Europa  Europe 2000 2000 2002 2002
2.4 T 142 kW (193 PS) B 5244 T, B 5254 T	03.1997→09.2002	 7.22517.04.0	AKF	EL	 B 5244 T, B 5254 T:  Europa  Europe 2000 2000 2002 2002
		 7.22240.09.0	LDRV	EL	 B 5244 T, B 5254 T: Produktionsdatum bis: 31.12.1999 Production date to: 31.12.1999

C70 II Convertible (542) 5

2.0 D 100 kW (136 PS) D 4204 T	01.2008→10.2009	 7.01771.01.0	DW-RK	EP	
		 7.01771.01.0	DW-TL	EP	
2.4 D 120 kW (163 PS) D 5244 T9	03.2007→06.2013	 7.00515.04.0	EUV-AGR	EP	
		 7.02325.05.0	DW-TL	EP	
D3 110 kW (150 PS) D 5204 T5	10.2010→06.2013	 7.02325.05.0	DW-TL	EP	
		 7.02613.02.0	EUV-AGR	EP	













C70 II Convertible (542) **5**

D4 130 kW (177 PS) D 5204 T	10.2010→06.2013	 7.02325.05.0	DW-TL	EP	
		7.02613.02.0	EUV-AGR	EP	
D5 132 kW (180 PS) D 5244 T13, D 5244 T8	03.2006→06.2013	 7.00515.04.0	EUV-AGR	EP	
T5 162 kW (220 PS) B 5254 T3	03.2006→02.2007	 7.28197.16.0	LDRV	EL	
T5 169-184 kW (230-250 PS) B 5254 T7	03.2007→06.2013	 7.28197.16.0	LDRV	EL	

S40 I (644) **6**

1.6 77 kW (105 PS) B 4164 S	09.1995→08.1999	 7.22517.04.0	AKF	EL	Fahrgestellnummer ab: 415000 Vehicle Identification Number from: 415000
		7.22240.15.0	EUV-SL	EL	Fahrgestellnummer ab: 130000 Vehicle Identification Number from: 130000
		7.06269.09.0	LLR	EL	
		7.06117.16.0	SV-NWV	EH	 Ohne Pfandrückgabe des Altteils. Keine Rückgabe des Magnetventils nötig. Without deposit return for used part. No return of the solenoid valve. Einlasseite Intake Side
1.6 80 kW (109 PS) B 4164 S2	01.2000→12.2003	 7.22517.04.0	AKF	EL	Fahrgestellnummer ab: 415000 Vehicle Identification Number from: 415000
		7.22240.15.0	EUV-LS	EL	
		7.22240.15.0	EUV-SL	EL	Fahrgestellnummer ab: 130000 Vehicle Identification Number from: 130000
		7.06117.16.0	SV-NWV	EH	 Ohne Pfandrückgabe des Altteils. Keine Rückgabe des Magnetventils nötig. Without deposit return for used part. No return of the solenoid valve. Einlasseite Intake Side
1.8 85 kW (116 PS) B 4184 S3	07.1995→08.1999	 7.22517.04.0	AKF	EL	Fahrgestellnummer ab: 415000 Vehicle Identification Number from: 415000
		7.22240.15.0	EUV-LS	EL	2000 2000
		7.22240.15.0	EUV-SL	EL	Fahrgestellnummer ab: 130000 Vehicle Identification Number from: 130000
		7.06117.16.0	SV-NWV	EH	 Ohne Pfandrückgabe des Altteils. Keine Rückgabe des Magnetventils nötig. Without deposit return for used part. No return of the solenoid valve. Einlasseite Intake Side
1.8 85 kW (115 PS) B 4184 S	01.1996→08.1999	 7.22517.04.0	AKF	EL	Fahrgestellnummer ab: 415000 Vehicle Identification Number from: 415000
		7.22240.15.0	EUV-SL	EL	Fahrgestellnummer ab: 130000 Vehicle Identification Number from: 130000
		7.06269.09.0	LLR	EL	

V





S40 I (644) **6**

			7.06117.16.0	SV-NWV	EH	<p>Ohne Pfandrückgabe des Altteils. Keine Rückgabe des Magnetventils nötig. Without deposit return for used part. No return of the solenoid valve. Einlassseite Intake Side</p>
1.8 85-90 kW (116-122 PS) B 4184 S2	03.1999→12.2003		7.22240.15.0	EUV-LS	EL	
			7.22240.15.0	EUV-SL	EL	Fahrgestellnummer ab: 130000 Vehicle Identification Number from: 130000
			7.06269.09.0	LLR	EL	<p>→12.1999</p>
			7.06117.16.0	SV-NWV	EH	<p>Ohne Pfandrückgabe des Altteils. Keine Rückgabe des Magnetventils nötig. Without deposit return for used part. No return of the solenoid valve. Einlassseite Intake Side</p>
1.8 85-90 kW (116-122 PS) B 4184 S2	06.2001→08.2003		7.22517.04.0	AKF	EL	Fahrgestellnummer ab: 415000 Vehicle Identification Number from: 415000
			7.22240.15.0	EUV-LS	EL	
			7.22240.15.0	EUV-SL	EL	Fahrgestellnummer ab: 130000 Vehicle Identification Number from: 130000
			7.06117.16.0	SV-NWV	EH	<p>Ohne Pfandrückgabe des Altteils. Keine Rückgabe des Magnetventils nötig. Without deposit return for used part. No return of the solenoid valve. Einlassseite Intake Side</p>
1.8 LPG 88-90 kW (120-122 PS) B 4184 S9	03.1999→12.2004		7.22517.04.0	AKF	EL	Fahrgestellnummer ab: 415000 Vehicle Identification Number from: 415000
			7.22240.15.0	EUV-LS	EL	
			7.06117.16.0	SV-NWV	EH	<p>Ohne Pfandrückgabe des Altteils. Keine Rückgabe des Magnetventils nötig. Without deposit return for used part. No return of the solenoid valve. Einlassseite Intake Side</p>
1.9 DI 75 kW (102 PS) D 4192 T4	07.2000→12.2003		7.21903.44.0	DW-AGR	EP	
1.9 DI 85 kW (116 PS) D 4192 T3	07.2000→12.2003		7.21903.44.0	DW-AGR	EP	
1.9 T4 147 kW (200 PS) B 4194 T	05.1997→07.2000		7.22517.04.0	AKF	EL	Fahrgestellnummer ab: 415000 Vehicle Identification Number from: 415000 " " Europa " " Europe
			7.22517.06.0	AKF	EL	
			7.22240.09.0	LDRV	EL	Fahrgestellnummer bis: CH414999 Vehicle Identification Number to: CH414999 Produktionsdatum bis: 31.12.1999 Production date to: 31.12.1999
			7.06269.09.0	LLR	EL	





S40 I (644) **6**

			7.06117.17.0	SV-NWV	EH <input type="checkbox"/>	Ohne Pfandrückgabe des Altteils. Keine Rückgabe des Magnetventils nötig. Without deposit return for used part. No return of the solenoid valve. Auslasseite Exhaust Side
1.9 T4 147 kW (200 PS) B 4194 T2	05.1997→07.2000		7.22517.06.0	AKF	EL →12.1999	
			7.22517.04.0	AKF	EL	Fahrgestellnummer ab: 415000 Vehicle Identification Number from: 415000 ■ Europa ■ Europe
			7.22240.15.0	EUV-LS	EL 2000 2000	
			7.22240.09.0	LDRV	EL	Fahrgestellnummer bis: CH414999 Vehicle Identification Number to: CH414999 Produktionsdatum bis: 31.12.1999 Production date to: 31.12.1999
			7.06269.09.0	LLR	EL <input type="checkbox"/>	→12.1999
			7.06117.17.0	SV-NWV	EH <input type="checkbox"/>	Ohne Pfandrückgabe des Altteils. Keine Rückgabe des Magnetventils nötig. Without deposit return for used part. No return of the solenoid valve. Auslasseite Exhaust Side
2.0 100-103 kW (136-140 PS) B 4204 S	07.1995→12.2003		7.22517.04.0	AKF	EL	Fahrgestellnummer ab: 415000 Vehicle Identification Number from: 415000
			7.22240.15.0	EUV-SL	EL	Fahrgestellnummer ab: 130000 Vehicle Identification Number from: 130000
			7.06269.09.0	LLR	EL <input type="checkbox"/>	
			7.06117.16.0	SV-NWV	EH <input type="checkbox"/>	Ohne Pfandrückgabe des Altteils. Keine Rückgabe des Magnetventils nötig. Without deposit return for used part. No return of the solenoid valve. Einlasseite Intake Side
2.0 100 kW (136 PS) B 4204 S2	07.1995→12.2003		7.22240.15.0	EUV-LS	EL 2000 2000	
			7.22240.15.0	EUV-SL	EL	Fahrgestellnummer ab: 130000 Vehicle Identification Number from: 130000
			7.06269.09.0	LLR	EL <input type="checkbox"/>	→12.1999
			7.06117.16.0	SV-NWV	EH <input type="checkbox"/>	Ohne Pfandrückgabe des Altteils. Keine Rückgabe des Magnetventils nötig. Without deposit return for used part. No return of the solenoid valve. Einlasseite Intake Side
2.0 100-103 kW (136-140 PS) B 4204 S	07.1995→08.1999		7.22517.04.0	AKF	EL	Fahrgestellnummer ab: 415000 Vehicle Identification Number from: 415000
			7.22240.15.0	EUV-SL	EL	Fahrgestellnummer ab: 130000 Vehicle Identification Number from: 130000
			7.06269.09.0	LLR	EL <input type="checkbox"/>	















V

S40 I (644)					6
			7.06117.16.0	SV-NWV	EH Ohne Pfandrückgabe des Altteils. Keine Rückgabe des Magnetventils nötig. Without deposit return for used part. No return of the solenoid valve. Einlassseite Intake Side
2.0 T 118-119 kW (160-162 PS) B 4204 T	10.1997→12.2003		7.22517.04.0	AKF	EL Fahrgestellnummer ab: 415000 Vehicle Identification Number from: 415000 " Europa " Europe
			7.22517.06.0	AKF	EL
			7.22240.09.0	LDRV	EL Fahrgestellnummer bis: CH414999 Vehicle Identification Number to: CH414999 Produktionsdatum bis: 31.12.1999 Production date to: 31.12.1999
			7.06269.09.0 7.06117.17.0	LLR SV-NWV	EL EH Ohne Pfandrückgabe des Altteils. Keine Rückgabe des Magnetventils nötig. Without deposit return for used part. No return of the solenoid valve. Auslassseite Exhaust Side
2.0 T 118-184 kW (160-250 PS) B 4204 T2, B 4204 T3	07.2000→06.2001		7.22517.04.0	AKF	EL B 4204 T2, B 4204 T3: Fahrgestellnummer ab: 415000 Vehicle Identification Number from: 415000 " Europa " Europe
			7.22240.15.0 7.06117.17.0	EUV-LS SV-NWV	EL EH Ohne Pfandrückgabe des Altteils. Keine Rückgabe des Magnetventils nötig. Without deposit return for used part. No return of the solenoid valve. " B 4204 T2, B 4204 T3: Auslassseite Exhaust Side
2.0 T 120-121 kW (163-165 PS) B 4204 T3	06.2001→12.2003		7.22517.04.0	AKF	EL Fahrgestellnummer ab: 415000 Vehicle Identification Number from: 415000 " Europa " Europe
			7.22240.15.0 7.06117.17.0	EUV-LS SV-NWV	EL EH Ohne Pfandrückgabe des Altteils. Keine Rückgabe des Magnetventils nötig. Without deposit return for used part. No return of the solenoid valve. Auslassseite Exhaust Side
2.0 T4 147 kW (200 PS) B 4204 T5	07.2000→12.2003		7.22517.04.0	AKF	EL Fahrgestellnummer ab: 415000 Vehicle Identification Number from: 415000 " Europa " Europe
			7.22240.15.0 7.06117.17.0	EUV-LS SV-NWV	EL EH Ohne Pfandrückgabe des Altteils. Keine Rückgabe des Magnetventils nötig. Without deposit return for used part. No return of the solenoid valve. Auslassseite Exhaust Side



V

























S40 II (544) **7**

1.6 D 80-81 kW (109-110 PS) D 4164 T	01.2005→12.2012	 7.00968.04.0	DW-TL	EP	
1.6 D2 84 kW (114 PS) D 4162 T	10.2010→12.2012	 7.07400.04.0* ↳ 7.01633.06.0 7.07400.05.0* ↳ 7.01633.06.0	STE DW-TL STE DW-TL	EP EP EP EP	für Fahrzeuge mit Schaltgetriebe for vehicles with manual transmission für Fahrzeuge mit Automatikgetriebe for vehicles with automatic transmission
1.8 92 kW (125 PS) B 4184 S11	04.2004→12.2010	 7.02256.48.0	STE	EP	
1.8 FlexFuel 92 kW (125 PS) B 4184 S8	01.2006→12.2010	 7.02256.48.0	STE	EP	
2.0 107 kW (146 PS) B 4204 S3	10.2006→12.2012	 7.02256.48.0	STE	EP	
2.0 D 100 kW (136 PS) D 4204 T	01.2004→12.2010	 7.01771.01.0 7.01771.01.0	DW-RK DW-TL	EP EP	
2.0 F 107 kW (146 PS) B 4204 S4	10.2009→12.2012	 7.02256.48.0	STE	EP	
2.4 CDI 120 kW (163 PS) D 5244 T9	03.2007→12.2010	 7.00515.04.0	EUV-AGR	EP	
2.4 D5 132 kW (180 PS) D 5244 T13, D 5244 T8	03.2006→12.2010	 7.00515.04.0	EUV-AGR	EP	
D3 110 kW (150 PS) D 5204 T5	10.2010→12.2012	 7.02325.05.0 7.02613.02.0	DW-TL EUV-AGR	EP EP	
D4 130 kW (177 PS) D 5204 T	10.2010→12.2012	 7.02325.05.0 7.02613.02.0	DW-TL EUV-AGR	EP EP	
T5 162 kW (220 PS) B 5254 T3	01.2004→12.2007	 7.28197.16.0	LDRV	EL	
T5 169-184 kW (230-250 PS) B 5254 T7	03.2007→12.2012	 7.28197.16.0	LDRV	EL	
T5 AWD 162 kW (220 PS) B 5254 T3	04.2004→12.2007	 7.28197.16.0	LDRV	EL	
T5 AWD 169-184 kW (230-250 PS) B 5254 T7	03.2007→12.2010	 7.28197.16.0	LDRV	EL	

S60 I (384) **8**



2.0 T 132 kW (180 PS) B 5204 T5	07.2000→04.2010	 7.22517.04.0 7.22240.13.0	AKF LDRV	EL EL	Fahrgestellnummer bis: 92351 Vehicle Identification Number to: 92351 ## Europa ## Europe Fahrgestellnummer ab: 92352 Vehicle Identification Number from: 92352
2.3 T5 195 kW (265 PS) B 5234 T7	07.2000→09.2002	 7.22517.04.0 7.22240.13.0	AKF LDRV	EL EL	Fahrgestellnummer bis: 92351 Vehicle Identification Number to: 92351 ## Europa ## Europe Fahrgestellnummer ab: 92352 Vehicle Identification Number from: 92352
2.3 T5 147-184 kW (239-250 PS) B 5234 T3	09.2000→12.2004	 7.22517.04.0 7.22240.13.0	AKF LDRV	EL EL	Fahrgestellnummer bis: 92351 Vehicle Identification Number to: 92351 ## Europa ## Europe Fahrgestellnummer ab: 92352 Vehicle Identification Number from: 92352

V











					
S60 I (384)					
2.4 103 kW (140 PS) B 5244 S2	07.2000→04.2010		7.22517.04.0	AKF	EL Fahrgestellnummer bis: 92351 Vehicle Identification Number to: 92351 Europa Europe
2.4 125 kW (170 PS) B 5244 S	11.2000→04.2010		7.22517.04.0	AKF	EL Fahrgestellnummer bis: 92351 Vehicle Identification Number to: 92351 Europa Europe
2.4 132 kW (180 PS) B 5244 T4	01.2005→10.2006		7.22517.04.0	AKF	EL Fahrgestellnummer bis: 92351 Vehicle Identification Number to: 92351 Europa Europe
2.4 Bifuel (CNG) 103 kW (140 PS) B 5244 SG	07.2001→04.2010		7.22510.03.0	AKF	EL
			7.22517.04.0	AKF	Europa Europe
2.4 Bifuel (LPG) 103 kW (140 PS) B 5244 SG2	07.2001→04.2010		7.22517.04.0	AKF	Europa Europe
2.4 CDI 85 kW (116 PS) D 5244 T3	10.2003→12.2005		7.22517.04.0	AKF	EL Fahrgestellnummer bis: 92351 Vehicle Identification Number to: 92351 Europa Europe
			7.21903.63.0	DW-TL	EP
			7.22240.15.0	EUV-LS	EL
			7.22240.13.0	LDRV	EL Fahrgestellnummer ab: 92352 Vehicle Identification Number from: 92352
2.4 D 96-120 kW (131-163 PS) D 5244 T2	05.2001→04.2010		7.21903.63.0	DW-TL	EP
			7.22240.15.0	EUV-LS	EL
2.4 D 93 kW (126 PS) D 5244 T7	03.2005→04.2010		7.00515.04.0	EUV-AGR	EP
			7.22240.15.0	EUV-LS	EL
2.4 D 90 kW (122 PS) D 5244 T6	05.2005→12.2006		7.00515.04.0	EUV-AGR	EP
			7.22240.15.0	EUV-LS	EL
2.4 D 120 kW (163 PS) D 5244 T5	07.2005→12.2009		7.00515.04.0	EUV-AGR	EP
			7.22240.15.0	EUV-LS	EL
2.4 D5 120 kW (163 PS) D 5244 T	01.2001→04.2010		7.21903.63.0	DW-TL	EP
2.4 D5 136 kW (185 PS) D 5244 T4	03.2005→04.2010		7.00515.04.0	EUV-AGR	EP
			7.22240.15.0	EUV-LS	EL
			7.22240.13.0	LDRV	EL Fahrgestellnummer ab: 92352 Vehicle Identification Number from: 92352
2.4 T 147 kW (200 PS) B 5244 T3	07.2000→04.2010		7.22240.13.0	LDRV	EL Fahrgestellnummer ab: 92352 Vehicle Identification Number from: 92352
2.4 T AWD 147 kW (200 PS) B 5244 T3	06.2001→04.2010		7.22240.13.0	LDRV	EL Fahrgestellnummer ab: 92352 Vehicle Identification Number from: 92352
2.4 T5 191 kW (260 PS) B 5244 T5	04.2004→04.2010		7.22517.04.0	AKF	EL Fahrgestellnummer bis: 92351 Vehicle Identification Number to: 92351 Europa Europe
			7.28197.16.0	LDRV	EL
2.5 T 153-162 kW (209-220 PS) B 5254 T2	01.2003→04.2010		7.22510.03.0	AKF	EL























S60 I (384) **8**

			7.22517.04.0	AKF	EL	Fahrgestellnummer bis: 92351 Vehicle Identification Number to: 92351 ** Europa ** Europe
			7.22240.13.0	LDRV	EL	Fahrgestellnummer ab: 92352 Vehicle Identification Number from: 92352
2.5 T AWD 153-162 kW (209-220 PS) B 5254 T2	07.2002→04.2010		7.22517.04.0	AKF	EL	Fahrgestellnummer bis: 92351 Vehicle Identification Number to: 92351 ** Europa ** Europe
			7.22240.13.0	LDRV	EL	Fahrgestellnummer ab: 92352 Vehicle Identification Number from: 92352
R 2,5 T AWD 220-224 kW (299-305 PS) B 5254 T4	01.2003→04.2010		7.22510.03.0	AKF	EL	
			7.22517.04.0	AKF	EL	Fahrgestellnummer bis: 92351 Vehicle Identification Number to: 92351 ** Europa ** Europe
			7.28197.16.0	LDRV	EL	
T5 147-184 kW (239-250 PS) B 5234 T3	07.2000→04.2010		7.22517.04.0	AKF	EL	Fahrgestellnummer bis: 92351 Vehicle Identification Number to: 92351 ** Europa ** Europe
			7.22240.13.0	LDRV	EL	Fahrgestellnummer ab: 92352 Vehicle Identification Number from: 92352

S60 II (134) **9**

1.5 T2 90 kW (122 PS) B 4154 T5	10.2015→05.2018		7.05367.05.0	SUV	EL	
1.5 T3 112 kW (152 PS) B 4154 T4	03.2015→05.2018		7.05367.05.0	SUV	EL	
2.0 D2 88-145 kW (120-197 PS) D 4204 T20, D 4204 T8	03.2015→05.2018		7.04664.02.0	DW-TL	EP	
			7.00515.05.0	EUV-AGR	EP	
2.0 D3 110 kW (150 PS) D 4204 T9	03.2015→05.2018		7.04664.02.0	DW-TL	EP	
			7.00515.05.0	EUV-AGR	EP	
2.0 D4 140-147 kW (190-200 PS) D 4204 T14	03.2015→05.2018		7.04664.02.0	DW-TL	EP	
			7.00515.05.0	EUV-AGR	EP	
2.0 D5 165-171 kW (224-232 PS) D 4204 T11	03.2015→05.2018		7.04664.02.0	DW-TL	EP	
			7.00515.05.0	EUV-AGR	EP	
2.0 T 149 kW (203 PS) B 4204 T6	04.2010→12.2011		7.28197.16.0	LDRV	EL	
			7.06117.52.0	SV-NWV	EH	Einlassseite Intake Side
			7.06117.55.0	SV-NWV	EH	
2.0 T 132 kW (180 PS) B 5204 T8	05.2012→12.2015		7.28197.16.0	LDRV	EL	
2.0 T3 112 kW (152 PS) B 4204 T37	03.2015→05.2018		7.05367.05.0	SUV	EL	
2.0 T4 140 kW (190 PS) B 4204 T19	03.2015→05.2018		7.05367.05.0	SUV	EL	
2.0 T5 DRIVE 176-180 kW (239-245 PS) B 4204 T7	09.2014→12.2015		7.28197.16.0	LDRV	EL	

V























					
S60 II (134)					
2.4 D4 AWD 140-162 kW (190-220 PS) D 5244 T21	03.2015→05.2018		7.02325.05.0	DW-TL	EP
			7.02613.02.0	EUV-AGR	EP
			7.02221.01.0	LDRV	EL
2.5 T5 AWD 183 kW (249 PS) B 5254 T14	03.2015→12.2018		7.28197.16.0	LDRV	EL
3.0 T AWD 258 kW (351 PS) B 6304 T5	04.2014→12.2018		7.02256.39.0	AKF	EL
			7.06117.18.0	SV-NWV	EH mit Dichtring with O-ring Ohne Pfandrückgabe des Altteils. Keine Rückgabe des Magnetventils nötig. Without deposit return for used part. No return of the solenoid valve.
D3 120 kW (163 PS) D 5204 T2, D 5204 T3	04.2010→12.2014		7.02325.05.0	DW-TL	EP
			7.02613.02.0	EUV-AGR	EP
D3 100 kW (136 PS) D 5204 T7	05.2012→12.2015		7.02325.05.0	DW-TL	EP
			7.02613.02.0	EUV-AGR	EP
D4 120 kW (163 PS) D 5204 T3	04.2010→12.2014		7.02325.05.0	DW-TL	EP
			7.02613.02.0	EUV-AGR	EP
D4 133 kW (181 PS) D 4204 T5	09.2013→12.2015		7.04664.02.0	DW-TL	EP
			7.00515.05.0	EUV-AGR	EP
D4 Polestar AWD 140-162 kW (190-220 PS) D 5244 T21	03.2015→07.2018		7.02325.05.0	DW-TL	EP
			7.02221.01.0	LDRV	EL
D5 151 kW (205 PS) D 5244 T10	04.2010→12.2011		7.02325.05.0	DW-TL	EP
			7.02613.02.0	EUV-AGR	EP
			7.02221.01.0	LDRV	EL
D5 158-169 kW (215-230 PS) D 5244 T11, D 5244 T15	04.2011→12.2015		7.02325.05.0	DW-TL	EP
			7.02613.02.0	EUV-AGR	EP
			7.02221.01.0	LDRV	EL
D5 158-169 kW (215-230 PS) D 5244 T15	04.2014→12.2015		7.02325.05.0	DW-TL	EP
			7.02613.02.0	EUV-AGR	EP
			7.02221.01.0	LDRV	EL
D5 AWD 151 kW (205 PS) D 5244 T10	04.2010→12.2011		7.02325.05.0	DW-TL	EP
			7.02613.02.0	EUV-AGR	EP
			7.02221.01.0	LDRV	EL
D5 AWD 158-169 kW (215-230 PS) D 5244 T15	04.2011→12.2015		7.02325.05.0	DW-TL	EP
			7.02613.02.0	EUV-AGR	EP
			7.02221.01.0	LDRV	EL
D5 AWD 158-169 kW (215-230 PS) D 5244 T15	04.2014→12.2015		7.02325.05.0	DW-TL	EP
			7.02613.02.0	EUV-AGR	EP
			7.02221.01.0	LDRV	EL
DRIVE / D2 84 kW (114 PS) D 4162 T	01.2011→12.2015		7.07400.02.0*	STE	EP für Fahrzeuge mit Automatikgetriebe for vehicles with automatic transmission
			7.01633.06.0	DW-TL	EP



S60 II (134) **9**

			7.07400.03.0*	STE	EP	für Fahrzeuge mit Schaltgetriebe for vehicles with manual transmission
			↳ 7.01633.06.0	DW-TL	EP	
T3 110 kW (150 PS) B 4164 T3	04.2010→12.2015		7.07400.19.0*	EUV-VB	EP	mit Halter with holder Fahrgestellnummer bis: 128365 Vehicle Identification Number to: 128365
			↳ 7.22687.44.0	EUV-VB	EP	
			7.03162.09.0	LDRV	EP	Fahrgestellnummer bis: 128365 Vehicle Identification Number to: 128365
			7.04492.07.0	LDRV	EP	Fahrgestellnummer ab: 128366 Vehicle Identification Number from: 128366
			7.04615.03.0	SUV	EL	ch. 128366→
T4 132-147 kW (180-200 PS) B 4164 T	04.2010→12.2015		7.07400.19.0*	EUV-VB	EP	mit Halter with holder Fahrgestellnummer bis: 128365 Vehicle Identification Number to: 128365
			↳ 7.22687.44.0	EUV-VB	EP	
			7.03162.09.0	LDRV	EP	Fahrgestellnummer bis: 128365 Vehicle Identification Number to: 128365
			7.04492.07.0	LDRV	EP	Fahrgestellnummer ab: 128366 Vehicle Identification Number from: 128366
			7.04615.03.0	SUV	EL	ch. 128366→
T4F 132 kW (180 PS) B 4164 T2	04.2011→12.2015		7.07400.19.0*	EUV-VB	EP	mit Halter with holder Fahrgestellnummer bis: 128365 Vehicle Identification Number to: 128365
			↳ 7.22687.44.0	EUV-VB	EP	
			7.03162.09.0	LDRV	EP	Fahrgestellnummer bis: 128365 Vehicle Identification Number to: 128365
			7.04492.07.0	LDRV	EP	Fahrgestellnummer ab: 128366 Vehicle Identification Number from: 128366
			7.04615.03.0	SUV	EL	ch. 128366→
T5 176-180 kW (239-245 PS) B 4204 T7	04.2010→12.2014		7.28197.16.0	LDRV	EL	
			7.06117.52.0	SV-NWV	EH	2012
			7.06117.53.0	SV-NWV	EH	2012
			7.06117.55.0	SV-NWV	EH	Einlassseite Intake Side 2011 2011
T5 183-187 kW (249-254 PS) B 5254 T12	01.2013→12.2016		7.28197.16.0	LDRV	EL	
T5 225 kW (306 PS) B 4204 T9	08.2013→05.2018		7.05367.05.0	SUV	EL	
T5 180-186 kW (245-253 PS) B 4204 T11	09.2013→12.2018		7.02325.06.0	DW-TL	EP	
T5 154-157 kW (210-214 PS) B 5204 T9	11.2013→03.2015		7.28197.16.0	LDRV	EL	
T5 AWD 183-187 kW (249-254 PS) B 5254 T12	08.2015→12.2018		7.28197.16.0	LDRV	EL	
T6 225 kW (306 PS) B 4204 T9	09.2013→12.2018		7.02325.06.0	DW-TL	EP	
			7.05367.05.0	SUV	EL	
T6 AWD 224-242 kW (304-329 PS) B 6304 T4	04.2010→12.2015		7.02256.39.0	AKF	EL	

V

					
S60 II (134)					
			7.06117.18.0	SV-NWV	EH mit Dichtring with O-ring Ohne Pfandrückgabe des Altteils. Keine Rückgabe des Magnetventils nötig. Without deposit return for used part. No return of the solenoid valve.
T6 AWD 224-242 kW (304-329 PS) B 6304 T4	04.2014→12.2015		7.02256.39.0	AKF	EL
			7.06117.18.0	SV-NWV	EH mit Dichtring with O-ring Ohne Pfandrückgabe des Altteils. Keine Rückgabe des Magnetventils nötig. Without deposit return for used part. No return of the solenoid valve.
T6 AWD 242 kW (329 PS) B 6304 T3	04.2014→12.2015		7.06117.18.0	SV-NWV	EH mit Dichtring with O-ring Ohne Pfandrückgabe des Altteils. Keine Rückgabe des Magnetventils nötig. Without deposit return for used part. No return of the solenoid valve.
T6 AWD 225 kW (306 PS) B 4204 T9	09.2015→12.2018		7.05367.05.0	SUV	EL
S60 III (224)					
2.0 T6 AWD 235-246 kW (320-334 PS) B 4204 T27	05.2019→		7.05367.05.0	SUV	EL
2.0 T8 Plug-in Hybrid AWD 223-246 kW (303-334 PS) B 4204 T35	05.2019→		7.05367.05.0	SUV	EL
2.0 T8 R-Design Hybrid AWD 223-246 kW (303-334 PS) B 4204 T35	04.2020→		7.05367.05.0	SUV	EL
T6 AWD 228-240 kW (310-326 PS) B 4204 T29	05.2019→		7.05367.05.0	SUV	EL
T6 Drive-E Polestar AWD 233-245 kW (317-333 PS) B 4204 T48	02.2019→		7.05367.05.0	SUV	EL
T6 Hybrid Polestar AWD 233-245 kW (317-333 PS) B 4204 T48	05.2019→		7.05367.05.0	SUV	EL
T6 Twin Engine AWD 186 kW (253 PS) B 4204 T46	02.2019→		7.05367.05.0	SUV	EL
T8 Plug-in Hybrid AWD 223-246 kW (303-334 PS) B 4204 T27, B 4204 T35	05.2019→		7.05367.05.0	SUV	EL
T8 Twin Engine AWD 223-287 kW (303-390 PS) B 4204 T34	02.2019→		7.05367.05.0	SUV	EL
T8 Twin Engine Polestar AWD 233-245 kW (317-333 PS) B 4204 T48	10.2019→		7.05367.05.0	SUV	EL
S70 (874)					
2.0 132 kW (180 PS) B 5204 T2	01.1997→11.2000		7.22517.04.0	AKF	EL  Europa  Europe 2000 2000 2002 2002
			7.22240.09.0	LDRV	EL Produktionsdatum bis: 31.12.1999 Production date to: 31.12.1999

V



S70 (874) **11**

















<p>2.0 120 kW (163 PS) B 5204 T4</p>	<p>01.1997→11.2000</p>	<p> PIERBURG</p> <p></p> <p>7.22517.04.0</p> <p>7.22240.09.0</p>	<p>AKF</p> <p>LDRV</p>	<p>EL</p> <p>EL</p> <p>Produktionsdatum bis: 31.12.1999 Production date to: 31.12.1999</p>	<p>Europa Europe 2000 2000 2001 2001</p>
<p>2.0 Turbo 166 kW (226 PS) B 5204 T3</p>	<p>01.1997→11.2000</p>	<p></p> <p>7.22517.04.0</p> <p>7.22240.09.0</p>	<p>AKF</p> <p>LDRV</p>	<p>EL</p> <p>EL</p> <p>Produktionsdatum bis: 31.12.1999 Production date to: 31.12.1999</p>	<p>Europa Europe 2000 2000 2001 2001</p>
<p>2.3 147-184 kW (239-250 PS) B 5234 T3</p>	<p>11.1996→11.2000</p>	<p></p> <p>7.22517.04.0</p> <p>7.22240.09.0</p>	<p>AKF</p> <p>LDRV</p>	<p>EL</p> <p>EL</p> <p>Produktionsdatum bis: 31.12.1999 Production date to: 31.12.1999</p>	<p>Europa Europe 2000 2000 2002 2002</p>
<p>2.3 195 kW (265 PS) B 5234 T7</p>	<p>04.1999→09.2000</p>	<p></p> <p>7.22517.04.0</p> <p>7.22240.09.0</p>	<p>AKF</p> <p>LDRV</p>	<p>EL</p> <p>EL</p> <p>Produktionsdatum bis: 31.12.1999 Production date to: 31.12.1999</p>	<p>Europa Europe 2000 2000 2001 2001</p>
<p>2.3 T-5 147-184 kW (239-250 PS) B 5234 T3</p>	<p>01.1997→11.2000</p>	<p></p> <p>7.28194.01.0</p> <p>7.22517.04.0</p> <p>7.22240.09.0</p>	<p>AKF</p> <p>AKF</p> <p>LDRV</p>	<p>EL</p> <p>EL</p> <p>Produktionsdatum bis: 31.12.1999 Production date to: 31.12.1999</p>	<p>Europa Europe 2000 2000 2002 2002</p>
<p>2.3 T5 AWD 147-184 kW (239-250 PS) B 5234 T3</p>	<p>11.1996→09.1998</p>	<p></p> <p>7.22517.04.0</p> <p>7.22240.09.0</p>	<p>AKF</p> <p>LDRV</p>	<p>EL</p> <p>EL</p> <p>Produktionsdatum bis: 31.12.1999 Production date to: 31.12.1999</p>	<p>Europa Europe 2000 2000 2002 2002</p>
<p>2.3 T5 AWD 176-184 kW (239-250 PS) B 5234 T4</p>	<p>07.1997→09.2000</p>	<p></p> <p>7.22517.04.0</p> <p>7.22240.09.0</p>	<p>AKF</p> <p>LDRV</p>	<p>EL</p> <p>EL</p> <p>Produktionsdatum bis: 31.12.1999 Production date to: 31.12.1999</p>	<p>Europa Europe 2000 2000 2001 2001</p>
<p>2.3 Turbo 176-184 kW (239-250 PS) B 5234 T4</p>	<p>01.1997→11.2000</p>	<p></p> <p>7.22517.04.0</p> <p>7.22240.09.0</p>	<p>AKF</p> <p>LDRV</p>	<p>EL</p> <p>EL</p> <p>Produktionsdatum bis: 31.12.1999 Production date to: 31.12.1999</p>	<p>Europa Europe 1999 1999</p>

V

S70 (874)
11

2.4 121-125 kW (165-170 PS) B 5254 S	01.1997→11.2000	 7.22517.04.0	AKF	EL	Europa Europe 2000 2000 2002 2002
2.4 125 kW (170 PS) B 5244 S	01.1997→11.2000	 7.22517.06.0 7.22517.04.0	AKF AKF	EL EL	→12.1999 Europa Europe 2000 2000 2002 2002
2.4 121-125 kW (165-170 PS) B 5254 S	06.1998→11.2000	 7.22517.06.0 7.28194.01.0 7.22517.04.0	AKF AKF AKF	EL EL EL	01.1999→ Europa Europe 2000 2000 2002 2002
2.4 103 kW (140 PS) B 5244 S2	08.1999→11.2000	 7.22517.06.0 7.22517.04.0	AKF AKF	EL EL	→12.1999 Europa Europe 2000 2000 2002 2002
2.4 AWD 121-125 kW (165-170 PS) B 5254 S	10.1998→05.1999	 7.22517.04.0	AKF	EL	Europa Europe 2000 2000 2002 2002
2.4 AWD 103 kW (140 PS) B 5244 S2	04.1999→09.2000	 7.22517.06.0 7.22517.04.0	AKF AKF	EL EL	→12.1999 Europa Europe 2000 2000 2002 2002
2.4 AWD 125 kW (170 PS) B 5244 S	04.1999→09.2000	 7.22517.06.0 7.28194.01.0	AKF AKF	EL EL	→12.1999
2.4 Blu-Fuel 103 kW (140 PS) B 5244 S2	07.1997→09.2000	 7.22517.04.0	AKF	EL	Europa Europe 2000 2000 2001 2001
2.4 T5 AWD 142 kW (193 PS) B 5254 T	11.1996→04.1999	 7.22517.04.0 7.22240.09.0	AKF LDRV	EL EL	Europa Europe 2000 2000 2002 2002

V

			 PIERBURG		
S70 (874)					11
2.4 Turbo 142 kW (193 PS) B 5244 T, B 5254 T	01.1997→11.2000		7.22517.04.0	AKF	EL  B 5244 T, B 5254 T:  Europa  Europe 1999 1999
			7.22240.09.0	LDRV	EL  B 5244 T, B 5254 T: Produktionsdatum bis: 31.12.1999 Production date to: 31.12.1999
S80 I (184)					12
2.0 120 kW (163 PS) B 5204 T4	06.1998→07.2006		7.22517.06.0	AKF	EL →12.1999
			7.22517.04.0	AKF	EL Fahrgestellnummer ab: 64000 Vehicle Identification Number from: 64000 Fahrgestellnummer bis: 239999 Vehicle Identification Number to: 239999
			7.22240.09.0	LDRV	EL Produktionsdatum bis: 31.12.1999 Production date to: 31.12.1999
			7.22240.13.0	LDRV	EL Fahrgestellnummer ab: 240000 Vehicle Identification Number from: 240000
2.0 T 166 kW (226 PS) B 5204 T3	06.1998→07.2006		7.22517.06.0	AKF	EL →12.1999
			7.22517.04.0	AKF	EL Fahrgestellnummer ab: 64000 Vehicle Identification Number from: 64000 Fahrgestellnummer bis: 239999 Vehicle Identification Number to: 239999
			7.22240.09.0	LDRV	EL Produktionsdatum bis: 31.12.1999 Production date to: 31.12.1999
			7.22240.13.0	LDRV	EL Fahrgestellnummer ab: 240000 Vehicle Identification Number from: 240000
2.0 T 132 kW (180 PS) B 5204 T5	12.1999→07.2006		7.22517.06.0	AKF	EL →12.1999
			7.22517.04.0	AKF	EL Fahrgestellnummer ab: 64000 Vehicle Identification Number from: 64000 Fahrgestellnummer bis: 239999 Vehicle Identification Number to: 239999
			7.22240.13.0	LDRV	EL Fahrgestellnummer ab: 240000 Vehicle Identification Number from: 240000
2.3 R 195 kW (265 PS) B 5234 T7	04.2000→08.2005		7.22517.04.0	AKF	EL Fahrgestellnummer ab: 64000 Vehicle Identification Number from: 64000 Fahrgestellnummer bis: 239999 Vehicle Identification Number to: 239999
			7.22240.13.0	LDRV	EL Fahrgestellnummer ab: 240000 Vehicle Identification Number from: 240000
2.4 103 kW (140 PS) B 5244 S2	01.1999→07.2006		7.22517.06.0	AKF	EL →12.1999
			7.22517.04.0	AKF	EL Fahrgestellnummer ab: 64000 Vehicle Identification Number from: 64000 Fahrgestellnummer bis: 239999 Vehicle Identification Number to: 239999
2.4 125 kW (170 PS) B 5244 S	01.1999→07.2006		7.22517.06.0	AKF	EL →12.1999
			7.22517.04.0	AKF	EL Fahrgestellnummer ab: 64000 Vehicle Identification Number from: 64000 Fahrgestellnummer bis: 239999 Vehicle Identification Number to: 239999









V

					
S80 I (184)					12
2.4 Bifuel (CNG) 103 kW (140 PS) B 5244 SG2	09.2001→07.2006		7.22517.04.0	AKF	EL 2003 2003
2.4 Bifuel (LPG) 103 kW (140 PS) B 5244 SG	09.2001→07.2006		7.22517.04.0	AKF	EL 2003 2003
2.4 D 96-120 kW (131-163 PS) D 5244 T2	10.2001→07.2006		7.21903.63.0	DW-TL	EP
			7.22240.15.0	EUV-LS	EL
2.4 D5 120 kW (163 PS) D 5244 T	08.2001→07.2006		7.21903.63.0	DW-TL	EP
			7.22240.15.0	EUV-LS	EL
2.4 LTP 132 kW (180 PS) B 5244 T4	06.2004→07.2006		7.22517.04.0	AKF	EL Fahrgestellnummer ab: 64000 Vehicle Identification Number from: 64000 Fahrgestellnummer bis: 239999 Vehicle Identification Number to: 239999
			7.22240.13.0	LDRV	EL Fahrgestellnummer ab: 240000 Vehicle Identification Number from: 240000
2.4 T 147 kW (200 PS) B 5244 T3	06.2000→07.2006		7.22517.04.0	AKF	EL Fahrgestellnummer ab: 64000 Vehicle Identification Number from: 64000 Fahrgestellnummer bis: 239999 Vehicle Identification Number to: 239999
			7.22240.13.0	LDRV	EL Fahrgestellnummer ab: 240000 Vehicle Identification Number from: 240000
2.4 T5 AWD 147 kW (200 PS) B 5244 T3	04.2000→09.2003		7.22517.04.0	AKF	EL Fahrgestellnummer ab: 64000 Vehicle Identification Number from: 64000 Fahrgestellnummer bis: 239999 Vehicle Identification Number to: 239999
			7.22240.13.0	LDRV	EL Fahrgestellnummer ab: 240000 Vehicle Identification Number from: 240000
2.5 T 153-162 kW (209-220 PS) B 5254 T2	03.2003→07.2006		7.22517.04.0	AKF	EL Fahrgestellnummer ab: 64000 Vehicle Identification Number from: 64000 Fahrgestellnummer bis: 239999 Vehicle Identification Number to: 239999
			7.22240.13.0	LDRV	EL Fahrgestellnummer ab: 240000 Vehicle Identification Number from: 240000
2.5 T AWD 153-162 kW (209-220 PS) B 5254 T2	07.2003→07.2006		7.22517.04.0	AKF	EL Fahrgestellnummer ab: 64000 Vehicle Identification Number from: 64000 Fahrgestellnummer bis: 239999 Vehicle Identification Number to: 239999
			7.22240.13.0	LDRV	EL Fahrgestellnummer ab: 240000 Vehicle Identification Number from: 240000
2.5 TDI 103 kW (140 PS) D 5252 T	01.1999→07.2006		7.22240.15.0	EUV-LS	EL
2.8 T6 200 kW (272 PS) B 6284 T	05.1998→12.2001		7.22517.06.0	AKF	EL →12.1999
			7.22517.04.0	AKF	EL Fahrgestellnummer ab: 64000 Vehicle Identification Number from: 64000 Fahrgestellnummer bis: 239999 Vehicle Identification Number to: 239999
			7.22240.09.0	LDRV	EL Produktionsdatum bis: 31.12.1999 Production date to: 31.12.1999
			7.22240.13.0	LDRV	EL































S80 I (184) **12**

2.9 150 kW (204 PS) B 6304 S3	05.1998→07.2006	 7.22517.04.0	AKF	EL	Fahrgestellnummer ab: 64000 Vehicle Identification Number from: 64000 Fahrgestellnummer bis: 239999 Vehicle Identification Number to: 239999
		 7.22517.06.0	AKF	EL	
2.9 147 kW (200 PS) B 6294 S	03.1999→07.2006	 7.22517.06.0	AKF	EL	→12.1999
		 7.22517.04.0	AKF	EL	Fahrgestellnummer ab: 64000 Vehicle Identification Number from: 64000 Fahrgestellnummer bis: 239999 Vehicle Identification Number to: 239999
3.0 144 kW (196 PS) B 6294 S2	06.2001→07.2006	 7.22517.04.0	AKF	EL	Fahrgestellnummer ab: 64000 Vehicle Identification Number from: 64000 Fahrgestellnummer bis: 239999 Vehicle Identification Number to: 239999
3.0 T6 200 kW (272 PS) B 6294 T	06.2001→07.2006	 7.22517.04.0	AKF	EL	Fahrgestellnummer ab: 64000 Vehicle Identification Number from: 64000 Fahrgestellnummer bis: 239999 Vehicle Identification Number to: 239999
		 7.22240.13.0	LDRV	EL	
2.4F 20V (CNG) 103 kW (140 PS) B 5244 SG	01.2001→09.2005	 7.22517.04.0	AKF	EL	2003 2003

S80 II (124) **13**

1.6 D DRIVe 80-81 kW (109-110 PS) D 4164 T	01.2010→12.2011	 7.00968.04.0	DW-TL	EP	
1.6 DRIVe 84 kW (114 PS) D 4162 T	06.2011→01.2014	 7.07400.02.0*	STE	EP	für Fahrzeuge mit Automatikgetriebe for vehicles with automatic transmission
		↳ 7.01633.06.0	DW-TL	EP	
		7.07400.03.0*	STE	EP	für Fahrzeuge mit Schaltgetriebe for vehicles with manual transmission
		↳ 7.01633.06.0	DW-TL	EP	
2.0 107 kW (146 PS) B 4204 S3	01.2008→09.2012	 7.02256.48.0	STE	EP	
2.0 FlexFuel 107 kW (146 PS) B 4204 S4	01.2008→12.2011	 7.02256.48.0	STE	EP	
2.0 T 149 kW (203 PS) B 4204 T6	01.2010→05.2011	 7.28197.16.0	LDRV	EL	
		7.06117.52.0	SV-NWV	EH	
		7.06117.53.0	SV-NWV	EH	2012 2012
		7.06117.55.0	SV-NWV	EH	Einlassseite Intake Side 2011 2011
2.0 TDi 100 kW (136 PS) D 4204 T	02.2008→03.2011	 7.01771.01.0	DW-RK	EP	
		7.01771.01.0	DW-TL	EP	
2.4 D 120 kW (163 PS) D 5244 T5	03.2006→06.2009	 7.00515.04.0	EUV-AGR	EP	
2.4 D 120 kW (163 PS) D 5244 T19	07.2009→03.2011	 7.02613.02.0	EUV-AGR	EP	
2.4 D 129 kW (175 PS) D 5244 T14	01.2010→03.2011	 7.02613.02.0	EUV-AGR	EP	
2.5 T 147 kW (200 PS) B 5254 T6	03.2006→12.2011	 7.28197.16.0	LDRV	EL	













V

					
S80 II (124)					
13					
2.5 T 170 kW (231 PS) B 5254 T10	01.2010→12.2012		7.28197.16.0	LDRV	EL
2.5 T 183-187 kW (249-254 PS) B 5254 T12	01.2012→04.2016		7.28197.16.0	LDRV	EL
2.5 T 183 kW (249 PS) B 5254 T14	09.2012→12.2016		7.28197.16.0	LDRV	EL
2.5 T FlexFuel 147 kW (200 PS) B 5254 T8	05.2008→12.2011		7.28197.16.0	LDRV	EL
2.5 T FlexFuel 170 kW (231 PS) B 5254 T11	01.2010→12.2011		7.28197.16.0	LDRV	EL
3.2 168-177 kW (228-238 PS) B 6324 S	03.2006→12.2010		7.02256.39.0 7.06117.18.0	AKF SV-NWV	EL EH mit Dichtring with O-ring Ohne Pfandrückgabe des Altteils. Keine Rückgabe des Magnetventils nötig. Without deposit return for used part. No return of the solenoid valve.
3.2 179 kW (243 PS) B 6324 S5	01.2010→12.2014		7.02256.39.0 7.06117.18.0	AKF SV-NWV	EL EH mit Dichtring with O-ring Ohne Pfandrückgabe des Altteils. Keine Rückgabe des Magnetventils nötig. Without deposit return for used part. No return of the solenoid valve.
3.2 AWD 168-177 kW (228-238 PS) B 6324 S	01.2007→12.2010		7.02256.39.0 7.06117.18.0	AKF SV-NWV	EL EH mit Dichtring with O-ring Ohne Pfandrückgabe des Altteils. Keine Rückgabe des Magnetventils nötig. Without deposit return for used part. No return of the solenoid valve.
3.2 AWD 179 kW (243 PS) B 6324 S5	01.2010→12.2012		7.02256.39.0 7.06117.18.0	AKF SV-NWV	EL EH mit Dichtring with O-ring Ohne Pfandrückgabe des Altteils. Keine Rückgabe des Magnetventils nötig. Without deposit return for used part. No return of the solenoid valve.
D3 100 kW (136 PS) D 5204 T7	05.2012→05.2014		7.02325.05.0 7.02613.02.0	DW-TL EUV-AGR	EP EP
D3 / D4 120 kW (163 PS) D 5204 T2, D 5204 T3	01.2010→12.2016		7.02325.05.0 7.02613.02.0	DW-TL EUV-AGR	EP EP
D4 133 kW (181 PS) D 4204 T5	09.2013→12.2016		7.04664.02.0 7.00515.05.0	DW-TL EUV-AGR	EP EP
D5 136 kW (185 PS) D 5244 T4	03.2006→08.2009		7.00515.04.0 7.22240.15.0	EUV-AGR EUV-LS	EP EL
D5 151 kW (205 PS) D 5244 T10	01.2010→12.2011		7.02325.05.0 7.02325.04.0 7.02613.02.0 7.02221.01.0	DW-TL DW-TL EUV-AGR LDRV	EP EP EP EL  ch. 134101→ Fahrgestellnummer bis: 134000 Vehicle Identification Number to: 134000
D5 158-169 kW (215-230 PS) D 5244 T11, D 5244 T15	06.2011→04.2015		7.02325.05.0	DW-TL	EP

























V



S80 II (124) **13**

			7.02613.02.0 7.02221.01.0	EUV-AGR LDRV	EP EL	
D5 AWD 136 kW (185 PS) D 5244 T4	01.2007→05.2009		7.00515.04.0	EUV-AGR	EP	
D5 AWD 151 kW (205 PS) D 5244 T10	01.2010→12.2011		7.02325.05.0 7.02325.04.0 7.02613.02.0 7.02221.01.0	DW-TL DW-TL EUV-AGR LDRV	EP EP EP EL	 ch. 134101→ Fahrgestellnummer bis: 134000 Vehicle Identification Number to: 134000
D5 AWD 158-169 kW (215-230 PS) D 5244 T15	06.2011→04.2015		7.02325.05.0 7.02613.02.0 7.02221.01.0	DW-TL EUV-AGR LDRV	EP EP EL	
T4 132-147 kW (180-200 PS) B 4164 T	10.2010→04.2014		7.07400.19.0* ↳ 7.22687.44.0 7.03162.09.0 7.04492.07.0 7.04615.03.0	EUV-VB EUV-VB LDRV LDRV SUV	EP EP EP EP EL	mit Halter with holder Fahrgestellnummer bis: 159557 Vehicle Identification Number to: 159557 Fahrgestellnummer bis: 159557 Vehicle Identification Number to: 159557 Fahrgestellnummer ab: 159558 Vehicle Identification Number from: 159558  ch. 159558→
T4F 132 kW (180 PS) B 4164 T2	05.2011→01.2014		7.07400.19.0* ↳ 7.22687.44.0 7.03162.09.0 7.04492.07.0 7.04615.03.0	EUV-VB EUV-VB LDRV LDRV SUV	EP EP EP EP EL	mit Halter with holder Fahrgestellnummer bis: 159557 Vehicle Identification Number to: 159557 Fahrgestellnummer bis: 159557 Vehicle Identification Number to: 159557 Fahrgestellnummer ab: 159558 Vehicle Identification Number from: 159558  ch. 159558→
T5 176-180 kW (239-245 PS) B 4204 T7	10.2010→12.2016		7.28197.16.0 7.06117.52.0 7.06117.53.0 7.06117.55.0	LDRV SV-NWV SV-NWV SV-NWV	EL EH EH EH	2012 2012 Einlassseite Intake Side 2011 2011
T5 180-186 kW (245-253 PS) B 4204 T11	09.2013→05.2014		7.02325.06.0	DW-TL	EP	
T6 AWD 210 kW (286 PS) B 6304 T2	01.2007→12.2010		7.02256.39.0 7.06117.18.0	AKF SV-NWV	EL EH	mit Dichtring with O-ring Ohne Pfandrückgabe des Altteils. Keine Rückgabe des Magnetventils nötig. Without deposit return for used part. No return of the solenoid valve.
T6 AWD 224-242 kW (304-329 PS) B 6304 T4	10.2010→12.2016		7.02256.39.0 7.06117.18.0	AKF SV-NWV	EL EH	mit Dichtring with O-ring Ohne Pfandrückgabe des Altteils. Keine Rückgabe des Magnetventils nötig. Without deposit return for used part. No return of the solenoid valve.





V

					
S90 I (964)					14
2.5 125 kW (170 PS) B 6254 FS	11.1996→10.1998		7.22240.15.0	EUV-SL	EL 1998 1998
2.9 150 kW (204 PS) B 6304 GS	01.1997→05.1998		7.22240.15.0	EUV-SL	EL 1998 1998
S90 II (234)					15
2.0 D3 110 kW (150 PS) D 4204 T16, D 4204 T9	03.2016→08.2018		7.04664.02.0	DW-TL	EP
			7.00515.05.0	EUV-AGR	EP
2.0 D4 140-147 kW (190-200 PS) D 4204 T14	03.2016→		7.04664.02.0	DW-TL	EP
			7.00515.05.0	EUV-AGR	EP
2.0 D4 120 kW (163 PS) D 4204 T7	09.2018→		7.04664.02.0	DW-TL	EP
			7.00515.05.0	EUV-AGR	EP
2.0 D4 AWD 140-147 kW (190-200 PS) D 4204 T14	03.2016→		7.04664.02.0	DW-TL	EP
			7.00515.05.0	EUV-AGR	EP
2.0 D5 AWD 173-177 kW (235-241 PS) D 4204 T23	03.2016→		7.04664.02.0	DW-TL	EP
			7.00515.05.0	EUV-AGR	EP
2.0 T6 AWD 235-246 kW (320-334 PS) B 4204 T27	03.2016→		7.05367.05.0	SUV	EL
2.0 T6 AWD 228-240 kW (310-326 PS) B 4204 T29	10.2017→		7.05367.05.0	SUV	EL
2.0 T6 Drive-E Polestar AWD 228-240 kW (310-326 PS) B 4204 T29	10.2017→		7.05367.05.0	SUV	EL
2.0 T8 Hybrid AWD 223-287 kW (303-390 PS) B 4204 T34	04.2018→		7.05367.05.0	SUV	EL
2.0 T8 Hybrid Polestar AWD 223-287 kW (303-390 PS) B 4204 T34	01.2019→		7.05367.05.0	SUV	EL
2.0 T8 Plug-in Hybrid AWD 223-246 kW (303-334 PS) B 4204 T35	10.2017→		7.05367.05.0	SUV	EL
2.0 T8 Plug-in Hybrid AWD 223-246 kW (303-334 PS) B 4204 T35	10.2017→		7.05367.05.0	SUV	EL
D4 Drive-E Polestar 140-147 kW (190-200 PS) D 4204 T14	03.2016→		7.04664.02.0	DW-TL	EP
			7.00515.05.0	EUV-AGR	EP
D4 Drive-E Polestar AWD 140-147 kW (190-200 PS) D 4204 T14	03.2016→		7.04664.02.0	DW-TL	EP
			7.00515.05.0	EUV-AGR	EP
T6 Drive-E Polestar AWD 235-246 kW (320-334 PS) B 4204 T27	03.2016→		7.05367.05.0	SUV	EL
T8 Plug-in Hybrid Polestar AWD 223-246 kW (303-334 PS) B 4204 T35	10.2017→		7.05367.05.0	SUV	EL

V



V40 Estate (645) 16

<p>1.6 77 kW (105 PS) B 4164 S</p>	<p>12.1995→08.1999</p>	<p> 7.22517.04.0 7.22240.15.0 7.06269.09.0 7.06117.16.0</p>	<p>AKF EUV-SL LLR SV-NWV</p>	<p>EL Fahrgestellnummer ab: 415000 Vehicle Identification Number from: 415000 EL Fahrgestellnummer ab: 130000 Vehicle Identification Number from: 130000 EL <input type="radio"/> EH <input type="radio"/> Ohne Pfandrückgabe des Altteils. Keine Rückgabe des Magnetventils nötig. Without deposit return for used part. No return of the solenoid valve. Einlassseite Intake Side</p>
<p>1.6 80 kW (109 PS) B 4164 S2</p>	<p>01.2000→06.2004</p>	<p> 7.22517.04.0 7.22240.15.0 7.22240.15.0 7.06117.16.0</p>	<p>AKF EUV-LS EUV-SL SV-NWV</p>	<p>EL Fahrgestellnummer ab: 415000 Vehicle Identification Number from: 415000 EL Fahrgestellnummer ab: 130000 Vehicle Identification Number from: 130000 EH <input type="radio"/> Ohne Pfandrückgabe des Altteils. Keine Rückgabe des Magnetventils nötig. Without deposit return for used part. No return of the solenoid valve. Einlassseite Intake Side</p>
<p>1.8 85 kW (116 PS) B 4184 S3</p>	<p>07.1995→08.1999</p>	<p> 7.22517.04.0 7.22240.15.0 7.22240.15.0 7.06117.16.0</p>	<p>AKF EUV-LS EUV-SL SV-NWV</p>	<p>EL Fahrgestellnummer ab: 415000 Vehicle Identification Number from: 415000 EL 2000 2000 EL Fahrgestellnummer ab: 130000 Vehicle Identification Number from: 130000 EH <input type="radio"/> Ohne Pfandrückgabe des Altteils. Keine Rückgabe des Magnetventils nötig. Without deposit return for used part. No return of the solenoid valve. Einlassseite Intake Side</p>
<p>1.8 85 kW (115 PS) B 4184 S</p>	<p>01.1996→08.1999</p>	<p> 7.22517.04.0 7.22240.15.0 7.06269.09.0 7.06117.16.0</p>	<p>AKF EUV-SL LLR SV-NWV</p>	<p>EL Fahrgestellnummer ab: 415000 Vehicle Identification Number from: 415000 EL Fahrgestellnummer ab: 130000 Vehicle Identification Number from: 130000 EL <input type="radio"/> EH <input type="radio"/> Ohne Pfandrückgabe des Altteils. Keine Rückgabe des Magnetventils nötig. Without deposit return for used part. No return of the solenoid valve. Einlassseite Intake Side</p>
<p>1.8 85-90 kW (116-122 PS) B 4184 S2</p>	<p>03.1999→06.2004</p>	<p> 7.22240.15.0 7.22240.15.0 7.06269.09.0</p>	<p>EUV-LS EUV-SL LLR</p>	<p>EL Fahrgestellnummer ab: 130000 Vehicle Identification Number from: 130000 EL <input type="radio"/> →12.1999</p>

V













V40 Estate (645) **16**

			7.06117.16.0	SV-NWV	EH	<p>Ohne Pfandrückgabe des Altteils. Keine Rückgabe des Magnetventils nötig. Without deposit return for used part. No return of the solenoid valve. Einlassseite Intake Side</p>
1.8 Bi-Fuel 88-90 kW (120-122 PS) B 4184 S9	11.1999→08.2003		7.22517.04.0	AKF	EL	Fahrgestellnummer ab: 415000 Vehicle Identification Number from: 415000
			7.22240.15.0 7.06117.16.0	EUV-LS SV-NWV	EL EH	<p>Ohne Pfandrückgabe des Altteils. Keine Rückgabe des Magnetventils nötig. Without deposit return for used part. No return of the solenoid valve. Einlassseite Intake Side</p>
1.8 Blu-Fuel 85-90 kW (116-122 PS) B 4184 S2	06.2001→08.2003		7.22517.04.0	AKF	EL	Fahrgestellnummer ab: 415000 Vehicle Identification Number from: 415000
			7.22240.15.0	EUV-LS	EL	
			7.22240.15.0 7.06117.16.0	EUV-SL SV-NWV	EL EH	<p>Fahrgestellnummer ab: 130000 Vehicle Identification Number from: 130000</p> <p>Ohne Pfandrückgabe des Altteils. Keine Rückgabe des Magnetventils nötig. Without deposit return for used part. No return of the solenoid valve. Einlassseite Intake Side</p>
1.8 LPG 88-90 kW (120-122 PS) B 4184 S9	03.1999→06.2004		7.22517.04.0	AKF	EL	Fahrgestellnummer ab: 415000 Vehicle Identification Number from: 415000
			7.22240.15.0	EUV-LS	EL	
			7.06117.16.0	SV-NWV	EH	<p>Ohne Pfandrückgabe des Altteils. Keine Rückgabe des Magnetventils nötig. Without deposit return for used part. No return of the solenoid valve. Einlassseite Intake Side</p>
1.9 DI 75 kW (102 PS) D 4192 T4	07.2000→06.2004		7.21903.44.0	DW-AGR	EP	
1.9 DI 85 kW (116 PS) D 4192 T3	07.2000→06.2004		7.21903.44.0	DW-AGR	EP	
1.9 T4 147 kW (200 PS) B 4194 T	05.1997→07.2000		7.22517.04.0	AKF	EL	Fahrgestellnummer ab: 415000 Vehicle Identification Number from: 415000 " Europa " Europe
			7.22517.06.0 7.22240.09.0	AKF LDRV	EL EL	Fahrgestellnummer bis: CH414999 Vehicle Identification Number to: CH414999 Produktionsdatum bis: 31.12.1999 Production date to: 31.12.1999
			7.06269.09.0 7.06117.17.0	LLR SV-NWV	EL EH	<p>Ohne Pfandrückgabe des Altteils. Keine Rückgabe des Magnetventils nötig. Without deposit return for used part. No return of the solenoid valve. Auslassseite Exhaust Side</p>





V40 Estate (645) 16





















<p>1.9 T4 147 kW (200 PS) B 4194 T2</p>	<p>05.1997→07.2000</p>	<p> 7.22517.04.0 7.22240.15.0 7.22240.09.0</p>	<p>AKF EUV-LS LDRV</p>	<p>EL Fahrgestellnummer ab: 415000 Vehicle Identification Number from: 415000 ■ Europa ■ Europe EL 2000 2000 EL Fahrgestellnummer bis: CH414999 Vehicle Identification Number to: CH414999 Produktionsdatum bis: 31.12.1999 Production date to: 31.12.1999</p>
<p>2.0 100-103 kW (136-140 PS) B 4204 S, B 4204 S2</p>	<p>07.1995→06.2004</p>	<p> 7.22517.04.0 7.22240.15.0 7.22240.15.0 7.06269.09.0 7.06117.16.0</p>	<p>AKF EUV-LS EUV-SL LLR SV-NWV</p>	<p>EL  B 4204 S, B 4204 S2: Fahrgestellnummer ab: 415000 Vehicle Identification Number from: 415000 EL 2000 2000 EL  B 4204 S, B 4204 S2: Fahrgestellnummer ab: 130000 Vehicle Identification Number from: 130000 EL  →12.1999 EH  Ohne Pfandrückgabe des Altteils. Keine Rückgabe des Magnetventils nötig. Without deposit return for used part. No return of the solenoid valve.  B 4204 S, B 4204 S2: Einlasseite Intake Side</p>
<p>2.0 100-103 kW (136-140 PS) B 4204 S</p>	<p>07.1995→08.1999</p>	<p> 7.22517.04.0 7.22240.15.0 7.06269.09.0 7.06117.16.0</p>	<p>AKF EUV-SL LLR SV-NWV</p>	<p>EL Fahrgestellnummer ab: 415000 Vehicle Identification Number from: 415000 EL Fahrgestellnummer ab: 130000 Vehicle Identification Number from: 130000 EL  EH  Ohne Pfandrückgabe des Altteils. Keine Rückgabe des Magnetventils nötig. Without deposit return for used part. No return of the solenoid valve. Einlasseite Intake Side</p>
<p>2.0 118-119 kW (160-162 PS) B 4204 T</p>	<p>09.1999→12.2000</p>	<p> 7.22517.04.0 7.22240.09.0</p>	<p>AKF LDRV</p>	<p>EL Fahrgestellnummer ab: 415000 Vehicle Identification Number from: 415000 ■ Europa ■ Europe EL Fahrgestellnummer bis: CH414999 Vehicle Identification Number to: CH414999 Produktionsdatum bis: 31.12.1999 Production date to: 31.12.1999</p>
<p>V 2.0 118-184 kW (160-250 PS) B 4204 T2</p>	<p>09.1999→12.2000</p>	<p> 7.22517.04.0 7.22240.15.0 7.22240.09.0</p>	<p>AKF EUV-LS LDRV</p>	<p>EL Fahrgestellnummer ab: 415000 Vehicle Identification Number from: 415000 ■ Europa ■ Europe EL Fahrgestellnummer bis: CH414999 Vehicle Identification Number to: CH414999 Produktionsdatum bis: 31.12.1999 Production date to: 31.12.1999</p>

V40 Estate (645)						
16						
2.0 T 118-119 kW (160-162 PS) B 4204 T	10.1997→07.2000		7.22517.04.0	AKF	EL	Fahrgestellnummer ab: 415000 Vehicle Identification Number from: 415000 " Europa " Europe
			7.22517.06.0	AKF	EL	
			7.22240.09.0	LDRV	EL	Fahrgestellnummer bis: CH414999 Vehicle Identification Number to: CH414999 Produktionsdatum bis: 31.12.1999 Production date to: 31.12.1999
			7.06269.09.0	LLR	EL	
			7.06117.17.0	SV-NWV	EH	 Ohne Pfandrückgabe des Altteils. Keine Rückgabe des Magnetventils nötig. Without deposit return for used part. No return of the solenoid valve. Auslasseite Exhaust Side
2.0 T 118-184 kW (160-250 PS) B 4204 T2	07.1999→06.2004		7.22517.06.0	AKF	EL	→12.1999
			7.22240.15.0	EUV-LS	EL	
			7.22240.09.0	LDRV	EL	Fahrgestellnummer bis: CH414999 Vehicle Identification Number to: CH414999 Produktionsdatum bis: 31.12.1999 Production date to: 31.12.1999
			7.06269.09.0	LLR	EL	 →12.1999
			7.06117.17.0	SV-NWV	EH	 Ohne Pfandrückgabe des Altteils. Keine Rückgabe des Magnetventils nötig. Without deposit return for used part. No return of the solenoid valve. Auslasseite Exhaust Side
2.0 T 120-121 kW (163-165 PS) B 4204 T3	06.2001→06.2004		7.22517.04.0	AKF	EL	Fahrgestellnummer ab: 415000 Vehicle Identification Number from: 415000 " Europa " Europe
			7.22240.15.0	EUV-LS	EL	
			7.06117.17.0	SV-NWV	EH	 Ohne Pfandrückgabe des Altteils. Keine Rückgabe des Magnetventils nötig. Without deposit return for used part. No return of the solenoid valve. Auslasseite Exhaust Side
2.0 T4 147 kW (200 PS) B 4204 T5	07.2000→06.2004		7.22517.04.0	AKF	EL	Fahrgestellnummer ab: 415000 Vehicle Identification Number from: 415000 " Europa " Europe
			7.22240.15.0	EUV-LS	EL	
			7.06117.17.0	SV-NWV	EH	 Ohne Pfandrückgabe des Altteils. Keine Rückgabe des Magnetventils nötig. Without deposit return for used part. No return of the solenoid valve. Auslasseite Exhaust Side
V40 Hatchback (525, 526)						
17						
D2 84 kW (114 PS) D 4162 T	03.2012→		7.07400.04.0*	STE	EP	für Fahrzeuge mit Schaltgetriebe for vehicles with manual transmission
			↳7.01633.06.0	DW-TL	EP	

V



V40 Hatchback (525, 526) 17

			7.07400.05.0*	STE	EP	für Fahrzeuge mit Automatikgetriebe for vehicles with automatic transmission
			↳ 7.01633.06.0	DW-TL	EP	
D2 88-145 kW (120-197 PS) D 4204 T13, D 4204 T8	02.2015→08.2018		7.04664.02.0	DW-TL	EP	
			7.00515.05.0	EUV-AGR	EP	
D3 110 kW (150 PS) D 5204 T6	03.2012→03.2015		7.02325.05.0	DW-TL	EP	
			7.02613.02.0	EUV-AGR	EP	
D3 110 kW (150 PS) D 4204 T16, D 4204 T9	04.2015→		7.04664.02.0	DW-TL	EP	
			7.00515.05.0	EUV-AGR	EP	
D4 130 kW (177 PS) D 5204 T4	03.2012→		7.02325.05.0	DW-TL	EP	
			7.02613.02.0	EUV-AGR	EP	
D4 140-147 kW (190-200 PS) D 4204 T14	05.2014→		7.04664.02.0	DW-TL	EP	
			7.00515.05.0	EUV-AGR	EP	
T2 90 kW (122 PS) B 4154 T3, B 4154 T5	02.2015→08.2018		7.05367.05.0	SUV	EL	
T2 90 kW (122 PS) B 4204 T17, B 4204 T38	02.2015→		7.05367.05.0	SUV	EL	
T2 GTDi 88 kW (120 PS) B 4164 T4	03.2013→12.2015		7.07400.19.0*	EUV-VB	EP	mit Halter with holder
			↳ 7.22687.44.0	EUV-VB	EP	
			7.04492.07.0	LDRV	EP	
			7.04615.03.0	SUV	EL	
T3 112 kW (152 PS) B 4204 T33, B 4204 T37	02.2015→08.2018		7.05367.05.0	SUV	EL	
T3 112 kW (152 PS) B 4154 T2, B 4154 T4	02.2015→08.2018		7.05367.05.0	SUV	EL	
T3 90 kW (122 PS) B 4154 T6	09.2018→		7.05367.05.0	SUV	EL	
T3 GTDi 110 kW (150 PS) B 4164 T3	03.2012→		7.07400.19.0*	EUV-VB	EP	mit Halter with holder
			↳ 7.22687.44.0	EUV-VB	EP	
			7.04492.07.0	LDRV	EP	
			7.04615.03.0	SUV	EL	
T4 132 kW (180 PS) B 5204 T8	07.2013→12.2015		7.28197.16.0	LDRV	EL	
T4 132-147 kW (180-200 PS) B 4164 T	04.2014→12.2015		7.04492.07.0	LDRV	EP	
T4 140 kW (190 PS) B 4204 T19	08.2015→		7.05367.05.0	SUV	EL	
T4 GTDi 132-147 kW (180-200 PS) B 4164 T	03.2012→		7.07400.19.0*	EUV-VB	EP	mit Halter with holder
			↳ 7.22687.44.0	EUV-VB	EP	
			7.04492.07.0	LDRV	EP	
			7.04615.03.0	SUV	EL	
T5 183-187 kW (249-254 PS) B 5254 T12	12.2012→		7.28197.16.0	LDRV	EL	
T5 154-157 kW (210-214 PS) B 5204 T9	03.2013→12.2015		7.28197.16.0	LDRV	EL	
T5 183 kW (249 PS) B 5254 T14	01.2014→		7.28197.16.0	LDRV	EL	
T5 180-186 kW (245-253 PS) B 4204 T11	05.2014→		7.02325.06.0	DW-TL	EP	

V

V40 Hatchback (525, 526) 17

T5 154-157 kW (210-214 PS) B 5204 T9	01.2015→	7.28197.16.0	LDRV	EL	
T5 AWD 183-187 kW (249-254 PS) B 5254 T12	01.2013→	7.28197.16.0	LDRV	EL	
T5 AWD 154-157 kW (210-214 PS) B 5204 T9	03.2013→	7.28197.16.0	LDRV	EL	
T5 AWD 180-186 kW (245-253 PS) B 4204 T11	05.2014→	7.02325.06.0	DW-TL	EP	

V50 (545) 18

1.6 D 80-81 kW (109-110 PS) D 4164 T	01.2005→12.2011	7.00968.04.0	DW-TL	EP	
1.6 D2 84 kW (114 PS) D 4162 T	01.2010→12.2012	7.07400.04.0*	STE	EP	für Fahrzeuge mit Schaltgetriebe for vehicles with manual transmission
		↳ 7.01633.06.0	DW-TL	EP	
		7.07400.05.0*	STE	EP	für Fahrzeuge mit Automatikgetriebe for vehicles with automatic transmission
↳ 7.01633.06.0	DW-TL	EP			
1.8 92 kW (125 PS) B 4184 S11	04.2004→12.2010	7.02256.48.0	STE	EP	
1.8 FlexFuel 92 kW (125 PS) B 4184 S8	01.2005→12.2010	7.02256.48.0	STE	EP	
2.0 107 kW (146 PS) B 4204 S3	10.2006→12.2012	7.02256.48.0	STE	EP	
2.0 D 100 kW (136 PS) D 4204 T	04.2004→12.2010	7.01771.01.0	DW-AGR	EP	
		7.01771.01.0	DW-RK	EP	
		7.01771.01.0	DW-TL	EP	
2.0 FlexFuel 107 kW (146 PS) B 4204 S4	01.2010→12.2012	7.02256.48.0	STE	EP	
2.4 D5 132 kW (180 PS) D 5244 T13, D 5244 T8	03.2006→12.2010	7.00515.04.0	EUV-AGR	EP	
2.4 Tdi 120 kW (163 PS) D 5244 T9	05.2007→12.2010	7.00515.04.0	EUV-AGR	EP	
D3 110 kW (150 PS) D 5204 T5	10.2010→12.2012	7.02325.05.0	DW-TL	EP	
		7.02613.02.0	EUV-AGR	EP	
D4 130 kW (177 PS) D 5204 T	10.2010→12.2012	7.02325.05.0	DW-TL	EP	
		7.02613.02.0	EUV-AGR	EP	
T5 162 kW (220 PS) B 5254 T3	04.2004→12.2007	7.28197.16.0	LDRV	EL	
T5 169-184 kW (230-250 PS) B 5254 T7	03.2007→12.2012	7.28197.16.0	LDRV	EL	
T5 AWD 162 kW (220 PS) B 5254 T3	04.2004→12.2007	7.28197.16.0	LDRV	EL	
T5 AWD 169-184 kW (230-250 PS) B 5254 T7	03.2007→12.2010	7.28197.16.0	LDRV	EL	















V60 I (155, 157) 19

1.5 T2 90 kW (122 PS) B 4154 T5	10.2015→03.2017	7.05367.05.0	SUV	EL	
1.6 DRIVe 84 kW (114 PS) D 4162 T	02.2011→12.2015	7.07400.02.0*	STE	EP	für Fahrzeuge mit Automatikgetriebe for vehicles with automatic transmission
		↳ 7.01633.06.0	DW-TL	EP	
		7.07400.03.0*	STE	EP	für Fahrzeuge mit Schaltgetriebe for vehicles with manual transmission
↳ 7.01633.06.0	DW-TL	EP			

V



V60 I (155, 157) 19

2.0 BiFuel 154-157 kW (210-214 PS) B 5204 T9	03.2014→12.2015	 7.28197.16.0	LDRV	EL	
2.0 D2 88-145 kW (120-197 PS) D 4204 T20, D 4204 T8	03.2015→05.2018	 7.04664.02.0	DW-TL	EP	
		7.00515.05.0	EUV-AGR	EP	
2.0 D3 110 kW (150 PS) D 4204 T9	03.2015→05.2018	 7.04664.02.0	DW-TL	EP	
		7.00515.05.0	EUV-AGR	EP	
2.0 D4 140-147 kW (190-200 PS) D 4204 T14	03.2015→05.2018	 7.04664.02.0	DW-TL	EP	
		7.00515.05.0	EUV-AGR	EP	
2.0 T 149 kW (203 PS) B 4204 T6	07.2010→12.2012	 7.28197.16.0	LDRV	EL	
		7.06117.52.0	SV-NWV	EH	Einlassseite Intake Side
		7.06117.55.0	SV-NWV	EH	
2.0 T 132 kW (180 PS) B 5204 T8	01.2014→07.2018	 7.28197.16.0	LDRV	EL	
2.0 T4 140 kW (190 PS) B 4204 T19	03.2015→05.2018	 7.05367.05.0	SUV	EL	
2.4 D5 158-169 kW (215-230 PS) D 5244 T11, D 5244 T15	04.2011→12.2015	 7.02325.05.0	DW-TL	EP	
		7.02613.02.0	EUV-AGR	EP	
		7.02221.01.0	LDRV	EL	
2.4 D5 AWD 158-169 kW (215-230 PS) D 5244 T15	04.2011→12.2015	 7.02325.05.0	DW-TL	EP	
		7.02613.02.0	EUV-AGR	EP	
		7.02221.01.0	LDRV	EL	
2.4 D5 Hybrid AWD 120 kW (163 PS) D87PHEV	03.2015→05.2018	 7.02325.05.0	DW-TL	EP	
		7.02613.02.0	EUV-AGR	EP	
		7.02221.01.0	LDRV	EL	
2.4 Hybrid D6 AWD 158 kW (215 PS) D82PHEV	06.2012→12.2015	 7.02325.05.0	DW-TL	EP	
		7.02613.02.0	EUV-AGR	EP	
		7.02221.01.0	LDRV	EL	
3.0 T AWD 258 kW (351 PS) B 6304 T5	04.2014→05.2018	 7.02256.39.0	AKF	EL	
		7.06117.18.0	SV-NWV	EH	mit Dichtring with O-ring Ohne Pfandrückgabe des Altteils. Keine Rückgabe des Magnetventils nötig. Without deposit return for used part. No return of the solenoid valve.
D3 100 kW (136 PS) D 5204 T7	05.2012→12.2015	 7.02325.05.0	DW-TL	EP	
		7.02613.02.0	EUV-AGR	EP	
D3 / D4 120 kW (163 PS) D 5204 T2, D 5204 T3	07.2010→12.2014	 7.02325.05.0	DW-TL	EP	
		7.02613.02.0	EUV-AGR	EP	
D4 133 kW (181 PS) D 4204 T5	10.2013→12.2015	 7.04664.02.0	DW-TL	EP	
		7.00515.05.0	EUV-AGR	EP	
D4 AWD 120 kW (163 PS) D 5244 T17	05.2012→12.2015	 7.02325.05.0	DW-TL	EP	

V













V60 I (155, 157) **19**

			7.02613.02.0	EUV-AGR	EP	
			7.02221.01.0	LDRV	EL	
D4 AWD 133 kW (181 PS) D 5244 T12	10.2013→12.2015		7.02325.05.0	DW-TL	EP	
			7.02613.02.0	EUV-AGR	EP	
			7.02221.01.0	LDRV	EL	
D4 AWD 140-162 kW (190-220 PS) D 5244 T21	03.2015→05.2018		7.02325.05.0	DW-TL	EP	
			7.02613.02.0	EUV-AGR	EP	
			7.02221.01.0	LDRV	EL	
D4 Polestar AWD 140-162 kW (190-220 PS) D 5244 T21	03.2015→05.2018		7.02325.05.0	DW-TL	EP	
			7.02221.01.0	LDRV	EL	
D4 Polestar AWD 140-162 kW (190-220 PS) D 5244 T21	03.2015→05.2018		7.02325.05.0	DW-TL	EP	
			7.02221.01.0	LDRV	EL	
D5 151 kW (205 PS) D 5244 T10	07.2010→12.2011		7.02325.05.0	DW-TL	EP	
			7.02613.02.0	EUV-AGR	EP	
			7.02221.01.0	LDRV	EL	
D5 169 kW (230 PS) D 5244 T23	04.2014→12.2015		7.02325.05.0	DW-TL	EP	
			7.02613.02.0	EUV-AGR	EP	
			7.02221.01.0	LDRV	EL	
D5 165-171 kW (224-232 PS) D 4204 T11	03.2015→05.2018		7.04664.02.0	DW-TL	EP	
			7.00515.05.0	EUV-AGR	EP	
D5 AWD 151 kW (205 PS) D 5244 T10	07.2010→12.2011		7.02325.05.0	DW-TL	EP	
			7.02613.02.0	EUV-AGR	EP	
			7.02221.01.0	LDRV	EL	
D5 AWD 158-169 kW (215-230 PS) D 5244 T15	04.2014→12.2015		7.02325.05.0	DW-TL	EP	
			7.02221.01.0	LDRV	EL	
D6 Hybrid AWD 162 kW (220 PS) D97PHEV	03.2015→05.2018		7.02325.05.0	DW-TL	EP	
			7.02613.02.0	EUV-AGR	EP	
			7.02221.01.0	LDRV	EL	
T3 110 kW (150 PS) B 4164 T3	09.2010→12.2015		7.07400.19.0*	EUV-VB	EP	mit Halter with holder Fahrgestellnummer bis: 72374 Vehicle Identification Number to: 72374
			↳ 7.22687.44.0	EUV-VB	EP	
			7.03162.09.0	LDRV	EP	Fahrgestellnummer bis: 72374 Vehicle Identification Number to: 72374
			7.04492.07.0	LDRV	EP	Fahrgestellnummer ab: 72375 Vehicle Identification Number from: 72375
			7.04615.03.0	SUV	EL	ch. 72375→
T3 112 kW (152 PS) B 4204 T37	03.2015→05.2018		7.05367.05.0	SUV	EL	
T3 112 kW (152 PS) B 4154 T4	03.2015→05.2018		7.05367.05.0	SUV	EL	
T4 132-147 kW (180-200 PS) B 4164 T	09.2010→12.2015		7.07400.19.0*	EUV-VB	EP	mit Halter with holder Fahrgestellnummer bis: 72374 Vehicle Identification Number to: 72374



V



V60 I (155, 157) 19

			↳ 7.22687.44.0 7.03162.09.0 7.04492.07.0 7.04615.03.0	EUV-VB LDRV LDRV SUV	EP EP EP EL	Fahrgestellnummer bis: 72374 Vehicle Identification Number to: 72374 Fahrgestellnummer ab: 72375 Vehicle Identification Number from: 72375  ch. 72375→
T4F 132 kW (180 PS) B 4164 T2	04.2011→12.2015		7.07400.19.0* ↳ 7.22687.44.0 7.03162.09.0 7.04492.07.0 7.04615.03.0	EUV-VB LDRV LDRV SUV	EP EP EP EL	mit Halter with holder Fahrgestellnummer bis: 72374 Vehicle Identification Number to: 72374 Fahrgestellnummer bis: 72374 Vehicle Identification Number to: 72374 Fahrgestellnummer ab: 72375 Vehicle Identification Number from: 72375  ch. 72375→
T5 176-180 kW (239-245 PS) B 4204 T7	09.2010→12.2014		7.28197.16.0 7.06117.52.0 7.06117.53.0 7.06117.55.0	LDRV SV-NWV SV-NWV SV-NWV	EL EH EH EH	2012 2012 Einlassseite Intake Side 2011 2011
T5 176-180 kW (239-245 PS) B 4204 T7	08.2012→07.2014		7.28197.16.0	LDRV	EL	
T5 180-186 kW (245-253 PS) B 4204 T11	10.2013→12.2018		7.02325.06.0	DW-TL	EP	
T5 AWD 183 kW (249 PS) B 5254 T14	03.2015→05.2018		7.28197.16.0	LDRV	EL	
T5 AWD 183-187 kW (249-254 PS) B 5254 T12	04.2015→05.2018		7.28197.16.0	LDRV	EL	
T6 225 kW (306 PS) B 4204 T9	10.2013→12.2018		7.02325.06.0 7.05367.05.0	DW-TL SUV	EP EL	
T6 AWD 224-242 kW (304-329 PS) B 6304 T4	07.2010→12.2015		7.02256.39.0 7.06117.18.0	AKF SV-NWV	EL EH	mit Dichtring with O-ring Ohne Pfandrückgabe des Altteils. Keine Rückgabe des Magnetventils nötig. Without deposit return for used part. No return of the solenoid valve.
T6 AWD 225 kW (306 PS) B 4204 T9	10.2013→12.2018		7.05367.05.0	SUV	EL	
T6 AWD 224-242 kW (304-329 PS) B 6304 T3, B 6304 T4	04.2014→12.2015		7.02256.39.0 7.06117.18.0	AKF SV-NWV	EL EH	mit Dichtring with O-ring Ohne Pfandrückgabe des Altteils. Keine Rückgabe des Magnetventils nötig. Without deposit return for used part. No return of the solenoid valve.

V60 II (225, 227) 20

2.0 T6 Drive-E Polestar AWD 228-240 kW (310-326 PS) B 4204 T29	02.2018→		7.05367.05.0	SUV	EL	
D3 AWD 110 kW (150 PS) D 4204 T4	09.2018→		7.04664.02.0	DW-TL	EP	

V60 II (225, 227) 20

		7.00515.05.0	EUV-AGR	EP	
D4 140-147 kW (190-200 PS) D 4204 T14	02.2018→	 7.04664.02.0	DW-TL	EP	
		7.00515.05.0	EUV-AGR	EP	
D4 AWD 140-147 kW (190-200 PS) D 4204 T14	09.2018→	 7.04664.02.0	DW-TL	EP	
		7.00515.05.0	EUV-AGR	EP	
D4 Polestar 140-147 kW (190-200 PS) D 4204 T14	02.2018→	 7.04664.02.0	DW-TL	EP	
		7.00515.05.0	EUV-AGR	EP	
D4 Polestar AWD 140-147 kW (190-200 PS) D 4204 T14	02.2018→12.2020	 7.04664.02.0	DW-TL	EP	
		7.00515.05.0	EUV-AGR	EP	
T6 AWD 228-240 kW (310-326 PS) B 4204 T29	02.2018→	 7.05367.05.0	SUV	EL	
T6 Plug-in Hybrid AWD 186 kW (253 PS) B 4204 T46	03.2019→	 7.05367.05.0	SUV	EL	
T8 Plug-in Hybrid AWD 223-287 kW (303-390 PS) B 4204 T34	02.2018→	 7.05367.05.0	SUV	EL	
T8 Plug-in Hybrid Polestar AWD 233-245 kW (317-333 PS) B 4204 T48	05.2019→	 7.05367.05.0	SUV	EL	
T8 Plug-in Hybrid Polestar AWD 223-246 kW (303-334 PS) B 4204 T35	05.2019→	 7.05367.05.0	SUV	EL	





V70 I (875, 876) 21

2.0 132 kW (180 PS) B 5204 T2	01.1997→03.2000	 7.22517.04.0	AKF	EL	 Europa Europe 2000 2000 2001 2001
		7.22240.09.0	LDRV	EL	Produktionsdatum bis: 31.12.1999 Production date to: 31.12.1999
2.0 120 kW (163 PS) B 5204 T4	01.1997→12.2000	 7.22517.04.0	AKF	EL	 Europa Europe 2000 2000 2001 2001
		7.22240.09.0	LDRV	EL	Produktionsdatum bis: 31.12.1999 Production date to: 31.12.1999
2.0 Turbo 166 kW (226 PS) B 5204 T3	01.1997→12.2000	 7.22517.04.0	AKF	EL	 Europa Europe 2000 2000 2001 2001
		7.22240.09.0	LDRV	EL	Produktionsdatum bis: 31.12.1999 Production date to: 31.12.1999
2.0 Turbo AWD 166 kW (226 PS) B 5204 T3	01.1997→12.2000	 7.22517.04.0	AKF	EL	 Europa Europe 2000 2000 2001 2001
		7.22240.09.0	LDRV	EL	Produktionsdatum bis: 31.12.1999 Production date to: 31.12.1999

V



V70 I (875, 876) 21

<p>2.3 147-184 kW (239-250 PS) B 5234 T3</p>	<p>11.1996→11.2000</p>	<p> PIERBURG</p> <p> 7.22517.04.0</p> <p>7.22240.09.0</p>	<p>AKF</p> <p>LDRV</p>	<p>EL  Europa  Europe 2000 2000 2001 2001</p> <p>EL Produktionsdatum bis: 31.12.1999 Production date to: 31.12.1999</p>
<p>2.3 AWD 147-184 kW (239-250 PS) B 5234 T3</p>	<p>04.1997→09.1998</p>	<p> 7.22517.04.0</p> <p>7.22240.09.0</p>	<p>AKF</p> <p>LDRV</p>	<p>EL  Europa  Europe 2000 2000 2001 2001</p> <p>EL Produktionsdatum bis: 31.12.1999 Production date to: 31.12.1999</p>
<p>2.3 AWD 195 kW (265 PS) B 5234 T7</p>	<p>12.1998→02.2000</p>	<p> 7.22517.04.0</p> <p>7.22240.09.0</p>	<p>AKF</p> <p>LDRV</p>	<p>EL  Europa  Europe 2000 2000 2001 2001</p> <p>EL Produktionsdatum bis: 31.12.1999 Production date to: 31.12.1999</p>
<p>2.3 AWD 195 kW (265 PS) B 5234 T8</p>	<p>12.1998→02.2000</p>	<p> 7.22240.09.0</p>	<p>LDRV</p>	<p>EL Produktionsdatum bis: 31.12.1999 Production date to: 31.12.1999</p>
<p>2.3 T AWD 176-184 kW (239-250 PS) B 5234 T4</p>	<p>04.1997→03.2000</p>	<p> 7.22517.04.0</p> <p>7.22240.09.0</p>	<p>AKF</p> <p>LDRV</p>	<p>EL  Europa  Europe 2000 2000 2001 2001</p> <p>EL Produktionsdatum bis: 31.12.1999 Production date to: 31.12.1999</p>
<p>2.3 T-5 147-184 kW (239-250 PS) B 5234 T3</p>	<p>11.1996→12.2000</p>	<p> 7.28194.01.0</p> <p>7.22517.04.0</p> <p>7.22240.09.0</p>	<p>AKF</p> <p>AKF</p> <p>LDRV</p>	<p>EL 01.1999→</p> <p>EL  Europa  Europe 2000 2000 2001 2001</p> <p>EL Produktionsdatum bis: 31.12.1999 Production date to: 31.12.1999</p>
<p>2.3 T-5 AWD 147-184 kW (239-250 PS) B 5234 T3</p>	<p>01.1997→12.2000</p>	<p> 7.28194.01.0</p> <p>7.22517.04.0</p> <p>7.22240.09.0</p>	<p>AKF</p> <p>AKF</p> <p>LDRV</p>	<p>EL 01.1999→</p> <p>EL  Europa  Europe 2000 2000 2001 2001</p> <p>EL Produktionsdatum bis: 31.12.1999 Production date to: 31.12.1999</p>
<p>2.3 Turbo 176-184 kW (239-250 PS) B 5234 T4</p>	<p>12.1995→03.2000</p>	<p> 7.22517.04.0</p> <p>7.22240.09.0</p>	<p>AKF</p> <p>LDRV</p>	<p>EL  Europa  Europe 2000 2000 2001 2001</p> <p>EL Produktionsdatum bis: 31.12.1999 Production date to: 31.12.1999</p>
<p>2.4 125 kW (170 PS) B 5244 S</p>	<p>12.1995→05.2000</p>	<p> 7.22517.06.0</p>	<p>AKF</p>	<p>EL →12.1999</p>















V

V70 I (875, 876)
21



















			7.22517.04.0	AKF	EL	 Europa  Europe 2000 2000 2001 2001
			7.28194.01.0	AKF	EL	
2.4 121-125 kW (165-170 PS) B 5254 FS, B 5254 S	12.1995→05.2000		7.22517.04.0	AKF	EL	 B 5254 FS, B 5254 S:  Europa  Europe 2000 2000 2001 2001
2.4 121-125 kW (165-170 PS) B 5254 S	06.1998→12.1999		7.22517.06.0	AKF	EL	01.1999→
			7.28194.01.0	AKF	EL	
2.4 103 kW (140 PS) B 5244 S2	03.1999→12.2000		7.22517.04.0	AKF	EL	 Europa  Europe 2000 2000 2001 2001
2.4 Turbo 142 kW (193 PS) B 5244 T	04.1996→12.2000		7.28194.01.0	AKF	EL	01.1999→
			7.22517.04.0	AKF	EL	 Europa  Europe 1999 1999
			7.22240.09.0	LDRV	EL	Produktionsdatum bis: 31.12.1999 Production date to: 31.12.1999
2.4 Turbo 142 kW (193 PS) B 5254 T	01.1997→12.2000		7.22517.04.0	AKF	EL	 Europa  Europe 1999 1999
			7.22240.09.0	LDRV	EL	Produktionsdatum bis: 31.12.1999 Production date to: 31.12.1999
2.4 Turbo AWD 142 kW (193 PS) B 5244 T	04.1996→12.2000		7.28194.01.0	AKF	EL	01.1999→
			7.22517.04.0	AKF	EL	 Europa  Europe 1999 1999
			7.22240.09.0	LDRV	EL	Produktionsdatum bis: 31.12.1999 Production date to: 31.12.1999
2.4 Turbo AWD 142 kW (193 PS) B 5254 T	01.1997→12.2000		7.22517.04.0	AKF	EL	 Europa  Europe 1999 1999
			7.22240.09.0	LDRV	EL	Produktionsdatum bis: 31.12.1999 Production date to: 31.12.1999
2.4 Turbo AWD 195 kW (265 PS) B 5244 T2	03.1999→12.2000		7.22517.04.0	AKF	EL	 Europa  Europe 1999 1999
			7.28194.01.0	AKF	EL	
			7.22240.09.0	LDRV	EL	Produktionsdatum bis: 31.12.1999 Production date to: 31.12.1999
2.5 TDI 103 kW (140 PS) D 5252 T	01.1997→12.2000		7.22240.15.0	EUV-LS	EL	
2.5 TDi AWD 103 kW (140 PS) D 5252 T	11.1996→02.2000		7.22240.15.0	EUV-LS	EL	

V

V70 II (285) **22**

2.0 T 132 kW (180 PS) B 5204 T5	11.1999→08.2007		7.22517.04.0	AKF	EL	Fahrgestellnummer bis: 170999 Vehicle Identification Number to: 170999
			7.22240.13.0	LDRV	EL	Fahrgestellnummer ab: 171000 Vehicle Identification Number from: 171000
2.3 195 kW (265 PS) B 5234 T7	10.2000→09.2004		7.22510.03.0	AKF	EL	01.2002→
			7.22240.13.0	LDRV	EL	Fahrgestellnummer ab: 171000 Vehicle Identification Number from: 171000
2.3 147-184 kW (239-250 PS) B 5234 T3	03.2002→12.2004		7.22517.04.0	AKF	EL	Fahrgestellnummer bis: 170999 Vehicle Identification Number to: 170999
			7.22240.13.0	LDRV	EL	Fahrgestellnummer ab: 171000 Vehicle Identification Number from: 171000
2.3 AWD 195 kW (265 PS) B 5234 T7	10.2000→09.2004		7.28194.01.0	AKF	EL	
			7.22517.04.0	AKF	EL	Fahrgestellnummer bis: 170999 Vehicle Identification Number to: 170999
2.3 AWD 195 kW (265 PS) B 5234 T8	10.2000→09.2004		7.28194.01.0	AKF	EL	
			7.22510.03.0	AKF	EL	01.2002→
2.3 T5 147-184 kW (239-250 PS) B 5234 T3	11.1999→12.2004		7.28194.01.0	AKF	EL	
			7.22510.03.0	AKF	EL	01.2002→
			7.22517.04.0	AKF	EL	Fahrgestellnummer bis: 170999 Vehicle Identification Number to: 170999
			7.22240.13.0	LDRV	EL	Fahrgestellnummer ab: 171000 Vehicle Identification Number from: 171000
2.4 103 kW (140 PS) B 5244 S2	03.2000→08.2007		7.22510.03.0	AKF	EL	
			7.22517.04.0	AKF	EL	Fahrgestellnummer bis: 170999 Vehicle Identification Number to: 170999
2.4 125 kW (170 PS) B 5244 S	03.2000→08.2007		7.28194.01.0	AKF	EL	→12.2000
			7.22510.03.0	AKF	EL	
			7.22517.04.0	AKF	EL	Fahrgestellnummer bis: 170999 Vehicle Identification Number to: 170999
2.4 AWD 121-125 kW (165-170 PS) B 5254 S	03.2000→09.2003		7.22510.03.0	AKF	EL	
2.4 Bifuel (CNG) 103 kW (140 PS) B 5244 SG	09.2001→08.2007		7.22510.03.0	AKF	EL	
			7.22517.04.0	AKF	EL	Fahrgestellnummer bis: 170999 Vehicle Identification Number to: 170999
2.4 Bifuel (LPG) 103 kW (140 PS) B 5244 SG2	09.2001→08.2007		7.22510.03.0	AKF	EL	
			7.22517.04.0	AKF	EL	Fahrgestellnummer bis: 170999 Vehicle Identification Number to: 170999
2.4 CDI 90 kW (122 PS) D 5244 T6	07.2005→12.2008		7.00515.04.0	EUV-AGR	EP	
			7.22240.15.0	EUV-LS	EL	
2.4 D 96-120 kW (131-163 PS) D 5244 T2	07.2001→08.2007		7.21903.63.0	DW-TL	EP	
			7.22240.15.0	EUV-LS	EL	
2.4 D 93 kW (126 PS) D 5244 T7	04.2005→12.2008		7.00515.04.0	EUV-AGR	EP	
			7.22240.15.0	EUV-LS	EL	
			7.22240.13.0	LDRV	EL	Fahrgestellnummer ab: 171000 Vehicle Identification Number from: 171000

V

					
V70 II (285)					
2.4 D5 96-120 kW (131-163 PS) D 5244 T2, D 5244 T5	01.2001→12.2008		7.22240.15.0	EUV-LS	EL
2.4 D5 120 kW (163 PS) D 5244 T	01.2001→12.2008		7.21903.63.0	DW-TL	EP
			7.22240.15.0	EUV-LS	EL
2.4 D5 136 kW (185 PS) D 5244 T4	04.2005→12.2008		7.00515.04.0	EUV-AGR	EP
			7.22240.15.0	EUV-LS	EL
			7.22240.13.0	LDRV	EL
					Fahrgestellnummer ab: 171000 Vehicle Identification Number from: 171000
2.4 D5 AWD 96-120 kW (131-163 PS) D 5244 T, D 5244 T2	07.2002→08.2007		7.21903.63.0	DW-TL	EP
			7.22240.15.0	EUV-LS	EL
2.4 D5 AWD 120 kW (163 PS) D 5244 T5	07.2002→08.2007		7.00515.04.0	EUV-AGR	EP
			7.22240.15.0	EUV-LS	EL
2.4 D5 AWD 136 kW (185 PS) D 5244 T4	05.2005→08.2007		7.00515.04.0	EUV-AGR	EP
			7.22240.15.0	EUV-LS	EL
			7.22240.13.0	LDRV	EL
					Fahrgestellnummer ab: 171000 Vehicle Identification Number from: 171000
2.4 T 147 kW (200 PS) B 5244 T3	11.1999→08.2003		7.22510.03.0	AKF	EL
			7.22517.04.0	AKF	EL
			7.22240.13.0	LDRV	EL
					Fahrgestellnummer bis: 170999 Vehicle Identification Number to: 170999 Fahrgestellnummer ab: 171000 Vehicle Identification Number from: 171000
2.4 T AWD 147 kW (200 PS) B 5244 T3	09.2001→08.2002		7.22510.03.0	AKF	EL
			7.22517.04.0	AKF	EL
			7.22240.13.0	LDRV	EL
					Fahrgestellnummer bis: 170999 Vehicle Identification Number to: 170999 Fahrgestellnummer ab: 171000 Vehicle Identification Number from: 171000
2.4 T5 191 kW (260 PS) B 5244 T5	04.2004→08.2007		7.22517.04.0	AKF	EL
					Fahrgestellnummer bis: 170999 Vehicle Identification Number to: 170999
2.5 153-162 kW (209-220 PS) B 5254 T2	09.2003→08.2007		7.22240.13.0	LDRV	EL
					Fahrgestellnummer ab: 171000 Vehicle Identification Number from: 171000
2.5 AWD 153-162 kW (209-220 PS) B 5254 T2	09.2002→12.2004		7.22517.04.0	AKF	EL
			7.22240.13.0	LDRV	EL
					Fahrgestellnummer bis: 170999 Vehicle Identification Number to: 170999 Fahrgestellnummer ab: 171000 Vehicle Identification Number from: 171000
2.5 T 153-162 kW (209-220 PS) B 5254 T2	07.2001→08.2007		7.22510.03.0	AKF	EL
			7.22517.04.0	AKF	EL
			7.22240.13.0	LDRV	EL
					Fahrgestellnummer bis: 170999 Vehicle Identification Number to: 170999 Fahrgestellnummer ab: 171000 Vehicle Identification Number from: 171000
2.5 T AWD 153-162 kW (209-220 PS) B 5254 T2	07.2002→08.2007		7.22510.03.0	AKF	EL
			7.22517.04.0	AKF	EL
					Fahrgestellnummer bis: 170999 Vehicle Identification Number to: 170999

















V













V70 II (285) **22**

			7.22240.13.0	LDRV	EL	Fahrgestellnummer ab: 171000 Vehicle Identification Number from: 171000
2.5 TDI 103 kW (140 PS) D 5252 T	03.2000→08.2007		7.22240.15.0	EUV-LS	EL	
R 2,5 T AWD 220-224 kW (299-305 PS) B 5254 T4	03.2003→08.2007		7.22510.03.0	AKF	EL	
			7.22517.04.0	AKF	EL	Fahrgestellnummer bis: 170999 Vehicle Identification Number to: 170999
			7.28197.16.0	LDRV	EL	

V70 III (135) **23**

1.6 D 80-81 kW (109-110 PS) D 4164 T	07.2009→12.2011		7.00968.04.0	DW-TL	EP	
1.6 DRIVe / D2 84 kW (114 PS) D 4162 T	04.2011→12.2015		7.07400.02.0*	STE	EP	für Fahrzeuge mit Automatikgetriebe for vehicles with automatic transmission
			↳ 7.01633.06.0	DW-TL	EP	
			7.07400.03.0*	STE	EP	für Fahrzeuge mit Schaltgetriebe for vehicles with manual transmission
1.6 T4F 132 kW (180 PS) B 4164 T2	01.2011→12.2015		7.07400.19.0*	EUV-VB	EP	mit Halter with holder Fahrgestellnummer bis: 238745 Vehicle Identification Number to: 238745
			↳ 7.22687.44.0	EUV-VB	EP	
			7.03162.09.0	LDRV	EP	Fahrgestellnummer bis: 238745 Vehicle Identification Number to: 238745
			7.04492.07.0	LDRV	EP	Fahrgestellnummer ab: 238746 Vehicle Identification Number from: 238746
7.04615.03.0	SUV	EL	 ch. 238746→			
2.0 107 kW (146 PS) B 4204 S3	10.2007→12.2011		7.02256.48.0	STE	EP	
2.0 BiFuel 154-157 kW (210-214 PS) B 5204 T9	03.2013→12.2015		7.28197.16.0	LDRV	EL	
2.0 D 100 kW (136 PS) D 4204 T	10.2007→12.2015		7.01771.01.0	DW-RK	EP	
			7.01771.01.0	DW-TL	EP	
2.0 FlexiFuel 107 kW (146 PS) B 4204 S4	01.2008→12.2011		7.02256.48.0	STE	EP	
2.0 GDI 154-157 kW (210-214 PS) B 5204 T9	04.2012→12.2015		7.28197.16.0	LDRV	EL	
2.0 T 149 kW (203 PS) B 4204 T6	09.2009→12.2011		7.28197.16.0	LDRV	EL	
			7.06117.52.0	SV-NWV	EH	
			7.06117.55.0	SV-NWV	EH	Einlassseite Intake Side
2.4 D 120 kW (163 PS) D 5244 T5	04.2007→07.2009		7.00515.04.0	EUV-AGR	EP	
2.4 D 129 kW (175 PS) D 5244 T14	04.2009→12.2010		7.02613.02.0	EUV-AGR	EP	
2.4 D 120 kW (163 PS) D 5244 T19	08.2009→12.2010		7.02613.02.0	EUV-AGR	EP	
2.5 T 147 kW (200 PS) B 5254 T6	08.2007→12.2009		7.28197.16.0	LDRV	EL	
2.5 T 170 kW (231 PS) B 5254 T10	04.2009→12.2012		7.28197.16.0	LDRV	EL	
2.5 T FlexiFuel 147 kW (200 PS) B 5254 T8	05.2008→12.2009		7.28197.16.0	LDRV	EL	













V

					
V70 III (135)					
23					
2.5 T FlexiFuel 170 kW (231 PS) B 5254 T11	04.2009→12.2011		7.28197.16.0	LDRV	EL
3.2 168-177 kW (228-238 PS) B 6324 S	08.2007→12.2010		7.02256.39.0	AKF	EL
			7.06117.18.0	SV-NWV	EH
3.2 179 kW (243 PS) B 6324 S5	04.2010→12.2014		7.02256.39.0	AKF	EL
			7.06117.18.0	SV-NWV	EH
3.2 AWD 168-177 kW (228-238 PS) B 6324 S	04.2007→12.2010		7.02256.39.0	AKF	EL
			7.06117.18.0	SV-NWV	EH
3.2 AWD 179 kW (243 PS) B 6324 S5	04.2010→12.2015		7.02256.39.0	AKF	EL
			7.06117.18.0	SV-NWV	EH
D2 88 kW (120 PS) D 4204 T20	03.2015→04.2016		7.04664.02.0	DW-TL	EP
			7.00515.05.0	EUV-AGR	EP
D3 100 kW (136 PS) D 5204 T7	10.2007→12.2015		7.02325.05.0	DW-TL	EP
			7.02613.02.0	EUV-AGR	EP
D3 110 kW (150 PS) D 4204 T9	03.2015→04.2016		7.04664.02.0	DW-TL	EP
			7.00515.05.0	EUV-AGR	EP
D3 / D4 120 kW (163 PS) D 5204 T2, D 5204 T3	03.2010→12.2015		7.02325.05.0	DW-TL	EP
			7.02613.02.0	EUV-AGR	EP
D4 133 kW (181 PS) D 4204 T5	10.2013→04.2016		7.04664.02.0	DW-TL	EP
			7.00515.05.0	EUV-AGR	EP
D4 AWD 120 kW (163 PS) D 5244 T17	10.2007→12.2015		7.02325.05.0	DW-TL	EP
			7.02613.02.0	EUV-AGR	EP
			7.02221.01.0	LDRV	EL
D4 AWD 133 kW (181 PS) D 5244 T12	10.2013→04.2016		7.02325.05.0	DW-TL	EP
			7.02613.02.0	EUV-AGR	EP
			7.02221.01.0	LDRV	EL
D5 136 kW (185 PS) D 5244 T4	04.2007→12.2009		7.00515.04.0	EUV-AGR	EP
			7.22240.15.0	EUV-LS	EL























V



V70 III (135) **23**

D5 151 kW (205 PS) D 5244 T10	10.2008→12.2011	 7.02325.05.0	DW-TL	EP	 ch. 167001→
		7.02325.04.0	DW-TL	EP	Fahrgestellnummer bis: 167000 Vehicle Identification Number to: 167000
		7.02613.02.0	EUV-AGR	EP	
		7.02221.01.0	LDRV	EL	
D5 158-169 kW (215-230 PS) D 5244 T11, D 5244 T15	04.2011→12.2015	 7.02325.05.0	DW-TL	EP	
		7.02613.02.0	EUV-AGR	EP	
		7.02221.01.0	LDRV	EL	
D5 AWD 136 kW (185 PS) D 5244 T4	04.2007→12.2009	 7.00515.04.0	EUV-AGR	EP	
		7.22240.15.0	EUV-LS	EL	
D5 AWD 151 kW (205 PS) D 5244 T10	12.2009→12.2011	 7.02325.05.0	DW-TL	EP	 ch. 167001→
		7.02325.04.0	DW-TL	EP	Fahrgestellnummer bis: 167000 Vehicle Identification Number to: 167000
		7.02613.02.0	EUV-AGR	EP	
		7.02221.01.0	LDRV	EL	
D5 AWD 158-169 kW (215-230 PS) D 5244 T15	04.2011→12.2015	 7.02325.05.0	DW-TL	EP	
		7.02613.02.0	EUV-AGR	EP	
		7.02221.01.0	LDRV	EL	
T4 132-147 kW (180-200 PS) B 4164 T	10.2010→12.2015	 7.07400.19.0*	EUV-VB	EP	mit Halter with holder Fahrgestellnummer bis: 238745 Vehicle Identification Number to: 238745
		↳ 7.22687.44.0	EUV-VB	EP	
		7.03162.09.0	LDRV	EP	Fahrgestellnummer bis: 238745 Vehicle Identification Number to: 238745
		7.04492.07.0	LDRV	EP	Fahrgestellnummer ab: 238746 Vehicle Identification Number from: 238746
		7.04615.03.0	SUV	EL	 ch. 238746→
T4 140 kW (190 PS) B 4204 T19	03.2015→04.2016	 7.05367.05.0	SUV	EL	
T5 176-180 kW (239-245 PS) B 4204 T7	01.2010→12.2014	 7.28197.16.0	LDRV	EL	
		7.06117.52.0	SV-NWV	EH	2012
		7.06117.53.0	SV-NWV	EH	2012
		7.06117.55.0	SV-NWV	EH	Einlassseite Intake Side 2011 2011
T5 180-186 kW (245-253 PS) B 4204 T11	10.2013→04.2016	 7.02325.06.0	DW-TL	EP	
T6 AWD 210 kW (286 PS) B 6304 T2	08.2007→12.2010	 7.02256.39.0	AKF	EL	
		7.06117.18.0	SV-NWV	EH	mit Dichtring with O-ring Ohne Pfandrückgabe des Altteils. Keine Rückgabe des Magnetventils nötig. Without deposit return for used part. No return of the solenoid valve.







V

						
V70 III (135)						23
T6 AWD 224-242 kW (304-329 PS) B 6304 T4	01.2010→12.2015		7.02256.39.0	AKF	EL	mit Dichtring with O-ring Ohne Pfandrückgabe des Altteils. Keine Rückgabe des Magnetventils nötig. Without deposit return for used part. No return of the solenoid valve.
			7.06117.18.0	SV-NWV	EH	
V90 I Estate (965)						24
2.5 125 kW (170 PS) B 6254 FS	11.1996→10.1998		7.22240.15.0	EUV-SL	EL	1998 1998
2.9 132-150 kW (180-204 PS) B 6304 FS, B 6304 GS	01.1997→12.1998		7.22240.15.0	EUV-SL	EL	 B 6304 FS, B 6304 GS: 1998 1998
V90 II Estate (235, 236)						25
2.0 D3 110 kW (150 PS) D 4204 T16, D 4204 T9	03.2016→08.2018		7.04664.02.0	DW-TL	EP	
			7.00515.05.0	EUV-AGR	EP	
2.0 D3 AWD 110 kW (150 PS) D 4204 T4	03.2016→		7.04664.02.0	DW-TL	EP	
			7.00515.05.0	EUV-AGR	EP	
2.0 D4 140-147 kW (190-200 PS) D 4204 T14	03.2016→		7.04664.02.0	DW-TL	EP	
			7.00515.05.0	EUV-AGR	EP	
2.0 D4 120 kW (163 PS) D 4204 T7	09.2018→		7.04664.02.0	DW-TL	EP	
			7.00515.05.0	EUV-AGR	EP	
2.0 D4 AWD 140-147 kW (190-200 PS) D 4204 T14	03.2016→		7.04664.02.0	DW-TL	EP	
			7.00515.05.0	EUV-AGR	EP	
2.0 D4 AWD 120 kW (163 PS) D 4204 T7	09.2018→		7.04664.02.0	DW-TL	EP	
			7.00515.05.0	EUV-AGR	EP	
2.0 D5 AWD 173-177 kW (235-241 PS) D 4204 T23	03.2016→		7.04664.02.0	DW-TL	EP	
			7.00515.05.0	EUV-AGR	EP	
2.0 Hybrid AWD 223-246 kW (303-334 PS) B 4204 T35	03.2016→12.2018		7.05367.05.0	SUV	EL	
2.0 Polestar AWD 140-147 kW (190-200 PS) D 4204 T14	10.2016→		7.04664.02.0	DW-TL	EP	
			7.00515.05.0	EUV-AGR	EP	
2.0 Polestar AWD 173-177 kW (235-241 PS) D 4204 T23	10.2016→		7.04664.02.0	DW-TL	EP	
			7.00515.05.0	EUV-AGR	EP	
2.0 T6 AWD 235-246 kW (320-334 PS) B 4204 T27	03.2016→		7.05367.05.0	SUV	EL	
2.0 T6 AWD 228-240 kW (310-326 PS) B 4204 T29	10.2017→		7.05367.05.0	SUV	EL	
2.0 T6 Plug-in-Hybrid AWD 186 kW (253 PS) B 4204 T46	06.2020→		7.05367.05.0	SUV	EL	





V









V90 II Estate (235, 236) 25

2.0 T6 Polestar AWD 235-246 kW (320-334 PS) B 4204 T27	10.2016→12.2017		7.05367.05.0	SUV	EL	
2.0 T6 Polestar AWD 228-240 kW (310-326 PS) B 4204 T29	10.2017→		7.05367.05.0	SUV	EL	
2.0 T8 Hybrid AWD 223-287 kW (303-390 PS) B 4204 T34	04.2018→		7.05367.05.0	SUV	EL	
2.0 T8 Plug-in Hybrid Polestar AWD 223-287 kW (303-390 PS) B 4204 T34	05.2018→		7.05367.05.0	SUV	EL	
2.0 T8 Plug-in-Hybrid AWD 223-287 kW (303-390 PS) B 4204 T34	06.2020→		7.05367.05.0	SUV	EL	
T8 Plug-in Hybrid Polestar AWD 223-246 kW (303-334 PS) B 4204 T35	03.2016→		7.05367.05.0	SUV	EL	

XC40 (536) 26















2.0 D3 110 kW (150 PS) D 4204 T16	09.2018→		7.04664.02.0	DW-TL	EP	
			7.00515.05.0	EUV-AGR	EP	
2.0 D3 AWD 110 kW (150 PS) D 4204 T16	09.2018→		7.04664.02.0	DW-TL	EP	
			7.00515.05.0	EUV-AGR	EP	
2.0 D4 AWD 140-147 kW (190-200 PS) D 4204 T12	10.2017→		7.04664.02.0	DW-TL	EP	
			7.00515.05.0	EUV-AGR	EP	
D4 Polestar AWD 140-147 kW (190-200 PS) D 4204 T12	01.2019→		7.04664.02.0	DW-TL	EP	
			7.00515.05.0	EUV-AGR	EP	

XC60 I SUV (156) 27

2.0 T 149 kW (203 PS) B 4204 T6	12.2009→12.2012		7.28197.16.0	LDRV	EL	Einlassseite Intake Side
			7.06117.52.0	SV-NWV	EH	
			7.06117.55.0	SV-NWV	EH	
2.4 D 129 kW (175 PS) D 5244 T14	04.2009→12.2010		7.02613.02.0	EUV-AGR	EP	
2.4 D / D3 / D4 AWD 120 kW (163 PS) D 5244 T16	05.2008→02.2017		7.02325.05.0	DW-TL	EP	 ch. 126192→
			7.02325.04.0	DW-TL	EP	Fahrgestellnummer bis: 126191 Vehicle Identification Number to: 126191
			7.02613.02.0	EUV-AGR	EP	
			7.02221.01.0	LDRV	EL	
2.4 D / D3 / D4 AWD 120 kW (163 PS) D 5244 T17	05.2008→02.2017		7.02325.05.0	DW-TL	EP	
			7.02613.02.0	EUV-AGR	EP	
			7.02221.01.0	LDRV	EL	
2.4 D / D3 / D4 AWD 120 kW (163 PS) D 5244 T5	05.2008→02.2017		7.00515.04.0	EUV-AGR	EP	
			7.02256.39.0	AKF	EL	

V











XC60 I SUV (156)
27

			7.06117.18.0	SV-NWV	EH	mit Dichtring with O-ring Ohne Pfandrückgabe des Altteils. Keine Rückgabe des Magnetventils nötig. Without deposit return for used part. No return of the solenoid valve.
3.2 AWD 179 kW (243 PS) B 6324 S5	03.2010→12.2015		7.02256.39.0	AKF	EL	
			7.06117.18.0	SV-NWV	EH	mit Dichtring with O-ring Ohne Pfandrückgabe des Altteils. Keine Rückgabe des Magnetventils nötig. Without deposit return for used part. No return of the solenoid valve.
D3 100 kW (136 PS) D 5204 T7	04.2012→12.2015		7.02325.05.0	DW-TL	EP	
			7.02613.02.0	EUV-AGR	EP	
D3 110 kW (150 PS) D 4204 T4	03.2015→04.2017		7.04664.02.0	DW-TL	EP	
			7.00515.05.0	EUV-AGR	EP	
D3 / D4 120 kW (163 PS) D 5204 T2, D 5204 T3	03.2010→12.2014		7.02325.05.0	DW-TL	EP	
			7.02613.02.0	EUV-AGR	EP	
D4 133 kW (181 PS) D 4204 T5	10.2013→12.2015		7.04664.02.0	DW-TL	EP	
			7.00515.05.0	EUV-AGR	EP	
D4 140-147 kW (190-200 PS) D 4204 T14	03.2015→02.2017		7.04664.02.0	DW-TL	EP	
			7.00515.05.0	EUV-AGR	EP	
D4 AWD 133 kW (181 PS) D 5244 T12	10.2013→12.2015		7.02325.05.0	DW-TL	EP	
			7.02613.02.0	EUV-AGR	EP	
			7.02221.01.0	LDRV	EL	
D4 AWD 140-162 kW (190-220 PS) D 5244 T21	03.2015→02.2017		7.02325.05.0	DW-TL	EP	
			7.02613.02.0	EUV-AGR	EP	
			7.02221.01.0	LDRV	EL	
D5 158-169 kW (215-230 PS) D 5244 T11, D 5244 T15	06.2011→02.2017		7.02325.05.0	DW-TL	EP	
			7.02613.02.0	EUV-AGR	EP	
			7.02221.01.0	LDRV	EL	
D5 AWD 136 kW (185 PS) D 5244 T4	05.2008→12.2009		7.00515.04.0	EUV-AGR	EP	
D5 AWD 151 kW (205 PS) D 5244 T10	07.2009→06.2011		7.02325.05.0	DW-TL	EP	 ch. 126192→
			7.02325.04.0	DW-TL	EP	Fahrgestellnummer bis: 126191 Vehicle Identification Number to: 126191
			7.02613.02.0	EUV-AGR	EP	
			7.02221.01.0	LDRV	EL	
D5 AWD 158-169 kW (215-230 PS) D 5244 T11, D 5244 T15	04.2011→12.2015		7.02325.05.0	DW-TL	EP	
			7.02613.02.0	EUV-AGR	EP	
			7.02221.01.0	LDRV	EL	
D5 AWD 169 kW (230 PS) D 5244 T23	04.2014→12.2015		7.02325.05.0	DW-TL	EP	
			7.02613.02.0	EUV-AGR	EP	
			7.02221.01.0	LDRV	EL	
D5 AWD 162 kW (220 PS) D 5244 T20, D 5244 T22	03.2015→02.2017		7.02325.05.0	DW-TL	EP	

V



XC60 I SUV (156) **27**

			7.02613.02.0	EUV-AGR	EP	
			7.02221.01.0	LDRV	EL	
T5 176-180 kW (239-245 PS) B 4204 T7	09.2010→02.2017		7.28197.16.0	LDRV	EL	
			7.06117.52.0	SV-NWV	EH	2012 2012 Einlassseite Intake Side 2011 2011
			7.06117.53.0	SV-NWV	EH	
			7.06117.55.0	SV-NWV	EH	
T5 180-186 kW (245-253 PS) B 4204 T11	10.2013→02.2017		7.02325.06.0	DW-TL	EP	
T5 AWD 183-187 kW (249-254 PS) B 5254 T12	04.2014→02.2017		7.28197.16.0	LDRV	EL	
T5 AWD 183-187 kW (249-254 PS) B 5254 T12	04.2014→02.2017		7.28197.16.0	LDRV	EL	
T6 225 kW (306 PS) B 4204 T9	10.2013→02.2017		7.02325.06.0	DW-TL	EP	
			7.05367.05.0	SUV	EL	
T6 AWD 210 kW (286 PS) B 6304 T2	05.2008→12.2010		7.02256.39.0	AKF	EL	
			7.06117.18.0	SV-NWV	EH	mit Dichtring with O-ring Ohne Pfandrückgabe des Altteils. Keine Rückgabe des Magnetventils nötig. Without deposit return for used part. No return of the solenoid valve.
T6 AWD 224-242 kW (304-329 PS) B 6304 T4	03.2010→02.2017		7.02256.39.0	AKF	EL	
			7.06117.18.0	SV-NWV	EH	mit Dichtring with O-ring Ohne Pfandrückgabe des Altteils. Keine Rückgabe des Magnetventils nötig. Without deposit return for used part. No return of the solenoid valve.
T6 AWD 225 kW (306 PS) B 4204 T9	10.2013→12.2017		7.05367.05.0	SUV	EL	
T6 AWD 224-242 kW (304-329 PS) B 6304 T4	04.2014→12.2015		7.02256.39.0	AKF	EL	
			7.06117.18.0	SV-NWV	EH	mit Dichtring with O-ring Ohne Pfandrückgabe des Altteils. Keine Rückgabe des Magnetventils nötig. Without deposit return for used part. No return of the solenoid valve.

XC60 II (246) **28**

2.0 B4 Mild-Hybrid 186 kW (253 PS) B 4204 T46	01.2021→		7.05367.05.0	SUV	EL	
2.0 B5 Mild-Hybrid AWD 173 kW (235 PS) D 420 T2	04.2019→		7.04664.02.0	DW-TL	EP	
			7.00515.05.0	EUV-AGR	EP	
2.0 D3 110 kW (150 PS) D 4204 T4	03.2017→		7.04664.02.0	DW-TL	EP	
			7.00515.05.0	EUV-AGR	EP	
2.0 D4 140-147 kW (190-200 PS) D 4204 T14	03.2017→		7.04664.02.0	DW-TL	EP	
			7.00515.05.0	EUV-AGR	EP	

XC60 II (246) **28**





2.0 D4 120 kW (163 PS) D 4204 T7	12.2018→		7.04664.02.0	DW-TL	EP	
			7.00515.05.0	EUV-AGR	EP	
2.0 D4 AWD 140-147 kW (190-200 PS) D 4204 T14	03.2017→		7.04664.02.0	DW-TL	EP	
			7.00515.05.0	EUV-AGR	EP	
2.0 D4 Polestar 140-147 kW (190-200 PS) D 4204 T14	05.2020→		7.04664.02.0	DW-TL	EP	
			7.00515.05.0	EUV-AGR	EP	
2.0 D4 Polestar AWD 140-147 kW (190-200 PS) D 4204 T14	05.2020→		7.04664.02.0	DW-TL	EP	
			7.00515.05.0	EUV-AGR	EP	
2.0 D5 AWD 173-177 kW (235-241 PS) D 4204 T23	03.2017→		7.04664.02.0	DW-TL	EP	
			7.00515.05.0	EUV-AGR	EP	
2.0 D5 Polestar AWD 173-177 kW (235-241 PS) D 4204 T23	10.2018→		7.04664.02.0	DW-TL	EP	
			7.00515.05.0	EUV-AGR	EP	
2.0 T6 AWD 235-246 kW (320-334 PS) B 4204 T27	03.2017→		7.05367.05.0	SUV	EL	
2.0 T6 AWD 228-240 kW (310-326 PS) B 4204 T29	10.2017→		7.05367.05.0	SUV	EL	
2.0 T6 Polestar AWD 235-246 kW (320-334 PS) B 4204 T27	03.2017→		7.05367.05.0	SUV	EL	
2.0 T8 HYBRID AWD POLESTAR 246 kW (335 PS) B4204T49	05.2021→		7.05367.05.0	SUV	EL	
2.0 T8 Hybrid AWD 223-246 kW (303-334 PS) B 4204 T35	03.2017→		7.05367.05.0	SUV	EL	
2.0 T8 Hybrid AWD 223-246 kW (303-334 PS) B 4204 T35	03.2017→		7.05367.05.0	SUV	EL	
2.0 T8 Hybrid AWD 223-287 kW (303-390 PS) B 4204 T34	02.2018→		7.05367.05.0	SUV	EL	
2.0 T8 Hybrid Polestar AWD 223-287 kW (303-390 PS) B 4204 T34, B 4204 T48	01.2019→		7.05367.05.0	SUV	EL	
T6 Polestar AWD 240 kW (326 PS) B 4204 T29P	07.2019→		7.05367.05.0	SUV	EL	

XC70 CROSS COUNTRY I (295) **29**







2.0 T5 AWD 166 kW (226 PS) B 5204 T3	10.1997→03.1999		7.22517.04.0	AKF	EL	2000 2000 2002 2002
			7.22240.09.0	LDRV	EL	
2.4 D5 AWD 136 kW (185 PS) D 5244 T4	12.2005→08.2007		7.00515.04.0	EUV-AGR	EP	
			7.22240.15.0	EUV-LS	EL	





















XC70 CROSS COUNTRY I (295) **29**

2.4 D5 XC AWD 120 kW (163 PS) D 5244 T	09.2002→08.2007		7.21903.63.0	DW-TL	EP	01.2003→
			7.22240.15.0 7.22240.13.0	EUV-LS LDRV	EL EL	
2.4 T XC AWD 142 kW (193 PS) B 5254 T	11.1997→09.2002		7.22517.04.0	AKF	EL	2000 2000 2002 2002
			7.22240.09.0	LDRV	EL	Produktionsdatum bis: 31.12.1999 Production date to: 31.12.1999
2.4 T XC AWD 147 kW (200 PS) B 5244 T3	03.2000→09.2002		7.22517.04.0	AKF	EL	Fahrgestellnummer bis: 47999 Vehicle Identification Number to: 47999 ■ Europa ■ Europe
			7.22240.13.0	LDRV	EL	Fahrgestellnummer ab: 48000 Vehicle Identification Number from: 48000
2.5 T XC AWD 153-162 kW (209-220 PS) B 5254 T2	08.2002→07.2007		7.22517.04.0	AKF	EL	Fahrgestellnummer bis: 47999 Vehicle Identification Number to: 47999 ■ Europa ■ Europe
			7.22240.13.0	LDRV	EL	Fahrgestellnummer ab: 48000 Vehicle Identification Number from: 48000
2.5 T XC AWD 153-162 kW (209-220 PS) B 5254 T2	09.2002→08.2007		7.22510.03.0	AKF	EL	Fahrgestellnummer bis: 47999 Vehicle Identification Number to: 47999 ■ Europa ■ Europe
			7.22517.04.0	AKF	EL	
			7.22240.13.0	LDRV	EL	

XC70 II (136) **30**



2.4 D 129 kW (175 PS) D 5244 T14	06.2009→12.2010		7.02613.02.0	EUV-AGR	EP	
2.4 D / D4 AWD 120 kW (163 PS) D 5244 T16	08.2007→04.2016		7.02325.05.0	DW-TL	EP	 ch. 94001→
			7.02325.04.0	DW-TL	EP	Fahrgestellnummer bis: 94000 Vehicle Identification Number to: 94000
			7.02613.02.0 7.02221.01.0	EUV-AGR LDRV	EP EL	
			7.02325.05.0	DW-TL	EP	
2.4 D / D4 AWD 120 kW (163 PS) D 5244 T17	08.2007→04.2016		7.02613.02.0	EUV-AGR	EP	
			7.02221.01.0	LDRV	EL	
			7.00515.04.0	EUV-AGR	EP	
2.4 D / D4 AWD 120 kW (163 PS) D 5244 T5	08.2007→04.2016		7.02256.39.0	AKF	EL	
			7.06117.18.0	SV-NWV	EH	mit Dichtring with O-ring Ohne Pfandrückgabe des Altteils. Keine Rückgabe des Magnetventils nötig. Without deposit return for used part. No return of the solenoid valve.
3.2 AWD 168-177 kW (228-238 PS) B 6324 S	08.2007→12.2011		7.02256.39.0	AKF	EL	

V











					
XC70 II (136)					30
			7.06117.18.0	SV-NWV	EH mit Dichtring with O-ring Ohne Pfandrückgabe des Altteils. Keine Rückgabe des Magnetventils nötig. Without deposit return for used part. No return of the solenoid valve.
3.2 AWD 179 kW (243 PS) B 6324 S5	05.2010→12.2014		7.02256.39.0	AKF	EL
			7.06117.18.0	SV-NWV	EH mit Dichtring with O-ring Ohne Pfandrückgabe des Altteils. Keine Rückgabe des Magnetventils nötig. Without deposit return for used part. No return of the solenoid valve.
D3 120 kW (163 PS) D 5204 T2, D 5204 T3	04.2010→12.2015		7.02325.05.0	DW-TL	EP
			7.02613.02.0	EUV-AGR	EP
D4 133 kW (181 PS) D 4204 T5	10.2013→04.2016		7.04664.02.0	DW-TL	EP
			7.00515.05.0	EUV-AGR	EP
D4 AWD 133 kW (181 PS) D 5244 T12	10.2013→04.2016		7.02325.05.0	DW-TL	EP
			7.02613.02.0	EUV-AGR	EP
			7.02221.01.0	LDRV	EL
D5 AWD 136 kW (185 PS) D 5244 T4	04.2007→12.2009		7.00515.04.0	EUV-AGR	EP
			7.22240.15.0	EUV-LS	EL
D5 AWD 151 kW (205 PS) D 5244 T10	04.2009→12.2011		7.02325.05.0	DW-TL	EP  ch. 94001→
			7.02325.04.0	DW-TL	EP Fahrgestellnummer bis: 94000 Vehicle Identification Number to: 94000
			7.02613.02.0	EUV-AGR	EP
			7.02221.01.0	LDRV	EL
D5 AWD 158-169 kW (215-230 PS) D 5244 T11, D 5244 T15	04.2011→12.2015		7.02325.05.0	DW-TL	EP
			7.02613.02.0	EUV-AGR	EP
			7.02221.01.0	LDRV	EL
D5 AWD 158-169 kW (215-230 PS) D 5244 T15	11.2013→04.2016		7.02325.05.0	DW-TL	EP
			7.02221.01.0	LDRV	EL
D5 AWD 162 kW (220 PS) D 5244 T20	03.2015→04.2016		7.02325.05.0	DW-TL	EP
			7.02613.02.0	EUV-AGR	EP
			7.02221.01.0	LDRV	EL
T5 180-186 kW (245-253 PS) B 4204 T11	10.2013→12.2016		7.02325.06.0	DW-TL	EP
T5 AWD 183-187 kW (249-254 PS) B 5254 T12	08.2015→12.2016		7.28197.16.0	LDRV	EL
T6 AWD 210 kW (286 PS) B 6304 T2	01.2008→12.2016		7.06117.18.0	SV-NWV	EH mit Dichtring with O-ring Ohne Pfandrückgabe des Altteils. Keine Rückgabe des Magnetventils nötig. Without deposit return for used part. No return of the solenoid valve.









XC70 II (136) **30**

T6 AWD 224-242 kW (304-329 PS) B 6304 T4	01.2010→04.2015	 7.06117.18.0	SV-NWV	EH	mit Dichtring with O-ring Ohne Pfandrückgabe des Altteils. Keine Rückgabe des Magnetventils nötig. Without deposit return for used part. No return of the solenoid valve.
T6 AWD 183 kW (249 PS) B 5254 T14	03.2015→12.2016	 7.28197.16.0	LDRV	EL	

XC90 I (275) **31**











2.5 T AWD 153-162 kW (209-220 PS) B 5254 T2	10.2002→09.2014	 7.22240.13.0	LDRV	EL	
2.5 T AWD 154 kW (209 PS) B 5254 T9	10.2012→09.2014	 7.22240.13.0	LDRV	EL	
3.2 AWD 168-177 kW (228-238 PS) B 6324 S	03.2006→12.2010	 7.02256.39.0	AKF	EL	
		7.06117.18.0	SV-NWV	EH	mit Dichtring with O-ring Ohne Pfandrückgabe des Altteils. Keine Rückgabe des Magnetventils nötig. Without deposit return for used part. No return of the solenoid valve.
D3 / D5 120 kW (163 PS) D 5244 T5	04.2009→12.2014	 7.00515.04.0	EUV-AGR	EP	
		7.22240.15.0	EUV-LS	EL	
D5 AWD 120 kW (163 PS) D 5244 T	10.2002→12.2006	 7.21903.63.0	DW-TL	EP	
		7.22240.15.0	EUV-LS	EL	
D5 AWD 136 kW (185 PS) D 5244 T4	04.2005→12.2010	 7.00515.04.0	EUV-AGR	EP	
		7.22240.15.0	EUV-LS	EL	
D5 AWD 120 kW (163 PS) D 5244 T5	10.2007→12.2010	 7.22240.15.0	EUV-LS	EL	
D5 AWD 147-155 kW (200-211 PS) D 5244 T18	01.2011→12.2014	 7.00515.04.0	EUV-AGR	EP	
		7.22240.15.0	EUV-LS	EL	
D5 AWD 147-155 kW (200-211 PS) D 5244 T18	11.2013→09.2014	 7.22240.15.0	EUV-LS	EL	
T6 AWD 200 kW (272 PS) B 6294 T	10.2002→12.2006	 7.22240.13.0	LDRV	EL	

XC90 II (256) **32**

2.0 D5 Polestar AWD 173-177 kW (235-241 PS) D 4204 T23	10.2018→	 7.04664.02.0	DW-TL	EP	
		7.00515.05.0	EUV-AGR	EP	
2.0 T6 AWD 228-240 kW (310-326 PS) B 4204 T29	10.2017→	 7.05367.05.0	SUV	EL	
2.0 T8 Hybrid AWD 223-287 kW (303-390 PS) B 4204 T34	06.2020→	 7.05367.05.0	SUV	EL	
2.0 T8 Hybrid Polestar AWD 223-287 kW (303-390 PS) B 4204 T34	01.2019→	 7.05367.05.0	SUV	EL	
B5 Mild-Hybrid AWD 173 kW (235 PS) D 420 T2	04.2019→	 7.00515.05.0	EUV-AGR	EP	
D4 140-147 kW (190-200 PS) D 4204 T14	06.2015→12.2018	 7.04664.02.0	DW-TL	EP	

V





XC90 II (256) 32

		7.00515.05.0	EUV-AGR	EP	
D4 AWD 140 kW (190 PS) D 4204 T6	10.2015→12.2018	 7.04664.02.0	DW-TL	EP	
		7.00515.05.0	EUV-AGR	EP	
D5 AWD 165-171 kW (224-232 PS) D 4204 T11	09.2014→12.2016	 7.04664.02.0	DW-TL	EP	
		7.00515.05.0	EUV-AGR	EP	
D5 AWD 173-177 kW (235-241 PS) D 4204 T23	03.2016→12.2019	 7.04664.02.0	DW-TL	EP	
		7.00515.05.0	EUV-AGR	EP	
T6 AWD 235-246 kW (320-334 PS) B 4204 T27	09.2014→12.2018	 7.05367.05.0	SUV	EL	
T6 Polestar AWD 235-246 kW (320-334 PS) B 4204 T27	01.2017→	 7.05367.05.0	SUV	EL	
T6 Polestar AWD 240 kW (326 PS) B 4204 T29P	10.2017→	 7.05367.05.0	SUV	EL	
T8 Hybrid AWD 223-246 kW (303-334 PS) B 4204 T35	06.2015→12.2018	 7.05367.05.0	SUV	EL	
T8 Hybrid AWD 223-246 kW (303-334 PS) B 4204 T35	06.2015→	 7.05367.05.0	SUV	EL	
T8 Plug-in Hybrid Polestar AWD 223-246 kW (303-334 PS) B 4204 T35	06.2015→	 7.05367.05.0	SUV	EL	
T8 Twin Engine AWD 223-287 kW (303-390 PS) B 4204 T34	06.2019→	 7.05367.05.0	SUV	EL	

V40 Hatchback Van (525, 526) 33

1.6 D2/ DRIVe 84 kW (114 PS) D 4162 T	09.2013→12.2015	 7.07400.04.0*	STE	EP	für Fahrzeuge mit Schaltgetriebe for vehicles with manual transmission
		↳ 7.01633.06.0	DW-TL	EP	
		7.07400.05.0*	STE	EP	für Fahrzeuge mit Automatikgetriebe for vehicles with automatic transmission
		↳ 7.01633.06.0	DW-TL	EP	
2.0 D3 110 kW (150 PS) D 5204 T6	09.2013→12.2015	 7.02325.05.0	DW-TL	EP	
2.0 D4 130 kW (177 PS) D 5204 T4	09.2013→12.2014	 7.02325.05.0	DW-TL	EP	

V60 I Estate Van (155) 34

1.6 DRIVe 84 kW (114 PS) D 4162 T	09.2013→12.2015	 7.07400.02.0*	STE	EP	für Fahrzeuge mit Automatikgetriebe for vehicles with automatic transmission
		↳ 7.01633.06.0	DW-TL	EP	
		7.07400.03.0*	STE	EP	für Fahrzeuge mit Schaltgetriebe for vehicles with manual transmission
		↳ 7.01633.06.0	DW-TL	EP	
2.0 D3 100 kW (136 PS) D 5204 T7	09.2013→12.2015	 7.02325.05.0	DW-TL	EP	
2.0 D4 120 kW (163 PS) D 5204 T3	09.2013→12.2015	 7.02325.05.0	DW-TL	EP	
2.4 D5 158-169 kW (215-230 PS) D 5244 T15	09.2013→12.2015	 7.02325.05.0	DW-TL	EP	
		7.02221.01.0	LDRV	EL	

V





V70 III Estate Van (135) 35

2.0 D3 DRIVe 100 kW (136 PS) D 5204 T7	09.2013→	 7.02325.05.0	DW-TL	EP
2.4 D5 158-169 kW (215-230 PS) D 5244 T11, D 5244 T15	09.2013→	 7.02325.05.0	DW-TL	EP
		7.02221.01.0	LDRV	EL



XC60 I VAN (156) 36

D4 AWD 120 kW (163 PS) D 5244 T17	09.2013→02.2017	 7.02221.01.0	LDRV	EL
D5 AWD 158-169 kW (215-230 PS) D 5244 T11, D 5244 T15	09.2013→02.2017	 7.02221.01.0	LDRV	EL

XC70 II VAN (136) 37

2.4 D4 AWD 120 kW (163 PS) D 5244 T17	09.2013→04.2016	 7.02221.01.0	LDRV	EL
2.4 D5 AWD 158-169 kW (215-230 PS) D 5244 T15	09.2013→	 7.02221.01.0	LDRV	EL

XC90 I VAN (275) 38

2.4 D4 120 kW (163 PS) D 5244 T5	09.2013→12.2014	 7.22240.15.0	EUV-LS	EL
2.4 D5 AWD 147-155 kW (200-211 PS) D 5244 T18	09.2013→12.2014	 7.22240.15.0	EUV-LS	EL

V



ENGINE

39

ENGINE 160-661 kW (218-900 PS)
 D 12 D-A MH, D 12 D-B MP, D 12
 D-D MP, D 12 D-F MP, D 12 D-G
 MP, D 12 D-H MP, D13B-B MP,
 D13B-D MP, D13B-E MG, D13B-E
 MG (FE), D13B-E MH, D13B-F
 MG, D13B-F MG (FE), D13B-J MP,
 D13B-M MP, D13B-N MH,
 D13B-N MH (FE), D13C1-A MG,
 D13C1-A MH, D13C1-A MP,
 D13C2-A MG, D13C2-A MH,
 D13C2-A MP, D8A1-A MP,
 D8A2-A MP, D8A3-A MP, D8A4-A
 MP, TAD 1344 GE-B, TAD 1345
 GE-B, TAD 1381 VE, TAD 1382 VE,
 TAD 1383 VE, TAD 1384 VE, TAD
 1385 VE, TAD 1662 VE EU5, TAD
 840 GE, TAD 880 VE, TAD 881
 VE, TAD 882 VE, TAD 883 VE, TAD
 884 VE, TAD1140VE,
 TAD1141VE, TAD1142VE,
 TAD1150VE, TAD1151VE,
 TAD1152VE, TAD1170VE,
 TAD1171VE, TAD1172VE,
 TAD1344GE, TAD1345GE,
 TAD1345VE, TAD1350VE,
 TAD1351VE, TAD1352VE,
 TAD1353GE, TAD1353VE,
 TAD1360VE, TAD1361VE,
 TAD1362VE, TAD1363VE,
 TAD1364VE, TAD1365VE,
 TAD1371VE, TAD1372VE,
 TAD1373VE, TAD1374VE,
 TAD1375VE, TAD1640VE-B,
 TAD1641VE-B, TAD1642VE-B,
 TAD1643VE-B, TAD1650GE,
 TAD1650VE, TAD1650VE-B,
 TAD1651GE, TAD1651VE,
 TAD1660VE, TAD1661VE,
 TAD1662VE, TAD1670VE,
 TAD1671VE, TAD1672VE,
 TAD542VE, TAD552VE,
 TAD843VE, TAD853VE

















7.01282.02.0

LDRV

EL



















V



					
S60					
1					
T8 PHEV AWD 223 kW (303 PS) B4204T34	12.2019→		7.05367.05.0	SUV	EL
T8 PHEV AWD 223 kW (303 PS) B4204T34	12.2019→		7.05367.05.0	SUV	EL
S60L					
2					
1.5 T3 112 kW (152 PS) B 4154 T4	06.2015→12.2019		7.05367.05.0	SUV	EL
2.0 T 132-157 kW (180-214 PS) B 5204 T8	06.2014→12.2019		7.02325.06.0	DW-TL	EP
2.0 T4 140 kW (190 PS) B 4204 T19	06.2015→12.2019		7.05367.05.0	SUV	EL
S90					
3					
T8 Plug-in-Hybrid AWD 235 kW (320 PS) B4204T35	06.2018→		7.05367.05.0	SUV	EL
T8 Plug-in-Hybrid AWD 235 kW (320 PS) B4204T35	06.2018→		7.05367.05.0	SUV	EL
T8 Plug-in-Hybrid AWD 223 kW (303 PS) B4204T34	06.2020→		7.05367.05.0	SUV	EL
T8 Plug-in-Hybrid AWD 223 kW (303 PS) B4204T34	06.2020→		7.05367.05.0	SUV	EL
XC60 II					
4					
T8 Plug-in Hybrid AWD 235 kW (320 PS) B4204T35	06.2018→		7.05367.05.0	SUV	EL
T8 Plug-in Hybrid AWD 223 kW (303 PS) B4204T34	06.2020→		7.05367.05.0	SUV	EL

S80L
1

2.0 T 149 kW (203 PS) B4204T6	12.2010→01.2013	 7.28197.16.0	LDRV	EL	
		7.06117.52.0	SV-NWV	EH	
		7.06117.53.0	SV-NWV	EH	2012
		7.06117.55.0	SV-NWV	EH	2012 Einlassseite Intake Side
					2011 2011
2.0 T 176-177 kW (239-241 PS) B 4204 T7	06.2011→06.2013	 7.28197.16.0	LDRV	EL	
		7.06117.52.0	SV-NWV	EH	
		7.06117.53.0	SV-NWV	EH	
2.5 147-162 kW (200-220 PS) B 5254 T6	03.2009→12.2010	 7.28197.16.0	LDRV	EL	
3.0 AWD 210 kW (286 PS) B 6304 T2	03.2009→12.2010	7.06117.18.0	SV-NWV	EH	mit Dichtring with O-ring
					Ohne Pfandrückgabe des Altteils. Keine Rückgabe des Magnetventils nötig.
					Without deposit return for used part. No return of the solenoid valve.
3.0 AWD 224 kW (305 PS) B 6304 T, B 6304 T4	12.2010→12.2015	7.06117.18.0	SV-NWV	EH	mit Dichtring with O-ring
					Ohne Pfandrückgabe des Altteils. Keine Rückgabe des Magnetventils nötig.
					Without deposit return for used part. No return of the solenoid valve.

			 PIERBURG		
BORA (152) 1					
1.4 TSI 96 kW (131 PS) CFB	06.2010→03.2016		7.02901.05.0	SUV	EL
CC Saloon (990, 991) 2					
1.8 118 kW (160 PS) CEAA	07.2010→		7.22880.01.0	EUV-AGK	EL
			7.22880.01.0	EUV-AGR	EL
			7.22880.01.0	EUV-KK	EL
			7.22880.01.0	EUV-LS	EL
			7.22880.01.0	EUV-ML	EL
			7.22880.01.0	EUV-SL	EL
			7.02901.05.0	SUV	EL
2.0 147 kW (200 PS) CGMA	07.2010→		7.22880.01.0	EUV-AGK	EL
			7.22880.01.0	EUV-AGR	EL
			7.22880.01.0	EUV-KK	EL
			7.22880.01.0	EUV-LS	EL
			7.22880.01.0	EUV-ML	EL
			7.22880.01.0	EUV-SL	EL
			7.02901.05.0	SUV	EL
MAGOTAN (B6, 9X2) 3					
1.4 TSI 96 kW (131 PS) CFBA	01.2010→07.2011		7.02901.05.0	SUV	EL
MAGOTAN (B7L, 942) 4					
1.4 TSI 96 kW (131 PS) CFBA	07.2011→12.2016		7.02901.05.0	SUV	EL
1.8 TSI 118 kW (160 PS) CEAA	07.2011→12.2016		7.22880.01.0	EUV-AGK	EL
			7.22880.01.0	EUV-AGR	EL
			7.22880.01.0	EUV-KK	EL
			7.22880.01.0	EUV-LS	EL
			7.22880.01.0	EUV-ML	EL
			7.22880.01.0	EUV-SL	EL
			7.02901.05.0	SUV	EL
2.0 TSI 147 kW (200 PS) CGMA	07.2011→12.2015		7.22880.01.0	EUV-AGK	EL
			7.22880.01.0	EUV-AGR	EL
			7.22880.01.0	EUV-KK	EL
			7.22880.01.0	EUV-LS	EL
			7.22880.01.0	EUV-ML	EL
			7.22880.01.0	EUV-SL	EL
			7.02901.05.0	SUV	EL
SAGITAR (9L2) 5					
1.4 TSI 96 kW (131 PS) CFB	09.2009→12.2012		7.02901.05.0	SUV	EL
1.6 74-75 kW (101-102 PS) BWH	02.2006→12.2012		7.10014.00.0	AKF	EL
SAGITAR (BK2) 6					
1.8 TSI 118 kW (160 PS) CEAA	03.2012→12.2016		7.22880.01.0	EUV-AGK	EL
			7.22880.01.0	EUV-AGR	EL



















SAGITAR (BK2) 6

			7.22880.01.0	EUV-KK	EL	
			7.22880.01.0	EUV-LS	EL	
			7.22880.01.0	EUV-ML	EL	
			7.22880.01.0	EUV-SL	EL	
			7.22880.01.0	EUV-SR	EL	
2.0 GLI 147 kW (200 PS) CGMA	04.2013->		7.22880.01.0	EUV-AGK	EL	
			7.22880.01.0	EUV-AGR	EL	
			7.22880.01.0	EUV-KK	EL	
			7.22880.01.0	EUV-LS	EL	
			7.22880.01.0	EUV-ML	EL	
			7.22880.01.0	EUV-SL	EL	
			7.22880.01.0	EUV-SR	EL	
			7.02901.05.0	SUV	EL	
230 TSI 96 kW (131 PS) CFBA, DAGA	03.2012->		7.02901.05.0	SUV	EL	

CADDY (9HB) 7

1.6 74 kW (101 PS) BRY	03.2005->12.2007		7.10014.00.0	AKF	EL	
---------------------------	------------------	---	--------------	-----	----	--



			 PIERBURG			
LAMANDO (BM1, BM2)						1
330 TSI 132 kW (180 PS) CUFA	01.2015→		7.02901.05.0	SUV	EL	
LAVIDA (181)						2
1.4 TSI 96 kW (131 PS) CFB, CFBA	03.2010→12.2013		7.02901.05.0	SUV	EL	
LAVIDA (182, 184)						3
1.4 TSI 96 kW (131 PS) CFBA	09.2012→12.2013		7.02901.05.0	SUV	EL	
PASSAT B5 (9F8)						4
1.9 D 85 kW (115 PS) BPZ	01.2008→04.2009		7.22903.28.0	DW-TL	EP	
2.8 140 kW (190 PS) BBG	12.2001→12.2006		7.01805.01.0	EUV-SR	EL	
PASSAT B7 (A42, A43)						5
1.4 TSI 96 kW (131 PS) CFBA	09.2011→12.2015		7.02901.05.0	SUV	EL	
1.8 TSI 118 kW (160 PS) CEAA	04.2011→12.2018		7.22880.01.0	EUV-AGK	EL	
			7.22880.01.0	EUV-AGR	EL	
			7.22880.01.0	EUV-KK	EL	
			7.22880.01.0	EUV-LS	EL	
			7.22880.01.0	EUV-ML	EL	
			7.22880.01.0	EUV-SL	EL	
			7.22880.01.0	EUV-SR	EL	
7.02901.05.0	SUV	EL				
2.0 TSI 147 kW (200 PS) CGMA	04.2011→12.2015		7.22880.01.0	EUV-AGK	EL	
			7.22880.01.0	EUV-AGR	EL	
			7.22880.01.0	EUV-KK	EL	
			7.22880.01.0	EUV-LS	EL	
			7.22880.01.0	EUV-ML	EL	
			7.22880.01.0	EUV-SL	EL	
			7.22880.01.0	EUV-SR	EL	
7.02901.05.0	SUV	EL				
POLO Hatchback (621)						6
1.4 GTI 96 kW (131 PS) CFBA	09.2012→12.2015		7.02901.05.0	SUV	EL	
POLO JINQING (9J3)						7
1.6 77 kW (105 PS) BMH	06.2006→12.2012		7.06117.54.0	SV-NWV	EL	
POLO JINQU (9J4)						8
1.6 77 kW (105 PS) BMH	06.2006→12.2012		7.06117.54.0	SV-NWV	EL	
SANTANA Estate (331, 334)						9
1.8 66-70 kW (90-95 PS) JV	03.1985→12.2000		7.01805.01.0	EUV-LS	EL	
TIGUAN (591, 592)						10
1.4 TSI 96 kW (131 PS) CFBA	11.2011→		7.02901.05.0	SUV	EL	
300 TSI 118 kW (160 PS) CEAA	03.2010→		7.22880.01.0	EUV-AGK	EL	
			7.22880.01.0	EUV-AGR	EL	
			7.22880.01.0	EUV-KK	EL	

V

TIGUAN (591, 592) 10

			7.22880.01.0	EUV-LS	EL	
			7.22880.01.0	EUV-ML	EL	
			7.22880.01.0	EUV-SL	EL	
			7.22880.01.0	EUV-SR	EL	
			7.02901.05.0	SUV	EL	
300 TSI 4motion 118 kW (160 PS) CEAA	03.2010→		7.22880.01.0	EUV-AGK	EL	
			7.22880.01.0	EUV-AGR	EL	
			7.22880.01.0	EUV-KK	EL	
			7.22880.01.0	EUV-LS	EL	
			7.22880.01.0	EUV-ML	EL	
			7.22880.01.0	EUV-SL	EL	
			7.22880.01.0	EUV-SR	EL	
			7.02901.05.0	SUV	EL	
330 TSI 4motion 147 kW (200 PS) CGMA	03.2010→		7.22880.01.0	EUV-AGK	EL	
			7.22880.01.0	EUV-AGR	EL	
			7.22880.01.0	EUV-KK	EL	
			7.22880.01.0	EUV-LS	EL	
			7.22880.01.0	EUV-ML	EL	
			7.22880.01.0	EUV-SL	EL	
			7.22880.01.0	EUV-SR	EL	
			7.02901.05.0	SUV	EL	

TOURAN (9R1, 9R3) 11

1.4 TSI 96 kW (131 PS) CFBA	12.2010→		7.02901.05.0	SUV	EL	
--------------------------------	----------	---	--------------	-----	----	--



D

ALPHANUMERISCHE LISTE



E

ALPHANUMERICAL LIST

REF-No.		 PIERBURG	REF-No.		 PIERBURG
001-10-18563	BBR AUTOMOTIVE	7.06117.01.0	03C145710A	VOLKSWAGEN	7.04247.02.0
001-10-22695	BBR AUTOMOTIVE	7.06117.00.0	03C145710B	VOLKSWAGEN	7.04247.02.0
001-10-23692	BBR AUTOMOTIVE	7.00887.21.0	03C145710C	VOLKSWAGEN	7.04247.02.0
001-30-15644	BBR AUTOMOTIVE	7.06117.20.0	03C145710D	AUDI	7.04247.02.0
0015407097	SSANGYONG	7.21071.50.0	03C145710D	SEAT	7.04247.02.0
0015408697	SSANGYONG	7.21071.50.0	03C145710D	SKODA	7.04247.02.0
00K04627212AB	CHRYSLER	7.03003.01.0	03C145710D	VOLKSWAGEN	7.04247.02.0
0149817	BMW	7.06117.00.0	03C145710E	SKODA	7.04247.02.0
0149817	ROLLS-ROYCE	7.06117.00.0	03C145710E	VOLKSWAGEN	7.04247.02.0
02.12.085	TRUCKTEC	7.06117.20.0	03C906283	VOLKSWAGEN	7.01044.03.0
	FAHRZEUGTEILE GM		03C906283A	AUDI	7.02588.04.0
02.12.130	TRUCKTEC	7.06117.24.0	03C906283A	SEAT	7.02588.04.0
	FAHRZEUGTEILE GM		03C906283A	SKODA	7.02588.04.0
02.12.201	TRUCKTEC	7.06117.21.0	03C906283A	VOLKSWAGEN	7.02588.04.0
	FAHRZEUGTEILE GM		03C906283B	AUDI	7.02588.04.0
02.17.081	TRUCKTEC	7.00782.12.0	03C906283B	SEAT	7.02588.04.0
	FAHRZEUGTEILE GM		03C906283B	SKODA	7.02588.04.0
02.17.175	TRUCKTEC	7.00782.16.0	03C906283B	VOLKSWAGEN	7.02588.04.0
	FAHRZEUGTEILE GM		03C906455	AUDI	7.06117.54.0
02.42.070	TRUCKTEC	7.02256.37.0	03C906455	VOLKSWAGEN	7.06117.54.0
	FAHRZEUGTEILE GM		03C906455A	AUDI	7.06117.54.0
02.42.317	TRUCKTEC	7.00782.04.0	03C906455A	SEAT	7.06117.54.0
	FAHRZEUGTEILE GM		03C906455A	SKODA	7.06117.54.0
026906283D	VOLKSWAGEN	7.01805.01.0	03C906455A	VOLKSWAGEN	7.06117.54.0
026906283G	VOLKSWAGEN	7.01805.01.0	03H906455	AUDI	7.06117.37.0
026906283H	AUDI	7.01805.01.0	03H906455	SKODA	7.06117.37.0
026906283H	VOLKSWAGEN	7.01805.01.0	03H906455	VOLKSWAGEN	7.06117.37.0
026906283J	AUDI	7.01805.01.0	0410035	BMW	7.06117.00.0
026906283J	SEAT	7.01805.01.0	0410035	ROLLS-ROYCE	7.06117.00.0
026906283J	SKODA	7.01805.01.0	04627212AB	CHRYSLER	7.03003.01.0
026906283J	VOLKSWAGEN	7.01805.01.0	04892991AA	CHRYSLER	7.02909.07.0
0280142347	BOSCH	7.10014.00.0	04893902AB	CHRYSLER	7.02909.12.0
028906283A	SKODA	7.21895.55.0	04E906455	AUDI	7.06117.48.0
028906283A	VOLKSWAGEN	7.21895.55.0	04E906455	SEAT	7.06117.48.0
028906283F	SEAT	7.21895.55.0	04E906455	SKODA	7.06117.48.0
028906283F	SEMEX	7.21895.55.0	04E906455	VOLKSWAGEN	7.06117.48.0
028906283F	SKODA	7.21895.55.0	04E906455B	AUDI	7.06117.48.0
028906283F	VOLKSWAGEN	7.21895.55.0	04E906455B	SEAT	7.06117.48.0
028906283H	AUDI	7.01805.01.0	04E906455B	SKODA	7.06117.48.0
028906283H	VOLKSWAGEN	7.01805.01.0	04E906455B	VOLKSWAGEN	7.06117.48.0
028906283J	SKODA	7.21895.55.0	04E906455D	AUDI	7.06117.48.0
028906283J	VOLKSWAGEN	7.21895.55.0	04E906455D	SEAT	7.06117.48.0
028906283N	AUDI	7.01037.02.0	04E906455D	SKODA	7.06117.48.0
028906283N	SEAT	7.01037.02.0	04E906455D	VOLKSWAGEN	7.06117.48.0
028906283N	VOLKSWAGEN	7.01037.02.0	04E906455H	AUDI	7.06117.48.0
028906283Q	VOLKSWAGEN	7.01805.01.0	04E906455H	SEAT	7.06117.48.0
037906283A	AUDI	7.22402.03.0	04E906455H	SKODA	7.06117.48.0
037906283A	SEAT	7.22402.03.0	04E906455H	VOLKSWAGEN	7.06117.48.0
037906283A	SKODA	7.22402.03.0	05099822AA	CHRYSLER	7.02256.37.0
037906283A	VOLKSWAGEN	7.22402.03.0	05099822AA	DODGE	7.02256.37.0
037906283B	AUDI	7.02461.01.0	05099822AA	JEEP	7.02256.37.0
037906283B	SEAT	7.02461.01.0	054906267	AUDI	7.21483.54.0
037906283B	SKODA	7.02461.01.0	054906267	SEAT	7.21483.54.0
037906283B	VOLKSWAGEN	7.02461.01.0	054906267	VOLKSWAGEN	7.21483.54.0
037906283C	AUDI	7.22880.01.0	054906267A	AUDI	7.21483.54.0
037906283C	SEAT	7.22880.01.0	054906267A	SEAT	7.21483.54.0
037906283C	SKODA	7.22880.01.0	054906267A	VOLKSWAGEN	7.21483.54.0
037906283C	VOLKSWAGEN	7.22880.01.0	058133517B	AUDI	7.10014.00.0
037906283D	AUDI	7.28098.04.0	058133517B	SEAT	7.10014.00.0
037906283D	BENTLEY	7.28098.04.0	058133517B	SKODA	7.10014.00.0
037906283D	SEAT	7.28098.04.0	058133517B	VOLKSWAGEN	7.10014.00.0
037906283D	VOLKSWAGEN	7.28098.04.0	059906627A	VOLKSWAGEN	7.21903.49.0
037975	CITROEN	7.01115.08.0	059906627B	AUDI	7.22903.17.0
037975	DS	7.01115.08.0	059906627C	VOLKSWAGEN	7.22903.16.0
037975	PEUGEOT	7.01115.08.0	059906628A	AUDI	7.01019.01.0
037977	CITROEN	7.01115.08.0	059906628A	VOLKSWAGEN	7.01019.01.0
037977	DS	7.01115.08.0	059906628B	AUDI	7.01019.01.0
037977	PEUGEOT	7.01115.08.0	059906628B	VOLKSWAGEN	7.01019.01.0
03C145710	VOLKSWAGEN	7.04247.02.0	064847202010	MAGNETI MARELLI	7.06117.35.0

REF-No.		 PIERBURG	REF-No.		 PIERBURG
064847202010	MAGNETI MARELLI	7.06117.38.0	06H145710F	AUDI	7.02901.05.0
066906455	VOLKSWAGEN	7.06117.44.0	06H145710F	SEAT	7.02901.05.0
066906455B	VOLKSWAGEN	7.06117.43.0	06H145710F	SKODA	7.02901.05.0
066906455C	AUDI	7.06117.44.0	06H145710F	VOLKSWAGEN	7.02901.05.0
066906455C	SEAT	7.06117.44.0	06H145710J	AUDI	7.02901.05.0
066906455C	VOLKSWAGEN	7.06117.44.0	06H145710J	SEAT	7.02901.05.0
066906455E	AUDI	7.06117.43.0	06H145710J	SKODA	7.02901.05.0
066906455E	VOLKSWAGEN	7.06117.43.0	06H145710J	VOLKSWAGEN	7.02901.05.0
066906455F	AUDI	7.06117.44.0	06H906283B	AUDI	7.03280.04.0
066906455F	SEAT	7.06117.44.0	06H906283B	PORSCHE	7.03280.04.0
066906455F	VOLKSWAGEN	7.06117.44.0	06H906283B	SEAT	7.03280.04.0
066906455H	AUDI	7.06117.43.0	06H906283B	SKODA	7.03280.04.0
066906455H	VOLKSWAGEN	7.06117.43.0	06H906283B	VOLKSWAGEN	7.03280.04.0
06A906283F	SEAT	7.01037.02.0	06H906283F	AUDI	7.02256.18.0
06A906283F	SKODA	7.01037.02.0	06H906283F	SEAT	7.02256.18.0
06A906283F	VOLKSWAGEN	7.01037.02.0	06H906283F	SKODA	7.02256.18.0
06E109257L	AUDI	7.06117.42.0	06H906283F	VOLKSWAGEN	7.02256.18.0
06E109257M	AUDI	7.06117.47.0	06J109259A	AUDI	7.06117.26.0
06E109257M	VOLKSWAGEN	7.06117.47.0	06J109259A	SEAT	7.06117.26.0
06E109257N	AUDI	7.06117.47.0	06J109259A	SKODA	7.06117.26.0
06E109257N	VOLKSWAGEN	7.06117.47.0	06J109259A	VOLKSWAGEN	7.06117.26.0
06E109257S	AUDI	7.06117.47.0	06L109259	VOLKSWAGEN	7.06117.26.0
06E109257S	VOLKSWAGEN	7.06117.47.0	06L109259A	AUDI	7.06117.26.0
06E109257T	AUDI	7.06117.47.0	06L109259A	SEAT	7.06117.26.0
06E109257T	VOLKSWAGEN	7.06117.47.0	06L109259A	SKODA	7.06117.26.0
06F109257A	AUDI	7.06117.46.0	06L109259A	VOLKSWAGEN	7.06117.26.0
06F109257A	SEAT	7.06117.46.0	06L109259D	AUDI	7.06117.26.0
06F109257A	SKODA	7.06117.46.0	06L109259D	SKODA	7.06117.26.0
06F109257A	VOLKSWAGEN	7.06117.46.0	06L109259D	VOLKSWAGEN	7.06117.26.0
06F109257B	AUDI	7.06117.37.0	07.14.209	TRUCKTEC FAHRZEUGTEILE GM	7.00415.07.0
06F109257B	SEAT	7.06117.37.0	07.16.045	TRUCKTEC FAHRZEUGTEILE GM	7.02184.01.0
06F109257B	VOLKSWAGEN	7.06117.37.0	07.16.047	TRUCKTEC FAHRZEUGTEILE GM	7.02256.00.0
06F109257C	AUDI	7.06117.46.0	077906283B	AUDI	7.22687.50.0
06F109257C	SEAT	7.06117.46.0	077906283B	VOLKSWAGEN	7.22687.50.0
06F109257C	SKODA	7.06117.46.0	077906283D	AUDI	7.22687.50.0
06F109257C	VOLKSWAGEN	7.06117.46.0	077906283D	VOLKSWAGEN	7.22687.50.0
06F145710B	AUDI	7.00415.07.0	078133455D	AUDI	7.05432.12.0
06F145710B	VOLKSWAGEN	7.00415.07.0	078906283A	AUDI	7.22687.49.0
06F145710C	AUDI	7.00415.07.0	078906283A	BENTLEY	7.22687.49.0
06F145710C	SKODA	7.00415.07.0	078906283A	SEAT	7.22687.49.0
06F145710G	AUDI	7.00415.07.0	078906283A	SKODA	7.22687.49.0
06F145710G	SEAT	7.00415.07.0	078906283A	VOLKSWAGEN	7.22687.49.0
06F145710G	SKODA	7.00415.07.0	078906283C	AUDI	7.22687.49.0
06F145710G	VOLKSWAGEN	7.00415.07.0	078906283C	BENTLEY	7.22687.49.0
06F906283A	VOLKSWAGEN	7.00470.07.0	078906283C	SEAT	7.22687.49.0
06F906283B	VOLKSWAGEN	7.00470.07.0	078906283C	SKODA	7.22687.49.0
06F906283D	AUDI	7.00470.07.0	078906283C	VOLKSWAGEN	7.22687.49.0
06F906283D	SEAT	7.00470.07.0	079906283B	AUDI	7.28098.15.0
06F906283D	SKODA	7.00470.07.0	079906283B	VOLKSWAGEN	7.28098.15.0
06F906283D	VOLKSWAGEN	7.00470.07.0	079906283D	AUDI	7.28098.15.0
06F906283F	AUDI	7.00470.07.0	079906283D	VOLKSWAGEN	7.28098.15.0
06F906283F	SEAT	7.00470.07.0	08.12.083	TRUCKTEC FAHRZEUGTEILE GM	7.06117.00.0
06F906283F	SKODA	7.00470.07.0	08.12.084	TRUCKTEC FAHRZEUGTEILE GM	7.06117.02.0
06F906283F	VOLKSWAGEN	7.00470.07.0	08.12.085	TRUCKTEC FAHRZEUGTEILE GM	7.06117.01.0
06H109259A	AUDI	7.06117.26.0	08.12.086	TRUCKTEC FAHRZEUGTEILE GM	7.06117.36.0
06H109259A	SEAT	7.06117.26.0	08.16.011	TRUCKTEC FAHRZEUGTEILE GM	7.22796.01.0
06H109259A	SKODA	7.06117.26.0	08.16.020	TRUCKTEC FAHRZEUGTEILE GM	7.00887.22.0
06H109259A	VOLKSWAGEN	7.06117.26.0	08187	VDO	7.05432.11.0
06H109259C	AUDI	7.06117.26.0	08424	OSSCA	7.05432.12.0
06H109259C	VOLKSWAGEN	7.06117.26.0	0892016	METZGER	7.03085.02.0
06H145710C	AUDI	7.02901.05.0			
06H145710C	SEAT	7.02901.05.0			
06H145710C	SKODA	7.02901.05.0			
06H145710C	VOLKSWAGEN	7.02901.05.0			
06H145710D	AUDI	7.01830.13.0			
06H145710D	SEAT	7.01830.13.0			
06H145710D	SKODA	7.01830.13.0			
06H145710D	VOLKSWAGEN	7.01830.13.0			

NUMBERFINDER

REF-No.		REF-No.			
0892026	METZGER	7.21903.48.0	0892571	METZGER	7.28311.04.0
0892046	METZGER	7.02256.50.0	0892579	METZGER	7.01777.18.0
0892059	METZGER	7.03088.01.0	0892580	METZGER	7.02256.20.0
0892070	METZGER	7.02256.19.0	0892581	METZGER	7.02212.02.0
0892077	METZGER	7.02256.00.0	0892582	METZGER	7.28328.07.0
0892084	METZGER	7.02256.48.0	0892583	METZGER	7.22903.19.0
0892109	METZGER	7.02256.03.0	0892586	METZGER	7.22240.15.0
0892110	METZGER	7.04247.02.0	0892588	METZGER	7.00782.12.0
0892114	METZGER	7.02256.22.0	0892592	METZGER	7.00868.02.0
0892116	METZGER	7.02184.01.0	0892619	METZGER	7.02256.48.0
0892119	METZGER	7.00580.01.0	0892660	METZGER	7.00580.01.0
0892121	METZGER	7.01830.13.0	0892661	METZGER	7.00262.02.0
0892127	METZGER	7.03073.01.0	0892666	METZGER	7.02183.01.0
0892128	METZGER	7.04423.01.0	0892668	METZGER	7.01421.01.0
0892141	METZGER	7.00470.07.0	0892670	METZGER	7.00782.04.0
0892157	METZGER	7.01421.01.0	0892671	METZGER	7.21903.63.0
0892162	METZGER	7.02256.07.0	0892672	METZGER	7.02063.02.0
0892163	METZGER	7.00968.04.0	0892676	METZGER	7.00887.19.0
0892198	METZGER	7.02461.01.0	0892678	METZGER	7.22903.16.0
0892201	METZGER	7.22355.01.0	0892679	METZGER	7.00272.03.0
0892212	METZGER	7.00868.02.0	0892680	METZGER	7.03280.04.0
0892213	METZGER	7.22796.01.0	0892713	METZGER	7.00887.22.0
0892214	METZGER	7.28098.04.0	0892718	METZGER	7.01814.12.0
0892215	METZGER	7.02588.04.0	0892722	METZGER	7.02256.23.0
0892217	METZGER	7.00262.02.0	0892724	METZGER	7.02909.07.0
0892218	METZGER	7.00782.04.0	0892727	METZGER	7.00326.03.0
0892263	METZGER	7.21071.50.0	0892729	METZGER	7.22908.03.0
0892264	METZGER	7.00513.10.0	0892815	METZGER	7.00017.03.0
0892267	METZGER	7.28197.16.0	0899004	METZGER	7.06117.54.0
0892269	METZGER	7.02063.02.0	0899007	METZGER	7.02256.41.0
0892270	METZGER	7.01777.17.0	0899008	METZGER	7.06117.07.0
0892274	METZGER	7.01019.01.0	0899009	METZGER	7.06117.08.0
0892275	METZGER	7.22240.13.0	0899011	METZGER	7.06117.05.0
0892281	METZGER	7.04216.05.0	0899012	METZGER	7.06117.06.0
0892282	METZGER	7.03833.02.0	0899035	METZGER	7.06117.26.0
0892283	METZGER	7.01762.04.0	0899047	METZGER	7.06117.00.0
0892287	METZGER	7.01870.06.0	0899065	METZGER	7.06117.35.0
0892288	METZGER	7.00782.12.0	0899065	METZGER	7.06117.38.0
0892290	METZGER	7.02256.49.0	0899090	METZGER	7.06117.20.0
0892293	METZGER	7.00607.02.0	0899092	METZGER	7.06117.00.0
0892294	METZGER	7.00782.16.0	0899104	METZGER	7.06117.01.0
0892295	METZGER	7.00964.03.0	0899109	METZGER	7.06117.46.0
0892296	METZGER	7.02256.17.0	0899111	METZGER	7.06117.45.0
0892297	METZGER	7.02256.27.0	0899112	METZGER	7.06117.60.0
0892299	METZGER	7.00612.01.0	0899121	METZGER	7.06117.37.0
0892300	METZGER	7.03003.01.0	0899122	METZGER	7.06117.48.0
0892302	METZGER	7.00887.19.0	0899126	METZGER	7.06117.55.0
0892305	METZGER	7.02221.01.0	0899146	METZGER	7.06117.14.0
0892306	METZGER	7.02901.05.0	0899150	METZGER	7.06117.47.0
0892308	METZGER	7.02256.24.0	0899258	METZGER	7.08681.00.0
0892314	METZGER	7.01633.04.0	0899260	METZGER	7.08681.04.0
0892333	METZGER	7.01044.03.0	0899261	METZGER	7.08681.05.0
0892335	METZGER	7.01835.06.0	0899262	METZGER	7.08681.06.0
0892338	METZGER	7.01024.02.0	08SKV036	ESEN SKV	7.05432.12.0
0892345	METZGER	7.00272.03.0	08SKV222	ESEN SKV	7.06269.28.0
0892381	METZGER	7.01115.08.0	08SKV232	ESEN SKV	7.06269.27.0
0892392	METZGER	7.01343.04.0	08SKV235	ESEN SKV	7.05432.13.0
0892394	METZGER	7.03653.01.0	0908001	METZGER	7.06269.02.0
0892395	METZGER	7.01633.06.0	0908002	METZGER	7.05432.01.0
0892423	METZGER	7.00887.22.0	0908003	METZGER	7.05432.00.0
0892424	METZGER	7.00887.21.0	0908005	METZGER	7.06269.01.0
0892453	METZGER	7.22880.01.0	0908006	METZGER	7.06269.03.0
0892455	METZGER	7.01632.02.0	0908007	METZGER	7.06269.04.0
0892461	METZGER	7.02256.18.0	0908008	METZGER	7.06269.23.0
0892467	METZGER	7.21903.70.0	0908010	METZGER	7.06269.22.0
0892499	METZGER	7.02325.05.0	0908011	METZGER	7.05432.13.0
0892559	METZGER	7.02184.01.0	0908012	METZGER	7.06269.27.0
0892561	METZGER	7.04423.01.0	0908013	METZGER	7.06269.24.0
0892562	METZGER	7.22796.01.0	0908014	METZGER	4.02003.62.0



REF-No.		 PIERBURG	REF-No.		 PIERBURG
0908016	METZGER	7.05432.11.0	1110967	FORD	7.05432.03.0
0908019	METZGER	7.05432.02.0	1111360	FORD	7.02183.01.0
0908020	METZGER	7.05432.06.0	1111361	FORD	7.02256.00.0
0908029	METZGER	7.05432.09.0	1111362	FORD	7.01037.02.0
0908042	METZGER	7.06269.06.0	1111363	FORD	7.02184.01.0
0908045	METZGER	7.06269.05.0	1112424	FORD	7.28098.04.0
0908046	METZGER	7.06269.21.0	1112972	FORD	7.06269.04.0
0908053	METZGER	7.05432.04.0	1113127	FORD	7.06269.23.0
0908055	METZGER	7.05432.12.0	1113873	FORD	7.06269.22.0
0908058	METZGER	7.06269.10.0	1115249	FORD	7.06269.00.0
0908059	METZGER	7.06269.11.0	1115250	FORD	7.06269.05.0
0908069	METZGER	7.06269.03.0	1116004100	JP GROUP	7.02256.00.0
09110714	OPEL	7.02256.19.0	1116006100	JP GROUP	7.02183.01.0
09110714	VAUXHALL	7.02256.19.0	1116006200	JP GROUP	7.00470.07.0
09110766	OPEL	7.02256.04.0	1116006500	JP GROUP	7.00580.01.0
09110766	VAUXHALL	7.02256.04.0	1117550200	JP GROUP	7.01830.13.0
0928400309	BOSCH	7.02256.23.0	1119900602	JP GROUP	7.02184.01.0
0928400414	BOSCH	7.02256.24.0	1119940	FORD	7.02256.51.0
0928400464	BOSCH	7.02256.25.0	11331764001	VIKA	7.10014.00.0
0928400530	BOSCH	7.02256.31.0	11360149817	BMW	7.06117.00.0
0928400536	BOSCH	7.02256.26.0	11360149817	ROLLS-ROYCE	7.06117.00.0
0928402197	BOSCH	7.02256.27.0	11360410035	BMW	7.06117.00.0
1003802	FORD	7.21903.70.0	11360410035	ROLLS-ROYCE	7.06117.00.0
1003803	FORD	7.21895.55.0	11361433667	BMW	7.06117.10.0
1008370102	AUTOMEGA	7.06269.01.0	11361707323	BMW	7.06117.00.0
1008990026	MEYLE	7.05432.00.0	11361707323	ROLLS-ROYCE	7.06117.00.0
10106275	SWAG	7.00017.03.0	11367501775	BMW	7.06117.10.0
101169	FEBI	7.00380.11.0	11367516293	BMW	7.06117.01.0
1014398	FORD	7.06269.02.0	11367524489	BMW	7.06117.10.0
102108	FEBI	7.05432.02.0	11367560462	BMW	7.06117.00.0
1022494	FORD	7.06269.24.0	11367560462	ROLLS-ROYCE	7.06117.00.0
102775	FEBI	7.06117.02.0	11367561265	BMW	7.06117.36.0
102993	FEBI	7.06117.14.0	11367561265	ROLLS-ROYCE	7.06117.36.0
1030996	FORD	7.06269.27.0	11367564734	BMW	7.06117.02.0
1031090	FORD	7.21903.75.0	11367564734	MINI (BMW)	7.06117.02.0
103204	FEBI	7.01771.01.0	11367566652	BMW	7.06117.02.0
103359	FEBI	7.06117.10.0	11367566652	MINI (BMW)	7.06117.02.0
103360	FEBI	7.06117.01.0	11367585425	BMW	7.06117.01.0
103361	FEBI	7.06117.00.0	11367585776	BMW	7.06117.36.0
1037136	FORD	7.21483.54.0	11367585776	ROLLS-ROYCE	7.06117.36.0
104311	FEBI	7.06117.39.0	11367587760	BMW	7.06117.02.0
1058383	FORD	4.02003.62.0	11367587760	MINI (BMW)	7.06117.02.0
1058430	FORD	7.02256.47.0	11367604292	BMW	7.06117.02.0
1058510073	AUTOMEGA	7.01420.02.0	11367604292	MINI (BMW)	7.06117.02.0
106275	FEBI	7.00017.03.0	11367610060	BMW	7.06117.36.0
1063996	FORD	7.06269.02.0	11367838467	BMW	7.06117.58.0
107437	FEBI	7.06117.46.0	11367841700	BMW	7.06117.58.0
107454	FEBI	7.06117.36.0	11367843117	BMW	7.06117.58.0
1075436	FORD	7.06269.04.0	11367851299	BMW	7.06117.36.0
1079561	FORD	7.02256.07.0	11368605123	BMW	7.06117.36.0
108232	FEBI	7.02256.18.0	11368605123	ROLLS-ROYCE	7.06117.36.0
1086369	FORD	7.06269.03.0	11368610388	BMW	7.06117.02.0
108816	TOPRAN	7.02183.01.0	11368610388	MINI (BMW)	7.06117.02.0
108817	TOPRAN	7.02184.01.0	113758	TOPRAN	7.05432.12.0
108818	TOPRAN	7.00868.02.0	1148062	FORD	7.00964.03.0
10921AA220	SUBARU	7.06117.41.0	1149611	FORD	7.06269.04.0
10921AA230	SUBARU	7.06117.41.0	1149683	FORD	7.05432.13.0
10921AA231	SUBARU	7.06117.41.0	115383	TOPRAN	7.02256.00.0
10948644	SWAG	7.22355.01.0	1158510073	AUTOMEGA	7.01420.02.0
110500	SEIM	7.05432.11.0	115962	TOPRAN	7.10014.00.0
110502	SEIM	7.05432.02.0	116493	TOPRAN	7.22402.03.0
110510	SEIM	7.05432.01.0	116500	TOPRAN	7.01830.13.0
110519	SEIM	7.05432.06.0	11657552946	BMW	7.01777.17.0
1108370102	AUTOMEGA	7.06269.01.0	11657552946	MINI (BMW)	7.01777.17.0
11091712101	VIKA	7.06117.46.0	11657566324	MINI (BMW)	7.01115.08.0
11091777601	VIKA	7.06117.47.0	11657566781	BMW	7.01777.17.0
11091777701	VIKA	7.06117.47.0	11657566781	MINI (BMW)	7.01777.17.0
11091777801	VIKA	7.06117.42.0	11657578683	MINI (BMW)	7.01115.08.0
11102775	SWAG	7.06117.02.0	11657590581	BMW	7.01762.04.0

NUMBERFINDER

REF-No.		 PIERBURG	REF-No.		 PIERBURG
11657593273	MINI (BMW)	7.01115.08.0	1247969	OPEL	7.06117.57.0
11657595373	BMW	7.01777.17.0	1247969	VAUXHALL	7.06117.57.0
11657595373	MINI (BMW)	7.01777.17.0	1247970	OPEL	7.06117.56.0
11657599547	BMW	7.01777.17.0	1247970	VAUXHALL	7.06117.56.0
11657599547	MINI (BMW)	7.01777.17.0	1251026	FORD	7.02256.48.0
11657602293	BMW	7.01762.04.0	12568078	BUICK	7.06117.03.0
11657609210	BMW	7.04216.05.0	12568078	CHEVROLET	7.06117.03.0
11657609210	ROLLS-ROYCE	7.04216.05.0	12568078	GMC	7.06117.03.0
11657808032	BMW	7.02256.27.0	12568078	HUMMER	7.06117.03.0
11657808032	MINI (BMW)	7.02256.27.0	12568078	OLDSMOBILE	7.06117.03.0
11657811814	BMW	7.02256.27.0	12568078	SAAB	7.06117.03.0
11657811814	MINI (BMW)	7.02256.27.0	12576768	BUICK	7.06117.03.0
11658509323	BMW	7.02256.27.0	12576768	CHEVROLET	7.06117.03.0
11658509323	MINI (BMW)	7.02256.27.0	12576768	GMC	7.06117.03.0
11658636606	MINI (BMW)	7.05367.05.0	12576768	HUMMER	7.06117.03.0
116895	TOPRAN	7.02901.05.0	12576768	OLDSMOBILE	7.06117.03.0
116957	TOPRAN	7.02256.41.0	12576768	SAAB	7.06117.03.0
116983	TOPRAN	7.22903.19.0	12578	OSSCA	7.06269.03.0
11740396414	BMW	7.02318.01.0	12578517	BUICK	7.06117.05.0
11741741130	BMW	7.02318.01.0	12578517	CHEVROLET	7.06117.05.0
11741742712	BMW	7.02318.01.0	12578517	OPEL	7.06117.05.0
11742246175	BMW	7.21903.73.0	12578517	PONTIAC	7.06117.05.0
11742247906	BMW	7.22796.01.0	12578517	VAUXHALL	7.06117.05.0
11747537612	BMW	7.00784.01.0	12578518	BUICK	7.06117.06.0
11747548706	BMW	7.00887.19.0	12578518	CHEVROLET	7.06117.06.0
11747582652	BMW	7.00887.20.0	12578518	OPEL	7.06117.06.0
11747584628	BMW	7.00887.21.0	12578518	PONTIAC	7.06117.06.0
11747584628	ROLLS-ROYCE	7.00887.21.0	12578518	VAUXHALL	7.06117.06.0
11747595374	BMW	7.00887.19.0	12586722	BUICK	7.06117.04.0
11747595375	BMW	7.00887.20.0	12586722	CADILLAC	7.06117.04.0
11747626350	BMW	7.00887.19.0	12588943	CHEVROLET	7.06117.04.0
11747626351	BMW	7.00887.21.0	12588943	OPEL	7.06117.04.0
11747626351	ROLLS-ROYCE	7.00887.21.0	12588943	VAUXHALL	7.06117.04.0
11747628987	BMW	7.00887.20.0	12597025	BUICK	7.06117.03.0
11747649407	BMW	7.00887.22.0	12597025	CHEVROLET	7.06117.03.0
11747796338	BMW	7.02256.27.0	12597025	GMC	7.06117.03.0
11747796338	MINI (BMW)	7.02256.27.0	12597025	HUMMER	7.06117.03.0
11747796634	BMW	7.22796.01.0	12597025	OLDSMOBILE	7.06117.03.0
11747805391	BMW	7.02063.02.0	12597025	SAAB	7.06117.03.0
11747810831	BMW	7.02318.01.0	12599817	OPEL	5.02549.03.0
11747810831	MINI (BMW)	7.02318.01.0	12599817	VAUXHALL	5.02549.03.0
11747810831	ROLLS-ROYCE	7.02318.01.0	12602516	BUICK	7.06117.03.0
117714	TOPRAN	7.06117.47.0	12602516	CHEVROLET	7.06117.03.0
12.27015	DT-DIESEL TECHNIC AG	7.05432.02.0	12602516	GMC	7.06117.03.0
12123-00QAA	NISSAN	7.08681.15.0	12602516	HUMMER	7.06117.03.0
1216000200	JP GROUP	7.06269.01.0	12602516	OLDSMOBILE	7.06117.03.0
1227883	FORD	7.00036.03.0	12602516	SAAB	7.06117.03.0
1231919	FORD	7.00964.03.0	12603911	OPEL	5.02549.03.0
1231919	FORD	7.28328.07.0	12603911	VAUXHALL	5.02549.03.0
1235022	OPEL	7.06117.07.0	12615613	CHEVROLET	7.06117.04.0
1235022	VAUXHALL	7.06117.07.0	12615613	OPEL	7.06117.04.0
1235039	OPEL	7.06117.04.0	12615613	VAUXHALL	7.06117.04.0
1235039	VAUXHALL	7.06117.04.0	12615873	BUICK	7.06117.03.0
1235095	OPEL	7.06117.05.0	12615873	CHEVROLET	7.06117.03.0
1235095	VAUXHALL	7.06117.05.0	12615873	GMC	7.06117.03.0
1235116	OPEL	7.06117.05.0	12615873	HUMMER	7.06117.03.0
1235116	VAUXHALL	7.06117.05.0	12615873	OLDSMOBILE	7.06117.03.0
1235299	OPEL	7.06117.08.0	12615873	SAAB	7.06117.03.0
1235299	VAUXHALL	7.06117.08.0	12626012	CHEVROLET	7.06117.04.0
1235417	OPEL	7.06117.04.0	12626012	GMC	7.06117.04.0
1235417	VAUXHALL	7.06117.04.0	12626012	OPEL	7.06117.04.0
1247368	OPEL	7.06117.06.0	12626012	VAUXHALL	7.06117.04.0
1247368	VAUXHALL	7.06117.06.0	12627116	BUICK	7.06117.56.0
1247631	OPEL	7.06117.06.0	12627116	CADILLAC	7.06117.56.0
1247631	VAUXHALL	7.06117.06.0	12627116	CHEVROLET	7.06117.56.0
1247756	OPEL	7.06117.56.0	12627116	GMC	7.06117.56.0
1247756	VAUXHALL	7.06117.56.0	12627116	OPEL	7.06117.56.0
1247757	OPEL	7.06117.57.0	12627116	VAUXHALL	7.06117.56.0
1247757	VAUXHALL	7.06117.57.0	12627117	BUICK	7.06117.57.0



REF-No.		 PIERBURG	REF-No.		 PIERBURG
12627117	CADILLAC	7.06117.57.0	12655421	BUICK	7.06117.06.0
12627117	CHEVROLET	7.06117.57.0	12655421	CHEVROLET	7.06117.06.0
12627117	GMC	7.06117.57.0	12655421	OPEL	7.06117.06.0
12627117	OPEL	7.06117.57.0	12655421	PONTIAC	7.06117.06.0
12627117	VAUXHALL	7.06117.57.0	12655421	SAAB	7.06117.06.0
12628347	BUICK	7.06117.05.0	12655421	VAUXHALL	7.06117.06.0
12628347	CHEVROLET	7.06117.05.0	12655433	BUICK	7.06117.56.0
12628347	OPEL	7.06117.05.0	12655433	CADILLAC	7.06117.56.0
12628347	PONTIAC	7.06117.05.0	12655433	CHEVROLET	7.06117.56.0
12628347	SAAB	7.06117.05.0	12655433	GMC	7.06117.56.0
12628347	VAUXHALL	7.06117.05.0	12655433	OPEL	7.06117.56.0
12628348	BUICK	7.06117.06.0	12655433	VAUXHALL	7.06117.56.0
12628348	CHEVROLET	7.06117.06.0	12655434	BUICK	7.06117.57.0
12628348	OPEL	7.06117.06.0	12655434	CADILLAC	7.06117.57.0
12628348	PONTIAC	7.06117.06.0	12655434	CHEVROLET	7.06117.57.0
12628348	SAAB	7.06117.06.0	12655434	GMC	7.06117.57.0
12628348	VAUXHALL	7.06117.06.0	12655434	OPEL	7.06117.57.0
12633354	OPEL	7.02721.06.0	12655434	VAUXHALL	7.06117.57.0
12633354	VAUXHALL	7.02721.06.0	12662736	BUICK	7.06117.57.0
12633355	BUICK	5.02549.03.0	12662736	CADILLAC	7.06117.57.0
12633355	CHEVROLET	5.02549.03.0	12662736	CHEVROLET	7.06117.57.0
12633355	PONTIAC	5.02549.03.0	12662736	GMC	7.06117.57.0
12633355	SATURN	5.02549.03.0	12662736	OPEL	7.06117.57.0
12633411	OPEL	5.02549.03.0	12662736	VAUXHALL	7.06117.57.0
12633411	VAUXHALL	5.02549.03.0	12662737	BUICK	7.06117.56.0
12636175	BUICK	7.06117.04.0	12662737	CADILLAC	7.06117.56.0
12636175	CADILLAC	7.06117.04.0	12662737	CHEVROLET	7.06117.56.0
12636175	CHEVROLET	7.06117.04.0	12662737	GMC	7.06117.56.0
12636175	GMC	7.06117.04.0	12662737	OPEL	7.06117.56.0
12636175	OPEL	7.06117.04.0	12662737	VAUXHALL	7.06117.56.0
12636175	PONTIAC	7.06117.04.0	12787706	CADILLAC	7.28311.04.0
12636175	SAAB	7.06117.04.0	12787706	OPEL	7.28311.04.0
12636175	SATURN	7.06117.04.0	12787706	SAAB	7.28311.04.0
12636175	VAUXHALL	7.06117.04.0	12787706	VAUXHALL	7.28311.04.0
12646783	BUICK	7.06117.05.0	12791172	CADILLAC	7.00045.00.0
12646783	CHEVROLET	7.06117.05.0	12791172	OPEL	7.00045.00.0
12646783	OPEL	7.06117.05.0	12791172	SAAB	7.00045.00.0
12646783	PONTIAC	7.06117.05.0	12791172	VAUXHALL	7.00045.00.0
12646783	SAAB	7.06117.05.0	12798364	CADILLAC	7.00175.04.0
12646783	VAUXHALL	7.06117.05.0	12798364	OPEL	7.00175.04.0
12646784	BUICK	7.06117.06.0	12798364	SAAB	7.00175.04.0
12646784	CHEVROLET	7.06117.06.0	12798364	VAUXHALL	7.00175.04.0
12646784	OPEL	7.06117.06.0	1297000100	JP GROUP	7.05432.01.0
12646784	PONTIAC	7.06117.06.0	1297000200	JP GROUP	7.05432.00.0
12646784	SAAB	7.06117.06.0	1297000300	JP GROUP	7.05432.11.0
12646784	VAUXHALL	7.06117.06.0	12992408	CHEVROLET	7.06117.08.0
12649146	BUICK	7.03357.04.0	12992408	OPEL	7.06117.08.0
12649146	CADILLAC	7.03357.04.0	12992408	VAUXHALL	7.06117.08.0
12649146	CHEVROLET	7.03357.04.0	1305301	FORD	7.28328.07.0
12649146	OPEL	7.03357.04.0	13105950	CHEVROLET	7.02256.38.0
12649146	VAUXHALL	7.03357.04.0	13105950	OPEL	7.02256.38.0
12653327	BUICK	7.03381.15.0	13105950	VAUXHALL	7.02256.38.0
12653327	CADILLAC	7.03381.15.0	1313848	FORD	7.00968.04.0
12653327	CHEVROLET	7.03381.15.0	1355856	FORD	7.06117.55.0
12653327	OPEL	7.03381.15.0	1357313	FORD	7.02256.48.0
12653327	VAUXHALL	7.03381.15.0	1357314	FORD	7.02256.51.0
12653613	BUICK	7.03381.14.0	1358402	FORD	7.06269.22.0
12653613	OPEL	7.03381.14.0	13637591625	BMW	7.03075.02.0
12653613	VAUXHALL	7.03381.14.0	1371924	FORD	7.28197.16.0
12653854	BUICK	7.02721.06.0	1381190	FORD	7.01349.01.0
12653854	CHEVROLET	7.02721.06.0	138671	HUECO	7.06269.03.0
12653854	OPEL	7.02721.06.0	138672	HITACHI	7.06269.02.0
12653854	VAUXHALL	7.02721.06.0	138672	HUECO	7.06269.02.0
12655420	BUICK	7.06117.05.0	138673	HUECO	7.06269.00.0
12655420	CHEVROLET	7.06117.05.0	138674	HUECO	7.06269.05.0
12655420	OPEL	7.06117.05.0	138675	HUECO	7.06269.11.0
12655420	PONTIAC	7.06117.05.0	138676	HUECO	7.06269.07.0
12655420	SAAB	7.06117.05.0	138678	HUECO	7.06269.01.0
12655420	VAUXHALL	7.06117.05.0	138682	HUECO	7.06269.09.0

NUMBERFINDER



REF-No.			REF-No.		
138688	HUECO	7.06269.06.0	1449602	FORD	7.01771.01.0
138693	HITACHI	7.06269.26.0	14788	STANDARD	7.05432.09.0
138694	HUECO	7.06269.10.0	14789	STANDARD	7.05432.04.0
1387082	FORD	7.01122.03.0	14793	STANDARD	7.05432.02.0
139311	HITACHI	7.02256.27.0	14799	STANDARD	7.05432.01.0
139312	HITACHI	7.02256.24.0	14800	STANDARD	7.05432.00.0
139325	HITACHI LI	7.01870.06.0	14802	STANDARD	7.06269.01.0
139326	HITACHI	7.01762.04.0	14804	STANDARD	7.05432.06.0
139327	HITACHI	7.01830.13.0	14825	STANDARD	7.05432.12.0
139328	HITACHI	7.00470.07.0	14827	STANDARD	7.06269.20.0
139329	HITACHI	7.02256.49.0	14829	STANDARD	7.06269.03.0
139331	HITACHI	7.02588.04.0	14834	STANDARD	7.06269.04.0
139332	HITACHI	7.01037.02.0	14835	STANDARD	7.06269.23.0
139333	HITACHI	7.22240.13.0	14836	STANDARD	7.06269.02.0
139334	HITACHI	7.00272.03.0	14838	STANDARD	7.05432.03.0
139335	HITACHI	7.00580.01.0	14839	STANDARD	7.06269.22.0
139336	HITACHI	7.01019.01.0	14840	STANDARD	7.05432.13.0
139337	HITACHI	7.02063.02.0	14842	STANDARD	7.06269.27.0
139338	HITACHI	7.02183.01.0	14843	STANDARD	7.06269.24.0
139339	HITACHI	7.00513.10.0	14845	STANDARD	7.06269.26.0
139340	HITACHI	7.00868.02.0	14847	STANDARD	7.05432.11.0
139341	HITACHI	7.00968.04.0	14852	STANDARD	7.06269.10.0
139343	HITACHI	7.02184.01.0	14854	STANDARD	7.06269.06.0
139345	HITACHI	7.03085.02.0	14875	STANDARD	7.06269.28.0
139348	HITACHI	7.01771.01.0	14877	STANDARD	7.06269.05.0
139350	HITACHI	7.22796.01.0	14879	STANDARD	7.06269.21.0
139354	HITACHI LI	7.21903.70.0	14956-00Q0C	NISSAN	7.02256.21.0
140015610	AUTOMEGA	7.02256.00.0	14956-00Q0H	NISSAN	7.02256.21.0
1406290	FORD	7.01122.03.0	14956-00Q1K	NISSAN	7.02256.17.0
1406752	FORD	7.01349.01.0	14956-00Q1L	NISSAN	7.01814.12.0
14103	STANDARD	7.22240.15.0	14956-00Q1M	NISSAN	7.01814.12.0
14104	STANDARD	7.02318.01.0	14956-00Q1P	NISSAN	7.01343.04.0
14104	STANDARD	7.28170.03.0	14956-00Q2B	NISSAN	7.01814.22.0
14132	STANDARD	7.22138.50.0	14956-00QAA	NISSAN	7.02256.04.0
1416000600	JP GROUP	7.22796.01.0	14956-00QAL	NISSAN	7.02256.21.0
14182	OSSCA	7.06269.02.0	14956-3VD0A	NISSAN	7.01814.12.0
142-45	STANDARD	7.22903.17.0	14956-4ED0A	NISSAN	7.01343.04.0
14209	STANDARD	7.22796.01.0	14956-AW400	NISSAN	7.00265.02.0
14220	STANDARD	7.00612.01.0	14956-AW401	NISSAN	7.00265.02.0
14221	STANDARD	7.02256.50.0	14956-EB300	NISSAN	7.02212.02.0
14222	STANDARD	7.01024.02.0	14956-EB30A	NISSAN	7.02212.02.0
14226	STANDARD	7.02256.49.0	14956-EB70A	NISSAN	7.02212.02.0
14227	STANDARD	7.21483.54.0	14956-EB70B	NISSAN	7.02212.02.0
14232	STANDARD	7.01805.01.0	14956-JD70A	NISSAN	7.02256.17.0
14233	STANDARD	7.02183.01.0	14956-JF00A	NISSAN	7.01738.01.0
14234	STANDARD	7.02256.22.0	149566740R	RENAULT	7.01814.22.0
14235	STANDARD	7.02256.14.0	149567097R	RENAULT	7.02256.17.0
14237	STANDARD	7.00968.04.0	14SKV913	ESEN SKV	7.02256.00.0
14243	STANDARD	7.02063.02.0	150013610	AUTOMEGA	7.05432.13.0
14248	STANDARD	7.02256.00.0	150026710	AUTOMEGA	7.05432.12.0
14249	STANDARD	7.02256.48.0	1514130	FORD	7.02256.00.0
14250	STANDARD	7.01343.04.0	1520531	FORD	7.01037.02.0
14252	STANDARD	7.01777.17.0	152412073R	DACIA	7.08681.15.0
14253	STANDARD	7.22240.13.0	152412073R	RENAULT	7.08681.15.0
14263	STANDARD	7.02256.26.0	152417599R	DACIA	7.08681.15.0
14269	STANDARD	7.03280.04.0	152417599R	RENAULT	7.08681.15.0
14270	STANDARD	7.03280.04.0	1541400	FORD	7.00607.02.0
14280	STANDARD	7.01835.06.0	154384	FERRARI	7.01805.01.0
14282	STANDARD	7.02901.05.0	1544172	FORD	7.06117.38.0
14285	STANDARD	7.03554.10.0	1562514	FORD	7.00607.02.0
14291	STANDARD	7.02588.04.0	1594606	FORD	7.02184.01.0
14292	STANDARD	7.01044.03.0	1594631	FORD	7.02183.01.0
1430793	FORD	7.01122.03.0	161842	CITROEN	7.00612.01.0
1433667	BMW	7.06117.10.0	161842	PEUGEOT	7.00612.01.0
1437213	FORD	7.02256.39.0	1618C9	CITROEN	7.00968.04.0
14483-00Q0A	NISSAN	7.01152.02.0	1618C9	PEUGEOT	7.00968.04.0
144839204R	DACIA	7.02476.09.0	1618J6	CITROEN	7.00612.01.0
144839204R	RENAULT	7.02476.09.0	1618J6	PEUGEOT	7.00612.01.0
1448857	FORD	7.02256.25.0	1618JH	CITROEN	7.00968.04.0



REF-No.		 PIERBURG	REF-No.		 PIERBURG
1618JH	PEUGEOT	7.00968.04.0	17301	STANDARD	7.06117.08.0
1618PE	CITROEN	7.01633.06.0	17302	STANDARD	7.06117.38.0
1618PE	DS	7.01633.06.0	17304	STANDARD	7.06117.34.0
1618PE	PEUGEOT	7.01633.06.0	17307	STANDARD	7.06117.07.0
1618QW	CITROEN	7.01981.07.0	17308	STANDARD	7.06117.01.0
1618QW	PEUGEOT	7.01981.07.0	17309	STANDARD	7.06117.02.0
1618S4	CITROEN	7.01632.02.0	17310	STANDARD	7.06117.54.0
1618S4	PEUGEOT	7.01632.02.0	17312	STANDARD	7.06117.48.0
1618X2	CITROEN	7.01633.04.0	17313	STANDARD	7.06117.45.0
1618X2	PEUGEOT	7.01633.04.0	17314	STANDARD	7.08681.09.0
162625	CITROEN	7.02256.03.0	17315	STANDARD	7.06117.15.0
162625	PEUGEOT	7.02256.03.0	17318	STANDARD	7.06117.00.0
1628247	FORD	7.06269.26.0	17324	STANDARD	7.06117.26.0
1628924280	CITROEN	7.06117.45.0	17348	STANDARD	7.06117.46.0
1628924280	DS	7.06117.45.0	17351	STANDARD	7.06117.47.0
1628924280	OPEL	7.06117.45.0	173543	FEBI	7.01777.17.0
1628924280	PEUGEOT	7.06117.45.0	1741240	FORD	7.07400.01.0
1628924280	VAUXHALL	7.06117.45.0	1742031	FORD	7.07400.19.0
1628HC	CITROEN	7.02256.23.0	174380	FEBI	7.06117.47.0
1628HC	PEUGEOT	7.02256.23.0	1761191	FORD	7.06117.12.0
1628LQ	CITROEN	7.02256.24.0	17670-0W010	LEXUS	7.04654.10.0
1628LQ	PEUGEOT	7.02256.24.0	17670-0W010	TOYOTA	7.04654.10.0
1628LR	CITROEN	7.02256.23.0	17670-0W011	LEXUS	7.04654.10.0
1628LR	PEUGEOT	7.02256.23.0	17670-0W011	TOYOTA	7.04654.10.0
1628ZT	CITROEN	7.00964.03.0	1767049	FORD	7.07400.12.0
1628ZT	PEUGEOT	7.00964.03.0	178309	FERRARI	7.22687.44.0
1684632	FORD	7.06117.52.0	18007	OSSCA	7.06117.42.0
1690936	FORD	7.07400.01.0	18008	OSSCA	7.06117.47.0
1699659	FORD	7.07400.01.0	18009	OSSCA	7.06117.47.0
17-0097	MAXGEAR	7.22903.17.0	18011	OSSCA	7.06117.46.0
17-0098	MAXGEAR	7.22903.16.0	1801870	FORD	7.04615.03.0
17-0101	MAXGEAR	7.00868.02.0	1810809	FORD	7.04492.07.0
17-0102	MAXGEAR	7.00580.01.0	18117-73J00	SUZUKI	7.02256.24.0
17-0104	MAXGEAR	7.02063.02.0	18117-73J00-000	SUZUKI	7.02256.24.0
17-0105	MAXGEAR	7.00887.19.0	18117-79J50	SUZUKI	7.02534.01.0
17-0107	MAXGEAR	7.02256.26.0	18117-79J51	SUZUKI	7.02534.01.0
17-0111	MAXGEAR	7.02256.23.0	18117-79J51-000	SUZUKI	7.02534.01.0
17-0174	MAXGEAR	7.00612.01.0	18137-84E00	SUZUKI	7.02256.28.0
170182	FEBI	7.06117.60.0	1820748	FORD	7.03162.09.0
170184	FEBI	7.06117.60.0	18523-63P00	SUZUKI	7.01981.07.0
1702205	FORD	7.07400.00.0	18643	FEBI	7.06269.01.0
170365	FEBI	7.02318.01.0	1875539	FORD	7.07400.13.0
1706722	FORD	7.07400.00.0	18792	OSSCA	7.06117.55.0
1707323	BMW	7.06117.00.0	18793	OSSCA	7.06117.04.0
1707323	ROLLS-ROYCE	7.06117.00.0	18873	OSSCA	7.06117.03.0
17108187	OPEL	7.05432.11.0	18874	OSSCA	7.06117.10.0
17108187	VAUXHALL	7.05432.11.0	18875	OSSCA	7.06117.53.0
17111946	BUICK	7.05432.11.0	18876	OSSCA	7.06117.52.0
17111946	OLDSMOBILE	7.05432.11.0	19061285601	VIKA	7.00470.07.0
17111946	OPEL	7.05432.11.0	19204X	CITROEN	7.05432.06.0
17111946	PONTIAC	7.05432.11.0	19204X	PEUGEOT	7.05432.06.0
17111946	VAUXHALL	7.05432.11.0	1920FX	CITROEN	7.06117.34.0
17111947	OPEL	7.05432.11.0	1920FX	PEUGEOT	7.06117.34.0
17111947	VAUXHALL	7.05432.11.0	1920GR	CITROEN	7.06117.34.0
17112023	OPEL	7.05432.00.0	1920GR	PEUGEOT	7.06117.34.0
17112023	VAUXHALL	7.05432.00.0	1920N1	CITROEN	7.05432.02.0
17112027	GM HOLDEN LTD	7.05432.01.0	1920N1	PEUGEOT	7.05432.02.0
17112027	OPEL	7.05432.01.0	1920W6	CITROEN	7.05432.04.0
17112027	VAUXHALL	7.05432.01.0	1920W6	PEUGEOT	7.05432.04.0
17112031	OPEL	7.05432.00.0	1922R7	CITROEN	7.06117.45.0
17112031	VAUXHALL	7.05432.00.0	1922R7	DS	7.06117.45.0
17113196	OPEL	7.05432.11.0	1922R7	PEUGEOT	7.06117.45.0
17113196	VAUXHALL	7.05432.11.0	1922S2	CITROEN	7.01777.18.0
1714043	FORD	7.07400.01.0	1922S2	DS	7.01777.18.0
171460	FEBI	7.02588.04.0	1922S2	PEUGEOT	7.01777.18.0
1724230	FORD	7.01981.07.0	1922V5	CITROEN	7.06117.45.0
1725727	FORD	7.07400.00.0	1922V5	DS	7.06117.45.0
1727567	FORD	7.07400.01.0	1922V5	PEUGEOT	7.06117.45.0
17300	STANDARD	7.06117.35.0	1922V6	CITROEN	7.01777.18.0

REF-No.			REF-No.		
1922V6	DS	7.01777.18.0	1K0906283A	VOLKSWAGEN	7.02256.00.0
1922V6	PEUGEOT	7.01777.18.0	1K0906627	VOLKSWAGEN	7.00580.01.0
1922V8	CITROEN	7.01777.19.0	1K0906627A	AUDI	7.00868.02.0
1922V8	DS	7.01777.19.0	1K0906627A	SEAT	7.00868.02.0
1922V8	PEUGEOT	7.01777.19.0	1K0906627A	SKODA	7.00868.02.0
1922V9	CITROEN	7.06117.45.0	1K0906627A	VOLKSWAGEN	7.00868.02.0
1922V9	DS	7.06117.45.0	1K0906627D	AUDI	7.02183.01.0
1922V9	PEUGEOT	7.06117.45.0	1K0906627D	SEAT	7.02183.01.0
19280	OSSCA	7.06269.28.0	1K0906627D	SKODA	7.02183.01.0
1928498092	BOSCH	7.02256.28.0	1K0906627D	VOLKSWAGEN	7.02183.01.0
1928498191	BOSCH	7.02256.30.0	1K0906627E	AUDI	7.02184.01.0
19623	OSSCA	7.06117.00.0	1K0906627E	SEAT	7.02184.01.0
1997319	OPEL	7.02256.22.0	1K0906627E	SKODA	7.02184.01.0
1997319	VAUXHALL	7.02256.22.0	1K0906627E	VOLKSWAGEN	7.02184.01.0
1E05-20-660	MAZDA	7.06269.28.0	1K1820035C	VOLKSWAGEN	7.02256.40.0
1E05-20-660A	MAZDA	7.06269.27.0	1K1820035D	VOLKSWAGEN	7.02256.40.0
1E07-20-350	MAZDA	7.02256.47.0	1K1820035E	VOLKSWAGEN	7.02256.40.0
1E07-20-350A	MAZDA	7.02256.47.0	1M5O-9C728-AA	FORD	7.00036.03.0
1H0906627	AUDI	7.21903.70.0	1S4U-9F715-BC	FORD	7.06269.23.0
1H0906627	SEAT	7.21903.70.0	1S7E-9F715-CA	FORD	7.06269.10.0
1H0906627	SKODA	7.21903.70.0	1S7G-9F715-AD	FORD	7.06269.22.0
1H0906627	VOLKSWAGEN	7.21903.70.0	1S7G-9F715-AE	FORD	7.06269.22.0
1H0906627A	AUDI	7.21903.75.0	1S7G-9J559-BA	FORD	7.02256.51.0
1H0906627A	SEAT	7.21903.75.0	1S7G-9J559-BB	FORD	7.02256.51.0
1H0906627A	SKODA	7.21903.75.0	1S7Z-9F715-CA	FORD	7.06269.10.0
1H0906627A	VOLKSWAGEN	7.21903.75.0	1T0820036	AUDI	7.02256.41.0
1J0906283B	AUDI	7.02256.00.0	1T0820036	VOLKSWAGEN	7.02256.41.0
1J0906283B	SEAT	7.02256.00.0	1T0820036A	VOLKSWAGEN	7.02256.41.0
1J0906283B	SKODA	7.02256.00.0	1T0820036C	AUDI	7.02256.41.0
1J0906283B	VOLKSWAGEN	7.02256.00.0	1T0820036C	VOLKSWAGEN	7.02256.41.0
1J0906283C	AUDI	7.02256.00.0	1T0820036D	AUDI	7.02256.41.0
1J0906283C	SEAT	7.02256.00.0	1T0820036D	SEAT	7.02256.41.0
1J0906283C	VOLKSWAGEN	7.02256.00.0	1T0820036D	VOLKSWAGEN	7.02256.41.0
1J0906283D	AUDI	7.28098.04.0	2,80001E+12	CONTINENTAL	7.06117.36.0
1J0906283D	BENTLEY	7.28098.04.0	2001530032	SMART	7.08681.15.0
1J0906283D	SEAT	7.28098.04.0	2007602	FORD	7.07400.16.0
1J0906283D	VOLKSWAGEN	7.28098.04.0	20103360	SWAG	7.06117.01.0
1J0906627	AUDI	7.02183.01.0	20103361	SWAG	7.06117.00.0
1J0906627	SEAT	7.02183.01.0	2010734	FORD	7.04492.07.0
1J0906627	SKODA	7.02183.01.0	20107454	SWAG	7.06117.36.0
1J0906627	VOLKSWAGEN	7.02183.01.0	2017134	FORD	7.07400.14.0
1J0906627A	AUDI	7.02184.01.0	20241	OSSCA	7.05432.13.0
1J0906627A	SEAT	7.02184.01.0	2026021	FORD	7.06117.38.0
1J0906627A	SKODA	7.02184.01.0	2026089	FORD	7.06117.33.0
1J0906627A	VOLKSWAGEN	7.02184.01.0	205301	RUVILLE	7.06117.08.0
1J0906627B	AUDI	7.00868.02.0	205304	RUVILLE	7.06117.07.0
1J0906627B	SEAT	7.00868.02.0	205636	TOPRAN	7.06269.01.0
1J0906627B	VOLKSWAGEN	7.00868.02.0	205702	RUVILLE	7.06117.26.0
1J0906627C	VOLKSWAGEN	7.00580.01.0	205704	RUVILLE	7.06117.26.0
1K0820036	VOLKSWAGEN	7.02256.40.0	205801	RUVILLE	7.06117.38.0
1K0820036B	AUDI	7.02256.40.0	205802	RUVILLE	7.06117.38.0
1K0820036B	SKODA	7.02256.40.0	205804	RUVILLE	7.06117.35.0
1K0820036B	VOLKSWAGEN	7.02256.40.0	205805	RUVILLE	7.06117.08.0
1K0820036C	AUDI	7.02256.40.0	205901	RUVILLE	7.06117.34.0
1K0820036C	VOLKSWAGEN	7.02256.40.0	206167	TOPRAN	7.05432.01.0
1K0820036D	AUDI	7.02256.40.0	206168	TOPRAN	7.05432.00.0
1K0820036D	SKODA	7.02256.40.0	206169	TOPRAN	7.05432.11.0
1K0820036D	VOLKSWAGEN	7.02256.40.0	2070880	FORD	7.07400.15.0
1K0820036F	SEAT	7.02256.40.0	2091307	FORD	7.07400.12.0
1K0820036F	SKODA	7.02256.40.0	2093005	FORD	7.08681.00.0
1K0820036F	VOLKSWAGEN	7.02256.40.0	2094612	FORD	7.07400.16.0
1K0906283	AUDI	7.02256.00.0	21-5003	IPD INDUSTRIAL PARTS DISTRIBUT	7.06117.43.0
1K0906283	SEAT	7.02256.00.0	21-5008	IPD INDUSTRIAL PARTS DISTRIBUT	7.06117.56.0
1K0906283A	AUDI	7.02256.00.0	21-5012	IPD INDUSTRIAL PARTS DISTRIBUT	7.06117.38.0
1K0906283A	BENTLEY	7.02256.00.0	21-5015	IPD INDUSTRIAL PARTS DISTRIBUT	7.06117.10.0
1K0906283A	LAMBORGHINI	7.02256.00.0			
1K0906283A	SEAT	7.02256.00.0			
1K0906283A	SKODA	7.02256.00.0			

REF-No.		 PIERBURG	REF-No.		 PIERBURG
21-5016	IPD INDUSTRIAL PARTS DISTRIBUT	7.06117.37.0	24420570	OPEL	7.02256.28.0
21-5017	IPD INDUSTRIAL PARTS DISTRIBUT	7.06117.36.0	24420570	VAUXHALL	7.02256.28.0
21-5019	IPD INDUSTRIAL PARTS DISTRIBUT	7.06117.44.0	2508671	HUECO	7.06269.03.0
21-5020	IPD INDUSTRIAL PARTS DISTRIBUT	7.06117.48.0	2508672	HITACHI	7.06269.02.0
21-5023	IPD INDUSTRIAL PARTS DISTRIBUT	7.06117.54.0	2508672	HUECO	7.06269.02.0
21-5026	IPD INDUSTRIAL PARTS DISTRIBUT	7.06117.53.0	2508673	HUECO	7.06269.00.0
21-5027	IPD INDUSTRIAL PARTS DISTRIBUT	7.06117.47.0	2508674	HUECO	7.06269.05.0
21-5031	IPD INDUSTRIAL PARTS DISTRIBUT	7.06117.52.0	2508675	HUECO	7.06269.11.0
21-5035	IPD INDUSTRIAL PARTS DISTRIBUT	7.06117.34.0	2508676	HUECO	7.06269.07.0
21-5036	IPD INDUSTRIAL PARTS DISTRIBUT	7.06117.01.0	2508678	HUECO	7.06269.01.0
21-5039	IPD INDUSTRIAL PARTS DISTRIBUT	7.06117.14.0	2508682	HUECO	7.06269.09.0
21-5041	IPD INDUSTRIAL PARTS DISTRIBUT	7.06117.46.0	2508688	HUECO	7.06269.06.0
21-5043	IPD INDUSTRIAL PARTS DISTRIBUT	7.06117.45.0	2508693	HITACHI	7.06269.26.0
21-5045	IPD INDUSTRIAL PARTS DISTRIBUT	7.06117.00.0	2508694	HUECO	7.06269.10.0
21-5055	IPD INDUSTRIAL PARTS DISTRIBUT	7.06117.39.0	2509311	HITACHI	7.02256.27.0
21-5059	IPD INDUSTRIAL PARTS DISTRIBUT	7.06117.57.0	2509312	HITACHI	7.02256.24.0
21-5062	IPD INDUSTRIAL PARTS DISTRIBUT	7.06117.35.0	2509325	HITACHI LI	7.01870.06.0
21-5066	IPD INDUSTRIAL PARTS DISTRIBUT	7.06117.58.0	2509326	HITACHI	7.01762.04.0
21-5072	IPD INDUSTRIAL PARTS DISTRIBUT	7.06117.60.0	2509328	HITACHI	7.00470.07.0
21-5080	IPD INDUSTRIAL PARTS DISTRIBUT	7.06117.42.0	2509331	HITACHI	7.02588.04.0
21-5085	IPD INDUSTRIAL PARTS DISTRIBUT	7.06117.53.0	2509333	HITACHI	7.22240.13.0
21-5086	IPD INDUSTRIAL PARTS DISTRIBUT	7.06117.52.0	2509334	HITACHI	7.00272.03.0
21-5096	HEPU	7.06117.16.0	2509335	HITACHI	7.00580.01.0
21-5102	IPD INDUSTRIAL PARTS DISTRIBUT	7.08681.00.0	2509336	HITACHI	7.01019.01.0
21-5104	IPD INDUSTRIAL PARTS DISTRIBUT	7.08681.09.0	2509337	HITACHI	7.02063.02.0
2100016	METZGER	7.22402.03.0	2509338	HITACHI	7.02183.01.0
2100018	METZGER	7.02256.28.0	2509339	HITACHI	7.00513.10.0
2100019	METZGER	7.02256.31.0	2509345	HITACHI	7.03085.02.0
21160	FEBI	7.05432.01.0	2509354	HITACHI LI	7.21903.70.0
21507	OSSCA	7.06117.54.0	25183381	OPEL	7.02256.16.0
219244290500	MAGNETI MARELLI	7.05432.09.0	25183381	VAUXHALL	7.02256.16.0
2237841	FORD	7.07400.18.0	25195245	BUICK	7.06117.07.0
2246175	BMW	7.21903.73.0	25195245	CADILLAC	7.06117.07.0
2247906	BMW	7.22796.01.0	25195245	CHEVROLET	7.06117.07.0
2250151	METZGER	7.10014.00.0	25195245	OPEL	7.06117.07.0
230016079057	MAGNETI MARELLI	7.05432.02.0	25195245	VAUXHALL	7.06117.07.0
230016079077	MAGNETI MARELLI	7.05432.04.0	252925	CITROEN	7.02256.05.0
230204010118	MAGNETI MARELLI	7.05432.02.0	252925	PEUGEOT	7.02256.05.0
230222000118	MAGNETI MARELLI	7.05432.06.0	25295	OSSCA	7.06117.37.0
23392	OSSCA	7.22402.03.0	25334477	OPEL	7.02256.31.0
23796-AX010	NISSAN	7.06117.14.0	25334477	VAUXHALL	7.02256.31.0
23796-AX02A	NISSAN	7.06117.14.0	257422	CITROEN	7.08681.05.0
240610049	WE-PARTS	7.05432.13.0	257422	PEUGEOT	7.08681.05.0
240610066	WE-PARTS	7.06269.02.0	257423	CITROEN	7.08681.04.0
240610074	WE-PARTS	7.06269.03.0	257423	PEUGEOT	7.08681.04.0
240610079	WE-PARTS	7.06269.27.0	257424	CITROEN	7.08681.03.0
240610082	WE-PARTS	7.06269.28.0	257424	PEUGEOT	7.08681.03.0
			257425	CITROEN	7.08681.06.0
			257425	PEUGEOT	7.08681.06.0
			25819-0R010	LEXUS	7.00513.10.0
			25819-0R010	TOYOTA	7.00513.10.0
			25819-0R011	LEXUS	7.00513.10.0
			25819-0R011	TOYOTA	7.00513.10.0
			25819-0R012	LEXUS	7.00513.10.0
			25819-0R012	TOYOTA	7.00513.10.0
			25819-0W010	LEXUS	7.00513.19.0
			25819-0W010	TOYOTA	7.00513.19.0
			25860-0R010	LEXUS	7.03584.01.0
			25860-0R010	TOYOTA	7.03584.01.0
			25860-0R011	LEXUS	7.03584.01.0
			25860-0R011	TOYOTA	7.03584.01.0
			26016	FEBI	7.05432.00.0
			26248	FEBI	7.06269.02.0
			26249	FEBI	7.06269.03.0
			27-0154	MAXGEAR	7.22796.01.0
			27-0192	MAXGEAR	7.02256.00.0
			27-0551	MAXGEAR	7.06117.45.0
			27-0683	MAXGEAR	7.06117.06.0
			27-0684	MAXGEAR	7.06117.05.0

NUMBERFINDER

REF-No.			REF-No.		
27-0690	MAXGEAR	7.06117.34.0	31293964	VOLVO	7.02325.05.0
27-0692	MAXGEAR	7.06117.37.0	31316633	VOLVO	7.06117.52.0
2751530059	MAYBACH	7.00017.02.0	31316634	VOLVO	7.06117.55.0
27727	OSSCA	7.06117.36.0	31338491	VOLVO	7.07400.05.0
27728	OSSCA	7.06117.60.0	31339808	VOLVO	7.04664.02.0
2800014010180	CONTINENTAL	7.06117.00.0	31339862	VOLVO	7.07400.19.0
287732	FERRARI	7.03003.12.0	31339879	VOLVO	7.00515.05.0
287732	MASERATI	7.03003.12.0	31370533	VOLVO	7.04492.07.0
2D0906283A	VOLKSWAGEN	7.21071.50.0	31370534	VOLVO	7.03162.09.0
2E0906283	VOLKSWAGEN	7.02256.37.0	31370551	VOLVO	7.04615.03.0
2M50-9K378-AA	FORD	7.00036.03.0	31375551	VOLVO	7.02256.48.0
2S619S468AD	FORD	7.00964.03.0	31375758	VOLVO	7.07400.02.0
2S6A-9F715-BA	FORD	7.05432.13.0	31375759	VOLVO	7.07400.03.0
2S6A-9F715-BB	FORD	7.05432.13.0	31375760	VOLVO	7.07400.04.0
3.024.363	KAYSER	7.02256.23.0	31401109	VOLVO	7.02325.06.0
3.024.368	KAYSER	7.02256.24.0	31422233	VOLVO	7.02613.02.0
3.024.373	KAYSER	7.02256.26.0	31430034	VOLVO	7.22240.15.0
3.024.379	KAYSER	7.02256.25.0	315495	FERRARI	7.02909.12.0
3.024.389	KAYSER	7.02256.27.0	31686139	VOLVO	7.04492.07.0
3.256151	SIDAT	7.02256.14.0	32817	OSSCA	7.00868.02.0
3.256509	SIDAT	7.02256.03.0	33100050	SWAG	7.06117.60.0
3.256511	SIDAT	7.02256.04.0	33100189	SWAG	7.02318.01.0
3.256521	SIDAT	7.02256.15.0	331240006	WE-PARTS	7.02184.01.0
3.256605	SIDAT	7.02256.05.0	331240009	WE-PARTS	7.00612.01.0
3.256705	SIDAT	7.02256.06.0	331240010	WE-PARTS	7.02183.01.0
3008170254	AUTOMEGA	7.05432.01.0	331240011	WE-PARTS	7.21903.70.0
3008170255	AUTOMEGA	7.05432.00.0	331240012	WE-PARTS	7.00868.02.0
3008260550	AUTOMEGA	7.05432.11.0	331240014	WE-PARTS	7.22880.01.0
3008370102	AUTOMEGA	7.06269.01.0	331240015	WE-PARTS	7.22402.03.0
3009598	FORD	7.06269.21.0	331240016	WE-PARTS	7.21483.54.0
30100220494	AUTOMEGA	7.06269.24.0	331240017	WE-PARTS	7.22796.01.0
30103580402	AUTOMEGA	7.06269.22.0	331240019	WE-PARTS	7.02256.50.0
30108232	SWAG	7.02256.18.0	331240021	WE-PARTS	7.02461.01.0
301330455078D	AUTOMEGA	7.05432.12.0	331240023	WE-PARTS	7.02256.23.0
302445	TOPRAN	7.06269.03.0	331240026	WE-PARTS	7.02256.07.0
302446	TOPRAN	7.06269.02.0	331240027	WE-PARTS	7.02256.29.0
302677	TOPRAN	7.06269.24.0	331240029	WE-PARTS	7.00968.04.0
302678	TOPRAN	7.06269.23.0	331240030	WE-PARTS	7.00580.01.0
302679	TOPRAN	7.06269.22.0	331240031	WE-PARTS	7.21071.50.0
302680	TOPRAN	7.06269.27.0	331240032	WE-PARTS	7.22138.50.0
302681	TOPRAN	7.06269.04.0	331240033	WE-PARTS	7.22355.01.0
302682	TOPRAN	7.06269.26.0	331240034	WE-PARTS	7.00326.03.0
302683	TOPRAN	7.05432.13.0	331240035	WE-PARTS	7.22572.01.0
304993	TOPRAN	7.06117.38.0	331240040	WE-PARTS	7.01024.02.0
304996	TOPRAN	7.02256.07.0	331240046	WE-PARTS	7.04423.01.0
30608	FEBI	7.05432.11.0	331240050	WE-PARTS	7.02256.21.0
30611668	VOLVO	7.22240.15.0	331240051	WE-PARTS	7.02256.49.0
30618057	NEDCAR	7.21903.44.0	331240052	WE-PARTS	7.00513.10.0
30618057	VOLVO	7.21903.44.0	331240053	WE-PARTS	7.00272.03.0
30637251	VOLVO	7.21903.63.0	331240054	WE-PARTS	7.01633.04.0
30650769	VOLVO	7.01771.01.0	331240055	WE-PARTS	7.02063.02.0
30658188	VOLVO	7.02256.48.0	331240056	WE-PARTS	7.01019.01.0
30670448	VOLVO	7.22240.13.0	331240057	WE-PARTS	7.00887.19.0
30670449	VOLVO	7.28197.16.0	331240058	WE-PARTS	7.00470.07.0
30711101	VOLVO	7.00968.04.0	331240060	WE-PARTS	7.22903.17.0
30731116	VOLVO	7.06117.18.0	331240062	WE-PARTS	7.21903.49.0
30757400	VOLVO	7.02256.48.0	331240063	WE-PARTS	7.22903.16.0
30774761	VOLVO	7.02325.04.0	331240064	WE-PARTS	7.02256.26.0
3090602831K0A	AUTOMEGA	7.02256.00.0	331240070	WE-PARTS	7.02256.19.0
30939245	SWAG	7.01830.13.0	331240077	WE-PARTS	7.02256.17.0
30939307	SWAG	7.04247.02.0	331240078	WE-PARTS	7.02256.20.0
30940198	SWAG	7.06117.26.0	331240079	WE-PARTS	7.02256.27.0
30945698	SWAG	7.02256.00.0	331240080	WE-PARTS	7.00036.03.0
30948643	SWAG	7.00868.02.0	331240082	WE-PARTS	7.01039.03.0
30948643	SWAG	7.02184.01.0	331240083	WE-PARTS	7.02588.04.0
31216025	VOLVO	7.01771.01.0	331240090	WE-PARTS	7.00782.16.0
31219138	VOLVO	7.02221.01.0	331240091	WE-PARTS	7.00782.12.0
31219977	VOLVO	7.02613.02.0	331240094	WE-PARTS	7.21903.44.0
31251224	VOLVO	7.06117.18.0	331240097	WE-PARTS	7.03294.02.0

REF-No.		 PIERBURG	REF-No.		 PIERBURG
331240098	WE-PARTS	7.03653.01.0	3645859	VAUXHALL	7.08681.00.0
331240101	WE-PARTS	7.02256.44.0	3647128	FORD	7.06269.20.0
331240103	WE-PARTS	7.02256.45.0	3648862	OPEL	7.01777.19.0
331240105	WE-PARTS	7.03833.02.0	3648862	VAUXHALL	7.01777.19.0
331240109	WE-PARTS	7.01777.17.0	3750201	FORD	7.06269.21.0
331240110	WE-PARTS	7.01814.12.0	381180005	WE-PARTS	7.06117.34.0
331240120	WE-PARTS	7.28098.15.0	381180006	WE-PARTS	7.06117.38.0
331240121	WE-PARTS	7.01343.04.0	381180008	WE-PARTS	7.06117.35.0
331240122	WE-PARTS	7.22240.13.0	381180009	WE-PARTS	7.06117.35.0
331240124	WE-PARTS	7.10014.00.0	381180013	WE-PARTS	7.06117.08.0
331240133	WE-PARTS	7.02256.48.0	381180016	WE-PARTS	7.08681.09.0
331240138	WE-PARTS	7.02256.51.0	381180018	WE-PARTS	7.06117.06.0
331240153	WE-PARTS	7.00887.21.0	381180019	WE-PARTS	7.06117.05.0
331240160	WE-PARTS	7.00887.22.0	381180022	WE-PARTS	7.06117.33.0
331240161	WE-PARTS	7.03280.04.0	381180032	WE-PARTS	7.06117.00.0
331240162	WE-PARTS	7.03073.01.0	381180033	WE-PARTS	7.06117.02.0
331240164	WE-PARTS	7.02325.05.0	381180034	WE-PARTS	7.06117.46.0
331240165	WE-PARTS	7.01044.03.0	381180039	WE-PARTS	7.06117.45.0
331240166	WE-PARTS	7.01632.02.0	381180050	WE-PARTS	7.06117.54.0
331240169	WE-PARTS	7.03554.10.0	381180052	WE-PARTS	7.06117.48.0
331240170	WE-PARTS	7.03584.01.0	381180053	WE-PARTS	7.06117.10.0
331240171	WE-PARTS	7.02613.02.0	381180057	WE-PARTS	7.06117.42.0
331240174	WE-PARTS	7.02534.01.0	381180059	WE-PARTS	7.06117.58.0
331240175	WE-PARTS	7.22903.34.0	381180061	WE-PARTS	7.06117.14.0
331240177	WE-PARTS	7.02256.31.0	381180067	WE-PARTS	7.06117.45.0
331240178	WE-PARTS	7.28311.04.0	381180070	WE-PARTS	7.06117.38.0
331240180	WE-PARTS	7.00887.20.0	381180074	WE-PARTS	7.06117.45.0
331240185	WE-PARTS	7.02256.25.0	381180076	WE-PARTS	7.06117.34.0
331240190	WE-PARTS	7.00612.01.0	381180088	WE-PARTS	7.08681.09.0
331240195	WE-PARTS	7.02256.49.0	381180091	WE-PARTS	7.06117.37.0
331240195	WE-PARTS	7.22240.09.0	3819161	VOLVO-PENTA	7.01282.02.0
331240196	WE-PARTS	7.00612.01.0	38276	FEBI	7.21903.63.0
331240196	WE-PARTS	7.01771.01.0	390531	KARMANN	7.21895.55.0
331240200	WE-PARTS	7.03003.01.0	3909620	FORD	7.06269.11.0
331240201	WE-PARTS	7.04423.01.0	3910186	FORD	7.06269.21.0
331240205	WE-PARTS	7.22908.03.0	39245	FEBI	7.01830.13.0
331240206	WE-PARTS	7.01777.18.0	39307	FEBI	7.04247.02.0
331240212	WE-PARTS	7.00607.04.0	39546	FEBI	7.01421.01.0
331240215	WE-PARTS	7.02256.27.0	3998144	FORD	7.02256.46.0
331240222	WE-PARTS	7.02325.04.0	39SKV007	ESEN SKV	7.06117.39.0
331240235	WE-PARTS	7.00017.03.0	39SKV008	ESEN SKV	7.06117.35.0
331240238	WE-PARTS	7.02221.01.0	39SKV009	ESEN SKV	7.06117.46.0
331240239	WE-PARTS	7.02968.02.0	39SKV011	ESEN SKV	7.06117.42.0
331240241	WE-PARTS	7.22240.15.0	39SKV014	ESEN SKV	7.06117.36.0
331240243	WE-PARTS	7.04492.07.0	3H4Z-6M280-AA	LAND ROVER	7.06117.10.0
34284	OSSCA	7.22796.01.0	3M5Q-9E882-BA	FORD	7.28328.07.0
3508280	FORD	7.02256.46.0	3M5Q-9E882-BB	FORD	7.28328.07.0
35120-27000	HYUNDAI	7.03085.02.0	3M5Q-9E882-CC	FORD	7.00968.04.0
35120-27050	HYUNDAI	7.00272.03.0	3M5Q9E882BA	FORD	7.00964.03.0
35120-27050	KIA	7.00272.03.0	3W0906283A	BENTLEY	7.22687.15.0
35120-2A400	HYUNDAI	7.03294.02.0	3W0906283B	BENTLEY	7.22687.16.0
35120-2A400	KIA	7.03294.02.0	4.66756	DT-DIESEL TECHNIC AG	7.21071.50.0
35120-2A900	HYUNDAI	7.00272.03.0	4.69095	DT-DIESEL TECHNIC AG	7.00782.04.0
35120-2A900	KIA	7.00272.03.0	4.73325	DT-DIESEL TECHNIC AG	7.00782.12.0
3557957	OPEL	7.01115.08.0	40109	FEBI	7.06117.34.0
3557957	VAUXHALL	7.01115.08.0	40198	FEBI	7.06117.26.0
359000601150	MAGNETI MARELLI	7.06269.03.0	40844	OSSCA	7.01024.02.0
359000603740	MAGNETI MARELLI	7.02184.01.0	408825	TOPRAN	7.22355.01.0
36001345	VOLVO	7.06117.52.0	40918643	SWAG	7.06269.01.0
36001346	VOLVO	7.06117.55.0	40921160	SWAG	7.05432.01.0
36001878	VOLVO	7.06117.53.0	40926016	SWAG	7.05432.00.0
36002683	VOLVO	7.06117.17.0	40930608	SWAG	7.05432.11.0
36002684	VOLVO	7.06117.16.0	40939546	SWAG	7.01421.01.0
36002690	VOLVO	7.06117.18.0	40946085	SWAG	7.06117.08.0
3639451	OPEL	7.06117.45.0	40946086	SWAG	7.06117.07.0
3639451	VAUXHALL	7.06117.45.0	41162	OSSCA	7.06117.34.0
3639832	OPEL	7.08681.09.0	4138506	FORD	7.06269.10.0
3639832	VAUXHALL	7.08681.09.0	4174707	FORD	7.06269.20.0
3645859	OPEL	7.08681.00.0	421270009	WE-PARTS	7.02256.41.0



REF-No.			REF-No.		
42556657	IVECO	7.00607.04.0	45-7008	IPD INDUSTRIAL PARTS DISTRIBUT	7.05432.02.0
427000110	INA SCHÄFFLER KG	7.06117.08.0	45-7019	IPD INDUSTRIAL PARTS DISTRIBUT	7.05432.06.0
427000610	INA SCHÄFFLER KG	7.06117.26.0	45-7022	IPD INDUSTRIAL PARTS DISTRIBUT	7.05432.13.0
427000710	INA SCHÄFFLER KG	7.06117.34.0	45-7023	IPD INDUSTRIAL PARTS DISTRIBUT	7.05432.09.0
427000810	INA SCHÄFFLER KG	7.06117.38.0	45-7025	IPD INDUSTRIAL PARTS DISTRIBUT	7.05432.11.0
427000910	INA SCHÄFFLER KG	7.06117.38.0	45-7028	IPD INDUSTRIAL PARTS DISTRIBUT	7.05432.04.0
427001310	INA SCHÄFFLER KG	7.06117.35.0	45-7031	IPD INDUSTRIAL PARTS DISTRIBUT	7.05432.12.0
427001410	INA SCHÄFFLER KG	7.06117.08.0	45-7037	IPD INDUSTRIAL PARTS DISTRIBUT	7.06269.01.0
427001810	INA SCHÄFFLER KG	7.06117.07.0	45-7039	IPD INDUSTRIAL PARTS DISTRIBUT	7.06269.02.0
427003410	INA SCHÄFFLER KG	7.06117.26.0	45-7040	IPD INDUSTRIAL PARTS DISTRIBUT	7.06269.26.0
43002025F	VM MOTORI	7.21903.48.0	45-7041	IPD INDUSTRIAL PARTS DISTRIBUT	7.06269.06.0
43002032F	VM MOTORI	7.01010.03.0	45-7044	IPD INDUSTRIAL PARTS DISTRIBUT	7.06269.03.0
431870001	WE-PARTS	7.00175.04.0	45-7045	IPD INDUSTRIAL PARTS DISTRIBUT	7.06269.22.0
431870002	WE-PARTS	7.01115.08.0	45-7046	IPD INDUSTRIAL PARTS DISTRIBUT	7.06269.23.0
431870003	WE-PARTS	7.01830.13.0	45-7050	IPD INDUSTRIAL PARTS DISTRIBUT	7.06269.04.0
431870004	WE-PARTS	7.02909.07.0	45-7055	IPD INDUSTRIAL PARTS DISTRIBUT	7.05432.09.0
431870005	WE-PARTS	7.01835.06.0	45-7056	IPD INDUSTRIAL PARTS DISTRIBUT	7.06269.27.0
431870007	WE-PARTS	7.01870.06.0	45-7061	IPD INDUSTRIAL PARTS DISTRIBUT	7.06269.10.0
431870007	WE-PARTS	7.04818.04.0	45-7102	IPD INDUSTRIAL PARTS DISTRIBUT	7.06269.00.0
431870008	WE-PARTS	7.02901.05.0	45-8280	IPD INDUSTRIAL PARTS DISTRIBUT	7.02256.00.0
431870011	WE-PARTS	7.02909.12.0	45-8284	IPD INDUSTRIAL PARTS DISTRIBUT	7.02184.01.0
431870013	WE-PARTS	7.05367.05.0	45-8287	IPD INDUSTRIAL PARTS DISTRIBUT	7.00580.01.0
4391570	FORD	7.06269.21.0	45-8289	IPD INDUSTRIAL PARTS DISTRIBUT	7.22903.19.0
4402714	OPEL	7.02256.19.0	45-8290	IPD INDUSTRIAL PARTS DISTRIBUT	7.02256.00.0
4402714	VAUXHALL	7.02256.19.0	45-8299	IPD INDUSTRIAL PARTS DISTRIBUT	7.00612.01.0
4402766	OPEL	7.02256.04.0	45-8300	IPD INDUSTRIAL PARTS DISTRIBUT	7.00782.04.0
4402766	VAUXHALL	7.02256.04.0	45-8302	IPD INDUSTRIAL PARTS DISTRIBUT	7.01019.01.0
4414112	OPEL	7.02256.04.0	45-8303	IPD INDUSTRIAL PARTS DISTRIBUT	7.01771.01.0
4414112	VAUXHALL	7.02256.04.0	45-8304	IPD INDUSTRIAL PARTS DISTRIBUT	7.02063.02.0
4418507	OPEL	7.01152.02.0	45-8309	IPD INDUSTRIAL PARTS DISTRIBUT	7.02256.20.0
4418507	OPEL	7.04779.00.0	45-8310	IPD INDUSTRIAL PARTS DISTRIBUT	7.02256.23.0
4418507	VAUXHALL	7.01152.02.0	45-8311	IPD INDUSTRIAL PARTS DISTRIBUT	7.02256.25.0
4418507	VAUXHALL	7.04779.00.0	45-8314	IPD INDUSTRIAL PARTS DISTRIBUT	7.22796.01.0
4423116	OPEL	7.01814.12.0	45-8316	IPD INDUSTRIAL PARTS DISTRIBUT	7.22903.17.0
4423116	VAUXHALL	7.01814.12.0	45-8318	IPD INDUSTRIAL PARTS DISTRIBUT	7.28328.07.0
4423153	OPEL	7.01814.12.0	45-8364	IPD INDUSTRIAL PARTS DISTRIBUT	7.00868.02.0
4423153	VAUXHALL	7.01814.12.0			
4424170	OPEL	7.01814.22.0			
4424170	VAUXHALL	7.01814.22.0			
4429072	FORD	7.06269.21.0			
4431859	OPEL	7.01152.02.0			
4431859	OPEL	7.04779.00.0			
4431859	VAUXHALL	7.01152.02.0			
4431859	VAUXHALL	7.04779.00.0			
4433986	OPEL	7.02256.19.0			
4433986	VAUXHALL	7.02256.19.0			
44375	FEBI	7.02256.03.0			
44714	OSSCA	7.06117.53.0			
45-6005	IPD INDUSTRIAL PARTS DISTRIBUT	7.06117.26.0			
45-6006	IPD INDUSTRIAL PARTS DISTRIBUT	7.06117.34.0			
45-6008	IPD INDUSTRIAL PARTS DISTRIBUT	7.06117.38.0			
45-6010	IPD INDUSTRIAL PARTS DISTRIBUT	7.06117.35.0			
45-6011	IPD INDUSTRIAL PARTS DISTRIBUT	7.06117.08.0			
45-6020	IPD INDUSTRIAL PARTS DISTRIBUT	7.06117.26.0			
45-6021	IPD INDUSTRIAL PARTS DISTRIBUT	7.06117.07.0			
45-7002	IPD INDUSTRIAL PARTS DISTRIBUT	7.06269.09.0			
45-7003	IPD INDUSTRIAL PARTS DISTRIBUT	7.06269.07.0			
45-7005	IPD INDUSTRIAL PARTS DISTRIBUT	7.05432.01.0			
45-7006	IPD INDUSTRIAL PARTS DISTRIBUT	7.05432.00.0			

REF-No.		 PIERBURG	REF-No.		 PIERBURG
45-8372	IPD INDUSTRIAL PARTS	7.01010.03.0	4M5G-9J559-NA	FORD	7.02256.48.0
	DISTRIBUT		4M5G-9J559-NB	FORD	7.02256.48.0
45-8388	IPD INDUSTRIAL PARTS	7.22903.34.0	5,71822E+11	MAGNETI MARELLI	7.22138.50.0
	DISTRIBUT		50051596	ALFA ROMEO	7.02909.12.0
45-8563	IPD INDUSTRIAL PARTS	7.02256.26.0	50081100000	BORGWARNER TURBO	7.01039.03.0
	DISTRIBUT			SYSTEMS	
45461	FEBI	7.02256.49.0	50103204	SWAG	7.01771.01.0
45464	FEBI	7.02256.50.0	502684	TOPRAN	7.22796.01.0
45465	FEBI	7.02256.20.0	502734	TOPRAN	7.06117.01.0
45466	FEBI	7.00607.02.0	502925	TOPRAN	7.06117.00.0
45698	FEBI	7.02256.00.0	50539432	ALFA ROMEO	7.02909.12.0
46085	FEBI	7.06117.08.0	50926248	SWAG	7.06269.02.0
46086	FEBI	7.06117.07.0	50926249	SWAG	7.06269.03.0
46419651	ALFA ROMEO	7.02256.03.0	51.09413-0004	MAN	7.00380.04.0
46524556	ALFA ROMEO	7.02256.03.0	51.09413-0004	NEOPLAN BUS GMBH	7.00380.04.0
46524556	FIAT	7.02256.03.0	51.09413-0006	MAN	7.00380.04.0
46524556	LANCIA	7.02256.03.0	51.09413-0006	NEOPLAN BUS GMBH	7.00380.04.0
46749673	ABARTH	7.02256.49.0	51.09413-0007	MAN	7.00380.11.0
46749673	ALFA ROMEO	7.02256.49.0	51.09413-0007	NEOPLAN BUS GMBH	7.00380.11.0
46749673	FIAT	7.02256.49.0	51.09413-0008	MAN	7.01904.03.0
46749673	LANCIA	7.02256.49.0	51.09413-0009	MAN	7.00380.11.0
46754960	FIAT	7.28170.03.0	51.09413-0009	NEOPLAN BUS GMBH	7.00380.11.0
46754960	LANCIA	7.28170.03.0	51.09413-0017	MAN	7.00380.11.0
46767324	ALFA ROMEO	7.02256.50.0	51.09413-0017	NEOPLAN BUS GMBH	7.00380.11.0
46767324	FIAT	7.02256.50.0	51.09413-0022	MAN	7.00380.11.0
46767324	LANCIA	7.02256.50.0	51.09413-0022	NEOPLAN BUS GMBH	7.00380.11.0
46768250	ALFA ROMEO	7.21903.48.0	51.09413-6010	MAN	7.00380.11.0
46768250	LANCIA	7.21903.48.0	51.09413-6010	NEOPLAN BUS GMBH	7.00380.11.0
467682500	FIAT	7.21903.48.0	51.09413-6011	MAN	7.01904.03.0
46813569	FIAT	7.02256.14.0	51.09413-6012	MAN	7.00380.04.0
46813570	ALFA ROMEO	7.02256.50.0	51.09413-6012	NEOPLAN BUS GMBH	7.00380.04.0
46813570	FIAT	7.02256.50.0	51.09413-6036	MAN	7.00380.11.0
46813570	LANCIA	7.02256.50.0	51.09413-6036	NEOPLAN BUS GMBH	7.00380.11.0
46813571	ABARTH	7.02256.49.0	51.09413-6049	MAN	7.00380.11.0
46813571	ALFA ROMEO	7.02256.49.0	51.09413-6049	NEOPLAN BUS GMBH	7.00380.11.0
46813571	FIAT	7.02256.49.0	5116028	FORD	7.06117.53.0
46813571	LANCIA	7.02256.49.0	5146080	FORD	7.06117.33.0
4709404	OPEL	7.02534.01.0	5170590	FORD	7.02087.05.0
4709404	VAUXHALL	7.02534.01.0	51884840	ALFA ROMEO	7.03003.01.0
4711019	OPEL	7.02534.01.0	51884840	CHRYSLER	7.03003.01.0
4711019	VAUXHALL	7.02534.01.0	51884840	FIAT	7.03003.01.0
47275	FEBI	7.06117.17.0	51884840	LANCIA	7.03003.01.0
47610	FEBI	7.00968.04.0	5202390	FORD	7.07400.06.0
47950	FEBI	7.02256.17.0	5213714	FORD	7.07400.06.0
4801997	OPEL	7.02256.16.0	5216866	FORD	7.07400.06.0
4801997	VAUXHALL	7.02256.16.0	5217293	FORD	7.07400.06.0
4804963	OPEL	5.02549.03.0	5218897	FORD	7.07400.06.0
4804963	VAUXHALL	5.02549.03.0	5243591	FORD	7.02256.48.0
4805105	OPEL	7.06117.05.0	5247043	FORD	7.07400.06.0
4805105	VAUXHALL	7.06117.05.0	5291775	FORD	7.03306.16.0
4805106	OPEL	7.06117.06.0	5314259	FORD	7.02256.53.0
4805106	VAUXHALL	7.06117.06.0	55188059	FIAT	7.00607.02.0
4810757	OPEL	5.02549.03.0	55190509	ALFA ROMEO	7.06117.35.0
4810757	VAUXHALL	5.02549.03.0	55190509	FIAT	7.06117.35.0
4814188	OPEL	7.06117.05.0	55190509	LANCIA	7.06117.35.0
4814188	VAUXHALL	7.06117.05.0	55203202	FIAT	7.00607.02.0
4814189	OPEL	7.06117.06.0	55206832	ALFA ROMEO	7.02256.20.0
4814189	VAUXHALL	7.06117.06.0	55206832	FIAT	7.02256.20.0
4817549	OPEL	5.02549.03.0	55206832	LANCIA	7.02256.20.0
4817549	VAUXHALL	5.02549.03.0	55209166	ALFA ROMEO	7.06117.38.0
48418	FEBI	7.06117.35.0	55209166	CHRYSLER	7.06117.38.0
48419	FEBI	7.06117.38.0	55209166	FIAT	7.06117.38.0
48643	FEBI	7.00868.02.0	55209166	LANCIA	7.06117.38.0
48644	FEBI	7.22355.01.0	55209167	ALFA ROMEO	7.06117.38.0
49002006F	VM MOTORI	7.01805.01.0	55209167	CHRYSLER	7.06117.38.0
4940126	FORD	7.05432.13.0	55209167	FIAT	7.06117.38.0
49554	OSSCA	7.06117.52.0	55209167	LANCIA	7.06117.38.0
4966826	SAAB	7.22593.03.0	55210433	ABARTH	7.01835.06.0
4E0906628	AUDI	7.22903.36.0	55210433	ALFA ROMEO	7.01835.06.0

REF-No.			REF-No.		
55210433	FIAT	7.01835.06.0	555063	ERA SPA	7.22355.01.0
55210433	LANCIA	7.01835.06.0	555157	ERA SPA	7.02256.03.0
55212441	ABARTH	7.01835.06.0	555158	ERA SPA	7.02183.01.0
55212441	ALFA ROMEO	7.01835.06.0	555158A	ERA SPA	7.02183.01.0
55212441	FIAT	7.01835.06.0	555159	ERA SPA	7.00964.03.0
55212441	LANCIA	7.01835.06.0	555159A	ERA SPA	7.00964.03.0
55212441	OPEL	7.01835.06.0	555160	ERA SPA	7.28328.07.0
55212441	VAUXHALL	7.01835.06.0	555160A	ERA SPA	7.28328.07.0
55219921	FIAT	7.01981.07.0	555161	ERA SPA	7.00968.04.0
55219921	LANCIA	7.01981.07.0	555163	ERA SPA	7.02256.50.0
55221800	ALFA ROMEO	7.02909.07.0	555170	ERA SPA	7.00607.02.0
55221800	FIAT	7.02909.07.0	555171	ERA SPA	7.00868.02.0
55221800	LANCIA	7.02909.07.0	555171A	ERA SPA	7.00868.02.0
55228986	ALFA ROMEO	7.03003.01.0	555172	ERA SPA	7.28098.04.0
55228986	FIAT	7.03003.01.0	555173	ERA SPA	7.02184.01.0
55228986	LANCIA	7.03003.01.0	555173A	ERA SPA	7.02184.01.0
55256638	ALFA ROMEO	7.03003.01.0	555175	ERA SPA	7.02461.01.0
55256638	FIAT	7.03003.01.0	555176	ERA SPA	7.22796.01.0
55256638	LANCIA	7.03003.01.0	555176A	ERA SPA	7.22796.01.0
55257853	ABARTH	7.01835.06.0	555179	ERA SPA	7.22687.39.0
55257853	ALFA ROMEO	7.01835.06.0	555180	ERA SPA	7.01024.02.0
55257853	FIAT	7.01835.06.0	555182	ERA SPA	7.02256.22.0
55257853	JEEP	7.01835.06.0	555193	ERA SPA	7.02256.49.0
55257853	LANCIA	7.01835.06.0	555195	ERA SPA	7.22903.19.0
55257853	OPEL	7.01835.06.0	555196	ERA SPA	7.22138.50.0
55257853	VAUXHALL	7.01835.06.0	555197	ERA SPA	7.02318.01.0
55272793	FIAT	7.04881.08.0	555197	ERA SPA	7.28170.03.0
55352099	OPEL	7.01024.02.0	555198	ERA SPA	7.01037.02.0
55352099	VAUXHALL	7.01024.02.0	555218	ERA SPA	7.00326.03.0
55354158	CADILLAC	7.00326.03.0	555218A	ERA SPA	7.00326.03.0
55354158	OPEL	7.00326.03.0	555231	ERA SPA	7.00782.04.0
55354158	SAAB	7.00326.03.0	555233	ERA SPA	7.01633.04.0
55354158	VAUXHALL	7.00326.03.0	555234	ERA SPA	7.01771.01.0
55354529	OPEL	7.01421.01.0	555235	ERA SPA	7.02063.02.0
55354529	VAUXHALL	7.01421.01.0	555235A	ERA SPA	7.02063.02.0
554002	ERA SPA	7.06117.38.0	555236	ERA SPA	7.01019.01.0
554003	ERA SPA	7.06117.08.0	555237	ERA SPA	7.22903.17.0
554004	ERA SPA	7.06117.05.0	555237A	ERA SPA	7.22903.17.0
554004A	ERA SPA	7.06117.05.0	555288	ERA SPA	7.02256.26.0
554005	ERA SPA	7.06117.06.0	555288A	ERA SPA	7.02256.26.0
554005A	ERA SPA	7.06117.06.0	555300	ERA SPA	7.00272.03.0
554011A	ERA SPA	7.06117.46.0	555300A	ERA SPA	7.00272.03.0
554022	ERA SPA	7.06117.35.0	555331	ERA SPA	7.02256.23.0
554028A	ERA SPA	7.06117.01.0	555332	ERA SPA	7.21903.44.0
554030A	ERA SPA	7.06117.00.0	555332A	ERA SPA	7.21903.44.0
554036	ERA SPA	7.06117.42.0	555333	ERA SPA	7.00612.01.0
554038A	ERA SPA	7.06117.58.0	555333A	ERA SPA	7.00612.01.0
554041	ERA SPA	7.06117.45.0	555334	ERA SPA	7.22240.09.0
554042	ERA SPA	7.06117.43.0	555344	ERA SPA	7.01777.17.0
554043	ERA SPA	7.06117.44.0	555345	ERA SPA	7.28098.15.0
554045A	ERA SPA	7.06117.14.0	555346	ERA SPA	7.01343.04.0
554046	ERA SPA	7.06117.34.0	555377	ERA SPA	7.02256.49.0
554052	ERA SPA	7.06117.48.0	555379	ERA SPA	7.00513.10.0
55491644	CHEVROLET	7.08681.01.0	555383	ERA SPA	7.02256.19.0
55491644	OPEL	7.08681.01.0	555388	ERA SPA	7.02256.17.0
55491644	VAUXHALL	7.08681.01.0	555389	ERA SPA	7.03003.01.0
55494509	CHEVROLET	7.03073.01.0	555391	ERA SPA	7.01039.03.0
55494509	OPEL	7.03073.01.0	555392	ERA SPA	7.03653.01.0
55494509	VAUXHALL	7.03073.01.0	555393	ERA SPA	7.02256.44.0
55494584	OPEL	7.03652.01.0	555394	ERA SPA	7.02256.43.0
55494584	VAUXHALL	7.03652.01.0	555395	ERA SPA	7.01814.12.0
55495843	OPEL	7.03381.14.0	555413	ERA SPA	7.02256.20.0
55495843	VAUXHALL	7.03381.14.0	555433	ERA SPA	7.22903.34.0
55499273	OPEL	7.03653.01.0	555436	ERA SPA	7.03294.02.0
55499273	VAUXHALL	7.03653.01.0	555439	ERA SPA	7.04423.01.0
55499323	OPEL	7.03381.14.0	555442	ERA SPA	7.00782.11.0
55499323	VAUXHALL	7.03381.14.0	555443	ERA SPA	7.00782.12.0
555055	ERA SPA	7.21903.48.0	555445	ERA SPA	7.01633.06.0
555057	ERA SPA	7.03085.02.0	555446	ERA SPA	7.02534.01.0

REF-No.	 PIERBURG	REF-No.	 PIERBURG		
555447	ERA SPA	7.02256.27.0	55574696	VAUXHALL	7.03460.02.0
555450A	ERA SPA	7.21903.49.0	55574896	CHEVROLET	7.02256.44.0
555453	ERA SPA	7.21071.50.0	55574896	GMC	7.02256.44.0
555456	ERA SPA	7.00887.20.0	55574896	OPEL	7.02256.44.0
555457	ERA SPA	7.02325.04.0	55574896	VAUXHALL	7.02256.44.0
555475	ERA SPA	7.21903.73.0	55574902	BUICK	7.03833.02.0
555476	ERA SPA	7.22880.01.0	55574902	CHEVROLET	7.03833.02.0
555477	ERA SPA	7.00470.07.0	55574902	GM HOLDEN LTD	7.03833.02.0
555478	ERA SPA	7.21903.63.0	55574902	OPEL	7.03833.02.0
555479	ERA SPA	7.03073.01.0	55574902	VAUXHALL	7.03833.02.0
555481	ERA SPA	7.03833.02.0	55575611	CHEVROLET	7.03978.01.0
555482	ERA SPA	7.00580.01.0	55575611	OPEL	7.03978.01.0
555483	ERA SPA	7.02256.31.0	55575611	SAAB	7.03978.01.0
555484	ERA SPA	7.02588.04.0	55575611	VAUXHALL	7.03978.01.0
555485	ERA SPA	7.22240.15.0	55577092	OPEL	7.01039.03.0
555486	ERA SPA	7.22903.16.0	55577092	VAUXHALL	7.01039.03.0
55557806	OPEL	7.01024.02.0	55577948	OPEL	7.01981.07.0
55557806	VAUXHALL	7.01024.02.0	55577948	VAUXHALL	7.01981.07.0
55557829	OPEL	7.01039.03.0	55578222	CHEVROLET	7.08681.02.0
55557829	SAAB	7.01039.03.0	55578222	OPEL	7.08681.02.0
55557829	VAUXHALL	7.01039.03.0	55578222	VAUXHALL	7.08681.02.0
55558101	OPEL	7.01420.02.0	55579900	OPEL	7.04423.01.0
55558101	VAUXHALL	7.01420.02.0	55579900	VAUXHALL	7.04423.01.0
55559239	OPEL	7.03833.02.0	55580532	OPEL	7.07400.10.0
55559239	VAUXHALL	7.03833.02.0	55580532	VAUXHALL	7.07400.10.0
55561101	OPEL	7.02256.43.0	55583695	CHEVROLET	7.02256.45.0
55561101	VAUXHALL	7.02256.43.0	55588503	OPEL	7.03855.02.0
55562223	BUICK	7.06117.07.0	55588503	VAUXHALL	7.03855.02.0
55562223	CADILLAC	7.06117.07.0	55588662	OPEL	7.03856.02.0
55562223	CHEVROLET	7.06117.07.0	55588662	VAUXHALL	7.03856.02.0
55562223	OPEL	7.06117.07.0	55590075	OPEL	7.08681.01.0
55562223	VAUXHALL	7.06117.07.0	55590075	VAUXHALL	7.08681.01.0
55563532	OPEL	7.01421.01.0	55590347	CHEVROLET	7.02461.03.0
55563532	VAUXHALL	7.01421.01.0	55590347	OPEL	7.02461.03.0
55563534	OPEL	7.01420.02.0	55590347	VAUXHALL	7.02461.03.0
55563534	VAUXHALL	7.01420.02.0	55598157	OPEL	7.08681.01.0
55565584	OPEL	7.03653.01.0	55598157	VAUXHALL	7.08681.01.0
55565584	VAUXHALL	7.03653.01.0	556000	ERA SPA	7.06269.02.0
55566510	CADILLAC	7.00175.04.0	556000A	ERA SPA	7.06269.02.0
55566510	OPEL	7.00175.04.0	556001	ERA SPA	7.05432.01.0
55566510	SAAB	7.00175.04.0	556002	ERA SPA	7.05432.00.0
55566510	VAUXHALL	7.00175.04.0	556003	ERA SPA	7.05432.11.0
55566898	CHEVROLET	7.03073.01.0	556005	ERA SPA	7.06269.01.0
55566898	OPEL	7.03073.01.0	556006	ERA SPA	7.06269.07.0
55566898	VAUXHALL	7.03073.01.0	556021	ERA SPA	7.06269.24.0
55567050	ALFA ROMEO	7.06117.08.0	556022	ERA SPA	7.06269.23.0
55567050	CHEVROLET	7.06117.08.0	556023	ERA SPA	7.06269.22.0
55567050	FIAT	7.06117.08.0	556024	ERA SPA	7.06269.27.0
55567050	OPEL	7.06117.08.0	556024A	ERA SPA	7.06269.27.0
55567050	VAUXHALL	7.06117.08.0	556025	ERA SPA	7.06269.04.0
55567313	OPEL	7.07400.09.0	556026	ERA SPA	7.06269.03.0
55567313	VAUXHALL	7.07400.09.0	556026A	ERA SPA	7.06269.03.0
55572802	OPEL	7.03856.02.0	556027	ERA SPA	7.06269.26.0
55572802	VAUXHALL	7.03856.02.0	556028	ERA SPA	7.05432.03.0
55572809	OPEL	7.03855.00.0	556029	ERA SPA	7.05432.13.0
55572809	VAUXHALL	7.03855.00.0	556030	ERA SPA	7.05432.02.0
55573259	BUICK	7.03351.12.0	556032	ERA SPA	7.05432.06.0
55573259	OPEL	7.03351.12.0	556044	ERA SPA	7.05432.09.0
55573259	VAUXHALL	7.03351.12.0	556049	ERA SPA	7.06269.28.0
55573362	CHEVROLET	7.03978.01.0	556049A	ERA SPA	7.06269.28.0
55573362	OPEL	7.03978.01.0	556055	ERA SPA	7.05432.04.0
55573362	SAAB	7.03978.01.0	556056	ERA SPA	7.05432.12.0
55573362	VAUXHALL	7.03978.01.0	556059	ERA SPA	7.06269.05.0
55573732	OPEL	7.03652.01.0	556060	ERA SPA	7.06269.11.0
55573732	SAAB	7.03652.01.0	556061	ERA SPA	7.06269.10.0
55573732	VAUXHALL	7.03652.01.0	556063	ERA SPA	7.06269.21.0
55573801	OPEL	7.03653.01.0	556071	ERA SPA	7.06269.09.0
55573801	VAUXHALL	7.03653.01.0	556131	ERA SPA	7.02256.48.0
55574696	OPEL	7.03460.02.0	55938276	SWAG	7.21903.63.0



NUMBERFINDER



REF-No.			REF-No.		
55947275	SWAG	7.06117.17.0	5X4Q-9S468-BC	JAGUAR	7.01121.02.0
571822112073	MAGNETI MARELLI	7.02256.03.0	6000616750	FIAT	7.01814.12.0
571822112080	MAGNETI MARELLI	7.02184.01.0	6000616752	FIAT	7.01814.22.0
571822112081	MAGNETI MARELLI	7.00868.02.0	60104311	SWAG	7.06117.39.0
571822112089	MAGNETI MARELLI	7.22796.01.0	60588380	ALFA ROMEO	7.01805.01.0
571822112120	MAGNETI MARELLI	7.00782.04.0	60608904	FIAT	7.06269.06.0
58-0008	MAXGEAR	7.06269.02.0	60608904	LANCIA	7.06269.06.0
58-0010	MAXGEAR	7.06269.03.0	60801980	ABARTH	7.02256.49.0
58-0057	MAXGEAR	7.06269.27.0	60801980	ALFA ROMEO	7.02256.49.0
58-0062	MAXGEAR	7.06269.04.0	60801980	FIAT	7.02256.49.0
58-0065	MAXGEAR	7.05432.12.0	60801980	LANCIA	7.02256.49.0
58-0081	MAXGEAR	7.00415.07.0	60809716	FIAT	7.02256.03.0
58-0082	MAXGEAR	7.00968.04.0	60809716	LANCIA	7.02256.03.0
58-0112	MAXGEAR	7.01115.08.0	60812822	FIAT	7.02256.03.0
5801259656	IVECO	7.00607.04.0	60812822	LANCIA	7.02256.03.0
5801895672	IVECO	7.22517.06.0	60816462	ALFA ROMEO	7.02256.50.0
5802204141	IVECO	7.22517.06.0	60816462	FIAT	7.02256.50.0
5807452	OPEL	7.02256.22.0	60816462	LANCIA	7.02256.50.0
5807452	VAUXHALL	7.02256.22.0	6140360010	MEYLE	7.06269.01.0
5807468	OPEL	7.02256.38.0	6172132	FORD	7.06269.26.0
5807468	VAUXHALL	7.02256.38.0	618057	NEDCAR	7.21903.44.0
5807482	OPEL	7.02256.43.0	618057	VOLVO	7.21903.44.0
5807482	VAUXHALL	7.02256.43.0	6188593	FORD	7.06269.26.0
5850129	OPEL	7.01024.02.0	62102108	SWAG	7.05432.02.0
5850129	VAUXHALL	7.01024.02.0	6235597	OPEL	7.06117.08.0
5850793	OPEL	7.00045.00.0	6235597	VAUXHALL	7.06117.08.0
5850793	VAUXHALL	7.00045.00.0	6235710	OPEL	7.06117.04.0
5851010	OPEL	7.22138.50.0	6235710	VAUXHALL	7.06117.04.0
5851010	VAUXHALL	7.22138.50.0	62940109	SWAG	7.06117.34.0
5851015	OPEL	7.21903.73.0	62947610	SWAG	7.00968.04.0
5851015	VAUXHALL	7.21903.73.0	639805	TOPRAN	7.06117.34.0
5851019	OPEL	7.22138.50.0	639807	TOPRAN	7.00470.07.0
5851019	VAUXHALL	7.22138.50.0	639813	TOPRAN	7.01039.03.0
5851039	OPEL	7.03085.02.0	639813	TOPRAN	7.03833.02.0
5851039	VAUXHALL	7.03085.02.0	639821	TOPRAN	7.03280.04.0
5851045	OPEL	7.02256.26.0	639904	TOPRAN	7.00580.01.0
5851045	VAUXHALL	7.02256.26.0	639905	TOPRAN	7.01633.04.0
5851052	OPEL	7.28311.04.0	639906	TOPRAN	7.02256.27.0
5851052	VAUXHALL	7.28311.04.0	639910	TOPRAN	7.03073.01.0
5851073	OPEL	7.01420.02.0	639911	TOPRAN	7.03085.02.0
5851073	VAUXHALL	7.01420.02.0	639912	TOPRAN	7.01019.01.0
5851415	OPEL	7.07400.09.0	639914	TOPRAN	7.01777.17.0
5851415	VAUXHALL	7.07400.09.0	646140	OPEL	7.08681.01.0
5851600	OPEL	7.01420.02.0	646140	VAUXHALL	7.08681.01.0
5851600	VAUXHALL	7.01420.02.0	646167	OPEL	7.08681.01.0
5851609	OPEL	7.01421.01.0	646167	VAUXHALL	7.08681.01.0
5851609	VAUXHALL	7.01421.01.0	646179	OPEL	7.08681.02.0
5860057	OPEL	7.03833.02.0	646179	VAUXHALL	7.08681.02.0
5860057	VAUXHALL	7.03833.02.0	65.25902-0013	MAN	7.02256.41.0
5860854	OPEL	7.00326.03.0	65.25902-0019	MAN	7.02256.00.0
5860854	VAUXHALL	7.00326.03.0	6580879	FORD	7.02256.29.0
5860928	OPEL	7.00175.04.0	6580881	FORD	7.02256.29.0
5860928	VAUXHALL	7.00175.04.0	663025	ERA SPA	7.02256.40.0
59001107102	BORGWARNER TURBO SYSTEMS	7.01762.04.0	6631853	FORD	7.06269.26.0
59001107136	BORGWARNER TURBO SYSTEMS	7.04269.04.0	6631855	FORD	7.06269.26.0
59001170500	BORGWARNER TURBO SYSTEMS	7.01039.03.0	670002843	MASERATI	7.28286.13.0
59524	VDO	7.05432.01.0	68086987AA	CHRYSLER	7.02256.37.0
59603	VDO	7.05432.00.0	68086987AA	DODGE	7.02256.37.0
5H42-9D475-AA	LAND ROVER	7.21903.73.0	68086987AA	JEEP	7.02256.37.0
5S7Q-9S468-AA	FORD	7.01122.03.0	6944998	FORD	7.06269.28.0
5S7Q-9S468-AB	FORD	7.01122.03.0	6G9N-9C915-CA	FORD	7.02256.39.0
5S7Q-9S468-AC	FORD	7.01122.03.0	6G9N-9M424-AA	LAND ROVER	7.06117.18.0
5S7Q-9S468-AD	FORD	7.01122.03.0	6G9Q-9E882-CA	FORD	7.01771.01.0
5WK90631X	VDO	7.06269.01.0	6M21-12B573-AA	FORD	7.02256.00.0
5X4Q-9S468-BA	JAGUAR	7.01121.02.0	6M21-12B573-BA	FORD	7.01037.02.0
5X4Q-9S468-BB	JAGUAR	7.01121.02.0	6M21-12B573-CA	FORD	7.02183.01.0
			6M21-12B573-DA	FORD	7.02184.01.0
			6M34-9J459-BA	FORD	7.02256.25.0
			6M5G-9K378-AA	FORD	7.28197.16.0



REF-No.		 PIERBURG	REF-No.		 PIERBURG
6M8G-6M280-AA	FORD	7.06117.55.0	716060	AUTEX	7.06117.39.0
6M8Z-6M280-AA	FORD	7.06117.55.0	716061	AUTEX	7.06117.05.0
6NW009141-001	HELLA INCORPORATED	7.06269.01.0	716064	AUTEX	7.06117.57.0
6NW009141-007	HELLA INCORPORATED	7.06269.01.0	716067	AUTEX	7.06117.35.0
6NW009141-011	HELLA INCORPORATED	4.02003.62.0	716071	AUTEX	7.06117.58.0
6NW009141-021	HELLA INCORPORATED	7.06269.03.0	716077	AUTEX	7.06117.60.0
6NW009141-031	HELLA INCORPORATED	7.06269.02.0	716085	AUTEX	7.06117.42.0
6NW009141-041	HELLA INCORPORATED	7.06269.05.0	716090	AUTEX	7.06117.53.0
6NW009141-081	HELLA INCORPORATED	7.06269.26.0	716091	AUTEX	7.06117.52.0
6NW009141-091	HELLA INCORPORATED	7.06269.06.0	716101	AUTEX	7.06117.16.0
6NW009141-101	HELLA INCORPORATED	7.06269.07.0	716107	AUTEX	7.08681.00.0
6NW009141-111	HELLA INCORPORATED	7.06269.09.0	716109	AUTEX	7.08681.09.0
6NW009141-121	HELLA INCORPORATED	7.05432.01.0	71737621	ALFA ROMEO	7.08681.03.0
6NW009141-131	HELLA INCORPORATED	7.05432.00.0	71737621	FIAT	7.08681.03.0
6NW009141-141	HELLA INCORPORATED	7.05432.11.0	71737621	LANCIA	7.08681.03.0
6NW009141-211	HELLA INCORPORATED	7.05432.02.0	71737622	ALFA ROMEO	7.08681.04.0
6NW009141-341	HELLA INCORPORATED	7.05432.06.0	71737622	FIAT	7.08681.04.0
6NW009141-371	HELLA INCORPORATED	7.05432.03.0	71737622	LANCIA	7.08681.04.0
6NW009141-401	HELLA INCORPORATED	7.05432.09.0	71737623	ALFA ROMEO	7.08681.05.0
6NW009141-441	HELLA INCORPORATED	7.05432.04.0	71737623	FIAT	7.08681.05.0
6NW009141-461	HELLA INCORPORATED	7.05432.12.0	71737623	LANCIA	7.08681.05.0
6NW009141-511	HELLA INCORPORATED	7.06269.00.0	71737624	ALFA ROMEO	7.08681.06.0
6NW009141-531	HELLA INCORPORATED	7.06269.27.0	71737624	FIAT	7.08681.06.0
6NW009141-541	HELLA INCORPORATED	7.06269.24.0	71737624	LANCIA	7.08681.06.0
6NW009141-551	HELLA INCORPORATED	7.06269.22.0	71744383	ALFA ROMEO	7.06117.08.0
6NW009141-561	HELLA INCORPORATED	7.06269.23.0	71744383	FIAT	7.06117.08.0
6NW009141-571	HELLA INCORPORATED	7.06269.04.0	71746654	FIAT	7.02534.01.0
6NW009141-581	HELLA INCORPORATED	7.06269.01.0	71749996	FIAT	7.08681.07.0
6NW009141-601	HELLA INCORPORATED	7.05432.00.0	71750167	FIAT	7.02534.01.0
6NW009141-631	HELLA INCORPORATED	7.05432.02.0	71752639	ALFA ROMEO	7.08681.06.0
6NW009141-651	HELLA INCORPORATED	7.05432.04.0	71752639	FIAT	7.08681.06.0
6NW009141-661	HELLA INCORPORATED	7.05432.11.0	71752639	LANCIA	7.08681.06.0
6NW009141-711	HELLA INCORPORATED	7.05432.06.0	71753780	ALFA ROMEO	7.08681.03.0
6S7Q-9S468-AA	FORD	7.01349.01.0	71753780	FIAT	7.08681.03.0
6S7Q-9S468-AB	FORD	7.01349.01.0	71753780	LANCIA	7.08681.03.0
6X4Q-9S468-BA	JAGUAR	7.01569.04.0	71753781	ALFA ROMEO	7.08681.04.0
6X4Q-9S468-BB	JAGUAR	7.01569.04.0	71753781	FIAT	7.08681.04.0
6X4Q-9S468-BC	JAGUAR	7.01569.04.0	71753781	LANCIA	7.08681.04.0
7.16165	DT-DIESEL TECHNIC AG	7.00607.02.0	71753782	ALFA ROMEO	7.08681.05.0
7001400C1	NAVISTAR	7.03964.01.0	71753782	FIAT	7.08681.05.0
701719	TOPRAN	7.02256.17.0	71753782	LANCIA	7.08681.05.0
7084580	FORD	7.06269.02.0	71753848	ALFA ROMEO	7.01981.07.0
70859134	VOLVO	7.06269.09.0	71753848	FIAT	7.01981.07.0
70944375	SWAG	7.02256.03.0	71753848	LANCIA	7.01981.07.0
70945461	SWAG	7.02256.49.0	71773490	FIAT	7.08681.13.0
70945464	SWAG	7.02256.50.0	71773491	FIAT	7.08681.14.0
70945465	SWAG	7.02256.20.0	7212143	FORD	7.06269.11.0
70945466	SWAG	7.00607.02.0	721455	TOPRAN	7.05432.02.0
70948418	SWAG	7.06117.35.0	721458	TOPRAN	7.05432.06.0
70948419	SWAG	7.06117.38.0	721465	TOPRAN	7.05432.04.0
7117213	FORD	7.06269.28.0	723814	TOPRAN	7.00968.04.0
716008	AUTEX	7.06117.43.0	7331606	FORD	7.02256.47.0
716013	AUTEX	7.06117.56.0	7501775	BMW	7.06117.10.0
716017	AUTEX	7.06117.38.0	7514006	HOFFER	7.05432.00.0
716020	AUTEX	7.06117.10.0	7514011	HOFFER	7.05432.09.0
716021	AUTEX	7.06117.37.0	7514012	HOFFER	7.05432.02.0
716022	AUTEX	7.06117.36.0	7514014	HOFFER	7.05432.04.0
716024	AUTEX	7.06117.44.0	7514021	HOFFER	7.05432.01.0
716025	AUTEX	7.06117.48.0	7514022	HOFFER	7.05432.06.0
716028	AUTEX	7.06117.54.0	7514025	HOFFER	7.05432.09.0
716031	AUTEX	7.06117.53.0	7514041	HOFFER	7.05432.11.0
716032	AUTEX	7.06117.47.0	7514056	HOFFER	7.05432.03.0
716036	AUTEX	7.06117.52.0	7514057	HOFFER	7.05432.13.0
716040	AUTEX	7.06117.34.0	7515013	HOFFER	7.06269.02.0
716044	AUTEX	7.06117.14.0	7515014	HOFFER	7.06269.01.0
716046	AUTEX	7.06117.46.0	7515015	HOFFER	7.06269.06.0
716048	AUTEX	7.06117.45.0	7515022	HOFFER	7.06269.26.0
716050	AUTEX	7.06117.00.0	7515023	HOFFER	7.06269.03.0
716058	AUTEX	7.06117.06.0	7515027	HOFFER	7.06269.24.0

NUMBERFINDER

REF-No.			REF-No.		
7515028	HOFFER	7.06269.23.0	7808032	BMW	7.02256.27.0
7515029	HOFFER	7.06269.22.0	7808032	MINI (BMW)	7.02256.27.0
7515030	HOFFER	7.06269.27.0	7810831	BMW	7.02318.01.0
7515031	HOFFER	7.06269.04.0	7811814	BMW	7.02256.27.0
7515033	HOFFER	7.06269.28.0	7811814	MINI (BMW)	7.02256.27.0
7515035	HOFFER	7.06269.07.0	784065	OPEL	7.08681.05.0
7516293	BMW	7.06117.01.0	784065	VAUXHALL	7.08681.05.0
7519474	HOFFER	7.02256.28.0	784068	OPEL	7.08681.03.0
7524489	BMW	7.06117.10.0	784068	VAUXHALL	7.08681.03.0
7548706	BMW	7.00887.19.0	784069	OPEL	7.08681.04.0
7552946	BMW	7.01777.17.0	784069	VAUXHALL	7.08681.04.0
7552946	MINI (BMW)	7.01777.17.0	7851299	BMW	7.06117.36.0
7560462	BMW	7.06117.00.0	7D0963375	VOLKSWAGEN	7.02256.06.0
7560462	ROLLS-ROYCE	7.06117.00.0	7G9N-9M424-AA	LAND ROVER	7.06117.18.0
7561265	BMW	7.06117.36.0	7L0819076	VOLKSWAGEN	7.02256.42.0
7561265	ROLLS-ROYCE	7.06117.36.0	7L0819076A	VOLKSWAGEN	7.02256.42.0
7564734	BMW	7.06117.02.0	7L0819076B	VOLKSWAGEN	7.02256.42.0
7564734	MINI (BMW)	7.06117.02.0	7L0819076C	AUDI	7.02256.42.0
7566324	MINI (BMW)	7.01115.08.0	7L0819076C	VOLKSWAGEN	7.02256.42.0
7566652	BMW	7.06117.02.0	7L0819076E	VOLKSWAGEN	7.02256.42.0
7566652	MINI (BMW)	7.06117.02.0	7L0820989	VOLKSWAGEN	7.02256.42.0
7566781	BMW	7.01777.17.0	7PP906046	PORSCHE	7.22687.51.0
7566781	MINI (BMW)	7.01777.17.0	7PP906270	PORSCHE	7.22280.02.0
7578683	MINI (BMW)	7.01115.08.0	8.029.319	HOFFER	7.21903.44.0
7582652	BMW	7.00887.20.0	801000776401	MAGNETI MARELLI	7.05432.06.0
7584628	BMW	7.00887.21.0	8010034	METZGER	7.03162.09.0
7584628	ROLLS-ROYCE	7.00887.21.0	8021688	HOFFER	7.08681.00.0
7585425	BMW	7.06117.01.0	8029036	HOFFER	7.02256.24.0
7585776	BMW	7.06117.36.0	8029055	HOFFER	7.02184.01.0
7585776	ROLLS-ROYCE	7.06117.36.0	8029058	HOFFER	7.02256.22.0
7587760	BMW	7.06117.02.0	8029082	HOFFER	7.00612.01.0
7587760	MINI (BMW)	7.06117.02.0	8029084	HOFFER	7.02183.01.0
7591625	BMW	7.03075.02.0	8029086	HOFFER	7.21903.70.0
759179	OPEL	7.08681.06.0	8029087	HOFFER	7.00868.02.0
759179	VAUXHALL	7.08681.06.0	8029088	HOFFER	7.28098.04.0
7593273	MINI (BMW)	7.01115.08.0	8029089	HOFFER	7.22880.01.0
7595373	BMW	7.01777.17.0	8029090	HOFFER	7.22402.03.0
7595373	MINI (BMW)	7.01777.17.0	8029091	HOFFER	7.21483.54.0
7595374	BMW	7.00887.19.0	8029093	HOFFER	7.22796.01.0
7595375	BMW	7.00887.20.0	8029095	HOFFER	7.02256.50.0
7599547	BMW	7.01777.17.0	8029096	HOFFER	7.22903.19.0
7599547	MINI (BMW)	7.01777.17.0	8029097	HOFFER	7.02461.01.0
7604292	BMW	7.06117.02.0	8029098	HOFFER	7.22687.39.0
7604292	MINI (BMW)	7.06117.02.0	8029100	HOFFER	7.02256.23.0
7609210	BMW	7.04216.05.0	8029126	HOFFER	7.00612.01.0
7609210	ROLLS-ROYCE	7.04216.05.0	8029127	HOFFER	7.02256.07.0
7610060	BMW	7.06117.36.0	8029128	HOFFER	7.02256.29.0
7626350	BMW	7.00887.19.0	8029131	HOFFER	7.03085.02.0
7626351	BMW	7.00887.21.0	8029132	HOFFER	7.00968.04.0
7626351	ROLLS-ROYCE	7.00887.21.0	8029133	HOFFER	7.00580.01.0
7628987	BMW	7.00887.20.0	8029135	HOFFER	7.21071.50.0
7649407	BMW	7.00887.22.0	8029136	HOFFER	7.22138.50.0
7700100788	RENAULT	7.02256.19.0	8029137	HOFFER	7.02318.01.0
7700101689	FIAT	7.02256.05.0	8029137	HOFFER	7.28170.03.0
7700101689	LANCIA	7.02256.05.0	8029138	HOFFER	7.22355.01.0
7700101689	RENAULT	7.02256.05.0	8029139	HOFFER	7.00326.03.0
7700109099	RENAULT	7.02256.04.0	8029140	HOFFER	7.22572.01.0
7700113071	RENAULT	7.02256.04.0	8029148	HOFFER	7.01024.02.0
7700377175	RENAULT	7.21903.75.0	8029149	HOFFER	7.02256.49.0
7700859134	RENAULT	7.06269.09.0	8029149	HOFFER	7.22240.09.0
7700870084	RENAULT	7.06269.07.0	8029151	HOFFER	7.01037.02.0
77364771	FIAT	7.02256.30.0	8029154	HOFFER	7.01805.01.0
7766269	ALFA ROMEO	7.05432.09.0	8029186	HOFFER	7.01420.02.0
7766269	FIAT	7.05432.09.0	8029186	HOFFER	7.03088.01.0
7766269	LANCIA	7.05432.09.0	8029186	HOFFER	7.04423.01.0
7796338	BMW	7.02256.27.0	8029194	HOFFER	7.02256.14.0
7796338	MINI (BMW)	7.02256.27.0	8029196	HOFFER	7.02256.15.0
7796634	BMW	7.22796.01.0	8029220	HOFFER	7.02256.21.0
7805391	BMW	7.02063.02.0	8029223	HOFFER	7.02256.49.0



REF-No.		 PIERBURG	REF-No.		 PIERBURG
8029226	HOFFER	7.00513.10.0	80299009	HOFFER	7.02221.01.0
8029228	HOFFER	7.01633.04.0	80299010	HOFFER	7.02968.02.0
8029229	HOFFER	7.01771.01.0	80299011	HOFFER	7.04492.07.0
8029231	HOFFER	7.01019.01.0	80299013	HOFFER	7.22240.15.0
8029232	HOFFER	7.00887.19.0	8029905	HOFFER	7.02256.40.0
8029233	HOFFER	7.00470.07.0	8029908	HOFFER	7.02256.42.0
8029235	HOFFER	7.22903.17.0	8029909	HOFFER	7.02256.41.0
8029237	HOFFER	7.21903.49.0	805059	METZGER	7.08681.03.0
8029238	HOFFER	7.22903.16.0	805060	MEAT&DORIA	7.08681.04.0
8029239	HOFFER	7.02256.26.0	805061	MEAT&DORIA	7.08681.05.0
8029247	HOFFER	7.02256.19.0	805064	MEAT&DORIA	7.08681.06.0
8029250	HOFFER	7.02256.16.0	8091500	HOFFER	7.06117.08.0
8029265	HOFFER	7.02256.17.0	8091505	HOFFER	7.06117.34.0
8029268	HOFFER	7.02256.20.0	8091505E	HOFFER	7.06117.34.0
8029285	HOFFER	7.00175.04.0	8091506	HOFFER	7.06117.38.0
8029287	HOFFER	7.01830.13.0	8091506A1	HOFFER	7.06117.38.0
8029288	HOFFER	7.02909.07.0	8091508	HOFFER	7.06117.35.0
8029289	HOFFER	7.01835.06.0	8091508A1	HOFFER	7.06117.35.0
8029290	HOFFER	7.01762.04.0	8091519	HOFFER	7.06117.08.0
8029291	HOFFER	7.00036.03.0	8091521	HOFFER	7.08681.09.0
8029294	HOFFER	7.04818.04.0	8091521E	HOFFER	7.08681.09.0
8029295	HOFFER	7.02901.05.0	8091523	HOFFER	7.06117.06.0
8029301	HOFFER	7.01039.03.0	8091524	HOFFER	7.06117.05.0
8029302	HOFFER	7.02588.04.0	8091527	HOFFER	7.06117.33.0
8029303	HOFFER	7.02318.01.0	8091537	HOFFER	7.06117.00.0
8029314	HOFFER	7.00782.16.0	8091538	HOFFER	7.06117.02.0
8029315	HOFFER	7.00782.12.0	8091539	HOFFER	7.06117.46.0
8029316	HOFFER	7.04423.01.0	8091554	HOFFER	7.06117.45.0
8029321	HOFFER	7.21903.63.0	8091554E	HOFFER	7.06117.45.0
8029322	HOFFER	7.21903.73.0	8091557	HOFFER	7.06117.54.0
8029324	HOFFER	7.03294.02.0	8091559	HOFFER	7.06117.48.0
8029325	HOFFER	7.03653.01.0	8091560	HOFFER	7.06117.10.0
8029328	HOFFER	7.02256.44.0	8091564	HOFFER	7.06117.42.0
8029330	HOFFER	7.02256.45.0	8091566	HOFFER	7.06117.58.0
8029332	HOFFER	7.03833.02.0	8091583	HOFFER	7.06117.37.0
8029334	HOFFER	7.02256.00.0	8091584	HOFFER	7.06117.60.0
8029335	HOFFER	7.04615.03.0	8091589	HOFFER	7.06117.36.0
8029339	HOFFER	7.01777.17.0	8091594	HOFFER	7.06117.16.0
8029340	HOFFER	7.01814.12.0	81.178	SIDAT	7.00175.04.0
8029368	HOFFER	7.28197.16.0	81.179	SIDAT	7.01115.08.0
8029369	HOFFER	7.28098.15.0	81.181	SIDAT	7.02909.07.0
8029374	HOFFER	7.01343.04.0	81.182	SIDAT	7.01835.06.0
8029375	HOFFER	7.22240.13.0	81.183	SIDAT	7.01762.04.0
8029384	HOFFER	7.10014.00.0	81.186	SIDAT	7.01870.06.0
8029440	HOFFER	7.02256.48.0	81.186	SIDAT	7.04818.04.0
8029449	HOFFER	7.02256.51.0	81.187	SIDAT	7.02901.05.0
8029493	HOFFER	7.03280.04.0	81.284	SIDAT	7.00782.16.0
8029499	HOFFER	7.03073.01.0	81.285	SIDAT	7.00782.12.0
8029519	HOFFER	7.01633.06.0	81.286	SIDAT	7.04423.01.0
8029520	HOFFER	7.02325.05.0	81.289A2	SIDAT	7.21903.44.0
8029530	HOFFER	7.01044.03.0	81.297	SIDAT	7.02256.44.0
8029531	HOFFER	7.01632.02.0	81.300	SIDAT	7.02256.45.0
8029532	HOFFER	7.00607.04.0	81.302	SIDAT	7.03653.01.0
8029536	HOFFER	7.03554.10.0	81.332	SIDAT	7.03833.02.0
8029540	HOFFER	7.03584.01.0	81.340	SIDAT	7.04247.02.0
8029599	HOFFER	7.02613.02.0	81.370	SIDAT	7.04615.03.0
8029731	HOFFER	7.02534.01.0	81.585	SIDAT	7.02909.12.0
8029732	HOFFER	7.22903.34.0	81180	SIDAT	7.01830.13.0
8029734	HOFFER	7.02256.25.0	81289	SIDAT	7.21903.44.0
8029736	HOFFER	7.02256.31.0	81291	SIDAT	7.21903.63.0
8029737	HOFFER	7.28311.04.0	81292	SIDAT	7.21903.73.0
8029738	HOFFER	7.22280.02.0	81301	SIDAT	7.03294.02.0
8029770	HOFFER	7.22908.03.0	817186	OPEL	7.02256.43.0
8029773	HOFFER	7.01777.18.0	817186	VAUXHALL	7.02256.43.0
8029818	HOFFER	7.02909.12.0	817253	OPEL	7.05432.00.0
8029873	HOFFER	7.02325.04.0	817253	VAUXHALL	7.05432.00.0
8029897	HOFFER	7.05367.05.0	817254	GM HOLDEN LTD	7.05432.01.0
80299000	HOFFER	7.02436.02.0	817254	OPEL	7.05432.01.0
80299005	HOFFER	7.00017.03.0	817254	VAUXHALL	7.05432.01.0

REF-No.			REF-No.		
817255	OPEL	7.05432.00.0	83.1722	SIDAT	7.00017.03.0
817255	VAUXHALL	7.05432.00.0	83.1826	SIDAT	7.02221.01.0
817256	OPEL	7.05432.11.0	83.1827	SIDAT	7.02968.02.0
817256	VAUXHALL	7.05432.11.0	83.1828	SIDAT	7.04492.07.0
817640	OPEL	7.05432.11.0	83.2688	SIDAT	7.08681.00.0
817640	VAUXHALL	7.05432.11.0	83.660	SIDAT	7.00607.02.0
820003215010	MAGNETI MARELLI	7.05432.11.0	83.660	SIDAT	7.01421.01.0
820003253010	MAGNETI MARELLI	7.05432.00.0	83.661	SIDAT	7.03085.02.0
820003390010	MAGNETI MARELLI	7.06269.23.0	83.662	SIDAT	7.22355.01.0
820003391010	MAGNETI MARELLI	7.06269.03.0	83.750	SIDAT	7.21903.70.0
820003398010	MAGNETI MARELLI	7.06269.02.0	83.752	SIDAT	7.00868.02.0
8200120126	RENAULT	7.01152.02.0	83.753	SIDAT	7.02256.24.0
8200162073	RENAULT	7.01152.02.0	83.756	SIDAT	7.28098.04.0
8200201099	DACIA	7.02256.21.0	83.758	SIDAT	7.02256.22.0
8200201099	RENAULT	7.02256.21.0	83.759	SIDAT	7.02183.01.0
8200211431	RENAULT	7.06269.07.0	83.762	SIDAT	7.02184.01.0
8200240058	RENAULT	7.06117.39.0	83.763	SIDAT	7.00612.01.0
8200247248	RENAULT	7.01152.02.0	83.764	SIDAT	7.02256.04.0
8200270451	RENAULT	7.01152.02.0	83.765	SIDAT	7.02256.14.0
8200412085	RENAULT	7.01152.02.0	83.767	SIDAT	7.02256.15.0
8200413185	RENAULT	7.06117.39.0	83.769	SIDAT	7.00968.04.0
8200486264	RENAULT	7.01152.02.0	83.771	SIDAT	7.22903.19.0
8200575400	RENAULT	7.02256.15.0	83.772	SIDAT	7.00612.01.0
8200603558	DACIA	7.01343.04.0	83.773	SIDAT	7.02256.23.0
8200603558	RENAULT	7.01343.04.0	83.774	SIDAT	7.02461.01.0
8200625684	DACIA	7.02256.21.0	83.775	SIDAT	7.00782.04.0
8200625684	RENAULT	7.02256.21.0	83.776	SIDAT	7.02256.50.0
8200642783	DACIA	7.06117.15.0	83.777	SIDAT	7.22796.01.0
8200642783	RENAULT	7.06117.15.0	83.778	SIDAT	7.02256.07.0
8200661049	DACIA	7.02256.21.0	83.780	SIDAT	7.22687.39.0
8200661049	RENAULT	7.02256.21.0	83.782	SIDAT	7.22402.03.0
8200762597	RENAULT	7.02256.19.0	83.783	SIDAT	7.22880.01.0
8200790180	DACIA	7.01814.12.0	83.785	SIDAT	7.00262.02.0
8200790180	RENAULT	7.01814.12.0	83.799	SIDAT	7.21903.49.0
8200823650	RENAULT	7.06117.39.0	83.801	SIDAT	7.21071.50.0
8200926308	DACIA	7.01814.12.0	83.803	SIDAT	7.01024.02.0
8200926308	RENAULT	7.01814.12.0	83.804	SIDAT	7.01420.02.0
82102993	SWAG	7.06117.14.0	83.804	SIDAT	7.03088.01.0
826548	OPEL	7.05432.11.0	83.804	SIDAT	7.04423.01.0
826548	VAUXHALL	7.05432.11.0	83.806	SIDAT	7.02256.21.0
826550	OPEL	7.05432.11.0	83.807	SIDAT	7.02256.49.0
826550	VAUXHALL	7.05432.11.0	83.842	SIDAT	7.00580.01.0
82947950	SWAG	7.02256.17.0	83.843	SIDAT	7.22138.50.0
83.1001	SIDAT	7.02256.00.0	83.844	SIDAT	7.02318.01.0
83.1024	SIDAT	7.01777.17.0	83.844	SIDAT	7.28170.03.0
83.1025	SIDAT	7.01814.12.0	83.845	SIDAT	7.00326.03.0
83.1042	SIDAT	7.01343.04.0	83.846	SIDAT	7.22572.01.0
83.1043	SIDAT	7.22240.13.0	83.852	SIDAT	7.02256.49.0
83.1054	SIDAT	7.10014.00.0	83.853	SIDAT	7.01037.02.0
83.1156	SIDAT	7.02256.48.0	83.855	SIDAT	7.01805.01.0
83.1161	SIDAT	7.02256.51.0	83.869	SIDAT	7.02256.16.0
83.1186	SIDAT	7.00887.21.0	83.871	SIDAT	7.02256.17.0
83.1204	SIDAT	7.00887.22.0	83.873	SIDAT	7.02256.19.0
83.1205	SIDAT	7.03280.04.0	83.874	SIDAT	7.02256.20.0
83.1246	SIDAT	7.03073.01.0	83.879	SIDAT	7.02256.40.0
83.127-2	SIDAT	7.02325.05.0	83.880	SIDAT	7.02256.41.0
83.1270	SIDAT	7.01633.06.0	83.886	SIDAT	7.02256.42.0
83.1283	SIDAT	7.03554.10.0	83.898	SIDAT	7.00513.10.0
83.1305	SIDAT	7.01044.03.0	83.899	SIDAT	7.00272.03.0
83.1306	SIDAT	7.01632.02.0	83.901	SIDAT	7.00612.01.0
83.1307	SIDAT	7.00607.04.0	83.902	SIDAT	7.02063.02.0
83.1317	SIDAT	7.03584.01.0	83.903	SIDAT	7.01019.01.0
83.1381	SIDAT	7.02613.02.0	83.904	SIDAT	7.00887.19.0
83.1445	SIDAT	7.02256.25.0	83.905	SIDAT	7.00470.07.0
83.1447	SIDAT	7.02256.31.0	83.906	SIDAT	7.01003.01.0
83.1448	SIDAT	7.28311.04.0	83.946	SIDAT	7.02256.26.0
83.1450	SIDAT	7.00887.20.0	83.948	SIDAT	7.02256.27.0
83.1485	SIDAT	7.22908.03.0	83.948A2	SIDAT	7.02256.27.0
83.1495	SIDAT	7.01777.18.0	83.961	SIDAT	7.02588.04.0

REF-No.		 PIERBURG	REF-No.		 PIERBURG
83.962	SIDAT	7.02318.01.0	8510260	LAND ROVER	7.06117.10.0
831.041	SIDAT	7.28098.15.0	851042	OPEL	7.03978.01.0
831.690	SIDAT	7.02325.04.0	851042	VAUXHALL	7.03978.01.0
831031	SIDAT	7.02212.02.0	851044	OPEL	7.03460.02.0
831040	SIDAT	7.28197.16.0	851044	VAUXHALL	7.03460.02.0
831442	SIDAT	7.02534.01.0	851046	OPEL	7.01981.07.0
831443	SIDAT	7.22903.34.0	851046	VAUXHALL	7.01981.07.0
831447	METZGER	7.02256.31.0	851057	OPEL	7.04423.01.0
831448	SIDAT	7.28311.04.0	851057	VAUXHALL	7.04423.01.0
831449	SIDAT	7.22280.02.0	851060	OPEL	7.03855.00.0
831725	SIDAT	7.05367.05.0	851060	VAUXHALL	7.03855.00.0
831727	SIDAT	7.02436.02.0	851070	OPEL	7.07400.10.0
83666	MAPCO	7.22796.01.0	851070	VAUXHALL	7.07400.10.0
837102	OPEL	7.06269.01.0	851081	OPEL	7.01421.01.0
837102	VAUXHALL	7.06269.01.0	851081	VAUXHALL	7.01421.01.0
837104	OPEL	7.06269.01.0	851100	OPEL	7.01981.07.0
837104	VAUXHALL	7.06269.01.0	851100	VAUXHALL	7.01981.07.0
83757	SIDAT	7.22903.17.0	851129	OPEL	7.03855.02.0
83800	SIDAT	7.22903.16.0	851129	VAUXHALL	7.03855.02.0
83840	MAPCO	7.02184.01.0	851130	OPEL	7.03856.02.0
83901	SIDAT	7.01771.01.0	851130	VAUXHALL	7.03856.02.0
83955	SIDAT	7.00036.03.0	851138	OPEL	7.03856.02.0
83956	SIDAT	7.03003.01.0	851138	VAUXHALL	7.03856.02.0
84006	MEAT&DORIA	7.05432.00.0	851277	OPEL	7.03653.01.0
84011	MEAT&DORIA	7.05432.09.0	851277	VAUXHALL	7.03653.01.0
84012	MEAT&DORIA	7.05432.02.0	860146	OPEL	7.03085.02.0
84014	MEAT&DORIA	7.05432.04.0	860146	VAUXHALL	7.03085.02.0
84021	MEAT&DORIA	7.05432.01.0	860223	OPEL	7.02721.06.0
84022	MEAT&DORIA	7.05432.06.0	860223	VAUXHALL	7.02721.06.0
84025	MEAT&DORIA	7.05432.09.0	860245	OPEL	7.00175.04.0
84041	MEAT&DORIA	7.05432.11.0	860245	VAUXHALL	7.00175.04.0
84056	MEAT&DORIA	7.05432.03.0	860370	OPEL	7.03351.12.0
84057	MEAT&DORIA	7.05432.13.0	860370	VAUXHALL	7.03351.12.0
85013	MEAT&DORIA	7.06269.02.0	860411	OPEL	7.03088.01.0
85014	MEAT&DORIA	7.06269.01.0	860411	VAUXHALL	7.03088.01.0
85015	MEAT&DORIA	7.06269.06.0	860416	OPEL	7.02461.03.0
85022	MEAT&DORIA	7.06269.26.0	860416	VAUXHALL	7.02461.03.0
85023	MEAT&DORIA	7.06269.03.0	860472	OPEL	7.02721.06.0
85027	MEAT&DORIA	7.06269.24.0	860472	VAUXHALL	7.02721.06.0
85028	MEAT&DORIA	7.06269.23.0	860485	OPEL	7.03088.01.0
85029	MEAT&DORIA	7.06269.22.0	860485	VAUXHALL	7.03088.01.0
85030	MEAT&DORIA	7.06269.27.0	860489	OPEL	7.02461.01.0
85031	MEAT&DORIA	7.06269.04.0	860489	VAUXHALL	7.02461.01.0
85033	MEAT&DORIA	7.06269.28.0	860512	OPEL	7.03357.04.0
85035	MEAT&DORIA	7.06269.07.0	860512	VAUXHALL	7.03357.04.0
850351	OPEL	7.03833.02.0	8605123	BMW	7.06117.36.0
850351	VAUXHALL	7.03833.02.0	8605123	ROLLS-ROYCE	7.06117.36.0
850388	OPEL	7.01039.03.0	860521	OPEL	7.03381.15.0
850388	VAUXHALL	7.01039.03.0	860521	VAUXHALL	7.03381.15.0
850430	OPEL	7.01039.03.0	860656	OPEL	7.03381.14.0
850430	VAUXHALL	7.01039.03.0	860656	VAUXHALL	7.03381.14.0
850436	OPEL	7.01024.02.0	8610388	BMW	7.06117.02.0
850436	VAUXHALL	7.01024.02.0	8610388	MINI (BMW)	7.06117.02.0
850437	OPEL	7.02256.28.0	8627005	VOLVO	7.22517.06.0
850437	VAUXHALL	7.02256.28.0	8627299	VOLVO	7.22240.13.0
850441	OPEL	7.01039.03.0	8631285	VOLVO	7.28194.01.0
850441	VAUXHALL	7.01039.03.0	8636606	MINI (BMW)	7.05367.05.0
850531	OPEL	7.01835.06.0	8653857	VOLVO	7.02256.39.0
850531	VAUXHALL	7.01835.06.0	8699233	VOLVO	7.00515.04.0
850774	OPEL	7.02256.44.0	87.004	SIDAT	7.05432.00.0
850774	VAUXHALL	7.02256.44.0	87.008	SIDAT	7.05432.09.0
8509323	BMW	7.02256.27.0	87.009	SIDAT	7.05432.02.0
8509323	MINI (BMW)	7.02256.27.0	87.011	SIDAT	7.05432.04.0
851014	OPEL	7.03073.01.0	87.015	SIDAT	7.05432.01.0
851014	VAUXHALL	7.03073.01.0	87.016	SIDAT	7.05432.06.0
851017	OPEL	7.03978.01.0	87.032	SIDAT	7.05432.11.0
851017	VAUXHALL	7.03978.01.0	87.047	SIDAT	7.05432.03.0
851026	OPEL	7.03653.01.0	87.048	SIDAT	7.05432.13.0
851026	VAUXHALL	7.03653.01.0	87.052	SIDAT	7.06269.02.0



NUMBERFINDER

REF-No.			REF-No.		
87.053	SIDAT	7.06269.01.0	899120	METZGER	7.06117.36.0
87.054	SIDAT	7.06269.06.0	899259	MEAT&DORIA	7.08681.03.0
87.060	SIDAT	7.06269.26.0	8E0906627A	AUDI	7.22903.19.0
87.061	SIDAT	7.06269.03.0	8E0906627C	AUDI	7.22903.28.0
87.065	SIDAT	7.06269.24.0	8E0906627C	SKODA	7.22903.28.0
87.066	SIDAT	7.06269.23.0	8E0906627C	VOLKSWAGEN	7.22903.28.0
87.067	SIDAT	7.06269.22.0	8E0906628	AUDI	7.22903.34.0
87.068	SIDAT	7.06269.27.0	8E0906628	SKODA	7.22903.34.0
87.069	SIDAT	7.06269.04.0	8E0906628	VOLKSWAGEN	7.22903.34.0
87.071	SIDAT	7.06269.28.0	8E0906628A	AUDI	7.22903.18.0
87.073	SIDAT	7.06269.07.0	8E0906628B	AUDI	7.22903.37.0
87.080	SIDAT	7.06117.08.0	8E0906628C	AUDI	7.22903.37.0
87.083	SIDAT	7.06117.34.0	9.407.0.767.007.4	MWM	7.01024.02.0
87.083A2	SIDAT	7.06117.34.0	90103256	SWAG	7.00272.03.0
87.084	SIDAT	7.06117.38.0	9036	MEAT&DORIA	7.02256.24.0
87.084A2	SIDAT	7.06117.38.0	9039	MEAT&DORIA	7.21903.48.0
87.086	SIDAT	7.06117.35.0	90411546	OPEL	7.06269.01.0
87.086A2	SIDAT	7.06117.35.0	90411546	VAUXHALL	7.06269.01.0
87.102	SIDAT	7.06117.08.0	90424141	OPEL	7.01039.03.0
87.104	SIDAT	7.08681.09.0	90424141	VAUXHALL	7.01039.03.0
87.104A2	SIDAT	7.08681.09.0	90530039	OPEL	7.22138.50.0
87.107	SIDAT	7.06117.06.0	90530039	SAAB	7.22138.50.0
87.108	SIDAT	7.06117.05.0	90530039	VAUXHALL	7.22138.50.0
87.111	SIDAT	7.06117.33.0	9054	MEAT&DORIA	7.00964.03.0
87.121	SIDAT	7.06117.00.0	90541705	OPEL	7.21903.73.0
87.123	SIDAT	7.06117.46.0	90541705	VAUXHALL	7.21903.73.0
87.126	SIDAT	7.06117.01.0	90542357	OPEL	7.22138.50.0
87.138	SIDAT	7.06117.45.0	90542357	SAAB	7.22138.50.0
87.138A2	SIDAT	7.06117.45.0	90542357	VAUXHALL	7.22138.50.0
87.182	SIDAT	7.06117.54.0	9055	MEAT&DORIA	7.02184.01.0
87.184	SIDAT	7.06117.48.0	9057	MEAT&DORIA	7.21903.75.0
87.185	SIDAT	7.06117.10.0	9058	MEAT&DORIA	7.02256.22.0
87.189	SIDAT	7.06117.42.0	9060	MEAT&DORIA	7.22903.19.0
87.191	SIDAT	7.06117.58.0	9082	MEAT&DORIA	7.00612.01.0
87.193	SIDAT	7.06117.14.0	9082	MEAT&DORIA	7.28328.07.0
87.202	SIDAT	7.06117.37.0	9083	MEAT&DORIA	7.00964.03.0
87.203	SIDAT	7.06117.60.0	9084	MEAT&DORIA	7.02183.01.0
8790107	KNECHT	7.22098.04.0	9085	MEAT&DORIA	7.00607.02.0
87TF-9F715-AA	FORD	7.06269.26.0	9086	MEAT&DORIA	7.21903.70.0
87TF-9F715-AB	FORD	7.06269.26.0	9087	MEAT&DORIA	7.00868.02.0
87TF-9F715-CA	FORD	7.06269.26.0	9088	MEAT&DORIA	7.28098.04.0
87TF-9F715-CB	FORD	7.06269.26.0	9089	MEAT&DORIA	7.22880.01.0
881324034	TRISCAN A/S	7.22138.50.0	9090	MEAT&DORIA	7.22402.03.0
881329103	TRISCAN A/S	7.02184.01.0	9091	MEAT&DORIA	7.21483.54.0
881329104	TRISCAN A/S	7.00868.02.0	9093	MEAT&DORIA	7.22796.01.0
88459	SIDAT	7.02256.28.0	9095	MEAT&DORIA	7.02256.50.0
892164	METZGER	7.01771.01.0	9096	MEAT&DORIA	7.22903.19.0
892191	METZGER	7.21483.54.0	9096	MEAT&DORIA	7.22903.28.0
892192	METZGER	7.03294.02.0	9097	MEAT&DORIA	7.02461.01.0
892199	METZGER	7.22240.09.0	9098	MEAT&DORIA	7.22687.39.0
892200	METZGER	7.02256.29.0	9099	MEAT&DORIA	7.03088.01.0
892219	METZGER	7.01037.02.0	9100	MEAT&DORIA	7.02256.23.0
892244	METZGER	7.28098.15.0	91167214	OPEL	7.02256.04.0
892262	METZGER	7.22138.50.0	91167214	VAUXHALL	7.02256.04.0
892281	METZGER	7.04216.05.0	9125	MEAT&DORIA	7.00782.04.0
892292	METZGER	7.01039.03.0	9125243	VOLVO	7.22517.06.0
892294	METZGER	7.00782.11.0	9126	MEAT&DORIA	7.00612.01.0
892555	METZGER	7.00968.04.0	9128	MEAT&DORIA	7.02256.29.0
892677	METZGER	7.22903.17.0	9129	MEAT&DORIA	7.00262.02.0
89474	MEAT&DORIA	7.02256.28.0	9131	MEAT&DORIA	7.03085.02.0
896025	NEDCAR	7.22517.04.0	9132	MEAT&DORIA	7.00968.04.0
8972183310	ISUZU	7.03085.02.0	9133	MEAT&DORIA	7.00580.01.0
8972191550	ISUZU	7.03088.01.0	9135	MEAT&DORIA	7.21071.50.0
8972882490	ISUZU	7.02461.01.0	9136	HOFFER	7.22138.50.0
8972882491	ISUZU	7.02461.01.0	9136	MEAT&DORIA	7.22138.50.0
8981056560	ISUZU	7.03085.02.0	9137	MEAT&DORIA	7.02318.01.0
8981056561	ISUZU	7.03085.02.0	9137	MEAT&DORIA	7.28170.03.0
8981056570	ISUZU	7.03088.01.0	9138	MEAT&DORIA	7.22355.01.0
899118	METZGER	7.06117.34.0	9139	MEAT&DORIA	7.00326.03.0



REF-No.	 PIERBURG	REF-No.	 PIERBURG		
9140	MEAT&DORIA	7.22572.01.0	9315	MEAT&DORIA	7.00782.12.0
9148	MEAT&DORIA	7.01024.02.0	9316	MEAT&DORIA	7.04423.01.0
9149	MEAT&DORIA	7.02256.49.0	93161882	OPEL	7.01152.02.0
91500	MEAT&DORIA	7.06117.08.0	93161882	OPEL	7.04779.00.0
91505	MEAT&DORIA	7.06117.34.0	93161882	VAUXHALL	7.01152.02.0
91505A1	MEAT&DORIA	7.06117.34.0	93161882	VAUXHALL	7.04779.00.0
91505E	MEAT&DORIA	7.06117.34.0	93174808	OPEL	7.02256.26.0
91506	MEAT&DORIA	7.06117.38.0	93174808	VAUXHALL	7.02256.26.0
91506A1	MEAT&DORIA	7.06117.38.0	93177025	OPEL	7.06269.01.0
91508	MEAT&DORIA	7.06117.35.0	93177025	VAUXHALL	7.06269.01.0
91508A1	MEAT&DORIA	7.06117.35.0	93177026	OPEL	7.06269.01.0
9151	MEAT&DORIA	7.01037.02.0	93177026	VAUXHALL	7.06269.01.0
91519	MEAT&DORIA	7.06117.08.0	93185739	CHEVROLET	7.02256.43.0
91521	MEAT&DORIA	7.08681.09.0	93185739	OPEL	7.02256.43.0
91521E	MEAT&DORIA	7.08681.09.0	93185739	VAUXHALL	7.02256.43.0
91527	MEAT&DORIA	7.06117.33.0	93194302	OPEL	7.02534.01.0
91537	MEAT&DORIA	7.06117.00.0	93194302	VAUXHALL	7.02534.01.0
91538	MEAT&DORIA	7.06117.02.0	93196657	OPEL	7.02534.01.0
91539	MEAT&DORIA	7.06117.46.0	93196657	VAUXHALL	7.02534.01.0
9154	MEAT&DORIA	7.01805.01.0	93198237	OPEL	7.02256.19.0
91542	MEAT&DORIA	7.06117.01.0	93198237	VAUXHALL	7.02256.19.0
91554	MEAT&DORIA	7.06117.45.0	9321	MEAT&DORIA	7.21903.63.0
91554E	MEAT&DORIA	7.06117.45.0	9322	MEAT&DORIA	7.21903.73.0
91557	MEAT&DORIA	7.06117.54.0	9324	MEAT&DORIA	7.03294.02.0
91559	MEAT&DORIA	7.06117.48.0	9325	MEAT&DORIA	7.03653.01.0
9155936	VOLVO	7.22240.09.0	9328	MEAT&DORIA	7.02256.44.0
91560	MEAT&DORIA	7.06117.10.0	9330	MEAT&DORIA	7.02256.45.0
91564	MEAT&DORIA	7.06117.42.0	933111	GEBE	7.06269.27.0
91566	MEAT&DORIA	7.06117.58.0	933161	GEBE	7.05432.13.0
91583	MEAT&DORIA	7.06117.37.0	9332	MEAT&DORIA	7.03833.02.0
91584	MEAT&DORIA	7.06117.60.0	9334	MEAT&DORIA	7.02256.00.0
91589	MEAT&DORIA	7.06117.36.0	9335	MEAT&DORIA	7.04615.03.0
91594	MEAT&DORIA	7.06117.16.0	933601	GEBE	7.06269.28.0
91688	MEAT&DORIA	7.08681.00.0	9339	MEAT&DORIA	7.01777.17.0
9186	MEAT&DORIA	7.01420.02.0	9340	MEAT&DORIA	7.01814.12.0
9186	MEAT&DORIA	7.04423.01.0	9368	MEAT&DORIA	7.28197.16.0
9194	MEAT&DORIA	7.02256.14.0	9369	MEAT&DORIA	7.28098.15.0
9196	MEAT&DORIA	7.02256.15.0	9374	MEAT&DORIA	7.01343.04.0
9202388	VOLVO	7.06117.17.0	9375	MEAT&DORIA	7.22240.13.0
9220	MEAT&DORIA	7.02256.21.0	9384	MEAT&DORIA	7.10014.00.0
9223	MEAT&DORIA	7.02256.49.0	93857976	OPEL	7.01152.02.0
9226	MEAT&DORIA	7.00513.10.0	93857976	OPEL	7.04779.00.0
9228	MEAT&DORIA	7.01633.04.0	93857976	VAUXHALL	7.01152.02.0
9229	MEAT&DORIA	7.00612.01.0	93857976	VAUXHALL	7.04779.00.0
9229	MEAT&DORIA	7.01771.01.0	938F-9F715-AB	FORD	7.06269.28.0
9231	MEAT&DORIA	7.01019.01.0	938F-9F715-AC	FORD	7.06269.28.0
9232	MEAT&DORIA	7.00887.19.0	9440	MEAT&DORIA	7.02256.48.0
9235	MEAT&DORIA	7.22903.17.0	9449	MEAT&DORIA	7.02256.51.0
9237	MEAT&DORIA	7.21903.49.0	9454789	VOLVO	7.06117.16.0
9238	MEAT&DORIA	7.22903.16.0	9465528	VOLVO	7.28197.16.0
9239	MEAT&DORIA	7.02256.26.0	94660515500	PORSCHE	7.04638.01.0
9247	MEAT&DORIA	7.02256.19.0	9470775	VOLVO	7.22517.04.0
9250	MEAT&DORIA	7.02256.16.0	9486016	VOLVO	7.22510.03.0
9265	MEAT&DORIA	7.02256.17.0	9487441	VOLVO	7.06117.53.0
9268	MEAT&DORIA	7.02256.20.0	9493	MEAT&DORIA	7.03280.04.0
9285	MEAT&DORIA	7.00175.04.0	9499	MEAT&DORIA	7.03073.01.0
9287	MEAT&DORIA	7.01830.13.0	9508103	OPEL	7.06269.01.0
9288	MEAT&DORIA	7.02909.07.0	9508103	VAUXHALL	7.06269.01.0
9289	MEAT&DORIA	7.01835.06.0	9519	MEAT&DORIA	7.01633.06.0
9290	MEAT&DORIA	7.01762.04.0	9520	MEAT&DORIA	7.02325.05.0
9291	MEAT&DORIA	7.00036.03.0	9530	MEAT&DORIA	7.01044.03.0
9294	MEAT&DORIA	7.04818.04.0	9531	MEAT&DORIA	7.01632.02.0
9295	MEAT&DORIA	7.02901.05.0	9532	MEAT&DORIA	7.00607.04.0
92AB-9D474-BA	FORD	7.02256.29.0	9536	MEAT&DORIA	7.03554.10.0
92AB-9H465-AA	FORD	7.02256.29.0	9540	MEAT&DORIA	7.03584.01.0
9301	MEAT&DORIA	7.01039.03.0	95511629	OPEL	7.01981.07.0
9302	MEAT&DORIA	7.02588.04.0	95511629	VAUXHALL	7.01981.07.0
9303	MEAT&DORIA	7.02318.01.0	95512347	OPEL	7.08681.05.0
9314	MEAT&DORIA	7.00782.16.0	95512347	VAUXHALL	7.08681.05.0



NUMBERFINDER

REF-No.			REF-No.		
95512349	OPEL	7.08681.03.0	959294	AUTEX	7.22903.19.0
95512349	VAUXHALL	7.08681.03.0	959295	AUTEX	7.02256.00.0
95512351	OPEL	7.08681.04.0	959303	AUTEX	7.00272.03.0
95512351	VAUXHALL	7.08681.04.0	959304	AUTEX	7.00612.01.0
95512357	OPEL	7.08681.06.0	959306	AUTEX	7.00964.03.0
95512357	VAUXHALL	7.08681.06.0	959307	AUTEX	7.01019.01.0
95517930	OPEL	7.01814.12.0	959308	AUTEX	7.01771.01.0
95517930	VAUXHALL	7.01814.12.0	959314	AUTEX	7.02256.20.0
95517972	OPEL	7.01814.12.0	959315	AUTEX	7.02256.23.0
95517972	VAUXHALL	7.01814.12.0	959316	AUTEX	7.02256.25.0
95520982	OPEL	7.01814.22.0	959317	AUTEX	7.21903.44.0
95520982	VAUXHALL	7.01814.22.0	959319	AUTEX	7.22796.01.0
95525930	OPEL	7.06117.45.0	959321	AUTEX	7.22903.17.0
95525930	VAUXHALL	7.06117.45.0	959369	AUTEX	7.00868.02.0
95557215100	PORSCHE	7.02256.42.0	959377	AUTEX	7.01010.03.0
95557215101	PORSCHE	7.02256.42.0	959393	AUTEX	7.22903.34.0
95557282400	PORSCHE	7.02256.42.0	959406	AUTEX	7.22903.16.0
95557282401	PORSCHE	7.02256.42.0	959568	AUTEX	7.02256.26.0
95557282402	PORSCHE	7.02256.42.0	9599	MEAT&DORIA	7.02613.02.0
95557282403	PORSCHE	7.02256.41.0	95BB-9E882-AB	FORD	7.02256.47.0
95557282404	PORSCHE	7.02256.42.0	95BB-9E882-AC	FORD	7.02256.47.0
95557282405	PORSCHE	7.02256.41.0	95BF-9F715-AB	FORD	7.06269.02.0
95560512330	PORSCHE	7.22880.01.0	95BF-9F715-AC	FORD	7.06269.02.0
95560528300	PORSCHE	7.02256.00.0	95SKV402	ESEN SKV	7.01830.13.0
95560528301	PORSCHE	7.02256.00.0	95VW-9E882-AA	FORD	7.21483.54.0
95560528310	PORSCHE	7.02256.00.0	95VW12B573BA	FORD	7.21895.55.0
9564448480	FIAT	7.05432.02.0	95VW12B573BB	FORD	7.21895.55.0
957010	AUTEX	7.06117.26.0	95VW12B573CA	FORD	7.21903.70.0
957011	AUTEX	7.06117.34.0	95VW12B573CB	FORD	7.21903.75.0
957013	AUTEX	7.06117.38.0	95WF-9F715-AD	FORD	4.02003.62.0
957015	AUTEX	7.06117.35.0	95XF-9F715-AA	FORD	7.06269.02.0
957016	AUTEX	7.06117.08.0	9618971180	FIAT	7.02256.23.0
957025	AUTEX	7.06117.26.0	9628971180	FIAT	7.02256.23.0
957026	AUTEX	7.06117.07.0	9635704380	FIAT	7.02256.24.0
958007	AUTEX	7.06269.09.0	9635704380	LANCIA	7.02256.24.0
958008	AUTEX	7.06269.07.0	9649309780	CITROEN	7.06117.34.0
958010	AUTEX	7.05432.01.0	9649309780	PEUGEOT	7.06117.34.0
958011	AUTEX	7.05432.00.0	9652570180	CITROEN	7.00968.04.0
958013	AUTEX	7.05432.02.0	9652570180	PEUGEOT	7.00968.04.0
958024	AUTEX	7.05432.06.0	9652997580	CITROEN	7.00968.04.0
958027	AUTEX	7.05432.13.0	9652997580	PEUGEOT	7.00968.04.0
958028	AUTEX	7.05432.09.0	9654282880	CITROEN	7.00612.01.0
958030	AUTEX	7.05432.11.0	9654282880	PEUGEOT	7.00612.01.0
958033	AUTEX	7.05432.04.0	9659067880	CITROEN	7.01632.02.0
958036	AUTEX	7.05432.12.0	9659067880	FIAT	7.01632.02.0
958042	AUTEX	7.06269.01.0	9659067880	LANCIA	7.01632.02.0
958044	AUTEX	7.06269.02.0	9659067880	PEUGEOT	7.01632.02.0
958045	AUTEX	7.06269.26.0	9661960380	FIAT	7.01633.04.0
958046	AUTEX	7.06269.06.0	9661960380	LANCIA	7.01633.04.0
958049	AUTEX	7.06269.03.0	9661960380	PSA	7.01633.04.0
958050	AUTEX	7.06269.22.0	9672875080	CITROEN	7.01633.06.0
958051	AUTEX	7.06269.23.0	9672875080	DS	7.01633.06.0
958055	AUTEX	7.06269.04.0	9672875080	PEUGEOT	7.01633.06.0
958060	AUTEX	7.05432.09.0	9675081780	CITROEN	7.08681.09.0
958061	AUTEX	7.06269.27.0	9675081780	DS	7.08681.09.0
958066	AUTEX	7.06269.10.0	9675081780	OPEL	7.08681.09.0
95810530400	PORSCHE	7.06117.47.0	9675081780	PEUGEOT	7.08681.09.0
95810530401	PORSCHE	7.06117.47.0	9675081780	VAUXHALL	7.08681.09.0
95810530402	PORSCHE	7.06117.47.0	97001298	LOMBARDINI	7.21903.48.0
95810530403	PORSCHE	7.06117.47.0	97060512300	PORSCHE	7.28098.16.0
958107	AUTEX	7.06269.00.0	97218331	OPEL	7.03085.02.0
95810925900	PORSCHE	7.06117.26.0	97218331	VAUXHALL	7.03085.02.0
95810925910	PORSCHE	7.06117.26.0	97219155	OPEL	7.03088.01.0
95814571000	PORSCHE	7.02901.05.0	97219155	VAUXHALL	7.03088.01.0
95860512340	PORSCHE	7.28098.04.0	97288249	CHEVROLET	7.02461.01.0
959285	AUTEX	7.02256.00.0	97288249	OPEL	7.02461.01.0
959288	AUTEX	7.02183.01.0	97288249	VAUXHALL	7.02461.01.0
959289	AUTEX	7.02184.01.0	9731	MEAT&DORIA	7.02534.01.0
959292	AUTEX	7.00580.01.0	9732	MEAT&DORIA	7.22903.34.0



REF-No.		 PIERBURG	REF-No.		 PIERBURG
9734	MEAT&DORIA	7.02256.25.0	A0001532859	MERCEDES-BENZ	7.04927.08.0
9736	MEAT&DORIA	7.02256.31.0	A0005003201	MERCEDES-BENZ	7.02256.37.0
9737	MEAT&DORIA	7.28311.04.0	A0015400097	MERCEDES-BENZ	7.21071.50.0
9770	MEAT&DORIA	7.22908.03.0	A0015400897	MERCEDES-BENZ	7.21071.50.0
9773	MEAT&DORIA	7.01777.18.0	A0015401497	MERCEDES-BENZ	7.21071.50.0
978F-9F715-AB	FORD	7.06269.24.0	A0015401597	MERCEDES-BENZ	7.21071.50.0
98105656	OPEL	7.03085.02.0	A0015402097	MERCEDES-BENZ	7.21071.50.0
98105656	VAUXHALL	7.03085.02.0	A0015403597	MERCEDES-BENZ	7.21071.50.0
98105657	OPEL	7.03088.01.0	A0015406997	MERCEDES-BENZ	7.21042.01.0
98105657	VAUXHALL	7.03088.01.0	A0015407097	MERCEDES-BENZ	7.21071.50.0
9817070380	CITROEN	7.08681.00.0	A0015408697	MERCEDES-BENZ	7.21071.50.0
9817070380	DS	7.08681.00.0	A0025401497	MERCEDES-BENZ	7.02256.37.0
9817070380	PEUGEOT	7.08681.00.0	A0025401897	MERCEDES-BENZ	7.22355.01.0
9818	MEAT&DORIA	7.02909.12.0	A0025406897	MERCEDES-BENZ	7.02288.01.0
98500116	CHEVROLET	7.03964.01.0	A0025407097	MERCEDES-BENZ	7.02256.37.0
9873	MEAT&DORIA	7.02325.04.0	A0041539328	MERCEDES-BENZ	7.00262.02.0
9897	MEAT&DORIA	7.05367.05.0	A0051535528	MERCEDES-BENZ	7.00782.04.0
98AB-9E882-AA	FORD	7.02256.07.0	A0061536628	MERCEDES-BENZ	7.00782.04.0
99000	MEAT&DORIA	7.02436.02.0	A0071531428	MERCEDES-BENZ	7.00782.12.0
99005	MEAT&DORIA	7.00017.03.0	A0081535428	MERCEDES-BENZ	7.00782.11.0
99009	MEAT&DORIA	7.02221.01.0	A0091533128	MERCEDES-BENZ	7.00782.12.0
99010	MEAT&DORIA	7.02968.02.0	A0101531328	MERCEDES-BENZ	7.00782.16.0
99011	MEAT&DORIA	7.04492.07.0	A1040500177	MERCEDES-BENZ	7.06117.20.0
99013	MEAT&DORIA	7.22240.15.0	A1110510077	MERCEDES-BENZ	7.06117.21.0
9905	MEAT&DORIA	7.02256.40.0	A1110510177	MERCEDES-BENZ	7.06117.21.0
99061559001	VIKA	7.02184.01.0	A1190510077	MERCEDES-BENZ	7.06117.20.0
99061559101	VIKA	7.00868.02.0	A2001530032	MERCEDES-BENZ	7.08681.15.0
99061712001	VIKA	7.06117.54.0	A2001530032	SMART	7.08681.15.0
99061780101	VIKA	7.06117.37.0	A2661530059	MERCEDES-BENZ	7.00017.03.0
99061780201	VIKA	7.06117.48.0	A2710510177	MERCEDES-BENZ	7.06117.24.0
99061780401	VIKA	7.06117.43.0	A2720510077	MERCEDES-BENZ	7.06117.60.0
99061780501	VIKA	7.06117.44.0	A2720510177	MERCEDES-BENZ	7.06117.60.0
99061814501	VIKA	7.03280.04.0	A2751530059	MAYBACH	7.00017.02.0
9908	MEAT&DORIA	7.02256.42.0	A2751530059	MERCEDES-BENZ	7.00017.02.0
9909	MEAT&DORIA	7.02256.41.0	A2751530159	MERCEDES-BENZ	7.01003.01.0
9945635	ALFA ROMEO	7.05432.09.0	A2791530059	MERCEDES-BENZ	7.01003.01.0
9945635	FIAT	7.05432.09.0	A2C59514681	VDO	7.06269.09.0
9945635	LANCIA	7.05432.09.0	A2C59514682	VDO	7.06269.07.0
9950635	ALFA ROMEO	7.05432.09.0	A4539064900	MERCEDES-BENZ	7.01343.04.0
9950635	FIAT	7.05432.09.0	A4705060500	MERCEDES-BENZ	7.01814.22.0
9950635	LANCIA	7.05432.09.0	A6071530028	MERCEDES-BENZ	7.01814.12.0
99660512301	PORSCHE	7.22280.02.0	A6261530028	MERCEDES-BENZ	7.01814.12.0
99660515500	PORSCHE	7.22908.03.0	A95160	VDO	7.05432.01.0
99660520100	PORSCHE	7.22098.04.0	A95214	VDO	7.05432.00.0
99660520101	PORSCHE	7.22098.04.0	A95269	VDO	7.05432.02.0
99660521300	PORSCHE	7.22892.02.0	A96052	VDO	7.05432.03.0
99660521301	PORSCHE	7.22892.02.0	A97104	VDO	7.05432.06.0
9S51-12K073-AA	FORD	7.06117.38.0	A97113	VDO	7.05432.06.0
9S51-12K073-AB	FORD	7.06117.38.0	A98101	VDO	7.05432.03.0
9S51-8A080-AA	FORD	7.00607.02.0	A98102	VDO	7.05432.13.0
9S51-9E882-AA	FORD	7.00607.02.0	AA5E-9U465-AB	FORD	7.02328.08.0
9X2Q-9H465-AA	JAGUAR	7.02428.02.0	AA5E-9U465-AC	FORD	7.02328.08.0
9X2Q-9H465-AA	LAND ROVER	7.02428.02.0	AA5E-9U465-AD	FORD	7.02328.08.0
9X2Q-9H465-BA	JAGUAR	7.02436.02.0	AA5Z-9U465-A	FORD	7.02328.08.0
9X2Q-9H465-BA	LAND ROVER	7.02436.02.0	AA5Z-9U465-A	LINCOLN	7.02328.08.0
9X2Q-9K378-AB	JAGUAR	7.07400.11.0	ABV0009	HITACHI	7.06269.10.0
9X2Q-9K378-AB	LAND ROVER	7.07400.11.0	ABV509H9	HITACHI	7.06269.10.0
9X2Q-9K378-AC	JAGUAR	7.07400.11.0	AEPW-015	AVESA	7.21903.44.0
9X2Q-9K378-AC	LAND ROVER	7.07400.11.0	AEPW-027	AVESA	7.22903.16.0
9X4Q-9S468-AA	JAGUAR	7.01569.05.0	AEPW-028	AVESA	7.22903.17.0
9X4Q-9S468-AB	JAGUAR	7.01569.05.0	AEPW-029	AVESA	7.22903.18.0
9X4Q-9S468-AC	JAGUAR	7.01569.05.0	AEPW-054	AVESA	7.22402.03.0
A0001406460	MERCEDES-BENZ	7.21071.50.0	AEPW-055	AVESA	7.01024.02.0
A0001531159	MERCEDES-BENZ	7.01870.06.0	AEPW-057	AVESA	7.21071.50.0
A0001531700	MERCEDES-BENZ	7.00782.12.0	AEPW-058	AVESA	7.21483.54.0
A0001531800	MERCEDES-BENZ	7.00782.16.0	AEPW-063	AVESA	7.22240.13.0
A0001531859	MERCEDES-BENZ	7.04818.04.0	AEPW-066	AVESA	7.22687.39.0
A0001531900	MERCEDES-BENZ	7.00782.11.0	AEPW-073	AVESA	7.00612.01.0
A0001532059	MERCEDES-BENZ	7.04927.08.0	AEPW-076	AVESA	7.28311.04.0



NUMBERFINDER



REF-No.			REF-No.		
AEPW-078	AVESA	7.00326.03.0	BMS54531	BUGIAD	7.06117.07.0
AEPW-098	AVESA	7.01632.02.0	BMS54536	BUGIAD	7.06117.52.0
AEPW-111	AVESA	7.02256.26.0	BMS54537	BUGIAD	7.06117.36.0
AEPW-119	AVESA	7.00782.12.0	BMS54540	BUGIAD	7.06117.01.0
AEPW-120	AVESA	7.01044.03.0	BMS54542	BUGIAD	7.06117.00.0
AEPW-125	AVESA	7.01010.03.0	BS51-9V443-AA	FORD	7.01981.07.0
AEPW-128	AVESA	7.02256.17.0	BS7E-9J559-AA	FORD	7.02256.48.0
AEPW-131	AVESA	7.01343.04.0	BSP23504	BUGIAD	7.02256.00.0
AEPW-157	AVESA	7.04423.01.0	BSP24899	BUGIAD	7.06117.48.0
AEPW114	AVESA	7.02256.25.0	BSP25036	BUGIAD	7.02901.05.0
AEPW116	AVESA	7.00470.07.0	BSP25113	BUGIAD	7.01037.02.0
AESP106-1B	HITACHI	7.06269.00.0	C2D58332	JAGUAR	7.02428.02.0
AESP106-1C	HITACHI	4.02003.62.0	C2D58333	JAGUAR	7.02436.02.0
AESP106-2A	HITACHI	7.06269.03.0	C2S44622	JAGUAR	7.01569.04.0
AESP106-2B	HITACHI	7.06269.02.0	C2S45002	JAGUAR	7.01569.04.0
AESP109-25	HITACHI	7.06269.11.0	C2S45071	JAGUAR	7.01121.02.0
AESP109-S2	HITACHI	7.06269.05.0	C2S47828	JAGUAR	7.01569.05.0
AESP207-11A	HITACHI	7.06269.26.0	C2S51385	JAGUAR	7.01569.04.0
AESP207-13A	HITACHI	7.06269.01.0	C2S51386	JAGUAR	7.01569.05.0
AESP207-15	HITACHI	7.06269.06.0	C95128	VDO	7.05432.09.0
AESP207-17A	HITACHI	7.06269.07.0	C95166	VDO	7.05432.11.0
AESP209-12	HITACHI	7.06269.09.0	C95185	VDO	7.05432.04.0
AG9G-6M280-AD	FORD	7.06117.52.0	CAS1000	STANDARD	7.06117.35.0
AG9G-6M280-AD	JAGUAR	7.06117.52.0	CAS1001	STANDARD	7.06117.08.0
AG9G-6M280-AD	LAND ROVER	7.06117.52.0	CAS1002	STANDARD	7.06117.38.0
AJ05-18-741	MAZDA	7.02256.46.0	CAS1004	STANDARD	7.06117.34.0
AJ813114	JAGUAR	7.06117.53.0	CAS1007	STANDARD	7.06117.07.0
AV6035	AUTLOG	7.02256.00.0	CAS1008	STANDARD	7.06117.01.0
AV6037	AUTLOG	7.22796.01.0	CAS1009	STANDARD	7.06117.02.0
AV6129	AUTLOG	7.02183.01.0	CAS1010	STANDARD	7.06117.54.0
AV6130	AUTLOG	7.00868.02.0	CAS1012	STANDARD	7.06117.48.0
AV6131	AUTLOG	7.02184.01.0	CAS1013	STANDARD	7.06117.45.0
AV6132	AUTLOG	7.00580.01.0	CAS1014	STANDARD	7.08681.09.0
AV6134	AUTLOG	7.01633.04.0	CAS1015	STANDARD	7.06117.15.0
AV6141	AUTLOG	7.01115.08.0	CAS1018	STANDARD	7.06117.00.0
AV6151	AUTLOG	7.03280.04.0	CAS1024	STANDARD	7.06117.26.0
AV6163	AUTLOG	7.22903.16.0	CB5E-9E882-AA	FORD	7.04663.14.0
AV6168	AUTLOG	7.22903.19.0	CB5Z-9E882-A	FORD	7.04663.14.0
AV6175	AUTLOG	7.01814.12.0	CEV1054	CSV ELECTRONIC PARTS	7.10014.00.0
AV6189	AUTLOG	7.22903.17.0	CEV1161	CSV ELECTRONIC PARTS	7.02256.51.0
AV6Q-9S468-AE	FORD	7.07400.01.0	CEV1186	CSV ELECTRONIC PARTS	7.00887.21.0
AV6Q-9S468-AF	FORD	7.07400.01.0	CEV1204	CSV ELECTRONIC PARTS	7.00887.21.0
AV6Q-9S468-AG	FORD	7.07400.01.0	CEV1307	CSV ELECTRONIC PARTS	7.00607.04.0
AV6Q-9S468-AH	FORD	7.07400.01.0	CEV1317	CSV ELECTRONIC PARTS	7.03584.01.0
AV6Q-9S468-AJ	FORD	7.07400.01.0	CEV1448	CSV ELECTRONIC PARTS	7.28311.04.0
AVM-001	AVESA	7.02256.31.0	CEV1450	CSV ELECTRONIC PARTS	7.00887.20.0
AVR-607	AVESA	7.06269.02.0	CEV4285	CSV ELECTRONIC PARTS	7.00782.12.0
AVR-607B1	AVESA	7.06269.03.0	CEV4286	CSV ELECTRONIC PARTS	7.04423.01.0
AVR-619	AVESA	7.06269.27.0	CEV4297	CSV ELECTRONIC PARTS	7.02256.44.0
B02/01	VDO	7.05432.09.0	CEV4302	CSV ELECTRONIC PARTS	7.03653.01.0
B04/01	VDO	7.05432.02.0	CEV4310	CSV ELECTRONIC PARTS	7.03653.01.0
B14/00	VDO	7.05432.04.0	CEV4585	CSV ELECTRONIC PARTS	7.02909.12.0
B22/01	VDO	7.05432.06.0	CEV4722	CSV ELECTRONIC PARTS	7.00017.03.0
BB5E-6M280-AB	FORD	7.06117.53.0	CEV4752	CSV ELECTRONIC PARTS	7.00868.02.0
BB5E-6M280-AB	JAGUAR	7.06117.53.0	CEV4752	CSV ELECTRONIC PARTS	7.02184.01.0
BB5E-6M280-AB	LAND ROVER	7.06117.53.0	CEV4754	CSV ELECTRONIC PARTS	7.02256.03.0
BG9Q-9S468-AC	FORD	7.07400.00.0	CEV4756	CSV ELECTRONIC PARTS	7.28098.04.0
BG9Q-9S468-AD	FORD	7.07400.00.0	CEV4759	CSV ELECTRONIC PARTS	7.02183.01.0
BGR13082	BUGIAD	7.00782.04.0	CEV4762	CSV ELECTRONIC PARTS	7.00868.02.0
BL3E-9K378-BA	FORD	7.02087.05.0	CEV4762	CSV ELECTRONIC PARTS	7.02184.01.0
BL3Z-9K378-A	FORD	7.02087.05.0	CEV4770	CSV ELECTRONIC PARTS	7.02256.29.0
BM5G-9K378-BA	FORD	7.03162.09.0	CEV4772	CSV ELECTRONIC PARTS	7.00612.01.0
BM5G-9S468-BC	FORD	7.07400.19.0	CEV4776	CSV ELECTRONIC PARTS	7.02256.50.0
BMS54507	BUGIAD	7.06117.46.0	CEV4777	CSV ELECTRONIC PARTS	7.22796.01.0
BMS54511	BUGIAD	7.06117.47.0	CEV4778	CSV ELECTRONIC PARTS	7.02256.07.0
BMS54512	BUGIAD	7.06117.37.0	CEV4803	CSV ELECTRONIC PARTS	7.01024.02.0
BMS54514	BUGIAD	7.06117.47.0	CEV4806	CSV ELECTRONIC PARTS	7.02256.21.0
BMS54526	BUGIAD	7.06117.57.0	CEV4807	CSV ELECTRONIC PARTS	7.02256.49.0
BMS54527	BUGIAD	7.06117.56.0	CEV4807	CSV ELECTRONIC PARTS	7.22240.09.0



REF-No.		 PIEBURG	REF-No.		 PIEBURG
CEV4842	CSV ELECTRONIC PARTS	7.00580.01.0	DS7G-9S468-DD	FORD	7.07400.16.0
CEV4845	CSV ELECTRONIC PARTS	7.00326.03.0	DS7G-9S468-DE	FORD	7.07400.16.0
CEV4852	CSV ELECTRONIC PARTS	7.02256.49.0	DS7G-9S468-EA	FORD	7.07400.18.0
CEV4902	CSV ELECTRONIC PARTS	7.02063.02.0	DS7Z-9S468-B	FORD	7.07400.17.0
CEV4904	CSV ELECTRONIC PARTS	7.00887.19.0	DS7Z-9S468-F	FORD	7.07400.16.0
CEV4905	CSV ELECTRONIC PARTS	7.00470.07.0	E3EE-9F715-A1B	FORD	7.06269.26.0
CEV4946	CSV ELECTRONIC PARTS	7.02256.26.0	ECA001	STANDARD	7.06117.35.0
CEV4948	CSV ELECTRONIC PARTS	7.02256.27.0	ECA002	STANDARD	7.06117.08.0
CEV4962	CSV ELECTRONIC PARTS	7.02318.01.0	ECA003	STANDARD	7.06117.38.0
CEV5156	CSV ELECTRONIC PARTS	7.02256.48.0	ECA005	STANDARD	7.06117.34.0
CEV5187	CSV ELECTRONIC PARTS	7.02901.05.0	ECA008	STANDARD	7.06117.07.0
CEV5246	CSV ELECTRONIC PARTS	7.03073.01.0	ECA009	STANDARD	7.06117.01.0
CJ5E-6B297-AA	FORD	7.06117.33.0	ECA010	STANDARD	7.06117.02.0
CJ5E-6B297-AA	LINCOLN	7.06117.33.0	ECA011	STANDARD	7.06117.54.0
CJ5E-6B297-AA	MERCURY	7.06117.33.0	ECA013	STANDARD	7.06117.48.0
CJ5E-6B297-AB	FORD	7.06117.33.0	ECA014	STANDARD	7.06117.45.0
CJ5E-9961-BA	FORD	7.07400.06.0	ECA015	STANDARD	7.08681.09.0
CJ5E-9961-BB	FORD	7.07400.06.0	ECA016	STANDARD	7.06117.15.0
CJ5E-9961-BC	FORD	7.07400.06.0	ECA019	STANDARD	7.06117.00.0
CJ5E-9961-BD	FORD	7.07400.06.0	ECA025	STANDARD	7.06117.26.0
CJ5E-9961-BE	FORD	7.07400.06.0	EE0816	ELTA	7.08681.09.0
CJ5E-9961-BF	FORD	7.07400.06.0	EE6146	ELTA	7.21483.54.0
CJ5E-9961-CA	FORD	7.03306.16.0	EE6252	ELTA	7.01771.01.0
CJ5G-9K378-BA	FORD	7.04492.07.0	EE6254	ELTA	7.02256.48.0
CJ5G-9K378-BB	FORD	7.04492.07.0	EE6800	ELTA	7.00968.04.0
CJ5G-9U465-BA	FORD	7.04615.03.0	EE6809	ELTA	7.22796.01.0
CJ5Z-6M280-A	FORD	7.06117.33.0	EE6810	ELTA	7.22138.50.0
CJ5Z-6M280-A	LINCOLN	7.06117.33.0	EE6815	ELTA	7.22903.17.0
CJ5Z-6M280-A	MERCURY	7.06117.33.0	EE6818	ELTA	7.02184.01.0
CJ5Z-9961-C	FORD	7.03306.16.0	EE6824	ELTA	7.02256.49.0
CJ5Z-9K378-A	FORD	7.04492.07.0	EE6830	ELTA	7.01024.02.0
CJ5Z-9K378-B	FORD	7.04492.07.0	EE6832	ELTA	7.02063.02.0
CJ5Z-9U465-A	FORD	7.04615.03.0	EE7005	ELTA	7.05432.13.0
CM5G-6M280-FA	FORD	7.06117.12.0	EE7013	ELTA	7.06269.27.0
CM5G-9S468-GC	FORD	7.07400.12.0	EE7084	ELTA	7.06269.28.0
CM5G-9S468-GH	FORD	7.07400.12.0	EIC001	STANDARD	7.06269.02.0
CM5Z-6M280-D	FORD	7.06117.12.0	EIC002	STANDARD	7.06269.27.0
CM5Z-9S468-F	FORD	7.07400.12.0	EIC003	STANDARD	7.06269.04.0
COLAC050N	DIPA SPORT	7.02256.31.0	EIC006	STANDARD	7.06269.23.0
CV10000	DELPHI	7.05432.00.0	EIC008	STANDARD	7.05432.11.0
CV10000-11B1	DELPHI	7.05432.00.0	EIC010	STANDARD	7.05432.00.0
CV10001	DELPHI	7.05432.01.0	EIC011	STANDARD	7.05432.02.0
CV10001-11B1	DELPHI	7.05432.01.0	EIC012	STANDARD	7.06269.22.0
CV10002-11B1	DELPHI	7.05432.11.0	EIC015	STANDARD	7.06269.24.0
CV10177-12B1	DELPHI	7.05432.09.0	EIC016	STANDARD	7.05432.13.0
CV10181-12B1	DELPHI	7.05432.04.0	EIC018	STANDARD	7.06269.03.0
CV10191-12B1	DELPHI	7.05432.02.0	EIC024	STANDARD	7.06269.01.0
CV10217	DELPHI	7.05432.02.0	EIC026	STANDARD	7.05432.06.0
CV10220-12B1	DELPHI	7.06269.02.0	EIC035	STANDARD	7.05432.03.0
CV10221-12B1	DELPHI	7.06269.03.0	EIC036	STANDARD	7.06269.26.0
CV10224-12B1	DELPHI	7.05432.11.0	EIC039	STANDARD	7.05432.01.0
CV10225	DELPHI	7.06117.14.0	EIC044	STANDARD	7.05432.09.0
CV10225-12B1	DELPHI	7.06117.14.0	EIC051	STANDARD	7.05432.04.0
CV10226	DELPHI	7.06117.15.0	EIC055	STANDARD	7.06269.05.0
CV10226-12B1	DELPHI	7.06117.15.0	EIC057	STANDARD	7.06269.21.0
CVC4880	CSV ELECTRONIC PARTS	7.02256.41.0	EIC085	STANDARD	7.05432.12.0
CVI4138C	CSV ELECTRONIC PARTS	7.06117.45.0	EIC087	STANDARD	7.06269.20.0
CVR3068	CSV ELECTRONIC PARTS	7.06269.27.0	EIC094	STANDARD	7.06269.10.0
CVR3086	CSV ELECTRONIC PARTS	7.06117.35.0	ESV006	STANDARD	7.02318.01.0
CVR3104	CSV ELECTRONIC PARTS	7.08681.09.0	ESV006	STANDARD	7.28170.03.0
CVR3107	CSV ELECTRONIC PARTS	7.06117.06.0	ESV016	STANDARD	7.22796.01.0
CVR3108	CSV ELECTRONIC PARTS	7.06117.05.0	ESV028	STANDARD	7.02256.50.0
CVR3128	CSV ELECTRONIC PARTS	7.06117.45.0	ESV033	STANDARD	7.02256.49.0
CVR3182	CSV ELECTRONIC PARTS	7.06117.54.0	ESV046	STANDARD	7.01805.01.0
CVR3184	CSV ELECTRONIC PARTS	7.06117.48.0	ESV048	STANDARD	7.02256.22.0
CVR3193	CSV ELECTRONIC PARTS	7.06117.14.0	ESV049	STANDARD	7.02256.14.0
D5109	VDO	7.05432.12.0	ESV053	STANDARD	7.02256.00.0
D95109	VDO	7.05432.12.0	ESV067	STANDARD	7.02063.02.0
DS7G-9S468-DA	FORD	7.07400.17.0	ESV070	STANDARD	7.02256.48.0



NUMBERFINDER



REF-No.			REF-No.		
ESV071	STANDARD	7.01343.04.0	FDR165	LUCAS	7.02461.01.0
ESV096	STANDARD	7.01835.06.0	FDR179	LUCAS	7.28170.03.0
ESV098	STANDARD	7.02901.05.0	FDR206	LUCAS	7.22796.01.0
ESV101	STANDARD	7.03554.10.0	FDR218	LUCAS	7.02256.22.0
EV004	STANDARD	7.02318.01.0	FDR222	LUCAS	7.00964.03.0
EV004	STANDARD	7.28170.03.0	FDR230	LUCAS	7.02184.01.0
EV017	STANDARD	7.22796.01.0	FDR236	LUCAS	7.21483.54.0
EV029	STANDARD	7.02256.50.0	FDR241	LUCAS	7.02183.01.0
EV034	STANDARD	7.02256.49.0	FDR243	LUCAS	7.28328.07.0
EV040	STANDARD	7.01805.01.0	FDR247	LUCAS	7.02256.21.0
EV042	STANDARD	7.02256.22.0	FDR259	LUCAS	7.02256.49.0
EV043	STANDARD	7.02256.14.0	FDR261	LUCAS	7.21903.73.0
EV049	STANDARD	7.02063.02.0	FDR280	LUCAS	7.01805.01.0
EV052	STANDARD	7.00968.04.0	FDR282	LUCAS	7.00868.02.0
EV055	STANDARD	7.02256.00.0	FDR283	LUCAS	7.22903.19.0
EV056	STANDARD	7.02256.48.0	FDR313	LUCAS	7.02256.14.0
EV057	STANDARD	7.01343.04.0	FDR323	LUCAS	7.00968.04.0
EV088	STANDARD	7.01835.06.0	FDR398	LUCAS	7.01024.02.0
EV090	STANDARD	7.02901.05.0	FDR399	LUCAS	7.22355.01.0
EV093	STANDARD	7.03554.10.0	FDR420	LUCAS	7.01633.04.0
F-347234.03	INA SCHÄFFLER KG	7.06117.34.0	FDR421	LUCAS	7.22903.17.0
F-347241.03	INA SCHÄFFLER KG	7.06117.35.0	FDR422	LUCAS	7.02063.02.0
F-347512.13	INA SCHÄFFLER KG	7.06117.07.0	FDR423	LUCAS	7.01019.01.0
F-347555.02	INA SCHÄFFLER KG	7.06117.08.0	FDR521	LUCAS	7.22240.13.0
F-347793.05	INA SCHÄFFLER KG	7.06117.26.0	FDR526	LUCAS	7.02256.48.0
F00099M200	BOSCH	7.05432.09.0	FDR7001	LUCAS	7.00612.01.0
F00099M431	BOSCH	7.05432.02.0	FDR7002	LUCAS	7.02256.50.0
F1FG-9S468-AB	FORD	7.07400.13.0	FDR7005	LUCAS	7.01037.02.0
F1FG-9S468-AC	FORD	7.07400.14.0	FDR7006	LUCAS	7.01343.04.0
F1FG-9S468-AD	FORD	7.07400.15.0	FDR7007	LUCAS	7.01777.17.0
F1FZ-9S468-B	FORD	7.07400.14.0	FDR7009	LUCAS	7.22240.09.0
F1FZ-9S468-C	FORD	7.07400.15.0	FDR7010	LUCAS	7.02256.23.0
F2GE-9E882-BA	FORD	7.02256.53.0	FDR7011	LUCAS	7.21903.44.0
F2GZ-9E882-A	FORD	7.02256.53.0	FDR7014	LUCAS	7.02256.26.0
F53E-9F715-AA	FORD	7.06269.11.0	FDR7016	LUCAS	7.22903.34.0
F53E-9F715-AB	FORD	7.06269.11.0	FDR7018	LUCAS	7.00272.03.0
F57E-9J459-CA	FORD	7.02256.46.0	FDR7020	LUCAS	7.03280.04.0
F57Z-9J459-C	FORD	7.02256.46.0	FDR7029	LUCAS	7.01830.13.0
F5DE-9F715-BB	FORD	7.06269.21.0	FDR7030	LUCAS	7.01835.06.0
F63E-9F715-AA	FORD	7.06269.21.0	FDR7031	LUCAS	7.01870.06.0
F63E-9J459-AA	FORD	7.02256.46.0	FDR7032	LUCAS	7.02901.05.0
F63Z-9J459-AA	FORD	7.02256.46.0	FDR7034	LUCAS	7.02325.05.0
FDB1527	LUCAS	7.05432.12.0	FDR7035	LUCAS	7.03554.10.0
FDB1532	LUCAS	7.06269.28.0	FDR7037	LUCAS	7.00887.19.0
FDB1533	LUCAS	7.06269.05.0	FDR7041	LUCAS	7.01044.03.0
FDB1534	LUCAS	7.06269.11.0	FDR7047	LUCAS	7.03294.02.0
FDB1535	LUCAS	7.06269.21.0	GM5Q-6846-AA	FORD	7.08681.00.0
FDB1548	LUCAS	7.06269.20.0	H72031281	HELLA INCORPORATED	7.22280.02.0
FDB1552	LUCAS	7.06269.10.0	H805059	HOFFER	7.08681.03.0
FDB3004	LUCAS	7.06269.20.0	H805060	HOFFER	7.08681.04.0
FDB845	LUCAS	7.05432.04.0	H805061	HOFFER	7.08681.05.0
FDB848	LUCAS	7.05432.02.0	H805064	HOFFER	7.08681.06.0
FDB855	LUCAS	7.05432.06.0	HF07-15-16ZA	MAZDA	7.09000.03.0
FDB947	LUCAS	7.06269.07.0	IAV001	STANDARD	7.05432.00.0
FDB953	LUCAS	7.05432.00.0	IAV002	STANDARD	7.06269.26.0
FDB954	LUCAS	7.05432.01.0	IAV010	STANDARD	7.05432.11.0
FDB957	LUCAS	7.05432.09.0	IAV011	STANDARD	7.05432.01.0
FDB966	LUCAS	7.06269.03.0	IAV012	STANDARD	7.06269.01.0
FDB972	LUCAS	7.05432.12.0	IAV018	STANDARD	7.06269.02.0
FDB976	LUCAS	7.06269.04.0	IAV059	STANDARD	7.05432.09.0
FDB977	LUCAS	7.06269.23.0	IAV060	STANDARD	7.05432.04.0
FDB978	LUCAS	7.06269.02.0	IAV063	STANDARD	7.05432.02.0
FDB980	LUCAS	7.05432.03.0	IAV095	STANDARD	7.06269.06.0
FDB981	LUCAS	7.06269.22.0	IAV106	STANDARD	7.06269.03.0
FDB982	LUCAS	7.05432.13.0	IAV107	STANDARD	7.05432.06.0
FDB984	LUCAS	7.06269.27.0	IAV162	STANDARD	7.05432.12.0
FDB985	LUCAS	7.06269.24.0	IAV167	STANDARD	7.05432.03.0
FDB987	LUCAS	7.06269.26.0	IAV170	STANDARD	7.06269.22.0
FDB989	LUCAS	7.05432.11.0	IAV171	STANDARD	7.05432.13.0

REF-No.		 PIERBURG	REF-No.		 PIERBURG
IAV172	STANDARD	7.06269.04.0	LEV077	STANDARD	7.03280.04.0
IAV173	STANDARD	7.06269.23.0	LEV087	STANDARD	7.01835.06.0
IAV177	STANDARD	7.06269.24.0	LEV089	STANDARD	7.02901.05.0
IAV178	STANDARD	7.06269.27.0	LEV093	STANDARD	7.03554.10.0
IAV182	STANDARD	7.06269.20.0	LNN000010	LAND ROVER	7.06117.10.0
IAV184	STANDARD	7.06269.05.0	LR001484	LAND ROVER	7.06117.18.0
IAV188	STANDARD	7.06269.21.0	LR011224	LAND ROVER	7.06117.18.0
IAV189	STANDARD	7.06269.10.0	LR024995	LAND ROVER	7.06117.53.0
ICD00124	DELPHI	7.05432.11.0	LR025652	LAND ROVER	7.06117.52.0
JDE27203	JAGUAR	7.07400.11.0	LR029417	LAND ROVER	7.07400.11.0
JDE38292	JAGUAR	7.07400.11.0	LR049972	LAND ROVER	7.04663.14.0
K04627212AB	FIAT	7.03003.01.0	LR076235	LAND ROVER	7.07400.11.0
K04893902AB	CHRYSLER	7.02909.12.0	LR116598	LAND ROVER	7.02428.02.0
KT3002	AUTLOG	7.06117.00.0	LR116599	LAND ROVER	7.02436.02.0
KT3013	AUTLOG	7.06117.46.0	LVEP118	MOTAQUIP	7.06117.35.0
L309-14-420A	MAZDA	7.06117.55.0	LVEP125	MOTAQUIP	7.06117.08.0
L3K9-14-420A	MAZDA	7.06117.55.0	LVEP156	MOTAQUIP	7.06117.38.0
L801-18-741	MAZDA	7.02256.51.0	LVEP160	MOTAQUIP	7.06117.20.0
LAV006	STANDARD	7.05432.02.0	LVEP171	MOTAQUIP	7.06117.01.0
LAV009	STANDARD	7.05432.01.0	LVEP174	MOTAQUIP	7.06117.07.0
LAV011	STANDARD	7.06269.01.0	LVEP176	MOTAQUIP	7.06117.54.0
LAV013	STANDARD	7.05432.06.0	LVEP178	MOTAQUIP	7.06117.14.0
LAV027	STANDARD	7.06269.20.0	LVEP183	MOTAQUIP	7.06117.48.0
LAV031	STANDARD	7.06269.04.0	LVEP184	MOTAQUIP	7.08681.09.0
LAV032	STANDARD	7.06269.23.0	LVER129	MOTAQUIP	7.02256.48.0
LAV035	STANDARD	7.05432.03.0	LVEV101	MOTAQUIP	7.01024.02.0
LAV036	STANDARD	7.06269.22.0	LVEV102	MOTAQUIP	7.22240.13.0
LAV037	STANDARD	7.05432.13.0	LVEV103	MOTAQUIP	7.02256.49.0
LAV039	STANDARD	7.06269.27.0	LVEV106	MOTAQUIP	7.28170.03.0
LAV040	STANDARD	7.06269.24.0	LVEV107	MOTAQUIP	7.22138.50.0
LAV042	STANDARD	7.06269.26.0	LVEV111	MOTAQUIP	7.22796.01.0
LAV044	STANDARD	7.05432.11.0	LVEV114	MOTAQUIP	7.02063.02.0
LAV048	STANDARD	7.06269.10.0	LVEV115	MOTAQUIP	7.00868.02.0
LAV068	STANDARD	7.06269.28.0	LVEV123	MOTAQUIP	7.00968.04.0
LAV072	STANDARD	7.06269.21.0	LVEV125	MOTAQUIP	7.02256.00.0
LCS101	STANDARD	7.06117.35.0	LVEV127	MOTAQUIP	7.22903.17.0
LCS493	STANDARD	7.06117.08.0	LVEV139	MOTAQUIP	7.00612.01.0
LCS508	STANDARD	7.06117.38.0	LVEV140	MOTAQUIP	7.02256.50.0
LCS512	STANDARD	7.06117.34.0	LVEV143	MOTAQUIP	7.01771.01.0
LCS589	STANDARD	7.06117.07.0	LVEV144	MOTAQUIP	7.02256.21.0
LCS594	STANDARD	7.06117.01.0	LVEV145	MOTAQUIP	7.02256.23.0
LCS598	STANDARD	7.06117.02.0	LVEV148	MOTAQUIP	7.02184.01.0
LCS599	STANDARD	7.06117.54.0	LVEV149	MOTAQUIP	7.01777.17.0
LCS601	STANDARD	7.06117.48.0	LVEV154	MOTAQUIP	7.06117.34.0
LCS605	STANDARD	7.06117.45.0	LVEV168	MOTAQUIP	7.02461.01.0
LCS606	STANDARD	7.08681.09.0	LVEV170	MOTAQUIP	7.21483.54.0
LCS607	STANDARD	7.06117.15.0	LVEV173	MOTAQUIP	7.01343.04.0
LCS614	STANDARD	7.06117.00.0	LVEV176	MOTAQUIP	7.06117.02.0
LCS631	STANDARD	7.06117.26.0	LVEV179	MOTAQUIP	7.02325.05.0
LCS707	STANDARD	7.06117.46.0	LVEV180	MOTAQUIP	7.03554.10.0
LCS710	STANDARD	7.06117.47.0	LVEV187	MOTAQUIP	7.01044.03.0
LEV001	STANDARD	7.22240.15.0	LVEV188	MOTAQUIP	7.02256.26.0
LEV002	STANDARD	7.28170.03.0	LVEV194	MOTAQUIP	7.00887.19.0
LEV011	STANDARD	7.22796.01.0	LVEV201	MOTAQUIP	7.02901.05.0
LEV022	STANDARD	7.00612.01.0	LVEV202	MOTAQUIP	7.22903.34.0
LEV023	STANDARD	7.02256.50.0	LVIS129	MOTAQUIP	7.06269.03.0
LEV024	STANDARD	7.01024.02.0	LVIS132	MOTAQUIP	7.06269.28.0
LEV028	STANDARD	7.02256.49.0	LVIS155	MOTAQUIP	7.06269.27.0
LEV029	STANDARD	7.21483.54.0	LVIS167	MOTAQUIP	7.06269.04.0
LEV036	STANDARD	7.02256.22.0	LVIS169	MOTAQUIP	7.05432.13.0
LEV039	STANDARD	7.00968.04.0	LVIS184	MOTAQUIP	7.06269.02.0
LEV044	STANDARD	7.02063.02.0	MK667899	FUSO	7.02968.02.0
LEV046	STANDARD	7.22903.17.0	MK667899	MITSUBISHI	7.02968.02.0
LEV049	STANDARD	7.02256.00.0	MN982564	MITSUBISHI	7.01633.06.0
LEV050	STANDARD	7.02256.48.0	OCV001	FAI AUTOMOTIVE	7.06117.07.0
LEV051	STANDARD	7.01343.04.0	OCV002	FAI AUTOMOTIVE	7.06117.45.0
LEV053	STANDARD	7.01777.17.0	OCV0102	BG AUTOMOTIVE	7.06117.54.0
LEV067	STANDARD	7.22138.50.0	OCV0104	BG AUTOMOTIVE	7.06117.37.0
LEV071	STANDARD	7.02256.26.0	OCV0105	BG AUTOMOTIVE	7.06117.48.0



REF-No.			REF-No.		
OCV011	FAI AUTOMOTIVE	7.06117.54.0	SL10064	DELPHI	7.06117.03.0
OCV0110	BG AUTOMOTIVE	7.06117.42.0	SL10064-11B1	DELPHI	7.06117.03.0
OCV0112	BG AUTOMOTIVE	7.06117.43.0	SL10068-12B1	DELPHI	7.02256.38.0
OCV0113	BG AUTOMOTIVE	7.06117.44.0	SL10069-12B1	DELPHI	7.02256.39.0
OCV017	FAI AUTOMOTIVE	7.06117.52.0	SL10174-12B1	DELPHI	7.02256.38.0
OCV019	FAI AUTOMOTIVE	7.06117.53.0	STC4198	LAND ROVER	7.21903.73.0
OCV020	FAI AUTOMOTIVE	7.06117.37.0	SU001-A7931	TOYOTA	7.08681.00.0
OCV022	FAI AUTOMOTIVE	7.06117.46.0	SU001-A9195	TOYOTA	7.08681.09.0
OCV024	FAI AUTOMOTIVE	7.06117.36.0	SU003-00096	SCION	7.06117.41.0
OCV025	FAI AUTOMOTIVE	7.06117.01.0	SU003-00096	TOYOTA	7.06117.41.0
OCV026	FAI AUTOMOTIVE	7.06117.00.0	SU003-07806	SCION	7.06117.41.0
OCV044	FAI AUTOMOTIVE	7.06117.14.0	SU003-07806	TOYOTA	7.06117.41.0
OCV083	FAI AUTOMOTIVE	7.06117.57.0	TRBCP001N	DIPA SPORT	7.01814.12.0
OCV084	FAI AUTOMOTIVE	7.06117.56.0	TRBCP004PRBN	DIPA SPORT	7.28311.04.0
OCV0900	BG AUTOMOTIVE	7.06117.00.0	TRBCP059PRBN	DIPA SPORT	7.22138.50.0
OCV0901	BG AUTOMOTIVE	7.06117.02.0	V10-0866	VAICO	7.06117.26.0
OCV0902	BG AUTOMOTIVE	7.06117.01.0	V10-0998	VAICO	7.28098.15.0
OCV0903	BG AUTOMOTIVE	7.06117.10.0	V10-3728	VAICO	7.06117.46.0
OCV0905	BG AUTOMOTIVE	7.06117.36.0	V10-3731	VAICO	7.06117.54.0
OCV1401	BG AUTOMOTIVE	7.08681.09.0	V10-3926	VAICO	7.06117.48.0
OCV2200	BG AUTOMOTIVE	7.06117.35.0	V10-4332	VAICO	7.06117.37.0
OCV2201	BG AUTOMOTIVE	7.06117.38.0	V10-4334	VAICO	7.06117.42.0
OCV2304	BG AUTOMOTIVE	7.06117.33.0	V10-4338	VAICO	7.06117.43.0
OCV6700	BG AUTOMOTIVE	7.06117.34.0	V10-4339	VAICO	7.06117.44.0
OCV7300	BG AUTOMOTIVE	7.06117.39.0	V10-4340	VAICO	7.06117.47.0
OCVV-001	AISIN	7.06117.17.0	V10-63-0013	VEMO	7.02461.01.0
OCVV-002	AISIN	7.06117.18.0	V10-63-0016	VEMO	7.02184.01.0
OCVV-003	AISIN	7.06117.16.0	V10-63-0016-1	VEMO	7.02184.01.0
OCVV-902	AISIN	7.06117.18.0	V10-63-0022	VEMO	7.01037.02.0
PMK000030	MG	7.22908.03.0	V10-63-0036	VEMO	7.01019.01.0
PMK000030	ROVER	7.22908.03.0	V10-63-0037-1	VEMO	7.00470.07.0
PMK100130	LAND ROVER	7.22572.01.0	V10-63-0038	VEMO	7.21903.49.0
PN63K0	DAYCO	7.00607.02.0	V10-63-0051	VEMO	7.21483.54.0
PP65T0	DAYCO	7.00607.02.0	V10-63-0056-1	VEMO	7.21903.70.0
S550-18741	MAZDA	7.05314.02.0	V10-63-0065	VEMO	7.02256.00.0
SEB1299	LUCAS	7.06117.35.0	V10-63-0067	VEMO	7.22687.39.0
SEB7773	LUCAS	7.06117.08.0	V10-63-0074	VEMO	7.22880.01.0
SEB7774	LUCAS	7.06117.38.0	V10-63-0106	VEMO	7.00580.01.0
SEB7776	LUCAS	7.06117.34.0	V10-63-0107	VEMO	7.22903.37.0
SEB7779	LUCAS	7.06117.07.0	V10-63-0109	VEMO	7.22903.17.0
SEB7780	LUCAS	7.06117.01.0	V10-63-0110	VEMO	7.22903.19.0
SEB7782	LUCAS	7.06117.54.0	V10-63-0128	VEMO	7.02256.18.0
SEB7784	LUCAS	7.06117.48.0	V10-63-0131	VEMO	7.00968.04.0
SEB7785	LUCAS	7.06117.45.0	V10-63-0144	VEMO	7.02183.01.0
SEB7786	LUCAS	7.08681.09.0	V10-63-0158	VEMO	7.00868.02.0
SEB7790	LUCAS	7.06117.00.0	V10-63-0185	VEMO	7.22903.34.0
SEB7791	LUCAS	7.06117.14.0	V10-77-0031	VEMO	7.10014.00.0
SEB7795	LUCAS	7.06117.20.0	V10-77-1010	VEMO	7.01830.13.0
SEB7797	LUCAS	7.06117.05.0	V10-77-1023	VEMO	7.02901.05.0
SEB7798	LUCAS	7.06117.06.0	V10-77-1030	VEMO	7.04247.02.0
SEB7820	LUCAS	7.06117.46.0	V10-77-1038	VEMO	7.01044.03.0
SEB7823	LUCAS	7.06117.47.0	V10-77-1057	VEMO	7.28098.04.0
SH02-18-741	MAZDA	7.03554.10.0	V10-77-1058	VEMO	7.22402.03.0
SH03-18-741	MAZDA	7.03554.10.0	V10-77-1059	VEMO	7.02256.18.0
SK6107	GK	7.08681.00.0	V15-77-0009	VEMO	7.02256.40.0
SL10003-12B1	DELPHI	7.02256.22.0	V15-77-0010	VEMO	7.02256.41.0
SL10045-12B1	DELPHI	7.21903.70.0	V20-2650	VAICO	7.06117.01.0
SL10047-12B1	DELPHI	7.22880.01.0	V20-2651	VAICO	7.06117.10.0
SL10049-12B1	DELPHI	7.21071.50.0	V20-2760	VAICO	7.06117.00.0
SL10050-12B1	DELPHI	7.01421.01.0	V20-2761	VAICO	7.06117.02.0
SL10051-12B1	DELPHI	7.02256.50.0	V20-2954	VAICO	7.06117.36.0
SL10053-12B1	DELPHI	7.03085.02.0	V20-2955	VAICO	7.06117.58.0
SL10054-12B1	DELPHI	7.00607.02.0	V20-63-0009	VEMO	7.02063.02.0
SL10055-12B1	DELPHI	7.28098.04.0	V20-63-0009-1	VEMO	7.02063.02.0
SL10056-12B1	DELPHI	7.22355.01.0	V20-63-0010	VEMO	7.00887.19.0
SL10058-12B1	DELPHI	7.22593.03.0	V20-63-0013	VEMO	7.02256.27.0
SL10061-12B1	DELPHI	7.01024.02.0	V20-63-0013-1	VEMO	7.02256.27.0
SL10062-12B1	DELPHI	7.01420.02.0	V20-63-0037	VEMO	7.00887.21.0
SL10063-12B1	DELPHI	7.02461.01.0	V20-63-0039	VEMO	7.22796.01.0



REF-No.	 PIERBURG	REF-No.	 PIERBURG		
V20-63-0040	VEMO	7.00887.20.0	V40-77-0002	VEMO	7.05432.00.0
V20-63-0041	VEMO	7.00887.22.0	V40-77-0003	VEMO	7.05432.11.0
V20-77-0023	VEMO	7.04216.05.0	V40-77-0004	VEMO	7.06269.01.0
V20-77-0024	VEMO	7.01762.04.0	V40-77-0004-1	VEMO	7.06269.01.0
V20-77-0025	VEMO	7.01115.08.0	V40-77-0021	VEMO	7.02256.22.0
V22-0526	VAICO	7.06117.34.0	V41-0030	VAICO	7.06117.52.0
V22-54-0001	VEMO	7.08681.00.0	V42-0629	VAICO	7.06117.45.0
V22-63-0001	VEMO	7.02256.24.0	V42-63-0003	VEMO	7.01633.04.0
V24-1704	VAICO	7.06117.35.0	V42-63-0007	VEMO	7.02256.23.0
V24-1705	VAICO	7.06117.38.0	V42-77-0004	VEMO	7.06269.07.0
V24-63-0006	VEMO	7.02256.14.0	V42-77-0005	VEMO	7.05432.02.0
V24-63-0016	VEMO	7.02256.50.0	V45-63-0006	VEMO	7.22908.03.0
V24-63-0034	VEMO	7.02256.20.0	V45-77-0003	VEMO	7.22280.02.0
V24-77-0007	VEMO	7.01835.06.0	V46-1727	VAICO	7.06117.39.0
V24-77-0008	VEMO	7.02909.07.0	V46-63-0025	VEMO	7.01814.12.0
V24-77-0016	VEMO	7.06269.06.0	V46-63-0026	VEMO	7.02256.17.0
V25-0930	VAICO	7.06117.33.0	V47-63-0001	VEMO	7.02256.19.0
V25-63-0003	VEMO	7.01771.01.0	V48-0217	VAICO	7.06117.53.0
V25-63-0020	VEMO	7.02256.29.0	V48-0218	VAICO	7.06117.52.0
V25-63-0024	VEMO	7.02256.48.0	V49-63-0002	VEMO	7.22572.01.0
V25-63-0032	VEMO	7.02256.25.0	V51-0076	VAICO	7.06117.03.0
V25-63-0033	VEMO	7.02256.51.0	V51-0124	VAICO	7.06117.07.0
V25-63-0062	VEMO	7.04492.07.0	V52-63-0007	VEMO	7.03294.02.0
V25-77-0001-1	VEMO	7.06269.02.0	V52-63-0009	VEMO	7.00272.03.0
V25-77-0002-1	VEMO	7.06269.03.0	V70-63-0001	VEMO	7.00513.10.0
V25-77-0004	VEMO	7.06269.23.0	V758776080	CITROEN	7.06117.45.0
V25-77-0005	VEMO	7.06269.04.0	V758776080	DS	7.06117.45.0
V25-77-0006	VEMO	4.02003.62.0	V758776080	PEUGEOT	7.06117.45.0
V25-77-0007	VEMO	7.06269.24.0	V759327380	CITROEN	7.01115.08.0
V25-77-0008	VEMO	7.06269.22.0	V759327380	DS	7.01115.08.0
V25-77-0009	VEMO	7.05432.03.0	V759327380	PEUGEOT	7.01115.08.0
V25-77-0010	VEMO	7.05432.13.0	V95-0501	VAICO	7.06117.16.0
V25-77-0017	VEMO	7.06269.11.0	V95-63-0014	VEMO	7.02325.05.0
V25-77-0018	VEMO	7.06269.05.0	V95-63-0016	VEMO	7.21903.63.0
V25-77-0026	VEMO	7.06269.27.0	V95-63-0036	VEMO	7.02325.04.0
V25-77-0027	VEMO	7.06269.28.0	V95-77-0001	VEMO	7.06269.09.0
V30-1136	VAICO	7.06117.24.0	V95-77-0010	VEMO	7.22517.04.0
V30-2762	VAICO	7.06117.60.0	V96-63-0002	VEMO	7.02256.49.0
V30-3638	VAICO	7.06117.60.0	V96-63-0002	VEMO	7.22240.09.0
V30-3638-BEK	VAICO	7.06117.60.0	V96-63-0003	VEMO	7.02221.01.0
V30-63-0019	VEMO	7.22355.01.0	V96-63-0004	VEMO	7.22240.13.0
V30-63-0026	VEMO	7.21071.50.0	V96-66-0001	VEMO	7.22240.15.0
V30-63-0029	VEMO	7.00782.16.0	VAL003N	DIPA SPORT	7.06117.38.0
V30-63-0035	VEMO	7.00782.12.0	VAL008N	DIPA SPORT	7.02461.01.0
V30-63-0043	VEMO	7.00262.02.0	VALM010N	DIPA SPORT	7.05432.02.0
V30-63-0044	VEMO	7.00782.04.0	VALM024N	DIPA SPORT	7.05432.13.0
V30-77-0028	VEMO	7.01870.06.0	VVTS2002	MOTIVE	7.06117.46.0
V32-0239	VAICO	7.06117.55.0	VVTS2003	MOTIVE	7.06117.37.0
V38-0347	VAICO	7.06117.14.0	VVTS2013	MOTIVE	7.06117.47.0
V40-1424	VAICO	7.06117.05.0	VVTS2014	MOTIVE	7.06117.47.0
V40-1425	VAICO	7.06117.06.0	VVTS2128	MOTIVE	7.06117.53.0
V40-1426	VAICO	7.06117.08.0	VVTS2129	MOTIVE	7.06117.52.0
V40-1557	VAICO	7.06117.04.0	VVTS2134	MOTIVE	7.06117.57.0
V40-1560	VAICO	7.06117.56.0	VVTS2135	MOTIVE	7.06117.56.0
V40-1561	VAICO	7.06117.57.0	VVTS2138	MOTIVE	7.06117.53.0
V40-63-0012	VEMO	7.03085.02.0	VVTS2139	MOTIVE	7.06117.52.0
V40-63-0013	VEMO	7.03088.01.0	VVTS2143	MOTIVE	7.06117.60.0
V40-63-0033	VEMO	7.01024.02.0	WE01-13-726	MAZDA	7.02256.25.0
V40-63-0039	VEMO	7.02256.26.0	WEKR0653	ZZVF	7.06117.45.0
V40-63-0039-1	VEMO	7.02256.26.0	WG1013319	WILMINK	7.02256.17.0
V40-63-0041	VEMO	7.04423.01.0	WG1013324	WILMINK	7.02184.01.0
V40-63-0043	VEMO	7.03833.02.0	WG1013328	WILMINK	7.00612.01.0
V40-63-0054	VEMO	7.00326.03.0	WG1013329	WILMINK	7.02183.01.0
V40-63-0056	VEMO	7.01421.01.0	WG1013330	WILMINK	7.21903.70.0
V40-63-0060	VEMO	7.28311.04.0	WG1013331	WILMINK	7.21483.54.0
V40-63-0061	VEMO	7.22138.50.0	WG1013332	WILMINK	7.02256.23.0
V40-63-0069	VEMO	7.03653.01.0	WG1013336	WILMINK	7.02256.07.0
V40-63-0100	VEMO	7.02256.44.0	WG1013338	WILMINK	7.03085.02.0
V40-77-0001	VEMO	7.05432.01.0	WG1013339	WILMINK	7.00580.01.0

REF-No.		REF-No.	
WG1013340	WILMINK 7.22138.50.0	WG1025764	WILMINK 7.01830.13.0
WG1013342	WILMINK 7.22355.01.0	WG1025767	WILMINK 7.01835.06.0
WG1013343	WILMINK 7.00326.03.0	WG1025778	WILMINK 7.02063.02.0
WG1013347	WILMINK 7.01024.02.0	WG1025801	WILMINK 7.02183.01.0
WG1013348	WILMINK 7.02256.49.0	WG1025802	WILMINK 7.02184.01.0
WG1013352	WILMINK 7.03088.01.0	WG1025866	WILMINK 7.02256.07.0
WG1013352	WILMINK 7.04423.01.0	WG1025872	WILMINK 7.02256.17.0
WG1013367	WILMINK 7.02256.20.0	WG1025873	WILMINK 7.02256.19.0
WG1013369	WILMINK 7.02588.04.0	WG1025874	WILMINK 7.02256.20.0
WG1013370	WILMINK 7.02318.01.0	WG1025877	WILMINK 7.02256.23.0
WG1013373	WILMINK 7.02256.44.0	WG1025879	WILMINK 7.02256.25.0
WG1013375	WILMINK 7.02256.45.0	WG1025880	WILMINK 7.02256.26.0
WG1013376	WILMINK 7.02256.00.0	WG1025881	WILMINK 7.02256.27.0
WG1013379	WILMINK 7.00868.02.0	WG1025882	WILMINK 7.02256.28.0
WG1013380	WILMINK 7.22796.01.0	WG1025883	WILMINK 7.02256.29.0
WG1013382	WILMINK 7.22903.19.0	WG1025885	WILMINK 7.02256.31.0
WG1013385	WILMINK 7.00968.04.0	WG1025888	WILMINK 7.02318.01.0
WG1013388	WILMINK 7.02256.49.0	WG1025892	WILMINK 7.02461.01.0
WG1013390	WILMINK 7.01771.01.0	WG1025953	WILMINK 7.02588.04.0
WG1013391	WILMINK 7.02256.26.0	WG1026241	WILMINK 7.03003.01.0
WG1013393	WILMINK 7.02256.27.0	WG1026245	WILMINK 7.03088.01.0
WG1013396	WILMINK 7.00782.16.0	WG1026251	WILMINK 7.03294.02.0
WG1013397	WILMINK 7.00782.12.0	WG1026257	WILMINK 7.03652.01.0
WG1013399	WILMINK 7.03653.01.0	WG1026258	WILMINK 7.03653.01.0
WG1013810	WILMINK 7.22880.01.0	WG1026299	WILMINK 7.03833.02.0
WG1013811	WILMINK 7.22687.39.0	WG1026315	WILMINK 7.04423.01.0
WG1013812	WILMINK 7.21071.50.0	WG1026316	WILMINK 7.04615.03.0
WG1013813	WILMINK 7.02256.19.0	WG1026461	WILMINK 7.05432.12.0
WG1013816	WILMINK 7.02256.50.0	WG1026487	WILMINK 7.06117.05.0
WG1013822	WILMINK 7.02461.01.0	WG1026488	WILMINK 7.06117.06.0
WG1014414	WILMINK 7.05432.13.0	WG1026489	WILMINK 7.06117.07.0
WG1014418	WILMINK 7.06269.02.0	WG1026493	WILMINK 7.06269.02.0
WG1014427	WILMINK 7.06269.03.0	WG1026494	WILMINK 7.06269.03.0
WG1014434	WILMINK 7.06269.27.0	WG1026564	WILMINK 7.21071.50.0
WG1014435	WILMINK 7.06269.04.0	WG1026580	WILMINK 7.21483.54.0
WG1014437	WILMINK 7.06269.28.0	WG1026642	WILMINK 7.21903.44.0
WG1014447	WILMINK 7.28098.04.0	WG1026643	WILMINK 7.21903.48.0
WG1014448	WILMINK 7.22402.03.0	WG1026646	WILMINK 7.21903.63.0
WG1014642	WILMINK 7.06117.08.0	WG1026647	WILMINK 7.21903.70.0
WG1014645	WILMINK 7.06117.34.0	WG1026672	WILMINK 7.22138.50.0
WG1014646	WILMINK 7.06117.38.0	WG1026731	WILMINK 7.22240.09.0
WG1014648	WILMINK 7.06117.35.0	WG1026732	WILMINK 7.22240.13.0
WG1014759	WILMINK 7.01835.06.0	WG1026733	WILMINK 7.22240.15.0
WG1015407	WILMINK 7.00036.03.0	WG1026735	WILMINK 7.22280.02.0
WG1015408	WILMINK 7.03833.02.0	WG1026763	WILMINK 7.22355.01.0
WG1025540	WILMINK 7.00036.03.0	WG1026767	WILMINK 7.22402.03.0
WG1025554	WILMINK 7.00272.03.0	WG1026793	WILMINK 7.22517.04.0
WG1025557	WILMINK 7.00326.03.0	WG1026802	WILMINK 7.22572.01.0
WG1025564	WILMINK 7.00380.04.0	WG1026857	WILMINK 7.22796.01.0
WG1025655	WILMINK 7.00470.07.0	WG1026871	WILMINK 7.22880.01.0
WG1025658	WILMINK 7.00513.10.0	WG1026873	WILMINK 7.22903.16.0
WG1025663	WILMINK 7.00580.01.0	WG1026874	WILMINK 7.22903.17.0
WG1025664	WILMINK 7.00607.02.0	WG1026875	WILMINK 7.22903.19.0
WG1025665	WILMINK 7.00612.01.0	WG1026877	WILMINK 7.22908.03.0
WG1025692	WILMINK 7.00782.12.0	WG1027017	WILMINK 7.28098.04.0
WG1025698	WILMINK 7.00868.02.0	WG1027030	WILMINK 7.28170.03.0
WG1025700	WILMINK 7.00887.19.0	WG1027033	WILMINK 7.28197.16.0
WG1025701	WILMINK 7.00887.20.0	WG1027049	WILMINK 7.02256.50.0
WG1025707	WILMINK 7.00964.03.0	WG1027054	WILMINK 7.28311.04.0
WG1025708	WILMINK 7.00968.04.0	WG1027056	WILMINK 7.28328.07.0
WG1025712	WILMINK 7.01010.03.0	WG1032995	WILMINK 7.06269.02.0
WG1025713	WILMINK 7.01019.01.0	WG1033028	WILMINK 7.05432.13.0
WG1025714	WILMINK 7.01024.02.0	WG1033037	WILMINK 7.05432.12.0
WG1025716	WILMINK 7.01039.03.0	WG1054730	WILMINK 7.06269.02.0
WG1025717	WILMINK 7.01044.03.0	WG1054731	WILMINK 7.06269.03.0
WG1025750	WILMINK 7.01633.04.0	WG1054869	WILMINK 7.06117.34.0
WG1025756	WILMINK 7.01771.01.0	WG1268327	WILMINK 7.01777.17.0
WG1025757	WILMINK 7.01777.17.0	WG1268328	WILMINK 7.28098.15.0
WG1025761	WILMINK 7.01814.12.0	WG1268329	WILMINK 7.01343.04.0

REF-No.	 PIERBURG	REF-No.	 PIERBURG		
WG1268330	WILMINK	7.22240.13.0	WG1494646	WILMINK	7.01019.01.0
WG1307335	WILMINK	7.22903.34.0	WG1494647	WILMINK	7.22903.17.0
WG1348198	WILMINK	7.03073.01.0	WG1494695	WILMINK	7.02256.26.0
WG1354040	WILMINK	7.06269.04.0	WG1494706	WILMINK	7.00272.03.0
WG1354448	WILMINK	7.01632.02.0	WG1494736	WILMINK	7.02256.23.0
WG1354452	WILMINK	7.02221.01.0	WG1494738	WILMINK	7.00612.01.0
WG1354456	WILMINK	7.02256.41.0	WG1494739	WILMINK	7.22240.09.0
WG1354458	WILMINK	7.02325.04.0	WG1494749	WILMINK	7.01777.17.0
WG1354460	WILMINK	7.02534.01.0	WG1494750	WILMINK	7.28098.15.0
WG1354462	WILMINK	7.03073.01.0	WG1494751	WILMINK	7.01343.04.0
WG1354540	WILMINK	7.22903.18.0	WG1494781	WILMINK	7.00513.10.0
WG1354542	WILMINK	7.28098.15.0	WG1494785	WILMINK	7.02256.19.0
WG1354742	WILMINK	7.06117.24.0	WG1494789	WILMINK	7.02256.17.0
WG1408930	WILMINK	7.02256.29.0	WG1494790	WILMINK	7.03003.01.0
WG1408936	WILMINK	7.02256.21.0	WG1494793	WILMINK	7.03653.01.0
WG1408938	WILMINK	7.02063.02.0	WG1494794	WILMINK	7.02256.44.0
WG1408939	WILMINK	7.01019.01.0	WG1494795	WILMINK	7.02256.43.0
WG1408940	WILMINK	7.00470.07.0	WG1494796	WILMINK	7.01814.12.0
WG1408942	WILMINK	7.22903.17.0	WG1494804	WILMINK	7.06269.02.0
WG1408960	WILMINK	7.01039.03.0	WG1494843	WILMINK	7.06269.27.0
WG1408961	WILMINK	7.21903.44.0	WG1494844	WILMINK	7.06269.27.0
WG1408974	WILMINK	7.28197.16.0	WG1494845	WILMINK	7.06269.04.0
WG1409095	WILMINK	7.06117.08.0	WG1494847	WILMINK	7.06269.03.0
WG1429300	WILMINK	7.02256.00.0	WG1494848	WILMINK	7.06269.03.0
WG1430091	WILMINK	7.06117.08.0	WG1494852	WILMINK	7.05432.13.0
WG1430092	WILMINK	7.06117.07.0	WG1494890	WILMINK	7.06269.28.0
WG1430630	WILMINK	7.06117.17.0	WG1494891	WILMINK	7.06269.28.0
WG1431748	WILMINK	7.02256.49.0	WG1494901	WILMINK	7.05432.12.0
WG1431750	WILMINK	7.02256.50.0	WG1494978	WILMINK	7.02256.48.0
WG1431751	WILMINK	7.02256.20.0	WG1498206	WILMINK	7.06117.15.0
WG1442272	WILMINK	7.02256.00.0	WG1719796	WILMINK	7.01632.02.0
WG1442406	WILMINK	7.06117.08.0	WG1719799	WILMINK	7.03554.10.0
WG1442407	WILMINK	7.06117.07.0	WG1725019	WILMINK	7.06117.34.0
WG1442608	WILMINK	7.06117.17.0	WG1725021	WILMINK	7.06117.38.0
WG1492206	WILMINK	7.00017.03.0	WG1725023	WILMINK	7.06117.35.0
WG1492207	WILMINK	7.00380.11.0	WG1725024	WILMINK	7.06117.08.0
WG1492211	WILMINK	7.00887.21.0	WG1725025	WILMINK	7.06117.26.0
WG1492212	WILMINK	7.00887.22.0	WG1726477	WILMINK	7.01904.03.0
WG1492226	WILMINK	7.03280.04.0	WG1726481	WILMINK	7.02325.05.0
WG1492283	WILMINK	7.06117.14.0	WG1726485	WILMINK	7.03162.09.0
WG1492284	WILMINK	7.06117.15.0	WG1726502	WILMINK	7.04492.07.0
WG1492286	WILMINK	7.06117.20.0	WG1726517	WILMINK	7.06117.16.0
WG1494442	WILMINK	7.06117.38.0	WG1726519	WILMINK	7.06117.60.0
WG1494443	WILMINK	7.06117.08.0	WG1741835	WILMINK	7.06117.46.0
WG1494444	WILMINK	7.06117.05.0	WG1741837	WILMINK	7.06117.54.0
WG1494445	WILMINK	7.06117.06.0	WG1741839	WILMINK	7.06117.37.0
WG1494498	WILMINK	7.21903.48.0	WG1741840	WILMINK	7.06117.48.0
WG1494499	WILMINK	7.03085.02.0	WG1741841	WILMINK	7.06117.47.0
WG1494506	WILMINK	7.22355.01.0	WG1741843	WILMINK	7.06117.42.0
WG1494578	WILMINK	7.02183.01.0	WG1741845	WILMINK	7.06117.43.0
WG1494579	WILMINK	7.00964.03.0	WG1741846	WILMINK	7.06117.44.0
WG1494580	WILMINK	7.28328.07.0	WG1741847	WILMINK	7.06117.00.0
WG1494581	WILMINK	7.00968.04.0	WG1741848	WILMINK	7.06117.02.0
WG1494588	WILMINK	7.00607.02.0	WG1741849	WILMINK	7.06117.01.0
WG1494589	WILMINK	7.00868.02.0	WG1741850	WILMINK	7.06117.10.0
WG1494590	WILMINK	7.28098.04.0	WG1741851	WILMINK	7.06117.58.0
WG1494591	WILMINK	7.02184.01.0	WG1741852	WILMINK	7.06117.36.0
WG1494593	WILMINK	7.02461.01.0	WG1741855	WILMINK	7.08681.09.0
WG1494594	WILMINK	7.22796.01.0	WG1741856	WILMINK	7.06117.35.0
WG1494595	WILMINK	7.03088.01.0	WG1741857	WILMINK	7.06117.38.0
WG1494596	WILMINK	7.22687.39.0	WG1741863	WILMINK	7.06117.33.0
WG1494597	WILMINK	7.01024.02.0	WG1741907	WILMINK	7.06117.34.0
WG1494610	WILMINK	7.22903.19.0	WG1741908	WILMINK	7.06117.39.0
WG1494611	WILMINK	7.22138.50.0	WG1741935	WILMINK	7.06117.07.0
WG1494612	WILMINK	7.02318.01.0	WG1749484	WILMINK	7.10014.00.0
WG1494629	WILMINK	7.00326.03.0	WG1749517	WILMINK	7.02256.48.0
WG1494643	WILMINK	7.01633.04.0	WG1749521	WILMINK	7.00887.21.0
WG1494644	WILMINK	7.01771.01.0	WG1749524	WILMINK	7.00887.22.0
WG1494645	WILMINK	7.02063.02.0	WG1749525	WILMINK	7.03280.04.0

NUMBERFINDER

REF-No.		REF-No.			
WG1749529	WILMINK	7.03073.01.0	WG1905318	WILMINK	7.22908.03.0
WG1749539	WILMINK	7.02325.05.0	WG1906898	WILMINK	7.02256.28.0
WG1749544	WILMINK	7.03584.01.0	WG1924849	WILMINK	7.00607.04.0
WG1749596	WILMINK	7.02256.41.0	WG1924854	WILMINK	7.01777.19.0
WG1749613	WILMINK	7.08681.09.0	WG1924859	WILMINK	7.02428.02.0
WG1749614	WILMINK	7.06117.06.0	WG1924875	WILMINK	7.02968.02.0
WG1749615	WILMINK	7.06117.05.0	WG1924908	WILMINK	7.06117.12.0
WG1777574	WILMINK	7.02256.20.0	WG1924910	WILMINK	7.06117.34.0
WG1794784	WILMINK	7.22355.01.0	WG1924912	WILMINK	7.06117.36.0
WG1795416	WILMINK	7.06117.26.0	WG1924913	WILMINK	7.06117.37.0
WG1795503	WILMINK	7.00868.02.0	WG1925587	WILMINK	7.06117.14.0
WG1795911	WILMINK	7.00968.04.0	WG1925605	WILMINK	7.00272.03.0
WG1796014	WILMINK	7.06117.35.0	WG1937840	WILMINK	7.01282.02.0
WG1796015	WILMINK	7.06117.38.0	WG1937842	WILMINK	7.02436.02.0
WG1796042	WILMINK	7.02256.17.0	WG1967345	WILMINK	7.08681.00.0
WG1796301	WILMINK	7.02613.02.0	WG2008307	WILMINK	7.02256.51.0
WG1796411	WILMINK	7.01044.03.0	WG2015757	WILMINK	7.02183.01.0
WG1796492	WILMINK	7.06117.05.0	WG2015768	WILMINK	7.22903.19.0
WG1796493	WILMINK	7.06117.06.0	WG2015771	WILMINK	7.00326.03.0
WG1796495	WILMINK	7.06117.46.0	WG2015777	WILMINK	7.01019.01.0
WG1796508	WILMINK	7.06117.01.0	WG2015778	WILMINK	7.22903.17.0
WG1796510	WILMINK	7.06117.00.0	WG2015792	WILMINK	7.02256.26.0
WG1796517	WILMINK	7.06117.58.0	WG2015793	WILMINK	7.00272.03.0
WG1796550	WILMINK	7.04423.01.0	WG2015802	WILMINK	7.21903.44.0
WG1796558	WILMINK	7.02256.27.0	WG2015803	WILMINK	7.00612.01.0
WG1804734	WILMINK	7.00513.10.0	WG2015807	WILMINK	7.22402.03.0
WG1806749	WILMINK	7.06117.00.0	WG2015812	WILMINK	7.22880.01.0
WG1806750	WILMINK	7.06117.26.0	WG2015813	WILMINK	7.00470.07.0
WG1807518	WILMINK	7.06117.35.0	WG2015814	WILMINK	7.21903.63.0
WG1807522	WILMINK	7.06117.33.0	WG2015815	WILMINK	7.03073.01.0
WG1807532	WILMINK	7.06117.00.0	WG2015817	WILMINK	7.03833.02.0
WG1807533	WILMINK	7.06117.02.0	WG2015819	WILMINK	7.02256.31.0
WG1807534	WILMINK	7.06117.46.0	WG2015820	WILMINK	7.02588.04.0
WG1807537	WILMINK	7.06117.01.0	WG2015821	WILMINK	7.22240.15.0
WG1807548	WILMINK	7.06117.45.0	WG2015822	WILMINK	7.22903.16.0
WG1807550	WILMINK	7.06117.54.0	WG2025986	WILMINK	7.06117.60.0
WG1807552	WILMINK	7.06117.48.0	WG2026340	WILMINK	7.00017.03.0
WG1807553	WILMINK	7.06117.10.0	WG2028340	WILMINK	7.06117.01.0
WG1807557	WILMINK	7.06117.42.0	WG2028341	WILMINK	7.06117.00.0
WG1807559	WILMINK	7.06117.58.0	WG2099675	WILMINK	7.08681.00.0
WG1820356	WILMINK	7.06117.34.0	WG2099705	WILMINK	7.02325.04.0
WG1822304	WILMINK	7.00868.02.0	WG2136490	WILMINK	7.04492.07.0
WG1822305	WILMINK	7.02184.01.0	WG2168226	WILMINK	7.00017.03.0
WG1822306	WILMINK	7.22796.01.0	WG2168232	WILMINK	7.22240.15.0
WG1822318	WILMINK	7.22903.34.0	WG2172990	WILMINK	7.00782.16.0
WG1822325	WILMINK	7.21071.50.0	WG2172991	WILMINK	7.03964.01.0
WG1822326	WILMINK	7.00887.20.0	X10-739-002-001	VDO	7.06269.01.0
WG1822327	WILMINK	7.02325.04.0	X10-739-002-002	VDO	4.02003.62.0
WG1822659	WILMINK	7.06117.45.0	X10-739-002-003	VDO	7.06269.02.0
WG1822663	WILMINK	7.06117.34.0	X10-739-002-005	VDO	7.06269.26.0
WG1837574	WILMINK	7.06117.38.0	X10-739-002-006	VDO	7.06269.06.0
WG1888895	WILMINK	7.06117.01.0	XCS6338	ELTA	7.06117.35.0
WG1899348	WILMINK	7.01633.04.0	XCS6338	ELTA	7.06117.38.0
WG1899349	WILMINK	7.00887.19.0	XEG9039	ELTA	7.00968.04.0
WG1899351	WILMINK	7.21903.49.0	XEG9067	ELTA	7.22796.01.0
WG1899352	WILMINK	7.22903.16.0	XEG9068	ELTA	7.02184.01.0
WG1899356	WILMINK	7.21903.63.0	XEG9107	ELTA	7.22138.50.0
WG1899360	WILMINK	7.01814.12.0	XEG9115	ELTA	7.22903.17.0
WG1899374	WILMINK	7.02256.51.0	XEG9129	ELTA	7.02256.49.0
WG1899386	WILMINK	7.00607.04.0	XEG9152	ELTA	7.21483.54.0
WG1899403	WILMINK	7.02534.01.0	XEG9213	ELTA	7.01024.02.0
WG1899404	WILMINK	7.22903.34.0	XEG9221	ELTA	7.02063.02.0
WG1899405	WILMINK	7.02256.31.0	XEG9339	ELTA	7.01771.01.0
WG1899406	WILMINK	7.28311.04.0	XEG9341	ELTA	7.02256.48.0
WG1899407	WILMINK	7.22280.02.0	XELV1	QUINTON HAZEL	7.00868.02.0
WG1899408	WILMINK	7.00887.20.0	XELV116	QUINTON HAZEL	7.02256.20.0
WG1899422	WILMINK	7.01777.18.0	XELV117	QUINTON HAZEL	7.02534.01.0
WG1900599	WILMINK	7.06117.34.0	XELV118	QUINTON HAZEL	7.00272.03.0
WG1900603	WILMINK	7.06117.14.0	XELV12	QUINTON HAZEL	7.02318.01.0

REF-No.		 PIERBURG	REF-No.		 PIERBURG
XELV12	QUINTON HAZEL	7.28170.03.0	XS6U-9F715-AA	FORD	7.06269.03.0
XELV13	QUINTON HAZEL	7.22240.15.0	Y601-18-740	MAZDA	7.00968.04.0
XELV14	QUINTON HAZEL	7.02256.29.0	YDJ100000	LAND ROVER	7.02318.01.0
XELV149	QUINTON HAZEL	7.02325.05.0	YF09-18-741	MAZDA	7.02256.46.0
XELV2	QUINTON HAZEL	7.22796.01.0	YM21-12B573-AA	FORD	7.02183.01.0
XELV20	QUINTON HAZEL	7.00607.02.0	YM21-12B573-BA	FORD	7.02184.01.0
XELV21	QUINTON HAZEL	7.22355.01.0	YM21-12B573-EA	FORD	7.02256.00.0
XELV24	QUINTON HAZEL	7.02184.01.0	YM21-12B573-FA	FORD	7.01037.02.0
XELV26	QUINTON HAZEL	7.22903.19.0	YM21-12B573-GA	FORD	7.28098.04.0
XELV28	QUINTON HAZEL	7.02256.49.0	YS6A-9F715-AB	FORD	7.05432.03.0
XELV32	QUINTON HAZEL	7.01024.02.0	YU3E-9F715-AA	FORD	7.06269.20.0
XELV33	QUINTON HAZEL	7.02256.50.0	ZV13313	ZZVF	7.02256.48.0
XELV34	QUINTON HAZEL	7.00612.01.0	ZV2475W	ZZVF	7.06117.10.0
XELV35	QUINTON HAZEL	7.22138.50.0	ZV280BF	ZZVF	7.06117.53.0
XELV4	QUINTON HAZEL	7.21903.73.0	ZV314MF	ZZVF	7.02256.51.0
XELV41	QUINTON HAZEL	7.02183.01.0	ZV361AF	ZZVF	7.06117.52.0
XELV42	QUINTON HAZEL	7.02256.22.0	ZV9142LK	ZZVF	7.06117.55.0
XELV45	QUINTON HAZEL	7.00968.04.0	ZV93516	ZZVF	7.02256.27.0
XELV49	QUINTON HAZEL	7.01633.04.0	ZVAK002	ZZVF	7.06117.42.0
XELV50	QUINTON HAZEL	7.02063.02.0	ZVAK047	ZZVF	7.06117.54.0
XELV51	QUINTON HAZEL	7.01019.01.0	ZVAK119	ZZVF	7.06117.39.0
XELV52	QUINTON HAZEL	7.22903.17.0	ZVFA97	ZZVF	7.06117.46.0
XELV55	QUINTON HAZEL	7.02256.00.0			
XELV56	QUINTON HAZEL	7.01343.04.0			
XELV58	QUINTON HAZEL	7.01777.17.0			
XELV59	QUINTON HAZEL	7.22240.13.0			
XELV61	QUINTON HAZEL	7.06117.35.0			
XELV62	QUINTON HAZEL	7.06117.08.0			
XELV67	QUINTON HAZEL	7.02256.23.0			
XELV71	QUINTON HAZEL	7.06117.39.0			
XELV73	QUINTON HAZEL	7.06117.45.0			
XELV75	QUINTON HAZEL	7.01814.12.0			
XFP8605	ELTA	7.05432.13.0			
XFP8610	ELTA	7.06269.27.0			
XFP8625	ELTA	7.06269.28.0			
XICV13	QUINTON HAZEL	7.06269.03.0			
XICV15	QUINTON HAZEL	7.05432.13.0			
XICV16	QUINTON HAZEL	7.06269.24.0			
XICV19	QUINTON HAZEL	7.06269.22.0			
XICV2	QUINTON HAZEL	7.06269.23.0			
XICV20	QUINTON HAZEL	7.05432.02.0			
XICV21	QUINTON HAZEL	7.05432.00.0			
XICV23	QUINTON HAZEL	7.05432.11.0			
XICV24	QUINTON HAZEL	7.05432.01.0			
XICV27	QUINTON HAZEL	7.06269.26.0			
XICV28	QUINTON HAZEL	7.05432.03.0			
XICV37	QUINTON HAZEL	7.05432.06.0			
XICV39	QUINTON HAZEL	7.06269.01.0			
XICV4	QUINTON HAZEL	7.06269.04.0			
XICV45	QUINTON HAZEL	7.06269.21.0			
XICV47	QUINTON HAZEL	7.06269.05.0			
XICV49	QUINTON HAZEL	7.06269.28.0			
XICV51	QUINTON HAZEL	7.05432.04.0			
XICV58	QUINTON HAZEL	7.05432.09.0			
XICV6	QUINTON HAZEL	7.06269.27.0			
XICV7	QUINTON HAZEL	7.06269.02.0			
XICV73	QUINTON HAZEL	7.06269.20.0			
XICV78	QUINTON HAZEL	7.06269.10.0			
XL2E-9F715-AB	FORD	7.06269.20.0			
XM2U-9F715-AA	FORD	7.06269.00.0			
XM2U-9F715-BA	FORD	7.06269.05.0			
XR858494	JAGUAR	7.06117.52.0			
XS2E-9F715-BA	FORD	7.06269.21.0			
XS2E-9F715-BB	FORD	7.06269.21.0			
XS2E-9F715-BC	FORD	7.06269.21.0			
XS4U-9F715-BB	FORD	7.06269.27.0			
XS4U-9F715-DA	FORD	7.06269.04.0			
XS4U-9F715-DB	FORD	7.06269.04.0			
XS4U-9F715-FA	FORD	7.06269.04.0			

D

ARTIKELNUMMER ALT - NEU

E

ARTICLE NUMBER OLD - NEW

PIERBURG-No. OLD → NEW

old	new	old	new
3.21875.03.0	7.08681.15.0	7.00519.01.0	7.00607.02.0
3.48970.00.0	7.08681.08.0	7.00527.01.0	7.01420.02.0
3.48970.01.0	7.08681.08.0	7.00527.03.0	7.01420.02.0
4.02003.01.0	7.06269.01.0	7.00579.00.0	7.22796.01.0
4.02003.32.0	7.06269.02.0	7.00579.01.0	7.22796.01.0
4.02003.54.0	7.06269.04.0	7.00579.03.0	7.22796.01.0
4.02003.55.0	7.06269.26.0	7.00580.00.0	7.00580.01.0
4.02003.56.0	7.06269.06.0	7.00607.00.0	7.00607.02.0
4.02003.57.0	7.06269.07.0	7.00607.01.0	7.00607.04.0
4.02003.59.0	7.06269.09.0	7.00612.00.0	7.00612.01.0
4.02003.63.0	7.06269.03.0	7.00712.00.0	7.00968.04.0
4.07501.02.0	7.05432.02.0	7.00733.01.0	7.04247.02.0
4.07501.50.0	7.05432.00.0	7.00733.02.0	7.04247.02.0
4.07501.51.0	7.05432.01.0	7.00733.03.0	7.04247.02.0
4.07501.52.0	7.05432.12.0	7.00756.00.0	7.00756.05.0
5.02308.00.0	7.06269.01.0	7.00756.03.0	7.00756.05.0
5.02308.01.0	7.06269.01.0	7.00782.00.0	7.00782.04.0
5.02549.00.0	5.02549.03.0	7.00782.02.0	7.00782.04.0
5.02549.01.0	5.02549.03.0	7.00782.03.0	7.00782.12.0
5.02549.02.0	5.02549.03.0	7.00782.05.0	7.00782.11.0
5.32742.02.0	7.05432.11.0	7.00782.08.0	7.00782.12.0
7.00017.00.0	7.00017.02.0	7.00782.10.0	7.00782.16.0
7.00017.01.0	7.00017.03.0	7.00782.17.0	7.00782.11.0
7.00036.00.0	7.00036.03.0	7.00782.18.0	7.00782.12.0
7.00175.00.0	7.00175.04.0	7.00782.19.0	7.00782.16.0
7.00175.01.0	7.00175.04.0	7.00784.00.0	7.00784.01.0
7.00175.02.0	7.00175.04.0	7.00866.00.0	7.02212.02.0
7.00237.00.0	7.22908.03.0	7.00866.01.0	7.02212.02.0
7.00262.00.0	7.00262.02.0	7.00868.00.0	7.00868.02.0
7.00265.00.0	7.00265.02.0	7.00887.00.0	7.00887.19.0
7.00265.01.0	7.00265.02.0	7.00887.01.0	7.00887.19.0
7.00272.00.0	7.00272.03.0	7.00887.02.0	7.00887.20.0
7.00272.01.0	7.00272.03.0	7.00887.03.0	7.00887.21.0
7.00272.02.0	7.00272.03.0	7.00887.04.0	7.00887.19.0
7.00326.00.0	7.00326.03.0	7.00887.05.0	7.00887.20.0
7.00326.02.0	7.00326.03.0	7.00887.10.0	7.00887.19.0
7.00380.00.0	7.00380.04.0	7.00887.11.0	7.00887.21.0
7.00380.01.0	7.00380.04.0	7.00887.12.0	7.00887.21.0
7.00380.02.0	7.00380.11.0	7.00887.13.0	7.00887.19.0
7.00380.05.0	7.00380.11.0	7.00887.14.0	7.00887.20.0
7.00380.06.0	7.00380.11.0	7.00887.15.0	7.00887.19.0
7.00380.08.0	7.00380.11.0	7.00887.16.0	7.00887.20.0
7.00415.02.0	7.00415.07.0	7.00887.17.0	7.00887.20.0
7.00415.02.0	7.01830.13.0	7.00887.18.0	7.00887.22.0
7.00415.03.0	7.00415.07.0	7.00917.00.0	7.01421.01.0
7.00415.03.0	7.01830.13.0	7.00964.01.0	7.00964.03.0
7.00415.05.0	7.00415.07.0	7.00966.02.0	7.28328.07.0
7.00415.05.0	7.01830.13.0	7.00967.01.0	7.00612.01.0
7.00426.00.0	7.01024.02.0	7.00967.02.0	7.00612.01.0
7.00426.00.5	7.01024.02.0	7.00968.01.0	7.00968.04.0
7.00426.01.0	7.01024.02.0	7.00968.02.0	7.00968.04.0
7.00426.02.0	7.01024.02.0	7.00968.03.0	7.00968.04.0
7.00426.05.0	7.01024.02.0	7.01003.00.0	7.01003.01.0
7.00470.00.0	7.00470.07.0	7.01003.02.0	7.01003.01.0
7.00470.01.0	7.00470.07.0	7.01010.00.0	7.01010.03.0
7.00470.03.0	7.00470.07.0	7.01019.00.0	7.01019.01.0
7.00470.04.0	7.00470.07.0	7.01024.00.0	7.01024.02.0
7.00470.06.0	7.00470.07.0	7.01024.00.5	7.01024.02.0
7.00483.00.0	7.21903.48.0	7.01025.00.0	7.01024.02.0
7.00498.00.0	7.01024.02.0	7.01037.00.0	7.01037.02.0
7.00498.01.0	7.01024.02.0	7.01037.01.0	7.01037.02.0
7.00498.02.0	7.01024.02.0	7.01039.00.0	7.01039.03.0
7.00513.07.0	7.00513.10.0	7.01039.01.0	7.01039.03.0
7.00513.08.0	7.00513.10.0	7.01044.00.0	7.01044.03.0
7.00513.16.0	7.00513.19.0	7.01115.00.0	7.01115.08.0
7.00515.00.0	7.00515.04.0	7.01115.02.0	7.01115.08.0
7.00515.02.0	7.00515.05.0	7.01115.04.0	7.01115.08.0
7.00519.00.0	7.00607.02.0	7.01115.05.0	7.01115.08.0

PIERBURG-No. OLD → NEW

PIERBURG-No. OLD → NEW

old	new	old	new
7.01115.06.0	7.01115.08.0	7.02212.01.0	7.02212.02.0
7.01121.00.0	7.01121.02.0	7.02221.00.0	7.02221.01.0
7.01121.01.0	7.01121.02.0	7.02274.00.0	7.03833.02.0
7.01122.00.0	7.01122.03.0	7.02288.00.0	7.02288.01.0
7.01122.01.0	7.01122.03.0	7.02318.00.0	7.02318.01.0
7.01122.02.0	7.01122.03.0	7.02325.00.0	7.02325.04.0
7.01152.00.0	7.01152.02.0	7.02325.02.0	7.02325.05.0
7.01153.00.0	7.02461.01.0	7.02325.03.0	7.02325.06.0
7.01158.00.0	7.03833.02.0	7.02328.03.0	7.02328.08.0
7.01282.00.0	7.01282.02.0	7.02328.04.0	7.02328.08.0
7.01299.00.0	7.01777.17.0	7.02328.05.0	7.02328.08.0
7.01343.00.0	7.01343.04.0	7.02428.00.0	7.02428.02.0
7.01343.03.0	7.01343.04.0	7.02428.01.0	7.02428.02.0
7.01349.00.0	7.01349.01.0	7.02445.00.0	7.04247.02.0
7.01396.00.0	5.02549.03.0	7.02445.01.0	7.04247.02.0
7.01420.01.0	7.01420.02.0	7.02461.00.0	7.02461.01.0
7.01420.03.0	7.03978.01.0	7.02461.02.0	7.02461.03.0
7.01421.00.0	7.01421.01.0	7.02476.05.0	7.02476.09.0
7.01432.00.0	7.02534.01.0	7.02476.07.0	7.02476.09.0
7.01441.00.0	7.01441.04.0	7.02533.00.0	7.02588.04.0
7.01441.01.0	7.01441.04.0	7.02534.00.0	7.02534.01.0
7.01441.02.0	7.01441.04.0	7.02588.00.0	7.02588.04.0
7.01441.03.0	7.01441.04.0	7.02588.02.0	7.02588.04.0
7.01569.00.0	7.01569.04.0	7.02613.00.0	7.02613.02.0
7.01569.01.0	7.01569.04.0	7.02613.01.0	7.02613.02.0
7.01569.02.0	7.01569.05.0	7.02721.04.0	7.02721.06.0
7.01569.03.0	7.01569.05.0	7.02814.00.0	7.03085.02.0
7.01632.00.0	7.01632.02.0	7.02815.00.0	7.03088.01.0
7.01632.01.0	7.01632.02.0	7.02901.00.0	7.02901.05.0
7.01633.00.0	7.01633.04.0	7.02901.01.0	7.02901.05.0
7.01633.02.0	7.01633.06.0	7.02901.08.0	7.02901.05.0
7.01633.03.0	7.01633.06.0	7.02909.01.0	7.02909.07.0
7.01633.05.0	7.01633.06.0	7.02909.02.0	7.02909.07.0
7.01738.00.0	7.01738.01.0	7.02909.03.0	7.02909.12.0
7.01762.00.0	7.01762.04.0	7.02909.10.0	7.02909.12.0
7.01762.02.0	7.01762.04.0	7.02968.01.0	7.02968.02.0
7.01762.03.0	7.01762.04.0	7.03003.00.0	7.03003.01.0
7.01771.00.0	7.01771.01.0	7.03073.00.0	7.03073.01.0
7.01777.00.0	7.01777.18.0	7.03075.00.0	7.03075.02.0
7.01777.01.0	7.01777.18.0	7.03075.01.0	7.03075.02.0
7.01777.02.0	7.01777.17.0	7.03085.00.0	7.03085.02.0
7.01777.03.0	7.01777.18.0	7.03088.00.0	7.03088.01.0
7.01777.10.0	7.01777.17.0	7.03162.08.0	7.03162.09.0
7.01777.11.0	7.01777.18.0	7.03280.00.0	7.03280.04.0
7.01777.12.0	7.01777.17.0	7.03294.00.0	7.03294.02.0
7.01777.13.0	7.01777.19.0	7.03294.01.0	7.03294.02.0
7.01777.14.0	7.01777.18.0	7.03306.06.0	7.03306.16.0
7.01805.00.0	7.01805.01.0	7.03306.09.0	7.03306.16.0
7.01805.00.1	7.01805.01.0	7.03351.01.0	7.03351.12.0
7.01806.00.0	7.01805.01.0	7.03351.04.0	7.03351.12.0
7.01814.05.0	7.01814.12.0	7.03351.05.0	7.03351.12.0
7.01814.13.0	7.01814.22.0	7.03351.06.0	7.03351.12.0
7.01830.04.0	7.01830.13.0	7.03357.01.0	7.03357.04.0
7.01835.02.0	7.01835.06.0	7.03381.08.0	7.03381.14.0
7.01835.03.0	7.01835.06.0	7.03381.09.0	7.03381.15.0
7.01870.02.0	7.01870.06.0	7.03381.11.0	7.03381.14.0
7.01904.01.0	7.01904.03.0	7.03381.12.0	7.03381.14.0
7.01981.05.0	7.01981.07.0	7.03381.13.0	7.03381.14.0
7.02063.01.0	7.02063.02.0	7.03473.00.0	7.03833.02.0
7.02084.00.0	7.01805.01.0	7.03507.03.0	7.03306.16.0
7.02084.03.0	7.01805.01.0	7.03507.04.0	7.03306.16.0
7.02084.05.0	7.01805.01.0	7.03554.04.0	7.03554.10.0
7.02087.03.0	7.02087.05.0	7.03554.09.0	7.03554.10.0
7.02183.00.0	7.02183.01.0	7.03584.00.0	7.03584.01.0
7.02184.00.0	7.02184.01.0	7.03652.00.0	7.03652.01.0
7.02197.00.0	7.03653.01.0	7.03653.00.0	7.03653.01.0
7.02207.04.0	7.02207.05.0	7.03833.00.0	7.03833.02.0
7.02212.00.0	7.02212.02.0	7.03833.01.0	7.03833.02.0

PIERBURG-No. OLD → NEW

PIERBURG-No. OLD → NEW

old	new	old	new
7.03856.00.0	7.03856.02.0	7.21895.80.0	7.21895.55.0
7.03964.00.0	7.03964.01.0	7.21903.04.0	7.21903.73.0
7.03978.00.0	7.03978.01.0	7.21903.05.0	7.21903.75.0
7.04001.00.0	7.03833.02.0	7.21903.10.0	7.03085.02.0
7.04010.00.0	7.03833.02.0	7.21903.11.0	7.21903.48.0
7.04011.01.0	7.04011.05.0	7.21903.12.0	7.03088.01.0
7.04216.02.0	7.04216.05.0	7.21903.15.0	7.21903.75.0
7.04216.03.0	7.04216.05.0	7.21903.16.0	7.03085.02.0
7.04247.01.0	7.04247.02.0	7.21903.20.0	7.21903.70.0
7.04269.02.0	7.04269.04.0	7.21903.20.1	7.21903.70.0
7.04423.00.0	7.04423.01.0	7.21903.20.2	7.21903.70.0
7.04492.01.0	7.04492.07.0	7.21903.20.3	7.21903.70.0
7.04492.02.0	7.04492.07.0	7.21903.20.5	7.21903.70.0
7.04492.03.0	7.04492.07.0	7.21903.21.0	7.21903.49.0
7.04492.05.0	7.04492.07.0	7.21903.21.1	7.21903.49.0
7.04492.06.0	7.04492.07.0	7.21903.21.5	7.21903.49.0
7.04615.01.0	7.04615.03.0	7.21903.23.0	7.21903.73.0
7.04638.00.0	7.04638.01.0	7.21903.25.0	7.21903.75.0
7.04654.04.0	7.04654.10.0	7.21903.25.1	7.21903.75.0
7.04654.08.0	7.04654.10.0	7.21903.25.2	7.21903.75.0
7.04663.00.0	7.04663.14.0	7.21903.25.5	7.21903.75.0
7.04664.00.0	7.04664.02.0	7.21903.29.0	7.21903.63.0
7.04818.00.0	7.04818.04.0	7.21903.38.0	7.03085.02.0
7.04927.02.0	7.04927.08.0	7.21903.39.0	7.03088.01.0
7.04927.03.0	7.04927.08.0	7.21903.39.5	7.03088.01.0
7.05314.01.0	7.05314.02.0	7.21903.43.0	7.21903.44.0
7.05367.01.0	7.05367.05.0	7.22098.10.0	7.22098.04.0
7.05367.01.1	7.05367.05.0	7.22098.11.0	7.22098.04.0
7.05798.00.0	7.01835.06.0	7.22138.00.0	7.22138.50.0
7.05804.00.0	7.02909.12.0	7.22138.00.1	7.22138.50.0
7.06117.13.0	7.06117.24.0	7.22138.00.5	7.22138.50.0
7.06117.25.0	7.06117.60.0	7.22240.03.0	7.22240.09.0
7.07123.00.0	7.03073.01.0	7.22240.06.0	7.22240.13.0
7.07131.00.0	7.03652.01.0	7.22240.08.0	7.22240.13.0
7.07131.04.0	7.03653.01.0	7.22240.10.0	7.22240.15.0
7.07810.00.0	7.21071.50.0	7.22240.11.0	7.22240.13.0
7.07860.00.0	7.21071.50.0	7.22280.01.0	7.22280.02.0
7.09000.00.0	7.09000.03.0	7.22280.04.0	7.22280.02.0
7.12930.00.0	7.21071.50.0	7.22341.00.0	7.02318.01.0
7.12931.00.0	7.21071.50.0	7.22341.08.0	7.02318.01.0
7.12932.00.0	7.21071.50.0	7.22355.00.0	7.22355.01.0
7.12953.00.0	7.21071.50.0	7.22393.00.0	7.02461.01.0
7.12961.00.0	7.21071.50.0	7.22402.00.0	7.22402.03.0
7.12979.00.0	7.21071.50.0	7.22402.00.1	7.22402.03.0
7.12981.00.0	7.21071.50.0	7.22402.00.2	7.22402.03.0
7.12982.00.0	7.21071.50.0	7.22402.50.0	7.22402.03.0
7.20330.00.0	7.21071.50.0	7.22448.00.0	7.02461.01.0
7.20649.00.0	7.21071.50.0	7.22448.03.0	7.02461.01.0
7.21042.00.0	7.21042.01.0	7.22510.02.0	7.22510.03.0
7.21071.00.0	7.21071.50.0	7.22517.00.0	7.22517.06.0
7.21102.00.0	7.01805.01.0	7.22517.01.0	7.22517.06.0
7.21483.01.0	7.21483.54.0	7.22517.02.0	7.22517.04.0
7.21483.01.1	7.21483.54.0	7.22517.03.0	7.22517.06.0
7.21483.01.2	7.21483.54.0	7.22572.00.0	7.22572.01.0
7.21483.01.5	7.21483.54.0	7.22593.02.0	7.22593.03.0
7.21483.04.0	7.21483.54.0	7.22687.00.0	7.22687.49.0
7.21483.04.5	7.21483.54.0	7.22687.02.0	7.22687.44.0
7.21610.00.0	7.01805.01.0	7.22687.10.0	7.22687.50.0
7.21610.13.0	7.01805.01.0	7.22687.24.0	7.22687.44.0
7.21704.00.0	7.01805.01.0	7.22687.27.0	7.22687.46.0
7.21704.50.0	7.01805.01.0	7.22687.28.0	7.22687.46.0
7.21895.00.0	7.21895.55.0	7.22687.31.0	7.22687.49.0
7.21895.00.5	7.21895.55.0	7.22687.32.0	7.22687.50.0
7.21895.13.0	7.21895.55.0	7.22687.37.0	7.22687.51.0
7.21895.13.2	7.21895.55.0	7.22796.00.0	7.22796.01.0
7.21895.30.0	7.21895.55.0	7.22880.00.0	7.22880.01.0
7.21895.50.0	7.21895.55.0	7.22880.06.0	7.22880.01.0
7.21895.63.0	7.21895.55.0	7.22892.00.0	7.22892.02.0

PIERBURG-No. OLD → NEW

old	new	old	new
7.22892.01.0	7.22892.02.0		
7.22895.30.0	7.01037.02.0		
7.22903.01.0	→7.02183.01.0		
7.22903.02.0	→7.00868.02.0		
7.22903.03.0	7.00580.01.0		
7.22903.04.0	7.02184.01.0		
7.22903.08.0	7.22903.36.0		
7.22903.09.0	7.22903.37.0		
7.22903.13.0	7.22903.28.0		
7.22903.14.0	7.22903.37.0		
7.22903.15.0	7.01019.01.0		
7.22903.20.0	7.02183.01.0		
7.22903.21.0	7.22903.16.0		
7.22903.22.0	7.22903.17.0		
7.22903.25.0	7.02184.01.0		
7.22903.25.2	7.02184.01.0		
7.22903.27.0	7.00580.01.0		
7.22903.30.0	7.22903.18.0		
7.22903.33.0	7.22903.34.0		
7.22903.35.0	7.22903.19.0		
7.22903.45.0	7.00868.02.0		
7.22908.00.0	7.22908.03.0		
7.28098.00.0	7.28098.04.0		
7.28098.02.0	7.28098.15.0		
7.28098.06.0	7.28098.04.0		
7.28098.07.0	7.28098.15.0		
7.28098.08.0	7.28098.16.0		
7.28098.13.0	7.28098.15.0		
7.28148.00.0	7.02256.49.0		
7.28148.01.0	7.02256.49.0		
7.28148.02.0	7.02256.49.0		
7.28170.00.0	7.28170.03.0		
7.28170.02.0	7.28170.03.0		
7.28194.00.0	7.28194.01.0		
7.28197.01.0	7.28197.16.0		
7.28197.03.0	7.28197.16.0		
7.28201.00.0	7.01039.03.0		
7.28286.00.0	7.02256.50.0		
7.28286.03.0	7.02256.50.0		
7.28286.04.0	7.02256.50.0		
7.28286.06.0	7.03584.01.0		
7.28286.10.0	7.28286.13.0		
7.28311.01.0	7.28311.04.0		
7.28311.02.0	7.28311.04.0		
7.28328.00.0	7.00964.03.0		
7.28328.04.0	7.28328.07.0		
7.28328.05.0	7.00964.03.0		
7.28417.00.0	7.01152.02.0		
7.28417.01.0	7.01152.02.0		
7.28417.02.0	7.01152.02.0		
7.28417.04.0	7.01152.02.0		
7.28417.06.0	7.01152.02.0		

Voraussetzungen für Kundenretouren (keine Reklamationen)

Lieber Geschäftspartner,

für Retouren von Waren gibt es vielerlei Gründe. Sollten Sie etwas zurückschicken, bitten wir Sie folgende Hinweise zu beachten.

Voraussetzungen für Retouren verkaufsfähiger Ware:

- Die Verpackung muss unbeschädigt, nicht beschrieben oder beklebt und sauber sein.
- Die Ware muss original verpackt sein.
- Bitte informieren Sie vor jeder Retoure Ihren Gebietsverkaufsleiter.
- Sie erhalten von Ihrem Gebietsverkaufsleiter eine Retourenauftragsnummer. Bitte geben Sie diese Nummer bei Ihrer Rücksendung an.
- Fügen Sie bei Ihrer Retoure pro Artikelposition eine Kopie der Rechnung bei.
- Das Rechnungsdatum darf nicht länger als 3 Jahre zurück liegen.

Die Abzüge vom Warenwert sind abhängig vom Rechnungsdatum und lauten wie folgt:

a) Rechnungsdatum nicht älter als	3 Monate	0%
b) Rechnungsdatum	3–12 Monate	20%
c) Rechnungsdatum	13–24 Monate	30%
d) Rechnungsdatum	25–36 Monate	40%

Wir behalten uns vor, durch ungeplante Kontrollprozesse oder sonstige Aufwände, die daraus entstandenen Kosten entsprechend in Abzug zu bringen. Nähere Informationen hierzu erhalten Sie von Ihrem Gebietsverkaufsleiter.

Grundsätzlich nicht zurückgenommen werden können:

- Waren aus Sonderverkäufen
- landesspezifische Waren
- Abverkaufsprodukte
- Produkte, die durch andere Artikel ersetzt wurden
- nicht mit uns abgestimmte Retouren
- Waren in unverkäuflichem Zustand (siehe oben)
- Kataloge und andere Drucksachen, CD/DVD, Werbematerial

Bitte stimmen Sie das weitere Vorgehen vor der Rücklieferung mit uns ab.

Vielen Dank.

Ihr Vertriebsteam

Requirements for customer returns (not claims)

Dear business partner,

There are many reasons why goods may need to be returned. Should you need to return goods to us where no claims apply, please observe the following instructions.

Requirements for returning saleable goods:

- The packaging must be clean and free from damage, writing and labels.
- The goods must be in their original packaging.
- Please inform your area sales manager before returning any goods.
- Your area sales manager will provide you with a returns order number.
Please include the number on your return.
- A copy of the invoice must be included with your return for each item position.
- The invoice must be dated within the last three years.

The deductions from the value of the goods depend on the invoice date and are as follows:

a) Invoice date not more than 3 months ago	0%
b) Invoice date 3-12 months	20%
c) Invoice date 13-24 months	30%
d) Invoice date 25-36 months	40%

We reserve the right to apply deductions for costs incurred as a result of inspections, re-storage processes and any other unplanned expenditure. Please contact your area sales manager for more information.

The following can not be returned:

- Goods from special sales
- Country-specific goods
- Sale products
- Products that have been replaced with other articles
- Returns that have not been agreed with us
- Goods in an unsaleable condition (see above)
- Catalogues and other printed items, CDs/DVDs, advertising material

Please agree the further procedure with us before returning the goods.

Thank you.

Your sales team

Vorgehensweise bei Reklamationen

Sehr geehrter Motorservice Partner,

für eine schnelle und reibungslose Reklamationsbearbeitung bitten wir um die Beachtung der nachfolgenden Punkte.

Voraussetzungen für Reklamationen

Der Motorservice Handelspartner garantiert gegenüber Motorservice, dass die Voraussetzungen für eine Reklamation erfüllt sind. Der Handelspartner von Motorservice hat im Vorfeld geprüft, ob das reklamierte Teil aus dem Motorservice Lieferprogramm stammt. Ferner ist anhand von Lieferscheinen oder Rechnungen zu prüfen und zu belegen, dass seit der Lieferung des Ersatzteils weniger als 12 Monate vergangen sind. Der Handelsweg muss eingehalten werden.

Einreichung von Reklamationen

Wenn die Teile über den Motorservice OnlineShop bestellt wurden, erfolgt die Einreichung der Reklamation direkt über den OnlineShop. Bitte wählen Sie hierzu im Menü „Mein Konto“ den Eintrag „Reklamationen“ und geben Sie die Daten in das bereitgestellte Webformular ein. Für alle übrigen Reklamationen benutzen Sie bitte das nachfolgende Formular. Bitte beachten Sie, dass die für die Bearbeitung notwendigen Pflichtdatenfelder vollständig ausgefüllt sind. Der Umfang der Reklamation (Schadenshöhe) muss stets vollständig angegeben werden. Darüber hinaus sind wir auch umgehend über ggf. entstandene Personenschäden zu informieren. Werden Reparatur- oder Folgekosten geltend gemacht, müssen die entsprechenden Rechnungen als Kopie beigefügt werden. Nachträglich eingereichte Kostenansprüche, die nach unserer Diagnose oder Ergebnismitteilung eingehen, können nicht mehr anerkannt werden.

Rücksendung von Reklamationsteilen

Senden Sie Reklamationsteile nur dann zurück, wenn diese explizit von Motorservice zurückgefordert werden. Ob und welche Teile zurückgesendet werden müssen, teilen wir Ihnen nach Eingang der Reklamationsmeldung mit. Produkte, die aus mehreren Teilen bestehen, müssen stets in dem Umfang zurückgesandt werden, wie diese bezogen wurden. Wir behalten uns vor, Teile die ebenfalls beschädigt wurden bzw. zur Schadensentstehung beigetragen haben, anzufordern oder nachzufordern, auch wenn diese nicht zum Lieferprogramm von Motorservice gehören.

Reklamationsteile sind für Motorservice kostenfrei einzusenden. Wenn in einer Lieferung Teile von unterschiedlichen Reklamationen enthalten sind, müssen diese jeweils separat verpackt und gekennzeichnet werden. Teile aus Reklamationen die über das Online Reklamationsmanagement eingereicht werden, müssen für den Rückversand mit dem von der Webanwendung bereit gestellten Rücksendetikett versehen werden. Bereits benutzte Teile müssen frei von Öl und sonstigen Verunreinigungen sein. Der Handelspartner muss sicherstellen, dass die Teile ordnungsgemäß verpackt sind und beim Transport nicht beschädigt werden können. Die Teile sind zweckmäßig in einer Originalverpackung unter Einhaltung größtmöglicher Sorgfalt einzusenden. Der Rücktransport erfolgt auf Risiko und Gefahr des Handelspartners. Bei einem Teilerückversand außerhalb der europäischen Union sind die zolltechnischen Bestimmungen (z. B. Mitsendung einer Proformarechnung, Mitteilung der ursprünglichen Handelsrechnungsnummer, Teiledeklaration) in jedem Fall einzuhalten.

Adressen für den Teilerückversand :

PIERBURG Schadensteile:
MS Motorservice International GmbH
Hamburger Straße 15
41540 Dormagen, Germany

Alle Neuteilreklamationen und alle sonstigen Schadensteile
MS Motorservice International GmbH
Wilhelm-Maybach-Straße 14-18
74196 Neuenstadt, Germany

Zerstörende Bauteilprüfungen

Im Rahmen der Reklamationsbearbeitung kann es nötig sein, Teile oder Baugruppen für eine Diagnose oder Werkstoffprüfung zu zerlegen oder einer zerstörenden Prüfung zu unterziehen. Sofern Sie sich bei der Einreichung der Reklamation schriftlich einverstanden erklärt haben, übernehmen wir für die bei der Analyse entstandenen Beschädigungen keine Haftung.

Sonstiges

Teile sind nur dann reklamationstauglich, wenn diese bestimmungsgemäß eingesetzt bzw. verwendet wurden. Modifizierte Teile, bereits zerlegte Komponenten und Teile, an denen Reparaturversuche unternommen wurden, sind nicht reklamationstauglich. Teile aus abgelehnten Reklamationen werden verschrottet, sofern diese nicht explizit zurückgefordert werden. Im Rahmen der Gewährleistung erstattete Teile gehen in das Eigentum von Motorservice über. Aus organisatorischen Gründen kann die Reklamationsabwicklung ausschließlich in den Sprachen Deutsch oder Englisch erfolgen.

Reklamationsformular

Adressangaben:

Ihre Schadensnummer (nicht Artikelnummer):

Motorservice Kundennummer:

Teilebezeichnung*:

Firmenname und Adresse*:

Artikelnummer*:

Anzahl Reklamationsteile*:

Kaufdatum*:

Rechnungsnummer:

Name Ihres Kunden (Werkstatt, Motoreninstandsetzer):

Neuteilerekklamation (nur ausfüllen bei unbenutzten Teilen):

 Beschädigung

 Produktfehler

 Einbauproblem

 Verpackungsfehler

 Transportschaden

 Falsche Spezifikation

 Korrosion/Schmutz

 Sonstiges

Schadensfall (nur ausfüllen, wenn die Teile im Betrieb beschädigt wurden):

Kraftstoffart*:

 Diesel

 Benzin

 Alkohol

 Gas (LPG, CNG, ...)

Applikation*:

 Straßenfahrzeug

 Industrieanwendung

 Marineanwendung

 Agrarfahrzeug

Motorenhersteller*:

Motorentyp/Motornummer*:

Schlüsselnummer (zu 2 und 3):

Baujahr/Erstzulassung*:

Teile-Einbaudatum*:

+

km-Stand/Betriebsstunden*:

Schadensdatum*:

+

km-Stand/Betriebsstunden*:

Schadensbeschreibung*: (fügen Sie ggf. eine Anlage bei, falls der Platz nicht ausreicht)

Schadensumfang/Forderung*:

 nur Teileersatz

Schadenssumme in Euro*:

 Teileersatz inklusive Reparaturkosten (bitte Reparaturrechnung beifügen)

 Bitte senden Sie die Teile im Fall einer Ablehnung wieder zurück.

 Ich bin damit einverstanden, dass die Teile im Zuge der Untersuchung bei Bedarf zerlegt, geöffnet oder einer zerstörenden Prüfung unterzogen werden werden.

Ort/Datum*:

Sachbearbeiter*:

Procedure in case of claims

Dear Motorservice Partner,

In order to ensure fast and trouble-free processing of claims, please observe the following points.

Prerequisites for claims

The Motorservice trading partner guarantees Motorservice that the prerequisites for a claim are met. The Motorservice trading partner has already verified whether the part subject to the claim is part of the Motorservice product range. Furthermore, it is to be checked and proven based on delivery notes or invoices that less than 12 months have passed since delivery of the spare part. The trade route must be adhered to.

Submitting claims

If the parts were ordered via the Motorservice OnlineShop, claims must be submitted directly via the OnlineShop. To do this, please select the "Claims" entry in the "My account" menu and enter the data in the web form provided. For all other claims, please use the following form. Please ensure that the compulsory fields required to process the claim are filled out completely. The scope of the claim (amount of loss) must always be fully specified. Furthermore, we need to be notified immediately about any resulting personal injury. If repair or follow-up costs are claimed, copies of the respective invoices must be enclosed. Claims for costs that were handed in after our diagnostics or communication of results cannot be accepted.

Returning claim parts

Claim parts should only be returned if explicitly requested by Motorservice. We will inform you whether and which parts have to be returned following receipt of your claim. Products made up of several parts must always be returned as a whole in the same scope as they were purchased. We reserve the right to request parts that were also damaged or that contributed to the damage being caused, even if they are not part of the Motorservice product range.

Claim parts must be sent in without incurring a charge for Motorservice. If a delivery includes parts relating to different claims, they must each be packaged and labelled separately. For parts from claims submitted via the online claims management, the returns label provided by the web application must be used for the return. Already used parts must be free from oil and other impurities. The trading partner must ensure that the parts are packaged properly and cannot be damaged during transport. The parts must be sent in appropriate original packaging with the greatest possible care. The items are returned at the trade partner's own risk and peril. When returning parts from outside the European Union, customs agreements (e.g. sending of a pro-forma invoice, communication of the original commercial invoice no., part declaration) must be adhered to at all times.

Destructive component testing

When processing claims, it may be necessary to dismantle parts or assembly groups for diagnostics or material inspection, or to subject them to destructive testing. If you gave your consent in writing when submitting the claim, we can accept no liability for any damage that may occur during the analysis.

Other

Parts can only be claimed if they were deployed or used for their intended purpose. Modified parts, components and parts already taken apart in the course of repair attempts cannot be claimed. Parts from rejected claims will be scrapped unless an explicit request has been made for them to be returned. Parts refunded within the scope of the warranty become the property of Motorservice. For organisational reasons, only German or English can be used when dealing with claims.

Addresses for returning parts:

PIERBURG damaged parts:

**MS Motorservice International GmbH
Hamburger Straße 15
41540 Dormagen, Germany**

All claims relating to new parts and all other damaged parts

**MS Motorservice International GmbH
Wilhelm-Maybach-Straße 14-18
74196 Neuenstadt, Germany**

Claims form

Address details:
Your claim number (not item number):

Motorservice customer number:

Part designation*:

Company name and address*:

Item number*:

Number of faulty parts*:

Date of purchase*:

Invoice number:

Name of your customer (repair shop, engine reconditioner):

 New part return (only to be completed for unused parts):
 Damage
 Product defect
 Installation problem
 Packaging fault
 Damage in transit
 Wrong specification
 Corrosion/dirt
 Other
 Event of damage (only to be completed if parts were damaged during operation):
Type of fuel*:
 Diesel
 Petrol
 Alcohol
 Gas (LPG, CNG, ...)
Application*:
 Road vehicle
 Industrial application
 Marine application
 Agricultural vehicle
Engine manufacturer*:

Engine type/engine number*:

Key number (for 2 and 3):

Model year/initial registration*:

Part date of installation*:

km status/hours of operation*:

+

Damage date*:

+

km status/hours of operation*:

Damage description*: (if required, add an attachment if not enough space is available)

Extent of damage/claim*:
 only part replacement
Total claim in Euro*:

 Part replacement incl. repair costs (please enclose repair invoice)
 In case of refusal, please return the parts.
 I agree the parts to be taken apart, opened or submitted to destructive testing within the scope of examination as required.
Place/date*:
Case handler*:

1. Geltungsbereich

1.1 Die Verkaufs- und Lieferbedingungen der MS Motorservice International GmbH (im Folgenden „Verkäufer“ genannt) gelten ausschließlich. Entgegenstehende oder von diesen Verkaufs- und Lieferbedingungen abweichende Bedingungen des Käufers werden nicht anerkannt, es sei denn, der Verkäufer hat ausdrücklich und schriftlich der Geltung abweichender Bedingungen zugestimmt. Diese Verkaufs- und Lieferbedingungen gelten auch dann, wenn der Verkäufer in Kenntnis entgegenstehender oder von den eigenen Verkaufs- und Lieferbedingungen abweichender Bedingungen des Käufers die Lieferung an den Käufer vorbehaltlos durchführt.

1.2 Von diesen Verkaufs- und Lieferbedingungen abweichende oder sie ergänzende separate Vereinbarungen zwischen den Parteien gelten vorrangig. Sie werden dort, sofern keine speziellen Regelungen getroffen sind, durch die vorliegenden Verkaufs- und Lieferbedingungen ergänzt. Für den Inhalt derartiger Vereinbarungen ist ein schriftlicher Vertrag bzw. die schriftliche Bestätigung des Verkäufers maßgebend.

1.3 Die Verkaufs- und Lieferbedingungen gelten auch für alle zukünftigen Geschäfte mit dem Käufer. Durch Bestellung des Käufers, spätestens aber durch Annahme der Ware, werden diese Verkaufs- und Lieferbedingungen vom Käufer anerkannt.

1.4 Diese Verkaufs- und Lieferbedingungen gelten nur gegenüber Unternehmern.

2. Angebot und Auftragsbestätigung

2.1 Angebote des Verkäufers sind stets unverbindlich. Ist eine Bestellung des Käufers, rechtlich als Angebot zu qualifizieren, gilt diese erst dann als angenommen, wenn sie vom Verkäufer innerhalb von vier Wochen schriftlich bestätigt wird. Spätestens kommt der Vertrag mit Versendung oder der Mitteilung über den Bereitstellungszeitpunkt der bestellten Ware, bei Teillieferung mit Absendung der ersten Lieferung, zustande.

2.2 Änderungen und sonstige Vereinbarungen sind nur dann verbindlich, wenn sie vom Verkäufer schriftlich bestätigt werden.

2.3 Die in den Angeboten enthaltenen Unterlagen, Zeichnungen, Gewichtszu- und Maßangaben, Muster etc. sind nur ungefähre Angaben und stellen keine Beschaffenheitsmerkmale dar. Der Verkäufer ist berechtigt, von den Beschreibungen im Angebot abzuweichen, sofern diese Abweichungen nicht grundlegender oder wesentlicher Art sind und der vertragsgemäße Zweck nicht wesentlich eingeschränkt wird.

2.4 Soweit Waren nach Käuferzeichnungen gefertigt werden, sind die vom Käufer erstellten und vom Verkäufer genehmigten Zeichnungen maßgeblich. Abweichungen von genehmigten Zeichnungen sind besonders zu vereinbaren und etwaige Mehrkosten hierfür sind dem Verkäufer zu vergüten.

3. Schutzrechte

3.1 Der Verkäufer behält sich an allen Abbildungen, Zeichnungen, Kalkulationen und sonstigen Unterlagen das Eigentums- und Urheberrecht vor; sie dürfen ohne vorherige schriftliche Zustimmung des Verkäufers weder für andere als die vom Verkäufer angegebenen Zwecke verwendet noch Dritten zugänglich gemacht werden. Dies gilt insbesondere für solche schriftlichen Unterlagen, die als „vertraulich“, „geheim“ oder ähnlich bezeichnet sind.

3.2 Der Verkäufer haftet nur für Ansprüche, die sich bei vertragsgemäßer Verwendung der Waren aus der Verletzung von Schutzrechten und Schutzrechtsanmeldungen (Schutzrechte) ergeben, von denen mindestens eines aus der Schutzrechtsfamilie entweder vom Europäischen Patentamt oder in einem der Staaten Bundesrepublik Deutschland, Frankreich, Großbritannien, Österreich, China, Japan oder USA veröffentlicht ist.

3.3 Erfolgen Lieferungen nach Zeichnungen oder sonstigen Angaben des Käufers und werden hierdurch Schutzrechte Dritter verletzt, stellt der Käufer den Verkäufer im Innenverhältnis von sämtlichen Ansprüchen frei.

4. Empfehlungen, Informationen und Auskünfte

Empfehlungen, Informationen und Auskünfte sind unverbindlich, soweit sie sich nicht auf die Ware selbst beziehen.

5. Preise

5.1 Alle Preise sind Nettopreise und gelten „ab Werk“ (Incoterms®2020, „EXW“) ausschließlich Verpackung, Fracht, Porto und Wertsicherung. Die gesetzliche Umsatzsteuer in der jeweils gültigen Höhe wird hinzugerechnet.

5.2 Etwaiger Mehraufwand, der durch Änderungswünsche entsteht, kann dem Käufer vom Verkäufer in Rechnung gestellt werden.

5.3 Treten nach Abschluss des Vertrages Ereignisse ein, die die Selbstkosten des Verkäufers beim Einkauf, der Herstellung und/oder dem Versand der Ware verteuern, so ist der Verkäufer zu entsprechender Preiserhöhung berechtigt.

6. Zahlungsbedingungen

6.1 Rechnungen sind innerhalb von 14 Tagen ab Rechnungsdatum ohne Abzug zur Zahlung fällig. Der Verkäufer ist, auch im Rahmen einer laufenden Geschäftsbeziehung, jederzeit berechtigt, eine Lieferung ganz oder teilweise nur gegen Vorkasse durchzuführen. Skonto gilt nur bei ausdrücklicher schriftlicher Vereinbarung.

6.2 Der Verkäufer ist berechtigt, selbst bei entgegenstehender Zweckbindung des Käufers eine Zahlung zunächst auf die jeweils älteste, nicht titulierte Schuld anzurechnen. Sind bereits Kosten oder Zinsen entstanden, ist der Verkäufer berechtigt, Zahlungen zunächst auf die Kosten, dann auf die Zinsen und zuletzt auf die Hauptleistung anzurechnen.

6.3 Das Recht zur Aufrechnung steht dem Käufer nur zu, wenn und soweit seine Gegenansprüche rechtskräftig festgestellt, unbestritten oder vom Verkäufer schriftlich anerkannt sind. Das Zurückbehaltungsrecht des Käufers ist auf Ansprüche aus dem Vertragsverhältnis beschränkt.

6.4 Der Verkäufer ist berechtigt, Verzugszinsen in Höhe des jeweils gültigen gesetzlichen Verzugszinssatzes zu verlangen. Das Recht, einen höheren Verzugschaden nachzuweisen, bleibt ausdrücklich vorbehalten.

7. Lieferung / Lieferzeit / Verzug

7.1 Lieferfristen und Liefertermine gelten nur dann als verbindlich vereinbart, wenn diese vom Verkäufer ausdrücklich schriftlich zugesagt werden. Der Verkäufer ist an den Liefertermin bzw. die Lieferfrist nicht gebunden, wenn der Käufer seinen Obliegenheiten (Zahlung von Abschlägen, Beibringung erforderlicher Unterlagen, Beistellungen zur Fertigung etc.) nicht rechtzeitig nachkommt. Die Einrede des nichterfüllten Vertrages bleibt vorbehalten.

7.2 Lieferfristen beginnen frühestens am dem Tag, an dem der Vertrag schriftlich geschlossen wurde und alle technischen Fragen geklärt sind.

7.3 Bei Änderungswünschen des Käufers ist der Verkäufer von der Einhaltung eines etwaig vereinbarten Liefertermins bzw. der Lieferfrist befreit. Die Parteien werden in diesem Fall einen neuen Liefertermin oder eine neue Lieferfrist vereinbaren.

7.4 Sofern nichts Abweichendes vereinbart wird, ist der Liefertermin bzw. die Lieferfrist eingehalten, wenn der Verkäufer die Ware an dem vereinbarten Ort bereitgestellt hat.

7.5 Wegen Lieferverzögerungen, die nicht auf Vorsatz oder grober Fahrlässigkeit des Verkäufers beruhen, kann der Käufer keine Ansprüche geltend machen. Dies gilt auch bei sonstigen Störungen, insbesondere für Lieferverzögerungen aufgrund von höherer Gewalt, Arbeitskämpfen, Unruhen, Epidemien und/oder Pandemien, Cyberattacken, behördlichen Maßnahmen, Ausbleiben von Zulieferern der Zulieferanten und sonstigen unvorhersehbaren, unabwendbaren und schwerwiegenden Ereignissen. Der vereinbarte Liefertermin bzw. die Lieferfrist verschiebt sich in diesen Fällen entsprechend der Dauer des Lieferhindernisses, der Verkäufer informiert den Käufer hierüber und wird, sofern möglich, einen neuen voraussichtlichen Liefertermin mitteilen. Der Ersatz von entgangenem Gewinn und Schäden aus Betriebsunterbrechung ist auf Vorsatz beschränkt.

7.6 Kommt der Käufer in Annahmeverzug oder verletzt er sonstige Mitwirkungspflichten, so ist der Verkäufer berechtigt, den insoweit entstandenen Schaden einschließlich etwaiger Mehraufwendungen ersetzt zu verlangen. Der Verkäufer ist darüber hinaus berechtigt, dem Käufer eine angemessene Annahmefrist zu setzen und nach deren fruchtlosem Verstreichen vom Vertrag zurückzutreten und Schadensersatz statt der Leistung zu verlangen.

7.7 Teillieferungen sind in zumutbarem Umfang zulässig. Insofern sind Ansprüche des Käufers wegen der Teillieferung oder einer verspäteten Lieferung der Restmenge ausgeschlossen.

8. Eigentumsvorbehalt

8.1 Der Verkäufer behält sich das Eigentum an sämtlichen gelieferten Waren bis zum Eingang aller Zahlungen aus der Lieferbeziehung, auch der zukünftig entstehenden Verbindlichkeiten, vor. Bei vertragswidrigem Verhalten, insbesondere bei Zahlungsverzug, ist der Verkäufer berechtigt, die Waren zurückzufordern.

8.2 Der Käufer ist verpflichtet, die gelieferten Waren pfleglich zu behandeln und während der Dauer des Eigentumsvorbehaltes auf eigene Kosten gegen jede Form des Untergangs zum Kaufpreis zu versichern. Der Verkäufer bleibt berechtigt, die Ware auf Kosten des Käufers selbst zu versichern.

8.3 Bei Pfändungen oder sonstigen Eingriffen Dritter hat der Käufer den Verkäufer unverzüglich schriftlich zu benachrichtigen, damit dieser Drittwiderspruchsklage oder andere Rechtsmittel erheben kann. Soweit der Dritte die hierdurch entstehenden gerichtlichen und außergerichtlichen Kosten nicht erstattet, haftet hierfür der Käufer.

8.4 Der Käufer ist berechtigt, die Ware im ordentlichen Geschäftsgang weiter zu verkaufen; er tritt dem Verkäufer jedoch bereits jetzt alle Forderungen in Höhe des Faktura-Endbetrages (einschließlich gesetzlicher Umsatzsteuer) der Forderung ab, die ihm aus der Weiterveräußerung gegen seine Abnehmer oder Dritte erwachsen, und zwar unabhängig davon, ob die Ware ohne oder nach Verarbeitung weiterverkauft wurde. Zur Einziehung dieser Forderung bleibt der Käufer auch nach Auslieferung berechtigt. Die Befugnis des Verkäufers, die Forderung selbst einzuziehen, bleibt davon unberührt.

8.5 Wird die gelieferte Ware mit anderen, nicht dem Verkäufer gehörenden Gegenständen untrennbar vermischt oder verbunden, so erwirbt der Verkäufer das Miteigentum an der neuen oder verbundenen Sache im Verhältnis des Wertes der gelieferten Ware (Faktura-Endbetrag, einschließlich gesetzlicher Mehrwertsteuer) zu der oder den anderen Gegenständen zum Zeitpunkt der Vermischung oder Verbindung. Der Käufer verwahrt das so entstandene Allein- oder Miteigentum für den Verkäufer.

8.6 Übersteigt der Wert der gegebenen Sicherheiten die Forderungen des Verkäufers insgesamt um mehr als 20 %, so ist der Verkäufer auf Verlangen des Käufers verpflichtet, die überschüssigen Sicherheiten nach Wahl des Verkäufers freizugeben.

8.7 Falls und soweit die maßgebliche Rechtsordnung keine Vereinbarung eines Eigentumsvorbehalts zulässt, wird der Käufer den Verkäufer bei Inanspruchnahme von Warenkredit angemessene andere Sicherheiten stellen.

9. Versand, Gefahrenübergang

9.1 Der Versand erfolgt auf Gefahr des Käufers. Die Gefahr geht stets spätestens mit Absendung der Ware, auch wenn weitere Leistungen von dem Verkäufer übernommen werden, auf den Käufer über.

9.2 Verzögert sich der Versand infolge von Umständen, die der Verkäufer nicht zu vertreten hat, so geht die Gefahr vom Tage der Anzeige der Versandbereitschaft auf den Käufer über. Auf schriftlichen Wunsch des Käufers wird die Sendung von dem Verkäufer gegen Bruch-, Transport-, Feuer- und Wasserschäden auf Kosten des Käufers versichert.

9.3 Transport- und alle sonstigen Verpackungen nach Maßgabe des Verpackungsgesetzes werden nicht zurückgenommen; ausgenommen sind Paletten. Der Käufer ist verpflichtet, die Entsorgung der Verpackung auf eigene Kosten zu besorgen.

10. Fertigungsmittel

10.1 Soweit der Käufer dem Verkäufer Fertigungsmittel (z.B. Werkzeuge, Formen) zur Verfügung stellt, sind diese dem Verkäufer kostenfrei zuzusenden. Für deren Untergang, Verschlechterung oder unvollständige Rücklieferung und daraus resultierende Schäden haftet der nur bei grober Fahrlässigkeit oder Vorsatz. Dies gilt nicht, soweit gesetzlich zwingend gehaftet wird.

10.2 Wenn Fertigungsmittel vom Verkäufer im Auftrag des Käufers angefertigt oder beschafft werden, stellt der Verkäufer dem Käufer hierfür die Kosten gesondert in Rechnung. Die Fertigungsmittel bleiben Eigentum des Verkäufers. Zur Herausgabe an den Käufer ist der Verkäufer nicht verpflichtet. Vorstehendes gilt auch für Folgewerkzeuge. Die nachfolgende Regelung in Ziffer 10.3 bleibt hiervon unberührt.

10.3 Im Falle der Amortisation der Kosten der Fertigungsmittel über den Teilepreis übernimmt der Käufer bei Nichtamortisation eines Werkzeuges die nicht gedeckten Kosten einschließlich der Kosten der sonstigen typengebundenen Einrichtungen. Kosten für Modelle gehen stets in vollem Umfang zu Lasten des Käufers.

10.4 Vom Verkäufer dem Käufer ausgehändigte Zeichnungen und Unterlagen sowie Vorschläge des Verkäufers für die Gestaltung und zur Herstellung der Ware dürfen an Dritte nicht weitergegeben und können vom Verkäufer jederzeit zurückverlangt werden.

11. Sachmängelhaftung / Haftung

11.1 Der Verkäufer haftet nicht für Schäden, die durch Verletzung von Bedienungs-, Wartungs- und Einbauvorschriften, ungeeignete, nicht bestimmungsgemäße oder unsachgemäße Verwendung, fehlerhafte oder nachlässige Behandlung, natürlicher Verschleiß, falsche Lagerung oder vom Käufer oder Dritten vorgenommene Veränderungen der Ware auftreten. Die Waren dürfen vom Käufer oder Dritten nur durch unterwiesenes Fachpersonal eingebaut werden.

11.2 Dem Verkäufer steht das Wahlrecht zwischen Nachbesserung und Neulieferung zu. Der Käufer hat dem Verkäufer die beanstandete Ware auf dessen Verlangen zu Untersuchungszwecken zu übergeben. Sofern dem Verkäufer aufgrund eines unberechtigten Mangelbeseitigungsverlangens des Käufers Kosten entstehen (insbesondere Prüf- und Transportkosten), so kann der Verkäufer Erstattung dieser Kosten verlangen.

11.3 Die zum Zwecke der Nacherfüllung erforderlichen Aufwendungen werden nicht vom Verkäufer getragen, soweit die Aufwendungen sich dadurch erhöhen, dass die Ware nach der Lieferung an einen anderen Ort als den ursprünglichen Lieferort verbracht worden ist.

11.4 Erfolgt die Inanspruchnahme des Verkäufers durch den Käufer im Wege des Rückgriffs, nachdem der Käufer selbst wegen Mängel von seinem Kunden in Anspruch genommen worden ist, so gilt für die Rechtsdurchsetzung § 445a BGB.

11.5 Ansprüche aus Sachmängelhaftung verjähren in einem Jahr ab Übergabe der Ware, es sei denn, die Sachmängelhaftungsansprüche beruhen auf einer grob fahrlässigen oder vorsätzlichen Pflichtverletzung des Verkäufers oder seines Erfüllungsgehilfen oder auf einer Verletzung von Leben, Körper oder Gesundheit. Bei Mängelgewährleistungsansprüchen, die der Käufer im Wege des Rückgriffs gem. § 445a BGB gegen den Verkäufer geltend macht, gilt uneingeschränkt die Verjährungsregelung des § 445b BGB.

11.6 Der Käufer ist verpflichtet, seiner Untersuchungspflicht nach § 377 HGB auch bei Weiterveräußerung der Ware nachzukommen.

11.7 Das Rückgriffsrecht des Käufers gegen den Verkäufer wegen solcher Ansprüche aus Sachmängelhaftung, die dem Käufer von dessen Abnehmern entgegengesetzt werden, ist ausgeschlossen, wenn der Käufer seiner Untersuchungs- und Rüfepflicht nicht nachgekommen ist oder die Ware durch Verarbeitung abgeändert wurde.

11.8 Die Haftung des Verkäufers nach den gesetzlichen Bestimmungen auf Schadensersatz ist uneingeschränkt gegeben, wenn eine dem Verkäufer zurechenbare Pflichtverletzung auf Vorsatz oder grober Fahrlässigkeit beruht. Soweit die dem Verkäufer zurechenbare Pflichtverletzung auf einfacher Fahrlässigkeit beruht und eine wesentliche Vertragspflicht schuldhaft verletzt ist, ist die Schadensersatzhaftung auf den vorhersehbaren Schaden beschränkt, der typischerweise in vergleichbaren Fällen eintritt. Im Übrigen ist die Haftung ausgeschlossen.

11.9 Der Ersatz von entgangenem Gewinn und Schäden aus Betriebsunterbrechung ist auf Vorsatz und grobe Fahrlässigkeit beschränkt.

11.10 Die Haftung nach den Bestimmungen des Produkthaftungsgesetzes oder vergleichbarer, unabdingbarer Rechte auch ausländischer Rechtsordnungen bleibt unberührt. Unberührt bleibt auch die Haftung wegen Verletzung von Leben, Körper und Gesundheit.

11.11 Soweit eine Haftung nach Tatbeständen der Ziffer 11.9 begründet wird, ist die Haftung des Verkäufers bei ausländischen Rechtsordnungen im Verhältnis zum Käufer insoweit beschränkt, als es nach dem jeweiligen ausländischen Recht zulässig wäre.

11.12 Soweit die Schadensersatzhaftung des Verkäufers ausgeschlossen oder eingeschränkt ist, gilt dies auch im Hinblick auf die persönliche Schadensersatzhaftung der Mitarbeiter, Vertreter und Erfüllungsgehilfen des Verkäufers.

12. Abtretungsverbot

12.1 Sämtliche Ansprüche des Käufers gegen den Verkäufer sind nicht abtretbar.

12.2 Der Verkäufer ist jederzeit auch ohne Zustimmung des Käufers dazu berechtigt, insbesondere mit ihm verbundene Unternehmen (im Sinne von § 15 AktG) als Erfüllungsgehilfen bei der Angebotserstellung und Vertragsabwicklung einzubinden.

13. Produkthaftung / Hinweispflichten

13.1 Der Käufer darf die Ware nur bestimmungsgemäß verwenden und muss dafür sorgen, dass diese Ware nur an mit den Produktgefahren und -risiken vertraute Personen weiterveräußert wird.

13.2 Der Käufer ist verpflichtet, bei Verwendung der Ware als Grundstoff und Teilprodukt von eigenen Produkten beim Inverkehrbringen des Endprodukts seiner Pflicht auch im Hinblick auf die von dem Verkäufer gelieferte Ware nachzukommen. Im Innenverhältnis stellt der Käufer den Verkäufer von der Geltendmachung von Ansprüchen bei Verletzung dieser Obliegenheit auf erstes Anfordern frei.

14. Geheimhaltung

Der Käufer muss alle geschäftlichen und technischen Informationen, die er vom Verkäufer erhalten hat, Dritten gegenüber wie Geschäfts- und Betriebsgeheimnisse behandeln, soweit diese nicht allgemein bekannt sind. Derartige Informationen dürfen ausschließlich zum vertragsgemäßen Zweck an Dritte, die über eine entsprechende Geheimhaltungsvereinbarung eingebunden sind, weitergegeben werden.

15. Datenschutz

Der Verkäufer erhebt, verarbeitet und nutzt personenbezogene Daten des Käufers nur unter Einhaltung der einschlägigen Datenschutzbestimmungen. Dementsprechend werden personenbezogene Daten des Käufers nur bei Vorliegen einer gesetzlichen Erlaubnis oder Vorliegen einer Einwilligung verwendet.

16. Sonstiges

16.1 Erfüllungsort ist der Ort des jeweiligen Verkäuferwerkes.

16.2 Gerichtsstand für sämtliche Streitigkeiten aus dem Vertrag ist Heilbronn. Der Verkäufer ist jedoch berechtigt, den Käufer auch an dessen allgemeinen Gerichtsstand zu verklagen.

16.3 Für die Abwicklung von Verträgen auf Grundlage dieser Verkaufs- und Lieferbedingungen gilt ausschließlich deutsches Recht unter Ausschluss des Kollisionsrechts und des UN-Kaufrechts (CISG).

16.4 Die Parteien sind verpflichtet, im Rahmen der Durchführung der Vertragsbeziehung sämtliche geltenden gesetzlichen Bestimmungen einzuhalten.

16.5 Soweit eine oder mehrere der vorstehenden Bestimmungen ganz oder teilweise unwirksam sein sollte, so bleibt die Gültigkeit der übrigen Bestimmungen hiervon unberührt. Die ungültige Bestimmung ist dann durch eine gesetzlich zulässige Bestimmung zu ersetzen, mit der Sinn und Zweck dieser Verkaufs- und Lieferbedingungen in möglichst gleicher Weise erreicht werden.

1. Scope of Application

- 1.1** The Terms and Conditions of Sale and Delivery of MS Motorservice International GmbH (hereinafter referred to as the "Seller") shall apply exclusively. Opposing terms of the Buyer or terms that deviate from these Terms and Conditions of Sale and Delivery shall not apply unless the Seller has expressly agreed to the validity of deviating terms in writing. These Terms and Conditions of Sale and Delivery shall also apply if the Seller effects delivery to the Buyer without reservation in full knowledge of opposing terms of the Buyer or terms that deviate from its own Terms and Conditions of Sale and Delivery.
- 1.2** Separate agreements between the parties deviating from or supplementing these Terms and Conditions of Sale and Delivery shall take precedence. They shall be supplemented by these Terms and Conditions of Sale and Delivery unless special provisions have been agreed. The content of such agreements is contingent on a written contract or the written confirmation of the Seller.
- 1.3** The Terms and Conditions of Sale and Delivery shall also apply to future business transactions with the Buyer. By placing a purchase order and at the latest upon acceptance of the goods, the Buyer accepts these Terms and Conditions of Sale and Delivery.
- 1.4** These Terms and Conditions of Sale and Delivery shall only apply in B2B relationships.

2. Offer and Order Confirmation

- 2.1** Offers by the Seller shall in all cases be non-binding. If a purchase order from the Buyer legally qualifies as an offer, it shall only be accepted once it has been confirmed in writing by the Seller within four weeks. The contract shall come into effect at the latest once the ordered goods have been dispatched or their delivery time has been communicated, and in case of partial delivery, once the first delivery has been dispatched.
- 2.2** Modifications and other agreements shall only be binding once they have been confirmed by the Seller in writing.
- 2.3** The documents, drawings, details relating to weight and dimensions, samples etc. contained in the offers are only approximate specifications and shall not constitute guaranteed qualities. The Seller shall be entitled to deviate from the descriptions in the offer to the extent that these deviations are not of a fundamental or significant nature and the purpose according to the contract is not substantially restricted.
- 2.4** Insofar as goods are manufactured according to Buyer's drawings, the drawings created by the Buyer and approved by the Seller shall be decisive. Deviations from approved drawings must be separately agreed and any additional costs in this regard shall be reimbursed to the Seller.

3. Industrial Property Rights

- 3.1** The Seller shall reserve industrial property rights and copyright to all illustrations, drawings, calculations, and other documents; these items may neither be used for purposes other than those stipulated by the Seller, nor made accessible to third parties without the prior written consent of the Seller. This shall apply in particular to written documents that are designated as "confidential", "secret" or similar.
- 3.2** The Seller shall only be liable for claims relating to violations of industrial property rights and applications for industrial property rights resulting from contractual use of the goods, if at least one property right from the family of industrial property rights has been published by the European Patents Office or in one of the following states: Federal Republic of Germany, France, United Kingdom, Austria, China, Japan or the USA.
- 3.3** Where deliveries are effected according to drawings or other specifications from the Buyer and where third-party property rights are breached as a result of this, the Buyer shall indemnify the Seller against any claims internally.

4. Recommendations and Information

Recommendations and information shall be non-binding insofar as they do not refer to the goods themselves.

5. Prices

- 5.1** All prices are net prices and shall be quoted ex works (Incoterms® 2020, "EXW") excluding packaging, freight, postage and insurance. Statutory VAT shall be added at the current applicable rate.
- 5.2** Any additional costs incurred as a result of modification requests may be charged to the Buyer by the Seller.
- 5.3** Where events occur after conclusion of the contract that result in increased costs for the Seller in terms of primary purchasing costs, manufacture and/or shipment of the goods, the Seller shall be entitled to increase its prices accordingly.

6. Conditions of Payment

- 6.1** Invoices shall be due for payment within 14 days of the invoice date without any deductions. Even as part of an active business relationship, the Seller is entitled, at any time, to only carry out a delivery, either fully or in part, in exchange for payment in advance. Discounts shall only apply where expressly agreed in writing.
- 6.2** The Seller shall be entitled to offset a payment against the oldest, not specifically titled debt, even where the Buyer has earmarked the payment for a different purpose. Where costs or interest have already been incurred, the Seller shall be entitled to offset payments, in the first instance, against the costs, then against the interest, and finally against the principal debt.
- 6.3** The Buyer shall only have the right to offset insofar as its counterclaims are legally binding, are uncontested or have been acknowledged in writing by the Seller. The right of retention on the part of the Buyer shall be limited to claims arising from the contractual relationship.
- 6.4** The Seller is entitled to charge default interest at the applicable statutory default interest rate. The right to prove a higher default damage shall be expressly reserved.

7. Delivery / Delivery Time / Delay

- 7.1** Delivery periods and delivery dates shall only be deemed to have been agreed with binding effect where these are expressly confirmed in writing by the Seller. The Seller shall not be bound to the delivery date or delivery period where the Buyer does not meet its obligations in due time (to make anticipated payments, to provide required documents, to supply materials for manufacture etc.). The plea for non-fulfilment of the contract shall remain reserved.
- 7.2** Delivery periods begin at the earliest on the day of written conclusion of the contract and once all technical issues have been clarified.
- 7.3** In the event of change requests from the Buyer, the Seller shall be exempt from compliance with any agreed delivery date or delivery period. In such cases, the parties shall agree a new delivery date or a new delivery period.
- 7.4** Unless otherwise agreed, the delivery date or delivery period shall be deemed to have been adhered to when the Seller has made the goods available at the location agreed.
- 7.5** The Buyer may not assert claims due to delivery delays that do not result from intent or gross negligence on the part of the Seller. In particular, including with regard to other disruptions, this shall apply to delivery delays caused by force majeure, labour disputes, unrest, epidemics and/or pandemics, cyber-attacks, official measures, failure to deliver by suppliers and any other unforeseeable, unavoidable and serious events. In such cases, the agreed delivery date or delivery period shall be extended according to the duration of the delivery impediment. The Seller shall notify the Buyer of this and, where possible, specify a new expected delivery date. Compensation for loss of profit and stop of production shall be limited to intent.
- 7.6** Where the Buyer delays acceptance or violates any other obligation to cooperate, the Seller shall be entitled to demand compensation for damage suffered in this respect, including any additional costs. Furthermore, the Seller shall have the right to set an appropriate acceptance period for the Buyer and to withdraw from the contract where this period has expired to no avail, and to demand compensation for damage instead of the performance.
- 7.7** Partial deliveries shall be permitted to a reasonable extent. In this regard, claims made by the Buyer due to partial delivery or delayed delivery of the remaining goods shall be excluded.

8. Retention of Title

- 8.1** The Seller shall reserve title of all goods delivered until all payments pertaining to the supplier relationship, including any dues as shall arise in the future, have been effected in full. In the event of conduct contrary to contract, in particular as regards payment default, the Seller shall be entitled to claim back the goods.
- 8.2** The Buyer shall be obliged to handle the delivered goods with care and to insure them at their purchase price against any kind of loss at its own expense during the period of retention of title. The Seller shall remain entitled to insure the goods itself at the expense of the Buyer.
- 8.3** In case of pledge or other third-party intervention, the Buyer shall immediately notify the Seller in writing so that the latter can initiate a third-party action or other legal remedies. Where the third party fails to reimburse the legal and extrajudicial costs arising from this, the Buyer shall be liable for such costs.
- 8.4** The Buyer shall be entitled to sell on the goods in the ordinary course of business; it hereby, however, assigns to the Seller all receivables arising from the resale to its customers or third parties to the value of the final invoice amount (including statutory VAT) of the receivables, irrespective of whether the goods were sold without or following further processing. The Buyer shall remain entitled to collect these receivables even after delivery. The Buyer's right to collect the receivables itself shall remain unaffected by this.

8.5 Where the goods delivered are inseparably mixed or combined with other items not belonging to the Seller, the Seller shall acquire joint ownership of the new or combined product in proportion to the value of the goods delivered (final invoice amount, including statutory VAT) in relation to the value of the other items at the time of combination or mixing. The Buyer shall safeguard the resulting sole ownership or joint ownership on behalf of the Seller.

8.6 Where the value of the securities granted exceeds the claims of the Seller by more than a total of 20%, the Seller shall be obliged to release the excess securities upon request of the Buyer, at the Seller's option.

8.7 If and to the extent that an agreement on the retention of title is not permitted under the relevant legal system, the Buyer shall provide the Seller with alternative appropriate securities on taking advantage of credit on goods.

9. Shipment, Transfer of Risk

- 9.1** Shipment shall be carried out at the risk of the Buyer. The risk shall transfer to the Buyer when the goods are dispatched at the very latest, even if the Seller has other services to perform.
- 9.2** Where shipment is delayed due to circumstances beyond the Seller's control, the risk shall pass to the Buyer from the day of notification of readiness for shipment. Upon written request of the Buyer and at the Buyer's expense, the Seller shall insure the shipment against breakage, damage in transit, as well as fire and water damage.
- 9.3** In accordance with the Packaging Act (Verpackungsgesetz), transport packaging and any other packaging shall not be taken back, with the exception of pallets. The Buyer shall be obliged to dispose of the packaging at its own expense.

10 Manufacturing Equipment

- 10.1** Insofar as the Buyer provides manufacturing equipment (e.g. tools, templates) to the Seller, these shall be sent to the Seller at no charge. The Seller can only be held liable for their loss, deterioration or incomplete return, including damage resulting from this, in cases of gross negligence or intent. This shall not apply in cases of legally mandatory liability.
- 10.2** Where manufacturing equipment is produced or procured by the Seller at the Buyer's request, the Seller shall invoice the Buyer for the costs for such equipment separately. The manufacturing equipment shall remain the property of the Seller. The Seller shall not be obliged to hand over said equipment to the Buyer. The above shall also apply in respect of follow-on tools. The following provision in Item 10.3 shall remain unaffected by this.
- 10.3** In the event of amortization of costs for the manufacturing equipment in excess of the part cost, the Buyer shall assume the costs not covered in case of non-amortization of a tool, including the costs for other type-specific equipment. Costs for models shall in all cases be for the account of the Buyer.
- 10.4** Drawings and documents provided to the Buyer by the Seller, as well as recommendations by the Seller in respect of design and production of the goods, may not be forwarded to third parties and can be claimed back by the Seller at any time.

11. Liability for Defects / Liability

- 11.1** The Seller shall not be liable for any damage caused by non-compliance with operating, maintenance and fitting instructions, inappropriate or improper use, faulty or negligent handling, natural wear and tear, incorrect storage or modification of the goods by the Buyer or third parties. Installation of the goods by the Buyer or a third party may only be carried out by trained and qualified personnel.
- 11.2** The Seller shall have the right to decide whether to remedy a defect or provide new goods. At the request of the Seller, the Buyer must hand the goods in question over to the Seller for examination. If the Seller incurs costs as a result of an unjustified request by the Buyer for the rectification of a defect (especially examination and transport costs), the Seller can demand compensation for these costs.
- 11.3** Expenses required for purposes of cure shall not be borne by the Seller in the event of increased expenses as a result of subsequent relocation of the goods to a location other than that of the original place of delivery.
- 11.4** If the Seller is sued by the Buyer by way of recourse after the Buyer itself has been sued by its customer due to defects, § 445a BGB (Bürgerliches Gesetzbuch - German Civil Code) shall apply to the enforcement of rights.
- 11.5** Claims based on liability for defects shall expire one year after handover of the goods unless the warranty claims are based on grossly negligent or wilful breach of obligation on the part of the Seller or one of its vicarious agents or on injury to life, limb, or health. Warranty claims for defects brought against the Seller by the Buyer by way of recourse in accordance with § 445a BGB are subject, without restriction, to the limitation period set out in § 445b BGB.
- 11.6** The Buyer shall also undertake to fulfil its obligation of examination pursuant to § 377 HGB (Handelsgesetzbuch - German Commercial Code) in the case of resale of the goods.
- 11.7** The Buyer's right of recourse against the Seller as a result of such claims based on liability for material defects made against the Buyer by its customers shall be excluded if the same has not fulfilled its obligation of examination and notification or if the goods have been modified by means of processing.
- 11.8** The Seller's liability for compensation according to statutory provisions shall apply without limitation if the same is responsible for breach of obligation based on intent or gross negligence. Insofar as a breach of obligation based on ordinary negligence is attributable to the Seller and an essential contractual obligation has been culpably violated, compensation for damages shall be limited to the amount of foreseeable damage that typically occurs in comparable cases. In all other cases, liability shall be excluded.
- 11.9** Compensation for loss of profit and damage resulting from business interruptions shall be limited to intent and gross negligence.
- 11.10** Liability according to the provisions of the Product Liability Law or similar, non-derogable rights of foreign jurisdiction shall remain unaffected. Liability resulting from injury to life, limb, and health shall also remain unaffected.
- 11.11** Insofar as liability arises according to the facts in Item 11.9, the liability of the Seller in case of foreign jurisdiction shall be limited in relation to the Buyer to the extent permissible according to the relevant foreign law.
- 11.12** Where the Seller's liability for compensation is excluded or limited, this shall also apply with regard to personal liability for compensation on the part of the Seller's employees, representatives, or vicarious agents.

12. Non-assignment Clause

- 12.1** All claims by the Buyer against the Seller shall be non-assignable.
- 12.2** The Seller is entitled at all times, even without the consent of the Buyer, to involve affiliated companies (in the sense of § 15 AktG (Aktengesetz - German Stock Corporation Act)) in particular in the generation of quotations and execution of contracts as vicarious agents.

13. Product Liability / Notification Obligation

- 13.1** The Buyer shall only use the goods according to their purpose and shall ensure that these goods are only resold to persons familiar with the hazards and risks associated with the goods.
- 13.2** The Buyer shall also undertake to fulfil its obligation to issue warnings in respect to the goods delivered by the Seller where the former uses these goods as base material or components for its own products when placing the final product on the market. The Buyer shall indemnify the Seller internally against assertion of claims arising from breach of this obligation upon first request.

14. Confidentiality

The Buyer shall treat as trade and company secret all business and technical information received from the Seller to the extent that this information is not public knowledge. Information of this nature may only be forwarded for the purposes of the contract to third parties who are bound by an appropriate non-disclosure agreement.

15. Data Protection

The Seller shall only collect, process and use personal data concerning the Buyer in accordance with the relevant data protection regulations. Consequently, personal data concerning the Buyer shall only be used on the basis of a legal ground or consent.

16. Other

- 16.1** The place of performance shall be the location of the relevant plant of the Seller.
- 16.2** The place of jurisdiction for all disputes arising from the contract shall be Heilbronn. The Seller shall, however, be entitled to file suit against the Buyer at its general place of jurisdiction as well.
- 16.3** Contracts based on these Terms and Conditions of Sale and Delivery shall be solely subject to German law excluding its conflict-of-laws provisions and the UN Convention on Contracts for the International Sale of Goods (CISG).
- 16.4** The parties shall be obliged to comply with all statutory provisions within the framework of the contractual relationship.
- 16.5** Should one or several of the above provisions be ineffective in whole or in part, the validity of the remaining provisions shall remain unaffected by this. The invalid provision shall in that case be replaced by a legally valid provision that most closely approximates the meaning and purpose of these Terms and Conditions of Sale and Delivery.

1. Domaine de validité

1.1 Les conditions générales de vente et de livraison de la société MS Motorservice International GmbH (ci-après dénommée le « Vendeur ») s'appliquent à l'exclusion de toutes autres. Aucune condition de l'Acheteur, contraire aux présentes conditions de vente et de livraison ou différentes, n'est admise, excepté si le Vendeur a donné son accord exprès et écrit à l'application de conditions différentes. Les présentes conditions de vente et de livraison s'appliquent également si le Vendeur, en connaissance de conditions de l'Acheteur contraires ou différentes des siennes propres, effectue sans réserve la livraison à l'Acheteur.

1.2 Toute convention distincte passée entre les parties et différente des présentes conditions de vente et de livraison ou les complétant, s'applique en priorité. Sauf réglementation spécifique applicable, les présentes conditions de vente et de livraison complètent lesdites conventions. Le contenu de ces dernières est déterminé par un contrat écrit ou une attestation écrite du Vendeur.

1.3 Les présentes conditions de vente et de livraison sont de même applicables à toutes les opérations commerciales futures avec l'Acheteur. L'Acheteur accepte ces conditions de vente et de livraison en passant commande, et au plus tard en réceptionnant la marchandise.

1.4 Les présentes conditions de vente et de livraison ne s'appliquent qu'aux entreprises.

2. Offre et confirmation de commande

2.1 Les offres du Vendeur s'entendent toujours sans engagement. Une commande de l'Acheteur qui pourra être juridiquement qualifiée d'offre, n'est réputée acceptée que dès lors que le Vendeur l'a confirmée par écrit dans un délai de quatre semaines. Le contrat est conclu au plus tard lors de l'expédition ou de la communication de la date de mise à disposition de la marchandise commandée, et pour les livraisons partielles, lors de l'envoi de la première livraison.

2.2 Les modifications et autres conventions ne présentent un caractère contraignant qu'une fois confirmées par écrit par le Vendeur.

2.3 Les documents, dessins, indications de poids et de mesure, modèles, etc. figurant dans les offres ne sont que des indications approximatives ne constituant pas des caractéristiques. Le Vendeur est autorisé à apporter des variantes aux descriptifs figurant dans l'offre pourvu que celles-ci ne soient pas de nature fondamentale ou essentielle et qu'elles ne constituent pas un obstacle substantiel à l'objet du contrat.

2.4 Si les marchandises sont fabriquées d'après des dessins de l'Acheteur, les dessins faits par celui-ci et approuvés par le Vendeur font foi. Les différences apportées aux dessins approuvés doivent être convenues séparément et les coûts supplémentaires éventuels en découlant donnent lieu à une rémunération du Vendeur.

3. Droits de protection

3.1 Le Vendeur demeure titulaire des droits d'auteur et de propriété intellectuelle sur l'ensemble des illustrations, dessins, calculs et autres documents ; cette documentation ne peut être utilisée, sans autorisation préalable du Vendeur, à d'autres fins que celles spécifiées par le Vendeur, ni être communiquée à des tiers. La présente clause s'applique notamment aux documents écrits portant la mention « confidentiel » ou « secret » ou une mention similaire.

3.2 La responsabilité du Vendeur est uniquement engagée en cas de recours exercé dans le cadre de l'utilisation contractuelle des marchandises suite à une violation de droits de protection et de demandes de droits de protection (droits de protection) dont un au moins appartenant à la famille des droits de protection est publié soit par l'Office européen des brevets soit dans l'un des États suivants : Allemagne, France, Grande-Bretagne, Chine, Japon ou USA.

3.3 Dans le cas où des livraisons effectuées sur la base de dessins ou autres indications de l'Acheteur violeraient les droits de protection de tiers, l'Acheteur dégage le Vendeur de tout recours dans le cadre de leurs relations internes.

4. Recommandations, informations et renseignements

Les recommandations, informations et renseignements sont sans engagement pour autant qu'ils ne se rapportent pas à la marchandise elle-même.

5. Prix

5.1 Tous nos prix sont nets et s'entendent « départ usine » (Incoterms® 2020, « EXW »), à l'exclusion de l'emballage, des frais, du port et de la garantie de valeur. La TVA est facturée en sus au taux légal en vigueur.

5.2 Le Vendeur peut facturer à l'Acheteur les éventuels coûts supplémentaires découlant de demandes de modifications.

5.3 En cas d'événements intervenant après la conclusion du contrat qui encheriraient le prix de revient du Vendeur pour ce qui est de l'achat, la production et/ou l'expédition de la marchandise, le Vendeur se réserve le droit d'appliquer une augmentation de prix correspondante.

6. Modalités de paiement

6.1 Les factures sont payables sans déduction aucune dans les 14 jours suivant la date de facture. Le Vendeur se réserve à tout moment le droit d'exiger un paiement anticipé avant tout ou partie d'une livraison, et ce même dans le cadre d'une relation commerciale établie. Aucune remise n'est consentie en l'absence d'accord exprès par écrit.

6.2 Le Vendeur se réserve le droit, même en cas d'affectation différente de la part de l'Acheteur, d'imputer un paiement en premier lieu sur la dette en souffrance la plus ancienne. En cas de frais ou d'intérêts déjà constatés, le Vendeur pourra imputer les paiements d'abord sur les frais, puis sur les intérêts et, en dernier lieu, sur la prestation principale.

6.3 L'Acheteur ne pourra prétendre à un règlement par compensation que si et pour autant que son contre-prétentions ont un caractère exécutoire, qu'elles n'ont pas été contestées ou que le Vendeur les a reconnues par écrit. Le droit de rétention de l'Acheteur est limité aux créances découlant de la relation contractuelle.

6.4 Le Vendeur pourra exiger des intérêts de retard d'un montant correspondant au taux d'intérêt légal respectivement en vigueur. Il se réserve expressément le droit d'apporter la preuve d'un préjudice plus élevé résultant du retard.

7. Livraison / délai de livraison / retard

7.1 Les délais et dates de livraison ne sont réputés fermes que pour autant qu'ils ont été approuvés expressément par écrit par le Vendeur. Le Vendeur n'est pas tenu de respecter la date ou le délai de livraison si l'Acheteur ne remplit pas ses obligations (paiement d'acomptes, fourniture de documents nécessaires, fournitures requises pour la fabrication, etc.) dans les délais impartis. Le Vendeur se réserve le droit de faire valoir l'exception d'inexécution du contrat.

7.2 Les délais de livraison courent au plus tôt à compter de la date à laquelle le contrat est conclu par écrit et à laquelle l'ensemble des questions techniques est réglé.

7.3 Dans l'hypothèse où l'Acheteur demanderait des modifications, le Vendeur n'est plus tenu de respecter la date ou le délai de livraison éventuellement convenus. Dans ce cas, les parties conviendront d'une nouvelle date ou d'un nouveau délai de livraison.

7.4 Sauf convention contraire, la date ou le délai de livraison est réputé respecté dès lors que le Vendeur met la marchandise à disposition au lieu convenu.

7.5 L'Acheteur ne peut faire valoir aucun droit en cas de retard de livraison qui ne serait causé ni intentionnellement ni du fait d'une négligence grave du Vendeur. Ceci s'applique également en cas de perturbations de toute nature, notamment lorsque les retards de livraison résultent d'un cas de force majeure, de mouvements sociaux, d'épidémies et/ou de pandémies, de cyberattaques, de mesures administratives, d'un défaut de livraison par des fournisseurs ainsi que de tout événement grave, imprévisible et inéluctable. Dans ces cas, la date ou le délai de livraison convenu est reporté d'une durée égale à celle des circonstances faisant obstacle à la livraison. Le Vendeur en informe l'Acheteur et communique, dans la mesure du possible, une nouvelle date de livraison prévue. Il ne pourra être fait droit à une demande d'indemnisation pour manque à gagner et préjudices découlant d'une interruption d'exploitation qu'en cas de faute intentionnelle.

7.6 En cas de retard de l'Acheteur pour la réception ou de manquement de sa part à toute autre obligation de coopération, le Vendeur pourra exiger l'indemnisation du préjudice, y compris des coûts supplémentaires qui en résulteraient. Le Vendeur a en outre le droit de fixer à l'Acheteur un délai de réception raisonnable et, après expiration infructueuse de ce délai, de résilier le contrat et d'exiger une indemnisation en lieu et place de la prestation.

7.7 Les livraisons partielles sont autorisées dans une mesure raisonnable. Il s'ensuit que tout recours de la part l'Acheteur en cas de livraison partielle ou de retard de livraison des quantités restantes est exclu.

8. Réserve de propriété

8.1 Le Vendeur conserve la propriété de l'ensemble des marchandises livrées jusqu'à réception de l'ensemble des paiements, y compris les engagements à venir, résultant de la relation de fourniture. En cas de faute contractuelle, notamment de retard de paiement, le Vendeur se réserve le droit de réclamer la marchandise.

8.2 L'Acheteur est tenu de prendre soin de la marchandise livrée et de l'assurer à ses frais, pour son prix d'achat, contre toute forme de disparition pendant la durée de la réserve de propriété. Le Vendeur conserve le droit d'assurer lui-même la marchandise aux frais de l'Acheteur.

8.3 En cas de saisie ou autres interventions de tiers, l'Acheteur est tenu d'informer le Vendeur sans délai et par écrit, afin que ce dernier puisse faire valoir sa tierce opposition ou user d'autres voies de droit. Si le tiers ne rembourse pas les coûts judiciaires et extra judiciaires qui en résultent, la responsabilité de l'Acheteur est alors engagée.

8.4 L'Acheteur est autorisé à revendre la marchandise dans le cadre d'opérations commerciales régulières ; il cède toutefois d'ores et déjà au Vendeur l'ensemble des créances, résultant de la revente de la marchandise en question à ses clients ou à des tiers à hauteur du montant final de la facture (y compris la TVA applicable), et ce indépendamment du fait que la marchandise ait été revendue sans ou après transformation. L'Acheteur est autorisé à recouvrer cette créance même après la livraison. La faculté du Vendeur de recouvrer lui-même ladite créance n'en est pas affectée.

8.5 Si la marchandise livrée est mélangée ou alliée de manière indissociable à d'autres objets n'appartenant pas au Vendeur, ce dernier acquiert de ce fait une copropriété sur la chose nouvelle ou alliée au prorata de la valeur initiale de la marchandise livrée (montant final de la facture, TVA applicable comprise) par rapport à celle-ci ou aux autres éléments au moment du mélange ou de l'alliage. L'Acheteur sera le dépositaire pour le Vendeur de la propriété exclusive ou de la copropriété ainsi engendrée.

8.6 Si la valeur des sûretés qui ont été consenties excède les créances du Vendeur de plus de vingt pour cent (20 %), celui-ci s'engage à libérer les sûretés excédentaires selon son choix, sur demande de l'Acheteur.

8.7 Dans l'hypothèse où le système juridique en vigueur n'autoriserait pas de clause contractuelle de réserve de propriété, l'Acheteur faisant usage d'un crédit commercial s'engage à fournir au Vendeur d'autres garanties appropriées.

9. Expédition, transfert de risque

9.1 L'expédition s'effectue au risque de l'Acheteur. Le risque est toujours transféré à l'Acheteur au plus tard lors de l'envoi de la marchandise, même lorsque d'autres prestations sont acceptées par le Vendeur.

9.2 Si l'expédition subit un retard suite à des circonstances qui ne sont pas imputables au Vendeur, le risque est transféré à l'Acheteur à la date de l'avis d'expédition. Sur demande écrite de l'Acheteur, le Vendeur assurera l'envoi, aux frais de l'Acheteur, contre le bris, les dommages dus au transport, au feu et à l'eau.

9.3 Les emballages de transport et autres ne sont pas repris conformément à la législation sur les emballages, à l'exception des palettes. L'Acheteur est tenu de procéder à ses propres frais à l'élimination des emballages.

10. Moyens de fabrication

10.1 Dès lors que l'Acheteur met à la disposition du Vendeur des moyens de fabrication (p. ex. outillage/outils, moules), ces derniers doivent être envoyés gratuitement au Vendeur. La responsabilité du Vendeur ne pourra être engagée en ce qui concerne leur disparition, leur dégradation ou leur réexpédition incomplète et les dommages en résultant qu'en cas de négligence grave ou de faute intentionnelle. La présente clause ne s'applique pas si la responsabilité est obligatoire de par la loi.

10.2 Si l'Acheteur charge le Vendeur de fabriquer ou d'acheter des moyens de fabrication, les coûts afférents sont facturés à l'Acheteur séparément. Les moyens de fabrication restent la propriété du Vendeur. Celui-ci n'est pas tenu de les restituer à l'Acheteur. Il en ira de même des outillages complémentaires. La règle suivante énoncée au paragraphe 10.3 n'en est pas affectée.

10.3 En cas d'amortissement des coûts des moyens de fabrication supérieur au prix des pièces, l'Acheteur prendra à sa charge les coûts non couverts en cas de non amortissement d'un outil, y compris les coûts des divers équipements spécifiques. Les coûts des modèles sont toujours intégralement à la charge de l'Acheteur.

10.4 La transmission à des tiers des dessins (schémas) et des documents remis à l'Acheteur par le Vendeur, ainsi que les propositions de ce dernier visant à la conception et à la production de la marchandise, n'est pas autorisée ; le Vendeur peut à tout moment en exiger la restitution.

11. Responsabilité pour défaut de qualité / responsabilité

11.1 Le Vendeur décline toute responsabilité pour les dommages résultant d'un manquement aux consignes de manœuvre, de maintenance et de montage, de l'usage inapproprié ou non conforme ou incorrect de la marchandise, d'un traitement impropre ou négligent, de l'usure naturelle, d'un stockage inapproprié ou encore de modifications opérées sur la marchandise par l'Acheteur ou par des tiers. Le montage des marchandises par l'Acheteur ou par des tiers ne doit être effectué que par du personnel qualifié et compétent.

11.2 Le Vendeur a le choix entre réparations et remplacement. Sur demande, l'Acheteur est tenu de remettre au Vendeur la marchandise faisant l'objet de la réclamation à des fins de vérification. Dans le cas où une demande d'élimination de défaut injustifiée émise par l'Acheteur engendre des coûts pour le Vendeur (en particulier des frais de contrôle et de transport), le Vendeur peut exiger le remboursement desdits coûts.

11.3 Le Vendeur ne prend pas à sa charge les frais nécessaires à l'élimination du défaut s'ils sont augmentés du fait que la marchandise a été transportée ultérieurement à la livraison dans un autre endroit que le lieu initial de livraison.

11.4 Si le recours de l'Acheteur prend la forme d'une demande de reprise auprès du Vendeur après que l'Acheteur a lui-même fait l'objet d'un recours pour défaut déposé par son client, l'article 445a du Code civil allemand (BGB) s'applique.

11.5 Les droits issus de la responsabilité pour vice se prescrivent par 12 mois à compter de la remise de la marchandise, excepté si les droits de garantie en raison des défauts de la chose résultent d'un manquement intentionnel ou d'une négligence grave de la part du Vendeur ou de ses agents d'exécution ou d'une atteinte à la vie, à l'intégrité physique ou à la santé. Dans les cas où l'Acheteur fait valoir ses droits à la garantie des vices à l'encontre du Vendeur à des fins de reprise dans le cadre de l'article 445a du Code civil allemand (BGB), la réglementation sur la prescription de l'article 445b du Code civil allemand s'applique sans restriction aucune.

11.6 L'Acheteur est tenu de respecter son obligation d'examen de la marchandise conformément à l'article 377 du Code civil allemand (HGB), même en cas de revente de celle-ci.

11.7 En cas de réclamation pour défauts matériels déposée contre l'Acheteur par ses propres clients, tout droit de recours de l'Acheteur à l'encontre du Vendeur est exclu si l'Acheteur n'a pas respecté son obligation d'examiner les marchandises et d'aviser le Vendeur des défauts qu'il découvre ou si la marchandise a été soumise à un processus de modification.

11.8 La responsabilité légale du Vendeur en matière d'indemnisation est limitée en cas de manquement intentionnel à ses obligations ou de négligence grave de sa part. Dans le cas où le Vendeur manquerait à ses obligations par négligence de conduite et où il serait porté atteinte de manière fautive à une obligation contractuelle majeure, le droit aux dommages et intérêts sera limité au dommage prévisible, intervenant de manière caractéristique dans des cas comparables. Toute responsabilité est exclue dans les autres cas.

11.9 Il ne pourra être fait droit à une demande d'indemnisation pour manque à gagner et préjudices découlant d'une interruption d'exploitation qu'en cas de faute intentionnelle et de négligence grave.

11.10 La responsabilité en vertu des dispositions de la loi sur la responsabilité du fait des produits ou de normes comparables et impératives de législations étrangères subsiste. Demeure également inchangée la responsabilité en cas d'atteinte à la vie, à l'intégrité du corps et à la santé.

11.11 Dans le cas d'une responsabilité fondée, découlant de faits mentionnés au paragraphe 11.9, la responsabilité du Vendeur vis-à-vis de l'Acheteur, dans le cadre de législations étrangères, est limitée dans la même mesure qu'elle le serait par la législation étrangère en question.

11.12 Toute exclusion ou limitation de la responsabilité du Vendeur en matière d'indemnisation s'applique également à la responsabilité personnelle des employés, représentants et agents d'exécution du Vendeur.

12. Interdiction de cession

12.1 Tous les droits de l'Acheteur à l'encontre du Vendeur sont incessibles.

12.2 Le Vendeur se réserve le droit, à tout moment et sans l'accord de l'Acheteur, d'engager des entreprises, notamment celles qui lui sont liées (au sens de l'article 15 de la loi allemande sur les sociétés anonymes « Aktiengesetz ») en qualité d'agents d'exécution aux fins de l'élaboration des offres et de l'exécution du contrat.

13. Responsabilité du fait des produits défectueux / obligations d'information

13.1 L'Acheteur ne devra utiliser la marchandise que de manière conforme à sa destination et devra veiller à ce qu'elle ne soit revendue qu'à des personnes au fait des dangers et risques du produit.

13.2 Si l'Acheteur utilise le produit comme matériau de base ou comme sous-produit de ses propres produits, il est tenu, lors de la mise en circulation du produit final, de respecter son obligation d'avertissement, relative également à la marchandise qui lui a été fournie par le Vendeur. Dans le cadre de leurs relations internes, l'Acheteur libérera le Vendeur, à sa première demande, de tout recours exercé contre ce dernier pour manquement à ces obligations.

14. Confidentialité

Vis-à-vis des tiers, l'Acheteur est tenu de garder le secret en matière commerciale et industrielle sur toutes les informations commerciales et techniques qu'il a reçues de la part du Vendeur, dans la mesure où elles ne sont pas généralement connues. Les informations de cette nature ne pourront être communiquées qu'à des fins exclusivement contractuelles à des tiers liés par un accord de confidentialité approprié.

15. Protection des données

Le Vendeur collecte, traite et exploite les données à caractère personnel de l'Acheteur dans le cadre exclusif de la réglementation applicable sur la protection des données. En conséquence, l'utilisation des données à caractère personnel de l'Acheteur est soumise à autorisation légale ou au consentement de l'Acheteur.

16. Divers

16.1 Le lieu d'exécution est celui où se trouve l'usine du Vendeur concernée.

16.2 Le tribunal compétent pour tout litige découlant du contrat est Heilbronn. Toutefois, le Vendeur est autorisé à assigner l'Acheteur également devant le tribunal de droit commun compétent pour sa domiciliation.

16.3 L'exécution de contrats basée sur les présentes conditions de vente et de livraison est exclusivement régie par le droit allemand, à l'exclusion des règles de conflits de lois et de la Convention des Nations Unies sur les contrats de vente internationale de marchandises (CIVIM).

16.4 Les parties sont tenues, dans le cadre de l'exécution de la relation contractuelle, de respecter l'ensemble des dispositions légales en vigueur.

16.5 En cas d'invalidité totale ou partielle d'une ou plusieurs clauses ci-dessus, la validité des autres clauses n'en sera pas affectée. La clause invalide devra être remplacée par une clause légale s'approchant au plus près du sens et de l'objectif des présentes conditions de vente et de livraison.

1.1. Ámbito de validez

- 1.1** Se aplicarán exclusivamente las condiciones de venta y entrega de MS Motorservice International GmbH (en adelante, «vendedor»). Las condiciones contrarias o que difieran de las presentes condiciones de venta y entrega del comprador se rechazarán, salvo que el vendedor haya aceptado expresamente por escrito la validez de las condiciones divergentes. Estas condiciones de venta y entrega también se aplicarán si el vendedor realiza la entrega al comprador sin reservas teniendo conocimiento de condiciones contrarias del comprador o que diverjan de las condiciones de venta y entrega propias.
- 1.2** Tienen prioridad los acuerdos separados entre las partes que se desvíen o complementen estos términos y condiciones de venta y entrega. Salvo que se hayan dictado disposiciones especiales, se completan con las presentes condiciones de venta y entrega. Para el contenido de semejantes acuerdos es decisivo un contrato escrito o una confirmación escrita del vendedor.
- 1.3** Las condiciones de venta y entrega también se aplicarán a todas las actividades futuras con el comprador. El comprador aceptará estas condiciones de venta y entrega con la realización del pedido, no obstante, a más tardar, al aceptar la mercancía.
- 1.4** Las presentes condiciones de venta y entrega solo aplican para empresas.

2. Oferta y confirmación del pedido

- 2.1** Las ofertas del vendedor no son obligatorias. Si un pedido efectuado por el comprador se considera legalmente una oferta, solo se considerará aceptado si el vendedor lo confirma por escrito en un plazo de cuatro semanas. A más tardar, el contrato se celebrará con el envío de la mercancía pedida o cuando se notifique que la mercancía solicitada está disponible; en caso de entregas parciales, cuando se envía la primera entrega.
- 2.2** Las modificaciones y otros acuerdos solo son vinculantes cuando el vendedor los confirme por escrito.
- 2.3** Los documentos, planos, pesos y dimensiones, muestras, etcétera, contenidos en las ofertas solo contienen datos aproximados y no constituyen características garantizadas. El vendedor tiene derecho a divergir de las descripciones de la oferta en tanto dichas divergencias no sean de carácter básico o fundamental, y no limiten en lo esencial la finalidad del contrato.
- 2.4** Cuando las mercancías se producen de acuerdo con los dibujos de los compradores, los planos elaborados por el comprador y aprobados por vendedor serán determinantes. Las divergencias de los planos autorizados deben acordarse por separado y cualquier coste añadido al respecto deberá remunerarse al vendedor.

3. Derechos protegidos

- 3.1** El vendedor se reserva los derechos de propiedad y de autor con respecto a todas las ilustraciones, planos, cálculos y demás documentos y no se podrán emplear para fines diferentes de los indicados por el vendedor ni relevarse a terceros, salvo que se disponga de una autorización previa por escrito del vendedor. Esto se aplica especialmente a la documentación escrita designada como «confidencial», «secreta» o de forma similar.
- 3.2** El vendedor solo es responsable de los daños ocasionados por el uso contractualmente correcto de las mercancías derivadas de la violación de los derechos protegidos y solicitudes de los derechos protegidos (derechos protegidos), de los cuales al menos uno de la familia de los derechos protegidos figurará en la lista de la Oficina Europea de Patentes o en uno de los estados de la República Federal de Alemania, Francia, Gran Bretaña, Austria, China, Japón o los EE. UU.
- 3.3** Si las entregas se realizan basándose en planos u otra información proporcionada por el comprador y con ello se violan los derechos de propiedad de terceros, el comprador deberá indemnizar internamente al vendedor por todas las reclamaciones.

4. Recomendaciones, información y declaraciones

Las recomendaciones, la información y las declaraciones no son vinculantes, siempre que no se refieran a la mercancía misma.

5. Precios

- 5.1** Todos los precios son precios netos y se entenderán «franco fábrica» («EXW» Incoterms®2020) sin el embalaje, transporte, franqueo y garantía de valor. Se agregará el impuesto legal sobre las ventas a la tasa aplicable.
- 5.2** El vendedor podrá facturarle al comprador cualquier gasto adicional resultante de solicitudes de modificación.
- 5.3** Si, tras celebrarse el contrato, se produjeran hechos que encarecieran los gastos directos del vendedor en la compra, la fabricación y/o el envío de la mercancía, el vendedor tendrá derecho a un incremento correspondiente del precio.

6. Condiciones de pago

- 6.1** Las facturas deberán abonarse sin descuento en un plazo de 14 días a partir de la fecha de la factura. El vendedor tiene derecho en cualquier momento, incluso durante una relación comercial en curso, a realizar una entrega total o parcial solo contra pago por adelantado. Los descuentos solo se aplicarán en caso de acuerdo expreso por escrito.
- 6.2** El vendedor tendrá derecho de facturar primero el pago de una deuda más antigua no titulada, incluso con la asignación obligatoria contraria del comprador. Si ya se han generado costes o intereses, el vendedor tendrá derecho a facturar primero el pago de los costes, a continuación, el de los intereses y, por último, el de la prestación principal.
- 6.3** El derecho a compensación corresponderá al comprador solo cuando sus contraprestaciones hayan adquirido firmeza legal, sean indiscutibles o hayan sido reconocidas por escrito por el vendedor. El derecho de retención del comprador estará limitado a los derechos de la relación contractual.
- 6.4** El vendedor tendrá derecho a exigir intereses de demora por el importe del tipo de interés de demora respectivo legalmente vigente. Queda reservado expresamente el derecho a acreditar mayores daños por demora.

7. Entrega/plazo de entrega/demora

- 7.1** Los plazos y fechas de entrega solo se aplicarán si el vendedor los acepta expresamente por escrito. El vendedor no estará obligado a cumplir con la fecha o plazo de entrega si el comprador incumple sus obligaciones (pago de los adelantos, aportación de los documentos necesarios, contribuciones a la producción, etcétera) en el tiempo previsto. Queda reservada la excepción por incumplimiento del contrato.
- 7.2** Los plazos de entrega comenzarán no antes del día en que se firme el contrato y todas las cuestiones técnicas hayan quedado resueltas.
- 7.3** Si el comprador solicita modificaciones, el vendedor quedará exento de cumplir con cualquier fecha o plazo de entrega acordado. En este caso, las partes acordarán una nueva fecha o un nuevo plazo de entrega.
- 7.4** Si no se acuerda nada distinto, la fecha o el plazo de entrega se cumplirá cuando el vendedor haya puesto a disposición la mercancía en el lugar acordado.
- 7.5** El cliente no podrá presentar ninguna reclamación debido a demoras en la entrega que no se deriven de una acción dolosa o negligencia grave del vendedor. Esto se aplica también para otros inconvenientes, especialmente, a las demoras en la entrega debidas a fuerza mayor, conflictos laborales, disturbios, epidemias y/o pandemias, ataques cibernéticos, medidas oficiales, carencia de suministros por parte de proveedores, así como a otros eventos imprevisibles, inevitables y de gravedad. En estos casos, la fecha o plazo de entrega acordado se aplazará en función de la duración del impedimento para la entrega, por lo que el vendedor informará al comprador y, si es posible, facilitará una nueva fecha prevista de entrega. La indemnización por pérdida de beneficios y daños resultante de la interrupción del servicio se limitará al dolo.
- 7.6** Si el comprador incurre en demora en la aceptación o infringe otros deberes de cooperación, el vendedor tendrá derecho a exigir una indemnización por los daños causados, que incluye los posibles gastos adicionales. Asimismo, el vendedor tendrá derecho a establecer un plazo de aceptación razonable para el comprador y, después de su vencimiento sin haber resultado, a rescindir el contrato y exigir una indemnización por daños en lugar de la prestación.
- 7.7** Se permitirán las entregas parciales de manera razonable. En este sentido, quedan excluidas las reclamaciones del comprador debido a la entrega parcial o una entrega con retraso de la cantidad restante.

8. Reserva de dominio

- 8.1** El vendedor conservará la propiedad de todas las mercancías entregadas hasta la recepción de todos los pagos correspondientes a la relación de suministro y futuras obligaciones correspondientes. En caso de incumplimiento del contrato, especialmente, en caso de demora del pago, el vendedor tendrá derecho a exigir la devolución de las mercancías.
- 8.2** El comprador estará obligado a tratar las mercancías entregadas con cuidado y a asegurarlas por cuenta propia contra cualquier forma de pérdida durante el período de reserva de dominio por el precio de compra. El vendedor seguirá teniendo derecho a asegurar el mismo la mercancía a cargo del comprador.
- 8.3** El comprador deberá comunicar sin dilación alguna y por escrito al vendedor cualquier caso de embargo o demás intervenciones de terceros, de modo que éste pueda ejercitar la reclamación por tercera u otros recursos. En tanto que la parte tercera no restituya los costes judiciales y extrajudiciales generados por ello, el comprador asumirá la responsabilidad al respecto.
- 8.4** El comprador tendrá derecho a revender la mercancía en el transcurso normal de su actividad comercial. No obstante, este cederá en ese momento al vendedor la totalidad de los cobros pendientes por el importe de la suma final de la factura (incluido el impuesto sobre el valor añadido) correspondiente al crédito que haya obtenido de la reventa frente a sus clientes o terceros, independientemente de si la mercancía fue vendida sin ser procesada o después de ello. El comprador conserva el derecho de cobrar esta deuda incluso después de la entrega. El derecho del vendedor a cobrar la deuda él mismo no será afectado.

- 8.5** Si las mercancías entregadas se mezclan o combinan inseparablemente con otras mercancías que no pertenecen al vendedor, el vendedor adquirirá la copropiedad del nuevo o combinado objeto en relación al valor de la mercancía entregada (importe de la suma final de la factura legal IVA incluido) para el otro u otros objetos en el momento de la mezcla o combinación. El comprador custodiará para el vendedor la propiedad o copropiedad así surgida.
- 8.6** En el caso de que el valor de las garantías entregadas exceda del valor de los créditos del vendedor en total en más de un 20 %, el vendedor tendrá la obligación de liberar, a elección del vendedor, el exceso de las garantías a solicitud del comprador.
- 8.7** Si y en tanto que el ordenamiento jurídico determinante no permita el acuerdo de una reserva de dominio, el comprador aportará otros avales razonables al vendedor si se utilizan créditos comerciales.

9. Envío, transmisión del riesgo

- 9.1** El envío se efectuará a riesgo del comprador. El riesgo se transmitirá al comprador, a más tardar, con el envío de la mercancía, también si el vendedor se hace cargo de otras prestaciones.
- 9.2** Si la entrega se retrasa debido a circunstancias de las que el vendedor no es responsable, el riesgo pasará al comprador en el momento en que se comunica al comprador que la mercancía está lista para el envío. Previa solicitud por escrito del comprador, el vendedor asegurará el envío contra daños por rotura, transporte, fuego y agua, y el comprador se hará cargo de los costes.
- 9.3** De conformidad con la ley de embalajes, no se aceptará la devolución de embalajes de transporte y demás embalajes; a excepción de las paletas. El comprador está obligado a eliminar el embalaje por cuenta propia.

10. Elementos de producción

- 10.1** En caso de que el comprador suministre elementos de producción (tales como herramientas y/o moldes), dichos elementos deberán enviarse sin coste alguno al vendedor. El vendedor asume la responsabilidad por su pérdida, deterioro o devolución incompleta y averías resultantes solo en casos de negligencia grave o dolo. Esto no se aplica si la responsabilidad es obligatoria por ley.
- 10.2** Si el vendedor fabrica o adquiere los elementos de producción en nombre del comprador, el vendedor facturará al comprador los costos por separado. El vendedor conservará la plena propiedad de los elementos de producción, sin que exista ninguna obligación de entregarlos al comprador. Lo anterior se aplica también a los útiles secuenciales. Esto no afecta a la regulación siguiente del apartado 10.3.
- 10.3** Si los costes de los elementos de producción se amortizan mediante el precio de las piezas, si una herramienta no se amortiza, el comprador asume los costes no cubiertos, incluidos los costes de otras instalaciones específicas del tipo. Los costes de los modelos siempre corren a cargo del comprador en su totalidad.
- 10.4** Los planos y la documentación entregados al comprador por el vendedor, así como las propuestas del vendedor para diseñar y fabricar la mercancía, no podrán entregarse a terceros y el vendedor podrá exigir su devolución en cualquier momento.

11. Responsabilidad por saneamiento de defectos/responsabilidad

- 11.1** El vendedor no asume responsabilidad por los daños causados por el incumplimiento de las instrucciones para el manejo, mantenimiento y montaje, la utilización inadecuada o indebida, el uso erróneo o negligente y el desgaste natural, el almacenamiento incorrecto o por las manipulaciones realizadas por el comprador o por terceros en la mercancía. El comprador o terceros solo podrán montar las mercancías empleando a personal especializado e instruido.
- 11.2** El vendedor tendrá derecho de elegir entre la reparación o sustitución del artículo defectuoso por uno nuevo. El comprador tiene que entregarle al vendedor la mercancía en cuestión a petición de éste para fines de inspección. Si el vendedor incurre en costes (en particular, costes de inspección y transporte) debido a la solicitud injustificada del comprador de rectificar un defecto, el vendedor puede exigir el reembolso de estos costes.
- 11.3** El vendedor no se hará cargo de los costes necesarios con fines de cumplimiento posterior si estos aumentan debido a que, tras la entrega, la mercancía hubiera sido llevada a otro lugar distinto al lugar de entrega original.
- 11.4** Si el comprador reclama al vendedor mediante recurso después de que el propio comprador haya sido demandado por su cliente por defectos, se aplicará el artículo 445a del Código Civil alemán (BGB, en sus siglas en alemán).
- 11.5** Las reclamaciones relacionadas con la responsabilidad por saneamiento de defectos caducarán después de un año desde la entrega de la mercancía, salvo que las reclamaciones de responsabilidad debida a defectos materiales se fundamenten en un incumplimiento doloso o gravemente negligente del contrato por parte del vendedor o sus auxiliares ejecutivos o en lo que concierne a daños personales que afecten a la integridad física y la salud. En caso de reclamaciones de garantía por defectos que el comprador oponga al vendedor mediante recurso de conformidad con el artículo 445a del Código Civil alemán (BGB, en sus siglas en alemán), se aplicará sin restricciones el plazo de prescripción del artículo 445b del Código Civil alemán (BGB).
- 11.6** El comprador estará obligado a cumplir con la obligación de realizar inspecciones de acuerdo con la legislación alemana, art. 377 del código de comercio alemán, incluso con la reventa de la mercancía.
- 11.7** El derecho de recurso del comprador contra el vendedor en cuanto a la responsabilidad por saneamiento de defectos, al que los clientes del comprador puedan oponerse, quedará excluido cuando el comprador no cumpla con la obligación de realizar pruebas y reclamaciones o cuando la mercancía haya sido sometida a una transformación.
- 11.8** La responsabilidad del vendedor en virtud de las disposiciones legales para la responsabilidad por daños y perjuicios se cumplirá íntegramente cuando un incumplimiento imputable de una obligación del vendedor se fundamenta en dolo o negligencia grave. En la medida en que el incumplimiento imputable de la obligación del vendedor se fundamenta en una negligencia simple y se viole una obligación esencial del contrato, la responsabilidad por daños y perjuicios se limitará al daño previsible que se produce normalmente en casos similares. Por lo demás, quedará excluida la responsabilidad.
- 11.9** La indemnización por pérdida de beneficios y daños resultante de la interrupción del servicio se limita al dolo y negligencia grave.
- 11.10** Esto no afectará a la responsabilidad según las disposiciones de la ley alemana de responsabilidad relativa a los productos defectuosos o también los derechos fundamentales comparables de otras legislaciones extranjeras. Tampoco se verá afectada la responsabilidad debida a lesiones a la vida, la integridad física y la salud.
- 11.11** Si se fundamenta una responsabilidad según los hechos del apartado 11.9, la responsabilidad del vendedor frente al comprador en el caso de ordenamientos jurídicos extranjeros se limitará en la medida en que estuviera permitido por la legislación extranjera correspondiente.
- 11.12** Siempre que la responsabilidad por daños y perjuicios del vendedor se excluya o esté limitada, esto también se aplicará respecto a la responsabilidad personal por daños y perjuicios de los empleados, representantes y auxiliares ejecutivos.

12. Prohibición de cesión

- 12.1** Todas las reclamaciones del comprador frente al vendedor no serán transferibles.
- 12.2** El vendedor tiene derecho en cualquier momento, incluso sin el consentimiento del comprador, a recurrir a empresas afiliadas a él (en el sentido del artículo 15 AktG (Ley de las sociedades anónimas alemana)) como agentes auxiliares en la preparación de la oferta y la ejecución del contrato.

13. Responsabilidad relativa a los productos defectuosos/deber de advertencia

- 13.1** El comprador podrá utilizar la mercancía solo de la manera prevista y deberá asegurarse de que esta mercancía se revenda solo a las personas familiarizadas con los peligros y riesgos del producto.
- 13.2** Al usar los productos como producto primario y subproducto en propios productos, el comprador estará obligado a cumplir también con el deber de advertencia en cuanto a los productos entregados por el vendedor al comercializar el producto final. En las relaciones internas, el comprador renunciará a toda pretensión contra el vendedor en cuanto al incumplimiento de la presente obligación al primer requerimiento.

14. Obligación de confidencialidad

El comprador deberá tratar toda la información comercial y técnica que ha recibido del vendedor, en tanto esta no sea conocida con carácter general, como secreto comercial e industrial frente a terceros. Este tipo de información solo se podrá transmitir a terceras partes, que deberán comprometerse con el correspondiente acuerdo de confidencialidad, con fines contractuales.

15. Protección de datos

El vendedor recopila, procesa y utiliza los datos personales del comprador únicamente de conformidad con las normas de protección de datos pertinentes. En consecuencia, los datos personales del comprador solo se utilizarán si existe permiso o consentimiento legal.

16. Otros

- 16.1** El lugar de cumplimiento será el lugar en el que se encuentre la fábrica de venta correspondiente.
- 16.2** La jurisdicción para todos los litigios derivados del contrato será la de Heilbronn (Alemania). No obstante, el vendedor también tendrá derecho a demandar al comprador en su jurisdicción general.
- 16.3** Para la ejecución de los contratos sobre la base de las presentes condiciones de venta y entrega, se aplicará exclusivamente la ley alemana con exclusión del derecho de colisión y del derecho de adquisición de las Naciones Unidas (CISG).
- 16.4** En el contexto de la ejecución de la relación contractual, las partes están obligadas a cumplir todas las disposiciones legales aplicables.
- 16.5** Si una o varias de las disposiciones anteriores resultara total o parcialmente inválida, esto no afectará a la validez de las demás disposiciones. La disposición ineficaz deberá sustituirse por una disposición legal admisible con la que se obtengan el sentido y la finalidad de estas condiciones de venta y entrega en la medida de lo posible.

1. Ambito di validità

- 1.1** Valgono esclusivamente le Condizioni di vendita e di consegna di MS Motorservice International GmbH (di seguito denominata "Venditore"). Condizioni dell'Acquirente contrapposte o diverse dalle presenti Condizioni di vendita e di consegna non saranno riconosciute come valide a meno che il Venditore non ne abbia espressamente autorizzato per iscritto la validità. Le presenti Condizioni di vendita e di consegna sono valide anche qualora il Venditore esegua la consegna all'Acquirente senza riserve pur essendo a conoscenza di condizioni dell'Acquirente contrapposte o diverse dalle proprie Condizioni commerciali e di consegna.
- 1.2** Accordi tra le parti separati derogatori o integrativi rispetto alle presenti Condizioni di vendita e di consegna godono di priorità. In assenza di accordi specifici sono integrati dalle presenti Condizioni di vendita e di consegna. Il contenuto di tali accordi è soggetto a un contratto scritto oppure a una conferma scritta dell'Acquirente.
- 1.3** Le Condizioni di vendita e di consegna sono valide anche per tutte le operazioni commerciali future intrattenute con l'Acquirente. L'Acquirente riconosce e accetta le presenti Condizioni di vendita e di consegna inoltrando l'ordine, al più tardi con l'accettazione della merce.
- 1.4** Le presenti Condizioni di vendita e di consegna sono valide solo nei confronti di imprenditori.

2. Offerta e conferma d'ordine

- 2.1** L'offerta del Venditore sono sempre da considerarsi non vincolanti. Un ordine dell'Acquirente, classificabile come offerta in termini legali, viene considerato accettato solo nel momento in cui viene confermato per iscritto dal Venditore entro un periodo di quattro settimane. Il contratto sarà perfezionato al più tardi con l'invio o la comunicazione della data di fornitura della merce ordinata o dell'invio della prima fornitura in caso di consegne parziali.
- 2.2** Modifiche o altri accordi saranno vincolanti unicamente qualora vengano confermati per iscritto dal Venditore.
- 2.3** La documentazione, i disegni, i dati riguardanti pesi e dimensioni, i campioni ecc. contenuti nelle offerte sono informazioni approssimative e non rappresentano caratteristiche di configurazione. Il Venditore ha diritto a derogare alle descrizioni riportate nell'offerta purché dette deroghe non siano di natura fondamentale o essenziale e non limitino sostanzialmente lo scopo conforme al contratto.
- 2.4** Se le merci devono essere prodotte in base a disegni specifici dell'Acquirente, saranno determinanti i disegni approntati dall'Acquirente e approvati dal Venditore. Deroghe ai disegni approvati dovranno essere concordate separatamente e qualsiasi spesa aggiuntiva da esse derivante dovrà essere rimborsata al Venditore.

3. Diritti di protezione

- 3.1** Il Venditore si riserva i diritti di proprietà e d'autore su qualsiasi illustrazione, disegno, calcolo e altra documentazione che, quindi, non potranno essere utilizzati a scopi diversi da quelli indicati dal Venditore stesso né essere resi accessibili a terze persone senza previa autorizzazione scritta del Venditore. Ciò si applica soprattutto alla documentazione scritta definita dai termini "confidenziale", "segreta" o simili.
- 3.2** Il Venditore è unicamente responsabile di rivendicazioni derivanti, nonostante un utilizzo della merce conforme al contratto, dalla violazione di diritti di protezione e diritti di protezione depositati (diritti di protezione) di cui almeno uno appartenente alla famiglia di diritti di protezione sia stato pubblicato dall'Ufficio Brevetti Europeo o in uno degli Stati Repubblica Federale Tedesca, Francia, Gran Bretagna, Austria, Cina, Giappone o USA.
- 3.3** In caso di consegne eseguite sulla base di disegni o altri dati dell'Acquirente che ledono i diritti di protezione di terzi, nel rapporto interno l'Acquirente esonera il Venditore da qualsiasi rivendicazione.

4. Raccomandazioni, informazioni e precisazioni

Raccomandazioni, informazioni e precisazioni non sono vincolanti purché non si riferiscano alla merce stessa.

5. Prezzi

- 5.1** Tutti i prezzi si intendono al netto e sono validi "franco magazzino" (Incoterms®2020, "EXW") esclusi l'imballaggio, il trasporto, l'affrancatura e l'assicurazione del valore della merce. Ai prezzi si dovrà aggiungere l'imposta legale sul valore aggiunto di volta in volta valida.
- 5.2** Il Venditore può addebitare all'Acquirente qualsiasi eccedenza di spesa derivante da richieste di modifica.
- 5.3** In caso di eventi insorti dopo la stipula del contratto che causino l'aumento dei prezzi di costo del Venditore per l'acquisto, la produzione e/o la spedizione della merce, il Venditore avrà diritto ad aumentare i prezzi corrispondentemente.

6. Condizioni di pagamento

- 6.1** Le fatture devono essere pagate al netto entro 14 giorni dalla data della fattura. Il Venditore si riserva il diritto di effettuare, in qualsiasi momento anche nel contesto di un rapporto commerciale in corso, una consegna in toto o in parte solo dietro pagamento anticipato. Uno sconto vale unicamente previo esplicito accordo scritto.
- 6.2** Il Venditore ha diritto ad imputare un pagamento dapprima al debito più lontano non titolato, anche in caso di destinazione contrapposta allo scopo da parte dell'Acquirente. Se sono già insorti costi o interessi, il Venditore ha diritto ad imputare pagamenti dapprima ai costi, poi agli interessi e infine alla prestazione principale.
- 6.3** L'Acquirente detiene il diritto alla compensazione unicamente se e quando le sue controprese siano dichiarate aventi valore legale, incontestate o riconosciute per iscritto dal Venditore. Il diritto di ritenzione dell'Acquirente è limitato alle rivendicazioni derivanti dal rapporto contrattuale.
- 6.4** Il Venditore ha diritto ad esigere interessi di mora ad un tasso che è pari al tasso di interesse legale in vigore. Resta esplicitamente salvo il diritto a comprovare un danno di mora maggiore.

7. Consegna / periodo di consegna / ritardo

- 7.1** Le date e i periodi di consegna sono considerati vincolanti unicamente se sono stati espressamente promessi per iscritto dal Venditore. Il Venditore non è vincolato alla data o al periodo di consegna se l'Acquirente non ottempera tempestivamente ai suoi obblighi (pagamento di account, fornitura della necessaria documentazione, concessioni in comodato d'uso per fini produttivi, ecc.). Con riserva di eccezione di inadempimento.
- 7.2** I periodi di consegna hanno inizio non prima del giorno in cui è stato stipulato il contratto per iscritto e sono state chiarite tutte le questioni di carattere tecnico.
- 7.3** In caso di richieste di modifica da parte dell'Acquirente, il Venditore è esonerato dall'osservanza della data o del periodo di consegna eventualmente concordati. In questo caso, le parti dovranno concordare una nuova data o un nuovo periodo di consegna.
- 7.4** Se non diversamente concordato, la data o il periodo di consegna sono da considerarsi osservati quando il Venditore ha consegnato la merce nel luogo concordato.
- 7.5** L'Acquirente non ha diritto ad alcuna rivendicazione per ritardi della consegna che non siano dovuti a dolo o colpa grave del Venditore. Ciò si applica anche ad altri inconvenienti, soprattutto a ritardi della consegna dovuti a cause di forza maggiore, conflitti sindacali, agitazioni, epidemie e/o pandemie, attacchi informatici, provvedimenti delle autorità, mancate consegne da parte di subfornitori e altri eventi imprevedibili, inevitabili e gravi. In questi casi, la data o il periodo di consegna concordati saranno prorogati in misura corrispondente alla durata dell'ostacolo alla consegna; il Venditore informerà l'Acquirente in merito e, laddove possibile, comunicherà una nuova data di consegna prevista. Il rimborso di lucro cessante e danni derivanti dall'interruzione della produzione è limitato al dolo.
- 7.6** In caso di mora di accettazione da parte dell'Acquirente o qualora quest'ultimo violi altri obblighi di collaborazione, il Venditore avrà diritto a pretendere il rimborso del danno eventualmente insorto comprese tutte le spese supplementari. Il Venditore, inoltre, ha diritto ad imporre all'Acquirente un termine di accettazione ragionevole, scaduto il quale, senza esito, avrà diritto a recedere dal contratto nonché ad esigere il rimborso del danno invece della prestazione.
- 7.7** Forniture parziali sono ammesse in misura accettabile. Pertanto si escludono rivendicazioni dell'Acquirente per forniture parziali o forniture ritardate dell'ordinativo restante.

8. Diritto di riservato dominio

- 8.1** Il Venditore si riserva la proprietà di tutte le merci consegnate fino al percepimento di tutti i pagamenti derivanti dal rapporto di fornitura, anche degli obblighi futuri. In caso di comportamento contrario ai termini del contratto, in particolare in caso di ritardo dei pagamenti, il Venditore ha diritto a reclamare la restituzione della merce.
- 8.2** L'Acquirente è tenuto a trattare la merce consegnata con la dovuta cura e ad assicurarla a proprie spese per il valore a nuovo contro qualsiasi forma di perimento per tutta la durata del diritto di riservato dominio. Il Venditore resta autorizzato ad assicurare lui stesso la merce a spese dell'Acquirente.
- 8.3** In caso di pignoramenti o altri interventi di terze persone, l'Acquirente deve informarne immediatamente il Venditore per iscritto affinché quest'ultimo possa tentare opposizione di terzi o ricorrere ad altri mezzi legali. Se il terzo non rimborsa le spese giudiziali ed extragiudiziali da ciò derivanti, ne sarà responsabile l'Acquirente.
- 8.4** L'Acquirente ha diritto a rivendere la merce nell'andamento regolare degli affari; egli, tuttavia, cede già ora al Venditore tutti i crediti pari all'importo finale della fattura del credito (compresa l'imposta legale sul valore aggiunto) derivantigli dalla rivendita ai propri clienti o a terzi, indipendentemente da che la merce sia stata rivenduta prima o dopo una lavorazione. L'Acquirente continua ad avere diritto al recupero di questo credito anche dopo la consegna. Resta salva l'autorizzazione del Venditore a recuperare autonomamente il credito.

8.5 Se la merce consegnata viene indissolubilmente commista o unita ad altri oggetti non appartenenti al Venditore, quest'ultimo diventa comproprietario della cosa nuova o unita in rapporto del valore della merce consegnata (importo finale della fattura, compresa imposta legale sul valore aggiunto) al o agli altri oggetti al momento della commistione o dell'unione. L'Acquirente custodisce la proprietà esclusiva o la comproprietà così insorta per il Venditore.

8.6 Se il valore delle garanzie fornite supera i crediti del Venditore complessivamente di oltre il 20 % e l'Acquirente lo richiede, il Venditore sarà tenuto a svincolare le garanzie eccedenti a propria discrezione.

8.7 Se e nella misura in cui l'ordinamento giuridico determinante non ammette accordi sul diritto di riservato dominio, in caso di ricorso al credito su merci l'Acquirente fornirà al Venditore ulteriori garanzie ragionevoli.

9. Spedizione, trapasso di rischio

- 9.1** La spedizione avviene a rischio e pericolo dell'Acquirente. Il rischio passa sempre all'Acquirente anche se vengono assunte altre prestazioni dal Venditore, al più tardi con la spedizione della merce.
- 9.2** In caso di ritardi di spedizione non imputabili al Venditore, il rischio viene trasmesso all'Acquirente dal giorno in cui viene comunicata la disponibilità alla spedizione. Su richiesta scritta dell'Acquirente, il Venditore assicurerà la spedizione contro danni di rottura, di trasporto, causati da incendio e dall'acqua a spese dell'Acquirente.
- 9.3** Come previsto dalla normativa sugli imballaggi, gli imballaggi di trasporto e tutti gli altri imballaggi non saranno ripresi in consegna; fanno eccezione i pallet. L'Acquirente è tenuto a procedere a proprie spese allo smaltimento degli imballaggi.

10. Mezzi di produzione

- 10.1** Se l'Acquirente fornisce al Venditore mezzi di produzione (ad esempio attrezzi, stampi), questi dovranno essere spediti al Venditore gratuitamente. Il Venditore dovrà rispondere del loro perimento, del deterioramento o di una restituzione incompleta e dei danni che ne derivano solo in caso di colpa grave o dolo. Ciò non si applica qualora la responsabilità del Venditore sia prevista da disposizioni legali obbligatorie.
- 10.2** Se il Venditore produce o acquista mezzi di produzione su ordine dell'Acquirente, egli addebiterà all'Acquirente le spese pro quota con una fattura separata. I mezzi di produzione restano di proprietà del Venditore. Il Venditore non è tenuto a cedere detti mezzi all'Acquirente. Quanto summenzionato si applica anche alle attrezzature seguenti. Resta salva la seguente regola del punto 10.3.
- 10.3** Se è previsto l'ammortamento dei costi dei mezzi di produzione oltre il prezzo del pezzo, in caso di mancato ammortamento di un attrezzo l'Acquirente si accolla le spese scoperte, comprese le spese per ulteriori attrezzature specifiche. Le spese per i modelli sono sempre interamente a carico dell'Acquirente.
- 10.4** I disegni e la documentazione consegnati dal Venditore all'Acquirente nonché le proposte del Venditore circa il design e la produzione della merce non possono essere trasmessi a terzi e il Venditore ha diritto ad esigerne la restituzione in qualsiasi momento.

11. Garanzia per i vizi della cosa / responsabilità

- 11.1** Il Venditore non è responsabile per danni causati dall'inosservanza di istruzioni per l'uso, di manutenzione e specifiche di montaggio, utilizzo non appropriato, non secondo destinazione o non professionale, trattamento scorretto o negligente, usura naturale, scorretto stoccaggio o modifiche apportate alla merce dall'Acquirente o da terze persone. Le merci possono essere montate dall'Acquirente o da terzi esclusivamente ricorrendo a personale specializzato e addestrato.
- 11.2** Il Venditore ha diritto di scegliere tra una riparazione e una nuova consegna. L'Acquirente è tenuto a consegnare al Venditore la merce contestata qualora lo richieda a scopo di ispezione. Il Venditore potrà chiedere un risarcimento all'Acquirente per gli eventuali costi sostenuti in relazione all'eliminazione ingiustificata del difetto (in particolare costi di ispezione e trasporto).
- 11.3** Le spese necessarie all'adempimento successivo non sono a carico del Venditore se, dopo la consegna, aumentano a causa del trasporto della merce dopo la consegna in un altro luogo rispetto a quello originario.
- 11.4** Qualora l'Acquirente faccia valere il proprio diritto di regresso nei confronti del Venditore, dopo che l'Acquirente stesso è stato citato dal suo cliente per vizi, trova applicazione il § 445a del Codice Civile tedesco.
- 11.5** Le rivendicazioni derivanti dalla garanzia per i vizi della cosa cadono in prescrizione dopo un anno dal trasferimento della merce a meno che la responsabilità del danno non derivi da una prevaricazione per colpa grave o dolo del Venditore o del suo ausiliario o da delitti contro la vita, l'incolumità e la salute individuale. Qualora l'Acquirente faccia valere diritti di garanzia per vizi nei confronti del Venditore esercitando il regresso ai sensi del § 445a del Codice civile tedesco trovano applicazione, senza limitazione alcuna, le disposizioni sulla prescrizione di cui al § 445b del Codice civile tedesco.
- 11.6** L'Acquirente è tenuto ad ottemperare al proprio obbligo di controllo ai sensi del § 377 del Codice Commerciale tedesco anche in caso di rivendita della merce.
- 11.7** È escluso il diritto di regresso dell'Acquirente nei confronti del Venditore per diritti derivanti dalla garanzia per i vizi della cosa rivendicati nei confronti dell'Acquirente dai suoi clienti qualora l'Acquirente non ottemperi al suo obbligo di controllo e ricorso oppure la merce sia stata modificata tramite elaborazione successiva.
- 11.8** La responsabilità del Venditore conformemente alle disposizioni di legge riguardanti il risarcimento dei danni è illimitata se una prevaricazione imputabile al venditore è causata da dolo o colpa grave. Se la prevaricazione imputabile al Venditore è causata da semplice negligenza e sussiste la violazione colposa di un obbligo contrattuale fondamentale, la responsabilità del danno è limitata al danno prevedibile tipico che incorre in casi equiparabili. La responsabilità è esclusa nei casi restanti.
- 11.9** Il rimborso di lucro cessante e danni derivanti dall'interruzione della produzione è limitato ai casi di dolo o colpa grave.
- 11.10** Resta salva la responsabilità ai sensi delle disposizioni della legge sulla responsabilità del prodotto o leggi comparabili inalienabili di ordinamenti giuridici stranieri. Salva resta anche la responsabilità per delitti contro la vita, l'incolumità e la salute individuale.
- 11.11** In caso di responsabilità fondata ai sensi della fattispecie al punto 11.9, la responsabilità del Venditore prevista da ordinamenti giuridici stranieri in rapporto all'Acquirente è limitata all'entità che verrebbe ammessa dal rispettivo diritto straniero.
- 11.12** Se la responsabilità del danno del Venditore è esclusa o limitata, la colpa in eligendo si estende anche ai danni causati da collaboratori, rappresentanti ed ausiliari del Venditore.

12. Divieto di cessione

- 12.1** Tutti i diritti dell'Acquirente nei confronti del Venditore sono incedibili.
- 12.2** Il Venditore ha diritto a coinvolgere, in qualsiasi momento e senza il consenso dell'Acquirente, in particolare aziende correlate (ai sensi del § 15 AktG, Legge tedesca sulle società per azioni) in qualità di ausiliari per la stesura di offerte e l'evasione di contratti.

13. Responsabilità del prodotto / obblighi di avviso

- 13.1** L'Acquirente può utilizzare la merce solo secondo la sua destinazione e deve assicurarsi che detta merce venga rivenduta unicamente a persone a conoscenza dei pericoli e dei rischi connessi al prodotto.
- 13.2** Se utilizza la merce come prodotto base e parziale di prodotti propri, al momento della messa in circolazione del prodotto finale l'Acquirente è tenuto ad adempiere al proprio obbligo di avvertimento anche per quanto riguarda la merce fornita dal Venditore. Nel rapporto interno, l'Acquirente esonera il Venditore dall'esercizio di diritti in caso di violazione della suddetta obbligazione su prima richiesta.

14. Segretezza

Nei confronti di terzi, l'Acquirente è tenuto a trattare tutte le informazioni commerciali e tecniche ricevute dal Venditore come segreti commerciali e aziendali, purché non siano di dominio pubblico. Dette informazioni possono essere trasmesse a terzi, esclusivamente allo scopo previsto dal contratto, che siano vincolati da un corrispondente accordo di segretezza.

15. Tutela dei dati

Il Venditore raccoglie, tratta e utilizza i dati personali dell'Acquirente nel rispetto delle disposizioni relative alla tutela dei dati pertinenti. Pertanto i dati personali dell'Acquirente saranno utilizzati esclusivamente sulla base di una autorizzazione legale o di un consenso.

16. Altro

- 16.1** Luogo di adempimento è il luogo del corrispondente stabilimento del Venditore.
- 16.2** Foro competente per qualsiasi controversia derivante dal contratto è il Tribunale di Heilbronn. Tuttavia, il Venditore ha diritto a citare in giudizio l'Acquirente anche dinanzi al foro competente generale di quest'ultimo.
- 16.3** Per l'evasione di contratti basati sulle presenti Condizioni di vendita e di consegna si applica unicamente il Diritto tedesco con esclusione del Diritto dei conflitti di competenza e della Convenzione sulla Vendita Internazionale di Beni (CISG).
- 16.4** Le parti sono tenute ad ottemperare a tutte le disposizioni di legge vigenti nell'ambito dell'espletamento del rapporto contrattuale.
- 16.5** In caso di inefficacia totale o parziale di una o più di una delle clausole summenzionate, le restanti clausole restano tuttavia valide. La clausola invalida dovrà quindi essere sostituita da una clausola ammessa dalla legge che permetta di adempiere al senso e allo scopo delle presenti Condizioni di vendita e di consegna possibilmente nello stesso modo.

1. Сфера применения

1.1 Условия продажи и поставки MS Motorservice International GmbH (далее – «продавец») имеют исключительное действие. Противоположные или отличающиеся от настоящих условий продажи и поставки условия покупателя не признаются, за исключением случаев, когда продавец однозначно письменно признал их действительность. Настоящие условия продажи и поставки действительны и в том случае, если продавец, зная противоположные или отличающиеся от собственных условий продажи и поставки условия покупателя, осуществляет поставку для покупателя без предварительных договоренностей.

1.2 Отдельные соглашения между сторонами, отступающие от данных условий продажи и поставки, или дополняющие их, имеют преимущество. В этой части, если не выключены какие-либо специальные положения, эти соглашения дополняют настоящие условия продажи и поставки. Для вступления в силу содержания таких соглашений требуется письменный договор или письменное подтверждение продавца.

1.3 Условия продажи и поставки распространяются и на все будущие сделки с покупателем. Условия продажи и поставки признаются покупателем при размещении заказа, самое позднее – при приеме товара.

1.4 Настоящие условия продажи и поставки действуют только в отношении предпринимателей.

2. Предложение и подтверждение заказа

2.1 Предложения продавца всегда являются свободными. Если заказ покупателя квалифицируется с правовой точки зрения как предложение, он считается принятым только при его письменном подтверждении продавцом в течение четырех недель. Договор вступает в силу не позднее чем с момента отправки заказанного товара или уведомления о времени его готовности к отгрузке, при частичной поставке – с момента отправки первой партии.

2.2 Изменения и прочие соглашения являются обязательными только в случае их письменного подтверждения продавцом.

2.3 Содержащиеся в предложениях документы, чертежи, данные о весе и размерах, образцы и т. д., являются лишь приближительными данными, а не характеристиками качества. Продавец имеет право отклониться от описаний в предложениях, если такое отклонение не играет решающей или существенной роли, а цель договора при этом не будет существенно ограничена.

2.4 Если товары изготавливаются по чертежам покупателя, определяющими являются составленные покупателем и одобренные продавцом чертежи. Отклонения от уже одобренных чертежей согласовываются отдельно, а любые дополнительные расходы должны быть возмещены продавцу.

3. Патенты

3.1 Продавец сохраняет за собой право собственности и авторское право на все изображения, чертежи, расчеты и прочие документы; без предварительного письменного разрешения продавца они не могут быть использованы в целях, не указанных продавцом, либо переданы третьим лицам. В особенности это касается письменных документов с пометками «конфиденциально», «секретно» или подобными им.

3.2 Продавец несет ответственность только за претензии, возникшие при использовании товара в соответствии с договором, в связи с несоблюдением патентов и заявок на выдачу патентов (охраняемых прав), по меньшей мере, одним из семейства патентов был опубликован либо Европейским патентным ведомством, либо в одной из следующих стран: Федеративная Республика Германия, Франция, Великобритания, Австрия, Китай, Япония или США.

3.3 Если поставки осуществляются по чертежам или прочим данным покупателя, и при этом нарушаются патенты третьих лиц, покупатель, в рамках отношений партнеров по договору, снимает с продавца все претензии.

4. Рекомендации, информация и справки

Рекомендации, информация и справки являются необязательными, если они не относятся непосредственно к товару.

5. Цены

5.1 Все цены нетто и действуют на условиях франко-завод (Incoterms®2020, «EXW»), за исключением упаковки, фрахта, почтового сбора и индекса. Законодательно установленный налог с оборота в соответствующем размере начисляется дополнительно.

5.2 Возможные дополнительные затраты, возникшие в связи с пожеланиями покупателя по изменению, могут быть включены продавцом в счет покупателя.

5.3 В случае, если после заключения договора возникнут события, повышающие себестоимость товара продавца при его закупке, производстве и/или отправке, продавец имеет право на соответствующее повышение цены.

6. Условия оплаты

6.1 Счета подлежат полной оплате в течение 14 дней со дня выставления счета. Продавец вправе, в том числе в рамках текущих деловых отношений, в любое время осуществить поставку в полном объеме или частично только по предоплате. Скидки действуют только при наличии явного письменного соглашения.

6.2 Продавец имеет право, даже при противоположной целевой привязке покупателя, начислить оплату сначала в счет старого, не документированного долга. В случае возникновения расходов и процентов продавец имеет право зачесть платежи сначала на оплату расходов, затем процентов, и в последнюю очередь – на оплату основного продукта или услуги.

6.3 Право на взаимный зачет встречных требований покупатель имеет только в случае, если встречные требования определены имеющими законную силу, неоспоримыми или письменно признаны продавцом. Право покупателя отказаться от выполнения своих обязательств по договору ограничено претензиями, возникающими из договорных отношений.

6.4 Продавец имеет право требовать пеню за просрочку исполнения обязательства в размере действующей предусмотренной законодательством процентной ставки за просрочку платежа. Сохраняется право обоснования более высокого ущерба от просрочки.

7. Поставка / срок поставки / задержка

7.1 Договоренность о сроках и дате поставки считается обязательной только в случае, если они однозначно письменно одобрены продавцом. Продавец не обязан соблюдать дату и/или срок поставки, если покупатель не выполняет свои обязательства (выплата задатка, предоставление необходимых документов, размещение заказов на производство и т. д.) своевременно. Сохраняется право на возмещение стороны о неисполнении договора другой стороной.

7.2 Срок поставки начинается не ранее дня письменного заключения договора и разъяснения всех технических вопросов.

7.3 При наличии пожеланий покупателя по изменению, продавец освобождается от соблюдения любых согласованных даты и/или срока поставки. В данном случае стороны согласуют новую дату поставки или новые сроки поставки.

7.4 При отсутствии иных договоренностей, дата поставки или срок поставки считаются соблюденными, если товар доставлен продавцом в согласованное место.

7.5 Покупатель не имеет права предъявлять претензии по задержкам поставки, не вызванным умыслом или грубой халатностью продавца. В частности, в том числе при прочих нарушениях, это касается задержки поставки в связи с форс-мажорными обстоятельствами, забастовками, беспорядками, эпидемиями и/или пандемиями, кибератаками, административными мерами, отсутствием поставок товаров субпоставщиками и прочими непредвиденными, неотвратимыми и существенными обстоятельствами. Согласованные сроки и даты поставки в этом случае продлеваются в соответствии с длительностью действия фактора задержки поставки. Продавец информирует об этом покупателя и, по возможности, сообщает новую предположительную дату поставки. Возмещаются только упущенная прибыль и ущерб в связи с простоем, которые вызваны умышленными действиями.

7.6 В случае просрочки в получении поставленного товара покупателем или нарушения им прочих обязательств по содействию продавец имеет право требовать возмещения понесенного ущерба, включая возможные дополнительные расходы. Кроме того, продавец имеет право устанавливать приемлемый срок приема товара покупателем, а по истечении срока выйти из договора и потребовать возмещения ущерба в виде выполнения договорных обязательств.

7.7 Частичные поставки допустимы в приемлемом объеме. В связи с этим претензии покупателя по частичной поставке или задержанной поставке остаточной партии исключаются.

8. Оговорка об условиях перехода права собственности на товар

8.1 Продавец сохраняет право собственности на все поставленные товары до поступления всех платежей в рамках отношений, возникающих при осуществлении поставок, а также будущих обязательств. При действиях, противоречащих условиям договора, в частности, при задержке оплаты, продавец имеет право потребовать вернуть товар.

8.2 Покупатель обязуется бережно обращаться с поставленными товарами, и в течение срока перехода права собственности на товар, за собственный счет застраховать его против любого вида уничтожения по купольной стоимости. За продавцом сохраняется право самостоятельно страховать товар за счет покупателя.

8.3 При наложении ареста на имущество или прочих вменяемых третьих лиц покупатель обязан незамедлительно письменно информировать продавца, чтобы он смог подать иск третьего лица о праве собственности на имущество или иную апелляцию. В случае, если третьи лица не возместят возникшие в связи с этим судебные и внесудебные расходы, ответственность за них несет покупатель.

8.4 Покупатель имеет право продать товар в рамках нормального делового процесса, однако он уже сейчас уступает продавцу все требования в размере итоговой суммы по счету-фактуре (включая установленный законом налог с оборота), которые у него возникают при перепродаже по отношению к клиенту или третьему лицу, независимо от того, был ли товар перепродан без переработки или после нее. Покупатель имеет право на предъявление этого требования к оплате и после передачи товара. Это не отменяет право продавца на самостоятельное возмещение этого требования.

8.5 При нераздельном смешении и соединении поставленного товара с предметами, не являющимися собственностью продавца, продавец приобретает право долевой собственности на новое или соединенное имущество в пропорции, равной отношению стоимости поставленного товара (итоговая сумма по счету-фактуре, включая установленный законом налог на добавленную стоимость) к стоимости других товаров на момент смешения или соединения. Покупатель хранит для продавца возникшую таким образом единичную или долевую собственность.

8.6 Если стоимость предоставленного залога превышает стоимость требований продавца в общем более чем на 20 %, продавец обязуется по требованию покупателя вернуть тому избыточный залог по выбору продавца.

8.7 Если совокупность действующих правовых норм не допускает договоренности об условиях перехода права собственности на товар, покупатель обязан предоставить продавцу другие соразмерные гарантии при получении товарного кредита.

9. Отправка, переход рисков

9.1 Отправка осуществляется на риск покупателя. Риск всегда переходит на покупателя не позднее чем с момента отправления товара, даже если прочие услуги берет на себя продавец.

9.2 Если отправка задерживается вследствие обстоятельств, не зависящих от продавца, риск переходит на покупателя в день уведомления о готовности к отправке. По письменной просьбе покупателя отправляемый товар страхуется продавцом за счет покупателя на случай ущерба при поломке, повреждении при транспортировке, пожаре и наводнении.

9.3 Транспортная и прочая упаковка, за исключением палет, не принимается назад в соответствии с Законом об упаковке. Покупатель обязан осуществить утилизацию упаковки за собственный счет.

10. Средства производства

10.1 Если покупатель предоставляет в распоряжение продавца средства производства (например, инструменты, формы), то они должны поставляться продавцу бесплатно. Продавец берет на себя ответственность за их поломку, удушение или неполный возврат и следующий из этого ущерб только в случае грубой халатности или умышленных действий. Данное положение не действует, если законом устанавливается обязательная ответственность.

10.2 Когда средства производства изготавливаются или приобретаются продавцом по поручению покупателя, продавец включает в счет соответствующие издержки. Эти средства производства остаются в собственности продавца. Продавец не обязан выдавать их покупателю. Это относится также и к последовательным штампам. Изложенное ниже положение под пунктом 10.3 при этом сохраняет свою силу.

10.3 В случае амортизации расходов на средства производства по цене детали, покупатель берет на себя не покрытые расходы при неамортизации инструмента, включая расходы на прочее типизированное оборудование. Затраты на модели всегда покрываются в полном объеме за счет покупателя.

10.4 Запрещено передавать третьим лицам данные, выданные покупателем продавцом чертежи и документы, а также сообщать о предложениях продавца о конструировании и изготовлении товара. Данные чертежи и документы могут быть истребованы назад продавцом в любое время.

11. Ответственность за обнаруженные в изделии дефекты / ответственность

11.1 Продавец не несет ответственности за ущерб, вызванный нарушением предписаний инструкций по эксплуатации, техническому обслуживанию и монтажу, использованию не по назначению или неквалифицированным использованием, неправильным или небрежным обращением, естественным износом, неправильным хранением, или изменением товара продавцом или третьими лицами. Монтаж товара по поручению покупателя или третьих лиц должен выполняться только обученными специалистами.

11.2 Выбор между устранением дефектов и поставкой нового товара делает продавец. По требованию продавца покупатель должен передать ему рекламизированный товар для анализа. В случае возникновения расходов вследствие непропорционального требования со стороны покупателя об устранении дефектов (в частности, расходом на испытания и транспортных расходов) продавец может потребовать возмещения этих расходов.

11.3 Продавец не покрывает издержки, необходимые для устранения дефекта, если повышение издержек связано с перевозкой товара после поставки в иное место, чем исходное место поставки.

11.4 Если требование к продавцу предъявляется покупателем в порядке регресса, после того как к самому покупателю были предъявлены претензии его клиентом за дефекты в изделии, то для реализации прав применяется § 445a Гражданского уложения Германии.

11.5 Срок действия требований по ответственности за обнаруженные в изделии дефекты истекает через год с момента передачи товара, кроме случаев, когда требование устранения недостатков, обнаруженных в товаре, основано на неисполнении обязательств продавцом или лицом, действующим по поручению продавца, по грубой халатности или умыслу, или в случае ущерба жизни и здоровью, а также телесных повреждений. В случае претензий по гарантии отсутствия дефектов, которые предъявляются к продавцу покупателем в порядке регресса согласно § 445a Гражданского уложения Германии, в неограниченном объеме действует положение об исковой давности согласно § 445b Гражданского уложения Германии.

11.6 Покупатель обязуется выполнить свою обязанность исследования товара при покупке согласно § 377 Торгового уложения, в том числе и в случае перепродажи товара.

11.7 Исключается применение покупателем права регресса по отношению к продавцу в связи с такими требованиями устранения недостатков, выданными покупателем клиентам, если покупатель не выполнил свою обязанность исследования товара при покупке и обязанность немедленно извещать о претензиях к качеству товара, или если товар был изменен при переработке.

11.8 Ответственность продавца за возмещение ущерба согласно положениям закона не ограничена, если вменяемое продавцу невыполнение обязанностей основано на умысле или грубой халатности. Если вменяемое продавцу невыполнение обязанностей основано на простой халатности, и виновно нарушены важные договорные обязательства, ответственность за возмещение ущерба ограничивается прогнозируемым ущербом, обычно возникающим в аналогичных случаях. В остальных случаях ответственность исключена.

11.9 Возмещаются только упущенная прибыль и ущерб в связи с простым, которые вызваны умышленными действиями и грубой халатностью.

11.10 Это не затрагивает ответственность согласно Закону об ответственности за продукцию или аналогичным неотъемлемым правам зарубежных законодательств. Сохраняется ответственность за ущерб, нанесенный жизни и здоровью, а также при телесных повреждениях.

11.11 Если ответственность по фактам, указанным в пункте 11.9, обоснована, ответственность продавца по отношению к покупателю в рамках зарубежных законодательств ограничена пределами, допустимыми соответствующим зарубежным законодательством.

11.12 Если ответственность продавца за возмещение ущерба исключена или ограничена, это распространяется и на личную ответственность за возмещение ущерба сотрудников, представителей и лиц, действующих по поручению продавца.

12. Запрещение переуступки

12.1 Все требования покупателя по отношению к продавцу не подлежат переуступке.

12.2 Продавец вправе в любое время, в том числе без согласия покупателя, привлекать связанные с ним предприятия (согласно § 15 Закона об акционерных обществах) в качестве лиц, действующих по поручению продавца, к выставлению предложений и выполнению договоров.

13. Ответственность за продукцию / обязанность давать указания

13.1 Покупатель обязан использовать товар только по назначению и гарантировать перепродажу товара только лицам, ознакомленным с опасностями и рисками, связанными с продуктом.

13.2 Покупатель обязуется давать соответствующие указания в случае использования товара в качестве основного материала и компонента собственных продуктов при сырье конечного продукта, и относительно товара, поставленного продавцом. В рамках отношений партнеров по договору, покупатель освобождает продавца от предъявления претензий при нарушении этого обязательства по первому требованию.

14. Конфиденциальность

Покупатель обязан в отношении с третьими лицами обращаться со всей коммерческой и технической информацией, полученной от продавца, как с коммерческой и производственной тайной, кроме случаев, когда она общеизвестна. Подобная информация может быть передана третьим лицам, заключившим соглашение о конфиденциальности, только в целях, установленных договором.

15. Защита персональных данных

Продавец собирает, обрабатывает и использует персональные данные покупателя только при условии соблюдения действующих Положений о защите персональных данных. Согласно этим Положениям персональные данные покупателя используются только при наличии предусмотренного законом разрешения или согласия.

16. Прочие

16.1 Местом исполнения является местонахождение соответствующего завода продавца.

16.2 Местом судебного рассмотрения всех споров по данному договору является Хайльбронн. Однако продавец имеет право предъявить иск покупателю по месту его общей подсудности.

16.3 При исполнении договора по данным условиям продажи и поставки действует исключительно германское законодательство, за исключением случаев применения коллизионного права и Конвенции ООН о договорах международной купли-продажи товаров (CISG).

16.4 В рамках действия отношений по договору стороны обязуются выполнять все действующие положения закона.

16.5 Если одно или несколько изложенных выше положений окажется полностью или частично недействительным, остальные положения сохраняют силу. Недействительное положение должно быть заменено на законно допустимое положение, максимально приближенное к смыслу и цели данных условий продажи и поставки.

- ٥-٨ إذا كانت البضائع المسلمة مختلطة أو مدمجة بشكل مع أصناف أخرى لا تخص البائع لا يمكن فصله، فإن البائع يكتب ملكية مشتركة لهذه العناصر الجديدة أو المدمجة بنسبة قيمة البضائع المسلمة (مبلغ الفاتورة النهائية، بما في ذلك ضريبة القيمة المضافة) فيما يتعلق بكافة الأصناف التي جرى خلطها أو دمجها. ويحفظ المشتري بالملكية الزائدة أو المشتركة للبائع.
- ٦-٨ إذا تجاوزت قيمة الضمانات المقدمة لمطالبات البائع بأكثر من ٢٠٪، فإن البائع ملزم، بناءً على طلب المشتري، بتحرير الضمانات الزائدة وفقاً لتقدير البائع.
- ٧-٨ إذا لم يسمع النظم القانوني المعنى بالتوصل إلى اتفاق بشأن الاحتفاظ بحق الملكية، وإلى الحد الذي لا يسمح فيه بذلك، فإن المشتري يمدد البائع بالضمانات الأخرى المناسبة عند استخدام الائتمان التجاري.

٩- الشحن ونقل المخاطر

- ١-٩ الشحن يكون على مسؤولية المشتري. وتنتقل المخاطر إلى المشتري دائماً عند إرسال البضائع على أبعد تقدير، حتى لو قَدِم البائع خدمات أخرى.
- ٢-٩ إذا تأخر الشحن بسبب ظروف لا يتحمل البائع مسؤوليتها، فإن المسؤولية تنتقل إلى المشتري من يوم الإبلاغ عن جاهزية الشحن. بناءً على طلب كتابي من المشتري، سيوفر البائع بالتأمين على الكسر والنقل والحرائق والأضرار الناجمة عن المياه على نفقة المشتري.
- ٣-٩ يتم إرجاع عيوب النقل وجميع العيوب الأخرى وفقاً لقانون التبعة، تستثنى من ذلك المنصات. يلتزم المشتري بالتخلص من العيوب على نفقته الخاصة.

١٠ معدات الإنتاج

- ١-١٠ إذا قام المشتري بإمداد البائع بمعدات الإنتاج (مثل الأدوات والقوالب)، فيجب إرسالها إلى البائع مجاناً. ولا يتحمل البائع مسؤولية خسارتها أو تدهور حالتها أو عدم اكتمال تسليمها والأضرار الناتجة عن ذلك إلا في حالات الإهمال الجسيم أو التعمد. ولا يطبق ذلك إذا كانت المسؤولية الزامية بموجب القانون.
- ٢-١٠ إذا قام البائع بتوصيل معدات الإنتاج أو شراؤها نيابة عن المشتري، فيقوم البائع بإرسال فاتورة إلى المشتري بالتكاليف بشكل منفصل. وتبقى معدات الإنتاج ملكاً للبائع. ولا يلتزم البائع بتسليمها للمشتري. وينطبق ما ورد أعلاه أيضاً على الأدوات اللائحة. ولا تتأثر اللائحة التالية الواردة في القسم ٣-١٠ بذلك.
- ٣-١٠ إذا تم تسديد نظير معدات الإنتاج من سعر قطع الغيار، ولم يتم تسديد سعر المعدات، فإن المشتري يتحمل التكاليف غير المغطاة، بما في ذلك مصروفات توفير المعدات الأخرى ذات الصلة بالبيع. يتحمل المشتري تكاليف النماذج دائماً بالكامل.
- ٤-١٠ يتم نقل الرسوم والمستندات التي يسلمها البائع إلى المشتري بالإضافة إلى اقتراحات البائع لتصميم وتصنيع البضائع إلى أطراف أخرى، ويجوز للبائع أن يطلب إعانتها في أي وقت.

١١ المسؤولية عن العيوب المادية / المسؤولية

- ١-١١ البائع غير مسؤول عن الأضرار التي تحدث نتيجة لانتهاك التعليمات التشغيل والصيانة والتزييب، أو الاستخدام غير المناسب أو غير السليم أو غير المطابق للتعليمات، أو التعامل غير الصحيح أو الإهمال، أو الهبلى الطبيعي، أو التخزين غير الصحيح أو التغييرات في البضائع التي أجراها المشتري في غيره من الأطراف. لا يُسمح للمشتري في الأطراف الأخرى بتركيب البضائع إلا بمعرفة موظفين متخصصين مدربين.
- ٢-١١ يحق للبائع الاختيار بين إصلاح المنتج أو تسليم المنتج جديد. ويجب على المشتري تسليم البضائع المعنية إلى البائع بناءً على طلبه لفحصها. إذا تكبد البائع تكاليف (لا سيما تكاليف الاختبار والنقل) بسبب طلب المشتري غير المبرر لتصحيح عيب ما، فيمكن للبائع أن يطالب بسداد هذه التكاليف

- ٣-١١ لن يتحمل البائع النفقات اللازمة للوفاء بالحق المعقد إذا زانت النفقات بسبب نقل البضائع إلى موقع آخر غير موقع التسليم الأصلي بعد التسليم.
- ٤-١١ إذا رفع المشتري دعوى ضد البائع باستخدام حق الرجوع بعد أن تم رفع دعوى قضائية ضد المشتري نفسه من أحد عملائه بسبب وجود عيب، فإن المادة 445a من القانون المدني الألماني (BGB) تطبق على الإنقاذ القانوني.
- ٥-١١ تنتهي المطالبات الناشئة عن المسؤولية عن العيوب المادية بعد علم من تسليم البضائع، ما لم تكن مطالبات المسؤولية عن العيوب المادية مبنية على إهمال جسيم أو خرق متعمد للواجب من البائع أو وكيله الذي يوجب عنه أو على تضرر الحياة، أو إصابة الجسم أو الصحة في حالة المطالبات الخاصة بضمان العيوب التي يوكدها المشتري ضد البائع عن طريق حق الرجوع وفقاً للمادة 445a من القانون المدني الألماني (BGB)، تنطبق فترة التقادم المنصوص عليها في المادة 445b من القانون المدني الألماني (BGB) دون قيود.
- ٦-١١ يلتزم المشتري بلوفاء بالتزامه بالتحقق وفقاً للمادة ٣٧٧ من القانون التجاري الألماني (HGB) حتى عند إعادة بيع البضائع.
- ٧-١١ يُستبعد حق المشتري في الرجوع على البائع بسبب المطالبات الناشئة عن المسؤولية عن العيوب المادية التي يتم توكيدها ضد المشتري من عملائه إذا لم يتم المشتري بلوفاء بالتزامه بالتحقق والإبلاغ عن العيوب أو إذا تم تعديل البضائع من خلال معالجتها.
- ٨-١١ عند استخدام البضائع كمادة خام وكجزء من منتج ما، يلتزم المشتري بالامتثال لالتزامه بالتحرير عند طرح المنتج النهائي في السوق، الأجنبية، فيما يتعلق بالمشتري، محدودة بالحد الذي ينص عليه القانون الأجنبي المعنى.
- ٩-١١ يقتصر التعويض عن الأرباح المفقودة والأضرار الناجمة عن انقطاع الأعمال الناجم عن التعمد والإهمال الجسيم.
- ١٠-١١ تبقى المسؤولية بموجب أحكام قانون مسؤولية المنتج أو الحقوق الشبيهة التي لا غنى عنها، بما في ذلك الأنظمة القانونية الأجنبية، دون مساس. كما تبقى المسؤولية عن الأضرار التي تلحق بالحياة والجسم والصحة دون مساس.
- ١١-١١ إلى الحد الذي يتم فيه تحديد المسؤولية بناءً على الواقع الواردة في القسم ٩-١١، تكون مسؤولية البائع المنصوص عليها في القوانين الشركات المساهمة) وبصوفهم وكلاء يوثبون عنه في إعداد العرض وتنفيذ العقد.
- ١٢-١١ إلى الحد الذي يتم فيه استبعاد أو تقييد مسؤولية البائع عن الأضرار، ينطبق ذلك أيضاً فيما يتعلق بالمسؤولية الشخصية عن الأضرار التي تلحق بموظفي البائع وممثليه وكلاءه الموقّنين.

١٢ حظر التنازل

- ١-١٢ لا يمكن التنازل عن جميع مطالبات المشتري ضد البائع.
- ٢-١٢ يحق للبائع في أي وقت، حتى دون موافقة المشتري، أن يُشرك الشركات التابعة له (بالمعنى المقصود في المادة ١٥ من قانون الشركات المساهمة) وبصوفهم وكلاء يوثبون عنه في إعداد العرض وتنفيذ العقد.

١٣ التزامات المنتج/ واجب الإخطار

- ١-١٣ لا يُسمح للمشتري باستخدام البضائع إلا على النحو المطبق للتعليمات ويجب عليه التأكد من عدم إعادة بيع هذه البضائع إلا للأشخاص الذين لديهم دراية بمخاطر المنتج والأخطار الناجمة عنه.
- ٢-١٣ عند استخدام البضائع كمادة خام وكجزء من منتج ما، يلتزم المشتري بالامتثال لالتزامه بالتحرير عند طرح المنتج النهائي في السوق، بما في ذلك ما يتعلق بالبضائع التي يسلمها البائع. في العلاقة الداخلية، يعنى المشتري البائع من تأكيد المطالبات في حالة انتهاك هذا الالتزام عند الطلب الأول.

١٤- المسؤولية

يجب على المشتري التعامل مع كافة المعلومات التجارية والتقنية الواردة عن البائع على أنها أسرار تجارية وأسرار تشغيلية تجاه أي أطراف أخرى، ما لم تكن معروفة بشكل عام. لا يُسمح بنقل هذه المعلومات إلا إلى أطراف أخرى ملزمة بتقافية حماية بيانات معينة ولغرض الوفاء بالعقد.

١٥- حماية البيانات

لا يقوم البائع بجمع ومعالجة واستخدام البيانات الشخصية للمشتري إلا بما يتوافق مع لوائح حماية البيانات ذات الصلة. وبناءً على ذلك، فإنه لن يستخدم البيانات الشخصية الخاصة بالمشتري إلا في حالة وجود تصريح أو موافقة قانونية.

١٦- نقاط أخرى

- ١-١٦ مكان التنفيذ هو موقع مصنع البائع المعنى.
- ٢-١٦ محل التقاضي لجميع النزاعات الناشئة عن العقد هو مدينة هيلبرون. ومع ذلك، يحق للبائع أيضاً مقاضاة المشتري في مقر محل التقاضي العام الخاص به.
- ٣-١٦ بالتسليم لإبرام العقد بناءً على شروط البيع والتسليم هذه، ينطبق القانون الألماني حصراً، باستثناء الأمور التي بها تنازع في القوانين واتفاقية الأمم المتحدة بشأن عقود البيع الدولي للبضائع (CISG).
- ٤-١٦ يلتزم الطرفان بالامتثال لجميع الأحكام القانونية المعمول بها عند تنفيذ العلاقة التعاقدية.
- ٥-١٦ إذا أصبح حكم أو أكثر من الأحكام المذكورة أعلاه غير فعال كلياً أو جزئياً، فإن صلاحية الأحكام المتبقية تبقى دون مساس. ويجب عندئذ استبدال الحكم غير الساري بأخر سار قانوناً ويحقق المعنى والغرض من شروط البيع والتسليم هذه بطريقة شبيهة بقدر الإمكان.

١- نطاقريان

- ١-١ تنطبق شروط البيع والتسليم الخاصة بشركة MS Motorservice International GmbH (المشار إليها فيما يلي "البائع") حصرياً. ومن ثم، إن يتم الاعتراف بشروط المشتري التي تتعارض أو تعيد عن شروط البيع والتسليم هذه إلا إذا وافق البائع كتابياً وبشكل واضح على صيغة هذه الشروط المخالفة. تنطبق شروط البيع والتسليم هذه أيضاً إذا قام البائع بالتوريد إلى المشتري دون أي تحفظ على الرغم من علمه بشروط المشتري التي تتعارض أو تعيد عن شروط البيع والتسليم الخاصة بالمشتري.
- ٢-١ تكون الأولوية للاتفاقيات المنفصلة بين الطرفين والتي تتخلف عن شروط البيع والتسليم هذه أو تستكملها. ما لم يتم وضع قواعد خاصة، سيتم استكمالها بشروط البيع والتسليم هذه. جديرٌ بالذكر أن العقد المكتوب أو التأكيد الكتابي من البائع يعتبر حاسماً بالنسبة لمحتوى هذه الاتفاقيات.
- ٣-١ تنطبق شروط البيع والتسليم أيضاً على كافة المعاملات المستقلة مع المشتري. بموجب تقديم المشتري لطلب، وحتى قبول البائع على أبعد تقدير، يكون المشتري قد وافق على شروط البيع والتسليم هذه.
- ٤-١ تنطبق شروط البيع والتسليم هذه على الشركات فقط.

٢- العرض وتأكيد الطلب

- ١-٢ العروض التي يقدمها البائع غير ملزمة دائماً. فإذا كان طلب المشتري مؤهل قانوناً ليتمل عرضاً، فإنه لن يعتبر مقبولاً إلا إذا أكد البائع كتابياً في غضون أربعة أسابيع، يتم إبرام العقد عند إرسال البضائع المطلوبة أو عند توفير البضائع المطلوبة على أبعد تقدير، في حالة التسليم الجزئي، يكون العقد مُبرماً عند إرسال الدفعة الأولى.
- ٢-٢ التغييرات والاتفاقيات الأخرى لا تكون ملزمة إلا إذا أكدها البائع كتابياً.
- ٣-٢ المستندات والرسومات ومعلومات الوزن والقياس والميزان وما إلى ذلك، الواردة في العروض تعتبر معلومات تقريبية فحسب ولا تمثل أي خصائص للحمولة. يحق للبائع الحيود عن الأوصاف الواردة في العرض، بشرط ألا تكون هذه الاختلافات جوهرية أو أساسية ولا تضر بالعرض التعاقدية بشكل كبير.
- ٤-٢ إذا تم تصنيع البضائع وفقاً لرسومات المشتري، فإن الرسومات التي أعدها المشتري ووافق عليها البائع تكون هي الحاسمة. يجب الاتفاق على وجه التحديد على الاختلافات عن الرسومات المعتمدة ويجب سداد أي مصروفات إضافية ناجمة عن ذلك إلى البائع.

٣- حقوق الملكية

- ١-٣ يحفظ البائع بحقوق الملكية وحقوق الطبع والنشر فيما يتعلق بكافة الرسومات التوضيحية والرسومات والحسابات وغيرها من المستندات؛ ولا يُسمح باستخدامها لأغراض أخرى غير تلك التي جدها البائع أو ابتناها لأي أطراف أخرى دون الحصول على موافقة كتابية مسبقة من البائع. وينطبق ذلك بشكل خاص على المستندات المكتوبة التي تم تصنيفها على أنها "سريرة" أو "خاصة" أو ما شابه ذلك.
- ٢-٣ البائع غير مسؤول إلا عن المطالبات التي تنشأ عن انتهاك حقوق الملكية وتسجيلات حقوق الملكية (حقوق الملكية) عند استخدام البضائع وفقاً للعقد، والتي يندرج أحدها على الأقل في حقوق الملكية إما عن طريق النشر بمعرفة مكتب براءات الاختراع الأوروبي أو في إحدى جمهوريات ألمانيا الاتحادية أو فرنسا أو بريطانيا العظمى أو النمسا أو الصين أو اليابان أو الولايات المتحدة الأمريكية.
- ٣-٣ إذا تم تسليم بناءً على رسومات أو معلومات أخرى مقدمة من المشتري وترتب عن ذلك انتهاك حقوق ملكية طرف آخر، فيجب على المشتري تعويض البائع داخلياً عن جميع المطالبات.

٤- التوصيات والمعلومات والبيانات

التوصيات والمعلومات والبيانات لا تعتبر ملزمة إلا إذا كانت تتعلق بالبضائع نفسها.

٥- الأسعار

- ١-٥ جميع الأسعار تشير إلى الأسعار الصافية وتسري على "تسليم المصنع" (EXW - Incoterms®2020) باستثناء التعليف والشحن والبريد وتأمين القيمة. تصاف ضريبة المبيعات القانونية بقميتها السارية.
- ٢-٥ قد يُرسل البائع فاتورة بأي مصروفات إضافية ناجمة عن طلبات التغيير إلى المشتري.
- ٣-٥ إذا حدثت أي تغييرات بعد إبرام العقد أتى إلى زيادة تكلفة شراء وإنتاج و/أو شحن البضائع للبائع، فيحق للبائع زيادة السعر المتفق عليه وفقاً لذلك.

٦- شروط الدفع

- ١-٦ تصيب الفواتير مستحقة الدفع دون أي خصومات خلال ١٤ يوماً من تاريخ الفاتورة. ويحق للبائع في أي وقت، حتى في إطار علاقة العمل المستمر، تنفيذ التسليم كلياً أو جزئياً نظير الدفعة المقدمة فقط. ولا ينطبق الخصم إلا إذا تم الاتفاق عليه صراحةً بصيغة كتابية.
- ٢-٦ يحق للبائع إجراء مقاصة مبدئية للمدفوعات نظير الدينون القديمة غير المصنفة، حتى لو كان غرض المشتري مخالفاً لذلك. إذا تكبد البائع تكاليف أو فوائد بالفعل، فيحق له تعويض المدفوعات أو لا بقيمة هذه التكاليف، ثم نظير الفائدة وأخيراً نظير الخدمة الرئيسية.
- ٣-٦ لا يحق للمشتري التعويض إلا إذا كانت مطالباته المعنية قد تم إثباتها قانونياً أو كانت غير متنازع عليها أو إذا اعترف بها البائع كتابياً وإلى الحد الذي تكون فيه هذه العمليات سارية قانوناً. يقتصر حق المشتري في الاحتفاظ بالحق في المطالبات الناشئة عن العلاقة التعاقدية.
- ٤-٦ يحق للبائع تحصيل الفائدة الافتراضية بمعدل الفرض القانوني المعمول به. ويبقى الحق في إثبات الأضرار الأعلى الناجمة عن التأخير محفوظاً.

٧- التوريد / وقت التسليم / التأخير

- ١-٧ لا تعتبر فترات التسليم وتواريخ التسليم ملزمة إلا إذا وافق عليها البائع صراحةً في صيغة كتابية. لا يلتزم البائع بتاريخ التسليم أو فترة التسليم إذا لم يف المشتري بالتمهات في الوقت المناسب (تحرير الدفعات المقدمة، وتوفير المستندات اللازمة، وإثابة الإنتاج، وما إلى ذلك). ويبقى الحق في معارضة العقد غير المكتمل محفوظاً.
- ٢-٧ تبدأ فترات التسليم في أقرب وقت من اليوم الذي تم فيه إبرام العقد كتابياً وتم توضيح جميع الأسلة الفنية.
- ٣-٧ إذا طلب المشتري إجراء تغييرات، فيكون البائع معيّناً من الالتزام بأي تاريخ تسليم أو بفترة التسليم المتفق عليها. وفي هذه الحالة، يتفق الطرفان على مهلة أو موعد نهائي جديد للتسليم.
- ٤-٧ ما لم يتم الاتفاق على خلاف ذلك، يكون تاريخ التسليم أو مهلة التسليم مستوفاه إذا وُفر البائع البضائع في الموقع المتفق عليه.
- ٥-٧ لا يمكن للمشتري تأكيد أي مطالبات بسبب التأخير في التسليم والتي لا تكون بسبب التعمد أو الإهمال الجسيم من طرف البائع. وينطبق ذلك أيضاً على الاختلالات الأخرى، ولا سيما تأخير التسليم بسبب القوة القاهرة، والنزاعات المالية، والإضرابات، والأوبئة و/أو الجوائح، والهجمات السيبرانية، والتدابير الحكومية، وعدم التسليم من الموردين وغيرها من الأحداث الخطيرة وغير المتوقعة والتي لا يمكن تجنبها. في هذه الحالات، سيتم تأجيل تاريخ التسليم أو مهلة التسليم المتفق عليها بحسب مدة وجود عائق التسليم، وسيقوم البائع بإبلاغ المشتري بذلك وسيقدم، إن أمكن، تاريخ تسليم متوقع جديد. يقتصر التعويض عن الأرباح المفقودة والأضرار الناجمة عن انقطاع الأعمال عمداً.
- ٦-٧ إذا أخفق المشتري في القول أو انتهاك التزامات التعاون الأخرى، فيحق للبائع المطالبة بالتعويض عن الضرر الناتج، بما في ذلك أي نفقات إضافية. ويحق للبائع أيضاً تحديد فترة قبول معقولة للمشتري، وإذا انتهت هذه الفترة، يحق له إلغاء العقد والمطالبة بالتعويض بدلاً من تنفيذ العقد.
- ٧-٧ يُسمح بالتسليم الجزئي إلى حد معقول. وفي ذلك الصدد، تستثنى مطالبات المشتري بسبب التسليم الجزئي أو التأخر في تسليم الكمية المتبقية.

٨- الاحتفاظ بالملكية

- ١-٨ يحفظ البائع ملكية كافة البضائع المسلمة حتى استلام كافة المدفوعات من علاقة التسليم، بما في ذلك الالتزامات المستقبلية. في حالة الإخلال بالعقد، وخاصة التأخر في السداد، يحق للبائع المطالبة بإعادة البضائع.
- ٢-٨ يلتزم المشتري بمعاملة البضائع المسلمة إليه بحرص وتأمينها على نفقته الخاصة ضد أي شكل من أشكال خسارة سعر الشراء طوال مدة الاحتفاظ بحق الملكية. ويبقى الحق مكتولاً للبائع في التأمين على البضائع بنفسه على نفقة المشتري.
- ٣-٨ في حالة مصادرة البضائع أو في حالة أي تدخلات أخرى من أطراف ثالثة، يجب على المشتري إخطار البائع كتابياً وعلى الفور حتى يتمكن البائع من تقديم مطالبات اعتراض تجاه الطرف الثالث أو يستخدم مبلغ الانصاف القانونية الأخرى. إذا لم يتم الطرف الثالث بسداد التكاليف القانونية وغير القضائية الناتجة، يكون المشتري مسؤولاً عن هذه التكاليف بنفسه.
- ٤-٨ يحق للمشتري إعادة بيع البضائع في سياق العمل العادي؛ ومع ذلك، فإنه يتنازل للبائع عندئذ عن جميع المطالبات بما يصل إلى مبلغ التكاليف القانونية وغير القضائية الناتجة، يكون المشتري مسؤولاً عن هذه التكاليف بنفسه.
- ٥-٨ الفاتورة النهائية (بما في ذلك ضريبة المبيعات القانونية) الخاص بالمطالبة التي تنشأ عن إعادة البيع إلى عملائه أو إلى أطراف ثالثة، بغض النظر عما إذا تمت إعادة بيع البضائع دون معالجتها أو بعد معالجتها، ويبقى الحق مكتولاً للمشتري في تحصيل هذه المطالبات حتى بعد التسليم. ولا تتأثر سلطة البائع في تحصيل هذه المطالبات بنفسه.

MS Motorservice International GmbH

Wilhelm-Maybach-Straße 14-18

74196 Neuenstadt, Germany

Telefon: +49 7139 9376-3333

Telefax: +49 7139 9376-2864

info@ms-motorservice.com

www.ms-motorservice.com



4 028977 479236

